



TABLES + SPACE DIVISION

PRICING EFFECTIVE JUNE 1, 2026

Indiana
FURNITURE

Our Pledge to People + Our Planet.

We've been making wood furniture longer than just about anyone...and we want to be doing so for a long time to come. That's a large part of why we take a stewardship approach to our resources. We believe that environmental sustainability and business profits need not be mutually exclusive. They can and should exist side by side in a mutually beneficial relationship. And for more than a century, we've been showing how it's done.

We've proven our commitment to a sustainable future by supporting the standards and programs that protect our home planet and human health. Whether it's local sourcing, reducing contaminants, implementing wellness and safety programs, or diverting waste from landfills, social responsibility is a part of every decision we make at Indiana Furniture.

One of the surest ways to reduce our impact on the planet is to make and buy things that last. And this one's a natural for us. Our products are made with craftsmanship and attention to detail that are a part of our legacy in wood manufacturing. And our products are backed by our 12-year warranty, which facilitates maintenance, servicing, and reassembly.

100% of our product lines:

- Are manufactured and assembled in the USA,
- Meet or exceed Indoor Air quality standards*,
- Meet or exceed BIFMA level® Sustainability standards and certification*,
- Conform to the BIFMA Compliance standards and certification*,
- Comply with TSCA Title VI (CARB) standards,
- and can contribute to LEED®, Green Globes®, and WELL® Sustainable Programs.



Specification Made Easy.

Whether you're looking to specify your office spaces or simply to visualize them in the options and surface materials you are desiring, we make it easy. You can find the entire Indiana Furniture portfolio on the following third-party, space-planning platforms.



To learn more, simply go to IndianaFurniture.com/resources.

General Information + Conditions of Sale	2
Warranty	3
Tables+Storage	5
Arlington (2900 Series)	7
Cameo (9100 Series)	13
Catalyst (8800 Series)	41
Chat (7500/7600 Series)	137
Natta by Pledge (NAT Series)	155
Phoenix (2100 Series)	157
Spark (7700 Series)	177
Strut (8800 Series)	191
Synergy (8200 Series)	255
Occasional Tables	269
General Occasional Tables Information	270
Arlington End, Lamp + Magazine Tables (2900 Series)	271
Bailey End + Cocktail Tables (720 Series)	273
Britta End + Cocktail (230 Series)	277
Canvas End + Magazine Tables (6600 Series)	279
Cicero End, Lamp, Magazine + Console Tables (290 Series)	281
Gesso End + Magazine Tables (6500 Series)	283
Gleem End + Magazine Tables (395 Series)	285
Jefferson End, Lamp & Magazine Tables (4600 Series)	287
Jot Auxiliary, End, Cocktail + Console Tables (410 Series)	289
Kirby Tables (919 Series)	293
Natta Tables by Pledge (NAT Series)	303
Otty Tables (840 Series)	305
Phoenix End + Magazine Tables (2100 Series)	309
Pitch Console, End + Magazine Tables (710 Series)	311
Plush Cocktail Tables (620 Series)	315
Spirit Tables by Pledge (S Series)	319
Workmate (350 Series)	321
Space Division	325
Square One (1700 Series)	327
Synergy (8200 Series)	347

ORDERING INFORMATION

All orders should be placed with:

Indiana Furniture
PO Box 270, 1919 Hospitality Dr., Ste. A
Jasper, IN 47547-0270

Fax: 812.482.9035

email: neworders@indianafurniture.com

ORDER PROCEDURE

To ensure timely processing, all orders must include:

- Purchase Order Number
- Sold To and Ship To Addresses
- Call Before Delivery Phone Number and Contact Name
- Complete Model Numbers and Quantity for All Units
- Finish Selections
- Fabric Vendor/Pattern/Color, if applicable
- Other Applicable Options
- Any Special Delivery or Product Instructions

A drawing or sketch of the planned configuration in modular applications will facilitate order processing.

How to Order illustrations are located at the beginning of each Series. Each model has additional information on How to Specify. For further clarification, contact Sales Support at 800.422.5727.

PRICING

All prices are suggested retail, F.O.B. Point of Origin, freight prepaid and allowed to one continental US destination. Prices, specifications and materials are subject to change without notice. Possession and/or distribution of this price list does not in itself constitute an offer to sell. Orders can be received only from authorized Indiana Furniture dealers. Orders will be billed at prices at time of shipment, unless previously acknowledged prior to the effective date of a price change, in which case billing will be at the price acknowledged.

Indiana Furniture accepts Visa, MasterCard and American Express. Please contact Sales Support for policy details.

ACKNOWLEDGMENT

Cleanly specified orders are acknowledged in a timely manner. The acknowledgment reflects how the order was entered, the estimated ship date, and other pertinent information. This acknowledgment serves as the final agreement between the customer and Indiana Furniture, and is the exclusive statement of the terms thereof. Changes must be requested within one business day of acknowledgment; after that, all production activities begin and the order becomes firm. Please examine this acknowledgment carefully and advise Indiana Furniture immediately of any discrepancies. The customer bears sole responsibility for order correctness.

Shipping fees (see Delivery + Freight Charges) are added at the time of invoicing. Shipping charges will be listed on direct bill and GSA orders due to the nature of the contract, but not on commercial or dealer-billed orders.

BUYER'S OBLIGATION: RIGHTS OF SELLER

If Indiana Furniture shall, at any time, doubt Buyer's financial responsibility, Indiana Furniture may decline to make shipments hereunder except upon receipt of cash payment in advance or security or other proof of responsibility satisfactory to Indiana Furniture. If buyer fails in any way to fulfill the terms and conditions set forth herein, Indiana Furniture may defer shipments until such default is corrected. Remedies provided herein shall be in addition to, and not in lieu of other remedies. Buyer agrees to abide by payment terms as listed on invoice. Buyer shall pay all reasonable costs and expenses, including attorney and collection fees, and late fees, incurred by Seller in connection with any amounts due for goods ordered.

CANCELLATIONS + CHANGES

All products are built-to-order. Once acknowledged (See Acknowledgement), orders are considered firm and are not subject to cancellation or change without approval from Indiana Furniture. All approved changes are subject to additional charges and revised lead times.

PRODUCT DESIGN + SPECIFICATION CHANGES

Indiana Furniture reserves the right to make changes in design and construction or discontinue products without prior notice. Note: All dimensions listed in price list are nominal.

REPAIR CHARGES

Indiana Furniture will only pay repair charges if Sales Support gives prior written

authorization. No repair charge will be paid without advance approval at which time a repair authorization number will be issued and must appear on the invoice to Indiana Furniture for the completed work.

WAREHOUSE STORAGE CHARGES

If a shipment is held beyond 7 calendar days at your request, a **.084% per calendar day (2.52% per month) storage charge will be assessed**. The effective date will be 7 calendar days after the acknowledged ship date. Further, the prices applied to the order will be those in effect at the time of shipment.

DAMAGED/MISSING MERCHANDISE

The consignee is responsible for reporting all damage and shortages to Sales Support.

- The consignee must inspect all merchandise upon arrival.
- Do not refuse merchandise damaged in transit.
- Missing cartons and obvious damage must be noted on the freight bill at the time of delivery.
- Claims for missing cartons should be reported immediately for the best chance of recovery and to avoid delays in completing the delivery.
- Claims for both obvious and concealed damage must be filed within 15 calendar days of receipt of product
- Damaged merchandise must not have been moved from the original receiving location and must be reported prior to any attempt to install the product.
- All damaged merchandise, including the cartons and packing materials, must be retained for inspection by either the carrier or by an Indiana Furniture Sales Representative.

Be prepared to provide the following information when contacting Sales Support:

- Copy of Signed Freight Bill (with noted issues, if applicable)
- Original Order Number
- Model Number of the Damaged Item
- Photos of the Damaged Carton/Item

All damage claims are subject to review and approval. Once your damage claim has been evaluated, we will determine the best resolution, including repair or replacement where applicable. Indiana Furniture reserves the right to select the most cost effective way to resolve the claim.

DELIVERY + FREIGHT CHARGES

All shipments are F.O.B. Point of Origin, Jasper, IN, freight prepaid and allowed dock to dock on 53' trailer. Ownership and responsibility of the merchandise become that of the buyer upon delivery to the freight company. Shipments into Alaska, Hawaii, Canada, Mexico, Puerto Rico and other exports are freight prepaid and allowed to port of exit.

Shipping fees added at the time of invoicing.

- Shipments under \$3000 (net value, product only) will incur a \$300 net fee per shipment.
- Small-package carrier shipments:
 - Orders \$100 or less will receive a \$22 fee
 - Orders over \$100 will receive a \$40 fee

Carrier selection and routing are at Indiana Furniture's discretion. Requests for favored carriers and delivery times will be accommodated when possible.

After-hours delivery fees:

- Monday through Thursday after 3pm: \$300 per truck
- Friday after 3pm or weekends: \$600 per truck

Inside delivery and installation services are not included in the price shown. Any deviation from dock-to-dock delivery, such as but not limited to, non-dock, residential, or inside delivery must be specified on the order. Should these services be requested or required, please contact Sales Support regarding the availability of services and a quote. All charges incurred will be charged to the "Sold To" of the order.

BIFMA + ANSI TESTING

Indiana Furniture is a member of the Business and Institutional Furniture Manufacturer's Association (BIFMA). Tests developed by the BIFMA and approved by the American National Standards Institute (ANSI) determine the strength and durability of casegoods and seating in its everyday use. Although this testing does not serve as a warranty or guarantee, Indiana Furniture products within this price list have been tested by an independent verifying body and meet or exceed applicable BIFMA and ANSI Standards..

Subject to the limitations set forth in this warranty, Indiana Furniture Industries, Inc. ("Indiana Furniture") warrants to the original purchaser all product in this price list ("Product") to be free from defects in material and workmanship given normal use for a **12-year period from the date of manufacture**. During the applicable warranty period, Indiana Furniture, as its sole obligation, will repair or replace (in Indiana Furniture's sole discretion) any Product, Part, or Component covered by this warranty and sold after June 1, 2026, which fails under normal use as a result of a defect in material or workmanship. Normal use is defined as the equivalent of a single shift, 40-hour work week. Indiana Furniture will repair or replace the defective Product, Part, or Component with a comparable Product, Part, or Component.

Warranty periods are limited, from the date of manufacture, for certain Products, Parts, and Components as follows:

5-Year Warranty (from the date of manufacture)

- Triple Play Series
- Electrical Components Including Lighting, Power Ports (see exclusions), and Adjustable Height Components
- Pneumatic Cylinders on Caseloads, Tables, and Seating
- Textiles, Foam, and Decorative Trim
- Swivel Arm Pads
- Keyboard Kits and Monitor Arms

3-Year Warranty (from the date of manufacture)

- Dock 950 Wireless Charger
- Dock 150 Wireless and USB Charger

THIS WARRANTY DOES NOT COVER:

- Damage caused by a carrier or third party
- Normal or routine wear and tear
- Appearance, durability, quality, behavior, colorfastness, or any other attribute of customer's own materials or any non-standard Indiana Furniture material (including CF Stinson, Maharam, Momentum, Mayer, UltraFabrics, Architex, and other alliance programs) specified by the customer and applied to a Product
- Color, grain or texture of wood, laminate and other covering materials
- Changes in wood or fabric color due to aging or exposure to light
- Labor and Service not covered under warranty
- Installation Damage (Wall Panels damaged during the installation of additional Product including but not limited to Wall Panel Shelves, Tackboards, or TV Mounts)
- Products or Components attached in some manner to any other manufacturer's products or components (e.g., Indiana Furniture Conference Tops attached to another manufacturer's bases)
- Noncompliance with installation and maintenance instructions

As the manufacturer of the Product, Indiana Furniture stands behind its craftsmanship and pledges to do everything it can to reasonably resolve, as quickly as possible, any problems you may have with the Product within the terms and conditions of this warranty.

If you encounter a defect covered by the foregoing warranty, contact the dealer from whom you purchased the Product. If the dealer is unable to resolve your warranty issues, you should contact Indiana Furniture. Please ensure that you have all of the pertinent facts when contacting the dealer or Indiana Furniture, including the model number and factory order number from the inspection label attached to the Product.

INDIANA FURNITURE IS NOT PROVIDING, AND SPECIFICALLY DISCLAIMS, ANY OTHER WARRANTIES FOR THE PRODUCTS, EXPRESS OR IMPLIED, INCLUDING ANY IMPLIED WARRANTY OF MERCHANTABILITY OR FITNESS FOR A PARTICULAR PURPOSE. INDIANA FURNITURE SHALL NOT BE LIABLE TO THE PURCHASER OR ANY THIRD PARTY FOR CONSEQUENTIAL, INCIDENTAL, INDIRECT, OR SPECIAL DAMAGES, INCLUDING, WITHOUT LIMITATION, DAMAGES ARISING OUT OF OR RESULTING IN ANY MALFUNCTIONS, DELAYS, LOSS OF PROFIT, INTERRUPTION OF BUSINESS, PERSONAL INJURY, BODILY INJURY, DEATH, DISMEMBERMENT, OR PROPERTY DAMAGE.

Indiana Furniture Industries, Inc.
Attn: Sales Support
PO Box 270
1919 Hospitality Dr., Ste A
Jasper, Indiana 47547-0270
800.422.5727
Fax 812.482.9035
custserv@indianafurniture.com



Tables+Storage

Arlington offers all the grace and embellishments associated with traditional styling with an added emphasis on value. Finely crafted in select solids with walnut and cherry veneers and high pressure laminate worksurfaces, Arlington ensures quality and expert craftsmanship with a selection of configurations for today's functional workspaces.

CONSTRUCTION

Arlington features a Veneer chassis with your choice of a Veneer or HPL top. Units ship assembled unless otherwise noted.

VENEER

- Exposed surfaces feature select grade, plain sliced American Black Walnut or Cherry veneers, carefully selected and matched to assure proper balance and consistency

TOPS

- Veneer tops are 5-ply balanced construction and 1 3/16" thick with solid hardwood rims with butt corners
- High Pressure Laminate (HPL) tops are 3-ply balanced construction and 1 3/16" thick with solid hardwood rims with butt corners
- Grain direction runs left to right unless noted

CHASSIS

- Chassis is securely fastened using high quality European fastening systems and heavy-duty, 16-gauge joining brackets to assure maximum strength
- All units ship with heavy-duty, adjustable leveling glides to ensure proper leveling and compensation for uneven floors
- Bases are solid hardwood with mitered corners
- Construction offers tight tolerances and long term durability
- Vertical grain direction on chassis

DRAWERS

- Drawer fronts standard with matched veneer faces
- Drawer sides, back and front are woodgrain vinyl-wrapped, and are 1/2" thick
- 5-sided drawer construction for easy removal of drawer front
- Box and file drawers have 1/8" thick hardboard bottoms and tested for 100lb capacity
- Lateral file drawers feature 1/4" thick bottoms and tested for 200lb capacity
- All drawers feature full extension, progressive action slides with precision steel ball bearings
- All suspensions have a limited lifetime warranty

FILING

- All file drawers are standard with filing systems designed to accommodate a variety of filing requirements
- Letter width file drawers provide letter filing front to back and legal filing side to side
- Lateral file drawers provide legal or letter filing front to back or side to side

STORAGE

- All hinged doors include soft close hinges, unless noted
- One piece hinge and base plate combination
- Soft close hinges reduce stress placed on the cabinet when the door is closed and offers a quiet closure

LOCKING

- See [locking details](#) for locking door and drawer options
- Lock core available in black or silver and will coordinate with pull selection; See [locking details](#)
- Removable lock cylinders allow for units to be re-keyed at a later date if required
- Units are shipped randomly keyed as standard. Keyed alike units available upon request at no additional charge.

CORD MANAGEMENT

- Grommets are available in black or silver, please specify color
- See [optional grommet locations](#)
- Undersurface Wire Managers available for additional cord management; See [Accessories](#)

INTERIOR DRAWER DIMENSIONS & FILING CAPABILITIES

Model

29-2072SC 29-2066SC

Drawers

	W	L	D
Box	15 3/8"	16 1/2"	3 1/2"
File	15 3/8"	16 1/2"	8 29/32"

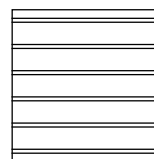

Legal Front to Back

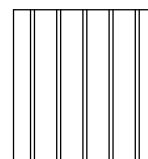

Legal Side to Side

Model

29-2072DL

Drawers

	W	L	D
Lateral File	24 7/8"	16 1/2"	9 7/32"

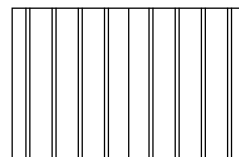

1 Row Letter or Legal Side to Side

HOW TO ORDER EXAMPLES

	QTY	Model No.	Description	Example
TOP/BASE	1	29-4296RT	Top Material	W
			Finish	CO
			Grommet/Power/ Data Location	OC
			Finish	CO
BASES	1	29-2828TB	Finish	CO
PORT	1	01-INTRFCIA		
CREDENZA	1	29-2072SC	Top Material	W
			Finish	CO
			Base Molding	BM3600
			Decorative Molding	M3600
			Pull	ARA
			Locking	LKT-HU
			Drawer Construction	STD

veneer (W) OPTIONS

Veneer features UVAdvantage, an ultra-violet finish, on all exposed surfaces by utilizing roll-coat UV technology.

Note: Base and decorative molding feature multi-step, hand-finished catalyzed finish.

AW	Artisan Walnut	HW	Harvest Walnut
CO	Columbian Walnut	LW	Legacy Walnut
DC	Dark Cherry	MW	Mahogany Walnut
DFW	Dark Forest Walnut	PNW	Pinnacle Walnut
EW	Espresso	SCH	Select Cherry
GC	Golden Cherry	SKC	Shaker Cherry
HNW	Henna Walnut	WC	Williamsburg Cherry

HPL (P) TOP OPTIONS

WOODGRAIN

CO	Columbian Walnut	PNW	Pinnacle Walnut
EF	Espresso	SCH	Select Cherry
GC	Golden Cherry	SKC	Shaker Cherry
MW	Mahogany Walnut	WC	Williamsburg Cherry

EDGE PROFILES

R Arlington



MOLDING LOCATIONS AND OPTIONS

Base Molding

Arlington and Wilmington Base Molding are skillfully applied on Credenzas to front and both sides with no molding on back for flush wall applications.



Arlington Base Molding



Wilmington Base Molding

Decorative Molding

Optional Decorative Molding is available with the Wilmington Base Molding package. Credenzas will feature decorative molding on the left and right sides only.

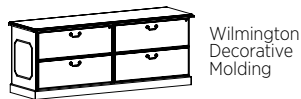

Wilmington Decorative Molding



No Decorative Molding

Molding selection must be specified on order.

Arlington Molding			
BM2900	Arlington Base Molding	\$	N/C
Wilmington Molding			
BM3600	Wilmington Base Molding	\$	N/C
M3600	Optional Wilmington Decorative Molding	\$	160

Note: Base and Decorative Molding features multi-step, hand-finished catalyzed finish

DRAWER AND DOOR PULL OPTIONS

Units with doors and drawers will feature coordinating pulls however door and drawer pulls cannot be intermixed. Antique Brass pulls are 5¼” and Liberty pull is 4¼”.

ARA	Arlington A, Antique Brass	JEF	Jefferson, Antique Brass
ARB	Arlington B, Antique Brass	ALB	Liberty, Aluminum
WLM	Wilmington, Antique Brass		



Arlington A - 5¼”



Arlington B- 5¼”



Jefferson- 5¼”



Wilmington- 5¼”



Liberty- 4¼”

LOCK CORE OPTIONS

Lock core will be black if Arlington, Wilmington or Jefferson pulls are selected. Lock core will be silver if Liberty Pulls are selected.

BLK	Black
SLV	Silver

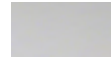

Silver



Black

CREDENZA LOCKING DOORS AND DRAWERS

Locking doors and drawers are available on credenzas. Please specify applicable code on order with model/unit and add upcharge.

Storage credenzas offer locking pedestals and locking doors with the lock positioned in the face of the drawer nearest to doors. Door lock is positioned in top right corner of left door.

LKT_P	Double Pedestal Lock	\$	454
LKT_HU	Double Pedestal and Double Door Locking	\$	545

LOCKING DOORS

Locking doors are available on specific units, where noted. You must specify WITH LOCKING when ordering and add upcharge.

LKT_HU	18”W Units	\$	76
LKT_HU	28”W to 368”W Units	\$	101

DRAWER OPTIONS

Units with drawers come standard with woodgrain vinyl-wrapped drawers with mitered corners. Optional wood dove tail construction for all box, file, and lateral file drawers is available. Must specify when ordering.

Pricing is per Drawer, not per Model/Unit.

MITER	Mitered Fold Construction	STD
DOVE	Wood Dove Tail Construction	\$ 49

CONFERENCE AND MEETING TABLE GROMMET OPTIONS

Arlington Meeting and Conference Tables offer Power/Data and grommets at a variety of locations. Available Power/Data and Grommets may be found on Pages 21 to 23

Must Specify Black (BLK) or Silver (SLV)

Grommet Locations

OC	On Center	CL	5½" Left of Center
EL	24½" from Left End	CR	5½" Right of Center
ER	24½" from Right End	BB	Centered Between Bases

Panel Base Location Availability by Top Size

96"W Tops	OC, EL+ER
120"W Tops	BB, CL, CR, CL+EL+ER, CR+EL+ER
144"W Tops	BB, CL, CR, CL+CR, EL+ER, CL+EL+ER, CR+EL+ER

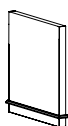

Power and Grommet Units only available **On Center (OC)** when Queen Anne Bases are selected.



Arlington Work Tables offer grommets at left/right and on center locations.

Must Specify Black (BLK) or Silver (SLV) Grommets

	Per Grommet
Locations Availability by Model	\$ 58
29-3672WT	GL/GR: Grommet Left and Right; 12" from end and 23" from user (Requires 2 grommets)
	GC: Grommet Center; 23" from user
29-3060WT	GL/GR: Grommet Left and Right; 9" from end and 23" from user (Requires 2 grommets)
	GC: Grommet Center; 9" from user

CERTIFICATIONS & COMPLIANCE

- Intertek Sustainability Certified
- BIFMA level® Certified
- BIFMA Compliant® Certified
- TSCA Title VI (formerly CARB) Compliance
- US Green Building's LEED® Contribution

Tops and Tables



Round Tops
[\(See Details\)](#)



1-Piece Rectangle Tops
[\(See Details\)](#)



2-Piece Rectangle Tops
[\(See Details\)](#)

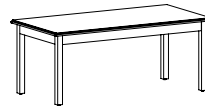

Work Tables
[\(See Details\)](#)

Bases

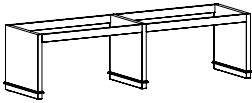

Rectangle Bases
1-Pc Top [\(See Details\)](#)
2-Pc Top [\(See Details\)](#)

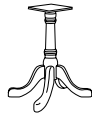

Queen Anne Bases
Round Tops [\(See Details\)](#)
1-Pc Top [\(See Details\)](#)
2-Pc Top [\(See Details\)](#)

Storage Components

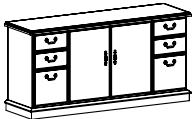

Storage Credenza
[\(See Details\)](#)

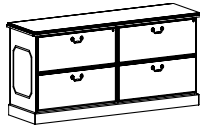

Credenza with Double Lateral
[\(See Details\)](#)



Door Bookcases
[\(See Details\)](#)



Wardrobe/Storage
[\(See Details\)](#)

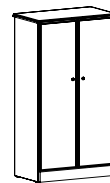

Double Wardrobe/Storage
[\(See Details\)](#)

Wire Management & Power/Data Accessories



For additional solutions for desking, storage, and accessories, see the [Arlington Casegoods](#) and [Accessories](#) Price Lists.

Item	Model No.	Width	Depth	Height	Ship Wt	Cubic Ft	List Price
	29-3636CT <i>Accommodates Three (3) Chairs</i>	36	36	30	50	3.3	P\$ 1834 W\$ 2260
	29-4242CT <i>Accommodates Four (4) Chairs</i>	42	42	30	51	4.5	P\$ 2110 W\$ 2592
	29-4848CT <i>Accommodates Five (5) Chairs</i>	48	48	30	58	5.9	P\$ 3028 W\$ 3556

Top Must Specify (in this order):

- Model #
- Top Material
- Finish/Color

Base Must Specify (in this order):

- Model #
- Finish/Color

Description

- Available with Veneer (W) or HPL (P) Top, Must Specify
- See Below for Queen Anne Base and Height Adjustable Pneumatic X-Base; Order Separately
- Power Options not Available

Base Options: Must Order Separately

Queen Anne Base



01-0606QB	Optional Queen Anne Base (1 Required)	54	22.4	\$ 1557
-----------	---------------------------------------	----	------	---------

Description

- Queen Anne Base Features Multi-Step, Hand-Finished Catalyzed Finish
- Four Legs with Adjustable Glides

1-PIECE TOP & BASES	Model No.	Width	Depth	Height	Ship Wt	Cubic Ft	List Price
	29-3672RT <i>Accommodates Six (6) Chairs</i>	72	36	30	91	6.6	P\$ 3559 W\$ 4147
	29-4296RT <i>Accommodates Eight (8) Chairs</i>	96	42	30	140	12.5	P\$ 4295 W\$ 5060

Must Specify (in this order):

- Model #
- Top Material
- Finish/Color
- Grommet/Power/Data Location
- Base Model #
- Base Finish

Description

- One (1) Piece Top
- Available with Veneer (W) or HPL (P) Top, Must Specify
- Top and Bases Shipped Separately
- Bases Must Specified. Top Price Includes Standard Two (2) Rectangle Bases with Two (2) Stretchers, Optional Queen Anne Bases Available (See Below)
- Queen Anne Base Features Multi-Step, Hand-Finished Catalyzed Finish
- Optional Power/Data/Grommets are Available ([See Details](#)), Must Order Separately

Base Options: Must Specify and Add

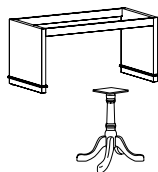

29-2828TB	Rectangular Bases (Includes Two (2) Bases and Two (2) Stretchers)	104	7.0	Included
01-0606QB	Queen Anne Base Upgrade (Includes Two (2) Bases)	54	22.4	\$ 1045

Item	Model No.	Width	Depth	Height	Ship Wt	Cubic Ft	List Price
2-PIECE TOPS & BASES	29-48120RT <i>Accommodates Ten (10) Chairs</i>	120	48	30	198	22.0	P\$ 5417 W\$ 6441
	29-48144RT <i>Accommodates Twelve (12) Chairs</i>	144	48	30	315	22.0	P\$ 8894 W\$ 10174



Must Specify (in this order):
 Model #
 Top Material
 Finish/Color
 Grommet/Power/Data Location
 Base Model #
 Base Finish

Description

- Two (2) Piece Top
- Available with Veneer (W) or HPL (P) Top, Must Specify
- Top and Bases Shipped Separately
- Bases Must Specified. Top Price Includes Standard Two (2) Rectangle Bases with Two (2) Stretchers, Optional Queen Anne Bases Available (See Below)
- Queen Anne Base Features Multi-Step, Hand-Finished Catalyzed Finish
- Optional Power/Data/Grommets are Available ([See Details](#)), Must Order Separately

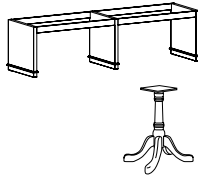

Base Options: Must Specify and Add

29-2828TB	Rectangular Bases (Includes Three (3) Bases and Four (4) Stretchers)	104	7.0	Included
01-0606QB	Queen Anne Base Upgrade (Includes Three (3) Bases)	80	33.6	\$ 1567

Item	Model No.	Width	Depth	Height	Ship Wt	Cubic Ft	List Price
WORK TABLES	29-3060WT <i>52" Kneespace</i>	60	30	30	89	8.0	P\$ 2121 W\$ 2481
	29-3672WT <i>64" Kneespace</i>	72	36	30	125	11.4	P\$ 2578 W\$ 3041

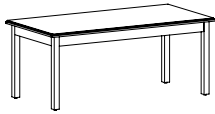

Must Specify (in this order):
 Model #
 Top Material
 Finish/Color
 Grommet Location/Color

Description

- Available with Veneer (W) or HPL (P) Top, Must Specify
- Left to Right Grain Direction on Worksurface
- Optional Factory-Installed, Worksurface Grommets Available; See Locations Below, Must Specify Grommet Color: Black (BLK) or Silver (SLV)
- Some Assembly Required
- Optional Wire Management ([See Units](#)), Power/Data/Grommets are Available ([See Details](#)), Must Order Separately

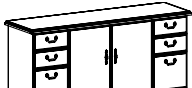
Item	Model No.	Width	Depth	Height	Ship Wt	Cubic Ft	List Price
STORAGE CREDENZA 	29-2066SC	66	20	30	217	30.5	P\$ 4252 W\$ 4650
	29-2072SC	72	20	30	237	30.5	P\$ 4896 W\$ 5314

Shown with Jefferson Drawer and Door Pulls (JEF)

Must Specify (in this order):

Model #
Top Material
Finish/Color
Base Molding
Decorative Molding
Pull
Locking
Drawer Construction

Description

- Standard With: Letter Width Box/Box/File in Pedestals, Left to Right Grain Direction on Worksurface
- Available with Veneer (W) or HPL (P) Top, Must Specify
- Top Profiled on only Three (3) Sides for Flush Wall Application
- Door Pull will Coordinate with Drawer Pull, [See Pull Options](#)
- Base Molding on Sides and User Side, Must Specify: Arlington or Wilmington (See Below)
- Standard with No Decorative Molding; Optional Wilmington Decorative Molding; Must Specify (See Below and [Molding Details](#))
- Optional Locking Pedestals (LKT-P) or Locking Pedestals and Doors (LKT-HU), ([See Details](#))
- Additional Options: Wood Dove Tail Drawers ([See Details](#))

Molding Options: Must Specify and Add

Arlington Molding Options

BM2900	Arlington Base Molding	N/C
--------	------------------------	-----

Wilmington Molding Options

BM3600	Wilmington Base Molding	N/C
M3600	Optional Wilmington Decorative Molding	\$ 160

Note: Wilmington Decorative Molding may only be used with Wilmington Base Molding

CREDENZA WITH DOUBLE LATERAL FILE 	29-2072DL	72	20	30	270	30.5	P\$ 5628 W\$ 6047
--	-----------	----	----	----	-----	------	----------------------

Shown with Jefferson Drawer and Door Pulls (JEF) and Optional Wilmington Decorative Molding

Must Specify (in this order):

Model #
Top Material
Finish/Color
Base Molding
Decorative Molding
Pull
Drawer Construction

Description

- Standard With: Four Locking Lateral File Drawers, Left to Right Grain Direction on Worksurface
- Available with Veneer (W) or HPL (P) Top, Must Specify
- Top Profiled on only Three (3) Sides for Flush Wall Application
- Base Molding on Sides and User Side, Must Specify: Arlington or Wilmington (See Below)
- Standard with No Decorative Molding; Optional Wilmington Decorative Molding; Must Specify (See Below and [Molding Details](#))
- Additional Options: Wood Dove Tail Drawers ([See Details](#))

Molding Options: Must Specify and Add

Arlington Molding Options

BM2900	Arlington Base Molding	N/C
--------	------------------------	-----

Wilmington Molding Options

BM3600	Wilmington Base Molding	N/C
M3600	Optional Wilmington Decorative Molding	\$ 160

Note: Wilmington Decorative Molding may only be used with Wilmington Base Molding

Pricing Codes:

P = HPL W = Veneer

[See Arlington Overview For Ordering Options](#)

Item	Model No.	Width	Depth	Height	Ship Wt	Cubic Ft	List Price
DOOR BOOKCASE	29-2870DB	28	15	70 $\frac{1}{8}$	78	17.8	\$ 2990

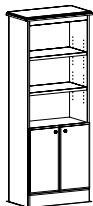

Shown with Arlington (ARB) Door Pull

Description

- Open Bookcase with Two (2) 1" Thick Adjustable Shelves
- Storage Behind Doors; One (1) Adjustable Shelf
- Top Profiled on only Three (3) Sides for Flush Wall Application
- Vertical Woodgrain
- Optional Locking Doors, [See Locking Options](#)

Must Specify (in this order):

- Model #
- Finish
- Pull
- Locking

WARDROBE/STORAGE CABINET	Hinged Left	Hinged Right	Width	Depth	Height	Ship Wt	Cubic Ft	List Price
	29-1870WL	29-1870WR	18	20	70 $\frac{1}{8}$	153	19.2	\$ 3522

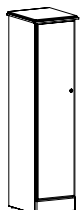

Shown as Left

Description

- Coat Rod Under Top Fixed Shelf and Three (3) Adjustable Shelves
- Adjustable Shelves can be Removed for Wardrobe Application
- Top Profiled on only Three (3) Sides for Flush Wall Application
- Must Specify Door Pull: Arlington B (ARB), Jefferson (JEF), and Liberty (ALB)
- Vertical Woodgrain
- Optional Locking Door, [See Locking Options](#)

Must Specify (in this order):

- Model #
- Finish
- Pull
- Locking

DOUBLE WARDROBE/STORAGE CABINET	29-3670WD	36	20	70 $\frac{1}{8}$	310	34.2	\$ 6218
---------------------------------	-----------	----	----	------------------	-----	------	---------

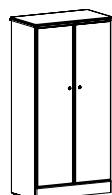

Description

- Three (3) Adjustable Shelves on Both Sides; Coat Rod Under Top Fixed Shelf on Right
- Recommended Against Wall
- Top Profiled on only Three (3) Sides for Flush Wall Application
- Must Specify Door Pull: Arlington B (ARB), Jefferson (JEF), and Liberty (ALB)
- Vertical Woodgrain
- Optional Locking Door, [See Locking Options](#)

Must Specify (in this order):

- Model #
- Finish
- Pull
- Locking

Item	Model No.		Width	Depth	Height	Ship Wt	Cubic Ft	List Price
ROUND GROMMET COVER	01-GRMTBK	Black	2 $\frac{3}{8}$ "	2 $\frac{3}{8}$ "	-	1	0.1	\$ 12
	01-GRMTSL	Silver						



OPEN MARKET ONLY
(SILVER)

Description

- 2 $\frac{3}{8}$ " (60mm) Round Grommet Cover
- Field Installed

INTERACT POWER & DATA	01-INTERACTG2A	Aluminum	9	5 $\frac{3}{8}$ "	2 $\frac{3}{4}$ "	5	0.2	\$ 987
	01-INTERACTG2B	Black						



Description

- Includes: Two (2) Power Outlets, **USB-A+C** Charging Ports, One (1) Telecom Plate Opening; Two (2) Keystone Openings for Voice/Data Jacks
- One (1) Telecom Plates Included with the Unit: One (1) 01-ABLAB Plate (Consists of One (1) RJ45 Cat 6, One (1) RJ11 Cat 3 Phone Jack)
- Convenience Plug on Bottom
- 6' Power Cord
- UL and CSA Recognized
- Additional Telecom Plates, [See Telecom Plate Options](#)

OASIS MINI POWER & DATA	01-OASISMA	Aluminum	14 $\frac{1}{4}$ "	6 $\frac{3}{8}$ "	2 $\frac{7}{8}$ "	11	0.3	\$ 3535
	01-OASISMB	Black						



Top View

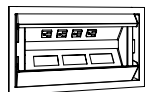

Description

- For Use with Conference Tables
- Plate Includes: Two (2) Data and Four (4) Power Outlets, 9' Power Cord
- Two (2) Telecom Plates Included with the Unit: One (1) 01-ABLAB Plate (Consists of One (1) RJ45 Cat 6, One (1) RJ11 Cat 3 Phone Jack); One (1) 01-ABLB Plate (Consists of One (1) RJ45 Cat 6)
- Soft Touch Hinged Lid
- UL Listed
- Additional Telecom Plates, [See Telecom Plate Options](#)

[See Arlington Overview For Ordering Options](#)

Item	Model No.		Width	Depth	Height	Ship Wt	Cubic Ft	List Price
WORKSURFACE POWER CENTER	01-INTRFC1A	Aluminum	14¼	6¾	2⅞	11	0.3	\$ 2287
	01-INTRFC1B	Black						



Description

- For Use with Conference Tables
- Four (4) Power Outlets, Three (3) Telecom Plate Openings
- Two (2) Telecom Plates Included with the Unit: One (1) 01-ABLAB Plate (Consists of One (1) RJ45 Cat 6, One (1) RJ11 Cat 3 Phone Jack); One (1) 01-ABLBB Plate (Consists of Two (2) RJ45 Cat 6)
- 6' Power Cord
- Convenience Plug on Bottom
- UL Listed/CSA Certified
- Additional Telecom Plates, [See Telecom Plate Options](#)

DUO CLAMP WITH NEMA PLUG	01-DUOCLAMPS	Silver	5½	3	7	1	0.2	\$ 634
	01-DUOCLAMPW	White						
	01-DUOCLAMPB	Black						

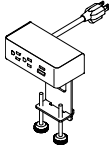

Description

- Clamps to Top and Includes: Two (2) Power Outlet, One (1) USB-A Charging Port and One (1) 60-Watt
- USB-C Power Delivery Port with GaN Technology with 10' Cord
- Clamps to Top and Features Silver Metal Trim
- Independent USB Circuit Controllers Deliver up to 2.1 Amps to Each Post
- All Mounting Hardware Included
- FCC Part 15A and UL Approved for Horizontal and Vertical Applications

WIRE MANAGEMENT CHANNEL	01-WMGR4		16	1½	¾	1	-	\$ 129
-------------------------	----------	--	----	----	---	---	---	--------

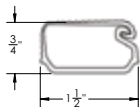

Description

- Set of Four (4) Black Plastic Wire Management Channels
- Snap Lock Channel
- Attaches with Adhesive Strips
- Ships via UPS Only

CABLE GRIP	01-WMGRCB		5¾	2¾	-	-	-	\$ 19
------------	-----------	--	----	----	---	---	---	-------

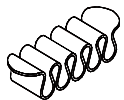

Description

- Under Surface Wire Management
- Black

[See Arlington Overview For Ordering Options](#)

Item	Model No.	Description	List Price
ECA TELECOM PLATES	01-ABL	Telecom Plate, Blank Plate	\$ 45
	01-ABL737373	Telecom Plate, Three (3) RJ45 Cat 5e	\$ 406
	01-ABLAB	Telecom Plate, One (1) RJ45 Cat 6, One (1) RJ11 Cat 3 Phone	\$ 228
	01-ABLAB102	Telecom Plate, One (1) RJ45 Cat 6, One (1) RJ11 Cat 3, One (1) USB W/72" Patch Cord	\$ 355
	01-ABLABB	Telecom Plate, Two (2) RJ45 Cat 6, One (1) RJ11 Cat 3 Phone	\$ 355
	01-ABLB	Telecom Plate, One (1) RJ45 Cat 6	\$ 165
	01-ABLBB	Telecom Plate, Two (2) RJ45 Cat 6	\$ 289
	01-ABLBBB	Telecom Plate, Three (3) RJ45 Cat 6	\$ 406
	01-ABLBBBB	Telecom Plate, (4) RJ45 Cat 6	\$ 528
	01-ABLBBC51	Telecom Plate, Two (2) RJ45 Cat 6, One (1) 15 Pin HD VGA w/72" Patch Cord	\$ 494
	01-ABLBC51L	Telecom Plate, One (1) RJ45 Cat 6, One (1) Mini Stereo Inline, One (1) 15 Pin HD VGA w/72" Patch Cord	\$ 455
	01-ABL3811	Telecom Plate, One (1) RJ45 Cat 6 Data Inline, One (1) RJ11 Cat 3 Phone Inline	\$ 219
	01-ABLC45	Telecom Plate, One (1) HDMI w/36" Patch Cord	\$ 327
	01-ABLC45C51L	Telecom Plate, One (1) Mini Stereo Inline, One (1) HDMI w/36" Patch Cord, One (1) 15 Pin HD VGA w/72" Patch Cord	\$ 618
	01-ABLC51L	Telecom Plate, One (1) 15 Pin HD VGA & One (1) Mini Stereo Inline Jack	\$ 330
	01-ABLCRDM	Telecom Plate, Three (3) Cord Bushings	\$ 106

Compatible with:

Interact Power & Data
01-INTERACTG2A, 01-INTERACTG2BPower Center
01-INTRFCIA, 01-INTRFCIB

Traditional components echo history and create timeless foundations for meeting rooms that complement our Jefferson and Arlington casegoods collections, and Cameo and Jefferson Reception options. Facilitate presentations with lecterns and visual presentation boards. Mobile serving carts and buffet height credenzas provide additional in-room utility.

CONSTRUCTION

Cameo Tables and Components feature your choice of either a Veneer or HPL top, Veneer bases, and Veneer chassis (where applicable).

VENEERS

- Exposed surfaces are select grade sliced American Black Walnut and Cherry veneers carefully selected and matched to assure proper balance and consistency

LAMINATES

- Exposed surfaces are produced from wood grained laminates fused to a particle-board core
- Each laminate offers lasting beauty, superior resistance to normal wear, and easy maintenance

TOPS

- Wood Veneer tops are 5-ply balanced construction and High Pressure Laminate (HPL) tops are 3-ply balanced construction
- Tops are 1 $\frac{3}{16}$ " thick with solid hardwood rims
- All buffets, credenzas, serving carts, video cabinets, and storage/wardrobe cabinets are shaped on user side only
- Grain direction runs left to right unless otherwise noted
- All Veneer tops, as well as Laminate tops up to 144" (12 feet), will have matching woodgrain. Laminate tops sized 156" (13 feet) and longer will have non-matching woodgrain

CHASSIS

- Tops and end panels are securely fastened using high quality European fastening systems to ensure maximum strength
- All units are equipped with heavy-duty, adjustable glides to ensure proper leveling and compensation for uneven floors

DRAWERS

- All drawer fronts are standard with elegant vertically matched walnut veneer faces
- Drawers feature 5-sided construction with $\frac{3}{4}$ " 3-ply fronts, $\frac{7}{16}$ " thick hardwood sides and $\frac{5}{32}$ " hardboard bottoms
- Units with 36" wide file drawers feature $\frac{1}{4}$ " thick drawer bottoms for maximum storage strength
- Drawer interiors are sanded, sealed, and finished to provide for a smooth, quality feel and appearance
- All drawers feature full extension, progressive action slides with precision steel ball bearings
- Box and file drawers are tested for 100lb capacity
- Lateral files are tested for 200lb capacity
- All suspensions have a limited lifetime warranty

STORAGE

- All hinged doors include soft close hinges, unless otherwise noted
- One piece hinge and base plate combination
- Soft close hinges reduce stress placed on the cabinet when the door is closed and offers a quiet closure

LOCKING

- All units with file drawers feature locking
- Removable lock cylinders allow for units to be re-keyed at a later date if required
- Units are shipped randomly keyed as standard. Keyed alike units available upon request at no additional charge.
- Keyed alike units available upon request at no additional charge
- Lock cores match pull color

INTERIOR DRAWER DIMENSIONS & FILING CAPABILITIES

Models

91-2472BFD 91-2436SV

Drawers

Box

W

14 $\frac{17}{32}$ "

L

19 $\frac{1}{4}$ "

D

3 $\frac{21}{32}$ "

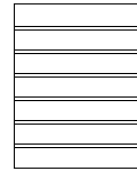

Legal Front to Back

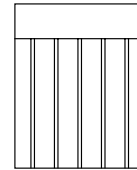

Legal Side to Side

Models

91-2436BF 91-2472BF

Drawers

Box

W

32 $\frac{9}{16}$ "

L

19 $\frac{1}{4}$ "

D

3 $\frac{21}{32}$ "

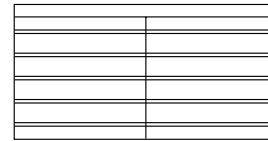

2 Rows Letter or Legal Front to Back

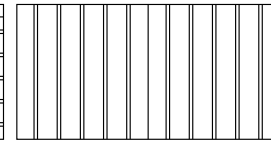

1 Row Letter or Legal Side to Side

Models

91-2472SBF

Drawers

Box

W

14 $\frac{17}{32}$ "

L

19 $\frac{1}{4}$ "

D

3 $\frac{21}{32}$ "

Box

32 $\frac{9}{16}$ "

19 $\frac{1}{4}$ "

3 $\frac{21}{32}$ "

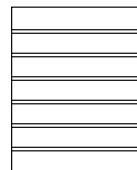

Legal Front to Back

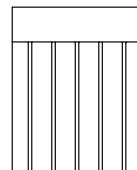

Legal Side to Side

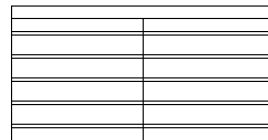

2 Rows Letter or Legal Front to Back

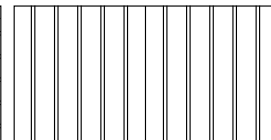

1 Row Letter or Legal Side to Side

HOW TO ORDER EXAMPLES

	QTY	MODEL NO.	DESCRIPTION	EXAMPLE
TOP	1	91-4296RT	Top Material	W
			Finish/Color	EW
			Edge Profile	C2
			Grommet/Power/ Data Location	EL
BASES	2	01-2028TB	Finish	EW
PORTS	2	01-OASISMA		
TELECOM PLATE	1	01-ABLAB		
MOBILE CART	1	91-2436SV	Top Material	P
			Finish/Color	EW
			Edge Profile	C2
			Pull	ALB
			Back Panel	1-GRMT
			Grommet Grommet Color	Black

VENEER (W) OPTIONS

Veneer features UV Advantage, an ultra-violet finish, on all exposed surfaces by utilizing roll-coat UV technology

AW	Artisan Walnut	LW	Legacy Walnut
CO	Columbian Walnut	MW	Mahogany Walnut
DC	Dark Cherry	MTS	Metropolis Sky
DFW	Dark Forest Walnut	PNW	Pinnacle Walnut
EW	Espresso	SCH	Select Cherry
GC	Golden Cherry	SKC	Shaker Cherry
HW	Harvest Walnut	WC	Williamsburg Cherry
HNW	Henna Walnut		

HPL (P) LAMINATE

WOODGRAIN			
CO	Columbian Walnut	PNW	Pinnacle Walnut
EF	Espresso	SCH	Select Cherry
GC	Golden Cherry	SKC	Shaker Cherry
MW	Mahogany Walnut	WC	Williamsburg Cherry

EDGE PROFILES

- C2 Jefferson
- R Arlington



Jefferson



Arlington

PULL OPTIONS

Units with doors and drawers will feature coordinating pulls however door and drawer pulls cannot be intermixed. Antique Brass pulls are 5¼" and Liberty pull is 4¼".

ARA	Arlington A, Brass	ALB	Liberty, Aluminum
ARB	Arlington B, Brass	WLM	Wilmington, Brass
JEF	Jefferson, Brass		



Arlington A



Arlington B



Jefferson



Wilmington



Liberty

GROMMET/POWER/DATA OPTIONS & LOCATIONS

See units and options in [accessories section](#) and the [general power and locations information section](#)

LOCKING DOORS

Locking doors are available on specific units, where noted. You must specify WITH LOCKING when ordering and add upcharge.

Lock core will be black if Arlington, Jefferson, and Wilmington brass pulls are selected and silver if Liberty Aluminum pulls are selected.

LKT_HU	18" W Units	\$	76
LKT_HU	42" W - 24" W Units	\$	101
LKT_HU	72" W - 48" W Units	\$	128

CERTIFICATIONS & COMPLIANCE

- Intertek Sustainability Certified
- BIFMA level® Certified
- BIFMA Compliant® Certified
- TSCA Title VI (formerly CARB) Compliance
- US Green Building's LEED® Contribution

Tops/Shapes

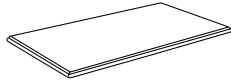

Rectangular [\(See Details\)](#)

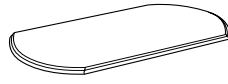

Arc Rectangular [\(See Details\)](#)



Racetrack [\(See Details\)](#)



Boat-Shaped [\(See Details\)](#)

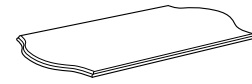

Wave-Rectangular [\(See Details\)](#)

Bases

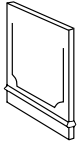

Rectangular [\(See Details\)](#)

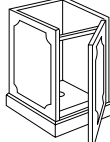

Square [\(See Details\)](#)

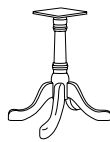

Queen Anne Base [\(See Details\)](#)

Storage Components

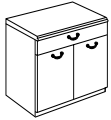

Two Door Buffet w/Drawer [\(See Details\)](#)

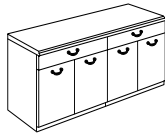

Four Door Buffet w/2 Drawers [\(See Details\)](#)

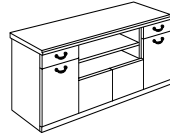

Four Door Buffet w/2 Drawers & Open Storage [\(See Details\)](#)

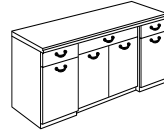

Four Door Buffet w/3 Drawers [\(See Details\)](#)

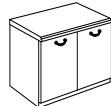

Two Door Credenza [\(See Details\)](#)

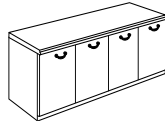

Four Door Credenza [\(See Details\)](#)

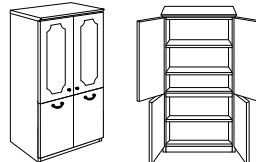

Storage Cabinet Double Doors [\(See Details\)](#)

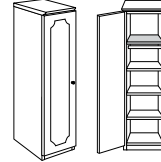

Wardrobe/Storage Cabinet [\(See Details\)](#)



Mobile Serving Cart [\(See Details\)](#)

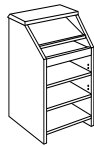

Lectern Stand [\(See Details\)](#)

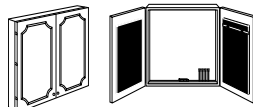

Visual Board [\(See Details\)](#)

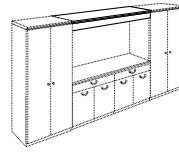

Visor Rail [\(See Details\)](#)

Wire Management & Power/Data Accessories



Item	Model No.	W	D	H	Ship Wt	Cubic Ft	List Price
RECTANGULAR TOPS 	72" or 6' - 1 Piece Top						
	91-3672RT	72	36	1 3/16	100	6.2	P\$ 3266 W\$ 3853
	96" or 8' - 1 Piece Top 96" or 8' - 1 Piece Top						
	91-4296RT	96	42	1 3/16	180	9.4	P\$ 5016 W\$ 5785
	120" or 10' - 2 Piece Tops 120" or 10' - 2 Piece Tops						
	91-48120RT	120	48	1 3/16	225	10.3	P\$ 6686 W\$ 7713
	144" or 12' - 2 Piece Tops						
	91-48144RT	144	48	1 3/16	275	12.3	P\$ 7460 W\$ 8747
	168" or 14' - 2 Piece Tops 168" or 14' - 2 Piece Tops						
	91-48168RT	168	48	1 3/16	325	13.6	P\$ 8871 W\$ 10543
	192" or 16' - 2 Piece Tops						
	91-48192RT	192	48	1 3/16	375	15.5	P\$ 8998 W\$ 11315

Must Specify (in this order):
Model #
Top Material
Finish/Color
Edge Profile
Grommet/Power/Data Location

Description

- Grain Runs the Width of the Table
- All Veneer Tops, as well as Laminate Tops up to 144" (12 feet), have Matching Woodgrain. Laminate Tops Sized 156" (13 feet) and Longer have Non-Matching Woodgrain
- Heavy-Duty Ganging Mechanisms Connect Two (2) Piece Tops
- See Bases and Number Required For Each Top Size, [See Rectangle, Square, and Queen Anne Base Options](#); Must Order Separately
- Optional Grommets and Power/Data; For Locations See [Power and Locations Information Section](#), See Units and Unit Options in [Accessories Section](#)

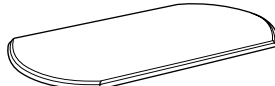
Item	Model No.	W	D	H	Ship Wt	Cubic Ft	List Price
ARC RECTANGULAR TOPS 	72" or 6' - 1 Piece Top						
	91-3672AR	72	36	1 3/16	100	6.2	P\$ 3604 W\$ 4190
	96" or 8' - 1 Piece Top						
	91-4296AR	96	42	1 3/16	180	9.4	P\$ 5656 W\$ 6426
	120" or 10' - 2 Piece Tops						
	91-48120AR	120	48	1 3/16	225	10.3	P\$ 7201 W\$ 8230
	144" or 12' - 2 Piece Tops						
	91-48144AR	144	48	1 3/16	275	12.3	P\$ 7972 W\$ 9255
	168" or 14' - 2 Piece Tops						
	91-48168AR	168	48	1 3/16	325	13.6	P\$ 9385 W\$ 11057
	192" or 16' - 2 Piece Tops						
	91-48192AR	192	48	1 3/16	375	15.5	P\$ 9514 W\$ 11828

Must Specify (in this order):
Model #
Top Material
Finish/Color
Edge Profile
Grommet/Power/Data Location

Description

- Grain Runs the Width of the Table
- All Veneer Tops, as well as Laminate Tops up to 144" (12 feet), have Matching Woodgrain. Laminate Tops Sized 156" (13 feet) and Longer have Non-Matching Woodgrain
- Heavy-Duty Ganging Mechanisms Connect Two (2) Piece Tops
- See Bases and Number Required For Each Top Size, [See Rectangle, Square, and Queen Anne Base Options](#); Must Order Separately
- Optional Grommets and Power/Data; For Locations See [Power and Locations Information Section](#), See Units and Unit Options in [Accessories Section](#)

Pricing Codes:
P = HPL W = Veneer

[See Cameo Overview For Ordering Options](#)

Item	Model No.	W	D	H	Ship Wt	Cubic Ft	List Price
RACETRACK TOPS 	72" or 6' - 1 Piece Top						
	91-3672AT	72	36	1 3/16	100	6.2	P\$ 4296 W\$ 4883
	96" or 8' - 1 Piece Top						
	91-4296AT	96	42	1 3/16	180	9.4	P\$ 6168 W\$ 6940
	120" or 10' - 2 Piece Tops						
	91-48120AT	120	48	1 3/16	225	10.3	P\$ 8103 W\$ 9129
	144" or 12' - 2 Piece Tops						
	91-48144AT	144	48	1 3/16	275	12.3	P\$ 9129 W\$ 10415
	168" or 14' - 2 Piece Tops						
	91-48168AT	168	48	1 3/16	325	13.6	P\$ 10672 W\$ 12342
	192" or 16' - 2 Piece Tops						
	91-48192AT	192	48	1 3/16	375	15.5	P\$ 11057 W\$ 13369

Must Specify (in this order):
Model #
Top Material
Finish/Color
Edge Profile
Grommet/Power/Data Location

Description

- Grain Runs the Width of the Table
- All Veneer Tops, as well as Laminate Tops up to 144" (12 feet), have Matching Woodgrain. Laminate Tops Sized 156" (13 feet) and Longer have Non-Matching Woodgrain
- Heavy-Duty Ganging Mechanisms Connect (2) Piece Tops
- See Bases and Number Required For Each Top Size, [See Rectangle, Square, and Queen Anne Base Options](#); Must Order Separately
- Optional Grommets and Power/Data; For Locations See [Power and Locations Information Section](#), See Units and Unit Options in [Accessories Section](#)

Item	Model No.	W	D	H	Ship Wt	Cubic Ft	List Price
BOAT-SHAPED TOPS 	72" or 6' - 1 Piece Top						
	91-3672BT	72	36	1 3/16	100	6.2	P\$ 4296 W\$ 4883
	96" or 8' - 1 Piece Top						
	91-4296BT	96	42	1 3/16	180	9.4	P\$ 6168 W\$ 6940
	120" or 10' - 2 Piece Tops						
	91-48120BT	120	48	1 3/16	225	10.3	P\$ 8103 W\$ 9129
	144" or 12' - 2 Piece Tops						
	91-48144BT	144	48	1 3/16	275	12.3	P\$ 9129 W\$ 10415
	168" or 14' - 2 Piece Tops						
	91-48168BT	168	48	1 3/16	325	13.6	P\$ 10672 W\$ 12342
	192" or 16' - 2 Piece Tops						
	91-48192BT	192	48	1 3/16	375	15.5	P\$ 11057 W\$ 13369

Must Specify (in this order):
Model #
Top Material
Finish/Color
Edge Profile
Grommet/Power/Data Location

Description

- Grain Runs the Width of the Table
- All Veneer Tops, as well as Laminate Tops up to 144" (12 feet), have Matching Woodgrain. Laminate Tops Sized 156" (13 feet) and Longer have Non-Matching Woodgrain
- Heavy-Duty Ganging Mechanisms Connect (2) Piece Tops
- See Bases and Number Required For Each Top Size, [See Rectangle, Square, and Queen Anne Base Options](#); Must Order Separately
- Optional Grommets and Power/Data; For Locations See [Power and Locations Information Section](#), See Units and Unit Options in [Accessories Section](#)

Pricing Codes:
P = HPL W = Veneer

[See Cameo Overview For Ordering Options](#)

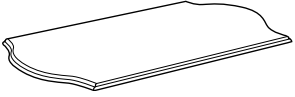
Item	Model No.	W	D	H	Ship Wt	Cubic Ft	List Price
WAVE-RECTANGULAR TOPS 	72" or 6' - 1 Piece Top						
	91-3672WR	72	36	1¾"	100	6.2	P\$ 3604 W\$ 4190
	96" or 8' - 1 Piece Top						
	91-4296WR	96	42	1¾"	180	9.4	P\$ 5656 W\$ 6426
	120" or 10' - 2 Piece Tops						
	91-48120WR	120	48	1¾"	225	10.3	P\$ 7201 W\$ 8230
Must Specify (in this order): Model # Top Material Finish/Color Edge Profile Grommet/Power/Data Location	144" or 12' - 2 Piece Tops						
	91-48144WR	144	48	1¾"	275	12.3	P\$ 7972 W\$ 9255
	168" or 14' - 2 Piece Tops						
	91-48168WR	168	48	1¾"	325	13.6	P\$ 9385 W\$ 11057
	192" or 16' - 2 Piece Tops						
	91-48192WR	192	48	1¾"	375	15.5	P\$ 9514 W\$ 11828

Description

- Grain Runs the Width of the Table
- All Veneer Tops, as well as Laminate Tops up to 144" (12 feet), have Matching Woodgrain. Laminate Tops Sized 156" (13 feet) and Longer have Non-Matching Woodgrain
- Heavy-Duty Ganging Mechanisms Connect (2) Piece Tops
- See Bases and Number Required For Each Top Size, See Rectangle Bases Below and Following Page; Must Order Separately
- Optional Grommets and Power/Data; For Locations See [Power and Locations Information Section](#), See Units and Unit Options in [Accessories Section](#)

RECTANGULAR BASE TRADITIONAL	For Use with 42"D or Less Tops						
	01-2028TB	20	2	28½"	32	2.3	W\$ 1548
For Use with 48"D Tops							
01-2428TB	24	2	28½"	38	2.7	W\$ 1650	

Description

- Veneer Panel Base
- Traditional Molding on Outer Side Standard; For No Decorative Molding Option, Must Specify (See Below)
- Stretchers are Included in Pricing; Must Specify Model (See Below)

Molding Option: Specify

NONE	No Decorative Molding	\$	N/C
------	-----------------------	----	-----

Table Width	72"	96"	120"	144"	168"	192"
Number of Bases Required	2	2	3	3	3	5
Stretcher Rail Needed	01-72STR	01-96STR	01-120STR	01-144STR	01-168STR	01-192STR

Note: Molding is applied to one side of outer extreme bases. If 3 or more bases are required, center bases will not have molding on either side.

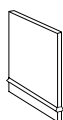
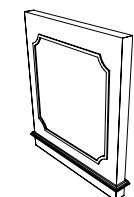

Must Specify (in this order):
 Model # and Quantity
 Finish
 No Molding
 Stretcher Rail

Item	Model No.	W	D	H	Ship Wt	Cubic Ft	List Price
SQUARE BASE TRADITIONAL	01-2020TSB	20	20	28½	57	8.4	W\$ 2252

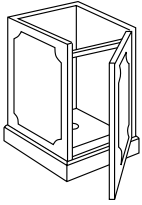

Description

- Panel Access Door Features Soft Close Hinges
- Traditional Molding Standard on All Sides; For No Decorative Molding Option, Must Specify (See Below)
- 2" Wire Management Opening Above Door; 2¾" (60mm) Wire Management Opening in Bottom
- Optional Grommet at Top Edge, Must Specify (See Below)

Options: Specify & Add

NONE	No Decorative Molding	\$	N/C
GCB1S	Grommet at Top Edge One (1) - Factory Installed	\$	58

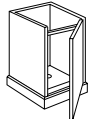

No Molding Option

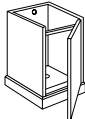

Grommet Option

Table Width	72"	96"	120"	144"	168"	192"
Number of Bases Required	2	2	3	3	3	3

Note: Recommended on tables 72"W or Larger. If specified on smaller tables, a ballast must be ordered separately. Contact Customer Service for more information.

Must Specify (in this order):

- Model # and Quantity
- Finish
- No Molding
- Grommet Option

QUEEN ANNE BASE	01-0606QB	24	24	28¾	35	10.8	W\$ 1557
-----------------	-----------	----	----	-----	----	------	----------

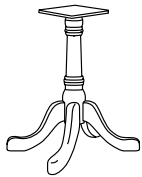

Description

- Classic Design Detail on Column
- Queen Anne Base Features Multi-Step, Hand-Finished Catalyzed Finish
- Four (4) Legs with Adjustable Glides

Table Width	72"	96"	120"	144"	168"	192"
Number of Bases Required	2	2	3	3	3	3

Must Specify (in this order):

- Model # and Quantity
- Finish

Item	Model No.	W	D	H	Ship Wt	Cubic Ft	List Price
TWO DOOR BUFFET WITH DRAWER	91-2436BF	36	24	36	189	21.7	P\$ 4859 W\$ 4949

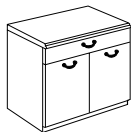
**Description**

- Top Edge Profiled on Approach Side Only ([See Edge Options](#)); Must Specify Edge Selection
- One (1) Drawer and Storage Behind Two (2) Doors with One (1) Adjustable Shelf

Must Specify (in this order):

Model #
Top Material
Finish/Color
Edge Profile
Pull

FOUR DOOR BUFFET WITH TWO DRAWERS	91-2472BF	72	24	36	342	45.6	P\$ 9233 W\$ 9385
-----------------------------------	-----------	----	----	----	-----	------	----------------------

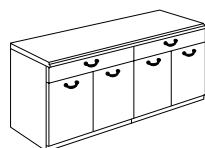
**Description**

- Top Edge Profiled on Approach Side Only ([See Edge Options](#)); Must Specify Edge Selection
- Two (2) Drawers and Storage Behind Four (4) Doors with Two (2) Adjustable Shelves

Must Specify (in this order):

Model #
Top Material
Finish/Color
Edge Profile
Pull

FOUR DOOR BUFFET WITH TWO DRAWERS AND OPEN STORAGE	91-2472BFD	72	24	36	337	45.6	P\$ 10648 W\$ 10803
--	------------	----	----	----	-----	------	------------------------

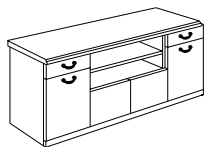
**Description**

- Top Edge Profiled on Approach Side Only ([See Edge Options](#)); Must Specify Edge Selection
- Two (2) Drawers with Open Storage with One (1) Adjustable Shelf
- Left and Right Storage Behind Doors with One (1) Adjustable Shelf
- Storage Behind Center Doors

Must Specify (in this order):

Model #
Top Material
Finish/Color
Edge Profile
Pull

FOUR DOOR BUFFET WITH THREE DRAWERS	91-2472SBF	72	24	36	362	45.6	P\$ 10648 W\$ 10803
-------------------------------------	------------	----	----	----	-----	------	------------------------

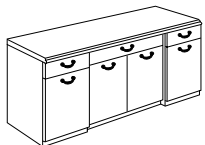
**Description**

- Top Edge Profiled on Approach Side Only ([See Edge Options](#)); Must Specify Edge Selection
- Three (3) Drawers and Storage Behind Four (4) Doors with Three (3) Adjustable Shelves
- Center Section is Stepped Back

Must Specify (in this order):

Model #
Top Material
Finish/Color
Edge Profile
Pull

Item	Model No.	W	D	H	Ship Wt	Cubic Ft	List Price
TWO DOOR CREDENZA	91-2436CC	36	24	30	150	17.6	P\$ 3764 W\$ 3853

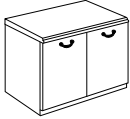

Must Specify (in this order):

- Model #
- Top Material
- Finish/Color
- Edge Profile
- Pull
- Locking Option

Description

- Top Edge Profiled on Approach Side Only ([See Edge Options](#)); Must Specify Edge Selection
- Two (2) Doors with One (1) Adjustable Shelf Behind Doors
- Additional Option: Locking Doors ([See Locking Options](#))

FOUR DOOR CREDENZA	91-2472CC	72	24	30	290	34.2	P\$ 7628 W\$ 7781
--------------------	-----------	----	----	----	-----	------	----------------------

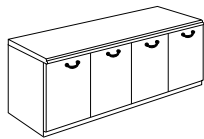

Must Specify (in this order):

- Model #
- Top Material
- Finish/Color
- Edge Profile
- Pull
- Locking Option

Description

- Top Edge Profiled on Approach Side Only ([See Edge Options](#)); Must Specify Edge Selection
- Four (4) Doors with Two (2) Adjustable Shelves Behind Doors
- Additional Option: Locking Doors ([See Locking Options](#))

DOUBLE DOOR STORAGE CABINET	91-3672SUD	36	24	72	285	42.0	W\$ 7825
-----------------------------	------------	----	----	----	-----	------	----------

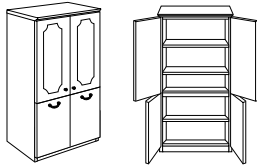

Must Specify (in this order):

- Model #
- Finish
- Edge Profile
- Knob
- Pull
- No Molding

Description

- Top Section has Two (2) Adjustable Shelves; Bottom Section has One (1) Adjustable Shelf
- Two (2) Knobs on Top Doors, Available with Antique Brass (TKN) Door Knob or Aluminum (ALK) Door Knob; Must Specify; Selection of Pulls on Bottom Doors

Options: Specify

NONE	No Decorative Molding	\$	N/C
------	-----------------------	----	-----

WARDROBE/STORAGE CABINET	HINGED LEFT	HINGED RIGHT	W	D	H	Ship Wt	Cubic Ft	List Price
	91-1872WL	91-1872WR	18	24	72	155	22.0	W\$ 6231

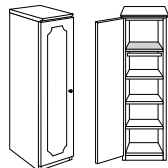

Must Specify (in this order):

- Model #
- Finish
- Edge Profile
- Knob
- No Molding

Description

- Available with Antique Brass (TKN) Door Knob or Aluminum (ALK) Door Knob; Must Specify
- Fixed Top Shelf; Coat Rod Under Fixed Shelf
- Three (3) Adjustable Shelves Behind Door
- Adjustable Shelves can be Removed for Wardrobe Application

Options: Specify

NONE	No Decorative Molding	\$	N/C
------	-----------------------	----	-----

Pricing Codes:
P = HPL W = Veneer

[See Cameo Overview For Ordering Options](#)

Item	Model No.	W	D	H	Ship Wt	Cubic Ft	List Price
VISOR RAIL	91-2472VR	72	24	5 $\frac{3}{16}$	100	8.9	W\$ 1608

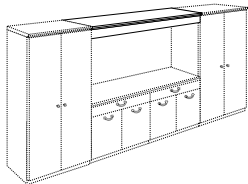

Must Specify (in this order):

Model #
Finish
Projection Screen
Task Light

Description

- Overhead Rail Creates Wall Unit
- For Use with 72" High Cabinets and Credenzas/Bufets (Ordered Separately)

Options: Specify & Add

1-PS	Projection Screen (Requires Field Installation)	\$ 1177
TL-0848	Task Light (Requires Field Installation)	\$ 493

SERVING CART	91-2436SV	36	24	36	149	24.0	P\$ 5827 W\$ 5919
--------------	-----------	----	----	----	-----	------	----------------------



Must Specify (in this order):

Model #
Top Material
Finish/Color
Edge Profile
Pull
Grommet Option

Description

- Top Edge Profiled on Approach Side Only; Must Specify Edge Selection
- Two (2) Box Drawers with Storage Behind Two (2) Doors
- Open Storage
- Locking Casters

Grommet Option: Specify & Add

1-GRMT	Grommet in Back Panel; Must Specify Black or Silver	\$ 58
--------	---	-------

LECTERN STAND	91-2650LS	26	24	50	130	21.9	W\$ 4633
---------------	-----------	----	----	----	-----	------	----------

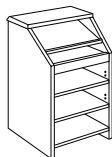

Must Specify (in this order):

Model #
Finish
Edge Profile

Description

- Top Edge Profiled on Approach Side Only; Must Specify Edge Selection
- Fixed Reading Shelf
- Pullout Shelf
- Two (2) Adjustable Storage Shelves in Lower Compartment
- Two (2) Locking and Two (2) Non-Locking Casters
- Wire Management Grommet in Bottom Shelf

Item	Model No.	W	D	H	Ship Wt	Cubic Ft	List Price
VISUAL BOARD	91-4848VB	48	5	48	150	11.0	W\$ 6686

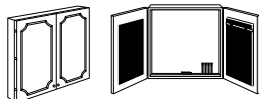

Must Specify (in this order):

- Model #
- Finish
- Project Screen
- Tackboard Fabric
- Pull

Description

- Tackboard on Each Door Standard in Black Fabric Unless Specified; Price Valid for Grades 1, 2, & 3 (See Other Pricing Below)
- Display Rail with Adjustable Hooks for Flipchart
- Magnetic Door Closure and Porcelain Non-Glare Writing Surface
- Includes Flipchart, Set of Four (4) Dry Erase Markers and Eraser, Mounting Hardware
- Does Not Feature Soft Close Hinges

Options: Specify & Add

	Grade 4	Grade 5	Grade 6	Grade 7	Grade 8	Grade 9	Grade 10
Tackboard Fabric Change	\$ 310	456	602	812	1030	1286	1580
1-PS Projection Screen (Requires Field Installation)							\$ 1177

Item	Model No.	Color	W	D	H	Ship Wt	Cubic Ft	List Price
ROUND GROMMET COVER	01-GRMTBK	Black	2 ³ / ₈	2 ³ / ₈	-	1	0.1	\$ 12
	01-GRMTSL	Silver						



OPEN MARKET ONLY
(SILVER)

Description

- 2³/₈" (60mm) Round Grommet Cover
- Field Installed

Item	Model No.	Material	W	D	H	Ship Wt	Cubic Ft	List Price
POWER 440	01-DATA440A	Aluminum	5 ⁵ / ₁₆	4 ³ / ₁₆	-	5	0.2	\$ 1068
	01-DATA440B	Black						



Description

- Two (2) Power Outlets
- Soft Touch Hinged Lid
- 6' Power Cord
- UL and CSA Recognized

Item	Model No.		W	D	H	Ship Wt	Cubic Ft	List Price
INTERACT POWER & DATA	01-INTERACTG2A	Aluminum	9	5 $\frac{3}{8}$	2 $\frac{3}{4}$	5	0.2	\$ 987
	01-INTERACTG2B	Black						



Description

- Includes: Two (2) Power Outlets, USB-A+C Charging Ports, One (1) Telecom Plate Opening; Two (2) Keystone Openings for Voice/Data Jacks
- One (1) Telecom Plates Included with the Unit: One (1) 01-ABLAB Plate (Consists of One (1) RJ45 Cat 6, One (1) RJ11 Cat 3 Phone Jack)
- Convenience Plug on Bottom
- 6' Power Cord
- UL and CSA Recognized
- Additional Telecom Plates, [See Telecom Plate Options](#)

TABLE POWER & DATA VAULT	01-CVAULTG2A		4 $\frac{1}{3}$	15 $\frac{7}{8}$	4 $\frac{1}{16}$	10	0.4	\$ 2154
--------------------------	--------------	--	-----------------	------------------	------------------	----	-----	---------



OPEN MARKET ONLY

Description

- Electric Drive Motor Rotates the Surface Technology 180° to the Proper Position
- Photo-Electronic Eye Prevents Rotation When Obstructed
- Two (2) Data Ports, Three (3) Power Outlets, and One (1) HDMI and Two (2) 5V USB
- 6' Power Cord
- UL and CSA Recognized

OASIS MINI POWER & DATA	01-OASISMA	Aluminum	14 $\frac{1}{4}$	6 $\frac{3}{8}$	2 $\frac{7}{8}$	11	0.3	\$ 3535
	01-OASISMB	Black						



Top View

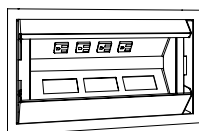

Description

- For Use with Conference Tables
- Soft Touch Hinged Lid
- Four (4) Power Outlets, Three (3) Telecom Plate Openings
- Two (2) Telecom Plates Included with the Unit: One (1) 01-ABLAB Plate (Consists of One (1) RJ45 Cat 6, One (1) RJ11 Cat 3 Phone Jack); One (1) 01-ABLB Plate (Consists of One (1) RJ45 Cat 6)
- 9' Power Cord
- UL Listed
- Additional Telecom Plates, [See Telecom Plate Options](#)

WORKSURFACE POWER CENTER	01-INTRFC1A	Aluminum	14 $\frac{1}{4}$	6 $\frac{3}{8}$	2 $\frac{7}{8}$	11	0.3	\$ 2287
	01-INTRFC1B	Black						

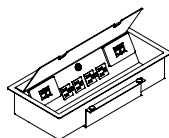

Description

- For Use with Conference Tables
- Four (4) Power Outlets, Three (3) Telecom Plate Openings
- Two (2) Telecom Plates Included with the Unit: One (1) 01-ABLAB Plate (Consists of One (1) RJ45 Cat 6, One (1) RJ11 Cat 3 Phone Jack); One (1) 01-ABLBB Plate (Consists of Two (2) RJ45 Cat 6)
- 6' Power Cord
- Convenience Plug on Bottom
- UL Listed/CSA Certified
- Additional Telecom Plates, [See Telecom Plate Options](#)

Item	Model No.		W	D	H	Ship Wt	Cubic Ft	List Price
POWER DATA PORT	01-DPORT4A	Aluminum	8	4	-	7	0.2	\$ 1211
	01-DPORT4B	Black						

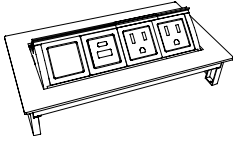

Description

- Includes: Two (2) Power Outlets, One (1) USB A+C, One (1) Open Port, 10' Power Cord, and Voice/Data Adapter Kit to Accept Couplers and Jacks When Required
- Retracts into Work Surface to Regain Productive Space; One-Touch Access to Power and Data
- Optional Telecom Port Components, See Compatible Units Below
- Water-Proof Simplex (Outlets)
- UL Recognized

USB PORT	01-USBPORT		-	-	-	-	-	\$ 178
----------	------------	--	---	---	---	---	---	--------

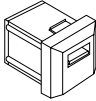

Description

- Passive USB-A Port with Increased Transfer Speed Up to 5 gbs/sec
- Simultaneous Read/Write Capability; Idle Device Power Saving State
- 6' Cord
- Compatible with 01-DPORT4A/B

VOICE COUPLER	01-VOICE1		-	-	-	-	-	\$ 80
---------------	-----------	--	---	---	---	---	---	-------

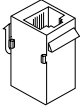

Description

- 6-Pin Modular Plug
- Molded Black; Cord Not included
- Compatible with 01-DPORT4A/B

DATA PORT	01-RJ4DATA		-	-	-	-	-	\$ 186
-----------	------------	--	---	---	---	---	---	--------



Description

- 8-Pin Modular Plug; Cat6 Ethernet Cable; Pre-terminated Cable
- 10' Cord
- Compatible with 01-DPORT4A/B

Item	Model No.		W	D	H	Ship Wt	Cubic Ft	List Price	
DUO CLAMP WITH NEMA PLUG	01-DUOCLAMPS	Silver	5½	3	7	1	0.2	\$ 634	
	01-DUOCLAMPW	White							
	01-DUOCLAMPB	Black							
		Description							
		<ul style="list-style-type: none"> Clamps to Top and Includes: Two (2) Power One (1) USB Charging Port and One (1) 60-Watt USB-C Power Delivery Port with GaN Technology with 10' Cord Silver Metal Trim Independent USB Circuit Controllers Deliver up to 2.1 Amps to Each Post All Mounting Hardware Included FCC Part 15A and UL Approved for Horizontal and Vertical Applications 							
TRIO CLAMP WITH NEMA PLUG	01-TRIOCLAMPS	Silver	8	3	7	1	0.2	\$ 743	
	01-TRIOCLAMPW	White							
	01-TRIOCLAMPB	Black							
		Description							
		<ul style="list-style-type: none"> Clamps to Top and Includes: Three (3) Power, One (1) USB Charging Port, One (1) 60-Watt USB-C Power Delivery Port with GaN Technology, One (1) Open Data; 10' Cord Silver Metal Trim Independent USB Circuit Controllers Deliver up to 2.1 Amps to Each Post HDMI, VGA, or RJ45 Accessories Sold Separately; See Below All Mounting Hardware Included FCC Part 15A and UL Approved for Horizontal and Vertical Applications 							
HDMI DATA PORT ACCESSORY	01-LCOMHDMI		-	-	-	1	0.2	\$ 183	
		Description							
		<ul style="list-style-type: none"> HDMI Port for Trio Clamp Units 							
		OPEN MARKET ONLY							
VGA DATA PORT ACCESSORY	01-LCOMVGA		-	-	-	1	0.2	\$ 134	
		Description							
		<ul style="list-style-type: none"> VGA Port for Trio Clamp Units 							
RJ45 DATA PORT ACCESSORY	01-LCOMRJ45		-	-	-	1	0.2	\$ 88	
		Description							
		<ul style="list-style-type: none"> RJ45 Port for Trio Clamp Units 							

Pricing Codes:
P = HPL W = Veneer

[See Cameo Overview For Ordering Options](#)

Item	Model No.	W	D	H	Ship Wt	Cubic Ft	List Price
WIRE MANAGERS	01-WMGR4	16	1½	¾	1	-	\$ 129

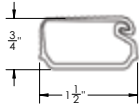

Description

- Four (4) Wire Manager Strips
- Black Plastic
- Snap Lock Channel
- Attaches with Adhesive Strips
- Can be Placed on All Units to Route Wires

CABLE GRIP	01-WMGRCB	5¾	2¾	-	-	-	\$ 19
------------	-----------	----	----	---	---	---	-------

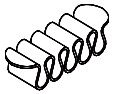

Description

- Under Surface Wire Management
- Black

POWER STRIP	01-PRSP	9	2	2	1	-	\$ 227
-------------	---------	---	---	---	---	---	--------

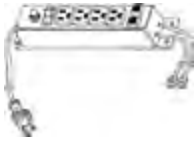

Description

- Includes Four (4) Outlets and Two (2) Phone Jacks
- Black Plastic with Rocker On/Off Switch
- 13 Amp Circuit Breaker
- 10' Power Cord and Two (2) 14' Phone Hook Up Cords
- UL Listed and CSA Certified
- Suitable for Surface or Recessed Mounting
- Ships via UPS Only

VESTA POWER CENTER	01-PDCTR	10¾	12	28¾	14	2.5	\$ 1968
--------------------	----------	-----	----	-----	----	-----	---------



Description

- Top Includes One (1) Power Outlet, Two (2) USB Ports and One (1) USBC Port; Base Includes Three (3) Outlets
- Available in White
- 120" Power Cord
- Built with Weight Distribution for Optimal Stability
- Base is 5" Tall

Item	Model No.	Description	List Price
ECA TELECOM PLATES	01-ABL	Telecom Plate, Blank Plate	\$ 45
	01-ABL737373	Telecom Plate, Three (3) RJ45 Cat 5e	\$ 406
	Compatible with:		
	01-ABLAB	Telecom Plate, One (1) RJ45 Cat 6, One (1) RJ11 Cat 3 Phone	\$ 228
	01-ABLAB102	Telecom Plate, One (1) RJ45 Cat 6, One (1) RJ11 Cat 3, One (1) USB W/72" Patch Cord	\$ 355
	01-ABLABB	Telecom Plate, Two (2) RJ45 Cat 6, One (1) RJ11 Cat 3 Phone	\$ 355
	01-ABLB	Telecom Plate, One (1) RJ45 Cat 6	\$ 165
	01-ABLB	Telecom Plate, Two (2) RJ45 Cat 6	\$ 289
	01-ABLB	Telecom Plate, Three (3) RJ45 Cat 6	\$ 406
	01-ABLB	Telecom Plate, Four (4) RJ45 Cat 6	\$ 528
	01-ABLBB	Telecom Plate, Two (2) RJ45 Cat 6, One (1) 15 Pin HD VGA w/72" Patch Cord	\$ 494
	01-ABLBBB	Telecom Plate, One (1) RJ45 Cat 6, One (1) Mini Stereo Inline, One (1) 15 Pin HD VGA w/72" Patch Cord	\$ 455
	01-ABLBBB	Telecom Plate, One (1) RJ45 Cat 6 Data Inline, One (1) RJ11 Cat 3 Phone Inline	\$ 219
	01-ABLBBB	Telecom Plate, One (1) HDMI w/36" Patch Cord	\$ 327
	01-ABLBBB	Telecom Plate, One (1) Mini Stereo Inline, One (1) HDMI w/36" Patch Cord, One (1) 15 Pin HD VGA w/72" Patch Cord	\$ 618
	01-ABLBBB	Telecom Plate, One (1) 15 Pin HD VGA & One (1) Mini Stereo Inline Jack	\$ 330
	01-ABLBBB	Telecom Plate, Three (3) Cord Bushings	\$ 106



Oasis Mini Power & Data
01-OASISMA, 01-OASISMB



Interact Power & Data
01-INTERACTG2A, 01-INTERACTG2B



Power Center
01-INTRFCIA, 01-INTRFCIB

[See Cameo Overview For Ordering Options](#)

Standard Cutout Types & General Location Information

- Grommets can be specified, at an upcharge, add \$11 for a field installed grommet cover or add \$50 for a factory installed grommet (unless otherwise noted).
- Power/Data Modules can be specified in standard locations at no additional charge.
- The selection of both the Power/Data Module and Base will determine cutout locations for each table size, as well as placement over or between bases.
- [See exact measurements of Module locations.](#)
- For specific locations available by table size see series pages, [see Cameo locations.](#)

Cutout Locations Available

OC = On Center
BB = Between Bases (*requires 2 modules*)
CL = Left of Center
CR = Right of Center
EL = End Left
ER = End Right
ML = Middle Left
MR = Middle Right

General Location of Cutouts

*For Tables with **Two (2) Bases** and **One (1) Location**:*

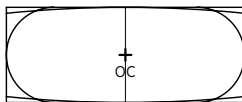

On Center
(OC)



One End
(EL)

*For Tables with **Two (2) Bases** and **Two (2) Locations**:*

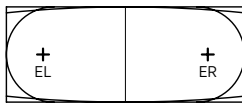

Both Ends
(EL + ER)

*For Tables with **Three (3) Bases** and **One (1) Location**:*

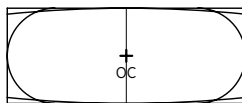

On Center
(OC)



One End
(EL)

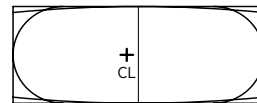

Off Center
(CL)

*For Tables with **Three (3) Bases** and **Two (2) Locations**:*

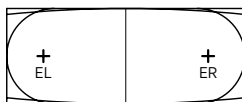

Both Ends
(EL + ER)

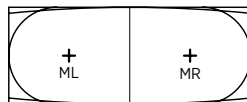

Middle of Each End
(ML + RL)

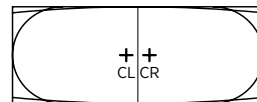

Off Center Left and Right
(CL + CR)

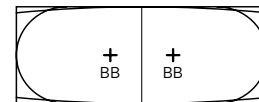

Between the Bases
(BB, Slightly Off Center Between Bases)

*For Tables with **Three (3) Bases** and **Three (3) Locations**:*

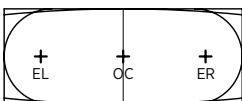

On Center and Both Ends
(OC + EL + ER)

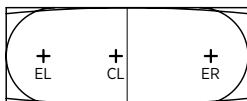

Left of Center and Both Ends
(CL + EL + ER)

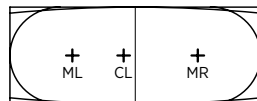

Off Center and Middle of Each End
(CL + ML + MR)

Continued on Next Page.

[See Cameo Overview For Ordering Options](#)

Standard Cutout Types & General Location Information (Continued)

- Grommets can be specified, at an upcharge, add \$11 for a field installed grommet cover or add \$50 for a factory installed grommet (unless otherwise noted).
- Power/Data Modules can be specified in standard locations at no additional charge.
- The selection of both the Power/Data Module and Base will determine cutout locations for each table size, as well as placement over or between bases.
- [See exact measurements of Module locations.](#)
- For specific locations available by table size see series pages, [see Cameo locations.](#)

Cutout Locations Available

OC = On Center
BB = Between Bases (*requires 2 modules*)
CL = Left of Center
CR = Right of Center
EL = End Left
ER = End Right
ML = Middle Left
MR = Middle Right

General Location of Cutouts

Continued from Previous Page

*For Tables with **Three (3) Bases** and **Four (4) Locations**:*

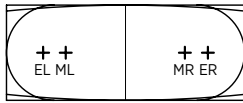

Middle of Each End and Both Ends
(ML + MR + EL + ER)

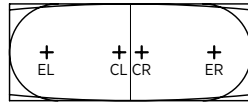

Off Center and Both Ends
(CL + CR + EL + ER)

*For Tables with **Five (5) Bases** and **One (1) Location**:*

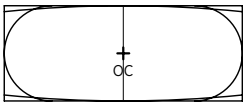

On Center
(OC)



One End
(EL)

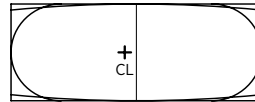

Off Center
(CL)

*For Tables with **Five (5) Bases** and **Two (2) Locations**:*

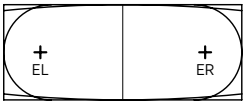

Both Ends
(EL + ER)

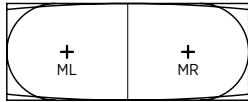

Middle of Each End
(ML + MR)

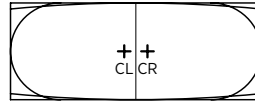

Off Center Left and Right
(CL + CR)

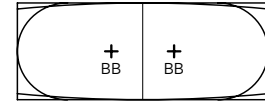

Between the Bases
(BB, Slightly Off Center Between Bases)

*For Tables with **Five (5) Bases** and **Three (3) Locations**:*

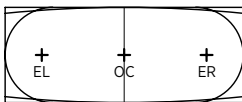

On Center and Both Ends
(OC + EL + ER)

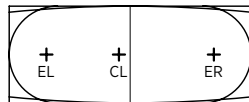

Left of Center and Both Ends
(CL + EL + ER)

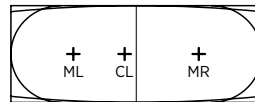

Off Center and Middle of Each End
(CL + ML + MR)

*For Tables with **Five (5) Bases** and **Four (4) Locations**:*



Middle of Each End and Both Ends
(ML + MR + EL + ER)

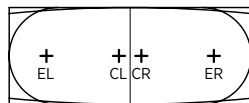







Off Center and Both Ends
(CL + CR + EL + ER)

[See Cameo Overview For Ordering Options](#)

Location Measurements By Module



	72" Tops	96" Tops	120", 144" & 168" Tops	192" Tops
	OC On Center BB Between Bases (requires 2 modules)		CL Left of Center CR Right of Center	EL End Left ER End Right ML Middle Left MR Middle Right
GROMMET 	OC Center of Table	OC Center of Table EL, EL + ER 24½" from end	CL, CL + CR 5½" from center EL, EL + ER 24½" from end CL + EL + ER, 5½" from center and CL + CR + EL + ER 24½" from end BB Slightly off centered between bases	CL, CL + CR 5½" from center EL, EL + ER 24½" from end CL + EL + ER, 5½" from center and CL + CR + EL + ER 24½" from end BB Slightly off centered between bases ML + MR 48" from end CL + ML + MR, 5½" from center and CL + CR + ML + MR 48" from end
POWER 440  INTERACT 	OC Center of Table	OC Center of Table EL, EL + ER 25" from end	OC Splits seam in center of bases EL, EL + ER 25" from end CL, CL + CR 5" from center CL + EL + ER, 5" from center and CL + CR + EL + ER 25" from end BB Slightly off centered between bases	OC Splits seam in center of bases EL, EL + ER 25" from end CL, CL + CR 5" from center CL + EL + ER, 5" from center and CL + CR + EL + ER 25" from end BB Slightly off centered between bases ML + MR 48" from end CL + ML + MR, 5" from center and CL + CR + ML + MR 48" from end
DPORT 4A  OASIS MINI,  INTRFC1  POWER & DATA VAULT 	OC Center of Table	OC Center of Table EL, EL + ER 29" from end	OC Splits seam in center of bases EL, EL + ER 29" from end CL + EL + ER, 9½" from center and CL + CR + EL + ER 29" from end CL, CL + CR 9½" from center BB Slightly off centered between bases	OC Splits seam in center of bases EL, EL + ER 29" from end CL + EL + ER, 9½" from center and CL + CR + EL + ER 29" from end CL, CL + CR 9½" from center BB Slightly off centered between bases ML + MR 48" from end OC+ EL + ER Splits center seam and 29" from end OC+ ML + MR Splits center seam and 48" from end CL + ML + MR, 9½" from center and CL + CR + ML + MR 48" from end

[See Cameo Overview For Ordering Options](#)



36"x72" & 42"x96" TOPS

For General Location Information, [See Cut Out Locations](#); For Exact Measurements of Locations, [See Details](#).

TOP LOCATIONS AVAILABLE BY BASE & MODULE COMBINATION

OC On Center

BB Between Bases (requires 2 modules)

CL Left of Center









CR Right of Center







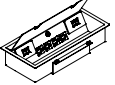



EL End Left

ER End Right

ML Middle Left

MR Middle Right

	36x72		
	RECTANGLE 	SQUARE 	QUEEN ANNE 
GROMMET 	OC	OC	OC
POWER & DATA VAULT 	OC		
OASIS MINI 	OC		
INTERACT 	OC		
INTRFC1 	OC		
POWER 440 	OC	OC	OC
DPORT4A 	OC	OC	OC

	42x96		
	RECTANGLE 	SQUARE 	QUEEN ANNE 
GROMMET 	OC EL EL + ER	OC EL EL + ER	OC
POWER & DATA VAULT 	OC EL EL + ER	OC EL EL + ER	OC
OASIS MINI 	OC EL EL + ER	OC EL EL + ER	OC
INTERACT 	OC EL EL + ER	OC EL EL + ER	OC
INTRFC1 	OC EL EL + ER	OC EL EL + ER	OC
POWER 440 	OC EL EL + ER	OC EL EL + ER	OC
DPORT4A 	OC EL EL + ER	OC EL EL + ER	OC

[See Cameo Overview For Ordering Options](#)















48"x120" & 48"x144" TOPS

For General Location Information, [See Cut Out Locations](#); For Exact Measurements of Locations, [See Details](#).

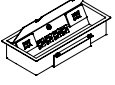
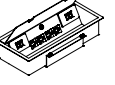
TOP LOCATIONS AVAILABLE BY BASE & MODULE COMBINATION

OC On Center **CL** Left of Center **EL** End Left **ML** Middle Left
BB Between Bases (requires 2 modules) **CR** Right of Center **ER** End Right **MR** Middle Right

48x120				48x144			
	RECTANGLE	SQUARE	QUEEN ANNE		RECTANGLE	SQUARE	QUEEN ANNE
GROMMET 	BB, CL or EL CL + CR EL + ER CL + EL + ER CL + CR + EL + ER	BB, CL or EL CL + CR EL + ER CL + EL + ER CL + CR + EL + ER	BB	GROMMET 	BB, CL or EL CL + CR EL + ER CL + EL + ER CL + CR + EL + ER	BB, CL or EL CL + CR EL + ER CL + EL + ER CL + CR + EL + ER	BB
POWER & DATA VAULT 	BB, CL or EL CL + CR EL + ER CL + EL + ER CL + CR + EL + ER	OC EL EL + ER OC + EL + ER		POWER & DATA VAULT 	BB, CL or EL CL + CR EL + ER CL + EL + ER CL + CR + EL + ER	OC BB EL EL + ER OC + EL + ER	BB
OASIS MINI 	BB, CL or EL CL + CR EL + ER CL + EL + ER CL + CR + EL + ER	OC EL EL + ER OC + EL + ER		OASIS MINI 	BB, CL or EL CL + CR EL + ER CL + EL + ER CL + CR + EL + ER	OC BB EL EL + ER OC + EL + ER	BB
INTERACT 	BB, CL or EL CL + CR EL + ER CL + EL + ER CL + CR + EL + ER	OC EL EL + ER OC + EL + ER	BB	INTERACT 	BB, CL or EL CL + CR EL + ER CL + EL + ER CL + CR + EL + ER	OC BB EL EL + ER OC + EL + ER	BB
INTRFC1 	BB, CL or EL CL + CR EL + ER CL + EL + ER CL + CR + EL + ER	OC EL EL + ER OC + EL + ER	BB	POWER CENTER 	BB, CL or EL CL + CR EL + ER CL + EL + ER CL + CR + EL + ER	OC BB EL EL + ER OC + EL + ER	BB
POWER 440 	BB, CL or EL CL + CR EL + ER CL + EL + ER CL + CR + EL + ER	BB, CL or EL CL + CR EL + ER CL + EL + ER CL + CR + EL + ER	BB	POWER 440 	BB, CL or EL CL + CR EL + ER CL + EL + ER CL + CR + EL + ER	BB, CL or EL CL + CR EL + ER CL + EL + ER CL + CR + EL + ER	BB
DPORT4A 	BB, CL or EL CL + CR EL + ER CL + EL + ER CL + CR + EL + ER	OC EL EL + ER OC + EL + ER	BB	DPORT4A 	BB, CL or EL CL + CR EL + ER CL + EL + ER CL + CR + EL + ER	OC BB EL EL + ER OC + EL + ER	BB

[See Cameo Overview For Ordering Options](#)



48"x168" & 48"x192" TOPS

For General Location Information, [See Cut Out Locations](#); For Exact Measurements of Locations, [See Details](#).

TOP LOCATIONS AVAILABLE BY BASE & MODULE COMBINATION

OC On Center

BB Between Bases (requires 2 modules)

CL Left of Center

CR Right of Center

EL End Left

ER End Right

ML Middle Left

MR Middle Right

48x168			
	RECTANGLE	SQUARE	QUEEN ANNE
	BB, CL or EL CL + CR EL + ER CL + EL + ER CL + CR + EL + ER	BB, CL or EL CL + CR EL + ER CL + EL + ER CL + CR + EL + ER	BB
	BB, CL or EL CL + CR EL + ER CL + EL + ER CL + CR + EL + ER	OC, BB or EL EL + ER OC + EL + ER	BB
	BB, CL or EL CL + CR EL + ER CL + EL + ER CL + CR + EL + ER	OC, BB or EL EL + ER OC + EL + ER	BB
	BB, CL or EL CL + CR EL + ER CL + EL + ER CL + CR + EL + ER	OC, BB or EL EL + ER OC + EL + ER	BB
	BB, CL or EL CL + CR EL + ER CL + EL + ER CL + CR + EL + ER	OC, BB or EL EL + ER OC + EL + ER	BB
	BB, CL or EL CL + CR EL + ER CL + EL + ER CL + CR + EL + ER	BB, CL or EL CL + CR EL + ER CL + EL + ER CL + CR + EL + ER	BB
	BB, CL or EL CL + CR EL + ER CL + EL + ER CL + CR + EL + ER	OC, BB or EL EL + ER OC + EL + ER	BB

48x192			
	RECTANGLE	SQUARE	QUEEN ANNE
	CL or EL CL + CR EL + ER ML + MR CL + EL + ER CL + ML + MR CL + CR + EL + ER CL + CR + ML + MR	BB, CL or EL CL + CR EL + ER ML + MR CL + EL + ER CL + ML + MR CL + CR + EL + ER CL + CR + ML + MR	BB ML + MR
	CL or EL CL + CR EL + ER ML + MR CL + EL + ER CL + ML + MR CL + CR + EL + ER CL + CR + ML + MR	OC, BB or EL EL + ER ML + MR OC + EL + ER OC + ML + MR	BB ML + MR
	CL or EL CL + CR EL + ER ML + MR CL + EL + ER CL + ML + MR CL + CR + EL + ER CL + CR + ML + MR	OC, BB or EL EL + ER ML + MR OC + EL + ER OC + ML + MR	BB ML + MR
	CL or EL CL + CR EL + ER ML + MR CL + EL + ER CL + ML + MR CL + CR + EL + ER CL + CR + ML + MR	OC, BB or EL EL + ER ML + MR OC + EL + ER OC + ML + MR	BB ML + MR
	CL or EL CL + CR EL + ER ML + MR CL + EL + ER CL + ML + MR CL + CR + EL + ER CL + CR + ML + MR	OC, BB or EL EL + ER ML + MR OC + EL + ER OC + ML + MR	BB ML + MR
	CL or EL CL + CR EL + ER ML + MR CL + EL + ER CL + ML + MR CL + CR + EL + ER CL + CR + ML + MR	BB, CL or EL CL + CR EL + ER ML + MR CL + EL + ER CL + ML + MR CL + CR + EL + ER CL + CR + ML + MR	BB ML + MR
	CL or EL CL + CR EL + ER ML + MR CL + EL + ER CL + ML + MR CL + CR + EL + ER CL + CR + ML + MR	OC, BB or EL EL + ER ML + MR OC + EL + ER OC + ML + MR	BB ML + MR

[See Cameo Overview For Ordering Options](#)

Catalyst Tables blend desired aesthetics, functionality, and technology to deliver a comprehensive solution for all types of meeting needs and spaces. The line boasts a broad selection of veneers, laminates, and glass with a variety of top shapes, and a vast range of sizes spanning from 36”D to 60”D and 36”W to 240”W, integrated power/data, and a variety of heights, including work, counter, and bar. Buffets, Credenzas, Waste Bins, and more will help to complete your space.

CONSTRUCTION

VENEER

- Exposed surfaces feature select grade plain-sliced hardwood veneers in Cherry, Maple, American Black Walnut, or composite veneers. Veneers are carefully selected and matched to assure proper balance and consistency
- Veneer features UVAdvantage, an ultra-violet finish, on all exposed surfaces by utilizing roll-coat UV technology

LAMINATE

- Thermally-Fused Laminate (TFL) and High-Pressure Laminate (HPL) are made of woodgrain and solid color laminates fused to particleboard core; each laminate offers lasting beauty, superior resistance to normal wear, and easy maintenance

TOPS

- Veneer (W) or HPL (P) Conference Tops available in five shapes: Rectangle, Boat, Modern Rectangle, Square and Round with woodgrain patterns following the depth (short) of Veneer (W) table tops while grain patterns follow the width (long) of HPL (P) table tops
- Tops are shaped on all four sides and are available in two thicknesses and five edge profiles
- Double Kerf (F), Duo (G) and Square (Y) available in Veneer (W) and HPL (P) tops with 3-ply balanced construction, 1 $\frac{1}{16}$ ” thick and matching 3mm wood or PVC edge bands on profiled edges; Designer White, Sugar Maple, and Williamsburg Cherry feature ABS edge bands
- Knife (K) edge profile tops are 1 $\frac{1}{16}$ ” thick with solid wood rims available on both Veneer (W) or HPL (P) tops
- Vertical Square (H) edge profile tops are 1 $\frac{1}{2}$ ” thick with 1.5mm wood edge band on Veneer (W) tops and 1mm PVC edge band on HPL (P) tops; Designer White, Sugar Maple, and Williamsburg Cherry feature ABS edge bands
- Huddle and Media tables are available in Square (Y), Double Kerf (F), Duo (G), and Knife (K) edge profiles and profiled on three sides with grain direction running the width of the table
- Credenzas, buffets, and other ancillary support models are available in Square (Y), Double Kerf (F), Duo (G), and Vertical Square (H) edge profiles and profiled on approach side only
- All Veneer tops, as well as Laminate tops up to 144” (12 feet), will have matching woodgrain. Laminate tops sized 156” (13 feet) and longer will have non-matching woodgrain
- All surfaces feature reverse slip matched pattern
- Back Painted, Tempered Glass Tops are $\frac{1}{4}$ ” thick and are attached to a substrate topped with black paper covering
- Tempered glass top has a $\frac{1}{16}$ ” overhang from the sub-top

LOCKING

- All box drawers feature locking
- Removable lock cylinders allow for units to be re-keyed at a later date, if required
- Units are shipped randomly keyed as standard
- Keyed alike units available upon request at no additional charge
- Lock core is predetermined by pull color. Black lock cores are used with black and gold pulls while silver lock cores are used with chrome and aluminum pulls
- Optional locking doors available on buffets and credenzas

BASES

- All rectangle bases are available in TFL (T) or Veneer (W), feature vertical grain direction and include L-bracket hardware for easy installation
- Rectangle box bases include removable access panel and wire management and support trough
- Huddle and Media table bases include removable access panel and wire management access
- $\frac{5}{16}$ ” metal accent available in four finishes—Aluminum, Black, Gold, and Platinum—enhances our rectangle accent bases and is now available on Huddle and Media tables
- All units ship with heavy-duty, adjustable leveling glides to ensure proper leveling and compensation for uneven floors

CHASSIS

- All credenzas are available in TFL (T) or Veneer (W) with vertical grain direction
- Chassis for storage units are securely fastened using high quality European fastening systems and heavy-duty 16-gauge joining brackets to assure maximum strength
- All units ship with heavy-duty, adjustable leveling glides to ensure proper leveling and compensation for uneven floors

DRAWERS

- Drawers feature 5-sided drawer construction allowing for easy removal of drawer fronts; All drawer fronts are standard with elegant vertically matched faces
- Drawer sides, back, and front are woodgrain vinyl-wrapped $\frac{1}{2}$ ” thick with $\frac{1}{8}$ ” thick hardboard bottoms
- Drawer interiors are dovetail construction with $\frac{7}{16}$ ” thick hardwood sides and backs, and $\frac{5}{32}$ ” thick hardboard bottoms
- All drawers feature full extension, progressive action slides with precision steel ball bearings
- Box drawers are tested for 100lb capacity
- All suspensions have a limited lifetime warranty

STORAGE

- All hinged doors are soft-close with one piece hinge and base plate combination
- Soft close hinges reduce stress placed on the cabinet when the door is closed and offers a quiet closure

HEIGHT ADJUSTABLE MECHANISMS

- Standard switch moves worksurface from desk to bar height; Optional advanced switch features Bluetooth capabilities to connect to smart device to set up various functions and enable automatic drive
- Built-in sensor provides anti-collision solution limits damage to a desk or an object if a collision occurs; sensor detects tilting as well as collision with both hard and soft obstacles
- Height adjustment range 30”H-45”H

INTEGRATED WIRE MANAGEMENT

- All Credenzas feature a 2”W wire management channel along back of the interior cabinet for easy accessibility to wall outlets
- Huddle and Media tables include integrated wire management with removable panel in chassis for convenient access to organize cables connected to TVs and power units.

INTERIOR DRAWER DIMENSIONS

Models

88-2496BF

	W	L	D
Box Drawers	15 $\frac{3}{4}$ "	16 $\frac{3}{8}$ "	3 $\frac{2}{32}$ "

Models

88-2484BF

	W	L	D
Box Drawers	30"	16 $\frac{3}{8}$ "	3 $\frac{2}{32}$ "
	13 $\frac{3}{8}$ "	16 $\frac{3}{8}$ "	3 $\frac{2}{32}$ "

Models

88-2472BF

88-2436BF

	W	L	D
Box Drawers	32 $\frac{5}{16}$ "	16 $\frac{3}{8}$ "	3 $\frac{2}{32}$ "

Models

88-2460BF

	W	L	D
Box Drawers	16 $\frac{1}{2}$ "	16 $\frac{3}{8}$ "	3 $\frac{2}{32}$ "

Models

88-2448BF

	W	L	D
Box Drawers	20 $\frac{15}{16}$ "	16 $\frac{3}{8}$ "	3 $\frac{2}{32}$ "

INTERIOR CABINET DIMENSIONS

Models

88-2496BF

	W	D	H
Double Door	36 $\frac{3}{4}$ "	22 $\frac{3}{8}$ "	23 $\frac{1}{2}$ "
Single Door with Waste Bin	18"	22 $\frac{3}{8}$ "	23 $\frac{1}{2}$ "

Models

88-2484BF

	W	D	H
Double Door	32"	22 $\frac{3}{8}$ "	23 $\frac{1}{2}$ "
Single Door with Waste Bin	15 $\frac{1}{2}$ "	22 $\frac{3}{8}$ "	23 $\frac{1}{2}$ "

Models

88-2472BF

88-2436BF

	W	D	H
Double Door	34 $\frac{3}{8}$ "	22 $\frac{3}{8}$ "	23 $\frac{1}{2}$ "
Single Door with Waste Bin	16 $\frac{3}{4}$ "	22 $\frac{3}{8}$ "	23 $\frac{1}{2}$ "

Models

88-2460BF

	W	D	H
Single Door	18 $\frac{3}{8}$ "	22 $\frac{3}{8}$ "	23 $\frac{1}{2}$ "

Models

88-2448BF

	W	D	H
Double Door	46 $\frac{3}{8}$ "	22 $\frac{3}{8}$ "	23 $\frac{1}{2}$ "
Single Door with Waste Bin	22 $\frac{3}{4}$ "	22 $\frac{3}{8}$ "	23 $\frac{1}{2}$ "

Models

88-2496CC

	W	D	H
Double Door	36 $\frac{3}{4}$ "	22 $\frac{3}{8}$ "	24 $\frac{3}{8}$ "
Single Door with Waste Bin	18"	22 $\frac{3}{8}$ "	24 $\frac{3}{8}$ "

Models

88-2484CC

	W	D	H
Double Door	32"	22 $\frac{3}{8}$ "	24 $\frac{3}{8}$ "
Single Door with Waste Bin	15 $\frac{1}{2}$ "	22 $\frac{3}{8}$ "	24 $\frac{3}{8}$ "

Models

88-2472CC

88-2436BF

	W	D	H
Double Door	34 $\frac{3}{8}$ "	22 $\frac{3}{8}$ "	24 $\frac{3}{8}$ "
Single Door with Waste Bin	16 $\frac{3}{4}$ "	22 $\frac{3}{8}$ "	24 $\frac{3}{8}$ "

Models

88-2460CC

	W	D	H
Single Door with Waste Bin	18 $\frac{3}{8}$ "	22 $\frac{3}{8}$ "	24 $\frac{3}{8}$ "

Models

88-2448CC

	W	D	H
Double Door	46 $\frac{3}{8}$ "	22 $\frac{3}{8}$ "	24 $\frac{3}{8}$ "
Single Door with Waste Bin	22 $\frac{3}{4}$ "	22 $\frac{3}{8}$ "	24 $\frac{3}{8}$ "

Models

88-2096CC

	W	D	H
Double Door	36 $\frac{3}{4}$ "	18 $\frac{3}{8}$ "	24 $\frac{3}{8}$ "
Single Door	17 $\frac{5}{8}$ "	18 $\frac{3}{8}$ "	24 $\frac{3}{8}$ "

Models

88-2084CC

	W	D	H
Double Door	32"	18 $\frac{3}{8}$ "	24 $\frac{3}{8}$ "
Single Door	15 $\frac{1}{2}$ "	18 $\frac{3}{8}$ "	24 $\frac{3}{8}$ "

INTERIOR CABINET DIMENSIONS CONTINUED

Models

88-2072CC	88-2036CC		
	W	D	H
Single Door	34 ³ / ₈ "	18 ³ / ₈ "	24 ³ / ₈ "

Models

88-2060CC			
	W	D	H
Single Door	18 ³ / ₈ "	18 ³ / ₈ "	24 ³ / ₈ "

Models

88-2048CC			
	W	D	H
Double Door	46 ³ / ₈ "	18 ³ / ₈ "	24 ³ / ₈ "

HOW TO ORDER EXAMPLES

SQUARE MEETING TABLE

	QTY	MODEL NO.	EXAMPLE
TOP	1	88-4848SQ	Top Material P Finish/Color FO Edge Profile 3MMW/F Glass Top Y Glass Color/Surface Finish GBLG Power/Data Location OC

BASE 1 08-2642LXBA

POWER 1 01-DUOBEZELS

MODERN RECTANGLE MEETING TABLES

	QTY	MODEL NO.	EXAMPLE
TOP	1	88-54192MR	Top Material W Finish/Color MAS Edge Profile 3MMW/F Glass Top Y Glass Color/Surface Finish GBLG Grommet/Power/Data DPORTA Grommet/Power/Data Location OC

BASES 1 88-2415406RAB Base Material W
 Base Finish/Color MAS
 Accent Finish/Color BL
 Metal Accent Color GLD

POWER 1 DPORTA

STORAGE & ACCESSORIES

Buffet Credenza			
QTY	MODEL NO.		EXAMPLE
1	88-2472BF	Top Material	W
		Top Finish/Color	MAS
		Edge Profile	3MMW/F
		Chassis Finish/Color	ORW
		Glass Top	Y
		Glass Color/Surface Finish	GBLG
		Studio Pull Color	GST
		Locking	LKT_BFD
		Drawer Construction	DOVE
		Drawer Track	SFTCL
		Vent	VENT
		Waste Bin	WBL

HUDDLE TABLE & ACCESSORIES

	QTY	MODEL NO.	EXAMPLE
	1	88-4860HT	Top Material W Top Finish/Color FO Edge Profile 3MMW/F Chassis Finish/Color PNW Metal Accent Option/Color GLD Accent Panel Finish/Color FO Glass Top Y Glass Color/Surface Finish GBLG TV/Monitor Stand MTSD Power/Data Location E5

POWER 1 01-DUOAIRB

TV/MONITOR STAND 1 01-TVMTG2

MEDIA TABLE & ACCESSORIES

	QTY	MODEL NO.	EXAMPLE
	1	88-4860MT	Top Material P Top Finish/Color PTK Edge Profile 3MMP/Y Chassis Finish/Color WNB Base Accent Panel Finish/Color PTK Media Back Panel TB Tackboard Fabric Stinson Spree Island Glass Top N Metal Accent Option/Color GLD TV/Monitor Stand LPTVMT Power/Data Location E10

POWER 1 01-DPORT4A

TV/MONITOR STAND 1 01-TVMTG2

VENEER (W) OPTIONS ON TOPS / EDGES, BASES, AND ACCENT PANELS

Veneer features UVAdvantage, an ultra-violet finish, on all exposed surfaces or our Catalyzed finish (where noted), which is a multi-step, finish process that provides years of lasting beauty.

AW	Artisan Walnut	MW	Mahogany Walnut
AS	Asian Night	MAS	Mesa Sunset*
CO	Columbian Walnut	MTS	Metropolis Sky
DC	Dark Cherry	ORW	Oak Riftwood*
DFW	Dark Forest Walnut	PNW	Pinnacle Walnut
EW	Espresso	SCH	Select Cherry
FO	Fawn Oak*	SKC	Shaker Cherry
GC	Golden Cherry	SM	Sugar Maple
HW	Harvest Walnut	WTA	Weathered Ash*
HNW	Henna Walnut	WC	Williamsburg Cherry
LW	Legacy Walnut		

* Low Sheen Finish

TFL (T) OPTIONS FOR BASES / ACCENT PANELS AND HPL (P) LAMINATE OPTIONS ON TOPS / EDGES

WOODGRAIN

AS	Asian Night	PNW	Pinnacle Walnut
BW	Beigewood	PTK	Portico Teak
CO	Columbian Walnut	RC	River Cherry
EF	Espresso	SPW	Sepia Walnut
FLW	Florence Walnut	SKC	Shaker Cherry
GC	Golden Cherry	SCH	Select Cherry
HVM	Harvest Maple	SBP	Smoky Brown Pear
KHE	Kirsche	TK	Studio Teak
MW	Mahogany Walnut	SM	Sugar Maple
MNR	Midnight Run	WTA	Weathered Ash
NTM	Natural Marrone	WNB	White Nebbia
ORW	Oak Riftwood	WC	Williamsburg Cherry

SOLID

BL	Black	FHG	Fashion Grey
WH	Designer White	SG	Slate Grey

EDGE PROFILES

Must specify edge profile selection. See individual product for availability.

Laminate (P) Top Edges

3MMP/F	Double Kerf	3MMP/Y	Square
3MMP/G	Duo	RIMP/K	Knife
3MMP/X	Fluted	HP	Vertical Square

Veneer (W) Top Edges

3MMW/F	Double Kerf	3MMW/Y	Square
3MMW/G	Duo	RIMW/K	Knife
3MMW/X	Fluted	HW	Vertical Square



Double Kerf (F) Duo (G) Fluted (X) Square (Y)



Knife (K) Vertical Square (H)

BASE METAL ACCENT COLOR OPTIONS

6" and 10" Rectangle Accent Bases feature 5/16" metal trim standard. Must specify color.

Huddle and Media Tables available with optional 5/16" metal trim. Must specify (NONE) for no metal accent or specify color and add upcharge.

METAL ACCENT \$ 194

ALUM	Aluminum	PLAT	Platinum
BLK	Black	GLD	Gold

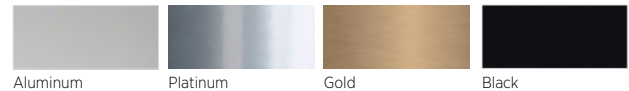

PULL OPTIONS

Buffets and Credenzas available with 13" Studio pulls on doors. Must specify and select color.

Lock core color is predetermined by pull color.

AST	Studio, Aluminum	CST	Studio, Chrome
BST	Studio, Black	GST	Studio, Gold



GLASS OPTIONS ON TOPS

Back painted tempered glass tops are 1/4" thick and available in Black or White with Gloss or Acid Etched finish. Glass top sits 1/16" on top of substrate top. Must specify color and finish.

GWHG	White Gloss	GBLG	Black Gloss
GWHA	White Acid Etched	GBLA	Black Acid Etched

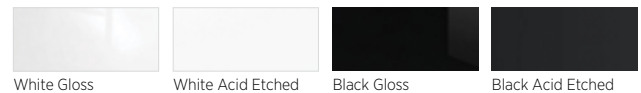

LOCK CORE COLOR OPTIONS











BLK	Black (Used with Black and Gold Pulls)
SLV	Silver (Used with Aluminum and Chrome Pulls)



GROMMET & POWER UNIT OPTIONS

Power units and grommets are available on Rectangle, Modern Rectangle, and Boat shaped tops. Each unit is sold separately and must be specified separately with surface mount location. Multiple locations may be selected. Only one unit per location.

Power units and Grommets Available in Rectangle, Modern Rectangle, and Boat Table Surfaces (See Units)

Description	Specify		
GROMMET			
	Black GBR60	\$	58
	Silver GSR60		
DUO BEZEL			
	Black 01-DUOBEZELB	\$	748
	Silver 01-DUOBEZELS		
	White 01-DUOBEZELW		
TRIO BEZEL			
	Black 01-TRIOBEZELB	\$	803
	Silver 01-TRIOBEZELS		
	White 01-TRIOBEZELW		
DOCK 150			
	Black 01-DOCK150B	\$	448
	White 01-DOCK150W		
DOCK 800			
	Black 01-DOCK800B	\$	2268
	White 01-DOCK800W		
DOCK 950			
	Black 01-DOCK950B	\$	294
	White 01-DOCK950W		
DPORT4			
	Aluminum 01-DPORT4A	\$	1211
	Black 01-DPORT4B		
ELLORA			
	Aluminum 01-ELLORA4A	\$	877
	Black 01-ELLORA4B		
	Aluminum 01-ELLORA6A	\$	944
	Black 01-ELLORA6B		
E2X			
	Aluminum 01-E2X4A	\$	1655
	Black 01-E2X4B		
	Aluminum 01-E2X6A	\$	1801
	Black 01-E2X6B		
INTERACTG2			
	Aluminum 01-INTERACTG2A	\$	987
	Black 01-INTERACTG2B		
OASIS			
	Aluminum 01-OASISMA	\$	3535
	Black 01-OASISMB		

Power and Data Location Information:

- Designate unit and location when specifying the top model. Power and Data Module needs to be ordered separately.
- Power and Data Modules specified at the time of order will be routed for field installation.
 - E1 Unit on One End
 - E2 Unit on Each End
 - OC Unit on Center
- All power units available **On Center (OC) only** when paired with two (2) or more of the following bases:
 - Cylinder Base
 - X-Base
 - Tubular X-Base
 - Square Base
 - Disc

Grommets and Power Units may be ordered in non-standard locations. Call Customer Service to assist with specification and/or please attach a drawing to the PO showing the location of the grommet. Note additional charges and lead times may apply.

Rectangle, Modern Rectangle, and Boat Top Locations

Power units available on Each End (E1 and E2) and On Center (OC) unless otherwise noted, when paired with any Rectangle Panel Base, Rectangle Box Base or Rectangle Accent Box Base.

Power units centered at locations below:

36" Tops	Centered 18"D	54" Tops	Centered 27"D
42" Tops	Centered 21"D	60" Tops	Centered 30"D
48" Tops	Centered 24"D		

72: OC 36" from end (available with OC Only)

84: OC 42" from end (available with OC Only)

96: OC 48" from end; E1/E2 29" from end

108 OC 54" from end; E1/E2 29" from end

120: OC 60" from end; E1/E2 29" from end

132: OC 66" from end; E1/E2 29" from end

144: OC 72" from end; E1/E2 29" from end

156: OC 78" from end; E1/E2 29" from end

168: OC 84" from end; E1/E2 29" from end

180: OC 90" from end; E1/E2 36" from end

192: OC 96" from end; E1/E2 36" from end

204: OC 102" from end; E1/E2 36" from end

216: OC 108" from end; E1/E2 36" from end

228: OC 114" from end; E1/E2 36" from end

240: OC 120" from end; E1/E2 36" from end

Example: 60x204 Modern Rectangle

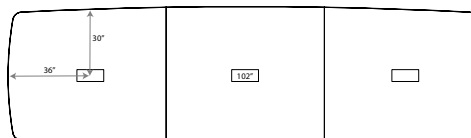

GROMMET OPTIONS & POWER UNIT OPTIONS CONTINUED

Huddle and Media Table Top Locations

- Designate unit and location when specifying your selection. Power and Data Module needs to be ordered separately.
- Power and Data Modules specified at the time of order will be routed for field installation.



Specify Option and Location:

NONE	No PDC
E5	5½" PDC End Location
E10	10" PDC End Location



Each unit is sold separately and must be specified with surface mount location. Multiple locations may be selected. Only one unit per location.

Power units and Grommets Available in Huddle and Media Table Surfaces (See Units)

Description	Specify		
GROMMET			
	Black GBR60	\$	58
	Silver GSR60		
DUO BEZEL			
	Black 01-DUOBEZELB	\$	748
	Silver 01-DUOBEZELS		
	White 01-DUOBEZELW		
DUO AIR			
	Black 01-DUOAIRB	\$	743
	Silver 01-DUOAIRS		
	White 01-DUOAIRW		
TRIO BEZEL			
	Black 01-TRIOBEZELB	\$	803
	Silver 01-TRIOBEZELS		
	White 01-TRIOBEZELW		
DPORT4			
	Aluminum 01-DPORT4A	\$	1211
	Black 01-DPORT4B		
ELLORA			
	Aluminum 01-ELLORA4A	\$	877
	Black 01-ELLORA4B		
	Aluminum 01-ELLORA6A	\$	944
	Black 01-ELLORA6B		

DRAWER TRACK OPTIONS

Soft close tracks are available on box drawers. Soft close drawer tracks have many benefits including reduced stress on the unit, extends the life of the drawer, and ensures a gentle close so fingers don't accidentally get pinched. Must specify when ordering.

Pricing is per Drawer, not per Model/Unit

SFTCL	Soft Close Drawer Track	\$	38
-------	-------------------------	----	----

VENT OPTION FOR CREDENZAS

Buffets and Credenzas feature optional ventilation grommets. Includes one vent per compartment.

Vents are 10" Down from top surface on Buffet Credenzas and 2⅞" on Credenzas.

NONE	No Vent Grommet		
VENT	Vented back panel	\$	76

Number of vents per unit:	
36"	1 vent
72" / 48"	2 vents
96" / 84" / 60"	3 vents

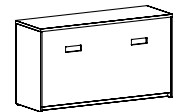

WASTE BIN OPTIONS

Buffet and 24" Credenzas are available with two (2) 41-quart beige waste bins in a pull out cabinet with silver hardware and divider panel. Adjacent cabinet features one (1) adjustable shelf. Studio pulls applied centered on doors when waste bin is selected. Locking not available.

WBL	Waste Bin on Left	\$	572
WBR	Waste Bin on Right	\$	572

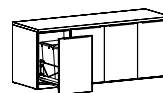

Shown as Left

LOCKING DOORS

Locking doors are available on Buffets and Credenzas. You must specify WITH LOCKING when ordering and add upcharge.

Note: When locking is selected with optional waste bin, locking will not apply to waste bin door.

LKT	96"W to 84"W Units	\$	149
LKT	72"W to 48"W Units	\$	128
LKT	36"W Units	\$	101

HEIGHT ADJUST SWITCH CONTROL OPTIONS

The Height adjustable Huddle Table available with two switch options. The standard switch is a simple up and down switch. The advanced switch features bluetooth connection to smart devices with the free Desk Connect™ app and built-in sensor-based anti-collision minimizing the risk of damage. Users can easily set up various functions, like favorite positions, reminders to stand, and enable automatic drive.

	DPISWCH Standard Up/Down Switch	STD
	DPIMSWCH Advanced Up/Down with Memory	\$ 149

CERTIFICATIONS & COMPLIANCE

- Intertek Sustainability Certified
- BIFMA level® Certified
- BIFMA Compliant® Certified
- TSCA Title VI (Formerly CARB) Compliance
- Contributes to LEED®, Green Globes®, and WELL® Sustainable Programs



Shown with Clutch Seating



Shown with Trift Seating



Shown with Spirit Seating



Shown with Rockstar Seating

Tops/Shapes

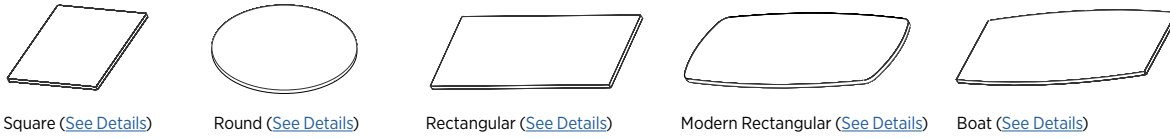

Square ([See Details](#)) Round ([See Details](#)) Rectangular ([See Details](#)) Modern Rectangular ([See Details](#)) Boat ([See Details](#))

Bases

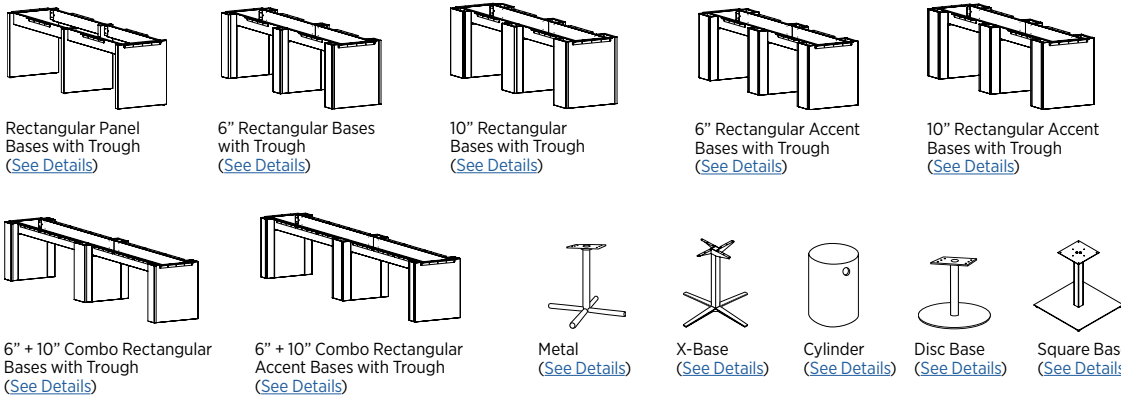

Rectangular Panel Bases with Trough ([See Details](#)) 6" Rectangular Bases with Trough ([See Details](#)) 10" Rectangular Bases with Trough ([See Details](#)) 6" Rectangular Accent Bases with Trough ([See Details](#)) 10" Rectangular Accent Bases with Trough ([See Details](#))

6" + 10" Combo Rectangular Bases with Trough ([See Details](#)) 6" + 10" Combo Rectangular Accent Bases with Trough ([See Details](#)) Metal ([See Details](#)) X-Base ([See Details](#)) Cylinder ([See Details](#)) Disc Base ([See Details](#)) Square Base ([See Details](#))

Huddle + Media Tables

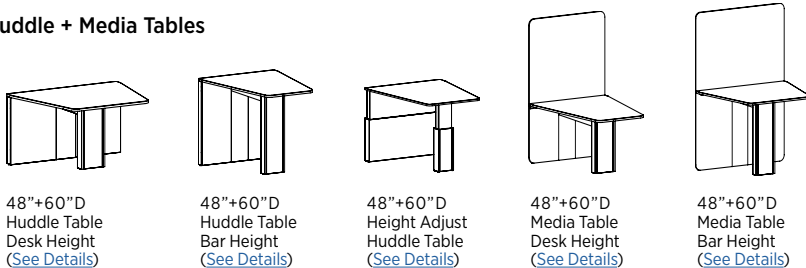

48"+60"D Huddle Table Desk Height ([See Details](#)) 48"+60"D Huddle Table Bar Height ([See Details](#)) 48"+60"D Height Adjust Huddle Table ([See Details](#)) 48"+60"D Media Table Desk Height ([See Details](#)) 48"+60"D Media Table Bar Height ([See Details](#))

Storage Components + Accessories

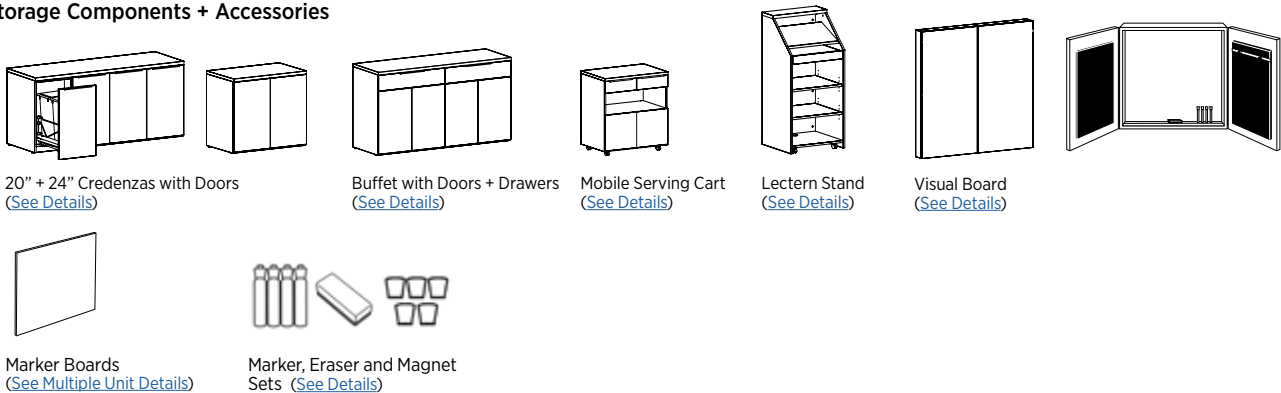

20" + 24" Credenzas with Doors ([See Details](#)) Buffet with Doors + Drawers ([See Details](#)) Mobile Serving Cart ([See Details](#)) Lectern Stand ([See Details](#)) Visual Board ([See Details](#))

Marker Boards ([See Multiple Unit Details](#)) Marker, Eraser and Magnet Sets ([See Details](#))

Wire Management & Power/Data Accessories ([See Details](#))

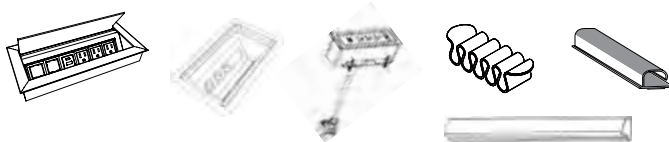

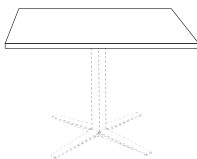
Item	Model No.	Material	W	D	H	Ship Wt	Cubic Ft	Edge Profile + Material	List Price
 <p>88-3636SQ Shown with 08-2036SXB (Metal X-Base) BASES SOLD SEPARATELY</p> <p><u>Must Specify (in this order):</u> Model # Top Material Top Finish/Color Edge Profile Glass (Y/N) Glass Color/Surface Finish</p>	88-3030SQ	Laminate	30	30	1 ³ / ₁₆	30	2.3	F, G, X, Y / P\$	617
					1 ³ / ₁₆			K / P\$	923
					1 ¹ / ₂			H / P\$	695
		Veneer	1 ³ / ₁₆	F, G, X, Y / W\$	709				
			1 ³ / ₁₆	K / W\$	1094				
			1 ¹ / ₂	H / W\$	758				
	Glass	1 ¹ / ₄	Acid Etched Glass Top \$	2912					
		1 ¹ / ₄	Gloss Glass Top \$	2510					
	88-3636SQ	Laminate	36	36	1 ³ / ₁₆	37	2.5	F, G, X, Y / P\$	726
					1 ³ / ₁₆			K / P\$	1085
					1 ¹ / ₂			H / P\$	839
			Veneer	1 ³ / ₁₆	F, G, X, Y / W\$	928			
1 ³ / ₁₆				K / W\$	1407				
1 ¹ / ₂				H / W\$	992				
Glass		1 ¹ / ₄	Acid Etched Glass Top \$	3805					
		1 ¹ / ₄	Gloss Glass Top \$	3228					
88-4242SQ		Laminate	42	42	1 ³ / ₁₆	70	3.4	F, G, X, Y / P\$	848
					1 ³ / ₁₆			K / P\$	1362
					1 ¹ / ₂			H / P\$	981
			Veneer	1 ³ / ₁₆	F, G, X, Y / W\$	971			
	1 ³ / ₁₆			K / W\$	1646				
	1 ¹ / ₂			H / W\$	1079				
	Glass	1 ¹ / ₄	Acid Etched Glass Top \$	4929					
		1 ¹ / ₄	Gloss Glass Top \$	4143					
	88-4848SQ	Laminate	48	48	1 ³ / ₁₆	82	7.2	F, G, X, Y / P\$	953
					1 ³ / ₁₆			K / P\$	1568
					1 ¹ / ₂			H / P\$	1063
			Veneer	1 ³ / ₁₆	F, G, X, Y / W\$	1084			
1 ³ / ₁₆				K / W\$	1817				
1 ¹ / ₂				H / W\$	1285				
Glass		1 ¹ / ₄	Acid Etched Glass Top \$	6116					
		1 ¹ / ₄	Gloss Glass Top \$	5092					

Description

- Tops Feature a 1-piece, 1³/₁₆" or 1¹/₂" Thick Top in Veneer (W) or HPL (P)
- Must Specify Edge Profile: 1³/₁₆" Thick/Double Kerf (F), Duo (G), Fluted (X), Square (Y), and Knife (K) Edge Profiles or 1¹/₂" Thick/Vertical Square (H)
- Due to Top Sizes and Base Placement, Power is Not Available on Square Tops
- Available with Back Painted Tempered Glass Top; Must Specify Color and Finish ([See Options](#))
- Bases Sold Separately ([See Multiple Base Options](#))



Double Kerf (F)
1³/₁₆"



Duo (G)
1³/₁₆"



Fluted (X)
1³/₁₆"



Square (Y)
1³/₁₆"



Knife (K)
1³/₁₆"



Vertical Square (H)
1¹/₂"

Pricing Codes:

P= HPL W= Wood Top

[See Catalyst Overview For Ordering Options](#)

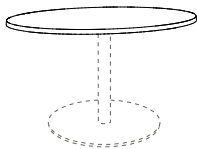
Item	Model No.	Material	W	D	H	Ship Wt	Cubic Ft	Edge Profile + Material	List Price			
ROUND - 1 PIECE TOP  88-4848CT Shown with 01-3230DBB (Disc Base) BASES SOLD SEPARATELY Must Specify (in this order): Model # Top Material Top Finish/Color Edge Profile Glass (Y/N) Glass Color/Surface Finish	88-3030CT	Laminate	30	30	1 ³ / ₁₆	30	2.3	F, G, X, Y / P\$	684			
					1 ³ / ₁₆			K / P\$	1341			
					1 ¹ / ₂			H / P\$	715			
		Veneer			1 ³ / ₁₆	37	2.5	F, G, X, Y / W\$	767			
					1 ³ / ₁₆			K / W\$	1494			
					1 ¹ / ₂			H / W\$	825			
		Glass			1 ³ / ₁₆	37	2.5	Acid Etched Glass Top \$	3884			
					1 ¹ / ₂			Gloss Glass Top \$	3470			
		88-3636CT			Laminate	36	36	1 ³ / ₁₆	37	2.5	F, G, X, Y / P\$	785
								1 ³ / ₁₆			K / P\$	1613
1 ¹ / ₂	H / P\$		890									
Veneer	1 ³ / ₁₆		37	2.5				F, G, X, Y / W\$	988			
	1 ³ / ₁₆							K / W\$	1928			
	1 ¹ / ₂							H / W\$	1002			
Glass	1 ³ / ₁₆		37	2.5				Acid Etched Glass Top \$	4377			
	1 ¹ / ₂							Gloss Glass Top \$	3782			
88-4242CT	Laminate		42	42				1 ³ / ₁₆	70	3.4	F, G, X, Y / P\$	904
								1 ³ / ₁₆			K / P\$	1830
		1 ¹ / ₂			H / P\$	976						
		Veneer			1 ³ / ₁₆	70	3.4	F, G, X, Y / W\$	1035			
					1 ³ / ₁₆			K / W\$	2125			
					1 ¹ / ₂			H / W\$	1130			
		Glass			1 ³ / ₁₆	70	3.4	Acid Etched Glass Top \$	5483			
					1 ¹ / ₂			Gloss Glass Top \$	4680			
		88-4848CT			Laminate	48	48	1 ³ / ₁₆	90	5.5	F, G, X, Y / P\$	1014
								1 ³ / ₁₆			K / P\$	2124
1 ¹ / ₂	H / P\$		1042									
Veneer	1 ³ / ₁₆		90	5.5				F, G, X, Y / W\$	1149			
	1 ³ / ₁₆							K / W\$	2388			
	1 ¹ / ₂							H / W\$	1340			
Glass	1 ³ / ₁₆		90	5.5				Acid Etched Glass Top \$	6800			
	1 ¹ / ₂							Gloss Glass Top \$	5743			

Additional Round Tops on Next Page.



Pricing Codes:
 P= HPL W= Wood Top

[See Catalyst Overview For Ordering Options](#)

Item	Model No.	Material	W	D	H	Ship Wt	Cubic Ft	Edge Profile + Material	List Price	
<i>CONTINUED FROM PREVIOUS PAGE</i>	88-5454CT	Laminate	54	54	1 ³ / ₁₆	114	6.8	F, G, X, Y / P\$	1118	
					1 ³ / ₁₆			K / P\$	2246	
					1 ¹ / ₂			H / P\$	1158	
					Veneer			1 ³ / ₁₆	F, G, X, Y / W\$	1400
					Veneer			1 ³ / ₁₆	K / W\$	2456
					Veneer			1 ¹ / ₂	H / W\$	1637
	88-6060CT	Laminate	60	60	1 ³ / ₁₆	143	8.4	F, G, X, Y / P\$	1163	
					1 ³ / ₁₆			K / P\$	2461	
					1 ¹ / ₂			H / P\$	1216	
					Veneer			1 ³ / ₁₆	F, G, X, Y / W\$	1577
					Veneer			1 ³ / ₁₆	K / W\$	2760
					Veneer			1 ¹ / ₂	H / W\$	1864
		Glass					Acid Etched Glass Top \$	8149		
							Gloss Glass Top \$	6809		

Must Specify (in this order):

- Model #
- Top Material
- Top Finish/Color
- Edge Profile
- Glass (Y/N)
- Glass Color/Surface Finish

Description

- Tops Feature a 1-piece, 1³/₁₆" or 1¹/₂" Thick Top in Veneer (W) or HPL (P)
- Must Specify Edge Profile: 1³/₁₆" Thick/Double Kerf (F), Duo (G), Fluted (X), Square (Y), and Knife (K) Edge Profiles or 1¹/₂" Thick/Vertical Square (H)
- 60" and 54" Tops Feature Catalyzed Finish
- Due to Top Sizes and Base Placement, Power is Not Available on Round Tops
- Available with Back Painted Tempered Glass Top; Must Specify Color and Finish [\(See Options\)](#)
- Bases Sold Separately [\(See Multiple Base Options\)](#)



Double Kerf (F)
1³/₁₆"



Duo (G)
1³/₁₆"



Fluted (X)
1³/₁₆"



Square (Y)
1³/₁₆"



Knife (K)
1³/₁₆"



Vertical Square (H)
1¹/₂"

Pricing Codes:

P= HPL W= Wood Top

[See Catalyst Overview For Ordering Options](#)

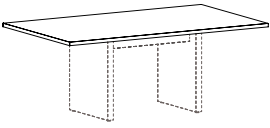
Item	Model No.	Material	W	D	H	Ship Wt	Cubic Ft	Edge Profile + Material	List Price	
RECTANGLE SHAPE MEETING TOP 36"D  88-3672RT Shown with 88-2034RPB (Rectangle Panel Base) BASES SOLD SEPARATELY	72"W x 36"D or 6' - 1 Piece Rectangle Top									
	88-3672RT	Laminate	72	36	1 ³ / ₁₆	109	10.3	F, G, X, Y / P\$	1180	
					1 ³ / ₁₆			K / P\$	1900	
					1 ¹ / ₂			H / P\$	1332	
		Veneer			1 ³ / ₁₆			F, G, X, Y / W\$	1388	
					1 ³ / ₁₆			K / W\$	2194	
					1 ¹ / ₂			H / W\$	1657	
		Glass			1/4			Acid Etched Glass Top \$	7088	
					1/4			Gloss Glass Top \$	5970	
	84"W x 36"D or 7' - 1 Piece Rectangle Top									
	88-3684RT	Laminate	84	36	1 ³ / ₁₆	126	11.3	F, G, X, Y / P\$	1456	
					1 ³ / ₁₆			K / P\$	2249	
				1 ¹ / ₂			H / P\$	1670		
	Veneer			1 ³ / ₁₆			F, G, X, Y / W\$	1640		
				1 ³ / ₁₆			K / W\$	2733		
				1 ¹ / ₂			H / W\$	1914		
	Glass			1/4			Acid Etched Glass Top \$	8200		
				1/4			Gloss Glass Top \$	6897		
96"W x 36"D or 8' - 1 Piece Rectangle Top										
88-3696RT	Laminate	96	36	1 ³ / ₁₆	142	12.9	F, G, X, Y / P\$	1529		
				1 ³ / ₁₆			K / P\$	2411		
				1 ¹ / ₂			H / P\$	1734		
	Veneer			1 ³ / ₁₆			F, G, X, Y / W\$	1731		
				1 ³ / ₁₆			K / W\$	2866		
				1 ¹ / ₂			H / W\$	2084		
	Glass			1/4			Acid Etched Glass Top \$	9121		
				1/4			Gloss Glass Top \$	7632		

Must Specify (in this order):

- Model #
- Top Material
- Top Finish/Color
- Edge Profile
- Glass (Y/N)
- Glass Color/Surface Finish
- Power/Data
- Power/Data Location

Description

- Tops Available with Veneer (W) or HPL (P) Top in 1³/₁₆" and 1¹/₂" Thicknesses
- Must Specify Edge Profile: 1³/₁₆" Thick/Double Kerf (F), Duo (G), Fluted (X), Square (Y), and Knife (K) Edge Profiles or 1¹/₂" Thick/Vertical Square (H)
- Veneer (W) Top Grain Runs Depth of Top and HPL (P) Top Grain Runs Width of Top
- Available with Back Painted Tempered Glass Top; Must Specify Color and Finish ([See Options](#))
- Power and Data Options Available; Sold Separately ([See Multiple Power Unit Details](#))
- Bases Sold Separately ([See Multiple Base Options](#))



Double Kerf (F)
1³/₁₆"



Duo (G)
1³/₁₆"



Fluted (X)
1³/₁₆"



Square (Y)
1³/₁₆"



Knife (K)
1³/₁₆"



Vertical Square (H)
1¹/₂"

Pricing Codes:

P= HPL W= Wood Top

[See Catalyst Overview For Ordering Options](#)

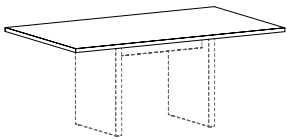
Item	Model No.	Material	W	D	H	Ship Wt	Cubic Ft	Edge Profile + Material	List Price	
RECTANGLE SHAPE MEETING TOP 42"D  88-4272RT Shown with 88-2034RPB (Rectangle Panel Base) BASES SOLD SEPARATELY	72"W x 42"D or 6' - 1 Piece Rectangle Top									
	88-4272RT	Laminate	72	42	1 3/16	126	11.3	F, G, X, Y / P\$	1261	
					1 3/16			K / P\$	2137	
					1 1/2			H / P\$	1440	
		Veneer			1 3/16			F, G, X, Y / W\$	1579	
					1 3/16			K / W\$	2393	
					1 1/2			H / W\$	1884	
		Glass			1/4			Acid Etched Glass Top \$	7866	
					1/4			Gloss Glass Top \$	6563	
	84"W x 42"D or 7' - 1 Piece Rectangle Top									
	88-4284RT	Laminate	84	42	1 3/16	145	13.1	F, G, X, Y / P\$	1520	
					1 3/16			K / P\$	2438	
				1 1/2			H / P\$	1729		
	Veneer			1 3/16			F, G, X, Y / W\$	1740		
				1 3/16			K / W\$	2879		
				1 1/2			H / W\$	2094		
	Glass			1/4			Acid Etched Glass Top \$	8973		
				1/4			Gloss Glass Top \$	7453		
96"W x 42"D or 8' - 1 Piece Rectangle Top										
88-4296RT	Laminate	96	42	1 3/16	164	15.0	F, G, X, Y / P\$	1562		
				1 3/16			K / P\$	2620		
				1 1/2			H / P\$	1803		
	Veneer			1 3/16			F, G, X, Y / W\$	1890		
				1 3/16			K / W\$	3024		
				1 1/2			H / W\$	2290		
	Glass			1/4			Acid Etched Glass Top \$	10041		
				1/4			Gloss Glass Top \$	8303		
108"W x 42"D or 9' - 2 Piece Rectangle Top										
88-42108RT	Laminate	108	42	1 3/16	260	27.0	F, G, X, Y / P\$	2077		
				1 3/16			K / P\$	3251		
				1 1/2			H / P\$	2351		
	Veneer			1 3/16			F, G, X, Y / W\$	2312		
				1 3/16			K / W\$	3767		
				1 1/2			H / W\$	2764		
	Glass			1/4			Acid Etched Glass Top \$	11515		
				1/4			Gloss Glass Top \$	9561		

Additional 42" Rectangle Shaped Tops on Next Page



Double Kerf (F)
1 3/16"



Duo (G)
1 3/16"



Fluted (X)
1 3/16"



Square (Y)
1 3/16"



Knife (K)
1 3/16"



Vertical Square (H)
1 1/2"

Pricing Codes:
P= HPL W= Wood Top

[See Catalyst Overview For Ordering Options](#)

Item	Model No.	Material	W	D	H	Ship Wt	Cubic Ft	Edge Profile + Material	List Price
<i>42"D CONTINUED FROM PREVIOUS PAGE</i>	120"W x 42"D or 10' - 2 Piece Rectangle Top								
	88-42120RT	Laminate	120	42	1 $\frac{3}{16}$	268	27.0	F, G, X, Y / P\$	2121
					1 $\frac{3}{16}$			K / P\$	3450
					1 $\frac{1}{2}$			H / P\$	2424
Must Specify (in this order): Model # Top Material Top Finish/Color Edge Profile Glass (Y/N) Glass Color/Surface Finish Power/Data Power/Data Location	Veneer				1 $\frac{3}{16}$			F, G, X, Y / W\$	2467
					1 $\frac{3}{16}$			K / W\$	3916
					1 $\frac{1}{2}$			H / W\$	2965
	Glass					$\frac{1}{4}$		Acid Etched Glass Top \$	12587
						$\frac{1}{4}$		Gloss Glass Top \$	10415

Description

- Tops Available with Veneer (W) or HPL (P) Top in 1 $\frac{3}{16}$ " and 1 $\frac{1}{2}$ " Thicknesses
- Must Specify Edge Profile: 1 $\frac{3}{16}$ " Thick/Double Kerf (F), Duo (G), Fluted (X), Square (Y), and Knife (K) Edge Profiles or 1 $\frac{1}{2}$ " Thick/Vertical Square (H)
- Veneer (W) Top Grain Runs Depth of Top and HPL (P) Top Grain Runs Width of Top
- Available with Back Painted Tempered Glass Top; Must Specify Color and Finish ([See Options](#))
- Power and Data Options Available; Sold Separately ([See Multiple Power Unit Details](#))
- Bases Sold Separately ([See Multiple Base Options](#))



Double Kerf (F)
1 $\frac{3}{16}$ "



Duo (G)
1 $\frac{3}{16}$ "



Fluted (X)
1 $\frac{3}{16}$ "



Square (Y)
1 $\frac{3}{16}$ "



Knife (K)
1 $\frac{3}{16}$ "



Vertical Square (H)
1 $\frac{1}{2}$ "

Pricing Codes:

P= HPL W= Wood Top

[See Catalyst Overview For Ordering Options](#)

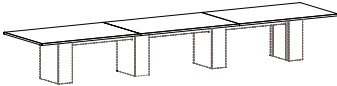
Item	Model No.	Material	W	D	H	Ship Wt	Cubic Ft	Edge Profile + Material	List Price	
RECTANGLE SHAPE MEETING TOP 48" D  88-48216RT Shown with 88-2417810RB (10" Rectangle Base) BASES SOLD SEPARATELY	72"W x 48"D or 6' - 1 Piece Rectangle Top									
	88-4872RT	Laminate	72	48	1 ³ / ₁₆	152	8.6	F, G, X, Y / P\$	1336	
					1 ³ / ₁₆			K / P\$	2296	
					1 ¹ / ₂			H / P\$	1543	
		Veneer			1 ³ / ₁₆			F, G, X, Y / W\$	1759	
					1 ³ / ₁₆			K / W\$	2587	
					1 ¹ / ₂			H / W\$	2103	
		Glass			1/4			Acid Etched Glass Top \$	8813	
					1/4			Gloss Glass Top \$	7323	
	84"W x 48"D or 7' - 1 Piece Rectangle Top									
	88-4884RT	Laminate	84	48	1 ³ / ₁₆	174	10.0	F, G, X, Y / P\$	1599	
					1 ³ / ₁₆			K / P\$	2578	
				1 ¹ / ₂			H / P\$	1839		
	Veneer			1 ³ / ₁₆			F, G, X, Y / W\$	1859		
				1 ³ / ₁₆			K / W\$	2972		
				1 ¹ / ₂			H / W\$	2258		
	Glass			1/4			Acid Etched Glass Top \$	9990		
				1/4			Gloss Glass Top \$	8254		
96"W x 48"D or 8' - 1 Piece Rectangle Top										
88-4896RT	Laminate	96	48	1 ³ / ₁₆	196	11.3	F, G, X, Y / P\$	1647		
				1 ³ / ₁₆			K / P\$	2858		
				1 ¹ / ₂			H / P\$	1923		
	Veneer			1 ³ / ₁₆			F, G, X, Y / W\$	2112		
				1 ³ / ₁₆			K / W\$	3214		
				1 ¹ / ₂			H / W\$	2561		
	Glass			1/4			Acid Etched Glass Top \$	11283		
				1/4			Gloss Glass Top \$	9296		
108"W x 48"D or 9' - 2 Piece Rectangle Top										
88-48108RT	Laminate	108	48	1 ³ / ₁₆	218	23.5	F, G, X, Y / P\$	2384		
				1 ³ / ₁₆			K / P\$	3769		
				1 ¹ / ₂			H / P\$	2697		
	Veneer			1 ³ / ₁₆			F, G, X, Y / W\$	2824		
				1 ³ / ₁₆			K / W\$	4212		
				1 ¹ / ₂			H / W\$	3330		
	Glass			1/4			Acid Etched Glass Top \$	13126		
				1/4			Gloss Glass Top \$	10893		

Additional 48" Rectangle Shaped Tops on Next Page



Double Kerf (F)
1³/₁₆"



Duo (G)
1³/₁₆"



Fluted (X)
1³/₁₆"



Square (Y)
1³/₁₆"



Knife (K)
1³/₁₆"



Vertical Square (H)
1¹/₂"

Pricing Codes:
P= HPL W= Wood Top

[See Catalyst Overview For Ordering Options](#)

Item	Model No.	Material	W	D	H	Ship Wt	Cubic Ft	Edge Profile + Material	List Price		
<i>48"D CONTINUED FROM PREVIOUS PAGE</i>	120"W x 48"D or 10' - 2 Piece Rectangle Top										
	88-48120RT	Laminate	120	48	1 $\frac{3}{16}$ "	240	23.5	F, G, X, Y / P\$	2447		
					1 $\frac{3}{16}$ "			K / P\$	3958		
					1 $\frac{1}{2}$ "			H / P\$	2795		
		Veneer			1 $\frac{3}{16}$ "			F, G, X, Y / W\$	3074		
					1 $\frac{3}{16}$ "			K / W\$	4457		
					1 $\frac{1}{2}$ "			H / W\$	3634		
		Glass			$\frac{1}{4}$ "			Acid Etched Glass Top \$	14360		
					$\frac{1}{4}$ "			Gloss Glass Top \$	11878		
		132"W x 48"D or 11' - 2 Piece Rectangle Top									
	88-48132RT	Laminate	132	48	1 $\frac{3}{16}$ "	262	23.5	F, G, X, Y / P\$	2520		
					1 $\frac{3}{16}$ "			K / P\$	4233		
				1 $\frac{1}{2}$ "			H / P\$	2905			
	Veneer			1 $\frac{3}{16}$ "			F, G, X, Y / W\$	3335			
				1 $\frac{3}{16}$ "			K / W\$	4647			
				1 $\frac{1}{2}$ "			H / W\$	3949			
	Glass			$\frac{1}{4}$ "			Acid Etched Glass Top \$	15605			
				$\frac{1}{4}$ "			Gloss Glass Top \$	12873			
	144"W x 48"D or 12' - 2 Piece Rectangle Top										
88-48144RT	Laminate	144	48	1 $\frac{3}{16}$ "	284	23.5	F, G, X, Y / P\$	2584			
				1 $\frac{3}{16}$ "			K / P\$	4400			
				1 $\frac{1}{2}$ "			H / P\$	3003			
	Veneer			1 $\frac{3}{16}$ "			F, G, X, Y / W\$	3584			
				1 $\frac{3}{16}$ "			K / W\$	4922			
				1 $\frac{1}{2}$ "			H / W\$	4252			
	Glass			$\frac{1}{4}$ "			Acid Etched Glass Top \$	16837			
				$\frac{1}{4}$ "			Gloss Glass Top \$	13859			
	156"W x 48"D or 13' - 2 Piece Rectangle Top										
88-48156RT	Laminate	156	48	1 $\frac{3}{16}$ "	306	31.2	F, G, X, Y / P\$	3102			
				1 $\frac{3}{16}$ "			K / P\$	5051			
				1 $\frac{1}{2}$ "			H / P\$	3555			
	Veneer			1 $\frac{3}{16}$ "			F, G, X, Y / W\$	3851			
				1 $\frac{3}{16}$ "			K / W\$	5654			
				1 $\frac{1}{2}$ "			H / W\$	4572			
	Glass			$\frac{1}{4}$ "			Acid Etched Glass Top \$	18082			
				$\frac{1}{4}$ "			Gloss Glass Top \$	14856			

Must Specify (in this order):
 Model #
 Top Material
 Top Finish/Color
 Edge Profile
 Glass (Y/N)
 Glass Color/Surface Finish
 Power/Data
 Power/Data Location

Additional 48" Rectangle Shaped Tops on Next Page



Pricing Codes:
 P= HPL W= Wood Top

[See Catalyst Overview For Ordering Options](#)

Item	Model No.	Material	W	D	H	Ship Wt	Cubic Ft	Edge Profile + Material	List Price		
<i>48"D CONTINUED FROM PREVIOUS PAGE</i>	168"W x 48"D or 14' - 2 Piece Rectangle Top										
	88-48168RT	Laminate	168	48	1 ³ / ₁₆	328	31.2	F, G, X, Y / P\$	3149		
					1 ³ / ₁₆			K / P\$	5218		
					1 ¹ / ₂			H / P\$	3639		
		Veneer			1 ³ / ₁₆			F, G, X, Y / W\$	4041		
					1 ³ / ₁₆			K / W\$	5878		
					1 ¹ / ₂			H / W\$	4812		
		Glass			1/4			Acid Etched Glass Top \$	19301		
					1/4			Gloss Glass Top \$	15826		
		180"W x 48"D or 15' - 2 Piece Rectangle Top									
	88-48180RT	Laminate	180	48	1 ³ / ₁₆	350	31.2	F, G, X, Y / P\$	3318		
					1 ³ / ₁₆			K / P\$	5535		
					1 ¹ / ₂			H / P\$	3843		
		Veneer			1 ³ / ₁₆			F, G, X, Y / W\$	4384		
					1 ³ / ₁₆			K / W\$	6230		
					1 ¹ / ₂			H / W\$	5209		
		Glass			1/4			Acid Etched Glass Top \$	20645		
					1/4			Gloss Glass Top \$	16922		
	192"W x 48"D or 16' - 2 Piece Rectangle Top										
88-48192RT	Laminate	192	48	1 ³ / ₁₆	372	31.2	F, G, X, Y / P\$	3367			
				1 ³ / ₁₆			K / P\$	5800			
				1 ¹ / ₂			H / P\$	3924			
	Veneer			1 ³ / ₁₆			F, G, X, Y / W\$	4574			
				1 ³ / ₁₆			K / W\$	6361			
				1 ¹ / ₂			H / W\$	5450			
	Glass			1/4			Acid Etched Glass Top \$	21862			
				1/4			Gloss Glass Top \$	17893			
	204"W x 48"D or 17' - 3 Piece Rectangle Top										
88-48204RT	Laminate	204	48	1 ³ / ₁₆	394	24.0	F, G, X, Y / P\$	3891			
				1 ³ / ₁₆			K / P\$	6435			
				1 ¹ / ₂			H / P\$	4487			
	Veneer			1 ³ / ₁₆			F, G, X, Y / P\$	5409			
				1 ³ / ₁₆			K / W\$	7399			
				1 ¹ / ₂			H / W\$	6343			
	Glass			1/4			Acid Etched Glass Top \$	24026			
				1/4			Gloss Glass Top \$	19807			

Additional 48" Rectangle Shaped Tops on Next Page



Double Kerf (F)
1³/₁₆"



Duo (G)
1³/₁₆"



Fluted (X)
1³/₁₆"



Square (Y)
1³/₁₆"



Knife (K)
1³/₁₆"



Vertical Square (H)
1¹/₂"

Pricing Codes:

P= HPL W= Wood Top

[See Catalyst Overview For Ordering Options](#)

Item	Model No.	Material	W	D	H	Ship Wt	Cubic Ft	Edge Profile + Material	List Price		
<i>48"D CONTINUED FROM PREVIOUS PAGE</i>	216"W x 48"D or 18' - 3 Piece Rectangle Top										
	88-48216RT	Laminate	216	48	1 ³ / ₁₆	416	25.5	F, G, X, Y / P\$	3939		
					1 ¹ / ₂			K / P\$	6587		
					1 ³ / ₁₆			H / P\$	4572		
		Veneer			1 ³ / ₁₆			F, G, X, Y / W\$	5697		
					1 ³ / ₁₆			K / W\$	7427		
					1 ¹ / ₂			H / W\$	6684		
		Glass			1/4			Acid Etched Glass Top \$	25048		
					1/4			Gloss Glass Top \$	20581		
		228"W x 48"D or 19' - 3 Piece Rectangle Top									
	88-48228RT	Laminate	228	48	1 ³ / ₁₆	438	27.0	F, G, X, Y / P\$	4955		
					1 ³ / ₁₆			K / P\$	8011		
					1 ¹ / ₂			H / P\$	5623		
		Veneer			1 ³ / ₁₆			F, G, X, Y / W\$	6439		
					1 ³ / ₁₆			K / W\$	8774		
					1 ¹ / ₂			H / W\$	7479		
		Glass			1/4			Acid Etched Glass Top \$	26766		
					1/4			Gloss Glass Top \$	22052		
	240"W x 48"D or 20' - 3 Piece Rectangle Top										
88-48240RT	Laminate	240	48	1 ³ / ₁₆	460	28.5	F, G, X, Y / P\$	5004			
				1 ³ / ₁₆			K / P\$	8162			
				1 ¹ / ₂			H / P\$	5706			
	Veneer			1 ³ / ₁₆			F, G, X, Y / W\$	6728			
				1 ³ / ₁₆			K / W\$	9062			
				1 ¹ / ₂			H / W\$	7820			
	Glass			1/4			Acid Etched Glass Top \$	27986			
				1/4			Gloss Glass Top \$	23021			

Must Specify (in this order):
 Model #
 Top Material
 Top Finish/Color
 Edge Profile
 Glass (Y/N)
 Glass Color/Surface Finish
 Power/Data
 Power/Data Location

Description

- Tops Available with Veneer (W) or HPL (P) Top in 1³/₁₆" and 1¹/₂" Thicknesses
- Must Specify Edge Profile: 1³/₁₆" Thick/Double Kerf (F), Duo (G), Fluted (X), Square (Y), and Knife (K) Edge Profiles or 1¹/₂" Thick/Vertical Square (H)
- Veneer (W) Top Grain Runs Depth of Top and HPL (P) Top Grain Runs Width of Top
- All Veneer Tops, as well as Laminate Tops up to 144" (12 feet), have Matching Woodgrain. Laminate Tops Sized 156" (13 feet) and Longer have Non-Matching Woodgrain
- Available with Back Painted Tempered Glass Top; Must Specify Color and Finish ([See Options](#))
- Power and Data Options Available; Sold Separately ([See Multiple Power Unit Details](#))
- Dock800, Oasis, and E2X Power Units Available on Ends Only (E2 and E2) for 108"D - 156"D and 204"D-240"D Tops Bases Sold Separately ([See Multiple Base Options](#))



Double Kerf (F)
1³/₁₆"



Duo (G)
1³/₁₆"



Fluted (X)
1³/₁₆"



Square (Y)
1³/₁₆"



Knife (K)
1³/₁₆"



Vertical Square (H)
1¹/₂"

Pricing Codes:
 P= HPL W= Wood Top

[See Catalyst Overview For Ordering Options](#)

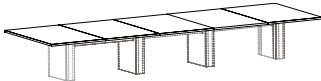
Item	Model No.	Material	W	D	H	Ship Wt	Cubic Ft	Edge Profile + Material	List Price	
RECTANGLE SHAPE MEETING TOP 54"D  88-54204RT Shown in Veneer with 88-2416606RAB (6" Rectangle Accent Base) BASES SOLD SEPARATELY	120"W x 54"D or 10' - 3 Piece Veneer (W) and 2 Piece HPL (P) Rectangle Top									
	88-54120RT	Laminate	120	54	1 3/16	260	12.1	F, G, X, Y / P\$	2732	
					1 3/16			K / P\$	4514	
					1 1/2			H / P\$	3126	
		Veneer			1 3/16			F, G, X, Y / W\$	4115	
					1 3/16			K / W\$	5565	
					1 1/2			H / W\$	4742	
		Glass			1/4			Acid Etched Glass Top \$	16750	
					1/4			Gloss Glass Top \$	13958	
	132"W x 54"D or 11' - 3 Piece Veneer (W) and 2 Piece HPL (P) Rectangle Top									
	88-54132RT	Laminate	132	54	1 3/16	285	13.2	F, G, X, Y / P\$	2800	
					1 3/16			K / P\$	4696	
				1 1/2			H / P\$	3234		
	Veneer			1 3/16			F, G, X, Y / W\$	4335		
				1 3/16			K / W\$	5850		
				1 1/2			H / W\$	5019		
	Glass			1/4			Acid Etched Glass Top \$	18132		
				1/4			Gloss Glass Top \$	15059		
144"W x 54"D or 12' - 3 Piece Veneer (W) and 2 Piece HPL (P) Rectangle Top										
88-54144RT	Laminate	144	54	1 3/16	309	15.0	F, G, X, Y / P\$	2867		
				1 3/16			K / P\$	4877		
				1 1/2			H / P\$	3342		
	Veneer			1 3/16			F, G, X, Y / W\$	4554		
				1 3/16			K / W\$	6138		
				1 1/2			H / W\$	5297		
	Glass			1/4			Acid Etched Glass Top \$	19512		
				1/4			Gloss Glass Top \$	16162		
156"W x 54"D or 13' - 4 Piece Veneer (W) and 2 Piece HPL (P) Rectangle Top										
88-54156RT	Laminate	156	54	1 3/16	334	16.0	F, G, X, Y / P\$	3396		
				1 3/16			K / P\$	5714		
				1 1/2			H / P\$	3908		
	Veneer			1 3/16			F, G, X, Y / W\$	5619		
				1 3/16			K / W\$	7417		
				1 1/2			H / W\$	6427		
	Glass			1/4			Acid Etched Glass Top \$	20731		
				1/4			Gloss Glass Top \$	17103		

Additional 54" Rectangle Shaped Tops on Next Page



Double Kerf (F)
1 3/16"



Duo (G)
1 3/16"



Fluted (X)
1 3/16"



Square (Y)
1 3/16"



Knife (K)
1 3/16"



Vertical Square (H)
1 1/2"

Pricing Codes:

P= HPL W= Wood Top

[See Catalyst Overview For Ordering Options](#)

Item	Model No.	Material	W	D	H	Ship Wt	Cubic Ft	Edge Profile + Material	List Price	
<i>54"D CONTINUED FROM PREVIOUS PAGE</i>	168"W x 54"D or 14' - 4 Piece Veneer (W) and 2 Piece HPL (P) Rectangle Top									
	88-54168RT	Laminate	168	54	1 1/16"	359	17.0	F, G, X, Y / P\$	3448	
					1 1/16"			K / P\$	5882	
					1 1/2"			H / P\$	4000	
		Veneer			1 1/16"			F, G, X, Y / W\$	5860	
					1 1/16"			K / W\$	7724	
					1 1/2"			H / W\$	6726	
		Glass			1/4"			Acid Etched Glass Top \$	22098	
					1/4"			Gloss Glass Top \$	18190	
	154"D x 180"W or 15' - 4 Piece Veneer (W) and 2 Piece HPL (P) Rectangle Top									
	88-54180RT	Laminate	180	54	1 1/16"	384	18.0	F, G, X, Y / P\$	3501	
					1 1/16"			K / P\$	6047	
					1 1/2"			H / P\$	4092	
		Veneer			1 1/16"			F, G, X, Y / W\$	6100	
					1 1/16"			K / W\$	8032	
				1 1/2"			H / W\$	7025		
	Glass			1/4"			Acid Etched Glass Top \$	23464		
				1/4"			Gloss Glass Top \$	19276		
192"W x 54"D or 16' - 4 Piece Veneer (W) and 2 Piece HPL (P) Rectangle Top										
88-54192RT	Laminate	192	54	1 1/16"	408	19.0	F, G, X, Y / P\$	3552		
				1 1/16"			K / P\$	6214		
				1 1/2"			H / P\$	4185		
	Veneer			1 1/16"			F, G, X, Y / W\$	6340		
				1 1/16"			K / W\$	8340		
				1 1/2"			H / W\$	7324		
	Glass			1/4"			Acid Etched Glass Top \$	24832		
				1/4"			Gloss Glass Top \$	20362		
204"W x 54"D or 17' - 5 Piece Veneer (W) and 3 Piece HPL (P) Rectangle Top										
88-54204RT	Laminate	204	54	1 1/16"	445	21.0	F, G, X, Y / P\$	4290		
				1 1/16"			K / P\$	7077		
				1 1/2"			H / P\$	4964		
	Veneer			1 1/16"			F, G, X, Y / W\$	7708		
				1 1/16"			K / W\$	9923		
				1 1/2"			H / W\$	8978		
	Glass			1/4"			Acid Etched Glass Top \$	27196		
				1/4"			Gloss Glass Top \$	22450		

Must Specify (in this order):
 Model #
 Top Material
 Top Finish/Color
 Edge Profile
 Glass (Y/N)
 Glass Color/Surface Finish
 Power/Data
 Power/Data Location

Additional 54" Rectangle Shaped Tops on Next Page



Double Kerf (F) 1 1/16" Duo (G) 1 1/16" Fluted (X) 1 1/16" Square (Y) 1 1/16" Knife (K) 1 1/16" Vertical Square (H) 1 1/2"

Pricing Codes:
 P= HPL W= Wood Top

[See Catalyst Overview For Ordering Options](#)

Item	Model No.	Material	W	D	H	Ship Wt	Cubic Ft	Edge Profile + Material	List Price
54"D CONTINUED FROM PREVIOUS PAGE									
216"W x 54"D or 18' - 5 Piece Veneer (W) and 3 Piece HPL (P) Rectangle Top									
	88-54216RT	Laminate	216	54	1 ³ / ₁₆	470	22.0	F, G, X, Y / P\$	4343
					1 ³ / ₁₆			K / P\$	7244
					1 ¹ / ₂			H / P\$	5055
Must Specify (in this order): Model # Top Material Top Finish/Color Edge Profile Glass (Y/N) Glass Color/Surface Finish Power/Data Power/Data Location		Veneer			1 ³ / ₁₆			F, G, X, Y / W\$	7969
					1 ³ / ₁₆			K / W\$	10251
					1 ¹ / ₂			H / W\$	9296
		Glass			1/4			Acid Etched Glass Top \$	28562
					1/4			Gloss Glass Top \$	23537
228"W x 54"D or 19' - 5 Piece Veneer (W) and 3 Piece HPL (P) Rectangle Top									
	88-54228RT	Laminate	228	54	1 ³ / ₁₆	495	23.0	F, G, X, Y / P\$	5009
					1 ³ / ₁₆			K / P\$	8318
					1 ¹ / ₂			H / P\$	5763
		Veneer			1 ³ / ₁₆			F, G, X, Y / W\$	8230
					1 ³ / ₁₆			K / W\$	10578
					1 ¹ / ₂			H / W\$	9616
		Glass			1/4			Acid Etched Glass Top \$	29986
					1/4			Gloss Glass Top \$	24681
240"W x 54"D or 20' - 5 Piece Veneer (W) and 3 Piece HPL (P) Rectangle Top									
	88-54240RT	Laminate	240	54	1 ³ / ₁₆	519	24.0	F, G, X, Y / P\$	5062
					1 ³ / ₁₆			K / P\$	8483
					1 ¹ / ₂			H / P\$	5855
		Veneer			1 ³ / ₁₆			F, G, X, Y / W\$	8492
					1 ³ / ₁₆			K / W\$	10907
					1 ¹ / ₂			H / W\$	9937
		Glass			1/4			Acid Etched Glass Top \$	31352
					1/4			Gloss Glass Top \$	25769

Description

- Tops Available with Veneer (W) or HPL (P) Top in 1³/₁₆" and 1¹/₂" Thicknesses
- Must Specify Edge Profile: 1³/₁₆" Thick/Double Kerf (F), Duo (G), Fluted (X), Square (Y), and Knife (K) Edge Profiles or 1¹/₂" Thick/Vertical Square (H)
- Veneer (W) Top Grain Runs Depth of Top and HPL (P) Top Grain Runs Width of Top
- All Veneer Tops, as well as Laminate Tops up to 144" (12 feet), have Matching Woodgrain. Laminate Tops Sized 156" (13 feet) and Longer have Non-Matching Woodgrain
- Available with Back Painted Tempered Glass Top; Must Specify Color and Finish ([See Options](#))
- Power and Data Options Available; Sold Separately ([See Multiple Power Unit Details](#))
- Bases Sold Separately ([See Multiple Base Options](#))



Double Kerf (F)
1³/₁₆"



Duo (G)
1³/₁₆"



Fluted (X)
1³/₁₆"



Square (Y)
1³/₁₆"



Knife (K)
1³/₁₆"



Vertical Square (H)
1¹/₂"

Pricing Codes:

P= HPL W= Wood Top

[See Catalyst Overview For Ordering Options](#)

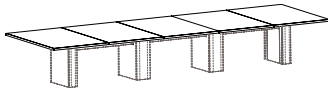
Item	Model No.	Material	W	D	H	Ship Wt	Cubic Ft	Edge Profile + Material	List Price	
RECTANGLE SHAPE MEETING TOP 60"D  88-60204RT Shown in Veneer with 88-24166C610RAB (6" + 10" Combo Rectangle Accent Base) BASES SOLD SEPARATELY	120"W x 60"D or 10' - 3 Piece Veneer (W) and 2 Piece HPL (P) Rectangle Top									
	88-60120RT	Laminate	120	60	1 3/16	287	13.3	F, G, X, Y / P\$	2785	
					1 3/16			K / P\$	4676	
					1 1/2			H / P\$	3224	
		Veneer			1 3/16			F, G, X, Y / W\$	4358	
					1 3/16			K / W\$	5862	
					1 1/2			H / W\$	5046	
		Glass			1/4			Acid Etched Glass Top \$	18244	
					1/4			Gloss Glass Top \$	15143	
	132"W x 60"D or 11' - 3 Piece Veneer (W) and 2 Piece HPL (P) Rectangle Top									
	88-60132RT	Laminate	132	60	1 3/16	323	14.6	F, G, X, Y / P\$	2857	
					1 3/16			K / P\$	4872	
				1 1/2			H / P\$	3341		
	Veneer			1 3/16			F, G, X, Y / W\$	4602		
				1 3/16			K / W\$	6177		
				1 1/2			H / W\$	5354		
	Glass			1/4			Acid Etched Glass Top \$	19773		
				1/4			Gloss Glass Top \$	16361		
144"W x 60"D or 12' - 3 Piece Veneer (W) and 2 Piece HPL (P) Rectangle Top										
88-60144RT	Laminate	144	60	1 3/16	342	16.0	F, G, X, Y / P\$	2929		
				1 3/16			K / P\$	5069		
				1 1/2			H / P\$	3457		
	Veneer			1 3/16			F, G, X, Y / W\$	4844		
				1 3/16			K / W\$	6491		
				1 1/2			H / W\$	5663		
	Glass			1/4			Acid Etched Glass Top \$	21301		
				1/4			Gloss Glass Top \$	17579		
156"W x 60"D or 13' - 4 Piece Veneer (W) and 2 Piece HPL (P) Rectangle Top										
88-60156RT	Laminate	156	60	1 3/16	376	17.2	F, G, X, Y / P\$	3461		
				1 3/16			K / P\$	5920		
				1 1/2			H / P\$	4034		
	Veneer			1 3/16			F, G, X, Y / W\$	5965		
				1 3/16			K / W\$	7829		
				1 1/2			H / W\$	6853		
	Glass			1/4			Acid Etched Glass Top \$	22671		
				1/4			Gloss Glass Top \$	18637		

Additional 60" Rectangle Shaped Tops on Next Page



Double Kerf (F)
1 3/16"



Duo (G)
1 3/16"



Fluted (X)
1 3/16"



Square (Y)
1 3/16"



Knife (K)
1 3/16"



Vertical Square (H)
1 1/2"

Pricing Codes:

P= HPL W= Wood Top

[See Catalyst Overview For Ordering Options](#)

Item	Model No.	Material	W	D	H	Ship Wt	Cubic Ft	Edge Profile + Material	List Price
60"D CONTINUED FROM PREVIOUS PAGE									
168"W x 60"D or 14' - 4 Piece Veneer (W) and 2 Piece HPL (P) Rectangle Top									
	88-60168RT	Laminate	168	60	1 ³ / ₁₆	403	18.5	F, G, X, Y / P\$	3519
					1 ³ / ₁₆			K / P\$	6101
					1 ¹ / ₂			H / P\$	4136
		Veneer			1 ³ / ₁₆			F, G, X, Y / W\$	6232
					1 ³ / ₁₆			K / W\$	8166
					1 ¹ / ₂			H / W\$	7185
		Glass			1/4			Acid Etched Glass Top \$	24183
					1/4			Gloss Glass Top \$	19840
180"W x 60"D or 15' - 4 Piece Veneer (W) and 2 Piece HPL (P) Rectangle Top									
	88-60180RT	Laminate	180	60	1 ³ / ₁₆	430	19.8	F, G, X, Y / P\$	3577
					1 ³ / ₁₆			K / P\$	6282
					1 ¹ / ₂			H / P\$	4236
		Veneer			1 ³ / ₁₆			F, G, X, Y / W\$	6499
					1 ³ / ₁₆			K / W\$	8504
					1 ¹ / ₂			H / W\$	7515
		Glass			1/4			Acid Etched Glass Top \$	25697
					1/4			Gloss Glass Top \$	21045
192"W x 60"D or 16' - 4 Piece Veneer (W) and 2 Piece HPL (P) Rectangle Top									
	88-60192RT	Laminate	192	60	1 ³ / ₁₆	458	21.1	F, G, X, Y / P\$	3634
					1 ³ / ₁₆			K / P\$	6462
					1 ¹ / ₂			H / P\$	4337
		Veneer			1 ³ / ₁₆			F, G, X, Y / W\$	6765
					1 ³ / ₁₆			K / W\$	8843
					1 ¹ / ₂			H / W\$	7845
		Glass			1/4			Acid Etched Glass Top \$	27210
					1/4			Gloss Glass Top \$	22248
204"W x 60"D or 17' - 5 Piece Veneer (W) and 3 Piece HPL (P) Rectangle Top									
	88-60204RT	Laminate	204	60	1 ³ / ₁₆	492	22.4	F, G, X, Y / P\$	4376
					1 ³ / ₁₆			K / P\$	7341
					1 ¹ / ₂			H / P\$	5127
		Veneer			1 ³ / ₁₆			F, G, X, Y / W\$	8200
					1 ³ / ₁₆			K / W\$	10497
					1 ¹ / ₂			H / W\$	9572
		Glass			1/4			Acid Etched Glass Top \$	29724
					1/4			Gloss Glass Top \$	24451

Must Specify (in this order):
 Model #
 Top Material
 Top Finish/Color
 Edge Profile
 Glass (Y/N)
 Glass Color/Surface Finish
 Power/Data
 Power/Data Location

Additional 60" Rectangle Shaped Tops on Next Page



Pricing Codes:
 P= HPL W= Wood Top

[See Catalyst Overview For Ordering Options](#)

Item	Model No.	Material	W	D	H	Ship Wt	Cubic Ft	Edge Profile + Material	List Price		
<i>60"D CONTINUED FROM PREVIOUS PAGE</i>	216"W x 60"D or 18' - 5 Piece Veneer (W) and 3 Piece HPL (P) Rectangle Top										
	88-60216RT	Laminate	216	60	1 ³ / ₁₆	519	23.7	F, G, X, Y / P\$	4433		
					1 ³ / ₁₆			K / P\$	7521		
					1 ¹ / ₂			H / P\$	5227		
		Veneer			1 ³ / ₁₆			F, G, X, Y / W\$	8489		
					1 ³ / ₁₆			K / W\$	10855		
					1 ¹ / ₂			H / W\$	9926		
		Glass			1/4			Acid Etched Glass Top \$	31239		
					1/4			Gloss Glass Top \$	25655		
		228"W x 60"D or 19' - 5 Piece Veneer (W) and 3 Piece HPL (P) Boat Top									
	88-60228BT	Laminate	228	60-48	1 ³ / ₁₆	547	25.0	F, G, X, Y / P\$	5300		
					1 ³ / ₁₆			K / P\$	9916		
				1 ¹ / ₂			H / P\$	6131			
	Veneer			1 ³ / ₁₆			F, G, X, Y / W\$	9073			
				1 ³ / ₁₆			K / W\$	13205			
				1 ¹ / ₂			H / W\$	10327			
	Glass			1/4			Acid Etched Glass Top \$	34679			
				1/4			Gloss Glass Top \$	28785			
	240"W x 60"D or 20' - 5 Piece Veneer (W) and 3 Piece HPL (P) Rectangle Top										
88-60240RT	Laminate	240	60	1 ³ / ₁₆	574	26.3	F, G, X, Y / P\$	5161			
				1 ³ / ₁₆			K / P\$	8790			
				1 ¹ / ₂			H / P\$	6044			
	Veneer			1 ³ / ₁₆			F, G, X, Y / W\$	9068			
				1 ³ / ₁₆			K / W\$	11577			
				1 ¹ / ₂			H / W\$	10636			
	Glass			1/4			Acid Etched Glass Top \$	34324			
				1/4			Gloss Glass Top \$	28120			

Must Specify (in this order):
 Model #
 Top Material
 Top Finish/Color
 Edge Profile
 Glass (Y/N)
 Glass Color/Surface Finish
 Power/Data
 Power/Data Location

Description

- Tops Available with Veneer (W) or HPL (P) Top in 1³/₁₆" and 1¹/₂" Thicknesses
- Must Specify Edge Profile: 1³/₁₆" Thick/Double Kerf (F), Duo (G), Fluted (X), Square (Y), and Knife (K) Edge Profiles or 1¹/₂" Thick/Vertical Square (H)
- Veneer (W) Top Grain Runs Depth of Top and HPL (P) Top Grain Runs Width of Top
- All Veneer Tops, as well as Laminate Tops up to 144" (12 feet), have Matching Woodgrain. Laminate Tops Sized 156" (13 feet) and Longer have Non-Matching Woodgrain
- Available with Back Painted Tempered Glass Top; Must Specify Color and Finish ([See Options](#))
- Power and Data Options Available; Sold Separately ([See Multiple Power Unit Details](#))
- Bases Sold Separately ([See Multiple Base Options](#))



Pricing Codes:
 P= HPL W= Wood Top

[See Catalyst Overview For Ordering Options](#)

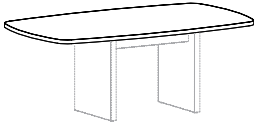
Item	Model No.	Material	W	D	H	Ship Wt	Cubic Ft	Edge Profile + Material	List Price	
MODERN RECTANGLE SHAPE MEETING TOP 36"D  88-3672MR Shown with 88-2034RBPB (Rectangle Panel Base) BASES SOLD SEPARATELY	72"W x 36"D or 6' - 1 Piece Modern Rectangle Top									
	88-3672MR	Laminate	72	36	1 ³ / ₁₆	109	10.3	F, G, X, Y / P\$	1242	
					1 ³ / ₁₆			K / P\$	2508	
					1 ¹ / ₂			H / P\$	1396	
		Veneer			1 ³ / ₁₆			F, G, X, Y / W\$	1460	
					1 ³ / ₁₆			K / W\$	2824	
					1 ¹ / ₂			H / W\$	1724	
		Glass			1/4			Acid Etched Glass Top \$	7658	
					1/4			Gloss Glass Top \$	6539	
	84"W x 36"D or 7' - 1 Piece Modern Rectangle Top									
	88-3684MR	Laminate	84	36	1 ³ / ₁₆	126	11.3	F, G, X, Y / P\$	1522	
					1 ³ / ₁₆			K / P\$	2897	
				1 ¹ / ₂			H / P\$	1734		
	Veneer			1 ³ / ₁₆			F, G, X, Y / W\$	1715		
				1 ³ / ₁₆			K / W\$	3317		
				1 ¹ / ₂			H / W\$	1982		
	Glass			1/4			Acid Etched Glass Top \$	8770		
				1/4			Gloss Glass Top \$	7467		
96"W x 36"D or 8' - 1 Piece Modern Rectangle Top										
88-3696MR	Laminate	96	36	1 ³ / ₁₆	142	12.9	F, G, X, Y / P\$	1597		
				1 ³ / ₁₆			K / P\$	3163		
				1 ¹ / ₂			H / P\$	1801		
	Veneer			1 ³ / ₁₆			F, G, X, Y / W\$	1808		
				1 ³ / ₁₆			K / W\$	3547		
				1 ¹ / ₂			H / W\$	2154		
	Glass			1/4			Acid Etched Glass Top \$	9782		
				1/4			Gloss Glass Top \$	8294		

Must Specify (in this order):
 Model #
 Top Material
 Top Finish/Color
 Edge Profile
 Glass (Y/N)
 Glass Color/Surface Finish
 Power/Data
 Power/Data Location

Description

- Tops Available with Veneer (W) or HPL (P) Top in 1³/₁₆" and 1¹/₂" Thicknesses
- Must Specify Edge Profile: 1³/₁₆" Thick/Double Kerf (F), Duo (G), Fluted (X), Square (Y), and Knife (K) Edge Profiles or 1¹/₂" Thick/Vertical Square (H)
- Veneer (W) Top Grain Runs Depth of Top and HPL (P) Top Grain Runs Width of Top
- Available with Back Painted Tempered Glass Top; Must Specify Color and Finish ([See Options](#))
- Power and Data Options Available; Sold Separately ([See Multiple Power Unit Details](#))
- Bases Sold Separately ([See Multiple Base Options](#))



Double Kerf (F)
1³/₁₆"



Duo (G)
1³/₁₆"



Fluted (X)
1³/₁₆"



Square (Y)
1³/₁₆"



Knife (K)
1³/₁₆"



Vertical Square (H)
1¹/₂"

Pricing Codes:

P= HPL W= Wood Top

[See Catalyst Overview For Ordering Options](#)

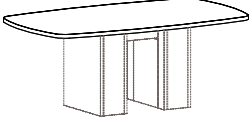
Item	Model No.	Material	W	D	H	Ship Wt	Cubic Ft	Edge Profile + Material	List Price	
MODERN RECTANGLE SHAPE MEETING TOP 42"D  88-42108MR Shown with 88-203406RAB (Rectangle Panel Base) BASES SOLD SEPARATELY	72"W x 42"D or 6' - 1 Piece Modern Rectangle Top									
	88-4272MR	Laminate	72	42	1 3/16	126	11.3	F, G, X, Y / P\$	1326	
					1 3/16			K / P\$	2766	
					1 1/2			H / P\$	1504	
		Veneer			1 3/16			F, G, X, Y / W\$	1652	
					1 3/16			K / W\$	3038	
					1 1/2			H / W\$	1952	
		Glass			1/4			Acid Etched Glass Top \$	8662	
					1/4			Gloss Glass Top \$	7359	
	84"W x 42"D or 7' - 1 Piece Modern Rectangle Top									
	88-4284MR	Laminate	84	42	1 3/16	145	13.1	F, G, X, Y / P\$	1585	
					1 3/16			K / P\$	3105	
				1 1/2			H / P\$	1794		
	Veneer			1 3/16			F, G, X, Y / W\$	1815		
				1 3/16			K / W\$	3478		
				1 1/2			H / W\$	2162		
	Glass			1/4			Acid Etched Glass Top \$	9852		
				1/4			Gloss Glass Top \$	8331		
96"W x 42"D or 8' - 1 Piece Modern Rectangle Top										
88-4296MR	Laminate	96	42	1 3/16	164	15.0	F, G, X, Y / P\$	1629		
				1 3/16			K / P\$	3346		
				1 1/2			H / P\$	1869		
	Veneer			1 3/16			F, G, X, Y / W\$	1965		
				1 3/16			K / W\$	3769		
				1 1/2			H / W\$	2360		
	Glass			1/4			Acid Etched Glass Top \$	11009		
				1/4			Gloss Glass Top \$	9272		
108"W x 42"D or 9' - 2 Piece Modern Rectangle Top										
88-42108MR	Laminate	108	42	1 3/16	260	27.0	F, G, X, Y / P\$	2209		
				1 3/16			K / P\$	4070		
				1 1/2			H / P\$	2482		
	Veneer			1 3/16			F, G, X, Y / W\$	2458		
				1 3/16			K / W\$	4556		
				1 1/2			H / W\$	2904		
	Glass			1/4			Acid Etched Glass Top \$	12539		
				1/4			Gloss Glass Top \$	10583		

Additional 42" Modern Rectangle Shaped Tops on Next Page



Double Kerf (F)
1 3/16"



Duo (G)
1 3/16"



Fluted (X)
1 3/16"



Square (Y)
1 3/16"



Knife (K)
1 3/16"



Vertical Square (H)
1 1/2"

Pricing Codes:

P= HPL W= Wood Top

[See Catalyst Overview For Ordering Options](#)

Item	Model No.	Material	W	D	H	Ship Wt	Cubic Ft	Edge Profile + Material	List Price
<i>42"D CONTINUED FROM PREVIOUS PAGE</i>	120"W x 42"D or 10' - 2 Piece Modern Rectangle Top								
	88-42120MR	Laminate	120	42	1 ³ / ₁₆	268	27.0	F, G, X, Y / P\$	2251
					1 ³ / ₁₆			K / P\$	4313
					1 ¹ / ₂			H / P\$	2555
Must Specify (in this order): Model # Top Material Top Finish/Color Edge Profile Glass (Y/N) Glass Color/Surface Finish Power/Data Power/Data Location		Veneer			1 ³ / ₁₆			F, G, X, Y / W\$	2613
					1 ³ / ₁₆			K / W\$	4858
					1 ¹ / ₂			H / W\$	3105
		Glass			1/4			Acid Etched Glass Top \$	13697
					1/4			Gloss Glass Top \$	11526

Description

- Tops Available with Veneer (W) or HPL (P) Top in 1³/₁₆" and 1¹/₂" Thicknesses
- Must Specify Edge Profile: 1³/₁₆" Thick/Double Kerf (F), Duo (G), Fluted (X), Square (Y), and Knife (K) Edge Profiles or 1¹/₂" Thick/Vertical Square (H)
- Veneer (W) Top Grain Runs Depth of Top and HPL (P) Top Grain Runs Width of Top
- Available with Back Painted Tempered Glass Top; Must Specify Color and Finish ([See Options](#))
- Power and Data Options Available; Sold Separately ([See Multiple Power Unit Details](#))
- Bases Sold Separately ([See Multiple Base Options](#))



Double Kerf (F)
1³/₁₆"



Duo (G)
1³/₁₆"



Fluted (X)
1³/₁₆"



Square (Y)
1³/₁₆"



Knife (K)
1³/₁₆"



Vertical Square (H)
1¹/₂"

Pricing Codes:

P= HPL W= Wood Top

[See Catalyst Overview For Ordering Options](#)

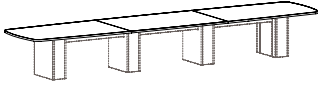
Item	Model No.	Material	W	D	H	Ship Wt	Cubic Ft	Edge Profile + Material	List Price	
MODERN RECTANGLE SHAPE MEETING TOP 48"D  88-48216MR Shown in HPL with 88-24178C610RAB (10" Rectangle Accent Base) BASES SOLD SEPARATELY	72"W x 48"D or 6' - 1 Piece Modern Rectangle Top									
	88-4872MR	Laminate	72	48	1 3/16	142	12.8	F, G, X, Y / P\$	1401	
					1 3/16			K / P\$	2957	
					1 1/2			H / P\$	1606	
		Veneer			1 3/16			F, G, X, Y / W\$	1831	
					1 3/16			K / W\$	3305	
					1 1/2			H / W\$	2170	
		Glass			1/4			Acid Etched Glass Top \$	9653	
					1/4			Gloss Glass Top \$	8163	
	84"W x 48"D or 7' - 1 Piece Modern Rectangle Top									
	88-4884MR	Laminate	84	48	1 3/16	164	15.0	F, G, X, Y / P\$	1665	
					1 3/16			K / P\$	3251	
				1 1/2			H / P\$	1904		
	Veneer			1 3/16			F, G, X, Y / W\$	1933		
				1 3/16			K / W\$	3663		
				1 1/2			H / W\$	2325		
	Glass			1/4			Acid Etched Glass Top \$	10913		
				1/4			Gloss Glass Top \$	9176		
96"W x 48"D or 8' - 1 Piece Modern Rectangle Top										
88-4896MR	Laminate	96	48	1 3/16	315	18.0	F, G, X, Y / P\$	1715		
				1 3/16			K / P\$	3653		
				1 1/2			H / P\$	1989		
	Veneer			1 3/16			F, G, X, Y / W\$	2188		
				1 3/16			K / W\$	3990		
				1 1/2			H / W\$	2632		
	Glass			1/4			Acid Etched Glass Top \$	12295		
				1/4			Gloss Glass Top \$	10309		
108"W x 48"D or 9' - 2 Piece Modern Rectangle Top										
88-48108MR	Laminate	108	48	1 3/16	218	23.5	F, G, X, Y / P\$	2515		
				1 3/16			K / P\$	4556		
				1 1/2			H / P\$	2828		
	Veneer			1 3/16			F, G, X, Y / W\$	2969		
				1 3/16			K / W\$	5130		
				1 1/2			H / W\$	3471		
	Glass			1/4			Acid Etched Glass Top \$	14192		
				1/4			Gloss Glass Top \$	11958		

Additional 48" Modern Rectangle Shaped Tops on Next Page



Double Kerf (F)
1 3/16"



Duo (G)
1 3/16"



Fluted (X)
1 3/16"



Square (Y)
1 3/16"



Knife (K)
1 3/16"



Vertical Square (H)
1 1/2"

Pricing Codes:

P= HPL W= Wood Top

[See Catalyst Overview For Ordering Options](#)

Item	Model No.	Material	W	D	H	Ship Wt	Cubic Ft	Edge Profile + Material	List Price		
<i>48" D CONTINUED FROM PREVIOUS PAGE</i>	120"W x 48"D or 10' - 2 Piece Modern Rectangle Top										
	88-48120MR	Laminate	120	48	1 3/16	240	23.5	F, G, X, Y / P\$	2578		
					1 3/16			K / P\$	4914		
					1 1/2			H / P\$	2926		
		Veneer			1 3/16			F, G, X, Y / W\$	3219		
					1 3/16			K / W\$	5408		
					1 1/2			H / W\$	3772		
		Glass			1/4			Acid Etched Glass Top \$	15513		
					1/4			Gloss Glass Top \$	13032		
		132"W x 48"D or 11' - 2 Piece Modern Rectangle Top									
	88-48132MR	Laminate	132	48	1 3/16	262	23.5	F, G, X, Y / P\$	2652		
					1 3/16			K / P\$	5179		
					1 1/2			H / P\$	3033		
		Veneer			1 3/16			F, G, X, Y / W\$	3481		
					1 3/16			K / W\$	5807		
				1 1/2			H / W\$	4087			
	Glass			1/4			Acid Etched Glass Top \$	16845			
				1/4			Gloss Glass Top \$	14115			
	144"W x 48"D or 12' - 2 Piece Modern Rectangle Top										
88-48144MR	Laminate	144	48	1 3/16	284	23.5	F, G, X, Y / P\$	2714			
				1 3/16			K / P\$	5435			
				1 1/2			H / P\$	3132			
	Veneer			1 3/16			F, G, X, Y / W\$	3731			
				1 3/16			K / W\$	6190			
				1 1/2			H / W\$	4390			
	Glass			1/4			Acid Etched Glass Top \$	18166			
				1/4			Gloss Glass Top \$	15187			
	156"W x 48"D or 13' - 2 Piece Modern Rectangle Top										
88-48156MR	Laminate	156	48	1 3/16	306	31.2	F, G, X, Y / P\$	3235			
				1 3/16			K / P\$	6014			
				1 1/2			H / P\$	3687			
	Veneer			1 3/16			F, G, X, Y / W\$	3999			
				1 3/16			K / W\$	6772			
				1 1/2			H / W\$	4711			
	Glass			1/4			Acid Etched Glass Top \$	19582			
				1/4			Gloss Glass Top \$	16355			

Must Specify (in this order):
 Model #
 Top Material
 Top Finish/Color
 Edge Profile
 Glass (Y/N)
 Glass Color/Surface Finish
 Power/Data
 Power/Data Location

Additional 48" Modern Rectangle Shaped Tops on Next Page



Double Kerf (F)
1 3/16"



Duo (G)
1 3/16"



Fluted (X)
1 3/16"



Square (Y)
1 3/16"



Knife (K)
1 3/16"



Vertical Square (H)
1 1/2"

Pricing Codes:
 P= HPL W= Wood Top

[See Catalyst Overview For Ordering Options](#)

Item	Model No.	Material	W	D	H	Ship Wt	Cubic Ft	Edge Profile + Material	List Price		
<i>48"D CONTINUED FROM PREVIOUS PAGE</i>	168"W x 48"D or 14' - 2 Piece Modern Rectangle Top										
	88-48168MR	Laminate	168	48	1 1/16"	328	31.2	F, G, X, Y / P\$	3283		
					1 1/16"			K / P\$	6401		
					1 1/2"			H / P\$	3771		
		Veneer			1 1/16"			F, G, X, Y / W\$	4189		
					1 1/16"			K / W\$	6978		
					1 1/2"			H / W\$	4954		
		Glass			1/4"			Acid Etched Glass Top \$	20889		
					1/4"			Gloss Glass Top \$	17414		
		180"W x 48"D or 15' - 2 Piece Modern Rectangle Top									
	88-48180MR	Laminate	180	48	1 1/16"	350	31.2	F, G, X, Y / P\$	3453		
					1 1/16"			K / P\$	6766		
					1 1/2"			H / P\$	3977		
		Veneer			1 1/16"			F, G, X, Y / W\$	4536		
					1 1/16"			K / W\$	7489		
					1 1/2"			H / W\$	5352		
		Glass			1/4"			Acid Etched Glass Top \$	22321		
					1/4"			Gloss Glass Top \$	18598		
	192"W x 48"D or 16' - 2 Piece Modern Rectangle Top										
88-48192MR	Laminate	192	48	1 1/16"	372	31.2	F, G, X, Y / P\$	3504			
				1 1/16"			K / P\$	7007			
				1 1/2"			H / P\$	4060			
	Veneer			1 1/16"			F, G, X, Y / W\$	4727			
				1 1/16"			K / W\$	7844			
				1 1/2"			H / W\$	5596			
	Glass			1/4"			Acid Etched Glass Top \$	23629			
				1/4"			Gloss Glass Top \$	19658			
	204"W x 48"D or 17' - 3 Piece Modern Rectangle Top										
88-48204MR	Laminate	204	48	1 1/16"	394	48.9	F, G, X, Y / P\$	4085			
				1 1/16"			K / P\$	7813			
				1 1/2"			H / P\$	4675			
	Veneer			1 1/16"			F, G, X, Y / W\$	5725			
				1 1/16"			K / W\$	9084			
				1 1/2"			H / W\$	6541			
	Glass			1/4"			Acid Etched Glass Top \$	25510			
				1/4"			Gloss Glass Top \$	21291			

Must Specify (in this order):
 Model #
 Top Material
 Top Finish/Color
 Edge Profile
 Glass (Y/N)
 Glass Color/Surface Finish
 Power/Data
 Power/Data Location

Additional 48" Modern Rectangle Shaped Tops on Next Page



Double Kerf (F) 1 1/16" Duo (G) 1 1/16" Fluted (X) 1 1/16" Square (Y) 1 1/16" Knife (K) 1 1/16" Vertical Square (H) 1 1/2"

Pricing Codes:
 P= HPL W= Wood Top

[See Catalyst Overview For Ordering Options](#)

Item	Model No.	Material	W	D	H	Ship Wt	Cubic Ft	Edge Profile + Material	List Price		
<i>48"D CONTINUED FROM PREVIOUS PAGE</i>	216"W x 48"D or 18' - 3 Piece Modern Rectangle Top										
	88-48216MR	Laminate	216	48	1 ³ / ₁₆	416	48.9	F, G, X, Y / P\$	4134		
					1 ³ / ₁₆			K / P\$	8053		
					1 ¹ / ₂			H / P\$	4759		
		Veneer			1 ³ / ₁₆			F, G, X, Y / W\$	6020		
					1 ³ / ₁₆			K / W\$	9482		
					1 ¹ / ₂			H / W\$	6883		
		Glass			1/4			Acid Etched Glass Top \$	26818		
					1/4			Gloss Glass Top \$	22351		
		228"W x 48"D or 19' - 3 Piece Modern Rectangle Top									
		88-48228MR	Laminate	228	48	1 ³ / ₁₆	438	48.9	F, G, X, Y / P\$	5151	
						1 ³ / ₁₆			K / P\$	9289	
					1 ¹ / ₂			H / P\$	5811		
		Veneer			1 ³ / ₁₆			F, G, X, Y / W\$	6770		
					1 ³ / ₁₆			K / W\$	10334		
					1 ¹ / ₂			H / W\$	7680		
		Glass			1/4			Acid Etched Glass Top \$	28557		
					1/4			Gloss Glass Top \$	23842		
		240"W x 48"D or 20' - 3 Piece Modern Rectangle Top									
		88-48240MR	Laminate	240	48	1 ³ / ₁₆	460	48.9	F, G, X, Y / P\$	5201	
						1 ³ / ₁₆			K / P\$	9530	
					1 ¹ / ₂			H / P\$	5894		
		Veneer			1 ³ / ₁₆			F, G, X, Y / W\$	7066		
					1 ³ / ₁₆			K / W\$	10731		
					1 ¹ / ₂			H / W\$	8020		
		Glass			1/4			Acid Etched Glass Top \$	29865		
					1/4			Gloss Glass Top \$	24900		

Must Specify (in this order):
 Model #
 Top Material
 Top Finish/Color
 Edge Profile
 Glass (Y/N)
 Glass Color/Surface Finish
 Power/Data
 Power/Data Location

Description

- Tops Available with Veneer (W) or HPL (P) Top in 1³/₁₆" and 1¹/₂" Thicknesses
- Must Specify Edge Profile: 1³/₁₆" Thick/Double Kerf (F), Duo (G), Fluted (X), Square (Y), and Knife (K) Edge Profiles or 1¹/₂" Thick/Vertical Square (H)
- Veneer (W) Top Grain Runs Depth of Top and HPL (P) Top Grain Runs Width of Top
- All Veneer Tops, as well as Laminate Tops up to 144" (12 feet), have Matching Woodgrain. Laminate Tops Sized 156" (13 feet) and Longer have Non-Matching Woodgrain
- Available with Back Painted Tempered Glass Top; Must Specify Color and Finish ([See Options](#))
- Power and Data Options Available; Sold Separately ([See Multiple Power Unit Details](#))
- Bases Sold Separately ([See Multiple Base Options](#))



Double Kerf (F)
1³/₁₆"



Duo (G)
1³/₁₆"



Fluted (X)
1³/₁₆"



Square (Y)
1³/₁₆"



Knife (K)
1³/₁₆"



Vertical Square (H)
1¹/₂"

Pricing Codes:

P= HPL W= Wood Top

[See Catalyst Overview For Ordering Options](#)

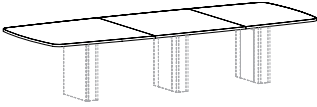
Item	Model No.	Material	W	D	H	Ship Wt	Cubic Ft	Edge Profile + Material	List Price	
MODERN RECTANGLE SHAPE MEETING TOP 54"D  88-54156MR Shown in HPL with 88-2411806RAB (6" Rectangle Accent Base) BASES SOLD SEPARATELY	120"W x 54"D or 10' - 3 Piece Veneer (W) and 2 Piece HPL (P) Modern Rectangle Top									
	88-54120MR	Laminate	120	54	1 1/16"	260	12.1	F, G, X, Y / P\$	2863	
					1 1/16"			K / P\$	5359	
					1 1/2"			H / P\$	3256	
		Veneer			1 1/16"			F, G, X, Y / W\$	4351	
					1 1/16"			K / W\$	6646	
					1 1/2"			H / W\$	4900	
		Glass			1/4"			Acid Etched Glass Top \$	17505	
					1/4"			Gloss Glass Top \$	14714	
	132"W x 54"D or 11' - 3 Piece Veneer (W) and 2 Piece HPL (P) Modern Rectangle Top									
	88-54132MR	Laminate	132	54	1 1/16"	285	13.2	F, G, X, Y / P\$	2931	
					1 1/16"			K / P\$	5630	
				1 1/2"			H / P\$	3364		
	Veneer			1 1/16"			F, G, X, Y / W\$	4586		
				1 1/16"			K / W\$	7047		
				1 1/2"			H / W\$	5184		
	Glass			1/4"			Acid Etched Glass Top \$	18970		
				1/4"			Gloss Glass Top \$	15900		
144"W x 54"D or 12' - 3 Piece Veneer (W) and 2 Piece HPL (P) Modern Rectangle Top										
88-54144MR	Laminate	144	54	1 1/16"	309	15.0	F, G, X, Y / P\$	3000		
				1 1/16"			K / P\$	5899		
				1 1/2"			H / P\$	3473		
	Veneer			1 1/16"			F, G, X, Y / W\$	4822		
				1 1/16"			K / W\$	7451		
				1 1/2"			H / W\$	7451		
	Glass			1/4"			Acid Etched Glass Top \$	20439		
				1/4"			Gloss Glass Top \$	17088		
156"W x 54"D or 13' - 4 Piece Veneer (W) and 2 Piece HPL (P) Modern Rectangle Top										
88-54156MR	Laminate	156	54	1 1/16"	334	16.0	F, G, X, Y / P\$	3529		
				1 1/16"			K / P\$	6641		
				1 1/2"			H / P\$	4040		
	Veneer			1 1/16"			F, G, X, Y / W\$	5841		
				1 1/16"			K / W\$	8748		
				1 1/2"			H / W\$	6632		
	Glass			1/4"			Acid Etched Glass Top \$	22264		
				1/4"			Gloss Glass Top \$	18635		

Must Specify (in this order):
 Model #
 Top Material
 Top Finish/Color
 Edge Profile
 Glass (Y/N)
 Glass Color/Surface Finish
 Power/Data
 Power/Data Location

Additional 54" Modern Rectangle Shaped Tops on Next Page



Pricing Codes:
 P= HPL W= Wood Top

[See Catalyst Overview For Ordering Options](#)

Item	Model No.	Material	W	D	H	Ship Wt	Cubic Ft	Edge Profile + Material	List Price		
<i>54" D CONTINUED FROM PREVIOUS PAGE</i>	168"W x 54"D or 14' - 4 Piece Veneer (W) and 2 Piece HPL (P) Modern Rectangle Top										
	88-54168MR	Laminate	168	54	1 3/16	359	17.0	F, G, X, Y / P\$	3582		
					1 3/16			K / P\$	6897		
					1 1/2			H / P\$	4134		
		Veneer			1 3/16			F, G, X, Y / W\$	6090		
					1 3/16			K / W\$	9174		
					1 1/2			H / W\$	6939		
		Glass			1/4			Acid Etched Glass Top \$	23720		
					1/4			Gloss Glass Top \$	19811		
		180"W x 54"D or 15' - 4 Piece Veneer (W) and 2 Piece HPL (P) Modern Rectangle Top									
	88-54180MR	Laminate	180	54	1 3/16	384	18.0	F, G, X, Y / P\$	3638		
					1 3/16			K / P\$	7153		
				1 1/2			H / P\$	4226			
	Veneer			1 3/16			F, G, X, Y / W\$	6337			
				1 3/16			K / W\$	9598			
				1 1/2			H / W\$	7244			
	Glass			1/4			Acid Etched Glass Top \$	25175			
				1/4			Gloss Glass Top \$	20987			
	192"W x 54"D or 16' - 4 Piece Veneer (W) and 2 Piece HPL (P) Modern Rectangle Top										
88-54192MR	Laminate	192	54	1 3/16	408	19.0	F, G, X, Y / P\$	3690			
				1 3/16			K / P\$	7408			
				1 1/2			H / P\$	4319			
	Veneer			1 3/16			F, G, X, Y / W\$	6586			
				1 3/16			K / W\$	10023			
				1 1/2			H / W\$	7550			
	Glass			1/4			Acid Etched Glass Top \$	26629			
				1/4			Gloss Glass Top \$	22161			
	204"W x 54"D or 17' - 5 Piece Veneer (W) and 3 Piece HPL (P) Modern Rectangle Top										
88-54204MR	Laminate	204	54	1 3/16	445	21.0	F, G, X, Y / P\$	4484			
				1 3/16			K / P\$	8442			
				1 1/2			H / P\$	5150			
	Veneer			1 3/16			F, G, X, Y / W\$	7983			
				1 3/16			K / W\$	11622			
				1 1/2			H / W\$	9009			
	Glass			1/4			Acid Etched Glass Top \$	28863			
				1/4			Gloss Glass Top \$	24118			

Additional 54" Modern Rectangle Shaped Tops on Next Page



Double Kerf (F)
1 3/16"



Duo (G)
1 3/16"



Fluted (X)
1 3/16"



Square (Y)
1 3/16"



Knife (K)
1 3/16"



Vertical Square (H)
1 1/2"

Pricing Codes:

P= HPL W= Wood Top

[See Catalyst Overview For Ordering Options](#)

Item	Model No.	Material	W	D	H	Ship Wt	Cubic Ft	Edge Profile + Material	List Price		
<i>54"D CONTINUED FROM PREVIOUS PAGE</i>	216"W 54"D or 18' - 5 Piece Veneer (W) and 3 Piece HPL (P) Modern Rectangle Top										
	88-54216MR	Laminate	216	54	1 ³ / ₁₆	470	22.0	F, G, X, Y / P\$	4538		
					1 ³ / ₁₆			K / P\$	8696		
					1 ¹ / ₂			H / P\$	5243		
		Veneer			1 ³ / ₁₆			F, G, X, Y / W\$	8254		
					1 ³ / ₁₆			K / W\$	12067		
					1 ¹ / ₂			H / W\$	9337		
		Glass			1 ¹ / ₄			Acid Etched Glass Top \$	30316		
					1 ¹ / ₄			Gloss Glass Top \$	25292		
		228"W x 54"D or 19' - 5 Piece Veneer (W) and 3 Piece HPL (P) Modern Rectangle Top									
	88-54228MR	Laminate	228	54	1 ³ / ₁₆	495	23.0	F, G, X, Y / P\$	5205		
					1 ³ / ₁₆			K / P\$	9582		
				1 ¹ / ₂			H / P\$	5949			
	Veneer			1 ³ / ₁₆			F, G, X, Y / W\$	8524			
				1 ³ / ₁₆			K / W\$	12513			
				1 ¹ / ₂			H / W\$	9664			
	Glass			1 ¹ / ₄			Acid Etched Glass Top \$	31810			
				1 ¹ / ₄			Gloss Glass Top \$	26507			
	240"W x 54"D or 20' - 5 Piece Veneer (W) and 3 Piece HPL (P) Modern Rectangle Top										
88-54240MR	Laminate	240	54	1 ³ / ₁₆	519	24.0	F, G, X, Y / P\$	5258			
				1 ³ / ₁₆			K / P\$	9837			
				1 ¹ / ₂			H / P\$	6042			
	Veneer			1 ³ / ₁₆			F, G, X, Y / W\$	8796			
				1 ³ / ₁₆			K / W\$	12959			
				1 ¹ / ₂			H / W\$	9992			
	Glass			1 ¹ / ₄			Acid Etched Glass Top \$	33265			
				1 ¹ / ₄			Gloss Glass Top \$	27681			

Must Specify (in this order):
 Model #
 Top Material
 Top Finish/Color
 Edge Profile
 Glass (Y/N)
 Glass Color/Surface Finish
 Power/Data
 Power/Data Location

Description

- Tops Available with Veneer (W) or HPL (P) Top in 1³/₁₆" and 1¹/₂" Thicknesses
- Must Specify Edge Profile: 1³/₁₆" Thick/Double Kerf (F), Duo (G), Fluted (X), Square (Y), and Knife (K) Edge Profiles or 1¹/₂" Thick/Vertical Square (H)
- Veneer (W) Top Grain Runs Depth of Top and HPL (P) Top Grain Runs Width of Top
- All Veneer Tops, as well as Laminate Tops up to 144" (12 feet), have Matching Woodgrain. Laminate Tops Sized 156" (13 feet) and Longer have Non-Matching Woodgrain
- Available with Back Painted Tempered Glass Top; Must Specify Color and Finish ([See Options](#))
- Power and Data Options Available; Sold Separately ([See Multiple Power Unit Details](#))
- Bases Sold Separately ([See Multiple Base Options](#))



Pricing Codes:
 P= HPL W= Wood Top

[See Catalyst Overview For Ordering Options](#)

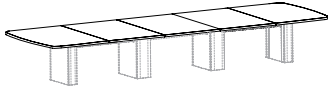
Item	Model No.	Material	W	D	H	Ship Wt	Cubic Ft	Edge Profile + Material	List Price	
MODERN RECTANGLE SHAPE MEETING TOP 60"D  88-60204MR Shown in Veneer with 88-24166C6106RAB (6" + 10" Combo Rectangle Accent Base) BASES SOLD SEPARATELY	120"W x 60"D or 10' - 3 Piece Veneer (W) and 2 Piece HPL (P) Modern Rectangle Top									
	88-60120MR	Laminate	120	60	1 3/16	287	13.3	F, G, X, Y / P\$	2916	
					1 3/16			K / P\$	5566	
					1 1/2			H / P\$	3354	
		Veneer			1 3/16			F, G, X, Y / W\$	4602	
					1 3/16			K / W\$	6994	
					1 1/2			H / W\$	5204	
		Glass			1/4			Acid Etched Glass Top \$	19040	
					1/4			Gloss Glass Top \$	15938	
	132"W x 60"D or 11' - 3 Piece Veneer (W) and 2 Piece HPL (P) Modern Rectangle Top									
	88-60132MR	Laminate	132	60	1 3/16	323	14.6	F, G, X, Y / P\$	2989	
					1 3/16			K / P\$	5848	
				1 1/2			H / P\$	3472		
	Veneer			1 3/16			F, G, X, Y / W\$	4862		
				1 3/16			K / W\$	7424		
				1 1/2			H / W\$	5519		
	Glass			1/4			Acid Etched Glass Top \$	20655		
				1/4			Gloss Glass Top \$	17244		
144"W x 60"D or 12' - 3 Piece Veneer (W) and 2 Piece HPL (P) Modern Rectangle Top										
88-60144MR	Laminate	144	60	1 3/16	342	16.0	F, G, X, Y / P\$	3062		
				1 3/16			K / P\$	6134		
				1 1/2			H / P\$	3589		
	Veneer			1 3/16			F, G, X, Y / W\$	5122		
				1 3/16			K / W\$	7858		
				1 1/2			H / W\$	5837		
	Glass			1/4			Acid Etched Glass Top \$	22274		
				1/4			Gloss Glass Top \$	18550		
156"W x 60"D or 13' - 4 Piece Veneer (W) and 2 Piece HPL (P) Modern Rectangle Top										
88-60156MR	Laminate	156	60	1 3/16	376	17.2	F, G, X, Y / P\$	3595		
				1 3/16			K / P\$	6891		
				1 1/2			H / P\$	4166		
	Veneer			1 3/16			F, G, X, Y / W\$	6187		
				1 3/16			K / W\$	9217		
				1 1/2			H / W\$	7058		
	Glass			1/4			Acid Etched Glass Top \$	24247		
				1/4			Gloss Glass Top \$	20214		

Additional 60" Modern Rectangle Shaped Tops on Next Page



Double Kerf (F)
1 3/16"



Duo (G)
1 3/16"



Fluted (X)
1 3/16"



Square (Y)
1 3/16"



Knife (K)
1 3/16"



Vertical Square (H)
1 1/2"

Pricing Codes:
P= HPL W= Wood Top

[See Catalyst Overview For Ordering Options](#)

Item	Model No.	Material	W	D	H	Ship Wt	Cubic Ft	Edge Profile + Material	List Price	
<i>60"D CONTINUED FROM PREVIOUS PAGE</i>	168"W x 60"D or 14' - 4 Piece Veneer (W) and 2 Piece HPL (P) Modern Rectangle Top									
	88-60168MR	Laminate	168	60	1 1/16"	403	18.5	F, G, X, Y / P\$	3654	
					1 3/16"			K / P\$	7160	
					1 1/2"			H / P\$	4267	
		Veneer			1 1/16"			F, G, X, Y / W\$	6461	
					1 3/16"			K / W\$	9671	
					1 1/2"			H / W\$	7396	
		Glass			1/4"			Acid Etched Glass Top \$	25849	
					1/4"			Gloss Glass Top \$	21507	
		180"W x 60"D or 15' - 4 Piece Veneer (W) and 2 Piece HPL (P) Modern Rectangle Top								
	88-60180MR	Laminate	180	60	1 1/16"	431	19.8	F, G, X, Y / P\$	3713	
					1 3/16"			K / P\$	7428	
				1 1/2"			H / P\$	4370		
	Veneer			1 1/16"			F, G, X, Y / W\$	6735		
				1 3/16"			K / W\$	10125		
				1 1/2"			H / W\$	7735		
	Glass			1/4"			Acid Etched Glass Top \$	27451		
				1/4"			Gloss Glass Top \$	22798		
	192"W x 60"D or 16' - 4 Piece Veneer (W) and 2 Piece HPL (P) Modern Rectangle Top									
88-60192MR	Laminate	192	60	1 1/16"	458	21.1	F, G, X, Y / P\$	3772		
				1 3/16"			K / P\$	7698		
				1 1/2"			H / P\$	4472		
	Veneer			1 1/16"			F, G, X, Y / W\$	7010		
				1 3/16"			K / W\$	10579		
				1 1/2"			H / W\$	8073		
	Glass			1/4"			Acid Etched Glass Top \$	29052		
				1/4"			Gloss Glass Top \$	24087		
	204"W x 60"D or 17' - 5 Piece Veneer (W) and 3 Piece HPL (P) Modern Rectangle Top									
88-60204MR	Laminate	204	60	1 1/16"	492	22.4	F, G, X, Y / P\$	4569		
				1 3/16"			K / P\$	8748		
				1 1/2"			H / P\$	5313		
	Veneer			1 1/16"			F, G, X, Y / W\$	8475		
				1 3/16"			K / W\$	12247		
				1 1/2"			H / W\$	9603		
	Glass			1/4"			Acid Etched Glass Top \$	31436		
				1/4"			Gloss Glass Top \$	26163		

Must Specify (in this order):
 Model #
 Top Material
 Top Finish/Color
 Edge Profile
 Glass (Y/N)
 Glass Color/Surface Finish
 Power/Data
 Power/Data Location

Additional 60" Modern Rectangle Shaped Tops on Next Page



Double Kerf (F) 1 1/16" Duo (G) 1 3/16" Fluted (X) 1 3/16" Square (Y) 1 3/16" Knife (K) 1 3/16" Vertical Square (H) 1 1/2"

Pricing Codes:
 P= HPL W= Wood Top

[See Catalyst Overview For Ordering Options](#)

Item	Model No.	Material	W	D	H	Ship Wt	Cubic Ft	Edge Profile + Material	List Price	
<i>60"D CONTINUED FROM PREVIOUS PAGE</i>	216"W x 60"D or 18' - 5 Piece Veneer (W) and 3 Piece HPL (P) Modern Rectangle Top									
	88-60216MR	Laminate	216	60	1 3/16	519	23.7	F, G, X, Y / P\$	4628	
					1 3/16			K / P\$	9018	
					1 1/2			H / P\$	5415	
<i>Must Specify (in this order):</i> Model # Top Material Top Finish/Color Edge Profile Glass (Y/N) Glass Color/Surface Finish Power/Data Power/Data Location	Veneer									
					1 3/16			F, G, X, Y / W\$	8774	
					1 3/16			K / W\$	12726	
					1 1/2			H / W\$	9966	
	Glass									
					1/4			Acid Etched Glass Top \$	33037	
				1/4			Gloss Glass Top \$	27453		
	228"W x 60"D or 19' - 5 Piece Veneer (W) and 3 Piece HPL (P) Modern Rectangle Top									
88-60228MR	Laminate	228	60	1 3/16	547	25.0	F, G, X, Y / P\$	5300		
				1 3/16			K / P\$	9916		
				1 1/2			H / P\$	6131		
	Veneer									
				1 3/16			F, G, X, Y / W\$	9073		
				1 3/16			K / W\$	13205		
				1 1/2			H / W\$	10327		
	Glass									
				1/4			Acid Etched Glass Top \$	34679		
				1/4			Gloss Glass Top \$	28785		
	240"W x 60"D or 20' - 5 Piece Veneer (W) and 3 Piece HPL (P) Modern Rectangle Top									
88-60240MR	Laminate	240	60	1 3/16	574	26.3	F, G, X, Y / P\$	5358		
				1 3/16			K / P\$	10186		
				1 1/2			H / P\$	6233		
	Veneer									
				1 3/16			F, G, X, Y / W\$	9373		
				1 3/16			K / W\$	13684		
				1 1/2			H / W\$	10691		
	Glass									
				1/4			Acid Etched Glass Top \$	36281		
				1/4			Gloss Glass Top \$	30076		

Description

- Tops Available with Veneer (W) or HPL (P) Top in 1 3/16" and 1 1/2" Thicknesses
- Must Specify Edge Profile: 1 3/16" Thick/Double Kerf (F), Duo (G), Fluted (X), Square (Y), and Knife (K) Edge Profiles or 1 1/2" Thick/Vertical Square (H)
- Veneer (W) Top Grain Runs Depth of Top and HPL (P) Top Grain Runs Width of Top
- All Veneer Tops, as well as Laminate Tops up to 144" (12 feet), have Matching Woodgrain. Laminate Tops Sized 156" (13 feet) and Longer have Non-Matching Woodgrain
- Available with Back Painted Tempered Glass Top; Must Specify Color and Finish ([See Options](#))
- Power and Data Options Available; Sold Separately ([See Multiple Power Unit Details](#))
- Bases Sold Separately ([See Multiple Base Options](#))



Double Kerf (F)
1 3/16"



Duo (G)
1 3/16"



Fluted (X)
1 3/16"



Square (Y)
1 3/16"



Knife (K)
1 3/16"



Vertical Square (H)
1 1/2"

Pricing Codes:

P= HPL W= Wood Top

[See Catalyst Overview For Ordering Options](#)

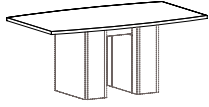
Item	Model No.	Material	W	D	H	Ship Wt	Cubic Ft	Edge Profile + Material	List Price	
BOAT SHAPE MEETING TOP 36"D  88-3696BT Shown with 88-203406RAB (6" Rectangle Accent Base) BASES SOLD SEPARATELY	72"W x 36"D or 6' - 1 Piece Boat Top									
	88-3672BT	Laminate	72	36-30	1 $\frac{3}{16}$ "	109	10.3	F, G, X, Y / P\$	1242	
					1 $\frac{3}{16}$ "			K / P\$	2508	
					1 $\frac{1}{2}$ "			H / P\$	1396	
		Veneer			1 $\frac{3}{16}$ "			F, G, X, Y / W\$	1460	
					1 $\frac{3}{16}$ "			K / W\$	2824	
					1 $\frac{1}{2}$ "			H / W\$	1724	
		Glass			$\frac{1}{4}$ "			Acid Etched Glass Top \$	7658	
					$\frac{1}{4}$ "			Gloss Glass Top \$	6539	
	84"W x 36"D or 7' - 1 Piece Boat Top									
	88-3684BT	Laminate	84	36-30	1 $\frac{3}{16}$ "	126	11.3	F, G, X, Y / P\$	1522	
					1 $\frac{3}{16}$ "			K / P\$	2897	
				1 $\frac{1}{2}$ "			H / P\$	1734		
	Veneer			1 $\frac{3}{16}$ "			F, G, X, Y / W\$	1715		
				1 $\frac{3}{16}$ "			K / W\$	3317		
				1 $\frac{1}{2}$ "			H / W\$	1982		
	Glass			$\frac{1}{4}$ "			Acid Etched Glass Top \$	8770		
				$\frac{1}{4}$ "			Gloss Glass Top \$	7467		
96"W x 36"D or 8' - 1 Piece Boat Top										
88-3696BT	Laminate	96	36-30	1 $\frac{3}{16}$ "	142	12.9	F, G, X, Y / P\$	1597		
				1 $\frac{3}{16}$ "			K / P\$	3163		
				1 $\frac{1}{2}$ "			H / P\$	1801		
	Veneer			1 $\frac{3}{16}$ "			F, G, X, Y / W\$	1808		
				1 $\frac{3}{16}$ "			K / W\$	3547		
				1 $\frac{1}{2}$ "			H / W\$	2154		
	Glass			$\frac{1}{4}$ "			Acid Etched Glass Top \$	9782		
				$\frac{1}{4}$ "			Gloss Glass Top \$	8294		

Must Specify (in this order):

Model #
 Top Material
 Top Finish/Color
 Edge Profile
 Glass (Y/N)
 Glass Color/Surface Finish
 Power/Data
 Power/Data Location

Description

- Tops Available with Veneer (W) or HPL (P) Top in 1 $\frac{3}{16}$ " and 1 $\frac{1}{2}$ " Thicknesses
- Must Specify Edge Profile: 1 $\frac{3}{16}$ " Thick/Double Kerf (F), Duo (G), Fluted (X), Square (Y), and Knife (K) Edge Profiles or 1 $\frac{1}{2}$ " Thick/Vertical Square (H)
- Veneer (W) Top Grain Runs Depth of Top and HPL (P) Top Grain Runs Width of Top
- Available with Back Painted Tempered Glass Top; Must Specify Color and Finish ([See Options](#))
- Power and Data Options Available; Sold Separately ([See Multiple Power Unit Details](#))
- Bases Sold Separately ([See Multiple Base Options](#))



Double Kerf (F)
1 $\frac{3}{16}$ "



Duo (G)
1 $\frac{3}{16}$ "



Fluted (X)
1 $\frac{3}{16}$ "



Square (Y)
1 $\frac{3}{16}$ "



Knife (K)
1 $\frac{3}{16}$ "



Vertical Square (H)
1 $\frac{1}{2}$ "

Pricing Codes:

P= HPL W= Wood Top

[See Catalyst Overview For Ordering Options](#)

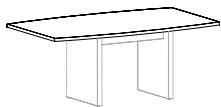
Item	Model No.	Material	W	D	H	Ship Wt	Cubic Ft	Edge Profile + Material	List Price	
BOAT SHAPE MEETING TOP 42"D  88-4272BT Shown with 88-2034RPB (Rectangle Panel Base) BASES SOLD SEPARATELY	72"W x 42"D or 6' - 1 Piece Boat Top									
	88-4272BT	Laminate	72	42-36	1 3/16	164	15.0	F, G, X, Y / P\$	1326	
					1 3/16			K / P\$	2766	
					1 1/2			H / P\$	1504	
		Veneer			1 3/16			F, G, X, Y / W\$	1652	
					1 3/16			K / W\$	3038	
					1 1/2			H / W\$	1952	
		Glass			1/4			Acid Etched Glass Top \$	8662	
					1/4			Gloss Glass Top \$	7359	
	84"W x 42"D or 7' - 1 Piece Boat Top									
	88-4284BT	Laminate	84	42-36	1 3/16	145	13.1	F, G, X, Y / P\$	1585	
					1 3/16			K / P\$	3105	
				1 1/2			H / P\$	1794		
	Veneer			1 3/16			F, G, X, Y / W\$	1815		
				1 3/16			K / W\$	3478		
				1 1/2			H / W\$	2162		
	Glass			1/4			Acid Etched Glass Top \$	9852		
				1/4			Gloss Glass Top \$	8331		
96"W x 42"D or 8' - 1 Piece Boat Top										
88-4296BT	Laminate	96	42-36	1 3/16	164	15.0	F, G, X, Y / P\$	1629		
				1 3/16			K / P\$	3346		
				1 1/2			H / P\$	1869		
	Veneer			1 3/16			F, G, X, Y / W\$	1965		
				1 3/16			K / W\$	3769		
				1 1/2			H / W\$	2360		
	Glass			1/4			Acid Etched Glass Top \$	11009		
				1/4			Gloss Glass Top \$	9272		
108"W x 42"D or 9' - 2 Piece Boat Top										
88-42108BT	Laminate	108	42-36	1 3/16	260	27.0	F, G, X, Y / P\$	2209		
				1 3/16			K / P\$	4070		
				1 1/2			H / P\$	2482		
	Veneer			1 3/16			F, G, X, Y / W\$	2458		
				1 3/16			K / W\$	4556		
				1 1/2			H / W\$	2904		
	Glass			1/4			Acid Etched Glass Top \$	12539		
				1/4			Gloss Glass Top \$	10583		

Additional 42" Boat Shaped Tops on Next Page



Double Kerf (F)
1 3/16"



Duo (G)
1 3/16"



Fluted (X)
1 3/16"



Square (Y)
1 3/16"



Knife (K)
1 3/16"



Vertical Square (H)
1 1/2"

Pricing Codes:
P= HPL W= Wood Top

[See Catalyst Overview For Ordering Options](#)

Item	Model No.	Material	W	D	H	Ship Wt	Cubic Ft	Edge Profile + Material	List Price
<i>42"D CONTINUED FROM PREVIOUS PAGE</i>	120"W x 42"D or 10' - 2 Piece Boat Top								
	88-42120BT	Laminate	120	42-36	1 $\frac{3}{16}$ "	268	27.0	F, G, X, Y / P\$	2251
					1 $\frac{3}{16}$ "			K / P\$	4313
					1 $\frac{1}{2}$ "			H / P\$	2555
<u>Must Specify (in this order):</u> Model # Top Material Top Finish/Color Edge Profile Glass (Y/N) Glass Color/Surface Finish Power/Data Power/Data Location	Veneer				1 $\frac{3}{16}$ "			F, G, X, Y / W\$	2613
					1 $\frac{3}{16}$ "			K / W\$	4858
					1 $\frac{1}{2}$ "			H / W\$	3105
	Glass					$\frac{1}{4}$ "		Acid Etched Glass Top \$	13697
						$\frac{1}{4}$ "		Gloss Glass Top \$	11526

Description

- Tops Available with Veneer (W) or HPL (P) Top in 1 $\frac{3}{16}$ " and 1 $\frac{1}{2}$ " Thicknesses
- Must Specify Edge Profile: 1 $\frac{3}{16}$ " Thick/Double Kerf (F), Duo (G), Fluted (X), Square (Y), and Knife (K) Edge Profiles or 1 $\frac{1}{2}$ " Thick/Vertical Square (H)
- Veneer (W) Top Grain Runs Depth of Top and HPL (P) Top Grain Runs Width of Top
- Available with Back Painted Tempered Glass Top; Must Specify Color and Finish ([See Options](#))
- Power and Data Options Available; Sold Separately ([See Multiple Power Unit Details](#))
- Bases Sold Separately ([See Multiple Base Options](#))



Double Kerf (F)
1 $\frac{3}{16}$ "



Duo (G)
1 $\frac{3}{16}$ "



Fluted (X)
1 $\frac{3}{16}$ "



Square (Y)
1 $\frac{3}{16}$ "



Knife (K)
1 $\frac{3}{16}$ "



Vertical Square (H)
1 $\frac{1}{2}$ "

Pricing Codes:
P= HPL W= Wood

[See Catalyst Overview For Ordering Options](#)

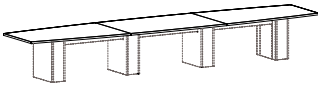
Item	Model No.	Material	W	D	H	Ship Wt	Cubic Ft	Edge Profile + Material	List Price	
BOAT SHAPE MEETING TOP 48"D  88-48216BT Shown with 88-2417810RAB (10" Rectangle Accent Base) BASES SOLD SEPARATELY	72"W x 48"D or 6' - 1 Piece Boat Top									
	88-4872BT	Laminate	72	48-36	1 ³ / ₁₆	142	12.8	F, G, X, Y / P\$	1401	
					1 ³ / ₁₆			K / P\$	2957	
					1 ¹ / ₂			H / P\$	1606	
		Veneer			1 ³ / ₁₆			F, G, X, Y / W\$	1831	
					1 ³ / ₁₆			K / W\$	3305	
					1 ¹ / ₂			H / W\$	2170	
		Glass			1/4			Acid Etched Glass Top \$	9653	
					1/4			Gloss Glass Top \$	8163	
	84"W x 48"D or 7' - 1 Piece Boat Top									
	88-4884BT	Laminate	84	48-36	1 ³ / ₁₆	164	15.0	F, G, X, Y / P\$	1665	
					1 ³ / ₁₆			K / P\$	3251	
				1 ¹ / ₂			H / P\$	1904		
	Veneer			1 ³ / ₁₆			F, G, X, Y / W\$	1933		
				1 ³ / ₁₆			K / W\$	3663		
				1 ¹ / ₂			H / W\$	2325		
	Glass			1/4			Acid Etched Glass Top \$	10913		
				1/4			Gloss Glass Top \$	9176		
96"W x 48"D or 8' - 1 Piece Boat Top										
88-4896BT	Laminate	96	48-36	1 ³ / ₁₆	295	27.0	F, G, X, Y / P\$	1715		
				1 ³ / ₁₆			K / P\$	3653		
				1 ¹ / ₂			H / P\$	1989		
	Veneer			1 ³ / ₁₆			F, G, X, Y / W\$	2188		
				1 ³ / ₁₆			K / W\$	3990		
				1 ¹ / ₂			H / W\$	2632		
	Glass			1/4			Acid Etched Glass Top \$	12295		
				1/4			Gloss Glass Top \$	10309		
108"W x 48"D or 9' - 2 Piece Boat Top										
88-48108BT	Laminate	108	48-36	1 ³ / ₁₆	218	23.5	F, G, X, Y / P\$	2515		
				1 ³ / ₁₆			K / P\$	4556		
				1 ¹ / ₂			H / P\$	2828		
	Veneer			1 ³ / ₁₆			F, G, X, Y / W\$	2969		
				1 ³ / ₁₆			K / W\$	5130		
				1 ¹ / ₂			H / W\$	3471		
	Glass			1/4			Acid Etched Glass Top \$	14192		
				1/4			Gloss Glass Top \$	11958		

Additional 48" Boat Shaped Tops on Next Page



Double Kerf (F)
1³/₁₆"



Duo (G)
1³/₁₆"



Fluted (X)
1³/₁₆"



Square (Y)
1³/₁₆"



Knife (K)
1³/₁₆"



Vertical Square (H)
1¹/₂"

Pricing Codes:
P= HPL W= Wood

[See Catalyst Overview For Ordering Options](#)

Item	Model No.	Material	W	D	H	Ship Wt	Cubic Ft	Edge Profile + Material	List Price	
<i>48"D CONTINUED FROM PREVIOUS PAGE</i>	120"W x 48"D x or 10' - 2 Piece Boat Top									
	88-48120BT	Laminate	120	48-36	1 $\frac{1}{16}$ "	240	23.5	F, G, X, Y / P\$	2578	
					1 $\frac{1}{16}$ "			K / P\$	4914	
					1 $\frac{1}{2}$ "			H / P\$	2926	
		Veneer			1 $\frac{1}{16}$ "			F, G, X, Y / W\$	3219	
					1 $\frac{1}{16}$ "			K / W\$	5408	
					1 $\frac{1}{2}$ "			H / W\$	3772	
		Glass			$\frac{1}{4}$ "			Acid Etched Glass Top \$	15513	
					$\frac{1}{4}$ "			Gloss Glass Top \$	13032	
	132"W x 48"D or 11' - 2 Piece Boat Top									
	88-48132BT	Laminate	132	48-36	1 $\frac{1}{16}$ "	262	23.5	F, G, X, Y / P\$	2652	
					1 $\frac{1}{16}$ "			K / P\$	5179	
					1 $\frac{1}{2}$ "			H / P\$	3033	
		Veneer			1 $\frac{1}{16}$ "			F, G, X, Y / W\$	3481	
					1 $\frac{1}{16}$ "			K / W\$	5807	
					1 $\frac{1}{2}$ "			H / W\$	4087	
		Glass			$\frac{1}{4}$ "			Acid Etched Glass Top \$	16845	
					$\frac{1}{4}$ "			Gloss Glass Top \$	14115	
144"W x 48"D or 12' - 2 Piece Boat Top										
88-48144BT	Laminate	144	48-36	1 $\frac{1}{16}$ "	284	23.5	F, G, X, Y / P\$	2714		
				1 $\frac{1}{16}$ "			K / P\$	5435		
				1 $\frac{1}{2}$ "			H / P\$	3132		
	Veneer			1 $\frac{1}{16}$ "			F, G, X, Y / W\$	3731		
				1 $\frac{1}{16}$ "			K / W\$	6190		
				1 $\frac{1}{2}$ "			H / W\$	4390		
	Glass			$\frac{1}{4}$ "			Acid Etched Glass Top \$	18166		
				$\frac{1}{4}$ "			Gloss Glass Top \$	15187		
156"W x 48"D or 13' - 2 Piece Boat Top										
88-48156BT	Laminate	156	48-36	1 $\frac{1}{16}$ "	306	31.2	F, G, X, Y / P\$	3235		
				1 $\frac{1}{16}$ "			K / P\$	6014		
				1 $\frac{1}{2}$ "			H / P\$	3687		
	Veneer			1 $\frac{1}{16}$ "			F, G, X, Y / W\$	3999		
				1 $\frac{1}{16}$ "			K / W\$	6772		
				1 $\frac{1}{2}$ "			H / W\$	4711		
	Glass			$\frac{1}{4}$ "			Acid Etched Glass Top \$	19582		
				$\frac{1}{4}$ "			Gloss Glass Top \$	16355		

Must Specify (in this order):

- Model #
- Top Material
- Top Finish/Color
- Edge Profile
- Glass (Y/N)
- Glass Color/Surface Finish
- Power/Data
- Power/Data Location

Additional 48" Boat Shaped Tops on Next Page



Double Kerf (F)
1 $\frac{1}{16}$ "



Duo (G)
1 $\frac{1}{16}$ "



Fluted (X)
1 $\frac{1}{16}$ "



Square (Y)
1 $\frac{1}{16}$ "



Knife (K)
1 $\frac{1}{16}$ "



Vertical Square (H)
1 $\frac{1}{2}$ "

Pricing Codes:
P= HPL W= Wood

[See Catalyst Overview For Ordering Options](#)

Item	Model No.	Material	W	D	H	Ship Wt	Cubic Ft	Edge Profile + Material	List Price		
<i>48"D CONTINUED FROM PREVIOUS PAGE</i>	168"W x 48"D or 14' - 2 Piece Boat Top										
	88-48168BT	Laminate	168	48-36	1 ³ / ₁₆	328	31.2	F, G, X, Y / P\$	3283		
					1 ³ / ₁₆			K / P\$	6401		
					1 ¹ / ₂			H / P\$	3771		
		Veneer			1 ³ / ₁₆			F, G, X, Y / W\$	4189		
					1 ³ / ₁₆			K / W\$	6978		
					1 ¹ / ₂			H / W\$	4954		
		Glass			1/4			Acid Etched Glass Top \$	20889		
					1/4			Gloss Glass Top \$	17414		
		180"W x 48"D or 15' - 2 Piece Boat Top									
	88-48180BT	Laminate	180	48-36	1 ³ / ₁₆	350	31.2	F, G, X, Y / P\$	3453		
					1 ³ / ₁₆			K / P\$	6766		
				1 ¹ / ₂			H / P\$	3977			
	Veneer			1 ³ / ₁₆			F, G, X, Y / W\$	4536			
				1 ³ / ₁₆			K / W\$	7489			
				1 ¹ / ₂			H / W\$	5352			
	Glass			1/4			Acid Etched Glass Top \$	22321			
				1/4			Gloss Glass Top \$	18598			
	192"W x 48"D or 16' - 2 Piece Boat Top										
88-48192BT	Laminate	192	48-36	1 ³ / ₁₆	372	31.2	F, G, X, Y / P\$	3504			
				1 ³ / ₁₆			K / P\$	7007			
				1 ¹ / ₂			H / P\$	4060			
	Veneer			1 ³ / ₁₆			F, G, X, Y / W\$	4727			
				1 ³ / ₁₆			K / W\$	7844			
				1 ¹ / ₂			H / W\$	5596			
	Glass			1/4			Acid Etched Glass Top \$	23629			
				1/4			Gloss Glass Top \$	19658			
	204"W x 48"D or 17' - 3 Piece Boat Top										
88-48204BT	Laminate	204	48-36	1 ³ / ₁₆	394	48.9	F, G, X, Y / P\$	4085			
				1 ³ / ₁₆			K / P\$	7813			
				1 ¹ / ₂			H / P\$	4675			
	Veneer			1 ³ / ₁₆			F, G, X, Y / W\$	5725			
				1 ³ / ₁₆			K / W\$	9084			
				1 ¹ / ₂			H / W\$	6541			
	Glass			1/4			Acid Etched Glass Top \$	25510			
				1/4			Gloss Glass Top \$	21291			

Must Specify (in this order):
 Model #
 Top Material
 Top Finish/Color
 Edge Profile
 Glass (Y/N)
 Glass Color/Surface Finish
 Power/Data
 Power/Data Location

Additional 48" Boat Shaped Tops on Next Page



Double Kerf (F)
1³/₁₆"



Duo (G)
1³/₁₆"



Fluted (X)
1³/₁₆"



Square (Y)
1³/₁₆"



Knife (K)
1³/₁₆"



Vertical Square (H)
1¹/₂"

Pricing Codes:
 P= HPL W= Wood

[See Catalyst Overview For Ordering Options](#)

Item	Model No.	Material	W	D	H	Ship Wt	Cubic Ft	Edge Profile + Material	List Price	
<i>48"D CONTINUED FROM PREVIOUS PAGE</i>	216"W x 48"D or 18' - 3 Piece Boat Top									
	88-48216BT	Laminate	216	48-36	1 $\frac{3}{16}$ "	416	48.9	F, G, X, Y / P\$	4134	
					1 $\frac{3}{16}$ "			K / P\$	8053	
					1 $\frac{1}{2}$ "			H / P\$	4759	
		Veneer			1 $\frac{3}{16}$ "			F, G, X, Y / W\$	6020	
					1 $\frac{3}{16}$ "			K / W\$	9482	
					1 $\frac{1}{2}$ "			H / W\$	6883	
		Glass			$\frac{1}{4}$ "			Acid Etched Glass Top \$	26818	
					$\frac{1}{4}$ "			Gloss Glass Top \$	22351	
		228"W x 48"D or 19' - 3 Piece Boat Top								
	88-48228BT	Laminate	228	48-36	1 $\frac{3}{16}$ "	438	48.9	F, G, X, Y / P\$	5151	
					1 $\frac{3}{16}$ "			K / P\$	9289	
					1 $\frac{1}{2}$ "			H / P\$	5811	
		Veneer			1 $\frac{3}{16}$ "			F, G, X, Y / W\$	6770	
					1 $\frac{3}{16}$ "			K / W\$	10334	
					1 $\frac{1}{2}$ "			H / W\$	7680	
		Glass			$\frac{1}{4}$ "			Acid Etched Glass Top \$	28557	
					$\frac{1}{4}$ "			Gloss Glass Top \$	23842	
	240"W x 48"D or 20' - 3 Piece Boat Top									
88-48240BT	Laminate	240	48-36	1 $\frac{3}{16}$ "	460	48.9	F, G, X, Y / P\$	5201		
				1 $\frac{3}{16}$ "			K / P\$	9530		
				1 $\frac{1}{2}$ "			H / P\$	5894		
	Veneer			1 $\frac{3}{16}$ "			F, G, X, Y / W\$	7066		
				1 $\frac{3}{16}$ "			K / W\$	10731		
				1 $\frac{1}{2}$ "			H / W\$	8020		
	Glass			$\frac{1}{4}$ "			Acid Etched Glass Top \$	29865		
				$\frac{1}{4}$ "			Gloss Glass Top \$	24900		

Must Specify (in this order):
 Model #
 Top Material
 Top Finish/Color
 Edge Profile
 Glass (Y/N)
 Glass Color/Surface Finish
 Power/Data
 Power/Data Location

Description

- Tops Available with Veneer (W) or HPL (P) Top in 1 $\frac{3}{16}$ " and 1 $\frac{1}{2}$ " Thicknesses
- Must Specify Edge Profile: 1 $\frac{3}{16}$ " Thick/Double Kerf (F), Duo (G), Fluted (X), Square (Y), and Knife (K) Edge Profiles or 1 $\frac{1}{2}$ " Thick/Vertical Square (H)
- Veneer (W) Top Grain Runs Depth of Top and HPL (P) Top Grain Runs Width of Top
- All Veneer Tops, as well as Laminate Tops up to 144" (12 feet), have Matching Woodgrain. Laminate Tops Sized 156" (13 feet) and Longer have Non-Matching Woodgrain
- Available with Back Painted Tempered Glass Top; Must Specify Color and Finish ([See Options](#))
- Power and Data Options Available; Sold Separately ([See Multiple Power Unit Details](#))
- Bases Sold Separately ([See Multiple Base Options](#))



Double Kerf (F)
1 $\frac{3}{16}$ "



Duo (G)
1 $\frac{3}{16}$ "



Fluted (X)
1 $\frac{3}{16}$ "



Square (Y)
1 $\frac{3}{16}$ "



Knife (K)
1 $\frac{3}{16}$ "



Vertical Square (H)
1 $\frac{1}{2}$ "

Pricing Codes:
 P= HPL W= Wood

[See Catalyst Overview For Ordering Options](#)

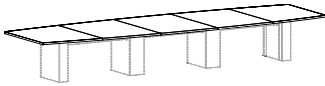
Item	Model No.	Material	W	D	H	Ship Wt	Cubic Ft	Edge Profile + Material	List Price	
BOAT SHAPE MEETING TOP 54"D  88-54204BT Shown in Veneer with 88-2416610RB (10" Rectangle Base) BASES SOLD SEPARATELY Must Specify (in this order): Model # Top Material Top Finish/Color Edge Profile Glass (Y/N) Glass Color/Surface Finish Power/Data Power/Data Location	120"W x 54"D or 10' - 3 Piece Veneer (W) and 2 Piece HPL (P) Boat Top									
	88-54120BT	Laminate	120	54-42	1 3/16	260	12.1	F, G, X, Y / P\$	2863	
					1 3/16			K / P\$	5359	
					1 1/2			H / P\$	3256	
		Veneer			1 3/16			F, G, X, Y / W\$	4351	
					1 3/16			K / W\$	6646	
					1 1/2			H / W\$	4900	
		Glass			1/4			Acid Etched Glass Top \$	17505	
					1/4			Gloss Glass Top \$	14714	
	132"W x 54"D or 11' - 3 Piece Veneer (W) and 2 Piece HPL (P) Boat Top									
	88-54132BT	Laminate	132	54-42	1 3/16	285	13.2	F, G, X, Y / P\$	2931	
					1 3/16			K / P\$	5630	
				1 1/2			H / P\$	3364		
	Veneer			1 3/16			F, G, X, Y / W\$	4586		
				1 3/16			K / W\$	7047		
				1 1/2			H / W\$	5184		
	Glass			1/4			Acid Etched Glass Top \$	18970		
				1/4			Gloss Glass Top \$	15900		
144"W x 54"D or 12' - 3 Piece Veneer (W) and 2 Piece HPL (P) Boat Top										
88-54144BT	Laminate	144	54-42	1 3/16	309	15.0	F, G, X, Y / P\$	3000		
				1 3/16			K / P\$	5899		
				1 1/2			H / P\$	3473		
	Veneer			1 3/16			F, G, X, Y / W\$	4822		
				1 3/16			K / W\$	7451		
				1 1/2			H / W\$	5472		
	Glass			1/4			Acid Etched Glass Top \$	20439		
				1/4			Gloss Glass Top \$	17088		
156"W x 54"D or 13' - 4 Piece Veneer (W) and 2 Piece HPL (P) Boat Top										
88-54156BT	Laminate	156	54-42	1 3/16	334	16.0	F, G, X, Y / P\$	3529		
				1 3/16			K / P\$	6641		
				1 1/2			H / P\$	4040		
	Veneer			1 3/16			F, G, X, Y / W\$	5841		
				1 3/16			K / W\$	8748		
				1 1/2			H / W\$	6632		
	Glass			1/4			Acid Etched Glass Top \$	22264		
				1/4			Gloss Glass Top \$	18635		

Additional 54" Boat Shaped Tops on Next Page



Double Kerf (F)
1 3/16"



Duo (G)
1 3/16"



Fluted (X)
1 3/16"



Square (Y)
1 3/16"



Knife (K)
1 3/16"



Vertical Square (H)
1 1/2"

Pricing Codes:
P= HPL W= Wood

[See Catalyst Overview For Ordering Options](#)

Item	Model No.	Material	W	D	H	Ship Wt	Cubic Ft	Edge Profile + Material	List Price		
<i>54"D CONTINUED FROM PREVIOUS PAGE</i>	168"W x 54"D or 14' - 4 Piece Veneer (W) and 2 Piece HPL (P) Boat Top										
	88-54168BT	Laminate	168	54-42	1 $\frac{1}{16}$ "	359	17.0	F, G, X, Y / P\$	3582		
					1 $\frac{1}{16}$ "			K / P\$	6897		
					1 $\frac{1}{2}$ "			H / P\$	4134		
		Veneer			1 $\frac{1}{16}$ "			F, G, X, Y / W\$	6090		
					1 $\frac{1}{16}$ "			K / W\$	9174		
					1 $\frac{1}{2}$ "			H / W\$	6939		
		Glass			$\frac{1}{4}$ "			Acid Etched Glass Top \$	23720		
					$\frac{1}{4}$ "			Gloss Glass Top \$	19811		
		180"W x 54"D or 15' - 4 Piece Veneer (W) and 2 Piece HPL (P) Boat Top									
	88-54180BT	Laminate	180	54-42	1 $\frac{1}{16}$ "	384	18.0	F, G, X, Y / P\$	3638		
					1 $\frac{1}{16}$ "			K / P\$	7153		
				1 $\frac{1}{2}$ "			H / P\$	4226			
	Veneer			1 $\frac{1}{16}$ "			F, G, X, Y / W\$	6337			
				1 $\frac{1}{16}$ "			K / W\$	9598			
				1 $\frac{1}{2}$ "			H / W\$	7244			
	Glass			$\frac{1}{4}$ "			Acid Etched Glass Top \$	25175			
				$\frac{1}{4}$ "			Gloss Glass Top \$	20987			
	192"W x 54"D or 16' - 4 Piece Veneer (W) and 2 Piece HPL (P) Boat Top										
88-54192BT	Laminate	192	54-42	1 $\frac{1}{16}$ "	408	19.0	F, G, X, Y / P\$	3690			
				1 $\frac{1}{16}$ "			K / P\$	7408			
				1 $\frac{1}{2}$ "			H / P\$	4319			
	Veneer			1 $\frac{1}{16}$ "			F, G, X, Y / W\$	6586			
				1 $\frac{1}{16}$ "			K / W\$	10023			
				1 $\frac{1}{2}$ "			H / W\$	7550			
	Glass			$\frac{1}{4}$ "			Acid Etched Glass Top \$	26629			
				$\frac{1}{4}$ "			Gloss Glass Top \$	22161			
	204"W x 54"D or 17' - 5 Piece Veneer (W) and 3 Piece HPL (P) Boat Top										
88-54204BT	Laminate	204	54-42	1 $\frac{1}{16}$ "	445	21.0	F, G, X, Y / P\$	4484			
				1 $\frac{1}{16}$ "			K / P\$	8442			
				1 $\frac{1}{2}$ "			H / P\$	5150			
	Veneer			1 $\frac{1}{16}$ "			F, G, X, Y / W\$	7983			
				1 $\frac{1}{16}$ "			K / W\$	11622			
				1 $\frac{1}{2}$ "			H / W\$	9009			
	Glass			$\frac{1}{4}$ "			Acid Etched Glass Top \$	28863			
				$\frac{1}{4}$ "			Gloss Glass Top \$	24118			

Must Specify (in this order):
 Model #
 Top Material
 Top Finish/Color
 Edge Profile
 Glass (Y/N)
 Glass Color/Surface Finish
 Power/Data
 Power/Data Location

Additional 54" Boat Shaped Tops on Next Page



Double Kerf (F) 1 $\frac{1}{16}$ " Duo (G) 1 $\frac{1}{16}$ " Fluted (X) 1 $\frac{1}{16}$ " Square (Y) 1 $\frac{1}{16}$ " Knife (K) 1 $\frac{1}{16}$ " Vertical Square (H) 1 $\frac{1}{2}$ "

Pricing Codes:
 P= HPL W= Wood

[See Catalyst Overview For Ordering Options](#)

Item	Model No.	Material	W	D	H	Ship Wt	Cubic Ft	Edge Profile + Material	List Price		
<i>54"D CONTINUED FROM PREVIOUS PAGE</i>	216"W x 54"D or 18' - 5 Piece Veneer (W) and 3 Piece HPL (P) Boat Top										
	88-54216BT	Laminate	216	54-42	1 3/16	470	22.0	F, G, X, Y / P\$	4538		
					1 3/16			K / P\$	8696		
					1 1/2			H / P\$	5243		
		Veneer			1 3/16			F, G, X, Y / W\$	8254		
					1 3/16			K / W\$	12067		
					1 1/2			H / W\$	9337		
		Glass			1/4			Acid Etched Glass Top \$	30316		
					1/4			Gloss Glass Top \$	25292		
		228"W x 54"D or 19' - 5 Piece Veneer (W) and 3 Piece HPL (P) Boat Top									
		88-54228BT	Laminate	228	54-42	1 3/16	495	23.0	F, G, X, Y / P\$	5205	
						1 3/16			K / P\$	9582	
					1 1/2			H / P\$	5949		
		Veneer			1 3/16			F, G, X, Y / W\$	8524		
					1 3/16			K / W\$	12513		
					1 1/2			H / W\$	9664		
		Glass			1/4			Acid Etched Glass Top \$	31810		
					1/4			Gloss Glass Top \$	26507		
		240"W x 54"D or 20' - 5 Piece Veneer (W) and 3 Piece HPL (P) Boat Top									
		88-54240BT	Laminate	240	54-42	1 3/16	519	24.0	F, G, X, Y / P\$	5258	
						1 3/16			K / P\$	9837	
					1 1/2			H / P\$	6042		
		Veneer			1 3/16			F, G, X, Y / W\$	8796		
					1 3/16			K / W\$	12959		
					1 1/2			H / W\$	9992		
		Glass			1/4			Acid Etched Glass Top \$	33265		
					1/4			Gloss Glass Top \$	27681		

Must Specify (in this order):

- Model #
- Top Material
- Top Finish/Color
- Edge Profile
- Glass (Y/N)
- Glass Color/Surface Finish
- Power/Data
- Power/Data Location

Description

- Tops Available with Veneer (W) or HPL (P) Top in 1 3/16" and 1 1/2" Thicknesses
- Must Specify Edge Profile: 1 3/16" Thick/Double Kerf (F), Duo (G), Fluted (X), Square (Y), and Knife (K) Edge Profiles or 1 1/2" Thick/Vertical Square (H)
- Veneer (W) Top Grain Runs Depth of Top and HPL (P) Top Grain Runs Width of Top
- All Veneer Tops, as well as Laminate Tops up to 144" (12 feet), have Matching Woodgrain. Laminate Tops Sized 156" (13 feet) and Longer have Non-Matching Woodgrain
- Available with Back Painted Tempered Glass Top; Must Specify Color and Finish ([See Options](#))
- Power and Data Options Available; Sold Separately ([See Multiple Power Unit Details](#))
- Bases Sold Separately ([See Multiple Base Options](#))



Double Kerf (F)
1 3/16"



Duo (G)
1 3/16"



Fluted (X)
1 3/16"



Square (Y)
1 3/16"



Knife (K)
1 3/16"



Vertical Square (H)
1 1/2"

Pricing Codes:
P= HPL W= Wood

[See Catalyst Overview For Ordering Options](#)

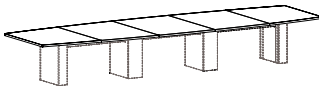
Item	Model No.	Material	W	D	H	Ship Wt	Cubic Ft	Edge Profile + Material	List Price	
BOAT SHAPE MEETING TOP 60"D  <p>88-60204BT Shown in Veneer with 88-24166C610RB (6" + 10" Combo Rectangle Base) BASES SOLD SEPARATELY</p>	120"W x 60"D or 10' - 3 Piece Veneer (W) and 2 Piece HPL (P) Boat Top									
	88-60120BT	Laminate	120	60-48	1 $\frac{1}{16}$ "	287	13.3	F, G, X, Y / P\$	2916	
					1 $\frac{1}{8}$ "			K / P\$	5566	
					1 $\frac{1}{2}$ "			H / P\$	3354	
		Veneer			1 $\frac{1}{16}$ "			F, G, X, Y / W\$	4602	
					1 $\frac{1}{8}$ "			K / W\$	6994	
					1 $\frac{1}{2}$ "			H / W\$	5204	
		Glass			$\frac{1}{4}$ "			Acid Etched Glass Top \$	19040	
					$\frac{1}{4}$ "			Gloss Glass Top \$	15938	
	132"W x 60"D or 11' - 3 Piece Veneer (W) and 2 Piece HPL (P) Boat Top									
	Must Specify (in this order): Model # Top Material Top Finish/Color Edge Profile Glass (Y/N) Glass Color/Surface Finish Power/Data Power/Data Location	88-60132BT	Laminate	132	60-48	1 $\frac{1}{16}$ "	323	14.6	F, G, X, Y / P\$	2989
						1 $\frac{1}{8}$ "			K / P\$	5848
					1 $\frac{1}{2}$ "			H / P\$	3472	
		Veneer			1 $\frac{1}{16}$ "			F, G, X, Y / W\$	4862	
					1 $\frac{1}{8}$ "			K / W\$	7424	
					1 $\frac{1}{2}$ "			H / W\$	5519	
		Glass			$\frac{1}{4}$ "			Acid Etched Glass Top \$	20655	
					$\frac{1}{4}$ "			Gloss Glass Top \$	17244	
144"W x 60"D or 12' - 3 Piece Veneer (W) and 2 Piece HPL (P) Boat Top										
88-60144BT		Laminate	144	60-48	1 $\frac{1}{16}$ "	342	16.0	F, G, X, Y / P\$	3062	
					1 $\frac{1}{8}$ "			K / P\$	6134	
					1 $\frac{1}{2}$ "			H / P\$	3589	
	Veneer			1 $\frac{1}{16}$ "			F, G, X, Y / W\$	5122		
				1 $\frac{1}{8}$ "			K / W\$	7858		
				1 $\frac{1}{2}$ "			H / W\$	5837		
	Glass			$\frac{1}{4}$ "			Acid Etched Glass Top \$	22274		
				$\frac{1}{4}$ "			Gloss Glass Top \$	18550		
156"W x 60"D or 13' - 4 Piece Veneer (W) and 2 Piece HPL (P) Boat Top										
88-60156BT	Laminate	156	60-48	1 $\frac{1}{16}$ "	376	17.2	F, G, X, Y / P\$	3595		
				1 $\frac{1}{8}$ "			K / P\$	6891		
				1 $\frac{1}{2}$ "			H / P\$	4166		
	Veneer			1 $\frac{1}{16}$ "			F, G, X, Y / W\$	6187		
				1 $\frac{1}{8}$ "			K / W\$	9217		
				1 $\frac{1}{2}$ "			H / W\$	7058		
	Glass			$\frac{1}{4}$ "			Acid Etched Glass Top \$	24247		
				$\frac{1}{4}$ "			Gloss Glass Top \$	20214		

Additional 60" Boat Shaped Tops on Next Page



Double Kerf (F)
1 $\frac{1}{16}$ "



Duo (G)
1 $\frac{1}{16}$ "



Fluted (X)
1 $\frac{1}{16}$ "



Square (Y)
1 $\frac{1}{16}$ "



Knife (K)
1 $\frac{1}{16}$ "



Vertical Square (H)
1 $\frac{1}{2}$ "

Pricing Codes:
P= HPL W= Wood

[See Catalyst Overview For Ordering Options](#)

Item	Model No.	Material	W	D	H	Ship Wt	Cubic Ft	Edge Profile + Material	List Price
60"D CONTINUED FROM PREVIOUS PAGE									
168"W x 60"D or 14' - 4 Piece Veneer (W) and 2 Piece HPL (P) Boat Top									
	88-60168BT	Laminate	168	60-48	1 ³ / ₁₆	403	18.5	F, G, X, Y / P\$	3654
					1 ³ / ₁₆			K / P\$	7160
					1 ¹ / ₂			H / P\$	4267
		Veneer			1 ³ / ₁₆			F, G, X, Y / W\$	6461
					1 ³ / ₁₆			K / W\$	9671
					1 ¹ / ₂			H / W\$	7396
		Glass			1/4			Acid Etched Glass Top \$	25849
					1/4			Gloss Glass Top \$	21507
180"W x 60"D or 15' - 4 Piece Veneer (W) and 2 Piece HPL (P) Boat Top									
	88-60180BT	Laminate	180	60-48	1 ³ / ₁₆	431	19.8	F, G, X, Y / P\$	3713
					1 ³ / ₁₆			K / P\$	7428
					1 ¹ / ₂			H / P\$	4370
		Veneer			1 ³ / ₁₆			F, G, X, Y / W\$	6735
					1 ³ / ₁₆			K / W\$	10125
					1 ¹ / ₂			H / W\$	7735
		Glass			1/4			Acid Etched Glass Top \$	27451
					1/4			Gloss Glass Top \$	22798
192"W x 60"D or 16' - 4 Piece Veneer (W) and 2 Piece HPL (P) Boat Top									
	88-60192BT	Laminate	192	60-48	1 ³ / ₁₆	458	21.1	F, G, X, Y / P\$	3772
					1 ³ / ₁₆			K / P\$	7698
					1 ¹ / ₂			H / P\$	4472
		Veneer			1 ³ / ₁₆			F, G, X, Y / W\$	7010
					1 ³ / ₁₆			K / W\$	10579
					1 ¹ / ₂			H / W\$	8073
		Glass			1/4			Acid Etched Glass Top \$	29052
					1/4			Gloss Glass Top \$	24087
204"W x 60"D or 17' - 5 Piece Veneer (W) and 3 Piece HPL (P) Boat Top									
	88-60204BT	Laminate	204	60-48	1 ³ / ₁₆	492	22.4	F, G, X, Y / P\$	4569
					1 ³ / ₁₆			K / P\$	8748
					1 ¹ / ₂			H / P\$	5313
		Veneer			1 ³ / ₁₆			F, G, X, Y / W\$	8475
					1 ³ / ₁₆			K / W\$	12247
					1 ¹ / ₂			H / W\$	9603
		Glass			1/4			Acid Etched Glass Top \$	31436
					1/4			Gloss Glass Top \$	26163

Must Specify (in this order):
 Model #
 Top Material
 Top Finish/Color
 Edge Profile
 Glass (Y/N)
 Glass Color/Surface Finish
 Power/Data
 Power/Data Location

Additional 60" Boat Shaped Tops on Next Page



Double Kerf (F)
1³/₁₆"



Duo (G)
1³/₁₆"



Fluted (X)
1³/₁₆"



Square (Y)
1³/₁₆"



Knife (K)
1³/₁₆"



Vertical Square (H)
1¹/₂"

Pricing Codes:
 P= HPL W= Wood

[See Catalyst Overview For Ordering Options](#)

Item	Model No.	Material	W	D	H	Ship Wt	Cubic Ft	Edge Profile + Material	List Price		
<i>60"D CONTINUED FROM PREVIOUS PAGE</i>	216"W x 60"D or 18' - 5 Piece Veneer (W) and 3 Piece HPL (P) Boat Top										
	88-60216BT	Laminate	216	60-48	1 ³ / ₁₆	519	23.7	F, G, X, Y / P\$	4628		
					1 ³ / ₁₆			K / P\$	9018		
					1 ¹ / ₂			H / P\$	5415		
		Veneer			1 ³ / ₁₆			F, G, X, Y / W\$	8774		
					1 ³ / ₁₆			K / W\$	12726		
					1 ¹ / ₂			H / W\$	9966		
		Glass			1 ¹ / ₄			Acid Etched Glass Top \$	33037		
					1 ¹ / ₄			Gloss Glass Top \$	27453		
		228"W x 60"D or 19' - 5 Piece Veneer (W) and 3 Piece HPL (P) Boat Top									
	88-60228BT	Laminate	228	60-48	1 ³ / ₁₆	547	25.0	F, G, X, Y / P\$	5300		
					1 ³ / ₁₆			K / P\$	9916		
				1 ¹ / ₂			H / P\$	6131			
	Veneer			1 ³ / ₁₆			F, G, X, Y / W\$	9073			
				1 ³ / ₁₆			K / W\$	13205			
				1 ¹ / ₂			H / W\$	10327			
	Glass			1 ¹ / ₄			Acid Etched Glass Top \$	34679			
				1 ¹ / ₄			Gloss Glass Top \$	28785			
	240"W x 60"D or 20' - 5 Piece Veneer (W) and 3 Piece HPL (P) Boat Top										
88-60240BT	Laminate	240	60-48	1 ³ / ₁₆	574	26.3	F, G, X, Y / P\$	5358			
				1 ³ / ₁₆			K / P\$	10186			
				1 ¹ / ₂			H / P\$	6233			
	Veneer			1 ³ / ₁₆			F, G, X, Y / W\$	9373			
				1 ³ / ₁₆			K / W\$	13684			
				1 ¹ / ₂			H / W\$	10691			
	Glass			1 ¹ / ₄			Acid Etched Glass Top \$	36281			
				1 ¹ / ₄			Gloss Glass Top \$	30076			

Must Specify (in this order):
 Model #
 Top Material
 Top Finish/Color
 Edge Profile
 Glass (Y/N)
 Glass Color/Surface Finish
 Power/Data
 Power/Data Location

Description

- Tops Available with Veneer (W) or HPL (P) Top in 1³/₁₆" and 1¹/₂" Thicknesses
- Must Specify Edge Profile: 1³/₁₆" Thick/Double Kerf (F), Duo (G), Fluted (X), Square (Y), and Knife (K) Edge Profiles or 1¹/₂" Thick/Vertical Square (H)
- Veneer (W) Top Grain Runs Depth of Top and HPL (P) Top Grain Runs Width of Top
- All Veneer Tops, as well as Laminate Tops up to 144" (12 feet), have Matching Woodgrain. Laminate Tops Sized 156" (13 feet) and Longer have Non-Matching Woodgrain
- Available with Back Painted Tempered Glass Top; Must Specify Color and Finish ([See Options](#))
- Power and Data Options Available; Sold Separately ([See Multiple Power Unit Details](#))
- Bases Sold Separately ([See Multiple Base Options](#))



Pricing Codes:
 P= HPL W= Wood

[See Catalyst Overview For Ordering Options](#)

Item	Model No.	Materials	W	D	H	Ship Wt	Cubic Ft	List Price	
RECTANGLE PANEL BASES WITH TROUGH 20"W	20"W Bases								
	Two (2) Panel Bases - For Use With 72" x 36" / 42" Surfaces								
	88-2034RPB	Laminate	20	34	28¾	66	6.7	T\$	1766
		Veneer						W\$	1953
	Two (2) Panel Bases - For Use With 84" x 36" / 42" Surfaces								
	88-2046RPB	Laminate	20	46	28¾	69	6.7	T\$	1851
		Veneer						W\$	1995
	Two (2) Panel Bases - For Use With 96" x 36" / 42" Surfaces								
	88-2058RPB	Laminate	20	58	28¾	72	6.7	T\$	2077
		Veneer						W\$	2173
	Two (2) Panel Bases - For Use With 108" x 42" Surfaces								
	88-2070RPB	Laminate	20	70	28¾	75	6.7	T\$	2121
		Veneer						W\$	2215
	Two (2) Panel Bases - For Use With 120" x 42" Surfaces								
	88-2082RPB	Laminate	20	82	28¾	78	6.7	T\$	2391
		Veneer						W\$	2439
	24"W Bases								
	Two (2) Panel Bases - For Use With 72" x 48" Surfaces								
	88-2434RPB	Laminate	24	34	28¾	78	6.9	T\$	1796
		Veneer						W\$	1971
	Two (2) Panel Bases - For Use With 84" x 48" Surfaces								
	88-2446RPB	Laminate	24	46	28¾	81	6.9	T\$	1880
		Veneer						W\$	2015
	Two (2) Panel Bases - For Use With 96" x 48" Surfaces								
	88-2458RPB	Laminate	24	58	28¾	84	6.9	T\$	2109
		Veneer						W\$	2191
	Two (2) Panel Bases - For Use With 108" x 48" Surfaces								
	88-2470RPB	Laminate	24	70	28¾	87	6.9	T\$	2151
		Veneer						W\$	2233
	Two (2) Panel Bases - For Use With 120" x 48" / 54" / 60" Surfaces								
	88-2482RPB	Laminate	24	82	28¾	90	6.9	T\$	2411
		Veneer						W\$	2468
	Three (3) Panel Bases - For Use With 132" x 48" / 54" / 60" Surfaces								
	88-2494RPB	Laminate	24	94	28¾	115	13.8	T\$	2989
		Veneer						W\$	3119

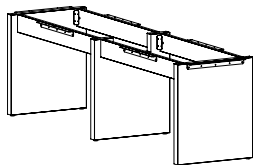

88-2494RPB Shown

TOPS SOLD SEPARATELY

Must Specify (in this order):

- Model #
- Material
- Finish / Color

Additional Rectangle Panel Bases on Next Page

Pricing Codes:
T= TFL W= Wood

[See Catalyst Overview For Ordering Options](#)

Item	Model No.	Materials	W	D	H	Ship Wt	Cubic Ft	List Price
<i>CONTINUED FROM PREVIOUS PAGE</i>	24"W Bases Continued							
	Three (3) Panel Bases - For Use With 144" x 48" / 54" / 60" Surfaces							
RECTANGLE PANEL BASES WITH TROUGH 20" + 24"W	88-24106RPB	Laminate	24	106	28¾	116	13.8	T\$ 3364
		Veneer						W\$ 3430
	Three (3) Panel Bases - For Use With 156" x 48" / 54" / 60" Surfaces							
	88-24118RPB	Laminate	24	118	28¾	118	13.8	T\$ 3444
		Veneer						W\$ 3473
	Three (3) Panel Bases - For Use With 168" x 48" / 54" / 60" Surfaces							
	88-24130RPB	Laminate	24	130	28¾	119	13.8	T\$ 3488
		Veneer						W\$ 3515
	Three (3) Panel Bases - For Use With 180" x 48" / 54" / 60" Surfaces							
	88-24142RPB	Laminate	24	142	28¾	120	13.8	T\$ 3516
		Veneer						W\$ 3555
	Three (3) Panel Bases - For Use With 192" x 48" / 54" / 60" Surfaces							
	88-24154RPB	Laminate	24	154	28¾	122	13.8	T\$ 3869
		Veneer						W\$ 4121
	Four (4) Panel Bases - For Use With 204" x 48" / 54" / 60" Surfaces							
	88-24166RPB	Laminate	24	166	28¾	155	14.3	T\$ 4838
		Veneer						W\$ 4888
	Four (4) Panel Bases - For Use With 216" x 48" / 54" / 60" Surfaces							
	88-24178RPB	Laminate	24	178	28¾	156	14.3	T\$ 4893
		Veneer						W\$ 4950
	Four (4) Panel Bases - For Use With 228" x 48" / 54" / 60" Surfaces							
	88-24190RPB	Laminate	24	190	28¾	158	14.3	T\$ 4928
		Veneer						W\$ 4985
	Four (4) Panel Bases - For Use With 240" x 48" / 54" / 60" Surfaces							
	88-24202RPB	Laminate	24	202	28¾	159	14.3	T\$ 4980
		Veneer						W\$ 5046

Must Specify (in this order):

Model #

Material

Finish / Color

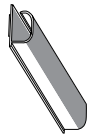

Wire Management
Channel

Description

- 2" Panel Bases with Trough, Stretcher Rails, and L-Bracket Hardware Included
- Available with TFL (T) or Veneer (W)
- Vertical Grain Direction on Bases
- Wire Management Channel Included; Two (2) Base Units Include One (1) Wire Management Channel and Three (3) Base Units Includes Two (2) Wire Management Channel
- Bases Require Some Assembly; Attachment Hardware Included
- Tops Sold Separately ([See Multiple Unit Details](#))

Pricing Codes:

T= TFL W= Wood

[See Catalyst Overview For Ordering Options](#)

Item	Model No.	Materials	W	D	H	Ship Wt	Cubic Ft	List Price	
6" RECTANGLE BASES WITH TROUGH AND REMOVABLE PANEL 20"W	20"W Bases								
	Two (2) 6" Rectangle Bases - For Use With 72" x 36" / 42" Surfaces								
	88-203406RB	Laminate	20	34	28¾	76	12.9	T\$	3113
		Veneer						W\$	4284
	Two (2) 6" Rectangle Bases - For Use With 84" x 36" / 42" Surfaces								
	88-204606RB	Laminate	20	46	28¾	79	12.9	T\$	3155
		Veneer						W\$	4367
	Two (2) 6" Rectangle Bases - For Use With 96" x 36" / 42" Surfaces								
	88-205806RB	Laminate	20	58	28¾	82	12.9	T\$	3331
		Veneer						W\$	4595
	Two (2) 6" Rectangle Bases - For Use With 108" x 42" Surfaces								
	88-207006RB	Laminate	20	70	28¾	86	12.9	T\$	3374
		Veneer						W\$	4631
	Two (2) 6" Rectangle Bases - For Use With 120" x 42" Surfaces								
	88-208206RB	Laminate	20	82	28¾	89	12.9	T\$	3551
		Veneer						W\$	4955
	24"W Bases								
	Two (2) 6" Rectangle Bases - For Use With 72" x 48" Surfaces								
	88-243406RB	Laminate	24	34	28¾	87	12.9	T\$	3172
		Veneer						W\$	4317
	Two (2) 6" Rectangle Bases - For Use With 84" x 48" Surfaces								
	88-244606RB	Laminate	24	46	28¾	90	12.9	T\$	3213
		Veneer						W\$	4402
	Two (2) 6" Rectangle Bases - For Use With 96" x 48" Surfaces								
	88-245806RB	Laminate	24	58	28¾	93	12.9	T\$	3390
		Veneer						W\$	4629
	Two (2) 6" Rectangle Bases - For Use With 108" x 48" Surfaces								
	88-247006RB	Laminate	24	70	28¾	96	12.9	T\$	3433
		Veneer						W\$	4664
	Two (2) 6" Rectangle Bases - For Use With 120" x 48" / 54" / 60" Surfaces								
	88-248206RB	Laminate	24	82	28¾	99	12.9	T\$	3609
		Veneer						W\$	4988
	Three (3) 6" Rectangle Bases - For Use With 132" x 48" / 54" / 60" Surfaces								
	88-249406RB	Laminate	24	94	28¾	102	12.9	T\$	4981
		Veneer						W\$	6831

Additional 6" Rectangle Panel Bases on Next Page

Pricing Codes:
T= TFL W= Wood

[See Catalyst Overview For Ordering Options](#)

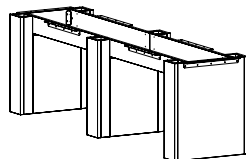

88-249406RB Shown

TOPS SOLD SEPARATELY

Must Specify (in this order):

Model #
Material
Finish / Color

Item	Model No.	Materials	W	D	H	Ship Wt	Cubic Ft	List Price	
CONTINUED FROM PREVIOUS PAGE - 6" RECTANGLE BASES WITH TROUGH AND REMOVABLE PANEL 20" + 24"W Must Specify (in this order): Model # Material Finish / Color	24"W Bases Continued								
	Three (3) 6" Rectangle Bases - For Use With 144" x 48" / 54" / 60" Surfaces								
	88-2410606RB	Laminate	24	106	28¾	106	19.6	T\$	5293
		Veneer						W\$	7240
	Three (3) 6" Rectangle Bases - For Use With 156" x 48" / 54" / 60" Surfaces								
	88-2411806RB	Laminate	24	118	28¾	108	19.6	T\$	5334
		Veneer						W\$	7285
	Three (3) 6" Rectangle Bases - For Use With 168" x 48" / 54" / 60" Surfaces								
	88-2413006RB	Laminate	24	130	28¾	110	19.6	T\$	5375
		Veneer						W\$	7328
	Three (3) 6" Rectangle Bases - For Use With 180" x 48" / 54" / 60" Surfaces								
	88-2414206RB	Laminate	24	142	28¾	112	19.6	T\$	5689
		Veneer						W\$	7688
	Three (3) 6" Rectangle Bases - For Use With 192" x 48" / 54" / 60" Surfaces								
	88-2415406RB	Laminate	24	154	28¾	114	19.6	T\$	5730
		Veneer						W\$	7962
	Four (4) 6" Rectangle Bases - For Use With 204" x 48" / 54" / 60" Surfaces								
	88-2416606RB	Laminate	24	166	28¾	152	26.3	T\$	7225
		Veneer						W\$	9882
	Four (4) 6" Rectangle Bases - For Use With 216" x 48" / 54" / 60" Surfaces								
88-2417806RB	Laminate	24	178	28¾	154	26.3	T\$	7277	
	Veneer						W\$	9942	
Four (4) 6" Rectangle Bases - For Use With 228" x 48" / 54" / 60" Surfaces									
88-2419006RB	Laminate	24	190	28¾	156	26.3	T\$	7314	
	Veneer						W\$	9979	
Four (4) 6" Rectangle Bases - For Use With 240" x 48" / 54" / 60" Surfaces									
88-2420206RB	Laminate	24	202	28¾	158	26.3	T\$	7367	
	Veneer						W\$	10023	

Description

- 6" Rectangle Bases with Trough, Stretcher Rails, and L-Bracket Hardware Included
- Available with TFL (T) or Veneer (W)
- Vertical Grain Direction on Bases
- Bases Include Interior Removable Panel for Wire Management Access; Removable Panel is 11⅞"W for 20" Bases and 15⅞"W for 24" Bases
- Wire Management Channel Included; Two (2) Base Units Include One (1) Wire Management Channel and Three (3) Base Units Includes Two (2) Wire Management Channel
- Removable Panels Attached with Z Brackets.
- Bases Require Some Assembly; Attachment Hardware Included
- Tops Sold Separately ([See Multiple Unit Details](#))

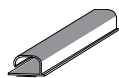
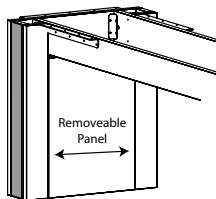

Wire Management
Channel

Pricing Codes:
T= TFL W= Wood

[See Catalyst Overview For Ordering Options](#)

Item	Model No.	Materials	W	D	H	Ship Wt	Cubic Ft	List Price	
10" RECTANGLE BASES WITH TROUGH AND REMOVABLE PANEL 24"W	20"W Bases								
	Two (2) 10" Rectangle Bases - For Use With 72" x 36" / 42" Surfaces								
	88-203410RB	Laminate	20	34	28¾	72	10.0	T\$	3204
		Veneer						W\$	4353
	Two (2) 10" Rectangle Bases - For Use With 84" x 36" / 42" Surfaces								
	88-204610RB	Laminate	20	46	28¾	75	10.0	T\$	3245
		Veneer						W\$	4437
	Two (2) 10" Rectangle Bases - For Use With 96" x 36" / 42" Surfaces								
	88-205810RB	Laminate	20	58	28¾	79	10.0	T\$	3422
		Veneer						W\$	4664
	Two (2) 10" Rectangle Bases - For Use With 108" x 42" Surfaces								
	88-207010RB	Laminate	20	70	28¾	82	10.0	T\$	3464
		Veneer						W\$	4701
	Two (2) 10" Rectangle Bases - For Use With 120" x 42" Surfaces								
	88-208210RB	Laminate	20	82	28¾	86	10.0	T\$	3641
		Veneer						W\$	5026
	24"W Bases								
	Two (2) 10" Rectangle Bases - For Use With 72" x 48" Surfaces								
	88-243410RB	Laminate	24	34	28¾	82	12.0	T\$	3187
		Veneer						W\$	4296
	Two (2) 10" Rectangle Bases - For Use With 84" x 48" Surfaces								
	88-244610RB	Laminate	24	46	28¾	86	12.0	T\$	3304
		Veneer						W\$	4470
	Two (2) 10" Rectangle Bases - For Use With 96" x 48" Surfaces								
	88-245810RB	Laminate	24	58	28¾	89	12.0	T\$	3480
		Veneer						W\$	4699
	Two (2) 10" Rectangle Bases - For Use With 108" x 48" Surfaces								
	88-247010RB	Laminate	24	70	28¾	93	12.0	T\$	3522
		Veneer						W\$	4734
	Two (2) 10" Rectangle Bases - For Use With 120" x 48" / 54" / 60" Surfaces								
	88-248210RB	Laminate	24	82	28¾	96	12.0	T\$	3700
		Veneer						W\$	5059
	Three (3) 10" Rectangle Bases - For Use With 132" x 48" / 54" / 60" Surfaces								
	88-249410RB	Laminate	24	94	28¾	137	18.2	T\$	5116
		Veneer						W\$	6935

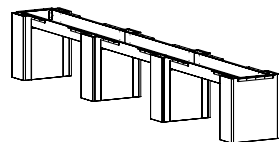

88-2419010RB Shown

TOPS SOLD SEPARATELY

Must Specify (in this order):

- Model #
- Material
- Finish / Color

Additional 10" Rectangle Panel Bases on Next Page

Pricing Codes:
T= TFL W= Wood

[See Catalyst Overview For Ordering Options](#)

Item	Model No.	Materials	W	D	H	Ship Wt	Cubic Ft	List Price	
10" RECTANGLE BASES WITH TROUGH AND REMOVABLE PANEL 24" + 20"W	24"W Bases Continued								
	Three (3) 10" Rectangle Bases - For Use With 144" x 48" / 54" / 60" Surfaces								
	88-241061ORB	Laminate	24	106	28¾	141	18.2	T\$	5428
		Veneer						W\$	7346
	Three (3) 10" Rectangle Bases - For Use With 156" x 48" / 54" / 60" Surfaces								
	88-241181ORB	Laminate	24	118	28¾	144	18.2	T\$	5470
		Veneer						W\$	7390
	Three (3) 10" Rectangle Bases - For Use With 168" x 48" / 54" / 60" Surfaces								
	88-241301ORB	Laminate	24	130	28¾	148	18.2	T\$	5512
		Veneer						W\$	7433
	Three (3) 10" Rectangle Bases - For Use With 180" x 48" / 54" / 60" Surfaces								
	88-241421ORB	Laminate	24	142	28¾	151	18.2	T\$	5823
		Veneer						W\$	7792
	Three (3) 10" Rectangle Bases - For Use With 192" x 48" / 54" / 60" Surfaces								
	88-241541ORB	Laminate	24	154	28¾	155	18.2	T\$	5866
		Veneer						W\$	8066
	Four (4) 10" Rectangle Bases - For Use With 204" x 48" / 54" / 60" Surfaces								
	88-241661ORB	Laminate	24	166	28¾	195	24.6	T\$	7405
	Veneer						W\$	10021	
Four (4) 10" Rectangle Bases - For Use With 216" x 48" / 54" / 60" Surfaces									
88-241781ORB	Laminate	24	178	28¾	198	24.6	T\$	7458	
	Veneer						W\$	10082	
Four (4) 10" Rectangle Bases - For Use With 228" x 48" / 54" / 60" Surfaces									
88-241901ORB	Laminate	24	190	28¾	202	24.6	T\$	7495	
	Veneer						W\$	10118	
Four (4) 10" Rectangle Bases - For Use With 240" x 48" / 54" / 60" Surfaces									
88-242021ORB	Laminate	24	202	28¾	205	24.6	T\$	7547	
	Veneer						W\$	10161	

Must Specify (in this order):

- Model #
- Material
- Finish / Color

Description

- 10" Rectangle Bases with Trough and Stretcher Rails
- Available with TFL (T) or Veneer (W)
- Vertical Grain Direction on Bases
- Bases Include Interior Removable Panel for Wire Management Access; Removable Panel is 11⅞"W for 20" Bases and 15⅞"W for 24" Bases
- Wire Management Channel Included; Two (2) Base Units Include One (1) Wire Management Channel and Three (3) Base Units Includes Two (2) Wire Management Channel
- Removable Panels Attached with Z Brackets.
- Bases Require Some Assembly; Attachment Hardware Included
- Tops Sold Separately ([See Multiple Unit Details](#))

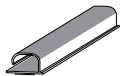
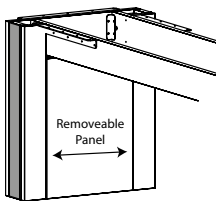

Wire Management Channel

Pricing Codes:
T= TFL W= Wood

[See Catalyst Overview For Ordering Options](#)

Item	Model No.	Materials	W	D	H	Ship Wt	Cubic Ft	List Price
6" + 10" COMBO RECTANGLE BASES WITH TROUGH AND REMOVABLE PANEL 24"W	Three (3) Bases Total: Two (2) 6" and One (1) 10" Rectangle Bases - For Use With 132" x 48" / 54" / 60" Surfaces							
	88-2494C61ORB	Laminate	24	94	28¾	137	18.2	T\$ 5026
		Veneer						W\$ 6866
	Three (3) Bases Total: Two (2) 6" and One (1) 10" Rectangle Bases - For Use With 144" x 48" / 54" / 60" Surfaces							
	88-24106C61ORB	Laminate	24	106	28¾	141	18.2	T\$ 5338
		Veneer						W\$ 7275
	Three (3) Bases Total: Two (2) 6" and One (1) 10" Rectangle Bases - For Use With 156" x 48" / 54" / 60" Surfaces							
	88-24118C61ORB	Laminate	24	118	28¾	144	18.2	T\$ 5379
		Veneer						W\$ 7320
	Three (3) Bases Total: Two (2) 6" and One (1) 10" Rectangle Bases - For Use With 168" x 48" / 54" / 60" Surfaces							
	88-24130C61ORB	Laminate	24	130	28¾	148	18.2	T\$ 5420
		Veneer						W\$ 7364
	Three (3) Bases Total: Two (2) 6" and One (1) 10" Rectangle Bases - For Use With 180" x 48" / 54" / 60" Surfaces							
	88-24142C61ORB	Laminate	24	142	28¾	151	18.2	T\$ 5734
		Veneer						W\$ 7722
	Three (3) Bases Total: Two (2) 6" and One (1) 10" Rectangle Bases - For Use With 192" x 48" / 54" / 60" Surfaces							
	88-24154C61ORB	Laminate	24	154	28¾	155	18.2	T\$ 6216
		Veneer						W\$ 8540
	Four (4) Bases Total: Two (2) 6" and Two (2) 10" Rectangle Bases - For Use With 204" x 48" / 54" / 60" Surfaces							
	88-24166C61ORB	Laminate	24	166	28¾	195	24.6	T\$ 7316
		Veneer						W\$ 9952
	Four (4) Bases Total: Two (2) 6" and Two (2) 10" Rectangle Bases - For Use With 216" x 48" / 54" / 60" Surfaces							
	88-24178C61ORB	Laminate	24	178	28¾	198	24.6	T\$ 7367
		Veneer						W\$ 10012
	Four (4) Bases Total: Two (2) 6" and Two (2) 10" Rectangle Bases - For Use With 228" x 48" / 54" / 60" Surfaces							
	88-24190C61ORB	Laminate	24	190	28¾	202	24.6	T\$ 7403
		Veneer						W\$ 10048
	Four (4) Bases Total: Two (2) 6" and Two (2) 10" Rectangle Bases - For Use With 240" x 48" / 54" / 60" Surfaces							
	88-24202C61ORB	Laminate	24	202	28¾	205	24.6	T\$ 7457
		Veneer						W\$ 10108

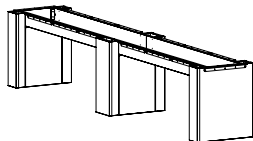

88-24142C61ORB Shown

TOPS SOLD SEPARATELY

Must Specify (in this order):

- Model #
- Material
- Finish / Color

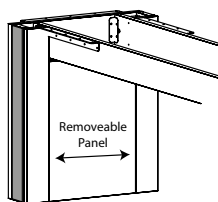

Removeable Panel

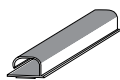

Wire Management Channel

Description

- 6" + 10" Rectangle Bases with Trough and Stretcher Rails; 6" Bases on Exterior and 10" Bases on Interior
- Available with TFL (T) or Veneer (W)
- Vertical Grain Direction on Bases
- Wire Management Channel Included; Two (2) Base Units Include One (1) Wire Management Channel and Three (3) Base Units Includes Two (2) Wire Management Channel
- Bases Include Interior Removable Panel for Wire Management. Removable Panel is 157/8"W and Attaches with Z Brackets.
- Bases Require Some Assembly; Attachment Hardware Included
- Tops Sold Separately ([See Multiple Unit Details](#))

Pricing Codes:
T= TFL W= Wood

[See Catalyst Overview For Ordering Options](#)

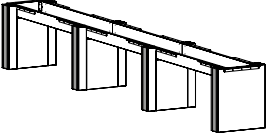
Item	Model No.	Materials	W	D	H	Ship Wt	Cubic Ft	List Price	
6" RECTANGLE ACCENT BASES WITH TROUGH AND REMOVABLE PANEL 24"W  88-2419006RAB Shown TOPS SOLD SEPARATELY Must Specify (in this order): Model # Base Finish/Color Metal Accent Option/Accent Panel Finish/Color	20"W Bases								
	Two (2) 6" Rectangle Bases - For Use With 72" x 36" / 42" Surfaces								
	88-203406RAB	Laminate	20	34	28 ³ / ₄	76	12.9	T\$	3624
		Veneer						W\$	4824
	Two (2) 6" Rectangle Bases - For Use With 84" x 36" / 42" Surfaces								
	88-204606RAB	Laminate	20	46	28 ³ / ₄	79	12.9	T\$	3667
		Veneer						W\$	4909
	Two (2) 6" Rectangle Bases - For Use With 96" x 36" / 42" Surfaces								
	88-205806RAB	Laminate	20	58	28 ³ / ₄	82	12.9	T\$	3844
		Veneer						W\$	5135
	Two (2) 6" Rectangle Bases - For Use With 108" x 42" Surfaces								
	88-207006RAB	Laminate	20	70	28 ³ / ₄	86	12.9	T\$	3886
		Veneer						W\$	5172
	Two (2) 6" Rectangle Bases - For Use With 120" x 42" Surfaces								
	88-208206RAB	Laminate	20	82	28 ³ / ₄	89	12.9	T\$	4063
		Veneer						W\$	5497
	24"W Bases								
	Two (2) 6" Rectangle Bases - For Use With 72" x 48" Surfaces								
	88-243406RAB	Laminate	24	34	28 ³ / ₄	87	12.9	T\$	3682
		Veneer						W\$	4858
Two (2) 6" Rectangle Bases - For Use With 84" x 48" Surfaces									
88-244606RAB	Laminate	24	46	28 ³ / ₄	90	12.9	T\$	3725	
	Veneer						W\$	4943	
Two (2) 6" Rectangle Bases - For Use With 96" x 48" Surfaces									
88-245806RAB	Laminate	24	58	28 ³ / ₄	93	12.9	T\$	3902	
	Veneer						W\$	5169	
Two (2) 6" Rectangle Bases - For Use With 108" x 48" Surfaces									
88-247006RAB	Laminate	24	70	28 ³ / ₄	96	12.9	T\$	3944	
	Veneer						W\$	5205	
Two (2) 6" Rectangle Bases - For Use With 120" x 48" / 54" / 60" Surfaces									
88-248206RAB	Laminate	24	82	28 ³ / ₄	99	12.9	T\$	5321	
	Veneer						W\$	7217	
Three (3) 6" Rectangle Bases - For Use With 132" x 48" / 54" / 60" Surfaces									
88-249406RAB	Laminate	24	94	28 ³ / ₄	102	12.9	T\$	5738	
	Veneer						W\$	7634	

Additional 6" Rectangle Accent Bases on Next Page.

Pricing Codes:
T= TFL W= Wood

[See Catalyst Overview For Ordering Options](#)

Item	Model No.	Materials	W	D	H	Ship Wt	Cubic Ft	List Price	
<i>CONTINUED FROM PREVIOUS PAGE</i>	24"W Bases Continued								
	Three (3) 6" Rectangle Bases - For Use With 144" x 48" / 54" / 60" Surfaces								
6" RECTANGLE ACCENT BASES WITH TROUGH AND REMOVABLE PANEL 24" + 20"W	88-2410606RAB	Laminate	24	106	28¾	106	19.6	T\$	6048
		Veneer						W\$	8044
	Three (3) 6" Rectangle Bases - For Use With 156" x 48" / 54" / 60" Surfaces								
	88-2411806RAB	Laminate	24	118	28¾	108	19.6	T\$	6091
		Veneer						W\$	8088
	Three (3) 6" Rectangle Bases - For Use With 168" x 48" / 54" / 60" Surfaces								
	88-2413006RAB	Laminate	24	130	28¾	110	19.6	T\$	6133
		Veneer						W\$	8132
	Three (3) 6" Rectangle Bases - For Use With 180" x 48" / 54" / 60" Surfaces								
	88-2414206RAB	Laminate	24	142	28¾	112	19.6	T\$	6444
		Veneer						W\$	8489
	Three (3) 6" Rectangle Bases - For Use With 192" x 48" / 54" / 60" Surfaces								
	88-2415406RAB	Laminate	24	154	28¾	114	19.6	T\$	6486
		Veneer						W\$	8766
	Four (4) 6" Rectangle Bases - For Use With 204" x 48" / 54" / 60" Surfaces								
	88-2416606RAB	Laminate	24	166	28¾	152	26.3	T\$	8227
		Veneer						W\$	10946
	Four (4) 6" Rectangle Bases - For Use With 216" x 48" / 54" / 60" Surfaces								
	88-2417806RAB	Laminate	24	178	28¾	154	26.3	T\$	8280
		Veneer						W\$	11006
	Four (4) 6" Rectangle Bases - For Use With 228" x 48" / 54" / 60" Surfaces								
	88-2419006RAB	Laminate	24	190	28¾	156	26.3	T\$	8316
		Veneer						W\$	11041
	Four (4) 6" Rectangle Bases - For Use With 240" x 48" / 54" / 60" Surfaces								
	88-2420206RAB	Laminate	24	202	28¾	158	26.3	T\$	8369
		Veneer						W\$	11086

Must Specify (in this order):

Model #
Base Finish/Color
Metal Accent Option/Accent Panel
Finish/Color

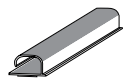
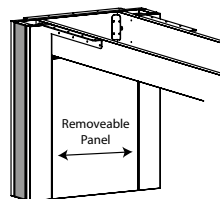

Wire Management
Channel

Description

- 6" Rectangle Bases with Trough and Stretcher Rails
- Available with TFL (T) or Veneer (W)
- 5/16" Metal Accent Available in Four (4) Colors: Aluminum, Black, Gold, and Platinum; Must Specify Color
- Vertical Grain Direction on Bases
- Bases Include Interior Removable Panel for Wire Management Access; Removable Panel is 15 7/8"W for 24" Bases and 11 7/8"W for 20" Bases
- Wire Management Channel Included; Two (2) Base Units Include One (1) Wire Management Channel and Three (3) Base Units Includes Two (2) Wire Management Channel
- Removable Panels Attached with Z Brackets.
- Bases Require Some Assembly; Attachment Hardware Included
- Tops Sold Separately ([See Multiple Unit Details](#))

Pricing Codes:
T= TFL W= Wood

[See Catalyst Overview For Ordering Options](#)

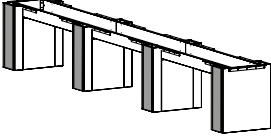
Item	Model No.	Materials	W	D	H	Ship Wt	Cubic Ft	List Price	
10" RECTANGLE ACCENT BASES WITH TROUGH AND REMOVABLE PANEL 24"W  88-241901ORAB Shown with Gray Accent Panel TOPS SOLD SEPARATELY Must Specify (in this order): Model # Base Finish/Color Metal Accent Color Accent Panel Finish/Color	20"W Bases								
	Two (2) 10" Rectangle Bases - For Use With 72" x 36" / 42" Surfaces								
	88-20341ORAB	Laminate	20	34	28¾	72	10.0	T\$	3598
		Veneer						W\$	4795
	Two (2) 10" Rectangle Bases - For Use With 84" x 36" / 42" Surfaces								
	88-20461ORAB	Laminate	20	46	28¾	75	10.0	T\$	3713
		Veneer						W\$	4969
	Two (2) 10" Rectangle Bases - For Use With 96" x 36" / 42" Surfaces								
	88-20581ORAB	Laminate	20	58	28¾	79	10.0	T\$	3890
		Veneer						W\$	5196
	Two (2) 10" Rectangle Bases - For Use With 108" x 42" Surfaces								
	88-20701ORAB	Laminate	20	70	28¾	82	10.0	T\$	3933
		Veneer						W\$	5232
	Two (2) 10" Rectangle Bases - For Use With 120" x 42" Surfaces								
	88-20821ORAB	Laminate	20	82	28¾	86	10.0	T\$	4109
		Veneer						W\$	5557
	24"W Bases								
	Two (2) 10" Rectangle Bases - For Use With 72" x 48" Surfaces								
	88-24341ORAB	Laminate	24	34	28¾	82	12.0	T\$	3655
		Veneer						W\$	4828
	Two (2) 10" Rectangle Bases - For Use With 84" x 48" Surfaces								
	88-24461ORAB	Laminate	24	46	28¾	86	12.0	T\$	3772
	Veneer						W\$	5002	
Two (2) 10" Rectangle Bases - For Use With 96" x 48" Surfaces									
88-24581ORAB	Laminate	24	58	28¾	89	12.0	T\$	3948	
	Veneer						W\$	5230	
Two (2) 10" Rectangle Bases - For Use With 108" x 48" Surfaces									
88-24701ORAB	Laminate	24	70	28¾	93	12.0	T\$	3990	
	Veneer						W\$	5266	
Two (2) 10" Rectangle Bases - For Use With 120" x 48" / 54" / 60" Surfaces									
88-24821ORAB	Laminate	24	82	28¾	96	12.0	T\$	4168	
	Veneer						W\$	5591	
Three (3) 10" Rectangle Bases - For Use With 132" x 48" / 54" / 60" Surfaces									
88-24941ORAB	Laminate	24	94	28¾	137	18.2	T\$	5812	
	Veneer						W\$	7728	

Additional 10" Rectangle Accent Bases on Next Page.

Pricing Codes:
 T= TFL W= Wood

[See Catalyst Overview For Ordering Options](#)

Item	Model No.	Materials	W	D	H	Ship Wt	Cubic Ft	List Price	
<i>CONTINUED FROM PREVIOUS PAGE</i>		24"W Bases Continued							
		Three (3) 10" Rectangle Bases - For Use With 144" x 48" / 54" / 60" Surfaces							
10" RECTANGLE ACCENT BASES WITH TROUGH AND REMOVABLE PANEL 24" + 20"W	88-241061ORAB	Laminate	24	106	28¾	141	18.2	T\$	6125
		Veneer						W\$	8138
		Three (3) 10" Rectangle Bases - For Use With 156" x 48" / 54" / 60" Surfaces							
	88-241181ORAB	Laminate	24	118	28¾	144	18.2	T\$	6166
		Veneer						W\$	8183
		Three (3) 10" Rectangle Bases - For Use With 168" x 48" / 54" / 60" Surfaces							
	88-241301ORAB	Laminate	24	130	28¾	148	18.2	T\$	6208
		Veneer						W\$	8227
		Three (3) 10" Rectangle Bases - For Use With 180" x 48" / 54" / 60" Surfaces							
	88-241421ORAB	Laminate	24	142	28¾	151	18.2	T\$	6521
		Veneer						W\$	8584
		Three (3) 10" Rectangle Bases - For Use With 192" x 48" / 54" / 60" Surfaces							
	88-241541ORAB	Laminate	24	154	28¾	155	18.2	T\$	6562
		Veneer						W\$	8861
		Four (4) 10" Rectangle Bases - For Use With 204" x 48" / 54" / 60" Surfaces							
	88-241661ORAB	Laminate	24	166	28¾	195	24.6	T\$	8330
		Veneer						W\$	11075
		Four (4) 10" Rectangle Bases - For Use With 216" x 48" / 54" / 60" Surfaces							
	88-241781ORAB	Laminate	24	178	28¾	198	24.6	T\$	8384
		Veneer						W\$	11136
		Four (4) 10" Rectangle Bases - For Use With 228" x 48" / 54" / 60" Surfaces							
	88-241901ORAB	Laminate	24	190	28¾	202	24.6	T\$	8420
		Veneer						W\$	11171
		Four (4) 10" Rectangle Bases - For Use With 240" x 48" / 54" / 60" Surfaces							
	88-242021ORAB	Laminate	24	202	28¾	205	24.6	T\$	8473
		Veneer						W\$	11215

Must Specify (in this order):
Model #
Base Finish/Color
Metal Accent Option
Accent Panel Finish/Color

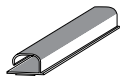
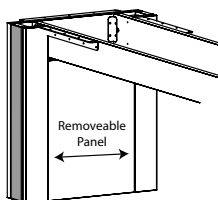

Wire Management Channel

Description

- 10" Rectangle Bases with Trough and Stretcher Rails
- Available with TFL (T) or Veneer (W)
- 5/16" Metal Accent Available in Four (4) Colors: Aluminum, Black, Gold, and Platinum; Must Specify Color
- Vertical Grain Direction on Bases
- Bases Include Interior Removable Panel for Wire Management Access; Removable Panel is 15 7/8"W for 24" Bases and 11 7/8"W for 20" Bases
- Wire Management Channel Included; Two (2) Base Units Include One (1) Wire Management Channel and Three (3) Base Units Includes Two (2) Wire Management Channel
- Removable Panels Attached with Z Brackets.
- Bases Require Some Assembly; Attachment Hardware Included
- Tops Sold Separately ([See Multiple Unit Details](#))

Catalyst

Pricing Codes:
T= TFL W= Wood

[See Catalyst Overview For Ordering Options](#)

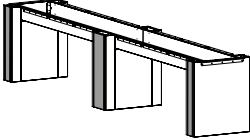
Item	Model No.	Materials	W	D	H	Ship Wt	Cubic Ft	List Price
6" + 10" COMBO RECTANGLE ACCENT BASES WITH TROUGH AND REMOVABLE PANEL 24"W	Three (3) Bases Total: Two (2) 6" and One (1) 10" Rectangle Bases - For Use With 132" x 48" / 54" / 60" Surfaces							
	88-2494C610RAB	Laminate	24	94	28¾	137	18.2	T\$ 5766
		Veneer						W\$ 7668
	Three (3) Bases Total: Two (2) 6" and One (1) 10" Rectangle Bases - For Use With 144" x 48" / 54" / 60" Surfaces							
	88-24106C610RAB	Laminate	24	106	28¾	141	18.2	T\$ 6078
		Veneer						W\$ 8079
88-24142C610RAB Shown with Gray Accent Panel	Three (3) Bases Total: Two (2) 6" and One (1) 10" Rectangle Bases - For Use With 156" x 48" / 54" / 60" Surfaces							
	88-24118C610RAB	Laminate	24	118	28¾	144	18.2	T\$ 6120
TOPS SOLD SEPARATELY		Veneer						W\$ 8123
	Three (3) Bases Total: Two (2) 6" and One (1) 10" Rectangle Bases - For Use With 168" x 48" / 54" / 60" Surfaces							
	88-24130C610RAB	Laminate	24	130	28¾	148	18.2	T\$ 6162
		Veneer						W\$ 8166
Must Specify (in this order): Model # Base Finish/Color Metal Accent Option Accent Panel Finish/Color	Three (3) Bases Total: Two (2) 6" and One (1) 10" Rectangle Bases - For Use With 180" x 48" / 54" / 60" Surfaces							
	88-24142C610RAB	Laminate	24	142	28¾	151	18.2	T\$ 6474
		Veneer						W\$ 8524
	Three (3) Bases Total: Two (2) 6" and One (1) 10" Rectangle Bases - For Use With 192" x 48" / 54" / 60" Surfaces							
	88-24154C610RAB	Laminate	24	154	28¾	155	18.2	T\$ 6514
		Veneer						W\$ 8800
	Four (4) Bases Total: Two (2) 6" and Two (2) 10" Rectangle Bases - For Use With 204" x 48" / 54" / 60" Surfaces							
	88-24166C610RAB	Laminate	24	166	28¾	195	24.6	T\$ 8284
		Veneer						W\$ 11016
	Four (4) Bases Total: Two (2) 6" and Two (2) 10" Rectangle Bases - For Use With 216" x 48" / 54" / 60" Surfaces							
	88-24178C610RAB	Laminate	24	178	28¾	198	24.6	T\$ 8335
		Veneer						W\$ 11075
	Four (4) Bases Total: Two (2) 6" and Two (2) 10" Rectangle Bases - For Use With 228" x 48" / 54" / 60" Surfaces							
	88-24190C610RAB	Laminate	24	190	28¾	202	24.6	T\$ 8374
		Veneer						W\$ 11111
	Four (4) Bases Total: Two (2) 6" and Two (2) 10" Rectangle Bases - For Use With 240" x 48" / 54" / 60" Surfaces							
	88-24202C610RAB	Laminate	24	202	28¾	205	24.6	T\$ 8426
		Veneer						W\$ 11172

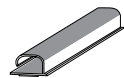
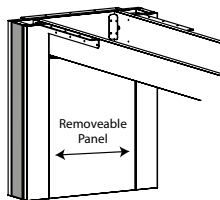

Wire Management Channel

Description

- 6" + 10" Rectangle Accent Bases with Trough and Stretcher Rails; 6" Bases on Exterior and 10" Bases on Interior
- Available with TFL (T) or Veneer (W)
- 5/8" Metal Accent Available in Four (4) Colors: Aluminum, Black, Gold, and Platinum; Must Specify Color
- Vertical Grain Direction on Bases
- Bases Include Interior Removable Panel for Wire Management. Removable Panel is 15 7/8"W and Attaches with Z Brackets.
- Wire Management Channel Included; Two (2) Base Units Include One (1) Wire Management Channel and Three (3) Base Units Includes Two (2) Wire Management Channel
- Bases Require Some Assembly; Attachment Hardware Included
- Tops Sold Separately ([See Multiple Unit Details](#))

Pricing Codes:
T= TFL W= Wood

[See Catalyst Overview For Ordering Options](#)

Item	Model No.		W	D	H	Ship Wt	Cubic Ft	List Price
	For Use With Round Tops: 30", 36", 42", Square Tops: 36", and Top Surfaces: 36"x72-96"							
	01-2430DBB	Black	24	24	27¾	32	3.2	\$ 1701
	01-2430DBA	Aluminum						
	For Use With Round Tops: 48", Square Tops: 42", and Top Surfaces: 42"x72-96" and 48"x72-96"							
	01-3230DBB	Black	32	32	27¾	32	3.2	\$ 2041
	01-3230DBA	Aluminum						
	Heavy Duty For Use With Round Tops 54" + 60" and Square Tops: 48"							
	01-2432HDBB	Black	32	32	27¾	42	4.1	\$ 2795
	01-2432HDBA	Aluminum						

Description

- 4" Diameter 14 Gauge Steel Column with 12"x12" Mounting Plate at Top of Column
- ¼" Thick Disc Plate with 5 Levelers
- Stiffener Bar Not Included; Must Order Separately ([See Stiffener Bars](#))
- See Number of Bases Required Per Top Width Below
- Power Units Available On Center When Using Two or More Disc Bases
- Some Assembly Required

Table Widths	Round+Square	72"	84"	96"
Number of Bases Required	1	2	2	2

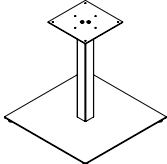
Item	Model No.		W	D	H	Ship Wt	Cubic Ft	List Price
	For Use With Round Tops: 36" and Square Tops: 30"							
	01-1630SBB	Black	16	16	27¾	32	3.2	\$ 995
	01-1630SBA	Aluminum						
	For Use With Round Tops: 42", Square Tops: 36", Top Surfaces: 36"x72-96"							
	01-2030SBB	Black	20	20	27¾	32	3.2	\$ 1060
	01-2030SBA	Aluminum						
	For Use With Round Tops: 48", Square Tops: 42", Top Surfaces: 42"x72-96" and 48"x72-96"							
	01-2630SBB	Black	26	26	27¾	32	3.2	\$ 1288
	01-2630SBA	Aluminum						

Description

- 2¾" Diameter Column with 12"x12" Mounting Plate at Top of Column
- Stiffener Bar Not Included; Must Order Separately ([See Stiffener Bars](#))
- See Number of Bases Required Per Top Width Below
- Power Units Available On Center When Using Two or More Square Bases
- Some Assembly Required

Table Widths	Round+Square	72"	84"	96"
Number of Bases Required	1	2	2	2

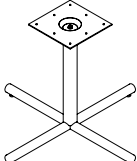
Item	Model No.		W	D	H	Ship Wt	Cubic Ft	List Price
TUBULAR X-BASE 	For Use With Round Tops: 36" + 42", Square Tops: 36", Top Surfaces: 36"x72-96"							
	01-3230TXB	Black	32	32	27¾	32	3.2	\$ 701
	01-3230TXA	Aluminum						
	For Use With Round Tops: 48", Square Tops: 42", Top Surfaces: 42"x72-96" and 48"x72-96"							
	01-3830TXB	Black	38	38	27¾	40	4.2	\$ 774
	01-3830TXA	Aluminum						

Description

- 3" Diameter Column
- See Number of Bases Required Per Top Width Below
- Stiffener Bar Not Included; Must Order Separately ([See Stiffener Bars](#))
- Power Units Available On Center When Using Two or More Tubular X-Bases
- Some Assembly Required

Table Widths	Round+Square	72"	84"	96"
Number of Bases Required	1	2	2	2

Item	Model No.		W	D	H	Ship Wt	Cubic Ft	List Price
METAL X-BASE 	For Use With Round + Square Tops: 42" + 48", Top Surfaces: 42"x72-96" and 48"x72-96"							
	<i>For 30"H Tables</i>							
	08-2630LXBB	Black	35½	35½	28	27	14.5	\$ 1380
	08-2630LXBA	Aluminum						
	<i>For 36"H Tables</i>							
	08-2636LXBB	Black	35½	35½	34	30	17.2	\$ 1444
	08-2636LXBA	Aluminum						
	<i>For 42"H Tables</i>							
	08-2642LXBB	Black	35½	35½	40	33	20.0	\$ 1496
	08-2642LXBA	Aluminum						
	For Use With Round + Square Tops: 30" + 36", Top Surfaces: 36"x72-96"							
	<i>For 30"H Tables</i>							
	08-2030SXBB	Black	29	29	28	21	11.6	\$ 1289
	08-2030SXBA	Aluminum						
<i>For 36"H Tables</i>								
08-2036SXBB	Black	29	29	34	24	13.7	\$ 1342	
08-2036SXBA	Aluminum							
<i>For 42"H Tables</i>								
08-2042SXBB	Black	29	29	40	27	15.9	\$ 1399	
08-2042SXBA	Aluminum							

Description

- See Number of Bases Required Per Top Width Below
- Not Available to be Sold Separately
- Stiffener Bar Not Included; Must Order Separately ([See Stiffener Bars](#))
- Power Units Available On Center When Using Two or More Metal X-Bases
- Ships Assembled

Table Widths	Round+Square	72"	84"	96"
Number of Bases Required	1	2	2	2

[See Catalyst Overview For Ordering Options](#)

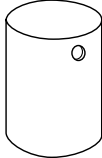
Item	Model No.	W	D	H	Ship Wt	Cubic Ft	List Price
CYLINDER BASE 	For Use With Round Tops: 36", Square Tops: 30", Top Surfaces: 36"x72-96"						
	01-1616CB	16	16	28½	101	7.2	W\$ 1572
	For Use With Round Tops: 42" + 48", Square Tops: 36" + 42", Top Surfaces: 42"x72-96", 48"x72-96"						
	01-2020CB	20	20	28½	136	10.9	W\$ 1720
	For Use With Round Tops: 54" + 60" and Square Tops: 48"						
	01-3030CB	30	30	28½	136	10.9	W\$ 4347

Must Specify (in this order):

- Model # and Quantity
- Finish
- Grommet Options

Description

- Standard with Two (2) Wire Management Access Points at Top Edge and 8" Access Point at Bottom
- Veneer Cylinder Base Features Multi-Step, Hand-Finished Catalyzed Finish
- Weighted for Stability
- See Number of Bases Required Per Top Width Below
- Power Units Available On Center When Using Two or More Cylinder Bases

Additional Grommet Options: Specify & Add

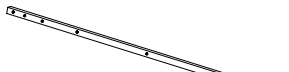

GCBIS	Only One (1) Access Point At Top Edge	N/C
NOGC	No Access Points At Top Edge	N/C

Table Widths	Round+Square	72"	84"	96"
Number of Bases Required	1	2	2	2

STIFFENER BAR 	01-00048SB	48	1¾	¾	5	0.3	\$ 134
	01-00060SB	60	1¾	¾	8	0.3	\$ 143

Description

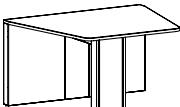
- Reinforce Worksurfaces with Large Kneespace Widths
- Includes End Caps to Cover Sharp Edges
- Recommended in Kneespaces 60" or Greater
- Field Installed

Item	Model No.	Material (Top+Chassis)	W	D	H	Ship Wt	Cubic Ft	Edge Profile + Material	List Price
48"×60"D HUDDLE TABLE DESK DESK HEIGHT 	88-4860HT	TFL+TFL	60	30-48	30	197	14.0	F, G, Y / T+T\$	3903
		HPL+TFL						F, G, Y / P+T\$	4240
								K / P+T\$	4914
		Veneer						F, G, Y / W\$	6068
								K / W\$	6697
		Glass+TFL						Acid Etched Glass Top +T\$	9781
								Gloss Glass Top +T\$	8490
		Glass+Veneer						Acid Etched Glass Top +W\$	12200
								Gloss Glass Top +W\$	10826
		88-4872HT						88-4872HT	TFL+TFL
HPL+TFL	F, G, Y / P+T\$		4483						
	K / P+T\$		5239						
Veneer	F, G, Y / W\$		6355						
	K / W\$		7071						
Glass+TFL	Acid Etched Glass Top +T\$		11260						
	Gloss Glass Top +T\$		9712						
Glass+Veneer	Acid Etched Glass Top +W\$		13735						
	Gloss Glass Top +W\$		12086						
 Optional Power Units (See Details)	88-4884HT		TFL+TFL	84	30-48	30	242		16.8
		HPL+TFL	F, G, Y / P+T\$					5102	
			K / P+T\$					5938	
		Veneer	F, G, Y / W\$					6701	
			K / W\$					7502	
		Glass+TFL	Acid Etched Glass Top +T\$					12620	
			Gloss Glass Top +T\$					10812	
		Glass+Veneer	Acid Etched Glass Top +W\$					15124	
			Gloss Glass Top +W\$					13200	
		 Optional TV/Monitor Stand (01-TVMTG2) (See Next Page for Details)	88-6048HT					TFL+TFL	
HPL+TFL	F, G, Y / P+T\$			4361					
	K / P+T\$			4998					
Glass+TFL	Acid Etched Glass Top +T\$			9902					
	Gloss Glass Top +T\$			8612					

Additional 60" Huddle Table Desks and Details on Next Page



Double Kerf (F)
1 3/16"



Duo (G)
1 3/16"



Square (Y)
1 3/16"



Knife (K)
1 3/16"

Pricing Codes:

T= TFL P= HPL W= Wood

[See Catalyst Overview For Ordering Options](#)

Item	Model No.	Material (Top+Chassis)	W	D	H	Ship Wt	Cubic Ft	Edge Profile + Material	List Price
<i>CONTINUED FROM PREVIOUS PAGE</i>	88-6060HT	TFL+TFL	60	36-60	30	220	15.4	F, G, Y / T+T\$	4258
		HPL+TFL						F, G, Y / P+T\$	4521
								K / P+T\$	5236
		Glass+TFL						Acid Etched Glass Top +T\$	11606
							Gloss Glass Top +T\$	9992	
48"+60"D HUDDLE TABLE DESK DESK HEIGHT	88-6072HT	TFL+TFL	72	36-60	30	242	16.8	F, G, Y / T+T\$	4589
		HPL+TFL						F, G, Y / P+T\$	4778
								K / P+T\$	5572
		Glass+TFL						Acid Etched Glass Top +T\$	13408
							Gloss Glass Top +T\$	11470	
	88-6084HT	TFL+TFL	84	36-60	30	242	16.8	F, G, Y / T+T\$	4810
		HPL+TFL						F, G, Y / P+T\$	5416
								K / P+T\$	6294
		Glass+TFL						Acid Etched Glass Top +T\$	15096
							Gloss Glass Top +T\$	12836	

Must Specify (in this order):

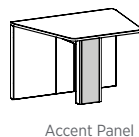
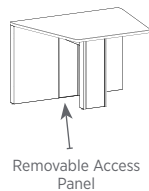

- Model #
- Top Material
- Top Finish/Color
- Edge Profile
- Chassis Color
- Base Accent Panel Finish/Color
- Glass (Y/N)
- Glass Color/Surface Finish
- Metal Accent/Color
- Power/Data Options
- TV Mount



Description

- Standard with: Built In Wire Management Through Removable Access Panel in Chassis, Woodgrain Patterns Follow the Width (Long) of Tops and Vertical Grain Direction on Chassis, Finished Back for Freestanding Open Spaces, and Some Assembly Required
- Tops, Chassis, and Accent Panel Available in Contrasting Finish/Colors; Must Specify Color of Each Component
- Available with TFL (T), Veneer (W), HPL (P), or Back Painted Tempered Glass (Black or White with Gloss or Acid Etched Finish) Top; Veneer (W) Options Available on 30"-48"D Models Only
- When Selecting Back Painted Tempered Glass Top; Must Specify Top Material, Top Finish/Color, Glass Color, Gloss or Acid Etched Finish ([See Options](#))
- When Knife Edge Profile is Selected, Chassis is Reduced by 3" for a Cohesive Connection to Top; Overall Dimensions will not be Affected
- Optional 5/16" Metal Accent Available on Base; Must Specify Color (See Below for Upcharge and Details)
- Optional TV/Monitor Stand Available (See Below); Must Specify TV/Monitor Stand Option (MTSD) and Order Stand Separately; If Selected, TV/Monitor Stand will be Located in E5 Location and Optional Power Unit Available in E10 Location
- Additional Options: Power and Data Options ([See Details](#))

Options: Must Specify & Add

	METAL ACCENT	Optional 5/16" Metal Accent Available in Base in Four (4) Colors; Must Specify No Metal Accent (NONE), Aluminum (ALUM), Black (BLK), Gold (GLD), and Platinum (PLAT)	\$ 194
	01-TVMTG2	TV/Monitor Stand: VESA Patterns up to 400mm x 400mm and Screens 32" up to 55", 30° Swivel for Easy Visibility, Must Be Specified for Top Routing, and Ships Separately for Field Installation	\$ 537
	OPEN MARKET ONLY		



Double Kerf (F)
1 3/16"



Duo (G)
1 3/16"





Square (Y)
1 3/16"



Knife (K)
1 3/16"

Pricing Codes:
T= TFL P= HPL

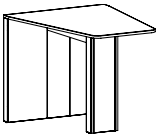
[See Catalyst Overview For Ordering Options](#)

Item	Model No.	Material (Top+Chassis)	W	D	H	Ship Wt	Cubic Ft	Edge Profile + Material	List Price	
48"×60"D HUDDLE TABLE DESK BAR HEIGHT 	88-4860THT	TFL+TFL	60	30-48	42	240	16.8	F, G, Y / T+T\$	4107	
		HPL+TFL							F, G, Y / P+T\$	4443
									K / P+T\$	5111
		Veneer							F, G, Y / W\$	6367
									K / W\$	6994
		Glass+TFL							Acid Etched Glass Top +T\$	9984
									Gloss Glass Top +T\$	8694
		Glass+Veneer							Acid Etched Glass Top +W\$	12499
									Gloss Glass Top +W\$	11125
		Must Specify (in this order): Model # Top Material Top Finish/Color Edge Profile Chassis Color Base Accent Panel Finish/Color Glass (Y/N) Glass Color/Surface Finish Metal Accent/Color Power/Data Options TV Mount	88-4872THT	TFL+TFL	72	30-48	42	263	18.2	F, G, Y / T+T\$
HPL+TFL									F, G, Y / P+T\$	4687
									K / P+T\$	5433
Veneer									F, G, Y / W\$	6655
									K / W\$	7368
Glass+TFL									Acid Etched Glass Top +T\$	11465
									Gloss Glass Top +T\$	9914
Glass+Veneer									Acid Etched Glass Top +W\$	14034
									Gloss Glass Top +W\$	12385
 Optional Power Units (See Details)	88-4884THT			TFL+TFL	84	30-48	42	285	19.6	F, G, Y / T+T\$
		HPL+TFL							F, G, Y / P+T\$	5304
									K / P+T\$	6134
		Veneer							F, G, Y / W\$	7000
									K / W\$	7800
		Glass+TFL							Acid Etched Glass Top +T\$	12823
									Gloss Glass Top +T\$	11017
		Glass+Veneer							Acid Etched Glass Top +W\$	15423
									Gloss Glass Top +W\$	13499
		 Optional TV/Monitor Stand (01-TVMTG2) (See Next Page for Details)	88-6048THT	TFL+TFL	48	36-60	42	248	18.6	F, G, Y / T+T\$
HPL+TFL									F, G, Y / P+T\$	4595
									K / P+T\$	5064
Glass+TFL									Acid Etched Glass Top +T\$	10136
									Gloss Glass Top +T\$	8844

Additional 60" Huddle Table Desks and Details on Next Page



Double Kerf (F) 1 3/16"
 Duo (G) 1 3/16"
 Square (Y) 1 3/16"
 Knife (K) 1 3/16"

Pricing Codes:
 T= TFL P= HPL W= Wood

[See Catalyst Overview For Ordering Options](#)

Item	Model No.	Material (Top+Chassis)	W	D	H	Ship Wt	Cubic Ft	Edge Profile + Material	List Price
<i>CONTINUED FROM PREVIOUS PAGE</i>	88-6060THT	TFL+TFL	60	36-60	42	275	20.3	F, G, Y / T+T\$	4492
		HPL+TFL						F, G, Y / P+T\$	4753
								K / P+T\$	5304
		Glass+TFL						Acid Etched Glass Top +T\$	11838
							Gloss Glass Top +T\$	10224	
48"+60"D HUDDLE TABLE DESK SEATED HEIGHT	88-6072THT	TFL+TFL	72	36-60	42	301	22.0	F, G, Y / T+T\$	4824
		HPL+TFL						F, G, Y / P+T\$	5010
								K / P+T\$	5641
		Glass+TFL						Acid Etched Glass Top +T\$	13640
							Gloss Glass Top +T\$	11703	
	88-6084THT	TFL+TFL	84	36-60	42	328	23.5	F, G, Y / T+T\$	5043
		HPL+TFL						F, G, Y / P+T\$	5649
								K / P+T\$	6361
		Glass+TFL						Acid Etched Glass Top +T\$	15328
							Gloss Glass Top +T\$	13070	

Must Specify (in this order):

- Model #
- Top Material
- Top Finish/Color
- Edge Profile
- Chassis Color
- Base Accent Panel Finish/Color
- Glass (Y/N)
- Glass Color/Surface Finish
- Metal Accent/Color
- Power/Data Options
- TV Mount

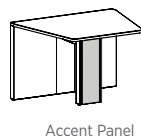
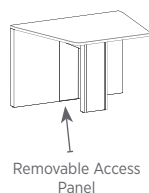

Description

- Standard with: Built In Wire Management Through Removable Access Panel in Chassis, Woodgrain Patterns Follow the Width (Long) of Tops and Vertical Grain Direction on Chassis, Finished Back for Freestanding Open Spaces, and Some Assembly Required
- Tops, Chassis, and Accent Panel Available in Contrasting Finish/Colors; Must Specify Color of Each Component
- Available with TFL (T), Veneer (W), HPL (P), or Back Painted Tempered Glass (Black or White with Gloss or Acid Etched Finish) Top; Veneer (W) Options Available on 30"-48"D Models Only
- When Selecting Back Painted Tempered Glass Top; Must Specify Top Material, Top Finish/Color, Glass Color, Gloss or Acid Etched Finish ([See Options](#))
- When Knife Edge Profile is Selected, Chassis is Reduced by 3" for a Cohesive Connection to Top; Overall Dimensions will not be Affected
- Optional 5/16" Metal Accent Available on Base; Must Specify Color (See Below for Upcharge and Details)
- Optional TV/Monitor Stand Available (See Below); Must Specify TV/Monitor Stand Option (MTSD) and Order Stand Separately; If Selected, TV/Monitor Stand will be Located in E5 Location and Optional Power Unit Available in E10 Location
- Additional Options: Power and Data Options ([See Details](#))

Options: Must Specify & Add



METAL ACCENT	Optional 5/16" Metal Accent Available in Base in Four (4) Colors; Must Specify No Metal Accent (NONE), Aluminum (ALUM), Black (BLK), Gold (GLD), and Platinum (PLAT)	\$ 194
01-TVMTG2 OPEN MARKET ONLY	TV/Monitor Stand: VESA Patterns up to 400mm x 400mm and Screens 32" up to 55", 30° Swivel for Easy Visibility, Must Be Specified for Top Routing, and Ships Separately for Field Installation	\$ 537



Pricing Codes:
T= TFL P= HPL

[See Catalyst Overview For Ordering Options](#)

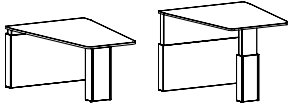
Item	Model No.	Material (Top+Chassis)	W	D	H	Ship Wt	Cubic Ft	Edge Profile + Material	List Price
48"D + 60"D HEIGHT ADJUSTABLE HUDDLE TABLE  Shown with Top Lowered and Raised	88-4860HAHT	TFL+TFL	60	30-48	30-45	276	16.4	F, G, Y / T+T\$	6687
		HPL+TFL						F, G, Y / P+T\$	7069
								K / P+T\$	7686
		Veneer						F, G, Y / W\$	10012
								K / W\$	10637
		Glass+TFL						Acid Etched Glass Top +T\$	12565
		Gloss Glass Top +T\$	11274						
		Glass+Veneer	Acid Etched Glass Top +W\$	16145					
			Gloss Glass Top +W\$	14770					
	88-4872HAHT	TFL+TFL	72	30-48	30-45	291	17.7	F, G, Y / T+T\$	6806
		HPL+TFL						F, G, Y / P+T\$	7132
								K / P+T\$	7824
Veneer		F, G, Y / W\$						10078	
		K / W\$						10789	
Glass+TFL		Acid Etched Glass Top +T\$						13860	
	Gloss Glass Top +T\$	12310							
	Glass+Veneer	Acid Etched Glass Top +W\$	17457						
		Gloss Glass Top +W\$	15808						
88-4884HAHT	TFL+TFL	84	30-48	30-45	352	22.3	F, G, Y / T+T\$	6925	
	HPL+TFL						F, G, Y / P+T\$	7690	
							K / P+T\$	8458	
	Veneer						F, G, Y / W\$	10369	
							K / W\$	11165	
	Glass+TFL						Acid Etched Glass Top +T\$	15154	
	Gloss Glass Top +T\$	13346							
	Glass+Veneer	Acid Etched Glass Top +W\$	18791						
		Gloss Glass Top +W\$	16867						
88-6048HAHT	TFL+TFL	48	36-60	30-45	288	17.6	F, G, Y / T+T\$	6826	
	HPL+TFL						F, G, Y / P+T\$	7209	
							K / P+T\$	7732	
	Glass+TFL	Acid Etched Glass Top +T\$	12705						
		Gloss Glass Top +T\$	11413						
88-6060HAHT	TFL+TFL	60	36-60	30-45	315	19.3	F, G, Y / T+T\$	6987	
	HPL+TFL						F, G, Y / P+T\$	7300	
							K / P+T\$	7898	
	Glass+TFL	Acid Etched Glass Top +T\$	14335						
		Gloss Glass Top +T\$	12721						

Must Specify (in this order):

- Model #
- Top Material
- Top Finish/Color
- Edge Profile
- Chassis Color
- Base Accent Panel Finish/Color
- Glass (Y/N)
- Glass Color/Surface Finish
- Metal Accent/Color
- Power/Data Options
- TV Mount
- Advanced Memory Switch



Optional Power Units
(See Details)



Optional TV/Monitor
Stand (01-TVMTG2)
(See Next Page
for Details)

Additional 60" Huddle Table Desks and Details on Next Page



Double Kerf (F)
1 3/16"



Duo (G)
1 3/16"



Square (Y)
1 3/16"



Knife (K)
1 3/16"

Pricing Codes:

T= TFL P= HPL W= Wood

[See Catalyst Overview For Ordering Options](#)

Item	Model No.	Material (Top+Chassis)	W	D	H	Ship Wt	Cubic Ft	Edge Profile + Material	List Price
<i>CONTINUED FROM PREVIOUS PAGE</i>	88-6072HAHT	TFL+TFL	72	36-60	30-45	333	20.9	F, G, Y / T+T\$	7134
		HPL+TFL						F, G, Y / P+T\$	7376
								K / P+T\$	8050
		Glass+TFL						Acid Etched Glass Top +T\$	15951
							Gloss Glass Top +T\$	14014	
48"D + 60"D HEIGHT ADJUSTABLE HUDDLE TABLE	88-6084HAHT	TFL+TFL	84	36-60	30-45	352	22.3	F, G, Y / T+T\$	7280
		HPL+TFL						F, G, Y / P+T\$	7948
								K / P+T\$	8698
		Glass+TFL						Acid Etched Glass Top +T\$	17567
							Gloss Glass Top +T\$	15307	

Must Specify (in this order):

- Model #
- Top Material
- Top Finish/Color
- Edge Profile
- Chassis Color
- Base Accent Panel Finish/Color
- Glass (Y/N)
- Glass Color/Surface Finish
- Metal Accent/Color
- Power/Data Options
- TV Mount
- Advanced Memory Switch

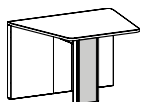

Accent Panel

Description

- Standard with: Built In Wire Management Through Removable Access Panel in Chassis, Woodgrain Patterns Follow the Width (Long) of Tops and Vertical Grain Direction on Chassis, Finished Back for Freestanding Open Spaces, and Some Assembly Required
- Tops, Chassis, and Accent Panel Available in Contrasting Finish/Colors; Must Specify Color of Each Component
- Available with TFL (T), Veneer (W), HPL (P), or Back Painted Tempered Glass (Black or White with Gloss or Acid Etched Finish) Top; Veneer (W) Options Available on 30"-48"D Models Only
- When Selecting Back Painted Tempered Glass Top; Must Specify Top Material, Top Finish/Color, Glass Color, Gloss or Acid Etched Finish ([See Options](#))
- When Knife Edge Profile is Selected, Chassis is Reduced by 3" for a Cohesive Connection to Top; Overall Dimensions will not be Affected
- Optional 5/16" Metal Accent Available on Base; Must Specify Color (See Below for Upcharge and Details)
- Optional TV/Monitor Stand Available (See Below); Must Specify TV/Monitor Stand Option (MTSD) and Order Stand Separately; If Selected, TV/Monitor Stand will be Located in E5 Location and Optional Power Unit Available in E10 Location
- Control Switch Standard (Up/Down) or Upgrade to Advanced Switch (DPIMSWCH-Up/Down/Set Reminders, and More); Switch is Field Installed ([See Switch Options](#))
- Additional Options: Power and Data Options ([See Details](#))

Options: Must Specify & Add



METAL ACCENT	Optional 5/16" Metal Accent Available in Base in Four (4) Colors; Must Specify No Metal Accent (NONE), Aluminum (ALUM), Black (BLK), Gold (GLD), and Platinum (PLAT)	\$ 194
01-TVMTG2 <small>OPEN MARKET ONLY</small>	TV/Monitor Stand: VESA Patterns up to 400mm x 400mm and Screens 32" up to 55", 30° Swivel for Easy Visibility, Must Be Specified for Top Routing, and Ships Separately for Field Installation	\$ 537
DPIMSWCH	Advanced Switch Features Bluetooth Connection with the Free Desk Connect™ App. Easily Set Up Various Functions, Like Favorite Positions, Set Reminders to Stand, and Enable Automatic Drive.	\$ 149



Double Kerf (F)
1 3/16"



Duo (G)
1 3/16"



Square (Y)
1 3/16"



Knife (K)
1 3/16"

Pricing Codes:
T= TFL P= HPL

[See Catalyst Overview For Ordering Options](#)

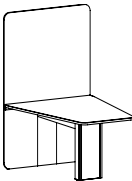
Item	Model No.	Material (Top+Chassis)	W	D	H	Ship Wt	Cubic Ft	Edge Profile + Material	List Price	
48"D MEDIA TABLE DESK HEIGHT 	88-4860MT	TFL+TFL	60	30-48	70 $\frac{7}{8}$	273	24.9	F, G, Y / T+T\$	4736	
		HPL+TFL							F, G, Y / P+T\$	5129
									K / P+T\$	5697
		Veneer							F, G, Y / W\$	7512
									K / W\$	8133
		Glass+TFL							Acid Etched Glass Top +T\$	10616
								Gloss Glass Top +T\$	9323	
	Glass+Veneer							Acid Etched Glass Top +W\$	13644	
								Gloss Glass Top +W\$	12270	
	88-4872MT	TFL+TFL	72	30-48	70 $\frac{7}{8}$	291	26.9	F, G, Y / T+T\$	5039	
		HPL+TFL							F, G, Y / P+T\$	5375
									K / P+T\$	6019
Veneer								F, G, Y / W\$	7799	
								K / W\$	8505	
Glass+TFL								Acid Etched Glass Top +T\$	12094	
							Gloss Glass Top +T\$	10543		
Glass+Veneer							Acid Etched Glass Top +W\$	15178		
							Gloss Glass Top +W\$	13529		
88-4884MT	TFL+TFL	84	30-48	70 $\frac{7}{8}$	310	28.9	F, G, Y / T+T\$	5188		
	HPL+TFL							F, G, Y / P+T\$	5961	
								K / P+T\$	6682	
	Veneer							F, G, Y / W\$	8096	
								K / W\$	8889	
	Glass+TFL							Acid Etched Glass Top +T\$	13416	
							Gloss Glass Top +T\$	11609		
Glass+Veneer							Acid Etched Glass Top +W\$	16519		
							Gloss Glass Top +W\$	14595		

Must Specify (in this order):

- Model #
- Top Material
- Top Finish/Color
- Edge Profile
- Chassis Color
- Base Accent Panel Finish/Color
- Media Back Panel Options
- Glass (Y/N)
- Glass Color/Surface Finish
- Metal Accent/Color
- Power/Data Options
- TV Mount



Optional Power Units
(See Details)



Optional TV/Monitor
Stand (01-LPTVMT)
(See Next Page
for Details)

See Options and Details on Next Page



Double Kerf (F)
1 $\frac{1}{16}$ "



Duo (G)
1 $\frac{3}{16}$ "



Square (Y)
1 $\frac{3}{16}$ "



Knife (K)
1 $\frac{3}{16}$ "

Pricing Codes:

T= TFL P= HPL W= Wood

[See Catalyst Overview For Ordering Options](#)

**48"D MEDIA TABLE
DESK HEIGHT
CONTINUED**

Must Specify (in this order):

- Model #
- Top Material
- Top Finish/Color
- Edge Profile
- Chassis Color
- Base Accent Panel Finish/Color
- Media Back Panel Options
- Glass (Y/N)
- Glass Color/Surface Finish
- Metal Accent/Color
- Power/Data Options
- TV Mount

Description

- Standard with: Woodgrain Patterns Follow the Width (Long) of Tops and Vertical Grain Direction on Chassis, Built In Wire Management Through Removable Access Panel in Chassis, Finished Back Panel Options for Freestanding Open Spaces, and Some Assembly Required
- Tops, Chassis, and Accent Panel Available in Contrasting Finish/Colors; Must Specify Color of Each Component
- Available with TFL (T), HPL (P), Veneer (W), or Back Painted Tempered Glass (Black or White with Gloss or Acid Etched Finish) Top
- Lower Portion of Media Back Panel will Match Chassis Finish/Color; Four (4) Options Available to Apply to Upper Portion: Panel (PNL), Dry Erase Board (DEB), Tackboard (TB), or Open Back (OPN); Must Specify (See Below for Options)
- When Selecting Back Painted Tempered Glass Top; Must Specify Top Material, Top Finish/Color, Glass Color, Gloss or Acid Etched Finish ([See Options](#))
- Optional 5/16" Metal Accent Available on Base; Must Specify Color (See Below for Upcharge and Details)
- Additional Options: Low Profile TV Mount (01-LPTVMT) (See Details Below) and Power and Data Options ([See Details](#))

Media Back Panel Options: Must Specify & Add

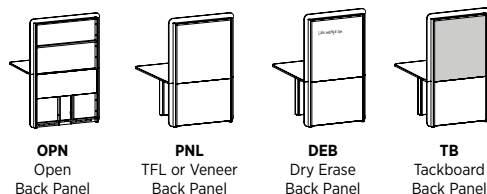

OPN	Open Back Option for Wall Applications	N/C
PNL	Panel Back - Back Panel Material Will Match Chassis Material	
	TFL Panel Back	\$ 390
	Veneer Panel Back	\$ 752
DEB	Dry Erase Panel	\$ 919
TB	Tackboard Panel	See Below
	Grade 1	2
	\$ 973	1046
	3	4
	1108	1167
	5	6
	1258	1349
	7	8
	1481	1617
	9	10
	1777	1961

Additional Options: Must Specify & Add



METAL ACCENT	Optional 5/16" Metal Accent Available in Base in Four (4) Colors; Must Specify No Metal Accent (NONE), Aluminum (ALUM), Black (BLK), Gold (GLD), and Platinum (PLAT)	\$ 194
01-LPTVMT	Optional Low Profile TV Mount (01-LPTVMT); Accommodates 26" to 55" TV/EA/Flat Screens up to 165lbs and Provides +/- 10° Tilt for Optimal Viewing, Sold Separately for Field Installation	\$ 537
OPEN MARKET ONLY		

Catalyst

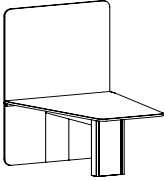
Item	Model No.	Material (Top+Chassis)	W	D	H	Ship Wt	Cubic Ft	Edge Profile + Material	List Price	
60"D MEDIA TABLE DESK HEIGHT 	88-6048MT	TFL+TFL	48	36-60	70%	289	24.6	F, G, Y / T+\$	4841	
		HPL+TFL						F, G, Y / P+\$	5239	
								K / P+\$	5770	
		Glass+TFL						Acid Etched Glass Top +T\$	10719	
								Gloss Glass Top +T\$	9429	
	88-6060MT	TFL+TFL	60	36-60	70%	311	26.6	F, G, Y / T+\$		5036
		HPL+TFL							F, G, Y / P+\$	5360
									K / P+\$	5964
		Glass+TFL							Acid Etched Glass Top +T\$	12384
								Gloss Glass Top +T\$	10771	
	88-6072MT	TFL+TFL	72	36-60	70%	333	28.6	F, G, Y / T+\$		5359
		HPL+TFL							F, G, Y / P+\$	5613
		K / P+\$							6293	
Glass+TFL		Acid Etched Glass Top +T\$							14177	
							Gloss Glass Top +T\$	12240		
88-6084MT	TFL+TFL	84	36-60	70%	356	30.6	F, G, Y / T+\$		5535	
	HPL+TFL							F, G, Y / P+\$	6214	
								K / P+\$	6970	
	Glass+TFL							Acid Etched Glass Top +T\$	15822	
							Gloss Glass Top +T\$	13562		

Must Specify (in this order):

- Model #
- Top Material
- Top Finish/Color
- Edge Profile
- Chassis Color
- Base Accent Panel Finish/Color
- Media Back Panel Options
- Glass (Y/N)
- Glass Color/Surface Finish
- Metal Accent/Color
- Power/Data Options
- TV Mount



Optional Power Units
[\(See Details\)](#)



Optional TV/Monitor
Stand (01-LPTVMT)
[\(See Next Page for
Details\)](#)

See Options and Details on Next Page



Double Kerf (F)
1 3/16"



Duo (G)
1 3/16"



Square (Y)
1 3/16"



Knife (K)
1 3/16"

Pricing Codes:

T= TFL P= HPL W= Wood

[See Catalyst Overview For Ordering Options](#)

**60"D MEDIA TABLE
DESK HEIGHT 60"D
CONTINUED**

Must Specify (in this order):

- Model #
- Top Material
- Top Finish/Color
- Edge Profile
- Chassis Color
- Base Accent Panel Finish/Color
- Media Back Panel Options
- Glass (Y/N)
- Glass Color/Surface Finish
- Metal Accent/Color
- Power/Data Options
- TV Mount

Description

- Standard with: Woodgrain Patterns Follow the Width (Long) of Tops and Vertical Grain Direction on Chassis, Built In Wire Management Through Removable Access Panel in Chassis, Finished Back Panel Options for Freestanding Open Spaces, and Some Assembly Required
- Tops, Chassis, and Accent Panel Available in Contrasting Finish/Colors; Must Specify Color of Each Component
- Available with TFL (T), HPL (P), or Back Painted Tempered Glass (Black or White with Gloss or Acid Etched Finish) Top
- Lower Portion of Media Back Panel will Match Chassis Finish/Color; Four (4) Options Available to Apply to Upper Portion: Panel (PNL), Dry Erase Board (DEB), Tackboard (TB), or Open Back (OPN); Must Specify (See Below for Options)
- When Selecting Back Painted Tempered Glass Top; Must Specify Top Material, Top Finish/Color, Glass Color, Gloss or Acid Etched Finish ([See Options](#))
- Optional 5/16" Metal Accent Available on Base; Must Specify Color (See Below for Upcharge and Details)
- Additional Options: Low Profile TV Mount (01-LPTVMT) (See Details Below) and Power and Data Options ([See Details](#))

Media Back Panel Options: Must Specify & Add

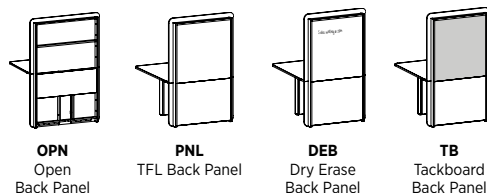

OPN	Open Back Option for Wall Applications	N/C
PNL	TFL Panel Back	\$ 462
DEB	Dry Erase Panel	\$ 991
TB	Tackboard Panel	See Below
	Grade	
	1	2
	3	4
	5	6
	7	8
	9	10
	\$ 1045	1132
	1207	1278
	1387	1497
	1654	1818
	2010	2230

Additional Options: Must Specify & Add

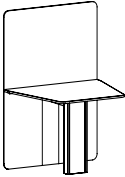

METAL ACCENT	Optional 5/16" Metal Accent Available in Base in Four (4) Colors; Must Specify No Metal Accent (NONE), Aluminum (ALUM), Black (BLK), Gold (GLD), and Platinum (PLAT)	\$ 194
01-LPTVMT	Optional Low Profile TV Mount (01-LPTVMT); Accommodates 26" to 55" TV/EA/Flat Screens up to 165lbs and Provides +/- 10° Tilt for Optimal Viewing, Sold Separately for Field Installation	\$ 537
OPEN MARKET ONLY		

Item	Model No.	Material (Top+Chassis)	W	D	H	Ship Wt	Cubic Ft	Edge Profile + Material	List Price
48"D MEDIA TABLE BAR HEIGHT 	88-4860TMT	TFL+TFL	60	30-48	82 $\frac{7}{8}$	273	24.9	F, G, Y / T+T\$	4948
		HPL+TFL						F, G, Y / P+T\$	5338
								K / P+T\$	5907
		Veneer						F, G, Y / W\$	8261
								K / W\$	8882
		Glass+TFL						Acid Etched Glass Top +T\$	10825
		Gloss Glass Top +T\$	9535						
	88-4872TMT	Glass+Veneer	Acid Etched Glass Top +W\$	14394					
			Gloss Glass Top +W\$	13019					
		TFL+TFL	72	30-48	82 $\frac{7}{8}$	291	26.9	F, G, Y / T+T\$	5250
		HPL+TFL						F, G, Y / P+T\$	5584
								K / P+T\$	6229
Veneer		F, G, Y / W\$						8547	
	K / W\$	9254							
Glass+TFL	Acid Etched Glass Top +T\$	12303							
	Gloss Glass Top +T\$	10755							
88-4884TMT	Glass+Veneer	Acid Etched Glass Top +W\$	15927						
		Gloss Glass Top +W\$	14278						
	TFL+TFL	84	30-48	82 $\frac{7}{8}$	310	28.9	F, G, Y / T+T\$	5397	
	HPL+TFL						F, G, Y / P+T\$	6172	
							K / P+T\$	6890	
	Veneer						F, G, Y / W\$	8846	
	K / W\$						9638		
Glass+TFL	Acid Etched Glass Top +T\$						13628		
	Gloss Glass Top +T\$	11820							
88-4884TMT	Glass+Veneer	Acid Etched Glass Top +W\$	17268						
		Gloss Glass Top +W\$	15344						

Must Specify (in this order):

- Model #
- Top Material
- Top Finish/Color
- Edge Profile
- Chassis Color
- Base Accent Panel Finish/Color
- Media Back Panel Options
- Glass (Y/N)
- Glass Color/Surface Finish
- Metal Accent/Color
- Power/Data Options
- TV Mount



Optional Power Units
(See Details)



Optional TV/Monitor
Stand (01-LPTVMT)
(See Next Page for
Details)

See Options and Details on Next Page



Double Kerf (F)
1 $\frac{3}{16}$ "



Duo (G)
1 $\frac{3}{16}$ "



Square (Y)
1 $\frac{3}{16}$ "



Knife (K)
1 $\frac{3}{16}$ "

T= TFL P = HPL W = Veneer

[See Catalyst Overview For Ordering Options](#)

**48"D MEDIA TABLE
BAR HEIGHT
CONTINUED**

Must Specify (in this order):

- Model #
- Top Material
- Top Finish/Color
- Edge Profile
- Chassis Color
- Base Accent Panel Finish/Color
- Media Back Panel Options
- Glass (Y/N)
- Glass Color/Surface Finish
- Metal Accent/Color
- Power/Data Options
- TV Mount

Description

- Standard with: Woodgrain Patterns Follow the Width (Long) of Tops and Vertical Grain Direction on Chassis, Built In Wire Management Through Removable Access Panel in Chassis, Finished Back Panel Options for Freestanding Open Spaces and Some Assembly Required
- Tops, Chassis, and Accent Panel Available in Contrasting Finish/Colors; Must Specify Color of Each Component
- Available with TFL (T), HPL (P), Veneer (W), or Back Painted Tempered Glass (Black or White with Gloss or Acid Etched Finish) Top
- Lower Portion of Media Back Panel will Match Chassis Finish/Color; Four (4) Options Available to Apply to Upper Portion: Panel (PNL), Dry Erase Board (DEB), Tackboard (TB), or Open Back (OPN); Must Specify (See Below for Options)
- When Selecting Back Painted Tempered Glass Top; Must Specify Top Material, Top Finish/Color, Glass Color, Gloss or Acid Etched Finish ([See Options](#))
- Optional 5/16" Metal Accent Available on Base; Must Specify Color (See Below for Upcharge and Details)
- Additional Options: Low Profile TV Mount (01-LPTVMT) (See Details Below) and Power and Data Options ([See Details](#))

Media Back Panel Options: Must Specify & Add

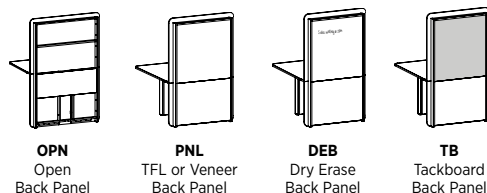

OPN	Open Back Option for Wall Applications	N/C
PNL	Panel Back - Back Panel Material Will Match Chassis Material	
	TFL Panel Back	\$ 466
	Veneer Panel Back	\$ 898
DEB	Dry Erase Panel	\$ 1065
TB	Tackboard Panel	See Below
	Grade 1	2
	\$ 1119	1192
	3	4
	1254	1313
	5	6
	1404	1495
	7	8
	1627	1763
	9	10
	1923	2107

Additional Options: Must Specify & Add



METAL ACCENT	Optional 5/16" Metal Accent Available in Base in Four (4) Colors; Must Specify No Metal Accent (NONE), Aluminum (ALUM), Black (BLK), Gold (GLD), and Platinum (PLAT)	\$ 194
01-LPTVMT	Optional Low Profile TV Mount (01-LPTVMT); Accommodates 26" to 55" TV/EA/Flat Screens up to 165lbs and Provides +/- 10° Tilt for Optimal Viewing, Sold Separately for Field Installation	\$ 537
OPEN MARKET ONLY		

Catalyst

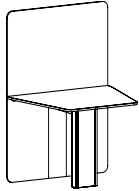
Item	Model No.	Material (Top+Chassis)	W	D	H	Ship Wt	Cubic Ft	Edge Profile + Material	List Price
60"D MEDIA TABLE BAR HEIGHT 	88-6048TMT	TFL+TFL	48	36-60	82 $\frac{7}{8}$	327	31.2	F, G, Y / T+T\$	5115
		HPL+TFL						F, G, Y / P+T\$	5498
								K / P+T\$	6036
		Glass+TFL						Acid Etched Glass Top +T\$	10994
								Gloss Glass Top +T\$	9701
		88-6060TMT						TFL+TFL	60
		HPL+TFL						F, G, Y / P+T\$	5616
								K / P+T\$	6233
		Glass+TFL						Acid Etched Glass Top +T\$	12654
								Gloss Glass Top +T\$	11042
	88-6072TMT	TFL+TFL	72	36-60	82 $\frac{7}{8}$	371	35.2	F, G, Y / T+T\$	5634
		HPL+TFL						F, G, Y / P+T\$	5878
							K / P+T\$	6567	
	Glass+TFL						Acid Etched Glass Top +T\$	14453	
							Gloss Glass Top +T\$	12515	
88-6084TMT	TFL+TFL	84	36-60	82 $\frac{7}{8}$	394	37.2	F, G, Y / T+T\$	5810	
	HPL+TFL						F, G, Y / P+T\$	6478	
							K / P+T\$	7244	
	Glass+TFL						Acid Etched Glass Top +T\$	16098	
							Gloss Glass Top +T\$	13837	

Must Specify (in this order):

- Model #
- Top Material
- Top Finish/Color
- Edge Profile
- Chassis Color
- Base Accent Panel Finish/Color
- Media Back Panel Options
- Glass (Y/N)
- Glass Color/Surface Finish
- Metal Accent/Color
- Power/Data Options
- TV Mount



Optional Power Units
(See Details)



Optional TV/Monitor
Stand (01-LPTVMT)
(See Next Page for
Details)

See Options and Details on Next Page



Double Kerf (F)
1 $\frac{3}{16}$ "



Duo (G)
1 $\frac{3}{16}$ "



Square (Y)
1 $\frac{3}{16}$ "



Knife (K)
1 $\frac{3}{16}$ "

Pricing Codes:
T= TFL P= HPL

[See Catalyst Overview For Ordering Options](#)

**60"D MEDIA TABLE
BAR HEIGHT
CONTINUED**

Must Specify (in this order):

- Model #
- Top Material
- Top Finish/Color
- Edge Profile
- Chassis Color
- Base Accent Panel Finish/Color
- Media Back Panel Options
- Glass (Y/N)
- Glass Color/Surface Finish
- Metal Accent/Color
- Power/Data Options
- TV Mount

Description

- Standard with: Woodgrain Patterns Follow the Width (Long) of Tops and Vertical Grain Direction on Chassis, Built In Wire Management Through Removable Access Panel in Chassis, Finished Back Panel Options for Freestanding Open Spaces and Some Assembly Required
- Tops, Chassis, and Accent Panel Available in Contrasting Finish/Colors; Must Specify Color of Each Component
- Available with TFL (T), HPL (P), or Back Painted Tempered Glass (Black or White with Gloss or Acid Etched Finish) Top
- Lower Portion of Media Back Panel will Match Chassis Finish/Color; Four (4) Options Available to Apply to Upper Portion: Panel (PNL), Dry Erase Board (DEB), Tackboard (TB), or Open Back (OPN); Must Specify (See Below for Options)
- When Selecting Back Painted Tempered Glass Top; Must Specify Top Material, Top Finish/Color, Glass Color, Gloss or Acid Etched Finish ([See Options](#))
- Optional 5/16" Metal Accent Available on Base; Must Specify Color (See Below for Upcharge and Details)
- Additional Options: Low Profile TV Mount (01-LPTVMT) (See Details Below) and Power and Data Options ([See Details](#))

Media Back Panel Options: Must Specify & Add

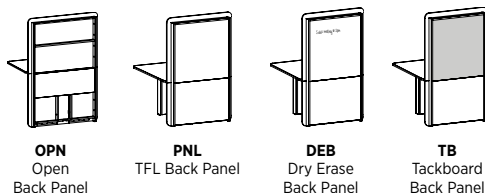

OPN	Open Back Option for Wall Applications	N/C
PNL	TFL Panel Back	\$ 552
DEB	Dry Erase Panel	\$ 1151
TB	Tackboard Panel	See Below
	Grade 1	
	2	3
	4	5
	6	7
	8	9
	10	
	\$ 1205	1292
	1367	1438
	1547	1657
	1814	1978
	2170	2390

Options: Must Specify & Add



METAL ACCENT	Optional 5/16" Metal Accent Available in Base in Four (4) Colors; Must Specify No Metal Accent (NONE), Aluminum (ALUM), Black (BLK), Gold (GLD), and Platinum (PLAT)	\$ 194
--------------	--	--------



01-LPTVMT	Optional Low Profile TV Mount (01-LPTVMT); Accommodates 26" to 55" TV/EA/Flat Screens up to 165lbs and Provides +/- 10° Tilt for Optimal Viewing, Sold Separately for Field Installation	\$ 537
-----------	--	--------

OPEN MARKET ONLY

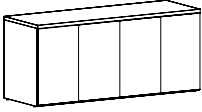
Item	Model No.	Material (Top+Chassis)	W	D	H	Ship Wt	Cubic Ft	Edge Profile + Material	List Price		
20"D CREDENZA 	88-2036CC <i>Two Doors</i>	HPL+TFL	36	20	30	135	15.5	F, G, X, Y / P+T\$	2010		
									H / P+T\$	2052	
		HPL+Veneer							F, G, X, Y / P+W\$	3014	
									H / P+W\$	3080	
		Veneer							F, G, X, Y / W\$	3209	
									H / W\$	3259	
		88-2048CC <i>Two Doors</i>	Glass+TFL						Acid Etched Glass Top +T\$	3207	
									Gloss Glass Top +T\$	2895	
	Glass+Veneer								Acid Etched Glass Top +W\$	4406	
									Gloss Glass Top +W\$	4096	
	88-2048CC <i>Two Doors</i>		88-2048CC <i>Two Doors</i>	HPL+TFL	48	20	30	165	24.1	F, G, X, Y / P+T\$	2358
											H / P+T\$
HPL+Veneer									F, G, X, Y / P+W\$	3732	
									H / P+W\$	3818	
Veneer									F, G, X, Y / W\$	3923	
									H / W\$	3991	
	88-2060CC <i>Three Doors</i>	Glass+TFL						Acid Etched Glass Top +T\$	4007		
								Gloss Glass Top +T\$	3592		
Glass+Veneer								Acid Etched Glass Top +W\$	5572		
								Gloss Glass Top +W\$	5158		
88-2060CC <i>Three Doors</i>		88-2060CC <i>Three Doors</i>	HPL+TFL	60	20	30	220	25.3	F, G, X, Y / P+T\$	3087	
										H / P+T\$	3154
	HPL+Veneer								F, G, X, Y / P+W\$	4776	
									H / P+W\$	4881	
	Veneer								F, G, X, Y / W\$	4964	
									H / W\$	5047	
	88-2060CC <i>Three Doors</i>	Glass+TFL						Acid Etched Glass Top +T\$	5183		
								Gloss Glass Top +T\$	4668		
Glass+Veneer								Acid Etched Glass Top +W\$	7062		
								Gloss Glass Top +W\$	6545		

Additional 20" Credenzas on Next Page



Double Kerf (F)
1 3/8"



Duo (G)
1 3/8"



Fluted (X)
1 3/8"



Square (Y)
1 3/8"



Vertical Square (H)
1 1/2"

Pricing Codes:

T= TFL P= HPL W= Wood

[See Catalyst Overview For Ordering Options](#)

Item	Model No.	Material (Top+Chassis)	W	D	H	Ship Wt	Cubic Ft	Edge Profile + Material	List Price
<i>CONTINUED FROM PREVIOUS PAGE</i>	88-2072CC <i>Four Doors</i>	HPL+TFL	72	20	30	260	35.6	F, G, X, Y / P+T\$	3522
								H / P+T\$	3604
		HPL+Veneer						F, G, X, Y / P+W\$	5526
								H / P+W\$	5650
		Veneer						F, G, X, Y / W\$	5711
								H / W\$	5810
		Glass+TFL						Acid Etched Glass Top +T\$	6070
								Gloss Glass Top +T\$	5449
		Glass+Veneer						Acid Etched Glass Top +W\$	8259
								Gloss Glass Top +W\$	7638
	88-2084CC <i>Five Doors</i>	HPL+TFL	84	20	30	338	35.1	F, G, X, Y / P+T\$	4383
								H / P+T\$	4478
		HPL+Veneer						F, G, X, Y / P+W\$	6757
								H / P+W\$	6902
		Veneer						F, G, X, Y / W\$	7142
								H / W\$	7257
		Glass+TFL						Acid Etched Glass Top +T\$	7224
								Gloss Glass Top +T\$	6500
		Glass+Veneer						Acid Etched Glass Top +W\$	9983
								Gloss Glass Top +W\$	9259
	88-2096CC <i>Five Doors</i>	HPL+TFL	96	20	30	398	39.9	F, G, X, Y / P+T\$	4803
								H / P+T\$	4909
		HPL+Veneer						F, G, X, Y / P+W\$	7572
								H / P+W\$	7737
		Veneer						F, G, X, Y / W\$	7955
								H / W\$	8085
		Glass+TFL						Acid Etched Glass Top +T\$	8093
								Gloss Glass Top +T\$	7266
		Glass+Veneer						Acid Etched Glass Top +W\$	11245
								Gloss Glass Top +W\$	10418

Must Specify (in this order):

- Model #
- Top Material
- Top Finish/Color
- Edge Profile
- Chassis Color
- Glass (Y/N)
- Glass Color/Surface Finish
- Pull
- Vent

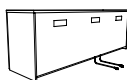

2"W wire management channel

Description

- Standard with: One (1) Adjustable Shelf Behind Touch Latch Doors, Top Profile on Approach Side, 2" Wire Management Channel Along Back of Interior Cabinet, Reverse Slip Matched Pattern on Top Surface, and Vertical Grain Direction on Chassis
- Available with Veneer (W), HPL (P), or Back Painted Tempered Glass (Black or White with Gloss or Acid Etched Finish) Top
- When Selecting Back Painted Tempered Glass Top; Must Specify Top Material, Top Finish/Color, Glass Color, Gloss or Acid Etched Finish and Edge Profile; [See Options](#)
- Tops and Chassis Available in Contrasting Finish/Colors; Must Specify Color of Each Component
- Touch Latch Doors Standard Without Pulls, Optional Studio Pulls; Must Specify Color
- Knife Edge not Available
- Additional Options: Locking Doors ([See Options Details](#)); Back Panel Vent ([See Options Details](#))

Pricing Codes:
T= TFL P= HPL

[See Catalyst Overview For Ordering Options](#)

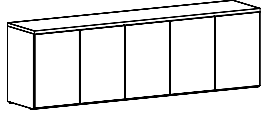
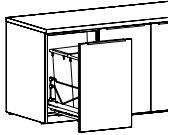
Item	Model No.	Material (Top+Chassis)	W	D	H	Ship Wt	Cubic Ft	Edge Profile + Material	List Price	
24" D CREDENZA  88-2496CC Shown  Waste Bin Option Shown as Left	88-2436CC <i>Two Doors</i>	HPL+TFL	36	24	30	150	18.3	F, G, X, Y / P+T\$	2141	
									H / P+T\$	2190
			HPL+Veneer						F, G, X, Y / P+W\$	3191
									H / P+W\$	3269
			Veneer						F, G, X, Y / W\$	3383
									H / W\$	3445
			Glass+TFL						Acid Etched Glass Top +T\$	3607
									Gloss Glass Top +T\$	3236
			Glass+Veneer						Acid Etched Glass Top +W\$	4850
									Gloss Glass Top +W\$	4479
Must Specify (in this order): Model # Top Material Top Finish/Color Edge Profile Chassis Color Glass (Y/N) Glass Color/Surface Finish Pull Locking Vent Waste Bin	88-2448CC <i>Two Doors</i>	HPL+TFL	48	24	30	185	20.4	F, G, X, Y / P+T\$	2532	
									H / P+T\$	2597
			HPL+Veneer						F, G, X, Y / P+W\$	3976
									H / P+W\$	4074
			Veneer						F, G, X, Y / W\$	4163
									H / W\$	4243
			Glass+TFL						Acid Etched Glass Top +T\$	4540
									Gloss Glass Top +T\$	4043
			Glass+Veneer						Acid Etched Glass Top +W\$	6170
									Gloss Glass Top +W\$	5674
88-2460CC <i>Three Doors</i>	88-2460CC <i>Three Doors</i>	HPL+TFL	60	24	30	240	29.9	F, G, X, Y / P+T\$	3345	
									H / P+T\$	3426
			HPL+Veneer						F, G, X, Y / P+W\$	5183
									H / P+W\$	5306
			Veneer						F, G, X, Y / W\$	5367
									H / W\$	5465
			Glass+TFL						Acid Etched Glass Top +T\$	5893
									Gloss Glass Top +T\$	5272
			Glass+Veneer						Acid Etched Glass Top +W\$	7915
									Gloss Glass Top +W\$	7294

Additional 24" Credenzas on Next Page



Double Kerf (F)
1 3/8"



Duo (G)
1 3/8"



Fluted (X)
1 3/8"



Square (Y)
1 3/8"



Vertical Square (H)
1 1/2"

Pricing Codes:

T= TFL P= HPL W= Wood

[See Catalyst Overview For Ordering Options](#)

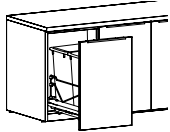
Item	Model No.	Material (Top+Chassis)	W	D	H	Ship Wt	Cubic Ft	Edge Profile + Material	List Price						
CONTINUED FROM PREVIOUS PAGE  <p>Waste Bin Option Shown as Left</p> Must Specify (in this order): Model # Top Material Top Finish/Color Edge Profile Chassis Color Glass (Y/N) Glass Color/Surface Finish Pull Vent Waste Bin	88-2472CC <i>Four Doors</i>	HPL+TFL	72	24	30	260	35.6	F, G, X, Y / P+T\$	3795						
								H / P+T\$	3891						
		HPL+Veneer						F, G, X, Y / P+W\$	5907						
								H / P+W\$	6051						
		Veneer						F, G, X, Y / W\$	6085						
								H / W\$	6202						
		88-2484CC <i>Five Doors</i>	Glass+TFL	84	24	30	353	41.4	Acid Etched Glass Top +T\$	6884					
			Gloss Glass Top +T\$						6139						
	Glass+Veneer		Acid Etched Glass Top +W\$						9174						
			Gloss Glass Top +W\$						8429						
	HPL+TFL		HPL+TFL						96	24	30	415	47.2	F, G, X, Y / P+T\$	5148
			H / P+T\$											5275	
HPL+Veneer	HPL+Veneer	F, G, X, Y / P+W\$	8067												
	H / P+W\$	8258													
Veneer	Veneer	F, G, X, Y / W\$	8442												
	H / W\$	8596													
	88-2496CC <i>Five Doors</i>	Glass+TFL	96	24	30	415	47.2	Acid Etched Glass Top +T\$	9160						
		Gloss Glass Top +T\$						8166							
Glass+Veneer		Glass+Veneer						Acid Etched Glass Top +W\$	12453						
		Gloss Glass Top +W\$						11460							

Description

- Standard with: One (1) Adjustable Shelf Behind Touch Latch Doors, Top Profile on Approach Side, 2" Wire Management Channel Along Back of Interior Cabinet, Reverse Slip Matched Pattern on Top Surface, and Vertical Grain Direction on Chassis
- Available with Veneer (W), HPL (P), or Back Painted Tempered Glass (Black or White with Gloss or Acid Etched Finish) Top
- When Selecting Back Painted Tempered Glass Top; Must Specify Top Material, Top Finish/Color, Glass Color, Gloss or Acid Etched Finish and Edge Profile ([See Options](#))
- Tops and Chassis Available in Contrasting Finish/Colors; Must Specify Color of Each Component
- Touch Latch Doors Standard Without Pulls, Optional Studio Pulls; Must Specify Pull Color ([See Options](#))
- Studio Pulls Will be Added and Centered on Top of Doors When Waste Bin is Selected; Must Specify Pull Color ([See Color Options](#)) and Optional Waste Bin ([See Options](#))
- Knife Edge not Available
- Additional Options: Locking Doors ([See Options Details](#)); Pull Out Waste Bin Available ([See Options Details](#)); Back Panel Vent ([See Options Details](#))

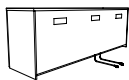

2"W wire management channel

Pricing Codes:
T= TFL P= HPL

[See Catalyst Overview For Ordering Options](#)

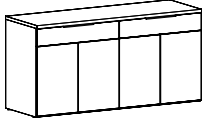
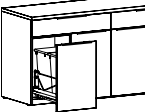
Item	Model No.	Material (Top+Chassis)	W	D	H	Ship Wt	Cubic Ft	Edge Profile + Material	List Price		
BUFFET CREDENZA WITH DRAWERS  Shown: 88-2472BF  Waste Bin Option Shown as Left	88-2436BF <i>Two Doors + One Drawer</i>	HPL+TFL	36	24	36	209	28.6	F, G, X, Y / P+T\$	2605		
									H / P+T\$	2654	
		HPL+Veneer							F, G, X, Y / P+W\$	3840	
									H / P+W\$	3916	
		Veneer							F, G, X, Y / W\$	4030	
									H / W\$	4091	
		Glass+TFL							Acid Etched Glass Top +T\$	4071	
									Gloss Glass Top +T\$	3699	
		Glass+Veneer							Acid Etched Glass Top +W\$	5498	
									Gloss Glass Top +W\$	5125	
			88-2448BF <i>Two Doors + Two Drawers</i>	HPL+TFL	48	24	36	209	28.6	F, G, X, Y / P+T\$	3121
										H / P+T\$	3185
HPL+Veneer								F, G, X, Y / P+W\$	4817		
								H / P+W\$	4917		
Veneer								F, G, X, Y / W\$	5004		
								H / W\$	5084		
Glass+TFL								Acid Etched Glass Top +T\$	5129		
								Gloss Glass Top +T\$	4632		
Glass+Veneer								Acid Etched Glass Top +W\$	7012		
								Gloss Glass Top +W\$	6517		
	88-2460BF <i>Three Doors + Three Drawers</i>	HPL+TFL	60	24	36	280	34.5	F, G, X, Y / P+T\$	4418		
								H / P+T\$	4499		
HPL+Veneer								F, G, X, Y / P+W\$	6540		
								H / P+W\$	6662		
Veneer								F, G, X, Y / W\$	6724		
								H / W\$	6822		
Glass+TFL								Acid Etched Glass Top +T\$	6967		
								Gloss Glass Top +T\$	6345		
Glass+Veneer								Acid Etched Glass Top +W\$	9272		
								Gloss Glass Top +W\$	8651		

Must Specify (in this order):

- Model #
- Top Material
- Top Finish/Color
- Edge Profile
- Chassis Color
- Glass (Y/N)
- Glass Color/Surface Finish
- Pull
- Locking
- Drawer Track
- Vent
- Waste Bin

Additional Buffet Credenzas on Next Page



Double Kerf (F)
1 3/8"



Duo (G)
1 3/8"



Fluted (X)
1 3/8"



Square (Y)
1 3/8"



Vertical Square (H)
1 1/2"

Pricing Codes:

T= TFL P= HPL W= Wood

[See Catalyst Overview For Ordering Options](#)

Item	Model No.	Material (Top+Chassis)	W	D	H	Ship Wt	Cubic Ft	Edge Profile + Material	List Price
<i>CONTINUED FROM PREVIOUS PAGE</i>	88-2472BF <i>Four Doors + Two Drawers</i>	HPL+TFL	72	24	36	342	42.3	F, G, X, Y / P+T\$	4595
								H / P+T\$	4690
		HPL+Veneer						F, G, X, Y / P+W\$	7055
								H / P+W\$	7199
		Veneer						F, G, X, Y / W\$	7232
								H / W\$	7351
		Glass+TFL						Acid Etched Glass Top +T\$	7684
								Gloss Glass Top +T\$	6940
		Glass+Veneer						Acid Etched Glass Top +W\$	10322
								Gloss Glass Top +W\$	9577
<i>Must Specify (in this order):</i> Model # Top Material Top Finish/Color Edge Profile Chassis Color Glass (Y/N) Glass Color/Surface Finish Pull Drawer Track Vent Waste Bin	88-2484BF <i>Five Doors + Three Drawers</i>	HPL+TFL	84	24	36	404	49.2	F, G, X, Y / P+T\$	5728
								H / P+T\$	5840
		HPL+Veneer						F, G, X, Y / P+W\$	8610
								H / P+W\$	8777
		Veneer						F, G, X, Y / W\$	8988
								H / W\$	9123
		Glass+TFL						Acid Etched Glass Top +T\$	9199
								Gloss Glass Top +T\$	8331
		Glass+Veneer						Acid Etched Glass Top +W\$	12459
								Gloss Glass Top +W\$	11589
	88-2496BF <i>Five Doors + Five Drawers</i>	HPL+TFL	96	24	36	466	56.0	F, G, X, Y / P+T\$	6548
								H / P+T\$	6674
		HPL+Veneer						F, G, X, Y / P+W\$	9989
								H / P+W\$	10179
		Veneer						F, G, X, Y / W\$	10364
								H / W\$	10517
		Glass+TFL						Acid Etched Glass Top +T\$	10559
								Gloss Glass Top +T\$	9567
		Glass+Veneer						Acid Etched Glass Top +W\$	14373
								Gloss Glass Top +W\$	13382

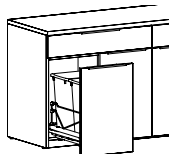

Waste Bin Option
Shown as Left

Description

- Standard with: Touch Latch Doors with One (1) Adjustable Shelf Behind Doors, Top Profile on Approach Side, 2" Wire Management Channel Along Back of Interior Cabinet, Reverse Slip Matched Pattern on Top Surface, and Vertical Grain Direction on Chassis
- Available with Veneer (W), HPL (P), or Back Painted Tempered Glass (Black or White with Gloss or Acid Etched Finish) Top with Veneer (W) or HPL (P) Chassis
- When Selecting Back Painted Tempered Glass Top; Must Specify Top Material, Top Finish/Color, Glass Color, Gloss or Acid Etched Finish and Edge Profile ([See Options](#))
- Tops and Chassis Available in Contrasting Finish/Colors; Must Specify Color of Each Component
- Studio Pull Centered on Drawer Fronts Standard; Must Specify Pull Color ([See Color Options](#))
- Touch Latch Doors Standard Without Pulls, Optional Studio Pulls; Must Specify Pull Color ([See Options](#))
- Studio Pulls Will be Added and Centered on Top of Doors When Waste Bin is Selected; Must Specify Pull Color ([See Color Options](#)) and Optional Waste Bin ([See Options](#))
- Knife Edge not Available
- Additional Options: Locking Doors ([See Options Details](#)); Pull Out Waste Bin ([See Options Details](#)); Back Panel Vent ([See Options Details](#)); Soft Close Drawers ([See Soft Close Option](#))

Pricing Codes:
T= TFL P= HPL

[See Catalyst Overview For Ordering Options](#)

Item	Model No.	Material (Top+Chassis)	W	D	H	Ship Wt	Cubic Ft	Edge Profile + Material	List Price
MOBILE SERVING CART 	88-2436SV	HPL+TFL	36	24	36	260	35.6	F, G, X, Y / P+T\$	2899
								H / P+T\$	2950
		HPL+Veneer						F, G, X, Y / P+W\$	4319
		H / P+W\$						4396	
		Veneer						F, G, X, Y / W\$	4511
								H / W\$	4573

Must Specify (in this order):

- Model #
- Top Material
- Top Finish/Color
- Edge Profile
- Optional Grommet

Description

- Top Edge Profiled on Approach Side Only (See Edge Options); Must Specify Edge Selection ([See Edge Details](#))
- Two (2) Box Drawers, Open Storage, and Storage Behind Two (2) Doors
- Locking Casters

Grommet Option: Specify & Add

1-GRMT	Grommet in Back Panel; Must Specify Black or Silver	\$ 58
--------	---	-------

ROUND GROMMET COVER FIELD INSTALLED	01-GRMTBK	Black	-	-	-	-	-	\$ 12
	01-GRMTSL	Silver						



OPEN MARKET ONLY
(SILVER)

Description

- 60mm Round Grommet Cover
- Field Installed

DOCK 950 WIRELESS CHARGER	01-DOCK950W	White	3 $\frac{3}{16}$ "	3 $\frac{3}{16}$ "	-	1	0.2	\$ 294
	01-DOCK950B	Black						



OPEN MARKET ONLY

Description

- For Use with Wireless Charging Enabled Devices
- 5 Watts Maximum Output with a Direct Current of 5V 2A and 10 Watts Maximum with Quick Charge 2.0
- LED will Confirm Pairing with Device and Begin Wireless Charging



Double Kerf (F)
1 $\frac{1}{16}$ "



Duo (G)
1 $\frac{1}{16}$ "



Fluted (X)
1 $\frac{1}{16}$ "



Square (Y)
1 $\frac{1}{16}$ "



Knife (K)
1 $\frac{1}{16}$ "



Vertical Square (H)
1 $\frac{1}{2}$ "

Pricing Codes:

T= TFL P= HPL W= Wood

[See Catalyst Overview For Ordering Options](#)

Item	Model No.		W	D	H	Ship Wt	Cubic Ft	List Price
WIRELESS AND USB CHARGER	01-DOCK150W	White	3	3	¾"	1	0.2	\$ 448
	01-DOCK150B	Black						



OPEN MARKET ONLY

Description

- For Use with Wireless Charging Enabled Devices and USB Charging Devices
- 5 Watt Maximum Output with a Direct Current Input of 5V 6A (Wireless Fast Charge)
- Pop-Up is ¾"H and Includes Three (3) USB Ports; One (1) 12 Watt Maximum with 2.4A (USB Fast Charge) and Two (2) 5 Watt with 1A (USB Standard Charge)
- LED Light will Confirm Pairing with Device and Begin Wireless Charging
- UL and cUL Certified

INTERACT POWER & DATA	01-INTERACTG2A	Aluminum	9	5⅝	2¾	5	0.2	\$ 987
	01-INTERACTG2B	Black						

**Description**

- Includes: Two (2) Power Outlets, USB-A+C Charging Ports, One (1) Telecom Plate Opening; Two (2) Keystone Openings for Voice/Data Jacks
- One (1) Telecom Plates Included with the Unit: One (1) 01-ABLAB Plate (Consists of One (1) RJ45 Cat 6, One (1) RJ11 Cat 3 Phone Jack)
- Convenience Plug on Bottom with 6' Power Cord
- UL and CSA Recognized
- Additional Telecom Plates, [See ECA Telecom Plate Options](#)

OASIS MINI POWER & DATA	01-OASISMA	Aluminum	15	9	5	11	0.3	\$ 3535
	01-OASISMB	Black						

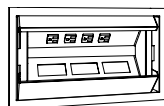

Top View

**Description**

- Soft Touch Hinged Lid
- Four (4) Power Outlets, Three (3) Telecom Plate Openings
- Two (2) Telecom Plates Included with the Unit: One (1) 01-ABLAB Plate (Consists of One (1) RJ45 Cat 6, One (1) RJ11 Cat 3 Phone Jack); One (1) 01-ABLB Plate (Consists of One (1) RJ45 Cat 6)
- 9' Power Cord
- UL Listed
- Additional Telecom Plates, [See ECA Telecom Plate Options](#)

DOCK800	01-DOCK800S	Silver	14	9	-			\$ 2268
	01-DOCK800B	Black						

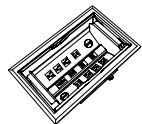





OPEN MARKET ONLY



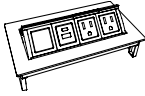

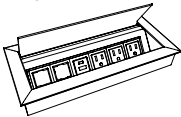
Description

- Stylish Aluminum Housing with Beveled Edges; Soft Touch Access and Closure
- Includes: Six (6) Power Outlets, Two (2) USB-A 5V Ports, Two (2) USB-C Charging Ports, One (1) RJ45 Ethernet Port, One (1) RJ11 Port, One (1) HDMI Port, and One (1) VGA Port
- 10' Power Cord
- UL and cUL Certified

[See Catalyst Overview For Ordering Options](#)

Item	Model No.		W	D	H	Ship Wt	Cubic Ft	List Price
	01-DPORT4A	Aluminum	8	4	-	7	0.2	\$ 1211
	01-DPORT4B	Black						
Description								
<ul style="list-style-type: none"> Includes: Two (2) Power Outlets, One (1) USB A+C, One (1) Open Port, 10' Power Cord, and Voice/Data Adapter Kit to Accept Couplers and Jacks When Required Retracts into Work Surface to Regain Productive Space; One-Touch Access to Power and Data Optional Telecom Port Components, See Compatible Units Below Water-Proof Simplex (Outlets) UL Recognized 								
 <p>01-E2X4</p>	01-E2X6A	Aluminum	11	9 ¹³ / ₁₆	-	6	0.7	\$ 1801
	01-E2X6B	Black						
	01-E2X4A	Aluminum	8	9 ¹³ / ₁₆	-	5	0.5	\$ 1655
	01-E2X4B	Black						
Description								
<ul style="list-style-type: none"> In Surface, Dual Side Application; Soft Touch Access to Power and Data Each Side has the Following: 11" Unit Includes Three (3) Power Outlets, One (1) USB A+C, and Two (2) Open Port on Each Side; 8" Unit Includes Two (2) Power Outlets, One (1) USB A+C, and One (1) Open Port Optional Telecom Port Components, See Compatible Units 6' Power Cord UL Listed 								
 <p>01-ELLORA6</p>	01-ELLORA6A	Aluminum	11	5	-	6	0.7	\$ 944
	01-ELLORA6B	Black						
	01-ELLORA4A	Aluminum	8	5	-	5	0.5	\$ 877
	01-ELLORA4B	Black						
Description								
<ul style="list-style-type: none"> In Surface Application; Soft Touch Access to Power and Data 11" Includes Three (3) Power Outlets, One (1) USB A+C, and Two (2) Open Port; 8" Includes Two (2) Power Outlets, One (1) USB A+C, and One (1) Open Port Optional Telecom Port Components, See Below for Compatible Units 6' Power Cord UL Recognized 								
	01-USBPORT		-	-	-	-	-	\$ 178
	Description							
<ul style="list-style-type: none"> Passive USB-A Port with Increased Transfer Speed Up to 5 gbs/sec Simultaneous Read/Write Capability; Idle Device Power Saving State 6' Cord Compatible with 01-DPORT4A, 01-DPORT4B, ELLORA4A, ELLORA4B, ELLORA6A, ELLORA6B, E2X4A, E2X4B, E2X6A, and E2X6B 								

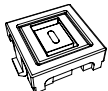
[See Catalyst Overview For Ordering Options](#)

Item	Model No.	W	D	H	Ship Wt	Cubic Ft	List Price
VOICE COUPLER	01-VOICE1	-	-	-	-	-	\$ 80
	<p>Description</p> <ul style="list-style-type: none"> • 6-Pin Modular Plug • Molded Black; Cord Not included • Compatible with 01-DPORT4A, 01-DPORT4B, ELLORA4A, ELLORA4B, ELLORA6A, ELLORA6B, E2X4A, E2X4B, E2X6A, and E2X6B 						
DATA PORT	01-RJ4DATA	-	-	-	-	-	\$ 186
	<p>Description</p> <ul style="list-style-type: none"> • 8-Pin Modular Plug; Cat6 Ethernet Cable; Pre-terminated Cable • 10' Cord • Compatible with 01-DPORT4A, 01-DPORT4B, ELLORA4A, ELLORA4B, ELLORA6A, ELLORA6B, E2X4A, E2X4B, E2X6A, and E2X6B 						
VGA CONNECTOR ACCESSORY	01-VGACON	-	-	-	1	0.2	\$ 165
	<p>Description</p> <ul style="list-style-type: none"> • VGA Port for 01-DPORT4A, 01-DPORT4B, ELLORA4A, ELLORA4B, ELLORA6A, ELLORA6B, E2X4A, E2X4B, E2X6A, and E2X6B • Enables Devices to Remote Display on Monitors • 10' Cord • Male/Female Connector 						
PASSIVE USB-C ACCESSORY	01-PUSBC	-	-	-	1	0.2	\$ 105
	<p>Description</p> <ul style="list-style-type: none"> • Passive USB-C Port ; Unit Provides Data Connection to Transfer Data Only, No Charging Capabilities • Compatible with 01-DPORT4A, 01-DPORT4B, ELLORA4A, ELLORA4B, ELLORA6A, ELLORA6B, E2X4A, E2X4B, E2X6A, and E2X6B • Male/Female Connector 						
CHARGING USB-A+C ACCESSORY	01-USBAC	-	-	-	1	0.2	\$ 313
	<p>Description</p> <ul style="list-style-type: none"> • For Charging Devices • 20 Watt Power Supply • USB+C Charging Port for 01-DPORT4A, 01-DPORT4B, ELLORA4A, ELLORA4B, ELLORA6A, ELLORA6B, E2X4A, E2X4B, E2X6A, and E2X6B 						

[See Catalyst Overview For Ordering Options](#)

Item	Model No.		W	D	H	Ship Wt	Cubic Ft	List Price
HDMI CONNECTOR ACCESSORY	01-HDMICON		-	-	-	1	0.2	\$ 137



Description

- HDMI Port for 01-DPORT4A, 01-DPORT4B, ELLORA4A, ELLORA4B, ELLORA6A, ELLORA6B, E2X4A, E2X4B, E2X6A, and E2X6B
- Connects to High Definition Displays
- Female/Female Connector
- 18" Cord

DUO AIR WITH NEMA PLUG	01-DUOAIRB	Black	7	5	4 ¹³ / ₂₀	1	0.2	\$ 743
	01-DUOAIRS	Silver						
	01-DUOAIRW	White						

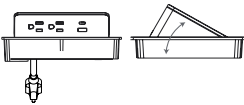

Description

- Standard with: Two (2) Tamper Resistant 15 Amp Power Outlets, One (1) USB-A Charging Port, One (1) 60-Watt USB-C Power Delivery Port with GaN Technology; 10' Cord and All Mounting Hardware
- Top Must Be Routed To Allow Unit to Sit Down Into the Top, Must Specify when Ordering Top
- Features a Sophisticated Pop-Up Access
- FCC Part 15A, UL Approved for Horizontal and Vertical Applications

DUO BEZEL WITH NEMA PLUG	01-DUOBEZELW	White	6 ¹ / ₂	2 ¹ / ₂	3 ¹ / ₁₀	1	0.2	\$ 748
	01-DUOBEZELB	Black						
	01-DUOBEZELS	Silver						



Description

- Standard with: Two (2) Power, One (1) USB-A Charging Port and One (1) 60-Watt USB-C Power Delivery Port with GaN Technology; 10' Cord, and All Mounting Hardware
- Worksurface Must Be Routed To Accept Unit, Which Sits Down Into Worksurface Supported By Attractive Slim Fit Bezel
- Independent USB Circuit Controllers Deliver up to 2.1 Amps to Each Post
- FCC Part 15A, UL Recognized for Horizontal and Vertical Applications

TRIO BEZEL WITH NEMA PLUG	01-TRIOBEZELW	White	9	2 ¹ / ₂	3	1	0.2	\$ 803
	01-TRIOBEZELB	Black						
	01-TRIOBEZELS	Silver						



Description

- Standard with: Three (3) Power Outlets, One (1) USB-A Charging Port, One (1) 60-Watt USB-C Power Delivery Port with GaN Technology, One (1) Open Data Port, 10' Cord, and All Mounting Hardware
- Worksurface Must Be Routed To Accept Unit, Which Sits Down Into Worksurface Supported By Attractive Slim Fit Bezel
- HDMI, VGA, and RJ45 Accessories for Open Data Port; Sold Separately, [See Accessories](#)
- Independent USB Circuit Controllers Deliver up to 2.1 Amps to Each Post
- FCC Part 15A, UL Recognized for Horizontal and Vertical Applications

[See Catalyst Overview For Ordering Options](#)

Item	Model No.		W	D	H	Ship Wt	Cubic Ft	List Price
UNDERMOUNT DUO WITH DAISY CHAIN PLUG	01-DCDUOUNDRW	White	6½	2½	3	1	0.2	\$ 652
	01-DCDUOUNDRB	Black						
	01-DCDUOUNDRS	Silver						



Description

- Sits Under Top and Includes: Two (2) Tamper Resistant 15 Amp Power Outlets, One (1) USB-A Charging Port and One (1) 60-Watt USB-C Power Delivery Port with GaN Technology, 10' Cord and All Mounting Hardware
- Requires Purl Daisy Chain Power Infeed, Specified Separately ([See Details](#))
- Non-Sequential System Allows up to Nine (9) Modules to be Connected with H-Block and Jumper Cord ([See Details](#))
- Independent USB Circuit Controllers Deliver up to 2.1 Amps to Each Post
- FCC Part 15A, RU Listed and UL Recognized for Horizontal Applications

UNDERMOUNT TRIO WITH DAISY CHAIN PLUG	01-DCTRIOUNDRW	White	9	2½	3	1	0.2	\$ 758
	01-DCTRIOUNDRB	Black						
	01-DCTRIOUNDRS	Silver						

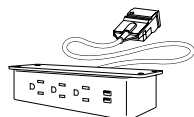

Description

- Sits Under Top and Includes: Three (3), Power, One (1) USB-A Charging Port, One (1) 60-Watt USB-C Power Delivery Port with GaN Technology, One (1) Open Data; 12" Cord and All Mounting Hardware
- Requires Purl Daisy Chain Power Infeed, Specified Separately ([See Details](#))
- Non-Sequential System Allows up to Nine (9) Modules to be Connected with H-Block and Jumper Cord ([See Details](#))
- Independent USB Circuit Controllers Deliver up to 2.1 Amps to Each Post
- FCC Part 15A, RU Listed and UL Recognized for Horizontal and Vertical Applications HDMI, VGA, or RJ45 Sold Separately ([See Accessories](#))

DUO BEZEL WITH PURL DAISY CHAIN PLUG	01-DCDUOBEZELW	White	6½	2½	3	1	0.2	\$ 631
	01-DCDUOBEZELB	Black						
	01-DCDUOBEZELS	Silver						



Description

- Standard with: Two (2) Tamper Resistant 15 Amp Power Outlets, One (1) USB-A Charging Port and One (1) 60-Watt USB-C Power Delivery Port with GaN Technology, 10' Cord and All Mounting Hardware
- Top Must Be Routed To Allow Unit to Sit Down Into the Top, Must Specify when Ordering Top
- Unit Supported By Attractive Slim Fit Bezel
- Requires Purl Daisy Chain Power Infeed, Specified Separately ([See Details](#))
- Non-Sequential System Allows up to Nine (9) Modules to be Connected with H-Block and Jumper Cord ([See Details](#))
- Independent USB Circuit Controllers Deliver up to 2.4 Amps to Each Post
- FCC Part 15A, RU Listed and UL Recognized for Horizontal and Vertical Applications

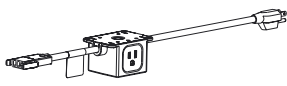
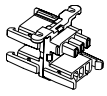
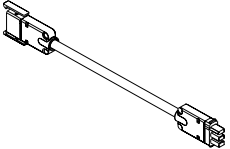
Item	Model No.		W	D	H	Ship Wt	Cubic Ft	List Price
TRIO BEZEL WITH PURL DAISY CHAIN PLUG	01-DCTRIOBEZELW	White	9	2½	3	1	0.2	\$ 723
	01-DCTRIOBEZELB	Black						
	01-DCTRIOBEZELS	Silver						
	Description <ul style="list-style-type: none"> Standard with: Three (3) Tamper Resistant 15 Amp Power Outlets, One (1) USB-A Charging Port, One (1) 60-Watt USB-C Power Delivery Port with GaN Technology, One (1) Open Data, 12" Cord and All Mounting Hardware Top Must Be Routed To Allow Unit to Sit Down Into the Top, Must Specify when Ordering Top Unit Supported By Attractive Slim Fit Bezel Requires Purl Daisy Chain Power Infeed, Specified Separately (See Details) Non-Sequential System Allows up to Nine (9) Modules to be Connected with H-Block and Jumper Cord (See Details) Independent USB Circuit Controllers Deliver up to 2.4 Amps to Each Post FCC Part 15A, RU Listed and UL Recognized for Horizontal and Vertical Applications HDMI, VGA, or RJ45 Sold Separately (See Accessories) 							
	<hr/>							
PURL DAISY CHAIN POWER INFEED	01-DCPOWER		-	-	-	1	0.2	\$ 227
	Description <ul style="list-style-type: none"> Includes One (1) Purl Connector Plug, 36" Daisy Chain Cord, One (1) 15 Amp Power Outlet, and a 120" Power Cord with a Nema Plug Powers up to Nine (9) Duo and Trio Purl Daisy Chain Units 15-Amp System Rating and Over-Current Protection System Requires H-BLOCK Connector Between Power Infeed and Each Jumper Cord, See Below For Purl Daisy Chain H-Block and Purl Daisy Chain Jumper Cords Details 							
	<hr/>							
PURL DAISY CHAIN H-BLOCK	01-DCHBLOCK		-	-	-	1	0.2	\$ 40
	Description <ul style="list-style-type: none"> Includes One (1) Power In and Three (3) Power Out Receptacles System Requires H-BLOCK Connector Between Power Infeed and Each Jumper Cord, See Purl Daisy Chain Power Infeed (Above) and Jumper Cords (See Below) 							
	<hr/>							
PURL DAISY CHAIN JUMPER CORD	01-DC2JUMP	24" Long	-	-	-	1	0.2	\$ 72
	01-DC3JUMP	36" Long	-	-	-	1	0.2	\$ 77
	01-DC4JUMP	48" Long	-	-	-	1	0.2	\$ 82
	01-DC5JUMP	60" Long	-	-	-	1	0.2	\$ 87
	01-DC6JUMP	72" Long	-	-	-	1	0.2	\$ 92
	Description <ul style="list-style-type: none"> Connects Duo and Trio Daisy Chain Units Non-Sequential System Allows up to None (9) Modules to be Connected 							
	<hr/>							

[See Catalyst Overview For Ordering Options](#)

Item	Model No.	W	D	H	Ship Wt	Cubic Ft	List Price
HDMI DATA PORT ACCESSORY	01-LCOMHDMI	-	-	-	1	0.2	\$ 183



OPEN MARKET ONLY

Description

- HDMI Port for Trio Bezel Units

VGA DATA PORT ACCESSORY	01-LCOMVGA	-	-	-	1	0.2	\$ 134
-------------------------	------------	---	---	---	---	-----	--------

**Description**

- VGA Port for Trio Bezel Units

RJ45 DATA PORT ACCESSORY	01-LCOMRJ45	-	-	-	1	0.2	\$ 88
--------------------------	-------------	---	---	---	---	-----	-------

**Description**

- RJ45 Port for Trio Bezel Units

WIRE MANAGEMENT CHANNEL	01-WMGR4	16	1½	¾	1	-	\$ 129
-------------------------	----------	----	----	---	---	---	--------

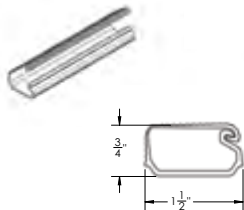
**Description**

- Set of Four (4) Black Plastic Wire Management Channels
- Snap Lock Channel
- Attaches with Adhesive Strips
- Ships via UPS Only

WIRE CHANNEL	01-32125	24	1½	1	.25	0.3	\$ 117
--------------	----------	----	----	---	-----	-----	--------

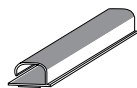
**Description**

- Available in Black
- Channels Attach with Two (2) Double-Sided Installation Tape
- Open J Channel for Easy Storage of Cables

CABLE GRIP	01-WMGRCB	5¾	2¾	-	-	-	\$ 19
------------	-----------	----	----	---	---	---	-------

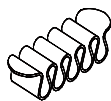
**Description**

- Under Surface Wire Management
- Black

[See Catalyst Overview For Ordering Options](#)

Item	Model No.	W	D	H	Ship Wt	Cubic Ft	List Price
MAGNETIC GLASS MARKER BOARD FOR USE WITH 30"H CREDENZA AND SHELVING	GMB-4048W	48	½	40⅞	67	11.0	\$ 3465
	GMB-4042W	42	½	40⅞	58	9.9	\$ 2929
	GMB-4036W	36	½	40⅞	50	8.8	\$ 2531
	GMB-4030W	30	½	40⅞	42	7.7	\$ 2131

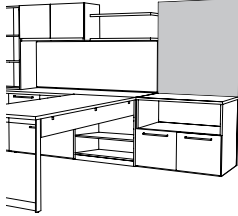

Description

- Available in Black (BLMKR) or White (WHMKR), Must Specify
- Tempered Glass Magnetic Marker Boards Include Mounting Brackets
- For Use over 30"H Desks and Credenzas with Wall Mount Hutches or Shelving
- For Rare Earth Magnets, Marker and Eraser Sets; [See Set Options](#)

Must Specify (in this order):

Model #
Color

MAGNETIC GLASS MARKER BOARD FOR USE WITH 30"H CREDENZA AND SHELVING	GMB-5248W	48	½	52⅞	86	13.5	\$ 4419
	GMB-5242W	42	½	52⅞	76	12.2	\$ 3732
	GMB-5236W	36	½	52⅞	65	10.8	\$ 3218
	GMB-5230W	30	½	52⅞	54	9.5	\$ 2705

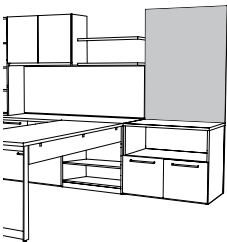

Description

- Available in Black (BLMKR) or White (WHMKR), Must Specify
- Tempered Glass Magnetic Marker Boards Include Mounting Brackets
- For Use Next to Tall Surface or Wall Mount Hutches
- For Rare Earth Magnets, Marker and Eraser Sets; [See Set Options](#)

Must Specify (in this order):

Model #
Color

MAGNETIC GLASS MARKER BOARD FOR USE FROM FLOOR TO TOP OF UNIT	GMB-8236W	36	½	82⅞	102	15.8	\$ 4934
	GMB-7036W	36	½	70⅞	87	13.8	\$ 4248
	GMB-5136W	36	½	51⅞	63	10.6	\$ 3104
	GMB-8230W	30	½	82⅞	85	13.8	\$ 4132
	GMB-7030W	30	½	70⅞	72	12.1	\$ 3562
	GMB-5130W	30	½	51⅞	53	9.3	\$ 2608

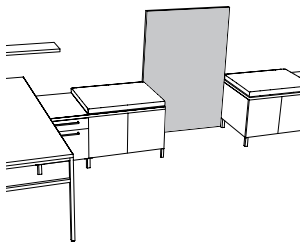

Description

- Available in Black (BLMKR) or White (WHMKR), Must Specify
- Tempered Glass Magnetic Marker Boards Are One (1) Piece with No Seams
- Mounting Brackets Included
- For Use From Floor to Top of Unit
- For Rare Earth Magnets, Marker and Eraser Sets; [See Details](#)

Must Specify (in this order):

Model #
Color



Rare Earth Magnets, Marker and Eraser set available; [See Details](#)

[See Catalyst Overview For Ordering Options](#)

Item	Model No.	Materials	W	D	H	Ship Wt	Cubic Ft	List Price
MARKER AND ERASER SET	01-MRKRSETBL	For Use with Black Marker Boards and Black Glass Doors						\$ 136
	01-MRKRSETWH	For Use with White Marker Boards and White Glass Doors						



Description

- 01-MRKRSETWH May Also be Used with Dry Erase Doors and Boards
- Includes 4 Markers and an Eraser

RARE EARTH MAGNET SET	01-MAGBL	For Use with White Marker Boards						\$ 127
	01-MAGWH	For Use with Black Marker Boards						



Description

- Includes Set of Five (5) Rare Earth Magnets
- To be Used with Tempered Glass Magnetic Marker Boards
- Comfort Grip with Stylish Protective Plastic Coating

VISUAL BOARD	88-4848VB	TFL	48	5	48	150	11.0	T\$ 3314
		Veneer						W\$ 5503

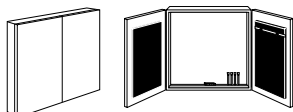

Must Specify (in this order):

- Model #
- Color
- Projection Screen
- Tackboard Fabric

Description

- Tackboard on Each Door Standard in Black Fabric Unless Specified; Price Valid for Grades 1, 2, & 3 (See Other Pricing Below)
- Display Rail with Adjustable Hooks for Flipchart
- Magnetic Porcelain Non-Glare Writing Surface
- Includes Flipchart, Set of Four (4) Dry Erase Markers and Eraser, Mounting Hardware
- Does Not Feature Soft Close Hinges

Options: Specify & Add

	Grade 4	5	6	7	8	9	10
Tackboard Fabric Change	\$ 310	456	602	812	1030	1286	1580
1-PS Projection Screen (Requires Field Installation)							\$ 1177

LECTERN STAND	88-2650LS	HPL+TFL	26	24	50	130	21.9	F, G, X, Y / P+T\$ 2143
								H / P+T\$ 2154
		HPL+Veneer						F, G, X, Y / P+W\$ 3870
								H / P+W\$ 3899
		Veneer						F, G, X, Y / W\$ 4022
							H / W\$ 4038	

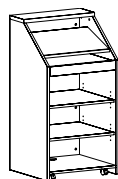





Must Specify (in this order):

- Model #
- Top Material
- Top Finish/Color
- Edge Profile

Description

- Top Edge Profiled on Approach Side Only (See Edge Options); Must Specify Edge Selection
- Fixed Shelf Angled for User Comfort, One (1) Pullout Shelf, and Two (2) Adjustable Shelves
- Two (2) Locking and Two (2) Non-Locking Casters
- Wire Management Grommet on Bottom Shelf

Item	Model No.	Description	List Price
ECA TELECOM PLATES	01-ABL	Telecom Plate, Blank Plate	\$ 45
	01-ABL737373	Telecom Plate, Three (3) RJ45 Cat 5e	\$ 406
Compatible with:	01-ABLAB	Telecom Plate, One (1) RJ45 Cat 6, One (1) RJ11 Cat 3 Phone	\$ 228
	01-ABLAB102	Telecom Plate, One (1) RJ45 Cat 6, One (1) RJ11 Cat 3, One (1) USB W/72" Patch Cord	\$ 355
	01-ABLABB	Telecom Plate, Two (2) RJ45 Cat 6, One (1) RJ11 Cat 3 Phone	\$ 355
Oasis Mini Power & Data 01-OASISMA, 01-OASISMB	01-ABLB	Telecom Plate, One (1) RJ45 Cat 6	\$ 165
	01-ABLBB	Telecom Plate, Two (2) RJ45 Cat 6	\$ 289
Interact Power & Data 01-INTERACTG2A, 01-INTERACTG2B	01-ABLBBB	Telecom Plate, Three (3) RJ45 Cat 6	\$ 406
	01-ABLBBBB	Telecom Plate, Four (4) RJ45 Cat 6	\$ 528
Power Center 01-INTRFCIA, 01-INTRFCIB	01-ABLBBC51	Telecom Plate, Two (2) RJ45 Cat 6, One (1) 15 Pin HD VGA w/72" Patch Cord	\$ 494
	01-ABLBC51L	Telecom Plate, One (1) RJ45 Cat 6, One (1) Mini Stereo Inline, One (1) 15 Pin HD VGA w/72" Patch Cord	\$ 455
	01-ABLC3811	Telecom Plate, One (1) RJ45 Cat 6 Data Inline, One (1) RJ11 Cat 3 Phone Inline	\$ 219
	01-ABLC45	Telecom Plate, One (1) HDMI w/36" Patch Cord	\$ 327
	01-ABLC45C51L	Telecom Plate, One (1) Mini Stereo Inline, One (1) HDMI w/36" Patch Cord, One (1) 15 Pin HD VGA w/72" Patch Cord	\$ 618
	01-ABLC51L	Telecom Plate, One (1) 15 Pin HD VGA & One (1) Mini Stereo Inline Jack	\$ 330
	01-ABLCRDM	Telecom Plate, Three (3) Cord Bushings	\$ 106

Chat Work Tables are the perfect place to gather and connect. With desk, counter, and bar heights in widths of 60" to 96" and depths of 24" to 48", Chat allows you to add style and functionality virtually anywhere. Select from veneer or laminate, then personalize the look and function with contrasting colors/finishes, optional power, and wire management.

CONSTRUCTION

Chat Tables feature a Veneer or TFL chassis with your choice of either a Veneer, TFL or HPL top. Units ship knocked-down with some assembly required on all models except 24"D Tables.

LAMINATES

- Exposed surfaces are woodgrain and solid color laminates fused to particle-board core
- Each laminate offers lasting beauty, superior resistance to normal wear, and easy maintenance

VENEERS

- Exposed surfaces feature select grade plain sliced hardwood Cherry, Maple, American Black Walnut, White Oak, or composite veneers
- Veneers are carefully selected and matched to assure proper balance and consistency

TOPS

- 75- models are standard with veneer chassis and available with veneer or HPL worksurfaces. 76- models are standard with TFL chassis and available with TFL or HPL worksurfaces.
- 76- Series worksurfaces are 1" thick with 3-ply balanced construction and available in Thermally-Fused Laminate (TFL) or High Pressure Laminate (HPL) with 3mm matching PVC rims contoured to selected profile on user sides and 1mm PVC rims on ends; Designer White, Sugar Maple, Williamsburg Cherry feature ABS edge bands
- 75- Series worksurfaces are 1 $\frac{1}{16}$ " thick with 3-ply balanced construction in Veneer and High Pressure Laminate (HPL) with 3mm wood edge-banded rims contoured to the selected profile on user sides and 1mm wood self edges on ends.
- Optional 1 $\frac{1}{2}$ " thick HPL worksurfaces are available in select colors. Please contact Customer Service or your local Sales Rep for pricing and lead times.
- Grain direction runs left-to-right unless otherwise noted
- Tops are shaped on user and approach sides

CHASSIS

- Chassis is securely fastened using high-quality European fastening systems and heavy-duty, 16-gauge joining brackets to assure maximum strength
- All units ship with heavy-duty, adjustable leveling glides to ensure proper leveling and compensation for uneven floors

CORD MANAGEMENT

- When grommets or power ports are specified, add Wire Management Upcharge and specify (WM) for the required double modesty on 36", 42" and 48"D work tables. 24"D work tables feature a 5 $\frac{1}{4}$ " recessed modesty panel for cord management and are intended to be used against the wall.

HOW TO ORDER EXAMPLES

MODEL NO.	DESCRIPTION	EXAMPLE
76-4260WT	Top Material	P
	Top Color	ORK
	Edge Profile	X
	Chassis Color	NTM
	Modesty/Color	NTM
	Wire Management	WM
	Grommet/Port Location	DOCK950-C
	Power/Data Options	DOCK950B

HOW TO ORDER EXAMPLES CONTINUE

MODEL NO.	DESCRIPTION	EXAMPLE
75-4260CWT	Top Material	W
	Top Color	PNW
	Edge Profile	Y
	Chassis Color	MAS
	Modesty/Color	ORW
	Wire Management	WM
	Grommet/Port Location	PDC-C
	Power/Data Options	01-DUOBEZELS

VENEER (W) OPTIONS

Veneer features UVAdvantage, an ultra-violet finish, on all exposed surfaces by utilizing roll-coat UV technology.

AW	Artisan Walnut	MW	Mahogany Walnut
AS	Asian Night	MAS	Mesa Sunset*
CO	Columbian Walnut	MTS	Metropolis Sky
DC	Dark Cherry	ORW	Oak Riftwood*
DFW	Dark Forest Walnut	PNW	Pinnacle Walnut
EW	Espresso	SCH	Select Cherry
FO	Fawn Oak*	SKC	Shaker Cherry
GC	Golden Cherry	SM	Sugar Maple
HW	Harvest Walnut	WTA	Weathered Ash*
HNW	Henna Walnut	WC	Williamsburg Cherry
LW	Legacy Walnut		

* Low Sheen Finish

TFL (T) AND HPL (P) LAMINATE OPTIONS

WOODGRAIN

AS	Asian Night	PNW	Pinnacle Walnut
BW	Beigewood	PTK	Portico Teak
CO	Columbian Walnut	RC	River Cherry
EF	Espresso	SCH	Select Cherry
FLW	Florence Walnut	SPW	Sepia Walnut
GC	Golden Cherry	SKC	Shaker Cherry
HVM	Harvest Maple	SBP	Smoky Brown Pear
KHE	Kirsche	TK	Studio Teak
MW	Mahogany Walnut	SM	Sugar Maple
MNR	Midnight Run	WTA	Weathered Ash
NTM	Natural Marrone	WNB	White Nebbia
ORW	Oak Riftwood	WC	Williamsburg Cherry

SOLID

BL	Black	FHG	Fashion Grey
WH	Designer White	SG	Slate Grey

1½" THICK WORKSURFACE HPL (P) LAMINATE OPTIONS

Tops 1½" thick are available in the following HPL colors. This top thickness will change the overall published height of unit. Please contact Customer Service or your local Sales Representative for pricing and lead times.

WOODGRAIN

AS Asian Night	PNW Pinnacle Walnut
BW Beigewood	PTK Portico Teak
CO Columbian Walnut	RC River Cherry
EF Espresso	SCH Select Cherry
FLW Florence Walnut	SPW Sepia Walnut
GC Golden Cherry	SKC Shaker Cherry
HVM Harvest Maple	SBP Smoky Brown Pear
KHE Kirsche	TK Studio Teak
MW Mahogany Walnut	SM Sugar Maple
MNR Midnight Run	WTA Weathered Ash
NTM Natural Marrone	WNB White Nebbia
ORW Oak Riftwood	WC Williamsburg Cherry
SOLID	
BL Black	FHG Fashion Grey
WH Designer White	SG Slate Grey

EDGE PROFILES

F Double Kerf	X Flute
G Duo	Y Square



Double Kerf (F) Duo (G) Flute (X) Square (Y)

GROMMET OPTIONS & POWER UNIT LOCATIONS

Double Modesty + Add Wire Management Upcharge required when Grommet, DOCK950, DOCK150 or DUO and TRIO Power is ordered. Must specify (WM) on order.

Grommets are available in standard locations. Please specify from locations listed below. Multiple locations may be selected. Only one unit per location. DUO and TRIO Power units, Dock 950 and Dock 150 must be specified separately. (See Accessories)







GROMMET/POWER LOCATIONS (Black = BLK and Silver = SLV)

GC Grommet, Center		\$ 58
GL Grommet, Left		\$ 58
GR Grommet, Right		\$ 58

DUO/TRIO BEZEL LOCATIONS - Must Order Separately

PDC-C Bezel, Center	
PDC-L Bezel, Left	
PDC-R Bezel, Right	

DOCK 950 + DOCK 150 LOCATIONS (See Dock Units) - Must Order Separately

DOCK950-L Wireless Charger, Left	
DOCK950-C Wireless Charger, Center	
DOCK950-R Wireless Charger, Right	
DOCK150-L Wireless and USB Charger, Left	
DOCK150-C Wireless and USB Charger, Center	
DOCK150-R Wireless and USB Charger, Right	

Grommets and Power Units may be ordered in non-standard locations. Call Customer Service to assist with specification and/or please attach a drawing to the PO showing the location of the grommet. Note additional charges and lead times may apply.

GROMMET/POWER UNIT LOCATIONS

Models

76-2460WT	76-2460CWT	76-2460TWT
75-2460WT	75-2460CWT	75-2460TWT
76-2472WT	76-2472CWT	76-2472TWT
75-2472WT	75-2472CWT	75-2472TWT
76-2484WT	76-2484CWT	76-2484TWT
75-2484WT	75-2484CWT	75-2484TWT
76-2496WT	76-2496CWT	76-2496TWT
75-2496WT	75-2496CWT	75-2496TWT

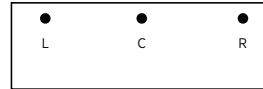

GL/R, PDC-L/-R, DOCK950-L/-R, DOCK150-L/-R: Located 6" from ends and 21½" from user side

GC/PDC-C/DOCK950-C/DOCK150-C: Located 21½" from user side

Models

76-4260WT	76-3660CWT	76-3660TWT
76-4272WT	76-3672CWT	76-3672TWT
76-4284WT	76-3684CWT	76-3684TWT
76-4296WT	76-3696CWT	76-3696TWT
76-4860WT	76-4260CWT	76-4260TWT
76-4884WT	76-4860CWT	76-4272TWT
76-4896WT	76-4296CWT	76-4284TWT
76-4872WT	76-4284CWT	76-4296TWT
	76-4272CWT	76-4860TWT
	76-4896CWT	76-4872TWT
	76-4884CWT	76-4884TWT
	76-4872CWT	76-4896TWT

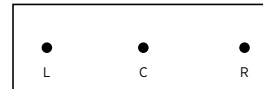

42" Work Tables

GL/R, PDC-L/-R, DOCK950-L/-R, DOCK150-L/-R: Located 6" from ends and 21" from user side

GC/PDC-C/DOCK950-C/DOCK150-C: Located 21" from user side

36" Work Tables

GL/R, PDC-L/-R, DOCK950-L/-R, DOCK150-L/-R: Located 6" from ends and 18" from user side

GC/PDC-C/DOCK950-C/DOCK150-C: Located 18" from user side

CERTIFICATIONS & COMPLIANCE

- Intertek Sustainability Certified
- BIFMA level® Certified
- BIFMA Compliant® Certified
- TSCA Title VI (formerly CARB) Compliance
- Contributes to LEED®, Green Globes®, and WELL® Sustainable Programs

WORK TABLES

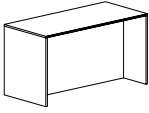

Desk Height Work Tables
[\(See Multiple Unit Details\)](#)

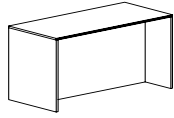

Counter Height Work Tables
[\(See Multiple Unit Details\)](#)

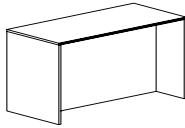

Bar Height Work Tables
[\(See Multiple Unit Details\)](#)

POWER/DATA ACCESSORIES - [See Product Details](#)

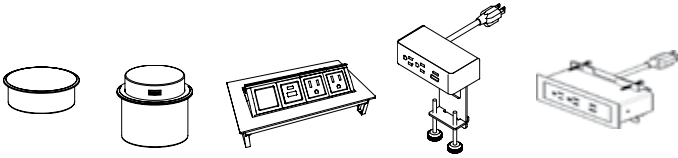

ACCESSORIES

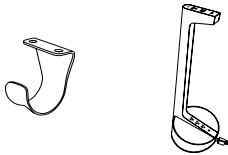

Item	Model No.	Material	Width	Depth	Height	Ship Wt	Cubic Ft	List Price
WORK TABLES	76-2460WT	TFL	60	24	30	129	29.8	T\$ 1412
	76-2460WT	HPL						P\$ 1656
DESK HEIGHT	75-2460WT	Veneer						W/P\$ 2504
	76-2472WT	TFL	72	24	30	143	35.6	T\$ 1511
	76-2472WT	HPL						P\$ 1776
	75-2472WT	Veneer						W/P\$ 2680
	76-2484WT	TFL	84	24	30	158	41.4	T\$ 1614
	76-2484WT	HPL						P\$ 1892
	75-2484WT	Veneer						W/P\$ 2861
	76-2496WT	TFL	96	24	30	173	47.2	T\$ 1710
	76-2496WT	HPL						P\$ 2024
	75-2496WT	Veneer						W/P\$ 3033
	76-4260WT	TFL	60	42	30	278	7.9	T\$ 1771
								Add Wire Management Upcharge \$ 309
	76-4260WT	HPL						P\$ 2099
								Add Wire Management Upcharge \$ 309
	75-4260WT	Veneer						W/P\$ 3136
								Add Wire Management Upcharge \$ 549
	76-4272WT	TFL	72	42	30	278	7.9	T\$ 1904
								Add Wire Management Upcharge \$ 352
	76-4272WT	HPL						P\$ 2263
								Add Wire Management Upcharge \$ 352
	75-4272WT	Veneer						W/P\$ 3373
								Add Wire Management Upcharge \$ 624
	76-4284WT	TFL	84	42	30	278	7.9	T\$ 2042
								Add Wire Management Upcharge \$ 396
	76-4284WT	HPL						P\$ 2422
								Add Wire Management Upcharge \$ 396
	75-4284WT	Veneer						W/P\$ 3618
								Add Wire Management Upcharge \$ 701
	76-4296WT	TFL	96	42	30	278	7.9	T\$ 2174
								Add Wire Management Upcharge \$ 433
	76-4296WT	HPL						P\$ 2598
								Add Wire Management Upcharge \$ 433
	75-4296WT	Veneer						W/P\$ 3856
								Add Wire Management Upcharge \$ 773

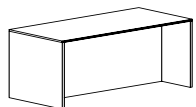

Must Specify (in this order):

- Model #
- Top Material
- Top Color
- Edge Profile
- Chassis Color
- Modesty/Color
- Wire Management
- Grommet/Port Location
- Power/Data Options

48" D Desk Height Work Tables on Next Page.

Pricing Codes:

T= TFL P= HPL W= Wood Top

[See Intro Section for Ordering Options](#)

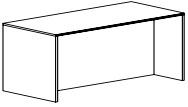
Item	Model No.	Material	Width	Depth	Height	Ship Wt	Cubic Ft	List Price
WORK TABLES DESK HEIGHT (CONTINUED) 	76-4860WT	TFL	60	48	30	242	9.0	T\$ 1968
								Add Wire Management Upcharge \$ 309
	76-4860WT	HPL						P\$ 2333
								Add Wire Management Upcharge \$ 309
	75-4860WT	Veneer						W/P\$ 3490
								Add Wire Management Upcharge \$ 549
	76-4872WT	TFL	72	48	30	242	9.0	T\$ 2130
								Add Wire Management Upcharge \$ 352
	76-4872WT	HPL						P\$ 2531
								Add Wire Management Upcharge \$ 352
	75-4872WT	Veneer						W/P\$ 3776
								Add Wire Management Upcharge \$ 624
	76-4884WT	TFL	84	48	30	242	9.0	T\$ 2292
								Add Wire Management Upcharge \$ 396
	76-4884WT	HPL						P\$ 2713
								Add Wire Management Upcharge \$ 396
	75-4884WT	Veneer						W/P\$ 4063
								Add Wire Management Upcharge \$ 701
76-4896WT	TFL	96	48	30	242	9.0	T\$ 2456	
							Add Wire Management Upcharge \$ 433	
76-4896WT	HPL						P\$ 2926	
							Add Wire Management Upcharge \$ 433	
75-4896WT	Veneer						W/P\$ 4350	
							Add Wire Management Upcharge \$ 773	

Must Specify (in this order):

- Model #
- Top Material
- Top Color
- Edge Profile
- Chassis Color
- Modesty/Color
- Wire Management
- Grommet/Port Location
- Power/Data Options

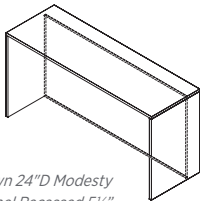

Shown 24"D Modesty Panel Recessed 5/4"

Description

- Available with TFL (T), HPL (P), or Veneer (W) Top; Must Specify
- Centered Modesty Available in Contrasting Colors
- 24"D Units Ship Assembled; Other Sizes Require Some Assembly
- 24"D Units Are Meant to be Used Against a Wall; Modesty Panel is Recessed 5/4"
- Add a Purse Hook to Hold Personal Items; [See Hook Details](#)
- Add Wire Management Upcharge and Specify (WM) When Ordering Grommet/Power Options as Double Modesty is Required for Wire Management
- Grommet and Power Data Port Units Available ([See Power Accessories](#)); [See PDC Locations](#)

Pricing Codes:

T= TFL P= HPL W= Wood Top

[See Intro Section for Ordering Options](#)

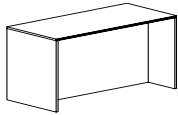
Item	Model No.	Material	Width	Depth	Height	Ship Wt	Cubic Ft	List Price
WORK TABLES COUNTER HEIGHT 	76-2460CWT	TFL	60	24	36	129	29.8	T\$ 1528
	76-2460CWT	HPL						P\$ 1774
	75-2460CWT	Veneer						W/P\$ 2712
	76-2472CWT	TFL	72	24	36	143	35.6	T\$ 1636
	76-2472CWT	HPL						P\$ 1899
	75-2472CWT	Veneer						W/P\$ 2905
	76-2484CWT	TFL	84	24	36	158	41.4	T\$ 1745
	76-2484CWT	HPL						P\$ 2026
	75-2484CWT	Veneer						W/P\$ 3098
	76-2496CWT	TFL	96	24	36	173	47.2	T\$ 1855
	76-2496CWT	HPL						P\$ 2168
	75-2496CWT	Veneer						W/P\$ 3290
	76-3660CWT	TFL	60	36	36	255	6.8	T\$ 1750
								Add Wire Management Upcharge \$ 339
	76-3660CWT	HPL						P\$ 2045
								Add Wire Management Upcharge \$ 339
	75-3660CWT	Veneer						W/P\$ 3108
								Add Wire Management Upcharge \$ 604
	76-3672CWT	TFL	72	36	36	283	8.1	T\$ 1881
								Add Wire Management Upcharge \$ 388
76-3672CWT	HPL						P\$ 2203	
							Add Wire Management Upcharge \$ 388	
75-3672CWT	Veneer						W/P\$ 3339	
							Add Wire Management Upcharge \$ 686	
76-3684CWT	TFL	84	36	36	315	9.5	T\$ 2015	
							Add Wire Management Upcharge \$ 433	
76-3684CWT	HPL						P\$ 2351	
							Add Wire Management Upcharge \$ 433	
75-3684CWT	Veneer						W/P\$ 3569	
							Add Wire Management Upcharge \$ 773	
76-3696CWT	TFL	96	36	36	346	10.8	T\$ 2143	
							Add Wire Management Upcharge \$ 484	
76-3696CWT	HPL						P\$ 2524	
							Add Wire Management Upcharge \$ 484	
75-3696CWT	Veneer						W/P\$ 3801	
							Add Wire Management Upcharge \$ 857	

Must Specify (in this order):

- Model #
- Top Material
- Top Color
- Edge Profile
- Chassis Color
- Modesty/Color
- Wire Management
- Grommet/Port Location
- Power/Data Options

42"D + 48"D Counter Height Work Tables on Next Page.

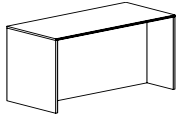
Item	Model No.	Material	Width	Depth	Height	Ship Wt	Cubic Ft	List Price
WORK TABLES COUNTER HEIGHT (CONTINUED)	76-4260CWT	TFL	60	42	36	278	7.9	T\$ 1862
								Add Wire Management Upcharge \$ 339
	76-4260CWT	HPL						P\$ 2192
								Add Wire Management Upcharge \$ 339
	75-4260CWT	Veneer						W/P\$ 3301
								Add Wire Management Upcharge \$ 604
	76-4272CWT	TFL	72	42	36	278	7.9	T\$ 2007
								Add Wire Management Upcharge \$ 388
	76-4272CWT	HPL						P\$ 2365
								Add Wire Management Upcharge \$ 388
	75-4272CWT	Veneer						W/P\$ 3553
								Add Wire Management Upcharge \$ 686
	76-4284CWT	TFL	84	42	36	278	7.9	T\$ 2148
								Add Wire Management Upcharge \$ 433
	76-4284CWT	HPL						P\$ 2529
								Add Wire Management Upcharge \$ 433
	75-4284CWT	Veneer						W/P\$ 3808
								Add Wire Management Upcharge \$ 773
	76-4296CWT	TFL	96	42	36	278	7.9	T\$ 2290
								Add Wire Management Upcharge \$ 484
	76-4296CWT	HPL						P\$ 2712
								Add Wire Management Upcharge \$ 484
	75-4296CWT	Veneer						W/P\$ 4059
								Add Wire Management Upcharge \$ 857
	76-4860CWT	TFL	60	48	36	242	9.0	T\$ 2036
								Add Wire Management Upcharge \$ 339
	76-4860CWT	HPL						P\$ 2403
								Add Wire Management Upcharge \$ 339
	75-4860CWT	Veneer						W/P\$ 3611
								Add Wire Management Upcharge \$ 604
	76-4872CWT	TFL	72	48	36	242	9.0	T\$ 2204
								Add Wire Management Upcharge \$ 388
	76-4872CWT	HPL						P\$ 2606
								Add Wire Management Upcharge \$ 388
	75-4872CWT	Veneer						W/P\$ 3906
								Add Wire Management Upcharge \$ 686
	76-4884CWT	TFL	84	48	36	242	9.0	T\$ 2372
								Add Wire Management Upcharge \$ 433
	76-4884CWT	HPL						P\$ 2797
								Add Wire Management Upcharge \$ 433
	75-4884CWT	Veneer						W/P\$ 4206
								Add Wire Management Upcharge \$ 773
	76-4896CWT	TFL	96	48	36	242	9.0	T\$ 2539
								Add Wire Management Upcharge \$ 484
	76-4896CWT	HPL						P\$ 3013
								Add Wire Management Upcharge \$ 484
	75-4896CWT	Veneer						W/P\$ 4501
								Add Wire Management Upcharge \$ 857

Must Specify (in this order):

- Model #
- Top Material
- Top Color
- Edge Profile
- Chassis Color
- Modesty/Color
- Wire Management
- Grommet/Port Location
- Power/Data Options

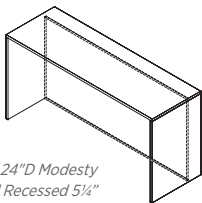

Shown 24"D Modesty Panel Recessed 5/4"

Description

- Available with TFL (T), HPL (P), or Veneer (W) Top; Must Specify
- Centered Modesty Available in Contrasting Colors
- 24"D Units Ship Assembled; Other Sizes Require Some Assembly
- 24"D Units Are Meant to be Used Against a Wall; Modesty Panel is Recessed 5/4"
- Add a Purse Hook to Hold Personal Items; [See Hook Details](#)
- Add Wire Management Upcharge and Specify (WM) When Ordering Grommet/Power Options as Double Modesty is Required for Wire Management
- Grommet and Power Data Port Units Available ([See Power Accessories](#)); [See PDC Locations](#)

Pricing Codes:

T= TFL P= HPL W= Wood Top

[See Intro Section for Ordering Options](#)

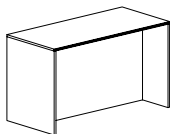
Item	Model No.	Material	Width	Depth	Height	Ship Wt	Cubic Ft	List Price
WORK TABLES	76-2460TWT	TFL	60	24	42	129	29.8	T\$ 1668
	BAR HEIGHT	HPL						P\$ 1913
	75-2460TWT	Veneer						W/P\$ 2961
	76-2472TWT	TFL	72	24	42	143	35.6	T\$ 1788
	76-2472TWT	HPL						P\$ 2051
	75-2472TWT	Veneer						W/P\$ 3174
	76-2484TWT	TFL	84	24	42	158	41.4	T\$ 1908
	76-2484TWT	HPL						P\$ 2189
	75-2484TWT	Veneer						W/P\$ 3383
	76-2496TWT	TFL	96	24	42	173	47.2	T\$ 2025
	76-2496TWT	HPL						P\$ 2339
	75-2496TWT	Veneer						W/P\$ 3594
	76-3660TWT	TFL	60	36	42	278	7.9	T\$ 1849
						Add Wire Management Upcharge		\$ 371
	76-3660TWT	HPL						P\$ 2142
						Add Wire Management Upcharge		\$ 371
	75-3660TWT	Veneer						W/P\$ 3282
						Add Wire Management Upcharge		\$ 655
	76-3672TWT	TFL	72	36	42	278	7.9	T\$ 1987
						Add Wire Management Upcharge		\$ 417
	76-3672TWT	HPL						P\$ 2306
						Add Wire Management Upcharge		\$ 417
	75-3672TWT	Veneer						W/P\$ 3527
						Add Wire Management Upcharge		\$ 744
	76-3684TWT	TFL	84	36	42	278	7.9	T\$ 2127
						Add Wire Management Upcharge		\$ 472
	76-3684TWT	HPL						P\$ 2464
						Add Wire Management Upcharge		\$ 472
	75-3684TWT	Veneer						W/P\$ 3772
						Add Wire Management Upcharge		\$ 839
	76-3696TWT	TFL	96	36	42	278	7.9	T\$ 2263
						Add Wire Management Upcharge		\$ 521
	76-3696TWT	HPL						P\$ 2644
						Add Wire Management Upcharge		\$ 521
	75-3696TWT	Veneer						W/P\$ 4015
						Add Wire Management Upcharge		\$ 927

Must Specify (in this order):

- Model #
- Top Material
- Top Color
- Edge Profile
- Chassis Color
- Modesty/Color
- Wire Management
- Grommet/Port Location
- Power/Data Options

42"D + 48"D Counter Height Work Tables on Next Page.

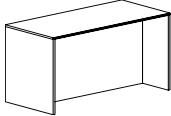
Item	Model No.	Material	Width	Depth	Height	Ship Wt	Cubic Ft	List Price
WORK TABLES BAR HEIGHT (CONTINUED)	76-4260TWT	TFL	60	42	42	278	7.9	T\$ 1953
								Add Wire Management Upcharge \$ 371
	76-4260TWT	HPL						P\$ 2282
								Add Wire Management Upcharge \$ 371
	75-4260TWT	Veneer						W/P\$ 3462
								Add Wire Management Upcharge \$ 655
	76-4272TWT	TFL	72	42	42	278	7.9	T\$ 2100
								Add Wire Management Upcharge \$ 417
	76-4272TWT	HPL						P\$ 2462
								Add Wire Management Upcharge \$ 417
	75-4272TWT	Veneer						W/P\$ 3726
								Add Wire Management Upcharge \$ 744
<u>Must Specify (in this order):</u> Model # Top Material Top Color Edge Profile Chassis Color Modesty/Color Wire Management Grommet/Port Location Power/Data Options	76-4284TWT	TFL	84	42	42	278	7.9	T\$ 2250
								Add Wire Management Upcharge \$ 472
	76-4284TWT	HPL						P\$ 2631
								Add Wire Management Upcharge \$ 472
	75-4284TWT	Veneer						W/P\$ 3991
								Add Wire Management Upcharge \$ 839
	76-4296TWT	TFL	96	42	42	278	7.9	T\$ 2399
								Add Wire Management Upcharge \$ 521
	76-4296TWT	HPL						P\$ 2826
								Add Wire Management Upcharge \$ 521
	75-4296TWT	Veneer						W/P\$ 4256
								Add Wire Management Upcharge \$ 927
	76-4860TWT		60	48	42	242	9.0	T\$ 2134
								Add Wire Management Upcharge \$ 371
	76-4860TWT	HPL						P\$ 2499
								Add Wire Management Upcharge \$ 371
	75-4860TWT	Veneer						W/P\$ 3783
								Add Wire Management Upcharge \$ 655
	76-4872TWT		72	48	42	242	9.0	T\$ 2310
								Add Wire Management Upcharge \$ 417
	76-4872TWT	HPL						P\$ 2709
								Add Wire Management Upcharge \$ 417
	75-4872TWT	Veneer						W/P\$ 4094
								Add Wire Management Upcharge \$ 744
	76-4884TWT		84	48	42	242	9.0	T\$ 2482
								Add Wire Management Upcharge \$ 472
	76-4884TWT	HPL						P\$ 2910
								Add Wire Management Upcharge \$ 472
	75-4884TWT	Veneer						W/P\$ 4405
								Add Wire Management Upcharge \$ 839
	76-4896TWT		96	48	42	242	9.0	T\$ 2660
								Add Wire Management Upcharge \$ 521
	76-4896TWT	HPL						P\$ 3131
								Add Wire Management Upcharge \$ 521
	75-4896TWT	Veneer						W/P\$ 4715
								Add Wire Management Upcharge \$ 927

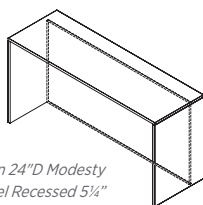

Shown 24"D Modesty Panel Recessed 5/8"



Description

- Available with TFL (T), HPL (P), or Veneer (W) Top; Must Specify
- Centered Modesty Available in Contrasting Colors
- 24"D Units Ship Assembled; Other Sizes Require Some Assembly
- 24"D Units Are Meant to be Used Against a Wall; Modesty Panel is Recessed 5/8"
- Add a Purse Hook to Hold Personal Items; [See Hook Details](#)
- Add Wire Management Upcharge and Specify (WM) When Ordering Grommet/Power Options as Double Modesty is Required for Wire Management
- Grommet and Power Data Port Units Available ([See Power Accessories](#)); [See PDC Locations](#)



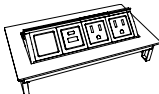

Pricing Codes:

T= TFL P= HPL W= Wood Top



[See Intro Section for Ordering Options](#)

Item	Model No.		Width	Depth	Height	Ship Wt	Cubic Ft	List Price
ROUND GROMMET COVER FIELD INSTALLED	01-GRMTBK	Black	-	-	-	-	-	\$ 12
	01-GRMTSL	Silver						
 <p>OPEN MARKET ONLY(SILVER)</p> <p>Description</p> <ul style="list-style-type: none"> • 60mm Round Grommet Cover • Field Installed 								
DOCK 950 WIRELESS CHARGER	01-DOCK950W	White	3 $\frac{3}{16}$	3 $\frac{3}{16}$	-	1	0.2	\$ 294
	01-DOCK950B	Black						
 <p>OPEN MARKET ONLY</p> <p>Description</p> <ul style="list-style-type: none"> • For Use with Wireless Charging Enabled Devices • 5 Watts Maximum Output with a Direct Current of 5V 2A and 10 Watts Maximum with Quick Charge 2.0 • Mounts in 76mm Round Cut-Out • LED will Confirm Pairing with Device and Begin Wireless Charging 								
DOCK 150 WIRELESS AND USB CHARGER	01-DOCK150W	White	3	3	$\frac{3}{4}$	1	0.2	\$ 448
	01-DOCK150B	Black						
 <p>OPEN MARKET ONLY</p> <p>Description</p> <ul style="list-style-type: none"> • For Use with Wireless Charging Enabled Devices and USB Charging Devices • 5 Watt Maximum Output with a Direct Current Input of 5V 6A (Wireless Fast Charge) • Mounts in 76mm Round Cut-Out • Pop-Up is $\frac{3}{4}$"H and Includes Three (3) USB Ports; One (1) 12 Watt Maximum with 2.4A (USB Fast Charge) and Two (2) 5 Watt with 1A (USB Standard Charge) • LED Light will Confirm Pairing with Device and Begin Wireless Charging • UL and cUL Certified 								
POWER DATA PORT	01-DPORT4A	Aluminum	8	4	-	7	0.2	\$ 1211
	01-DPORT4B	Black	8	4	-	7	0.2	\$ 1211
 <p>Description</p> <ul style="list-style-type: none"> • Includes: Two (2) Power Outlets, One (1) USB A+C, One (1) Open Port, 10' Power Cord, and Voice/Data Adapter Kit to Accept Couplers and Jacks When Required • Retracts into Work Surface to Regain Productive Space; One-Touch Access to Power and Data • Optional Telecom Port Components, See Compatible Units Below • Water-Proof Simplex (Outlets) • UL Recognized 								

[See Intro Section for Ordering Options](#)

Item	Model No.	Width	Depth	Height	Ship Wt	Cubic Ft	List Price
	01-USBPORT	-	-	-	-	-	\$ 178
<p>Description</p> <ul style="list-style-type: none"> • For Use with 01-DPORT4A and 01-DPORT4B • Passive USB-A Port with Increased Transfer Speed Up to 5 gbs/sec • Simultaneous Read/Write Capability • Idle Device Power Saving State • 6' Cord • See Voice Coupler and Data Port on Next Page 							
	01-VOICE1	-	-	-	-	-	\$ 80
<p>Description</p> <ul style="list-style-type: none"> • For Use with 01-DPORT4A and 01-DPORT4B • 6-Pin Modular Plug • Molded Black • Cord Not included 							
 <p>OPEN MARKET ONLY</p>	01-RJ4DATA	-	-	-	-	-	\$ 186
<p>Description</p> <ul style="list-style-type: none"> • For Use with 01-DPORT4A and 01-DPORT4B • 8-Pin Modular Plug; Cat6 Ethernet Cable; Pre-terminated Cable • 10' Cord 							
	01-VGACON	-	-	-	1	0.2	\$ 165
<p>Description</p> <ul style="list-style-type: none"> • VGA Port for 01-DPORT4A and 01-DPORT4B • Enables Devices to Remote Display on Monitors • 10' Cord • Male/Female Connector 							
	01-HDMICON	-	-	-	1	0.2	\$ 137
<p>Description</p> <ul style="list-style-type: none"> • HDMI Port for 01-DPORT4A and 01-DPORT4B • Connects to High Definition Displays • Female/Female Connector • 18" Cord 							

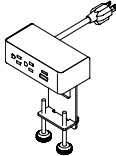
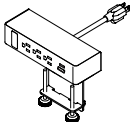
[See Intro Section for Ordering Options](#)

Item	Model No.		Width	Depth	Height	Ship Wt	Cubic Ft	List Price
DUO CLAMP WITH NEMA PLUG 	01-DUOCLAMPW	White	6½	3	7	1	0.2	\$ 634
	01-DUOCLAMPB	Black						
	01-DUOCLAMPS	Silver						
	Description <ul style="list-style-type: none"> Standard with: Two (2) Power Outlet, One (1) USB Charging Port and One (1) 60-Watt USB-C Power Delivery Port with GaN Technology with 10' Cord Clamps to Top and Features Silver Metal Trim Independent USB Circuit Controllers Deliver up to 2.1 Amps to Each Post All Mounting Hardware Included FCC Part 15A and UL Approved for Horizontal and Vertical Applications 							
TRIO CLAMP WITH NEMA PLUG 	01-TRIOCLAMPW	White	9	3	7	1	0.2	\$ 743
	01-TRIOCLAMPB	Black						
	01-TRIOCLAMPS	Silver						
	Description <ul style="list-style-type: none"> Standard with: Three (3) Power Outlets, One (1) USB Charging Port, One (1) 60-Watt USB-C Power Delivery Port with GaN Technology, One (1) Open Data with 10' Cord Clamps to Top and Features Silver Metal Trim Independent USB Circuit Controllers Deliver up to 2.1 Amps to Each Post HDMI, VGA, or RJ45 Sold Separately; See Accessories All Mounting Hardware Included FCC Part 15A and UL Approved for Horizontal and Vertical Applications 							
DUO BEZEL WITH NEMA PLUG 	01-DUOBEZELW	White	6½	2½	3	1	0.2	\$ 748
	01-DUOBEZELB	Black						
	01-DUOBEZELS	Silver						
	Description <ul style="list-style-type: none"> Sits On Top of the Worksurface and Includes: Two (2) Power, One (1) USB Charging Port and One (1) 60-Watt USB-C Power Delivery Port with GaN Technology with 10' Cord Independent USB Circuit Controllers Deliver up to 2.1 Amps to Each Post All Mounting Hardware Included FCC Part 15A and UL Approved for Horizontal and Vertical Applications 							
TRIO BEZEL WITH NEMA PLUG 	01-TRIOBEZELW	White	9	2½	3	1	0.2	\$ 803
	01-TRIOBEZELB	Black						
	01-TRIOBEZELS	Silver						
	Description <ul style="list-style-type: none"> Sits On Top of the Worksurface and Includes: Three (3) Power, One (1) USB Charging Port and One (1) 60-Watt USB-C Power Delivery Port with GaN Technology, One (1) Open Data, and 10' Cord Independent USB Circuit Controllers Deliver up to 2.1 Amps to Each Post HDMI, VGA, or RJ45 Sold Separately; See Accessories All Mounting Hardware Included FCC Part 15A and UL Approved for Horizontal and Vertical Applications 							

[See Intro Section for Ordering Options](#)

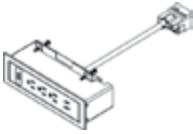
Item	Model No.		Width	Depth	Height	Ship Wt	Cubic Ft	List Price
DUO BEZEL WITH HARD WIRE CONNECTION 	Circuit 1							
	01-HWDUOBEZELW1	White	6½	2⅝	3	1	0.2	\$ 809
	01-HWDUOBEZELB1	Black						
	01-HWDUOBEZELS1	Silver						
	Circuit 2							
	01-HWDUOBEZELW2	White	6½	2⅝	3	1	0.2	\$ 809
	01-HWDUOBEZELB2	Black						
	01-HWDUOBEZELS2	Silver						
	Circuit 3							
	01-HWDUOBEZELW3	White	6½	2⅝	3	1	0.2	\$ 809
	01-HWDUOBEZELB3	Black						
	01-HWDUOBEZELS3	Silver						
Circuit 4								
01-HWDUOBEZELW4	White	6½	2⅝	3	1	0.2	\$ 809	
01-HWDUOBEZELB4	Black							
01-HWDUOBEZELS4	Silver							

Description

- Must Specify Color and Circuit
- Sits on worksurface and Includes: Two (2) Power, One (1) USB Charging Port and One (1) 60-Watt USB-C Power Delivery Port with GaN Technology, and All Mounting Hardware
- Independent USB Circuit Controllers Deliver up to 2.1 Amps to Each Post
- FCC Part 15A and UL Approved for Horizontal and Vertical Applications
- Maximum 10 Duo Units per Circuit
- Eight (8) Wire/Four (4) Circuit Hard Wire Power Unit
- See Power Entry, Jumper Cable, and Quad Block on Next Page

[See Intro Section for Ordering Options](#)

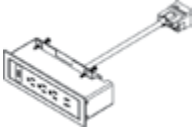
Item	Model No.		Width	Depth	Height	Ship Wt	Cubic Ft	List Price	
TRIO BEZEL WITH HARD WIRE CONNECTION 	Circuit 1								
	01-HWTRIOBEZELW1	White	9	2½	3	1	0.2	\$ 830	
	01-HWTRIOBEZELB1	Black							
	01-HWTRIOBEZELS1	Silver							
	Circuit 2								
	01-HWTRIOBEZELW2	White	9	2½	3	1	0.2	\$ 830	
	01-HWTRIOBEZELB2	Black							
	01-HWTRIOBEZELS2	Silver							
	Circuit 3								
	01-HWTRIOBEZELW3	White	9	2½	3	1	0.2	\$ 830	
	01-HWTRIOBEZELB3	Black							
	01-HWTRIOBEZELS3	Silver							
	Circuit 4								
	01-HWTRIOBEZELW4	White	9	2½	3	1	0.2	\$ 830	
	01-HWTRIOBEZELB4	Black							
	01-HWTRIOBEZELS4	Silver							

Description

- Must Specify Color and Circuit
- Sits on Worksurface and Includes: Three (3) Power, One (1) USB Charging Port and One (1) 60-Watt USB-C Power Delivery Port with GaN Technology, and All Mounting Hardware
- Independent USB Circuit Controllers Deliver up to 2.1 Amps to Each Post
- FCC Part 15A and UL Approved for Horizontal and Vertical Applications
- Maximum 6 Trio Units per Circuit
- Eight (8) Wire/Four (4) Circuit Hard Wire Power Unit
- HDMI, VGA, or RJ45 Sold Separately; [See Accessories](#)
- See Power Entry, Jumper Cable, and Quad Block Below and on Next Page

QUAD BLOCK HARD WIRED	01-HWQUADBLOCK		-	-	-	1	0.2	\$ 69
------------------------------	----------------	--	---	---	---	---	-----	-------

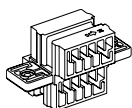

Description

- Eight (8) Wire/Four (4) Circuit Hard Wire Connector
- UL183 Compliant
- For Connecting Jumpers and Power Units
- Quantity of Four (4) Female Inputs

POWER ENTRY HARD WIRED	01-HWPOWERENTRY		72	-	-	1	0.2	\$ 357
-------------------------------	-----------------	--	----	---	---	---	-----	--------

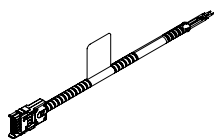

Description

- Eight (8) Wire/Four (4) Circuit Hard Wire Infeed
- UL183 Compliant

[See Intro Section for Ordering Options](#)

Item	Model No.	Width	Depth	Height	Ship Wt	Cubic Ft	List Price
 <p>JUMPER HARD WIRE CABLE</p>	01-HW2JUMP	24	-	-	1	0.2	\$ 213
	01-HW3JUMP	36	-	-	1	0.2	\$ 228
	01-HW4JUMP	48	-	-	1	0.2	\$ 235
	01-HW5JUMP	60	-	-	1	0.2	\$ 282
	01-HW6JUMP	72	-	-	1	0.2	\$ 299

Description

- Eight (8) Wire/Four (4) Circuit Hard Wire Jumper
- UL183 Compliant

DUO BEZEL WITH PURL DAISY CHAIN PLUG

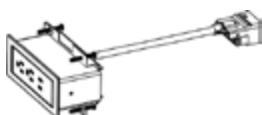

01-DCDUOBEZELW	White	6½	2½	3	1	0.2	\$ 631
01-DCDUOBEZELB	Black						
01-DCDUOBEZELS	Silver						

Description

- Standard with: Two (2) Tamper Resistant 15 Amp Power Outlets, One (1) USB-A Charging Port and One (1) 60-Watt USB-C Power Delivery Port with GaN Technology, 10' Cord and All Mounting Hardware
- Top Must Be Routed To Allow Unit to Sit Down Into the Top, Must Specify when Ordering Top
- Unit Supported By Attractive Slim Fit Bezel
- Requires Purl Daisy Chain Power Infeed, Specified Separately ([See Details](#))
- Non-Sequential System Allows up to Nine (9) Modules to be Connected with H-Block (See Below) and Jumper Cord ([See Details](#))
- Independent USB Circuit Controllers Deliver up to 2.4 Amps to Each Post
- FCC Part 15A, RU Listed and UL Recognized for Horizontal and Vertical Applications

TRIO BEZEL WITH PURL DAISY CHAIN PLUG

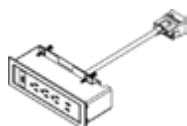

01-DCTRIOBEZELW	White	9	2½	3	1	0.2	\$ 723
01-DCTRIOBEZELB	Black						
01-DCTRIOBEZELS	Silver						

Description

- Standard with: Three (3) Tamper Resistant 15Amp Power Outlets, One (1) USB-A Charging Port, One (1) 60-Watt USB-C Power Delivery Port with GaN Technology, One (1) Open Data, 12' Cord and All Mounting Hardware
- Top Must Be Routed To Allow Unit to Sit Down Into the Top, Must Specify when Ordering Top
- Unit Supported By Attractive Slim Fit Bezel
- Requires Purl Daisy Chain Power Infeed, Specified Separately ([See Details](#))
- Non-Sequential System Allows up to Nine (9) Modules to be Connected with H-Block and Jumper Cord ([See Details](#))
- Independent USB Circuit Controllers Deliver up to 2.4Amps to Each Post
- FCC Part 15A, RU Listed and UL Recognized for Horizontal and Vertical Applications HDMI, VGA, or RJ45 Sold Separately ([See Accessories](#))

[See Intro Section for Ordering Options](#)

Item	Model No.	Width	Depth	Height	Ship Wt	Cubic Ft	List Price
PURL DAISY CHAIN POWER INFEED	01-DCPOWER	-	-	-	1	0.2	\$ 227

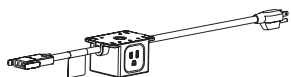

Description

- Includes One (1) Purl Connector Plug, 36" Daisy Chain Cord, One (1) 15 Amp Power Outlet, and a 120" Power Cord with a Nema Plug
- Powers up to Nine (9) Duo and Trio Purl Daisy Chain Units
- 15-Amp System Rating and Over-Current Protection
- System Requires H-BLOCK Connector Between Power Infeed and Each Jumper Cord, See Below For Purl Daisy Chain H-Block and Purl Daisy Chain Jumper Cords Details

PURL DAISY CHAIN H-BLOCK	01-DCHBLOCK	-	-	-	1	0.2	\$ 40
--------------------------	-------------	---	---	---	---	-----	-------

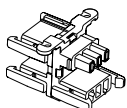

Description

- Includes One (1) Power In and Three (3) Power Out Receptacles
- System Requires H-BLOCK Connector Between Power Infeed and Each Jumper Cord, See Purl Daisy Chain Power Infeed (Above) and Jumper Cords (See Below)

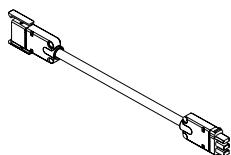

PURL DAISY CHAIN JUMPER CORD	01-DC2JUMP	<i>24" Long</i>	-	-	-	1	0.2	\$ 72
	01-DC3JUMP	<i>36" Long</i>	-	-	-	1	0.2	\$ 77
	01-DC4JUMP	<i>48" Long</i>	-	-	-	1	0.2	\$ 82
	01-DC5JUMP	<i>60" Long</i>	-	-	-	1	0.2	\$ 87
	01-DC6JUMP	<i>72" Long</i>	-	-	-	1	0.2	\$ 92



Description

- Connects Duo and Trio Daisy Chain Units
- Non-Sequential System Allows up to None (9) Modules to be Connected

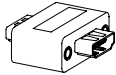
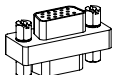
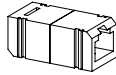
[See Intro Section for Ordering Options](#)

Item	Model No.	Material	Width	Depth	Height	Ship Wt	Cubic Ft	List Price
HDMI DATA PORT ACCESSORY	01-LCOMHDMI		-	-	-	1	0.2	\$ 183
	Description <ul style="list-style-type: none"> HDMI Port for Trio Bezel and Trio Clamp Units 							
OPEN MARKET ONLY								
VGA DATA PORT ACCESSORY	01-LCOMVGA		-	-	-	1	0.2	\$ 134
	Description <ul style="list-style-type: none"> VGA Port for Trio Bezel and Trio Clamp Units 							
RJ45 DATA PORT ACCESSORY	01-LCOMRJ45		-	-	-	1	0.2	\$ 88
	Description <ul style="list-style-type: none"> RJ45 Port for Trio Bezel and Trio Clamp Units 							
PURSE HOOK FOR WORK TABLE	01-HOOK		2	1¼	2 ⁹ / ₂₅			\$ 88
	Description <ul style="list-style-type: none"> Black Hook Includes Mounting Hardware Field Installed 							
VESTA POWER CENTER	01-PDCTR		10¾	12	28¼	14	2.5	\$ 1968
	Description <ul style="list-style-type: none"> Top Includes One (1) Power Outlet, Two (2) USB Ports and One (1) USBC Port; Base Includes Three (3) Outlet Available in White 120" Power Cord Built with Weight Distribution for Optimal Stability Base is 5" Tall 							

Pricing Codes:
T= TFL P= HPL W= Wood Top

[See Intro Section for Ordering Options](#)

Natta offers an agile solution for a variety of community spaces and meeting applications. With its simplicity of form, it can achieve a subtle effect and still provide an excellent solution for any meeting and breakout environment.

CONSTRUCTION

TOPS

- NAT-1 and NAT-2 Tops are High Pressure Laminate (HPL) and 3-ply balanced construction, 1½" thick with 1 mm PVC edge band and vertical square edge profile
- NAT-3 and NAT-4 Tops have 1½" thick HPL surface with 1mm PVC edge band Square edge profile
- Designer White, Sugar Maple, and Williamsburg Cherry feature ABS edge bands
- Grain direction runs left to right unless otherwise noted

CHASSIS

- All frames are made of solid European Beech with double-doweled or mortised and tenoned joints
- NAT-3 and NAT-4 Frames are individually hand assembled and sanded prior to being finished; Legs are 9¾"H on the rectangular table and 14"H on the square table and include non-marring nylon glides
- NAT-1 and NAT-2 units are equipped with heavy-duty, adjustable glides to ensure proper leveling and compensation for uneven floors
- All table units ship fully assembled with tops installed

HOW TO ORDER EXAMPLE

Model No.	Description	Example
NAT-1	Top Color Leg Finish	SBP SBP
MMIT-2	Top Color Leg Finish	WH BW

HPL (P) LAMINATE OPTIONS ON TOPS

WOODGRAIN

AS	Asian Night	PTK	Portico Teak
BW	Beigewood	RC	River Cherry
CO	Columbian Walnut	SCH	Select Cherry
EF	Espresso	SPW	Sepia Walnut
FLW	Florence Walnut	SKC	Shaker Cherry
GC	Golden Cherry	SBP	Smoky Brown Pear
KHE	Kirsche	TK	Studio Teak
MW	Mahogany Walnut	SM	Sugar Maple
MNR	Midnight Run	WTA	Weathered Ash
NTM	Natural Marrone	WNB	White Nebbia
ORW	Oak Riftwood	WC	Williamsburg Cherry
PNW	Pinnacle Walnut		

SOLID

BL	Black	FHG	Fashion Grey
WH	Designer White	SG	Slate Grey

WOOD FINISHES AVAILABLE ON BASE/LEGS

Indiana Furniture uses a multi-step, hand finishing process on all exposed wood frames.

Tables feature a catalyzed varnish finish which offers durability, lasting beauty, and resistance to normal wear.

AW	Artisan Walnut	MAS	Mesa Sunset*
AS	Asian Night	MTS	Metropolis Sky
BW	Beigewood*	MNR	Midnight Run
BL	Black	NTM	Natural Marrone*
CO	Columbian Walnut	ORW	Oak Riftwood*
DC	Dark Cherry	PNW	Pinnacle Walnut
DFW	Dark Forest Walnut*	PTK	Portico Teak*
WH	Designer White	RC	River Cherry*
EF	Espresso	SCH	Select Cherry
FO	Fawn Oak*	SPW	Sepia Walnut*
FLW	Florence Walnut*	SKC	Shaker Cherry
GC	Golden Cherry	SBP	Smoky Brown Pear*
HW	Harvest Walnut	TK	Studio Teak
HNW	Henna Walnut	SM	Sugar Maple
KHE	Kirsche	WTA	Weathered Ash*
LW	Legacy Walnut	WNB	White Nebbia
MW	Mahogany Walnut	WC	Williamsburg Cherry

* Low Sheen Finish

TABLE EDGE PROFILE



Vertical Square

CERTIFICATIONS & COMPLIANCE

- Intertek Sustainability Certified
- BIFMA level® Certified
- BIFMA Compliant Certified
- TSCA Title VI (Formerly CARB) Compliance
- US Green Building's LEED Contribution

STATEMENT OF LINE

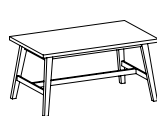

NAT-1: 30"H Table



NAT-2: 42"H Table



NAT-3:
Square Table

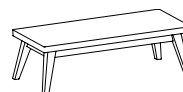

NAT-4:
Rectangle Table

See Next Page
For All Products

MEETING, COLLABORATIVE + LOUNGE TABLES (NAT SERIES)

Item	Model No.	W	D	H	Ship Wt	Cubic Ft	List Price
30"H MEETING TABLE	NAT-1	61½	35½	30½	106	43.7	\$ 2729

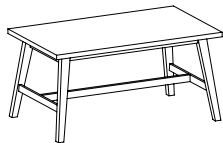

Description

- Features Square Edge Profile
- Available with Contrasting Top and Leg Color

Must Specify (in this order):

Model #
Top Color
Leg Finish

42"H MEETING TABLE	NAT-2	63	39	43	115	64.0	\$ 3374
--------------------	-------	----	----	----	-----	------	---------

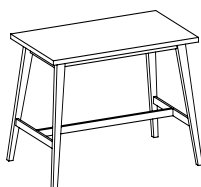

Description

- Features Square Edge Profile
- Available in Contrasting Top and Leg Color

Must Specify (in this order):

Model #
Top Color
Leg Finish

SQUARE TABLE	NAT-3	22	22	16	31	10.8	\$ 1131
--------------	-------	----	----	----	----	------	---------

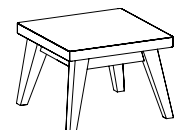

Description

- Features Square Edge Profile
- Available with Contrasting Top and Leg Color

Must Specify (in this order):

Model #
Top Color
Leg Finish

RECTANGLE TABLE	NAT-4	51	22	16	66	25.9	\$ 1541
-----------------	-------	----	----	----	----	------	---------

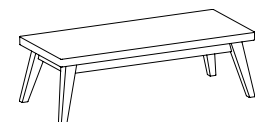

Description

- Features Square Edge Profile
- Available in Contrasting Surface and Leg Color

Must Specify (in this order):

Model #
Top Color
Leg Finish

[See Natta Overview For Ordering Options](#)

Crafted in select solids and American veneers, Phoenix's clean, transitional styling is at ease in both contemporary and traditional settings. It is a perfect choice for value-minded companies who want a sophisticated, yet uncomplicated, furniture solution.

CONSTRUCTION

Phoenix features a Veneer chassis with your choice of a Veneer or HPL top.

VENEER

- Exposed surfaces feature select grade sliced American Black Walnut or Cherry veneers carefully selected and matched to assure proper balance and consistency

TOPS

- Veneer tops are 5-ply balanced construction and 1 $\frac{1}{32}$ " thick with solid hardwood rims
- High Pressure Laminate (HPL) tops are 3-ply balanced construction and 1 $\frac{1}{32}$ " thick with solid hardwood rims
- Grain direction runs left to right unless noted

CHASSIS

- Chassis is securely fastened using high quality European fastening systems and heavy-duty, 16-gauge joining brackets to assure maximum strength
- Units feature finished backs unless otherwise noted
- All units equipped with heavy-duty, adjustable glides to ensure proper leveling and compensate for uneven floors

DRAWERS

- Drawer fronts standard with matched veneer faces
- Drawer sides, back and front are woodgrain vinyl-wrapped, and are $\frac{1}{2}$ " thick
- 5-sided drawer construction for easy removal of drawer fronts
- Lateral file drawers feature $\frac{1}{4}$ " thick bottoms and tested for 200lb capacity
- All drawers feature full extension, progressive action slides with precision steel ball bearings
- All suspensions have a limited lifetime warranty

FILING

- File drawers are standard with filing systems designed to accommodate a variety of filing requirements
- Letter width file drawers provide letter filing front to back and legal filing side to side

STORAGE

- All hinged doors include soft close hinges, unless noted
- One piece hinge and base plate combination
- Soft close hinges reduce stress placed on the cabinet when the door is closed and offers a quiet closure

LOCKING

- Storage credenzas feature standard locking; optional locking on wardrobe/storage cabinets
- Lock core will coordinate with pull selection unless otherwise noted
- Removable lock cylinders allow for units to be re-keyed at a later date if required
- Units are shipped randomly keyed as standard. Keyed alike units available upon request at no additional charge.

INTERIOR DRAWER DIMENSIONS & FILING CAPABILITIES

Models

21-2072SC 21-2066SC

Drawers

File W L D
12 $\frac{1}{8}$ " 16 $\frac{3}{16}$ " 9 $\frac{5}{16}$ "

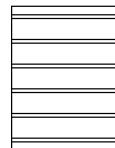

Letter Front to Back

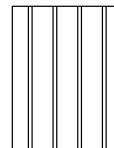

Legal Side to Side

HOW TO ORDER EXAMPLES

	Model No.	QTY	Description	Example
TABLE TOP	21-4848CT	1	Top Material	P
			Finish/Color	CO
BASE	01-3230DBB	1	Disc Base	
CREDENZA	21-2072SC	1	Top Material	W
			Finish/Color	CO
			Pull	NBT
			Flush Feature	-

VENEER (W) OPTIONS

Veneer features UVAdvantage, an ultra-violet finish, on all exposed surfaces by utilizing roll-coat UV technology.

Note: Base molding, decorative molding and cylinder base feature multi-step, hand-finished catalyzed finish.

AW	Artisan Walnut	LW	Legacy Walnut
CO	Columbian Walnut	MW	Mahogany Walnut
DC	Dark Cherry	MTS	Metropolis Sky
DFW	Dark Forest Walnut	PNW	Pinnacle Walnut
EW	Espresso	SCH	Select Cherry
GC	Golden Cherry	SKC	Shaker Cherry
HW	Harvest Walnut	WC	Williamsburg Cherry
HNW	Henna Walnut		

HPL (P) TOP OPTIONS

WOODGRAIN

CO	Columbian Walnut	PNW	Pinnacle Walnut
EF	Espresso	SCH	Select Cherry
GC	Golden Cherry	SKC	Shaker Cherry
MW	Mahogany Walnut	WC	Williamsburg Cherry

EDGE PROFILE

O Phoenix



FLUSH FEATURE OPTION

Select units feature multiple flush options allowing units to be placed next to each other. See specific units for details. Must specify when placing ordering.

- FL Flush Left
- FR Flush Right
- FLR Flush Left and Right

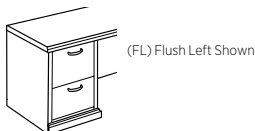

PULL OPTIONS

Note: Lock Core will match Pull Color

AAC Arc, Aluminum	AEL Elite, Aluminum
BAC Arc, Black	BEL Elite, Black
ABM Beam, Aluminum	AFL Flair, Aluminum
BBM Beam, Black	CFL Flair, Chrome
BBT Bow Tie, Black	AFC Focus, Aluminum
NBT Bow Tie, Nickel	BFC Focus, Black
ABU Buckle, Aluminum	AQD Quadra, Aluminum
BBU Buckle, Black	BQD Quadra, Black

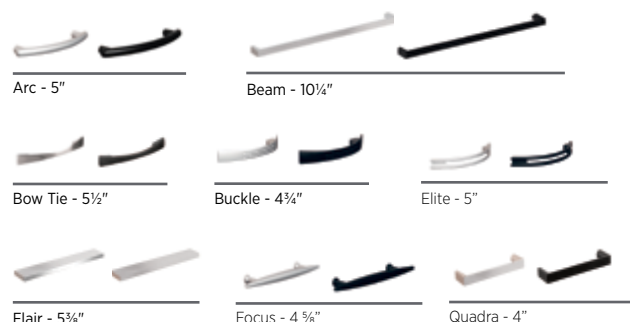

TABLE GROMMET & POWER UNIT OPTIONS

Power units and grommets are sold separately and must be specified separately with surface mount location. Multiple locations may be selected. Only one unit per location.

Power units and Grommets Available in Table Surfaces (See Units)

Grommet Specify Color: Black = BLK and Silver = SLV

DUO/TRIO BEZEL

- 01-DUOBEZEL Available in Black (B), Silver (S), or White (W)
- 01-TRIOBEZEL Available in Black (B), Silver (S), or White (W)

DOCK 950, DOCK 800 and DOCK 150

- DOCK950 Available in Black or White
- DOCK150 Available in Black or White
- DOCK800 Available in Black or Silver

Other Power Units

- DPORT4 Available in Aluminum or Black
- INTERACTG Available in Aluminum or Black
- OASISM Available in Aluminum or Black

TABLE GROMMET & POWER UNIT OPTIONS CONTINUED

Power/Data Location Information:

- Designate unit and location when specifying the top model. Power/Data Module need to be ordered separately.
- Power/Data Modules specified at the time of order will be routed for field installation.
 - E1 Unit on One End
 - E2 Unit on Each End
 - OC Unit on Center
- All power units available **On Center (OC) only** when paired with two (2) or more of the following bases:

- Cylinder Base
- X-Base
- Tubular X-Base
- Square Base
- Disc

Grommets and Power Units may be ordered in non-standard locations. Call Customer Service to assist with specification and/or please attach a drawing to the PO showing the location of the grommet. Note additional charges and lead times may apply.

Top Locations

Power units available on Each End (E1 and E2) and On Center (OC) unless otherwise noted, when paired with any Rectangle Panel Base, Rectangle Box Base or Rectangle Accent Box Base. ([See Unit Details](#))

Power units centered at locations below:

- 36" Tops centered 18"D
- 42" Tops centered 21"D
- 48" Tops centered 24"D

- 72: OC 36" from end (available with OC Only)
- 96: OC 48" from end; E1/E2 29" from end
- 120: OC 60" from end; E1/E2 29" from end
- 144: OC 72" from end; E1/E2 29" from end

LOCKING DOORS

Locking doors are available on Wardrobes. You must specify WITH LOCKING when ordering and add upcharge.

LKT_HU	18"W Units	\$	76
LKT_HU	30"W - 36"W Units	\$	101

LOCK CORE OPTIONS

Lock core will coordinate with pull color unless otherwise noted.

- BLK Black
- SLV Silver

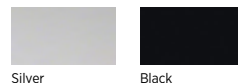

CERTIFICATIONS & COMPLIANCE

- Intertek Sustainability Certified
- BIFMA level® Certified
- BIFMA Compliant® Certified
- TSCA Title VI (formerly CARB) Compliance
- Contributes to LEED®, Green Globes®, and WELL® Sustainable Programs

Tops and Bases

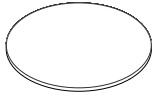

Round Tops
[\(See Details\)](#)



Rectangle Tops
[\(See Details\)](#)

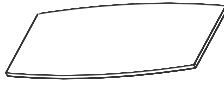

Boat Tops
[\(See Details\)](#)

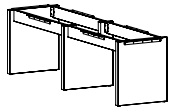

Rectangular Panel
Bases with Trough
[\(See Details\)](#)

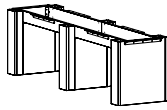

6" Rectangular Bases
with Trough
[\(See Details\)](#)

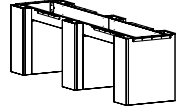

10" Rectangular
Bases with Trough
[\(See Details\)](#)

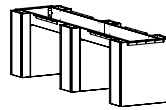

6" Rectangular Accent
Bases with Trough
[\(See Details\)](#)

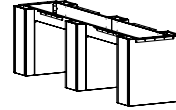

10" Rectangular Accent
Bases with Trough
[\(See Details\)](#)

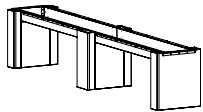

6" + 10" Combo Rectangular
Bases with Trough
[\(See Details\)](#)

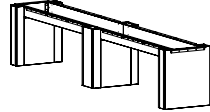

6" + 10" Combo Rectangular
Accent Bases with Trough
[\(See Details\)](#)



Disc Bases
[\(See Details\)](#)

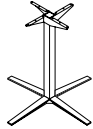

Small and Large X
Bases [\(See Details\)](#)



HA Pneumatic X
[\(See Details\)](#)



Metal Bases
[\(See Details\)](#)

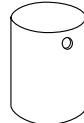

Cylinder
[\(See Details\)](#)

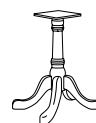

Queen Anne
[\(See Details\)](#)

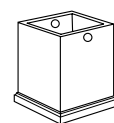

Square
[\(See Details\)](#)

Storage Components

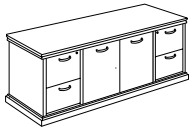

Storage Credenzas
[\(See Details\)](#)

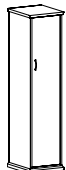

Wardrobe/Storage
[\(See Details\)](#)

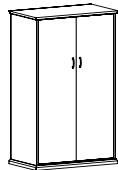

Double Wardrobe/ Storage
[\(See Details\)](#)

Wire Management & Power/Data Accessories

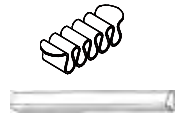

For additional solutions for desking, storage, and accessories, see the [Phoenix Caseloads](#) and [Accessories](#) Price Lists.

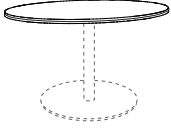
Item	Model No.		Width	Depth	Height	Ship Wt	Cubic Ft	List Price	
	21-3636CT	Accommodates Three (3) to Four (4) Chairs	36	36	30	35	3.4	P\$ 1572 W\$ 2001	
	21-4242CT	Accommodates Four (4) Chairs	42	42	30	40	4.4	P\$ 1697 W\$ 2181	
	21-4848CT	Accommodates Five (5) Chairs	48	48	30	60	5.7	P\$ 1831 W\$ 2363	

21-4242CT Shown with 01-2430DBA
(Disc Base)
BASES SOLD SEPARATELY

Must Specify (in this order):

Model #
Top Material
Finish/Color
Edge Profile

Description

- Available with Premium/Standard Veneer (PV/W) or HPL (P) Top, Must Specify
- Single Base Required; Ordered Separately, [See Details](#)
- Power Options not Available

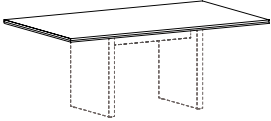
RECTANGULAR TOP	72" or 6' - 1 Piece Top								
	21-3672RT		72	36	1 $\frac{1}{16}$	100	6.2	P\$ 1937 W\$ 2051	
	96" or 8' - 1 Piece Top								
	21-4896RT		96	48	1 $\frac{1}{16}$	180	9.4	P\$ 2958 W\$ 3236	
	120" or 10' - 2 Piece Tops								
	21-4812ORT		120	48	1 $\frac{1}{16}$	225	10.3	P\$ 4663 W\$ 4925	
	144" or 12' - 2 Piece Tops								
	21-48144RT		144	48	1 $\frac{1}{16}$	275	12.3	P\$ 5102 W\$ 5449	

21-3672RT Shown with 88-2034RPB
(Rectangle Panel Base)
BASES SOLD SEPARATELY

Description

- Grain Runs the Width of the Table
- Available with Veneer (PV/W) or HPL (P) Top; Must Specify
- Heavy-Duty Ganging Mechanisms Connect Two (2) Piece Tops
- See Bases/Legs and Number Required For Each Top Size, [See Multiple Base Options](#); Must Order Separately
- Optional Grommets and Power/Data Units; [See Location Options](#), [See Power Units Available](#)

Pricing Codes:

T = TFL P = HPL W = Veneer

[See Phoenix Overview For Ordering Options](#)

Item	Model No.	Width	Depth	Height	Ship Wt	Cubic Ft	List Price
 <p>21-3672BT Shown with 88-2034RPB (Rectangle Panel Base) BASES SOLD SEPARATELY</p>	72" or 6' - 1 Piece Top						
	21-3672BT	72	36	1 $\frac{3}{16}$	100	6.2	P\$ 2629 W\$ 2719
	96" or 8' - 1 Piece Top						
	21-4896BT	96	48	1 $\frac{3}{16}$	180	9.4	P\$ 4310 W\$ 4661
	120" or 10' - 2 Piece Tops						
	21-48120BT	120	48	1 $\frac{3}{16}$	225	10.3	P\$ 5398 W\$ 5751
	144" or 12' - 2 Piece Tops						
	21-48144BT	144	48	1 $\frac{3}{16}$	275	12.3	P\$ 5930 W\$ 6382

Description

- Grain Runs the Width of the Table
- Available with Veneer (PV/W) or HPL (P) Top; Must Specify
- Heavy-Duty Ganging Mechanisms Connect Two (2) Piece Tops
- See Bases/Legs and Number Required For Each Top Size, See Below for Multiple Base Options; Must Order Separately
- Optional Grommets and Power/Data Units; [See Location Options](#), [See Power Units Available](#)

RECTANGLE PANEL BASES WITH TROUGH

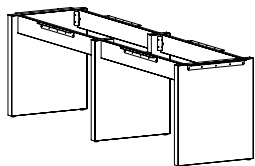

Must Specify (in this order):

Model #
Material
Finish / Color

Two (2) Panel Bases - For Use With 72" x 36" Surfaces							
88-2034RPB	Laminate	20	34	28 $\frac{3}{4}$	66	6.7	T\$ 1766
	Veneer						W\$ 1953
Two (2) Panel Bases - For Use With 96" x 48" Surfaces							
88-2458RPB	Laminate	24	58	28 $\frac{3}{4}$	84	6.9	T\$ 2109
	Veneer						W\$ 2191
Two (2) Panel Bases - For Use With 120" x 48" Surfaces							
88-2482RPB	Laminate	24	82	28 $\frac{3}{4}$	90	6.9	T\$ 2411
	Veneer						W\$ 2468
Three (3) Panel Bases - For Use With 144" x 48" Surfaces							
88-24106RPB	Laminate	24	106	28 $\frac{3}{4}$	116	13.8	T\$ 3364
	Veneer						W\$ 3430

Description

- 2" Panel Bases with Trough, Stretcher Rails, and L-Bracket Hardware Included
- Available with TFL (T) or Veneer (W)
- Vertical Grain Direction on Bases
- Bases Require Some Assembly; Attachment Hardware Included
- Tops Sold Separately

Item	Model No.		Width	Depth	Height	Ship Wt	Cubic Ft	List Price	
6" RECTANGLE BASES WITH TROUGH AND REMOVABLE PANEL	Two (2) 6" Rectangle Bases - For Use With 72" x 36" Surfaces								
	88-203406RB	Laminate	20	34	28¾	76	12.9	T\$	3113
		Veneer						W\$	4284
	Two (2) 6" Rectangle Bases - For Use With 96" x 48" Surfaces								
	88-245806RB	Laminate	24	58	28¾	93	12.9	T\$	3390
		Veneer						W\$	4629
Two (2) 6" Rectangle Bases - For Use With 120" x 48" Surfaces									
88-248206RB	Laminate	24	82	28¾	99	12.9	T\$	3609	
	Veneer						W\$	4988	
Three (3) 6" Rectangle Bases - For Use With 144" x 48" Surfaces									
88-2410606RB	Laminate	24	106	28¾	106	19.6	T\$	5293	
	Veneer						W\$	7240	

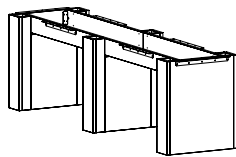

Must Specify (in this order):

- Model #
- Material
- Finish / Color

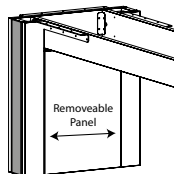

Description

- 6" Rectangle Bases with Trough and Stretcher Rails
- Available with TFL (T) or Veneer (W)
- Vertical Grain Direction on Bases
- Bases Include Interior Removable Panel for Wire Management Access. Removable Panel is 15¾"W for 24" Bases and 11¾"W for 20" Bases
- Removable Panels Attached with Z Brackets
- Bases Require Some Assembly; Attachment Hardware Included
- Tops Sold Separately

10" RECTANGLE BASES WITH TROUGH AND REMOVABLE PANEL	Two (2) 10" Rectangle Bases - For Use With 72" x 36" Surfaces								
	88-203410RB	Laminate	20	34	28¾	72	10.0	T\$	3204
		Veneer						W\$	4353
	Two (2) 10" Rectangle Bases - For Use With 96" x 48" Surfaces								
	88-245810RB	Laminate	24	58	28¾	89	12.0	T\$	3480
		Veneer						W\$	4699
Two (2) 10" Rectangle Bases - For Use With 120" x 48" Surfaces									
88-248210RB	Laminate	24	82	28¾	96	12.0	T\$	3700	
	Veneer						W\$	5059	
Three (3) 10" Rectangle Bases - For Use With 144" x 48" Surfaces									
88-2410610RB	Laminate	24	106	28¾	141	18.2	T\$	5428	
	Veneer						W\$	7346	

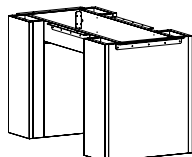

Must Specify (in this order):

- Model #
- Material
- Finish / Color

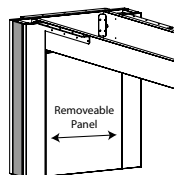

Description

- 6" Rectangle Bases with Trough and Stretcher Rails
- Available with TFL (T) or Veneer (W)
- Vertical Grain Direction on Bases
- Bases Include Interior Removable Panel for Wire Management Access. Removable Panel is 15¾"W for 24" Bases and 11¾"W for 20" Bases
- Removable Panels Attached with Z Brackets
- Bases Require Some Assembly; Attachment Hardware Included
- Tops Sold Separately

Pricing Codes:

T = TFL W = Veneer

[See Phoenix Overview For Ordering Options](#)

Item	Model No.		Width	Depth	Height	Ship Wt	Cubic Ft	List Price
6" + 10" COMBO RECTANGLE BASES WITH TROUGH AND REMOVABLE PANEL	Three (3) Bases Total: Two (2) 6" and One (1) 10" Rectangle Bases - For Use With 144" x 48" / 54" / 60" Surfaces							
	88-24106C610RB	Laminate	24	106	28¾	141	18.2	T\$ 5338
		Veneer						W\$ 7275

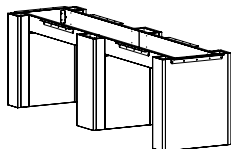

Must Specify (in this order):

- Model #
- Material
- Finish / Color

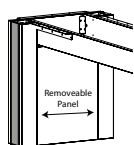

Description

- 6" + 10" Rectangle Bases with Trough and Stretcher Rails; 6" Bases on Exterior and 10" Bases on Interior
- Available with TFL (T) or Veneer (W)
- Vertical Grain Direction on Bases
- Bases Include Interior Removable Panel for Wire Management. Removable Panel is 15⅞"W and Attaches with Z Brackets.
- Bases Require Some Assembly; Attachment Hardware Included
- Tops Sold Separately

6" RECTANGLE ACCENT BASES WITH TROUGH AND REMOVABLE PANEL

Two (2) 6" Rectangle Bases - For Use With 72" x 36" Surfaces								
88-203406RAB	Laminate	20	34	28¾	76	12.9	T\$ 3624	
	Veneer						W\$ 4824	
Two (2) 6" Rectangle Bases - For Use With 96" x 48" Surfaces								
88-245806RAB	Laminate	24	58	28¾	93	12.9	T\$ 3902	
	Veneer						W\$ 5169	
Two (2) 6" Rectangle Bases - For Use With 120" x 48" Surfaces								
88-248206RAB	Laminate	24	82	28¾	99	12.9	T\$ 5321	
	Veneer						W\$ 7217	
Three (3) 6" Rectangle Bases - For Use With 144" x 48" Surfaces								
88-2410606RAB	Laminate	24	106	28¾	106	19.6	T\$ 6048	
	Veneer						W\$ 8044	

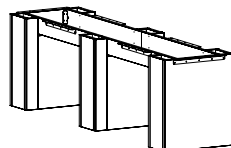

Must Specify (in this order):

- Model #
- Base Finish/Color
- Metal Accent Color
- Accent Panel Finish/Color

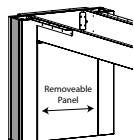

Description

- 6" Rectangle Bases with Trough and Stretcher Rails
- Available with TFL (T) or Veneer (W)
- ⅝" Metal Accent Available in Four (4) Colors: Aluminum, Black, Gold, and Platinum; Must Specify Color
- Vertical Grain Direction on Bases
- Bases Include Interior Removable Panel for Wire Management Access. Removable Panel is 15⅞"W for 24" Bases and 11⅞"W for 20" Bases
- Removable Panels Attached with Z Brackets
- Bases Require Some Assembly; Attachment Hardware Included
- Tops Sold Separately

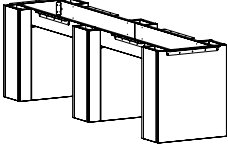
Item	Model No.		Width	Depth	Height	Ship Wt	Cubic Ft	List Price
10" RECTANGLE ACCENT BASES WITH TROUGH AND REMOVABLE PANEL 	Two (2) 10" Rectangle Bases - For Use With 72" x 36" Surfaces							
	88-203410RAB	Laminate	20	34	28¾	72	10.0	T\$ 3598
		Veneer						W\$ 4795
	Two (2) 10" Rectangle Bases - For Use With 96" x 48" Surfaces							
	88-245810RAB	Laminate	24	58	28¾	89	12.0	T\$ 3948
		Veneer						W\$ 5230
	Two (2) 10" Rectangle Bases - For Use With 120" x 48" Surfaces							
	88-248210RAB	Laminate	24	82	28¾	96	12.0	T\$ 4168
		Veneer						W\$ 5591
	Three (3) 10" Rectangle Bases - For Use With 144" x 48" Surfaces							
	88-2410610RAB	Laminate	24	106	28¾	141	18.2	T\$ 6125
		Veneer						W\$ 8138

Must Specify (in this order):
 Model #
 Base Finish/Color
 Metal Accent Color
 Accent Panel Finish/Color

Description

- 10" Rectangle Bases with Trough and Stretcher Rails
- Available with TFL (T) or Veneer (W)
- 5/16" Metal Accent Available in Four (4) Colors: Aluminum, Black, Gold, and Platinum; Must Specify Color
- Vertical Grain Direction on Bases
- Bases Include Interior Removable Panel for Wire Management Access. Removable Panel is 15 7/8"W for 24" Bases and 11 7/8"W for 20" Bases
- Removable Panels Attached with Z Brackets
- Bases Require Some Assembly; Attachment Hardware Included
- Tops Sold Separately

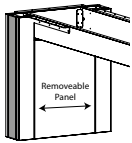

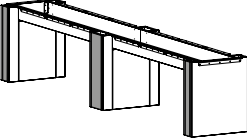

6" + 10" COMBO RECTANGLE ACCENT BASES WITH TROUGH AND REMOVABLE PANEL 	Three (3) Bases Total: Two (2) 6" and One (1) 10" Rectangle Bases - For Use With 60" / 54" / 48" x 144" Surfaces							
	88-24106C610RAB	Laminate	24	106	28¾	141	18.2	T\$ 6078
		Veneer						W\$ 8079

Must Specify (in this order):
 Model #
 Base Finish/Color
 Metal Accent Color
 Accent Panel Finish/Color

Description

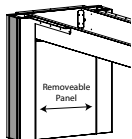
- 6" + 10" Rectangle Accent Bases with Trough and Stretcher Rails; 6" Bases on Exterior and 10" Bases on Interior
- Available with TFL (T) or Veneer (W)
- 5/16" Metal Accent Available in Four (4) Colors: Aluminum, Black, Gold, and Platinum; Must Specify Color
- Vertical Grain Direction on Bases
- Bases Include Interior Removable Panel for Wire Management. Removable Panel is 15 7/8"W and Attaches with Z Brackets
- Bases Require Some Assembly; Attachment Hardware Included
- Tops Sold Separately

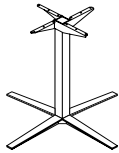

Item	Model No.		Width	Depth	Height	Ship Wt	Cubic Ft	List Price
DISC BASE 	For 36" and 42" Round Tops							
	01-2430DBB	Black	24	24	27¾	32	3.2	\$ 1701
	01-2430DBA	Aluminum						
	For 48" Round Tops							
	01-3230DBB	Black	30	30	27¾	42	4.1	\$ 2041
	01-3230DBA	Aluminum						
Description								
<ul style="list-style-type: none"> • 4" Diameter 14 Gauge Steel Column • 12"x12" Mounting Plate at Top of Column • ¼" Thick Disc Plate with 5 Levelers • Some Assembly Required 								
Table Widths						Round	72"	96"
Number of Bases Required						1	2	2

Item	Model No.		Width	Depth	Height	Ship Wt	Cubic Ft	List Price
METAL X-BASE 	For Use With Round: 36" and Top Surfaces: 72" x 36"							
	<i>For 30"H Tables</i>							
	08-2030SXBB	Black	29	29	28	21	11.6	\$ 1289
	08-2030SXBA	Aluminum						
	<i>For 36"H Tables</i>							
	08-2036SXBB	Black	29	29	34	24	13.7	\$ 1342
	08-2036SXBA	Aluminum						
	<i>For 42"H Tables</i>							
	08-2042SXBB	Black	29	29	40	27	15.9	\$ 1399
	08-2042SXBA	Aluminum						
	For Use With Round Tops: 42" + 48" and Top Surfaces: 96" x 48"							
	<i>For 30"H Tables</i>							
	08-2630LXBB	Black	35½	35½	28	27	14.5	\$ 1380
	08-2630LXBA	Aluminum						
	<i>For 36"H Tables</i>							
	08-2636LXBB	Black	35½	35½	34	30	17.2	\$ 1444
08-2636LXBA	Aluminum							
<i>For 42"H Tables</i>								
08-2642LXBB	Black	35½	35½	40	33	20.0	\$ 1496	
08-2642LXBA	Aluminum							
Description								
<ul style="list-style-type: none"> • See Number of Bases Required Per Top Width Below • Not Available to be Sold Separately • Power Units Available On Center When Using Two or More Metal X-Bases • Ships Assembled 								
Table Widths						Round	72"	96"
Number of Bases Required						1	2	2

Item	Model No.		Width	Depth	Height	Ship Wt	Cubic Ft	List Price
HEIGHT ADJUSTABLE PNEUMATIC X-BASE 	Maximum Round 36"							
	01-2626HAXBB	Black	22	22	26-45¾	1	0.2	\$ 1869
	01-2626HAXBA	Aluminum						
	Maximum Round 42"							
	01-3232HAXBB	Black	32	32	26-45¾	1	0.2	\$ 1907
	01-3232HAXBA	Aluminum						

Description

- Pre-Drilled Boring Pattern May Not Match Underside of Table Top
- Steel Mounting Plate: 8" x 8" x ¼"
- Eight (8) Bolts Included for Assembly
- Some Assembly Required

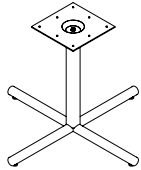
TUBULAR X-BASE 	For Use With Round Tops: 36" + 42" and Top Surfaces: 72" x 36"							
	01-3230TXB	Black	32	32	27¾	32	3.2	\$ 701
	01-3230TXA	Aluminum						
	For Use With Round Tops: 36" + 42" and Top Surfaces: 72" x 36"							
	01-3830TXB	Black	38	38	27¾	40	4.2	\$ 774
	01-3830TXA	Aluminum						

Description

- 3" Diameter Column
- See Number of Bases Required Per Top Width Below
- Power Units Available On Center When Using Two or More Tubular X-Bases
- Some Assembly Required

Table Widths	Round	72"	84"	96"
Number of Bases Required	1	2	2	2

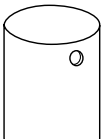
CYLINDER BASE 	For Tables 36"D							
	01-1616CB		16	16	28½	101	7.2	W\$ 1572
	For Tables 42"D to 48"D							
	01-2020CB		20	20	28½	136	10.9	W\$ 1720

Description

- Veneer Base Features Multi-Step, Hand-Finished Catalyzed Finish
- Weighted for Stability
- Two (2) Wire Management Black Grommets Standard at Top Edge; 8" Opening Standard at Bottom

Additional Grommet Options: Specify & Add

GCB1S	Only One (1) Grommet At Top Edge	\$	N/C
NOGC	No Grommets At Top Edge	\$	N/C

Must Specify (in this order):

Model #
Finish
Grommet Options

[See Phoenix Overview For Ordering Options](#)

Item	Model No.	Width	Depth	Height	Ship Wt	Cubic Ft	List Price
QUEEN ANNE BASE	01-0606QB	24	24	28¾	136	11.1	W\$ 1557

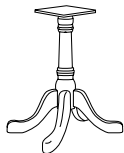

Description

- Classic Design Detail on Column
- Base Features Multi-Step, Hand-Finished Catalyzed Finish
- Four (4) Legs with Adjustable Glides

Must Specify (in this order):
Model #
Finish

SQUARE BASE	21-1616SB	16	16	28¾	41	6.0	W\$ 1269
	<i>For Use with 36" Top</i>						
	21-2020SB	20	20	28¾	57	8.4	W\$ 1364
	<i>For Use with 48" or 42" Tops</i>						

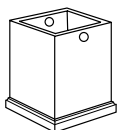

Description

- Veneer Base
- Two (2) Wire Management Black Grommets Standard at Top and 8" Wire Management Opening in Bottom

Must Specify (in this order):
Model #
Finish
Grommet Options

Options: Specify & Add

NOGC	No Grommet at Top Edge	\$	N/C
------	------------------------	----	-----



Item	Model No.	Width	Depth	Height	Ship Wt	Cubic Ft	List Price
STORAGE CREDENZA	21-2066SC	66	20 ⁷ / ₁₆	30	320	26.6	P\$ 4852 W\$ 5293
	21-2072SC	72	20 ⁷ / ₁₆	30	349	29.0	P\$ 5029 W\$ 5484

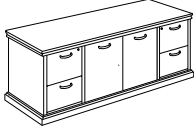

Must Specify (in this order):

- Model #
- Top Material
- Finish/Color
- Pull
- Flush Feature

Description

- Letter Width Locking File/File Pedestals
- Available with Veneer (W) or HPL (P) Top, Must Specify
- Fixed Storage Shelf Behind Doors
- Profiles on Three (3) Sides for Flush Wall Application Standard
- Flush Feature Available; Must Specify: Flush Left (FL), Flush Right (FR) or Flush Left and Right (FLR)
- Flush Option Reduces Unit by 3/4" Per Side and 1 1/2" for Both Flush Sides

WARDROBE/STORAGE CABINET

	Hinged Left	Hinged Right						
	21-1872WL	21-1872WR	18	20 ⁷ / ₁₆	70 ⁷ / ₈	152	19.2	W\$ 3438

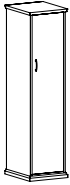

Shown as Right

Must Specify (in this order):

- Model #
- Finish
- Pull
- Locking Doors
- Flush Feature

Description

- Coat Rod Under Top Fixed Shelf
- Three (3) Adjustable Shelves; Adjustable Shelves can be Removed for Wardrobe Application
- Profiles on Three (3) Sides for Flush Wall Application Standard
- Flush Feature Available; Must Specify: Flush Left (FL), Flush Right (FR) or Flush on Both Sides (FLR)
- Flush Option Reduces Unit by 3/4" Per Side and 1 1/2" if Both Sides Are Selected to be Flush
- Optional Locking Doors ([See Locking Options](#)), Lock Core will Coordinate with Pull Color

DOUBLE WARDROBE/STORAGE

	21-3072WC		30	20 ⁷ / ₁₆	70 ⁷ / ₈	240	35.7	W\$ 4648
	21-3672WC		36	20 ⁷ / ₁₆	70 ⁷ / ₈	290	42.0	W\$ 4774

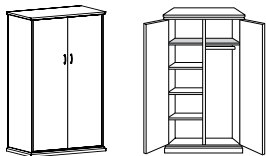

Must Specify (in this order):

- Model #
- Finish
- Pull
- Locking Doors
- Flush Feature





Description

- Fixed Top Shelf Behind Each Door
- Three (3) Adjustable Shelves on Left Side; Coat Rod Under Fixed Shelf on Right Side
- Profiled on Three (3) Sides for Flush Wall Applications Standard
- Flush Feature Available; Must Specify: Flush Left (FL), Flush Right (FR) or Flush on Both Sides (FLR)
- Flush Option Reduces Unit by 3/4" Per Side and 1 1/2" if Both Sides Are Selected to be Flush
- Optional Locking Doors ([See Locking Options](#)), Lock Core will Coordinate with Pull Color

Pricing Codes:

P = HPL W = Veneer

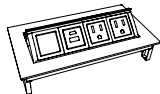
[See Phoenix Overview For Ordering Options](#)

Item	Model No.		Width	Depth	Height	Ship Wt	Cubic Ft	List Price
ROUND GROMMET COVER FIELD INSTALLED	01-GRMTBK	Black	-	-	-	-	-	\$ 12
	01-GRMTSL	Silver						
 <p>OPEN MARKET ONLY (SILVER)</p>		Description <ul style="list-style-type: none"> • 60mm Round Grommet Cover • Field Installed 						
DOCK 950 WIRELESS CHARGER	01-DOCK950W	White	3 $\frac{3}{10}$	3 $\frac{3}{10}$	-	1	0.2	\$ 294
	01-DOCK950B	Black						\$ 294
 <p>OPEN MARKET ONLY</p>		Description <ul style="list-style-type: none"> • For Use with Wireless Charging Enabled Devices • 5 Watts Maximum Output with a Direct Current of 5V 2A and 10 Watts Maximum with Quick Charge 2.0 • LED will Confirm Pairing with Device and Begin Wireless Charging 						
WIRELESS AND USB CHARGER	01-DOCK150W	White	3	3	$\frac{3}{4}$ "	1	0.2	\$ 448
	01-DOCK150B	Black						\$ 448
 <p>OPEN MARKET ONLY</p>		Description <ul style="list-style-type: none"> • For Use with Wireless Charging Enabled Devices and USB Charging Devices • 5 Watt Maximum Output with a Direct Current Input of 5V 6A (Wireless Fast Charge) • Pop-Up is $\frac{3}{4}$"H and Includes Three (3) USB Ports; One (1) 12 Watt Maximum with 2.4A (USB Fast Charge) and Two (2) 5 Watt with 1A (USB Standard Charge) • LED Light will Confirm Pairing with Device and Begin Wireless Charging • UL and cUL Certified 						
DPORT	01-DPORT4A	Aluminum	8	4	-	7	0.2	\$ 1211
	01-DPORT4B	Black						
		Description <ul style="list-style-type: none"> • Includes: Two (2) Power Outlets, One (1) USB A+C, One (1) Open Port, 10' Power Cord, and Voice/Data Adapter Kit to Accept Couplers and Jacks When Required • Retracts into Work Surface to Regain Productive Space; One-Touch Access to Power and Data • Optional Telecom Port Components, See Compatible Units Below • Water-Proof Simplex (Outlets) • UL Recognized 						
USB PORT	01-USBPORT		-	-	-	-	-	\$ 178
		Description <ul style="list-style-type: none"> • Passive USB-A Port with Increased Transfer Speed Up to 5 gbs/sec • Simultaneous Read/Write Capability; Idle Device Power Saving State • 6' Cord • Compatible with 01-DPORT4A, 01-DPORT4B 						

[See Phoenix Overview For Ordering Options](#)

Item	Model No.	Width	Depth	Height	Ship Wt	Cubic Ft	List Price
VOICE COUPLER	01-VOICE1	-	-	-	-	-	\$ 80

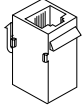

Description

- 6-Pin Modular Plug
- Molded Black; Cord Not included
- Compatible with 01-DPORT4A, 01-DPORT4B

DATA PORT	01-RJ4DATA	-	-	-	-	-	\$ 186
-----------	------------	---	---	---	---	---	--------



Description

- 8-Pin Modular Plug; Cat6 Ethernet Cable; Pre-terminated Cable
- 10' Cord
- Compatible with 01-DPORT4A, 01-DPORT4B

E2X  01-E2X4	01-E2X6A	Aluminum	11	9 ¹ / ₁₆	-	6	0.7	\$ 1801
	01-E2X6B	Black						
	01-E2X4A	Aluminum	8	9 ¹ / ₁₆	-	5	0.5	\$ 1655
	01-E2X4B	Black						

Description



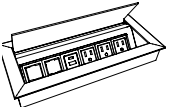

- In Surface, Dual Side Application; Soft Touch Access to Power and Data
- 11" Unit Includes Three (3) Power Outlets, One (1) USB A+C, and Two (2) Open Port on Each Side; 8" Unit Includes Two (2) Power Outlets, One (1) USB A+C, and One (1) Open Port on Each Side
- Optional Telecom Port Components, [See Compatible Units](#)
- 6' Power Cord
- UL Listed

ELLORA  01-ELLORA6	01-ELLORA6A	Aluminum	11	5	-	6	0.7	\$ 944
	01-ELLORA6B	Black						
	01-ELLORA4A	Aluminum	8	5	-	5	0.5	\$ 877
	01-ELLORA4B	Black						

Description

- In Surface Application; Soft Touch Access to Power and Data
- 11" Includes Three (3) Power Outlets, One (1) USB A+C, and Two (2) Open Port; 8" Includes Two (2) Power Outlets, One (1) USB A+C, and One (1) Open Port
- Optional Telecom Port Components, See Below for Compatible Units
- 6' Power Cord
- UL Recognized

[See Phoenix Overview For Ordering Options](#)

Item	Model No.	Width	Depth	Height	Ship Wt	Cubic Ft	List Price
VGA CONNECTOR ACCESSORY	01-VGACON	-	-	-	1	0.2	\$ 165
	Description <ul style="list-style-type: none"> VGA Port for 01-DPORT4A, 01-DPORT4B, ELLORA4A, ELLORA4B, ELLORA6A, ELLORA6B, E2X4A, E2X4B, E2X6A, and E2X6B Enables Devices to Remote Display on Monitors 10' Cord Male/Female Connector 						
PASSIVE USB-C ACCESSORY	01-PUSBC	-	-	-	1	0.2	\$ 105
	Description <ul style="list-style-type: none"> Passive USB-C Port ; Unit Provides Data Connection to Transfer Data Only, No Charging Capabilities Compatible with 01-DPORT4A, 01-DPORT4B, ELLORA4A, ELLORA4B, ELLORA6A, ELLORA6B, E2X4A, E2X4B, E2X6A, and E2X6B Male/Female Connector 						
CHARGING USB-A+C ACCESSORY	01-USBAC	-	-	-	1	0.2	\$ 313
	Description <ul style="list-style-type: none"> For Charging Devices 20 Watt Power Supply USB+C Charging Port for 01-DPORT4A, 01-DPORT4B, ELLORA4A, ELLORA4B, ELLORA6A, ELLORA6B, E2X4A, E2X4B, E2X6A, and E2X6B 						
HDMI CONNECTOR ACCESSORY	01-HDMICON	-	-	-	1	0.2	\$ 137
	Description <ul style="list-style-type: none"> HDMI Port for 01-DPORT4A, 01-DPORT4B, ELLORA4A, ELLORA4B, ELLORA6A, ELLORA6B, E2X4A, E2X4B, E2X6A, and E2X6B Connects to High Definition Displays Female/Female Connector 18" Cord 						

[See Phoenix Overview For Ordering Options](#)

Item	Model No.		Width	Depth	Height	Ship Wt	Cubic Ft	List Price
INTERACT POWER & DATA	01-INTERACTG2A	Aluminum	9	5½	2¾	5	0.2	\$ 987
	01-INTERACTG2B	Black						



Description

- Includes: Two (2) Power Outlets, USB-A+C Charging Ports, One (1) Telecom Plate Opening; Two (2) Keystone Openings for Voice/Data Jacks
- One (1) Telecom Plates Included with the Unit: One (1) 01-ABLAB Plate (Consists of One (1) RJ45 Cat 6, One (1) RJ11 Cat 3 Phone Jack)
- Convenience Plug on Bottom with 6' Power Cord
- UL and CSA Recognized
- Additional Telecom Plates, [See ECA Telecom Plate Options](#)

OASIS MINI POWER & DATA	01-OASISMA	Aluminum	15	9	5	11	0.3	\$ 3535
	01-OASISMB	Black						



Top View

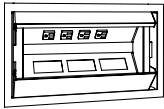

Description

- Soft Touch Hinged Lid
- Four (4) Power Outlets, Three (3) Telecom Plate Openings
- Two (2) Telecom Plates Included with the Unit: One (1) 01-ABLAB Plate (Consists of One (1) RJ45 Cat 6, One (1) RJ11 Cat 3 Phone Jack); One (1) 01-ABLB Plate (Consists of One (1) RJ45 Cat 6)
- 9' Power Cord
- UL Listed
- Additional Telecom Plates, [See ECA Telecom Plate Options](#)

DOCK800	01-DOCK800S	Silver	14	9	-			\$ 2268
	01-DOCK800B	Black						

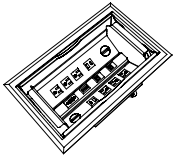

OPEN MARKET ONLY

Description

- Stylish Aluminum Housing with Beveled Edges; Soft Touch Access and Closure
- Includes: Six (6) Power Outlets, Two (2) USB-A 5V Ports, Two (2) USB-C Charging Ports, One (1) RJ45 Ethernet Port, One (1) RJ11 Port, One (1) HDMI Port, and One (1) VGA Port
- 10' Power Cord
- UL and cUL Certified

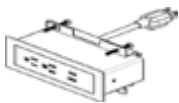

DUO BEZEL WITH NEMA PLUG	01-DUOBEZELW	White	6½	2½	3¼	1	0.2	\$ 748
	01-DUOBEZELB	Black						
	01-DUOBEZELS	Silver						



Description

- Standard with: Two (2) Power, One (1) USB-A Charging Port and One (1) 60-Watt USB-C Power Delivery Port with GaN Technology; 10' Cord and All Mounting Hardware
- Worksurface Must Be Routed To Accept Unit, Which Sits Down Into Worksurface Supported By Attractive Slim Fit Bezel
- Independent USB Circuit Controllers Deliver up to 2.1 Amps to Each Post
- FCC Part 15A, UL Recognized for Horizontal and Vertical Applications

[See Phoenix Overview For Ordering Options](#)

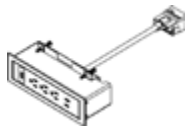
Item	Model No.		Width	Depth	Height	Ship Wt	Cubic Ft	List Price
TRIO BEZEL WITH NEMA PLUG 	01-TRIOBEZELW	White	9	2½	3	1	0.2	\$ 803
	01-TRIOBEZELB	Black						
	01-TRIOBEZELS	Silver						
	Description <ul style="list-style-type: none"> Standard with: Three (3) Power Outlets, One (1) USB-A Charging Port, One (1) 60-Watt USB-C Power Delivery Port with GaN Technology, One (1) Open Data Port; 10' Cord and All Mounting Hardware Worksurface Must Be Routed To Accept Unit, Which Sits Down Into Worksurface Supported By Attractive Slim Fit Bezel HDMI, VGA, and RJ45 Accessories for Open Data Port; Sold Separately, See Accessories Independent USB Circuit Controllers Deliver up to 2.1 Amps to Each Post FCC Part 15A, UL Recognized for Horizontal and Vertical Applications 							
DUO BEZEL WITH PURL DAISY CHAIN PLUG 	01-DCDUOBEZELW	White	6½	2½	3	1	0.2	\$ 631
	01-DCDUOBEZELB	Black						
	01-DCDUOBEZELS	Silver						
	Description <ul style="list-style-type: none"> Standard with: Two (2) Tamper Resistant 15 Amp Power Outlets, One (1) USB-A Charging Port and One (1) 60-Watt USB-C Power Delivery Port with GaN Technology, 10' Cord and All Mounting Hardware Top Must Be Routed To Allow Unit to Sit Down Into the Top, Must Specify when Ordering Top Unit Supported By Attractive Slim Fit Bezel Requires Purl Daisy Chain Power Infeed, Specified Separately (See Details) Non-Sequential System Allows up to Nine (9) Modules to be Connected with H-Block (See Below) and Jumper Cord (See Details) Independent USB Circuit Controllers Deliver up to 2.4 Amps to Each Post FCC Part 15A, RU Listed and UL Recognized for Horizontal and Vertical Applications 							
TRIO BEZEL WITH PURL DAISY CHAIN PLUG 	01-DCTRIOBEZELW	White	9	2½	3	1	0.2	\$ 723
	01-DCTRIOBEZELB	Black						
	01-DCTRIOBEZELS	Silver						
	Description <ul style="list-style-type: none"> Standard with: Three (3) Tamper Resistant 15Amp Power Outlets, One (1) USB-A Charging Port, One (1) 60-Watt USB-C Power Delivery Port with GaN Technology, One (1) Open Data, 12' Cord and All Mounting Hardware Top Must Be Routed To Allow Unit to Sit Down Into the Top, Must Specify when Ordering Top Unit Supported By Attractive Slim Fit Bezel Requires Purl Daisy Chain Power Infeed, Specified Separately (See Details) Non-Sequential System Allows up to Nine (9) Modules to be Connected with H-Block and Jumper Cord (See Details) Independent USB Circuit Controllers Deliver up to 2.4Amps to Each Post FCC Part 15A, RU Listed and UL Recognized for Horizontal and Vertical Applications HDMI, VGA, or RJ45 Sold Separately (See Accessories) 							

Item	Model No.	Width	Depth	Height	Ship Wt	Cubic Ft	List Price
PURL DAISY CHAIN POWER INFEED	01-DCPOWER	-	-	-	1	0.2	\$ 227

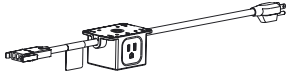

Description

- Includes One (1) Purl Connector Plug, 36" Daisy Chain Cord, One (1) 15 Amp Power Outlet, and a 120" Power Cord with a Nema Plug
- Powers up to Nine (9) Duo and Trio Purl Daisy Chain Units
- 15-Amp System Rating and Over-Current Protection
- System Requires H-BLOCK Connector Between Power Infeed and Each Jumper Cord, See Below For Purl Daisy Chain H-Block and Purl Daisy Chain Jumper Cords Details

PURL DAISY CHAIN H-BLOCK	01-DCHBLOCK	-	-	-	1	0.2	\$ 40
--------------------------	-------------	---	---	---	---	-----	-------

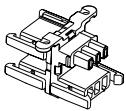

Description

- Includes One (1) Power In and Three (3) Power Out Receptacles
- System Requires H-BLOCK Connector Between Power Infeed and Each Jumper Cord, See Purl Daisy Chain Power Infeed (Above) and Jumper Cords (See Below)

PURL DAISY CHAIN JUMPER CORD	01-DC2JUMP	24" Long	-	-	-	1	0.2	\$ 72
	01-DC3JUMP	36" Long	-	-	-	1	0.2	\$ 77
	01-DC4JUMP	48" Long	-	-	-	1	0.2	\$ 82
	01-DC5JUMP	60" Long	-	-	-	1	0.2	\$ 87
	01-DC6JUMP	72" Long	-	-	-	1	0.2	\$ 92

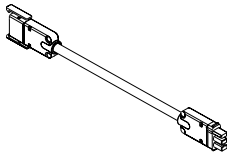

Description

- Connects Duo and Trio Daisy Chain Units
- Non-Sequential System Allows up to None (9) Modules to be Connected

HDMI DATA PORT ACCESSORY	01-LCOMHDMI	-	-	-	1	0.2	\$ 183
--------------------------	-------------	---	---	---	---	-----	--------

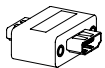

OPEN MARKET ONLY

Description

- HDMI Port for Trio Bezel Units
- See Additional Accessories on next page

[See Phoenix Overview For Ordering Options](#)

Item	Model No.	Width	Depth	Height	Ship Wt	Cubic Ft	List Price
VGA DATA PORT ACCESSORY	01-LCOMVGA	-	-	-	1	0.2	\$ 134

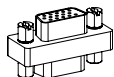
Description

- VGA Port for Trio Bezel Units

RJ45 DATA PORT ACCESSORY	01-LCOMRJ45	-	-	-	1	0.2	\$ 88
--------------------------	-------------	---	---	---	---	-----	-------

Description

- RJ45 Port for Trio Bezel Units

WIRE MANAGEMENT CHANNEL	01-WMGR4	16	1½	¾	1	-	\$ 129
-------------------------	----------	----	----	---	---	---	--------

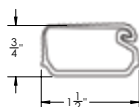
Description

- Set of Four (4) Black Plastic Wire Management Channels
- Snap Lock Channel
- Attaches with Adhesive Strips
- Ships via UPS Only

WIRE CHANNEL	01-32125	24	1%	1	.25	0.3	\$ 117
--------------	----------	----	----	---	-----	-----	--------

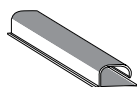
Description

- Available in Black
- Channels Attach with Two (2) Double-Sided Installation Tape
- Open J Channel for Easy Storage of Cables

CABLE GRIP	01-WMGRCB	5%	2%	-	-	-	\$ 19
------------	-----------	----	----	---	---	---	-------

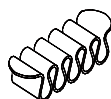
Description

- Under Surface Wire Management
- Black

Item	Model No.	Width	Depth	Height	Ship Wt	Cubic Ft	List Price
<p>ECA TELECOM PLATES</p> <p>Compatible with:</p>   <p>Oasis Mini Power & Data 01-OASISMA, 01-OASISMB</p>  <p>Interact Power & Data 01-INTERACTG2A, 01-INTERACTG2B</p>  <p>Power Center 01-INTRFCIA, 01-INTRFCIB</p>	01-ABL	Telecom Plate, Blank Plate					\$ 45
	01-ABL737373	Telecom Plate, Three (3) RJ45 Cat 5e					\$ 406
	01-ABLAB	Telecom Plate, One (1) RJ45 Cat 6, One (1) RJ11 Cat 3 Phone					\$ 228
	01-ABLAB102	Telecom Plate, One (1) RJ45 Cat 6, One (1) RJ11 Cat 3, One (1) USB W/72" Patch Cord					\$ 355
	01-ABLABB	Telecom Plate, Two (2) RJ45 Cat 6, One (1) RJ11 Cat 3 Phone					\$ 355
	01-ABLB	Telecom Plate, One (1) RJ45 Cat 6					\$ 165
	01-ABLBB	Telecom Plate, Two (2) RJ45 Cat 6					\$ 289
	01-ABLBBB	Telecom Plate, Three (3) RJ45 Cat 6					\$ 406
	01-ABLBBB	Telecom Plate, Four (4) RJ45 Cat 6					\$ 528
	01-ABLBBC51	Telecom Plate, Two (2) RJ45 Cat 6, One (1) 15 Pin HD VGA w/72" Patch Cord					\$ 494
	01-ABLBC51L	Telecom Plate, One (1) RJ45 Cat 6, One (1) Mini Stereo Inline, One (1) 15 Pin HD VGA w/72" Patch Cord					\$ 455
	01-ABLC3811	Telecom Plate, One (1) RJ45 Cat 6 Data Inline, One (1) RJ11 Cat 3 Phone Inline					\$ 219
	01-ABLC45	Telecom Plate, One (1) HDMI w/36" Patch Cord					\$ 327
	01-ABLC45C51L	Telecom Plate, One (1) Mini Stereo Inline, One (1) HDMI w/36" Patch Cord, One (1) 15 Pin HD VGA w/72" Patch Cord					\$ 618
	01-ABLC51L	Telecom Plate, One (1) 15 Pin HD VGA & One (1) Mini Stereo Inline Jack					\$ 330
	01-ABLCRDM	Telecom Plate, Three (3) Cord Bushings					\$ 106

[See Phoenix Overview For Ordering Options](#)

From classrooms to meeting rooms, libraries to auditoriums, our Spark multi-use tables couple design with functionality to create flexible learning and collaborative environments. With a variety of sizes, surface materials, and options for flip/nest, mobile, and static bases, as well as accessories like ganging brackets, modesty panels, power units, and lecterns, Spark can be easily configured, and reconfigured, to accommodate changing group sizes and engagement needs.

CONSTRUCTION

TOPS

- Thermally-Fused Laminate (TFL) and High-Pressure Laminate (HPL) are made of woodgrain and solid color laminates fused to particleboard core; each laminate offers lasting beauty, superior resistance to normal wear, and easy maintenance
- Veneer tops feature UVAdvantage, an ultra-violet finish on all exposed surfaces by utilizing roll-coat UV technology
- Tops feature Square (Y) edge profile with horizontal/left-to-right grain direction
- TFL tops are 1" thick with 3mm PVC rim, HPL tops are 1 $\frac{3}{16}$ " thick with 3mm PVC rim, and Veneer tops are 1 $\frac{3}{16}$ " thick with 3mm edge banding; Designer White, Sugar Maple, and Williamsburg Cherry feature ABS edge bands
- Tops are pre-drilled for the specified base assembly, ganging brackets and modesty panels
- Ganging Brackets are field installed with #10 x $\frac{7}{8}$ " pan head screws, mounting hardware include
- Lecterns feature 1" thick top with Vertical Square (H) edge profile and horizontal/left-to-right grain direction; TFL or HPL tops have 1mm PVC rim with a TFL chassis while Veneer tops have 0.5mm edge banding with a Veneer chassis

BASES

- Bases are powder-coated in Aluminum, Black, or Snow
- Legs feature built-in wire management and are steel with 3mm steel mounting plates
- Bases with casters feature 60mm locking casters and are paired with pre-determined coordinating colors: Aluminum and Snow bases are paired with white casters while Black bases are paired with black casters
- Static Base includes nylon adjustable glides
- Some Assembly Required

POWER/DATA/CORD MANAGEMENT

- Grommets are 2 $\frac{3}{8}$ " in diameter and available in black or silver in tops
- Power/Data units available for under-surface mount, routed into tops, or for use in standard grommet holes
- Power/Data Units comply with FCC Part 15A and UL
- Standard Power/Data plugs and Purl Daisy-Chain connections are available; Purl Daisy Chain is a non-sequential system; connect up to 9 modules

LECTERNS

- Height adjustable Lectern include a paddle-controlled pneumatic lift with 16" height adjustment range
- Lecterns feature Vertical Square (H) edge profile and 37mm black locking casters

ACOUSTIC

- Acoustic Surrounds on Lecterns and Modesty Panels are $\frac{1}{2}$ " (12mm) thick and constructed of 100% polyester made from up to 50% recycled materials without the use of adhesive or other bonding agents
- 100% recyclable

HOW TO ORDER EXAMPLES

Model No.	Description	Example
FLIP/NEST TOP		
77-2466TPN	Top Material	T
	Finish/Color	PNW
	Grommet Locations	C
	Grommet/Color	GBR60
T-LEG FLIP/NEST BASE		
77-2464TBC	Metal Color	ALUM
HINGED MODESTY		
77-1066HMD	Modesty Material	T
	Finish/Color	KHE
	Hinge Cap Color	ALUM
STATIC TOP		
77-2472TPS	Top Material	T
	Finish/Color	PTK
	Power/Data Location	LR
	Power/Data Unit	2 01-DCDUOAIRB
T-LEG STATIC BASE		
77-2402TLC	Metal Color	ALUM
FIXED ACOUSTIC MODESTY		
77-1072FMDA	Acoustic Color	CAD
	Hinge Cap Color	ALUM
HEIGHT ADJUSTABLE LECTERN		
77-2242HLS	Top Material	T
	Metal Color	ALUM
	Surround	CAD
	Power/Data Unit	DUOBEZELS

EDGE PROFILE

- Y Square (Tops)
- H Vertical Square (Lecterns)



Square



Vertical Square

TFL (T) & HPL (P) LAMINATE TOP AND MODESTY OPTIONS

WOODGRAIN

AS	Asian Night	PNW	Pinnacle Walnut
BW	Beigewood	PTK	Portico Teak
CO	Columbian Walnut	RC	River Cherry
EF	Espresso	SCH	Select Cherry
FLW	Florence Walnut	SPW	Sepia Walnut
GC	Golden Cherry	SKC	Shaker Cherry
HVM	Harvest Maple	SBP	Smoky Brown Pear
KHE	Kirsche	TK	Studio Teak
MW	Mahogany Walnut	SM	Sugar Maple
MNR	Midnight Run	WTA	Weathered Ash
NTM	Natural Marrone	WNB	White Nebbia
ORW	Oak Riftwood	WC	Williamsburg Cherry

SOLID

BL	Black	FHG	Fashion Grey
WH	Designer White	SG	Slate Grey

VENEER (W) TABLE TOP AND MODESTY OPTIONS

Tops feature UVAdvantage, an ultra-violet finish, on all exposed surfaces by utilizing roll-coat UV technology.

AW	Artisan Walnut	MW	Mahogany Walnut
AS	Asian Night	MAS	Mesa Sunset
CO	Columbian Walnut	MTS	Metropolis Sky
DC	Dark Cherry	ORW	Oak Riftwood*
DFW	Dark Forest Walnut	PNW	Pinnacle Walnut
EF	Espresso	SCH	Select Cherry
FO	Fawn Oak*	SKC	Shaker Cherry
GC	Golden Cherry	SM	Sugar Maple
HW	Harvest Walnut	WTA	Weathered Ash*
HNW	Henna Walnut	WC	Williamsburg Cherry
LW	Legacy Walnut		

* Low Sheen Finish

METAL COLOR OPTIONS

All bases and hinges available in your choice of three powder-coated colors: Aluminum, Black, and Snow.

Bases with casters feature 60mm locking casters and are paired with pre-determined coordinating colors. Aluminum and Snow bases are paired with white casters while Black bases are paired with black casters.

Must specify base color and hinge color when selecting hinged modesty panels.

ALUM	Aluminum
BLK	Black
SNO	Snow



ACOUSTIC MODESTIES AND LECTERN SURROUND OPTIONS

Acoustic Modesties and Surrounds on Lecterns with Storage are available in four colors. Must specify.

ASH	Ash	GRY	Grey
CAD	Cadet	MLK	Milky



GROMMET AND POWER/DATA INFORMATION

Grommets are available in tops. Tops may also be ordered without grommets or power units, please specify NONE on order.

Power/Data units must be specified separately with surface location. Specify location on order, as well as the power/data unit. Tops are routed for field placement at no additional charge.

Grommets and power units available in two locations: Centered (C) or Left/Right (LR). Only one grommet/power/data unit per location.

LOCATIONS:

NONE	No Grommets or Power Units
C	Centered
LR	Left and Right

Lecterns

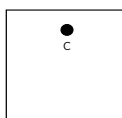

C: Located 11" from end, 17" from user side

24" Tops

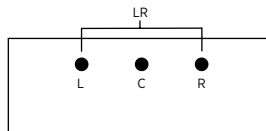

LR: Located 22" from end, 19" from user side

C: Located 19" from user side

30" Tops

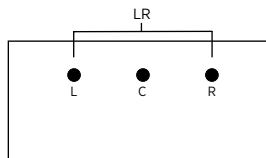

LR: Located 22" from end, 25" from user side

C: Located 25" from user side

GROMMET AND POWER/DATA LOCATIONS AND UNITS - CONTINUED

UNITS	SPECIFY	
Grommet		\$ 58



Black GBR60
Silver GSR60

NEMA PLUG UNITS:

Duo Air		\$ 743
Two (2) Electrical Power, (1) USB-A and (1) USB-C Outlets		



Black 01-DUOAIRB
Silver 01-DUOAIRS
White 01-DUOAIRW

Duo Bezel		\$ 748
Two (2) Electrical Power, (1) USB-A and (1) USB-C Outlets		



Black 01-DUOBEZELB
Silver 01-DUOBEZELS
White 01-DUOBEZELW

Duo Undermount		\$ 631
Two (2) Electrical Power, (1) USB-A and (1) USB-C Outlets		



Black 01-DUOUNDERB
Silver 01-DUOUNDERS
White 01-DUOUNDERW

PURL DAISY CHAIN UNITS:

Duo Air Purl Daisy Chain		\$ 748
Two (2) Electrical Power, (1) USB-A and (1) USB-C Outlets		



Black 01-DCDUOAIRB
Silver 01-DCDUOAIRS
White 01-DCDUOAIRW

Duo Bezel Purl Daisy Chain		\$ 631
Two (2) Electrical Power, (1) USB-A and (1) USB-C Outlets		



Black 01-DCDUOBEZELB
Silver 01-DCDUOBEZELS
White 01-DCDUOBEZELW

Duo Undermount Purl Daisy Chain		\$ 652
Two (2) Electrical Power, (1) USB-A and (1) USB-C Outlets		



Black 01-DCDUOUNDRB
Silver 01-DCDUOUNDRS
White 01-DCDUOUNDRW

Grommets and Power/Data Units may be ordered in non-standard locations. Call Sales Support to assist with specification and/or please attach a drawing to the PO showing the location of the grommet. Note additional charges and lead times may apply.

CERTIFICATIONS & COMPLIANCE

- Intertek Sustainability Certified
- BIFMA level® Certified
- BIFMA Compliant® Certified
- TSCA Title VI (formerly CARB) Compliance
- Contributes to LEED®, Green Globes®, and WELL® Sustainable Programs

Tops



Table Tops For T-Leg Flip/Nest Bases ([See Details](#))
24" and 30"D

Table Tops For T-Leg Static Bases ([See Details](#))
24" and 30"D

Bases

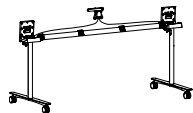

T-Leg Flip/Nest Base Assembly Kits
([See Details](#))

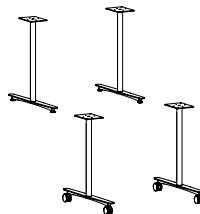

T-Leg Static Base Assembly Kits with
Glides and with Casters
([See Details](#))

Modesty Panels

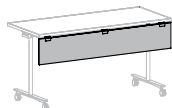

Hinged Modesty
([See Details](#))

Hinged Acoustic Modesty
([See Details](#))

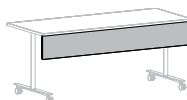

Fixed Modesty
([See Details](#))

Fixed Acoustic Modesty
([See Details](#))

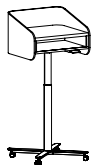

Height Adjustable
Lectern with Storage
([See Details](#))

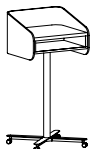

Lectern with Storage
([See Details](#))

Accessories

Power Units

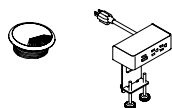

Wire Management



Ganging Bracket



Utility Hook



SPARK TABLES

MULTI-USE TABLES (77 SERIES)

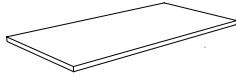
Item	Model No.	Material	W	D	H	Ship Wt	Cubic Ft	List Price
TABLE TOP FOR FLIP/NEST BASE 	77-2460TPN	TFL	60	24	1	54	3.5	T\$ 475
		HPL						P\$ 637
		Veneer						W\$ 764
	77-2466TPN	TFL	66	24	1	58	3.9	T\$ 499
		HPL						P\$ 647
		Veneer						W\$ 776
	77-2472TPN	TFL	72	24	1	62	4.2	T\$ 524
		HPL						P\$ 656
		Veneer						W\$ 787
77-3060TPN	TFL	60	30	1	65	4.3	T\$ 531	
	HPL						P\$ 657	
	Veneer						W\$ 788	
77-3066TPN	TFL	66	30	1	70	4.8	T\$ 560	
	HPL						P\$ 668	
	Veneer						W\$ 802	
77-3072TPN	TFL	72	30	1	76	5.2	T\$ 590	
	HPL						P\$ 785	
	Veneer						W\$ 942	

Must Specify (in this order):

Model #
Top Material
Top Finish/Color
Grommet/Power/Data Location

Description

- Standard with: Y Profile on Edges and Stiffener Bar
- Bases Sold Separately and Available with Glides or Casters, See Details Below
- Surfaces are Pre-Drilled for Flip/Nest Mechanism, Optional Ganging Brackets ([See Bracket Details](#)) and Hinged Modesty Panels: TFL or Veneer ([See Options](#)) and Acoustic ([See Options](#))
- Optional Grommet and Power/Data ([See Options](#))

T-LEG FLIP/NEST BASE ASSEMBLY KIT

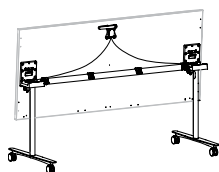

Shown with Top
(Tops Sold Separately)

Must Specify (in this order):

Model #
Metal Color



77-2458TBC	For 60"W Tops	58	24	28 $\frac{7}{8}$	36	6.4	\$ 1141
77-2464TBC	For 66"W Tops	64	24	28 $\frac{7}{8}$	36	6.4	\$ 1159
77-2470TBC	For 72"W Tops	70	24	28 $\frac{7}{8}$	36	6.4	\$ 1171
77-3058TBC	For 60"W Tops	58	30	28 $\frac{7}{8}$	38	6.4	\$ 1202
77-3064TBC	For 66"W Tops	64	30	28 $\frac{7}{8}$	38	6.4	\$ 1220
77-3070TBC	For 72"W Tops	70	30	28 $\frac{7}{8}$	38	6.4	\$ 1231

Description

- Base Available in Three (3) Metal Finish Colors: Aluminum (ALUM), Black (BLK), and Snow (SNO) ([See Metal Colors](#))
- Easily Accessed Flip/Nest Mechanism From Any Position For Effortless Nesting
- Caster Bases Include Four (4) 60mm Locking Casters with Coordinating Base Colors: Aluminum and Snow Bases are Paired with White Casters while Black Bases are Paired with Black Casters ([See Details](#))
- Base Features Wire Management Channel in Both Legs
- Tops Sold Separately, See Above for Coordinating Tops; Some Assembly Required

SPARK TABLES

MULTI-USE TABLES (77 SERIES)

Item	Model No.	Material	W	D	H	Ship Wt	Cubic Ft	List Price
TABLE TOPS FOR STATIC BASE	77-2460TPS	TFL	60	24	1	54	3.5	T\$ 603
		HPL			1 $\frac{3}{16}$			P\$ 766
		Veneer			1 $\frac{3}{16}$			W\$ 919
	77-2466TPS	TFL	64	24	1	58	3.9	T\$ 628
		HPL			1 $\frac{3}{16}$			P\$ 775
		Veneer			1 $\frac{3}{16}$			W\$ 930
	77-2472TPS	TFL	70	24	1	62	4.2	T\$ 652
		HPL			1 $\frac{3}{16}$			P\$ 785
		Veneer			1 $\frac{3}{16}$			W\$ 942
	77-3060TPS	TFL	58	30	1	65	4.3	T\$ 659
		HPL			1 $\frac{3}{16}$			P\$ 786
		Veneer			1 $\frac{3}{16}$			W\$ 943
	77-3066TPS	TFL	64	30	1	70	4.8	T\$ 689
		HPL			1 $\frac{3}{16}$			P\$ 797
		Veneer			1 $\frac{3}{16}$			W\$ 956
	77-3072TPS	TFL	70	30	1	76	5.2	T\$ 719
		HPL			1 $\frac{3}{16}$			P\$ 914
		Veneer			1 $\frac{3}{16}$			W\$ 1097

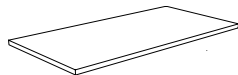

Must Specify (in this order):
 Model #
 Top Material
 Top Finish/Color
 Grommet/Power/Data Location

Description

- Standard with: Y Profile on Edges and Stiffener Bar
- Bases Sold Separately and Available with Glides or Casters, See Details Below
- Pre-Drilled for Optional Ganging Brackets ([See Bracket Details](#)) and Fixed Modesty Panels: TFL and Veneer ([See Options](#)) and Acoustic ([See Options](#))
- Optional Grommet and Power/Data ([See Options](#))

T-LEG STATIC BASE ASSEMBLY KIT



Base Shown with Adjustable Glides and Top (Tops Sold Separately)

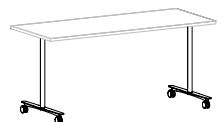

Bases Shown with Casters and Top (Tops Sold Separately)

Must Specify (in this order):
 Model #
 Metal Color

With Adjustable Glides:								
77-2402TLG	For 24"D Tops	2 $\frac{1}{4}$	24	28 $\frac{7}{8}$	19	5.6	\$	597
77-3002TLG	For 30"D Tops	2 $\frac{1}{4}$	24	28 $\frac{7}{8}$	21	5.6	\$	659
With Casters:								
77-2402TLC	For 24"D Tops	2 $\frac{1}{4}$	24	28 $\frac{7}{8}$	20	5.6	\$	632
77-3002TLC	For 30"D Tops	2 $\frac{1}{4}$	24	28 $\frac{7}{8}$	22	5.6	\$	693

Description

- Standard with Adjustable Nylon Glides or Caster Based on Model Number Selected
- Base Available in Three (3) Metal Finish Colors; Aluminum (ALUM), Black (BLK), and Snow (SNO) ([See Metal Colors](#))
- Caster Bases Include Four (4) 60mm Locking Casters with Coordinating Base Colors: Aluminum and Snow Bases are Paired with White Casters while Black Bases are Paired with Black Casters ([See Details](#))
- Base Features Wire Management Channel in Both Legs
- Tops Sold Separately, See Above for Coordinating Tops; Some Assembly Required

[See Overview For Ordering Options](#)

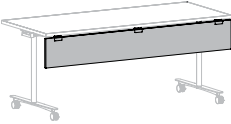
Item	Model No.	Material	W	D	H	Ship Wt	Cubic Ft	List Price		
HINGED MODESTY PANEL  Must Specify (in this order): Model # Modesty Material Finish/Color Metal Color	For 60"W Top									
	77-1060HMD	TFL	60	¾	10	13	1.2	T\$	503	
		Veneer						W\$	703	
	For 66"W Top									
	77-1066HMD	TFL	66	¾	10	15	1.4	T\$	509	
		Veneer						W\$	705	
	For 72"W Top									
	77-1072HMD	TFL	72	¾	10	17	1.6	T\$	514	
		Veneer						W\$	707	

Description

- For Use with Table Tops and T-Leg Flip/Nest Base Assembly Kit
- Select a TFL (T) or Veneer (W) Modesty and Finish/Color ([See Finish/Color Options](#))
- Hinge Caps Available in Three (3) Metal Colors: Aluminum (ALUM), Black (BLK), and Snow (SNO) ([See Metal Colors](#))

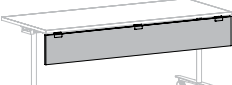
HINGED ACOUSTICAL MODESTY PANEL  Must Specify (in this order): Model # Metal Color Acoustic Color	77-1060HMDA	For 60"W Top	60	½	10	3	1.2	\$	754
	77-1066HMDA	For 66"W Top	66	½	10	4	1.4	\$	829
	77-1072HMDA	For 72"W Top	72	½	10	5	1.6	\$	904

Description

- For Use with Table Tops and T-Leg Flip/Nest Base Assembly Kit
- Hinge Caps Available in Three (3) Metal Colors: Aluminum (ALUM), Black (BLK), and Snow (SNO), ([See Metal Colors](#))
- Available in Four Color Options: Ash, Cadet, Gray, and Milky ([See Colors](#))

SPARK TABLES

MULTI-USE TABLES (77 SERIES)

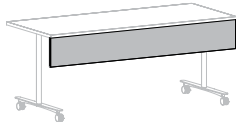
Item	Model No.		W	D	H	Ship Wt	Cubic Ft	List Price		
FIXED MODESTY PANEL  Must Specify (in this order): Model # Finish/Color	For 60"W Top									
	77-1060FMD	TFL Veneer	60	¾	10	13	1.2	T\$ W\$	339 528	
	For 66"W Top									
	77-1066FMD	TFL Veneer	66	¾	10	15	1.4	T\$ W\$	344 530	
	For 72"W Top									
	77-1072FMD	TFL Veneer	72	¾	10	17	1.6	T\$ W\$	350 532	

Description

- For Use with Table Tops and T-Leg Static Base Assembly Kit
- Select a TFL (T) or Veneer (W) Modesty and Finish/Color ([See Finish/Color Options](#))

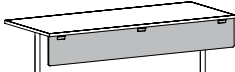
FIXED ACOUSTICAL MODESTY PANEL  Must Specify (in this order): Model # Metal Color Acoustic Color	77-1060FMDA	For 60"W Top	60	½	10	3	1.2	\$	650
	77-1066FMDA	For 66"W Top	66	½	10	4	1.4	\$	715
	77-1072FMDA	For 72"W Top	72	½	10	5	1.6	\$	780

Description

- For Use with Table Tops and T-Leg Static Base Assembly Kit
- Caps Available in Three (3) Metal Colors: Aluminum (ALUM), Black (BLK), and Snow (SNO), ([See Metal Colors](#))
- Available in Four Color Options: Ash, Cadet, Gray, and Milky ([See Colors](#))

GANGING BRACKETS  Shown as Locked and Unlocked	77-GANGBRK2	Silver	-	-	-	2	0.1	\$	98
--	-------------	--------	---	---	---	---	-----	----	----

Description

- Ganging Brackets are Sold in a Set of Two (2) to Firmly Connect Two Tables
- Simply Turn and Lock Bracket to Gang Tables End to End (2 sets), Front to End (2 sets), and Front to Front (4 sets)
- Field Installed with Screws, All Hardware Included
- All Spark Table Surfaces are Pre-Drilled for Easy Installation of Ganging Brackets

[See Overview For Ordering Options](#)

SPARK TABLES

MULTI-USE TABLES (77 SERIES)

Item	Model No.	Material	W	D	H	Ship Wt	Cubic Ft	List Price	
HEIGHT ADJUSTABLE LECTERN WITH STORAGE	77-2242HLS	TFL	22	22	29-45	55	11.7	T\$	2555
		HPL						P\$	2710
		Veneer						W\$	2758

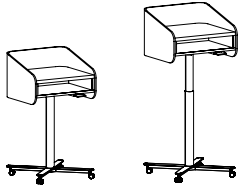

Shown Lowered Shown Raised

Must Specify (in this order):

- Model #
- Top Material
- Top Finish/Color
- Metal Color
- Surround Color
- Grommet/Power/Data Location

Description

- Standard with: Vertical Square (H) Edge Profile and 37mm Black Locking Casters and Paddle-Controlled Pneumatic Lift with 16" Height Adjustment Range
- Choose TFL (T), HPL (P), or Veneer (W) Top ([See Finish/Color Options](#))
- Base Available in Three (3) Metal Powder-Coated Colors; Aluminum (ALUM), Black (BLK), and Snow (SNO) ([See Metal Colors](#))
- Storage is 4"Hx21"Wx15¾"D
- Acoustic Surround is ½" (12mm) Thick, 15"Hx63½"W and Available in Four Color Options ([See Colors](#))
- For Additional Storage and Functionality, Add a [Utility Hook](#)
- Optional Grommet and Duo Bezel Power/Data Available on Center ([See Options](#))

LECTERN WITH STORAGE	77-2242LS	TFL	22	22	42	59	13.8	T\$	1860
		HPL						P\$	2015
		Veneer						W\$	2063

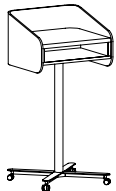

Must Specify (in this order):

- Model #
- Top Material
- Top Finish/Color
- Metal Color
- Surround Color
- Grommet/Power/Data Location

Description

- Standard with: Vertical Square (H) Edge Profile and 37mm Black Locking Casters
- Choose TFL (T), HPL (P), or Veneer (W) Top ([See Finish/Color Options](#))
- Base Available in Three (3) Metal Powder-Coated Colors; Aluminum (ALUM), Black (BLK), and Snow (SNO) ([See Metal Colors](#))
- Storage is 4"Hx21"Wx15¾"D
- Acoustic Surround is ½" (12mm) Thick, 15"Hx63½"W and Available in Four Color Options ([See Colors](#))
- For Additional Storage and Functionality, Add a [Utility Hook](#)
- Optional Grommet and Duo Bezel Power/Data Available on Center ([See Options](#))

SPARK TABLES

MULTI-USE TABLES (77 SERIES)

Item	Model No.		W	D	H	Ship Wt	Cubic Ft	List Price
ROUND GROMMET COVER FIELD INSTALLED	01-GRMTBK	Black	-	-	-	-	-	\$ 12
	01-GRMTSL	Silver						



Description

- 60mm Round Grommet Cover
- Field Installed

OPEN MARKET ONLY
(SILVER)

DUO CLAMP WITH NEMA PLUG	01-DUOCLAMPB	Black	6½	3	7	1	0.2	\$ 634
	01-DUOCLAMPS	Silver						
	01-DUOCLAMPW	White						

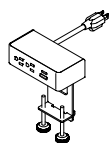

Description

- Standard with: Two (2) Tamper Resistant 15amp Power Outlets, One (1) USB-A Charging Port and One (1) 60-Watt USB-C Power Delivery Port with GaN Technology; 10' Cord and All Mounting Hardware
- Clamps to Top and Features Silver Metal Trim on All Color Options
- Independent USB Circuit Controllers Deliver up to 2.4 Amps to Each Post
- FCC Part 15A, UL Approved for Horizontal and Vertical Applications

DUO AIR WITH NEMA PLUG	01-DUOAIRB	Black	7	5	4½	1	0.2	\$ 743
	01-DUOAIRS	Silver						
	01-DUOAIRW	White						

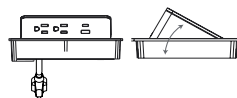

Description

- Standard with: Two (2) Tamper Resistant 15 Amp Power Outlets, One (1) USB-A Charging Port, One (1) 60-Watt USB-C Power Delivery Port with GaN Technology; 10' Cord and All Mounting Hardware
- Top Must Be Routed To Allow Unit to Sit Down Into the Top, Must Specify when Ordering Top
- Features a Sophisticated Pop-Up Access
- FCC Part 15A, UL Approved for Horizontal and Vertical Applications

[See Overview For Ordering Options](#)

Item	Model No.		W	D	H	Ship Wt	Cubic Ft	List Price
DUO BEZEL WITH NEMA PLUG	01-DUOBEZELB	Black	6½	2½	3¼	1	0.2	\$ 748
	01-DUOBEZELS	Silver						
	01-DUOBEZELW	White						

Description

- Standard with: Two (2) Tamper Resistant 15 Amp Power Outlets, One (1) USB-A Charging Port and One (1) 60-Watt USB-C Power Delivery Port with GaN Technology; 10' Cord and All Mounting Hardware
- Top Must Be Routed To Allow Unit to Sit Down Into the Top, Must Specify when Ordering Top
- Unit Supported By Attractive Slim Fit Bezel
- Independent USB Circuit Controllers Deliver up to 2.1 Amps to Each Post
- FCC Part 15A, UL Approved for Horizontal and Vertical Applications

DUO UNDERMOUNT WITH NEMA PLUG	01-DUOUNDERB	Black	6½	2½	3	1	0.2	\$ 605
	01-DUOUNDESR	Silver						
	01-DUOUNDERW	White						

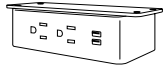
Description

- Sits Under Table Top and Includes: Two (2) Tamper Resistant 15amp Power Outlets, One (1) USB-A Charging Port and One (1) 60-Watt USB-C Power Delivery Port with GaN Technology; 10' Cord and All Mounting Hardware
- Independent USB Circuit Controllers Deliver up to 2.4 Amps to Each Post
- FCC Part 15A, UL Approved for Horizontal and Vertical Applications

DUO AIR WITH PURL DAISY CHAIN PLUG	01-DCDUOAIRB	Black	7	5	4¾	1	0.2	\$ 748
	01-DCDUOAIRS	Silver						
	01-DCDUOAIRW	White						

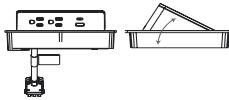
Description

- Standard with: Two (2) Tamper Resistant 15 Amp Power Outlets, One (1) USB-A Charging Port, One (1) 60-Watt USB-C Power Delivery Port with GaN Technology; 10' Cord and All Mounting Hardware
- Top Must Be Routed To Allow Unit to Sit Down Into the Top, Must Specify when Ordering Top
- Features a Sophisticated Pop-Up Access
- Requires Purl Daisy Chain Power Infeed, Specified Separately ([See Details](#))
- Non-Sequential System Allows up to Nine (9) Modules to be Connected with H-Block and Jumper Cord ([See Details](#))
- Independent USB Circuit Controllers Deliver up to 2.4 Amps to Each Post
- FCC Part 15A, UL Approved for Horizontal and Vertical Applications

SPARK TABLES

MULTI-USE TABLES (77 SERIES)

Item	Model No.		W	D	H	Ship Wt	Cubic Ft	List Price
DUO BEZEL WITH PURL DAISY CHAIN PLUG	01-DCDUOBEZELB	Black	6½	2½	3	1	0.2	\$ 631
	01-DCDUOBEZELS	Silver						
	01-DCDUOBEZELW	White						



Description

- Standard with: Two (2) Tamper Resistant 15 Amp Power Outlets, One (1) USB-A Charging Port and One (1) 60-Watt USB-C Power Delivery Port with GaN Technology; 10' Cord and All Mounting Hardware
- Top Must Be Routed To Allow Unit to Sit Down Into the Top, Must Specify when Ordering Top
- Unit Supported By Attractive Slim Fit Bezel
- Requires Purl Daisy Chain Power Infeed, Specified Separately ([See Details](#))
- Non-Sequential System Allows up to Nine (9) Modules to be Connected with H-Block and Jumper Cord ([See Details](#))
- Independent USB Circuit Controllers Deliver up to 2.4 Amps to Each Post
- FCC Part 15A, RU Listed and UL Recognized for Horizontal and Vertical Applications

UNDERMOUNT DUO WITH PURL DAISY CHAIN PLUG	01-DCDUOUNDRB	Black	6½	2½	3	1	0.2	\$ 652
	01-DCDUOUNDRS	Silver						
	01-DCDUOUNDRW	White						

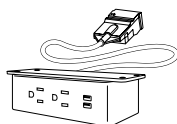

Description

- Sits Under Top and Includes: Two (2) Tamper Resistant 15 Amp Power Outlets, One (1) USB-A Charging Port and One (1) 60-Watt USB-C Power Delivery Port with GaN Technology with 12" Cord, and All Mounting Hardware
- Requires Purl Daisy Chain Power Infeed and H-BLOCK, Specified Separately ([See Details](#))
- Non-Sequential System Allows up to Nine (9) Modules to be Connected with H-Block and Jumper Cord ([See Detail](#))
- Independent USB Circuit Controllers Deliver up to 2.4 Amps to Each Post
- FCC Part 15A, RU Listed and UL Recognized for Horizontal Applications

PURL DAISY CHAIN POWER INFEEED	01-DCPOWER		-	-	-	1	0.2	\$ 227
--------------------------------	------------	--	---	---	---	---	-----	--------

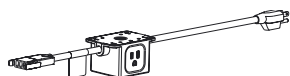

Description

- Includes One (1) Purl Connector Plug, 36" Daisy Chain Cord, One (1) 15 Amp Power Outlet, and a 120" Power Cord with a Nema Plug
- Powers up to Nine (9) Duo and Trio Purl Daisy Chain Units
- 15-Amp System Rating and Over-Current Protection
- System Requires H-BLOCK Connector Between Power Infeed and Each Jumper Cord, See Next Page for Purl Daisy Chain H-Block and Purl Daisy Chain Jumper Cords

[See Overview For Ordering Options](#)

SPARK TABLES

MULTI-USE TABLES (77 SERIES)

Item	Model No.	W	D	H	Ship Wt	Cubic Ft	List Price
PURL DAISY CHAIN H-BLOCK	01-DCHBLOCK	-	-	-	1	0.2	\$ 40

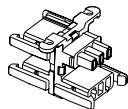

Description

- Includes One (1) Power In and Three (3) Power Out Receptacles
- System Requires H-BLOCK Connector Between Power Infeed and Each Jumper Cord, See H-Block and Jumper Cords

	PURL DAISY CHAIN JUMPER CORD	01-DC2JUMP	<i>24" Long</i>	-	-	-	1	0.2	\$ 72
		01-DC3JUMP	<i>36" Long</i>	-	-	-	1	0.2	\$ 77
		01-DC4JUMP	<i>48" Long</i>	-	-	-	1	0.2	\$ 82
		01-DC5JUMP	<i>60" Long</i>	-	-	-	1	0.2	\$ 87
		01-DC6JUMP	<i>72" Long</i>	-	-	-	1	0.2	\$ 92

Description

- Connects Duo and Trio Daisy Chain Units
- Non-Sequential System Allows up to Nine (9) Modules to be Connected

POWER STRIP	01-PRSP	9	2	2	1	-	\$ 227
-------------	---------	---	---	---	---	---	--------

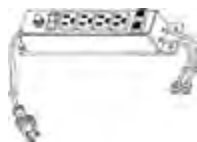

Description

- Includes Four (4) Outlets and Two (2) Phone Jacks
- Black Plastic with Rocker On/Off Switch
- 13 Amp Circuit Breaker
- 10' Power Cord and Two (2) 14' Phone Hook Up Cords
- UL and CSA Recognized
- Suitable for Surface or Recessed Mounting

WIRE MANAGEMENT CHANNEL	01-WMGR4	16	1½	¾	1	-	\$ 129
-------------------------	----------	----	----	---	---	---	--------

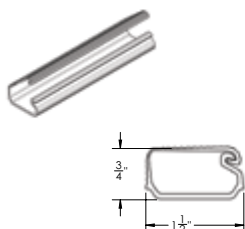

Description

- Set of Four (4) Black Plastic Wire Management Channels
- Snap Lock Channel
- Attaches with Adhesive Strips
- Ships via UPS Only

SPARK TABLES

MULTI-USE TABLES (77 SERIES)

Item	Model No.	W	D	H	Ship Wt	Cubic Ft	List Price
CABLE GRIP	01-WMGRCB	5 $\frac{3}{8}$	2 $\frac{5}{8}$	-	-	-	\$ 19

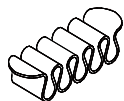

Description

- Under Surface Wire Management
- Black

UTILITY HOOK	01-HOOK	2	1 $\frac{3}{4}$	2 $\frac{1}{2}$			\$ 88
--------------	---------	---	-----------------	-----------------	--	--	-------



Description

- Ideal for Backpacks, Purses, Jackets, Hats, and More on Lecterns and Tables
- Black Hook Includes Mounting Hardware
- 25lbs. Weight Capacity
- Field Installed

[See Overview For Ordering Options](#)

Dress up a casual drop-in meeting room or add prestige to an executive suite. Strut Tables are designed with precision minimalist lines and angles to establish modern sensibility in any space. With tops available in round, square, rectangle, modern rectangle, and boat shapes, in a range of veneer, laminate, and glass options, and in sizes ranging from 3.5 square feet to 5 by 20 feet, Strut can accommodate small meeting spaces, cafes, private offices, or even large board rooms.

CONSTRUCTION

VENEER

- Exposed surfaces feature select grade plain-sliced hardwood veneers in Cherry, Maple, American Black Walnut, or composite veneers. Veneers are carefully selected and matched to assure proper balance and consistency
- Veneer features UVA Advantage, an ultra-violet finish, on all exposed surfaces by utilizing roll-coat UV technology

LAMINATE

- Thermally-Fused Laminate (TFL) and High-Pressure Laminate (HPL) are made of woodgrain and solid color laminates fused to particleboard core; each laminate offers lasting beauty, superior resistance to normal wear, and easy maintenance,

TOPS

- Veneer (W) or HPL (P) Tops available in five shapes: Rectangle, Boat, Modern Rectangle, Square and Round with woodgrain patterns following the depth (short) of Veneer (W) table tops while grain patterns follow the width (long) of HPL (P) table tops
- Tops are shaped on all four sides and are available in two thicknesses and six edge profiles
- Double Kerf (F), Duo (G), Fluted (X) and Square (Y) available in Veneer (W) and HPL (P) tops with 3-ply balanced construction, 1 $\frac{3}{16}$ " thick and matching 3mm wood or PVC edge bands on profiled edges; Designer White, Sugar Maple, and Williamsburg Cherry feature ABS edge bands
- Knife (K) edge profile tops are 1 $\frac{3}{16}$ " thick with solid wood rims available on both Veneer (W) or HPL (P) tops
- Vertical Square (H) edge profile tops are 1 $\frac{1}{2}$ " thick with 1.5mm wood edge band on Veneer (W) tops and 1mm PVC edge band on HPL (P) tops; Designer White, Sugar Maple, and Williamsburg Cherry feature ABS edge bands
- Tops will include with holes bored on bottom to ensure proper leg placement
- Credenzas, buffets, and other ancillary support models are available in Square (Y), Double Kerf (F), Duo (G), and Vertical Square (H) edge profiles and profiled on approach side only
- All Veneer tops, as well as Laminate tops up to 144" (12 feet), will have matching woodgrain. Laminate tops sized 156" (13 feet) and longer will have non-matching woodgrain
- All surfaces feature reverse slip matched pattern
- Back Painted, Tempered Glass Tops are $\frac{1}{4}$ " thick and are attached to a substrate topped with black paper covering
- Tempered glass top has a $\frac{1}{16}$ " overhang from the sub-top

LOCKING

- All units with file drawers feature locking
- Removable lock cylinders allow for units to be re-keyed at a later date, if required Units are shipped randomly keyed as standard
- Keyed alike units available upon request at no additional charge Lock core is predetermined by pull color. Black lock cores are used with black and gold pulls while silver lock cores are used with chrome and aluminum pulls
- Optional locking doors available on buffets and credenzas

LEGS

- Available in aluminum (ALUM) or black (BLK)
- Integrated wire management inside of leg to keep your space clean and free of wires
- Each leg has adjustable glides

CHASSIS

- All credenzas are available in TFL (T) or Veneer (W) with vertical grain direction
- Chassis for storage units are securely fastened
- using high quality European fastening systems and heavy-duty 16-gauge joining brackets to assure maximum strength
- All units ship with heavy-duty, adjustable leveling glides to ensure proper leveling and compensation for uneven floors

DRAWERS

- Drawers feature 5-sided drawer construction allowing for easy removal of drawer fronts; All drawer fronts are standard with elegant vertically matched faces
- Drawer sides, back, and front are woodgrain vinyl-wrapped $\frac{1}{2}$ " thick with $\frac{1}{8}$ " thick hardboard bottoms
- Drawer interiors are dovetail construction with $\frac{7}{16}$ " thick hardwood sides and backs, and $\frac{5}{32}$ " thick hardboard bottoms
- All drawers feature full extension, progressive action slides with precision steel ball bearings
- Box drawers are tested for 100lb capacity
- All suspensions have a limited lifetime warranty

STORAGE

- All hinged doors are soft-close with one piece hinge and base plate combination
- Soft close hinges reduce stress placed on the cabinet when the door is closed and offers a quiet closure
- All Credenzas feature a 2" W wire management channel along back of the interior cabinet for easy accessibility to wall outlets

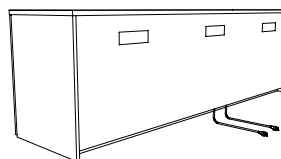

2" wire management channel

INTERIOR DRAWER DIMENSIONS

Models

88-2496BF

	W	L	D
Box Drawers	15 $\frac{3}{4}$ "	16 $\frac{3}{8}$ "	3 $\frac{2}{32}$ "

Models

88-2484BF

	W	L	D
Box Drawers	30"	16 $\frac{3}{8}$ "	3 $\frac{2}{32}$ "
	13 $\frac{3}{8}$ "	16 $\frac{3}{8}$ "	3 $\frac{2}{32}$ "

Models

88-2472BF

88-2436BF

	W	L	D
Box Drawers	32 $\frac{3}{16}$ "	16 $\frac{3}{8}$ "	3 $\frac{2}{32}$ "

Models

88-2460BF

	W	L	D
Box Drawers	16 $\frac{1}{2}$ "	16 $\frac{3}{8}$ "	3 $\frac{2}{32}$ "

Models

88-2448BF

	W	L	D
Box Drawers	20 $\frac{15}{16}$ "	16 $\frac{3}{8}$ "	3 $\frac{2}{32}$ "

INTERIOR CABINET DIMENSIONS

Models

88-2496BF

	W	D	H
Double Door	36 $\frac{3}{4}$ "	22 $\frac{3}{8}$ "	23 $\frac{1}{2}$ "
Single Door with Waste Bin	18"	22 $\frac{3}{8}$ "	23 $\frac{1}{2}$ "

Models

88-2484BF

	W	D	H
Double Door	32"	22 $\frac{3}{8}$ "	23 $\frac{1}{2}$ "
Single Door with Waste Bin	15 $\frac{1}{2}$ "	22 $\frac{3}{8}$ "	23 $\frac{1}{2}$ "

Models

88-2472BF

88-2436BF

	W	D	H
Double Door	34 $\frac{3}{8}$ "	22 $\frac{3}{8}$ "	23 $\frac{1}{2}$ "
Single Door with Waste Bin	16 $\frac{3}{4}$ "	22 $\frac{3}{8}$ "	23 $\frac{1}{2}$ "

Models

88-2460BF

	W	D	H
Single Door	18 $\frac{3}{8}$ "	22 $\frac{3}{8}$ "	23 $\frac{1}{2}$ "

Models

88-2448BF

	W	D	H
Double Door	46 $\frac{3}{8}$ "	22 $\frac{3}{8}$ "	23 $\frac{1}{2}$ "
Single Door with Waste Bin	22 $\frac{3}{4}$ "	22 $\frac{3}{8}$ "	23 $\frac{1}{2}$ "

Models

88-2496CC

	W	D	H
Double Door	36 $\frac{3}{4}$ "	22 $\frac{3}{8}$ "	24 $\frac{3}{8}$ "
Single Door with Waste Bin	18"	22 $\frac{3}{8}$ "	24 $\frac{3}{8}$ "

Models

88-2484CC

	W	D	H
Double Door	32"	22 $\frac{3}{8}$ "	24 $\frac{3}{8}$ "
Single Door with Waste Bin	15 $\frac{1}{2}$ "	22 $\frac{3}{8}$ "	24 $\frac{3}{8}$ "

Models

88-2472CC

88-2436BF

	W	D	H
Double Door	34 $\frac{3}{8}$ "	22 $\frac{3}{8}$ "	24 $\frac{3}{8}$ "
Single Door with Waste Bin	16 $\frac{3}{4}$ "	22 $\frac{3}{8}$ "	24 $\frac{3}{8}$ "

Models

88-2460CC

	W	D	H
Single Door with Waste Bin	18 $\frac{3}{8}$ "	22 $\frac{3}{8}$ "	24 $\frac{3}{8}$ "

Models

88-2448CC

	W	D	H
Double Door	46 $\frac{3}{8}$ "	22 $\frac{3}{8}$ "	24 $\frac{3}{8}$ "
Single Door with Waste Bin	22 $\frac{3}{4}$ "	22 $\frac{3}{8}$ "	24 $\frac{3}{8}$ "

Models

88-2096CC

	W	D	H
Double Door	36 $\frac{3}{4}$ "	18 $\frac{3}{8}$ "	24 $\frac{3}{8}$ "
Single Door	17 $\frac{3}{8}$ "	18 $\frac{3}{8}$ "	24 $\frac{3}{8}$ "

Models

88-2084CC

	W	D	H
Double Door	32"	18 $\frac{3}{8}$ "	24 $\frac{3}{8}$ "
Single Door	15 $\frac{1}{2}$ "	18 $\frac{3}{8}$ "	24 $\frac{3}{8}$ "

INTERIOR CABINET DIMENSIONS CONTINUED

Models

88-2072CC	88-2036CC		
	W	D	H
Single Door	34 ³ / ₈ "	18 ³ / ₈ "	24 ³ / ₈ "

Models

88-2060CC			
	W	D	H
Single Door	18 ³ / ₈ "	18 ³ / ₈ "	24 ³ / ₈ "

Models

88-2048CC			
	W	D	H
Double Door	46 ³ / ₈ "	18 ³ / ₈ "	24 ³ / ₈ "

HOW TO ORDER EXAMPLES

SQUARE MEETING TABLE

	QTY	MODEL NO.		EXAMPLE
TOP	1	88-4848SQ	Top/Edge Material Finish/Color Edge Profile Glass Top Glass Color/Surface Finish Power/Data Location	P FO 3MMW/F Y GBLG OC
BASE	1	01-2228STR4	Strut Legs (4 legs) Leg Color	ALUM
POWER	1	01-DUOBEZELS		

MODERN RECTANGLE MEETING TABLES

	QTY	MODEL NO.		EXAMPLE
TOP	1	88-54192MR	Top/Edge Material Top/Edge Finish/Color Edge Profile Glass Top Glass Color/Surface Finish Grommet/Power/Data Type Grommet/Power/Data Location	W MAS 3MMW/F Y GBLG DPORTA OC
BASES	2	01-2228STR4	Strut Legs (4 legs) Leg Color	BLK
POWER	1	DPORTA		

STORAGE & ACCESSORIES

Buffet Credenza			
QTY	MODEL NO.		EXAMPLE
1	88-2472BF	Top/Edge Material Finish/Color Edge Profile Chassis Finish/Color Glass Top Glass Color/Surface Finish Studio Pull Color Locking Drawer Construction Drawer Track Vent Waste Bin	W MAS 3MMW/F ORW Y GBLG GST LKT_BFD DOVE SFTCL VENT WBL

VENEER (W) OPTIONS ON TOPS / EDGES

Veneer features UVAdvantage, an ultra-violet finish, on all exposed surfaces or our Catalyzed finish (where noted), which is a multi-step, finish process that provides years of lasting beauty.

AW	Artisan Walnut	MW	Mahogany Walnut
AS	Asian Night	MAS	Mesa Sunset*
CO	Columbian Walnut	MTS	Metropolis Sky
DC	Dark Cherry	ORW	Oak Riftwood*
DFW	Dark Forest Walnut	PNW	Pinnacle Walnut
EW	Espresso	SCH	Select Cherry
FO	Fawn Oak*	SKC	Shaker Cherry
GC	Golden Cherry	SM	Sugar Maple
HW	Harvest Walnut	WTA	Weathered Ash*
HNW	Henna Walnut	WC	Williamsburg Cherry
LW	Legacy Walnut		

* Low Sheen Finish

**TFL (T) OPTIONS FOR CREDENZA TOPS AND HPL (P) LAMINATE
OPTIONS ON TOPS / EDGES**

WOODGRAIN			
AS	Asian Night	PNW	Pinnacle Walnut
BW	Beigewood	PTK	Portico Teak
CO	Columbian Walnut	RC	River Cherry
EF	Espresso	SPW	Seppia Walnut
FLW	Florence Walnut	SKC	Shaker Cherry
GC	Golden Cherry	SCH	Select Cherry
HVM	Harvest Maple	SBP	Smoky Brown Pear
KHE	Kirsche	TK	Studio Teak
MW	Mahogany Walnut	SM	Sugar Maple
MNR	Midnight Run	WTA	Weathered Ash
NTM	Natural Marrone	WC	Williamsburg Cherry
ORW	Oak Riftwood	WNB	White Nebbia
SOLID			
BL	Black	FHG	Fashion Grey
WH	Designer White	SG	Slate Grey

EDGE PROFILES

Double Kerf (F), Duo (G), Fluted (X), Square (Y) and Knife (K) edge profiles is 1 3/16" thick and available in Veneer (W) and HPL (P) tops. Vertical Square (H) edge profile available is 1 1/2" thick and also available Veneer (W) and HPL (P) tops. Knife (K) edge not available on buffet and credenzas.

Must specify edge profile.

Laminate (P) Top Edges

3MMP/F	Double Kerf (1 3/16" H)	3MMP/Y	Square (1 3/16" H)
3MMP/G	Duo (1 3/16" H)	RIMP/K	Knife (1 3/16" H)
3MMP/X	Fluted (1 3/16" H)	HP	Vertical Square (1 1/2" H)

Veneer (W) Top Edges

3MMW/F	Double Kerf (1 3/16" H)	3MMW/Y	Square (1 3/16" H)
3MMW/G	Duo (1 3/16" H)	RIMW/K	Knife (1 3/16" H)
3MMW/X	Fluted (1 3/16" H)	HW	Vertical Square (1 1/2" H)



Double Kerf (F) Duo (G) Fluted (X) Square (Y)



Knife (K) Vertical Square (H)

PULL OPTIONS

Buffets and Credenzas available with pulls on doors. Must specify and select color.

Lock core color is predetermined by pull color.

AST	Studio, Aluminum	CST	Studio, Chrome
BST	Studio, Black	GST	Studio, Gold



Aluminum Chrome Gold Black

GLASS OPTIONS ON TOPS

Back painted tempered glass tops are 1/4" thick and available in Black or White with Gloss or Acid Etched finish. Glass top sits 1/16" on top of substrate top.

GWHG	White Gloss	GBLG	Black Gloss
GWHA	White Acid Etched	GBLA	Black Acid Etched



White Gloss White Acid Etched Black Gloss Black Acid Etched

LOCK CORE COLOR OPTIONS

BLK	Black (Used with Black and Gold Pulls)
SLV	Silver (Used with Aluminum and Chrome Pulls)



Silver Black

GROMMET & POWER UNIT OPTIONS

Power units and grommets are available on Rectangle, Modern Rectangle, and Boat shaped tops. Each unit is sold separately and must be specified separately with surface mount location. Multiple locations may be selected. Only one unit per location.

Power units and Grommets Available in Rectangle, Modern Rectangle, and Boat Table Surfaces ([See Units](#))

Description	Specify		
-------------	---------	--	--

GROMMET			
	Black GBR60	\$	58
	Silver GSR60		

DUO BEZEL			
	Black 01-DUOBEZELB	\$	748
	Silver 01-DUOBEZELS		
	White 01-DUOBEZELW		

TRIO BEZEL			
	Black 01-TRIOBEZELB	\$	803
	Silver 01-TRIOBEZELS		
	White 01-TRIOBEZELW		

DOCK 150			
	Black 01-DOCK150B	\$	448
	White 01-DOCK150W		

DOCK 800			
	Black 01-DOCK800B	\$	2268
	White 01-DOCK800W		

DOCK 950			
	Black 01-DOCK950B	\$	294
	White 01-DOCK950W		

DPORT4			
	Aluminum 01-DPORT4A	\$	1211
	Black 01-DPORT4B		

ELLORA			
	Aluminum 01-ELLORA4A	\$	877
	Black 01-ELLORA4B		
	Aluminum 01-ELLORA6A	\$	944
	Black 01-ELLORA6B		

E2X			
	Aluminum 01-E2X4A	\$	1655
	Black 01-E2X4B		
	Aluminum 01-E2X6A	\$	1801
	Black 01-E2X6B		

INTERACTG2			
	Aluminum 01-INTERACTG2A	\$	987
	Black 01-INTERACTG2B		

OASIS			
	Aluminum 01-OASISMA	\$	3535
	Black 01-OASISMB		

GROMMET OPTIONS & POWER UNIT OPTIONS CONTINUED

Power and Data Location Information:

- Designate unit and location when specifying the top model. Power and Data Module needs to be ordered separately.
- Power and Data Modules specified at the time of order will be routed for field installation.

- E1 Unit on One End
- E2 Unit on Each End
- OC Unit on Center

- 72"W tops available with power units On Center (OC) only

Grommets and Power Units may be ordered in non-standard locations. Call Customer Service to assist with specification and/or please attach a drawing to the PO showing the location of the grommet. Note additional charges and lead times may apply.

Top Locations

Power units available on Each End (E1 and E2) and On Center (OC) unless otherwise noted, when paired with any Rectangle Panel Base, Rectangle Box Base or Rectangle Accent Box Base.

Power units centered at locations below:

36" Tops	Centered 18"D	54" Tops	Centered 27"D
42" Tops	Centered 21"D	60" Tops	Centered 30"D
48" Tops	Centered 24"D		

72: OC 36" from end (available with OC Only)

84: OC 42" from end (available with OC Only)

96: OC 48" from end; E1/E2 29" from end

108 OC 54" from end; E1/E2 29" from end

120: OC 60" from end; E1/E2 29" from end

132: OC 66" from end; E1/E2 29" from end

144: OC 72" from end; E1/E2 29" from end

156: OC 78" from end; E1/E2 29" from end

168: OC 84" from end; E1/E2 29" from end

180: OC 90" from end; E1/E2 36" from end

192: OC 96" from end; E1/E2 36" from end

204: OC 102" from end; E1/E2 36" from end

216: OC 108" from end; E1/E2 36" from end

228: OC 114" from end; E1/E2 36" from end

240: OC 120" from end; E1/E2 36" from end

Example: 60x204 Modern Rectangle

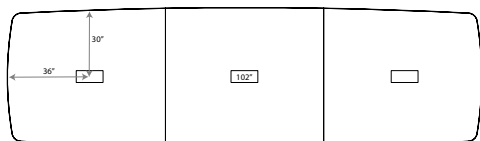

DRAWER TRACK OPTIONS

Soft close tracks are available on box drawers only. Soft close drawer tracks have many benefits including reduced stress on the unit, extends the life of the drawer, and ensures a gentle close so fingers don't accidentally get pinched. Must specify when ordering. **Pricing is per Drawer, not per Model/Unit**

SFTCL	Soft Close Drawer Track	\$	38
-------	-------------------------	----	----

WASTE BIN OPTIONS

Buffet and 24" Credenzas are available with two (2) 41-quart beige waste bins in a pull out cabinet with silver hardware and divider panel. Adjacent cabinet features one (1) adjustable shelf. Studio pulls applied centered on doors when waste bin is selected. Locking not available.

WBL	Waste Bin on Left	\$	572
WBR	Waste Bin on Right	\$	572

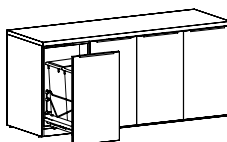

Shown as Left

VENT OPTION FOR CREDENZAS

Buffets and Credenzas feature optional ventilation grommets. Includes one vent per compartment.

Vents are 10" Down from top surface on Buffet Credenzas and 2 7/8" on Credenzas.

NONE	No Vent Grommet		
VENT	Vented back panel	\$	76

Number of vents per unit:

36"	1 vent
72" / 48"	2 vents
96" / 84" / 60"	3 vents

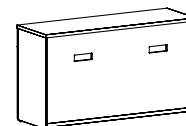

LOCKING DOORS

Locking doors are available on Buffets and Credenzas. You must specify WITH LOCKING when ordering and add upcharge.

Note: When locking is selected with optional waste bin, locking will not apply to waste bin door.

LKT_BFD	36"W Units	\$	101
LKT_BFD	72"W to 48"W Units	\$	128
LKT_BFD	96"W to 84"W Units	\$	149

CERTIFICATIONS & COMPLIANCE

- Intertek Sustainability Certified
- BIFMA level® Certified
- BIFMA Compliant® Certified
- TSCA Title VI (Formerly CARB) Compliance
- Contributes to LEED®, Green Globes®, and WELL® Sustainable Programs

Tops/Shapes + Bases

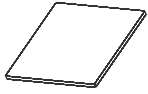

Square ([See Details](#))

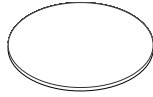

Round ([See Details](#))



Rectangular ([See Details](#))



Modern Rectangular ([See Details](#))



Boat ([See Details](#))

Strut Legs ([See Details](#))

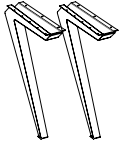

Set of 2 legs

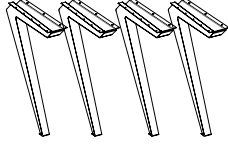

Set of 4 legs

Storage Components + Accessories

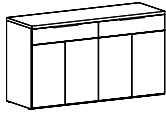

Buffet with Doors + Drawers
([See Details](#))

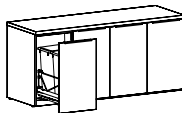

24" + 20" Credenzas with Doors
([See Details](#))

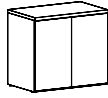

Mobile Serving Cart
([See Details](#))

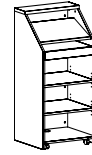

Lectern Stand
([See Details](#))

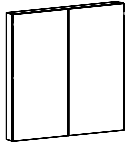

Visual Board
([See Details](#))

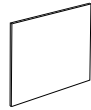
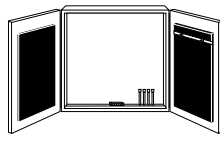

Marker Boards
([See Multiple Unit Details](#))



Marker, Eraser and Magnet
Sets ([See Details](#))

Wire Management + Power/Data Accessories ([See Details](#))

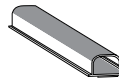
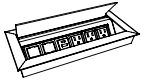



Shown with Rockstar Seating



Back of Credenza Shown with Vents



Buffet Credenza Shown with Waste Bin



Shown with Clutch Seating



Shown with Britta Seating

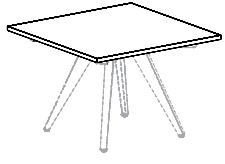

Lectern

Item	Model No.	Materials	W	D	H	Ship Wt	Cubic Ft	Edge Profile + Material	List Price	
 <p>88-4242SQ Shown BASES SOLD SEPARATELY</p> <p>Must Specify (in this order): Model # Top/Edge Material Top/Edge Finish/Color Edge Profile Glass (Y/N) Glass Color + Surface Finish Power/Data Power/Data Location</p>	88-4848SQ	Laminate	48	48	1 $\frac{3}{16}$ "	82	7.2	F, G, X, Y / P\$	953	
					1 $\frac{3}{16}$ "			K / P\$	1568	
					1 $\frac{1}{2}$ "			H / P\$	1063	
		Veneer			1 $\frac{3}{16}$ "			F, G, X, Y / W\$	1084	
					1 $\frac{3}{16}$ "			K / W\$	1817	
					1 $\frac{1}{2}$ "			H / W\$	1285	
	88-4848SQ	Glass	Laminate	48	48	1 $\frac{3}{16}$ "	82	7.2	F, G, X, Y / P\$	953
						1 $\frac{3}{16}$ "			K / P\$	1568
						1 $\frac{1}{2}$ "			H / P\$	1063
		Veneer				1 $\frac{3}{16}$ "			F, G, X, Y / W\$	1084
						1 $\frac{3}{16}$ "			K / W\$	1817
						1 $\frac{1}{2}$ "			H / W\$	1285
Glass	1 $\frac{1}{4}$ "	Acid Etched Glass Top \$	6116							
	1 $\frac{1}{4}$ "	Gloss Glass Top \$	5092							

Description

- Tops Feature a 1-piece, 1 $\frac{3}{16}$ " or 1 $\frac{1}{2}$ " Thick Top in Veneer (W) or HPL (P)
- Must Specify Edge Profile: 1 $\frac{3}{16}$ " Thick/Double Kerf (F), Duo (G), Fluted (X), Square (Y), and Knife (K) Edge Profiles or 1 $\frac{1}{2}$ " Thick/Vertical Square (H)
- Due to Top Sizes and Base Placement, Power is Not Available on Square Tops
- Available with Back Painted Tempered Glass Top; Must Specify Color and Finish ([See Options](#))
- Strut Legs Sold Separately ([See Leg Options](#))



Double Kerf (F)
1 $\frac{3}{16}$ "



Duo (G)
1 $\frac{3}{16}$ "



Fluted (X)
1 $\frac{3}{16}$ "



Square (Y)
1 $\frac{3}{16}$ "



Knife (K)
1 $\frac{3}{16}$ "



Vertical Square (H)
1 $\frac{1}{2}$ "

Pricing Codes:

P= HPL W= Wood Top

[See Strut Overview For Ordering Options](#)

Item	Model No.	Materials	W	D	H	Ship Wt	Cubic Ft	Edge Profile + Material	List Price	
 <p>88-4848CT Shown BASES SOLD SEPARATELY</p>	88-4848CT	Laminate	48	48	1 ³ / ₁₆	90	5.5	F, G, X, Y / P\$	1014	
					1 ³ / ₁₆			K / P\$	2124	
					1 ¹ / ₂			H / P\$	1042	
		Veneer			1 ³ / ₁₆			F, G, X, Y / W\$	1149	
					1 ³ / ₁₆			K / W\$	2388	
					1 ¹ / ₂			H / W\$	1340	
	Glass	1 ¹ / ₄	Acid Etched Glass Top \$	6800						
		1 ¹ / ₄	Gloss Glass Top \$	5743						
	<p>Must Specify (in this order):</p> <ul style="list-style-type: none"> Model # Top/Edge Material Top/Edge Finish/Color Edge Profile Glass (Y/N) Glass Color + Surface Finish Power/Data Type Power/Data Location 	88-5454CT	Laminate	54	54	1 ³ / ₁₆	114	6.8	F, G, X, Y / P\$	1118
						1 ³ / ₁₆			K / P\$	2246
						1 ¹ / ₂			H / P\$	1158
			Veneer			1 ³ / ₁₆			F, G, X, Y / W\$	1400
1 ³ / ₁₆						K / W\$			2456	
1 ¹ / ₂						H / W\$			1637	
Glass		1 ¹ / ₄	Acid Etched Glass Top \$	8149						
		1 ¹ / ₄	Gloss Glass Top \$	6809						
88-6060CT		Laminate	60	60	1 ³ / ₁₆	143	8.4	F, G, X, Y / P\$	1163	
					1 ³ / ₁₆			K / P\$	2461	
					1 ¹ / ₂			H / P\$	1216	
		Veneer			1 ³ / ₁₆			F, G, X, Y / W\$	1577	
	1 ³ / ₁₆				K / W\$			2760		
	1 ¹ / ₂				H / W\$			1864		
Glass	1 ¹ / ₄	Acid Etched Glass Top \$	9734							
	1 ¹ / ₄	Gloss Glass Top \$	8085							

Description

- Tops Feature a 1-piece, 1³/₁₆" or 1¹/₂" Thick Top in Veneer (W) or HPL (P)
- Must Specify Edge Profile: 1³/₁₆" Thick/Double Kerf (F), Duo (G), Fluted (X), Square (Y), and Knife (K) Edge Profiles or 1¹/₂" Thick/Vertical Square (H)
- Due to Top Sizes and Base Placement, Power is Not Available on Round Tops
- 60" and 54" Tops Feature Catalyzed Finish
- Available with Back Painted Tempered Glass Top; Must Specify Color and Finish ([See Options](#))
- Strut Legs Sold Separately ([See Leg Options](#))



Double Kerf (F)
1³/₁₆"



Duo (G)
1³/₁₆"



Fluted (X)
1³/₁₆"



Square (Y)
1³/₁₆"



Knife (K)
1³/₁₆"



Vertical Square (H)
1¹/₂"

Pricing Codes:
P= HPL W= Wood Top

[See Strut Overview For Ordering Options](#)

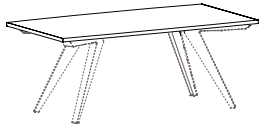
Item	Model No.	Materials	W	D	H	Ship Wt	Cubic Ft	Edge Profile + Material	List Price	
RECTANGLE SHAPE MEETING TOP 36"D  88-3672RT Shown BASES SOLD SEPARATELY	72"W x 36"D or 6' - 1 Piece Rectangle Top									
	88-3672RT	Laminate	72	36	1 $\frac{3}{16}$ "	109	10.3	F, G, X, Y / P\$	1180	
					1 $\frac{3}{16}$ "			K / P\$	1900	
					1 $\frac{1}{2}$ "			H / P\$	1332	
		Veneer			1 $\frac{3}{16}$ "			F, G, X, Y / W\$	1388	
					1 $\frac{3}{16}$ "			K / W\$	2194	
					1 $\frac{1}{2}$ "			H / W\$	1657	
		Glass			$\frac{1}{4}$ "			Acid Etched Glass Top \$	7088	
					$\frac{1}{4}$ "			Gloss Glass Top \$	5970	
	84"W x 36"D or 7' - 1 Piece Rectangle Top									
	88-3684RT	Laminate	84	36	1 $\frac{3}{16}$ "	126	11.3	F, G, X, Y / P\$	1456	
					1 $\frac{3}{16}$ "			K / P\$	2249	
					1 $\frac{1}{2}$ "			H / P\$	1670	
		Veneer			1 $\frac{3}{16}$ "			F, G, X, Y / W\$	1640	
					1 $\frac{3}{16}$ "			K / W\$	2733	
				1 $\frac{1}{2}$ "			H / W\$	1914		
	Glass			$\frac{1}{4}$ "			Acid Etched Glass Top \$	8200		
				$\frac{1}{4}$ "			Gloss Glass Top \$	6897		
96"W x 36"D or 8' - 1 Piece Rectangle Top										
88-3696RT	Laminate	96	36	1 $\frac{3}{16}$ "	142	12.9	F, G, X, Y / P\$	1529		
				1 $\frac{3}{16}$ "			K / P\$	2411		
				1 $\frac{1}{2}$ "			H / P\$	1734		
	Veneer			1 $\frac{3}{16}$ "			F, G, X, Y / W\$	1731		
				1 $\frac{3}{16}$ "			K / W\$	2866		
				1 $\frac{1}{2}$ "			H / W\$	2084		
	Glass			$\frac{1}{4}$ "			Acid Etched Glass Top \$	9121		
				$\frac{1}{4}$ "			Gloss Glass Top \$	7632		

Description

- Tops Available with Veneer (W) or HPL (P) Top in 1 $\frac{3}{16}$ " and 1 $\frac{1}{2}$ " Thicknesses
- Must Specify Edge Profile: 1 $\frac{3}{16}$ " Thick/Double Kerf (F), Duo (G), Fluted (X), Square (Y), and Knife (K) Edge Profiles or 1 $\frac{1}{2}$ " Thick/Vertical Square (H)
- Veneer (W) Top Grain Runs Depth of Top and HPL (P) Top Grain Runs Width of Top
- Available with Back Painted Tempered Glass Top; Must Specify Color and Finish ([See Options](#))
- Strut Legs Sold Separately ([See Leg Options](#))



Double Kerf (F)
1 $\frac{3}{16}$ "



Duo (G)
1 $\frac{3}{16}$ "



Fluted (X)
1 $\frac{3}{16}$ "



Square (Y)
1 $\frac{3}{16}$ "



Knife (K)
1 $\frac{3}{16}$ "



Vertical Square (H)
1 $\frac{1}{2}$ "

Pricing Codes:

P= HPL W= Wood Top

[See Strut Overview For Ordering Options](#)

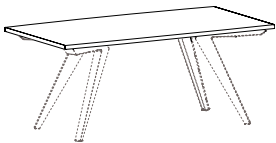
Item	Model No.	Materials	W	D	H	Ship Wt	Cubic Ft	Edge Profile + Material	List Price
RECTANGLE SHAPE MEETING TOP 42"D  88-4272RT Shown BASES SOLD SEPARATELY	42"D x 72"W or 6' - 1 Piece Rectangle Top								
	88-4272RT	Laminate	72	42	1 3/16	126	11.3	F, G, X, Y / P\$	1261
					1 3/16			K / P\$	2137
					1 1/2			H / P\$	1440
		Veneer			1 3/16			F, G, X, Y / W\$	1579
					1 3/16			K / W\$	2393
					1 1/2			H / W\$	1884
		Glass			1/4			Acid Etched Glass Top \$	7866
					1/4			Gloss Glass Top \$	6563
	42"D x 84"W or 7' - 1 Piece Rectangle Top								
	88-4284RT	Laminate	84	42	1 3/16	145	13.1	F, G, X, Y / P\$	1520
					1 3/16			K / P\$	2438
				1 1/2			H / P\$	1729	
	Veneer			1 3/16			F, G, X, Y / W\$	1740	
				1 3/16			K / W\$	2879	
				1 1/2			H / W\$	2094	
	Glass			1/4			Acid Etched Glass Top \$	8973	
				1/4			Gloss Glass Top \$	7453	
42"D x 96"W or 8' - 1 Piece Rectangle Top									
88-4296RT	Laminate	96	42	1 3/16	164	15.0	F, G, X, Y / P\$	1562	
				1 3/16			K / P\$	2620	
				1 1/2			H / P\$	1803	
	Veneer			1 3/16			F, G, X, Y / W\$	1890	
				1 3/16			K / W\$	3024	
				1 1/2			H / W\$	2290	
	Glass			1/4			Acid Etched Glass Top \$	10041	
				1/4			Gloss Glass Top \$	8303	

Must Specify (in this order):

- Model #
- Top/Edge Material
- Top/Edge Finish/Color
- Edge Profile
- Glass (Y/N)
- Glass Color + Surface Finish
- Power/Data Type
- Power/Data Location

Description

- Tops Available with Veneer (W) or HPL (P) Top in 1 3/16" and 1 1/2" Thicknesses
- Must Specify Edge Profile: 1 3/16" Thick/Double Kerf (F), Duo (G), Fluted (X), Square (Y), and Knife (K) Edge Profiles or 1 1/2" Thick/Vertical Square (H)
- Veneer (W) Top Grain Runs Depth of Top and HPL (P) Top Grain Runs Width of Top
- Available with Back Painted Tempered Glass Top; Must Specify Color and Finish ([See Options](#))
- Power and Data Options Available; Sold Separately ([See Multiple Power Unit Details](#))
- Strut Legs Sold Separately ([See Leg Options](#))



Double Kerf (F)
1 3/16"



Duo (G)
1 3/16"



Fluted (X)
1 3/16"



Square (Y)
1 3/16"



Knife (K)
1 3/16"



Vertical Square (H)
1 1/2"

Pricing Codes:

P= HPL W= Wood Top

[See Strut Overview For Ordering Options](#)

Item	Model No.	Materials	W	D	H	Ship Wt	Cubic Ft	Edge Profile + Material	List Price	
RECTANGLE SHAPE MEETING TOP 48" D  88-48216RT Shown BASES SOLD SEPARATELY	72"W x 48"D or 6' - 1 Piece Rectangle Top									
	88-4872RT	Laminate	72	48	1 3/16	152	8.6	F, G, X, Y / P\$	1336	
					1 3/16			K / P\$	2296	
					1 1/2			H / P\$	1543	
		Veneer			1 3/16			F, G, X, Y / W\$	1759	
					1 3/16			K / W\$	2587	
					1 1/2			H / W\$	2103	
		Glass			1/4			Acid Etched Glass Top \$	8813	
					1/4			Gloss Glass Top \$	7323	
	84"W x 48"D or 7' - 1 Piece Rectangle Top									
	88-4884RT	Laminate	84	48	1 3/16	174	10.0	F, G, X, Y / P\$	1599	
					1 3/16			K / P\$	2578	
				1 1/2			H / P\$	1839		
	Veneer			1 3/16			F, G, X, Y / W\$	1859		
				1 3/16			K / W\$	2972		
				1 1/2			H / W\$	2258		
	Glass			1/4			Acid Etched Glass Top \$	9990		
				1/4			Gloss Glass Top \$	8254		
96"W x 48"D or 8' - 1 Piece Rectangle Top										
88-4896RT	Laminate	96	48	1 3/16	196	11.3	F, G, X, Y / P\$	1647		
				1 3/16			K / P\$	2858		
				1 1/2			H / P\$	1923		
	Veneer			1 3/16			F, G, X, Y / W\$	2112		
				1 3/16			K / W\$	3214		
				1 1/2			H / W\$	2561		
	Glass			1/4			Acid Etched Glass Top \$	11283		
				1/4			Gloss Glass Top \$	9296		
108"W x 48"D or 9' - 2 Piece Rectangle Top										
88-48108RT	Laminate	108	48	1 3/16	218	23.5	F, G, X, Y / P\$	2384		
				1 3/16			K / P\$	3769		
				1 1/2			H / P\$	2697		
	Veneer			1 3/16			F, G, X, Y / W\$	2824		
				1 3/16			K / W\$	4212		
				1 1/2			H / W\$	3330		
	Glass			1/4			Acid Etched Glass Top \$	13126		
				1/4			Gloss Glass Top \$	10893		

Additional 48" Rectangle Shaped Tops on Next Page



Double Kerf (F)
1 3/16"



Duo (G)
1 3/16"



Fluted (X)
1 3/16"



Square (Y)
1 3/16"



Knife (K)
1 3/16"



Vertical Square (H)
1 1/2"

Pricing Codes:

P= HPL W= Wood Top

[See Strut Overview For Ordering Options](#)

Item	Model No.	Materials	W	D	H	Ship Wt	Cubic Ft	Edge Profile + Material	List Price
48"D CONTINUED FROM PREVIOUS PAGE									
120"W x 48"D or 10' - 2 Piece Rectangle Top									
	88-48120RT	Laminate	120	48	1 ³ / ₁₆	240	23.5	F, G, X, Y / P\$	2447
					1 ³ / ₁₆			K / P\$	3958
					1 ¹ / ₂			H / P\$	2795
		Veneer			1 ³ / ₁₆			F, G, X, Y / W\$	3074
					1 ³ / ₁₆			K / W\$	4457
					1 ¹ / ₂			H / W\$	3634
		Glass			1/4			Acid Etched Glass Top \$	14360
					1/4			Gloss Glass Top \$	11878
132"W x 48"D or 11' - 2 Piece Rectangle Top									
	88-48132RT	Laminate	132	48	1 ³ / ₁₆	262	23.5	F, G, X, Y / P\$	2520
					1 ³ / ₁₆			K / P\$	4233
					1 ¹ / ₂			H / P\$	2905
		Veneer			1 ³ / ₁₆			F, G, X, Y / W\$	3335
					1 ³ / ₁₆			K / W\$	4647
					1 ¹ / ₂			H / W\$	3949
		Glass			1/4			Acid Etched Glass Top \$	15605
					1/4			Gloss Glass Top \$	12873
144"W x 48"D or 12' - 2 Piece Rectangle Top									
	88-48144RT	Laminate	144	48	1 ³ / ₁₆	284	23.5	F, G, X, Y / P\$	2584
					1 ³ / ₁₆			K / P\$	4400
					1 ¹ / ₂			H / P\$	3003
		Veneer			1 ³ / ₁₆			F, G, X, Y / W\$	3584
					1 ³ / ₁₆			K / W\$	4922
					1 ¹ / ₂			H / W\$	4252
		Glass			1/4			Acid Etched Glass Top \$	16837
					1/4			Gloss Glass Top \$	13859
156"W x 48"D or 13' - 2 Piece Rectangle Top									
	88-48156RT	Laminate	156	48	1 ³ / ₁₆	306	31.2	F, G, X, Y / P\$	3102
					1 ³ / ₁₆			K / P\$	5051
					1 ¹ / ₂			H / P\$	3555
		Veneer			1 ³ / ₁₆			F, G, X, Y / W\$	3851
					1 ³ / ₁₆			K / W\$	5654
					1 ¹ / ₂			H / W\$	4572
		Glass			1/4			Acid Etched Glass Top \$	18082
					1/4			Gloss Glass Top \$	14856

Must Specify (in this order):

- Model #
- Top/Edge Material
- Top/Edge Finish/Color
- Edge Profile
- Glass (Y/N)
- Glass Color + Surface Finish
- Power/Data
- Power/Data Location

Additional 48" Rectangle Shaped Tops on Next Page



Double Kerf (F)
1³/₁₆"



Duo (G)
1³/₁₆"



Fluted (X)
1³/₁₆"



Square (Y)
1³/₁₆"



Knife (K)
1³/₁₆"



Vertical Square (H)
1¹/₂"

Pricing Codes:
P= HPL W= Wood Top

[See Strut Overview For Ordering Options](#)

Item	Model No.	Materials	W	D	H	Ship Wt	Cubic Ft	Edge Profile + Material	List Price		
<i>48" D CONTINUED FROM PREVIOUS PAGE</i>	168" W x 48" D or 14' - 2 Piece Rectangle Top										
	88-48168RT	Laminate	168	48	1 $\frac{3}{16}$ "	328	31.2	F, G, X, Y / P\$	3149		
					1 $\frac{3}{16}$ "			K / P\$	5218		
					1 $\frac{1}{2}$ "			H / P\$	3639		
		Veneer			1 $\frac{3}{16}$ "			F, G, X, Y / W\$	4041		
					1 $\frac{3}{16}$ "			K / W\$	5878		
					1 $\frac{1}{2}$ "			H / W\$	4812		
		Glass			$\frac{1}{4}$ "			Acid Etched Glass Top \$	19301		
					$\frac{1}{4}$ "			Gloss Glass Top \$	15826		
		180" W x 48" D or 15' - 2 Piece Rectangle Top									
	88-48180RT	Laminate	180	48	1 $\frac{3}{16}$ "	350	31.2	F, G, X, Y / P\$	3318		
					1 $\frac{3}{16}$ "			K / P\$	5535		
					1 $\frac{1}{2}$ "			H / P\$	3843		
		Veneer			1 $\frac{3}{16}$ "			F, G, X, Y / W\$	4384		
					1 $\frac{3}{16}$ "			K / W\$	6230		
					1 $\frac{1}{2}$ "			H / W\$	5209		
		Glass			$\frac{1}{4}$ "			Acid Etched Glass Top \$	20645		
					$\frac{1}{4}$ "			Gloss Glass Top \$	16922		
	192" W x 48" D or 16' - 2 Piece Rectangle Top										
88-48192RT	Laminate	192	48	1 $\frac{3}{16}$ "	372	31.2	F, G, X, Y / P\$	3367			
				1 $\frac{3}{16}$ "			K / P\$	5800			
				1 $\frac{1}{2}$ "			H / P\$	3924			
	Veneer			1 $\frac{3}{16}$ "			F, G, X, Y / W\$	4574			
				1 $\frac{3}{16}$ "			K / W\$	6361			
				1 $\frac{1}{2}$ "			H / W\$	5450			
	Glass			$\frac{1}{4}$ "			Acid Etched Glass Top \$	21862			
				$\frac{1}{4}$ "			Gloss Glass Top \$	17893			
	204" W x 48" D or 17' - 3 Piece Rectangle Top										
88-48204RT	Laminate	204	48	1 $\frac{3}{16}$ "	394	24.0	F, G, X, Y / P\$	3891			
				1 $\frac{3}{16}$ "			K / P\$	6435			
				1 $\frac{1}{2}$ "			H / P\$	4487			
	Veneer			1 $\frac{3}{16}$ "			F, G, X, Y / W\$	5409			
				1 $\frac{3}{16}$ "			K / W\$	7399			
				1 $\frac{1}{2}$ "			H / W\$	6343			
	Glass			$\frac{1}{4}$ "			Acid Etched Glass Top \$	24026			
				$\frac{1}{4}$ "			Gloss Glass Top \$	19807			

Additional 48" Rectangle Shaped Tops on Next Page



Double Kerf (F)
1 $\frac{3}{16}$ "



Duo (G)
1 $\frac{3}{16}$ "



Fluted (X)
1 $\frac{3}{16}$ "



Square (Y)
1 $\frac{3}{16}$ "



Knife (K)
1 $\frac{3}{16}$ "



Vertical Square (H)
1 $\frac{1}{2}$ "

Pricing Codes:

P= HPL W= Wood Top

[See Strut Overview For Ordering Options](#)

Item	Model No.	Materials	W	D	H	Ship Wt	Cubic Ft	Edge Profile + Material	List Price		
<i>48"D CONTINUED FROM PREVIOUS PAGE</i>	216"W x 48"D or 18' - 3 Piece Rectangle Top										
	88-48216RT	Laminate	216	48	1 3/16	416	25.5	F, G, X, Y / P\$	3939		
					1 1/2			K / P\$	6587		
					1 3/16			H / P\$	4572		
		Veneer			1 3/16			F, G, X, Y / W\$	5697		
					1 3/16			K / W\$	7427		
					1 1/2			H / W\$	6684		
		Glass			1/4			Acid Etched Glass Top \$	25048		
					1/4			Gloss Glass Top \$	20581		
	<i>Must Specify (in this order):</i> Model # Top/Edge Material Top/Edge Finish/Color Edge Profile Glass (Y/N) Glass Color + Surface Finish Power/Data Power/Data Location	228"W x 48"D or 19' - 3 Piece Rectangle Top									
		88-48228RT	Laminate	228	48	1 3/16	438	27.0	F, G, X, Y / P\$	4955	
						1 3/16			K / P\$	8011	
					1 1/2			H / P\$	5623		
		Veneer			1 3/16			F, G, X, Y / W\$	6439		
					1 3/16			K / W\$	8774		
					1 1/2			H / W\$	7479		
		Glass			1/4			Acid Etched Glass Top \$	26766		
					1/4			Gloss Glass Top \$	22052		
		240"W x 48"D or 20' - 3 Piece Rectangle Top									
		88-48240RT	Laminate	240	48	1 3/16	460	28.5	F, G, X, Y / P\$	5004	
						1 3/16			K / P\$	8162	
					1 1/2			H / P\$	5706		
		Veneer			1 3/16			F, G, X, Y / W\$	6728		
					1 3/16			K / W\$	9062		
					1 1/2			H / W\$	7820		
		Glass			1/4			Acid Etched Glass Top \$	27986		
					1/4			Gloss Glass Top \$	23021		

Description

- Tops Available with Veneer (W) or HPL (P) Top in 1 3/16" and 1 1/2" Thicknesses
- Must Specify Edge Profile: 1 3/16" Thick/Double Kerf (F), Duo (G), Fluted (X), Square (Y), and Knife (K) Edge Profiles or 1 1/2" Thick/Vertical Square (H)
- Veneer (W) Top Grain Runs Depth of Top and HPL (P) Top Grain Runs Width of Top
- All Veneer Tops, as well as Laminate Tops up to 144" (12 feet), have Matching Woodgrain. Laminate Tops Sized 156" (13 feet) and Longer have Non-Matching Woodgrain
- Available with Back Painted Tempered Glass Top; Must Specify Color and Finish ([See Options](#))
- Power and Data Options Available; Sold Separately ([See Multiple Power Unit Details](#))
- Dock800, Oasis, and E2X Power Units Available on Ends Only (E1 and E2) for 108"D - 156"D and 204"D-240"D Tops
- Strut Legs Sold Separately ([See Leg Options](#))



Double Kerf (F)
1 3/16"



Duo (G)
1 3/16"



Fluted (X)
1 3/16"



Square (Y)
1 3/16"



Knife (K)
1 3/16"



Vertical Square (H)
1 1/2"

Pricing Codes:
P= HPL W= Wood Top

[See Strut Overview For Ordering Options](#)

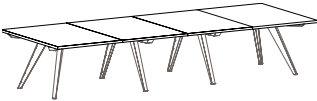
Item	Model No.	Materials	W	D	H	Ship Wt	Cubic Ft	Edge Profile + Material	List Price	
RECTANGLE SHAPE MEETING TOP 54"D  88-54156RT Shown in Veneer BASES SOLD SEPARATELY	120"W x 54"D or 10' - 3 Piece Veneer (W) and 2 Piece HPL (P) Rectangle Top									
	88-54120RT	Laminate	120	54	1 $\frac{3}{16}$ "	260	12.1	F, G, X, Y / P\$	2732	
					1 $\frac{3}{16}$ "			K / P\$	4514	
					1 $\frac{1}{2}$ "			H / P\$	3126	
		Veneer			1 $\frac{3}{16}$ "			F, G, X, Y / W\$	4115	
					1 $\frac{3}{16}$ "			K / W\$	5565	
					1 $\frac{1}{2}$ "			H / W\$	4742	
		Glass			1 $\frac{1}{4}$ "			Acid Etched Glass Top \$	16750	
					1 $\frac{1}{4}$ "			Gloss Glass Top \$	13958	
	132"W x 54"D or 11' - 3 Piece Veneer (W) and 2 Piece HPL (P) Rectangle Top									
	88-54132RT	Laminate	132	54	1 $\frac{3}{16}$ "	285	13.2	F, G, X, Y / P\$	2800	
					1 $\frac{3}{16}$ "			K / P\$	4696	
				1 $\frac{1}{2}$ "			H / P\$	3234		
	Veneer			1 $\frac{3}{16}$ "			F, G, X, Y / W\$	4335		
				1 $\frac{3}{16}$ "			K / W\$	5850		
				1 $\frac{1}{2}$ "			H / W\$	5019		
	Glass			1 $\frac{1}{4}$ "			Acid Etched Glass Top \$	18132		
				1 $\frac{1}{4}$ "			Gloss Glass Top \$	15059		
144"W x 54"D or 12' - 3 Piece Veneer (W) and 2 Piece HPL (P) Rectangle Top										
88-54144RT	Laminate	144	54	1 $\frac{3}{16}$ "	309	15.0	F, G, X, Y / P\$	2867		
				1 $\frac{3}{16}$ "			K / P\$	4877		
				1 $\frac{1}{2}$ "			H / P\$	3342		
	Veneer			1 $\frac{3}{16}$ "			F, G, X, Y / W\$	4554		
				1 $\frac{3}{16}$ "			K / W\$	6138		
				1 $\frac{1}{2}$ "			H / W\$	5297		
	Glass			1 $\frac{1}{4}$ "			Acid Etched Glass Top \$	19512		
				1 $\frac{1}{4}$ "			Gloss Glass Top \$	16162		
156"W x 54"D or 13' - 4 Piece Veneer (W) and 2 Piece HPL (P) Rectangle Top										
88-54156RT	Laminate	156	54	1 $\frac{3}{16}$ "	334	16.0	F, G, X, Y / P\$	3396		
				1 $\frac{3}{16}$ "			K / P\$	5714		
				1 $\frac{1}{2}$ "			H / P\$	3908		
	Veneer			1 $\frac{3}{16}$ "			F, G, X, Y / W\$	5619		
				1 $\frac{3}{16}$ "			K / W\$	7417		
				1 $\frac{1}{2}$ "			H / W\$	6427		
	Glass			1 $\frac{1}{4}$ "			Acid Etched Glass Top \$	20731		
				1 $\frac{1}{4}$ "			Gloss Glass Top \$	17103		

Additional 54" Rectangle Shaped Tops on Next Page



Double Kerf (F)
1 $\frac{3}{16}$ "



Duo (G)
1 $\frac{3}{16}$ "



Fluted (X)
1 $\frac{3}{16}$ "



Square (Y)
1 $\frac{3}{16}$ "



Knife (K)
1 $\frac{3}{16}$ "



Vertical Square (H)
1 $\frac{1}{2}$ "

Pricing Codes:

P= HPL W= Wood Top

[See Strut Overview For Ordering Options](#)

Item	Model No.	Materials	W	D	H	Ship Wt	Cubic Ft	Edge Profile + Material	List Price	
168"W x 54"D or 14' - 4 Piece Veneer (W) and 2 Piece HPL (P) Rectangle Top										
<i>54"D CONTINUED FROM PREVIOUS PAGE</i>	88-54168RT	Laminate	168	54	1 ³ / ₁₆ "	359	17.0	F, G, X, Y / P\$	3448	
					1 ³ / ₁₆ "			K / P\$	5882	
					1 ¹ / ₂ "			H / P\$	4000	
		Veneer			1 ³ / ₁₆ "			F, G, X, Y / W\$	5860	
					1 ³ / ₁₆ "			K / W\$	7724	
					1 ¹ / ₂ "			H / W\$	6726	
		Glass			1/4"			Acid Etched Glass Top \$	22098	
					1/4"			Gloss Glass Top \$	18190	
	180"W x 54"D or 15' - 4 Piece Veneer (W) and 2 Piece HPL (P) Rectangle Top									
	<i>Must Specify (in this order):</i> Model # Top/Edge Material Top/Edge Finish/Color Edge Profile Glass (Y/N) Glass Color + Surface Finish Power/Data Type Power/Data Location	88-54180RT	Laminate	180	54	1 ³ / ₁₆ "	384	18.0	F, G, X, Y / P\$	3501
					1 ³ / ₁₆ "			K / P\$	6047	
					1 ¹ / ₂ "			H / P\$	4092	
		Veneer			1 ³ / ₁₆ "			F, G, X, Y / W\$	6100	
					1 ³ / ₁₆ "			K / W\$	8032	
					1 ¹ / ₂ "			H / W\$	7025	
		Glass			1/4"			Acid Etched Glass Top \$	23464	
					1/4"			Gloss Glass Top \$	19276	
192"W x 54"D or 16' - 4 Piece Veneer (W) and 2 Piece HPL (P) Rectangle Top										
		88-54192RT	Laminate	192	54	1 ³ / ₁₆ "	408	19.0	F, G, X, Y / P\$	3552
					1 ³ / ₁₆ "			K / P\$	6214	
					1 ¹ / ₂ "			H / P\$	4185	
		Veneer			1 ³ / ₁₆ "			F, G, X, Y / W\$	6340	
					1 ³ / ₁₆ "			K / W\$	8340	
					1 ¹ / ₂ "			H / W\$	7324	
		Glass			1/4"			Acid Etched Glass Top \$	24832	
					1/4"			Gloss Glass Top \$	20362	
	204"W x 54"D or 17' - 5 Piece Veneer (W) and 3 Piece HPL (P) Rectangle Top									
		88-54204RT	Laminate	204	54	1 ³ / ₁₆ "	445	21.0	F, G, X, Y / P\$	4290
					1 ³ / ₁₆ "			K / P\$	7077	
					1 ¹ / ₂ "			H / P\$	4964	
		Veneer			1 ³ / ₁₆ "			F, G, X, Y / W\$	7708	
					1 ³ / ₁₆ "			K / W\$	9923	
					1 ¹ / ₂ "			H / W\$	8978	
		Glass			1/4"			Acid Etched Glass Top \$	27196	
					1/4"			Gloss Glass Top \$	22450	

Additional 54" Rectangle Shaped Tops on Next Page



Double Kerf (F)
1³/₁₆"



Duo (G)
1³/₁₆"



Fluted (X)
1³/₁₆"



Square (Y)
1³/₁₆"



Knife (K)
1³/₁₆"



Vertical Square (H)
1¹/₂"

Pricing Codes:
P= HPL W= Wood Top

[See Strut Overview For Ordering Options](#)

Item	Model No.	Materials	W	D	H	Ship Wt	Cubic Ft	Edge Profile + Material	List Price		
<i>54"D CONTINUED FROM PREVIOUS PAGE</i>	216"W x 54"D or 18' - 5 Piece Veneer (W) and 3 Piece HPL (P) Rectangle Top										
	88-54216RT	Laminate	216	54	1 $\frac{3}{16}$	470	22.0	F, G, X, Y / P\$	4343		
					1 $\frac{3}{16}$			K / P\$	7244		
					1 $\frac{1}{2}$			H / P\$	5055		
		Veneer			1 $\frac{3}{16}$			F, G, X, Y / W\$	7969		
					1 $\frac{3}{16}$			K / W\$	10251		
					1 $\frac{1}{2}$			H / W\$	9296		
		Glass			1 $\frac{1}{4}$			Acid Etched Glass Top \$	28562		
					1 $\frac{1}{4}$			Gloss Glass Top \$	23537		
	<i>Must Specify (in this order): Model # Top/Edge Material Top/Edge Finish/Color Edge Profile Glass (Y/N) Glass Color + Surface Finish Power/Data Power/Data Location</i>	228"W x 54"D or 19' - 5 Piece Veneer (W) and 3 Piece HPL (P) Rectangle Top									
		88-54228RT	Laminate	228	54	1 $\frac{3}{16}$	495	23.0	F, G, X, Y / P\$	5009	
						1 $\frac{3}{16}$			K / P\$	8318	
					1 $\frac{1}{2}$			H / P\$	5763		
		Veneer			1 $\frac{3}{16}$			F, G, X, Y / W\$	8230		
					1 $\frac{3}{16}$			K / W\$	10578		
					1 $\frac{1}{2}$			H / W\$	9616		
		Glass			1 $\frac{1}{4}$			Acid Etched Glass Top \$	29986		
					1 $\frac{1}{4}$			Gloss Glass Top \$	24681		
		240"W x 54"D or 20' - 5 Piece Veneer (W) and 3 Piece HPL (P) Rectangle Top									
		88-54240RT	Laminate	240	54	1 $\frac{3}{16}$	519	24.0	F, G, X, Y / P\$	5062	
						1 $\frac{3}{16}$			K / P\$	8483	
					1 $\frac{1}{2}$			H / P\$	5855		
		Veneer			1 $\frac{3}{16}$			F, G, X, Y / W\$	8492		
					1 $\frac{3}{16}$			K / W\$	10907		
					1 $\frac{1}{2}$			H / W\$	9937		
		Glass			1 $\frac{1}{4}$			Acid Etched Glass Top \$	31352		
					1 $\frac{1}{4}$			Gloss Glass Top \$	25769		

Description

- Tops Available with Veneer (W) or HPL (P) Top in 1 $\frac{3}{16}$ " and 1 $\frac{1}{2}$ " Thicknesses
- Must Specify Edge Profile: 1 $\frac{3}{16}$ " Thick/Double Kerf (F), Duo (G), Fluted (X), Square (Y), and Knife (K) Edge Profiles or 1 $\frac{1}{2}$ " Thick/Vertical Square (H)
- Veneer (W) Top Grain Runs Depth of Top and HPL (P) Top Grain Runs Width of Top
- All Veneer Tops, as well as Laminate Tops up to 144" (12 feet), have Matching Woodgrain. Laminate Tops Sized 156" (13 feet) and Longer have Non-Matching Woodgrain
- Available with Back Painted Tempered Glass Top; Must Specify Color and Finish ([See Options](#))
- Power and Data Options Available; Sold Separately ([See Multiple Power Unit Details](#))
- Strut Legs Sold Separately ([See Leg Options](#))



Double Kerf (F)
1 $\frac{3}{16}$ "



Duo (G)
1 $\frac{3}{16}$ "



Fluted (X)
1 $\frac{3}{16}$ "



Square (Y)
1 $\frac{3}{16}$ "



Knife (K)
1 $\frac{3}{16}$ "



Vertical Square (H)
1 $\frac{1}{2}$ "

Pricing Codes:

P= HPL W= Wood Top

[See Strut Overview For Ordering Options](#)

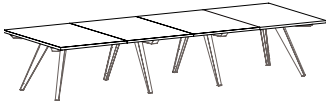
Item	Model No.	Materials	W	D	H	Ship Wt	Cubic Ft	Edge Profile + Material	List Price
RECTANGLE SHAPE MEETING TOP 60"D  88-60156RT Shown in Veneer BASES SOLD SEPARATELY	120"W x 60"D or 10' - 3 Piece Veneer (W) and 2 Piece HPL (P) Rectangle Top								
	88-60120RT	Laminate	120	60	1 ³ / ₁₆ "	287	13.3	F, G, X, Y / P\$	2785
					1 ³ / ₁₆ "			K / P\$	4676
					1 ¹ / ₂ "			H / P\$	3224
		Veneer			1 ³ / ₁₆ "			F, G, X, Y / W\$	4358
					1 ³ / ₁₆ "			K / W\$	5862
					1 ¹ / ₂ "			H / W\$	5046
		Glass			1/4"			Acid Etched Glass Top \$	18244
					1/4"			Gloss Glass Top \$	15143
	132"W x 60"D or 11' - 3 Piece Veneer (W) and 2 Piece HPL (P) Rectangle Top								
	88-60132RT	Laminate	132	60	1 ³ / ₁₆ "	323	14.6	F, G, X, Y / P\$	2857
					1 ³ / ₁₆ "			K / P\$	4872
				1 ¹ / ₂ "			H / P\$	3341	
	Veneer			1 ³ / ₁₆ "			F, G, X, Y / W\$	4602	
				1 ³ / ₁₆ "			K / W\$	6177	
				1 ¹ / ₂ "			H / W\$	5354	
	Glass			1/4"			Acid Etched Glass Top \$	19773	
				1/4"			Gloss Glass Top \$	16361	
144"W x 60"D or 12' - 3 Piece Veneer (W) and 2 Piece HPL (P) Rectangle Top									
88-60144RT	Laminate	144	60	1 ³ / ₁₆ "	342	16.0	F, G, X, Y / P\$	2929	
				1 ³ / ₁₆ "			K / P\$	5069	
				1 ¹ / ₂ "			H / P\$	3457	
	Veneer			1 ³ / ₁₆ "			F, G, X, Y / W\$	4844	
				1 ³ / ₁₆ "			K / W\$	6491	
				1 ¹ / ₂ "			H / W\$	5663	
	Glass			1/4"			Acid Etched Glass Top \$	21301	
				1/4"			Gloss Glass Top \$	17579	
156"W x 60"D or 13' - 4 Piece Veneer (W) and 2 Piece HPL (P) Rectangle Top									
88-60156RT	Laminate	156	60	1 ³ / ₁₆ "	376	17.2	F, G, X, Y / P\$	3461	
				1 ³ / ₁₆ "			K / P\$	5920	
				1 ¹ / ₂ "			H / P\$	4034	
	Veneer			1 ³ / ₁₆ "			F, G, X, Y / W\$	5965	
				1 ³ / ₁₆ "			K / W\$	7829	
				1 ¹ / ₂ "			H / W\$	6853	
	Glass			1/4"			Acid Etched Glass Top \$	22671	
				1/4"			Gloss Glass Top \$	18637	

Additional 60" Rectangle Shaped Tops on Next Page



Double Kerf (F)
1³/₁₆"



Duo (G)
1³/₁₆"



Fluted (X)
1³/₁₆"



Square (Y)
1³/₁₆"



Knife (K)
1³/₁₆"



Vertical Square (H)
1¹/₂"

Pricing Codes:
P= HPL W= Wood Top

[See Strut Overview For Ordering Options](#)

Item	Model No.	Materials	W	D	H	Ship Wt	Cubic Ft	Edge Profile + Material	List Price		
<i>60" D CONTINUED FROM PREVIOUS PAGE</i>	168"W x 60"D or 14' - 4 Piece Veneer (W) and 2 Piece HPL (P) Rectangle Top										
	88-60168RT	Laminate	168	60	1 3/16	403	18.5	F, G, X, Y / P\$	3519		
					1 3/16			K / P\$	6101		
					1 1/2			H / P\$	4136		
		Veneer			1 3/16			F, G, X, Y / W\$	6232		
					1 3/16			K / W\$	8166		
					1 1/2			H / W\$	7185		
		Glass			1/4			Acid Etched Glass Top \$	24183		
					1/4			Gloss Glass Top \$	19840		
		180"W x 60"D or 15' - 4 Piece Veneer (W) and 2 Piece HPL (P) Rectangle Top									
	88-60180RT	Laminate	180	60	1 3/16	430	19.8	F, G, X, Y / P\$	3577		
					1 3/16			K / P\$	6282		
					1 1/2			H / P\$	4236		
		Veneer			1 3/16			F, G, X, Y / W\$	6499		
					1 3/16			K / W\$	8504		
				1 1/2			H / W\$	7515			
	Glass			1/4			Acid Etched Glass Top \$	25697			
				1/4			Gloss Glass Top \$	21045			
	192"W x 60"D or 16' - 4 Piece Veneer (W) and 2 Piece HPL (P) Rectangle Top										
88-60192RT	Laminate	192	60	1 3/16	458	21.1	F, G, X, Y / P\$	3634			
				1 3/16			K / P\$	6462			
				1 1/2			H / P\$	4337			
	Veneer			1 3/16			F, G, X, Y / W\$	6765			
				1 3/16			K / W\$	8843			
				1 1/2			H / W\$	7845			
	Glass			1/4			Acid Etched Glass Top \$	27210			
				1/4			Gloss Glass Top \$	22248			
	204"W x 60"D or 17' - 5 Piece Veneer (W) and 3 Piece HPL (P) Rectangle Top										
88-60204RT	Laminate	204	60	1 3/16	492	22.4	F, G, X, Y / P\$	4376			
				1 3/16			K / P\$	7341			
				1 1/2			H / P\$	5127			
	Veneer			1 3/16			F, G, X, Y / W\$	8200			
				1 3/16			K / W\$	10497			
				1 1/2			H / W\$	9572			
	Glass			1/4			Acid Etched Glass Top \$	29724			
				1/4			Gloss Glass Top \$	24451			

Must Specify (in this order):
 Model #
 Top/Edge Material
 Top/Edge Finish/Color
 Edge Profile
 Glass (Y/N)
 Glass Color + Surface Finish
 Power/Data Type
 Power/Data Location

Additional 60" Rectangle Shaped Tops on Next Page



Double Kerf (F)
1 3/16"



Duo (G)
1 3/16"



Fluted (X)
1 3/16"



Square (Y)
1 3/16"



Knife (K)
1 3/16"



Vertical Square (H)
1 1/2"

Pricing Codes:
 P= HPL W= Wood Top

[See Strut Overview For Ordering Options](#)

Item	Model No.	Materials	W	D	H	Ship Wt	Cubic Ft	Edge Profile + Material	List Price
60"D CONTINUED FROM PREVIOUS PAGE									
216"W x 60"D or 18' - 5 Piece Veneer (W) and 3 Piece HPL (P) Rectangle Top									
	88-60216RT	Laminate	216	60	1 ³ / ₁₆	519	23.7	F, G, X, Y / P\$	4433
					1 ³ / ₁₆			K / P\$	7521
					1 ¹ / ₂			H / P\$	5227
		Veneer			1 ³ / ₁₆			F, G, X, Y / W\$	8489
					1 ³ / ₁₆			K / W\$	10855
					1 ¹ / ₂			H / W\$	9926
		Glass			1/4			Acid Etched Glass Top \$	31239
					1/4			Gloss Glass Top \$	25655
228"W x 60"D or 19' - 5 Piece Veneer (W) and 3 Piece HPL (P) Rectangle Top									
	88-60228RT	Laminate	228	60	1 ³ / ₁₆	547	25.0	F, G, X, Y / P\$	5104
					1 ³ / ₁₆			K / P\$	8609
					1 ¹ / ₂			H / P\$	5943
		Veneer			1 ³ / ₁₆			F, G, X, Y / W\$	8779
					1 ³ / ₁₆			K / W\$	11216
					1 ¹ / ₂			H / W\$	10280
		Glass			1/4			Acid Etched Glass Top \$	32809
					1/4			Gloss Glass Top \$	26917
240"W x 60"D or 20' - 5 Piece Veneer (W) and 3 Piece HPL (P) Rectangle Top									
	88-60240RT	Laminate	240	60	1 ³ / ₁₆	574	26.3	F, G, X, Y / P\$	5161
					1 ³ / ₁₆			K / P\$	8790
					1 ¹ / ₂			H / P\$	6044
		Veneer			1 ³ / ₁₆			F, G, X, Y / W\$	9068
					1 ³ / ₁₆			K / W\$	11577
					1 ¹ / ₂			H / W\$	10636
		Glass			1/4			Acid Etched Glass Top \$	34324
					1/4			Gloss Glass Top \$	28120

Must Specify (in this order):

- Model #
- Top/Edge Material
- Top/Edge Finish/Color
- Edge Profile
- Glass (Y/N)
- Glass Color + Surface Finish
- Power/Data Type
- Power/Data Location

Description

- Tops Available with Veneer (W) or HPL (P) Top in 1³/₁₆" and 1¹/₂" Thicknesses
- Must Specify Edge Profile: 1³/₁₆" Thick/Double Kerf (F), Duo (G), Fluted (X), Square (Y), and Knife (K) Edge Profiles or 1¹/₂" Thick/Vertical Square (H)
- Veneer (W) Top Grain Runs Depth of Top and HPL (P) Top Grain Runs Width of Top
- All Veneer Tops, as well as Laminate Tops up to 144" (12 feet), have Matching Woodgrain. Laminate Tops Sized 156" (13 feet) and Longer have Non-Matching Woodgrain
- Available with Back Painted Tempered Glass Top; Must Specify Color and Finish ([See Options](#))
- Power and Data Options Available; Sold Separately ([See Multiple Power Unit Details](#))
- Strut Legs Sold Separately ([See Leg Options](#))



Double Kerf (F)
1³/₁₆"



Duo (G)
1³/₁₆"



Fluted (X)
1³/₁₆"



Square (Y)
1³/₁₆"



Knife (K)
1³/₁₆"



Vertical Square (H)
1¹/₂"

Pricing Codes:

P= HPL W= Wood Top

[See Strut Overview For Ordering Options](#)

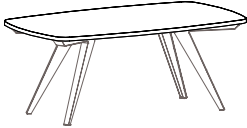
Item	Model No.	Materials	W	D	H	Ship Wt	Cubic Ft	Edge Profile + Material	List Price	
MODERN RECTANGLE SHAPE MEETING TOP 36"D  88-3672MR Shown BASES SOLD SEPARATELY	72"W x 36"D or 6' - 1 Piece Modern Rectangle Top									
	88-3672MR	Laminate	72	36	1 3/16	109	10.3	F, G, X, Y / P\$	1242	
					1 3/16			K / P\$	2508	
					1 1/2			H / P\$	1396	
		Veneer			1 3/16			F, G, X, Y / W\$	1460	
					1 3/16			K / W\$	2824	
					1 1/2			H / W\$	1724	
		Glass			1/4			Acid Etched Glass Top \$	7658	
					1/4			Gloss Glass Top \$	6539	
	84"W x 36"D or 7' - 1 Piece Modern Rectangle Top									
		88-3684MR	Laminate	84	36	1 3/16	126	11.3	F, G, X, Y / P\$	1522
						1 3/16			K / P\$	2897
					1 1/2			H / P\$	1734	
		Veneer			1 3/16			F, G, X, Y / W\$	1715	
					1 3/16			K / W\$	3317	
					1 1/2			H / W\$	1982	
		Glass			1/4			Acid Etched Glass Top \$	8770	
					1/4			Gloss Glass Top \$	7467	
96"W x 36"D or 8' - 1 Piece Modern Rectangle Top										
	88-3696MR	Laminate	96	36	1 3/16	142	12.9	F, G, X, Y / P\$	1597	
					1 3/16			K / P\$	3163	
					1 1/2			H / P\$	1801	
		Veneer			1 3/16			F, G, X, Y / W\$	1808	
					1 3/16			K / W\$	3547	
					1 1/2			H / W\$	2154	
		Glass			1/4			Acid Etched Glass Top \$	9782	
					1/4			Gloss Glass Top \$	8294	

Must Specify (in this order):

- Model #
- Top/Edge Material
- Top/Edge Finish/Color
- Edge Profile
- Glass (Y/N)
- Glass Color + Surface Finish
- Power/Data
- Power/Data Location

Description

- Tops Available with Veneer (W) or HPL (P) Top in 1 3/16" and 1 1/2" Thicknesses
- Must Specify Edge Profile: 1 3/16" Thick/Double Kerf (F), Duo (G), Fluted (X), Square (Y), and Knife (K) Edge Profiles or 1 1/2" Thick/Vertical Square (H)
- Veneer (W) Top Grain Runs Depth of Top and HPL (P) Top Grain Runs Width of Top
- Available with Back Painted Tempered Glass Top; Must Specify Color and Finish ([See Options](#))
- Power and Data Options Available; Sold Separately ([See Multiple Power Unit Details](#))
- Strut Legs Sold Separately ([See Leg Options](#))



Double Kerf (F)
1 3/16"



Duo (G)
1 3/16"



Fluted (X)
1 3/16"



Square (Y)
1 3/16"



Knife (K)
1 3/16"



Vertical Square (H)
1 1/2"

Pricing Codes:

P= HPL W= Wood Top

[See Strut Overview For Ordering Options](#)

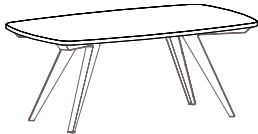
Item	Model No.	Materials	W	D	H	Ship Wt	Cubic Ft	Edge Profile + Material	List Price	
MODERN RECTANGLE SHAPE MEETING TOP 42"D  88-4272MR Shown BASES SOLD SEPARATELY	72"W x 42"D or 6' - 1 Piece Modern Rectangle Top									
	88-4272MR	Laminate	72	42	1 3/16	126	11.3	F, G, X, Y / P\$	1326	
					1 3/16			K / P\$	2766	
					1 1/2			H / P\$	1504	
		Veneer			1 3/16			F, G, X, Y / W\$	1652	
					1 3/16			K / W\$	3038	
					1 1/2			H / W\$	1952	
		Glass			1/4			Acid Etched Glass Top \$	8662	
					1/4			Gloss Glass Top \$	7359	
	84"W x 42"D or 7' - 1 Piece Modern Rectangle Top									
	88-4284MR	Laminate	84	42	1 3/16	145	13.1	F, G, X, Y / P\$	1585	
					1 3/16			K / P\$	3105	
				1 1/2			H / P\$	1794		
	Veneer			1 3/16			F, G, X, Y / W\$	1815		
				1 3/16			K / W\$	3478		
				1 1/2			H / W\$	2162		
	Glass			1/4			Acid Etched Glass Top \$	9852		
				1/4			Gloss Glass Top \$	8331		
96"W x 42"D or 8' - 1 Piece Modern Rectangle Top										
88-4296MR	Laminate	96	42	1 3/16	164	15.0	F, G, X, Y / P\$	1629		
				1 3/16			K / P\$	3346		
				1 1/2			H / P\$	1869		
	Veneer			1 3/16			F, G, X, Y / W\$	1965		
				1 3/16			K / W\$	3769		
				1 1/2			H / W\$	2360		
	Glass			1/4			Acid Etched Glass Top \$	11009		
				1/4			Gloss Glass Top \$	9272		

Must Specify (in this order):

- Model #
- Top/Edge Material
- Top/Edge Finish/Color
- Edge Profile
- Glass (Y/N)
- Glass Color + Surface Finish
- Power/Data
- Power/Data Location

Description

- Tops Available with Veneer (W) or HPL (P) Top in 1 3/16" and 1 1/2" Thicknesses
- Must Specify Edge Profile: 1 3/16" Thick/Double Kerf (F), Duo (G), Fluted (X), Square (Y), and Knife (K) Edge Profiles or 1 1/2" Thick/Vertical Square (H)
- Veneer (W) Top Grain Runs Depth of Top and HPL (P) Top Grain Runs Width of Top
- Available with Back Painted Tempered Glass Top; Must Specify Color and Finish ([See Options](#))
- Power and Data Options Available; Sold Separately ([See Multiple Power Unit Details](#))
- Strut Legs Sold Separately ([See Leg Options](#))



Double Kerf (F)
1 3/16"



Duo (G)
1 3/16"



Fluted (X)
1 3/16"



Square (Y)
1 3/16"



Knife (K)
1 3/16"



Vertical Square (H)
1 1/2"

Pricing Codes:
P= HPL W= Wood Top

[See Strut Overview For Ordering Options](#)

Item	Model No.	Materials	W	D	H	Ship Wt	Cubic Ft	Edge Profile + Material	List Price	
MODERN RECTANGLE SHAPE MEETING TOP 48"D  88-48216MR Shown BASES SOLD SEPARATELY	72"W x 48"D or 6' - 1 Piece Modern Rectangle Top									
	88-4872MR	Laminate	72	48	1 3/16	142	12.8	F, G, X, Y / P\$	1401	
					1 3/16			K / P\$	2957	
					1 1/2			H / P\$	1606	
		Veneer			1 3/16			F, G, X, Y / W\$	1831	
					1 3/16			K / W\$	3305	
					1 1/2			H / W\$	2170	
		Glass			1/4			Acid Etched Glass Top \$	9653	
					1/4			Gloss Glass Top \$	8163	
	84"W x 48"D or 7' - 1 Piece Modern Rectangle Top									
	88-4884MR	Laminate	84	48	1 3/16	164	15.0	F, G, X, Y / P\$	1665	
					1 3/16			K / P\$	3251	
					1 1/2			H / P\$	1904	
		Veneer			1 3/16			F, G, X, Y / W\$	1933	
					1 3/16			K / W\$	3663	
				1 1/2			H / W\$	2325		
	Glass			1/4			Acid Etched Glass Top \$	10913		
				1/4			Gloss Glass Top \$	9176		
96"W x 48"D or 8' - 1 Piece Modern Rectangle Top										
88-4896MR	Laminate	96	48	1 3/16	315	18.0	F, G, X, Y / P\$	1715		
				1 3/16			K / P\$	3653		
				1 1/2			H / P\$	1989		
	Veneer			1 3/16			F, G, X, Y / W\$	2188		
				1 3/16			K / W\$	3990		
				1 1/2			H / W\$	2632		
	Glass			1/4			Acid Etched Glass Top \$	12295		
				1/4			Gloss Glass Top \$	10309		
108"W x 48"D or 9' - 2 Piece Modern Rectangle Top										
88-48108MR	Laminate	108	48	1 3/16	218	23.5	F, G, X, Y / P\$	2515		
				1 3/16			K / P\$	4556		
				1 1/2			H / P\$	2828		
	Veneer			1 3/16			F, G, X, Y / W\$	2969		
				1 3/16			K / W\$	5130		
				1 1/2			H / W\$	3471		
	Glass			1/4			Acid Etched Glass Top \$	14192		
				1/4			Gloss Glass Top \$	11958		

Must Specify (in this order):

- Model #
- Top/Edge Material
- Top/Edge Finish/Color
- Edge Profile
- Glass (Y/N)
- Glass Color + Surface Finish
- Power/Data
- Power/Data Location

Additional 48" Modern Rectangle Shaped Tops on Next Page



Double Kerf (F)
1 3/16"



Duo (G)
1 3/16"



Fluted (X)
1 3/16"



Square (Y)
1 3/16"



Knife (K)
1 3/16"



Vertical Square (H)
1 1/2"

Pricing Codes:

P= HPL W= Wood Top

[See Strut Overview For Ordering Options](#)

Item	Model No.	Materials	W	D	H	Ship Wt	Cubic Ft	Edge Profile + Material	List Price		
<i>48"D CONTINUED FROM PREVIOUS PAGE</i>	120"W x 48"D or 10' - 2 Piece Modern Rectangle Top										
	88-48120MR	Laminate	120	48	1 ³ / ₁₆ "	240	23.5	F, G, X, Y / P\$	2578		
					1 ³ / ₁₆ "			K / P\$	4914		
					1 ¹ / ₂ "			H / P\$	2926		
		Veneer			1 ³ / ₁₆ "			F, G, X, Y / W\$	3219		
					1 ³ / ₁₆ "			K / W\$	5408		
					1 ¹ / ₂ "			H / W\$	3772		
		Glass			1/4"			Acid Etched Glass Top \$	15513		
					1/4"			Gloss Glass Top \$	13032		
		132"W x 48"D or 11' - 2 Piece Modern Rectangle Top									
	88-48132MR	Laminate	132	48	1 ³ / ₁₆ "	262	23.5	F, G, X, Y / P\$	2652		
					1 ³ / ₁₆ "			K / P\$	5179		
					1 ¹ / ₂ "			H / P\$	3033		
		Veneer			1 ³ / ₁₆ "			F, G, X, Y / W\$	3481		
					1 ³ / ₁₆ "			K / W\$	5807		
					1 ¹ / ₂ "			H / W\$	4087		
		Glass			1/4"			Acid Etched Glass Top \$	16845		
					1/4"			Gloss Glass Top \$	14115		
	144"W x 48"D or 12' - 2 Piece Modern Rectangle Top										
88-48144MR	Laminate	144	48	1 ³ / ₁₆ "	284	23.5	F, G, X, Y / P\$	2714			
				1 ³ / ₁₆ "			K / P\$	5435			
				1 ¹ / ₂ "			H / P\$	3132			
	Veneer			1 ³ / ₁₆ "			F, G, X, Y / W\$	3731			
				1 ³ / ₁₆ "			K / W\$	6190			
				1 ¹ / ₂ "			H / W\$	4390			
	Glass			1/4"			Acid Etched Glass Top \$	18166			
				1/4"			Gloss Glass Top \$	15187			
	156"W x 48"D or 13' - 2 Piece Modern Rectangle Top										
88-48156MR	Laminate	156	48	1 ³ / ₁₆ "	306	31.2	F, G, X, Y / P\$	3235			
				1 ³ / ₁₆ "			K / P\$	6014			
				1 ¹ / ₂ "			H / P\$	3687			
	Veneer			1 ³ / ₁₆ "			F, G, X, Y / W\$	3999			
				1 ³ / ₁₆ "			K / W\$	6772			
				1 ¹ / ₂ "			H / W\$	4711			
	Glass			1/4"			Acid Etched Glass Top \$	19582			
				1/4"			Gloss Glass Top \$	16355			

Must Specify (in this order):

- Model #
- Top/Edge Material
- Top/Edge Finish/Color
- Edge Profile
- Glass (Y/N)
- Glass Color + Surface Finish
- Power/Data
- Power/Data Location

Additional 48" Modern Rectangle Shaped Tops on Next Page



Double Kerf (F)
1³/₁₆"



Duo (G)
1³/₁₆"



Fluted (X)
1³/₁₆"



Square (Y)
1³/₁₆"



Knife (K)
1³/₁₆"



Vertical Square (H)
1¹/₂"

Pricing Codes:
P= HPL W= Wood Top

[See Strut Overview For Ordering Options](#)

Item	Model No.	Materials	W	D	H	Ship Wt	Cubic Ft	Edge Profile + Material	List Price		
<i>48"D CONTINUED FROM PREVIOUS PAGE</i>	168"W x 48"D or 14' - 2 Piece Modern Rectangle Top										
	88-48168MR	Laminate	168	48	1 $\frac{3}{16}$ "	328	31.2	F, G, X, Y / P\$	3283		
					1 $\frac{3}{16}$ "			K / P\$	6401		
					1 $\frac{1}{2}$ "			H / P\$	3771		
		Veneer			1 $\frac{3}{16}$ "			F, G, X, Y / W\$	4189		
					1 $\frac{3}{16}$ "			K / W\$	6978		
					1 $\frac{1}{2}$ "			H / W\$	4954		
		Glass			$\frac{1}{4}$ "			Acid Etched Glass Top \$	20889		
					$\frac{1}{4}$ "			Gloss Glass Top \$	17414		
		180"W x 48"D or 15' - 2 Piece Modern Rectangle Top									
	88-48180MR	Laminate	180	48	1 $\frac{3}{16}$ "	350	31.2	F, G, X, Y / P\$	3453		
					1 $\frac{3}{16}$ "			K / P\$	6766		
					1 $\frac{1}{2}$ "			H / P\$	3977		
		Veneer			1 $\frac{3}{16}$ "			F, G, X, Y / W\$	4536		
					1 $\frac{3}{16}$ "			K / W\$	7489		
					1 $\frac{1}{2}$ "			H / W\$	5352		
		Glass			$\frac{1}{4}$ "			Acid Etched Glass Top \$	22321		
					$\frac{1}{4}$ "			Gloss Glass Top \$	18598		
	192"W x 48"D or 16' - 2 Piece Modern Rectangle Top										
88-48192MR	Laminate	192	48	1 $\frac{3}{16}$ "	372	31.2	F, G, X, Y / P\$	3504			
				1 $\frac{3}{16}$ "			K / P\$	7007			
				1 $\frac{1}{2}$ "			H / P\$	4060			
	Veneer			1 $\frac{3}{16}$ "			F, G, X, Y / W\$	4727			
				1 $\frac{3}{16}$ "			K / W\$	7844			
				1 $\frac{1}{2}$ "			H / W\$	5596			
	Glass			$\frac{1}{4}$ "			Acid Etched Glass Top \$	23629			
				$\frac{1}{4}$ "			Gloss Glass Top \$	19658			
	204"W x 48"D or 17' - 3 Piece Modern Rectangle Top										
88-48204MR	Laminate	204	48	1 $\frac{3}{16}$ "	394	48.9	F, G, X, Y / P\$	4085			
				1 $\frac{3}{16}$ "			K / P\$	7813			
				1 $\frac{1}{2}$ "			H / P\$	4675			
	Veneer			1 $\frac{3}{16}$ "			F, G, X, Y / W\$	5725			
				1 $\frac{3}{16}$ "			K / W\$	9084			
				1 $\frac{1}{2}$ "			H / W\$	6541			
	Glass			$\frac{1}{4}$ "			Acid Etched Glass Top \$	25510			
				$\frac{1}{4}$ "			Gloss Glass Top \$	21291			

Must Specify (in this order):

- Model #
- Top/Edge Material
- Top/Edge Finish/Color
- Edge Profile
- Glass (Y/N)
- Glass Color + Surface Finish
- Power/Data
- Power/Data Location

Additional 48" Modern Rectangle Shaped Tops on Next Page



Double Kerf (F)
1 $\frac{3}{16}$ "



Duo (G)
1 $\frac{3}{16}$ "



Fluted (X)
1 $\frac{3}{16}$ "



Square (Y)
1 $\frac{3}{16}$ "



Knife (K)
1 $\frac{3}{16}$ "



Vertical Square (H)
1 $\frac{1}{2}$ "

Pricing Codes:

P= HPL W= Wood Top

[See Strut Overview For Ordering Options](#)

Item	Model No.	Materials	W	D	H	Ship Wt	Cubic Ft	Edge Profile + Material	List Price		
<i>48"D CONTINUED FROM PREVIOUS PAGE</i>	216"W x 48"D or 18' - 3 Piece Modern Rectangle Top										
	88-48216MR	Laminate	216	48	1 ³ / ₁₆	416	48.9	F, G, X, Y / P\$	4134		
					1 ³ / ₁₆			K / P\$	8053		
					1 ¹ / ₂			H / P\$	4759		
		Veneer			1 ³ / ₁₆			F, G, X, Y / W\$	6020		
					1 ³ / ₁₆			K / W\$	9482		
					1 ¹ / ₂			H / W\$	6883		
		Glass			1/4			Acid Etched Glass Top \$	26818		
					1/4			Gloss Glass Top \$	22351		
		228"W x 48"D or 19' - 3 Piece Modern Rectangle Top									
	88-48228MR	Laminate	228	48	1 ³ / ₁₆	438	48.9	F, G, X, Y / P\$	5151		
					1 ³ / ₁₆			K / P\$	9289		
					1 ¹ / ₂			H / P\$	5811		
		Veneer			1 ³ / ₁₆			F, G, X, Y / W\$	6770		
					1 ³ / ₁₆			K / W\$	10334		
					1 ¹ / ₂			H / W\$	7680		
		Glass			1/4			Acid Etched Glass Top \$	28557		
					1/4			Gloss Glass Top \$	23842		
	240"W x 48"D or 20' - 3 Piece Modern Rectangle Top										
88-48240MR	Laminate	240	48	1 ³ / ₁₆	460	48.9	F, G, X, Y / P\$	5201			
				1 ³ / ₁₆			K / P\$	9530			
				1 ¹ / ₂			H / P\$	5894			
	Veneer			1 ³ / ₁₆			F, G, X, Y / W\$	7066			
				1 ³ / ₁₆			K / W\$	10731			
				1 ¹ / ₂			H / W\$	8020			
	Glass			1/4			Acid Etched Glass Top \$	29865			
				1/4			Gloss Glass Top \$	24900			

Must Specify (in this order):

- Model #
- Top/Edge Material
- Top/Edge Finish/Color
- Edge Profile
- Glass (Y/N)
- Glass Color + Surface Finish
- Power/Data
- Power/Data Location

Description

- Tops Available with Veneer (W) or HPL (P) Top in 1³/₁₆" and 1¹/₂" Thicknesses
- Must Specify Edge Profile: 1³/₁₆" Thick/Double Kerf (F), Duo (G), Fluted (X), Square (Y), and Knife (K) Edge Profiles or 1¹/₂" Thick/Vertical Square (H)
- Veneer (W) Top Grain Runs Depth of Top and HPL (P) Top Grain Runs Width of Top
- All Veneer Tops, as well as Laminate Tops up to 144" (12 feet), have Matching Woodgrain. Laminate Tops Sized 156" (13 feet) and Longer have Non-Matching Woodgrain
- Available with Back Painted Tempered Glass Top; Must Specify Color and Finish ([See Options](#))
- Dock800, Oasis, and E2X Power Units Available on Ends Only (E1 and E2) for 108"D - 156"D and 204"D-240"D Tops
- Power and Data Options Available; Sold Separately ([See Multiple Power Unit Details](#))
- Strut Legs Sold Separately ([See Leg Options](#))



Double Kerf (F) 1³/₁₆" Duo (G) 1³/₁₆" Fluted (X) 1³/₁₆" Square (Y) 1³/₁₆" Knife (K) 1³/₁₆" Vertical Square (H) 1¹/₂"

Pricing Codes:
P= HPL W= Wood Top

[See Strut Overview For Ordering Options](#)

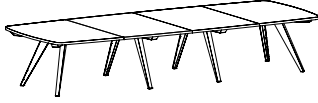
Item	Model No.	Materials	W	D	H	Ship Wt	Cubic Ft	Edge Profile + Material	List Price	
MODERN RECTANGLE SHAPE MEETING TOP 54"D  88-54156MR Shown in Veneer BASES SOLD SEPARATELY	120"W x 54"D or 10' - 3 Piece Veneer (W) and 2 Piece HPL (P) Modern Rectangle Top									
	88-54120MR	Laminate	120	54	1 $\frac{3}{16}$ "	260	12.1	F, G, X, Y / P\$	2863	
					1 $\frac{3}{16}$ "			K / P\$	5359	
					1 $\frac{1}{2}$ "			H / P\$	3256	
		Veneer			1 $\frac{3}{16}$ "			F, G, X, Y / W\$	4351	
					1 $\frac{3}{16}$ "			K / W\$	6646	
					1 $\frac{1}{2}$ "			H / W\$	4900	
		Glass			$\frac{1}{4}$ "			Acid Etched Glass Top \$	17505	
					$\frac{1}{4}$ "			Gloss Glass Top \$	14714	
	132"W x 54"D or 11' - 3 Piece Veneer (W) and 2 Piece HPL (P) Modern Rectangle Top									
	88-54132MR	Laminate	132	54	1 $\frac{3}{16}$ "	285	13.2	F, G, X, Y / P\$	2931	
					1 $\frac{3}{16}$ "			K / P\$	5630	
				1 $\frac{1}{2}$ "			H / P\$	3364		
	Veneer			1 $\frac{3}{16}$ "			F, G, X, Y / W\$	4586		
				1 $\frac{3}{16}$ "			K / W\$	7047		
				1 $\frac{1}{2}$ "			H / W\$	5184		
	Glass			$\frac{1}{4}$ "			Acid Etched Glass Top \$	18970		
				$\frac{1}{4}$ "			Gloss Glass Top \$	15900		
144"W x 54"D or 12' - 3 Piece Veneer (W) and 2 Piece HPL (P) Modern Rectangle Top										
88-54144MR	Laminate	144	54	1 $\frac{3}{16}$ "	309	15.0	F, G, X, Y / P\$	3000		
				1 $\frac{3}{16}$ "			K / P\$	5899		
				1 $\frac{1}{2}$ "			H / P\$	3473		
	Veneer			1 $\frac{3}{16}$ "			F, G, X, Y / W\$	4822		
				1 $\frac{3}{16}$ "			K / W\$	7451		
				1 $\frac{1}{2}$ "			H / W\$	7451		
	Glass			$\frac{1}{4}$ "			Acid Etched Glass Top \$	20439		
				$\frac{1}{4}$ "			Gloss Glass Top \$	17088		
156"W x 54"D or 13' - 4 Piece Veneer (W) and 2 Piece HPL (P) Modern Rectangle Top										
88-54156MR	Laminate	156	54	1 $\frac{3}{16}$ "	334	16.0	F, G, X, Y / P\$	3529		
				1 $\frac{3}{16}$ "			K / P\$	6641		
				1 $\frac{1}{2}$ "			H / P\$	4040		
	Veneer			1 $\frac{3}{16}$ "			F, G, X, Y / W\$	5841		
				1 $\frac{3}{16}$ "			K / W\$	8748		
				1 $\frac{1}{2}$ "			H / W\$	6632		
	Glass			$\frac{1}{4}$ "			Acid Etched Glass Top \$	22264		
				$\frac{1}{4}$ "			Gloss Glass Top \$	18635		

Additional 54" Modern Rectangle Shaped Tops on Next Page



Double Kerf (F)
1 $\frac{3}{16}$ "



Duo (G)
1 $\frac{3}{16}$ "



Fluted (X)
1 $\frac{3}{16}$ "



Square (Y)
1 $\frac{3}{16}$ "



Knife (K)
1 $\frac{3}{16}$ "



Vertical Square (H)
1 $\frac{1}{2}$ "

Pricing Codes:

P= HPL W= Wood Top

[See Strut Overview For Ordering Options](#)

Item	Model No.	Materials	W	D	H	Ship Wt	Cubic Ft	Edge Profile + Material	List Price	
168"W x 54"D or 14' - 4 Piece Veneer (W) and 2 Piece HPL (P) Modern Rectangle Top										
<i>54"D CONTINUED FROM PREVIOUS PAGE</i>	88-54168MR	Laminate	168	54	1 ³ / ₁₆	359	17.0	F, G, X, Y / P\$	3582	
					1 ³ / ₁₆			K / P\$	6897	
					1 ¹ / ₂			H / P\$	4134	
		Veneer			1 ³ / ₁₆			F, G, X, Y / W\$	6090	
					1 ³ / ₁₆			K / W\$	9174	
					1 ¹ / ₂			H / W\$	6939	
		Glass			1/4			Acid Etched Glass Top \$	23720	
					1/4			Gloss Glass Top \$	19811	
	180"W x 54"D or 15' - 4 Piece Veneer (W) and 2 Piece HPL (P) Modern Rectangle Top									
	Must Specify (in this order): Model # Top/Edge Material Top/Edge Finish/Color Edge Profile Glass (Y/N) Glass Color + Surface Finish Power/Data Power/Data Location	88-54180MR	Laminate	180	54	1 ³ / ₁₆	384	18.0	F, G, X, Y / P\$	3638
					1 ³ / ₁₆			K / P\$	7153	
					1 ¹ / ₂			H / P\$	4226	
		Veneer			1 ³ / ₁₆			F, G, X, Y / W\$	6337	
					1 ³ / ₁₆			K / W\$	9598	
					1 ¹ / ₂			H / W\$	7244	
		Glass			1/4			Acid Etched Glass Top \$	25175	
					1/4			Gloss Glass Top \$	20987	
192"W x 54"D or 16' - 4 Piece Veneer (W) and 2 Piece HPL (P) Modern Rectangle Top										
		88-54192MR	Laminate	192	54	1 ³ / ₁₆	408	19.0	F, G, X, Y / P\$	3690
					1 ³ / ₁₆			K / P\$	7408	
					1 ¹ / ₂			H / P\$	4319	
		Veneer			1 ³ / ₁₆			F, G, X, Y / W\$	6586	
					1 ³ / ₁₆			K / W\$	10023	
					1 ¹ / ₂			H / W\$	7550	
		Glass			1/4			Acid Etched Glass Top \$	26629	
					1/4			Gloss Glass Top \$	22161	
	204"W x 54"D or 17' - 5 Piece Veneer (W) and 3 Piece HPL (P) Modern Rectangle Top									
		88-54204MR	Laminate	204	54	1 ³ / ₁₆	445	21.0	F, G, X, Y / P\$	4484
					1 ³ / ₁₆			K / P\$	8442	
					1 ¹ / ₂			H / P\$	5150	
		Veneer			1 ³ / ₁₆			F, G, X, Y / W\$	7983	
					1 ³ / ₁₆			K / W\$	11622	
					1 ¹ / ₂			H / W\$	9009	
		Glass			1/4			Acid Etched Glass Top \$	28863	
					1/4			Gloss Glass Top \$	24118	

Additional 54" Modern Rectangle Shaped Tops on Next Page



Double Kerf (F)
1³/₁₆"



Duo (G)
1³/₁₆"



Fluted (X)
1³/₁₆"



Square (Y)
1³/₁₆"



Knife (K)
1³/₁₆"



Vertical Square (H)
1¹/₂"

Pricing Codes:
P= HPL W= Wood Top

[See Strut Overview For Ordering Options](#)

Item	Model No.	Materials	W	D	H	Ship Wt	Cubic Ft	Edge Profile + Material	List Price	
<i>54"D CONTINUED FROM PREVIOUS PAGE</i>	216"W x 54"D or 18' - 5 Piece Veneer (W) and 3 Piece HPL (P) Modern Rectangle Top									
	88-54216MR	Laminate	216	54	1 $\frac{3}{16}$ "	470	22.0	F, G, X, Y / P\$	4538	
					1 $\frac{3}{16}$ "			K / P\$	8696	
					1 $\frac{1}{2}$ "			H / P\$	5243	
		Veneer			1 $\frac{3}{16}$ "			F, G, X, Y / W\$	8254	
					1 $\frac{3}{16}$ "			K / W\$	12067	
					1 $\frac{1}{2}$ "			H / W\$	9337	
		Glass			1 $\frac{1}{4}$ "			Acid Etched Glass Top \$	30316	
					1 $\frac{1}{4}$ "			Gloss Glass Top \$	25292	
	228"W x 54"D or 19' - 5 Piece Veneer (W) and 3 Piece HPL (P) Modern Rectangle Top									
	88-54228MR	Laminate	228	54	1 $\frac{3}{16}$ "	495	23.0	F, G, X, Y / P\$	5205	
					1 $\frac{3}{16}$ "			K / P\$	9582	
					1 $\frac{1}{2}$ "			H / P\$	5949	
		Veneer			1 $\frac{3}{16}$ "			F, G, X, Y / W\$	8524	
					1 $\frac{3}{16}$ "			K / W\$	12513	
					1 $\frac{1}{2}$ "			H / W\$	9664	
		Glass			1 $\frac{1}{4}$ "			Acid Etched Glass Top \$	31810	
					1 $\frac{1}{4}$ "			Gloss Glass Top \$	26507	
240"W x 54"D or 20' - 5 Piece Veneer (W) and 3 Piece HPL (P) Modern Rectangle Top										
88-54240MR	Laminate	240	54	1 $\frac{3}{16}$ "	519	24.0	F, G, X, Y / P\$	5258		
				1 $\frac{3}{16}$ "			K / P\$	9837		
				1 $\frac{1}{2}$ "			H / P\$	6042		
	Veneer			1 $\frac{3}{16}$ "			F, G, X, Y / W\$	8796		
				1 $\frac{3}{16}$ "			K / W\$	12959		
				1 $\frac{1}{2}$ "			H / W\$	9992		
	Glass			1 $\frac{1}{4}$ "			Acid Etched Glass Top \$	33265		
				1 $\frac{1}{4}$ "			Gloss Glass Top \$	27681		

Must Specify (in this order):

Model #
 Top/Edge Material
 Top/Edge Finish/Color
 Edge Profile
 Glass (Y/N)
 Glass Color + Surface Finish
 Power/Data
 Power/Data Location

Description

- Tops Available with Veneer (W) or HPL (P) Top in 1 $\frac{3}{16}$ " and 1 $\frac{1}{2}$ " Thicknesses
- Must Specify Edge Profile: 1 $\frac{3}{16}$ " Thick/Double Kerf (F), Duo (G), Fluted (X), Square (Y), and Knife (K) Edge Profiles or 1 $\frac{1}{2}$ " Thick/Vertical Square (H)
- Veneer (W) Top Grain Runs Depth of Top and HPL (P) Top Grain Runs Width of Top
- All Veneer Tops, as well as Laminate Tops up to 144" (12 feet), have Matching Woodgrain. Laminate Tops Sized 156" (13 feet) and Longer have Non-Matching Woodgrain
- Available with Back Painted Tempered Glass Top; Must Specify Color and Finish ([See Options](#))
- Power and Data Options Available; Sold Separately ([See Multiple Power Unit Details](#))
- Strut Legs Sold Separately ([See Leg Options](#))



Double Kerf (F)
1 $\frac{3}{16}$ "



Duo (G)
1 $\frac{3}{16}$ "



Fluted (X)
1 $\frac{3}{16}$ "



Square (Y)
1 $\frac{3}{16}$ "



Knife (K)
1 $\frac{3}{16}$ "



Vertical Square (H)
1 $\frac{1}{2}$ "

Pricing Codes:

P= HPL W= Wood Top

[See Strut Overview For Ordering Options](#)

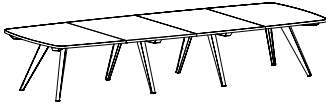
Item	Model No.	Materials	W	D	H	Ship Wt	Cubic Ft	Edge Profile + Material	List Price
MODERN RECTANGLE SHAPE MEETING TOP 60"D  88-60156MR Shown in Veneer BASES SOLD SEPARATELY	120"W x 60"D or 10' - 3 Piece Veneer (W) and 2 Piece HPL (P) Modern Rectangle Top								
	88-60120MR	Laminate	120	60	1 3/16"	287	13.3	F, G, X, Y / P\$	2916
					1 3/16"			K / P\$	5566
					1 1/2"			H / P\$	3354
		Veneer			1 3/16"			F, G, X, Y / W\$	4602
					1 3/16"			K / W\$	6994
					1 1/2"			H / W\$	5204
		Glass			1/4"			Acid Etched Glass Top \$	19040
					1/4"			Gloss Glass Top \$	15938
	132"W x 60"D or 11' - 3 Piece Veneer (W) and 2 Piece HPL (P) Modern Rectangle Top								
	88-60132MR	Laminate	132	60	1 3/16"	323	14.6	F, G, X, Y / P\$	2989
					1 3/16"			K / P\$	5848
				1 1/2"			H / P\$	3472	
	Veneer			1 3/16"			F, G, X, Y / W\$	4862	
				1 3/16"			K / W\$	7424	
				1 1/2"			H / W\$	5519	
	Glass			1/4"			Acid Etched Glass Top \$	20655	
				1/4"			Gloss Glass Top \$	17244	
144"W x 60"D or 12' - 3 Piece Veneer (W) and 2 Piece HPL (P) Modern Rectangle Top									
88-60144MR	Laminate	144	60	1 3/16"	342	16.0	F, G, X, Y / P\$	3062	
				1 3/16"			K / P\$	6134	
				1 1/2"			H / P\$	3589	
	Veneer			1 3/16"			F, G, X, Y / W\$	5122	
				1 3/16"			K / W\$	7858	
				1 1/2"			H / W\$	5837	
	Glass			1/4"			Acid Etched Glass Top \$	22274	
				1/4"			Gloss Glass Top \$	18550	
156"W x 60"D or 13' - 4 Piece Veneer (W) and 2 Piece HPL (P) Modern Rectangle Top									
88-60156MR	Laminate	156	60	1 3/16"	376	17.2	F, G, X, Y / P\$	3595	
				1 3/16"			K / P\$	6891	
				1 1/2"			H / P\$	4166	
	Veneer			1 3/16"			F, G, X, Y / W\$	6187	
				1 3/16"			K / W\$	9217	
				1 1/2"			H / W\$	7058	
	Glass			1/4"			Acid Etched Glass Top \$	24247	
				1/4"			Gloss Glass Top \$	20214	

Additional 60" Modern Rectangle Shaped Tops on Next Page



Pricing Codes:
P= HPL W= Wood Top

[See Strut Overview For Ordering Options](#)

Item	Model No.	Materials	W	D	H	Ship Wt	Cubic Ft	Edge Profile + Material	List Price	
<i>60"D CONTINUED FROM PREVIOUS PAGE</i>	168"W x 60"D or 14' - 4 Piece Veneer (W) and 2 Piece HPL (P) Modern Rectangle Top									
	88-60168MR	Laminate	168	60	1 3/16	403	18.5	F, G, X, Y / P\$	3654	
					1 3/16			K / P\$	7160	
					1 1/2			H / P\$	4267	
		Veneer			1 3/16			F, G, X, Y / W\$	6461	
					1 3/16			K / W\$	9671	
					1 1/2			H / W\$	7396	
		Glass			1/4			Acid Etched Glass Top \$	25849	
					1/4			Gloss Glass Top \$	21507	
	180"W x 60"D or 15' - 4 Piece Veneer (W) and 2 Piece HPL (P) Modern Rectangle Top									
	88-60180MR	Laminate	180	60	1 3/16	431	19.8	F, G, X, Y / P\$	3713	
					1 3/16			K / P\$	7428	
					1 1/2			H / P\$	4370	
		Veneer			1 3/16			F, G, X, Y / W\$	6735	
					1 3/16			K / W\$	10125	
					1 1/2			H / W\$	7735	
		Glass			1/4			Acid Etched Glass Top \$	27451	
					1/4			Gloss Glass Top \$	22798	
192"W x 60"D or 16' - 4 Piece Veneer (W) and 2 Piece HPL (P) Modern Rectangle Top										
88-60192MR	Laminate	192	60	1 3/16	458	21.1	F, G, X, Y / P\$	3772		
				1 3/16			K / P\$	7698		
				1 1/2			H / P\$	4472		
	Veneer			1 3/16			F, G, X, Y / W\$	7010		
				1 3/16			K / W\$	10579		
				1 1/2			H / W\$	8073		
	Glass			1/4			Acid Etched Glass Top \$	29052		
				1/4			Gloss Glass Top \$	24087		
204"W x 60"D or 17' - 5 Piece Veneer (W) and 3 Piece HPL (P) Modern Rectangle Top										
88-60204MR	Laminate	204	60	1 3/16	492	22.4	F, G, X, Y / P\$	4569		
				1 3/16			K / P\$	8748		
				1 1/2			H / P\$	5313		
	Veneer			1 3/16			F, G, X, Y / W\$	8475		
				1 3/16			K / W\$	12247		
				1 1/2			H / W\$	9603		
	Glass			1/4			Acid Etched Glass Top \$	31436		
				1/4			Gloss Glass Top \$	26163		

Must Specify (in this order):
 Model #
 Top/Edge Material
 Top/Edge Finish/Color
 Edge Profile
 Glass (Y/N)
 Glass Color + Surface Finish
 Power/Data
 Power/Data Location

Additional 60" Modern Rectangle Shaped Tops on Next Page



Double Kerf (F)
1 3/16"



Duo (G)
1 3/16"



Fluted (X)
1 3/16"



Square (Y)
1 3/16"



Knife (K)
1 3/16"



Vertical Square (H)
1 1/2"

Pricing Codes:
 P= HPL W= Wood Top

[See Strut Overview For Ordering Options](#)

Item	Model No.	Materials	W	D	H	Ship Wt	Cubic Ft	Edge Profile + Material	List Price	
<i>60"D CONTINUED FROM PREVIOUS PAGE</i>	216"W x 60"D or 18' - 5 Piece Veneer (W) and 3 Piece HPL (P) Modern Rectangle Top									
	88-60216MR	Laminate	216	60	1 ³ / ₁₆	519	23.7	F, G, X, Y / P\$	4628	
					1 ³ / ₁₆			K / P\$	9018	
					1 ¹ / ₂			H / P\$	5415	
		Veneer			1 ³ / ₁₆			F, G, X, Y / W\$	8774	
					1 ³ / ₁₆			K / W\$	12726	
					1 ¹ / ₂			H / W\$	9966	
		Glass			1/4			Acid Etched Glass Top \$	33037	
					1/4			Gloss Glass Top \$	27453	
	228"W x 60"D or 19' - 5 Piece Veneer (W) and 3 Piece HPL (P) Modern Rectangle Top									
	88-60228MR	Laminate	228	60	1 ³ / ₁₆	547	25.0	F, G, X, Y / P\$	5300	
					1 ³ / ₁₆			K / P\$	9916	
					1 ¹ / ₂			H / P\$	6131	
		Veneer			1 ³ / ₁₆			F, G, X, Y / W\$	9073	
					1 ³ / ₁₆			K / W\$	13205	
				1 ¹ / ₂			H / W\$	10327		
	Glass			1/4			Acid Etched Glass Top \$	34679		
				1/4			Gloss Glass Top \$	28785		
240"W x 60"D or 20' - 5 Piece Veneer (W) and 3 Piece HPL (P) Modern Rectangle Top										
88-60240MR	Laminate	240	60	1 ³ / ₁₆	574	26.3	F, G, X, Y / P\$	5358		
				1 ³ / ₁₆			K / P\$	10186		
				1 ¹ / ₂			H / P\$	6233		
	Veneer			1 ³ / ₁₆			F, G, X, Y / W\$	9373		
				1 ³ / ₁₆			K / W\$	13684		
				1 ¹ / ₂			H / W\$	10691		
	Glass			1/4			Acid Etched Glass Top \$	36281		
				1/4			Gloss Glass Top \$	30076		

Must Specify (in this order):
 Model #
 Top/Edge Material
 Top/Edge Finish/Color
 Edge Profile
 Glass (Y/N)
 Glass Color + Surface Finish
 Power/Data Type
 Power/Data Location

Description

- Tops Available with Veneer (W) or HPL (P) Top in 1³/₁₆" and 1¹/₂" Thicknesses
- Must Specify Edge Profile: 1³/₁₆" Thick/Double Kerf (F), Duo (G), Fluted (X), Square (Y), and Knife (K) Edge Profiles or 1¹/₂" Thick/Vertical Square (H)
- Veneer (W) Top Grain Runs Depth of Top and HPL (P) Top Grain Runs Width of Top
- All Veneer Tops, as well as Laminate Tops up to 144" (12 feet), have Matching Woodgrain. Laminate Tops Sized 156" (13 feet) and Longer have Non-Matching Woodgrain
- Available with Back Painted Tempered Glass Top; Must Specify Color and Finish ([See Options](#))
- Power and Data Options Available; Sold Separately ([See Multiple Power Unit Details](#))
- Strut Legs Sold Separately ([See Leg Options](#))



Double Kerf (F)
1³/₁₆"



Duo (G)
1³/₁₆"



Fluted (X)
1³/₁₆"



Square (Y)
1³/₁₆"



Knife (K)
1³/₁₆"



Vertical Square (H)
1¹/₂"

Pricing Codes:
 P= HPL W= Wood Top

[See Strut Overview For Ordering Options](#)

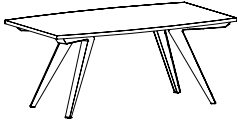
Item	Model No.	Materials	W	D	H	Ship Wt	Cubic Ft	Edge Profile + Material	List Price	
BOAT SHAPE MEETING TOP 36"D  <p>88-3696BT Shown BASES SOLD SEPARATELY</p>	72"W x 36"D or 6' - 1 Piece Boat Top									
	88-3672BT	Laminate	72	36-30	1 $\frac{3}{16}$ "	109	10.3	F, G, X, Y / P\$	1242	
					1 $\frac{3}{16}$ "			K / P\$	2508	
					1 $\frac{1}{2}$ "			H / P\$	1396	
		Veneer			1 $\frac{3}{16}$ "			F, G, X, Y / W\$	1460	
					1 $\frac{3}{16}$ "			K / W\$	2824	
					1 $\frac{1}{2}$ "			H / W\$	1724	
		Glass			1 $\frac{1}{4}$ "			Acid Etched Glass Top \$	7658	
					1 $\frac{1}{4}$ "			Gloss Glass Top \$	6539	
	84"W x 36"D or 7' - 1 Piece Boat Top									
	Must Specify (in this order): Model # Top/Edge Material Top/Edge Finish/Color Edge Profile Glass (Y/N) Glass Color + Surface Finish Power/Data Power/Data Location	88-3684BT	Laminate	84	36-30	1 $\frac{3}{16}$ "	126	11.3	F, G, X, Y / P\$	1522
						1 $\frac{3}{16}$ "			K / P\$	2897
					1 $\frac{1}{2}$ "			H / P\$	1734	
		Veneer			1 $\frac{3}{16}$ "			F, G, X, Y / W\$	1715	
					1 $\frac{3}{16}$ "			K / W\$	3317	
					1 $\frac{1}{2}$ "			H / W\$	1982	
		Glass			1 $\frac{1}{4}$ "			Acid Etched Glass Top \$	8770	
					1 $\frac{1}{4}$ "			Gloss Glass Top \$	7467	
96"W x 36"D or 8' - 1 Piece Boat Top										
88-3696BT		Laminate	96	36-30	1 $\frac{3}{16}$ "	142	12.9	F, G, X, Y / P\$	1597	
					1 $\frac{3}{16}$ "			K / P\$	3163	
					1 $\frac{1}{2}$ "			H / P\$	1801	
	Veneer			1 $\frac{3}{16}$ "			F, G, X, Y / W\$	1808		
				1 $\frac{3}{16}$ "			K / W\$	3547		
				1 $\frac{1}{2}$ "			H / W\$	2154		
	Glass			1 $\frac{1}{4}$ "			Acid Etched Glass Top \$	9782		
				1 $\frac{1}{4}$ "			Gloss Glass Top \$	8294		

Description

- Tops Available with Veneer (W) or HPL (P) Top in 1 $\frac{3}{16}$ " and 1 $\frac{1}{2}$ " Thicknesses
- Must Specify Edge Profile: 1 $\frac{3}{16}$ " Thick/Double Kerf (F), Duo (G), Fluted (X), Square (Y), and Knife (K) Edge Profiles or 1 $\frac{1}{2}$ " Thick/Vertical Square (H)
- Veneer (W) Top Grain Runs Depth of Top and HPL (P) Top Grain Runs Width of Top
- Available with Back Painted Tempered Glass Top; Must Specify Color and Finish ([See Options](#))
- Power and Data Options Available; Sold Separately ([See Multiple Power Unit Details](#))
- Strut Legs Sold Separately ([See Leg Options](#))



Double Kerf (F)
1 $\frac{3}{16}$ "



Duo (G)
1 $\frac{3}{16}$ "



Fluted (X)
1 $\frac{3}{16}$ "



Square (Y)
1 $\frac{3}{16}$ "



Knife (K)
1 $\frac{3}{16}$ "



Vertical Square (H)
1 $\frac{1}{2}$ "

Pricing Codes:

P= HPL W= Wood Top

[See Strut Overview For Ordering Options](#)

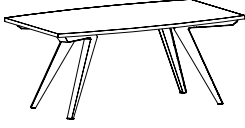
Item	Model No.	Materials	W	D	H	Ship Wt	Cubic Ft	Edge Profile + Material	List Price	
BOAT SHAPE MEETING TOP 42"D  88-3696BT Shown BASES SOLD SEPARATELY	72"W x 42"D or 6' - 1 Piece Boat Top									
	88-4272BT	Laminate	72	42-36	1 3/16	164	15.0	F, G, X, Y / P\$	1326	
					1 3/16			K / P\$	2766	
					1 1/2			H / P\$	1504	
		Veneer			1 3/16			F, G, X, Y / W\$	1652	
					1 3/16			K / W\$	3038	
					1 1/2			H / W\$	1952	
		Glass			1/4			Acid Etched Glass Top \$	8662	
					1/4			Gloss Glass Top \$	7359	
	84"W x 42"D or 7' - 1 Piece Boat Top									
	88-4284BT	Laminate	84	42-36	1 3/16	145	13.1	F, G, X, Y / P\$	1585	
					1 3/16			K / P\$	3105	
					1 1/2			H / P\$	1794	
		Veneer			1 3/16			F, G, X, Y / W\$	1815	
					1 3/16			K / W\$	3478	
				1 1/2			H / W\$	2162		
	Glass			1/4			Acid Etched Glass Top \$	9852		
				1/4			Gloss Glass Top \$	8331		
96"W x 42"D or 8' - 1 Piece Boat Top										
88-4296BT	Laminate	96	42-36	1 3/16	164	15.0	F, G, X, Y / P\$	1629		
				1 3/16			K / P\$	3346		
				1 1/2			H / P\$	1869		
	Veneer			1 3/16			F, G, X, Y / W\$	1965		
				1 3/16			K / W\$	3769		
				1 1/2			H / W\$	2360		
	Glass			1/4			Acid Etched Glass Top \$	11009		
				1/4			Gloss Glass Top \$	9272		

Must Specify (in this order):

- Model #
- Top/Edge Material
- Top/Edge Finish/Color
- Edge Profile
- Glass (Y/N)
- Glass Color + Surface Finish
- Power/Data
- Power/Data Location

Description

- Tops Available with Veneer (W) or HPL (P) Top in 1 3/16" and 1 1/2" Thicknesses
- Must Specify Edge Profile: 1 3/16" Thick/Double Kerf (F), Duo (G), Fluted (X), Square (Y), and Knife (K) Edge Profiles or 1 1/2" Thick/Vertical Square (H)
- Veneer (W) Top Grain Runs Depth of Top and HPL (P) Top Grain Runs Width of Top
- Available with Back Painted Tempered Glass Top; Must Specify Color and Finish ([See Options](#))
- Power and Data Options Available; Sold Separately ([See Multiple Power Unit Details](#))
- Strut Legs Sold Separately ([See Leg Options](#))



Double Kerf (F)
1 3/16"



Duo (G)
1 3/16"



Fluted (X)
1 3/16"



Square (Y)
1 3/16"



Knife (K)
1 3/16"



Vertical Square (H)
1 1/2"

Pricing Codes:
P= HPL W= Wood Top

[See Strut Overview For Ordering Options](#)

Item	Model No.	Materials	W	D	H	Ship Wt	Cubic Ft	Edge Profile + Material	List Price	
BOAT SHAPE MEETING TOP 48"D  88-48216BT Shown BASES SOLD SEPARATELY	72"W x 48"D or 6' - 1 Piece Boat Top									
	88-4872BT	Laminate	72	48-36	1 $\frac{3}{16}$ "	142	12.8	F, G, X, Y / P\$	1401	
					1 $\frac{3}{16}$ "			K / P\$	2957	
					1 $\frac{1}{2}$ "			H / P\$	1606	
		Veneer			1 $\frac{3}{16}$ "			F, G, X, Y / W\$	1831	
					1 $\frac{3}{16}$ "			K / W\$	3305	
					1 $\frac{1}{2}$ "			H / W\$	2170	
		Glass			$\frac{1}{4}$ "			Acid Etched Glass Top \$	9653	
					$\frac{1}{4}$ "			Gloss Glass Top \$	8163	
	84"W x 48"D or 7' - 1 Piece Boat Top									
	Must Specify (in this order): Model # Top/Edge Material Top/Edge Finish/Color Edge Profile Glass (Y/N) Glass Color + Surface Finish Power/Data Power/Data Location	88-4884BT	Laminate	84	48-36	1 $\frac{3}{16}$ "	164	15.0	F, G, X, Y / P\$	1665
						1 $\frac{3}{16}$ "			K / P\$	3251
					1 $\frac{1}{2}$ "			H / P\$	1904	
		Veneer			1 $\frac{3}{16}$ "			F, G, X, Y / W\$	1933	
					1 $\frac{3}{16}$ "			K / W\$	3663	
					1 $\frac{1}{2}$ "			H / W\$	2325	
		Glass			$\frac{1}{4}$ "			Acid Etched Glass Top \$	10913	
					$\frac{1}{4}$ "			Gloss Glass Top \$	9176	
96"W x 48"D or 8' - 1 Piece Boat Top										
88-4896BT		Laminate	96	48-36	1 $\frac{3}{16}$ "	295	27.0	F, G, X, Y / P\$	1715	
					1 $\frac{3}{16}$ "			K / P\$	3653	
					1 $\frac{1}{2}$ "			H / P\$	1989	
	Veneer			1 $\frac{3}{16}$ "			F, G, X, Y / W\$	2188		
				1 $\frac{3}{16}$ "			K / W\$	3990		
				1 $\frac{1}{2}$ "			H / W\$	2632		
	Glass			$\frac{1}{4}$ "			Acid Etched Glass Top \$	12295		
				$\frac{1}{4}$ "			Gloss Glass Top \$	10309		
108"W x 48"D or 9' - 2 Piece Boat Top										
88-48108BT	Laminate	108	48-36	1 $\frac{3}{16}$ "	218	23.5	F, G, X, Y / P\$	2515		
				1 $\frac{3}{16}$ "			K / P\$	4556		
				1 $\frac{1}{2}$ "			H / P\$	2828		
	Veneer			1 $\frac{3}{16}$ "			F, G, X, Y / W\$	2969		
				1 $\frac{3}{16}$ "			K / W\$	5130		
				1 $\frac{1}{2}$ "			H / W\$	3471		
	Glass			$\frac{1}{4}$ "			Acid Etched Glass Top \$	14192		
				$\frac{1}{4}$ "			Gloss Glass Top \$	11958		

Additional 48" Boat Shaped Tops on Next Page



Double Kerf (F)
1 $\frac{3}{16}$ "



Duo (G)
1 $\frac{3}{16}$ "



Fluted (X)
1 $\frac{3}{16}$ "



Square (Y)
1 $\frac{3}{16}$ "



Knife (K)
1 $\frac{3}{16}$ "



Vertical Square (H)
1 $\frac{1}{2}$ "

Pricing Codes:

P= HPL W= Wood Top

[See Strut Overview For Ordering Options](#)

Item	Model No.	Materials	W	D	H	Ship Wt	Cubic Ft	Edge Profile + Material	List Price		
<i>48" D CONTINUED FROM PREVIOUS PAGE</i>	120"W x 48"D or 10' - 2 Piece Boat Top										
	88-48120BT	Laminate	120	48-36	1 ³ / ₁₆	240	23.5	F, G, X, Y / P\$	2578		
					1 ³ / ₁₆			K / P\$	4914		
					1 ¹ / ₂			H / P\$	2926		
		Veneer			1 ³ / ₁₆			F, G, X, Y / W\$	3219		
					1 ³ / ₁₆			K / W\$	5408		
					1 ¹ / ₂			H / W\$	3772		
		Glass			1/4			Acid Etched Glass Top \$	15513		
					1/4			Gloss Glass Top \$	13032		
		132"W x 48"D or 11' - 2 Piece Boat Top									
	88-48132BT	Laminate	132	48-36	1 ³ / ₁₆	262	23.5	F, G, X, Y / P\$	2652		
					1 ³ / ₁₆			K / P\$	5179		
					1 ¹ / ₂			H / P\$	3033		
		Veneer			1 ³ / ₁₆			F, G, X, Y / W\$	3481		
					1 ³ / ₁₆			K / W\$	5807		
				1 ¹ / ₂			H / W\$	4087			
	Glass			1/4			Acid Etched Glass Top \$	16845			
				1/4			Gloss Glass Top \$	14115			
	144"W x 48"D or 12' - 2 Piece Boat Top										
88-48144BT	Laminate	144	48-36	1 ³ / ₁₆	284	23.5	F, G, X, Y / P\$	2714			
				1 ³ / ₁₆			K / P\$	5435			
				1 ¹ / ₂			H / P\$	3132			
	Veneer			1 ³ / ₁₆			F, G, X, Y / W\$	3731			
				1 ³ / ₁₆			K / W\$	6190			
				1 ¹ / ₂			H / W\$	4390			
	Glass			1/4			Acid Etched Glass Top \$	18166			
				1/4			Gloss Glass Top \$	15187			
	156"W x 48"D or 13' - 2 Piece Boat Top										
88-48156BT	Laminate	156	48-36	1 ³ / ₁₆	306	31.2	F, G, X, Y / P\$	3235			
				1 ³ / ₁₆			K / P\$	6014			
				1 ¹ / ₂			H / P\$	3687			
	Veneer			1 ³ / ₁₆			F, G, X, Y / W\$	3999			
				1 ³ / ₁₆			K / W\$	6772			
				1 ¹ / ₂			H / W\$	4711			
	Glass			1/4			Acid Etched Glass Top \$	19582			
				1/4			Gloss Glass Top \$	16355			

Must Specify (in this order):
 Model #
 Top/Edge Material
 Top/Edge Finish/Color
 Edge Profile
 Glass (Y/N)
 Glass Color + Surface Finish
 Power/Data
 Power/Data Location

Additional 48" Boat Shaped Tops on Next Page



Double Kerf (F)
1³/₁₆"



Duo (G)
1³/₁₆"



Fluted (X)
1³/₁₆"



Square (Y)
1³/₁₆"



Knife (K)
1³/₁₆"



Vertical Square (H)
1¹/₂"

Pricing Codes:
 P= HPL W= Wood Top

[See Strut Overview For Ordering Options](#)

Item	Model No.	Materials	W	D	H	Ship Wt	Cubic Ft	Edge Profile + Material	List Price		
<i>48"D CONTINUED FROM PREVIOUS PAGE</i>	168"W x 48"D or 14' - 2 Piece Boat Top										
	88-48168BT	Laminate	168	48-36	1 $\frac{1}{16}$ "	328	31.2	F, G, X, Y / P\$	3283		
					1 $\frac{1}{16}$ "			K / P\$	6401		
					1 $\frac{1}{2}$ "			H / P\$	3771		
		Veneer			1 $\frac{1}{16}$ "			F, G, X, Y / W\$	4189		
					1 $\frac{1}{16}$ "			K / W\$	6978		
					1 $\frac{1}{2}$ "			H / W\$	4954		
		Glass			$\frac{1}{4}$ "			Acid Etched Glass Top \$	20889		
					$\frac{1}{4}$ "			Gloss Glass Top \$	17414		
		180"W x 48"D or 15' - 2 Piece Boat Top									
	88-48180BT	Laminate	180	48-36	1 $\frac{1}{16}$ "	350	31.2	F, G, X, Y / P\$	3453		
					1 $\frac{1}{16}$ "			K / P\$	6766		
					1 $\frac{1}{2}$ "			H / P\$	3977		
		Veneer			1 $\frac{1}{16}$ "			F, G, X, Y / W\$	4536		
					1 $\frac{1}{16}$ "			K / W\$	7489		
				1 $\frac{1}{2}$ "			H / W\$	5352			
	Glass			$\frac{1}{4}$ "			Acid Etched Glass Top \$	22321			
				$\frac{1}{4}$ "			Gloss Glass Top \$	18598			
	192"W x 48"D or 16' - 2 Piece Boat Top										
88-48192BT	Laminate	192	48-36	1 $\frac{1}{16}$ "	372	31.2	F, G, X, Y / P\$	3504			
				1 $\frac{1}{16}$ "			K / P\$	7007			
				1 $\frac{1}{2}$ "			H / P\$	4060			
	Veneer			1 $\frac{1}{16}$ "			F, G, X, Y / W\$	4727			
				1 $\frac{1}{16}$ "			K / W\$	7844			
				1 $\frac{1}{2}$ "			H / W\$	5596			
	Glass			$\frac{1}{4}$ "			Acid Etched Glass Top \$	23629			
				$\frac{1}{4}$ "			Gloss Glass Top \$	19658			
	204"W x 48"D or 17' - 3 Piece Boat Top										
88-48204BT	Laminate	204	48-36	1 $\frac{1}{16}$ "	394	48.9	F, G, X, Y / P\$	4085			
				1 $\frac{1}{16}$ "			K / P\$	7813			
				1 $\frac{1}{2}$ "			H / P\$	4675			
	Veneer			1 $\frac{1}{16}$ "			F, G, X, Y / W\$	5725			
				1 $\frac{1}{16}$ "			K / W\$	9084			
				1 $\frac{1}{2}$ "			H / W\$	6541			
	Glass			$\frac{1}{4}$ "			Acid Etched Glass Top \$	25510			
				$\frac{1}{4}$ "			Gloss Glass Top \$	21291			

Must Specify (in this order):
 Model #
 Top/Edge Material
 Top/Edge Finish/Color
 Edge Profile
 Glass (Y/N)
 Glass Color + Surface Finish
 Power/Data
 Power/Data Location

Additional 48" Boat Shaped Tops on Next Page



Double Kerf (F)
1 $\frac{1}{16}$ "



Duo (G)
1 $\frac{1}{16}$ "



Fluted (X)
1 $\frac{1}{16}$ "



Square (Y)
1 $\frac{1}{16}$ "



Knife (K)
1 $\frac{1}{16}$ "



Vertical Square (H)
1 $\frac{1}{2}$ "

Pricing Codes:
 P= HPL W= Wood Top

[See Strut Overview For Ordering Options](#)

Item	Model No.	Materials	W	D	H	Ship Wt	Cubic Ft	Edge Profile + Material	List Price		
<i>48"D CONTINUED FROM PREVIOUS PAGE</i>	216"W x 48"D or 18' - 3 Piece Boat Top										
	88-48216BT	Laminate	216	48-36	1 ³ / ₁₆	416	48.9	F, G, X, Y / P\$	4134		
					1 ³ / ₁₆			K / P\$	8053		
					1 ¹ / ₂			H / P\$	4759		
		Veneer			1 ³ / ₁₆			F, G, X, Y / W\$	6020		
					1 ³ / ₁₆			K / W\$	9482		
					1 ¹ / ₂			H / W\$	6883		
		Glass			1/4			Acid Etched Glass Top \$	26818		
					1/4			Gloss Glass Top \$	22351		
		228"W x 48"D or 19' - 3 Piece Boat Top									
	88-48228BT	Laminate	228	48-36	1 ³ / ₁₆	438	48.9	F, G, X, Y / P\$	5151		
					1 ³ / ₁₆			K / P\$	9289		
					1 ¹ / ₂			H / P\$	5811		
		Veneer			1 ³ / ₁₆			F, G, X, Y / W\$	6770		
					1 ³ / ₁₆			K / W\$	10334		
					1 ¹ / ₂			H / W\$	7680		
		Glass			1/4			Acid Etched Glass Top \$	28557		
					1/4			Gloss Glass Top \$	23842		
	240"W x 48"D or 20' - 3 Piece Boat Top										
88-48240BT	Laminate	240	48-36	1 ³ / ₁₆	460	48.9	F, G, X, Y / P\$	5201			
				1 ³ / ₁₆			K / P\$	9530			
				1 ¹ / ₂			H / P\$	5894			
	Veneer			1 ³ / ₁₆			F, G, X, Y / W\$	7066			
				1 ³ / ₁₆			K / W\$	10731			
				1 ¹ / ₂			H / W\$	8020			
	Glass			1/4			Acid Etched Glass Top \$	29865			
				1/4			Gloss Glass Top \$	24900			

Must Specify (in this order):

- Model #
- Top/Edge Material
- Top/Edge Finish/Color
- Edge Profile
- Glass (Y/N)
- Glass Color + Surface Finish
- Power/Data
- Power/Data Location

Description

- Tops Available with Veneer (W) or HPL (P) Top in 1³/₁₆" and 1¹/₂" Thicknesses
- Must Specify Edge Profile: 1³/₁₆" Thick/Double Kerf (F), Duo (G), Fluted (X), Square (Y), and Knife (K) Edge Profiles or 1¹/₂" Thick/Vertical Square (H)
- Veneer (W) Top Grain Runs Depth of Top and HPL (P) Top Grain Runs Width of Top
- All Veneer Tops, as well as Laminate Tops up to 144" (12 feet), have Matching Woodgrain. Laminate Tops Sized 156" (13 feet) and Longer have Non-Matching Woodgrain
- Available with Back Painted Tempered Glass Top; Must Specify Color and Finish ([See Options](#))
- Dock800, Oasis, and E2X Power Units Available on Ends Only (E1 and E2) for 108"D - 156"D and 204"D-240"D Tops
- Power and Data Options Available; Sold Separately ([See Multiple Power Unit Details](#))
- Strut Legs Sold Separately ([See Leg Options](#))



Double Kerf (F)
1³/₁₆"



Duo (G)
1³/₁₆"



Fluted (X)
1³/₁₆"



Square (Y)
1³/₁₆"



Knife (K)
1³/₁₆"



Vertical Square (H)
1¹/₂"

Pricing Codes:

P= HPL W= Wood Top

[See Strut Overview For Ordering Options](#)

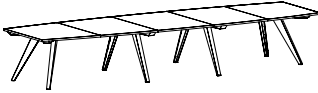
Item	Model No.	Materials	W	D	H	Ship Wt	Cubic Ft	Edge Profile + Material	List Price	
BOAT SHAPE MEETING TOP 54"D  <p>88-54204BT shown in Veneer BASES SOLD SEPARATELY</p>	120"W x 54"D or 10' - 3 Piece Veneer (W) and 2 Piece HPL (P) Boat Top									
	88-54120BT	Laminate	120	54-42	1 1/16"	260	12.1	F, G, X, Y / P\$	2863	
					1 1/16"			K / P\$	5359	
					1 1/2"			H / P\$	3256	
		Veneer			1 1/16"			F, G, X, Y / W\$	4351	
					1 1/16"			K / W\$	6646	
					1 1/2"			H / W\$	4900	
		Glass			1/4"			Acid Etched Glass Top \$	17505	
					1/4"			Gloss Glass Top \$	14714	
	132"W x 54"D or 11' - 3 Piece Veneer (W) and 2 Piece HPL (P) Boat Top									
	Must Specify (in this order): Model # Top/Edge Material Top/Edge Finish/Color Edge Profile Glass (Y/N) Glass Color + Surface Finish Power/Data Power/Data Location	88-54132BT	Laminate	132	54-42	1 1/16"	285	13.2	F, G, X, Y / P\$	2931
						1 1/16"			K / P\$	5630
					1 1/2"			H / P\$	3364	
		Veneer			1 1/16"			F, G, X, Y / W\$	4586	
					1 1/16"			K / W\$	7047	
					1 1/2"			H / W\$	5184	
		Glass			1/4"			Acid Etched Glass Top \$	18970	
					1/4"			Gloss Glass Top \$	15900	
144"W x 54"D or 12' - 3 Piece Veneer (W) and 2 Piece HPL (P) Boat Top										
88-54144BT		Laminate	144	54-42	1 1/16"	309	15.0	F, G, X, Y / P\$	3000	
					1 1/16"			K / P\$	5899	
					1 1/2"			H / P\$	3473	
	Veneer			1 1/16"			F, G, X, Y / W\$	4822		
				1 1/16"			K / W\$	7451		
				1 1/2"			H / W\$	5472		
	Glass			1/4"			Acid Etched Glass Top \$	20439		
				1/4"			Gloss Glass Top \$	17088		
156"W x 54"D or 13' - 4 Piece Veneer (W) and 2 Piece HPL (P) Boat Top										
88-54156BT	Laminate	156	54-42	1 1/16"	334	16.0	F, G, X, Y / P\$	3529		
				1 1/16"			K / P\$	6641		
				1 1/2"			H / P\$	4040		
	Veneer			1 1/16"			F, G, X, Y / W\$	5841		
				1 1/16"			K / W\$	8748		
				1 1/2"			H / W\$	6632		
	Glass			1/4"			Acid Etched Glass Top \$	22264		
				1/4"			Gloss Glass Top \$	18635		

Additional 54" Boat Shaped Tops on Next Page



Double Kerf (F)
1 1/16"



Duo (G)
1 1/16"



Fluted (X)
1 1/16"



Square (Y)
1 1/16"



Knife (K)
1 1/16"



Vertical Square (H)
1 1/2"

Pricing Codes:

P= HPL W= Wood Top

[See Strut Overview For Ordering Options](#)

Item	Model No.	Materials	W	D	H	Ship Wt	Cubic Ft	Edge Profile + Material	List Price		
168"W x 54"D or 14' - 4 Piece Veneer (W) and 2 Piece HPL (P) Boat Top											
<i>54"D CONTINUED FROM PREVIOUS PAGE</i>	88-54168BT	Laminate	168	54-42	1 ³ / ₁₆ "	359	17.0	F, G, X, Y / P\$	3582		
					1 ³ / ₁₆ "			K / P\$	6897		
					1 ¹ / ₂ "			H / P\$	4134		
					Veneer			1 ³ / ₁₆ "	F, G, X, Y / W\$	6090	
								1 ³ / ₁₆ "	K / W\$	9174	
								1 ¹ / ₂ "	H / W\$	6939	
		Glass		1/4"	Acid Etched Glass Top \$	23720					
				1/4"	Gloss Glass Top \$	19811					
		180"W x 54"D or 15' - 4 Piece Veneer (W) and 2 Piece HPL (P) Boat Top									
		<i>Must Specify (in this order):</i> Model # Top/Edge Material Top/Edge Finish/Color Edge Profile Glass (Y/N) Glass Color + Surface Finish Power/Data Power/Data Location	88-54180BT	Laminate	180	54-42	1 ³ / ₁₆ "	384	18.0	F, G, X, Y / P\$	3638
							1 ³ / ₁₆ "			K / P\$	7153
							1 ¹ / ₂ "			H / P\$	4226
Veneer							1 ³ / ₁₆ "			F, G, X, Y / W\$	6337
							1 ³ / ₁₆ "			K / W\$	9598
							1 ¹ / ₂ "			H / W\$	7244
Glass				1/4"	Acid Etched Glass Top \$	25175					
				1/4"	Gloss Glass Top \$	20987					
192"W x 54"D or 16' - 4 Piece Veneer (W) and 2 Piece HPL (P) Boat Top											
	88-54192BT			Laminate	192	54-42	1 ³ / ₁₆ "	408	19.0	F, G, X, Y / P\$	3690
							1 ³ / ₁₆ "			K / P\$	7408
							1 ¹ / ₂ "			H / P\$	4319
		Veneer					1 ³ / ₁₆ "			F, G, X, Y / W\$	6586
							1 ³ / ₁₆ "			K / W\$	10023
							1 ¹ / ₂ "			H / W\$	7550
		Glass		1/4"	Acid Etched Glass Top \$	26629					
				1/4"	Gloss Glass Top \$	22161					
		204"W x 54"D or 17' - 5 Piece Veneer (W) and 3 Piece HPL (P) Boat Top									
			88-54204BT	Laminate	204	54-42	1 ³ / ₁₆ "	445	21.0	F, G, X, Y / P\$	4484
							1 ³ / ₁₆ "			K / P\$	8442
							1 ¹ / ₂ "			H / P\$	5150
Veneer							1 ³ / ₁₆ "			F, G, X, Y / W\$	7983
							1 ³ / ₁₆ "			K / W\$	11622
							1 ¹ / ₂ "			H / W\$	9009
Glass				1/4"	Acid Etched Glass Top \$	28863					
				1/4"	Gloss Glass Top \$	24118					

Additional 54" Boat Shaped Tops on Next Page



Double Kerf (F)
1³/₁₆"



Duo (G)
1³/₁₆"



Fluted (X)
1³/₁₆"



Square (Y)
1³/₁₆"



Knife (K)
1³/₁₆"



Vertical Square (H)
1¹/₂"

Pricing Codes:
P= HPL W= Wood Top

[See Strut Overview For Ordering Options](#)

Item	Model No.	Materials	W	D	H	Ship Wt	Cubic Ft	Edge Profile + Material	List Price	
<i>54"D CONTINUED FROM PREVIOUS PAGE</i>	216"W x 54"D or 18' - 5 Piece Veneer (W) and 3 Piece HPL (P) Boat Top									
	88-54216BT	Laminate	216	54-42	1 $\frac{3}{16}$	470	22.0	F, G, X, Y / P\$	4538	
					1 $\frac{3}{16}$			K / P\$	8696	
					1 $\frac{1}{2}$			H / P\$	5243	
		Veneer			1 $\frac{3}{16}$			F, G, X, Y / W\$	8254	
					1 $\frac{3}{16}$			K / W\$	12067	
					1 $\frac{1}{2}$			H / W\$	9337	
		Glass			1 $\frac{1}{4}$			Acid Etched Glass Top \$	30316	
					1 $\frac{1}{4}$			Gloss Glass Top \$	25292	
	228"W x 54"D or 19' - 5 Piece Veneer (W) and 3 Piece HPL (P) Boat Top									
	88-54228BT	Laminate	228	54-42	1 $\frac{3}{16}$	495	23.0	F, G, X, Y / P\$	5205	
					1 $\frac{3}{16}$			K / P\$	9582	
					1 $\frac{1}{2}$			H / P\$	5949	
		Veneer			1 $\frac{3}{16}$			F, G, X, Y / W\$	8524	
					1 $\frac{3}{16}$			K / W\$	12513	
				1 $\frac{1}{2}$			H / W\$	9664		
	Glass			1 $\frac{1}{4}$			Acid Etched Glass Top \$	31810		
				1 $\frac{1}{4}$			Gloss Glass Top \$	26507		
240"W x 54"D or 20' - 5 Piece Veneer (W) and 3 Piece HPL (P) Boat Top										
88-54240BT	Laminate	240	54-42	1 $\frac{3}{16}$	519	24.0	F, G, X, Y / P\$	5258		
				1 $\frac{3}{16}$			K / P\$	9837		
				1 $\frac{1}{2}$			H / P\$	6042		
	Veneer			1 $\frac{3}{16}$			F, G, X, Y / W\$	8796		
				1 $\frac{3}{16}$			K / W\$	12959		
				1 $\frac{1}{2}$			H / W\$	9992		
	Glass			1 $\frac{1}{4}$			Acid Etched Glass Top \$	33265		
				1 $\frac{1}{4}$			Gloss Glass Top \$	27681		

Must Specify (in this order):

Model #
 Top/Edge Material
 Top/Edge Finish/Color
 Edge Profile
 Glass (Y/N)
 Glass Color + Surface Finish
 Power/Data
 Power/Data Location

Description

- Tops Available with Veneer (W) or HPL (P) Top in 1 $\frac{3}{16}$ " and 1 $\frac{1}{2}$ " Thicknesses
- Must Specify Edge Profile: 1 $\frac{3}{16}$ " Thick/Double Kerf (F), Duo (G), Fluted (X), Square (Y), and Knife (K) Edge Profiles or 1 $\frac{1}{2}$ " Thick/Vertical Square (H)
- Veneer (W) Top Grain Runs Depth of Top and HPL (P) Top Grain Runs Width of Top
- All Veneer Tops, as well as Laminate Tops up to 144" (12 feet), have Matching Woodgrain. Laminate Tops Sized 156" (13 feet) and Longer have Non-Matching Woodgrain
- Available with Back Painted Tempered Glass Top; Must Specify Color and Finish ([See Options](#))
- Power and Data Options Available; Sold Separately ([See Multiple Power Unit Details](#))
- Strut Legs Sold Separately ([See Leg Options](#))



Double Kerf (F)
1 $\frac{3}{16}$ "



Duo (G)
1 $\frac{3}{16}$ "



Fluted (X)
1 $\frac{3}{16}$ "



Square (Y)
1 $\frac{3}{16}$ "



Knife (K)
1 $\frac{3}{16}$ "



Vertical Square (H)
1 $\frac{1}{2}$ "

Pricing Codes:

P= HPL W= Wood Top

[See Strut Overview For Ordering Options](#)

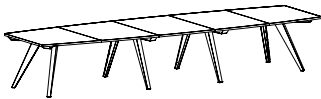
Item	Model No.	Materials	W	D	H	Ship Wt	Cubic Ft	Edge Profile + Material	List Price	
BOAT SHAPE MEETING TOP 60"D  88-60204BT shown in Veneer BASES SOLD SEPARATELY	120"W x 60"D or 10' - 3 Piece Veneer (W) and 2 Piece HPL (P) Boat Top									
	88-60120BT	Laminate	120	60-48	1 3/16"	287	13.3	F, G, X, Y / P\$	2916	
					1 3/16"			K / P\$	5566	
					1 1/2"			H / P\$	3354	
		Veneer			1 3/16"			F, G, X, Y / W\$	4602	
					1 3/16"			K / W\$	6994	
					1 1/2"			H / W\$	5204	
		Glass			1/4"			Acid Etched Glass Top \$	19040	
					1/4"			Gloss Glass Top \$	15938	
	132"W x 60"D or 11' - 3 Piece Veneer (W) and 2 Piece HPL (P) Boat Top									
	88-60132BT	Laminate	132	60-48	1 3/16"	323	14.6	F, G, X, Y / P\$	2989	
					1 3/16"			K / P\$	5848	
				1 1/2"			H / P\$	3472		
	Veneer			1 3/16"			F, G, X, Y / W\$	4862		
				1 3/16"			K / W\$	7424		
				1 1/2"			H / W\$	5519		
	Glass			1/4"			Acid Etched Glass Top \$	20655		
				1/4"			Gloss Glass Top \$	17244		
144"W x 60"D or 12' - 3 Piece Veneer (W) and 2 Piece HPL (P) Boat Top										
88-60144BT	Laminate	144	60-48	1 3/16"	342	16.0	F, G, X, Y / P\$	3062		
				1 3/16"			K / P\$	6134		
				1 1/2"			H / P\$	3589		
	Veneer			1 3/16"			F, G, X, Y / W\$	5122		
				1 3/16"			K / W\$	7858		
				1 1/2"			H / W\$	5837		
	Glass			1/4"			Acid Etched Glass Top \$	22274		
				1/4"			Gloss Glass Top \$	18550		
156"W x 60"D or 13' - 4 Piece Veneer (W) and 2 Piece HPL (P) Boat Top										
88-60156BT	Laminate	156	60-48	1 3/16"	376	17.2	F, G, X, Y / P\$	3595		
				1 3/16"			K / P\$	6891		
				1 1/2"			H / P\$	4166		
	Veneer			1 3/16"			F, G, X, Y / W\$	6187		
				1 3/16"			K / W\$	9217		
				1 1/2"			H / W\$	7058		
	Glass			1/4"			Acid Etched Glass Top \$	24247		
				1/4"			Gloss Glass Top \$	20214		

Additional 60" Boat Shaped Tops on Next Page



Double Kerf (F)
1 3/16"



Duo (G)
1 3/16"



Fluted (X)
1 3/16"



Square (Y)
1 3/16"



Knife (K)
1 3/16"



Vertical Square (H)
1 1/2"

Pricing Codes:
P= HPL W= Wood Top

[See Strut Overview For Ordering Options](#)

Item	Model No.	Materials	W	D	H	Ship Wt	Cubic Ft	Edge Profile + Material	List Price		
<i>60" D CONTINUED FROM PREVIOUS PAGE</i>	168"W x 60"D or 14' - 4 Piece Veneer (W) and 2 Piece HPL (P) Boat Top										
	88-60168BT	Laminate	168	60-48	1 1/16"	403	18.5	F, G, X, Y / P\$	3654		
					1 1/16"			K / P\$	7160		
					1 1/2"			H / P\$	4267		
		Veneer			1 1/16"			F, G, X, Y / W\$	6461		
					1 1/16"			K / W\$	9671		
					1 1/2"			H / W\$	7396		
		Glass			1/4"			Acid Etched Glass Top \$	25849		
					1/4"			Gloss Glass Top \$	21507		
		180"W x 60"D or 15' - 4 Piece Veneer (W) and 2 Piece HPL (P) Boat Top									
	88-60180BT	Laminate	180	60-48	1 1/16"	431	19.8	F, G, X, Y / P\$	3713		
					1 1/16"			K / P\$	7428		
					1 1/2"			H / P\$	4370		
		Veneer			1 1/16"			F, G, X, Y / W\$	6735		
					1 1/16"			K / W\$	10125		
					1 1/2"			H / W\$	7735		
		Glass			1/4"			Acid Etched Glass Top \$	27451		
					1/4"			Gloss Glass Top \$	22798		
	192"W x 60"D or 16' - 4 Piece Veneer (W) and 2 Piece HPL (P) Boat Top										
88-60192BT	Laminate	192	60-48	1 1/16"	458	21.1	F, G, X, Y / P\$	3772			
				1 1/16"			K / P\$	7698			
				1 1/2"			H / P\$	4472			
	Veneer			1 1/16"			F, G, X, Y / W\$	7010			
				1 1/16"			K / W\$	10579			
				1 1/2"			H / W\$	8073			
	Glass			1/4"			Acid Etched Glass Top \$	29052			
				1/4"			Gloss Glass Top \$	24087			
	204"W x 60"D or 17' - 5 Piece Veneer (W) and 3 Piece HPL (P) Boat Top										
88-60204BT	Laminate	204	60-48	1 1/16"	492	22.4	F, G, X, Y / P\$	4569			
				1 1/16"			K / P\$	8748			
				1 1/2"			H / P\$	5313			
	Veneer			1 1/16"			F, G, X, Y / W\$	8475			
				1 1/16"			K / W\$	12247			
				1 1/2"			H / W\$	9603			
	Glass			1/4"			Acid Etched Glass Top \$	31436			
				1/4"			Gloss Glass Top \$	26163			

Must Specify (in this order):
 Model #
 Top/Edge Material
 Top/Edge Finish/Color
 Edge Profile
 Glass (Y/N)
 Glass Color + Surface Finish
 Power/Data
 Power/Data Location

Additional 60" Boat Shaped Tops on Next Page



Double Kerf (F)
1 1/16"



Duo (G)
1 1/16"



Fluted (X)
1 1/16"



Square (Y)
1 1/16"



Knife (K)
1 1/16"



Vertical Square (H)
1 1/2"

Pricing Codes:
 P= HPL W= Wood Top

[See Strut Overview For Ordering Options](#)

Item	Model No.	Materials	W	D	H	Ship Wt	Cubic Ft	Edge Profile + Material	List Price	
<i>60"D CONTINUED FROM PREVIOUS PAGE</i>	216"W x 60"D or 18' - 5 Piece Veneer (W) and 3 Piece HPL (P) Boat Top									
	88-60216BT	Laminate	216	60-48	1 ³ / ₁₆	519	23.7	F, G, X, Y / P\$	4628	
					1 ³ / ₁₆			K / P\$	9018	
					1 ¹ / ₂			H / P\$	5415	
		Veneer			1 ³ / ₁₆			F, G, X, Y / W\$	8774	
					1 ³ / ₁₆			K / W\$	12726	
					1 ¹ / ₂			H / W\$	9966	
		Glass			1 ¹ / ₄			Acid Etched Glass Top \$	33037	
					1 ¹ / ₄			Gloss Glass Top \$	27453	
	228"W x 60"D or 19' - 5 Piece Veneer (W) and 3 Piece HPL (P) Boat Top									
	88-60228BT	Laminate	228	60-48	1 ³ / ₁₆	547	25.0	F, G, X, Y / P\$	5300	
					1 ³ / ₁₆			K / P\$	9916	
					1 ¹ / ₂			H / P\$	6131	
		Veneer			1 ³ / ₁₆			F, G, X, Y / W\$	9073	
					1 ³ / ₁₆			K / W\$	13205	
				1 ¹ / ₂			H / W\$	10327		
	Glass			1 ¹ / ₄			Acid Etched Glass Top \$	34679		
				1 ¹ / ₄			Gloss Glass Top \$	28785		
240"W x 60"D or 20' - 5 Piece Veneer (W) and 3 Piece HPL (P) Boat Top										
88-60240BT	Laminate	240	60-48	1 ³ / ₁₆	574	26.3	F, G, X, Y / P\$	5358		
				1 ³ / ₁₆			K / P\$	10186		
				1 ¹ / ₂			H / P\$	6233		
	Veneer			1 ³ / ₁₆			F, G, X, Y / W\$	9373		
				1 ³ / ₁₆			K / W\$	13684		
				1 ¹ / ₂			H / W\$	10691		
	Glass			1 ¹ / ₄			Acid Etched Glass Top \$	36281		
				1 ¹ / ₄			Gloss Glass Top \$	30076		

Must Specify (in this order):

- Model #
- Top/Edge Material
- Top/Edge Finish/Color
- Edge Profile
- Glass (Y/N)
- Glass Color + Surface Finish
- Power/Data
- Power/Data Location

Description

- Tops Available with Veneer (W) or HPL (P) Top in 1³/₁₆" and 1¹/₂" Thicknesses
- Must Specify Edge Profile: 1³/₁₆" Thick/Double Kerf (F), Duo (G), Fluted (X), Square (Y), and Knife (K) Edge Profiles or 1¹/₂" Thick/Vertical Square (H)
- Veneer (W) Top Grain Runs Depth of Top and HPL (P) Top Grain Runs Width of Top
- All Veneer Tops, as well as Laminate Tops up to 144" (12 feet), have Matching Woodgrain. Laminate Tops Sized 156" (13 feet) and Longer have Non-Matching Woodgrain
- Available with Back Painted Tempered Glass Top; Must Specify Color and Finish ([See Options](#))
- Power and Data Options Available; Sold Separately ([See Multiple Power Unit Details](#))
- Strut Legs Sold Separately ([See Leg Options](#))



Double Kerf (F)
1³/₁₆"



Duo (G)
1³/₁₆"



Fluted (X)
1³/₁₆"



Square (Y)
1³/₁₆"



Knife (K)
1³/₁₆"



Vertical Square (H)
1¹/₂"

Pricing Codes:
P= HPL W= Wood Top

[See Strut Overview For Ordering Options](#)

Item	Model No.		W	D	H	Ship Wt	Cubic Ft	List Price	
STRUT TABLE LEGS	01-2228STR2	1 Pair (2 Legs)	1½	22½	28⅞	32	4.5	\$	1433
	01-2228STR4	2 Pair (4 Legs)	1½	22½	28⅞	64	9.0	\$	2866

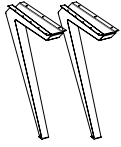

Must Specify (in this order):
Model # and Quantity
Color

Description

- Available in Aluminum (ALUM) or Black (BLK); Must Specify Color
- Integrated Wire Management Inside of Legs to Keep Your Space Clean and Free of Wires
- Stiffener Bars Included with Top for Additional Support
- Each Leg has Adjustable Glides
- Legs not Available To Be Sold Separately

Table Widths	42" - 96"	108" - 144"	156" - 192"	204" - 240"
Number of Legs Required	4	6	8	10
Quantity and Model #	(1) 01-2228STR4	(1) 01-2228STR4 + (1) 01-2228STR2	(2) 01-2228STR4	(2) 01-2228STR4 + (1) 01-2228STR2

[See Strut Overview For Ordering Options](#)

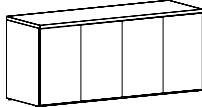
Item	Model No.	Materials	W	D	H	Ship Wt	Cubic Ft	Edge Profile + Material	List Price	
20"D CREDENZA 	88-2036CC <i>Two Doors</i>	TFL+HPL	36	20	30	135	15.5	F, G, X, Y / T+P\$	2010	
									H / T+P\$	2052
		Veneer+HPL							F, G, X, Y / W+P\$	3014
									H / W+P\$	3080
		Veneer							F, G, X, Y / W\$	3209
									H / W\$	3259
			Glass+TFL						Acid Etched Glass Top +T\$	3207
									Gloss Glass Top +T\$	2895
			Glass+Veneer						Acid Etched Glass Top +W\$	4406
									Gloss Glass Top +W\$	4096
		88-2048CC <i>Two Doors</i>	TFL+HPL	48	20	30	165	24.1	F, G, X, Y / T+P\$	2358
										H / T+P\$
Veneer+HPL									F, G, X, Y / W+P\$	3732
									H / W+P\$	3818
Veneer									F, G, X, Y / W\$	3923
									H / W\$	3991
		Glass+TFL						Acid Etched Glass Top +T\$	4007	
								Gloss Glass Top +T\$	3592	
		Glass+Veneer						Acid Etched Glass Top +W\$	5572	
								Gloss Glass Top +W\$	5158	
	88-2060CC <i>Three Doors</i>	TFL+HPL	60	20	30	220	25.3	F, G, X, Y / T+P\$	3087	
									H / T+P\$	3154
Veneer+HPL									F, G, X, Y / W+P\$	4776
									H / W+P\$	4881
Veneer									F, G, X, Y / W\$	4964
									H / W\$	5047
		Glass+TFL						Acid Etched Glass Top +T\$	5183	
								Gloss Glass Top +T\$	4668	
		Glass+Veneer						Acid Etched Glass Top +W\$	7062	
								Gloss Glass Top +W\$	6545	
	88-2072CC <i>Four Doors</i>	TFL+HPL	72	20	30	260	35.6	F, G, X, Y / T+P\$	3522	
									H / T+P\$	3604
Veneer+HPL									F, G, X, Y / W+P\$	5526
									H / W+P\$	5650
Veneer									F, G, X, Y / W\$	5711
									H / W\$	5810
		Glass+TFL						Acid Etched Glass Top +T\$	6070	
								Gloss Glass Top +T\$	5449	
		Glass+Veneer						Acid Etched Glass Top +W\$	8259	
								Gloss Glass Top +W\$	7638	

Additional 20" Credenzas on Next Page

Pricing Codes:
T= TFL P= HPL W= Wood Top

[See Strut Overview For Ordering Options](#)

Item	Model No.	Materials	W	D	H	Ship Wt	Cubic Ft	Edge Profile + Material	List Price	
20"D CONTINUED FROM PREVIOUS PAGE	88-2084CC Five Doors	TFL+HPL	84	20	30	338	35.1	F, G, X, Y / T+P\$	4383	
								H / T+P\$	4478	
		Veneer+HPL	84	20	30	338	35.1	35.1	F, G, X, Y / W+P\$	6757
									H / W+P\$	6902
		Veneer	84	20	30	338	35.1	35.1	F, G, X, Y / W\$	7142
									H / W\$	7257
		Glass+TFL	84	20	30	338	35.1	35.1	Acid Etched Glass Top +T\$	7224
									Gloss Glass Top +T\$	6500
		Glass+Veneer	84	20	30	338	35.1	35.1	Acid Etched Glass Top +W\$	9983
									Gloss Glass Top +W\$	9259
Must Specify (in this order): Model # Top/Edge Material Top/Edge Finish/Color Edge Profile Chassis Color Glass (Y/N) Glass Color + Surface Finish Pull Drawer Track Vent	88-2096CC Five Doors	TFL+HPL	96	20	30	398	39.9	F, G, X, Y / T+P\$	4803	
								H / T+P\$	4909	
		Veneer+HPL	96	20	30	398	39.9	39.9	F, G, X, Y / W+P\$	7572
									H / W+P\$	7737
		Veneer	96	20	30	398	39.9	39.9	F, G, X, Y / W\$	7955
									H / W\$	8085
		Glass+TFL	96	20	30	398	39.9	39.9	Acid Etched Glass Top +T\$	8093
									Gloss Glass Top +T\$	7266
		Glass+Veneer	96	20	30	398	39.9	39.9	Acid Etched Glass Top +W\$	11245
									Gloss Glass Top +W\$	10418

Description

- Standard with: One (1) Adjustable Shelf Behind Touch Latch Doors, Top Profile on Approach Side, 2" Wire Management Channel Along Back of Interior Cabinet, Reverse Slip Matched Pattern on Top Surface, and Vertical Grain Direction on Chassis
- Available with Veneer (W), HPL (P), or Back Painted Tempered Glass (Black or White with Gloss or Acid Etched Finish) Top
- When Selecting Back Painted Tempered Glass Top; Must Specify Glass Color, Gloss or Acid Etched Finish and Edge Profile; [See Options](#)
- Tops and Chassis Available in Contrasting Colors; Must Specific Color of Each Component
- Touch Latch Doors Standard Without Pulls, Optional Studio Pulls; Must Specify Pull Color ([See Color Options](#))
- Studio Pulls Will be Added and Centered on Top of Doors When Waste Bin is Selected; Must Specify Pull Color ([See Color Options](#)) and Optional Waste Bin ([See Options](#))
- Knife Edge not Available
- Additional Options: Locking Doors ([See Options Details](#)); Pull Out Waste Bin Available ([See Options Details](#)); Back Panel Vent ([See Options Details](#))



Double Kerf (F)
1 1/8"



Duo (G)
1 3/8"



Fluted (X)
1 3/8"



Square (Y)
1 3/8"



Vertical Square (H)
1 1/2"

Pricing Codes:

T= TFL P= HPL W= Wood Top

[See Strut Overview For Ordering Options](#)

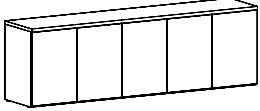
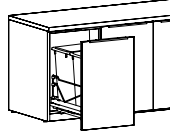
Item	Model No.	Materials	W	D	H	Ship Wt	Cubic Ft	Edge Profile + Material	List Price
 <p>24" D CREDENZA</p> <p>Shown: 88-2496CC</p>  <p>Waste Bin Option Shown as Left</p> <p>Must Specify (in this order): Model # Top/Edge Material Top/Edge Finish/Color Edge Profile Chassis Color Glass (Y/N) Glass Color + Surface Finish Pull Vent Waste Bin</p>	88-2436CC	TFL+HPL	36	24	30	150	18.3	F, G, X, Y / T+P\$	2141
	<i>Two Doors</i>							H / T+P\$	2190
	Veneer+HPL							F, G, X, Y / W+P\$	3191
								H / W+P\$	3269
	Veneer							F, G, X, Y / W\$	3383
								H / W\$	3445
	Glass+TFL							Acid Etched Glass Top +T\$	3607
								Gloss Glass Top +T\$	3236
	Glass+Veneer							Acid Etched Glass Top +W\$	4850
								Gloss Glass Top +W\$	4479
	88-2448CC	TFL+HPL	48	24	30	185	20.4	F, G, X, Y / T+P\$	2532
	<i>Two Doors</i>							H / T+P\$	2597
Veneer+HPL							F, G, X, Y / W+P\$	3976	
							H / W+P\$	4074	
Veneer							F, G, X, Y / W\$	4163	
							H / W\$	4243	
Glass+TFL							Acid Etched Glass Top +T\$	4540	
							Gloss Glass Top +T\$	4043	
Glass+Veneer							Acid Etched Glass Top +W\$	6170	
							Gloss Glass Top +W\$	5674	
88-2460CC	TFL+HPL	60	24	30	240	29.9	F, G, X, Y / T+P\$	3345	
<i>Three Doors</i>							H / T+P\$	3426	
Veneer+HPL							F, G, X, Y / W+P\$	5183	
							H / W+P\$	5306	
Veneer							F, G, X, Y / W\$	5367	
							H / W\$	5465	
Glass+TFL							Acid Etched Glass Top +T\$	5893	
							Gloss Glass Top +T\$	5272	
Glass+Veneer							Acid Etched Glass Top +W\$	7915	
							Gloss Glass Top +W\$	7294	
88-2472CC	TFL+HPL	72	24	30	260	35.6	F, G, X, Y / T+P\$	3795	
<i>Four Doors</i>							H / T+P\$	3891	
Veneer+HPL							F, G, X, Y / W+P\$	5907	
							H / W+P\$	6051	
Veneer							F, G, X, Y / W\$	6085	
							H / W\$	6202	
Glass+TFL							Acid Etched Glass Top +T\$	6884	
							Gloss Glass Top +T\$	6139	
Glass+Veneer							Acid Etched Glass Top +W\$	9174	
							Gloss Glass Top +W\$	8429	

Additional 24" Credenzas on Next Page

Pricing Codes:
T= TFL P= HPL W= Wood Top

[See Strut Overview For Ordering Options](#)

Item	Model No.	Materials	W	D	H	Ship Wt	Cubic Ft	Edge Profile + Material	List Price
24"D CONTINUED FROM PREVIOUS PAGE	88-2484CC <i>Five Doors</i>	TFL+HPL	84	24	30	353	41.4	F, G, X, Y / T+P\$	4698
								H / T+P\$	4808
		Veneer+HPL						F, G, X, Y / W+P\$	7196
								H / W+P\$	7364
		Veneer						F, G, X, Y / W\$	7573
								H / W\$	7710
		Glass+TFL						Acid Etched Glass Top +T\$	8167
								Gloss Glass Top +T\$	7299
		Glass+Veneer						Acid Etched Glass Top +W\$	11045
								Gloss Glass Top +W\$	10176
88-2496CC <i>Five Doors</i>	88-2496CC <i>Five Doors</i>	TFL+HPL	96	24	30	415	47.2	F, G, X, Y / T+P\$	5148
								H / T+P\$	5275
		Veneer+HPL						F, G, X, Y / W+P\$	8067
								H / W+P\$	8258
		Veneer						F, G, X, Y / W\$	8442
								H / W\$	8596
		Glass+TFL						Acid Etched Glass Top +T\$	9160
								Gloss Glass Top +T\$	8166
		Glass+Veneer						Acid Etched Glass Top +W\$	12453
								Gloss Glass Top +W\$	11460

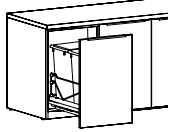

Waste Bin Option
Shown as Left

Must Specify (in this order):

Model #
Top/Edge Material
Top/Edge Finish/Color
Edge Profile
Chassis Color
Glass (Y/N)
Glass Color + Surface Finish
Pull
Vent
Waste Bin

Description

- Standard with: One (1) Adjustable Shelf Behind Touch Latch Doors, Top Profile on Approach Side, 2" Wire Management Channel Along Back of Interior Cabinet, Reverse Slip Matched Pattern on Top Surface, and Vertical Grain Direction on Chassis
- Available with Veneer (W), HPL (P), or Back Painted Tempered Glass (Black or White with Gloss or Acid Etched Finish) Top
- When Selecting Back Painted Tempered Glass Top; Must Specify Glass Color, Gloss or Acid Etched Finish and Edge Profile; [See Options](#)
- Tops and Chassis Available in Contrasting Colors; Must Specific Color of Each Component
- Studio Pull Centered on Drawer Fronts Standard; Must Specify Pull Color ([See Color Options](#))
- Touch Latch Doors Standard Without Pulls, Optional Studio Pulls; Must Specify Pull Color ([See Color Options](#))
- Studio Pulls Will be Added and Centered on Top of Doors When Waste Bin is Selected; Must Specify Pull Color ([See Color Options](#)) and Optional Waste Bin ([See Options](#))
- Knife Edge not Available
- Additional Options: Locking Doors ([See Options Details](#)); Pull Out Waste Bin ([See Options Details](#)); Back Panel Vent ([See Options Details](#)); Soft Close Drawers ([See Soft Close Option](#))



Double Kerf (F)
1 3/16"



Duo (G)
1 3/16"



Fluted (X)
1 3/16"



Square (Y)
1 3/16"





Vertical Square (H)
1 1/2"

Pricing Codes:

T= TFL P= HPL W= Wood Top

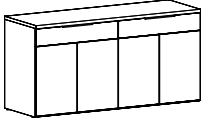
[See Strut Overview For Ordering Options](#)

Item	Model No.	Materials	W	D	H	Ship Wt	Cubic Ft	Edge Profile + Material	List Price	
BUFFET CREDENZA WITH DRAWERS  Shown: 88-2472BF  Waste Bin Option Shown as Left Must Specify (in this order): Model # Top/Edge Material Top/Edge Finish/Color Edge Profile Chassis Color Glass (Y/N) Glass Color + Surface Finish Pull Drawer Track Vent Waste Bin	88-2436BF	TFL+HPL	36	24	36	209	28.6	F, G, X, Y / T+P\$	2605	
								H / T+P\$	2654	
			Veneer+HPL						F, G, X, Y / W+P\$	3840
									H / W+P\$	3916
			Veneer						F, G, X, Y / W\$	4030
									H / W\$	4091
			Glass+TFL						Acid Etched Glass Top +T\$	4071
									Gloss Glass Top +T\$	3699
			Glass+Veneer						Acid Etched Glass Top +W\$	5498
									Gloss Glass Top +W\$	5125
		88-2448BF	TFL+HPL	48	24	36	209	28.6	F, G, X, Y / T+P\$	3121
									H / T+P\$	3185
		Veneer+HPL						F, G, X, Y / W+P\$	4817	
								H / W+P\$	4917	
		Veneer						F, G, X, Y / W\$	5004	
								H / W\$	5084	
		Glass+TFL						Acid Etched Glass Top +T\$	5129	
								Gloss Glass Top +T\$	4632	
		Glass+Veneer						Acid Etched Glass Top +W\$	7012	
								Gloss Glass Top +W\$	6517	
	88-2460BF	TFL+HPL	60	24	36	280	34.5	F, G, X, Y / T+P\$	4418	
								H / T+P\$	4499	
		Veneer+HPL						F, G, X, Y / W+P\$	6540	
								H / W+P\$	6662	
		Veneer						F, G, X, Y / W\$	6724	
								H / W\$	6822	
		Glass+TFL						Acid Etched Glass Top +T\$	6967	
								Gloss Glass Top +T\$	6345	
		Glass+Veneer						Acid Etched Glass Top +W\$	9272	
								Gloss Glass Top +W\$	8651	
	88-2472BF	TFL+HPL	72	24	36	342	42.3	F, G, X, Y / T+P\$	4595	
								H / T+P\$	4690	
		Veneer+HPL						F, G, X, Y / W+P\$	7055	
								H / W+P\$	7199	
		Veneer						F, G, X, Y / W\$	7232	
								H / W\$	7351	
		Glass+TFL						Acid Etched Glass Top +T\$	7684	
								Gloss Glass Top +T\$	6940	
		Glass+Veneer						Acid Etched Glass Top +W\$	10322	
								Gloss Glass Top +W\$	9577	

Additional Buffet Credenzas on Next Page

Pricing Codes:
T= TFL P= HPL W= Wood Top

[See Strut Overview For Ordering Options](#)

Item	Model No.	Materials	W	D	H	Ship Wt	Cubic Ft	Edge Profile + Material	List Price
<i>CONTINUED FROM PREVIOUS PAGE</i>	88-2484BF <i>Five Doors + Three Drawers</i>	TFL+HPL	84	24	36	404	49.2	F, G, X, Y / T+P\$	5728
								H / T+P\$	5840
		Veneer+HPL						F, G, X, Y / W+P\$	8610
								H / W+P\$	8777
		Veneer						F, G, X, Y / W\$	8988
								H / W\$	9123
		Glass+TFL						Acid Etched Glass Top +T\$	9199
								Gloss Glass Top +T\$	8331
		Glass+Veneer						Acid Etched Glass Top +W\$	12459
								Gloss Glass Top +W\$	11589
<i>Must Specify (in this order):</i> Model # Top/Edge Material Top/Edge Finish/Color Edge Profile Chassis Color Glass (Y/N) Glass Color + Surface Finish Pull Drawer Track Vent Waste Bin	88-2496BF <i>Five Doors + Five Drawers</i>	TFL+HPL	96	24	36	466	56.0	F, G, X, Y / T+P\$	6548
								H / T+P\$	6674
		Veneer+HPL						F, G, X, Y / W+P\$	9989
								H / W+P\$	10179
		Veneer						F, G, X, Y / W\$	10364
								H / W\$	10517
		Glass+TFL						Acid Etched Glass Top +T\$	10559
								Gloss Glass Top +T\$	9567
		Glass+Veneer						Acid Etched Glass Top +W\$	14373
								Gloss Glass Top +W\$	13382

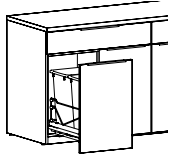

Waste Bin Option
Shown as Left

Description

- Standard with: Touch Latch Doors with One (1) Adjustable Shelf Behind Doors, Top Profile on Approach Side, 2" Wire Management Channel Along Back of Interior Cabinet, Reverse Slip Matched Pattern on Top Surface, and Vertical Grain Direction on Chassis
- Available with Veneer (W), HPL (P), or Back Painted Tempered Glass (Black or White with Gloss or Acid Etched Finish) Top with Veneer (W) or HPL (P) Chassis
- When Selecting Back Painted Tempered Glass Top; Must Specify Glass Color, Gloss or Acid Etched Finish and Edge Profile; [See Options](#)
- Tops and Chassis Available in Contrasting Colors; Must Specific Color of Each Component
- Studio Pull Centered on Drawer Fronts Standard; Must Specify Pull Color ([See Color Options](#))
- Touch Latch Doors Standard Without Pulls, Optional Studio Pulls; Must Specify Pull Color ([See Color Options](#))
- Studio Pulls Will be Added and Centered on Top of Doors When Waste Bin is Selected; Must Specify Pull Color ([See Color Options](#)) and Optional Waste Bin ([See Options](#))
- Knife Edge not Available
- Additional Options: Locking Doors ([See Options Details](#)); Pull Out Waste Bin ([See Options Details](#)); Back Panel Vent ([See Options Details](#)); Soft Close Drawers ([See Soft Close Option](#))



Double Kerf (F)
1 3/8"



Duo (G)
1 3/8"



Fluted (X)
1 3/8"



Square (Y)
1 3/8"



Vertical Square (H)
1 1/2"

Pricing Codes:

T= TFL P= HPL W= Wood Top

[See Strut Overview For Ordering Options](#)

Item	Model No.		W	D	H	Ship Wt	Cubic Ft		List Price	
	88-2436SV	TFL+HPL	36	24	36	260	35.6	F, G, X, Y / T+P\$	2899	
									H / T+P\$	2950
		Veneer+HPL							F, G, X, Y / W+P\$	4319
									H / W+P\$	4396
		Veneer							F, G, X, Y / W\$	4511
								H / W\$	4573	

Must Specify (in this order):

Model #
 Top/Edge Material
 Top/Edge Finish/Color
 Edge Profile
 Optional Grommet

Description

- Top Edge Profiled on Approach Side Only (See Edge Options); Must Specify Edge Selection ([See Edge Details](#))
- Two (2) Box Drawers, Open Storage, and Storage Behind Two (2) Doors
- Locking Casters

Grommet Option: Specify & Add

1-GRMT Grommet in Back Panel; Must Specify Black or Silver \$ 58

ROUND GROMMET COVER FIELD INSTALLED	01-GRMTBK	Black	-	-	-	-	-	-	\$ 12
	01-GRMTSL	Silver							



OPEN MARKET ONLY
(SILVER)

Description

- 60mm Round Grommet Cover
- Field Installed

DOCK 950 WIRELESS CHARGER	01-DOCK950W	White	3 $\frac{3}{16}$ "	3 $\frac{3}{16}$ "	-	1	0.2	\$ 294
	01-DOCK950B	Black						



OPEN MARKET ONLY

Description

- For Use with Wireless Charging Enabled Devices
- 5 Watts Maximum Output with a Direct Current of 5V 2A and 10 Watts Maximum with Quick Charge 2.0
- LED will Confirm Pairing with Device and Begin Wireless Charging

WIRELESS AND USB CHARGER	01-DOCK150W	White	3	3	$\frac{3}{4}$ "	1	0.2	\$ 448
	01-DOCK150B	Black						



OPEN MARKET ONLY





Description

- For Use with Wireless Charging Enabled Devices and USB Charging Devices
- 5 Watt Maximum Output with a Direct Current Input of 5V 6A (Wireless Fast Charge)
- Pop-Up is $\frac{3}{4}$ "H and Includes Three (3) USB Ports; One (1) 12 Watt Maximum with 2.4A (USB Fast Charge) and Two (2) 5 Watt with 1A (USB Standard Charge)
- LED Light will Confirm Pairing with Device and Begin Wireless Charging
- UL and cUL Certified



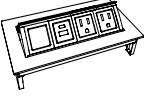

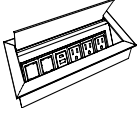
Pricing Codes:

T= TFL P= HPL W= Wood Top

[See Strut Overview For Ordering Options](#)

Item	Model No.		W	D	H	Ship Wt	Cubic Ft	List Price
	01-DPORT4A	Aluminum	8	4	-	7	0.2	\$ 1211
	01-DPORT4B	Black						
Description								
<ul style="list-style-type: none"> Includes: Two (2) Power Outlets, One (1) USB A+C, One (1) Open Port, 10' Power Cord, and Voice/Data Adapter Kit to Accept Couplers and Jacks When Required Retracts into Work Surface to Regain Productive Space; One-Touch Access to Power and Data Optional Telecom Port Components, See Compatible Units Below Water-Proof Simplex (Outlets) UL Recognized 								
 <p>01-E2X4</p>	01-E2X6A	Aluminum	11	9 ³ / ₁₆	-	6	0.7	\$ 1801
	01-E2X6B	Black						
	01-E2X4A	Aluminum	8	9 ³ / ₁₆	-	5	0.5	\$ 1655
	01-E2X4B	Black						
Description								
<ul style="list-style-type: none"> In Surface Application; Soft Touch Access to Power and Data Each Side has the Following: 11" Includes Three (3) Power Outlets, One (1) USB A+C, and Two (2) Open Port; 8" Includes Two (2) Power Outlets, One (1) USB A+C, and One (1) Open Port with 6' Power Cord Optional Telecom Port Components, See Compatible Units UL Listed 								
 <p>01-ELLORA6</p>	01-ELLORA6A	Aluminum	11	5	-	6	0.7	\$ 944
	01-ELLORA6B	Black						
	01-ELLORA4A	Aluminum	8	5	-	5	0.5	\$ 877
	01-ELLORA4B	Black						
Description								
<ul style="list-style-type: none"> In Surface Application; Soft Touch Access to Power and Data 11" Includes Three (3) Power Outlets, One (1) USB A+C, and Two (2) Open Port; 8" Includes Two (2) Power Outlets, One (1) USB A+C, and One (1) Open Port with 6' Power Cord Optional Telecom Port Components, See Below for Compatible Units UL Recognized 								
	01-USBPORT		-	-	-	-	-	\$ 178
	Description							
<ul style="list-style-type: none"> Passive USB-A Port with Increased Transfer Speed Up to 5 gbs/sec Simultaneous Read/Write Capability; Idle Device Power Saving State 6' Cord Compatible with 01-DPORT4A, 01-DPORT4B, ELLORA4A, ELLORA4B, ELLORA6A, ELLORA6B, E2X4A, E2X4B, E2X6A, and E2X6B 								

[See Strut Overview For Ordering Options](#)

Item	Model No.	W	D	H	Ship Wt	Cubic Ft	List Price
VOICE COUPLER	01-VOICE1	-	-	-	-	-	\$ 80
	<p>Description</p> <ul style="list-style-type: none"> 6-Pin Modular Plug Molded Black; Cord Not included Compatible with 01-DPORT4A, 01-DPORT4B, ELLORA4A, ELLORA4B, ELLORA6A, ELLORA6B, E2X4A, E2X4B, E2X6A, and E2X6B 						
DATA PORT	01-RJ4DATA	-	-	-	-	-	\$ 186
	<p>Description</p> <ul style="list-style-type: none"> 8-Pin Modular Plug; Cat6 Ethernet Cable; Pre-terminated Cable 10' Cord Compatible with 01-DPORT4A, 01-DPORT4B, ELLORA4A, ELLORA4B, ELLORA6A, ELLORA6B, E2X4A, E2X4B, E2X6A, and E2X6B 						
VGA CONNECTOR ACCESSORY	01-VGACON	-	-	-	1	0.2	\$ 165
	<p>Description</p> <ul style="list-style-type: none"> VGA Port for 01-DPORT4A, 01-DPORT4B, ELLORA4A, ELLORA4B, ELLORA6A, ELLORA6B, E2X4A, E2X4B, E2X6A, and E2X6B Enables Devices to Remote Display on Monitors 10' Cord Male/Female Connector 						
PASSIVE USB-C ACCESSORY	01-PUSBC	-	-	-	1	0.2	\$ 105
	<p>Description</p> <ul style="list-style-type: none"> Passive USB-C Port ; Unit Provides Data Connection to Transfer Data Only, No Charging Capabilities Compatible with 01-DPORT4A, 01-DPORT4B, ELLORA4A, ELLORA4B, ELLORA6A, ELLORA6B, E2X4A, E2X4B, E2X6A, and E2X6B Male/Female Connector 						
CHARGING USB-A+C ACCESSORY	01-USBAC	-	-	-	1	0.2	\$ 313
	<p>Description</p> <ul style="list-style-type: none"> For Charging Devices 20 Watt Power Supply USB+C Charging Port for 01-DPORT4A, 01-DPORT4B, ELLORA4A, ELLORA4B, ELLORA6A, ELLORA6B, E2X4A, E2X4B, E2X6A, and E2X6B 						

[See Strut Overview For Ordering Options](#)

Item	Model No.		W	D	H	Ship Wt	Cubic Ft	List Price
HDMI CONNECTOR ACCESSORY	01-HDMICON		-	-	-	1	0.2	\$ 137

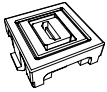

Description

- HDMI Port for 01-DPORT4A, 01-DPORT4B, ELLORA4A, ELLORA4B, ELLORA6A, ELLORA6B, E2X4A, E2X4B, E2X6A, and E2X6B
- Connects to High Definition Displays
- Female/Female Connector
- 18" Cord

INTERACT POWER & DATA	01-INTERACTG2A	Aluminum	9	5 $\frac{3}{8}$	2 $\frac{3}{4}$	5	0.2	\$ 987
	01-INTERACTG2B	Black						



Description

- Includes: Two (2) Power Outlets, USB-A+C Charging Ports, One (1) Telecom Plate Opening; Two (2) Keystone Openings for Voice/Data Jacks
- One (1) Telecom Plates Included with the Unit: One (1) 01-ABLAB Plate (Consists of One (1) RJ45 Cat 6, One (1) RJ11 Cat 3 Phone Jack)
- Convenience Plug on Bottom
- 6' Power Cord
- UL and CSA Recognized
- Additional Telecom Plates, [See ECA Telecom Plate Options](#)

OASIS MINI POWER & DATA	01-OASISMA	Aluminum	15	9	5	11	0.3	\$ 3535
	01-OASISMB	Black						



Top View

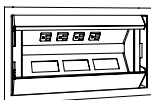

Description

- For Use with Conference Tables
- Soft Touch Hinged Lid
- Four (4) Power Outlets, Three (3) Telecom Plate Openings
- Two (2) Telecom Plates Included with the Unit: One (1) 01-ABLAB Plate (Consists of One (1) RJ45 Cat 6, One (1) RJ11 Cat 3 Phone Jack); One (1) 01-ABLB Plate (Consists of One (1) RJ45 Cat 6)
- 9' Power Cord
- UL Listed
- Additional Telecom Plates, [See ECA Telecom Plate Options](#)

DOCK800	01-DOCK800S	Silver	14	9	-			\$ 2268
	01-DOCK800B	Black						

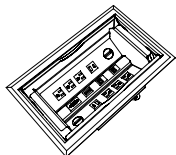

Description

- Stylish Aluminum Housing with Beveled Edges; Soft Touch Access and Closure
- Includes: Six (6) Power Outlets, Two (2) USB-A 5V Ports, Two (2) USB-C Charging Ports, One (1) RJ45 Ethernet Port, One (1) RJ11 Port, One (1) HDMI Port, and One (1) VGA Port
- 10' Power Cord
- UL and cUL Certified

OPEN MARKET ONLY

[See Strut Overview For Ordering Options](#)

Item	Model No.		W	D	H	Ship Wt	Cubic Ft	List Price
DUO BEZEL WITH NEMA PLUG	01-DUOBEZELW	White	6½	2¾	3	1	0.2	\$ 748
	01-DUOBEZELB	Black						
	01-DUOBEZELS	Silver						



Description

- Standard with: Two (2) Power, One (1) USB Charging Port and One (1) 60-Watt USB-C Power Delivery Port with GaN Technology; 10' Cord and All Mounting Hardware
- Worksurface Must Be Routed To Accept Unit, Which Sits Down Into Worksurface Supported By Attractive Slim Fit Bezel
- Independent USB Circuit Controllers Deliver up to 2.1 Amps to Each Post
- All Mounting Hardware Included
- FCC Part 15A and UL Approved for Horizontal and Vertical Applications

TRIO BEZEL WITH NEMA PLUG	01-TRIOBEZELW	White	9	2¾	3	1	0.2	\$ 803
	01-TRIOBEZELB	Black						
	01-TRIOBEZELS	Silver						



Description

- Standard with: Three (3) Power, One (1) USB Charging Port and One (1) 60-Watt USB-C Power Delivery Port with GaN Technology, One (1) Open Data; 10' Cord and All Mounting Hardware
- Worksurface Must Be Routed To Accept Unit, Which Sits Down Into Worksurface Supported By Attractive Slim Fit Bezel
- Independent USB Circuit Controllers Deliver up to 2.1 Amps to Each Post
- HDMI, VGA, or RJ45 Sold Separately; [See Accessories](#)
- FCC Part 15A and UL Approved for Horizontal and Vertical Applications

DUO BEZEL WITH PURL DAISY CHAIN PLUG	01-DCDUOBEZELW	White	6½	2¾	3	1	0.2	\$ 631
	01-DCDUOBEZELB	Black						
	01-DCDUOBEZELS	Silver						



Description

- Standard with: Two (2) Tamper Resistant 15 Amp Power Outlets, One (1) USB-A Charging Port and One (1) 60-Watt USB-C Power Delivery Port with GaN Technology, 10' Cord and All Mounting Hardware
- Top Must Be Routed To Allow Unit to Sit Down Into the Top, Must Specify when Ordering Top
- Unit Supported By Attractive Slim Fit Bezel
- Requires Purl Daisy Chain Power Infeed, Specified Separately ([See Details](#))
- Non-Sequential System Allows up to Nine (9) Modules to be Connected with H-Block and Jumper Cord ([See Details](#))
- Independent USB Circuit Controllers Deliver up to 2.4 Amps to Each Post
- FCC Part 15A, RU Listed and UL Recognized for Horizontal and Vertical Applications

[See Strut Overview For Ordering Options](#)

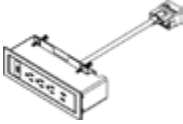
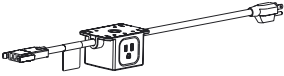
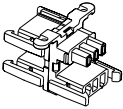
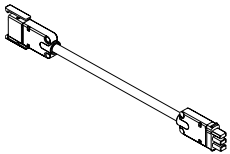
Item	Model No.		W	D	H	Ship Wt	Cubic Ft	List Price
TRIO BEZEL WITH PURL DAISY CHAIN PLUG	01-DCTRIOBEZELW	White	9	2½	3	1	0.2	\$ 723
	01-DCTRIOBEZELB	Black						
	01-DCTRIOBEZELS	Silver						
	Description							
	<ul style="list-style-type: none"> Standard with: Three (3) Tamper Resistant 15Amp Power Outlets, One (1) USB-A Charging Port, One (1) 60-Watt USB-C Power Delivery Port with GaN Technology, One (1) Open Data, 12' Cord and All Mounting Hardware Top Must Be Routed To Allow Unit to Sit Down Into the Top, Must Specify when Ordering Top Unit Supported By Attractive Slim Fit Bezel Requires Purl Daisy Chain Power Infeed, Specified Separately (See Below) Non-Sequential System Allows up to Nine (9) Modules to be Connected with H-Block and Jumper Cord (See Below for Details) Independent USB Circuit Controllers Deliver up to 2.4Amps to Each Post FCC Part 15A, RU Listed and UL Recognized for Horizontal and Vertical Applications HDMI, VGA, or RJ45 Sold Separately (See Accessories) 							
PURL DAISY CHAIN POWER INFEED	01-DCPOWER		-	-	-	1	0.2	\$ 227
	Description							
	<ul style="list-style-type: none"> Includes One (1) Purl Connector Plug, 36" Daisy Chain Cord, One (1) 15 Amp Power Outlet, and a 120" Power Cord with a Nema Plug Powers up to Nine (9) Duo and Trio Purl Daisy Chain Units 15-Amp System Rating and Over-Current Protection System Requires H-BLOCK Connector Between Power Infeed and Each Jumper Cord, See Below For Purl Daisy Chain H-Block and Purl Daisy Chain Jumper Cords Details 							
PURL DAISY CHAIN H-BLOCK	01-DCHBLOCK		-	-	-	1	0.2	\$ 40
	Description							
	<ul style="list-style-type: none"> Includes One (1) Power In and Three (3) Power Out Receptacles System Requires H-BLOCK Connector Between Power Infeed and Each Jumper Cord, See Purl Daisy Chain Power Infeed (Above) and Jumper Cords (See Below) 							
PURL DAISY CHAIN JUMPER CORD	01-DC2JUMP	24" Long	-	-	-	1	0.2	\$ 72
	01-DC3JUMP	36" Long	-	-	-	1	0.2	\$ 77
	01-DC4JUMP	48" Long	-	-	-	1	0.2	\$ 82
	01-DC5JUMP	60" Long	-	-	-	1	0.2	\$ 87
	01-DC6JUMP	72" Long	-	-	-	1	0.2	\$ 92
	Description							
	<ul style="list-style-type: none"> Connects Duo and Trio Daisy Chain Units Non-Sequential System Allows up to None (9) Modules to be Connected 							

[See Strut Overview For Ordering Options](#)

Item	Model No.	W	D	H	Ship Wt	Cubic Ft	List Price
HDMI DATA PORT ACCESSORY	01-LCOMHDMI	-	-	-	1	0.2	\$ 183

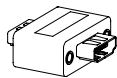

OPEN MARKET ONLY

Description

- HDMI Port for Trio Bezel Units

VGA DATA PORT ACCESSORY	01-LCOMVGA	-	-	-	1	0.2	\$ 134
-------------------------	------------	---	---	---	---	-----	--------

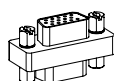
**Description**

- VGA Port for Trio Bezel Units

RJ45 DATA PORT ACCESSORY	01-LCOMRJ45	-	-	-	1	0.2	\$ 788
--------------------------	-------------	---	---	---	---	-----	--------

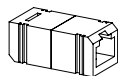
**Description**

- RJ45 Port for Trio Bezel Units

WIRE MANAGEMENT CHANNEL	01-WMGR4	16	1½	¾	1	-	\$ 129
-------------------------	----------	----	----	---	---	---	--------

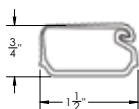
**Description**

- Set of Four (4) Black Plastic Wire Management Channels
- Snap Lock Channel
- Attaches with Adhesive Strips
- Ships via UPS Only

WIRE CHANNEL	01-32125	24	1½	1	.25	0.3	\$ 117
--------------	----------	----	----	---	-----	-----	--------

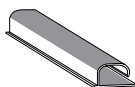
**Description**

- Available in Black
- Channels Attach with Two (2) Double-Sided Installation Tape
- Open J Channel for Easy Storage of Cables

[See Strut Overview For Ordering Options](#)

Item	Model No.	W	D	H	Ship Wt	Cubic Ft	Edge Profile + Material	List Price
CABLE GRIP	01-WMGRCB	5 $\frac{3}{8}$	2 $\frac{5}{8}$		-	-	\$	19

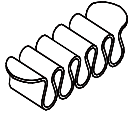

Description

- Under Surface Wire Management
- Black

MAGNETIC GLASS MARKER BOARD	GMB-4048W	48	$\frac{1}{2}$	40 $\frac{7}{8}$	67	11.0	\$	3465
FOR USE WITH 30"H CREDENZA AND SHELVING	GMB-4042W	42	$\frac{1}{2}$	40 $\frac{7}{8}$	58	9.9	\$	2929
	GMB-4036W	36	$\frac{1}{2}$	40 $\frac{7}{8}$	50	8.8	\$	2531
	GMB-4030W	30	$\frac{1}{2}$	40 $\frac{7}{8}$	42	7.7	\$	2131

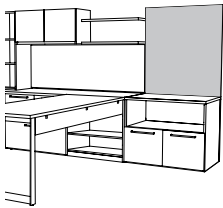

Description

- Available in Black (BLMKR) or White (WHMKR), Must Specify
- Tempered Glass Magnetic Marker Boards Include Mounting Brackets
- For Use over 30"H Desks and Credenzas with Wall Mount Hutches or Shelving
- For Rare Earth Magnets, Marker and Eraser Sets; [See Set Options](#)

Must Specify (in this order):

Model #
Color



Rare Earth Magnets, Marker and Eraser set available; [See Set Options](#)

MAGNETIC GLASS MARKER BOARD	GMB-5248W	48	$\frac{1}{2}$	52 $\frac{7}{8}$	86	13.5	\$	4419
FOR USE WITH 30"H CREDENZA AND SHELVING	GMB-5242W	42	$\frac{1}{2}$	52 $\frac{7}{8}$	76	12.2	\$	3732
	GMB-5236W	36	$\frac{1}{2}$	52 $\frac{7}{8}$	65	10.8	\$	3218
	GMB-5230W	30	$\frac{1}{2}$	52 $\frac{7}{8}$	54	9.5	\$	2705

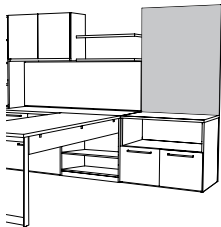

Description

- Available in Black (BLMKR) or White (WHMKR), Must Specify
- Tempered Glass Magnetic Marker Boards Include Mounting Brackets
- For Use Next to Tall Surface or Wall Mount Hutches
- For Rare Earth Magnets, Marker and Eraser Sets; [See Set Options](#)

Must Specify (in this order):

Model #
Color



Rare Earth Magnets, Marker and Eraser set available; [See Set Options](#)

[See Strut Overview For Ordering Options](#)

Item	Model No.	W	D	H	Ship Wt	Cubic Ft	List Price
MAGNETIC GLASS MARKER BOARD	GMB-8236W	36	½	82⅞	102	15.8	\$ 4934
FOR USE FROM FLOOR TO TOP OF UNIT	GMB-7036W	36	½	70⅞	87	13.8	\$ 4248
	GMB-5136W	36	½	51⅞	63	10.6	\$ 3104
	GMB-8230W	30	½	82⅞	85	13.8	\$ 4132
	GMB-7030W	30	½	70⅞	72	12.1	\$ 3562
	GMB-5130W	30	½	51⅞	53	9.3	\$ 2608

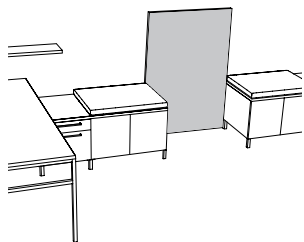

Must Specify (in this order):

Model #
Color

Description

- Available in Black (BLMKR) or White (WHMKR), Must Specify
- Tempered Glass Magnetic Marker Boards Are One (1) Piece with No Seams
- Mounting Brackets Included
- For Use From Floor to Top of Unit
- For Rare Earth Magnets, Marker and Eraser Sets; [See Set Options](#)



Rare Earth Magnets, Marker and Eraser set available; [See Set Options](#)

MARKER AND ERASER SET	01-MRKRSETBL	For Use with Black Marker Boards and Black Glass Doors	\$ 136
	01-MRKRSETWH	For Use with White Marker Boards and White Glass Doors	

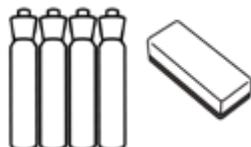

Description

- 01-MRKRSETWH May Also be Used with Dry Erase Doors and Boards
- Includes 4 Markers and an Eraser

RARE EARTH MAGNET SET	01-MAGBL	For Use with White Marker Boards	\$ 127
	01-MAGWH	For Use with Black Marker Boards	



Description

- Includes Set of Five (5) Rare Earth Magnets
- To be Used with Tempered Glass Magnetic Marker Boards
- Comfort Grip with Stylish Protective Plastic Coating

[See Strut Overview For Ordering Options](#)

Item	Model No.		W	D	H	Ship Wt	Cubic Ft	List Price
VISUAL BOARD	88-4848VB	TFL	48	5	48	150	11.0	T\$ 3314
		Veneer						W\$ 5503

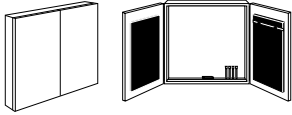

Must Specify (in this order):
 Model #
 Color
 Projection Screen
 Tackboard Fabric

Description

- Tackboard on Each Door Standard in Black Fabric Unless Specified; Price Valid for Grades 1, 2, & 3 (See Other Pricing Below)
- Display Rail with Adjustable Hooks for Flipchart
- Magnetic Porcelain Non-Glare Writing Surface
- Includes Flipchart, Set of Four (4) Dry Erase Markers and Eraser, Mounting Hardware
- Does Not Feature Soft Close Hinges

Options: Specify & Add

	Grade 4	Grade 5	Grade 6	Grade 7	Grade 8	Grade 9	Grade 10
Tackboard Fabric Change	\$ 310	456	602	812	1030	1286	1580
1-PS Projection Screen (Requires Field Installation)							\$ 1177

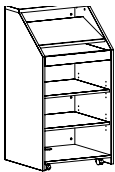

Item	Model No.		W	D	H	Ship Wt	Cubic Ft	List Price
LECTERN STAND	88-2650LS	TFL+HPL	26	24	50	130	21.9	F, G, X, Y / T+P\$ 2143
								H / T+P\$ 2154
		Veneer+HPL						F, G, X, Y / W+P\$ 3870
								H / W+P\$ 3899
		Veneer						F, G, X, Y / W\$ 4022
							H / W\$ 4038	



Must Specify (in this order):
 Model #
 Top/Edge Material
 Top/Edge Finish/Color
 Edge Profile

Description

- Top Edge Profiled on Approach Side Only (See Edge Options); Must Specify Edge Selection
- Fixed Shelf Angled for User Comfort, One (1) Pullout Shelf, and Two (2) Adjustable Shelves
- Two (2) Locking and Two (2) Non-Locking Casters
- Wire Management Grommet on Bottom Shelf

Item	Model No.	Description	List Price
ECA TELECOM PLATES			
	01-ABL	Telecom Plate, Blank Plate	\$ 45
	01-ABL737373	Telecom Plate, Three (3) RJ45 Cat 5e	\$ 406
Compatible with:	01-ABLAB	Telecom Plate, One (1) RJ45 Cat 6, One (1) RJ11 Cat 3 Phone	\$ 228
	01-ABLAB102	Telecom Plate, One (1) RJ45 Cat 6, One (1) RJ11 Cat 3, One (1) USB W/72" Patch Cord	\$ 355
	01-ABLABB	Telecom Plate, Two (2) RJ45 Cat 6, One (1) RJ11 Cat 3 Phone	\$ 355
Oasis Mini Power & Data 01-OASISMA, 01-OASISMB	01-ABLB	Telecom Plate, One (1) RJ45 Cat 6	\$ 165
	01-ABLBB	Telecom Plate, Two (2) RJ45 Cat 6	\$ 289
Interact Power & Data 01-INTERACTG2A, 01-INTERACTG2B	01-ABLBBB	Telecom Plate, Three (3) RJ45 Cat 6	\$ 406
	01-ABLBBBB	Telecom Plate, Four (4) RJ45 Cat 6	\$ 528
Power Center 01-INTRFCIA, 01-INTRFCIB	01-ABLBBC51	Telecom Plate, Two (2) RJ45 Cat 6, One (1) 15 Pin HD VGA w/72" Patch Cord	\$ 494
	01-ABLBC51L	Telecom Plate, One (1) RJ45 Cat 6, One (1) Mini Stereo Inline, One (1) 15 Pin HD VGA w/72" Patch Cord	\$ 455
	01-ABLC3811	Telecom Plate, One (1) RJ45 Cat 6 Data Inline, One (1) RJ11 Cat 3 Phone Inline	\$ 219
	01-ABLC45	Telecom Plate, One (1) HDMI w/36" Patch Cord	\$ 327
	01-ABLC45C51L	Telecom Plate, One (1) Mini Stereo Inline, One (1) HDMI w/36" Patch Cord, One (1) 15 Pin HD VGA w/72" Patch Cord	\$ 618
	01-ABLC51L	Telecom Plate, One (1) 15 Pin HD VGA & One (1) Mini Stereo Inline Jack	\$ 330
	01-ABLCRDM	Telecom Plate, Three (3) Cord Bushings	\$ 106

The Synergy Collection has partitions, tables, and seating to create spaces in an impromptu way without the need for complex architecture. Synergy Tables are a component of this thoughtful portfolio with soft rectangle and view-shaped seated, counter, and standing height tables, available as freestanding or with casters.

CONSTRUCTION

TABLES

- Table legs are 2"D, crafted from European Beech, and individually hand sanded prior to being finished with non-marring fixed nylon glides when casters are not selected
- Table tops have 1" thick Thermally-Fused Laminate (TFL) or High Pressure Laminate (HPL) surface with 3mm PVC edge band and Square edge profile; Designer White, Sugar Maple, and Williamsburg Cherry feature ABS edge bands



Square (Y)

- Tables require some assembly

POWER/DATA/CORD MANAGEMENT

- Table top grommets and power/data units are available on center
- Table tops feature undersurface a 2"H metal accent to conceal wires and additional cord management is available for order; [See Accessories](#)
- Power/Data units available for in-surface mounting and comply with FCC Part 15A and UL
- Partitions with TV mount include a black grommet below TV mount, center wire channel, and grommet in bottom of unit for a clean and easy access to power.

HOW TO ORDER EXAMPLES

MODEL	QTY	DESCRIPTION	EXAMPLE
82-3672BRT	1	Top Material	T
		TFL Top Color	NTM
		Metal Accent	ALUM
		Leg Color	ORW
		Leg Glide or Caster	BSC60 (Caster)
		Grommet/Power	C
POWER	1	Duo Bezel Nema Plug	01-DUOBEZELS
82-3672CVT	1	Top Material	T
		TFL Top Color	RC
		Metal Accent	ALUM
		Leg Color	RC
		Leg Glide or Caster	GLIDES
		Grommet/Power	C
POWER	1	Dock 950	01-DOCK950B

TFL (T) OR HPL (P) FOR TABLE TOP

WOODGRAIN

AS	Asian Night	PNW	Pinnacle Walnut
BW	Beigewood	PTK	Portico Teak
CO	Columbian Walnut	RC	River Cherry
EF	Espresso	SCH	Select Cherry
FLW	Florence Walnut	SPW	Sepia Walnut
GC	Golden Cherry	SKC	Shaker Cherry
HVM	Harvest Maple	SBP	Smoky Brown Pear
KHE	Kirsche	TK	Studio Teak
MW	Mahogany Walnut	SM	Sugar Maple
MNR	Midnight Run	WTA	Weathered Ash
NTM	Natural Marrone	WNB	White Nebbia
ORW	Oak Riftwood	WC	Williamsburg Cherry

SOLID

BL	Black	FHG	Fashion Grey
WH	Designer White	SG	Slate Grey

TABLE LEG WOOD FINISHES

Indiana Furniture uses a multi-step, hand finishing process on all exposed wood frames.

Units feature a catalyzed varnish finish which offers durability, lasting beauty, and resistance to normal wear.

AW	Artisan Walnut	MAS	Mesa Sunset*
AS	Asian Night	MTS	Metropolis Sky
BW	Beigewood*	MNR	Midnight Run
BL	Black	NTM	Natural Marrone*
CO	Columbian Walnut	ORW	Oak Riftwood*
DC	Dark Cherry	PNW	Pinnacle Walnut
DFW	Dark Forest Walnut*	PTK	Portico Teak*
WH	Designer White	RC	River Cherry*
EF	Espresso	SCH	Select Cherry
FO	Fawn Oak*	SPW	Sepia Walnut*
FLW	Florence Walnut*	SKC	Shaker Cherry
GC	Golden Cherry	SBP	Smoky Brown Pear*
HVM	Harvest Maple*	TK	Studio Teak
HW	Harvest Walnut	SM	Sugar Maple
HNW	Henna Walnut	WTA	Weathered Ash*
KHE	Kirsche	WNB	White Nebbia
LW	Legacy Walnut	WC	Williamsburg Cherry
MW	Mahogany Walnut		

* Low Sheen Finish

TABLE METAL ACCENT COLORS

Metal accents are featured on tables in three colors. Must specify color.

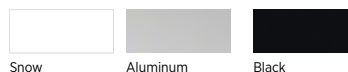

ALUM	Aluminum	SNO	Snow
BLK	Black		



Snow Aluminum Black

TABLE GLIDE OR CASTER OPTIONS

Tables available with casters or glides. Must specify.

	GLIDES	Fixed Glides	N/C
	BSC60	60mm Soft Caster	\$ 127

GROMMET & POWER/DATA UNIT OPTIONS & LOCATIONS

Grommets and Power/Data units available in center of table tops. Specify Center (C) location on order. Grommet and power/data units must be ordered separately. Tops may also be ordered without grommet/power units by specifying NO GROMMET on order.

Only one grommet/power/data unit per top. [See Product Details](#)

LOCATION OPTION

C On Center

GROMMET OPTIONS

GC Grommet, Center \$ 58

POWER/DATA UNIT OPTIONS [See Product Details and Pricing](#)

- DUO CLAMP Available in Black (B), Silver (S), or White (W)
- TRIO CLAMP Available in Black (B), Silver (S), or White (W)
- DUO BEZEL Available in Black (B), Silver (S), or White (W)
- TRIO BEZEL Available in Black (B), Silver (S), or White (W)
- DPORT4 Available in Aluminum or Black
- DOCK950 Available in Black or White
- DOCK150 Available in Black or White

CERTIFICATIONS & COMPLIANCE

- Intertek Sustainability Certified
- BIFMA Compliant® Certified
- TSCA Title VI (formerly CARB) Compliance
- Contributes to LEED®, Green Globes®, and WELL® Sustainable Programs

STATEMENT OF LINE

Synergy is a collection of partitions, tables, and seating to create spaces in an impromptu way without the need for complex architecture. See the entire Synergy Collection in the Space Division section.

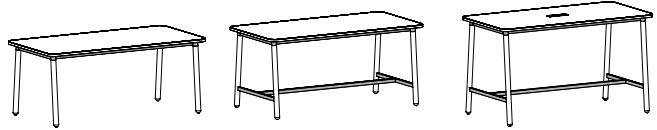

Seated Height Tables [\(See Details\)](#)

Counter Height Tables [\(See Details\)](#)

Standing Height Tables [\(See Details\)](#)

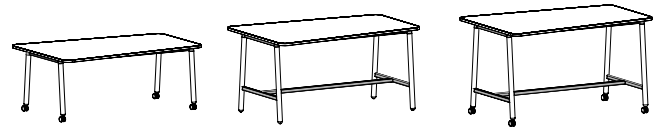

Seated Height View Tables [\(See Details\)](#)

Counter Height View Tables [\(See Details\)](#)

Standing Height View Tables [\(See Details\)](#)

Wire Management & Power/Data Accessories

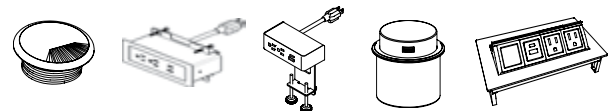

Power Options [\(See Multiple Unit Details\)](#)

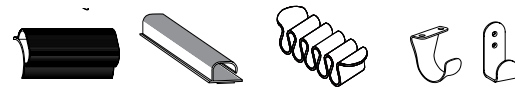

Wire Management & Other Accessories [\(See Multiple Unit Details\)](#)

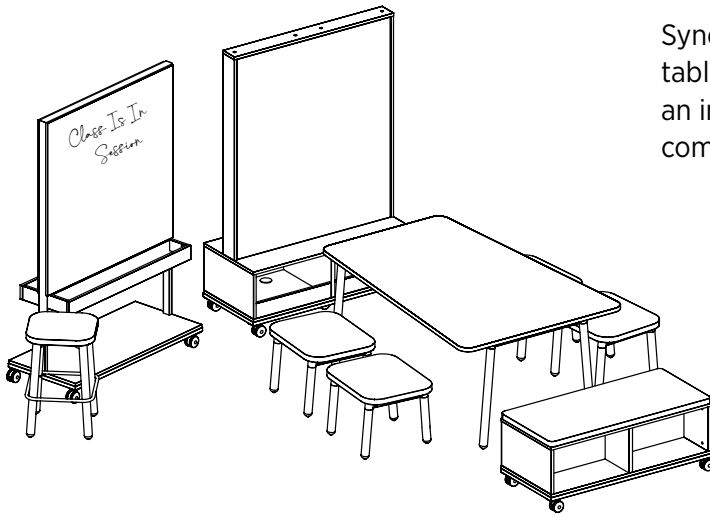

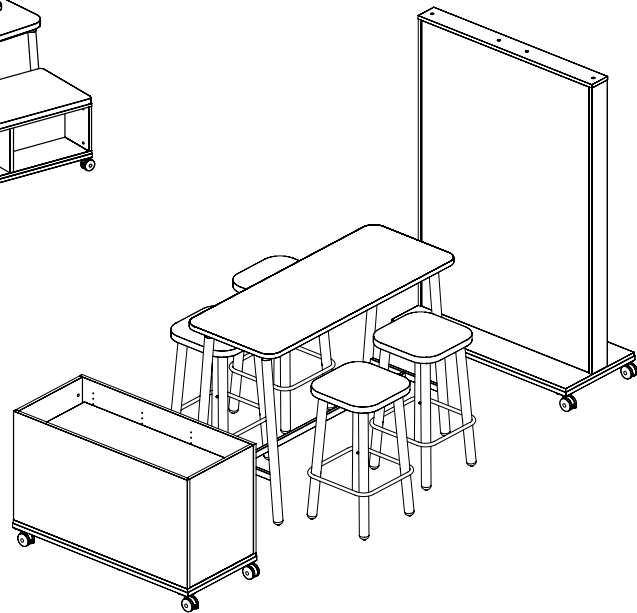

Synergy is a collection of partitions, tables, and seating to create spaces in an impromptu way without the need for complex architecture.

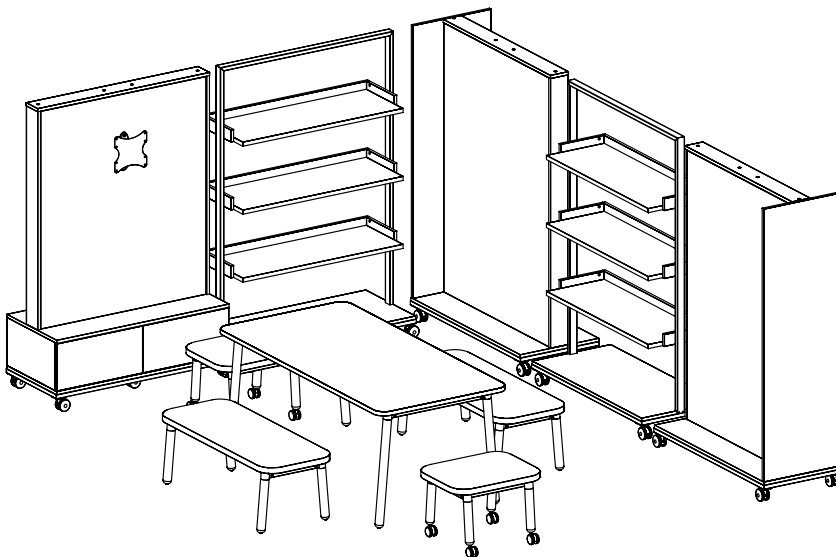

Synergy promotes flexibility to adapt to different interactions, forming areas to gather, separate, and then gather again...all in personalized ways, and all within the same open space.

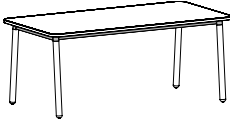

See the entire [Synergy Collection](#) under Space Division in this Price List.

Item	Model No.	W	D	H	Ship Wt	Cubic Ft	List Price	
  <p>Top Shape</p>	82-2460RT	60	24	30	67	10	T\$ 2277	P\$ 2367
	82-2472RT	72	24	30	76	12	T\$ 2406	P\$ 2466
	82-3060RT	60	30	30	76	11.1	T\$ 2351	P\$ 2392
	82-3072RT	72	30	30	86	13.3	T\$ 2495	P\$ 2618
	82-3660RT	60	36	30	90	14.4	T\$ 2529	P\$ 2653
	82-3672RT	72	36	30	103	17.1	T\$ 2687	P\$ 2751
	82-3684RT	84	36	30	115	19.9	T\$ 2836	P\$ 3355
	82-3696RT	96	36	30	126	22.7	T\$ 2929	P\$ 3388
	82-4272RT	72	42	30	115	19.3	T\$ 2831	P\$ 2928
	82-4284RT	84	42	30	127	22.4	T\$ 2939	P\$ 3388
	82-4296RT	96	42	30	141	25.5	T\$ 3046	P\$ 3426

Must Specify (in this order):



Model #
 Top Material
 Top Color
 Metal Accent Color
 Leg Color
 Leg Glide or Casters
 Grommet/Power



Use the Black Undermount Hook For Purses, Bags, Etc. [\(See Details\)](#)

Description

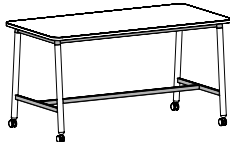
- TFL and HPL Tops ([See ColorsOptions](#))
- Undermount Metal Accents Measure 2"H, 1" Thick, and is Available in Black (BLK), Aluminum (ALUM), or Snow (SNO); Must Specify Color ([See Details](#))
- Top and Legs Available in Contrasting Colors ([See Leg Color Options](#))
- Legs Available with Fixed Glides (GLIDES) or Four (4) 60mm Casters (BSC60), Two (2) Locking and Two (2) Non-Locking ([See Details](#))
- Some Assembly Required
- Power and Grommet Available on Center Only ([See Options](#))



Item	Model No.	W	D	H	Ship Wt	Cubic Ft	List Price
 <p>Table Shown with Casters</p>  <p>Top Shape</p> <p>Must Specify (in this order): Model # Top Material Top Color Metal Accent Color Leg Color Leg Glide or Casters Grommet/Power</p>	82-2460CRT	60	24	36	76	10	T\$ 2806 P\$ 2897
	82-2472CRT	72	24	36	86	12	T\$ 2790 P\$ 2850
	82-3060CRT	60	30	36	85	11.1	T\$ 2881 P\$ 2921
	82-3072CRT	72	30	36	98	13.3	T\$ 2879 P\$ 3002
	82-3660CRT	60	36	36	101	14.4	T\$ 3086 P\$ 3209
	82-3672CRT	72	36	36	115	17.1	T\$ 3098 P\$ 3162
	82-3684CRT	84	36	36	126	19.9	T\$ 3248 P\$ 3766
	82-3696CRT	96	36	36	137	22.7	T\$ 3340 P\$ 3799
	82-4272CRT	72	42	36	126	19.3	T\$ 3243 P\$ 3339
	82-4284CRT	84	42	36	139	22.4	T\$ 3349 P\$ 3799
	82-4296CRT	96	42	36	152	25.5	T\$ 3457 P\$ 3837

Description

- TFL and HPL Tops ([See ColorsOptions](#))
- Undermount Metal Accents Measure 2"H, 1" Thick, and is Available in Black (BLK), Aluminum (ALUM), or Snow (SNO); Must Specify Color ([See Details](#))
- Top and Legs Available in Contrasting Colors ([See Leg Color Options](#))
- Legs Available with Fixed Glides (GLIDES) or Four (4) 60mm Casters (BSC60), Two (2) Locking and Two (2) Non-Locking ([See Details](#))
- Some Assembly Required
- Power and Grommet Available on Center Only ([See Options](#))

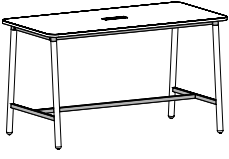

Use the Black Undermount Hook For Purses, Bags, Etc. ([See Details](#))

Item	Model No.	W	D	H	Ship Wt	Cubic Ft	List Price
 <p>Table Shown with TRIO on Center</p>  <p>Top Shape</p> <p><u>Must Specify (in this order):</u> Model # Top Material Top Color Metal Accent Color Leg Color Leg Glide or Casters Grommet/Power</p>	82-2460BRT	60	24	42	77	10	T\$ 2838 P\$ 2929
	82-2472BRT	72	24	42	88	12	T\$ 2997 P\$ 3056
	82-3060BRT	60	30	42	86	11.1	T\$ 2913 P\$ 2954
	82-3072BRT	72	30	42	100	13.3	T\$ 3086 P\$ 3208
	82-3660BRT	60	36	42	103	14.4	T\$ 3133 P\$ 3257
	82-3672BRT	72	36	42	117	17.1	T\$ 3319 P\$ 3384
	82-3684BRT	84	36	42	128	19.9	T\$ 3468 P\$ 3986
	82-3696BRT	96	36	42	139	22.7	T\$ 3561 P\$ 4022
	82-4272BRT	72	42	42	128	19.3	T\$ 3464 P\$ 3560
	82-4284BRT	84	42	42	141	22.4	T\$ 3570 P\$ 4021
	82-4296BRT	96	42	42	154	25.5	T\$ 3679 P\$ 4058

Description

- TFL and HPL Tops ([See ColorsOptions](#))
- Undermount Metal Accents Measure 2”H, 1” Thick, and is Available in Black (BLK), Aluminum (ALUM), or Snow (SNO); Must Specify Color ([See Details](#))
- Top and Legs Available in Contrasting Colors ([See Leg Color Options](#))
- Legs Available with Fixed Glides (GLIDES) or Four (4) 60mm Casters (BSC60), Two (2) Locking and Two (2) Non-Locking ([See Details](#))
- Some Assembly Required
- Power and Grommet Available on Center Only ([See Options](#))

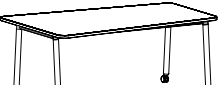
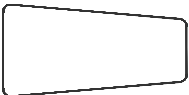

Use the Black Undermount Hook For Purses, Bags, Etc. ([See Details](#))

 <p>Table Shown with Casters</p>  <p>Top Shape</p> <p><u>Must Specify (in this order):</u> Model # Top Material Top Color Metal Accent Color Leg Color Leg Glide or Casters Grommet/Power</p>	82-2472VT	72	24-36	30	90	17.1	T\$ 2593 P\$ 2659
	82-3672VT	72	36-48	30	118	21	T\$ 2916 P\$ 2953

Description

- TFL and HPL Tops ([See ColorsOptions](#))
- Undermount Metal Accents Measure 2”H, 1” Thick, and is Available in Black (BLK), Aluminum (ALUM), or Snow (SNO); Must Specify Color ([See Details](#))
- Top and Legs Available in Contrasting Colors ([See Leg Color Options](#))
- Legs Available with Fixed Glides (GLIDES) or Four (4) 60mm Casters (BSC60), Two (2) Locking and Two (2) Non-Locking ([See Details](#))
- Some Assembly Required
- Power and Grommet Available on Center Only ([See Options](#))



Use the Black Undermount Hook For Purses, Bags, Etc. ([See Details](#))

Pricing Codes:
T= TFL P= HPL

[See Synergy Overview For Ordering Options](#)

Item	Model No.	W	D	H	Ship Wt	Cubic Ft	List Price
COUNTER HEIGHT VIEW TABLE	82-2472CVT	72	24-36	36	100	17.1	T\$ 2977 P\$ 3043
	82-3672CVT	72	36-48	36	129	21	T\$ 3327 P\$ 3363

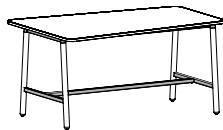

Top Shape

Must Specify (in this order):

- Model #
- Top Material
- Top Color
- Metal Accent Color
- Leg Color
- Leg Glide or Casters
- Grommet/Power

Description

- TFL and HPL Tops ([See ColorsOptions](#))
- Undermount Metal Accents Measure 2”H, 1” Thick, and is Available in Black (BLK), Aluminum (ALUM), or Snow (SNO); Must Specify Color ([See Details](#))
- Top and Legs Available in Contrasting Colors ([See Leg Color Options](#))
- Legs Available with Fixed Glides (GLIDES) or Four (4) 60mm Casters (BSC60), Two (2) Locking and Two (2) Non-Locking ([See Details](#))
- Some Assembly Required
- Power and Grommet Available on Center Only ([See Options](#))



Use the Black Undermount Hook For Purses, Bags, Etc. ([See Details](#))

Item	Model No.	W	D	H	Ship Wt	Cubic Ft	List Price
STANDING HEIGHT VIEW TABLE	82-2472BVT	72	24-36	42	102	17.1	T\$ 3183 P\$ 3249
	82-3672BVT	72	36-48	42	131	21	T\$ 3549 P\$ 3585

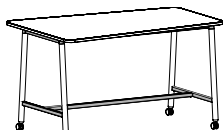

Table Shown with Casters



Top Shape

Must Specify (in this order):

- Model #
- Top Material
- Top Color
- Metal Accent Color
- Leg Color
- Leg Glide or Casters
- Grommet/Power

Description



- TFL and HPL Tops ([See ColorsOptions](#))
- Undermount Metal Accents Measure 2”H, 1” Thick, and is Available in Black (BLK), Aluminum (ALUM), or Snow (SNO); Must Specify Color ([See Details](#))
- Top and Legs Available in Contrasting Colors ([See Leg Color Options](#))
- Legs Available with Fixed Glides (GLIDES) or Four (4) 60mm Casters (BSC60), Two (2) Locking and Two (2) Non-Locking ([See Details](#))
- Some Assembly Required
- Power and Grommet Available on Center Only ([See Options](#))



Use the Black Undermount Hook For Purses, Bags, Etc. ([See Details](#))

Pricing Codes:
T= TFL P= HPL

[See Synergy Overview For Ordering Options](#)

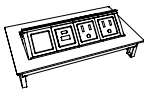
Item	Model No.		W	D	H	Ship Wt	Cubic Ft	List Price
ROUND GROMMET COVER 	01-GRMTB	Black	2 $\frac{3}{8}$	2 $\frac{3}{8}$	-	1	0.1	\$ 12
	01-GRMTSL	Silver						
OPEN MARKET ONLY (SILVER)	<p>Description</p> <ul style="list-style-type: none"> • 2$\frac{3}{8}$" (60mm) Round Grommet Cover • Field Installed 							
DOCK 950 WIRELESS CHARGER 	01-DOCK950W	White	3 $\frac{3}{16}$	3 $\frac{3}{16}$	-	1	0.2	\$ 294
	01-DOCK950B	Black						
OPEN MARKET ONLY	<p>Description</p> <ul style="list-style-type: none"> • For Use with Wireless Charging Enabled Devices • 5 Watts Maximum Output with a Direct Current of 5V 2A and 10 Watts Maximum with Quick Charge 2.0 • Mounts in 76mm Round Cut-Out • LED will Confirm Pairing with Device and Begin Wireless Charging 							
DOCK 150 WIRELESS AND USB CHARGER 	01-DOCK150W	White	3	3	$\frac{3}{4}$	1	0.2	\$ 448
	01-DOCK150B	Black						
OPEN MARKET ONLY	<p>Description</p> <ul style="list-style-type: none"> • For Use with Wireless Charging Enabled Devices and USB Charging Devices • 5 Watt Maximum Output with a Direct Current Input of 5V 6A (Wireless Fast Charge) • Mounts in 76mm Round Cut-Out • Pop-Up is $\frac{3}{4}$"H and Includes Three (3) USB Ports; One (1) 12 Watt Maximum with 2.4A (USB Fast Charge) and Two (2) 5 Watt with 1A (USB Standard Charge) • LED Light will Confirm Pairing with Device and Begin Wireless Charging • UL and cUL Certified 							
POWER DATA PORT 	01-DPORT4A	Aluminum	8	4	-	7	0.2	\$ 1211
	01-DPORT4B	Black						
	<p>Description</p> <ul style="list-style-type: none"> • Includes: Two (2) Power Outlets, One (1) USB A+C, One (1) Open Port, 10' Power Cord, and Voice/Data Adapter Kit to Accept Couplers and Jacks When Required • Retracts into Work Surface to Regain Productive Space; One-Touch Access to Power and Data • Optional Telecom Port Components, See Compatible Units on Next Page • Water-Proof Simplex (Outlets) • UL Recognized 							

Pricing Codes:
T= TFL P= HPL

[See Synergy Overview For Ordering Options](#)

Item	Model No.	W	D	H	Ship Wt	Cubic Ft	List Price
USB PORT	01-USBPORT	-	-	-	-	-	\$ 178

Description

- For Use with 01-DPORT4A and 01-DPORT4B
- Passive USB-A Port with Increased Transfer Speed Up to 5 gbs/sec
- Simultaneous Read/Write Capability
- Idle Device Power Saving State
- 6' Cord

VOICE COUPLER	01-VOICE1	-	-	-	-	-	\$ 80
---------------	-----------	---	---	---	---	---	-------

Description

- For Use with 01-DPORT4A and 01-DPORT4B
- 6-Pin Modular Plug
- Molded Black
- Cord Not included

DATA PORT	01-RJ4DATA	-	-	-	-	-	\$ 186
-----------	------------	---	---	---	---	---	--------



OPEN MARKET ONLY

Description

- For Use with 01-DPORT4A and 01-DPORT4B
- 8-Pin Modular Plug; Cat6 Ethernet Cable; Pre-terminated Cable
- 10' Cord

VGA CONNECTOR ACCESSORY	01-VGACON	-	-	-	1	0.2	\$ 165
-------------------------	-----------	---	---	---	---	-----	--------

Description

- VGA Port for 01-DPORT4A and 01-DPORT4B
- Enables Devices to Remote Display on Monitors
- 10' Cord
- Male/Female Connector



HDMI CONNECTOR ACCESSORY	01-HDMICON	-	-	-	1	0.2	\$ 137
--------------------------	------------	---	---	---	---	-----	--------

Description

- HDMI Port for 01-DPORT4A and 01-DPORT4B
- Connects to High Definition Displays
- Female/Female Connector
- 18" Cord

Pricing Codes:
T= TFL P= HPL

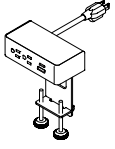
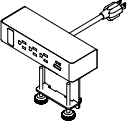
[See Synergy Overview For Ordering Options](#)

Item	Model No.		W	D	H	Ship Wt	Cubic Ft	List Price
DUO CLAMP WITH NEMA PLUG 	01-DUOCLAMPW	White	6½	3	7	1	0.2	\$ 634
	01-DUOCLAMPB	Black						
	01-DUOCLAMP S	Silver						
	Description <ul style="list-style-type: none"> • Standard with: Two (2) Power Outlet, One (1) USB Charging Port and One (1) 60-Watt USB-C Power • Delivery Port with GaN Technology with 10' Cord • Clamps to Top and Features Silver Metal Trim • Independent USB Circuit Controllers Deliver up to 2.1 Amps to Each Post • All Mounting Hardware Included • FCC Part 15A and UL Approved for Horizontal and Vertical Applications 							
TRIO CLAMP WITH NEMA PLUG 	01-TRIOCLAMPW	White	9	3	7	1	0.2	\$ 743
	01-TRIOCLAMPB	Black						
	01-TRIOCLAMP S	Silver						
	Description <ul style="list-style-type: none"> • Standard with: Three (3) Power Outlets, One (1) USB Charging Port, One (1) 60-Watt USB-C Power • Delivery Port with GaN Technology, One (1) Open Data with 10' Cord • Clamps to Top and Features Silver Metal Trim • Independent USB Circuit Controllers Deliver up to 2.1 Amps to Each Post • HDMI, VGA, or RJ45 Sold Separately; See Accessories • All Mounting Hardware Included • FCC Part 15A and UL Approved for Horizontal and Vertical Applications 							
DUO BEZEL WITH NEMA PLUG 	01-DUOBEZELW	White	6½	2½	3¼	1	0.2	\$ 748
	01-DUOBEZELB	Black						
	01-DUOBEZEL S	Silver						
	Description <ul style="list-style-type: none"> • Sits On Top of the Worksurface and Includes: Two (2) Power, One (1) USB Charging Port and One (1) 60-Watt USB-C Power Delivery Port with GaN Technology with 10' Cord • Independent USB Circuit Controllers Deliver up to 2.1 Amps to Each Post • All Mounting Hardware Included • FCC Part 15A and UL Approved for Horizontal and Vertical Applications 							
TRIO BEZEL WITH NEMA PLUG 	01-TRIOBEZELW	White	9	2½	3	1	0.2	\$ 803
	01-TRIOBEZELB	Black						
	01-TRIOBEZEL S	Silver						
	Description <ul style="list-style-type: none"> • Sits On Top of the Worksurface and Includes: Three (3) Power, One (1) USB Charging Port and One (1) 60-Watt USB-C Power Delivery Port with GaN Technology, One (1) Open Data, and 10' Cord • Independent USB Circuit Controllers Deliver up to 2.1 Amps to Each Post • HDMI, VGA, or RJ45 Sold Separately; See Accessories • All Mounting Hardware Included • FCC Part 15A and UL Approved for Horizontal and Vertical Applications 							

[See Synergy Overview For Ordering Options](#)

Item	Model No.	W	D	H	Ship Wt	Cubic Ft	List Price
HDMI DATA PORT ACCESSORY	01-LCOMHDMI	-	-	-	1	0.2	\$ 183

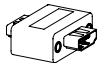
**Description**

- HDMI Port for Undermount Trio Clamp and Trio Bezel Units

OPEN MARKET ONLY

VGA DATA PORT ACCESSORY	01-LCOMVGA	-	-	-	1	0.2	\$ 134
-------------------------	------------	---	---	---	---	-----	--------

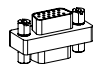
**Description**

- VGA Port for Undermount Trio Clamp and Trio Bezel Units

RJ45 DATA PORT ACCESSORY	01-LCOMRJ45	-	-	-	1	0.2	\$ 88
--------------------------	-------------	---	---	---	---	-----	-------

**Description**

- RJ45 Port for Undermount Trio Clamp and Trio Bezel Units

3" WIRE MANAGER FOR ROUND LEGS	01-0302WM	3	2	3/4	0.25	0.13	\$ 33
--------------------------------	-----------	---	---	-----	------	------	-------

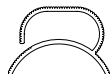
**Description**

- Black Vinyl Wire Management With Adhesive for Round Leg
- Quantity of Three (3)
- Attaches with Adhesive Strips
- Field Installed

WIRE CHANNEL	01-32125	24	1 1/2	1	.25	0.3	\$ 117
--------------	----------	----	-------	---	-----	-----	--------

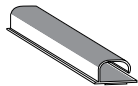
**Description**

- Available in Black
- Channel Attaches with Two (2) Double-Sided Installation Tape to Flat Surfaces
- Open J Channel for Easy Storage of Cables
- Field Installed

CABLE GRIP	01-WMGRCB	5 3/8	2 5/8	-	-	-	\$ 19
------------	-----------	-------	-------	---	---	---	-------

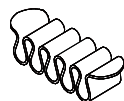
**Description**

- Black Under Surface Wire Management
- Cable Grip Attaches with Four (4) Screws, Hardware Included
- Field Installed

[See Synergy Overview For Ordering Options](#)

Item	Model No.	W	D	H	Ship Wt	Cubic Ft	List Price
BLACK UNDERMOUNT HOOK FOR TABLES	01-HOOK	2	1¾	2½ ₅			\$ 88

**Description**

- Black Hook Includes Mounting Hardware
- For Undermount Applications on Tables
- Field Installed

BLACK HOOK FOR VERTICAL SURFACES	01-ACCHOOKB	2	1¾	2½ ₅			\$ 69
-------------------------------------	-------------	---	----	-----------------	--	--	-------

**Description**

- Black Hook Includes Mounting Hardware
- For Use on Vertical Surfaces
- 20lbs Weight Capacity
- Field Installed

[See Synergy Overview For Ordering Options](#)



Occasional Tables

SURFACE MATERIAL DIGITAL IMAGES & BROCHURE

The finishes represented on Indiana Furniture's Surface Material Finish Brochure were reproduced using the finest technology available. Samples of our finishes and laminates are available for order through our Collateral Store. Please verify your desired finish before ordering as such orders are not subject to return to Indiana Furniture.

Contact your local Indiana Furniture Sales Representative or our Customer Service team should you need assistance.

GLIDES

All tables ship with non-marring glides, some series offering leveling glides as standard. See pricing pages for each series for more information.

FINISH

Indiana Furniture standard occasional table finishes correspond to casegoods and conferencing finishes and laminates. Minor variations in finish color and value may occur due to the natural characteristics of wood. Consult this price list for specific finish availability within each series.

Special Finishes: Indiana Furniture is able to accommodate our customer's needs for specific finish matches. Please submit a 3"x5" sample panel to Customer Service for quotation and lead time.

An overview of our finishes and laminate options can be found on the inside of the back cover of this price list.

Arlington offers all the grace and embellishments associated with traditional styling with an added emphasis on value. Finely crafted in select solids with walnut and cherry veneers and high pressure laminate worksurfaces, Arlington ensures quality and expert craftsmanship with a selection of configurations for today's functional workspaces.

CONSTRUCTION

- Veneers on exposed surfaces feature select grade, plain sliced American Black Walnut or Cherry veneers, carefully selected and matched to assure proper balance and consistency
- Veneer tops have a 5-ply balanced construction, 1 $\frac{3}{16}$ " thick with solid hardwood rims with butt corners
- HPL tops have a 3-ply balanced construction, 1 $\frac{3}{16}$ " thick, with solid hardwood rims with butt corners
- Grain direction runs left to right
- All units ship with heavy duty, adjustable leveling glides to ensure proper leveling and compensation for uneven floors
- Some Assembly Required

HOW TO ORDER EXAMPLE

Model No.	Description	Example
29-2124ET	Top Material Finish	W CO

VENEER (W) OPTIONS

Veneer features UVAdvantage, an ultra-violet finish, on all exposed surfaces by utilizing roll-coat UV technology. Apron rails and table legs use a multi-step, hand finished process with a catalyzed finish.

AW	Artisan Walnut	HW	Harvest Walnut
CO	Columbian Walnut	LW	Legacy Walnut
DC	Dark Cherry	MW	Mahogany Walnut
DFW	Dark Forest Walnut	PNW	Pinnacle Walnut
EW	Espresso	SCH	Select Cherry
GC	Golden Cherry	SKC	Shaker Cherry
HNW	Henna Walnut	WC	Williamsburg Cherry

HPL (P) TOP OPTIONS

WOODGRAIN

CO	Columbian Walnut	PNW	Pinnacle Walnut
EF	Espresso	SCH	Select Cherry
GC	Golden Cherry	SKC	Shaker Cherry
MW	Mahogany Walnut	WC	Williamsburg Cherry

TABLE EDGE PROFILE

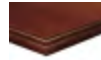

Arlington

CERTIFICATIONS & COMPLIANCE

- Intertek Sustainability Certified
- BIFMA level® Certified
- BIFMA Compliant® Certified
- TSCA Title VI (CARB) Compliance
- Contributes to LEED®, Green Globes®, and WELL® Sustainable Programs

STATEMENT OF LINE

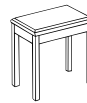

End Table:
29-2124ET
[\(See Details\)](#)

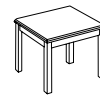

Lamp Table:
29-2424LT
[\(See Details\)](#)



Square Magazine
Table:
29-3636MT
[\(See Details\)](#)

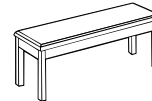

Magazine Table:
29-1847MT
[\(See Details\)](#)

Item	Model No.	W	D	H	Ship Wt	Cubic Ft	List Price	
END TABLE	29-2124ET	21	24	21½	25	2.0	P\$ 1185	W\$ 1380

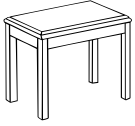

Must Specify (in this order):

Model #
Top Material
Finish/Color

Description

- Available with Veneer (W) or HPL (P) Top, Must Specify
- Hardwood Legs
- Some Assembly Required

LAMP TABLE	29-2424LT	24	24	21½	25	2.0	P\$ 1326	W\$ 1422
------------	-----------	----	----	-----	----	-----	----------	----------

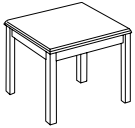

Must Specify (in this order):

Model #
Top Material
Finish/Color

Description

- Available with Veneer (W) or HPL (P) Top, Must Specify
- Hardwood Legs
- Some Assembly Required

MAGAZINE TABLE	29-1847MT	47	18	16	47	3.4	P\$ 1422	W\$ 1659
----------------	-----------	----	----	----	----	-----	----------	----------

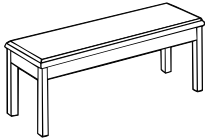

Must Specify (in this order):

Model #
Top Material
Finish/Color
Leg

Description

- Available with Veneer (W) or HPL (P) Top, Must Specify
- Left to Right Grain Direction on Worksurface
- Hardwood Legs
- Some Assembly Required
- Optional 30" Legs; See Below

Desk Base Molding Options: Must Specify and Add

SH-36	Optional 30" H Legs	\$ 257
-------	---------------------	--------

SQUARE MAGAZINE TABLE	29-3636MT	36	36	16	60	5.5	P\$ 1519	W\$ 1774
-----------------------	-----------	----	----	----	----	-----	----------	----------

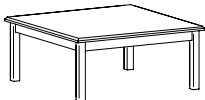

Must Specify (in this order):

Model #
Top Material
Finish/Color

Description

- Available with Veneer (W) or HPL (P) Top, Must Specify
- Hardwood Legs
- Some Assembly Required

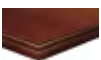

Wilmington/Arlington

Pricing Codes:

P= HPL W= Wood Top

For ordering options, [see overview at the beginning of this section.](#)

From lounge areas, to private office, to conference settings, the Bailey Collection can make a statement. Bailey tables are offered in square and rectangular cocktail tables, as well as end tables, in a wide range of veneers and laminates with two edge profiles.

CONSTRUCTION

- Bases for tables are manufactured using steel frames with a chrome finish
- The wood veneer tops are made of select grade sliced Black Walnut, Cherry, Maple, or composite veneers for maximum grain and color consistency
- Veneer tops are 1" with 1mm veneer edge bands
- Laminate tops are 1" with 1mm PVC edge bands; Designer White, Sugar Maple, and Williamsburg Cherry feature ABS edge bands
- Ships fully assembled

HOW TO ORDER EXAMPLE

Model No.	Description	Example
720-3030SQ	Finish	TK

TFL (T) AND HPL (P) LAMINATE OPTIONS

WOODGRAIN

AS	Asian Night	PNW	Pinnacle Walnut
BW	Beigewood	PTK	Portico Teak
CO	Columbian Walnut	RC	River Cherry
EF	Espresso	SCH	Select Cherry
FLW	Florence Walnut	SPW	Sepia Walnut
GC	Golden Cherry	SKC	Shaker Cherry
HVM	Harvest Maple	SBP	Smoky Brown Pear
MW	Mahogany Walnut	TK	Studio Teak
MNR	Midnight Run	SM	Sugar Maple
NTM	Natural Marrone	WTA	Weathered Ash
ORW	Oak Riftwood	WC	Williamsburg Cherry

SOLID

BL	Black	FHG	Fashion Grey
WH	Designer White	SG	Slate Grey

VENEER (W) OPTIONS AVAILABLE

Veneer tops feature UVAdvantage, an ultra-violet finish, on all exposed surfaces by utilizing roll-coat UV technology.

AW	Artisan Walnut	MW	Mahogany Walnut
AS	Asian Night	MAS	Mesa Sunset*
CO	Columbian Walnut	MTS	Metropolis Sky
DC	Dark Cherry	ORW	Oak Riftwood*
DFW	Dark Forest Walnut	PNW	Pinnacle Walnut
EW	Espresso	SCH	Select Cherry
FO	Fawn Oak*	SKC	Shaker Cherry
GC	Golden Cherry	SM	Sugar Maple
HW	Harvest Walnut	WTA	Weathered Ash*
HNW	Henna Walnut	WC	Williamsburg Cherry
LW	Legacy Walnut		

* Low Sheen Finish

TABLE EDGE PROFILE

- Y Square Edge
- K Knife Edge



Square Knife

CERTIFICATIONS & COMPLIANCE

- Intertek Sustainability Certified
- BIFMA level® Certified
- BIFMA Compliant® Certified
- TSCA Title VI (CARB) Compliance
- Contributes to LEED®, Green Globes®, and WELL® Sustainable Programs

STATEMENT OF LINE

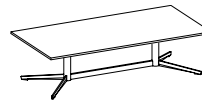

Rectangular
Cocktail Tables
([See Details](#))

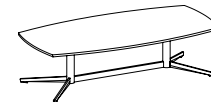

Soft Rectangular
Cocktail Tables
([See Details](#))



Square
Cocktail Tables
([See Details](#))



Soft Square
Cocktail Tables
([See Details](#))



Square
End Tables
([See Details](#))

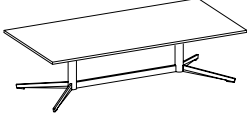
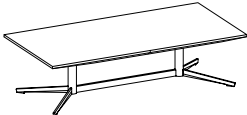

Soft Square
End Tables
([See Details](#))

Item	Model No.		W	D	H	Ship Wt	Cubic Ft	List Price		
RECTANGULAR COCKTAIL TABLE  	SQUARE EDGE									
	720-2550RT	TFL	25	50	14	34.9	3.2	T\$	1618	
	720-2550RTH	HPL	25	50	14	34.9	3.2	P\$	1900	
	719-2550RT	Veneer	25	50	14	34.9	3.2	W\$	2298	
	KNIFE EDGE									
	720-2550RTKH	HPL	25	50	14	34.9	3.2	P\$	2356	
719-2550RTK	Veneer	25	50	14	34.9	3.2	W\$	2467		

Must Specify (in this order):

Model #
Finish/Color

Description

- Standard with: Chrome Base
- Table Ships Fully Assembled

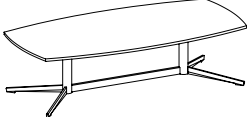
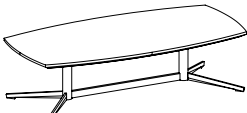
Item	Model No.		W	D	H	Ship Wt	Cubic Ft	List Price		
SOFT RECTANGULAR COCKTAIL TABLE  	SQUARE EDGE									
	720-2550SRT	TFL	25	50	14	34.9	3.2	T\$	1618	
	720-2550SRTH	HPL	25	50	14	34.9	3.2	P\$	1900	
	719-2550SRT	Veneer	25	50	14	34.9	3.2	W\$	2298	
	KNIFE EDGE									
	720-2550SRTKH	HPL	25	50	14	34.9	3.2	P\$	2356	
719-2550SRTK	Veneer	25	50	14	34.9	3.2	W\$	2467		

Must Specify (in this order):

Model #
Finish/Color

Description

- Standard with: Chrome Base
- Table Ships Fully Assembled





Square

Knife

Pricing Codes:

T= TFL P= HPL W= Wood Top

For ordering options, [see overview at the beginning of this section.](#)



Item	Model No.		W	D	H	Ship Wt	Cubic Ft	List Price		
SQUARE COCKTAIL TABLE  	SQUARE EDGE									
	720-3030SQ	TFL	30	30	14	29.7	2.80	T\$	1004	
	720-3030SQH	HPL	30	30	14	29.7	2.80	P\$	1362	
	719-3030SQ	Veneer	30	30	14	29.7	2.80	W\$	1582	
	KNIFE EDGE									
	720-3030SQKH	HPL	30	30	14	29.7	2.80	P\$	1717	
719-3030SQK	Veneer	30	30	14	29.7	2.80	W\$	1719		

Must Specify (in this order):

Model #
Finish/Color

Description

- Standard with: Chrome Base
- Table Ships Fully Assembled

Item	Model No.		W	D	H	Ship Wt	Cubic Ft	List Price		
SOFT SQUARE COCKTAIL TABLE  	SQUARE EDGE									
	720-3030SSQ	TFL	30	30	14	29.7	2.80	T\$	1004	
	720-3030SSQH	HPL	30	30	14	29.7	2.80	P\$	1362	
	719-3030SSQ	Veneer	30	30	14	29.7	2.80	W\$	1582	
	KNIFE EDGE									
	720-3030SSQKH	HPL	30	30	14	29.7	2.80	P\$	1717	
719-3030SSQK	Veneer	30	30	14	29.7	2.80	W\$	1719		

Must Specify (in this order):

Model #
Finish/Color

Description

- Standard with: Chrome Base
- Table Ships Fully Assembled



Square

Knife

Pricing Codes:

T= TFL P= HPL W= Wood Top

For ordering options, [see overview at the beginning of this section.](#)

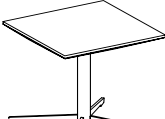

Item	Model No.		W	D	H	Ship Wt	Cubic Ft	List Price	
	SQUARE EDGE								
	720-2020ET	TFL	20	20	20	20	2.0	T\$	1097
	720-2020ETH	HPL	20	20	20	20	2.0	P\$	1361
	719-2020ET	Veneer	20	20	20	20	2.0	W\$	1444
	KNIFE EDGE								
	720-2020ETKH	HPL	20	20	20	20	2.0	P\$	1517
	719-2020ETK	Veneer	20	20	20	20	2.0	W\$	1586

Description

- Standard with: Chrome Base
- Table Ships Fully Assembled

Must Specify (in this order):

Model #
Finish/Color

Item	Model No.		W	D	H	Ship Wt	Cubic Ft	List Price	
	SQUARE EDGE								
	720-2020SET	TFL	20	20	20	20	2.0	T\$	1097
	720-2020SETH	HPL	20	20	20	20	2.0	P\$	1361
	719-2020SET	Veneer	20	20	20	20	2.0	W\$	1444
	KNIFE EDGE								
	720-2020SETKH	HPL	20	20	20	20	2.0	P\$	1517
	719-2020SETK	Veneer	20	20	20	20	2.0	W\$	1586

Description

- Standard with: Chrome Base
- Table Ships Fully Assembled

Must Specify (in this order):

Model #
Finish/Color



Square

Knife

Pricing Codes:

T= TFL P= HPL W= Wood Top

For ordering options, [see overview at the beginning of this section.](#)

The Britta Collection showcases a Mid-Century Scandinavian aesthetic with an appealing contemporary feel. Available in two edge styles and a broad range of finishes to create an inviting space with warm and energetic sensibility. Pair Britta tables with the collection's guest, single lounge, and settee options, which all feature a wall-saver design, to create an entire setting.

CONSTRUCTION

- The wood veneer table tops are 1" thick and are made of select grade sliced Walnut, Cherry, or Maple veneers for maximum grain and color consistency
- The knife edge profile features a 5-ply balanced construction with a solid hardwood rim; the square edge profile features a 3-ply balanced construction with a 3mm veneer edge band
- The aprons and legs are solid maple hardwood and ship with adjustable glides
- Ships fully assembled

HOW TO ORDER EXAMPLE

Model No.	Description	Example
231-1818ET	Finish Edge Profile	DFW K

VENEER (W) OPTIONS

Veneer tops feature UVAdvantage, an ultra-violet finish, on all exposed surfaces by utilizing roll-coat UV technology. Apron rails and table legs use a multi-step, hand finished process with a catalyzed finish.

AW	Artisan Walnut	LW	Legacy Walnut
CO	Columbian Walnut	MW	Mahogany Walnut
DC	Dark Cherry	MTS	Metropolis Sky
DFW	Dark Forest Walnut	PNW	Pinnacle Walnut
EW	Espresso	SCH	Select Cherry
GC	Golden Cherry	SKC	Shaker Cherry
HW	Harvest Walnut	SM	Sugar Maple
HNW	Henna Walnut	WC	Williamsburg Cherry

TABLE EDGE PROFILE

Y	Square Edge
K	Knife Edge



Square

Knife

CERTIFICATIONS & COMPLIANCE

- Intertek Sustainability Certified
- BIFMA level® Certified
- BIFMA Compliant® Certified
- TSCA Title VI (CARB) Compliance
- Contributes to LEED®, Green Globes®, and WELL® Sustainable Programs

STATEMENT OF LINE



Square End Table:
231-1818ET
[\(See Details\)](#)



Square Cocktail Table:
231-2323SCT
[\(See Details\)](#)



Rectangular Cocktail Table:
231-4723RCT
[\(See Details\)](#)

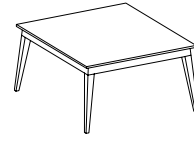

Square Cocktail Table:
231-3535SCT
[\(See Details\)](#)

Item	Model No.		W	D	H	Ship Wt	Cubic Ft	List Price	
END TABLE	231-1818ET	Square Edge	18	18	20	18	10.8	Y\$	1605
		Knife Edge						K\$	2053



Must Specify (in this order):

Model #
Finish
Edge

Description

- Standard with: Adjustable Glides
- Available with Square (Y) or Knife (K) Edge; Must Specify ([See Edges](#))
- Ships Fully Assembled

SMALL SQUARE COCKTAIL TABLE	231-2323SCT	Square Edge	23	23	16	21	10.8	Y\$	1641
		Knife Edge						K\$	2102



Must Specify (in this order):

Model #
Finish
Edge

Description

- Standard with: Adjustable Glides
- Available with Square (Y) or Knife (K) Edge; Must Specify ([See Edges](#))
- Ships Fully Assembled

SQUARE COCKTAIL TABLE	231-3535SCT	Square Edge	34 $\frac{7}{8}$	34 $\frac{7}{8}$	16	45	25.7	Y\$	1967
		Knife Edge						K\$	2526

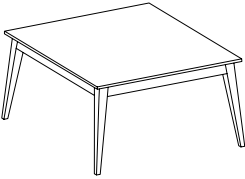

Must Specify (in this order):

Model #
Finish
Edge

Description

- Standard with: Adjustable Glides
- Available with Square (Y) or Knife (K) Edge; Must Specify ([See Edges](#))
- Ships Fully Assembled

RECTANGULAR COCKTAIL TABLE	231-4723RCT	Square Edge	46 $\frac{7}{8}$	23	16	36	23.1	Y\$	1924
		Knife Edge						K\$	2474

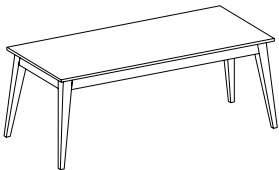

Must Specify (in this order):

Model #
Finish
Edge

Description

- Standard with: Adjustable Glides
- Available with Square (Y) or Knife (K) Edge; Must Specify ([See Edges](#))
- Ships Fully Assembled



Square

Knife

For ordering options, [see overview at the beginning of this section.](#)

Always stylish, comfortable and effortlessly adaptable, Canvas enlivens environments with refined aesthetics. Project a fresh, polished attitude with our enhanced selection of multidimensional components. Your creation of an ultra-functional workspace is limited only by your imagination.

CONSTRUCTION

- Exposed surfaces are produced from wood-grained or solid color laminates fused to a particle-board core.
- TFL chassis are fastened by screws and heavy-duty metal fasteners
- Tops are 1" thick thermally-fused (TFL) or high-pressure (HPL) laminate using 3mm PVC edge bands on profiled edges Grain direction runs left to right; Designer White, Sugar Maple, and Williamsburg Cherry feature ABS edge bands
- Slab ends come standard with adjustable levelers
- Ships fully assembled

HOW TO ORDER EXAMPLE

Model No.	Description	Example
66-2424ET	Top Material	T
	Top Color	FHG
	Edge Profile	F
	Chassis Color	WTA

TFL (T) AND HPL (P) LAMINATE OPTIONS

WOODGRAIN

AS	Asian Night	PNW	Pinnacle Walnut
BW	Beigewood	PTK	Portico Teak
CO	Columbian Walnut	RC	River Cherry
EF	Espresso	SCH	Select Cherry
FLW	Florence Walnut	SPW	Sepia Walnut
GC	Golden Cherry	SKC	Shaker Cherry
HVM	Harvest Maple	SBP	Smoky Brown Pear
KHE	Kirsche	TK	Studio Teak
MW	Mahogany Walnut	SM	Sugar Maple
MNR	Midnight Run	WTA	Weathered Ash
NTM	Natural Marrone	WC	Williamsburg Cherry
ORW	Oak Riftwood	WNB	White Nebbia

SOLID

BL	Black	FHG	Fashion Grey
WH	Designer White	SG	Slate Grey

TABLE EDGE PROFILE

F	Double Kerf	X	Fluted
G	Duo	Y	Square



Double Kerf



Duo



Flute



Square

CERTIFICATIONS & COMPLIANCE

- Intertek Sustainability Certified
- BIFMA level® Certified
- BIFMA Compliant® Certified
- TSCA Title VI (CARB) Compliance
- Contributes to LEED®, Green Globes®, and WELL® Sustainable Programs

STATEMENT OF LINE

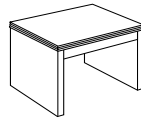

End Table:
66-2424ET
[\(See Details\)](#)

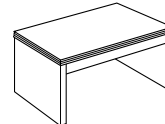

Magazine Table:
66-2442MT
[\(See Details\)](#)

Item	Model No.		W	D	H	Ship Wt	Cubic Ft	List Price	
END TABLE	66-2424ET	TFL	24	24	22	65	9.4	T\$	999
		HPL						P\$	1147

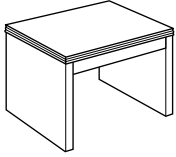

Must Specify (in this order):

Model #
Top Material
Top Color
Edge
Chassis Color

Description

- Standard with: TFL Slab Ends and Apron Rail, with Adjustable Glides
- Available in Contrasting Top and Chassis Color
- Choose from TFL (T) or HPL (P) Top in Four Edge Profiles ([See Colors and Details](#))
- Ships Fully Assembled

MAGAZINE TABLE	66-2442MT	TFL	42	24	16	70	11.9	T\$	1052
		HPL						P\$	1232

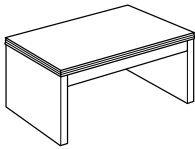

Must Specify (in this order):

Model #
Top Material
Top Color
Edge
Chassis Color

Description

- Standard with: TFL Slab Ends and Apron Rail, with Adjustable Glides
- Available in Contrasting Top and Chassis Color
- Choose from TFL (T) or HPL (P) Top in Four Edge Profiles ([See Colors and Details](#))
- Ships Fully Assembled



Double Kerf



Duo



Flute



Square

Pricing Codes:

T= TFL P= HPL

For ordering options, [see overview at the beginning of this section.](#)

Carefully matched select veneer tops with solid hardwood legs and aprons form a collection of beautiful wood tables suitable for nearly any application.

CONSTRUCTION

- Constructed of a 5-ply veneer top, 1½" thick
- Legs are solid Maple hardwood and ship with nylon glides
- Aprons are steam bent with Maple veneer faces
- Grain direction runs left to right
- Elliptical Magazine and Rounded End Tables ship fully assembled; all other models require some assembly

HOW TO ORDER EXAMPLE

Model No.	Description	Example
294-4222EMT	Finish	HW

VENEER (W) OPTIONS

Veneer tops feature UVAdvantage, an ultra-violet finish, on all exposed surfaces by utilizing roll-coat UV technology. Apron rails and table legs use a multi-step, hand finished process with a catalyzed finish.

AW	Artisan Walnut	LW	Legacy Walnut
CO	Columbian Walnut	MW	Mahogany Walnut
DC	Dark Cherry	MTS	Metropolis Sky
DFW	Dark Forest Walnut	PNW	Pinnacle Walnut
EW	Espresso	SCH	Select Cherry
GC	Golden Cherry	SKC	Shaker Cherry
HW	Harvest Walnut	SM	Sugar Maple
HNW	Henna Walnut	WC	Williamsburg Cherry

TABLE EDGE PROFILE



Phoenix

CERTIFICATIONS & COMPLIANCE

- Intertek Sustainability Certified
- BIFMA level® Certified
- BIFMA Compliant® Certified
- TSCA Title VI (CARB) Compliance
- Contributes to LEED®, Green Globes®, and WELL® Sustainable Programs

STATEMENT OF LINE

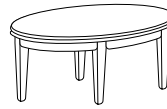

Elliptical Magazine Table:
294-4222EMT
[\(See Details\)](#)

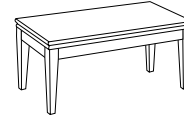

Magazine Table:
294-4222MT
[\(See Details\)](#)

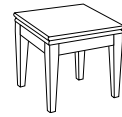

Lamp Table:
294-2222LT
[\(See Details\)](#)



End Table:
294-2622ET
[\(See Details\)](#)



Rounded End Table:
294-2222RET
[\(See Details\)](#)

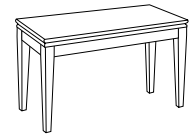

Console Table:
294-4216CT
[\(See Details\)](#)

Item	Model No.	W	D	H	Ship Wt	Cubic Ft	List Price
ELLIPTICAL MAGAZINE TABLE	294-4222EMT	42	22	16	48	14.4	\$ 3364

**Description**

- Ships Assembled

Must Specify (in this order):

Model #
Finish

MAGAZINE TABLE	294-4222MT	42	22	16	33	3.7	\$ 2170
----------------	------------	----	----	----	----	-----	---------

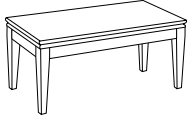
**Description**

- Some Assembly Required

Must Specify (in this order):

Model #
Finish

LAMP TABLE	294-2222LT	22	22	22	27	2.4	\$ 1656
------------	------------	----	----	----	----	-----	---------

**Description**

- Some Assembly Required

Must Specify (in this order):

Model #
Finish

END TABLE	294-2622ET	26	22	22	36	2.8	\$ 1746
-----------	------------	----	----	----	----	-----	---------

**Description**

- Some Assembly Required

Must Specify (in this order):

Model #
Finish

ROUNDED END TABLE	294-2222RET	22	22	22	24	2.4	\$ 2297
-------------------	-------------	----	----	----	----	-----	---------

**Description**

- Ships Assembled

Must Specify (in this order):

Model #
Finish

CONSOLE TABLE	294-4216CT	42	16	30	36	3.9	\$ 2068
---------------	------------	----	----	----	----	-----	---------

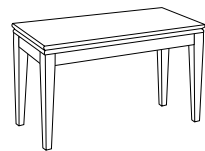
**Description**

- Some Assembly Required

Must Specify (in this order):

Model #
Finish



Phoenix

For ordering options, [see overview at the beginning of this section.](#)

A foundational suite of casegoods and tables primed to evolve with your needs. Gesso allows you to combine luxurious veneers, top grade laminates and other materials to create stylish, reconfigurable work spaces.

CONSTRUCTION

- Exposed surfaces feature select grade plain sliced hardwood veneers in Cherry, Maple, American Black Walnut, White Oak, or composite veneers
- Veneer and standard high pressure laminate tops are 3-ply balanced construction and 1 $\frac{3}{8}$ " thick, with 3mm wood edge-banded rims contoured to the selected profile
- Grain direction runs left to right
- All units ship with heavy duty, adjustable leveling glides to ensure proper leveling and compensation for uneven floors
- Ships fully assembled

HOW TO ORDER EXAMPLE

Model No.	Description	Example
65-2424ET	Top Material	W
	Finish	LW
	Edge Profile	G

VENEER (W) OPTIONS

Veneer tops feature UVAdvantage, an ultra-violet finish, on all exposed surfaces by utilizing roll-coat UV technology.

AW	Artisan Walnut	MW	Mahogany Walnut
AS	Asian Night	MAS	Mesa Sunset*
CO	Columbian Walnut	MTS	Metropolis Sky
DC	Dark Cherry	ORW	Oak Riftwood*
DFW	Dark Forest Walnut	PNW	Pinnacle Walnut
EW	Espresso	SCH	Select Cherry
FO	Fawn Oak*	SKC	Shaker Cherry
GC	Golden Cherry	SM	Sugar Maple
HW	Harvest Walnut	WTA	Weathered Ash*
HNW	Henna Walnut	WC	Williamsburg Cherry
LW	Legacy Walnut		

* Low Sheen Finish

HPL (P) LAMINATE OPTIONS

WOODGRAIN

AS	Asian Night	PNW	Pinnacle Walnut
CO	Columbian Walnut	SCH	Select Cherry
EF	Espresso	SKC	Shaker Cherry
GC	Golden Cherry	SM	Sugar Maple
MW	Mahogany Walnut	WTA	Weathered Ash
ORW	Oak Riftwood	WC	Williamsburg Cherry

TABLE EDGE PROFILE

F	Double Kerf	X	Fluted
G	Duo	Y	Square



Double Kerf

Duo

Flute

Square

CERTIFICATIONS & COMPLIANCE

- Intertek Sustainability Certified
- BIFMA level® Certified
- BIFMA Compliant® Certified
- TSCA Title VI (CARB) Compliance
- Contributes to LEED®, Green Globes®, and WELL® Sustainable Programs

STATEMENT OF LINE

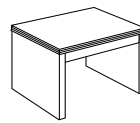

End Table:
65-2424ET
([See Details](#))

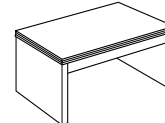

Magazine Table:
65-2442MT
([See Details](#))

END + MAGAZINE TABLES (6500 SERIES)

Item	Model No.		Width	Depth	Height	Ship Wt	Cubic Ft	List Price	
END TABLE	65-2424ET	HPL Veneer	24	24	22	65	9.4	W/P\$	1808

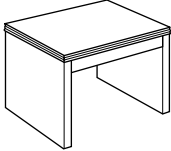

Description

- Standard with: Veneer Slab Ends and Apron Rail, with Adjustable Glides
- Choose from HPL (P) or Veneer (W) Top in Four Edge Profiles ([See Colors and Details](#))
- Ships Fully Assembled

Must Specify (in this order):

- Model #
- Top Material
- Finish/Color
- Edge

MAGAZINE TABLE	65-2442MT	HPL Veneer	42	24	16	70	11.9	W/P\$	1904
----------------	-----------	---------------	----	----	----	----	------	-------	------

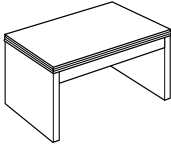

Description

- Standard with: Veneer Slab Ends and Apron Rail, with Adjustable Glides
- Choose from HPL (P) or Veneer (W) Top in Four Edge Profiles ([See Colors and Details](#))
- Ships Fully Assembled

Must Specify (in this order):

- Model #
- Top Material
- Finish/Color
- Edge



Double Kerf Duo Flute Square

Pricing Codes:
P= HPL W= Wood Top

Experience the staying power of classic design paired with keen, modern interiors. Gleem’s proven steam bending technique and handcrafted construction create a long lasting, superior chair. Create the perfect look, and provide lasting comfort for a diverse range of users.

CONSTRUCTION

- Exposed wood components are manufactured using European Beech and are free of spirits, discoloration, pits, shakes, and wormholes
- All chair joints are double-doweled or mortised and tenoned, screwed, and glued for maximum strength and durability
- Frames are individually hand assembled and sanded prior to being finished
- Non-marring nylon glides included in each leg at floor level
- Ships fully assembled

CERTIFICATIONS & COMPLIANCE

- Intertek Sustainability Certified
- BIFMA level® Certified
- BIFMA Compliant® Certified
- TSCA Title VI (CARB) Compliance
- Contributes to LEED®, Green Globes®, and WELL® Sustainable Programs

HOW TO ORDER EXAMPLE

Model No.	Description	Example
395	Top Material Finish	W LW

WOOD FINISHES

Indiana Furniture uses a multi-step, hand finishing process on all exposed wood frames.

Chairs feature a catalyzed varnish finish which offers durability, lasting beauty, and resistance to normal wear.

AW Artisan Walnut	MAS Mesa Sunset*
AS Asian Night	MTS Metropolis Sky
BW Beigewood*	MNR Midnight Run
BL Black	NTM Natural Marrone*
CO Columbian Walnut	ORW Oak Riftwood*
DC Dark Cherry	PNW Pinnacle Walnut
DFW Dark Forest Walnut*	PTK Portico Teak*
WH Designer White	RC River Cherry*
EF Espresso	SCH Select Cherry
FO Fawn Oak*	SPW Sepia Walnut*
FLW Florence Walnut*	SKC Shaker Cherry
GC Golden Cherry	SBP Smoky Brown Pear*
HVM Harvest Maple*	TK Studio Teak
HW Harvest Walnut	SM Sugar Maple
HNW Henna Walnut	WTA Weathered Ash*
KHE Kirsche	WNB White Nebbia
LW Legacy Walnut	WC Williamsburg Cherry
MW Mahogany Walnut	

* Low Sheen Finish

STATEMENT OF LINE

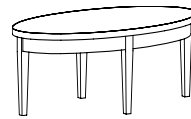

Elliptical Table
395-4222EMT
[\(See Details\)](#)

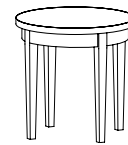

Round End Table
395-2222RET
[\(See Details\)](#)

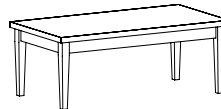

Magazine Table
395-4222MT
[\(See Details\)](#)

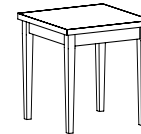

Lamp Table
395-2222LT
[\(See Details\)](#)

Item	Model No.	Width	Depth	Height	Ship Wt	Cubic Ft	List Price
LAMP TABLE	395-2222LT	22	22	22	18	11.6	T\$ 1361 W/P\$ 1496

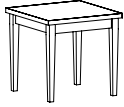

Description

- Standard with: Top Features Square Edge Profile, Wood Legs, and Adjustable Glides
- Choose Veneer (W), TFL (T), or HPL (P) Top
- Ships Fully Assembled

Must Specify (in this order):

Model #
Surface Material
Finish/Color

MAGAZINE TABLE	395-4222MT	42	22	16	33	14.4	T\$ 1590 W/P\$ 1734
----------------	------------	----	----	----	----	------	------------------------

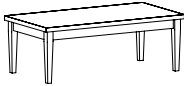

Description

- Standard with: Top Features Square Edge Profile, Wood Legs, and Adjustable Glides
- Choose Veneer (W), TFL (T), or HPL (P) Top
- Ships Fully Assembled

Must Specify (in this order):

Model #
Surface Material
Finish/Color

ROUND END TABLE	395-2222RET	22	22	22	18	11.6	T\$ 1425 W/P\$ 1594
-----------------	-------------	----	----	----	----	------	------------------------

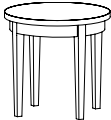

Description

- Standard with: Top Features Square Edge Profile, Wood Legs, and Adjustable Glides
- Choose Veneer (W), TFL (T), or HPL (P) Top
- Ships Fully Assembled

Must Specify (in this order):

Model #
Surface Material
Finish/Color

ELLIPTICAL TABLE	395-4222EMT	42	22	16	33	14.4	T\$ 1361 W/P\$ 1496
------------------	-------------	----	----	----	----	------	------------------------

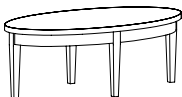

Description

- Standard with: Top Features Square Edge Profile, Wood Legs, and Adjustable Glides
- Choose Veneer (W), TFL (T), or HPL (P) Top
- Ships Fully Assembled

Must Specify (in this order):

Model #
Surface Material
Finish/Color

Jefferson echoes history and creates a timeless foundation for today's sophisticated work place. Finely crafted in select solids with walnut veneers, the tailored details of this collection accentuate our expert craftsmanship and perfect attention to detail.

CONSTRUCTION

- Veneers on exposed surfaces are select grade sliced American Black Walnut and Cherry are carefully selected and matched to assure proper balance and consistency
- Veneer and HPL tops featuring the C2 tops are 5-ply balanced construction, 1 $\frac{3}{16}$ " thick, with solid hardwood mitered rims
- Grain direction runs left to right
- All units ship with heavy duty, adjustable leveling glides to ensure proper leveling and compensation for uneven floors
- Some assembly required

HOW TO ORDER EXAMPLE

Model No.	Description	Example
46-1824ET	Top Material	W
	Finish	LW

SELECT VENEER (W) AND PREMIUM VENEER (PV) OPTIONS

Veneer tops feature UVAdvantage, an ultra-violet finish, on all exposed surfaces by utilizing roll-coat UV technology. Apron rails and table legs use a multi-step, hand finished process with a catalyzed finish.

AW	Artisan Walnut	LW	Legacy Walnut
CO	Columbian Walnut	MW	Mahogany Walnut
DC	Dark Cherry	MTS	Metropolis Sky
DFW	Dark Forest Walnut	PNW	Pinnacle Walnut
EW	Espresso	SCH	Select Cherry
GC	Golden Cherry	SKC	Shaker Cherry
HNW	Henna Walnut	WC	Williamsburg Cherry
HW	Harvest Walnut		

HPL (P) TOP OPTIONS

WOODGRAIN

CO	Columbian Walnut	PNW	Pinnacle Walnut
EF	Espresso	SCH	Select Cherry
GC	Golden Cherry	SKC	Shaker Cherry
MW	Mahogany Walnut	WC	Williamsburg Cherry

TABLE EDGE PROFILE



C2

CERTIFICATIONS & COMPLIANCE

- Intertek Sustainability Certified
- BIFMA level® Certified
- BIFMA Compliant® Certified
- TSCA Title VI (CARB) Compliance
- Contributes to LEED®, Green Globes®, and WELL® Sustainable Programs

STATEMENT OF LINE

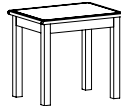

End Table:
46-1824ET
[\(See Details\)](#)

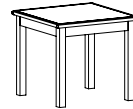

Lamp Table:
46-2424LT
[\(See Details\)](#)

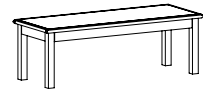

Magazine Table:
46-1847MT
[\(See Details\)](#)

Item	Model No.	W	D	H	Ship Wt	Cubic Ft	List Price
END TABLE	46-1824ET	24	18	21 ²⁵ / ₃₂	27	2.0	W/P\$ 1536 PV\$ 1721

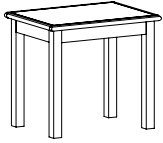
**Description**

- Available with Veneer (PV/W) or HPL (P) Top ([See Color Options](#))
- Hardwood Legs
- Some Assembly Required

Must Specify (in this order):

Model #
Top Material
Finish/Color

LAMP TABLE	46-2424LT	24	24	21 ²⁵ / ₃₂	37	3.3	W/P\$ 1956 PV\$ 2190
------------	-----------	----	----	----------------------------------	----	-----	-------------------------

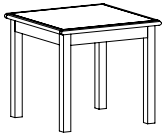
**Description**

- Available with Veneer (PV/W) or HPL (P) Top ([See Color Options](#))
- Hardwood Legs
- Some Assembly Required

Must Specify (in this order):

Model #
Top Material
Finish/Color

MAGAZINE TABLE	46-1847MT	47	18	15 ²⁵ / ₃₂	42	3.4	W/P\$ 1848 PV\$ 2069
----------------	-----------	----	----	----------------------------------	----	-----	-------------------------

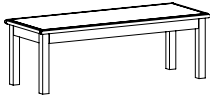
**Description**

- Available with Veneer (PV/W) or HPL (P) Top ([See Color Options](#))
- Hardwood Legs
- Optional 30"H Legs
- Some Assembly Required

Must Specify (in this order):

Model #
Top Material
Finish/Color
Leg

Leg Option: Specify & Add

SH-46	30"H Legs	20	0.9	\$ 252
-------	-----------	----	-----	--------

C2

P = HPL W = Veneer

Pricing Codes:

P = HPL W = Wood Top

For ordering options, [see overview at the beginning of this section.](#)

Discover the perfect table collection that goes anywhere. With a mix of materials, Jot complements a diverse range of interiors from ultra modern to classic. Its metal base, available in five refreshed colors, supports tops in solid surface, veneer, or laminate. Scaled for a perfect fit, Jot makes a great first impression front and center or corner-tucked for convenient storage. Jot's UV Advantage finish features a crystal clear topcoat developed for durability in high traffic areas.

CONSTRUCTION

- Veneer tops are 3/4" thick with veneer edge bands; made of select grade, sliced Black Walnut, Cherry, Maple, or Composite species
- TFL tops are 3/4" thick with a 1mm PVC edge band; Designer White, Sugar Maple, and Williamsburg Cherry feature ABS edge bands
- Solid surface tops are 3/4" thick and are available in six colors and two edge profiles
- Bases are manufactured using 3/4" steel frames and powder coated in your choice of five standard colors
- Joints on bases are mitered and fully welded for maximum strength and durability
- Tops are securely fastened to the bases with metal screws
- Ships fully assembled

HOW TO ORDER EXAMPLES

410-1412AT	Top Material	T
	Finish	TK
	Edge Detail (if applicable)	-
	Metal Base Color	ALUM

TFL (T) LAMINATE TABLE TOP OPTIONS

WOODGRAIN

AS	Asian Night	PNW	Pinnacle Walnut
BW	Beigewood	PTK	Portico Teak
CO	Columbian Walnut	RC	River Cherry
EF	Espresso	SPW	Sepia Walnut
FLW	Florence Walnut	SCH	Select Cherry
GC	Golden Cherry	SKC	Shaker Cherry
HVM	Harvest Maple	SBP	Smoky Brown Pear
KHE	Kirsche	TK	Studio Teak
MW	Mahogany Walnut	SM	Sugar Maple
MNR	Midnight Run	WTA	Weathered Ash
NTM	Natural Marrone	WNB	White Nebbia
ORW	Oak Riftwood	WC	Williamsburg Cherry

SOLID

BL	Black	FHG	Fashion Grey
WH	Designer White	SG	Slate Grey

VENEER (W) TABLE TOP OPTIONS

Tops feature UV Advantage, an ultra-violet finish, on all exposed surfaces by utilizing roll-coat UV technology.

AW	Artisan Walnut	MW	Mahogany Walnut
AS	Asian Night	MAS	Mesa Sunset*
CO	Columbian Walnut	MTS	Metropolis Sky
DC	Dark Cherry	ORW	Oak Riftwood*
DFW	Dark Forest Walnut	PNW	Pinnacle Walnut
EW	Espresso	SCH	Select Cherry
FO	Fawn Oak*	SKC	Shaker Cherry
GC	Golden Cherry	SM	Sugar Maple
HW	Harvest Walnut	WTA	Weathered Ash*
HNW	Henna Walnut	WC	Williamsburg Cherry
LW	Legacy Walnut		

* Low Sheen Finish

SOLID SURFACE (S) TABLE TOP OPTIONS

AR	Arroyo	SNW	Snow White
PE	Pebble Beach	SN	Starry Night
SE	Sedona	TN	Tundra

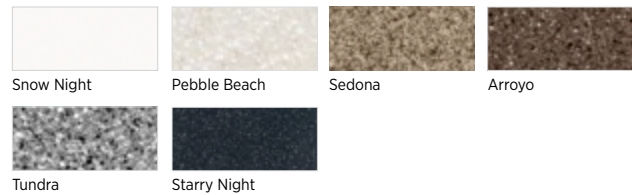

SOLID SURFACE EDGE PROFILE OPTIONS



Straight S1

METAL BASE OPTIONS

ALUM	Aluminum	OYST	Oyster
BLK	Black	SUGC	Sugar Cookie
MIST	Mist		



CERTIFICATIONS & COMPLIANCE

- Intertek Sustainability Certified
- BIFMA level® Certified
- BIFMA Compliant® Certified
- TSCA Title VI (CARB) Compliance
- Contributes to LEED®, Green Globes®, and WELL® Sustainable Programs

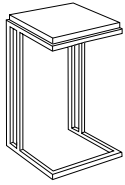

Auxiliary Table:
410-1412AT
[\(See Details\)](#)

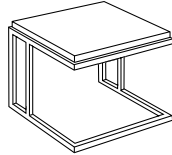

Square End Tables:
410-1818ET: 18"
410-2424ET: 24"
[\(See Details\)](#)

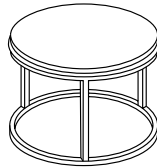

Round End Table:
410-2020CT
[\(See Details\)](#)

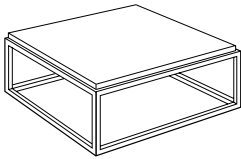

Square Cocktail Table:
410-3636SQ
[\(See Details\)](#)

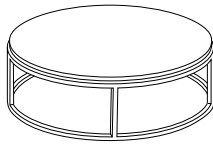

Round Cocktail Table:
410-3636CT
[\(See Details\)](#)

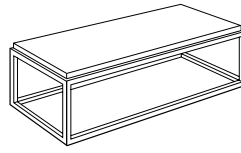

Rectangular Cocktail Table:
410-2248MT
[\(See Details\)](#)

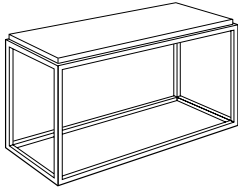

Console Table:
410-1848ST
[\(See Details\)](#)

Item	Model No.		W	D	H	Ship Wt	Cubic Ft	List Price
AUXILIARY TABLE	410-1412AT	TFL	12½	14	26½	46	8.6	T\$ 1460
		Veneer						W\$ 1640
		Solid Surface						S\$ 2663

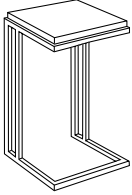

Must Specify (in this order):

Model #
Top Material
Finish/Color
Edge Profile (if applicable)
Base Color

Description

- Standard with: Decorative Metal Base and Nylon Glides
- Select Your Choice of TFL (T), Veneer (W), or Solid Surface (S) Top ([See Top and Base Color Options](#))

SQUARE END TABLE	410-2424ET	TFL	24	24	20	46	8.6	T\$ 1439
		Veneer						W\$ 1759
		Solid Surface						S\$ 3115
	410-1818ET	TFL	18	18	20	34	5.1	T\$ 1344
		Veneer						W\$ 1586
		Solid Surface						S\$ 2590

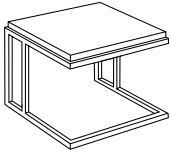

Must Specify (in this order):

Model #
Top Material
Finish/Color
Edge Profile (if applicable)
Base Color

Description

- Standard with: Decorative Metal Base and Nylon Glides
- Select Your Choice of TFL (T), Veneer (W), or Solid Surface (S) Top ([See Top and Base Color Options](#))

ROUND END TABLE	410-2020CT	TFL	20	20	20	36	6.2	T\$ 1306
		Veneer						W\$ 1668
		Solid Surface						S\$ 4866

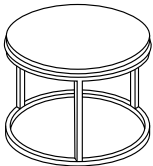

Must Specify (in this order):

Model #
Top Material
Finish/Color
Edge Profile (if applicable)
Base Color

Description

- Standard with: Decorative Metal Base and Adjustable Levelers
- Select Your Choice of TFL (T), Veneer (W), or Solid Surface (S) Top ([See Top and Base Color Options](#))

SQUARE COCKTAIL TABLE	410-3636SQ	TFL	36	36	15	68	13.4	T\$ 1726
		Veneer						W\$ 2087
		Solid Surface						S\$ 5164

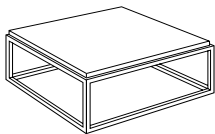

Must Specify (in this order):

Model #
Top Material
Finish/Color
Edge Profile (if applicable)
Base Color

Description

- Standard with: Decorative Metal Base and Nylon Glides
- Select Your Choice of TFL (T), Veneer (W), or Solid Surface (S) Top ([See Top and Base Color Options](#))

Pricing Codes:

T= TFL W= Wood Top S= Solid Surface

For ordering options, [see overview at the beginning of this section.](#)

Item	Model No.		W	D	H	Ship Wt	Cubic Ft	List Price
RECTANGULAR COCKTAIL TABLE	410-2248MT	TFL	48	22	15	92	11.0	T\$ 1643
		Veneer						W\$ 1946
		Solid Surface						S\$ 4225

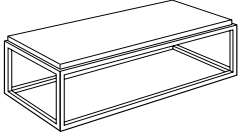

Must Specify (in this order):

Model #
 Top Material
 Finish/Color
 Edge Profile (if applicable)
 Base Color

Description

- Standard with: Decorative Metal Base and Nylon Glides
- Select Your Choice of TFL (T), Veneer (W), or Solid Surface (S) Top ([See Top and Base Color Options](#))

ROUND COCKTAIL TABLE	410-3636CT	TFL	36	36	15	68	13.4	T\$ 1631
		Veneer						W\$ 2073
		Solid Surface						S\$ 7438

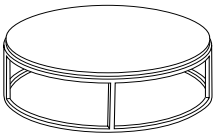

Must Specify (in this order):

Model #
 Top Material
 Finish/Color
 Edge Profile (if applicable)
 Base Color

Description

- Standard with: Decorative Metal Base and Adjustable Levelers
- Select Your Choice of TFL (T), Veneer (W), or Solid Surface (S) Top ([See Top and Base Color Options](#))

CONSOLE TABLE	410-1848ST	TFL	48	18	28	86	17.4	T\$ 1769
		Veneer						W\$ 2103
		Solid Surface						S\$ 4004

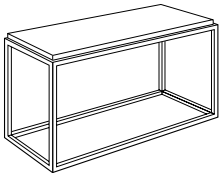

Must Specify (in this order):

Model #
 Top Material
 Finish/Color
 Edge Profile (if applicable)
 Base Color

Description

- Standard with: Decorative Metal Base and Adjustable Levelers
- Select Your Choice of TFL (T), Veneer (W), or Solid Surface (S) Top ([See Top and Base Color Options](#))

Pricing Codes:

T= TFL W= Wood Top S= Solid Surface

For ordering options, [see overview at the beginning of this section.](#)

Kirby offers a range of modern style for all your environment needs. Specify a casual look or elevate the tables to your desired level of sophistication. Available in a variety of sizes, shapes, edge profiles, and top surfaces (TFL, HPL, Veneer, Solid Surface, and Glass), and a mix of heights for nesting and creating a layered look. These versatile tables are perfect for reception areas, waiting rooms, personal spaces, collaborative areas, and so much more!

CONSTRUCTION

- Veneer, TFL, and HPL Tops with Square (H) edge are ¾" thick with 0.5 mm veneer and PVC or ABS edge bands
- Veneer and HPL Tops with Knife (KB) edge are 1⅜" thick with solid wood rims
- Solid Surface Tops are ½" thick with a straight (S1) self edge profile
- Back painted Glass Tops are ½" thick with a square self edge
- Non-marring nylon glides included in each leg
- Ships fully assembled

HOW TO ORDER EXAMPLE

Model No.	Description	Example
919-31300T18	Edge Profile, Top Material Top Color/Finish Leg Finish	S1, S SE RC
919-36360T15	Edge Profile, Top Material Top Color/Finish Leg Finish	GBLA AW PTK

TABLE EDGE PROFILES

- H Vertical Square Edge (*Veneer, TFL, and HPL*)
- KB Knife Edge (*Veneer and HPL*)
- S1 Straight (*Solid Surface*)



TFL (T) AND HPL (P) LAMINATE OPTIONS

WOODGRAIN

AS Asian Night	PNW Pinnacle Walnut
BW Beigewood	PTK Portico Teak
CO Columbian Walnut	RC River Cherry
EF Espresso	SCH Select Cherry
FLW Florence Walnut	SPW Sepia Walnut
GC Golden Cherry	SKC Shaker Cherry
HVM Harvest Maple	SBP Smoky Brown Pear
KHE Kirsche	TK Studio Teak
MW Mahogany Walnut	SM Sugar Maple
MNR Midnight Run	WTA Weathered Ash
NTM Natural Marrone	WNB White Nebbia
ORW Oak Riftwood	WC Williamsburg Cherry

SOLID

BL Black	FHG Fashion Grey
WH Designer White	SG Slate Grey

VENEER (W) OPTIONS AVAILABLE

Veneer tops feature UV Advantage, an ultra-violet finish, on all exposed surfaces by utilizing roll-coat UV technology.

AW Artisan Walnut	MW Mahogany Walnut
AS Asian Night	MAS Mesa Sunset*
CO Columbian Walnut	MTS Metropolis Sky
DC Dark Cherry	ORW Oak Riftwood*
DFW Dark Forest Walnut	PNW Pinnacle Walnut
EW Espresso	SCH Select Cherry
FO Fawn Oak*	SKC Shaker Cherry
GC Golden Cherry	SM Sugar Maple
HW Harvest Walnut	WTA Weathered Ash*
HNW Henna Walnut	WC Williamsburg Cherry
LW Legacy Walnut	

* Low Sheen Finish

SOLID SURFACE (S) TABLE TOP OPTIONS

Solid Surface tops are ½" thick with a straight (S1) self edge profile and available in six colors.

- AR Arroyo
- PE Pebble Beach
- SE Sedona
- SNW Snow White
- SN Starry Night
- TN Tundra



GLASS OPTIONS ON TOPS

Back painted tempered glass tops are ½" thick and available in Black or White with Gloss or Acid Etched finish.

- GBLG Black Gloss
- GBLA Black Acid Etched
- GWHG White Gloss
- GWHA White Acid Etched

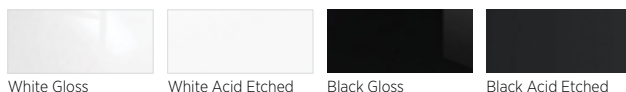

See Leg Color Options on Next Page.

For ordering options, [see overview at the beginning of this section.](#)

LEG WOOD FINISHES

Indiana Furniture uses a multi-step, hand finishing process on all exposed wood. Table legs feature a catalyzed varnish finish which offers durability, lasting beauty, and resistance to normal wear.

AW	Artisan Walnut	MAS	Mesa Sunset*
AS	Asian Night	MTS	Metropolis Sky
BW	Beigewood*	MNR	Midnight Run
BL	Black	NTM	Natural Marrone*
CO	Columbian Walnut	ORW	Oak Riftwood*
DC	Dark Cherry	PNW	Pinnacle Walnut
DFW	Dark Forest Walnut*	PTK	Portico Teak*
WH	Designer White	RC	River Cherry*
EF	Espresso	SCH	Select Cherry
FO	Fawn Oak*	SPW	Sepia Walnut*
FLW	Florence Walnut*	SKC	Shaker Cherry
GC	Golden Cherry	SBP	Smoky Brown Pear*
HVM	Harvest Maple*	TK	Studio Teak
HW	Harvest Walnut	SM	Sugar Maple
HNW	Henna Walnut	WTA	Weathered Ash*
KHE	Kirsche	WNB	White Nebbia
LW	Legacy Walnut	WC	Williamsburg Cherry
MW	Mahogany Walnut		

*Finish is Low Sheen

CERTIFICATIONS & COMPLIANCE

- Intertek® Sustainability Certified
- BIFMA level® Certified
- TSCA Title VI (CARB) Compliance
- Contributes to LEED®, Green Globes®, and WELL® Sustainable Programs

For ordering options, [see overview at the beginning of this section.](#)

Round Tables

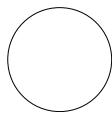

919-2020OT20
20"Wx20"Dx20"H
(See Details)



919-2424OT18
24"Wx24"Dx18"H
(See Details)



919-3030OT18
30"Wx30"Dx18"H
(See Details)



919-3636OT18
36"Wx36"Dx18"H
(See Details)



919-2424OT15
24"Wx24"Dx15"H
(See Details)



919-3030OT15
30"Wx30"Dx15"H
(See Details)



919-3636OT15
36"Wx36"Dx15"H
(See Details)

Soft Triangle Tables

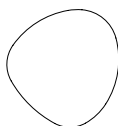

919-3130OT18
31"Wx30"Dx18"H
(See Details)



919-3836OT18
38"Wx36"Dx18"H
(See Details)



919-5131OT18
51"Wx31"Dx18"H
(See Details)



919-3130OT15
31"Wx30"Dx15"H
(See Details)



919-3836OT15
38"Wx36"Dx15"H
(See Details)



919-5131OT15
51"Wx31"Dx15"H
(See Details)

For ordering options, [see overview at the beginning of this section.](#)



For ordering options, [see overview at the beginning of this section.](#)

Item	Model No.		W	D	H	Ship Wt	Cubic Ft	Edge Profile + Material	List Price
20"H ROUND END TABLE 20"Wx20"D 	919-2020OT20	TFL	20	20	20	13	8.0	H / T\$	973
		HPL						H / P\$	1103
		HPL						KB / P\$	1536
		Veneer						H / W\$	1169
		Veneer						KB / W\$	1580
		Solid Surface						S1 / S\$	2326
		Glass						Acid Etched Glass Top \$	2310
Glass						Gloss Glass Top \$	1995		

Shown with Vertical
Square Edge

Must Specify (in this order):
Model #
Edge Profile/Top Material
Top Color/Finish
Leg Finish

Description

- Edge Profiles Available Include Square Edge (H), Knife Edge (KB), and Straight (S1) ([See Details](#))
- Choose Top Material TFL (T), HPL (P), Veneer (W), Solid Surface (S) or Glass (GWHG, GWHA, GBLG, GBLA); ([See Color Options](#))
- Available with Contrasting Top and Legs; Must Specify ([See Leg Colors](#))
- Ships assembled

18"H ROUND TABLE 24"Wx24"D 	919-2424OT18	TFL	24	24	18	19	6.4	H / T\$	1200
		HPL						H / P\$	1329
		HPL						KB / P\$	1815
		Veneer						H / W\$	1382
		Veneer						KB / W\$	1868
		Solid Surface						S1 / S\$	3037
		Glass						Acid Etched Glass Top \$	3168
Glass						Gloss Glass Top \$	2714		

Shown with
Knife Edge

Must Specify (in this order):
Model #
Edge Profile/Top Material
Top Color/Finish
Leg Finish

Description

- Edge Profiles Available Include Square Edge (H), Knife Edge (KB), and Straight (S1) ([See Details](#))
- Choose Top Material TFL (T), HPL (P), Veneer (W), Solid Surface (S) or Glass (GWHG, GWHA, GBLG, GBLA); ([See Color Options](#))
- Available with Contrasting Top and Legs; Must Specify ([See Leg Colors](#))
- Ships assembled

18"H ROUND TABLE 30"Wx30"D 	919-3030OT18	TFL	30	30	18	24	14.3	H / T\$	1264
		HPL						H / P\$	1397
		HPL						KB / P\$	1993
		Veneer						H / W\$	1456
		Veneer						KB / W\$	2035
		Solid Surface						S1 / S\$	4592
		Glass						Acid Etched Glass Top \$	4436
Glass						Gloss Glass Top \$	3726		

Shown with Vertical
Square Edge

Must Specify (in this order):
Model #
Edge Profile/Top Material
Top Color/Finish
Leg Finish

Description

- Edge Profiles Available Include Square Edge (H), Knife Edge (KB), and Straight (S1) ([See Details](#))
- Choose Top Material TFL (T), HPL (P), Veneer (W), Solid Surface (S) or Glass (GWHG, GWHA, GBLG, GBLA); ([See Color Options](#))
- Available with Contrasting Top and Legs; Must Specify ([See Leg Colors](#))
- Ships assembled

Edge Profile Options:



Vertical Square (H)
on (T), (P), or (W)



Knife (KB)
on (P) or (W)



Straight (S1)
on Solid Surfaces

Pricing Codes:

T= TFL P= HPL W= Wood Top S = Solid Surface

For ordering options, [see overview at the beginning of this section.](#)

Item	Model No.		W	D	H	Ship Wt	Cubic Ft	Edge Profile + Material	List Price	
18"H ROUND TABLE 36"WX36"D  Shown with Vertical Square Edge	919-3636OT18	TFL	36	36	18	31	14.3	H / T\$	1330	
		HPL							H / P\$	1509
		HPL							KB / P\$	2155
		Veneer							H / W\$	1517
		Veneer							KB / W\$	2253
		Solid Surface							S1 / S\$	5636
		Glass							Acid Etched Glass Top \$	5931
Glass							Gloss Glass Top \$	4909		

Must Specify (in this order):

Model #
 Edge Profile/Top Material
 Top Color/Finish
 Leg Finish

Description

- Edge Profiles Available Include Square Edge (H), Knife Edge (KB), and Straight (S1) ([See Details](#))
- Choose Top Material TFL (T), HPL (P), Veneer (W), Solid Surface (S) or Glass (GWHG, GWHA, GBLG, GBLA); ([See Color Options](#))
- Available with Contrasting Top and Legs; Must Specify ([See Leg Colors](#))
- Ships assembled

15"H ROUND TABLE 24"WX24"D  Shown with Knife Edge	919-2424OT15	TFL	24	24	15	18	6.4	H / T\$	1168	
		HPL							H / P\$	1297
		HPL							KB / P\$	1782
		Veneer							H / W\$	1350
		Veneer							KB / W\$	1836
		Solid Surface							S1 / S\$	3018
		Glass							Acid Etched Glass Top \$	3149
Glass							Gloss Glass Top \$	2695		

Must Specify (in this order):

Model #
 Edge Profile/Top Material
 Top Color/Finish
 Leg Finish

Description

- Edge Profiles Available Include Square Edge (H), Knife Edge (KB), and Straight (S1) ([See Details](#))
- Choose Top Material TFL (T), HPL (P), Veneer (W), Solid Surface (S) or Glass (GWHG, GWHA, GBLG, GBLA); ([See Color Options](#))
- Available with Contrasting Top and Legs; Must Specify ([See Leg Colors](#))
- Ships assembled

15"H ROUND TABLE 30"WX30"D  Shown with Knife Edge	919-3030OT15	TFL	30	30	15	23	14.3	H / T\$	1232	
		HPL							H / P\$	1365
		HPL							KB / P\$	1961
		Veneer							H / W\$	1424
		Veneer							KB / W\$	2002
		Solid Surface							S1 / S\$	4576
		Glass							Acid Etched Glass Top \$	4419
Glass							Gloss Glass Top \$	3709		

Must Specify (in this order):

Model #
 Edge Profile/Top Material
 Top Color/Finish
 Leg Finish

Description

- Edge Profiles Available Include Square Edge (H), Knife Edge (KB), and Straight (S1) ([See Details](#))
- Choose Top Material TFL (T), HPL (P), Veneer (W), Solid Surface (S) or Glass (GWHG, GWHA, GBLG, GBLA); ([See Color Options](#))
- Available with Contrasting Top and Legs; Must Specify ([See Leg Colors](#))
- Ships assembled

Edge Profile Options:



Vertical Square (H)
 on (T), (P), or (W)



Knife (KB)
 on (P) or (W)



Straight (S1)
 on Solid Surfaces

Pricing Codes:

T= TFL P= HPL W= Wood Top S= Solid Surface

For ordering options, [see overview at the beginning of this section.](#)

Item	Model No.		W	D	H	Ship Wt	Cubic Ft	Edge Profile + Material	List Price	
15"H ROUND TABLE 36"WX36"D  Shown with Vertical Square Edge	919-3636OT15	TFL	36	36	15	29	14.3	H / T\$	1298	
		HPL							H / P\$	1477
		HPL							KB / P\$	2122
		Veneer							H / W\$	1484
		Veneer							KB / W\$	2221
		Solid Surface							S1 / S\$	5622
		Glass							Acid Etched Glass Top \$	5917
Glass							Gloss Glass Top \$	4895		

Must Specify (in this order):

Model #
 Edge Profile/Top Material
 Top Color/Finish
 Leg Finish

Description

- Edge Profiles Available Include Square Edge (H), Knife Edge (KB), and Straight (S1) ([See Details](#))
- Choose Top Material TFL (T), HPL (P), Veneer (W), Solid Surface (S) or Glass (GWHG, GWHA, GBLG, GBLA); ([See Color Options](#))
- Available with Contrasting Top and Legs; Must Specify ([See Leg Colors](#))
- Ships assembled

18"H SOFT TRIANGLE TABLE 31"WX30"D  Shown with Vertical Square Edge	919-3130OT18	TFL	31	30	18	24	14.3	H / T\$	1272	
		HPL							H / P\$	1401
		HPL							KB / P\$	2006
		Veneer							H / W\$	1461
		Veneer							KB / W\$	2045
		Solid Surface							S1 / S\$	4569
		Glass							Acid Etched Glass Top \$	4627
Glass							Gloss Glass Top \$	3870		

Must Specify (in this order):

Model #
 Edge Profile/Top Material
 Top Color/Finish
 Leg Finish

Description

- Edge Profiles Available Include Square Edge (H), Knife Edge (KB), and Straight (S1) ([See Details](#))
- Choose Top Material TFL (T), HPL (P), Veneer (W), Solid Surface (S) or Glass (GWHG, GWHA, GBLG, GBLA); ([See Color Options](#))
- Available with Contrasting Top and Legs; Must Specify ([See Leg Colors](#))
- Ships assembled

18"H SOFT TRIANGLE TABLE 38"WX36"D  Shown with Knife Edge	919-3836OT18	TFL	38	36	18	31	15.7	H / T\$	1341	
		HPL							H / P\$	1514
		HPL							KB / P\$	2171
		Veneer							H / W\$	1521
		Veneer							KB / W\$	2267
		Solid Surface							S1 / S\$	6097
		Glass							Acid Etched Glass Top \$	6168
Glass							Gloss Glass Top \$	5089		

Must Specify (in this order):

Model #
 Edge Profile/Top Material
 Top Color/Finish
 Leg Finish

Description

- Edge Profiles Available Include Square Edge (H), Knife Edge (KB), and Straight (S1) ([See Details](#))
- Choose Top Material TFL (T), HPL (P), Veneer (W), Solid Surface (S) or Glass (GWHG, GWHA, GBLG, GBLA); ([See Color Options](#))
- Available with Contrasting Top and Legs; Must Specify ([See Leg Colors](#))
- Ships assembled

Edge Profile Options:



Vertical Square (H)
 on (T), (P), or (W)



Knife (KB)
 on (P) or (W)



Straight (S1)
 on Solid Surfaces

Pricing Codes:

T= TFL P= HPL W= Wood Top S= Solid Surface

For ordering options, [see overview at the beginning of this section.](#)

Item	Model No.		W	D	H	Ship Wt	Cubic Ft	Edge Profile + Material	List Price	
18"H SOFT TRIANGLE TABLE 51"WX31"D  Shown with Knife Edge	919-5131OT18	TFL	51	31	18	35	18.4	H / T\$	1380	
		HPL							H / P\$	1538
		HPL							KB / P\$	2196
		Veneer							H / W\$	1567
		Veneer							KB / W\$	2252
		Solid Surface							S1 / S\$	7137
		Glass							Acid Etched Glass Top \$	7004
		Glass							Gloss Glass Top \$	5757

Must Specify (in this order):

Model #
 Edge Profile/Top Material
 Top Color/Finish
 Leg Finish

Description

- Edge Profiles Available Include Square Edge (H), Knife Edge (KB), and Straight (S1) ([See Details](#))
- Choose Top Material TFL (T), HPL (P), Veneer (W), Solid Surface (S) or Glass (GWHG, GWHA, GBLG, GBLA); ([See Color Options](#))
- Available with Contrasting Top and Legs; Must Specify ([See Leg Colors](#))
- Ships assembled

15"H SOFT TRIANGLE TABLE 31"WX30"D  Shown with Vertical Square Edge	919-3130OT15	TFL	31	30	15	24	14.3	H / T\$	1240	
		HPL							H / P\$	1369
		HPL							KB / P\$	1973
		Veneer							H / W\$	1429
		Veneer							KB / W\$	2013
		Solid Surface							S1 / S\$	4553
		Glass							Acid Etched Glass Top \$	4610
		Glass							Gloss Glass Top \$	3852

Must Specify (in this order):

Model #
 Edge Profile/Top Material
 Top Color/Finish
 Leg Finish

Description

- Edge Profiles Available Include Square Edge (H), Knife Edge (KB), and Straight (S1) ([See Details](#))
- Choose Top Material TFL (T), HPL (P), Veneer (W), Solid Surface (S) or Glass (GWHG, GWHA, GBLG, GBLA); ([See Color Options](#))
- Available with Contrasting Top and Legs; Must Specify ([See Leg Colors](#))
- Ships assembled

Edge Profile Options:



Vertical Square (H)
on (T), (P), or (W)



Knife (KB)
on (P) or (W)



Straight (S1)
on Solid Surfaces

Pricing Codes:

T= TFL P= HPL W= Wood Top S= Solid Surface

For ordering options, [see overview at the beginning of this section.](#)

Item	Model No.		W	D	H	Ship Wt	Cubic Ft	Edge Profile + Material	List Price	
15"H SOFT TRIANGLE TABLE 38"W X 36"D  Shown with Vertical Square Edge	919-3836OT15	TFL	38	36	15	29	15.7	H / T\$	1308	
		HPL							H / P\$	1482
		HPL							KB / P\$	2139
		Veneer							H / W\$	1489
		Veneer							KB / W\$	2234
		Solid Surface							S1 / S\$	6084
		Glass							Acid Etched Glass Top \$	6154
		Glass							Gloss Glass Top \$	5075

Must Specify (in this order):

Model #
 Edge Profile/Top Material
 Top Color/Finish
 Leg Finish

Description

- Edge Profiles Available Include Square Edge (H), Knife Edge (KB), and Straight (S1) ([See Details](#))
- Choose Top Material TFL (T), HPL (P), Veneer (W), Solid Surface (S) or Glass (GWHG, GWHA, GBLG, GBLA); ([See Color Options](#))
- Available with Contrasting Top and Legs; Must Specify ([See Leg Colors](#))
- Ships assembled

15"H SOFT TRIANGLE TABLE 51"W X 31"D  Shown with Vertical Square Edge	919-5131OT15	TFL	51	31	15	34	18.4	H / T\$	1348	
		HPL							H / P\$	1506
		HPL							KB / P\$	2164
		Veneer							H / W\$	1535
		Veneer							KB / W\$	2219
		Solid Surface							S1 / S\$	7110
		Glass							Acid Etched Glass Top \$	6977
		Glass							Gloss Glass Top \$	5729

Must Specify (in this order):

Model #
 Edge Profile/Top Material
 Top Color/Finish
 Leg Finish

Description

- Edge Profiles Available Include Square Edge (H), Knife Edge (KB), and Straight (S1) ([See Details](#))
- Choose Top Material TFL (T), HPL (P), Veneer (W), Solid Surface (S) or Glass (GWHG, GWHA, GBLG, GBLA); ([See Color Options](#))
- Available with Contrasting Top and Legs; Must Specify ([See Leg Colors](#))
- Ships assembled

Edge Profile Options:



Vertical Square (H)
on (T), (P), or (W)



Knife (KB)
on (P) or (W)



Straight (S1)
on Solid Surfaces

Pricing Codes:

T= TFL P= HPL W= Wood Top S = Solid Surface

For ordering options, [see overview at the beginning of this section.](#)

Natta offers an agile solution for a variety of community spaces and meeting applications. With its simplicity of form, it can achieve a subtle effect and still provide an excellent solution for any meeting and breakout environment.

CONSTRUCTION

- Exposed parts are manufactured using European Beech
- Joints are double-doweled or mortised and tenoned, screwed, and glued for maximum strength and durability
- Frames are individually hand assembled and sanded prior to being finished; Legs are 9¾"H on the rectangular table and 14"H on the square table
- Non-marring nylon glides included in each leg at floor level
- Tables have 1½" thick HPL surface with 1mm PVC edge band Square edge profile; Designer White, Sugar Maple, and Williamsburg Cherry feature ABS edge bands
- Ships fully assembled

HOW TO ORDER EXAMPLE

Model No.	Description	Example
MMIT-2	Leg Finish	BW
	Top Color	WH

HPL (P) LAMINATE OPTIONS ON TABLES TOPS

WOODGRAIN

AS	Asian Night	PNW	Pinnacle Walnut
BW	Beigewood	PTK	Portico Teak
CO	Columbian Walnut	RC	River Cherry
EF	Espresso	SCH	Select Cherry
FLW	Florence Walnut	SPW	Sepia Walnut
GC	Golden Cherry	SKC	Shaker Cherry
HVM	Harvest Maple	SBP	Smoky Brown Pear
KHE	Kirsche	TK	Studio Teak
MW	Mahogany Walnut	SM	Sugar Maple
MNR	Midnight Run	WTA	Weathered Ash
NTM	Natural Marrone	WNB	White Nebbia
ORW	Oak Riftwood	WC	Williamsburg Cherry

SOLID

BL	Black	FHG	Fashion Grey
WH	Designer White	SG	Slate Grey

WOOD FINISHES AVAILABLE ON LEGS

AW	Artisan Walnut	MAS	Mesa Sunset*
AS	Asian Night	MTS	Metropolis Sky
BW	Beigewood*	MNR	Midnight Run
BL	Black	NTM	Natural Marrone*
CO	Columbian Walnut	ORW	Oak Riftwood*
DC	Dark Cherry	PNW	Pinnacle Walnut
DFW	Dark Forest Walnut*	PTK	Portico Teak*
WH	Designer White	RC	River Cherry*
EF	Espresso	SCH	Select Cherry
FO	Fawn Oak*	SPW	Sepia Walnut*
FLW	Florence Walnut*	SKC	Shaker Cherry
GC	Golden Cherry	SBP	Smoky Brown Pear*
HVM	Harvest Maple*	TK	Studio Teak
HW	Harvest Walnut	SM	Sugar Maple
HNW	Henna Walnut	WTA	Weathered Ash*
KHE	Kirsche	WNB	White Nebbia
LW	Legacy Walnut	WC	Williamsburg Cherry
MW	Mahogany Walnut		

* Low Sheen Finish

TABLE EDGE PROFILE



Square

CERTIFICATIONS & COMPLIANCE

- Intertek Sustainability Certified
- BIFMA level® Certified
- BIFMA Compliant® Certified
- TSCA Title VI (CARB) Compliance
- Contributes to LEED®, Green Globes®, and WELL® Sustainable Programs

STATEMENT OF LINE

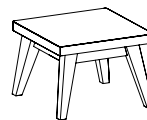

Square Table:
NAT-3
[\(See Details\)](#)

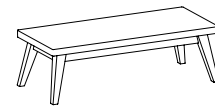

Rectangle Table:
NAT-4
[\(See Details\)](#)

Item	Model No.	Chair Width	Chair Depth	Chair Height	Seat Width	Seat Depth	Seat Height	Arm Height	Ship Wt	Cubic Ft
SQUARE TABLE	NAT-3		22	22	16	31	10.8		\$	1131

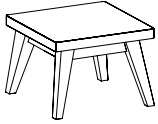

Description

- Features Square Edge Profile
- Available with Contrasting Top and Leg Color ([See Colors](#))

Must Specify (in this order):

Model #
Leg Finish
Top Color

RECTANGLE TABLE	NAT-4		51	22	16	66	25.9		\$	1541
-----------------	-------	--	----	----	----	----	------	--	----	------

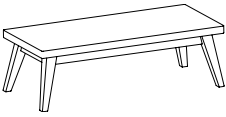

Description

- Features Square Edge Profile
- Available with Contrasting Top and Leg Color ([See Colors](#))

Must Specify (in this order):

Model #
Leg Finish
Top Color



Square

Otty Ottomans and Tables are designed for flexible environments where people can collaborate, brainstorm, or simply have a quick chat. Perfect for impromptu meetings, breakrooms, and all types of “we” spaces, Otty makes it easy to bring comfort to the workplace. And with a variety of options, like round and soft square styling, different heights, handles, glides and casters, contrasting fabrics, and table tops, you can easily configure and personalize your workspaces.

CONSTRUCTION

- Internal wood components and frame are manufactured using plywood; frames are individually hand assembled, and all joints are mortised and tenoned, and glued for maximum strength and durability
- High density, firm polyurethane foam construction 3” thick
- Table surfaces ¾” thick, available with Square (H) profile in Veneer (W), Thermally-Fused (TFL) or High-Pressure (HPL) Laminate using 1mm PVC edge bands on profiled edges; Designer White, Sugar Maple, and Williamsburg Cherry feature ABS edge bands
- Veneer tops feature UVAdvantage, an ultra-violet finish on all exposed surfaces by utilizing roll-coat UV technology.
- Table also available with Solid Surface tops, ¾” thick and available in six colors with Straight (S1) edge profile
- 18”D Tables available with four (4) 50mm non-locking casters; 24”D and 36”D Tables available with six (6)
- Ships fully assembled

HOW TO ORDER EXAMPLE

Model No.	Description	Example
840-1815ROT	Top Surface	PE
	Primary Upholstery	Mayer Arcade Latte
	Glides/Casters Option	CASTO

UPHOLSTERY OPTIONS + TIPS

Available in single. Select from a wide variety of graded-in or contract options, including fabric, vinyl, and leather. Contact our Sales Support Team for recommendations or evaluation of a material.

Upholstery Tips: Due to constant compression of the upholstery material, it is recommended to pick a material that does not easily fray. In most cases vinyl and vinyl-like materials will perform well. When evaluating a woven fabric material, check how easy it is to separate the woven strands. Typically, fabric materials with a thick backer or a non-linear weave pattern work best.

TFL (T) AND HPL (P) LAMINATE TABLE TOP OPTIONS

WOODGRAIN

AS Asian Night	PNW Pinnacle Walnut
BW Beigewood	PTK Portico Teak
CO Columbian Walnut	RC River Cherry
EF Espresso	SCH Select Cherry
FLW Florence Walnut	SPW Sepia Walnut
GC Golden Cherry	SKC Shaker Cherry
HVM Harvest Maple	SBP Smoky Brown Pear
KHE Kirsche	TK Studio Teak
MW Mahogany Walnut	SM Sugar Maple
MNR Midnight Run	WTA Weathered Ash
NTM Natural Marrone	WNB White Nebbia
ORW Oak Riftwood	WC Williamsburg Cherry

SOLID

BL Black	FHG Fashion Grey
WH Designer White	SG Slate Grey

VENEER (W) TABLE TOP OPTIONS

Veneer table tops feature UVAdvantage, an ultra-violet finish, on all exposed surfaces by utilizing roll-coat UV technology.

AW Artisan Walnut	MW Mahogany Walnut
AS Asian Night	MAS Mesa Sunset*
CO Columbian Walnut	MTS Metropolis Sky
DC Dark Cherry	ORW Oak Riftwood*
DFW Dark Forest Walnut	PNW Pinnacle Walnut
EW Espresso	SCH Select Cherry
FO Fawn Oak*	SKC Shaker Cherry
GC Golden Cherry	SM Sugar Maple
HW Harvest Walnut	WTA Weathered Ash*
HNW Henna Walnut	WC Williamsburg Cherry
LW Legacy Walnut	

* Low Sheen Finish

SOLID SURFACE (S) TABLE TOP OPTIONS

AR Arroyo	SNW Snow White
PE Pebble Beach	SN Starry Night
SE Sedona	TN Tundra

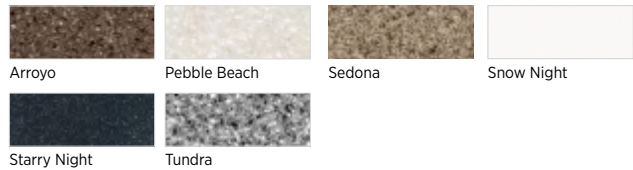

TABLE EDGE PROFILE

H Square Edge (Veneer, TFL, and HPL)
S1 Straight (Solid Surface)



CASTER OPTION

Tables come standard with glides. Optional hidden casters available to enhance and support users mobility. 18”W Tables available with four (4) glides or non-locking casters; 24” and 36”W Tables available with six (6) glides or non-locking casters.

GLIDE	Plastic High Glides, Standard	STD
CASTO	Black Casters	\$ 65

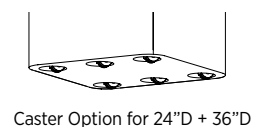
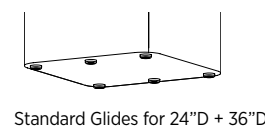
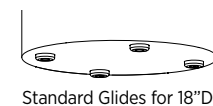

Round Tables (Upholstered Chassis with TFL, Veneer, or Solid Surface Top)

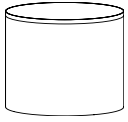

18"H Round Ottoman
Table
840-1818ROT
[\(See Details\)](#)

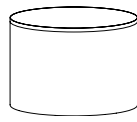

18"H Round Ottoman
Table
840-2418ROT
[\(See Details\)](#)

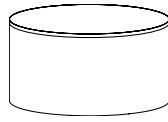

18"H Round Ottoman
Table
840-3618ROT
[\(See Details\)](#)

Square Tables (Upholstered Chassis with TFL, Veneer, or Solid Surface Top)

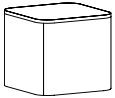

18"H Square Ottoman
Table
840-1818SOT
[\(See Details\)](#)

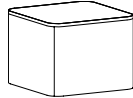

18"H Square Ottoman
Table
840-2418SOT
[\(See Details\)](#)

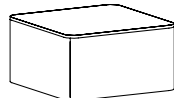

18"H Square Ottoman
Table
840-3618SOT
[\(See Details\)](#)

Item	Model No.	Chair Width	Chair Depth	Chair Height	Ship Wt	Cubic Ft	List Price
ROUND TABLE 18"Dx18"H	840-1818ROT	18	18	18	22.0	3.7	T\$ 717 P\$ 876 W\$ 966 S\$ 2261

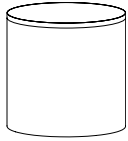

Must Specify (in this order):

- Model #
- Surface Material
- Top Color
- Upholstery
- Caster Option

Description

- Standard with: ¾" Thick Top Surface and Four (4) Black Glides
- Top Surface Available in TFL (T), HPL (P), Veneer (W), or Solid Surface (S) ([See Top Surface Details](#))
- Optional Four (4) Black Casters; Must Specify (CASTO), ([See Details](#))
- Add Upholstery Grade Pricing to Top Material Price

Add List Price/Grade	Yards	COM/1	2	3	4	5	6	7	8	9	10
Single Upholstery	1.25 \$	0	73	135	194	285	376	508	644	804	988

ROUND TABLE 24"Dx18"H	840-2418ROT	24	24	18	36.0	6.4	T\$ 954 P\$ 1108 W\$ 1185 S\$ 3009
--------------------------	-------------	----	----	----	------	-----	---



Must Specify (in this order):

- Model #
- Surface Material
- Top Color
- Upholstery
- Caster Option

Description

- Standard with: ¾" Thick Top Surface and Six (6) Black Glides
- Top Surface Available in TFL (T), HPL (P), Veneer (W), or Solid Surface (S) ([See Top Surface Details](#))
- Optional Six (6) Black Casters; Must Specify (CASTO), ([See Details](#))
- Add Upholstery Grade Pricing to Top Material Price

Add List Price/Grade	Yards	COM/1	2	3	4	5	6	7	8	9	10
Single Upholstery	1.25 \$	0	73	135	194	285	376	508	644	804	988

ROUND TABLE 36"Dx18"H	840-3618ROT	36	36	18	60.0	13.9	T\$ 1422 P\$ 1629 W\$ 1650 S\$ 6096
--------------------------	-------------	----	----	----	------	------	--

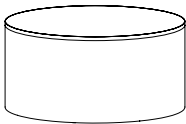

Must Specify (in this order):

- Model #
- Surface Material
- Top Color
- Upholstery
- Caster Option

Description

- Standard with: ¾" Thick Top Surface and Six (6) Black Glides
- Top Surface Available in TFL (T), HPL (P), Veneer (W), or Solid Surface (S) ([See Top Surface Details](#))
- Optional Six (6) Black Casters; Must Specify (CASTO), ([See Details](#))
- Add Upholstery Grade Pricing to Top Material Price

Add List Price/Grade	Yards	COM/1	2	3	4	5	6	7	8	9	10
840-3618ROT_USingle Upholstery	2.50 \$	0	145	270	388	570	753	1015	1288	1608	1975



Square



Straight

Pricing Codes:

T= TFL P= HPL W= Wood Top S = Solid Surface

For ordering options, [see overview at the beginning of this section.](#)

Item	Model No.	Chair Width	Chair Depth	Chair Height	Ship Wt	Cubic Ft	List Price
SOFT SQUARE TABLE 18"Dx18"H	840-1818SOT	18	18	18	25.0	3.7	T\$ 731
							P\$ 892
							W\$ 985
							S\$ 2274

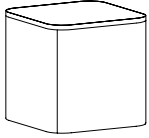

Must Specify (in this order):

- Model #
- Surface Material
- Top Color
- Upholstery
- Caster Option

Description

- Standard with: 3/4" Thick Top Surface and Four (4) Black Glides
- Top Surface Available in TFL (T), HPL (P), Veneer (W), or Solid Surface (S) ([See Top Surface Details](#))
- Optional Four (4) Black Casters; Must Specify (CASTO), ([See Details](#))
- Add Upholstery Grade Pricing to Top Material Price

List Price/Grade	Yards	COM/1	2	3	4	5	6	7	8	9	10
Single Upholstery	1.25 \$	0	73	135	194	285	376	508	644	804	988

SOFT SQUARE TABLE 24"Dx18"H	840-2418SOT	24	24	18	44.0	6.4	T\$ 936
							P\$ 1091
							W\$ 1174
							S\$ 2988

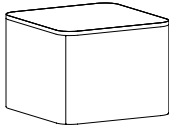

Must Specify (in this order):

- Model #
- Surface Material
- Top Color
- Upholstery
- Caster Option

Description

- Standard with: 3/4" Thick Top Surface and Six (6) Black Glides
- Top Surface Available in TFL (T), HPL (P), Veneer (W), or Solid Surface (S) ([See Top Surface Details](#))
- Optional Six (6) Black Casters; Must Specify (CASTO), ([See Details](#))
- Add Upholstery Grade Pricing to Top Material Price

List Price/Grade	Yards	COM/1	2	3	4	5	6	7	8	9	10
Single Upholstery	1.50 \$	0	87	162	233	342	452	609	773	965	1185

SOFT SQUARE TABLE 36"Dx18"H	840-3618SOT	36	36	18	83.0	13.9	T\$ 1448
							P\$ 1658
							W\$ 1685
							S\$ 6121

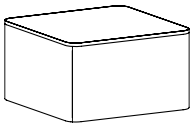

Must Specify (in this order):

- Model #
- Surface Material
- Top Color
- Upholstery
- Caster Option

Description

- Standard with: 3/4" Thick Top Surface and Six (6) Black Glides
- Top Surface Available in TFL (T), HPL (P), Veneer (W), or Solid Surface (S) ([See Top Surface Details](#))
- Optional Six (6) Black Casters; Must Specify (CASTO), ([See Details](#))
- Add Upholstery Grade Pricing to Top Material Price

List Price/Grade	Yards	COM/1	2	3	4	5	6	7	8	9	10
Single Upholstery	2.50 \$	0	145	270	388	570	753	1975	1288	1608	1975



Square



Straight

Pricing Codes:
T= TFL P= HPL W= Wood Top S= Solid Surface

For ordering options, [see overview at the beginning of this section.](#)

Crafted in American veneers, Phoenix's clean, transitional styling is at ease in both contemporary and traditional settings. It is a perfect choice for value-minded companies who want a sophisticated, yet uncomplicated, solution.

CONSTRUCTION

- Veneers on exposed surfaces are select grade sliced American Black Walnut and Cherry, and are carefully selected and matched to assure proper balance and consistency
- Veneer tops are 5-ply balanced construction and 1 $\frac{1}{32}$ " thick. High pressure laminate (HPL) tops are 3-ply balanced construction and 1 $\frac{1}{32}$ " thick
- Grain direction runs left to right
- All units ship with heavy duty, adjustable leveling glides to ensure proper leveling and compensation for uneven floors
- Some assembly required

HOW TO ORDER EXAMPLE

Model No.	Description	Example
21-1847MT	Top Material	P
	Finish	SKC

VENEER (W) OPTIONS

Veneer features UVAdvantage, an ultra-violet finish, on all exposed surfaces by utilizing roll-coat UV technology. Apron rails and table legs use a multi-step, hand finished process with a catalyzed finish.

AW	Artisan Walnut	LW	Legacy Walnut
CO	Columbian Walnut	MW	Mahogany Walnut
DC	Dark Cherry	MTS	Metropolis Sky
DFW	Dark Forest Walnut	PNW	Pinnacle Walnut
EW	Espresso	SCH	Select Cherry
GC	Golden Cherry	SKC	Shaker Cherry
HW	Harvest Walnut	WC	Williamsburg Cherry
HNW	Henna Walnut		

* Low Sheen Finish

HPL (P) TOP OPTIONS

CO	Columbian Walnut	PNW	Pinnacle Walnut
EF	Espresso	SCH	Select Cherry
GC	Golden Cherry	SKC	Shaker Cherry
MW	Mahogany Walnut	WC	Williamsburg Cherry

TABLE EDGE PROFILE



Phoenix

CERTIFICATIONS & COMPLIANCE

- Intertek Sustainability Certified
- BIFMA level® Certified
- BIFMA Compliant® Certified
- TSCA Title VI (CARB) Compliance
- Contributes to LEED®, Green Globes®, and WELL® Sustainable Programs

STATEMENT OF LINE

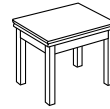

End Table:
21-1824ET
[\(See Details\)](#)

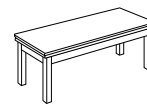

Magazine Table:
21-1847MT
[\(See Details\)](#)

Item	Model No.		W	D	H	Ship Wt	Cubic Ft	List Price
END TABLE	21-1824ET	HPL	18	24	22	25	2.0	P\$ 1070
		Veneer						W\$ 1130

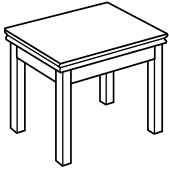

Description

- Available with Veneer (W) or HPL (P) Top ([See Color Options](#))
- Some Assembly Required

Must Specify (in this order):

Model #
Top Material
Finish/Color

MAGAZINE TABLE	21-1847MT	HPL	47	18	16	42	3.4	P\$ 1395
		Veneer						W\$ 1525

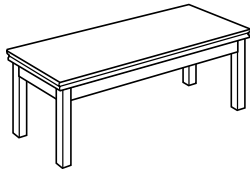

Description

- Available with Veneer (W) or HPL (P) Top ([See Color Options](#))
- Some Assembly Required
- Optional 30" Leg; See Below

Leg Option: Specify & Add

Must Specify (in this order):

Model #
Top Material
Finish/Color
Leg

30H-2SQ	30"H Legs					20	0.9	\$ 257
---------	-----------	--	--	--	--	----	-----	--------



Phoenix

Pricing Codes:

P= HPL W= Wood Top

For ordering options, [see overview at the beginning of this section.](#)

Pitch Tables bring a spectrum of options, all in one line, with a selection of square and rectangle end, magazine, and console tables. With it's classic style, Pitch is a go-to when you need an understated table with looks that say reliability. Available in wood and laminate tops with powder coated metal frames in three colors.

CONSTRUCTION

- Models feature a 1" thick top with a vertical square edge profile
- Veneer tops are made of select grade, sliced Black Walnut, Oak, Cherry, Maple, or Composite species with 0.5mm wood edge band
- High-Pressure (HPL) and Thermally-fused (TFL) Laminate tops have a 1mm PVC edge band
- Bases are manufactured using steel frames and powder coated in your choice of three standard colors
- Joints on bases are fully welded and sanded smooth for maximum strength and durability
- Tops are securely fastened to the bases with metal screws
- Ships fully assembled with adjustable glides

HOW TO ORDER EXAMPLES

710-3030SQ	Top Material	T
	Finish	PNW
	Metal Base Color	ALUM

TFL (T) LAMINATE TABLE TOP OPTIONS

WOODGRAIN

AS	Asian Night	PNW	Pinnacle Walnut
BW	Beigewood	PTK	Portico Teak
CO	Columbian Walnut	RC	River Cherry
EF	Espresso	SCH	Select Cherry
FLW	Florence Walnut	SPW	Sepia Walnut
GC	Golden Cherry	SKC	Shaker Cherry
HVM	Harvest Maple	SBP	Smoky Brown Pear
KHE	Kirsche	TK	Studio Teak
MW	Mahogany Walnut	SM	Sugar Maple
MNR	Midnight Run	WTA	Weathered Ash
NTM	Natural Marrone	WNB	White Nebbia
ORW	Oak Riftwood	WC	Williamsburg Cherry

SOLID

BL	Black	FHG	Fashion Grey
WH	Designer White	SG	Slate Grey

VENEER (W) TABLE TOP OPTIONS

Tops feature UV Advantage, an ultra-violet finish, on all exposed surfaces by utilizing roll-coat UV technology.

AW	Artisan Walnut	MW	Mahogany Walnut
AS	Asian Night	MAS	Mesa Sunset
CO	Columbian Walnut	MTS	Metropolis Sky
DC	Dark Cherry	ORW	Oak Riftwood*
DFW	Dark Forest Walnut	PNW	Pinnacle Walnut
EF	Espresso	SCH	Select Cherry
FO	Fawn Oak*	SKC	Shaker Cherry
GC	Golden Cherry	SM	Sugar Maple
HW	Harvest Walnut	WTA	Weathered Ash*
HNW	Henna Walnut	WC	Williamsburg Cherry
LW	Legacy Walnut		

* Low Sheen Finish

EDGE PROFILE

H Vertical Square



METAL BASE OPTIONS

ALUM	Aluminum
BLK	Black
SNO	Snow

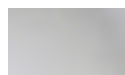

Aluminum



Black



Snow

CERTIFICATIONS & COMPLIANCE

- ETL Environmental Certification
- BIFMA level® Certified
- TSCA Title VI (CARB) Compliance
- US Green Building's LEED® Contribution

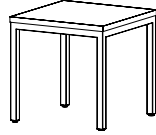

Square End Table
710-2020ET

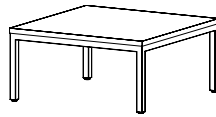

Square Magazine Table
710-3030SQ

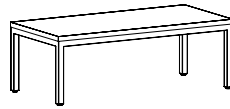

Rectangular Magazine Table
710-2042RT

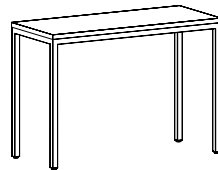

Console Table
710-1842ST

Item	Model No.		W	D	H	Ship Wt	Cubic Ft	List Price	
SQUARE END TABLE	710-2020ET	TFL	20	20	20	23	4.7	T\$	1510
		HPL						P\$	1687
		Veneer						W\$	1762

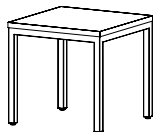

Must Specify (in this order):

- Model #
- Top Material
- Top Finish/Color
- Base Color

Description

- Standard with: 1/4" Powder Coated Steel Metal Base and Adjustable Glides
- Choose a HPL, TFL, or Veneer Top ([See Color Options](#))
- Available in Three Metal Base Colors ([See Metal Colors](#))
- Ships Fully Assembled

SQUARE MAGAZINE TABLE	710-3030SQ	TFL	30	30	15	37	7.9	T\$	1589
		HPL						P\$	1823
		Veneer						W\$	1924

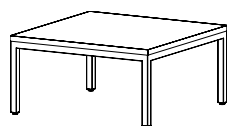

Must Specify (in this order):

- Model #
- Top Material
- Top Finish/Color
- Base Color

Description

- Standard with: 1/4" Powder Coated Steel Metal Base and Adjustable Glides
- Choose a HPL, TFL, or Veneer Top ([See Color Options](#))
- Available in Three Metal Base Colors ([See Metal Colors](#))
- Ships Fully Assembled

RECTANGULAR MAGAZINE TABLE	710-2042RT	TFL	42	20	15	36	7.3	T\$	1761
		HPL						P\$	1979
		Veneer						W\$	2072

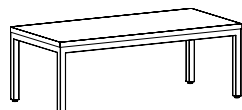

Must Specify (in this order):

- Model #
- Top Material
- Top Finish/Color
- Base Color

Description

- Standard with: 1/4" Powder Coated Steel Metal Base and Adjustable Glides
- Choose a HPL, TFL, or Veneer Top ([See Color Options](#))
- Available in Three Metal Base Colors ([See Metal Colors](#))
- Ships Fully Assembled

CONSOLE TABLE	710-1842ST	TFL	42	18	30	39	13.2	T\$	1810
		HPL						P\$	2017
		Veneer						W\$	2105

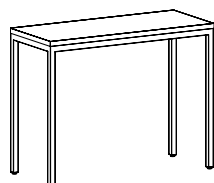

Must Specify (in this order):

- Model #
- Top Material
- Top Finish/Color
- Base Color

Description

- Standard with: 1/4" Powder Coated Steel Metal Base and Adjustable Glides
- Choose a HPL, TFL, or Veneer Top ([See Color Options](#))
- Available in Three Metal Base Colors ([See Metal Colors](#))
- Ships Fully Assembled

Pricing Codes:
T= TFL P= HPL W= Wood Top

For ordering options, see overview at the beginning of this section.

Plush Lounge seamlessly brings together the endurance needed for commercial spaces with the relaxed comforts of home. Introducing a smart range of freestanding and modular seating components, along with coordinating tables, that provide the flexibility and comfort needed in today's ever-changing environments.

CONSTRUCTION

- Exposed wood parts are kiln-dried hardwoods, selected from the highest grades of plain sliced hardwood veneers and are free of spirits, discoloration, pits, shakes, and wormholes
- Joints are mortised and tenoned, screwed, and glued for maximum strength and durability
- Maple Wood Legs are 2"Wx2½Dx6"H; Metal Legs are 2"Wx2"Dx6"H
- Non-marring adjustable nylon glides included at floor level
- Table tops are ¾" thick and feature a vertical square profiled edge



- Ships fully assembled

HOW TO ORDER EXAMPLES

TABLE		
620-2445CT	Top Material	W
	Finish/Color	ORW
	Cabinet Accent	CASG
	Leg	PLALUM
	Leg Finish	-
	Power Location	C
	Power	01-DUOBEZELS

TABLE LEG OPTIONS

Plush cocktail table comes standard with Black or Aluminum Metal legs. Optional Wood Leg matches our Iconic Caseloads Collection. Must Specify Leg and Color.

PLBLK	Black Metal Leg	STD
PLALUM	Aluminum Metal Leg	STD
ICON	Wood Leg (<i>Matches the Iconic Collection</i>)	\$ 368

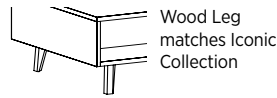
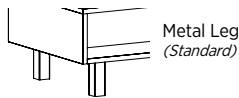

LEG WOOD FINISHES

Indiana Furniture uses a multi-step, hand finishing process on all exposed wood. Table legs feature a catalyzed varnish finish which offers durability, lasting beauty, and resistance to normal wear.

AW	Artisan Walnut	MAS	Mesa Sunset*
AS	Asian Night	MTS	Metropolis Sky
BW	Beigewood*	MNR	Midnight Run
BL	Black	NTM	Natural Marrone*
CO	Columbian Walnut	ORW	Oak Riftwood*
DC	Dark Cherry	PNW	Pinnacle Walnut
DFW	Dark Forest Walnut*	PTK	Portico Teak*
WH	Designer White	RC	River Cherry*
EF	Espresso	SCH	Select Cherry
FO	Fawn Oak*	SPW	Sepia Walnut*
FLW	Florence Walnut*	SKC	Shaker Cherry
GC	Golden Cherry	SBP	Smoky Brown Pear*
HVM	Harvest Maple*	TK	Studio Teak
HW	Harvest Walnut	SM	Sugar Maple
HNW	Henna Walnut	WTA	Weathered Ash*
KHE	Kirsche	WNB	White Nebbia
LW	Legacy Walnut	WC	Williamsburg Cherry
MW	Mahogany Walnut		

* Low Sheen Finish

VENEER TABLES WITH VENEER (W) OR HPL (P) TOP OPTIONS

Veneer tables feature UVAdvantage, an ultra-violet finish, on all exposed surfaces by utilizing roll-coat UV technology.

Veneer tables available with Veneer (W) or HPL (P) Top. Must specify Top Material and Finish Color. Tables are available with contrasting chassis and leg colors.

AW	Artisan Walnut	MW	Mahogany Walnut
AS	Asian Night	MAS	Mesa Sunset*
CO	Columbian Walnut	MTS	Metropolis Sky
DC	Dark Cherry	ORW	Oak Riftwood*
DFW	Dark Forest Walnut	PNW	Pinnacle Walnut
EW	Espresso	SCH	Select Cherry
FO	Fawn Oak*	SKC	Shaker Cherry
GC	Golden Cherry	SM	Sugar Maple
HW	Harvest Walnut	WTA	Weathered Ash*
HNW	Henna Walnut	WC	Williamsburg Cherry
LW	Legacy Walnut		

HPL COLOR OPTIONS WITH VENEER TABLES

AS	Asian Night	SKC	Shaker Cherry
CO	Columbian Walnut	SM	Sugar Maple
EW	Espresso	WTA	Weathered Ash*
ORW	Oak Riftwood*	WC	Williamsburg Cherry
PNW	Pinnacle Walnut		

* Low Sheen Finish

TFL TABLES WITH TFL (T) OR HPL (P) TOP OPTIONS

TFL tables available with TFL (T) or HPL (P) Top. Must specify Top Material and Color.

WOODGRAIN

AS	Asian Night	PTK	Portico Teak
BW	Beigewood	RC	River Cherry
CO	Columbian Walnut	SKC	Shaker Cherry
EF	Espresso	SPW	Sepia Walnut
FLW	Florence Walnut	SBP	Smoky Brown Pear
HVM	Harvest Maple	TK	Studio Teak
KHE	Kirsche	SM	Sugar Maple
MNR	Midnight Run	WTA	Weathered Ash
NTM	Natural Marrone	WNB	White Nebbia
ORW	Oak Riftwood	WC	Williamsburg Cherry
PNW	Pinnacle Walnut		

SOLID

BL	Black	WH	Designer White
----	-------	----	----------------

INTERIOR CABINET TABLE ACCENT HPL (P) OPTIONS

Select Veneer tables feature an optional interior HPL accent color. See specific veneer tables for details.

CABL	Black	CAFK	First Kiss
CABSH	Blush	CASG	Slate Grey
CAWH	Designer White	CASV	Summer Vacation
CAFHG	Fashion Grey	CASUS	Surfin USA

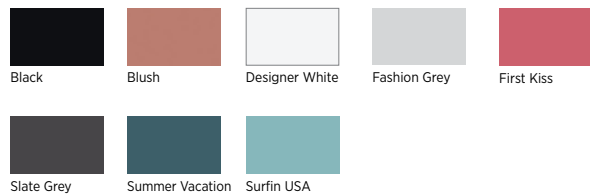

TABLE POWER OPTIONS

Power Options + Locations: Specify the grommet, power, and location.

Grommet	<i>Specify</i>		\$ 58
Black	GBR60		
Silver	GSR60		
Additional Power and Grommet Accessories, See Plush seating section			
D150 Wireless Charger			\$ 448
Wireless & Three (3) USB Ports			
Black	01-DOCK150B		
White	01-DOCK150W		
D950 Wireless & USB Charger			\$ 294
Wireless Charging			
Black	01-DOCK950B		
White	01-DOCK950W		
Kia Power			\$ 650
One (1) Electrical Power and one (1) USB A+C Outlets			
Black	01-COV1UBL		
Silver	01-COV1UAL		

TABLE POWER OPTIONS CONTINUE

DUOBEZEL			\$ 748
Two (2) Electrical Power, One (1) USB Charging Port and One (1) 60-Watt USB-C			
Black	01-DUOBEZELB		
White	01-DUOBEZELS		
Silver	01-DUOBEZELW		
TRIOBEZEL			\$ 803
Three (3) Electrical Power, One (1) USB Charging Port, One (1) 60-Watt USB-C, and One (1) Open Data Port			
Black	01-TRIOBEZELB		
White	01-TRIOBEZELS		
Silver	01-TRIOBEZELW		
<i>Open Port Options for TRIOBEZEL</i>			
VGA Data Port	01-LCOMVGA		\$ 134
HDMI Data Port (Open Market Only)	01-LCOMHDMI		\$ 183
RJ45 Data Port	01-LCOMRJ45		\$ 88
DPORT4			\$ 1211
Two (2) USB Outlets, and Two (2) Open Data Port			
Aluminum	01-DPORT4A		
Black	01-DPORT4B		
<i>Port Options for DPORTS</i>			
USB Port	01-USBPORT		\$ 178
Voice Coupler	01-VOICE1		\$ 80
Data Port	01-RJ4DATA		\$ 186

TABLE POWER LOCATIONS

NONE	None	LC	Left and Centered
C	Centered	RC	Right and Centered
R	Right	LR	Left and Right
L	Left	LCR	Left, Right and Centered

L/R: 6" from ends and 12" from front

C: 22½" from ends and 12" from front

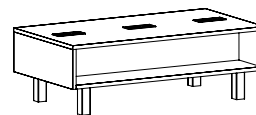

Cocktail Table Shown with Metal Leg and Three TRIOBEZEL on Left and Right and Center

All power options available in Left, Right and Center.

CERTIFICATIONS & COMPLIANCE

- CAL 117-2013 Compliance
- Intertek Sustainability Certified
- BIFMA level® Certified
- BIFMA Compliant® Certified
- TSCA Title VI (CARB) Compliance
- Contributes to LEED®, Green Globes®, and WELL® Sustainable Programs

Item	Model No.		W	D	H	Ship Wt	Cubic Ft	List Price	
COCKTAIL TABLE	620-2445CT	Veneer/HPL	45	24	15	77	9.4	W/P\$	2421
		Veneer Chassis							
	620-2445CTT	TFL	45	24	15	77	9.4	T\$	1479
		TFL Chassis						P\$	1615
		HPL							

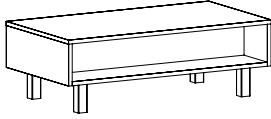

Shown with Metal Leg

Must Specify (in this order):
 Model #
 Top Material
 Finish/Color
 Cabinet Accent Color (Veneer Only)
 Leg
 Leg Finish/Color
 Power Location
 Power

Description

- Standard with: Metal Legs
- Chassis Available in Veneer (W) or TFL (T) (See [Veneer Finishes](#) and [TFL Color Options](#))
- Top Available with Veneer (W), TFL (T) or HPL (P) (See [Veneer/HPL Finishes](#) and [TFL/HPL Color Options](#))
- Primary Finish and Wood Legs Available in Contrasting Finish Colors
- 9"D Cubby Area on Both Sides of the Table
- Optional Cabinet Interior Accent Color Available on Veneer Tables Only ([See Color Options](#))
- See [Leg Options](#) and [Power Options](#)

Veneer Table Cabinet Accent Option: Specify Color & Add

Interior Cabinet Table Accent Color	Available on Veneer Tables Only (See Color Options)	\$	213
-------------------------------------	---	----	-----

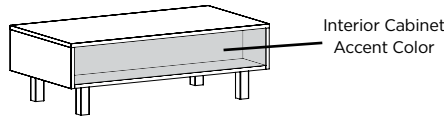

In partnership with Pledge, a UK-based company, we welcome Spirit.

Spirit has a refined and inviting form, and capitalizes on versatility and comfort. Complete your waiting area, welcoming lobby, or office space with Spirit tables.

CONSTRUCTION

- Non-marring nylon glides included in each leg at floor level
- Tables have 1" TFL or 1½" HPL surface thickness with 1mm PVC edge band and Square edge profile; Designer White, Sugar Maple, and Williamsburg Cherry feature ABS edge bands
- Bases are comprised of bent wire frames or hardwood legs securely attached to a metal substructure.
- Black or Aluminum Powder Coat, and Chrome wireframes
- Ships fully assembled

HOW TO ORDER EXAMPLE

Model No.	Description	Example
ST11C	Top Color	WTA
	Base	STWFA

TFL (T) AND HPL (P) LAMINATE TABLE OPTIONS

WOODGRAIN

AS	Asian Night	PNW	Pinnacle Walnut
BW	Beigewood	PTK	Portico Teak
CO	Columbian Walnut	RC	River Cherry
EF	Espresso	SCH	Select Cherry
FLW	Florence Walnut	SPW	Sepia Walnut
GC	Golden Cherry	SKC	Shaker Cherry
HVM	Harvest Maple	SBP	Smoky Brown Pear
KHE	Kirsche	TK	Studio Teak
MW	Mahogany Walnut	SM	Sugar Maple
MNR	Midnight Run	WTA	Weathered Ash
NTM	Natural Marrone	WNB	White Nebbia
ORW	Oak Riftwood	WC	Williamsburg Cherry

SOLID

BL	Black	FHG	Fashion Grey
WH	Designer White	SG	Slate Grey

TABLE BASE OPTIONS

Not all bases are available on each model. Check availability on pricing pages.

STWFA	Wireframe, Aluminum	N/C
STWFB	Wireframe, Black	N/C
STWFC	Wireframe, Chrome	\$ 66
SLBO	4-Star Wood Base, Blonde Oak	N/C
SLSPW	4-Star Wood Base, Spiced Walnut	N/C

TABLE EDGE PROFILE



Square

CERTIFICATIONS & COMPLIANCE

- Intertek Sustainability Certified
- BIFMA level® Certified
- BIFMA Compliant® Certified
- TSCA Title VI (CARB) Compliance
- Contributes to LEED®, Green Globes®, and WELL® Sustainable Programs

STATEMENT OF LINE



Spirit Table:
ST11C: TFL
ST11CH: HPL
[\(See Below\)](#)

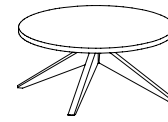

Spirit Round Table:
SLT-1W: TFL
SLT-1WH: HPL
[\(See Below\)](#)

Item	Model No.		W	D	H	Ship Wt	Cubic Ft	List Price	
SPIRIT TABLE	ST11C	TFL	27	27	17	31	11.4	T\$	949
	ST11CH	HPL	27	27	17	31	11.4	P\$	1145

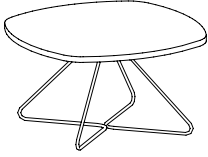

Must Specify (in this order):

Model #
Top Color
Base Color

Description

- Standard with: 1" TFL Top or 1½" HPL Top ([See Top Colors](#)) and Wireframe Base (See Below)
- Features Square Edge Profile

Leg Option: Specify & Add

STWFA	Wireframe, Aluminum	N/C
STWFB	Wireframe, Black	N/C
STWFC	Wireframe, Chrome	\$ 66

SPIRIT ROUND TABLE	SLT-1W	TFL	31½	31½	14½	31	11.4	T\$	1672
	SLT-1WH	HPL	31½	31½	14½	31	11.4	P\$	1853

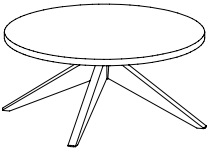

Must Specify (in this order):

Model #
Top Color
Base Color

Description

- Standard with: 1" TFL Top or 1½" HPL Top ([See Top Colors](#)) and 4-Star Swivel Wood Base (Select Blonde Oak or Spiced Walnut)
- Features Square Edge Profile



Square

Pricing Codes:
T= TFL P= HPL

320 Spirit

For ordering options, [see overview at the beginning of this section.](#)

PLEDGE

Workmate is the perfect sidekick to work anytime, anywhere. Compact and lightweight, simply pull it up or take it with you as a personal workspace on the go. Quick and easy height adjustability provides flexibility to move from seated to standing throughout the day, finding comfort no matter the environment. Great for group meetings, remote workers, finding a quiet nook, and so much more!

CONSTRUCTION

TABLES

- Stationary tables feature a ¾" thick top, while mobile tables feature a 1" thick top
- Veneer tops have a vertical square profile with a 0.5mm wood edge band while High-Pressure (HPL) and Thermally-Fused Laminate (TFL) tops have a vertical square profile with a 1mm PVC edge band; horizontal/left-to-right grain direction
- Height adjustable units feature a paddle with pneumatic lift; pull up tables have an adjustment range of 11" while mobile tables have an adjustment range of 16"
- Bases are manufactured using powder-coated steel bases in your choice of color; Joints are fully welded and sanded smooth for maximum strength and durability
- Stationary tables ship fully assembled with felt and nylon glides while mobile tables ship fully assembled with 37mm black locking casters already installed
- Tables have a weight capacity of 66lb

SURROUND

- Surrounds are ½" (12mm) thick and constructed of 100% polyester made from up to 50% recycled materials without the use of adhesive or other bonding agents.
- Panels are 100% recyclable
- Surround is 7¼"Hx53¼"W and utilizes a kerfing technique allowing the material to conform to the tops contours

HOW TO ORDER EXAMPLES

Model No.	Description	Example
350-2820HMT	Top Material	T
	Finish/Color	PNW
	Metal Finish Color	ALUM

TFL (T) AND HPL (P) LAMINATE TOP OPTIONS

WOODGRAIN

AS	Asian Night	PNW	Pinnacle Walnut
BW	Beigewood	PTK	Portico Teak
CO	Columbian Walnut	RC	River Cherry
EF	Espresso	SCH	Select Cherry
FLW	Florence Walnut	SPW	Sepia Walnut
GC	Golden Cherry	SKC	Shaker Cherry
HVM	Harvest Maple	SBP	Smoky Brown Pear
KHE	Kirsche	TK	Studio Teak
MW	Mahogany Walnut	SM	Sugar Maple
MNR	Midnight Run	WTA	Weathered Ash
NTM	Natural Marrone	WNB	White Nebbia
ORW	Oak Riftwood	WC	Williamsburg Cherry

SOLID

BL	Black	FHG	Fashion Grey
WH	Designer White	SG	Slate Grey

VENEER (W) TABLE TOP OPTIONS

Tops feature UVAdvantage, an ultra-violet finish, on all exposed surfaces by utilizing roll-coat UV technology.

AW	Artisan Walnut	MW	Mahogany Walnut
AS	Asian Night	MAS	Mesa Sunset
CO	Columbian Walnut	MTS	Metropolis Sky
DC	Dark Cherry	ORW	Oak Riftwood*
DFW	Dark Forest Walnut	PNW	Pinnacle Walnut
EF	Espresso	SCH	Select Cherry
FO	Fawn Oak*	SKC	Shaker Cherry
GC	Golden Cherry	SM	Sugar Maple
HW	Harvest Walnut	WTA	Weathered Ash*
HNW	Henna Walnut	WC	Williamsburg Cherry
LW	Legacy Walnut		

* Finish is Low Sheen

EDGE PROFILE

H Vertical Square



METAL COLOR OPTIONS

ALUM	Aluminum
BLK	Black
SNO	Snow

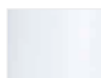

Snow White



Aluminum



Black

SURROUND OPTIONS

Surround on the Height Adjustable Mobile Table is available in four colors. Must specify.

ASH	Ash	GRY	Grey
CAD	Cadet	MLK	Milky



Milky



Cadet



Grey



Ash

CERTIFICATIONS & COMPLIANCE

- CAL 117-2013 Compliance
- Intertek Sustainability Certified
- BIFMA level® Certified
- BIFMA Complaint® Certified
- TSCA Title VI (CARB) Compliance
- Contributes to LEED®, Green Globes®, and WELL® Sustainable Programs



Pull-Up Table
350-2215PT
[\(See Details\)](#)

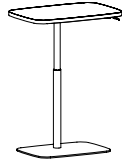

Height Adjustable
Pull-Up Table
(Raised)
350-2215HPT
[\(See Details\)](#)

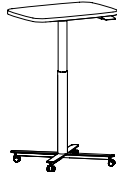

Height Adjustable
Mobile Table
(Raised)
350-2820HMT
[\(See Details\)](#)

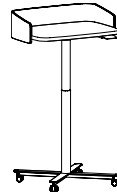

Height Adjustable
Mobile Table With
Surround
(Raised)
350-2820HMTS
[\(See Details\)](#)

For additional storage and functionality,
add a utility hook:



[Utility Hook](#)

Item	Model No.	Material	W	D	H	Ship Wt	Cubic Ft	List Price	
PULL-UP TABLE	350-2215PT	TFL	22	17¾"	27	27	5.2	T\$	934
		HPL						P\$	1057
		Veneer						W\$	1127



Must Specify (in this order):

Model #
Top Material
Top Finish/Color
Metal Color

Description

- Standard with Felt and Nylon Glides
- Top Dimensions: 22"Wx15"D/Base Dimensions: 13¼"Dx17¾"W
- 66lb Weight Capacity
- Choose a TFL (T), HPL (P), or Veneer (W) Top, [Choose Finish/Color Options](#)
- Base Available in Three (3) Metal Powder-Coated Colors; Aluminum (ALUM), Black (BLK), and Snow (SNO) [See Metal Colors](#)
- For additional storage and functionality, add a [utility hook](#)

HEIGHT ADJUSTABLE PULL-UP TABLE	350-2215HPT	TFL	22	17¾"	19-30	28	3.9	T\$	1399
		HPL						P\$	1521
		Veneer						W\$	1591

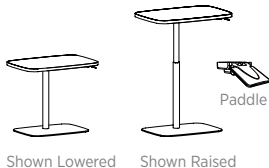

Must Specify (in this order):

Model #
Top Material
Top Finish/Color
Metal Color

Description

- Standard with Paddle-Controlled Pneumatic Lift with 11" Height Adjustment Range, and Felt and Nylon Glides
- Top Dimensions: 22"Wx15"D/Base Dimensions: 13¼"Dx17¾"W
- 66lb Weight Capacity
- Choose a TFL (T), HPL (P), or Veneer (W) Top, [Choose Finish/Color Options](#)
- Base Available in Three (3) Metal Powder-Coated Colors; Aluminum (ALUM), Black (BLK), and Snow (SNO) [See Metal Colors](#)
- Paddle for Pneumatic Lift Mounted on Side
- For additional storage and functionality, add a [utility hook](#)

HEIGHT ADJUSTABLE MOBILE WORK TABLE	350-2820HMT	TFL	28	21⅞"	29-45	32	9.4	T\$	1918
		HPL						P\$	2021
		Veneer						W\$	2074



Must Specify (in this order):

Model #
Top Material
Top Finish/Color
Metal Color

Description

- Standard with Paddle-Controlled Pneumatic Lift with 16" Height Adjustment Range, and Locking Casters
- Top Dimensions: 20"Dx28"W/Base Dimensions: 21⅞"Wx21⅞"D
- 66lb Weight Capacity
- Choose a TFL (T), HPL (P), or Veneer (W) Top, [Choose Finish/Color Options](#)
- Base Available in Three (3) Metal Powder-Coated Colors; Aluminum (ALUM), Black (BLK), and Snow (SNO) [See Metal Colors](#)
- Paddle for Pneumatic Lift Mounted on Front
- For additional storage and functionality, add a [utility hook](#)

Pricing Codes:
T = TFL P = HPL W = Veneer

[For ordering options, see overview at the beginning of this section.](#)

Item	Model No.	Material	W	D	H	Ship Wt	Cubic Ft	List Price
HEIGHT ADJUSTABLE MOBILE WORK TABLE WITH SURROUND	350-2820HMTS	TFL	29	21 $\frac{1}{8}$	29-45	33	11.4	T\$ 2568
		HPL						P\$ 2675
		Veneer						W\$ 2730

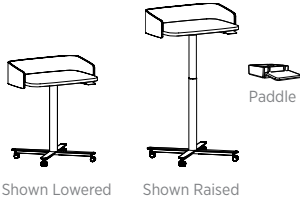

Description

- Standard with Paddle-Controlled Pneumatic Lift with 16" Height Adjustment Range, and Locking Casters
- Top Dimensions: 20"Dx28"W/Base Dimensions: 21 $\frac{1}{8}$ "Wx21 $\frac{1}{8}$ "D
- 66lb Weight Capacity
- Choose a TFL (T), HPL (P), or Veneer (W) Top, [Choose Finish/Color Options](#)
- Base Available in Three (3) Metal Powder-Coated Colors; Aluminum (ALUM), Black (BLK), and Snow (SNO)
- [See Metal Colors](#)
- Surround is $\frac{1}{2}$ " (12mm) Thick, 7 $\frac{1}{4}$ "Hx53 $\frac{1}{4}$ "W and Utilizes a Kerfing Technique Allowing the Material to Wrap Around the Corners of the Top; Available in Four Color Options; [See Colors](#)
- Paddle for Pneumatic Lift Mounted on Front
- For additional storage and functionality, add a [utility hook](#)

Must Specify (in this order):

Model #
Top Material
Top Finish/Color
Metal Color
Surround Color

UTILITY HOOK	01-HOOK		2	1 $\frac{3}{4}$	2 $\frac{9}{25}$			\$ 88
--------------	---------	--	---	-----------------	------------------	--	--	-------



Description

- Ideal for Backpacks, Purses, Jackets, Hats, and More
- Black Hook Includes Mounting Hardware, Field Installed
- 25lb Weight Capacity
- For best results, we recommend mounting under the surface, close by/adjacent to the base column.

Space Division

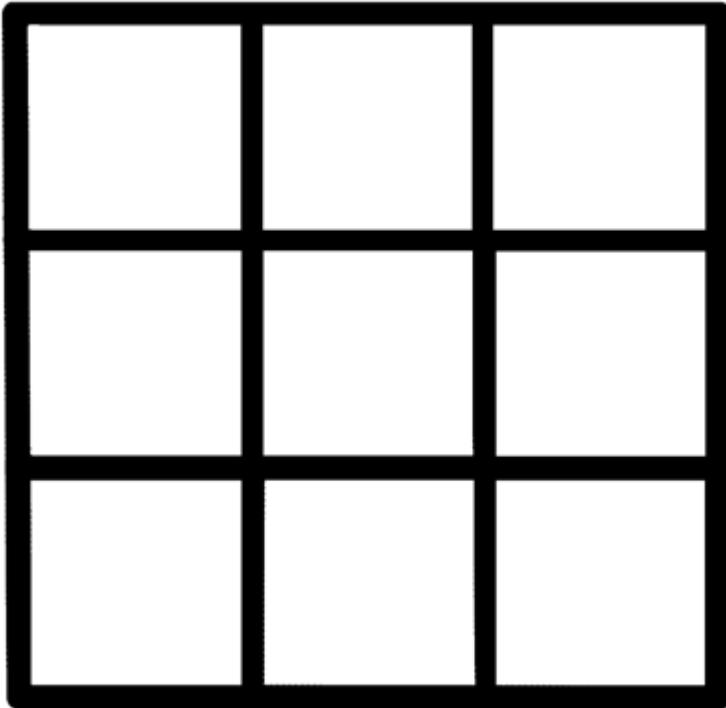

STEP 1: PLANNING FOR SQUARE ONE

Planning for Square One is based on configuring 12"x24" and 24"x24" blocks in nearly any manner to create space dividing walls, coves, work zones, and more within open environments.

Idea Starters/Typicals:

When you select one of our pre-configured Typicals, everything you need comes specified together, including the blocks, caps and posts, hardware, glides, and more.

- Select the typical number (e.g., 17-4), then specify the finish and hardware color.
- Add optional accessories (see Step #5).

Make Your Own Typicals:

There are endless opportunities with Square One, giving you the ability to create unique setups to meet the specific needs of your customers.

- We recommend utilizing our Specification/Drawing Services team, who can help in bringing your vision to life and ensure all the necessary components are included. To get started, just send us a drawing. You can use our easy online request form: [Design Request Form](#)
- Steps #2 - #5 outline the process for specifying your own typical. Please provide a drawing with the order to ensure accuracy.

STEP 2: SPECIFYING BLOCKS

When making your own typical, choose the quantity of blocks needed to create your design. We offer single blocks in two styles: 24"x24" and 12"x24".

- Blocks can go up to four high (8') and do runs of five wide (10') without a supporting wall or anchor to create stability.
- We recommend using single 12" x 24" blocks on the top or ends. If placing on the bottom or in the center of the design, using two of them together will ensure alignment with the holes bored on attachment items like End Caps, Corner Posts, etc.
- When creating an "L" or "T" design, we suggest going a minimum of three blocks wide to ensure stability without additional support.

STEP 3: CAPS, POSTS, CONNECTORS, AND SPANNERS

Next, determine what Caps, Posts, Connectors, and Spanners are needed to complete the design.

- End and Top Caps are necessary to ensure a clean and balanced aesthetic (as they hide the attachment hardware/ensure no empty holes are showing where attachments would have been).
- Square One offers connection beams to create 90° turns (Corner Posts), three walls (T-Connectors), four walls (X-Connectors), and span doorways or other openings (Horizontal Beam Spanners).
- End Caps, Posts, and Connectors should always be specified to run longer (taller) than the unit so that the end of the top cap or horizontal rail will not be seen (there are only a few exceptions).

STEP 4: HARDWARE, LEVELING, AND GENERAL ASSEMBLY

Whether connecting square to square or square to post, individual components come with the necessary hardware. Should you need more, we offer separate Bolt Kits to provide proper installation.

We offer heavy-duty, adjustable leveling glides to compensate for uneven floors. A tool (6mm allen driver bit) is also available to insert the glide nuts. The glides must be ordered separately from the blocks.

We do not offer connection methods to anchor to the floor or wall. We recommend discussing this with the building's facility manager for proper connection. Indiana Furniture will not be liable for wall or floor mounts that are not properly installed.

Assembly Instructions may be found on our website.

STEP 5: ACCESSORIES

Add function without sacrificing beauty. Acrylic Inserts, Tackable and Acoustical Panels, Dry Erase Boards, and TV mounts can give your space the ability for more privacy, collaboration, or brainstorming.

- Dry Erase Boards and Tackable Panels have onset installation.
- Dry Erase Boards can be mounted either vertically or horizontally.
- Acoustical Panels are either specified onset or inset, and Acrylic Inserts are inset.
- Tackable Panels are fully upholstered, so a clean aesthetic is seen from both sides of the blocks.
- Acrylic Inserts lock into insert retainers which are installed on top of the hardware, inside of the block, allowing for a quick and tight-fitting installation.
- Frosted Acrylic Inserts can be customized with a logo or image, giving you freedom to create a personal touch. Provide a .CDR, .AI, or .EPS file. Extended lead times may apply.
- We offer the Vesta Power Data Center and other similar items to add power within your Square One spaces created.



**Space Division.
Redefined.**



17-1 (Approximately 10' X 10' X 8')



17-2 (Approximately 8' X 8' X 8')



17-3 (Approximately 12' X 8' X 8')



17-4 (Approximately 10' X 8' X 8')

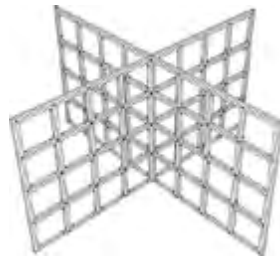

17-5 (Approximately 16' X 16' X 8')



17-6 (Approximately 8' X 8' X 8')



17-7 (Approximately 8' X 8')



17-8 (Approximately 12' X 8' X 8')

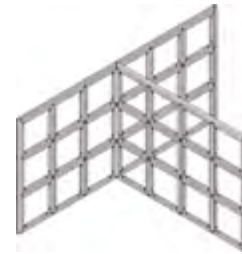

17-9 (Approximately 12' X 8' X 6')



17-10 (Approximately 4' X 8' X 8')



17-11 (Approximately 4' X 4' X 8')



17-12 (Approximately 2' X 4' X 8')



17-13 (Approximately 8' X 8' X 8')

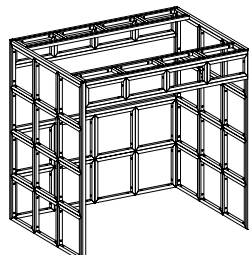

17-14 (Approximately 8' X 6' X 8')

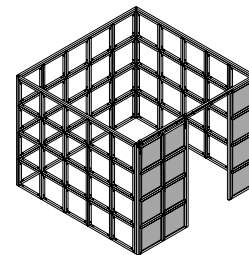

17-15 (Approximately 10' X 10' X 8')

Space Division. Redefined.

Square One is the clean, simple way to provide space division, functionality, and architectural design to any zone within the working environment. With individual building blocks that securely connect to one another and accessories like dry erase boards, barn doors, planter boxes, acrylic inserts, and tackable and acoustical panels, your personalization of Square One is only limited to your imagination. Square One is made of solid wood, providing a sustainable material for the workplace and bringing warmth and beauty to any space.

CONSTRUCTION

BLOCKS

- Blocks are manufactured using kiln-dried, solid European Beech and are attached using hardware, available in your choice of nickel or black, for durability and strength

FINISH

- Indiana Furniture uses a multi-step hand finishing process
- Blocks are pre-sanded for smoothness, then stained and finished with a catalyzed varnish finish which offers durability, lasting beauty, and resistance to normal wear
- Square One finishes were selected to complement casegoods, tables, and seating finishes which allows for easy blending of furniture components

END & TOP CAPS

- Measure 1¾"W and 1¾"D and come in a variety of lengths
- Used vertically and horizontally to provide a clean, balanced aesthetic by hiding the attachment hardware
- Caps are constructed of kiln-dried, solid European Beech and include blind threaded inserts for installation

CORNER POSTS

- Measure 1¾"W and 1¾"D and come in a variety of heights
- Used to create 90° turns
- Corner posts are constructed of kiln-dried, solid European Beech and include blind threaded inserts for installation

T-CONNECTORS

- Measure 1¾"W and 1¾"D and come in a variety of heights
- Used vertically and horizontally to create an intersection for three wall runs
- T-Connectors are constructed of kiln-dried, solid European Beech and include blind threaded inserts for installation

X-CONNECTORS

- Measure 1¾"W and 1¾"D and come in a variety of heights
- Used vertically to create an intersection for four wall runs
- X-Connectors are constructed of kiln-dried, solid European Beech and include blind threaded inserts for installation

HORIZONTAL BEAM SPANNERS

- Measure 1¾"D and 1¾"H and come in a variety of widths
- Used horizontally to provide structural support for doorways and other designed openings
- Spanners are constructed of kiln-dried, solid European Beech and include blind threaded inserts for installation

DRY ERASE BOARDS

- Available in 22½" or 46½" heights and multiple widths
- Installed onset, either vertically or horizontally
- Installation brackets are included; longer bolts for installation on-site are also included

ACOUSTICAL PANELS

- Constructed of 100% polyester made from up to 50% recycled materials without the use of adhesive or other bonding agents, Acoustical Panels are 100% recyclable
- Panels are ½" (12mm) thick and are available in multiple widths and lengths
- Sound absorption is average NRC 0.75 (50mm air gap) 1.0 NRC in mid-high frequencies
- Panels are installed inset with tabs or onset with dual-lock connectors

TACKABLE PANELS

- Tackable Panels are constructed of 7/16" corkboard and then covered, on both sides, in the textile of your choice
- Highly-skilled upholsterers hand tailor each unit to meet individual specifications
- Upholstery options include a broad range of styles, all pre-graded in this price list for ease of use
- Panels are installed onset with dual-lock connectors

ACRYLIC INSERTS

- Acrylic inserts are manufactured using high performance engineering resins and provide translucency, strength, clarity, and versatility
- Inserts are 20½"W and are available in 8½" and 20½" lengths
- Inserts are inset within the blocks with retainers for a tight-fitting installation
- Frosted acrylic options can be customized with logos and other designs as requested

LEVELING GLIDES

- Heavy-duty, adjustable leveling glides are available in black or nickel and are recommended to ensure proper leveling and compensation for uneven floors
- A tool (6mm allen driver bit) to install glides is also available to ensure proper installation

BARN DOOR HARDWARE

- Sliding system tracks are constructed of black powder coated steel
- Hardware includes tracks, hangers, track stops, screws, inserts, bracket, and sliding system
- Installation hardware will be shipped attached to components

PLANTER BOXES

- The planter box is made of ¾" thick thermally-fused laminate (TFL) fused particle-board core
- Grain direction runs horizontal
- Planter boxes are fastened together with screws and heavy-duty metal fasteners
- Optional insert is made of lightweight, fade-resistant, recyclable plastic

HOW TO ORDER EXAMPLES

IDEA STARTERS/TYPICALS

Model No.	Description	Example
17-1	Finish	EF
	Hardware Color	BLK

BLOCKS & RAILS

Model No.	Description	Example
17-2424BL	Finish	NB
	Hardware Color	NCKL

ACRYLIC INSERTS

Model No.	Description	Example
AI-2020AC	Acrylic Color	FSTA

PLANTER BOXES

Model No.	Description	Example
01-1909PL	TFL Color	AS
	Hardware Color	BLK
	Optional Insert	PBI

veneer (W) OPTIONS

Indiana Furniture uses a multi-step, hand finishing process on all exposed wood frames.

Square One models feature a catalyzed varnish finish which offers durability, lasting beauty, and resistance to normal wear.

AW	Artisan Walnut	MAS	Mesa Sunset*
AS	Asian Night	MTS	Metropolis Sky
AWH	Aspen White	MNR	Midnight Run
BW	Beigewood*	NTM	Natural Marrone*
BL	Black	NB	Natural Beech
CO	Columbian Walnut	ORW	Oak Riftwood*
DC	Dark Cherry	OR	Orchard
DFW	Dark Forest Walnut*	PNW	Pinnacle Walnut
WH	Designer White	PTK	Portico Teak*
EG	Ember Gray	RC	River Cherry*
EF	Espresso	SCH	Select Cherry
FO	Fawn Oak*	SPW	Sepia Walnut*
FLW	Florence Walnut*	SKC	Shaker Cherry
GC	Golden Cherry	SBP	Smoky Brown Pear*
HVM	Harvest Maple*	TK	Studio Teak
HW	Harvest Walnut	SM	Sugar Maple
HNW	Henna Walnut	TR	Truffle Rain
KHE	Kirsche	WTA	Weathered Ash*
LW	Legacy Walnut	WNB	White Nebbia
MW	Mahogany Walnut	WC	Williamsburg Cherry

* Low Sheen Finish

TFL (T) LAMINATE OPTIONS ON PLANTER BOXES

WOODGRAIN

AS	Asian Night	PNW	Pinnacle Walnut
BW	Beigewood	PTK	Portico Teak
CO	Columbian Walnut	RC	River Cherry
EF	Espresso	SCH	Select Cherry
FLW	Florence Walnut	SPW	Sepia Walnut
GC	Golden Cherry	SKC	Shaker Cherry
HVM	Harvest Maple	SBP	Smoky Brown Pear
KHE	Kirsche	TK	Studio Teak
MW	Mahogany Walnut	SM	Sugar Maple
MNR	Midnight Run	WTA	Weathered Ash
NTM	Natural Marrone	WNB	White Nebbia
ORW	Oak Riftwood	WC	Williamsburg Cherry

SOLID

BL	Black	FHG	Fashion Grey
WH	Designer White	SG	Slate Grey

HARDWARE/LEVELING GLIDES COLOR OPTIONS

BLK Black NCKL Nickel



Black

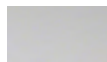

Nickel

ACOUSTICAL PANEL OPTIONS

ASH Ash GRY Grey
CAD Cadet MLK Milky

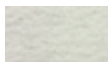

Milky



Cadet



Grey



Ash

ACRYLIC INSERT OPTIONS

FSTA Frosted TGWA Twigwork
RAFA Raffia TNSA Tinsel
WOVA Woven

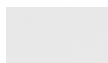

Frosted



Raffia



Woven



Twigwork



Tinsel

TACKABLE PANEL OPTIONS

Available in single upholstery in a wide variety of graded-in or contract options.

CERTIFICATIONS & COMPLIANCE

- CAL 117-2013 Compliance
- Intertek Sustainability Certified
- BIFMA level® Certified
- BIFMA Compliant® Certified
- TSCA Title VI (CARB) Compliance
- Contributes to LEED®, Green Globes®, and WELL® Sustainable Programs

Building Blocks

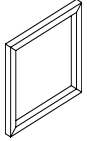

24"x24" Block
[\(See Details\)](#)

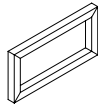

24"x12" Block
[\(See Details\)](#)

Hardware

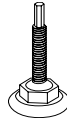

Leveling Glide Kits
[\(See Details\)](#)

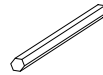

Allen Driver Bit
[\(See Details\)](#)

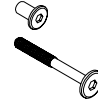

Bolt & Nut Kits
[\(See Details\)](#)

Connectors

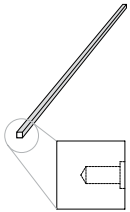

End Caps
[\(See Details\)](#)

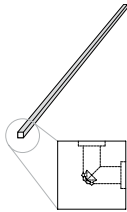

Corner Posts
[\(See Details\)](#)

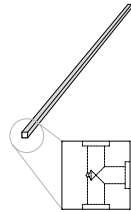

T-Connector Beams
[\(See Details\)](#)

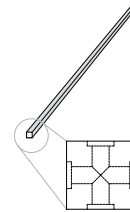

X-Connector Beams
[\(See Details\)](#)

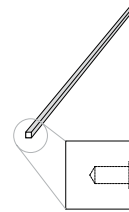

Horizontal Beam Spanners
[\(See Details\)](#)

Accessories

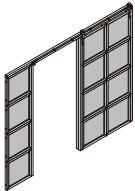

Barn Door Wall
[\(See Details\)](#)

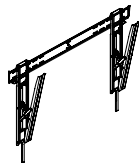

TV Mounts
[\(See Details\)](#)

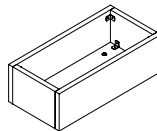

Planter Boxes
[\(See Details\)](#)



Tic-Tac-Toe Foam Game
[\(See Details\)](#)



Vesta Power Center
[\(See Details\)](#)

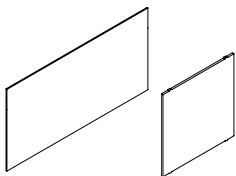

Onset & Inset Acoustical Panels
[\(See Details\)](#)

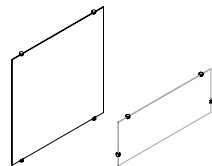

Acrylic Inset Panels
[\(See Details\)](#)



Dry Erase Boards
[\(See Details\)](#)

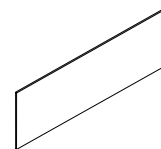

Tackable Panels
[\(See Details\)](#)

Item	Model No.	Qty	Description	List Price
HUDDLE (APPROXIMATELY 10' X 10' X 8')	17-1_1701			\$ 24586

**Consists of:**

17-2424BL	56	Single Block, 24" x 24"	\$ 18368
17-17596EC	4	End Cap, 96" (used vertically)	\$ 1760
17-175120EC	2	End Cap, 120" (used horizontally)	\$ 958
17-17597CP	4	Corner Post, 97¾"	\$ 1772
17-175120HBS	2	Horizontal Beam Spanner, 120"	\$ 916
17-LEVKIT	14	Leveler Kit, (2) Levelers	\$ 812

HUDDLE (APPROXIMATELY 8' X 8' X 8')	17-2			\$ 21692
--	------	--	--	----------

**Consists of:**

17-2424BL	48	Single Block, 24" x 24"	\$ 15744
17-17596EC	6	End Cap, 96" (4 used vertically, 2 used horizontally)	\$ 2640
17-17597CP	4	Corner Post, 97¾"	\$ 1772
17-17596HBS	2	Horizontal Beam Spanner, 96"	\$ 840
17-LEVKIT	12	Leveler Kit, (2) Levelers	\$ 696

HUDDLE (APPROXIMATELY 12' X 8' X 8')	17-3			\$ 21768
---	------	--	--	----------

**Consists of:**

17-2424BL	48	Single Block, 24" x 24"	\$ 15744
17-17596EC	4	End Cap, 96" (2 used vertically, 2 used horizontally)	\$ 1760
17-17597EC	2	End Cap, 97¾" (used vertically)	\$ 880
17-17596CP	2	Corner Post, 96"	\$ 886
17-17597CP	2	Corner Post, 97¾"	\$ 886
17-175120HBS	2	Horizontal Beam Spanner, 120"	\$ 916
17-LEVKIT	12	Leveler Kit, (2) Levelers	\$ 696

H-CONFIGURATION (APPROXIMATELY 10' X 8' X 8')	17-4			\$ 21768
--	------	--	--	----------

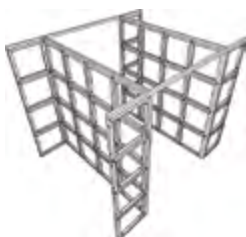
**Consists of:**

17-2424BL	48	Single Block, 24" x 24"	\$ 15744
17-17596EC	2	End Cap, 96" (used horizontally)	\$ 880
17-17597EC	4	End Cap, 97¾" (used vertically)	\$ 1760
17-17596CP	4	Corner Post, 96"	\$ 1772
17-175120HBS	2	Horizontal Beam Spanner, 120"	\$ 916
17-LEVKIT	12	Leveler Kit, (2) Levelers	\$ 696

[See Overview for Square One Ordering Options.](#)

Item	Model No.	Qty	Description	List Price
QUAD-CONFIGURATION (APPROXIMATELY 16' X 16' X 8')	17-5			\$ 25890

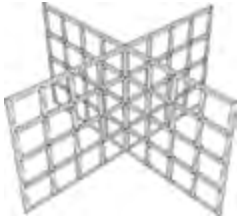
**Consists of:**

17-2424BL	64	Single Block, 24" x 24"	\$ 20992
17-17596EC	4	End Cap, 96" (used horizontally)	\$ 1760
17-17597EC	4	End Cap, 97¾" (used vertically)	\$ 1760
17-17597XB	1	X-Connector Beam, 97¾"	\$ 450
17-LEVKIT	16	Leveler Kit, (2) Levelers	\$ 928

WALL COVE (APPROXIMATELY 8' X 8' X 8')	17-6			\$ 11670
---	------	--	--	----------

**Consists of:**

17-2424BL	24	Single Block, 24" x 24"	\$ 7872
17-17596EC	3	End Cap, 96" (used horizontally)	\$ 1320
17-17597EC	4	End Cap, 97¾" (2 used vertically, 2 used horizontally)	\$ 1760
17-17596CP	1	Corner Post, 96" (used horizontally)	\$ 443
17-LEVKIT	4	Leveler Kit, (2) Levelers	\$ 232
17-12MMBOLTKIT	1	12mm Bolt Kit, qty 8	\$ 43

** This typical is not design for freestanding applications. This unit must be secured at the top to a rigid structure. Attachment hardware not included.*

SINGLE WALL (APPROXIMATELY 8' X 8')	17-7			\$ 6800
--	------	--	--	---------

**Consists of:**

17-2424BL	16	Single Block, 24" x 24"	\$ 5248
17-17596EC	1	End Cap, 96" (used horizontally)	\$ 440
17-17597EC	2	End Cap, 97¾" (used vertically)	\$ 880
17-LEVKIT	4	Leveler Kit, (2) Levelers	\$ 232





** This typical is not design for freestanding applications. This unit must be secured at the top to a rigid structure. Attachment hardware not included.*

T-CONFIGURATION (APPROXIMATELY 12' X 8' X 8')	17-8_1708			\$ 16759
--	-----------	--	--	----------

**Consists of:**

17-2424BL	40	Single Block, 24" x 24"	\$ 13120
17-17572EC	2	End Cap, 72" (used horizontally)	\$ 852
17-17596EC	1	End Cap, 96" (used horizontally)	\$ 440
17-17597EC	3	End Cap, 97¾" (used vertically)	\$ 1320
17-17597TCB	1	T-Connector Beam, 97¾"	\$ 447
17-LEVKIT	10	Leveler Kit, (2) Levelers	\$ 580

[See Overview for Square One Ordering Options.](#)

Item	Model No.	Qty	Description	List Price
T-CONFIGURATION (APPROXIMATELY 12' X 8' X 6')	17-9			\$ 13423
	Consists of:			
	17-2424BL	30	Single Block, 24" x 24"	\$ 9840
	17-17572EC	2	End Cap, 72" (used horizontally)	\$ 852
	17-17573EC	3	End Cap, 73¾" (used vertically)	\$ 1278
	17-17596EC	1	End Cap, 96" (used horizontally)	\$ 440
	17-17573TCB	1	T-Connector Beam, 73¾"	\$ 433
	17-LEVKIT	10	Leveler Kit, (2) Levelers	\$ 580
OFFSET DUAL BOOTH (APPROXIMATELY 4' X 8' X 8')	17-10			\$ 17418
	Consists of:			
	17-2424BL	36	Single Block, 24" x 24"	\$ 11808
	17-17548EC	2	End Cap, 48" (used horizontally)	\$ 704
	17-17597EC	4	End Cap, 97¾" (used vertically)	\$ 1760
	17-17524CP	2	Corner Post, 24" (used horizontally)	\$ 682
	17-17548CP	2	Corner Post, 48" (used horizontally)	\$ 708
	17-17548TCB	1	T-Connector Beam, 48"	\$ 355
	17-17596TCB	2	T-Connector Beam, 96"	\$ 894
	17-LEVKIT	8	Leveler Kit, (2) Levelers	\$ 464
	17-12MMBOLTKIT	1	12mm Bolt Kit, qty 8	\$ 43
DUAL BOOTH (APPROXIMATELY 4' X 4' X 8')	17-11			\$ 12578
	Consists of:			
	17-2424BL	24	Single Block, 24" x 24"	\$ 7872
	17-17524EC1711	4	End Cap, 24" (used horizontally)	\$ 1352
	17-17548EC1711	1	End Cap, 48" (used horizontally)	\$ 352
	17-17597EC1711	4	End Cap, 97¾" (used vertically)	\$ 1760
	17-17597TCB1711	2	T-Connector Beam, 97¾"	\$ 894
	17-LEVKIT	6	Leveler Kit, (2) Levelers	\$ 348
L COVE (APPROXIMATELY 2' X 4' X 8')	17-12			\$ 6123
	Consists of:			
	17-2424BL	12	Single Block, 24" x 24"	\$ 3936
	17-17524EC	1	End Cap, 24" (used horizontally)	\$ 338
	17-17548EC	1	End Cap, 48" (used horizontally)	\$ 352
	17-17597EC	2	End Cap, 97¾" (used vertically)	\$ 880
	17-17597CP	1	Corner Post, 97¾"	\$ 443
	17-LEVKIT	3	Leveler Kit, (2) Levelers	\$ 174

[See Overview for Square One Ordering Options.](#)

Item	Model No.	Qty	Description	List Price
C-CONFIGURATION (APPROXIMATELY 8' X 8' X 8')	17-13			\$ 19526

**Consists of:**

17-2424BL	48	Single Block, 24" x 24"	\$ 15744
17-17596EC	3	End Cap, 96" (used horizontally)	\$ 1320
17-17597EC	2	End Cap, 97¾" (used vertically)	\$ 880
17-17597CP	2	Corner Post, 97¾"	\$ 886
17-LEVKIT	12	Leveler Kit, (2) Levelers	\$ 696

GATEWAY COVE (APPROXIMATELY 8' X 6' X 8')	17-14			\$ 21501
--	-------	--	--	----------

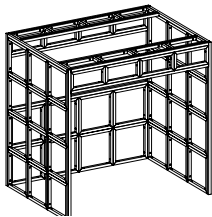
**Consists of:**

17-2424BL	32	Single Block, 24" x 24"	\$ 10496
17-2412BL	16	Single Block, 24" x 12"	\$ 4576
17-17596EC	5	End Cap, 96" (used horizontally)	\$ 2200
17-17572CP	2	Corner Post, 72" (used horizontally)	\$ 862
17-17596CP	2	Corner Post, 96" (used horizontally)	\$ 886
17-17597CP	4	Corner Post, 97¾" (used vertically)	\$ 1772
17-LEVKIT	10	Leveler Kit, (2) Levelers	\$ 580
17-12MMBOLTKit	3	12mm Bolt Kit, qty 8	\$ 129

MEETING ROOM WITH BARN DOOR (APPROXIMATELY 10' X 10' X 8')	17-15			\$ 34333
---	-------	--	--	----------

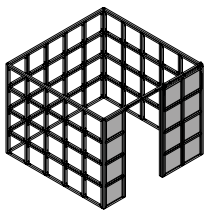
**Consists of:**

17-2424BL	60	Single Block, 24" x 24"	\$ 19680
17-175120EC	3	End Cap, 120" (used horizontally)	\$ 1437
17-17597CP	4	Corner Post, 97¾"	\$ 1772
17-4896BDBR	1	Barn Door Wall, Right	\$ 10574
17-LEVKIT	15	Leveler Kit, (2) Levelers	\$ 870

** Must Specify Acrylic and/or Acoustical Inserts for Use in Barn Door Wall (Total 20 Inserts);
Note: List Price Shown Above Does NOT Include These Required Inserts Due to Variance in Pricing. See
Page 307 for Acrylic and Acoustical Insert options.*

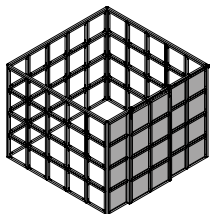

Shown as Right Barn Door

[See Overview for Square One Ordering Options.](#)

Item	Model No.	W	D	H	Ship Wt	Cubic Ft	List Price
SINGLE BLOCK 24" X 24"	17-2424BL	24	1 $\frac{3}{4}$	24	12	1.5	\$ 328

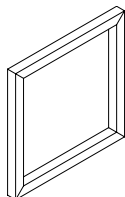

Description

- Includes Four (4) Bolts and Nuts for Installation

Must Specify (in this order):

Model # and Quantity
Finish
Hardware Color

SINGLE BLOCK 24" X 12"	17-2412BL	24	1 $\frac{3}{4}$	12	8	1.0	\$ 286
---------------------------	-----------	----	-----------------	----	---	-----	--------

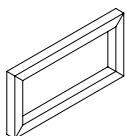

Description

- Includes Three (3) Bolts and Nuts for Installation
- Can Be Used Vertically or Horizontally
- Recommended for Use on Top or End of Configuration, Unless Used in Pairs
- We Recommend Using Single 12" x 24" Blocks on the Top or Ends. If Placing on the Bottom or In the Center of the Design, Using Two of Them Together Will Ensure Alignment with the Holes Bored on Attachment Items Like End Caps, Corner Posts, Etc.

Must Specify (in this order):

Model # and Quantity
Finish
Hardware Color

[See Overview for Square One Ordering Options.](#)

Item	Model No.	W	D	H	Ship Wt	Cubic Ft	List Price
END CAPS	17-17522EC	1¾	1¾	22¼	7	0.1	\$ 332
	17-17524EC	1¾	1¾	24	7	0.1	\$ 338
	17-17525EC <i>Vertical Use Only</i>	1¾	1¾	25¾	7	0.1	\$ 338
	17-17536EC	1¾	1¾	36	8	0.1	\$ 343
	17-17537EC <i>Vertical Use Only</i>	1¾	1¾	37¾	8	0.1	\$ 343
	17-17548EC	1¾	1¾	48	9	0.1	\$ 352
	17-17549EC <i>Vertical Use Only</i>	1¾	1¾	49¾	9	0.1	\$ 352
	17-17560EC	1¾	1¾	60	10	0.2	\$ 417
	17-17561EC <i>Vertical Use Only</i>	1¾	1¾	61¾	10	0.2	\$ 417
	17-17572EC	1¾	1¾	72	11	0.3	\$ 426
	17-17573EC <i>Vertical Use Only</i>	1¾	1¾	73¾	11	0.3	\$ 426
	17-17584EC	1¾	1¾	84	11	0.3	\$ 431
	17-17585EC <i>Vertical Use Only</i>	1¾	1¾	85¾	12	0.3	\$ 431
	17-17596EC	1¾	1¾	96	12	0.3	\$ 440
	17-17597EC <i>Vertical Use Only</i>	1¾	1¾	97¾	13	0.3	\$ 440
	17-175108EC	1¾	1¾	108	13	0.3	\$ 476
	17-175120EC	1¾	1¾	120	14	0.3	\$ 479

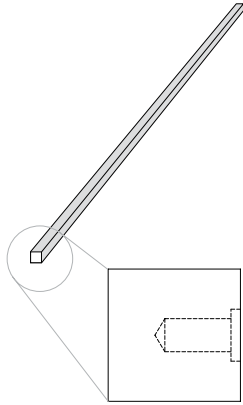

Must Specify (in this order):

Model # and Quantity
 Finish
 Hardware Color

Description

- Used Vertically and Horizontally to Provide a Clean, Balanced Aesthetic by Hiding Attachment Hardware
- Includes Bolts for Installation
- Blind-Threaded Insert for Installation

[See Overview for Square One Ordering Options.](#)

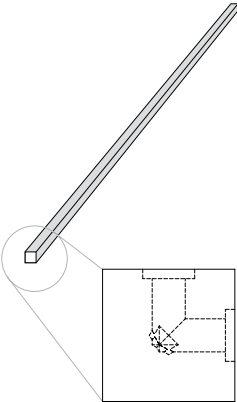
Item	Model No.	W	D	H	Ship Wt	Cubic Ft	List Price
CORNER POSTS 	17-17522CP	1¾	1¾	22¼	7	0.1	\$ 334
	17-17524CP	1¾	1¾	24	7	0.1	\$ 341
	17-17525CP	1¾	1¾	25¾	7	0.1	\$ 341
	17-17536CP	1¾	1¾	36	8	0.1	\$ 347
	17-17537CP	1¾	1¾	37¾	8	0.1	\$ 347
	17-17548CP	1¾	1¾	48	9	0.1	\$ 354
	17-17549CP	1¾	1¾	49¾	9	0.1	\$ 354
	17-17560CP	1¾	1¾	60	10	0.2	\$ 425
	17-17561CP	1¾	1¾	61¾	10	0.2	\$ 425
	17-17572CP	1¾	1¾	72	11	0.2	\$ 431
	17-17573CP	1¾	1¾	73¾	11	0.2	\$ 431
	17-17584CP	1¾	1¾	84	11	0.2	\$ 435
	17-17585CP	1¾	1¾	85¾	12	0.2	\$ 435
	17-17596CP	1¾	1¾	96	12	0.3	\$ 443
	17-17597CP	1¾	1¾	97¾	13	0.3	\$ 443

Must Specify (in this order):

Model # and Quantity
 Finish
 Hardware Color

Description

- Used Vertically to make 90° Turns
- Includes Bolts for Installation
- Blind-Threaded Insert for Installation

[See Overview for Square One Ordering Options.](#)

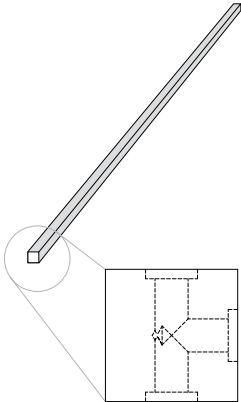
Item	Model No.	W	D	H	Ship Wt	Cubic Ft	List Price
	T-CONNECTOR BEAMS						
	17-17522TCB	1¾	1¾	22¼	7	0.1	\$ 338
	17-17524TCB	1¾	1¾	24	7	0.1	\$ 3343
	17-17525TCB	1¾	1¾	25¾	7	0.1	\$ 343
	17-17536TCB	1¾	1¾	36	8	0.1	\$ 351
	17-17537TCB	1¾	1¾	37¾	8	0.1	\$ 351
	17-17548TCB	1¾	1¾	48	9	0.1	\$ 355
	17-17549TCB	1¾	1¾	49¾	9	0.1	\$ 355
	17-17560TCB	1¾	1¾	60	10	0.2	\$ 430
	17-17561TCB	1¾	1¾	61¾	10	0.2	\$ 430
	17-17572TCB	1¾	1¾	72	11	0.2	\$ 433
	17-17573TCB	1¾	1¾	73¾	11	0.2	\$ 433
	17-17584TCB	1¾	1¾	84	11	0.2	\$ 442
	17-17585TCB	1¾	1¾	85¾	12	0.2	\$ 442
17-17596TCB	1¾	1¾	96	12	0.3	\$ 447	
17-17597TCB	1¾	1¾	97¾	13	0.3	\$ 447	

Must Specify (in this order):

Model # and Quantity
 Finish
 Hardware Color

Description

- Used Vertically to Connect Three (3) Walls
- Includes Bolts for Installation
- Blind-Threaded Insert for Installation

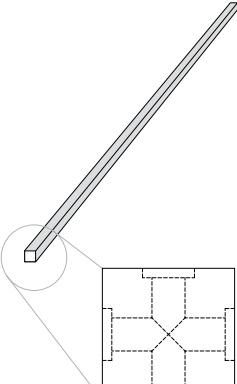
Item	Model No.	W	D	H	Ship Wt	Cubic Ft	List Price
	17-17522XB	1¾	1¾	22¾	7	0.1	\$ 341
	17-17525XB	1¾	1¾	25¾	7	0.1	\$ 345
	17-17537XB	1¾	1¾	37¾	8	0.1	\$ 353
	17-17549XB	1¾	1¾	49¾	9	0.1	\$ 357
	17-17561XB	1¾	1¾	61¾	10	0.2	\$ 433
	17-17573XB	1¾	1¾	73¾	11	0.2	\$ 441
	17-17585XB	1¾	1¾	85¾	12	0.2	\$ 446
	17-17597XB	1¾	1¾	97¾	13	0.3	\$ 450

Must Specify (in this order):

Model # and Quantity
Finish
Hardware Color

Description

- Used Vertically to Connect Four (4) Wall Runs
- Includes Bolts for Installation
- Blind-Threaded Insert for Installation

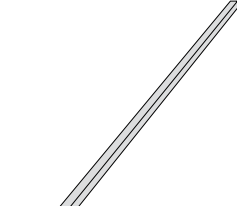
Item	Model No.	W	D	H	Ship Wt	Cubic Ft	List Price
	17-17572HBS	72	1¾	1¾	11	0.2	\$ 387
	17-17584HBS	84	1¾	1¾	11	0.2	\$ 398
	17-17596HBS	96	1¾	1¾	12	0.3	\$ 420
	17-175108HBS	108	1¾	1¾	12	0.3	\$ 435
	17-175120HBS	120	1¾	1¾	14	0.3	\$ 458

Description

- Used Horizontally to Provide Structural Support for Doorways and Other Openings
- Includes Bolts for Installation
- Blind-Threaded Insert for Installation
- Holes Bored Only on Ends to Accommodate Attachment

Must Specify (in this order):

Model # and Quantity
Finish
Hardware Color

[See Overview for Square One Ordering Options.](#)

Item	Model No.	W	D	H	Ship Wt	Cubic Ft	List Price
BARN DOOR WALL	Left	Right					
	17-4896BDBL	17-4896BDBR	120	4	103	289	271

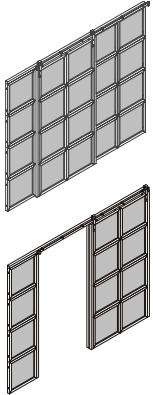

Shown as Right Barn Door

Must Specify (in this order):

Model #
Finish
Hardware Color
Acrylic or Acoustic Panels/Color

Description

- Standard with: Blocks, Beam Spanner, Four (4) End Caps, and Hardware to Create An *Approximately* 10"W x 8½"H Wall with Barn Door, including Leveling Glides
- Barn Door Features Soft Open and Soft Close to Avoid Door Slamming
- Must Specify Finish and Hardware Color (Door Track Available in Black Only)
- Must Specify Acrylic and/or Acoustical Inserts for Use in Barn Door Wall (Total 20 Inserts); Note: List Price Shown Above Does NOT Include These Required Inserts Due to Variance in Pricing

Must Specify Insert Options: 20 Acrylic and/or Acoustical Inserts (any combination)

AP-2020AP	Acoustic Insert - Must Specify Color Option and Add; See Acoustic Color Options		
ASH	Ash		\$ 291
CAD	Cadet		\$ 291
GRY	Grey		\$ 291
MLK	Milky		\$ 291
AI-2020AC	Acrylic Insert - Must Specify Color Option and Add; See Acrylic Color Options		
FSTA	Frosted		\$ 338
TGWA	Twigwork		\$ 650
WOVA	Woven		\$ 650
RAFA	Raffia		\$ 650
TNSA	Tinsel		\$ 650

Item	Model No.	W	D	H	Ship Wt	Cubic Ft	List Price
PLANTER BOX	01-1909PL	19¼	9½	6	16	2.0	\$ 631

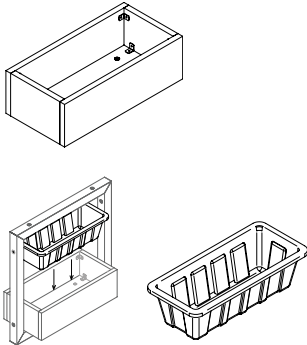
**Must Specify (in this order):**

Model #
TFL Color
Optional Planter Insert

Description

- Material is TFL. Must Specify TFL (T) Color; [See Color Options](#)
- Planter Will Ship with Attachment Hardware: Two (2) Black and Two (2) Nickel Bolts
- Horizontal Grain
- Planter Boxes Cannot be Installed on Both Sides of a Corner
- Optional Planter Box Insert Sold Separately

Option: Specify & Add

PBI	Planter Box Insert, Black Plastic		\$ 58
-----	-----------------------------------	--	-------

[See Overview for Square One Ordering Options.](#)

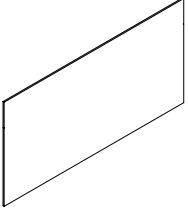
Item	Model No.	W	D	H	Ship Wt	Cubic Ft	List Price
ACOUSTICAL PANEL ONSET INSTALLATION 	22"H Panels						
	AP-2222AP	22¼	½	22¼	6	1.4	\$ 291
	AP-2234AP	34¼	½	22¼	7	2.1	\$ 411
	AP-2246AP	46¼	½	22¼	8	2.8	\$ 493
	AP-2258AP	58¼	½	22¼	8	3.4	\$ 586
	AP-2270AP	70¼	½	22¼	9	4.1	\$ 700
	46"H Panels						
	AP-4646AP	46¼	½	46¼	10	5.1	\$ 995
	AP-4658AP	58¼	½	46¼	12	6.3	\$ 1177
	AP-4670AP	70¼	½	46¼	13	7.6	\$ 1390

Must Specify (in this order):
Model #
Color

Description

- Onset Application, Installed with 9" Dual-Lock Connectors
- Sound Absorption Rating Average NRC 0.75 (50 mm Air Gap) 1.0 NRC in Mid-High Frequencies
- Cannot be Used on Same Side as TV Mount
- For Space Planning with Furniture, Note the Onset Application Will Add ½" to the Square One Blocks

Color Options: Must Specify; See Color Options

ASH	Ash
CAD	Cadet
GRY	Grey
MLK	Milky

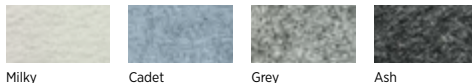

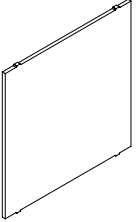
ACOUSTICAL PANEL INSET INSTALLATION 	For 12" Blocks						
	AP-0820AP	20¼	½	8¼	3	0.8	\$ 251
	For 24" Blocks						
AP-2020AP	20¼	½	20¼	6	1.4	\$ 291	

Description

- Inset Application; Includes Tabs to Secure in Place
- Sound Absorption Rating Average NRC 0.75 (50 mm Air Gap) 1.0 NRC in Mid-High Frequencies
- Cannot be Used with TV Mount

Color Options: Must Specify; See Color Options

ASH	Ash
CAD	Cadet
GRY	Grey
MLK	Milky

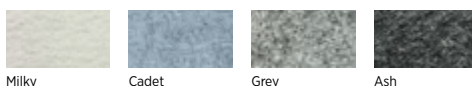

Must Specify (in this order):
Model #
Color

[See Overview for Square One Ordering Options.](#)

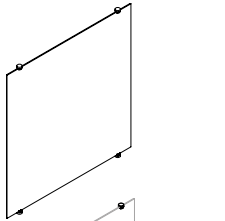



Item	Model No.	W	D	H	Ship Wt	Cubic Ft	List Price
ACRYLIC INSERTS							
For 12" Blocks							
	AI-0820AC	20¼	¼	8¼	6	2.0	\$ See Below
	<i>Horizontal Insert Applications</i>						
	AI-2008AC	8¼	¼	20¼	6	2.0	\$ See Below
	<i>Vertical Insert Applications</i>						
For 24" Blocks							
	AI-2020AC	20¼	¼	20¼	7	2.0	\$ See Below

Description

- Inserted Into 24" or 12" Blocks with Insert Retainers (Included)
- Raffia's Linear Pattern will be Installed Vertically on Both AI-2008AC (Vertical) and AI-0820AC (Horizontal)
- Frosted Acrylic Inserts can be customized with a logo or design using one of the following file types: .CDR, .AI, or .EPS. Email the image to customproduct@indianafurniture.com for a quote. Additional costs and lead times may apply. Note this as a special on your order when submitting.

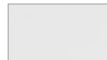
Color Options: Must Specify; See Color Options

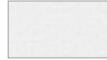
Must Specify (in this order):
Model #
Color
Special Custom Logo

	FSTA	Frosted	12" \$	220
			24" \$	338
	TGWA	Twigwork	12" \$	353
			24" \$	650
	WOVA	Woven	12" \$	353
			24" \$	650
	RAFA	Raffia (12" Blocks are Installed Vertically)	12" \$	353
			24" \$	650
	TNSA	Tinsel	12" \$	353
			24" \$	650

For 12" Blocks

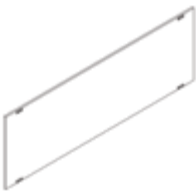

Raffia (RAFA)
Vertical Installation Standard

Item	Model No.	W	D	H	Ship Wt	Cubic Ft	List Price
DRY ERASE BOARDS							
22"H Panels							
	17-2246DEB	46¼	¾	22¼	11	0.2	\$ 847
	17-2258DEB	58¼	¾	22¼	11	0.2	\$ 1065
	17-2270DEB	70¼	¾	22¼	11	0.2	\$ 1318
46"H Panels							
	17-4646DEB	46¼	¾	46¼	11	0.2	\$ 1285
	17-4658DEB	58¼	¾	46¼	11	0.2	\$ 1619
	17-4670DEB	70¼	¾	46¼	11	0.2	\$ 1952

Must Specify (in this order):
Model #
Color

Description

- Nuts and Bolts Included for Onset Attachment
- May be Applied Horizontally or Vertically
- For Space Planning with Furniture, Note the Onset Application Will Add ¾" to the Square One Blocks

[See Overview for Square One Ordering Options.](#)

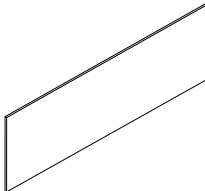
Item	Model No.	W	D	H	YARDS		GRADE COM/1/2/3	GRADE 4	GRADE 5	GRADE 6	GRADE 7	GRADE 8	GRADE 9	GRADE 10
TACKABLE PANELS														
22"H Panels (1 piece)														
	TB-2222TB	22¼	¾	22¼	1.75	\$	604	875	1003	1131	1315	1505	1729	1987
	TB-2234TB	34¼	¾	22¼	2.50	\$	787	1175	1357	1540	1802	2075	2395	2762
	TB-2246TB	46¼	¾	22¼	3.00	\$	965	1430	1649	1868	2183	2510	2894	3335
	TB-2258TB	58¼	¾	22¼	3.75	\$	1145	1726	2000	2274	2668	3076	3556	4108
	TB-2270TB	70¼	¾	22¼	4.50	\$	1319	2017	2345	2674	3146	3637	4213	4874
46"H Panels (2 pieces)														
	TB-4646TB	46¼	¾	46¼	6.00	\$	1824	2754	3192	3630	4260	4914	5682	6564
	TB-4658TB	58¼	¾	46¼	7.25	\$	2109	3233	3762	4291	5053	5843	6771	7837
	TB-4670TB	70¼	¾	46¼	8.75	\$	2391	3747	4386	5025	5944	6897	8017	9304

Must Specify (in this order):
Model #
Fabric Vendor/Pattern/Color

Description

- Installed with 9" Dual-Lock Connectors
- Tackable Panels are Fully Upholstered on Both Sides.
- For Space Planning with Furniture, Note the Onset Application Will Add ¾" to the Square One Blocks

Item	Model No.	W	D	H	Ship Wt	Cubic Ft	List Price
TV BRACKET	01-TVBR	3½	4	3	1	1.0	\$ 154

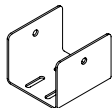

Description

- Black Metal
- Coordinates with TV Mount

TV MOUNT	01-TVMT	35¾	¾	21¾	15	0.5	\$ 1212
----------	---------	-----	---	-----	----	-----	---------

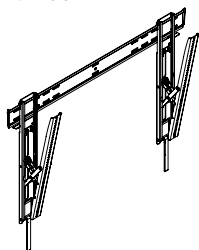

OPEN MARKET ONLY

Description

- Available in Black; Provides 12° of Smooth, Fingertip Tilt
- Compatible with Ultra-Thin TVs 2" (51 mm) Deep or Less; Typical Screen Sizes: 37" - 63"
- Weight Capacity: 100 lbs (45.4 kg)
- Can be Installed in Landscape Mode Only
- Must Order Two (2) 01-TVBR to Mount TV
- Not Compatible with Acrylic or Acoustical Inserts; Can be Used with Onset Acoustical Panels when Used on Opposite Sides

LEVELER KIT	17-LEVKIT				1	1.0	\$ 58
-------------	-----------	--	--	--	---	-----	-------

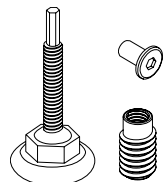

Description

- Includes Two (2) Levelers, Two (2) Insert Nuts and Two (2) Cap Nuts
- Must Specify Black (BLK) or Nickel (NCKL)

Must Specify (in this order):
Model # and Quantity
Hardware Color

[See Overview for Square One Ordering Options.](#)

Item	Model No.	W	D	H	Ship Wt	Cubic Ft	List Price
ALLEN DRIVER BIT	17-TOOL	-	-	-	1	1.0	\$ 65

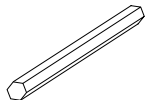
Description

- Used for Inserting Glide Insert Nuts for Levelers
- 6mm Allen Driver Bit

80MM BOLT AND NUT KIT	17-80MMBOLTKIT	-	-	-	1	1.0	\$ 56
-----------------------	----------------	---	---	---	---	-----	-------

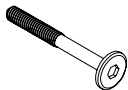

Description

- Quantity of Eight (8)
- For Connecting Block to Block
- Must Specify Black (BLK) or Nickel (NCKL)

Must Specify (in this order):

Model # and Quantity
Hardware Color

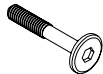
60MM BOLT AND NUT KIT	17-60MMBOLTKIT	-	-	-	1	1.0	\$ 44
-----------------------	----------------	---	---	---	---	-----	-------

Description

- Quantity of Eight (8)
- For Connecting Block to Beam, Post, or End Cap
- Must Specify Black (BLK) or Nickel (NCKL)

Must Specify (in this order):

Model # and Quantity
Hardware Color

12MM BOLT AND NUT KIT	17-12MMBOLTKIT	-	-	-	1	1.0	\$ 43
-----------------------	----------------	---	---	---	---	-----	-------

Description

- Quantity of Eight (8)
- For Covering Exposed Holes in Rails Only
- Must Specify Black (BLK) or Nickel (NCKL)

Must Specify (in this order):

Model # and Quantity
Hardware Color

[See Overview for Square One Ordering Options.](#)

Item	Model No.	W	D	H	Ship Wt	Cubic Ft	List Price
VESTA POWER CENTER	01-PDCTR	10¾	12	28¼	14	2.5	\$ 1968



Description

- Top Includes One (1) Power Outlet, Two (2) USB Ports and One (1) USBC Port; Base Includes Three (3) Outlet
- Available in White
- 120" Power Cord
- Built with Weight Distribution for Optimal Stability
- Base is 5" Tall

TIC-TAC-TOE FOAM GAME SET	17-XOSET	20¾	2	20¾	6	3.0	\$ 403
------------------------------	----------	-----	---	-----	---	-----	--------



Description

- Set Includes Five (5) Xs (Charcoal Gray) and Four (4) Os (Light Gray)
- Constructed of Polyurethane Foam

[See Overview for Square One Ordering Options.](#)

Synergy is a collection of partitions, tables, and seating to create spaces in an impromptu way without the need for complex architecture. This line promotes flexibility to adapt to different interactions, forming areas to gather, separate, and then gather again...all in personalized ways, and all within the same open space.

CONSTRUCTION

PARTITIONS

- Internal wood components are manufactured using plywood
- Partitions require some assembly including 75mm casters that are field installed
- Partitions Chassis consists of TFL frame, shelves (if applicable) and bottom panel

TABLES

- Table legs are 2"D, crafted from European Beech, and individually hand sanded prior to being finished with non-marring fixed nylon glides when casters are not selected
- Table tops have 1" thick Thermally-Fused Laminate (TFL) or High Pressure Laminate (HPL) surface with 3mm PVC edge band and Square edge profile; Designer White, Sugar Maple, and Williamsburg Cherry feature ABS edge bands



Square (Y)

- Tables require some assembly

SEATING

- All bench and stool joints are precisely fit with lag bolt connections for maximum strength and durability
- Stools and benches are rated for users up to 275lbs, ship fully assembled and feature 1½" thick High Grade Polyurethane Foam on the stools and bench seats
- Stool legs are 2"D, crafted from European Beech, and individually hand sanded prior to being finished with non-marring fixed nylon glides when casters are not selected

STORAGE

- Media Low Storage Partition on Casters includes soft close, touch latch hinged doors
- Soft close hinges reduce stress placed on the cabinet when the door is closed and offers a quiet closure
- Media Low Storage and Open Storage Partitions feature two (2) black grommets within the storage

PLANTER BOXES

- The planter box is made of ¾" thick thermally-fused laminate (TFL) particle-board core
- Grain direction runs horizontal
- Planter boxes are fastened together with screws and heavy-duty metal fasteners
- Optional Planter Insert is made of lightweight, fade-resistant, recyclable plastic

POWER/DATA/CORD MANAGEMENT

- Table top grommets and power/data units are available on center
- Table tops feature undersurface a 2"H metal accent to conceal wires and additional cord management is available for order; [See Accessories](#)
- Power/Data units available for in-surface mounting and comply with FCC Part 15A and UL
- Partitions with TV mount include a black grommet below TV mount, center wire channel, and grommet in bottom of unit for a clean and easy access to power.

HOW TO ORDER EXAMPLES

MODEL	QTY	DESCRIPTION	EXAMPLE
PARTITIONS			
82-4872PT	1	TFL Chassis Color Metal Accent Side A Panel Tackable Upholstery TV Mount Option	NTM ALUM TKBP (Tackable Panel) Mayer Fabrics Strata Cliff TVSA
		Side B Panel TFL Panel Color Hook Option	TFLP (TFL Panel) ORW HKSB
82-4872CPT	1	TFL Chassis Color Metal Accent Side A Panel TV Mount Option	KHE ALUM WHBP (Dry Erase Panel) TVSA
		Side B Panel TFL Panel Color Hook Option	TFLP (TFL Panel) CO HKSB
PLANTER			
82-4830PL	2	TFL Color Metal Accent	NTM ALUM
TABLE			
82-3672BRT	1	Top Material TFL Top Color Metal Accent Leg Color Leg Glide or Caster Grommet/Power	T NTM ALUM ORW BSC60 (Caster) C
POWER			
	1	Duo Bezel Nema Plug	01-DUOBEZELS
STOOLS			
821	4	Upholstery Leg Color Foot Ring Metal Accent	CF Stinson Drift Tidepool ORW ALUM

PARTITION PANEL OPTIONS

Each side of a partition with panels can be personalized to meet the needs of your space; referred to as Side A Panel and Side B Panel. Select from TFL, Tackable Upholstery, or Dry Erase. Dry Erase Partitions also offer Glass Magnetic Marker Board Panels.

When a TFL Panel or Tackable Upholstery Panel is selected for both Side A and Side B, the same TFL color, or the same upholstery, will be used on both sides for a cohesive aesthetic.

Must specify Side A and Side B panel selection on order.

TFLP	TFL Panel
TKBP	Tackable Upholstered Panel
WHBP	Dry Erase Panel
BLMMB	Black Glass Magnetic Marker Board (82-4872PDE Only)
WHMMB	White Glass Magnetic Marker Board (82-4872PDE Only)

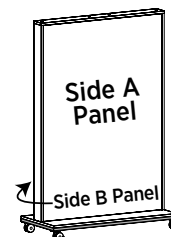

CONTRASTING TFL OPTIONS

Chassis, door fronts, and TFL panels available in contrasting colors. Must specify color of each component with order.

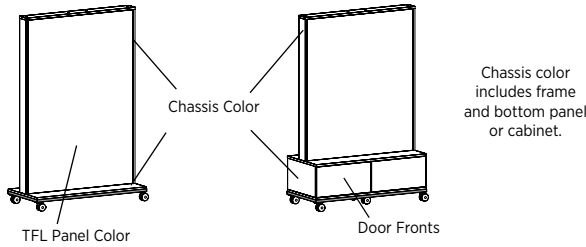

TFL (T) OR HPL (P) FOR TABLE TOP / TFL (T) OPTIONS FOR PARTITION CHASSIS AND PLANTER BOXES

WOODGRAIN

AS Asian Night	PNW Pinnacle Walnut
BW Beigewood	PTK Portico Teak
CO Columbian Walnut	RC River Cherry
EF Espresso	SCH Select Cherry
FLW Florence Walnut	SPW Sepia Walnut
GC Golden Cherry	SKC Shaker Cherry
HVM Harvest Maple	SBP Smoky Brown Pear
KHE Kirsche	TK Studio Teak
MW Mahogany Walnut	SM Sugar Maple
MNR Midnight Run	WTA Weathered Ash
NTM Natural Marrone	WNB White Nebbia
ORW Oak Riftwood	WC Williamsburg Cherry

SOLID

BL Black	FHG Fashion Grey
WH Designer White	SG Slate Grey

SEATING AND TABLE LEG WOOD FINISHES

Indiana Furniture uses a multi-step, hand finishing process on all exposed wood frames.

Units feature a catalyzed varnish finish which offers durability, lasting beauty, and resistance to normal wear.

AW Artisan Walnut	MAS Mesa Sunset*
AS Asian Night	MTS Metropolis Sky
BW Beigewood*	MNR Midnight Run
BL Black	NTM Natural Marrone*
CO Columbian Walnut	ORW Oak Riftwood*
DC Dark Cherry	PNW Pinnacle Walnut
DFW Dark Forest Walnut*	PTK Portico Teak*
WH Designer White	RC River Cherry*
EF Espresso	SCH Select Cherry
FO Fawn Oak*	SPW Sepia Walnut*
FLW Florence Walnut*	SKC Shaker Cherry
GC Golden Cherry	SBP Smoky Brown Pear*
HVM Harvest Maple*	TK Studio Teak
HW Harvest Walnut	SM Sugar Maple
HNW Henna Walnut	WTA Weathered Ash*
KHE Kirsche	WNB White Nebbia
LW Legacy Walnut	WC Williamsburg Cherry
MW Mahogany Walnut	

* Low Sheen Finish

PARTITION, TABLE, AND FOOT RING METAL ACCENT COLORS

Metal accents are featured on tables, partitions, and stools in three colors. Must specify color.

ALUM Aluminum	SNO Snow
BLK Black	

TV MOUNT OPTIONS

TV Mounts are available on one side only. TFL or Tackable Upholstered Panels may be selected with TV Mount. When a TV Mount is specified, a black grommet and channel to the bottom chassis is provided for cord management. TV mount bracket coordinates with 42" TVs or smaller and cannot exceed 50lbs. Must specify and add when ordering.

TVSA TV Mount Side A	\$ 211
TVSB TV Mount Side B	\$ 211
NONE No TV Mount	

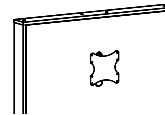

TV Mount includes a black grommet below mounting hardware and channel to the bottom chassis

HOOK OPTIONS

A set of four (4) black hooks are available on TFL, Tackable Upholstery, and Dry Erase Panels. Hooks can be selected for both sides and will be factory installed 6" from each end and 12" between each hook. Hooks feature a 20lbs weight capacity. Must specify and add when ordering. Hooks may be purchased individually for use on vertical surfaces. [See Product Details.](#)

HKSA Four (4) Black Hooks on Side A	\$ 164
HKSB Four (4) Black Hooks on Side B	\$ 164
NONE No Hooks	

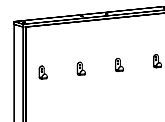

A set of four (4) black hooks with a 20lbs weight capacity per hook.

LOCKING DOOR OPTION

Locking doors are available on the Media Low Storage Partition on Casters. Must specify and add when ordering.

LKT-DB2 Locking Doors	\$ 101
-----------------------	--------

TABLE GLIDE OR CASTER OPTIONS

Tables available with casters or glides. Must specify.

GLIDES Fixed Glides	N/C
BSC60 60mm Soft Caster	\$ 127

GROMMET & POWER/DATA UNIT OPTIONS & LOCATIONS

Grommets and Power/Data units available in center of table tops. Specify Center (C) location on order. Grommet and power/data units must be ordered separately. Tops may also be ordered without grommet/power units by specifying NO GROMMET on order.

Only one grommet/power/data unit per top. [See Product Details](#)

LOCATION OPTION

C On Center

GROMMET OPTIONS

GC Grommet, Center \$ 58

POWER/DATA UNIT OPTIONS [See Product Details and Pricing](#)

DUO CLAMP Available in Black (B), Silver (S), or White (W)

TRIO CLAMP Available in Black (B), Silver (S), or White (W)

DUO BEZEL Available in Black (B), Silver (S), or White (W)

TRIO BEZEL Available in Black (B), Silver (S), or White (W)

DPORT4 Available in Aluminum or Black

DOCK950 Available in Black or White

DOCK150 Available in Black or White

CERTIFICATIONS & COMPLIANCE

- Intertek Sustainability Certified
- BIFMA Compliant® Certified
- TSCA Title VI (formerly CARB) Compliance
- Contributes to LEED®, Green Globes®, and WELL® Sustainable Programs

Partitions

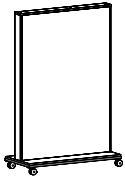

Partition on Casters [\(See Details\)](#)

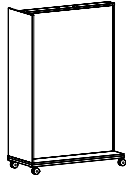

Corner Partition on Casters [\(See Details\)](#)

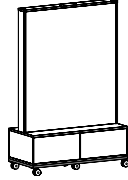

Media Low Storage Partition on Casters [\(See Details\)](#)

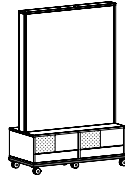

Media Low Open Storage Partition on Casters [\(See Details\)](#)

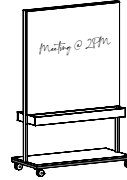

Dry Erase Partition on Casters [\(See Details\)](#)

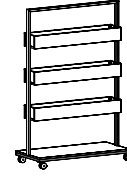

Planter Box Partition on Casters [\(See Details\)](#)

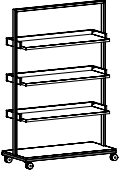

Shelf Partition on Casters [\(See Details\)](#)

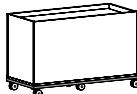

Planter on Casters [\(See Details\)](#)



Recycle Bin on Casters [\(See Details\)](#)

Tables

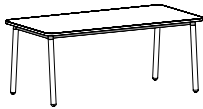

Seated Height Tables [\(See Details\)](#)

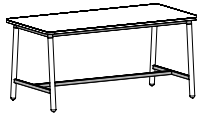

Counter Height Tables [\(See Details\)](#)

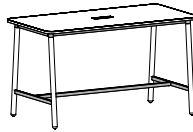

Standing Height Tables [\(See Details\)](#)

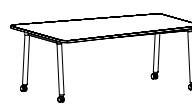

Seated Height View Tables [\(See Details\)](#)

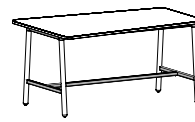

Counter Height View Tables [\(See Details\)](#)

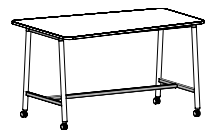

Standing Height View Tables [\(See Details\)](#)

Seating

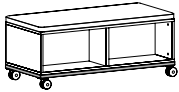

Cubby Bench With Casters [\(See Details\)](#)

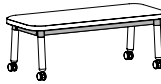

Team Bench With Casters [\(See Details\)](#)

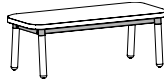

Team Bench With Glides [\(See Details\)](#)



Stool With Casters [\(See Details\)](#)



Stool With Glides [\(See Details\)](#)



Counter Height Stool With Glides [\(See Details\)](#)



Bar Height Stool With Glides [\(See Details\)](#)

Wire Management & Power/Data Accessories

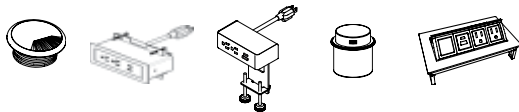

Power Options [\(See Multiple Unit Details\)](#)

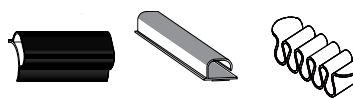

Wire Management [\(See Multiple Unit Details\)](#)



Accessories [\(See Details\)](#)

IDEA STARTERS

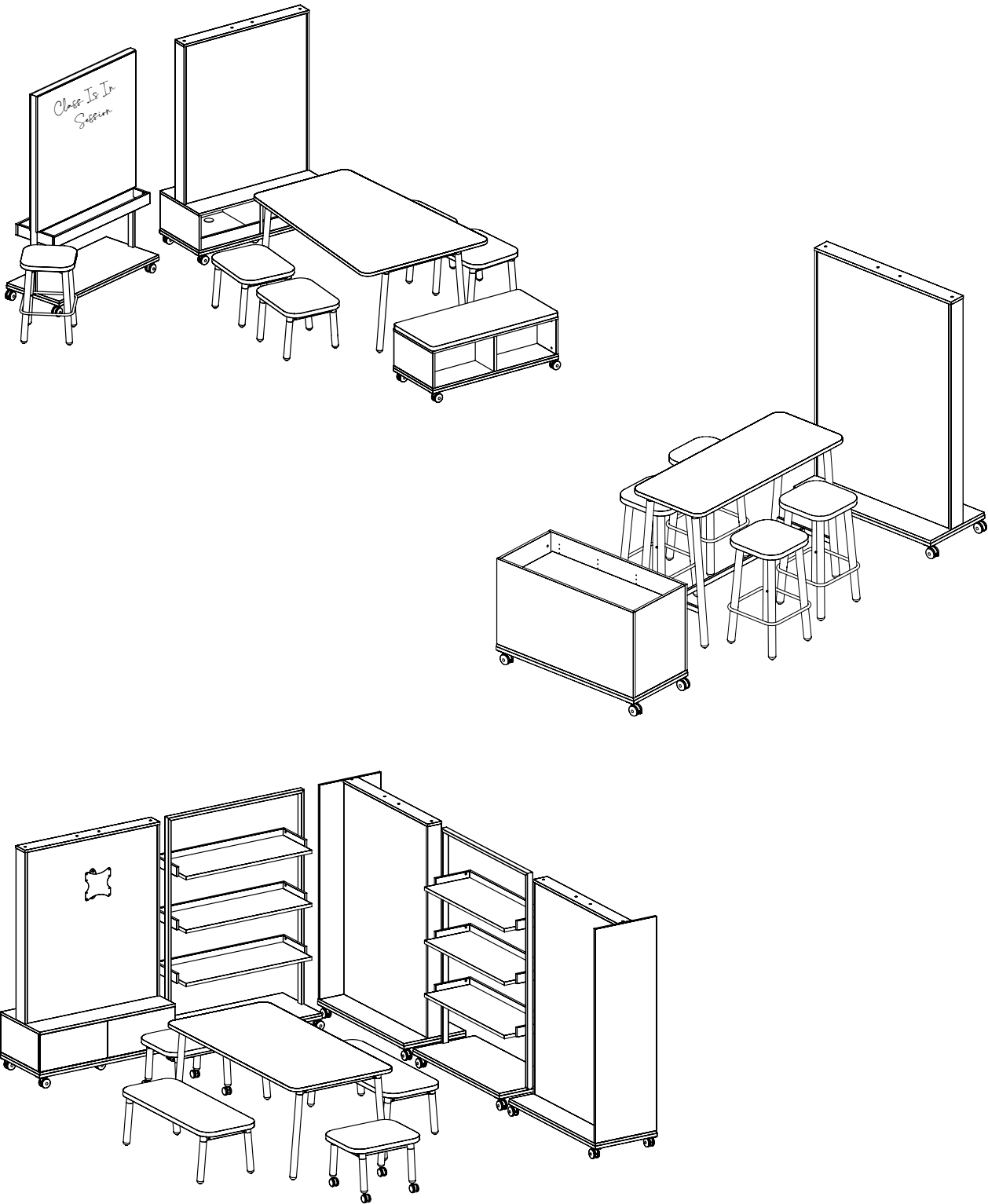

Item	Model No.	W	D	H	Ship Wt	Cubic Ft	List Price
PARTITION ON CASTERS	82-4872PT	48	22	73	290	48.6	T\$ 3225

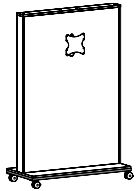

Side A Shown with TFL Panel and TV Mount

Must Specify (in this order):

- Model #
- TFL Chassis Color
- Metal Accent Finish
- Side A Panel Options
 - TFL Panel Color (If Applicable)
 - Tackable Upholstery (If Applicable)
 - TV Mount
 - Hook Options
- Side B Panel Options
 - TFL Panel Color (If Applicable)
 - Tackable Upholstery (If Applicable)
 - TV Mount
 - Hook Options

Description

- Standard with: Four (4) 75mm Casters are Field Installed; Two (2) Locking on Side A, Two (2) Non-Locking on Side B
- Must Specify TFL Chassis Color ([See TFL Colors](#))
- Chassis and TFL Panels (TFLP) Available in Contrasting Colors
- Metal Accent Color; Must Specify Black (BLK), Aluminum (ALUM), or Snow (SNO) ([See Color Details](#))
- Panels for Side A and Side B Available with TFL Panel (TFLP), Tackable Upholstered Panel (TKBP), Dry Erase Panels (WHBP); See Option Details Below
- When TFL Panels (TFLP) are Selected for Both Side A and B, Choose One Color
- When Tackable Upholstered Panels (TKBP) are Selected for Both Side A and B, Choose One Fabric
- Optional TV Mount and Black Grommet Available on One Side; Must Specify Side A (TVSA), Side B (TVSB), or No TV Mount (NONE), See Below
- Optional Hooks Available, Four (4) Black Hooks Included, Must Specify Hooks Side A (HKSA), Hooks Side B (HKSB), or No Hooks (NONE), See Below

Side A Specify & Add:

Side A Panel Options:

TFLP	TFL Panel	N/C
TKBP	Tackable Upholstered Panel	See Pricing Below
WHBP	Dry Erase Panels	\$ 308

Side A Panel Accessories Options: (Choose One)

TVSA	TV Mount Side A (Available on One Side Only)	\$ 211
HKSA	Four (4) Black Hooks Side A	\$ 164
NONE	No Accessories	N/C

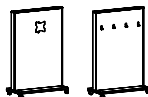

Side A (TKBP) Tackable Upholstered Panel Pricing

List Price/Grade	Yards	COM/1	2	3	4	5	6	7	8	9	10
Tackable Panel	2.00	\$ 308	424	524	618	764	910	1120	1338	1594	1888



Take Notes or Set Action Items with Dry Erase Panels and the Marker/Erase Sets ([See Sets](#))

Side B Specify & Add:

Side B Panel Options:

TFLP	TFL Panel	N/C
TKBP	Tackable Upholstered Panel	See Pricing Below
WHBP	Dry Erase Panels	\$ 308

Side B Panel Accessories Options: (Choose One)

TVSB	TV Mount Side B (Available on One Side Only)	\$ 211
HKSB	Four (4) Black Hooks Side B	\$ 164
NONE	No Accessories	N/C

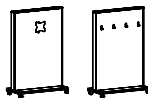

Side B (TKBP) Tackable Upholstered Panel Pricing - Must Match Side A

List Price/Grade	Yards	COM/1	2	3	4	5	6	7	8	9	10
Tackable Panel	2.00	\$ 308	424	524	618	764	910	1120	1338	1594	1888

Item	Model No.	W	D	H	Ship Wt	Cubic Ft	List Price
CORNER PARTITION ON CASTERS	82-4872CPT	48	22	73	311	48.6	T\$ 3331

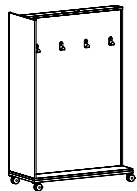

Side A Shown with Dry Erase Panel and Hooks

Must Specify (in this order):

- Model #
- TFL Chassis Color
- Metal Accent Finish
- Side A Panel Options
 - TFL Panel Color (If Applicable)
 - Tackable Upholstery (If Applicable)
 - TV Mount
 - Hook Options
- Side B Panel Options
 - TFL Panel Color (If Applicable)
 - Tackable Upholstery (If Applicable)
 - TV Mount
 - Hook Options

Description

- Corner Panel on Left When Facing Side A
- Standard with: Four (4) 75mm Casters are Field Installed; Two (2) Locking on Side A, Two (2) Non-Locking on Side B
- Must Specify TFL Chassis Color ([See TFL Colors](#))
- Chassis and TFL Panels (TFLP) Available in Contrasting Colors
- Metal Accent Color; Must Specify Black (BLK), Aluminum (ALUM), or Snow (SNO) ([See Color Details](#))
- Panels for Side A and Side B Available with TFL Panel (TFLP), Tackable Upholstered Panel (TKBP), Dry Erase Panels (WHBP); See Option Details Below
- When TFL Panels (TFLP) are Selected for Both Side A and B, Choose One Color
- When Tackable Upholstered Panels (TKBP) are Selected for Both Side A and B, Choose One Fabric
- Optional TV Mount and Black Grommet Available on One Side; Must Specify Side A (TVSA), Side B (TVSB), or No TV Mount (NONE), See Below
- Optional Hooks Available, Four (4) Black Hooks Included, Must Specify Hooks Side A (HKSA), Hooks Side B (HKSB), or No Hooks (NONE), See Below

Side A Specify & Add:

Side A Panel Options:		
TFLP	TFL Panel	N/C
TKBP	Tackable Upholstered Panel	See Pricing Below
WHBP	Dry Erase Panels	\$ 308

Side A Panel Accessories Options: (Choose One)

TVSA	TV Mount Side A (Available on One Side Only)	\$ 211
HKSA	Four (4) Black Hooks Side A	\$ 164
NONE	No Accessories	N/C

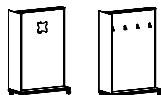

Side A (TKBP) Tackable Upholstered Panel Pricing

List Price/Grade	Yards	COM/1	2	3	4	5	6	7	8	9	10
Tackable Panel	2.00	\$ 308	424	524	618	764	910	1120	1338	1594	1888



Take Notes or Set Action Items with Dry Erase Panels and the Marker/Erase Sets ([See Sets](#))

Side B Specify & Add:

Side B Panel Options:		
TFLP	TFL Panel	N/C
TKBP	Tackable Upholstered Panel	See Pricing Below
WHBP	Dry Erase Panels	\$ 308

Side B Panel Accessories Options: (Choose One)

TVSB	TV Mount Side B (Available on One Side Only)	\$ 211
HKSB	Four (4) Black Hooks Side B	\$ 164
NONE	No Accessories	N/C

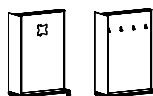

Side B (TKBP) Tackable Upholstered Panel Pricing - Must Match Side A

List Price/Grade	Yards	COM/1	2	3	4	5	6	7	8	9	10
Tackable Panel	2.00	\$ 308	424	524	618	764	910	1120	1338	1594	1888

Item	Model No.	W	D	H	Ship Wt	Cubic Ft	List Price
MEDIA LOW STORAGE PARTITION ON CASTERS	82-4872PMLS	48	22	73	290	48.6	T\$ 3782

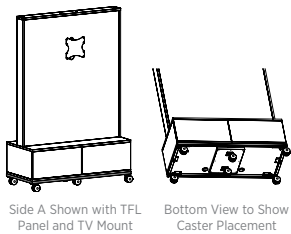

Side A Shown with TFL Panel and TV Mount Bottom View to Show Caster Placement

Description

- Standard with: Six (6) 75mm Casters are Field Installed; Two (2) Locking on Side A, Two (2) Non-Locking on Side B, and Two (2) Non-Locking in Center of Bottom
- Two (2) Black Grommets on Side A for Easy Accessibility to Power
- Must Specify TFL Chassis Color ([See TFL Colors](#))
- Chassis and TFL Panels (TFLP) Available in Contrasting Colors
- Metal Accent Color; Must Specify Black (BLK), Aluminum (ALUM), or Snow (SNO) ([See Color Details](#))
- Panels for Side A and Side B Available with TFL Panel (TFLP), Tackable Upholstered Panel (TKBP), Dry Erase Panels (WHBP); See Option Details Below
- When TFL Panels (TFLP) are Selected for Both Side A and B, Choose One Color
- When Tackable Upholstered Panels (TKBP) are Selected for Both Side A and B, Choose One Fabric
- Optional TV Mount Available on One Side; Must Specify Side A (TVSA), Side B (TVSB), or No TV Mount (NONE), See Below
- Optional Hooks Available, Four (4) Black Hooks Included, Must Specify Hooks Side A (HKSA), Hooks Side B (HKSB), or No Hooks (NONE), See Below
- Non-Locking, Touch Latch, Soft Close Doors Standard with Optional Locking, [See Details](#)
- Safely Write on Optional Black and White Glass Magnetic Marker Panel With Marker and Eraser, [Sets See Set Details](#)
- Rare Earth Magnets Easily Work on Glass Magnetic Marker Panels; [See Set Details](#)

Must Specify (in this order):

- Model #
- TFL Chassis Color
- Metal Accent Finish
- Side A Panel Options
 - TFL Panel Color (If Applicable)
 - Tackable Upholstery (If Applicable)
 - TV Mount
 - Hook Options
- Side B Panel Options
 - TFL Panel Color (If Applicable)
 - Tackable Upholstery (If Applicable)
 - TV Mount
 - Hook Options
- Door Color
- Locking Door Option

Side A Specify & Add:

Side A Panel Options:		
TFLP	TFL Panel	N/C
TKBP	Tackable Upholstered Panel	See Pricing Below
WHBP	Dry Erase Panels	\$ 308

Side A Panel Accessories Options: (Choose One)

TVSA	TV Mount Side A (Available on One Side Only)	\$ 211
HKSA	Four (4) Black Hooks Side A	\$ 164
NONE	No Accessories	N/C

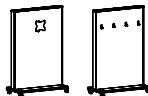

Side A (TKBP) Tackable Upholstered Panel Pricing

List Price/Grade	Yards	COM/1	2	3	4	5	6	7	8	9	10
Tackable Panel	1.75	\$ 271	373	460	542	670	798	982	1172	1396	1654



Take Notes or Set Action Items with Dry Erase Panels and the Marker/Eraser Sets ([See Sets](#))

Side B Specify & Add:

Side B Panel Options:		
TFLP	TFL Panel	N/C
TKBP	Tackable Upholstered Panel	See Pricing Below
WHBP	Dry Erase Panels	\$ 308

Side B Panel Accessories Options: (Choose One)

TVSB	TV Mount Side B (Available on One Side Only)	\$ 211
HKSB	Four (4) Black Hooks Side B	\$ 164
NONE	No Accessories	N/C

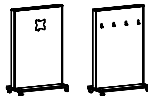

Side B (TKBP) Tackable Upholstered Panel Pricing - Must Match Side A

List Price/Grade	Yards	COM/1	2	3	4	5	6	7	8	9	10
Tackable Panel	1.75	\$ 271	373	460	542	670	798	982	1172	1396	1654

P = HPL W = Veneer

[See Synergy Overview For Ordering Options](#)

Item	Model No.	W	D	H	Ship Wt	Cubic Ft	List Price
MEDIA LOW OPEN STORAGE PARTITION ON CASTERS	82-4872PML0S	48	22	73	311	48.6	T\$ 3629

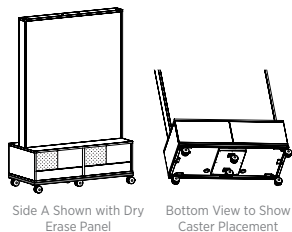

Description

- Standard with: Six (6) 75mm Casters are Field Installed; Two (2) Locking on Side A, Two (2) Non-Locking on Side B, and Two (2) Non-Locking in Center of Bottom
- Two (2) Black Grommets Included, One (1) Black Grommet Inside Each Cubby for Easy Accessibility to Power
- Two (2) Open Storage Cubbies Per Unit; 22½"W x 20"D x 12"H with an 8" Opening in Front and 4" Guard to Contain Stored Items when Unit is Moved. Patterned Portion of Art Shows Back Panel
- Must Specify TFL Chassis Color ([See TFL Colors](#))
- Chassis and TFL Panels (TFLP) Available in Contrasting Colors
- Metal Accent Color; Must Specify Black (BLK), Aluminum (ALUM), or Snow (SNO) ([See Color Details](#))
- Panels for Side A and Side B Available with TFL Panel (TFLP), Tackable Upholstered Panel (TKBP), Dry Erase Panels (WHBP); See Option Details Below
- When TFL Panels (TFLP) are Selected for Both Side A and B, Choose One Color
- When Tackable Upholstered Panels (TKBP) are Selected for Both Side A and B, Choose One Fabric
- Optional TV Mount Available on One Side; Must Specify Side A (TVSA), Side B (TVSB), or No TV Mount(NONE), See Below
- Optional Hooks Available, Four (4) Black Hooks Included, Must Specify Hooks Side A (HKSA), Hooks Side B (HKSB), or No Hooks (NONE), See Below
- Safely Write on Optional Black and White Glass Magnetic Marker Panel With Marker and Eraser, [Sets See Set Details](#)
- Rare Earth Magnets Easily Work on Glass Magnetic Marker Panels; [See Set Details](#)

Must Specify (in this order):

- Model #
- TFL Chassis Color
- Metal Accent Finish
- Side A Panel Options
 - TFL Panel Color (If Applicable)
 - Tackable Upholstery (If Applicable)
 - TV Mount
 - Hook Options
- Side B Panel Options
 - TFL Panel Color (If Applicable)
 - Tackable Upholstery (If Applicable)
 - TV Mount
 - Hook Options

Side A Specify & Add:

Side A Panel Options:

TFLP	TFL Panel	N/C
TKBP	Tackable Upholstered Panel	See Pricing Below
WHBP	Dry Erase Panels	\$ 308

Side A Panel Accessories Options: (Choose One)

TVSA	TV Mount Side A (Available on One Side Only)	\$ 211
HKSA	Four (4) Black Hooks Side A	\$ 164
NONE	No Accessories	N/C

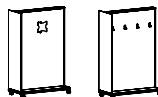

Side A (TKBP) Tackable Upholstered Panel Pricing

List Price/Grade	Yards	COM/1	2	3	4	5	6	7	8	9	10
Tackable Panel	1.75	\$ 271	373	460	542	670	798	982	1172	1396	1654



Take Notes or Set Action Items with Dry Erase Panels and the Marker/Eraser Sets ([See Sets](#))

Side B Specify & Add:

Side B Panel Options:

TFLP	TFL Panel	N/C
TKBP	Tackable Upholstered Panel	See Pricing Below
WHBP	Dry Erase Panels	\$ 308

Side B Panel Accessories Options: (Choose One)

TVSB	TV Mount Side B (Available on One Side Only)	\$ 211
HKSB	Four (4) Black Hooks Side B	\$ 164
NONE	No Accessories	N/C

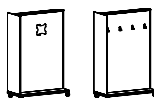

Side B (TKBP) Tackable Upholstered Panel Pricing - Must Match Side A

List Price/Grade	Yards	COM/1	2	3	4	5	6	7	8	9	10
Tackable Panel	1.75	\$ 271	373	460	542	670	798	982	1172	1396	1654

P = HPL W = Veneer

Item	Model No.	W	D	H	Ship Wt	Cubic Ft	List Price
DRY ERASE PARTITION ON CASTERS	82-4872PDE	48	22	73	290	48.6	WHBP \$ 4463
							BLMMB \$ 11739
							WHMMB \$ 11739

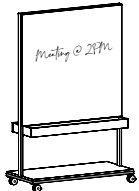

Shown with Dry Erase Panels

Description

- Standard with: Four (4) 75mm Casters are Field Installed; Two (2) Locking on Side A, Two (2) Non-Locking on Side B
- Must Specify TFL Chassis Color ([See TFL Colors](#))
- Metal Accent Color; Must Specify Black (BLK), Aluminum (ALUM), or Snow (SNO) ([See Color Details](#))
- Panels Available with Dry Erase Panels (WHBP), Black Glass Magnetic Marker Panels (BLMMB), or White Glass Magnetic Marker Panels (WHMMB)
- Safely Write on Optional Black and White Glass Magnetic Marker Panel With Marker and Eraser Sets ([See Set Details](#))
- Pin a Note with the Rare Earth Magnets on Glass Magnetic Marker Panels ([See Set Details](#))

Must Specify (in this order):

Model #
TFL Chassis Color
Metal Accent Finish
Panel Options



Take Notes or Set Action Items with the Marker/Eraser and Magnet Sets ([See Sets](#))

PLANTER BOX PARTITION ON CASTERS	82-4872PPB	48	22	73	160	48.6	T\$ 3936
----------------------------------	------------	----	----	----	-----	------	----------

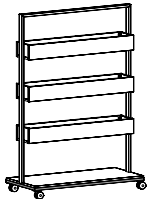

Description

- Standard with: Three Planter Boxes, Four (4) 75mm Casters are Field Installed; Two (2) Locking on Side A, Two (2) Non-Locking on Side B
- Planter Boxes are 9"D x 6"H
- Must Specify TFL Chassis Color; ([See TFL Colors](#))
- Metal Accent Color; Must Specify Black (BLK), Aluminum (ALUM), or Snow (SNO) ([See Color Details](#))
- We Recommend Using Optional Planter Inserts (See Below) to Protect Planter Boxes from Water

Must Specify (in this order):

Model #
TFL Chassis Color
Metal Accent Finish
Planter Inserts

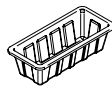

Option: Specify & Add

PBI6	Planter Box Insert, Six (6) Black Plastic Inserts	\$ 307
------	---	--------

Item	Model No.	W	D	H	Ship Wt	Cubic Ft	List Price
SHELF PARTITION ON CASTERS	82-4872PSP	48	22	73	105	48.6	T\$ 4003

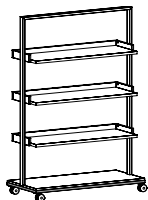

Description

- Standard with: Four (4) 75mm Casters are Field Installed; Two (2) Locking on Side A, Two (2) Non-Locking on Side B
- Shelves are 44½"W x 16"D with 16⅞" Between Each Shelf
- Shelves Feature 100lb Weight Capacity
- Must Specify TFL Chassis Color ([See TFL Colors](#))
- Metal Accent Color; Must Specify Black (BLK), Aluminum (ALUM), or Snow (SNO) ([See Color Details](#))

Must Specify (in this order):

Model #
TFL Chassis Color
Metal Accent Finish

PLANTER ON CASTERS	82-4830PL	48	22	31	178	19.6	T\$ 2281
--------------------	-----------	----	----	----	-----	------	----------

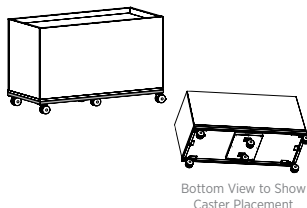

Description

- Standard with: Six (6) 75mm Casters are Field Installed; Two (2) Locking on Side A, Two (2) Non-Locking on Side B, and Two (2) Non-Locking in Center of Bottom
- Top Shelf is 1" Smaller for Easy Removal and Adjusts From 1⅞" to 8⅞" Deep to Accommodate Different Sized Flower Pots
- Shelf Feature 100lb Weight Capacity
- Must Specify TFL Chassis Color ([See TFL Colors](#))
- Metal Accent Color; Must Specify Black (BLK), Aluminum (ALUM), or Snow (SNO) ([See Color Details](#))
- Flower Pots or Planters Not Included

Must Specify (in this order):

Model #
TFL Chassis Color
Metal Accent Finish

RECYCLE BIN ON CASTERS	82-4830RB	48	22	31	183	19.6	T\$ 2561
------------------------	-----------	----	----	----	-----	------	----------

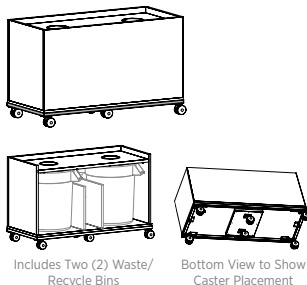



Description

- Standard with: Two (2) 20 Gallon Waste/Recycle Bins, Six (6) 75mm Casters are Field Installed; Two (2) Locking on Side A, Two (2) Non-Locking on Side B, and Two (2) Non-Locking in Center of Bottom
- Top Shelf 1" Smaller for Easy Removal to Access Recycle Bins; Fixed Side Panels
- Must Specify TFL Chassis Color ([See TFL Colors](#))
- Metal Accent Color; Must Specify Black (BLK), Aluminum (ALUM), or Snow (SNO) ([See Color Details](#))

Must Specify (in this order):

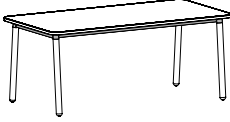
Model #
TFL Chassis Color
Metal Accent Finish

Item	Model No.	W	D	H	Ship Wt	Cubic Ft	List Price
  <p>Top Shape</p>	82-2460RT	60	24	30	67	10	T\$ 2277 P\$ 2367
	82-2472RT	72	24	30	76	12	T\$ 2406 P\$ 2466
	82-3060RT	60	30	30	76	11.1	T\$ 2351 P\$ 2392
	82-3072RT	72	30	30	86	13.3	T\$ 2495 P\$ 2618
	82-3660RT	60	36	30	90	14.4	T\$ 2529 P\$ 2653
	82-3672RT	72	36	30	103	17.1	T\$ 2687 P\$ 2751
	82-3684RT	84	36	30	115	19.9	T\$ 2836 P\$ 3355
	82-3696RT	96	36	30	126	22.7	T\$ 2929 P\$ 3388
	82-4272RT	72	42	30	115	19.3	T\$ 2831 P\$ 2928
	82-4284RT	84	42	30	127	22.4	T\$ 2939 P\$ 3388
	82-4296RT	96	42	30	141	25.5	T\$ 3046 P\$ 3426

Must Specify (in this order):

Model #
 Top Material
 Top Color
 Metal Accent Color
 Leg Color
 Leg Glide or Casters
 Grommet/Power





Use the Black Undermount Hook For Purses, Bags, Etc. [\(See Details\)](#)

Description

- TFL and HPL Tops ([See TFL and HPL Colors](#))
- Undermount Metal Accents Measure 2"H, 1" Thick, and is Available in Black (BLK), Aluminum (ALUM), or Snow (SNO); Must Specify Color ([See Details](#))
- Top and Legs Available in Contrasting Colors ([See Leg Color Options](#))
- Legs Available with Fixed Glides (GLIDES) or Four (4) 60mm Casters (BSC60), Two (2) Locking and Two (2) Non-Locking ([See Details](#))
- Some Assembly Required
- Power and Grommet Available on Center Only ([See Options](#))

T= TFL P= HPL

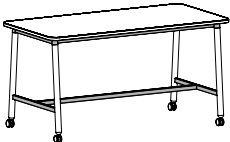
[See Synergy Overview For Ordering Options](#)

Item	Model No.	W	D	H	Ship Wt	Cubic Ft	List Price
 <p>Table Shown with Casters</p>  <p>Top Shape</p> <p>Must Specify (in this order): Model # Top Material Top Color Metal Accent Color Leg Color Leg Glide or Casters Grommet/Power</p>	82-2460CRT	60	24	36	76	10	T\$ 2806 P\$ 2897
	82-2472CRT	72	24	36	86	12	T\$ 2790 P\$ 2850
	82-3060CRT	60	30	36	85	11.1	T\$ 2881 P\$ 2921
	82-3072CRT	72	30	36	98	13.3	T\$ 2879 P\$ 3002
	82-3660CRT	60	36	36	101	14.4	T\$ 3086 P\$ 3209
	82-3672CRT	72	36	36	115	17.1	T\$ 3098 P\$ 3162
	82-3684CRT	84	36	36	126	19.9	T\$ 3248 P\$ 3766
	82-3696CRT	96	36	36	137	22.7	T\$ 3340 P\$ 3799
	82-4272CRT	72	42	36	126	19.3	T\$ 3243 P\$ 3339
	82-4284CRT	84	42	36	139	22.4	T\$ 3349 P\$ 3799
	82-4296CRT	96	42	36	152	25.5	T\$ 3457 P\$ 3837

Description



- TFL and HPL Tops ([See TFL and HPL Colors](#))
- Undermount Metal Accents Measure 2"H, 1" Thick, and is Available in Black (BLK), Aluminum (ALUM), or Snow (SNO); Must Specify Color ([See Details](#))
- Top and Legs Available in Contrasting Colors ([See Leg Color Options](#))
- Legs Available with Fixed Glides (GLIDES) or Four (4) 60mm Casters (BSC60), Two (2) Locking and Two (2) Non-Locking ([See Details](#))
- Some Assembly Required
- Power and Grommet Available on Center Only ([See Options](#))



Use the Black Undermount Hook For Purses, Bags, Etc. ([See Details](#))

T= TFL P= HPL

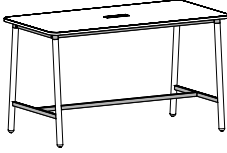
[See Synergy Overview For Ordering Options](#)

Item	Model No.	W	D	H	Ship Wt	Cubic Ft	List Price
 Table Shown with TRIO on Center  Top Shape	82-2460BRT	60	24	42	77	10	T\$ 2838 P\$ 2929
	82-2472BRT	72	24	42	88	12	T\$ 2997 P\$ 3056
	82-3060BRT	60	30	42	86	11.1	T\$ 2913 P\$ 2954
	82-3072BRT	72	30	42	100	13.3	T\$ 3086 P\$ 3208
	82-3660BRT	60	36	42	103	14.4	T\$ 3133 P\$ 3257
	82-3672BRT	72	36	42	117	17.1	T\$ 3319 P\$ 3384
	82-3684BRT	84	36	42	128	19.9	T\$ 3468 P\$ 3986
	82-3696BRT	96	36	42	139	22.7	T\$ 3561 P\$ 4022
	82-4272BRT	72	42	42	128	19.3	T\$ 3464 P\$ 3560
	82-4284BRT	84	42	42	141	22.4	T\$ 3570 P\$ 4021
	82-4296BRT	96	42	42	154	25.5	T\$ 3679 P\$ 4058

Must Specify (in this order):

Model #

Top Material

Top Color

Metal Accent Color

Leg Color

Leg Glide or Casters

Grommet/Power



Use the Black Undermount Hook For Purses, Bags, Etc. [\(See Details\)](#)

Description

- TFL and HPL Tops ([See TFL and HPL Colors](#))
- Undermount Metal Accents Measure 2"H, 1" Thick, and is Available in Black (BLK), Aluminum (ALUM), or Snow (SNO); Must Specify Color ([See Details](#))
- Top and Legs Available in Contrasting Colors ([See Leg Color Options](#))
- Legs Available with Fixed Glides (GLIDES) or Four (4) 60mm Casters (BSC60), Two (2) Locking and Two (2) Non-Locking ([See Details](#))
- Some Assembly Required
- Power and Grommet Available on Center Only ([See Options](#))

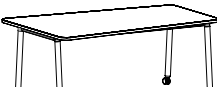
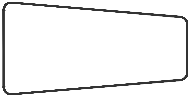
Item	Model No.	W	D	H	Ship Wt	Cubic Ft	List Price
 Table Shown with Casters  Top Shape	82-2472VT	72	24-36	30	90	17.1	T\$ 2593 P\$ 2659
	82-3672VT	72	36-48	30	118	21	T\$ 2916 P\$ 2953

Description

- TFL and HPL Tops ([See TFL and HPL Colors](#))
- Undermount Metal Accents Measure 2"H, 1" Thick, and is Available in Black (BLK), Aluminum (ALUM), or Snow (SNO); Must Specify Color ([See Details](#))
- Top and Legs Available in Contrasting Colors ([See Leg Color Options](#))
- Legs Available with Fixed Glides (GLIDES) or Four (4) 60mm Casters (BSC60), Two (2) Locking and Two (2) Non-Locking ([See Details](#))
- Some Assembly Required
- Power and Grommet Available on Center Only ([See Options](#))



Use the Black Undermount Hook For Purses, Bags, Etc. [\(See Details\)](#)

T= TFL P= HPL

[See Synergy Overview For Ordering Options](#)

Item	Model No.	W	D	H	Ship Wt	Cubic Ft	List Price
COUNTER HEIGHT VIEW TABLE	82-2472CVT	72	24-36	36	100	17.1	T\$ 2977 P\$ 3043
	82-3672CVT	72	36-48	36	129	21	T\$ 3327 P\$ 3363

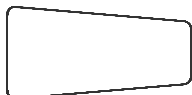
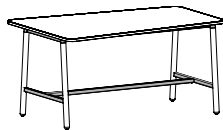

Top Shape

Must Specify (in this order):

- Model #
- Top Material
- Top Color
- Metal Accent Color
- Leg Color
- Leg Glide or Casters
- Grommet/Power

Description

- TFL and HPL Tops ([See TFL and HPL Colors](#))
- Undermount Metal Accents Measure 2”H, 1” Thick, and is Available in Black (BLK), Aluminum (ALUM), or Snow (SNO); Must Specify Color ([See Details](#))
- Top and Legs Available in Contrasting Colors ([See Leg Color Options](#))
- Legs Available with Fixed Glides (GLIDES) or Four (4) 60mm Casters (BSC60), Two (2) Locking and Two (2) Non-Locking ([See Details](#))
- Some Assembly Required
- Power and Grommet Available on Center Only ([See Options](#))



Use the Black Undermount Hook For Purses, Bags, Etc. ([See Details](#))

STANDING HEIGHT VIEW TABLE	82-2472BVT	72	24-36	42	102	17.1	T\$ 3183 P\$ 3249
	82-3672BVT	72	36-48	42	131	21	T\$ 3549 P\$ 3585

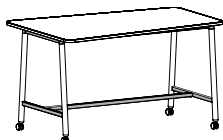

Table Shown with Casters



Top Shape

Must Specify (in this order):

- Model #
- Top Material
- Top Color
- Metal Accent Color
- Leg Color
- Leg Glide or Casters
- Grommet/Power

Description

- TFL and HPL Tops ([See TFL and HPL Colors](#))
- Undermount Metal Accents Measure 2”H, 1” Thick, and is Available in Black (BLK), Aluminum (ALUM), or Snow (SNO); Must Specify Color ([See Details](#))
- Top and Legs Available in Contrasting Colors ([See Leg Color Options](#))
- Legs Available with Fixed Glides (GLIDES) or Four (4) 60mm Casters (BSC60), Two (2) Locking and Two (2) Non-Locking ([See Details](#))
- Some Assembly Required
- Power and Grommet Available on Center Only ([See Options](#))



Use the Black Undermount Hook For Purses, Bags, Etc. ([See Details](#))

T= TFL P= HPL

[See Synergy Overview For Ordering Options](#)

Item	Model No.	Seat Width	Seat Depth	Seat Height	Ship Wt	Cubic Ft
CUBBY BENCH	820-4822MCB	48	19	17½	47	9.2

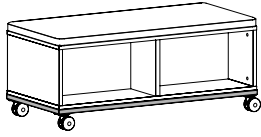

Must Specify (in this order):

- Model #
- Upholstery
- Chassis Finish
- Metal Accent Color

Description

- Standard with: Four (4) 75mm Non-Locking Casters
- Two (2) Cubbies on Each Side, Four (4) Cubbies Total; Each Cubby is 22½"W x 10¼"D x 12"H
- Cushion is One Piece
- Must Specify TFL Chassis ([See TFL Colors](#))
- Metal Accent Measures 1" Square, Available in Black (BLK), Aluminum (ALUM), or Snow (SNO); Must Specify Color ([See Details](#))

List Price/Grade	Yards	COM/1	2	3	4	5	6	7	8	9	10	L1	L2
Single Upholstery	1.50	\$ 2027	2114	2189	2260	2369	2479	2636	2800	2992	3212	2579	2816

Item	Model No.	Seat Width	Seat Depth	Seat Height	Ship Wt	Cubic Ft
TEAM BENCH WITH CASTERS	820-4819MTB	48	19	17½	47	9.2

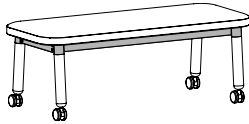

Must Specify (in this order):

- Model #
- Upholstery
- Leg Finish
- Metal Accent Color

Description

- Standard with 60mm Non-Locking Casters
- Legs are 2"D, Must Specify Color ([See Leg Colors](#))
- Metal Accent Measures 2"H and 1" Thick, Available in Black (BLK), Aluminum (ALUM), or Snow (SNO); Must Specify Color ([See Details](#))

List Price/Grade	Yards	COM/1	2	3	4	5	6	7	8	9	10	L1	L2
Single Upholstery	1.50	\$ 2055	2142	2217	2288	2397	2507	2664	2828	3020	3240	2607	2844

Item	Model No.	Seat Width	Seat Depth	Seat Height	Ship Wt	Cubic Ft
TEAM BENCH WITH GLIDES	820-4819TB	48	19	17½	47	9.2

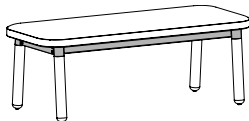

Must Specify (in this order):

- Model #
- Upholstery
- Leg Finish
- Metal Accent Color

Description

- Standard with Fixed Glides
- Legs are 2"D, Must Specify Color ([See Leg Colors](#))
- Metal Accent Measures 2"H and 1" Thick, Available in Black (BLK), Aluminum (ALUM), or Snow (SNO); Must Specify Color ([See Details](#))

List Price/Grade	Yards	COM/1	2	3	4	5	6	7	8	9	10	L1	L2
Single Upholstery	1.50	\$ 1940	2027	2102	2173	2282	2392	2549	2713	2905	3125	2492	2729

[See Synergy Overview For Ordering Options](#)

Item	Model No.	Seat Width	Seat Depth	Seat Height	Ship Wt	Cubic Ft
STOOL WITH CASTERS	820-2419MFS	24	19	17½	29	4.6

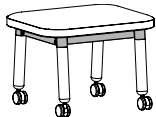

Stool Shown with Casters

Description

- Standard with 60mm Non-Locking Casters
- Legs are 2”D, Must Specify Color ([See Leg Colors](#))
- Metal Accent Measures 2”H and 1” Thick, Available in Black (BLK), Aluminum (ALUM), or Snow (SNO); Must Specify Color ([See Details](#))

Must Specify (in this order):

- Model #
- Upholstery
- Leg Finish
- Metal Accent Color

List Price/Grade	Yards	COM/1	2	3	4	5	6	7	8	9	10	L1	L2
Single Upholstery	1.00	\$ 1781	1839	1889	1936	2009	2082	2187	2296	2424	2571	2149	2307

Item	Model No.	Seat Width	Seat Depth	Seat Height	Ship Wt	Cubic Ft
STOOL WITH GLIDES	820-2419FS	24	19	17½	29	4.6

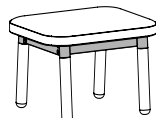

Stool Shown with Casters

Description

- Standard with Fixed Glides
- Legs are 2”D, Must Specify Color ([See Leg Colors](#))
- Metal Accent Measures 2”H and 1” Thick, Available in Black (BLK), Aluminum (ALUM), or Snow (SNO); Must Specify Color ([See Details](#))

Must Specify (in this order):

- Model #
- Upholstery
- Leg Finish
- Metal Accent Color

List Price/Grade	Yards	COM/1	2	3	4	5	6	7	8	9	10	L1	L2
Single Upholstery	1.00	\$ 1666	1724	1774	1821	1894	1967	2072	2181	2309	2456	2034	2192

Item	Model No.	Seat Width	Seat Depth	Seat Height	Ship Wt	Cubic Ft
COUNTER HEIGHT STOOL	821	16¾	16¾	27½	23	5.1

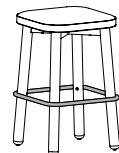

Description

- Standard with Fixed Glides
- Legs are 2”D, Must Specify Color ([See Leg Colors](#))
- Foot Ring Available in Black (BLK), Aluminum (ALUM), or Snow (SNO); Must Specify Color ([See Details](#))

Must Specify (in this order):

- Model #
- Upholstery
- Leg Finish
- Foot Ring Color

List Price/Grade	Yards	COM/1	2	3	4	5	6	7	8	9	10	L1	L2
Single Upholstery	1.00	\$ 1495	1553	1603	1650	1723	1796	1901	2010	2138	2285	1863	2021

Item	Model No.	Seat Width	Seat Depth	Seat Height	Ship Wt	Cubic Ft
BAR HEIGHT STOOL	822	16¾	16¾	31½	22	4.5



Description



- Standard with Fixed Glides
- Legs are 2”D, Must Specify Color ([See Leg Colors](#))
- Foot Ring Available in Black (BLK), Aluminum (ALUM), or Snow (SNO); Must Specify Color ([See Details](#))

Must Specify (in this order):

- Model #
- Upholstery
- Leg Finish
- Foot Ring Color

List Price/Grade	Yards	COM/1	2	3	4	5	6	7	8	9	10	L1	L2
Single Upholstery	1.00	\$ 1533	1591	1641	1688	1761	1834	1939	2048	2176	2323	1901	2059

[See Synergy Overview For Ordering Options](#)

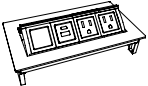
Item	Model No.		W	D	H	Ship Wt	Cubic Ft	List Price
ROUND GROMMET COVER 	01-GRMTB	Black	2 $\frac{3}{8}$	2 $\frac{3}{8}$	-	1	0.1	\$ 12
	01-GRMTSL	Silver						
OPEN MARKET ONLY (SILVER)	<p>Description</p> <ul style="list-style-type: none"> • 2$\frac{3}{8}$" (60mm) Round Grommet Cover • Field Installed 							
DOCK 950 WIRELESS CHARGER 	01-DOCK950W	White	3 $\frac{3}{16}$	3 $\frac{3}{16}$	-	1	0.2	\$ 294
	01-DOCK950B	Black						
OPEN MARKET ONLY	<p>Description</p> <ul style="list-style-type: none"> • For Use with Wireless Charging Enabled Devices • 5 Watts Maximum Output with a Direct Current of 5V 2A and 10 Watts Maximum with Quick Charge 2.0 • Mounts in 76mm Round Cut-Out • LED will Confirm Pairing with Device and Begin Wireless Charging 							
DOCK 150 WIRELESS AND USB CHARGER 	01-DOCK150W	White	3	3	$\frac{3}{4}$	1	0.2	\$ 448
	01-DOCK150B	Black						
OPEN MARKET ONLY	<p>Description</p> <ul style="list-style-type: none"> • For Use with Wireless Charging Enabled Devices and USB Charging Devices • 5 Watt Maximum Output with a Direct Current Input of 5V 6A (Wireless Fast Charge) • Mounts in 76mm Round Cut-Out • Pop-Up is $\frac{3}{4}$"H and Includes Three (3) USB Ports; One (1) 12 Watt Maximum with 2.4A (USB Fast Charge) and Two (2) 5 Watt with 1A (USB Standard Charge) • LED Light will Confirm Pairing with Device and Begin Wireless Charging • UL and cUL Certified 							
POWER DATA PORT 	01-DPORT4A	Aluminum	8	4	-	7	0.2	\$ 1211
	01-DPORT4B	Black						
	<p>Description</p> <ul style="list-style-type: none"> • Includes: Two (2) Power Outlets, One (1) USB A+C, One (1) Open Port, 10' Power Cord, and Voice/Data Adapter Kit to Accept Couplers and Jacks When Required • Retracts into Work Surface to Regain Productive Space; One-Touch Access to Power and Data • Optional Telecom Port Components, See Compatible Units on Next Page • Water-Proof Simplex (Outlets) • UL Recognized 							

[See Synergy Overview For Ordering Options](#)

Item	Model No.	W	D	H	Ship Wt	Cubic Ft	List Price
USB PORT	01-USBPORT	-	-	-	-	-	\$ 178

Description

- For Use with 01-DPORT4A and 01-DPORT4B
- Passive USB-A Port with Increased Transfer Speed Up to 5 gbs/sec
- Simultaneous Read/Write Capability
- Idle Device Power Saving State
- 6' Cord

VOICE COUPLER	01-VOICE1	-	-	-	-	-	\$ 80
---------------	-----------	---	---	---	---	---	-------

Description

- For Use with 01-DPORT4A and 01-DPORT4B
- 6-Pin Modular Plug
- Molded Black
- Cord Not included

DATA PORT	01-RJ4DATA	-	-	-	-	-	\$ 186
-----------	------------	---	---	---	---	---	--------



OPEN MARKET ONLY

Description

- For Use with 01-DPORT4A and 01-DPORT4B
- 8-Pin Modular Plug; Cat6 Ethernet Cable; Pre-terminated Cable
- 10' Cord

VGA CONNECTOR ACCESSORY	01-VGACON	-	-	-	1	0.2	\$ 165
-------------------------	-----------	---	---	---	---	-----	--------

Description

- VGA Port for 01-DPORT4A and 01-DPORT4B
- Enables Devices to Remote Display on Monitors
- 10' Cord
- Male/Female Connector

HDMI CONNECTOR ACCESSORY	01-HDMICON	-	-	-	1	0.2	\$ 137
--------------------------	------------	---	---	---	---	-----	--------

Description

- HDMI Port for 01-DPORT4A and 01-DPORT4B
- Connects to High Definition Displays
- Female/Female Connector
- 18" Cord

[See Synergy Overview For Ordering Options](#)

Item	Model No.		W	D	H	Ship Wt	Cubic Ft	List Price
DUO CLAMP WITH NEMA PLUG	01-DUOCLAMPW	White	6½	3	7	1	0.2	\$ 634
	01-DUOCLAMPB	Black						
	01-DUOCLAMP S	Silver						

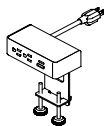

Description

- Standard with: Two (2) Power Outlet, One (1) USB Charging Port and One (1) 60-Watt USB-C Power
- Delivery Port with GaN Technology with 10' Cord
- Clamps to Top and Features Silver Metal Trim
- Independent USB Circuit Controllers Deliver up to 2.1 Amps to Each Post
- All Mounting Hardware Included
- FCC Part 15A and UL Approved for Horizontal and Vertical Applications

TRIO CLAMP WITH NEMA PLUG	01-TRIOCLAMPW	White	9	3	7	1	0.2	\$ 743
	01-TRIOCLAMPB	Black						
	01-TRIOCLAMP S	Silver						

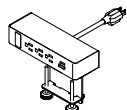

Description

- Standard with: Three (3) Power Outlets, One (1) USB Charging Port, One (1) 60-Watt USB-C Power
- Delivery Port with GaN Technology, One (1) Open Data with 10' Cord
- Clamps to Top and Features Silver Metal Trim
- Independent USB Circuit Controllers Deliver up to 2.1 Amps to Each Post
- HDMI, VGA, or RJ45 Sold Separately; [See Accessories](#)
- All Mounting Hardware Included
- FCC Part 15A and UL Approved for Horizontal and Vertical Applications

DUO BEZEL WITH NEMA PLUG	01-DUOBEZELW	White	6½	2½	3¼	1	0.2	\$ 748
	01-DUOBEZELB	Black						
	01-DUOBEZELS	Silver						



Description

- Sits On Top of the Worksurface and Includes: Two (2) Power, One (1) USB Charging Port and One (1)
- 60-Watt USB-C Power Delivery Port with GaN Technology with 10' Cord
- Independent USB Circuit Controllers Deliver up to 2.1 Amps to Each Post
- All Mounting Hardware Included
- FCC Part 15A and UL Approved for Horizontal and Vertical Applications

TRIO BEZEL WITH NEMA PLUG	01-TRIOBEZELW	White	9	2½	3	1	0.2	\$ 803
	01-TRIOBEZELB	Black						
	01-TRIOBEZELS	Silver						



Description

- Sits On Top of the Worksurface and Includes: Three (3) Power, One (1) USB Charging Port and One (1)
- 60-Watt USB-C Power Delivery Port with GaN Technology, One (1) Open Data, and 10' Cord
- Independent USB Circuit Controllers Deliver up to 2.1 Amps to Each Post
- HDMI, VGA, or RJ45 Sold Separately; [See Accessories](#)
- All Mounting Hardware Included
- FCC Part 15A and UL Approved for Horizontal and Vertical Applications

[See Synergy Overview For Ordering Options](#)

Item	Model No.	W	D	H	Ship Wt	Cubic Ft	List Price
HDMI DATA PORT ACCESSORY	01-LCOMHDMI	-	-	-	1	0.2	\$ 183

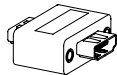
Description

- HDMI Port for Undermount Trio Clamp and Trio Bezel Units

OPEN MARKET ONLY

VGA DATA PORT ACCESSORY	01-LCOMVGA	-	-	-	1	0.2	\$ 134
-------------------------	------------	---	---	---	---	-----	--------

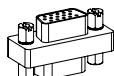
Description

- VGA Port for Undermount Trio Clamp and Trio Bezel Units

RJ45 DATA PORT ACCESSORY	01-LCOMRJ45	-	-	-	1	0.2	\$ 88
--------------------------	-------------	---	---	---	---	-----	-------

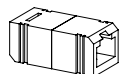
Description

- RJ45 Port for Undermount Trio Clamp and Trio Bezel Units

MARKER AND ERASER SET	01-MRKRSETBL	For Use with Black Glass Magnetic Marker Panels	\$ 136
	01-MRKRSETWH	For Use with White Glass Magnetic Marker Panels	





Description

- 01-MRKRSETWH May Also be Used with Dry Erase Panels
- Includes 4 Markers and an Eraser

RARE EARTH MAGNET SET	01-MAGBL	Black Magnets	\$ 127
	01-MAGWH	White Magnets	

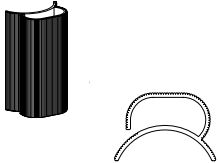
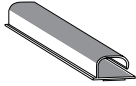
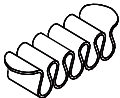
Description

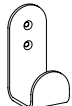
- Includes Set of Five (5) Rare Earth Magnets
- To be Used with Black and White Glass Magnetic Marker Panels
- Comfort Grip with Stylish Protective Plastic Coating

Item	Model No.	W	D	H	Ship Wt	Cubic Ft	List Price
3" WIRE MANAGER FOR ROUND LEGS	01-0302WM	3	2	¾	0.25	0.13	\$ 33
	Description	<ul style="list-style-type: none"> • Black Vinyl Wire Management With Adhesive for Round Leg • Quantity of Three (3) • Attaches with Adhesive Strips • Field Installed 					
WIRE CHANNEL	01-32125	24	1½	1	.25	0.3	\$ 117
	Description	<ul style="list-style-type: none"> • Available in Black • Channel Attaches with Two (2) Double-Sided Installation Tape to Flat Surfaces • Open J Channel for Easy Storage of Cables • Field Installed 					
CABLE GRIP	01-WMGRCB	5%	2%	-	-	-	\$ 19
	Description	<ul style="list-style-type: none"> • Black Under Surface Wire Management • Cable Grip Attaches with Four (4) Screws, Hardware Included • Field Installed 					
BLACK UNDERMOUNT HOOK FOR TABLES	01-HOOK	2	1¾	2½			\$ 88
	Description	<ul style="list-style-type: none"> • Black Hook Includes Mounting Hardware • For Undermount Applications on Tables • Field Installed 					
BLACK HOOK FOR VERTICAL SURFACES	01-ACCHOOKB	2	1¾	2½			\$ 69
	Description	<ul style="list-style-type: none"> • Black Hook Includes Mounting Hardware • For Use on Vertical Surfaces • 20lbs Weight Capacity • Field Installed 					

[See Synergy Overview For Ordering Options](#)

Surface Materials

Veneer Finishes, Laminate Colors + Leg/Wood Finish Options

Our veneer casegoods feature our UV topcoat finish, UVAdvantage. The result is a low-emitting finish that provides exceptional depth, clarity, durability and chemical resistance throughout the life of the product. Refer online for finish and color availability by product series.

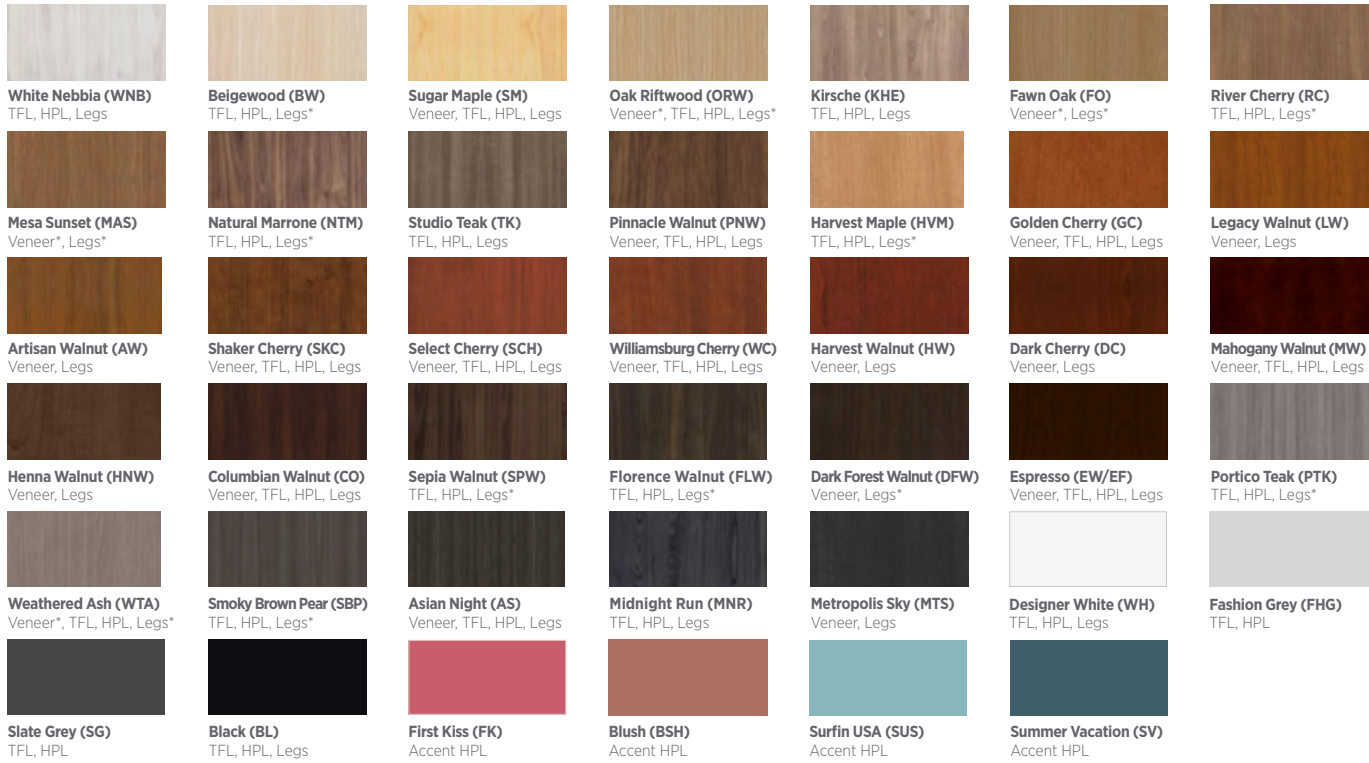

* Veneer/Wood Finish is Low Sheen

Frosted + High Gloss Acrylics



Solid Surfaces



Metal Finishes

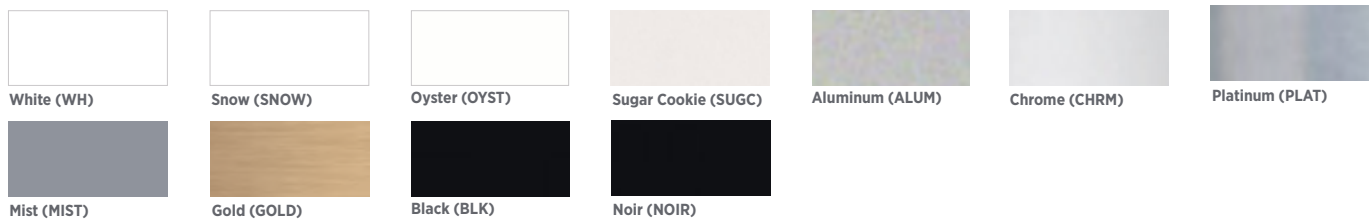

Glass Options

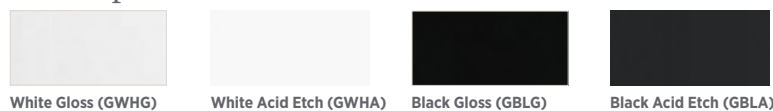

Acoustic/Surround Options



Colors represented are high-resolution reproductions and may vary slightly from the actual product. To order samples, please contact our Customer Service team or order online at indianafurniture.com. Graining and finish colors may vary, yet will continue to complement across Veneer, HPL, TFL and Seating products due to the inherent differences of these materials.

Indiana[®]

FURNITURE

PO Box 270

1919 Hospitality Drive, Suite A
Jasper, Indiana 47547-0270

Tel 812.482.5727

Toll 800.422.5727

Fax 812.482.9035

sales@indianafurniture.com

www.indianafurniture.com

Federal Classification: Small Business

©2026 Indiana Furniture 6/26

