



CANVAS RECEPTION

PRICING EFFECTIVE JUNE 1, 2026

Indiana
FURNITURE

Our Pledge to People + Our Planet.

We've been making wood furniture longer than just about anyone...and we want to be doing so for a long time to come. That's a large part of why we take a stewardship approach to our resources. We believe that environmental sustainability and business profits need not be mutually exclusive. They can and should exist side by side in a mutually beneficial relationship. And for more than a century, we've been showing how it's done.

We've proven our commitment to a sustainable future by supporting the standards and programs that protect our home planet and human health. Whether it's local sourcing, reducing contaminants, implementing wellness and safety programs, or diverting waste from landfills, social responsibility is a part of every decision we make at Indiana Furniture.

One of the surest ways to reduce our impact on the planet is to make and buy things that last. And this one's a natural for us. Our products are made with craftsmanship and attention to detail that are a part of our legacy in wood manufacturing. And our products are backed by our 12-year warranty, which facilitates maintenance, servicing, and reassembly.

100% of our product lines:

- Are manufactured and assembled in the USA,
- Meet or exceed Indoor Air quality standards*,
- Meet or exceed BIFMA level® Sustainability standards and certification*,
- Conform to the BIFMA Compliance standards and certification*,
- Comply with TSCA Title VI (CARB) standards,
- and can contribute to LEED®, Green Globes®, and WELL® Sustainable Programs.



Specification Made Easy.

Whether you're looking to specify your office spaces or simply to visualize them in the options and surface materials you are desiring, we make it easy. You can find the entire Indiana Furniture portfolio on the following third-party, space-planning platforms.



To learn more, simply go to IndianaFurniture.com/resources.

Explore Canvas Reception models, sizes, and premium details to heighten function and luxury for the user, the environment, and all of your visitors. Choose from waterfall transaction counters with paper slots, conventional transaction counters available in a variety of materials, matching or contrasting overlays, backlighting, extended gallery returns with storage, ADA returns, and more!

CONSTRUCTION

Canvas Reception features a TFL chassis with your choice of TFL or HPL Top and TFL, HPL, or Solid Surface transaction counters. Units ship assembled unless otherwise noted.

LAMINATES

- Exposed surfaces are woodgrain and solid color laminates
- Worksurfaces are bonded to the core with a PVA adhesive in a cold press to prevent separation of the laminate from the core
- Each laminate offers lasting beauty, superior resistance to normal wear, and easy maintenance

TOPS

- Worksurfaces are 1" thick thermally-fused laminate (TFL) or High Pressure Laminate (HPL) with 1mm matching PVC rims in a square profile; Designer White, Sugar Maple, Williamsburg Cherry feature ABS edge bands
- Worksurfaces are shaped on all four sides and fit flush with adjoining worksurfaces for a clean aesthetic
- Transaction tops in TFL or HPL are edge-banded and have a self-edge on all sides
- Accent tops of 3/8" glass with 1/4" silver standoffs are available
- Transaction tops in Solid Surface materials are 1/2" thick and available in 6 standard colors

CHASSIS/COMPONENTS

- TFL chassis and storage components
- Worksurfaces, storage components and end panels are securely fastened using high quality European fastening systems, 16-gauge joining brackets and wooden dowels to assure maximum strength
- Exposed edges have matching PVC edge band
- All units are equipped with heavy-duty glides featuring 1 1/4" adjustment to ensure proper leveling and compensation for uneven floors
- All modular components have standard wire openings from inside the pedestal to the kneespace allowing quick access to technology below

DRAWERS

- Drawers feature 5-sided construction allowing for easy removal of drawer fronts
- Drawer fronts are 3-ply, 3/4" thick thermally fused laminate on both faces with matching PVC banded edges
- All drawer sides are 1/2" thick woodgrain vinyl-wrapped construction with mitered corners
- Box and file drawers have 1/8" thick hardboard bottoms and tested for 100lb capacity
- Lateral files feature 1/4" thick bottoms. Drawers are tested for 200lb of equally distributed weight (ex: hanging file folders) and 65lbs of bottom load weight (ex: stacked catalogs)
- All drawers feature full extension, progressive action slides with precision steel ball bearings
- All suspensions have a limited lifetime warranty

FILING

- All file drawers are standard with filing systems designed to accommodate a variety of filing requirements
- Letter width file drawers provide letter filing front to back and legal filing side to side
- Lateral file drawers provide legal or letter filing front to back or side to side

LOCKING

- All units with file drawers feature locking
- Removable lock cylinders allow for units to be re-keyed at a later date, if required
- Units are shipped randomly keyed as standard
- Keyed alike units available upon request at no additional charge
- Lock core will match pull color (if applicable, otherwise specify)

INTERIOR DRAWER DIMENSIONS

Model

66-2415PD1

Drawers

	W	L	D
Box	12 1/8"	16 3/16"	3 1/2"
File	12 1/8"	16 3/16"	9 5/16"

Model

66-2418PD1

Drawers

	W	L	D
Box	14 9/32"	15 1/8"	3 1/2"
File	14 9/32"	15 1/8"	9 5/16"

Model

66-2436LF1

Drawers

	W	L	D
Lat File	32 7/32"	15 1/16"	9 7/32"

Model

66-2430LF1

Drawers

	W	L	D
Lat File	26 7/32"	15 1/16"	9 7/32"

Model

66-2430LF2L

66-2430LF2R

Drawers

	W	L	D
Box	11 5/16"	16 3/16"	3 1/2"
File	12 1/8"	16 3/16"	9 5/16"
Lat File	26 7/32"	15 1/16"	9 1/4"

Model

66-2436LF2L

66-2436LF2R

Drawers

	W	L	D
Box	14 9/32"	15 1/8"	3 1/2"
File	14 9/32"	15 1/8"	9 5/16"
Lat File	32 7/32"	15 1/16"	9 7/32"

Model

66-2415PD2

Drawers

	W	L	D
File	12 1/8"	16 3/16"	9 5/16"

Model

66-2418PD2

Drawers

	W	L	D
File	14 9/32"	15 1/8"	9 5/16"

INTERIOR DRAWER DIMENSIONS (CONTINUED)

Model

66-2436OMF

Drawers	W	L	D
File	14 ⁹ / ₃₂ "	15 ¹ / ₈ "	3 ¹ / ₂ "
Lat File	32 ⁹ / ₃₂ "	15 ¹ / ₈ "	9 ⁷ / ₃₂ "

Model

66-2430OMF

Drawers	W	L	D
Box	11 ⁵ / ₁₆ "	16 ³ / ₁₆ "	3 ¹ / ₂ "
Lat File	26 ⁹ / ₃₂ "	15 ¹ / ₈ "	9 ¹ / ₄ "

Model

64-2595ERSWD2L46 64-2595ERSWD2L41 64-2583ERSWD2L23
64-2595ERSWD2L35 64-2583ERSWD2L34 64-2583ERSWD2L29

Drawers	W	L	D
Box	14 ⁹ / ₃₂ "	15 ¹ / ₈ "	3 ¹ / ₂ "
File	14 ⁹ / ₃₂ "	15 ¹ / ₈ "	9 ⁵ / ₁₆ "

FILING CAPABILITIES

Drawers with Dimensions: 11⁵/₁₆"W x 16³/₁₆"L

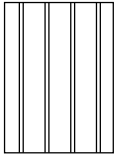

Letter or Legal Side to Side

Drawers with Dimensions: 12¹/₈"W x 16⁵/₃₂"L



Letter Front to Back

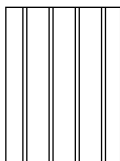

Letter or Legal Side to Side

Drawers with Dimensions: 12¹/₈"W x 16³/₁₆"L

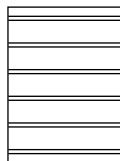

Letter Front to Back

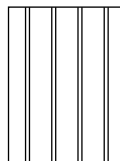

Legal Side to Side

Drawers with Dimensions: 14⁹/₃₂"W x 15¹/₈"L

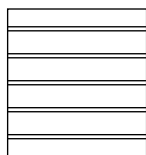

Letter Front to Back

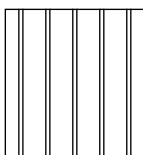

Legal Side to Side

Drawers with Dimensions: 26⁹/₃₂"W x 15¹/₈"L

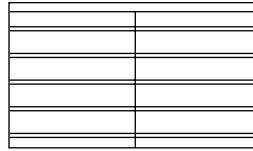

2 Rows Letter Front to Back

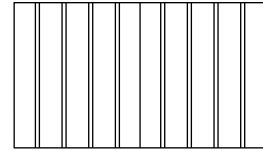

1 Row Legal Side to Side

Drawers with Dimensions: 32⁹/₃₂"W x 15¹/₈"L

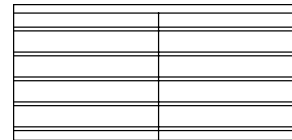

2 Rows Letter Front to Back

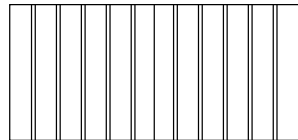

1 Row Legal Side to Side

HOW TO ORDER EXAMPLES

	QTY	MODEL NO.	DESCRIPTION	EXAMPLE
DESK SHELL	1	64-3066RSRL	Color	AS
			Overlay	HGA
			Overlay Color	WHA
			Back Lighting	YES
			Grommet	GL
			Grommet Color	BLK
			PDC Type	CHGSP
			PDC Location	C
			PDC Color	N/A
	RETURN SHELL	1	64-2583ERSWD1R41	Color
			Overlay	NO
			Grommet	GL
			Grommet Color	BLK
			PDC Type	HWDUO-BEZEL
			PDC Location	C
			PDC Color/Circuits	S3
			Door Style	DEB
			Grain Direction	N/A
			Door Lock	YES
		Lock Color	BLK	
PED	2	66-2418PD2	Color	AS
			Drawer Color	AS
			Grain Direction	VERTICAL
			Pull/Color	AAV
			Wire Management	WMLR

TFL (T) AND HPL (P) LAMINATE OPTIONS

WOODGRAIN

AS Asian Night	PNW Pinnacle Walnut
BW Beigewood	PTK Portico Teak
CO Columbian Walnut	RC River Cherry
EF Espresso	SCH Select Cherry
FLW Florence Walnut	SPW Sepia Walnut
GC Golden Cherry	SKC Shaker Cherry
HVM Harvest Maple	SBP Smoky Brown Pear
KHE Kirsche	TK Studio Teak
MW Mahogany Walnut	SM Sugar Maple
MNR Midnight Run	WTA Weathered Ash
NTM Natural Marrone	WNB White Nebbia
ORW Oak Riftwood	WC Williamsburg Cherry

SOLID

BL Black	FHG Fashion Grey
WH Designer White	SG Slate Grey

SOLID SURFACE (S) TRANSACTION COUNTER OPTIONS

AR Arroyo	SNW Snow White
PE Pebble Beach	SN Starry Night
SE Sedona	TN Tundra

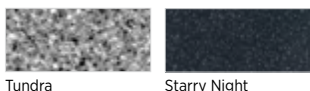
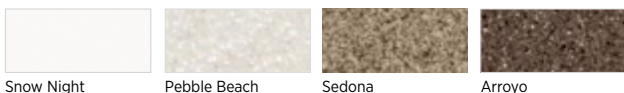

ACRYLIC OVERLAY OPTIONS

FST Frosted	WHA White
BLA Black	WMA Wired Mercury
GPA Graphite	



EDGE PROFILES

CHASSIS/WORKSURFACES/TRANSACTION COUNTERS

H Square

SOLID SURFACE TRANSACTION COUNTERS

S1 Straight



Square

Straight

PULL OPTIONS

Note: Lock Core will match Pull Color

AACE Ace, Aluminum	BBT Bow Tie, Black
BACE Ace, Black	NBT Bow Tie, Nickel
GACE Ace, Gold	AFL Flair, Aluminum
AAV Alcove, Aluminum	CFL Flair, Chrome
BAV Alcove, Black	AQD Quadra, Aluminum
CAV Alcove, Chrome	BQD Quadra, Black
AAC Arc, Aluminum	AST Studio, Aluminum
BAC Arc, Black	BST Studio, Black
ABM Beam, Aluminum	CST Studio, Chrome
BBM Beam, Black	GST Studio, Gold

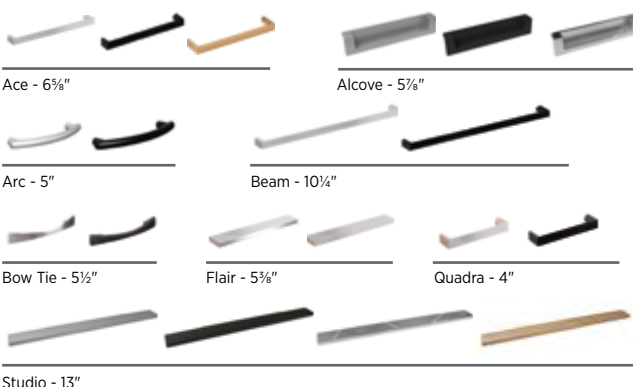

GROMMET OPTIONS & POWER UNIT LOCATIONS

Desk grommets are available in standard locations. Please specify using table below. Multiple unit locations may be selected. Only one unit per location.

Grommets are available on hutches in standard locations for task light management at no additional charge. Please specify HUGRMT.

Multiple locations may be selected. Only one unit per location.

GROMMET LOCATIONS (Black = BLK and Silver = SLV)

GC	Grommet, Center - Specify BLK or SLV	\$	58
GL	Grommet, Left - Specify BLK or SLV	\$	58
GR	Grommet, Right - Specify BLK or SLV	\$	58

DUO/TRIO BEZEL LOCATIONS

PDC-C	Bezel, Center
PDC-L	Bezel, Left
PDC-R	Bezel, Right

See Additional Options on Next Page.

GROMMET OPTIONS & POWER UNIT LOCATIONS CONTINUED

DOCK 950 and DOCK 150 LOCATIONS (See Dock Units)

DOCK950-L	D950 Wireless Charger, Left	\$	294
DOCK950-C	D950 Wireless Charger, Center	\$	294
DOCK950-R	D950 Wireless Charger, Right	\$	294
DOCK150-L	D150 Wireless and USB Charger, Left	\$	448
DOCK150-C	D150 Wireless and USB Charger, Center	\$	448
DOCK150-R	D150 Wireless and USB Charger, Right	\$	448

Verify Grommet Option is available on the model(s) you are specifying using the following location information. Grommets, Power Units, Dock 950 and Dock 150 may be ordered in non-standard locations. Call Customer Service to assist with specification and/or please attach a drawing to the PO showing the location of the grommet. Note additional charges and lead times may apply.

Power Units, Dock 950 and Dock 150 must be specified separately with surface mount location.

GROMMET OPTIONS & POWER UNIT LOCATIONS (CONTINUED)

Models

64-3696RSRL	64-3672RSRL	64-3660ARSRR
64-3696RSRR	64-3672RSRR	64-3654ARSRL
64-3696RS	64-3672RS	64-3654ARSRR
64-3694B46	64-3672ARSRL	64-3648ARSRL
64-3690RSRL	64-3672ARSRR	64-3648ARSRR
64-3690RSRR	64-3666RSRL	64-3642ARSRL
64-3690RS	64-3666RSRR	64-3642ARSRR
64-3688B40	64-3666RS	64-3636ARSRL
64-3684RSRL	64-3666ARSRL	64-3636ARSRR
64-3684RSRR	64-3666ARSRR	64-3630ARSRL
64-3684RS	64-3660RSRL	64-3630ARSRR
64-3678RSRL	64-3660RSRR	
64-3678RSRR	64-3660RS	
64-3678RS	64-3660ARSRL	

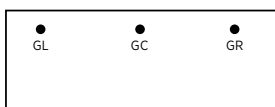

GL/GR/PDC-L/PDC-R/DOCK950-L/DOCK950-R/DOCK150-L/DOCK150-R: Located 6" from ends and 32" from user side
GC/PDC-C/DOCK950-C/DOCK150-C: Located 32" from user side

Models

64-3096RSRL	64-3084RSRL	64-3066RSRL
64-3096RSRR	64-3084RSRR	64-3066RSRR
64-3096RS	64-3084RS	64-3066RS
64-3094B46	64-3078RSRL	64-3060RSRL
64-3090RSRL	64-3078RSRR	64-3060RSRR
64-3090RSRR	64-3078RS	64-3060RSPDC
64-3090RS	64-3072RSRL	64-3060RS
64-3090RS	64-3072RSRR	
64-3088B40	64-3072RS	

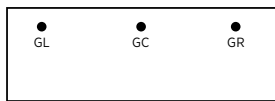

GL/GR/PDC-L/PDC-R/CHGSP-L/CHGSP-R: Located 6" from ends and 26" from user side
GC/PDC-C/CHGSP-C: Located 26" from user side

Models

64-2596RSRL	64-2584RSRR	64-2566RS
64-2596RSRR	64-2583ERSL58	64-2560RSRL
64-2596RS	64-2583ERSR58	64-2560RSRR
64-2595ERSWD2L46	64-2583ERSL53	64-2560RS
64-2595ERSWD2R46	64-2583ERSR53	64-2559ERSL34
64-2595ERSWD2L41	64-2583ERSL47	64-2559ERSR34
64-2595ERSWD2R41	64-2583ERSR47	64-2559ERSL29
64-2595ERSWD2L35	64-2578RSRL	64-2559ERSR29
64-2595ERSWD2R35	64-2578RSRR	64-2559ERSL23
64-2595ERSWD1L58	64-2578RS	64-2559ERSR23
64-2595ERSWD1R58	64-2572RSRL	64-3072ARSRL
64-2595ERSWD1L53	64-2572RSRR	64-3072ARSRR
64-2595ERSWD1R53	64-2572RS	64-3066ARSRL
64-2595ERSWD1L47	64-2571ERSWD1L34	64-3066ARSRR
64-2595ERSWD1R47	64-2571ERSWD1R34	64-3060ARSRL
64-2595ERSL70	64-2571ERSWD1L29	64-3060ARSRR
64-2595ERSR70	64-2571ERSWD1R29	64-3054ARSRL
64-2595ERSL65	64-2571ERSWD1L23	64-3054ARSRR
64-2595ERSR65	64-2571ERSWD1R23	64-3048ARSRL
64-2595ERSL59	64-2571ERSL46	64-3048ARSRR
64-2595ERSR59	64-2571ERSR46	64-3042ARSRL
64-2594B46	64-2571ERSL41	64-3042ARSRR
64-2590RSRL	64-2571ERSR41	64-3036ARSRL
64-2590RSRR	64-2571ERSL35	64-3036ARSRR
64-2590RS	64-2571ERSR35	64-3030ARSRL
64-2588B40	64-2566RSRL	64-3030ARSRR
64-2584RSRL	64-2566RSRR	



GL/GR/PDC-L/PDC-R/CHGSP-L/CHGSP-R: Located 6" from ends and 20" from user side
GC/PDC-C/CHGSP-C: Located 20" from user side

LOCKING DOORS

Locking doors are available. You must specify WITH LOCKING when ordering and add upcharge.

LKT	12"W to 18"W Units	\$	76
LKT	24"W to 42"W Units	\$	101

CERTIFICATIONS & COMPLIANCE

- Intertek Sustainability Certified
- BIFMA level® Certified
- BIFMA Compliant Certified
- TSCA Title VI (formerly CARB) Compliance
- Contributes to LEED®, Green Globes®, and WELL® Sustainable Programs

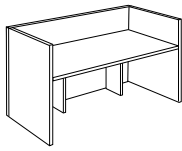

Reception Desk Shell with Gallery Screen
[\(See Details\)](#)

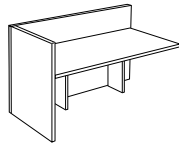

Single Reception Desk Shell with Gallery Screen
[\(See Details\)](#)

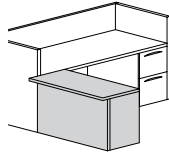

ADA Reception Return Shell
[\(See Details\)](#)

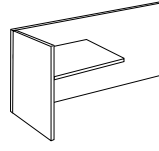

Return Shell with Extended Gallery Screen
[\(See Details\)](#)

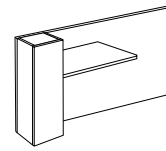

Narrow Tower Storage Return with Extended Gallery Screen
[\(See Details\)](#)

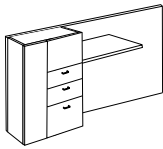

Tower Storage Return with Gallery Screen
[\(See Details\)](#)

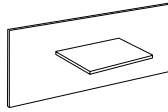

Reception Bridge with Gallery Screen
[\(See Details\)](#)

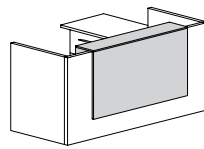

Waterfall Transaction Kits with Paper Slots
[\(See Details\)](#)

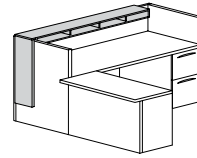

Corner Waterfall Transaction Kits with Paper Slots
[\(See Details\)](#)

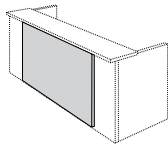

Overlay Panels
TFL [\(See Details\)](#)
High Gloss Acrylic [\(See Details\)](#)
Frosted Acrylic [\(See Details\)](#)

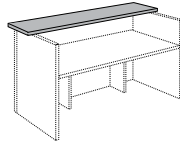

Transaction Top
TFL, HPL, and Solid Surface
[\(See Multiple Unit Details\)](#)

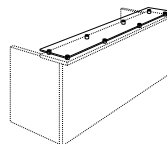

Optional Glass Transaction Top
[\(See Multiple Unit Details\)](#)

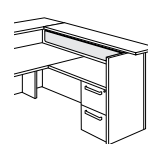

Tackboards for use under Transaction Counters
[\(See Details\)](#)

Modular Component Pedestals



Box/Box/File Pedestal
[\(See Details\)](#)



File/File Pedestal
[\(See Details\)](#)

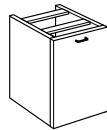

Door Bookcase Pedestal
[\(See Details\)](#)

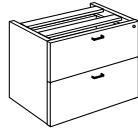

Lateral File Pedestal
[\(See Details\)](#)

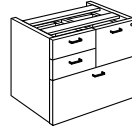

Multi-File Pedestal
[\(See Details\)](#)

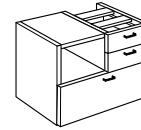

Open Multi-File Pedestal
[\(See Details\)](#)

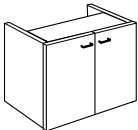

Pedestal with Doors
[\(See Details\)](#)

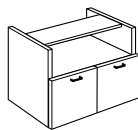

Pedestal with Doors and Open Compartment
[\(See Details\)](#)

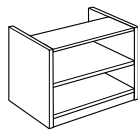

Pedestal Open Storage
[\(See Details\)](#)

Accessories + Power Options

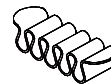
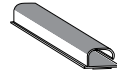
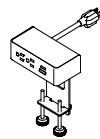
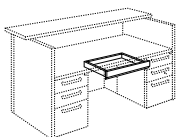

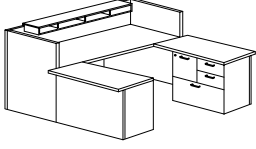
Item	Model No.	Width	Depth	Height	Ship Wt	Cubic Ft	List Price
	64-1	106	97	42	813	199.2	T\$ 10079 P\$ 10945
	CONSIST OF:		QTY				
	64-3096RS	1	Reception Desk Shell with Gallery Screen		T\$ 2454 P\$ 2798		
	64-1284TKS	1	Waterfall Transaction Kit with Paper Slots		T\$ 2117		
	64-3060ARSRL	1	ADA Reception Return Shell - Left		T\$ 1112 P\$ 1373		
	66-2430LF1	1	Modular Pedestal with Lateral File		T\$ 1502		
	64-3060ARSRR	1	ADA Reception Return Shell - Right		T\$ 1112 P\$ 1373		
	66-2430LF2L	1	Modular Pedestal with Multi-File		T\$ 1782		

Products are available as left or right, where applicable

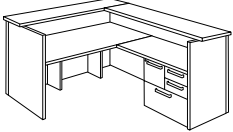
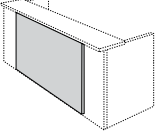
  Optional Overlay	64-2	102	87	42	596	154.6	T\$ 7050 P\$ 8053 Add Optional Glass Top to TFL or HPL Pricing +Glass \$ 3688
	CONSIST OF:		QTY				
	64-3090RSRL	1	Single Reception Desk Shell with Gallery Screen		T\$ 2127 P\$ 2465		
	64-2583ERSR53	1	Return Shell with Extended Gallery Screen		T\$ 1332 P\$ 1547		
	66-2430LF2L	1	Modular Pedestal with Multi-File		T\$ 1782		
	64-1296TP	1	Transaction Top - 99" Wide		T\$ 591 P\$ 827 Add Optional Glass Top to TFL or HPL Pricing +Glass \$ 2066		
	64-1275TP	1	Transaction Top - 75" Wide		T\$ 532 P\$ 746 Add Optional Glass Top to TFL or HPL Pricing +Glass \$ 1622		
	64-OT90	1	Overlay Panel - For Use With 90" Desks		\$ 686 Optional Back Lighting Not Included		

Products are available as left or right, where applicable

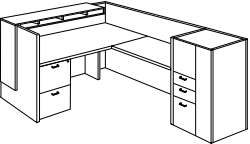
	64-3	96¾	96¾	42	664	161.9	T\$ 8959 P\$ 9487
	CONSIST OF:		QTY				
	64-3096RSRL	1	Single Reception Desk Shell with Gallery Screen		T\$ 2183 P\$ 2529		
	64-1284CTKSL	1	Corner Waterfall Transaction Kit with Paper Slots		T\$ 2248		
	64-2595ERSWD2R41	1	Tower Storage Return with Gallery Screen		T\$ 3176 P\$ 3358		
	66-2418PD2	1	Modular Pedestal with File/File		T\$ 1352		

Products are available as left or right, where applicable

Pricing Codes:
T = TFL P = HPL

[See Canvas Reception Overview for Ordering Options](#)

CANVAS™

LAMINATE RECEPTION + COMPONENTS (6400 SERIES)

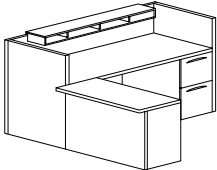
Item	Model No.	Width	Depth	Height	Ship Wt	Cubic Ft	List Price
	64-4	89	96	42	604	139.6	T\$ 8328
							P\$ 8900

CONSIST OF:**QTY**

64-3084RS	1	Single Reception Desk Shell with Gallery Screen	T\$ 2333
			P\$ 2644
64-3060ARSRL	1	ADA Reception Return Shell - Left	T\$ 1112
			P\$ 1373
64-1272TKS	1	Waterfall Transaction Kit with Paper Slots	T\$ 1749
66-2430LF2R	1	Modular Pedestal with Multi-File	T\$ 1782
66-2418PD2	1	Modular Pedestal with File/File	T\$ 1352

Products are available as left or right, where applicable

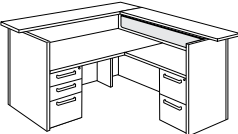
	64-5	78	87	42	559	135.9	T\$ 7056
							P\$ 7993
							Add Optional Glass Top to TFL or HPL Pricing Glass \$ 3244

CONSIST OF:**QTY**

64-3072RSRL	1	Single Reception Desk Shell with Gallery Screen	T\$ 1605
			P\$ 1899
64-2583ERSR53	1	Return Shell with Extended Gallery Screen	T\$ 1332
			P\$ 1547
64-1275TP	2	Transaction Top - 75" Wide	T\$ 1064
			P\$ 1492
		Add Optional Glass Top to TFL or HPL Pricing	+Glass \$ 3244
66-2418PD1	1	Modular Pedestal with Box/Box/File	T\$ 1352
66-2418PD2	1	Modular Pedestal with File/File	T\$ 1352
TB-6272	1	Tackboard (Optional)	G1\$ 283

Products are available as left or right, where applicable

Pricing Codes:

T = TFL P = HPL

[See Canvas Reception Overview for Ordering Options](#)

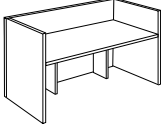
Item	Model No.		Width	Depth	Height	Ship Wt	Cubic Ft	List Price
RECEPTION DESK SHELL WITH GALLERY SCREEN	64-2560RS	58" Worksurface	60	25	41	156	40.0	T\$ 1388
		Kneespace 58"; No Additional Support Needed						P\$ 1629
	64-2566RS	64" Worksurface	66	25	41	167	44.6	T\$ 1500
								P\$ 1742
	64-2572RS	70" Worksurface	72	25	41	177	49.2	T\$ 1560
								P\$ 1817
	64-2578RS	76" Worksurface	78	25	41	188	53.8	T\$ 1630
								P\$ 1893
Must Specify (in this order): Model # Top Material Top Color Chassis Color Overlay Overlay Color Back Lighting Grommet Location Grommet Color PDC Type PDC Location PDC Color	64-2584RS	82" Worksurface	84	25	41	198	58.4	T\$ 1700
								P\$ 1974
	64-2590RS	88" Worksurface	90	25	41	234	75.8	T\$ 1763
								P\$ 2060
	64-2596RS	94" Worksurface	96	25	41	245	80.3	T\$ 1828
								P\$ 2132
	64-3060RS	58" Worksurface	60	30	41	181	48.2	T\$ 1731
								P\$ 1992
	64-3066RS	64" Worksurface	66	30	41	192	57.5	T\$ 1804
								P\$ 2083
	64-3072RS	70" Worksurface	72	30	41	202	62.1	T\$ 1873
								P\$ 2165
	64-3078RS	76" Worksurface	78	30	41	213	66.7	T\$ 2252
								P\$ 2555
	64-3084RS	82" Worksurface	84	30	41	223	71.3	T\$ 2333
								P\$ 2644
	64-3090RS	88" Worksurface	90	30	41	234	75.8	T\$ 2392
								P\$ 2730
	64-3096RS	94" Worksurface	96	30	41	245	80.3	T\$ 2454
								P\$ 2798
	64-3660RS	58" Worksurface	60	36	41	203	57.3	T\$ 1944
								P\$ 2230
	64-3666RS	64" Worksurface	66	36	41	214	62.8	T\$ 2018
								P\$ 2318
	64-3672RS	70" Worksurface	72	36	41	226	68.3	T\$ 2097
								P\$ 2411
	64-3678RS	76" Worksurface	78	36	41	237	73.8	T\$ 2461
								P\$ 2781
	64-3684RS	82" Worksurface	84	36	41	249	79.3	T\$ 2536
								P\$ 2865
	64-3690RS	88" Worksurface	90	36	41	261	84.8	T\$ 2597
								P\$ 2957
	64-3696RS	94" Worksurface	96	36	41	272	90.3	T\$ 2672
								P\$ 3039

Description

- Horizontal Woodgrain on Chassis; Side-to-Side Woodgrain on Top
- Available with TFL (T) or HPL (P) Top; Must Specify
- Top and Chassis Available in Contrasting Colors; Must Specify Color of Each Component
- Stiffener Bar Recommended in Kneespaces 60" or Greater When Unsupported By Pedestal, [See Stiffener Bar](#)
- Optional Overlay Panel for Approach Side of Gallery Screen, [See Overlay Options](#)
- Additional Options: Waterfall Transaction Kit ([See Kit Options](#)), TFL, HPL, or Solid Surface Transaction Tops ([See Multiple Unit Details](#)), Power Options (Sold Separately, [See Accessories](#))

Pricing Codes:

T = TFL P = HPL

[See Canvas Reception Overview for Ordering Options](#)

Item	Model No.	Width	Depth	Height	Ship Wt	Cubic Ft	List Price	
SINGLE RECEPTION DESK SHELL WITH GALLERY SCREEN	LEFT	RIGHT						
	64-2560RSRL	64-2560RSRR	60	25	41	123	T\$ 1152	
	58" Worksurface, Kneespace 58"; No Additional Support Needed							P\$ 1389
	64-2566RSRL	64-2566RSRR	66	25	41	133	T\$ 1260	
	64" Worksurface							P\$ 1504
	64-2572RSRL	64-2572RSRR	72	25	41	143	T\$ 1319	
	70" Worksurface							P\$ 1575
	64-2578RSRL	64-2578RSRR	78	25	41	153	T\$ 1385	
	76" Worksurface							P\$ 1650
	64-2584RSRL	64-2584RSRR	84	25	41	163	T\$ 1451	
	82" Worksurface							P\$ 1726
	64-2590RSRL	64-2590RSRR	90	25	41	174	T\$ 1518	
	88" Worksurface							P\$ 1815
	64-2596RSRL	64-2596RSRR	96	25	41	184	T\$ 1584	
	94" Worksurface							P\$ 1888
	64-3060RSRL	64-3060RSRR	60	30	41	144	T\$ 1468	
	58" Worksurface							P\$ 1729
	64-3066RSRL	64-3066RSRR	66	30	41	155	T\$ 1539	
	64" Worksurface							P\$ 1818
	64-3072RSRL	64-3072RSRR	72	30	41	165	T\$ 1605	
	70" Worksurface							P\$ 1899
	64-3078RSRL	64-3078RSRR	78	30	41	176	T\$ 1985	
	76" Worksurface							P\$ 2288
	64-3084RSRL	64-3084RSRR	84	30	41	186	T\$ 2063	
	82" Worksurface							P\$ 2374
	64-3090RSRL	64-3090RSRR	90	30	41	196	T\$ 2127	
	88" Worksurface							P\$ 2465
	64-3096RSRL	64-3096RSRR	96	30	41	206	T\$ 2183	
	94" Worksurface							P\$ 2529
	64-3660RSRL	64-3660RSRR	60	36	41	179	T\$ 1653	
	58" Worksurface							P\$ 1940
	64-3666RSRL	64-3666RSRR	66	36	41	190	T\$ 1724	
	64" Worksurface							P\$ 2023
	64-3672RSRL	64-3672RSRR	72	36	41	201	T\$ 1806	
	70" Worksurface							P\$ 2121
	64-3678RSRL	64-3678RSRR	78	36	41	291	T\$ 2166	
	76" Worksurface							P\$ 2486
	64-3684RSRL	64-3684RSRR	84	36	41	303	T\$ 2242	
	82" Worksurface							P\$ 2573
	64-3690RSRL	64-3690RSRR	90	36	41	315	T\$ 2300	
	88" Worksurface							P\$ 2660
	64-3696RSRL	64-3696RSRR	96	36	41	326	T\$ 2355	
	94" Worksurface							P\$ 2722

Desk Shell Shaded
(Shown as Left)

Must Specify (in this order):

Model #
Top Material
Top Color
Chassis Color
Overlay
Overlay Color
Back Lighting
Grommet Location
Grommet Color
PDC Type
PDC Location
PDC Color

Description

- Horizontal Woodgrain on Chassis; Side-to-Side Woodgrain on Top
- Available with TFL (T) or HPL (P) Top; Must Specify
- Top and Chassis Available in Contrasting Colors; Must Specify Color of Each Component
- Stiffener Bar Recommended in Kneespaces 60" or Greater When Surface is Not Supported By Pedestal, [See Stiffener Bar](#)
- Not for Freestanding, Must Attach to Return or Bridge Components
- Optional Overlay Panel for Approach Side of Gallery Screen, [See Overlay Options](#)
- Additional Options: Waterfall Transaction Kit ([See Kit Options](#)), TFL, HPL, or Solid Surface Transaction Tops ([See Multiple Unit Details](#)), Power Options (Sold Separately, [See Accessories](#))

Pricing Codes:

T = TFL P = HPL

[See Canvas Reception Overview for Ordering Options](#)

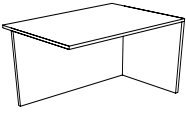
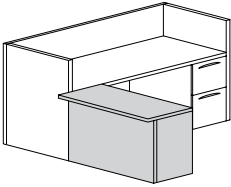
Item	Model No.	Width	Depth	Height	Ship Wt	Cubic Ft	List Price	
ADA RECEPTION RETURN SHELL	LEFT	RIGHT						
	64-3030ARSRL	64-3030ARSRR	30	30	30	62	19.0	T\$ 819 P\$ 995
	64-3036ARSRL	64-3036ARSRR	36	30	30	71	22.5	T\$ 864 P\$ 1048
	64-3042ARSRL	64-3042ARSRR	42	30	30	80	26.0	T\$ 929 P\$ 1137
Shown as Right	64-3048ARSRL	64-3048ARSRR	48	30	30	89	29.5	T\$ 990 P\$ 1218
	64-3054ARSRL	64-3054ARSRR	54	30	30	98	33.0	T\$ 1051 P\$ 1296
	64-3060ARSRL	64-3060ARSRR	60	30	30	107	36.5	T\$ 1112 P\$ 1373
	64-3066ARSRL	64-3066ARSRR	66	30	30	116	40.0	T\$ 1178 P\$ 1456
Return Shell Shaded (Shown as Left)	64-3072ARSRL	64-3072ARSRR	72	30	30	125	43.6	T\$ 1281 P\$ 1575
	64-3630ARSRL	64-3630ARSRR	30	36	30	71	22.5	T\$ 886 P\$ 1070
Must Specify (in this order): Model # Top Material Top Color Chassis Color Grommet Location Grommet Color PDC Type PDC Location PDC Color	64-3636ARSRL	64-3636ARSRR	36	36	30	81	26.7	T\$ 950 P\$ 1153
	64-3642ARSRL	64-3642ARSRR	42	36	30	92	30.9	T\$ 1014 P\$ 1237
	64-3648ARSRL	64-3648ARSRR	48	36	30	92	30.9	T\$ 1084 P\$ 1325
	64-3654ARSRL	64-3654ARSRR	54	36	30	113	39.5	T\$ 1146 P\$ 1410
	64-3660ARSRL	64-3660ARSRR	60	36	30	123	43.5	T\$ 1219 P\$ 1507
	64-3666ARSRL	64-3666ARSRR	66	36	30	134	47.7	T\$ 1276 P\$ 1575
	64-3672ARSRL	64-3672ARSRR	72	36	30	144	51.9	T\$ 1332 P\$ 1646

Description

- Horizontal Woodgrain on Chassis; Side-to-Side Woodgrain on Top
- Available with TFL (T) or HPL (P) Top; Must Specify
- Top and Chassis Available in Contrasting Colors; Must Specify Color of Each Component
- Stiffener Bar Recommended in Kneespaces 60" or Greater When Unsupported By Pedestal, [See Stiffener Bar](#)
- 5" Overhang on Approach Side
- Must Attach to Reception Desk Shell or Panel End of Single Reception Desk Shell

Pricing Codes:

T = TFL P = HPL

[See Canvas Reception Overview for Ordering Options](#)

Item	Model No.	Width	Depth	Height	Ship Wt	Cubic Ft	List Price
RETURN SHELL WITH EXTENDED GALLERY SCREEN	LEFT	RIGHT					
	64-2559ERSL23	64-2559ERSR23	59	25	41	107	T\$ 1069 P\$ 1217
	23" Worksurface; To Connect to 36" Deep Single Desk Shell						
	64-2559ERSL29	64-2559ERSR29	59	25	41	109	T\$ 1088 P\$ 1243
	29" Worksurface; To Connect to 30" Deep Single Desk Shell						
	64-2559ERSL34	64-2559ERSR34	59	25	41	112	T\$ 1106 P\$ 1266
	34" Worksurface; To Connect to 25" Deep Single Desk Shell						
	64-2571ERSL35	64-2571ERSR35	71	25	41	127	T\$ 1212 P\$ 1372
	35" Worksurface; To Connect to 36" Deep Single Desk Shell						
	64-2571ERSL41	64-2571ERSR41	71	25	41	129	T\$ 1235 P\$ 1416
	41" Worksurface; To Connect to 30" Deep Single Desk Shell						
	64-2571ERSL46	64-2571ERSR46	71	25	41	131	T\$ 1252 P\$ 1453
	46" Worksurface; To Connect to 25" Deep Single Desk Shell						
	64-2583ERSL47	64-2583ERSR47	83	25	41	148	T\$ 1311 P\$ 1513
	47" Worksurface; To Connect to 36" Deep Single Desk Shell						
	64-2583ERSL53	64-2583ERSR53	83	25	41	151	T\$ 1332 P\$ 1547
	53" Worksurface; To Connect to 30" Deep Single Desk Shell						
	64-2583ERSL58	64-2583ERSR58	83	25	41	154	T\$ 1350 P\$ 1589
	58" Worksurface; To Connect to 25" Deep Single Desk Shell						
	64-2595ERSL59	64-2595ERSR59	95	25	41	172	T\$ 1411 P\$ 1650
	59" Worksurface; To Connect to 36" Deep Single Desk Shell						
	64-2595ERSL65	64-2595ERSR65	95	25	41	174	T\$ 1427 P\$ 1670
	65" Worksurface; To Connect to 30" Deep Single Desk Shell						
	64-2595ERSL70	64-2595ERSR70	95	25	41	176	T\$ 1445 P\$ 1701
	70" Worksurface; To Connect to 25" Deep Single Desk Shell						

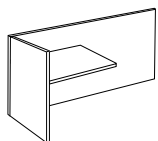

Shown as Left

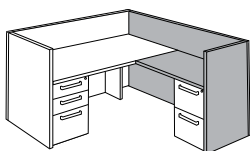

Return Shell Shaded (Shown as Right)

Must Specify (in this order):

- Model #
- Top Material
- Top Color
- Chassis Color
- Overlay
- Overlay Color
- Overlay Back Lighting
- Grommet Location
- Grommet Color
- PDC Type
- PDC Location
- PDC Color

Description

- Horizontal Woodgrain on Chassis; Front to Back Woodgrain on Top
- Top and Chassis Available in Contrasting Colors; Must Specify Color of Each Component
- Available with TFL (T) or HPL (P) Top; Must Specify
- 24" Deep Worksurfaces
- Side-to-Side Woodgrain on Top over 60"
- Stiffener Bar Recommended in Kneespaces 60" or Greater When Unsupported By Pedestal, [See Stiffener Bar](#)
- Optional Overlay Panel for Approach Side of Gallery Screen, [See Overlay Options](#)
- Additional Options: Waterfall Transaction Kit ([See Kit Options](#)), TFL, HPL, or Solid Surface Transaction Tops ([See Multiple Unit Details](#)), Power Options (Sold Separately, [See Accessories](#))

Pricing Codes:
T = TFL P = HPL

[See Canvas Reception Overview for Ordering Options](#)

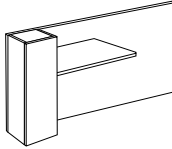
Item	Model No.	Width	Depth	Height	Ship Wt	Cubic Ft	List Price
NARROW TOWER STORAGE RETURN WITH EXTENDED GALLERY SCREEN  Shown as Left Must Specify (in this order): Model # Top Material Top Color Chassis Color Overlay Overlay Color Overlay Back Lighting Grommet Location Grommet Color PDC Type PDC Location PDC Color Door Style/Color Door Grain Direction Locking Door Lock Core Color	LEFT	RIGHT					
	64-2571ERSWD1L23	64-2571ERSWD1R23	71	25	41	161	T\$ 1866
	23" Worksurface; To Connect to 36" Deep Single Desk Shell						P\$ 2015
	64-2571ERSWD1L29	64-2571ERSWD1R29	71	25	41	164	T\$ 1886
	29" Worksurface; To Connect to 30" Deep Single Desk Shell						P\$ 2042
	64-2571ERSWD1L34	64-2571ERSWD1R34	71	25	41	167	T\$ 1906
	34" Worksurface; To Connect to 25" Deep Single Desk Shell						P\$ 2065
	64-2583ERSWD1L35	64-2583ERSWD1R35	83	25	41	181	T\$ 1968
	35" Worksurface; To Connect to 36" Deep Single Desk Shell						P\$ 2128
	64-2583ERSWD1L41	64-2583ERSWD1R41	83	25	41	184	T\$ 1987
	41" Worksurface; To Connect to 30" Deep Single Desk Shell						P\$ 2169
	64-2583ERSWD1L46	64-2583ERSWD1R46	83	25	41	188	T\$ 2007
	46" Worksurface; To Connect to 25" Deep Single Desk Shell						P\$ 2207
	64-2595ERSWD1L47	64-2595ERSWD1R47	95	25	41	201	T\$ 2067
47" Worksurface; To Connect to 36" Deep Single Desk Shell						P\$ 2269	
64-2595ERSWD1L53	64-2595ERSWD1R53	95	25	41	204	T\$ 2090	
53" Worksurface; To Connect to 30" Deep Single Desk Shell						P\$ 2304	
64-2595ERSWD1L58	64-2595ERSWD1R58	95	25	41	208	T\$ 2106	
58" Worksurface; To Connect to 25" Deep Single Desk Shell						P\$ 2345	

Description

- Standard with Horizontal Woodgrain on Chassis; Front to Back Woodgrain on Worksurface Top; Vertical Woodgrain on Door Fronts
- Worksurface Top and Chassis Available in Contrasting Colors; Must Specify Color of Each Component
- Available with TFL (T) or HPL (P) Worksurface Top; Must Specify
- Worksurface Top Flush with Storage Cabinet Door Front
- 12" Wide Tower Features Touch Latch Door, Coat Rod, and Two (2) Adjustable Shelves Behind Door
- For Use with Single Reception Desk Shell
- Door Options: Dry Erase (See below), High Gloss Acrylic (See Below), Panel Door with Horizontal Grain Direction on Door Front ([See Color Options](#)); Must Specify
- Optional Locking Door ([See Options](#)); Must Specify and Add
- Optional Overlay Panel for Approach Side of Gallery Screen, [See Overlay Options](#)
- Additional Options: Waterfall Transaction Kit ([See Kit Options](#)), TFL, HPL, or Solid Surface Transaction Tops ([See Multiple Unit Details](#)), Power Options (Sold Separately, [See Accessories](#))

Door Options: Specify & Add

1-DEB	Dry Erase Board	\$ 135
1-HGA	High Gloss Acrylic; Must Specify Color	
	GPA Graphite Acrylic	\$ 512
	BLA Black, Wired Mercury or White Acrylic	\$ 463

Pricing Codes:

T = TFL P = HPL

[See Canvas Reception Overview for Ordering Options](#)

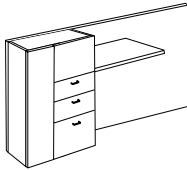
Item	Model No.	Width	Depth	Height	Ship Wt	Cubic Ft	List Price	
TOWER STORAGE RETURN WITH GALLERY SCREEN  Shown as Left <u>Must Specify (in this order):</u> Model # Top Material Top Color Chassis Color Overlay Overlay Color Overlay Back Lighting Drawer Pull Door/Drawer Color Door/Drawer Grain Direction Locking Door Lock Core Color Grommet Location Grommet Color PDC Type PDC Location PDC Color	LEFT	RIGHT						
	64-2583ERSWD2L23	64-2583ERSWD2R23	83	25	41	230	T\$ 3058	
	23" Worksurface; To Connect to 36" Deep Single Desk Shell							P\$ 3208
	64-2583ERSWD2L29	64-2583ERSWD2R29	83	25	41	234	T\$ 3078	
	29" Worksurface; To Connect to 30" Deep Single Desk Shell							P\$ 3232
	64-2583ERSWD2L34	64-2583ERSWD2R34	83	25	41	238	T\$ 3095	
	34" Worksurface; To Connect to 25" Deep Single Desk Shell							P\$ 3255
	64-2595ERSWD2L35	64-2595ERSWD2R35	95	25	41	251	T\$ 3153	
	35" Worksurface; To Connect to 36" Deep Single Desk Shell							P\$ 3315
	64-2595ERSWD2L41	64-2595ERSWD2R41	95	25	41	254	T\$ 3176	
41" Worksurface; To Connect to 30" Deep Single Desk Shell							P\$ 3358	
64-2595ERSWD2L46	64-2595ERSWD2R46	95	25	41	258	T\$ 3193		
46" Worksurface; To Connect to 25" Deep Single Desk Shell							P\$ 3395	

Description

- Standard with Horizontal Woodgrain on Chassis; Front to Back Woodgrain on Worksurface Top; Vertical Woodgrain on Door Fronts
- Worksurface Top and Chassis Available in Contrasting Colors; Must Specify Color of Each Component
- Must Select Drawer Pull Options, [See Pull Options](#)
- Worksurface Top Flush with Storage Cabinet Door Front
- Tower Features Touch Latch Door and 6 $\frac{7}{8}$ " Coat Rod
- Box/Box/File Locking Pedestal Provides Legal or Letter Filing
- For Use With Single Reception Desk Shell
- Optional Horizontal Grain Direction on Door and Drawer Fronts; Must Specify
- Optional Locking Doors ([See Options](#)); Must Specify and Add
- Optional Overlay Panel for Approach Side of Gallery Screen, [See Overlay Options](#)
- Additional Options: Waterfall Transaction Kit ([See Kit Options](#)), TFL, HPL, or Solid Surface Transaction Tops ([See Multiple Unit Details](#)), Power Options (Sold Separately, [See Accessories](#))

Pricing Codes:

T = TFL P = HPL

[See Canvas Reception Overview for Ordering Options](#)

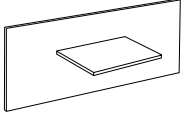
Item	Model No.		Width	Depth	Height	Ship Wt	Cubic Ft	List Price
RECEPTION BRIDGE WITH GALLERY SCREEN 	64-2588B40	40" Worksurface	90	25	41	116	10.9	T\$ 1100 P\$ 1283
	64-2594B46	46" Worksurface	96	25	41	126	11.7	T\$ 1145 P\$ 1346
	64-3088B40	40" Worksurface	90	30	41	121	10.9	T\$ 1124 P\$ 1332
	64-3094B46	46" Worksurface	96	30	41	132	11.7	T\$ 1173 P\$ 1401
	64-3688B40	40" Worksurface	90	36	41	127	10.9	T\$ 1152 P\$ 1374
	64-3694B46	46" Worksurface	96	36	41	139	11.7	T\$ 1203 P\$ 1445

Must Specify (in this order):

Model #
 Top Material
 Top Color
 Chassis Color
 Overlay
 Overlay Color
 Overlay Back Lighting
 Grommet Location
 Grommet Color
 PDC Type
 PDC Location
 PDC Color

Description

- For Use With Two 25" Deep Single Reception Desk Shells; Must Attach to Open End of Shells
- Cannot Be Used with 30" or 36" Reception Desk Shells
- Available with TFL (T) or HPL (P) Worksurface Top; Must Specify
- Worksurface Top and Chassis Available in Contrasting Colors; Must Specify Color of Each Component
- Optional Overlay Panel for Approach Side of Gallery Screen, [See Overlay Options](#)
- Some Assembly Required
- Additional Options: Waterfall Transaction Kit ([See Kit Options](#)), TFL, HPL, or Solid Surface Transaction Tops ([See Multiple Unit Details](#)), Power Options (Sold Separately, [See Accessories](#))

Pricing Codes:

T = TFL P = HPL

[See Canvas Reception Overview for Ordering Options](#)

Item	Model No.	Width	Depth	Height	Ship Wt	Cubic Ft	List Price
MODULAR PEDESTAL WITH BOX/BOX/FILE	66-2415PD1	15¾	23¾	28¾	98	8.9	T\$ 1281
	66-2418PD1	18	23¾	28¾	93	7.8	T\$ 1352



Must Specify (in this order):

- Model #
- Chassis Color
- Drawer Front Color
- Drawer Front Grain Direction
- Pull
- Wire Management

Description

- Box/Box/File Locking Modular Pedestal; Letter Width
- For Use With Desk and Return Shells
- Open Back
- Grain Runs Vertical on Drawer Fronts. Optional Horizontal Grain Direction on Drawer Fronts; Must Specify

Options: Specify & Add

WML	Wire Management - Left Panel	\$ 58
WMR	Wire Management - Right Panel	\$ 58
WMLR	Wire Management - Left and Right Panel	\$ 116

MODULAR PEDESTAL WITH FILE/FILE	66-2415PD2	15¾	23¾	28¾	98	8.9	T\$ 1281
	66-2418PD2	18	23¾	28¾	93	7.8	T\$ 1352



Must Specify (in this order):

- Model #
- Chassis Color
- Drawer Front Color
- Drawer Front Grain Direction
- Pull
- Wire Management

Description

- File/File Locking Modular Pedestal; Letter Width
- For Use With Desk and Return Shells
- Open Back
- Grain Runs Vertical on Drawer Fronts. Optional Horizontal Grain Direction on Drawer Fronts; Must Specify

Options: Specify & Add

WML	Wire Management - Left Panel	\$ 58
WMR	Wire Management - Right Panel	\$ 58
WMLR	Wire Management - Left and Right Panel	\$ 116

MODULAR PEDESTAL WITH DOOR BOOKCASE	Left	Right	Width	Depth	Height	Ship Wt	Cubic Ft	List Price
	66-2418PD4L	66-2418PD4R						

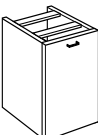

Must Specify (in this order):

- Model #
- Chassis Color
- Drawer Front Color
- Drawer Front Grain Direction
- Pull
- Wire Management

Description

- Adjustable Shelf Inside Cabinet
- For Use With Desk and Return Shells
- Open Back
- Grain Runs Vertical on Door Front. Optional Horizontal Grain Direction on Door Fronts; Must Specify
- Optional Locking Doors ([See Options](#)); [Must Specify](#) and Add

Options: Specify & Add

WML	Wire Management - Left Panel	\$ 58
WMR	Wire Management - Right Panel	\$ 58
WMLR	Wire Management - Left and Right Panel	\$ 116

Pricing Codes:

T = TFL P = HPL

[See Canvas Reception Overview for Ordering Options](#)

Item	Model No.	Width	Depth	Height	Ship Wt	Cubic Ft	List Price
MODULAR PEDESTAL WITH LATERAL FILE	66-2430LF1	30	23¼	28¼	128	14.9	T\$ 1502
	66-2436LF1	36	23¼	28¼	154	18.5	T\$ 1615

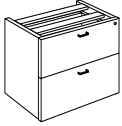

Must Specify (in this order):
 Model #
 Chassis Color
 Drawer Front Color
 Drawer Front Grain Direction
 Pull
 Wire Management

Description

- Lateral/Lateral Locking Modular Pedestal
- For Use With Desk and Return Shells
- Open Back
- Legal or Letter Filing Front to Back or Side to Side
- Grain Runs Vertical on Drawer Fronts. Optional Horizontal Grain Direction on Drawer Fronts; Must Specify

Options: Specify & Add

WML	Wire Management - Left Panel	\$ 58
WMR	Wire Management - Right Panel	\$ 58
WMLR	Wire Management - Left and Right Panel	\$ 116

MODULAR PEDESTAL WITH MULTI-FILE	Left	Right	Width	Depth	Height	Ship Wt	Cubic Ft	List Price
	66-2430LF2L	66-2430LF2R	30	23¼	28¼	128	14.9	T\$ 1782
66-2436LF2L	66-2436LF2R	36	23¼	28¼	153	18.5	T\$ 1854	

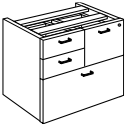

Must Specify (in this order):
 Model #
 Chassis Color
 Drawer Front Color
 Drawer Front Grain Direction
 Pull
 Wire Management

Description

- Box/Box/File/Lateral Locking Modular Pedestal
- For Use With Desk and Return Shells
- Open Back
- Lateral File Drawer Provides Legal or Letter Filing Front to Back or Side to Side
- Grain Runs Vertical on Drawer Fronts. Optional Horizontal Grain Direction on Drawer Fronts; Must Specify

Options: Specify & Add

WML	Wire Management - Left Panel	\$ 58
WMR	Wire Management - Right Panel	\$ 58
WMLR	Wire Management - Left and Right Panel	\$ 116

MODULAR PEDESTAL WITH OPEN MULTI-FILE	66-2430OMF	30	23¼	28¼	118	14.9	T\$ 1708
	66-2436OMF	36	23¼	28¼	128	18.5	T\$ 1780

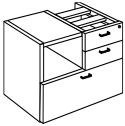

Must Specify (in this order):
 Model #
 Chassis Color
 Drawer Front Color
 Drawer Front Grain Direction
 Pull
 Wire Management

Description

- Box/Box/Lateral Locking Modular Pedestal
- Upper Section Provides 12¾" Clearance for Open Storage
- For Use With Desk and Return Shells
- Open Back
- Lateral File Drawer Provides Legal or Letter Filing Front to Back or Side to Side
- Grain Runs Vertical on Drawer Fronts. Optional Horizontal Grain Direction on Drawer Fronts; Must Specify

Options: Specify & Add

WML	Wire Management - Left Panel	\$ 58
WMR	Wire Management - Right Panel	\$ 58
WMLR	Wire Management - Left and Right Panel	\$ 116

Pricing Codes:
 T = TFL P = HPL

[See Canvas Reception Overview for Ordering Options](#)

Item	Model No.	Width	Depth	Height	Ship Wt	Cubic Ft	List Price
MODULAR PEDESTAL WITH DOORS	66-2430DB	30	23¼	28¼	87	14.9	T\$ 1211
	66-2436DB	36	23¼	28¼	105	18.5	T\$ 1532

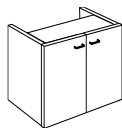

Must Specify (in this order):

Model #
Chassis Color
Drawer Front Color
Drawer Front Grain Direction
Pull
Wire Management

Description

- 12" Deep Adjustable Shelf Behind Doors
- For Use With Desk and Return Shells
- Open Back
- Grain Runs Vertical on Door Fronts. Optional Horizontal Grain Direction on Door Fronts; Must Specify
- Optional Locking Doors ([See Options](#)); Must Specify and Add

Options: Specify & Add

WML	Wire Management - Left Panel	\$ 58
WMR	Wire Management - Right Panel	\$ 58
WMLR	Wire Management - Left and Right Panel	\$ 116

MODULAR PEDESTAL WITH DOORS AND OPEN COMPARTMENT	66-2430ODB	30	23¼	28¼	108	14.9	T\$ 1119
	66-2436ODB	36	23¼	28¼	118	18.5	T\$ 1447

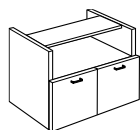

Must Specify (in this order):

Model #
Chassis Color
Drawer Front Color
Drawer Front Grain Direction
Pull
Wire Management

Description

- Upper Section Provides 12¾" Clearance for Open Storage
- Lower Section Provides Storage Behind Two (2) Doors
- For Use With Desk and Return Shells
- Open Back
- Grain Runs Vertical on Door Fronts. Optional Horizontal Grain Direction on Door Fronts; Must Specify
- Optional Locking Doors ([See Options](#)); Must Specify and Add

Options: Specify & Add

WML	Wire Management - Left Panel	\$ 58
WMR	Wire Management - Right Panel	\$ 58
WMLR	Wire Management - Left and Right Panel	\$ 116

MODULAR PEDESTAL WITH OPEN STORAGE	66-2430MBC	30	22 ¹⁵ / ₃₂	28¼	108	14.9	T\$ 1062
	66-2436MBC	36	22 ¹⁵ / ₃₂	28¼	118	18.5	T\$ 1252

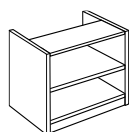

Must Specify (in this order):

Model #
Chassis Color
Wire Management

Description

- For Use With Desk and Return Shells
- Open Back
- One (1) Adjustable Shelf

Options: Specify & Add

WML	Wire Management - Left Panel	\$ 58
WMR	Wire Management - Right Panel	\$ 58
WMLR	Wire Management - Left and Right Panel	\$ 116

Pricing Codes:

T = TFL P = HPL

[See Canvas Reception Overview for Ordering Options](#)

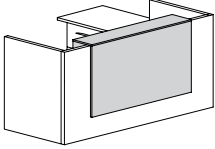
Item	Model No.	Width	Depth	Height	Ship Wt	Cubic Ft	List Price
WATERFALL TRANSACTION KIT WITH PAPER SLOTS 	64-1224TKS Two Slots	24	12	38	29	5.1	T\$ 1262
	64-1230TKS Two Slots	30	12	38	36	6.2	T\$ 1315
	64-1236TKS Two Slots	36	12	38	43	7.3	T\$ 1367
	64-1242TKS Two Slots	42	12	38	50	8.4	T\$ 1476
	64-1248TKS Three Slots; For Use With 60" Gallery	48	12	38	57	9.5	T\$ 1532
	64-1254TKS Three Slots; For Use With 66" Gallery	54	12	38	64	10.6	T\$ 1586
	64-1260TKS Four Slots; For Use With 72" Gallery	60	12	38	71	11.7	T\$ 1645
	64-1266TKS Four Slots; For Use With 78" Gallery	66	12	38	78	12.8	T\$ 1696
	64-1272TKS Four Slots; For Use With 84" Gallery	72	12	38	85	13.9	T\$ 1749
	64-1278TKS Four Slots; For Use With 90" Gallery	78	12	38	91	15.0	T\$ 2060
	64-1284TKS Five Slots; For Use With 96" Gallery	84	12	38	98	16.1	T\$ 2117

Must Specify (in this order):

Model #
Color
Paper Slot Divider Color
Support Bracket Color

Description

- Two (2) Support Brackets Included; Must Specify: Black (BLK) or Silver (SLV)
- Paper Slot Divider; Must Specify Color: Chrome or Laminate in Matching or Contrasting Color
- Some Assembly Required

Pricing Codes:

T = TFL P = HPL

[See Canvas Reception Overview for Ordering Options](#)

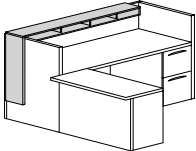
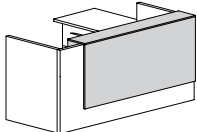
Item	Model No.	Width	Depth	Height	Ship Wt	Cubic Ft	List Price	
CORNER WATERFALL TRANSACTION KIT WITH PAPER SLOTS  Shown as Left  Must Specify (in this order): Model # Color Paper Slot Divider Color Support Bracket Color	Left	Right						
	64-1224CTKSL	64-1224CTKSR	24	12	38	37	5.1	T\$ 1385
	Two Slots							
	64-1230CTKSL	64-1230CTKSR	30	12	38	44	6.2	T\$ 1441
	Two Slots							
	64-1236CTKSL	64-1236CTKSR	36	12	38	51	7.3	T\$ 1492
	Two Slots							
	64-1242CTKSL	64-1242CTKSR	42	12	38	58	8.4	T\$ 1600
	Two Slots							
	64-1248CTKSL	64-1248CTKSR	48	12	38	65	9.5	T\$ 1661
	Three Slots							
	64-1254CTKSL	64-1254CTKSR	54	12	38	71	10.6	T\$ 1712
	Three Slots; For Use With 60" Gallery							
64-1260CTKSL	64-1260CTKSR	60	12	38	78	11.7	T\$ 1773	
Four Slots; For Use With 66" Gallery								
64-1266CTKSL	64-1266CTKSR	66	12	38	85	12.8	T\$ 1827	
Four Slots; For Use With 72" Gallery								
64-1272CTKSL	64-1272CTKSR	72	12	38	92	13.9	T\$ 1881	
Four Slots; For Use With 78" Gallery								
64-1278CTKSL	64-1278CTKSR	78	12	38	99	15.0	T\$ 2192	
Four Slots; For Use With 84" Gallery								
64-1284CTKSL	64-1284CTKSR	84	12	38	106	16.1	T\$ 2248	
Five Slots; For Use With 90" Gallery								
64-1290CTKSL	64-1290CTKSR	90	12	38	113	17.2	T\$ 2304	
Five Slots; For Use With 96" Gallery								

Description

- One (1) Support Brackets Included; Must Specify: Black (BLK) or Silver (SLV)
- Paper Slot Divider; Must Specify Color: Chrome or Laminate in Matching or Contrasting Color
- Some Assembly Required

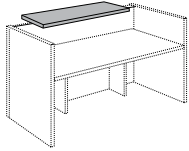
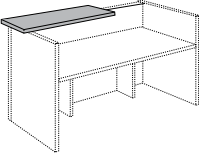
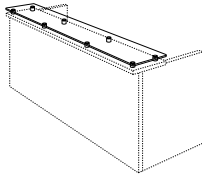
Item	Model No.	Width	Depth	Height	Ship Wt	Cubic Ft	List Price
TRANSACTION TOPS FRONT TO BACK GRAIN	64-2412TP	24	12	1	7	0.6	T\$ 370 P\$ 515 Optional Glass Top Add \$ 742
	64-2712TP	27	12	1	8	0.7	T\$ 377 P\$ 530 Optional Glass Top Add \$ 761
 <i>Two (2) Support Bracket Required</i>	64-3012TP	30	12	1	9	0.8	T\$ 387 P\$ 543 Optional Glass Top Add \$ 983
	64-3312TP	33	12	1	10	0.9	T\$ 392 P\$ 548 Optional Glass Top Add \$ 1006
 <i>One (1) Support Bracket Required</i>	64-3612TP	36	12	1	11	1.0	T\$ 397 P\$ 557 Optional Glass Top Add \$ 1049
	64-3912TP	39	12	1	12	1.1	T\$ 403 P\$ 564 Optional Glass Top Add \$ 1070
 <i>Optional Glass Transaction Top for TFL or HPL Transaction Tops</i>	64-4212TP	42	12	1	13	1.2	T\$ 407 P\$ 572 Optional Glass Top Add \$ 1110
	64-4512TP	45	12	1	14	1.3	T\$ 417 P\$ 582 Optional Glass Top Add \$ 1131
<i>Must Specify (in this order): Model # Transaction Top Material Color Glass Transaction Top Support Bracket Color</i>	64-4812TP	48	12	1	15	1.4	T\$ 437 P\$ 612 Optional Glass Top Add \$ 1174
	64-5112TP	51	12	1	16	1.5	T\$ 441 P\$ 620 Optional Glass Top Add \$ 1192
<i>Additional Transaction Tops on next page.</i>	64-5412TP	54	12	1	16	1.6	T\$ 449 P\$ 628 Optional Glass Top Add \$ 1414
	64-5712TP	57	12	1	17	1.7	T\$ 454 P\$ 636 Optional Glass Top Add \$ 1435
	64-6012TP	60	12	1	18	1.8	T\$ 461 P\$ 648 Optional Glass Top Add \$ 1477

Description

- Square (H) Edge Profile On All Sides With Front to Back Grain Direction on All Sizes
- 1½" Overhang on Approach and Side Depending on Placement
- If Top is Not Supported By An End Panel, Support Bracket is Required (Not Included)
- Support Brackets Required; See Below and Must Specify: Black (BLK) or Silver (SLV)
- Optional Glass Transaction Top with 1/4" Silver Standoff, See "Optional Glass Top Add" Pricing and Specify (SOG)
- Optional Glass Transaction Top Field Installed

Support Brackets Required for Non-Supported End: Specify & Add



01-0607SSB	Black	\$ 54
01-0607SSS	Silver	\$ 54

Pricing Codes:
T = TFL P = HPL

[See Canvas Reception Overview for Ordering Options](#)

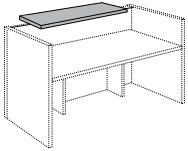
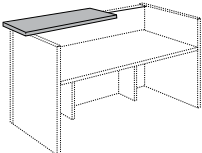
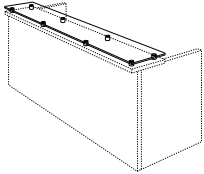
Item	Model No.	Width	Depth	Height	Ship Wt	Cubic Ft	List Price
TRANSACTION TOPS SIDE TO SIDE GRAIN	64-1224TP	24	12	1	7	0.6	T\$ 370 P\$ 515 Optional Glass Top Add \$ 742
	64-1227TP	27	12	1	8	0.7	T\$ 377 P\$ 530 Optional Glass Top Add \$ 761
	64-1230TP	30	12	1	9	0.8	T\$ 387 P\$ 543 Optional Glass Top Add \$ 983
	64-1233TP	33	12	1	10	0.9	T\$ 392 P\$ 548 Optional Glass Top Add \$ 1006
	64-1236TP	36	12	1	11	1.0	T\$ 539 P\$ 557 Optional Glass Top Add \$ 1049
	64-1239TP	39	12	1	12	1.1	T\$ 403 P\$ 564 Optional Glass Top Add \$ 1070
	64-1242TP	42	12	1	13	1.2	T\$ 407 P\$ 572 Optional Glass Top Add \$ 1110
	64-1245TP	45	12	1	14	1.3	T\$ 417 P\$ 582 Optional Glass Top Add \$ 1131
Optional Glass Transaction Top for TFL or HPL Transaction Tops	64-1248TP	48	12	1	15	1.4	T\$ 437 P\$ 612 Optional Glass Top Add \$ 1174
	64-1251TP	51	12	1	16	1.5	T\$ 441 P\$ 620 Optional Glass Top Add \$ 1192
Must Specify (in this order): Model # Transaction Top Material Color Glass Transaction Top Support Bracket Color	64-1254TP	54	12	1	16	1.6	T\$ 449 P\$ 628 Optional Glass Top Add \$ 1414
	64-1257TP	57	12	1	17	1.7	T\$ 455 P\$ 637 Optional Glass Top Add \$ 1435
Additional Transaction Tops on next page.	64-1260TP	60	12	1	18	1.8	T\$ 461 P\$ 648 Optional Glass Top Add \$ 1477
	64-1263TP	63	12	1	19	1.9	T\$ 468 P\$ 653 Optional Glass Top Add \$ 1496

Description

- Square (H) Edge Profile On All Sides With Side to Side Grain Direction on All Sizes
- 1½" Overhang on Approach and Side Depending on Placement
- If Top is Not Supported By An End Panel, Support Bracket is Required (Not Included)
- Support Brackets Required; See Below and Must Specify: Black (BLK) or Silver (SLV)
- Optional Glass Transaction Top with ¼" Silver Standoff, See "Optional Glass Top Add" Pricing and Specify (SOG)
- Optional Glass Transaction Top Field Installed

Support Brackets Required for Non-Supported End: Specify & Add

01-0607SSB	Black	\$ 54
01-0607SSS	Silver	\$ 54



Pricing Codes:
T = TFL P = HPL

[See Canvas Reception Overview for Ordering Options](#)

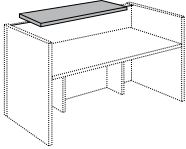
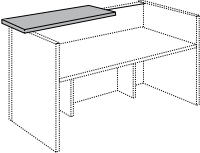
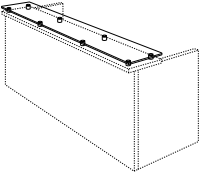
Item	Model No.	Width	Depth	Height	Ship Wt	Cubic Ft	List Price
 Two (2) Support Bracket Required  One (1) Support Bracket Required  Optional Glass Transaction Top for TFL or HPL Transaction Tops Must Specify (in this order): Model # Transaction Top Material Color Glass Transaction Top Support Bracket Color	64-1266TP	66	12	1	21	2.1	T\$ 474 P\$ 663 Optional Glass Top Add \$ 1539
	64-1269TP	69	12	1	21	2.1	T\$ 479 P\$ 670 Optional Glass Top Add \$ 1560
	64-1272TP	72	12	1	22	2.2	T\$ 527 P\$ 736 Optional Glass Top Add \$ 1580
	64-1275TP	75	12	1	23	2.3	T\$ 532 P\$ 746 Optional Glass Top Add \$ 1622
	64-1278TP	78	12	1	24	2.4	T\$ 539 P\$ 754 Optional Glass Top Add \$ 1664
	64-1278TP	78	12	1	24	2.4	T\$ 539 P\$ 754 Optional Glass Top Add \$ 1664
	64-1281TP	81	12	1	25	2.5	T\$ 544 P\$ 763 Optional Glass Top Add \$ 1866
	64-1284TP	84	12	1	26	2.6	T\$ 551 P\$ 770 Optional Glass Top Add \$ 1906
	64-1287TP	87	12	1	26	2.7	T\$ 557 P\$ 780 Optional Glass Top Add \$ 1927
	64-1290TP	90	12	1	27	2.8	T\$ 563 P\$ 788 Optional Glass Top Add \$ 1970
	64-1293TP	93	12	1	28	2.9	T\$ 568 P\$ 795 Optional Glass Top Add \$ 1987
	64-1296TP	96	12	1	29	3.0	T\$ 591 P\$ 827 Optional Glass Top Add \$ 2066

Description

- Square (H) Edge Profile On All Sides With Side to Side Grain Direction on All Sizes
- 1½" Overhang on Approach and Side Depending on Placement
- If Top is Not Supported By An End Panel, Support Bracket is Required (Not Included)
- Support Brackets Required; See Below and Must Specify: Black (BLK) or Silver (SLV)
- Optional Glass Transaction Top with 1¼" Silver Standoff, See "Optional Glass Top Add" Pricing and Specify (SOG)
- Optional Glass Transaction Top Field Installed

Support Brackets Required for Non-Supported End: Specify & Add

01-0607SSB	Black	\$ 54
01-0607SSS	Silver	\$ 54



Additional Transaction Tops on next page.

Pricing Codes:
T = TFL P = HPL

[See Canvas Reception Overview for Ordering Options](#)

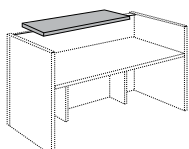
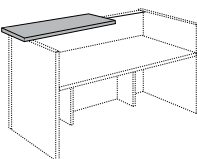
Item	Model No.	Width	Depth	Height	Ship Wt	Cubic Ft	List Price	
TRANSACTION TOP WITH SOLID SURFACE	64-1224SSTP	24	12	1½	25	0.6	\$ 917	
	64-1227SSTP	27	12	1½	28	0.7	\$ 1248	
	64-1230SSTP	30	12	1½	32	0.8	\$ 1277	
	64-1233SSTP	33	12	1½	35	0.9	\$ 1315	
	64-1236SSTP	36	12	1½	38	1.0	\$ 1352	
	Two (2) Support Bracket Required	64-1239SSTP	39	12	1½	41	1.1	\$ 1578
	64-1242SSTP	42	12	1½	44	1.2	\$ 1612	
	64-1245SSTP	45	12	1½	48	1.3	\$ 1651	
		64-1248SSTP	48	12	1½	51	1.4	\$ 1696
		64-1251SSTP	51	12	1½	54	1.5	\$ 1924
	One (1) Support Bracket Required	64-1254SSTP	54	12	1½	57	1.6	\$ 1960
	64-1257SSTP	57	12	1½	60	1.7	\$ 2002	
Must Specify (in this order): Model # Color Support Bracket Color	64-1260SSTP	60	12	1½	64	1.8	\$ 2051	
	64-1263SSTP	63	12	1½	67	1.9	\$ 2252	
	64-1266SSTP	66	12	1½	70	2.0	\$ 2293	
	64-1269SSTP	69	12	1½	73	2.1	\$ 2337	
	64-1272SSTP	72	12	1½	76	2.2	\$ 2390	
	64-1275SSTP	75	12	1½	80	2.3	\$ 2624	
	64-1278SSTP	78	12	1½	83	2.4	\$ 2668	
	64-1281SSTP	81	12	1½	86	2.5	\$ 2718	
	64-1284SSTP	84	12	1½	89	2.5	\$ 2778	
	64-1287SSTP	87	12	1½	92	2.7	\$ 2955	
64-1290SSTP	90	12	1½	96	2.8	\$ 3004		
64-1293SSTP	93	12	1½	99	2.9	\$ 3063		
64-1296SSTP	96	12	1½	102	3.0	\$ 3128		

Description

- Straight (S1) Edge Profile On All Sides
- 1½" Overhang on Approach and Side Depending on Placement
- If Top is Not Supported By An End Panel, Support Bracket is Required (Not Included)
- Support Brackets Available in Black or Silver: See Below and Must Specify



Support Brackets Required for Non-Supported End: Specify & Add

01-0607SSB	Black	\$ 54
01-0607SSS	Silver	\$ 54

Pricing Codes:

T = TFL P = HPL

[See Canvas Reception Overview for Ordering Options](#)

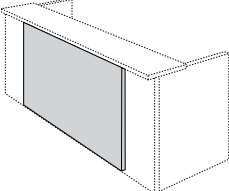
Item	Model No.	Width	Depth	Height	Ship Wt	Cubic Ft	List Price
 <p>Shaded Overlay Panel (Shown with Optional Transactional Top)</p>	64-OT60 For Use With 60" Desk or 58" Return	36	¾	41	28	2.8	T\$ 481
	64-OT66 For Use With 66" Desk	42	¾	41	33	3.2	T\$ 527
	64-OT72 For Use With 72" Desk or 71" Return	48	¾	41	38	3.6	T\$ 570
	64-OT78 For Use With 78" Desk	54	¾	41	42	4.0	T\$ 612
	64-OT84 For Use With 84" Desk or 83" Return	60	¾	41	47	4.4	T\$ 650
	64-OT90 For Use With 90" Desk	66	¾	41	52	4.8	T\$ 686
	64-OT96 For Use With 96" Desk or 95" Return	72	¾	41	57	5.2	T\$ 722

Must Specify (in this order):

Model #
Color
Overlay Back Lighting

Description

- Horizontal Woodgrain
- Designed to be Used with a Transaction Top
- Not Compatible with Waterfall Transaction Kit
- Optional Back Lighting

Options: Specify & Add

BKLIT	Back Lighting						\$ 1701
-------	---------------	--	--	--	--	--	---------

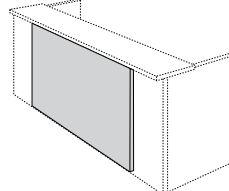
 <p>Shaded Overlay Panel (Shown with Optional Transactional Top)</p>	64-OFA60 For Use With 60" Desk or 58" Return	36	¼	41	9	2.8	\$ 1414
	64-OFA66 For Use With 66" Desk	42	¼	41	11	3.2	\$ 1624
	64-OFA72 For Use With 72" Desk or 71" Return	48	¼	41	13	3.6	\$ 1792
	64-OFA78 For Use With 78" Desk	54	¼	41	15	4.0	\$ 1948
	64-OFA84 For Use With 84" Desk or 83" Return	60	¼	41	17	4.4	\$ 2112
	64-OFA90 For Use With 90" Desk	66	¼	41	19	4.8	\$ 2300
	64-OFA96 For Use With 96" Desk or 95" Return	72	¼	41	21	5.2	\$ 2406

Description

- Features Decorative Hardware, 1¼" Silver Standoffs
- Designed to be Used with a Transaction Top
- Optional Custom Engraving Available; Call Customer Service For Lead Times and Pricing

Pricing Codes:

T = TFL P = HPL

[See Canvas Reception Overview for Ordering Options](#)

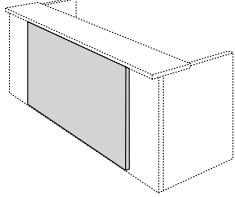
Item	Model No.	Width	Depth	Height	Ship Wt	Cubic Ft	List Price
OVERLAY PANEL, HIGH GLOSS ACRYLIC  Shaded Overlay Panel (Shown with Optional Transactional Top) Must Specify (in this order): Model # Color Overlay Back Lighting	64-OHGA60	36	¼	41	28	2.8	\$ 1492
	For Use With 60" Desk or 58" Return						GPA\$ 1955
	64-OHGA66	42	¼	41	33	3.2	\$ 1704
	For Use With 66" Desk						GPA\$ 2246
	64-OHGA72	48	¼	41	38	3.6	\$ 1914
	For Use With 72" Desk or 71" Return						GPA\$ 2534
	64-OHGA78	54	¼	41	42	4.0	\$ 2116
	For Use With 78" Desk						GPA\$ 2815
	64-OHGA84	60	¼	41	47	4.4	\$ 2323
	For Use With 84" Desk or 83" Return						GPA\$ 3095
64-OHGA90	66	¼	41	52	4.8	\$ 2526	
For Use With 90" Desk						GPA\$ 3375	
64-OHGA96	72	¼	41	57	5.2	\$ 2724	
For Use With 96" Desk or 95" Return						GPA\$ 3655	

Description

- Must Specify Color: Black (BLA), Wired Mercury (WMA), White (WHA) or Graphite Acrylic (GPA); Graphite Acrylic Pricing (GPA\$)
- Designed to be Used with a Transaction Top
- Optional Back Lighting

Options: Specify & Add

BKLIT	Back Lighting	\$ 1701
-------	---------------	---------

Item	Model No.	Width	Depth	Height	Ship Wt	Cubic Ft	List Price
STIFFENER BAR 	01-00060SB	60	1¼	¾	8	0.3	\$ 143
	01-00048SB	48	1¼	¾	5	0.3	\$ 134

Description

- Reinforces Worksurfaces with Large Kneespace Widths
- Includes End Caps to Cover Sharp Edges
- Field Installed
- Recommended in Kneespaces 60" or Greater

Item	Model No.	Color	Width	Depth	Height	Ship Wt	Cubic Ft	List Price
TRANSACTION SUPPORT BRACKET 	01-0607SSB	Black	6	-	-	1	1.0	\$ 54
	01-0607SSS	Silver						

Description

- For Use With Unsupported Transaction Tops and Waterfall Transaction Kits

Pricing Codes:

T = TFL P = HPL

[See Canvas Reception Overview for Ordering Options](#)

Item	Model No.		Width	Depth	Height	Ship Wt	Cubic Ft	List Price
ROUND GROMMET COVER FIELD INSTALLED	01-GRMTBK	Black	-	-	-	-	-	\$ 12
	01-GRMTSL	Silver						



OPEN MARKET ONLY
(SILVER)

Description

- 60mm Round Grommet Cover
- Field Installed

DOCK 950 WIRELESS CHARGER	01-DOCK950W	White	3 $\frac{3}{16}$ "	3 $\frac{3}{16}$ "	-	1	0.2	\$ 294
	01-DOCK950B	Black						



OPEN MARKET ONLY

Description

- For Use with Wireless Charging Enabled Devices
- 5 Watts Maximum Output with a Direct Current of 5V 2A and 10 Watts Maximum with Quick Charge 2.0
- Mounts in 76mm Round Cut-Out
- LED will Confirm Pairing with Device and Begin Wireless Charging

DOCK 150 WIRELESS AND USB CHARGER	01-DOCK150W	White	3	3	3 $\frac{1}{4}$ "	1	0.2	\$ 448
	01-DOCK150B	Black						







OPEN MARKET ONLY

Description

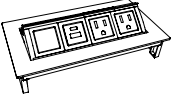
- For Use with Wireless Charging Enabled Devices and USB Charging Devices
- 5 Watt Maximum Output with a Direct Current Input of 5V 6A (Wireless Fast Charge)
- Mounts in 76mm Round Cut-Out
- Pop-Up is 3 $\frac{1}{4}$ "H and Includes Three (3) USB Ports; One (1) 12 Watt Maximum with 2.4A (USB Fast Charge) and Two (2) 5 Watt with 1A (USB Standard Charge)
- LED Light will Confirm Pairing with Device and Begin Wireless Charging
- UL and cUL Certified

[See Canvas Reception Overview for Ordering Options](#)

Item	Model No.		Width	Depth	Height	Ship Wt	Cubic Ft	List Price
POWER DATA PORT 	01-DPORT4A	Aluminum	8	4	-	7	0.2	\$ 1211
	01-DPORT4B	Black	8	4	-	7	0.2	\$ 1211
Description <ul style="list-style-type: none"> • Retracts into Work Surface to Regain Productive Space • One-Touch Access to Power and Data • Two Power Outlets and Two Open Ports for Data • Water-Proof Simplex (Outlets) • Includes a Voice/Data Adapter Kit to Accept Couplers and Jacks When Required • 6' Power Cord 								
USB PORT 	01-USBPORT		-	-	-	-	-	\$ 178
Description <ul style="list-style-type: none"> • For Use with 01-DPORT4A and 01-DPORT4B • Passive USB-A Port with Increased Transfer Speed Up to 5 gbs/sec • Simultaneous Read/Write Capability • Idle Device Power Saving State • 6' Cord 								
VOICE COUPLER 	01-VOICE1		-	-	-	-	-	\$ 80
Description <ul style="list-style-type: none"> • For Use with 01-DPORT4A and 01-DPORT4B • 6-Pin Modular Plug • Molded Black • Cord Not included 								
DATA PORT 	01-RJ4DATA		-	-	-	-	-	\$ 186
Description <ul style="list-style-type: none"> • For Use with 01-DPORT4A and 01-DPORT4B • 8-Pin Modular Plug • Cat6 Ethernet Cable • Pre-terminated Cable • 10' Cord 								
PASSIVE USB-C ACCESSORY 	01-PUSBC		-	-	-	1	0.2	\$ 105
Description <ul style="list-style-type: none"> • Passive USB-C Port ; Unit Provides Data Connection to Transfer Data Only, No Charging Capabilities • Compatible with 01-DPORT4A and 01-DPORT4B • Male/Female Connector 								

OPEN MARKET ONLY

[See Canvas Reception Overview for Ordering Options](#)

Item	Model No.	Width	Depth	Height	Ship Wt	Cubic Ft	List Price
CHARGING USB-A+C ACCESSORY	01-USBAC	-	-	-	1	0.2	\$ 313

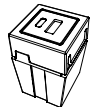

OPEN MARKET ONLY

Description

- For Charging Devices
- 20 Watt Power Supply
- USB+C Charging Port for 01-DPORT4A and 01-DPORT4B

HDMI CONNECTOR ACCESSORY	01-HDMICON	-	-	-	1	0.2	\$ 137
--------------------------	------------	---	---	---	---	-----	--------



OPEN MARKET ONLY

Description

- HDMI Port for 01-DPORT4A and 01-DPORT4B
- Connects to High Definition Displays
- Female/Female Connector
- 18" Cord

VGA CONNECTOR ACCESSORY	01-VGACON	-	-	-	1	0.2	\$ 165
-------------------------	-----------	---	---	---	---	-----	--------

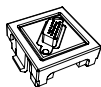

OPEN MARKET ONLY

Description

- VGA Port for 01-DPORT4A and 01-DPORT4B
- Enables Devices to Remote Display on Monitors
- 10' Cord
- Male/Female Connector

DUO CLAMP WITH NEMA PLUG	01-DUOCLAMPW	White	5 ½	3	7	1	0.2	\$ 634
	01-DUOCLAMPB	Black						
	01-DUOCLAMP S	Silver						

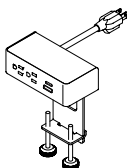
**Description**

- Clamps to Top and Includes: Two (2) Power, One (1) USB Charging Port and One (1) 60-Watt USB-C Power Delivery Port with GaN Technology with 10' Cord
- Silver Metal Trim
- Independent USB Circuit Controllers Deliver up to 2.1 Amps to Each Post
- All Mounting Hardware Included
- FCC Part 15A and UL Approved for Horizontal and Vertical Applications

[See Canvas Reception Overview for Ordering Options](#)

Item	Model No.		Width	Depth	Height	Ship Wt	Cubic Ft	List Price
TRIO CLAMP WITH NEMA PLUG	01-TRIOCLAMPW	White	8	3	7	1	0.2	\$ 743
	01-TRIOCLAMPB	Black						
	01-TRIOCLAMPS	Silver						

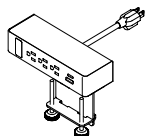

Description

- Silver Metal Trim
- Clamps to Top and Includes: Three (3) Power, One (1) USB Charging Port, One (1) 60-Watt USB-C Power Delivery Port with GaN Technology, One (1) Open Data and 10' Cord
- Independent USB Circuit Controllers Deliver up to 2.1 Amps to Each Post
- HDMI, VGA, or RJ45 Sold Separately; [See Accessories](#)
- All Mounting Hardware Included
- FCC Part 15A and UL Approved for Horizontal and Vertical Applications

UNDERMOUNT DUO WITH NEMA PLUG	01-DUUNDERW	White	6½	2½	3	1	0.2	\$ 605
	01-DUUNDERB	Black						
	01-DUUNDERS	Silver						



Description

- Two (2) Power, One (1) USB Charging Port and One (1) 60-Watt USB-C Power Delivery Port with GaN Technology with 10' Cord
- Sits Under the Worksurface
- Independent USB Circuit Controllers Deliver up to 2.1 Amps to Each Post
- All Mounting Hardware Included
- FCC Part 15A and UL Approved for Horizontal and Vertical Applications



UNDERMOUNT TRIO WITH NEMA PLUG	01-TRIOUNDERW	White	6½	2½	3	1	0.2	\$ 726
	01-TRIOUNDERB	Black						
	01-TRIOUNDERS	Silver						



Description

- Sits On Top of the Worksurface and Includes: Three (3) Power, One (1) USB Charging Port, One (1) 60-Watt USB-C Power Delivery Port with GaN Technology, One (1) Open Data with 10' Cord
- Independent USB Circuit Controllers Deliver up to 2.1 Amps to Each Post
- HDMI, VGA, or RJ45 Sold Separately; [See Accessories](#)
- All Mounting Hardware Included
- FCC Part 15A and UL Approved for Horizontal and Vertical Applications

[See Canvas Reception Overview for Ordering Options](#)

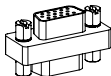
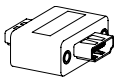
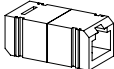
Item	Model No.		Width	Depth	Height	Ship Wt	Cubic Ft	List Price
DUO BEZEL WITH NEMA PLUG 	01-DUOBEZELW	White	9	2½	3	1	0.2	\$ 748
	01-DUOBEZELB	Black						
	01-DUOBEZELS	Silver						
Description <ul style="list-style-type: none"> Sits On Top of the Worksurface and Includes: Two (2) Power, One (1) USB Charging Port and One (1) 60-Watt USB-C Power Delivery Port with GaN Technology with 10' Cord Independent USB Circuit Controllers Deliver up to 2.1 Amps to Each Post All Mounting Hardware Included FCC Part 15A and UL Approved for Horizontal and Vertical Applications 								
TRIO BEZEL WITH NEMA PLUG 	01-TRIOBEZELW	White	6½	2½	3	1	0.2	\$ 803
	01-TRIOBEZELB	Black						
	01-TRIOBEZELS	Silver						
Description <ul style="list-style-type: none"> Sits On Top of the Worksurface and Includes: Three (3) Power One (1) USB Charging Port, One (1) 60-Watt USB-C Power Delivery Port with GaN Technology, One (1) Open Data with 10' Cord Independent USB Circuit Controllers Deliver up to 2.1 Amps to Each Post HDMI, VGA, or RJ45 Sold Separately; See Accessories All Mounting Hardware Included FCC Part 15A and UL Approved for Horizontal and Vertical Applications 								
VGA DATA PORT ACCESSORY 	01-LCOMVGA		-	-	-	1	0.2	\$ 134
Description <ul style="list-style-type: none"> VGA Port for Trio Clamp, Trio Bezel and Undermount Trio Units 								
HDMI DATA PORT ACCESSORY 	01-LCOMHDMI		-	-	-	1	0.2	\$ 183
Description <ul style="list-style-type: none"> HDMI Port for Trio Clamp, Trio Bezel and Undermount Trio Units 								
OPEN MARKET ONLY								
RJ45 DATA PORT ACCESSORY 	01-LCOMRJ45		-	-	-	1	0.2	\$ 88
Description <ul style="list-style-type: none"> RJ45 Port for Trio Clamp, Trio Bezel and Undermount Trio Units 								

[See Canvas Reception Overview for Ordering Options](#)

Item	Model No.	Width	Depth	Height	Ship Wt	Cubic Ft	List Price
WIRE MANAGEMENT CHANNEL	01-WMGR4	16	1½	¾	1	-	\$ 129

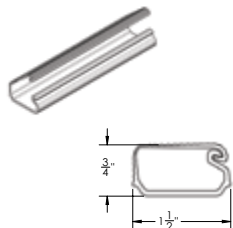

Description

- Set of Four (4) Black Plastic Wire Management Channels
- Snap Lock Channel
- Attaches with Adhesive Strips
- Ships via UPS Only

WIRE CHANNEL	01-32125	24	1⅝	1	.25	0.3	\$ 117
--------------	----------	----	----	---	-----	-----	--------

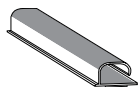

Description

- Available in Black
- Channels Attach with Two (2) Double-Sided Installation Tape
- Open J Channel for Easy Storage of Cables

CABLE GRIP	01-WMGRCB	5⅞	1½	-	-	-	\$ 19
------------	-----------	----	----	---	---	---	-------

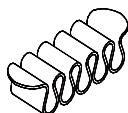

Description

- Under Surface Wire Management
- Black

LINK 360 CABLE MANAGER	01-0251LINKSLV	Silver	5⅞	3 ⅞	30-51	4	3.0	\$ 432
	01-0251LINKBLK	Black	5⅞	3 ⅞	30-51	4	3.0	\$ 391

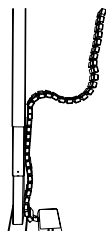

Description

- Kit Includes: 50 Link 360™ elements, One (1) Quad Connector, One (1) Dumbbell Connector, One (1) Foot Assembly with Two (2) Magnetic Clips
- Can Be Used For Height-Adjustable Mechanisms Up To 51" or Free-Standing Use

Pricing Codes:
T = TFL P = HPL

[See Canvas Reception Overview for Ordering Options](#)

Item	Model No.	Width	Depth	Height	Ship Wt	Cubic Ft	List Price
CENTER DRAWER	66-1622CD	22	16	2	7	1.4	T\$ 435

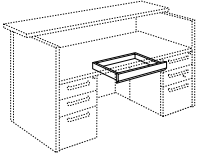

Description

- Attaches Under Worksurfaces
- Built in Pen Tray
- Field Installed Only
- Grain Runs Vertical on Drawer Fronts. Optional Horizontal Grain Direction on Drawer Fronts; Must Specify

Must Specify (in this order):

- Model #
- Color
- Grain Direction

VESTA POWER CENTER	01-PDCTR	10¾	12	28¾	14	2.5	\$ 1968
--------------------	----------	-----	----	-----	----	-----	---------



Description

- Top Includes One (1) Power Outlet, Two (2) USB Ports and One (1) USBC Port; Base Includes Three (3) Outlet
- Available in White
- 120" Power Cord
- Built with Weight Distribution for Optimal Stability
- Base is 5" Tall

DESK SHELL TACKBOARDS
9" H

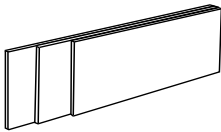

Must Specify (in this order):

- Model #
- Tackboard Fabric Vendor, Pattern, and Color

Model #	Size	COM ydg	COM, 1, 2 or 3	Grades						
				4	5	6	7	8	9	10
TB-6260	60"	1.75	\$ 242	513	641	769	953	1143	1367	1625
TB-6266	66"	2.00	\$ 257	567	713	859	1069	1287	1543	1837
TB-6272	72"	2.25	\$ 283	632	796	960	1197	1442	1730	2061
TB-6278	78"	2.50	\$ 344	732	914	1097	1359	1632	1952	2319
TB-6284	84"	2.50	\$ 351	739	921	1104	1366	1639	1959	2326
TB-6290	90"	2.75	\$ 371	797	998	1199	1488	1787	2139	2544
TB-6296	96"	3.00	\$ 389	854	1073	1292	1607	1934	2318	2759

Description

- All tackboards 78" and longer are Two (2) pieces
- Field Installed
- For Use with Transaction Tops
- Not Compatible with Waterfall Transaction Kit

Pricing Codes:

T = TFL P = HPL

[See Canvas Reception Overview for Ordering Options](#)

ORDERING INFORMATION

All orders should be placed with:

Indiana Furniture
1919 Hospitality Dr., Ste. A
Jasper, IN 47546

Fax: 812.482.9035

email: neworders@indianafurniture.com

ORDER PROCEDURE

To ensure timely processing, all orders must include:

- Purchase Order Number
- Sold To and Ship To Addresses
- Call Before Delivery Phone Number and Contact Name
- Complete Model Numbers and Quantity for All Units
- Finish Selections
- Fabric Vendor/Pattern/Color, if applicable
- Other Applicable Options
- Any Special Delivery or Product Instructions

A drawing or sketch of the planned configuration in modular applications will facilitate order processing.

How to Order illustrations are located at the beginning of each Series. Each model has additional information on How to Specify. For further clarification, contact Sales Support at 800.422.5727.

PRICING

All prices are suggested retail, F.O.B. Point of Origin, freight prepaid and allowed to one continental US destination. Prices, specifications and materials are subject to change without notice. Possession and/or distribution of this price list does not in itself constitute an offer to sell. Orders can be received only from authorized Indiana Furniture dealers. Orders will be billed at prices at time of shipment, unless previously acknowledged prior to the effective date of a price change, in which case billing will be at the price acknowledged.

Indiana Furniture accepts Visa, MasterCard and American Express. Please contact Sales Support for policy details.

ACKNOWLEDGMENT

Cleanly specified orders are acknowledged in a timely manner. The acknowledgment reflects how the order was entered, the estimated ship date, and other pertinent information. This acknowledgment serves as the final agreement between the customer and Indiana Furniture, and is the exclusive statement of the terms thereof. Changes must be requested within one business day of acknowledgment; after that, all production activities begin and the order becomes firm. Please examine this acknowledgment carefully and advise Indiana Furniture immediately of any discrepancies. The customer bears sole responsibility for order correctness.

Shipping fees (see Delivery + Freight Charges) are added at the time of invoicing. Shipping charges will be listed on direct bill and GSA orders due to the nature of the contract, but not on commercial or dealer-billed orders.

BUYER'S OBLIGATION: RIGHTS OF SELLER

If Indiana Furniture shall, at any time, doubt Buyer's financial responsibility, Indiana Furniture may decline to make shipments hereunder except upon receipt of cash payment in advance or security or other proof of responsibility satisfactory to Indiana Furniture. If buyer fails in any way to fulfill the terms and conditions set forth herein, Indiana Furniture may defer shipments until such default is corrected. Remedies provided herein shall be in addition to, and not in lieu of other remedies. Buyer agrees to abide by payment terms as listed on invoice. Buyer shall pay all reasonable costs and expenses, including attorney and collection fees, and late fees, incurred by Seller in connection with any amounts due for goods ordered.

CANCELLATIONS + CHANGES

All products are built-to-order. Once acknowledged (See Acknowledgement), orders are considered firm and are not subject to cancellation or change without approval from Indiana Furniture. All approved changes are subject to additional charges and revised lead times.

PRODUCT DESIGN + SPECIFICATION CHANGES

Indiana Furniture reserves the right to make changes in design and construction or discontinue products without prior notice. Note: All dimensions listed in price list are nominal.

REPAIR CHARGES

Indiana Furniture will only pay repair charges if Sales Support gives prior written

authorization. No repair charge will be paid without advance approval at which time a repair authorization number will be issued and must appear on the invoice to Indiana Furniture for the completed work.

WAREHOUSE STORAGE CHARGES

If a shipment is held beyond 7 calendar days at your request, a **.084% per calendar day (2.52% per month) storage charge will be assessed**. The effective date will be 7 calendar days after the acknowledged ship date. Further, the prices applied to the order will be those in effect at the time of shipment.

DAMAGED/MISSING MERCHANDISE

The consignee is responsible for reporting all damage and shortages to Sales Support.

- The consignee must inspect all merchandise upon arrival.
- Do not refuse merchandise damaged in transit.
- Missing cartons and obvious damage must be noted on the freight bill at the time of delivery.
- Claims for missing cartons should be reported immediately for the best chance of recovery and to avoid delays in completing the delivery.
- Claims for both obvious and concealed damage must be filed within 15 calendar days of receipt of product
- Damaged merchandise must not have been moved from the original receiving location and must be reported prior to any attempt to install the product.
- All damaged merchandise, including the cartons and packing materials, must be retained for inspection by either the carrier or by an Indiana Furniture Sales Representative.

Be prepared to provide the following information when contacting Sales Support:

- Copy of Signed Freight Bill (with noted issues, if applicable)
- Original Order Number
- Model Number of the Damaged Item
- Photos of the Damaged Carton/Item

All damage claims are subject to review and approval. Once your damage claim has been evaluated, we will determine the best resolution, including repair or replacement where applicable. Indiana Furniture reserves the right to select the most cost effective way to resolve the claim.

DELIVERY + FREIGHT CHARGES

All shipments are F.O.B. Point of Origin, Jasper, IN, freight prepaid and allowed dock to dock on 53' trailer. Ownership and responsibility of the merchandise become that of the buyer upon delivery to the freight company. Shipments into Alaska, Hawaii, Canada, Mexico, Puerto Rico and other exports are freight prepaid and allowed to port of exit.

Shipping fees added at the time of invoicing.

- Shipments under \$3000 (net value, product only) will incur a \$300 net fee per shipment.
- Small-package carrier shipments:
 - Orders \$100 or less will receive a \$22 fee
 - Orders over \$100 will receive a \$40 fee

Carrier selection and routing are at Indiana Furniture's discretion. Requests for favored carriers and delivery times will be accommodated when possible.

After-hours delivery fees:

- Monday through Thursday after 3pm: \$300 per truck
- Friday after 3pm or weekends: \$600 per truck

Inside delivery and installation services are not included in the price shown. Any deviation from dock-to-dock delivery, such as but not limited to, non-dock, residential, or inside delivery must be specified on the order. Should these services be requested or required, please contact Sales Support regarding the availability of services and a quote. All charges incurred will be charged to the "Sold To" of the order.

BIFMA + ANSI TESTING

Indiana Furniture is a member of the Business and Institutional Furniture Manufacturer's Association (BIFMA). Tests developed by the BIFMA and approved by the American National Standards Institute (ANSI) determine the strength and durability of casegoods and seating in its everyday use. Although this testing does not serve as a warranty or guarantee, Indiana Furniture products within this price list have been tested by an independent verifying body and meet or exceed applicable BIFMA and ANSI Standards..

Subject to the limitations set forth in this warranty, Indiana Furniture Industries, Inc. ("Indiana Furniture") warrants to the original purchaser all product in this price list ("Product") to be free from defects in material and workmanship given normal use for a **12-year period from the date of manufacture**. During the applicable warranty period, Indiana Furniture, as its sole obligation, will repair or replace (in Indiana Furniture's sole discretion) any Product, Part, or Component covered by this warranty and sold after June 1, 2026, which fails under normal use as a result of a defect in material or workmanship. Normal use is defined as the equivalent of a single shift, 40-hour work week. Indiana Furniture will repair or replace the defective Product, Part, or Component with a comparable Product, Part, or Component.

Warranty periods are limited, from the date of manufacture, for certain Products, Parts, and Components as follows:

5-Year Warranty (from the date of manufacture)

- Triple Play Series
- Electrical Components Including Lighting, Power Ports (see exclusions), and Adjustable Height Components
- Pneumatic Cylinders on Caseloads, Tables, and Seating
- Textiles, Foam, and Decorative Trim
- Swivel Arm Pads
- Keyboard Kits and Monitor Arms

3-Year Warranty (from the date of manufacture)

- Dock 950 Wireless Charger
- Dock 150 Wireless and USB Charger

THIS WARRANTY DOES NOT COVER:

- Damage caused by a carrier or third party
- Normal or routine wear and tear
- Appearance, durability, quality, behavior, colorfastness, or any other attribute of customer's own materials or any non-standard Indiana Furniture material (including CF Stinson, Maharam, Momentum, Mayer, UltraFabrics, Architex, and other alliance programs) specified by the customer and applied to a Product
- Color, grain or texture of wood, laminate and other covering materials
- Changes in wood or fabric color due to aging or exposure to light
- Labor and Service not covered under warranty
- Installation Damage (Wall Panels damaged during the installation of additional Product including but not limited to Wall Panel Shelves, Tackboards, or TV Mounts)
- Products or Components attached in some manner to any other manufacturer's products or components (e.g., Indiana Furniture Conference Tops attached to another manufacturer's bases)
- Noncompliance with installation and maintenance instructions

As the manufacturer of the Product, Indiana Furniture stands behind its craftsmanship and pledges to do everything it can to reasonably resolve, as quickly as possible, any problems you may have with the Product within the terms and conditions of this warranty.

If you encounter a defect covered by the foregoing warranty, contact the dealer from whom you purchased the Product. If the dealer is unable to resolve your warranty issues, you should contact Indiana Furniture. Please ensure that you have all of the pertinent facts when contacting the dealer or Indiana Furniture, including the model number and factory order number from the inspection label attached to the Product.

INDIANA FURNITURE IS NOT PROVIDING, AND SPECIFICALLY DISCLAIMS, ANY OTHER WARRANTIES FOR THE PRODUCTS, EXPRESS OR IMPLIED, INCLUDING ANY IMPLIED WARRANTY OF MERCHANTABILITY OR FITNESS FOR A PARTICULAR PURPOSE. INDIANA FURNITURE SHALL NOT BE LIABLE TO THE PURCHASER OR ANY THIRD PARTY FOR CONSEQUENTIAL, INCIDENTAL, INDIRECT, OR SPECIAL DAMAGES, INCLUDING, WITHOUT LIMITATION, DAMAGES ARISING OUT OF OR RESULTING IN ANY MALFUNCTIONS, DELAYS, LOSS OF PROFIT, INTERRUPTION OF BUSINESS, PERSONAL INJURY, BODILY INJURY, DEATH, DISMEMBERMENT, OR PROPERTY DAMAGE.

Indiana Furniture Industries, Inc.
Attn: Sales Support
1919 Hospitality Dr., Ste A
Jasper, Indiana 47546
800.422.5727
Fax 812.482.9035
custserv@indianafurniture.com

Surface Materials

Veneer Finishes, Laminate Colors + Leg/Wood Finish Options

Our veneer casegoods feature our UV topcoat finish, UVAdvantage. The result is a low-emitting finish that provides exceptional depth, clarity, durability and chemical resistance throughout the life of the product. Refer online for finish and color availability by product series.

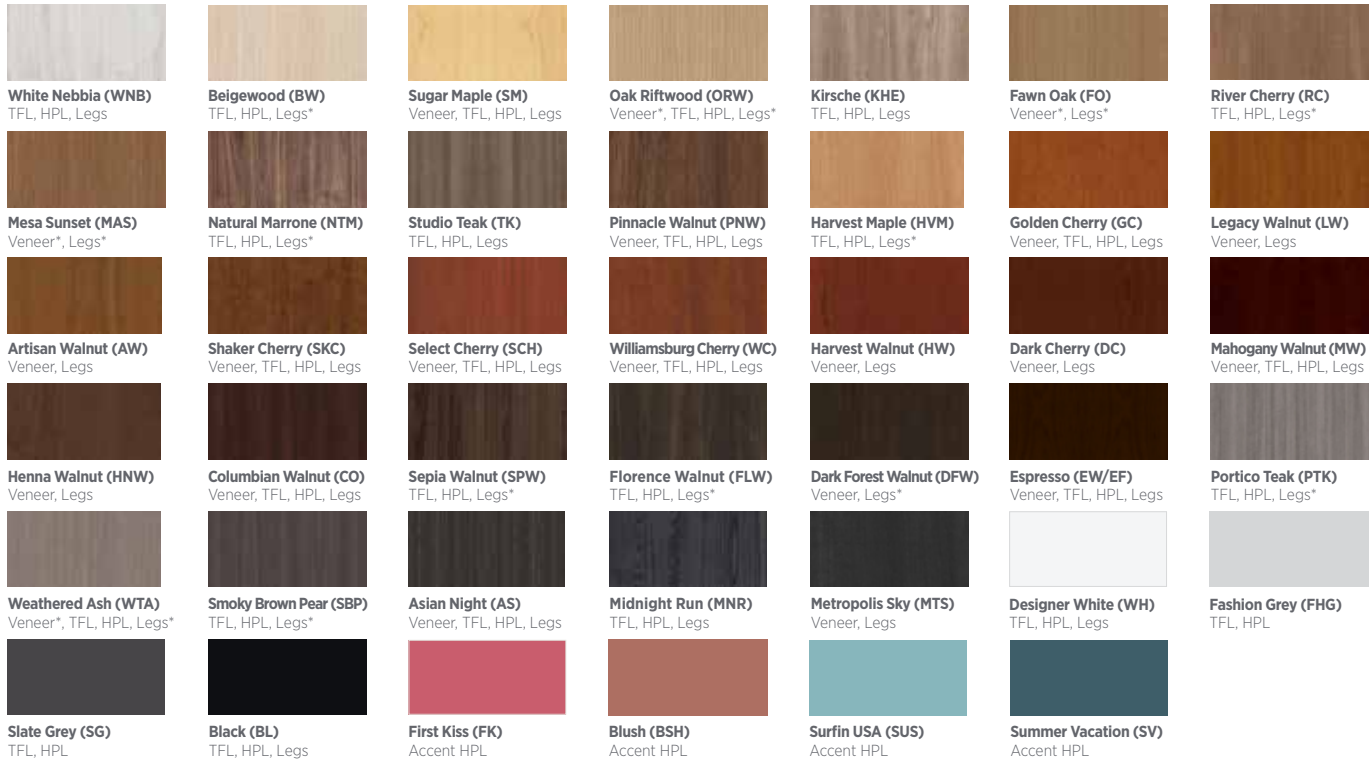

* Veneer/Wood Finish is Low Sheen

Frosted + High Gloss Acrylics

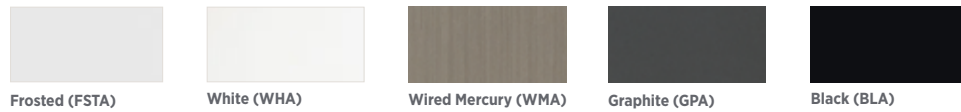

Solid Surfaces



Metal Finishes

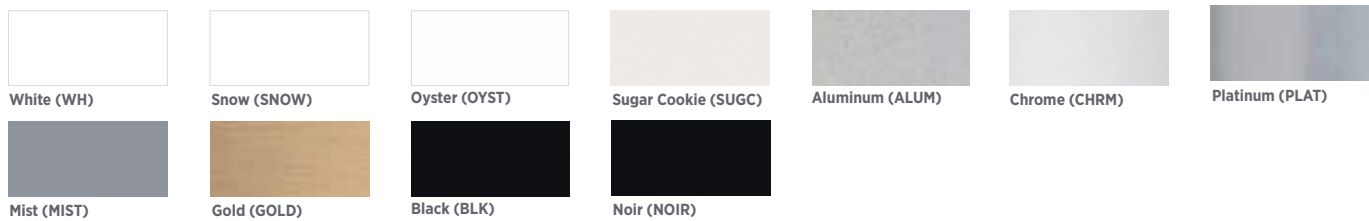

Glass Options

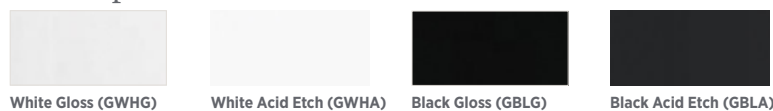

Acoustic/Surround Options



Colors represented are high-resolution reproductions and may vary slightly from the actual product. To order samples, please contact our Customer Service team or order online at indianafurniture.com. Graining and finish colors may vary, yet will continue to complement across Veneer, HPL, TFL and Seating products due to the inherent differences of these materials.

Indiana[®]

FURNITURE

1919 Hospitality Drive, Suite A
Jasper, Indiana 47546

Tel 812.482.5727

Tol 800.422.5727

Fax 812.482.9035

sales@indianafurniture.com

www.indianafurniture.com

Federal Classification: Small Business

©2025 Indiana Furniture 6/25

