



ACCESSORIES

PRICING EFFECTIVE JUNE 1, 2026

Indiana
FURNITURE

Our Pledge to People + Our Planet.

We've been making wood furniture longer than just about anyone...and we want to be doing so for a long time to come. That's a large part of why we take a stewardship approach to our resources. We believe that environmental sustainability and business profits need not be mutually exclusive. They can and should exist side by side in a mutually beneficial relationship. And for more than a century, we've been showing how it's done.

We've proven our commitment to a sustainable future by supporting the standards and programs that protect our home planet and human health. Whether it's local sourcing, reducing contaminants, implementing wellness and safety programs, or diverting waste from landfills, social responsibility is a part of every decision we make at Indiana Furniture.

One of the surest ways to reduce our impact on the planet is to make and buy things that last. And this one's a natural for us. Our products are made with craftsmanship and attention to detail that are a part of our legacy in wood manufacturing. And our products are backed by our 12-year warranty, which facilitates maintenance, servicing, and reassembly.

100% of our product lines:

- Are manufactured and assembled in the USA,
- Meet or exceed Indoor Air quality standards*,
- Meet or exceed BIFMA level® Sustainability standards and certification*,
- Conform to the BIFMA Compliance standards and certification*,
- Comply with TSCA Title VI (CARB) standards,
- and can contribute to LEED®, Green Globes®, and WELL® Sustainable Programs.



Specification Made Easy.

Whether you're looking to specify your office spaces or simply to visualize them in the options and surface materials you are desiring, we make it easy. You can find the entire Indiana Furniture portfolio on the following third-party, space-planning platforms.



To learn more, simply go to IndianaFurniture.com/resources.

Accessories

Grommets



Power + Coordinating Accessories

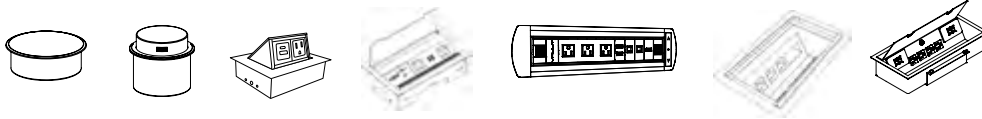

Power Units with Accessories

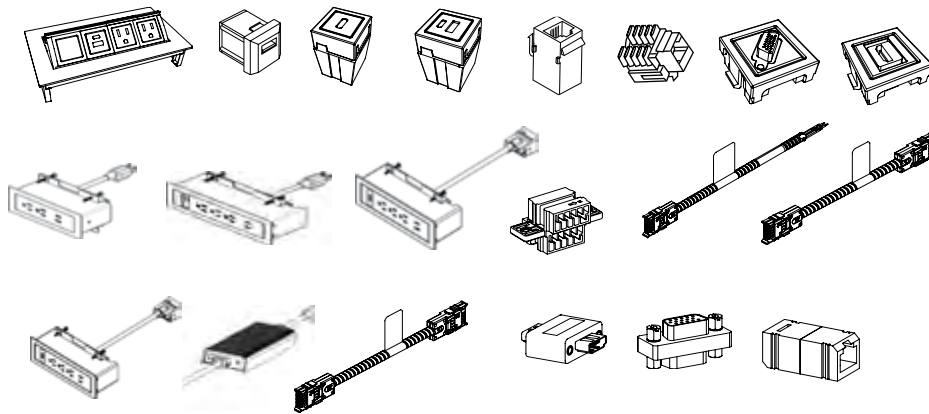

Wire Management

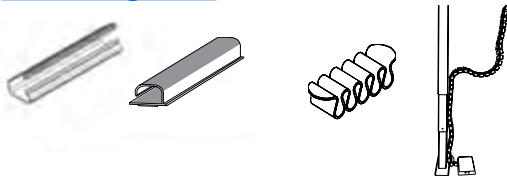

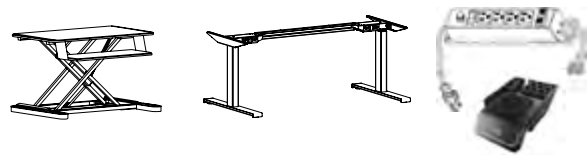

Height Adjust Components

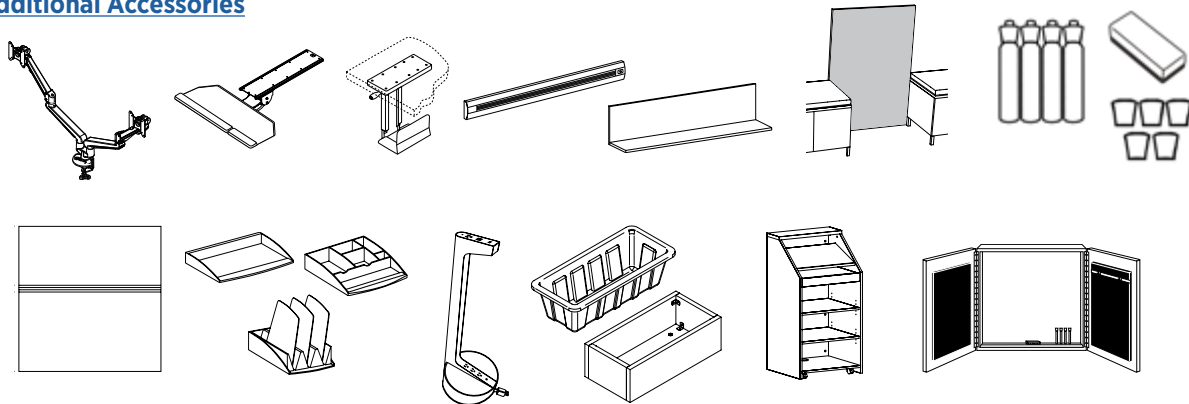

Additional Accessories

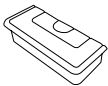

Item	Model No.		Width	Depth	Height	Ship Wt	Cubic Ft	List Price
ROUND GROMMET COVER FIELD INSTALLED	01-GRMTBK	Black	-	-	-	-	-	\$ 12
	01-GRMTSL	Silver						
 OPEN MARKET ONLY (SILVER)	Description <ul style="list-style-type: none"> • 60mm Round Grommet Cover • Field Installed 							
RECTANGULAR GROMMET	01-HUGRMTSL	Silver	-	-	-	1	.1	\$ 12
 OPEN MARKET ONLY	Description <ul style="list-style-type: none"> • For Use with Surface Mount Hatches Only • 70mm x 30mm Silver Rectangular Grommet with Cover • Field Installed 							
DOCK 950 WIRELESS CHARGER	01-DOCK950W	White	3 $\frac{3}{16}$	3 $\frac{3}{16}$	-	1	0.2	\$ 294
	01-DOCK950B	Black						
 OPEN MARKET ONLY	Description <ul style="list-style-type: none"> • For Use with Wireless Charging Enabled Devices • 5 Watts Maximum Output with a Direct Current of 5V 2A and 10 Watts Maximum with Quick Charge 2.0 • Mounts in 76mm Round Cut-Out • LED will Confirm Pairing with Device and Begin Wireless Charging 							
DOCK 150 WIRELESS AND USB CHARGER	01-DOCK150W	White	3	3	$\frac{3}{4}$	1	0.2	\$ 448
	01-DOCK150B	Black						
 OPEN MARKET ONLY	Description <ul style="list-style-type: none"> • For Use with Wireless Charging Enabled Devices and USB Charging Devices • 5 Watt Maximum Output with a Direct Current Input of 5V 6A (Wireless Fast Charge) • Mounts in 76mm Round Cut-Out • Pop-Up is $\frac{3}{4}$"H and Includes Three (3) USB Ports; One (1) 12 Watt Maximum with 2.4A (USB Fast Charge) and Two (2) 5 Watt with 1A (USB Standard Charge) • LED Light will Confirm Pairing with Device and Begin Wireless Charging • UL and cUL Certified 							

Item	Model No.		Width	Depth	Height	Ship Wt	Cubic Ft	List Price
POWER 440	01-DATA440A	Aluminum	5 $\frac{5}{16}$	4 $\frac{3}{8}$	—	5	0.2	\$ 1068
	01-DATA440B	Black						

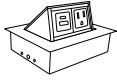
Description

- One (1) USB A+C and One (1) Power Outlets
- Soft Touch Hinged Lid
- 6' Power Cord

INTERACT POWER AND DATA	01-INTERACTG2A	Aluminum	9	5 $\frac{3}{8}$	2 $\frac{3}{4}$	5	0.2	\$ 987
	01-INTERACTG2B	Black						

Description

- Two (2) Power Outlets, USB-A+C Charging Ports, One (1) Data, One (1) Voice Telecom Plate Included
- Shown with Optional Telecom Plates; Sold Separately ([See Telecom Plates](#))
- Convenience Plug on Bottom
- 6' Power Cord
- UL and CSA Recognized

POWER AND DATA VAULT	01-CVAULTG2A	Silver	4 $\frac{1}{3}$	15 $\frac{7}{8}$	4 $\frac{1}{16}$	10	0.4	\$ 2154
----------------------	--------------	--------	-----------------	------------------	------------------	----	-----	---------



OPEN MARKET ONLY

Description

- Electric Drive Motor Rotates the Surface Technology 180° to the Proper Position
- Photo-Electronic Eye Prevents Rotation When Obstructed
- Two (2) Data Ports, Three (3) Power Outlets, One (1) HDMI and Two (2) 5V USB
- 6' Power Cord

OASIS MINI POWER & DATA	01-OASISMA	Aluminum	15	9	4 $\frac{15}{16}$	7	0.7	\$ 3535
	01-OASISMB	Black						

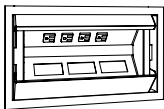

Top View

Description

- Includes Four (4) Power Outlets, Two (2) Data Ports, and One (1) Voice Telecom Plate
- Soft Touch Hinged Lid
- 9' Cord with Nema Plug; Fits 15A/120V AC Receptacles
- UL Listed
- Opening for One (1) Additional Telecom Plate; Sold Separately ([See Telecom Plates](#))

Item	Model No.		Width	Depth	Height	Ship Wt	Cubic Ft	List Price
POWER CENTER	01-INTRFC1A	Aluminum	14¼	6¾	3¾	11	0.3	\$ 2287
	01-INTRFC1B	Black						

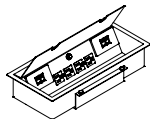

Description

- Four (4) Power Receptacles in Two (2) 15 Amp Duplexes
- One (1) 15 Amp Circuit Breaker
- One (1) Voice Port and Three (3) Data Ports
- One (1) Convenience Plug on Bottom
- 6' Foot Cord
- UL Listed/CSA Certified

NOTE: To order voice/data modules for your specific requirements contact the local computer or telecommunications installation service in your area.

DATA PORT 4	01-DPORT4A	Aluminum	8	4	—	7	0.2	\$ 1211
	01-DPORT4B	Black						

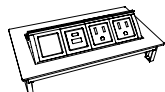

Description

- Includes: Two (2) Power Outlets, One (1) USB A+C, One (1) Open Port, 10' Power Cord, and Voice/Data Adapter Kit to Accept Couplers and Jacks When Required
- Retracts into Work Surface to Regain Productive Space; One-Touch Access to Power and Data
- Optional Telecom Port Components, See Compatible Units Below and On Next Page
- Water-Proof Simplex (Outlets)
- UL Recognized

USB PORT	01-USBPORT		-	-	-	-	-	\$ 178
----------	------------	--	---	---	---	---	---	--------



Description

- Passive USB-A Port with Increased Transfer Speed Up to 5 gbs/sec
- For Use with 01-DPORT4A and 01-DPORT4B
- Simultaneous Read/Write Capability
- Idle Device Power Saving State

PASSIVE USB-C ACCESSORY	01-PUSBC		-	-	-	1	0.2	\$ 105
-------------------------	----------	--	---	---	---	---	-----	--------



Description

- Passive USB-C Port ; Unit Provides Data Connection to Transfer Data Only, No Charging Capabilities
- Compatible with 01-DPORT4A and 01-DPORT4B
- Male/Female Connector

OPEN MARKET ONLY

Item	Model No.	Width	Depth	Height	Ship Wt	Cubic Ft	List Price
CHARGING USB-A+C ACCESSORY	01-USBAC	-	-	1	0.2		\$ 313



OPEN MARKET ONLY

Description

- For Charging Devices
- 20 Watt Power Supply
- USB+C Charging Port for 01-DPORT4A and 01-DPORT4B

VGA CONNECTOR ACCESSORY	01-VGACON	-	-	1	0.2		\$ 165
-------------------------	-----------	---	---	---	-----	--	--------

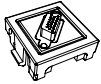

OPEN MARKET ONLY

Description

- VGA Port for 01-DPORT4A and 01-DPORT4B
- Enables Devices to Remote Display on Monitors
- 10' Cord
- Male/Female Connector

HDMI CONNECTOR ACCESSORY	01-HDMICON	-	-	1	0.2		\$ 137
--------------------------	------------	---	---	---	-----	--	--------



OPEN MARKET ONLY

Description

- HDMI Port for 01-DPORT4A and 01-DPORT4B
- Connects to High Definition Displays
- Female/Female Connector
- 18" Cord

VOICE COUPLER	01-VOICE1	-	-	-	-	-	\$ 80
---------------	-----------	---	---	---	---	---	-------

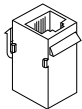

**Description**



- For Use with 01-DPORT4A and 01-DPORT4B
- 6-Pin Modular Plug
- Molded Black
- Cord Not included

DATA PORT	01-RJ4DATA	-	-	-	-	-	\$ 186
-----------	------------	---	---	---	---	---	--------

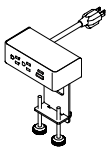
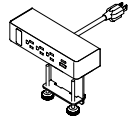
**Description**

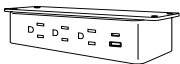
- For Use with 01-DPORT4A and 01-DPORT4B
- 8-Pin Modular Plug, Cat6 Ethernet Cable, Pre-terminated Cable
- 10' Cord

Item	Model No.		Width	Depth	Height	Ship Wt	Cubic Ft	List Price
DUO CLAMP WITH NEMA PLUG 	01-DUOCLAMPW	White	6½	3	7	1	0.2	\$ 634
	01-DUOCLAMPB	Black						
	01-DUOCLAMPS	Silver						
	Description <ul style="list-style-type: none"> Standard with: Two (2) Power Outlet, One (1) USB Charging Port and One (1) 60-Watt USB-C Power Delivery Port with GaN Technology with 10' Cord Clamps to Top and Features Silver Metal Trim Independent USB Circuit Controllers Deliver up to 2.1 Amps to Each Post All Mounting Hardware Included FCC Part 15A and UL Approved for Horizontal and Vertical Applications 							
TRIO CLAMP WITH NEMA PLUG 	01-TRIOCLAMPW	White	9	3	7	1	0.2	\$ 743
	01-TRIOCLAMPB	Black						
	01-TRIOCLAMPS	Silver						
	Description <ul style="list-style-type: none"> Standard with: Three (3) Power Outlets, One (1) USB Charging Port, One (1) 60-Watt USB-C Power Delivery Port with GaN Technology, One (1) Open Data with 10' Cord Clamps to Top and Features Silver Metal Trim Independent USB Circuit Controllers Deliver up to 2.1 Amps to Each Post HDMI, VGA, or RJ45 Sold Separately; See Accessories All Mounting Hardware Included FCC Part 15A and UL Approved for Horizontal and Vertical Applications 							
UNDERMOUNT DUO WITH NEMA PLUG 	01-DUOUNDERW	White	6½	2½	3	1	0.2	\$ 605
	01-DUOUNDERB	Black						
	01-DUOUNDERS	Silver						
	Description <ul style="list-style-type: none"> Sits Under Worksurface and Includes: Two (2) Power, One (1) USB Charging Port and One (1) 60-Watt USB-C Power Delivery Port with GaN Technology with 10' Cord All Mounting Hardware Independent USB Circuit Controllers Deliver up to 2.1 Amps to Each Post FCC Part 15A, UL Approved for Horizontal and Vertical Applications 							
UNDERMOUNT TRIO WITH NEMA PLUG 	01-TRIOUNDERW	White	9	2½	3	1	0.2	\$ 726
	01-TRIOUNDERB	Black						
	01-TRIOUNDERS	Silver						
	Description <ul style="list-style-type: none"> Sits Under Worksurfaces and Includes: Three (3) Power, One (1) USB Charging Port, One (1) 60-Watt USB-C Power Delivery Port with GaN Technology, One (1) Open Port and 10' Cord, All Mounting Hardware HDMI, VGA, or RJ45 Accessory for Open Port Specified Separately, See Accessories Independent USB Circuit Controllers Deliver up to 2.1 Amps to Each Post FCC Part 15A, UL Approved for Horizontal and Vertical Applications 							

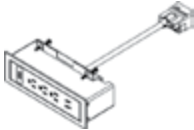
Item	Model No.		Width	Depth	Height	Ship Wt	Cubic Ft	List Price	
DUO BEZEL WITH NEMA PLUG 	01-DUOBEZELW	White	6½	2⅝	3	1	0.2	\$ 748	
	01-DUOBEZELB	Black							
	01-DUOBEZELS	Silver							
	Description								
<ul style="list-style-type: none"> Sits On Top of the Worksurface and Includes: Two (2) Power, One (1) USB Charging Port and One (1) 60-Watt USB-C Power Delivery Port with GaN Technology with 10' Cord Independent USB Circuit Controllers Deliver up to 2.1 Amps to Each Post All Mounting Hardware Included FCC Part 15A and UL Approved for Horizontal and Vertical Applications 									
TRIO BEZEL WITH NEMA PLUG 	01-TRIOBEZELW	White	9	2⅝	3	1	0.2	\$ 803	
	01-TRIOBEZELB	Black							
	01-TRIOBEZELS	Silver							
	Description								
<ul style="list-style-type: none"> Sits On Top of the Worksurface and Includes: Three (3) Power, One (1) USB Charging Port and One (1) 60-Watt USB-C Power Delivery Port with GaN Technology, One (1) Open Data, and 10' Cord Independent USB Circuit Controllers Deliver up to 2.1 Amps to Each Post HDMI, VGA, or RJ45 Sold Separately; See Accessories All Mounting Hardware Included FCC Part 15A and UL Approved for Horizontal and Vertical Applications 									
DUO BEZEL WITH HARD WIRE CONNECTION 	Circuit 1								
	01-HWDUOBEZELW1	White	6½	2⅝	3	1	0.2	\$ 809	
	01-HWDUOBEZELB1	Black							
	01-HWDUOBEZELS1	Silver							
	Circuit 2								
	01-HWDUOBEZELW2	White	6½	2⅝	3	1	0.2	\$ 809	
	01-HWDUOBEZELB2	Black							
	01-HWDUOBEZELS2	Silver							
	Circuit 3								
	01-HWDUOBEZELW3	White	6½	2⅝	3	1	0.2	\$ 809	
	01-HWDUOBEZELB3	Black							
	01-HWDUOBEZELS3	Silver							
	Circuit 4								
	01-HWDUOBEZELW4	White	6½	2⅝	3	1	0.2	\$ 809	
	01-HWDUOBEZELB4	Black							
	01-HWDUOBEZELS4	Silver							
Description									
<ul style="list-style-type: none"> Must Specify Color and Circuit Sits on worksurface and Includes: Two (2) Power, One (1) USB Charging Port and One (1) 60-Watt USB-C Power Delivery Port with GaN Technology, and All Mounting Hardware Independent USB Circuit Controllers Deliver up to 2.1 Amps to Each Post FCC Part 15A and UL Approved for Horizontal and Vertical Applications Maximum 10 Duo Units per Circuit Eight (8) Wire/Four (4) Circuit Hard Wire Power Unit See Power Entry, Jumper Cable, and Quad Block on Next Page 									

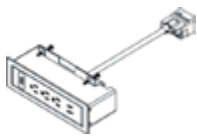
Item	Model No.		Width	Depth	Height	Ship Wt	Cubic Ft	List Price	
TRIO BEZEL WITH HARD WIRE CONNECTION 	Circuit 1								
	01-HWTRIOBEZELW1	White	9	2½	3	1	0.2	\$ 830	
	01-HWTRIOBEZELB1	Black							
	01-HWTRIOBEZELS1	Silver							
	Circuit 2								
	01-HWTRIOBEZELW2	White	9	2½	3	1	0.2	\$ 830	
	01-HWTRIOBEZELB2	Black							
	01-HWTRIOBEZELS2	Silver							
	Circuit 3								
	01-HWTRIOBEZELW3	White	9	2½	3	1	0.2	\$ 830	
	01-HWTRIOBEZELB3	Black							
	01-HWTRIOBEZELS3	Silver							
	Circuit 4								
	01-HWTRIOBEZELW4	White	9	2½	3	1	0.2	\$ 830	
	01-HWTRIOBEZELB4	Black							
	01-HWTRIOBEZELS4	Silver							

Description

- Must Specify Color and Circuit
- Sits on Worksurface and Includes: Three (3) Power, One (1) USB Charging Port and One (1) 60-Watt USB-C Power Delivery Port with GaN Technology, and All Mounting Hardware
- Independent USB Circuit Controllers Deliver up to 2.1 Amps to Each Post
- FCC Part 15A and UL Approved for Horizontal and Vertical Applications
- Maximum 6 Trio Units per Circuit
- Eight (8) Wire/Four (4) Circuit Hard Wire Power Unit
- HDMI, VGA, or RJ45 Sold Separately; [See Accessories](#)
- See Power Entry, Jumper Cable, and Quad Block Below and on Next Page

POWER ENTRY FOR HARD WIRE CONNECTION

01-HWPOWERENTRY		72	-	-	1	0.2	\$ 357
-----------------	--	----	---	---	---	-----	--------

Description

- Eight (8) Wire/Four (4) Circuit Hard Wire Infeed
- UL183 Compliant

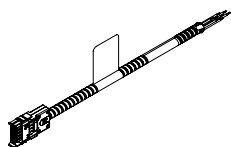

JUMPER CABLE FOR HARD WIRE CONNECTION

01-HW2JUMP		24	-	-	1	0.2	\$ 213
01-HW3JUMP		36	-	-	1	0.2	\$ 228
01-HW4JUMP		48	-	-	1	0.2	\$ 235
01-HW5JUMP		60	-	-	1	0.2	\$ 282
01-HW6JUMP		72	-	-	1	0.2	\$ 299

Description

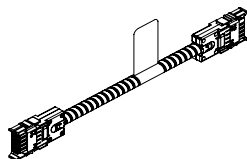
- Eight (8) Wire/Four (4) Circuit Hard Wire Jumper
- UL183 Compliant

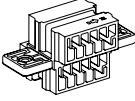
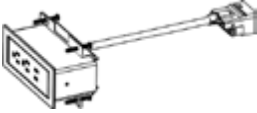
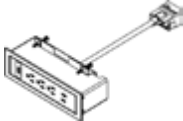

Item	Model No.		Width	Depth	Height	Ship Wt	Cubic Ft	List Price
QUAD BLOCK FOR HARD WIRE CONNECTION	01-HWQUADBLOCK					1	0.2	\$ 69
	Description							
	<ul style="list-style-type: none"> • Eight (8) Wire/Four (4) Circuit Hard Wire Connector • UL183 Compliant • For Connecting Jumpers and Power Units • Quantity of Four (4) Female Inputs 							
DUO BEZEL WITH PURL DAISY CHAIN PLUG	01-DCDUOBEZELW	White	6½	2⅝	3	1	0.2	\$ 631
	01-DCDUOBEZELB	Black						
	01-DCDUOBEZELS	Silver						
	Description							
	<ul style="list-style-type: none"> • Standard with: Two (2) Tamper Resistant 15 Amp Power Outlets, One (1) USB-A Charging Port and One (1) 60-Watt USB-C Power Delivery Port with GaN Technology, 10' Cord and All Mounting Hardware • Top Must Be Routed To Allow Unit to Sit Down Into the Top, Must Specify when Ordering Top • Unit Supported By Attractive Slim Fit Bezel • Requires Purl Daisy Chain Power Infeed, Specified Separately (See Details) • Non-Sequential System Allows up to Nine (9) Modules to be Connected with H-Block (See Below) and Jumper Cord (See Details) • Independent USB Circuit Controllers Deliver up to 2.4 Amps to Each Post • FCC Part 15A, RU Listed and UL Recognized for Horizontal and Vertical Applications 							
TRIO BEZEL WITH PURL DAISY CHAIN PLUG	01-DCTRIOBEZELW	White	9	2⅝	3	1	0.2	\$ 723
	01-DCTRIOBEZELB	Black						
	01-DCTRIOBEZELS	Silver						
	Description							
	<ul style="list-style-type: none"> • Standard with: Three (3) Tamper Resistant 15 Amp Power Outlets, One (1) USB-A Charging Port, One (1) 60-Watt USB-C Power Delivery Port with GaN Technology, One (1) Open Data, 12" Cord and All Mounting Hardware • Top Must Be Routed To Allow Unit to Sit Down Into the Top, Must Specify when Ordering Top • Unit Supported By Attractive Slim Fit Bezel • Requires Purl Daisy Chain Power Infeed, Specified Separately (See Details) • Non-Sequential System Allows up to Nine (9) Modules to be Connected with H-Block and Jumper Cord (See Details) • Independent USB Circuit Controllers Deliver up to 2.4 Amps to Each Post • FCC Part 15A, RU Listed and UL Recognized for Horizontal and Vertical Applications HDMI, VGA, or RJ45 Sold Separately (See Accessories) 							

Item	Model No.	Width	Depth	Height	Ship Wt	Cubic Ft	List Price
PURL DAISY CHAIN POWER INFEEED	01-DCPOWER	-	-	-	1	0.2	\$ 227

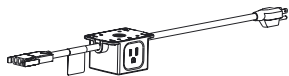

Description

- One (1) Purl Connector Plug, 36" Daisy Chain Cord, One (1) 15 Amp Power Outlet, and a 120" Power Cord with a Nema Plug
- Powers up to Nine (9) Duo and Trio Purl Daisy Chain Units
- 15-Amp System Rating and Over-Current Protection
- System Requires H-BLOCK Connector Between Power Infeed and Each Jumper Cord, See Below For Purl Daisy Chain H-Block and Purl Daisy Chain Jumper Cords Details

PURL DAISY CHAIN H-BLOCK	01-DCHBLOCK	-	-	-	1	0.2	\$ 40
--------------------------	-------------	---	---	---	---	-----	-------

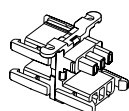

Description

- Includes One (1) Power In and Three (3) Power Out Receptacles
- System Requires H-BLOCK Connector Between Power Infeed and Each Jumper Cord, See Purl Daisy Chain Power Infeed (Above) and Jumper Cords (See Below)

PURL DAISY CHAIN JUMPER CORD	01-DC2JUMP	<i>24" Long</i>	-	-	-	1	0.2	\$ 72
	01-DC3JUMP	<i>36" Long</i>	-	-	-	1	0.2	\$ 77
	01-DC4JUMP	<i>48" Long</i>	-	-	-	1	0.2	\$ 82
	01-DC5JUMP	<i>60" Long</i>	-	-	-	1	0.2	\$ 87
	01-DC6JUMP	<i>72" Long</i>	-	-	-	1	0.2	\$ 92

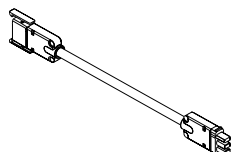

Description

- Connects Duo and Trio Daisy Chain Units
- Non-Sequential System Allows up to None (9) Modules to be Connected

HDMI DATA PORT ACCESSORY	01-LCOMHDMI	-	-	-	1	0.2	\$ 183
--------------------------	-------------	---	---	---	---	-----	--------

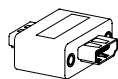

Description

- HDMI Port for Trio Clamp and Trio Bezel Units

OPEN MARKET ONLY

Item	Model No.	Width	Depth	Height	Ship Wt	Cubic Ft	List Price
VGA DATA PORT ACCESSORY	01-LCOMVGA	-	-	-	1	0.2	\$ 134

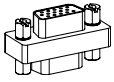
Description

- VGA Port for Trio Clamp and Trio Bezel Units

RJ45 DATA PORT ACCESSORY	01-LCOMRJ45	-	-	-	1	0.2	\$ 88
--------------------------	-------------	---	---	---	---	-----	-------

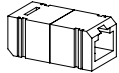
Description

- RJ45 Port for Trio Clamp and Trio Bezel Units

WIRE MANAGEMENT CHANNEL	01-WMGR4	16	1½	1	1	-	\$ 129
-------------------------	----------	----	----	---	---	---	--------

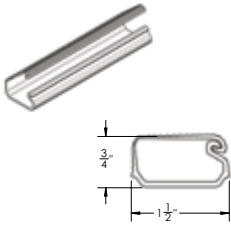
Description

- Set of Four (4) Black Plastic Wire Management Channels
- Snap Lock Channel
- Attaches with Adhesive Strips
- Ships via UPS Only

WIRE CHANNEL	01-32125	24	1 5/8	1	.25	0.3	\$ 117
--------------	----------	----	-------	---	-----	-----	--------

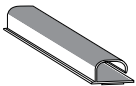
Description

- Available in Black
- Channels Attach with Two (2) Double-Sided Installation Tape
- Open J Channel for Easy Storage of Cables

CABLE GRIP	01-WMGRCB	5 3/8	1½	-	-	-	\$ 19
------------	-----------	-------	----	---	---	---	-------

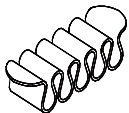

INSTALLATION VIEW

Description

- Under Surface Wire Management
- Black

Item	Model No.		Width	Depth	Height	Ship Wt	Cubic Ft	List Price
LINK 360 CABLE MANAGER	01-0251LINKSLV	Silver	5 3/16	3 3/16	30-51	4	3.0	\$ 432
	01-0251LINKBLK	Black	5 3/16	3 3/16	30-51	4	3.0	\$ 391

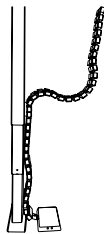

Description

- Kit Includes: 50 Link 360™ elements, One (1) Quad Connector, One (1) Dumbbell Connector, One (1) Foot Assembly with Two (2) Magnetic Clips
- Can Be Used For Height-Adjustable Mechanisms Up To 51" or Free-Standing Use

HEIGHT ADJUSTABLE WORKSTATION	01-S2SBLK	Black	35 1/2	25	6-22	49	6.5	\$ 1666
-------------------------------	-----------	-------	--------	----	------	----	-----	---------

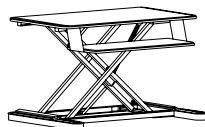

Description

- Height Adjustable
- Weight Capacity: 35lbs
- One-Handed Operation; Platforms Move Simultaneously
- Keyboard Platform: 10 1/2"D x 26 4/8"W
- Worksurface: 21"D x 35 1/2"W
- Can be Used on Worksurface 24"D x 35"W

28"D ELECTRIC HEIGHT ADJUSTABLE TABLE LIFT	01-2854ELB	Black	54-78	28	22-48	30	2.4	\$ 2029
	01-2854ELA	Silver						

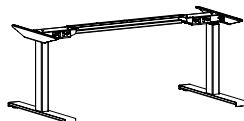

Description

- Standard with Up/Down Control Switch, 10.5' Power Cord, Integrated Anti-Collision Feature, Leveling Glides
- Standard Up/Down Control Switch can be Mounted for Left or Right Users; Upgrade to Advanced Memory Switch (01-MSWCH with Memory, Reminders, and Bluetooth), Must Specify and See Below for Details
- Adjusts to Accommodate Tops 54-78"W and 30"-36"D; Tops Sold Separately
- Lifting Capacity (Including Worksurface): 363 lbs
- Some Assembly Required; Installation Instructions Included

22"D ELECTRIC HEIGHT ADJUSTABLE TABLE LIFT	01-2254ELB	Black	54-78	22	22-48	58	2.4	\$ 2029
	01-2254ELA	Silver						



Description

- Standard with Up/Down Control Switch, 10.5' Power Cord, Anti-Collision Safety Feature, Leveling Glides
- Standard Up/Down Control Switch can be Mounted for Left or Right Users; Upgrade to Advanced Memory Switch (01-MSWCH with Memory, Reminders, and Bluetooth), Must Specify and See Below for Details
- Adjusts to Accommodate Tops 54-78"W and 24"D; Tops Sold Separately
- Lifting Capacity (Including Worksurface): 363 lbs
- Some Assembly Required; Installation Instructions Included

Item	Model No.		Width	Depth	Height	Ship Wt	Cubic Ft	List Price
22"D ELECTRIC HEIGHT ADJUSTABLE TABLE LIFT	01-2242ELB	Black	42-48	22	22-48	55	2.4	\$ 2029
	01-2242ELA	Silver						

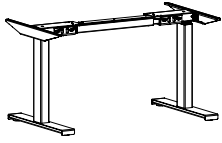

Description

- Standard with Up/Down Control Switch, 10.5' Power Cord, Anti-Collision Safety Feature, Leveling Glides
- Standard Up/Down Control Switch can be Mounted for Left or Right Users; Upgrade to Advanced Memory Switch (01-MSWCH with Memory, Reminders, and Bluetooth), Must Specify and See Below for Details
- Adjusts to Accommodate Tops 42-48"W and 24"D; Tops Sold Separately
- Lifting Capacity (Including Worksurface): 363 lbs
- Some Assembly Required; Installation Instructions Included

ELECTRIC HEIGHT ADJUSTABLE ADVANCED SWITCH WITH MEMORY	01-MSWCH		3 $\frac{1}{8}$	4 $\frac{3}{8}$	1 $\frac{1}{8}$	$\frac{1}{2}$	0.8	\$ 247
--	----------	--	-----------------	-----------------	-----------------	---------------	-----	--------



Description

- Black Unit with Black Cord
- Bluetooth Capabilities
- Three Stand-Up Reminders
- Four Height Memory Positions

OPEN MARKET ONLY

POWER STRIP	01-PRSP		9	2	2	1	-	\$ 227
-------------	---------	--	---	---	---	---	---	--------

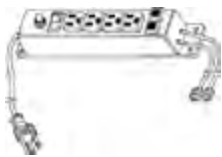

Description

- Includes Four (4) Outlets and Two (2) Phone Jacks
- Black Plastic with Rocker On/Off Switch
- 13 Amp Circuit Breaker
- 10' Power Cord and Two (2) 14' Phone Hook Up Cords
- UL Listed and CSA Certified
- Suitable for Surface or Recessed Mounting

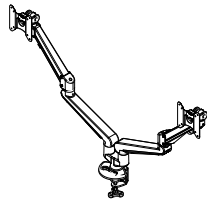
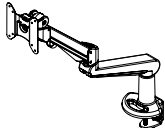
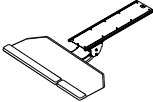
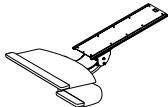
Item	Model No.		Width	Depth	Height	Ship Wt	Cubic Ft	List Price
DUAL ARTICULATING MONITOR ARM	01-MLEDGE2A	Aluminum	-	-	-	15	1.4	\$ 1454
	01-MLEDGE2B	Black						
	Description							
	<ul style="list-style-type: none"> • Includes Desk Clamp and Grommet Mount • Dual Mount with Independent Adjustment • 180° Lockout Feature. 6.5"H to 19.5"H Adjustment • 21" Monitor Extension, 3.5" Monitor Retraction • +30/-25° Monitor Tilt; 360° Swivel at Two Points • 17.6lb Weight Capacity per Arm • Enclosed Cable Management • VESA 75mm and VESA 100mm Compatible with Quick Monitor Release 							
SINGLE MONITOR ARM	01-MLEDGE1A	Aluminum	-	-	-	13	2.2	\$ 857
	01-MLEDGE1B	Black						
	Description							
	<ul style="list-style-type: none"> • Includes Desk Clamp and Grommet Mount • 180° Lockout Feature, 6.5"H to 19.5"H Adjustment • 21" Monitor Extension, 3.5" Monitor Retraction • +30/-25° Monitor Tilt • 17.6lb Weight Capacity • Enclosed Cable Management • VESA 75mm and VESA 100mm Compatible with Quick Monitor Release 							
ARTICULATING KEYBOARD CORNER PLATFORM	01-KB2CC		25	10½	4½	16	1.4	\$ 921
	Description							
	<ul style="list-style-type: none"> • Works with 17"+ Diagonal Work Surface; 25" Cut Corner Platform • Keyboard and Mouse on Same Level with Single Palm Rest on Both Sides • +/- 15° Tilt Adjustment & 360° Rotation • Independent Tilt Adjustment; Lift & Lock 7"H Adjustment • Cannot Be Used on 20"D Unit • Not Available with Optional Center Grommet • Track Measures 21" 							
	Options: Specify & Add							
	KB2CC	Factory Installed						\$ 231
KEYBOARD MECHANISM WITH KEYBOARD PLATFORM AND MOUSE TRAY AND PALM REST	01-KB3		26½	14	4.5	16	1.4	\$ 1012
	Description							
	<ul style="list-style-type: none"> • 18¾" Platform with Swivel-Below Mouse Platform • Palm Rest for Mousing Surface • +/- 15° Tilt Adjustment & 360° Rotation • Independent Tilt Adjustment; Lift & Lock 7"H Adjustment • Cannot Be Used on 20" Deep Unit • Left or Right Handed Mouse Platform • Not Available with Optional Center Grommet • Track Measures 21" 							
	Options: Specify & Add							
	KB3	Factory Installed						\$ 231

Item	Model No.		Width	Depth	Height	Ship Wt	Cubic Ft	List Price
CPU HOLDER	01-CPUMINIA	Aluminum	-	-	-	16	.4	\$ 429

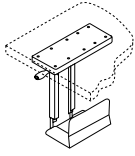

Description

- Vertically Mounts to Undersurface; No Tools Required for Adjustment
- 360° Swivel
- 13 $\frac{3}{8}$ " Ball Bearing Glide Track
- 3 $\frac{1}{4}$ "W-6"W and 16"H - 23"H Adjustment
- 55lb Load Capacity
- Fits CPU's 5"H - 20"H Overall Height

LED TASKLIGHT	TL-0824		22 $\frac{1}{2}$	$\frac{7}{8}$	1 $\frac{5}{8}$	-	-	\$ 408
	<i>84-LED, 7 Watts</i>							
	TL-0848		47 $\frac{1}{2}$	$\frac{7}{8}$	1 $\frac{5}{8}$	-	-	\$ 493
	<i>240-LED, 18 Watts</i>							

Description

- Includes the Power Supply and Three (3) Upper Wire Management Grommet
- Rocker Style On/Off Switch with 10' Power Cord
- Grommet Color will Match Lower Grommet Color

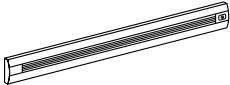
LED TASKLIGHT	01-47LED17		16 $\frac{3}{8}$	2	$\frac{3}{4}$	-	-	\$ 765
	<i>24-LED, 9.1 Watts</i>							
	01-94LED31		30 $\frac{1}{8}$	2	$\frac{3}{4}$	-	-	\$ 1323
	<i>48-LED, 17.6 Watts</i>							
	01-188LED58		57 $\frac{3}{8}$	2	$\frac{3}{4}$	-	-	\$ 1825
<i>96-LED, 33.7 Watts</i>								

Description

- Includes the Power Supply and Three (3) Upper Wire Management Grommet
- 12' Power Cord
- Grommet Color will Match Lower Grommet Color
- Optional Occupancy Sensor Shuts Off After 30 Minutes of Inactivity and Turns On Immediately When Reentering the Detection Area

Options: Specify & Add

01-OSRP	Occupancy Sensor							\$ 405
---------	------------------	--	--	--	--	--	--	--------

Item	Model No.		Width	Depth	Height	Ship Wt	Cubic Ft	List Price
L SHELF  Must Specify (in this order): Model # Color	66-1530LS	64 lbs Weight Limit	30	15	17	30	6.0	T\$ 592
	66-1536LS	64 lbs Weight Limit	36	15	17	35	7.1	T\$ 652
	66-1542LS	90 lbs Weight Limit	42	15	17	40	8.2	T\$ 712
	66-1548LS	90 lbs Weight Limit	48	15	17	45	9.3	T\$ 769
	66-1554LS	90 lbs Weight Limit	54	15	17	50	10.5	T\$ 825
	66-1560LS	128 lbs Weight Limit	60	15	17	55	11.6	T\$ 884
	66-1566LS	128lbs Weight Limit	66	15	17	60	12.7	T\$ 943
	66-1572LS	154 lbs Weight Limit	72	15	17	65	13.8	T\$ 1000
	66-1578LS	154 lbs Weight Limit	78	15	17	70	14.9	T\$ 1062
	66-1584LS	154 lbs Weight Limit	84	15	17	75	16.0	T\$ 1121
	66-1590LS	192 lbs Weight Limit	90	15	17	80	17.2	T\$ 1182
	66-1596LS	192 lbs Weight Limit	96	15	17	85	18.3	T\$ 1244

Description

- Weight Capacity is a Distributed Load
- Not Liable for Wall Mount Units that are not Properly Installed

Item	Model No.		Width	Depth	Height	Ship Wt	Cubic Ft	List Price
FLOATING SHELF  Must Specify (in this order): Model # Color	66-0930FS	40 lbs Weight Limit	30	9	1	6	0.7	T\$ 403
	66-0936FS	40 lbs Weight Limit	36	9	1	8	0.8	T\$ 446
	66-0942FS	57 lbs Weight Limit	42	9	1	9	0.9	T\$ 492
	66-0948FS	57 lbs Weight Limit	48	9	1	10	1.1	T\$ 536
	66-0954FS	57 lbs Weight Limit	54	9	1	12	1.3	T\$ 580
	66-0960FS	82 lbs Weight Limit	60	9	1	13	1.4	T\$ 621
	66-0966FS	82 lbs Weight Limit	66	9	1	14	1.5	T\$ 666
	66-0972FS	99 lbs Weight Limit	72	9	1	16	1.6	T\$ 711
	66-0978FS	99 lbs Weight Limit	78	9	1	16	1.8	T\$ 746
	66-0984FS	99 lbs Weight Limit	84	9	1	18	1.9	T\$ 780
	66-0990FS	123 lbs Weight Limit	90	9	1	19	2.1	T\$ 817
	66-0996FS	123 lbs Weight Limit	96	9	1	20	2.2	T\$ 852

Description

- Weight Capacity is a Distributed Load
- Not Liable for Wall Mount Units that are not Properly Installed

ACCESSORIES

MAGNETIC GLASS MARKER BOARDS

Item	Model No.	Width	Depth	Height	Ship Wt	Cubic Ft	List Price
MAGNETIC GLASS MARKER BOARD	GMB-5230W	30	½	52¾	54	9.5	\$ 2705
COORDINATES WITH 30"H DESKS AND CREDENZA AND TALL WALL MOUNT HUTCHES OR SHELVING	GMB-5236W	36	½	52¾	65	10.8	\$ 3218
	GMB-5242W	42	½	52¾	76	12.2	\$ 3732
	GMB-5248W	48	½	52¾	86	13.5	\$ 4419

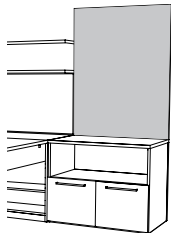

Description

- Available in Black (BLMKR) or White (WHMKR), Must Specify
- Mounting Brackets Included
- Coordinates With Tall Surface or Wall Mount Hutches
- See Rare Earth Magnets, Marker and Eraser Sets Below
- Find Additional Magnetic Glass Marker Boards in Casegoods Collections

Must Specify (in this order):

Model #
Color

MAGNETIC GLASS MARKER BOARD	GMB-5130W	30	½	51¾	53	9.3	\$ 2608
FOR USE FROM FLOOR TO TOP OF UNIT	GMB-7030W	30	½	70¾	72	12.1	\$ 3562
	GMB-8230W	30	½	82¾	85	13.8	\$ 4132
	GMB-5136W	36	½	51¾	63	10.6	\$ 3104
	GMB-7036W	36	½	70¾	87	13.8	\$ 4248
	GMB-8236W	36	½	82¾	102	15.8	\$ 4934

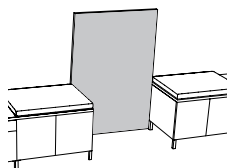

Description

- Available in Black (BLMKR) or White (WHMKR), Must Specify
- Marker Boards Are One (1) Piece with No Seams
- Mounting Brackets Included
- See Rare Earth Magnets, Marker and Eraser Sets Below
- Find Additional Magnetic Glass Marker Boards in Casegoods Collections

Must Specify (in this order):

Model #
Color

MARKER AND ERASER SET	01-MRKRSETBL	For Use with Black Marker Boards and Black Glass Doors	\$ 136
	01-MRKRSETWH	For Use with White Marker Boards and White Glass Doors	



Description

- 01-MRKRSETWH May Also be Used with Standard Dry Erase Doors and Boards
- Includes Four (4) Markers and an Eraser

RARE EARTH MAGNET SET	01-MAGBL	Black Magnets	\$ 127
	01-MAGWH	White Magnets	



Description

- Includes Set of Five (5) Rare Earth Magnets
- To be Used with Tempered Glass Magnetic Marker Boards
- Comfort Grip with Stylish Protective Plastic Coating

23" TALL TOOL RAIL WORK WALL

FOR SURFACE OR WALL MOUNT HUTCHES AND 30"H CREDENZA

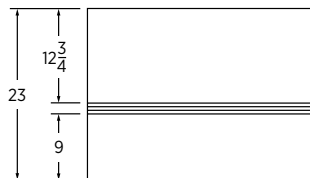

Must Specify (in this order):

- Model #
- Tackboard on Top or Bottom
- Dry Erase on Top or Bottom
- Tackboard Fabric Vendor, Pattern, and Color

Tackboard/Dry Erase Locations

- TB-TB: Tackboard Over Tackboard (Use Grade Prices)
- DEB-TB: Dry Erase Over Tackboard (Use Grade Prices)
- DEB-DEB: Dry Erase Over Dry Erase (Use Grade 1 Prices)

Model #	Size	COM ydg	COM, 1, 2 or 3	Grades												
				4	5	6	7	8	9	10						
WW-2330TRH	30"	1.00	\$ 743	898	971	1044	1149	1258	1386	1533						
WW-2336TRH	36"	1.25	\$ 805	999	1090	1181	1313	1449	1609	1793						
WW-2342TRH	42"	1.25	\$ 826	1020	1111	1202	1334	1470	1630	1814						
WW-2348TRH	48"	1.50	\$ 893	1126	1235	1345	1502	1666	1858	2078						
WW-2354TRH	54"	1.75	\$ 982	1253	1381	1509	1693	1883	2107	2365						
WW-2360TRH	60"	2.00	\$ 1008	1318	1464	1610	1820	2038	2294	2588						
WW-2366TRH	66"	2.00	\$ 1071	1381	1527	1673	1883	2101	2357	2651						
WW-2372TRH	72"	2.25	\$ 1134	1483	1647	1811	2048	2293	2581	2912						
WW-2378TRH	78"	2.50	\$ 1423	1811	1993	2176	2438	2711	3031	3398						
WW-2384TRH	84"	2.50	\$ 1478	1866	2048	2231	2493	2766	3086	3453						
WW-2390TRH	90"	2.75	\$ 1630	2056	2257	2458	2747	3046	3398	3803						
WW-2396TRH	96"	3.00	\$ 1734	2199	2418	2637	2952	3279	3663	4104						
WW-23102TRH	102"	3.25	\$ 1811	2315	2552	2789	3131	3485	3901	4379						
WW-23108TRH	108"	3.50	\$ 1900	2443	2698	2954	3321	3703	4151	4665						

Description

- Aluminum Tool Rail
- Work Walls 78" and Larger will Ship in 4 Pieces
- See Work Wall Accessories on Next Page

31" TALL TOOL RAIL WORK WALL

FOR USE WITH WALL MOUNT HUTCHES AND 21"H CREDENZA

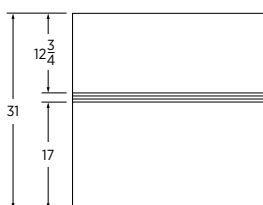

Must Specify (in this order):

- Model #
- Tackboard on Top or Bottom
- Dry Erase on Top or Bottom
- Tackboard Fabric Vendor, Pattern, and Color

Tackboard/Dry Erase Locations

- TB-TB: Tackboard Over Tackboard (Use Grade Prices)
- DEB-TB: Dry Erase Over Tackboard (Use Grade Prices)
- DEB-DEB: Dry Erase Over Dry Erase (Use Grade 1 Prices)

Model #	Size	COM ydg	COM, 1, 2 or 3	Grades												
				4	5	6	7	8	9	10						
WW-3130TTRW	30"	1.00	\$ 959	1114	1187	1260	1365	1474	1602	1749						
WW-3136TTRW	36"	1.25	\$ 1041	1235	1326	1417	1549	1685	1845	2029						
WW-3142TTRW	42"	1.25	\$ 1064	1258	1349	1440	1572	1708	1868	2052						
WW-3148TTRW	48"	1.50	\$ 1156	1389	1498	1608	1765	1929	2121	2341						
WW-3154TTRW	54"	1.75	\$ 1260	1531	1659	1787	1971	2161	2385	2643						
WW-3160TTRW	60"	2.00	\$ 1319	1629	1775	1921	2131	2349	2605	2899						
WW-3166TTRW	66"	2.00	\$ 1402	1712	1858	2004	2214	2432	2688	2982						
WW-3172TTRW	72"	2.25	\$ 1460	1809	1973	2137	2374	2619	2907	3238						
WW-3178TTRW	78"	2.50	\$ 1756	2144	2326	2509	2771	3044	3364	3731						
WW-3184TTRW	84"	2.50	\$ 1837	2225	2407	2590	2852	3125	3445	3812						
WW-3190TTRW	90"	2.75	\$ 2054	2480	2681	2882	3171	3470	3822	4227						
WW-3196TTRW	96"	3.00	\$ 2181	2646	2865	3084	3399	3726	4110	4551						
WW-31102TTRW	102"	3.25	\$ 2264	2768	3005	3242	3584	3938	4354	4832						
WW-31108TTRW	108"	3.50	\$ 2392	2935	3190	3446	3813	4195	4643	5157						

Description

- Aluminum Tool Rail
- Work Walls 78" and Larger will Ship in 4 Pieces
- See Work Wall Accessories on Next Page

Item	Model No.		Width	Depth	Height	Ship Wt	Cubic Ft	List Price
LEGAL TRAY	01-LGLTRAYC	Clear	14 $\frac{7}{8}$	10 $\frac{1}{2}$	1 $\frac{1}{8}$			\$ 128

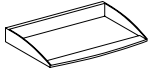

FOLDER SORTER	01-FLDRSRTRC	Clear	7 $\frac{1}{4}$	12 $\frac{3}{8}$	7 $\frac{1}{8}$			\$ 143
---------------	--------------	-------	-----------------	------------------	-----------------	--	--	--------

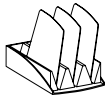

ACCESSORIES TRAY	01-ACCTRAYC	Clear	9 $\frac{1}{4}$	10 $\frac{1}{8}$	1 $\frac{1}{8}$			\$ 138
------------------	-------------	-------	-----------------	------------------	-----------------	--	--	--------

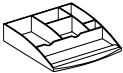

VESTA POWER CENTER	01-PDCTR		10 $\frac{3}{4}$	12	28 $\frac{1}{4}$	14	2.5	\$ 1968
--------------------	----------	--	------------------	----	------------------	----	-----	---------



Description

- Top Includes One (1) Power Outlet, Two (2) USB Ports and One (1) USBC Port; Base Includes Three (3) Outlet
- Available in White
- 120" Power Cord
- Built with Weight Distribution for Optimal Stability
- Base is 5" Tall

Item	Model No.	Width	Depth	Height	Ship Wt	Cubic Ft	List Price
PLANTER BOX	01-1909PL	19¼	9½	6	16	2.0	T\$ 631

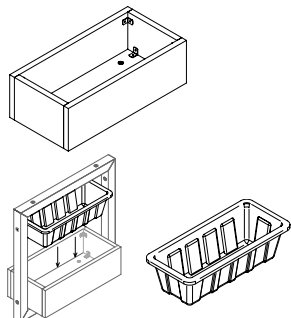

Description

- Material is TFL. Must Specify TFL (T) Color; [See Colors and Specify](#)
- Planter Will Ship with Attachment Hardware: Two (2) Black and Two (2) Nickel Bolts
- Horizontal Grain
- Planter Boxes Cannot be Installed on Both Sides of a Corner
- Optional Planter Box Insert Sold Separately

Option: Specify & Add

PBI	Planter Box Insert, Black Plastic	\$	58
-----	-----------------------------------	----	----

Must Specify (in this order):

- Model #
- TFL Color
- Optional Planter Insert

Item	Model No.	Width	Depth	Height	Ship Wt	Cubic Ft	List Price
VISUAL BOARD	66-4848VB	48	5	48	150	11.0	T\$ 3004

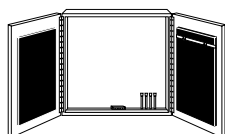

Description

- Standard with: Flipchart, Set of Four Dry Erase Markers, Eraser, Mounting Hardware, Tackboard on Each Door in Black Fabric, Display Rail with Adjustable Hooks for Flipchart
- Price Valid for Fabric Grades 1, 2, and 3, See Below For Higher Grade Fabric Pricing
- Does Not Feature Soft Close Hinges
- Magnetic Porcelain Non-Glare Writing Surface
- Find Textile Partners on Our Website; [Click Here](#)
- TFL Laminate Colors and Pulls can be Found Under Coordinating Casegoods Collections

Must Specify (in this order):

- Model #
- Color
- Tackboard Fabric Vendor, Pattern, and Color
- Pull
- Projection Screen Installation

Options: Specify & Add

		GRADE	4	5	6	7	8	9	10
TB-4214	Tackboard	\$	310	456	602	812	1030	1286	1580
1-PS	Optional Factory Installed Projection Screen								\$ 1177

Item	Model No.	Material	Width	Depth	Height	Ship Wt	Options	List Price	
LECTERN STAND	88-2650LS	TFL+HPL	24	23	49	130	21.9	F, G, Y / T+P\$	2143
								H / T+P\$	2154
		Veneer+HPL	F, G, Y / W+P\$	3870					
			H / W+P\$	3899					
			F, G, Y / W\$	4022					
Veneer	H / W\$	4038							

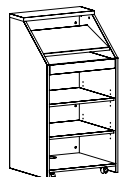



Description

- Top Edge Profiled on Approach Side Only (See Edge Options); Must Specify Edge Selection
- Fixed Shelf Angled for User Comfort, One (1) Pullout Shelf, and Two (2) Adjustable Shelves
- Two (2) Locking and Two (2) Non-Locking Casters
- Wire Management Grommet on Second and Bottom Shelf, Middle Shelf Features Wire Management Grommet Cut Out

Must Specify (in this order):

- Model #
- Color

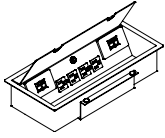
Item	Model No.		List Price
ECA TELECOM PLATES COMPATIBLE WITH:  Oasis Mini Power & Data 01-OASISMA, 01-OASISMB  Interact Power & Data 01-INTERACTG2A, 01-INTERACTG2B  Worksurface Power Center 01-INTRFCIA, 01-INTRFCIB	01-ABL	Telecom Plate, Blank Plate	\$ 45
	01-ABL737373	Telecom Plate, (3) RJ45 Cat 5e	\$ 406
	01-ABLAB	Telecom Plate, (1) RJ45 Cat 6, (1) RJ11 Cat 3 Phone	\$ 228
	01-ABLAB102	Telecom Plate, (1) RJ45 Cat 6, (1) RJ11 Cat 3, (1) USB W/72" Patch Cord	\$ 355
	01-ABLABB	Telecom Plate, (2) RJ45 Cat 6, (1) RJ11 Cat 3 Phone	\$ 355
	01-ABLB	Telecom Plate, (1) RJ45 Cat 6	\$ 165
	01-ABLBB	Telecom Plate, (2) RJ45 Cat 6	\$ 289
	01-ABLBBB	Telecom Plate, (3) RJ45 Cat 6	\$ 406
	01-ABLBBB	Telecom Plate, (4) RJ45 Cat 6	\$ 528
	01-ABLBBC51	Telecom Plate, (2) RJ45 Cat 6, (1) 15 Pin HD VGA w/72" Patch Cord	\$ 494
	01-ABLBC51L	Telecom Plate, (1) RJ45 Cat 6, (1) Mini Stereo Inline, (1) 15 Pin HD VGA w/72" Patch Cord	\$ 455
	01-ABLC3811	Telecom Plate, (1) RJ45 Cat 6 Data Inline, (1) RJ11 Cat 3 Phone Inline	\$ 219
	01-ABLC45	Telecom Plate, (1) HDMI w/36" Patch Cord	\$ 327
	01-ABLC45C51L	Telecom Plate, (1) Mini Stereo Inline, (1) HDMI w/36" Patch Cord, (1) 15 Pin HD VGA w/72" Patch Cord	\$ 618
	01-ABLC51L	Telecom Plate, (1) 15 Pin HD VGA & (1) Mini Stereo Inline Jack	\$ 330
	01-ABLCRDM	Telecom Plate, (3) Cord Bushings	\$ 106

ORDERING INFORMATION

All orders should be placed with:

Indiana Furniture
PO Box 270, 1919 Hospitality Dr., Ste. A
Jasper, IN 47547-0270

Fax: 812.482.9035

email: neworders@indianafurniture.com

ORDER PROCEDURE

To ensure timely processing, all orders must include:

- Purchase Order Number
- Sold To and Ship To Addresses
- Call Before Delivery Phone Number and Contact Name
- Complete Model Numbers and Quantity for All Units
- Finish Selections
- Fabric Vendor/Pattern/Color, if applicable
- Other Applicable Options
- Any Special Delivery or Product Instructions

A drawing or sketch of the planned configuration in modular applications will facilitate order processing.

How to Order illustrations are located at the beginning of each Series. Each model has additional information on How to Specify. For further clarification, contact Sales Support at 800.422.5727.

PRICING

All prices are suggested retail, F.O.B. Point of Origin, freight prepaid and allowed to one continental US destination. Prices, specifications and materials are subject to change without notice. Possession and/or distribution of this price list does not in itself constitute an offer to sell. Orders can be received only from authorized Indiana Furniture dealers. Orders will be billed at prices at time of shipment, unless previously acknowledged prior to the effective date of a price change, in which case billing will be at the price acknowledged.

Indiana Furniture accepts Visa, MasterCard and American Express. Please contact Sales Support for policy details.

ACKNOWLEDGMENT

Cleanly specified orders are acknowledged in a timely manner. The acknowledgment reflects how the order was entered, the estimated ship date, and other pertinent information. This acknowledgment serves as the final agreement between the customer and Indiana Furniture, and is the exclusive statement of the terms thereof. Changes must be requested within one business day of acknowledgment; after that, all production activities begin and the order becomes firm. Please examine this acknowledgment carefully and advise Indiana Furniture immediately of any discrepancies. The customer bears sole responsibility for order correctness.

Shipping fees (see Delivery + Freight Charges) are added at the time of invoicing. Shipping charges will be listed on direct bill and GSA orders due to the nature of the contract, but not on commercial or dealer-billed orders.

BUYER'S OBLIGATION: RIGHTS OF SELLER

If Indiana Furniture shall, at any time, doubt Buyer's financial responsibility, Indiana Furniture may decline to make shipments hereunder except upon receipt of cash payment in advance or security or other proof of responsibility satisfactory to Indiana Furniture. If buyer fails in any way to fulfill the terms and conditions set forth herein, Indiana Furniture may defer shipments until such default is corrected. Remedies provided herein shall be in addition to, and not in lieu of other remedies. Buyer agrees to abide by payment terms as listed on invoice. Buyer shall pay all reasonable costs and expenses, including attorney and collection fees, and late fees, incurred by Seller in connection with any amounts due for goods ordered.

CANCELLATIONS + CHANGES

All products are built-to-order. Once acknowledged (See Acknowledgement), orders are considered firm and are not subject to cancellation or change without approval from Indiana Furniture. All approved changes are subject to additional charges and revised lead times.

PRODUCT DESIGN + SPECIFICATION CHANGES

Indiana Furniture reserves the right to make changes in design and construction or discontinue products without prior notice. Note: All dimensions listed in price list are nominal.

REPAIR CHARGES

Indiana Furniture will only pay repair charges if Sales Support gives prior written

authorization. No repair charge will be paid without advance approval at which time a repair authorization number will be issued and must appear on the invoice to Indiana Furniture for the completed work.

WAREHOUSE STORAGE CHARGES

If a shipment is held beyond 7 calendar days at your request, a **.084% per calendar day (2.52% per month) storage charge will be assessed**. The effective date will be 7 calendar days after the acknowledged ship date. Further, the prices applied to the order will be those in effect at the time of shipment.

DAMAGED/MISSING MERCHANDISE

The consignee is responsible for reporting all damage and shortages to Sales Support.

- The consignee must inspect all merchandise upon arrival.
- Do not refuse merchandise damaged in transit.
- Missing cartons and obvious damage must be noted on the freight bill at the time of delivery.
- Claims for missing cartons should be reported immediately for the best chance of recovery and to avoid delays in completing the delivery.
- Claims for both obvious and concealed damage must be filed within 15 calendar days of receipt of product
- Damaged merchandise must not have been moved from the original receiving location and must be reported prior to any attempt to install the product.
- All damaged merchandise, including the cartons and packing materials, must be retained for inspection by either the carrier or by an Indiana Furniture Sales Representative.

Be prepared to provide the following information when contacting Sales Support:

- Copy of Signed Freight Bill (with noted issues, if applicable)
- Original Order Number
- Model Number of the Damaged Item
- Photos of the Damaged Carton/Item

All damage claims are subject to review and approval. Once your damage claim has been evaluated, we will determine the best resolution, including repair or replacement where applicable. Indiana Furniture reserves the right to select the most cost effective way to resolve the claim.

DELIVERY + FREIGHT CHARGES

All shipments are F.O.B. Point of Origin, Jasper, IN, freight prepaid and allowed dock to dock on 53' trailer. Ownership and responsibility of the merchandise become that of the buyer upon delivery to the freight company. Shipments into Alaska, Hawaii, Canada, Mexico, Puerto Rico and other exports are freight prepaid and allowed to port of exit.

Shipping fees added at the time of invoicing.

- Shipments under \$3000 (net value, product only) will incur a \$300 net fee per shipment.
- Small-package carrier shipments:
 - Orders \$100 or less will receive a \$22 fee
 - Orders over \$100 will receive a \$40 fee

Carrier selection and routing are at Indiana Furniture's discretion. Requests for favored carriers and delivery times will be accommodated when possible.

After-hours delivery fees:

- Monday through Thursday after 3pm: \$300 per truck
- Friday after 3pm or weekends: \$600 per truck

Inside delivery and installation services are not included in the price shown. Any deviation from dock-to-dock delivery, such as but not limited to, non-dock, residential, or inside delivery must be specified on the order. Should these services be requested or required, please contact Sales Support regarding the availability of services and a quote. All charges incurred will be charged to the "Sold To" of the order.

BIFMA + ANSI TESTING

Indiana Furniture is a member of the Business and Institutional Furniture Manufacturer's Association (BIFMA). Tests developed by the BIFMA and approved by the American National Standards Institute (ANSI) determine the strength and durability of casegoods and seating in its everyday use. Although this testing does not serve as a warranty or guarantee, Indiana Furniture products within this price list have been tested by an independent verifying body and meet or exceed applicable BIFMA and ANSI Standards..

Subject to the limitations set forth in this warranty, Indiana Furniture Industries, Inc. ("Indiana Furniture") warrants to the original purchaser all product in this price list ("Product") to be free from defects in material and workmanship given normal use for a **12-year period from the date of manufacture**. During the applicable warranty period, Indiana Furniture, as its sole obligation, will repair or replace (in Indiana Furniture's sole discretion) any Product, Part, or Component covered by this warranty and sold after June 1, 2026, which fails under normal use as a result of a defect in material or workmanship. Normal use is defined as the equivalent of a single shift, 40-hour work week. Indiana Furniture will repair or replace the defective Product, Part, or Component with a comparable Product, Part, or Component.

Warranty periods are limited, from the date of manufacture, for certain Products, Parts, and Components as follows:

5-Year Warranty (from the date of manufacture)

- Triple Play Series
- Electrical Components Including Lighting, Power Ports (see exclusions), and Adjustable Height Components
- Pneumatic Cylinders on Caseloads, Tables, and Seating
- Textiles, Foam, and Decorative Trim
- Swivel Arm Pads
- Keyboard Kits and Monitor Arms

3-Year Warranty (from the date of manufacture)

- Dock 950 Wireless Charger
- Dock 150 Wireless and USB Charger

THIS WARRANTY DOES NOT COVER:

- Damage caused by a carrier or third party
- Normal or routine wear and tear
- Appearance, durability, quality, behavior, colorfastness, or any other attribute of customer's own materials or any non-standard Indiana Furniture material (including CF Stinson, Maharam, Momentum, Mayer, UltraFabrics, Architex, and other alliance programs) specified by the customer and applied to a Product
- Color, grain or texture of wood, laminate and other covering materials
- Changes in wood or fabric color due to aging or exposure to light
- Labor and Service not covered under warranty
- Installation Damage (Wall Panels damaged during the installation of additional Product including but not limited to Wall Panel Shelves, Tackboards, or TV Mounts)
- Products or Components attached in some manner to any other manufacturer's products or components (e.g., Indiana Furniture Conference Tops attached to another manufacturer's bases)
- Noncompliance with installation and maintenance instructions

As the manufacturer of the Product, Indiana Furniture stands behind its craftsmanship and pledges to do everything it can to reasonably resolve, as quickly as possible, any problems you may have with the Product within the terms and conditions of this warranty.

If you encounter a defect covered by the foregoing warranty, contact the dealer from whom you purchased the Product. If the dealer is unable to resolve your warranty issues, you should contact Indiana Furniture. Please ensure that you have all of the pertinent facts when contacting the dealer or Indiana Furniture, including the model number and factory order number from the inspection label attached to the Product.

INDIANA FURNITURE IS NOT PROVIDING, AND SPECIFICALLY DISCLAIMS, ANY OTHER WARRANTIES FOR THE PRODUCTS, EXPRESS OR IMPLIED, INCLUDING ANY IMPLIED WARRANTY OF MERCHANTABILITY OR FITNESS FOR A PARTICULAR PURPOSE. INDIANA FURNITURE SHALL NOT BE LIABLE TO THE PURCHASER OR ANY THIRD PARTY FOR CONSEQUENTIAL, INCIDENTAL, INDIRECT, OR SPECIAL DAMAGES, INCLUDING, WITHOUT LIMITATION, DAMAGES ARISING OUT OF OR RESULTING IN ANY MALFUNCTIONS, DELAYS, LOSS OF PROFIT, INTERRUPTION OF BUSINESS, PERSONAL INJURY, BODILY INJURY, DEATH, DISMEMBERMENT, OR PROPERTY DAMAGE.

Indiana Furniture Industries, Inc.
Attn: Sales Support
PO Box 270
1919 Hospitality Dr., Ste A
Jasper, Indiana 47547-0270
800.422.5727
Fax 812.482.9035
custserv@indianafurniture.com

Surface Materials

Veneer Finishes, Laminate Colors + Leg/Wood Finish Options

Our veneer casegoods feature our UV topcoat finish, UVAdvantage. The result is a low-emitting finish that provides exceptional depth, clarity, durability and chemical resistance throughout the life of the product. Refer online for finish and color availability by product series.

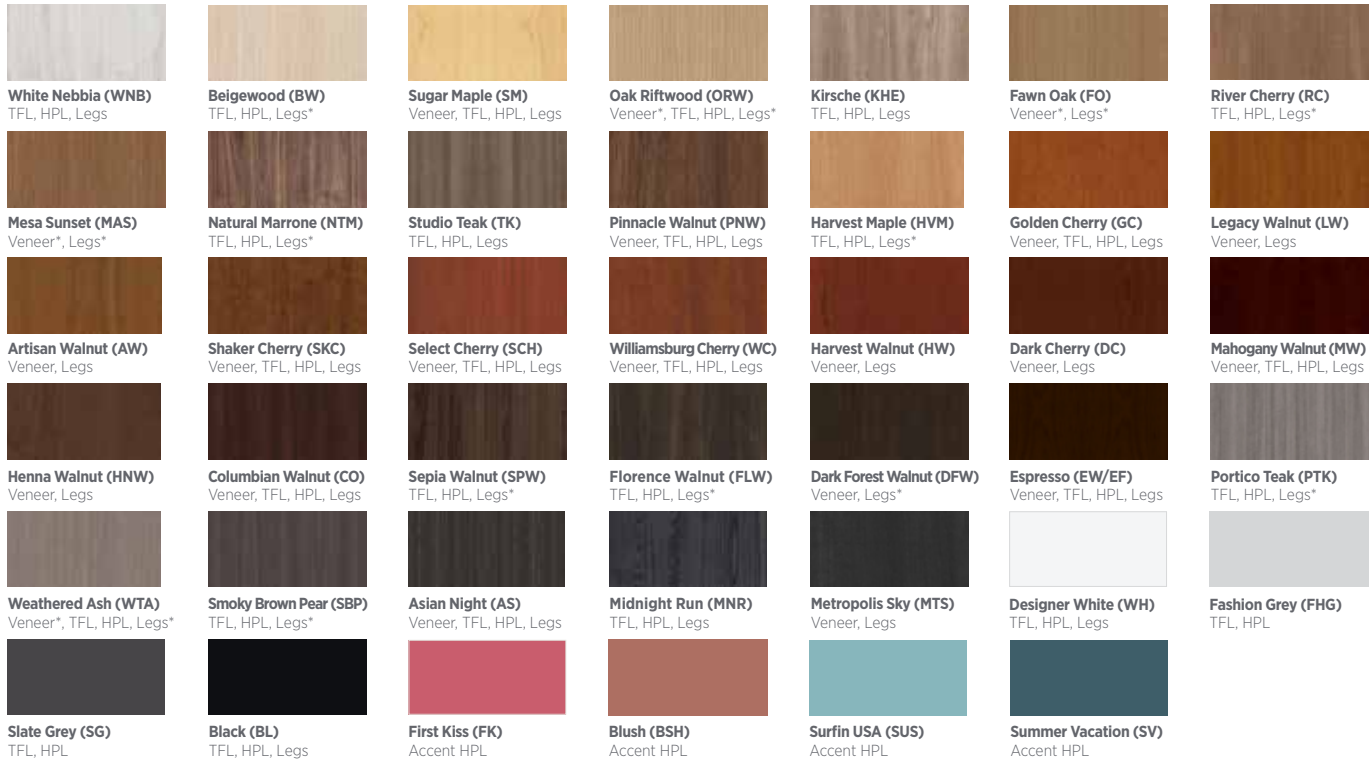

* Veneer/Wood Finish is Low Sheen

Frosted + High Gloss Acrylics

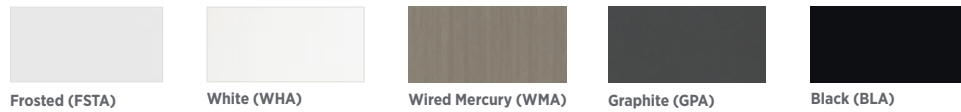

Solid Surfaces



Metal Finishes

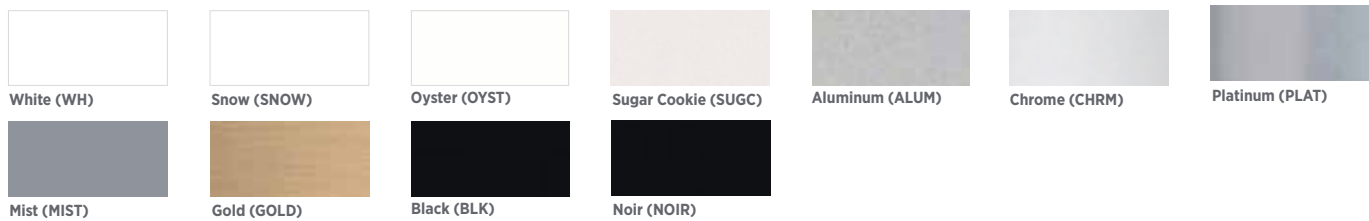

Glass Options

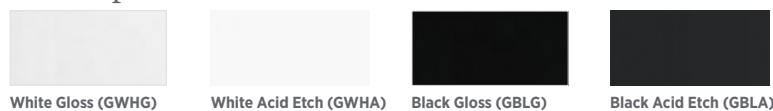

Acoustic/Surround Options



Colors represented are high-resolution reproductions and may vary slightly from the actual product. To order samples, please contact our Customer Service team or order online at indianafurniture.com. Graining and finish colors may vary, yet will continue to complement across Veneer, HPL, TFL and Seating products due to the inherent differences of these materials.

Indiana[®] FURNITURE

PO Box 270

1919 Hospitality Drive, Suite A
Jasper, Indiana 47546

Tel 812.482.5727

Toll 800.422.5727

Fax 812.482.9035

sales@indianafurniture.com

www.indianafurniture.com

Federal Classification: Small Business

©2026 Indiana Furniture 6/26

