

Indiana
FURNITURE

CASEGOODS + RECEPTION

PRICING EFFECTIVE MAY 13, 2024

Being over a century old hasn't slowed us down! Sure, we are still the reliable, ethical company that was born in southern Indiana, steeped in quality, craftsmanship, and service. But have you seen our latest introductions? We are making a splash with design and challenging the concept of modern offices. Go ahead. Take a look. You know you want to.

Our Pledge to People + Our Planet.

We've been making wood furniture longer than just about anyone...and we want to be doing so for a long time to come. That's a large part of why we take a stewardship approach to our resources. We believe that environmental sustainability and business profits need not be mutually exclusive. They can and should exist side by side in a mutually beneficial relationship. And for more than a century, we've been showing how it's done.

We've proven our commitment to a sustainable future by supporting the standards and programs that protect our home planet and human health. Whether it's local sourcing, reducing contaminants, implementing wellness and safety programs, or diverting waste from landfills, social responsibility is a part of every decision we make at Indiana Furniture.

One of the surest ways to reduce our impact on the planet is to make and buy things that last. And this one's a natural for us. Our products are made with craftsmanship and attention to detail that are a part of our more than a century-long legacy in wood manufacturing. And our products are backed by our 12-year warranty, which facilitates maintenance, servicing and reassembly.

All of our product lines:

- Are manufactured and assembled in the USA,
- Meet or exceed Indoor Air quality standards*,
- Meet or exceed BIFMA level® Sustainability standards and certification*,
- Conform to the BIFMA Compliance standards*,
- Comply with TSCA Title VI (CARB) standards,
- and can contribute to U.S. Green Building's LEED Program.

To learn more, simply go to www.IndianaFurniture.com/resources.



Ease of Specification

Whether you're looking to specify your office spaces or simply to visualize them in the options and surface materials you are desiring, we make it easy. You can find the entire Indiana Furniture portfolio on the following third-party, space-planning platforms.



* Recently launched or new products may still be in testing; Cush Pillows is currently not BIFMA Compliant due to no available compliance test.

Jefferson echoes history and creates a timeless foundation for today's sophisticated work place. Finely crafted in select solids with Walnut and Cherry veneers, the tailored details of this collection accentuate our expert craftsmanship and perfect attention to detail.

Jefferson forges traditional styling with modern sensibility with new Height Adjustable options and coordinating reception models, allowing the premium feel and flexibility of Jefferson to easily function throughout entire facilities.

CONSTRUCTION

Jefferson features a Veneer chassis with your choice of a Veneer or HPL top. Units ship assembled unless otherwise noted.

VENEER

- Choose from premium or select veneer on exposed surfaces in American Black Walnut or Cherry species in bookmatched veneer faces
- Veneers are carefully selected and matched to assure proper balance and consistency

TOPS

- Veneer tops offer a 5-ply balanced construction, 1 3/16" thick with solid hardwood mitered rims
- High Pressure Laminate (HPL) tops offer a 3-ply balanced construction, 1 3/16" thick with solid hardwood mitered rims
- Grain direction runs left-to-right unless otherwise noted
- All Jefferson tops are standard with the Jefferson edge profile (C2), unless otherwise noted.



CHASSIS

- Chassis is securely fastened using high quality European fastening systems, heavy-duty, 16-gauge joining brackets and wood dowels to assure maximum strength
- Bases are solid hardwood with mitered corners
- All units have finished veneer backs
- Construction offers tight tolerances and long term durability
- All units equipped with heavy-duty, adjustable glides to ensure proper leveling and compensate for uneven floors
- Vertical grain direction on chassis

DRAWERS

- Drawer fronts standard with bookmatched veneer faces
- Fronts are 3-ply construction and 3/4" thick
- Drawer interiors are dovetail, wood constructed with 7/16" hardwood sides and backs and 5/32" thick hardboard bottoms
- All drawers feature full extension, progressive action slides with precision steel ball bearings
- Box and file drawers are tested for 100lb capacity
- Lateral files feature 3/4" thick bottoms. Drawers are tested for 200lb of equally distributed weight (ex: hanging file folders) and 65lbs of bottom load weight (ex: stacked catalogs)
- All suspensions have a limited lifetime warranty
- Optional soft close ([see soft close options](#)) is available on center, tray, box, and file drawers, unless otherwise noted; **File drawers with the soft close option feature front-to-back filing.**

FILING

- All file drawers are standard with filing systems designed to accommodate a variety of filing requirements
- **Optional soft close on box and file drawers allows front-to-back filing in file drawer**

FILING (CONT.)

- Legal width file drawers provide legal filing front to back, and letter or legal filing side to side
- Letter width file drawers provide letter filing front to back, and letter or legal filing side to side

STORAGE

- All hinged doors include soft close hinges, unless noted
- Soft close hinges reduce stress placed on the cabinet when the door is closed and offers a quiet closure

LOCKING

- Central locking is standard on all desks and optional for credenzas and returns; one key in the lock cylinder locks all drawers in the desk
- Lock core color will coordinate with pull selection (brass pulls will have black cores, while aluminum pulls will have silver cores)
- Removable lock cylinders allow for units to be re-keyed at a later date if required
- Units are shipped randomly keyed as standard. Keyed alike units available upon request at no additional charge.

CORD MANAGEMENT

- Grommets are standard in back panels of returns, bridges, kneespace credenzas, and hutch units (does not apply to height adjustable or reception units)
- Grommets may be ordered in the tops of desks, returns, bridges, credenzas, and component worksurfaces
- [See all optional grommet locations](#)
- Undersurface Wire Managers are available for additional cord management; [See Multiple Units](#)

HEIGHT ADJUSTABILITY

- Electric-powered height adjustable mechanisms are offered in 2-channel for single surface height adjustment and 3-channel for simultaneous, two surface height adjustment
- Height adjustable legs available in black finish only
- Height adjustment range 30"H to 45"H
- 5-year warranty
- Recommended load capacity of 180lbs
- Two control switches are available, including an up/down switch (standard with product, unless noted) and an advanced switch with Bluetooth capabilities, position memory, three stand up reminder intervals, and more; gently adjust worksurface with a one second stop at each memory position
- The standard control switch is factory installed on all units except bridges and 3-channel units
- Bridges, returns, and credenzas will not have a standard grommet on the back panel
- New wire management mesh wrap included when worksurface grommet is selected
- Grommets and one wire management channel provided within kneespace to manage wires from switch and control box; two wire management channels will be shipped with desk shells

INTERIOR DRAWER DIMENSIONS

Models

46-4284DPS 46-4278DPS 46-3672CHS

| Drawers | W | L | D |
|---------|----------------------------------|------------------------------------|-----------------------------------|
| Tray | 15 ³ / ₈ " | 19 ³ / ₈ " | 12 ⁷ / ₃₂ " |
| Box | 15 ³ / ₈ " | 19 ³ / ₈ " | 3 ²¹ / ₃₂ " |
| File | 15 ³ / ₈ " | 25 ³ / ₄ " | 8 ²⁹ / ₃₂ " |
| Center | 30 ⁵ / ₈ " | 19 ¹¹ / ₃₂ " | 12 ⁷ / ₃₂ " |

Models

46-3672LPS 46-3672RPS

| Drawers | W | L | D |
|---------|----------------------------------|------------------------------------|-----------------------------------|
| Tray | 15 ³ / ₈ " | 19 ³ / ₈ " | 12 ⁷ / ₃₂ " |
| Box | 15 ³ / ₈ " | 19 ³ / ₈ " | 3 ²¹ / ₃₂ " |
| File | 15 ³ / ₈ " | 25 ³ / ₄ " | 8 ²⁹ / ₃₂ " |
| Center | 25 ³ / ₄ " | 19 ¹¹ / ₃₂ " | 12 ⁷ / ₃₂ " |

Models

46-3672DPS 46-3066DPS

| Drawers | W | L | D |
|---------|----------------------------------|------------------------------------|-----------------------------------|
| Tray | 12 ³ / ₈ " | 19 ³ / ₈ " | 12 ⁷ / ₃₂ " |
| Box | 12 ³ / ₈ " | 19 ³ / ₈ " | 3 ²¹ / ₃₂ " |
| File | 12 ³ / ₈ " | 25 ³ / ₄ " | 8 ²⁹ / ₃₂ " |
| Center | 30 ⁵ / ₈ " | 19 ¹¹ / ₃₂ " | 12 ⁷ / ₃₂ " |

Models

46-3066LPS 46-3066RPS

| Drawers | W | L | D |
|---------|----------------------------------|------------------------------------|-----------------------------------|
| Tray | 12 ³ / ₈ " | 19 ³ / ₈ " | 12 ⁷ / ₃₂ " |
| Box | 12 ³ / ₈ " | 19 ³ / ₈ " | 3 ²¹ / ₃₂ " |
| File | 12 ³ / ₈ " | 25 ³ / ₄ " | 8 ²⁹ / ₃₂ " |
| Center | 22 ⁷ / ₈ " | 19 ¹¹ / ₃₂ " | 12 ⁷ / ₃₂ " |

Models

46-4284DP 46-4278DP 46-3672CH

| Drawers | W | L | D |
|---------|----------------------------------|------------------------------------|------------------------------------|
| Box | 15 ³ / ₈ " | 19 ³ / ₈ " | 3 ²¹ / ₃₂ " |
| File | 15 ³ / ₈ " | 25 ³ / ₄ " | 11 ¹³ / ₃₂ " |
| Center | 30 ⁵ / ₈ " | 19 ¹¹ / ₃₂ " | 12 ⁷ / ₃₂ " |

Models

46-3672LP 46-3672RP

| Drawers | W | L | D |
|---------|----------------------------------|----------------------------------|------------------------------------|
| Box | 15 ³ / ₈ " | 19 ³ / ₈ " | 3 ²¹ / ₃₂ " |
| File | 15 ³ / ₈ " | 25 ³ / ₄ " | 11 ¹³ / ₃₂ " |
| Center | 25 ³ / ₄ " | 19 ³ / ₈ " | 12 ⁷ / ₃₂ " |

Models

46-3672DP 46-3066DP

| Drawers | W | L | D |
|---------|----------------------------------|----------------------------------|------------------------------------|
| Box | 12 ³ / ₈ " | 19 ³ / ₈ " | 3 ²¹ / ₃₂ " |
| File | 12 ³ / ₈ " | 25 ³ / ₄ " | 11 ¹³ / ₃₂ " |
| Center | 30 ⁵ / ₈ " | 19 ³ / ₈ " | 12 ⁷ / ₃₂ " |

Models

46-3066LP 46-3066RP

| Drawers | W | L | D |
|---------|----------------------------------|----------------------------------|------------------------------------|
| Box | 12 ³ / ₈ " | 19 ³ / ₈ " | 3 ²¹ / ₃₂ " |
| File | 12 ³ / ₈ " | 25 ³ / ₄ " | 11 ¹³ / ₃₂ " |
| Center | 22 ⁷ / ₈ " | 19 ³ / ₈ " | 12 ⁷ / ₃₂ " |

Models

46-2448LF 46-2448RF 46-2442LF 46-2442RF
46-2066KC 46-2066LC 46-2066RC

| Drawers | W | L | D |
|---------|----------------------------------|-----------------------------------|------------------------------------|
| Box | 12 ³ / ₈ " | 16 ⁷ / ₃₂ " | 3 ²¹ / ₃₂ " |
| File | 12 ³ / ₈ " | 16 ⁷ / ₃₂ " | 11 ¹³ / ₃₂ " |

Models

46-2072SC1 46-2072KC 46-2072LC 46-2072RC

| Drawers | W | L | D |
|---------|----------------------------------|-----------------------------------|------------------------------------|
| Box | 15 ³ / ₈ " | 16 ⁷ / ₃₂ " | 3 ²¹ / ₃₂ " |
| File | 15 ³ / ₈ " | 16 ⁷ / ₃₂ " | 11 ¹³ / ₃₂ " |

Models

46-2072KC1

| Drawers | W | L | D |
|---------|----------------------------------|-----------------------------------|------------------------------------|
| Box | 15 ³ / ₈ " | 16 ⁷ / ₃₂ " | 3 ²¹ / ₃₂ " |
| File | 15 ³ / ₈ " | 16 ⁷ / ₃₂ " | 11 ¹³ / ₃₂ " |
| Center | 30 ⁵ / ₈ " | 14 ³ / ₁₆ " | 12 ⁷ / ₃₂ " |

Models

46-2066KC1

| Drawers | W | L | D |
|---------|----------------------------------|-----------------------------------|------------------------------------|
| Box | 12 ³ / ₈ " | 16 ⁷ / ₃₂ " | 3 ²¹ / ₃₂ " |
| File | 12 ³ / ₈ " | 16 ⁷ / ₃₂ " | 11 ¹³ / ₃₂ " |
| Center | 30 ⁵ / ₈ " | 14 ³ / ₁₆ " | 12 ⁷ / ₃₂ " |

Models

46-2036L2 46-2036L4 46-2034L2FE 46-2034L4FE
46-2072LL 46-2072RL 46-2072DL 46-2066LL
46-2066RL

| Drawers | W | L | D |
|---------|----------------------------------|----------------------------------|-----------------------------------|
| File | 12 ³ / ₈ " | 25 ³ / ₄ " | 8 ¹³ / ₃₂ " |

Models

46-1829MU

| Drawers | W | L | D |
|---------|----------------------------------|-----------------------------------|-----------------------------------|
| Box | 25 ¹ / ₂ " | 16 ⁷ / ₃₂ " | 3 ²¹ / ₃₂ " |
| File | 25 ¹ / ₂ " | 16 ⁷ / ₃₂ " | 8 ¹³ / ₃₂ " |

Models

46-1829MF

| Drawers | W | L | D |
|---------|----------------------------------|-----------------------------------|-----------------------------------|
| File | 25 ¹ / ₂ " | 16 ⁷ / ₃₂ " | 8 ¹³ / ₃₂ " |

INTERIOR DRAWER DIMENSIONS

| Models | | | |
|----------------|----------------------------------|----------------------------------|-----------------------------------|
| 46-3672TD | 43-3066TD | 46-3672TDQ | 43-3066TDQ |
| Drawers | W | L | D |
| Center | 30 ³ / ₈ " | 19 ³ / ₈ " | 12 ⁷ / ₃₂ " |

| Models | | | |
|----------------|----------------------------------|-----------------------------------|-----------------------------------|
| 46-1818MU | | | |
| Drawers | W | L | D |
| Box | 15 ³ / ₈ " | 19 ³ / ₈ " | 3 ²¹ / ₃₂ " |
| File | 15 ³ / ₈ " | 16 ⁷ / ₃₂ " | 8 ²⁹ / ₃₂ " |

| Models | | | |
|----------------|----------------------------------|-----------------------------------|-----------------------------------|
| 46-1818MF | 46-2072KC2 | 46-2072LC2 | 46-2072RC2 |
| Drawers | W | L | D |
| File | 15 ³ / ₈ " | 16 ⁷ / ₃₂ " | 8 ²⁹ / ₃₂ " |

| Models | | | |
|----------------|----------------------------------|-----------------------------------|-----------------------------------|
| 46-2448LF2 | 46-2448RF2 | 46-2442LF2 | 46-2442RF2 |
| 46-2066KC2 | 46-2066LC2 | 46-2066RC2 | 46-2448LF2STS |
| 46-2448RF2STS | 46-2442LF2STS | 46-2442RF2STS | 46-2448LF2SR |
| 46-2448RF2SR | 46-2442LF2SR | 46-2442RF2SR | 46-2472RCL |
| 46-2472RCR | 46-2466RCL | 46-2466RCR | 46-2448RPD2L |
| 46-2448RPD2R | | | |
| Drawers | W | L | D |
| File | 12 ³ / ₈ " | 16 ⁷ / ₃₂ " | 8 ²⁹ / ₃₂ " |

| Models | | | |
|----------------|----------------------------------|-----------------------------------|-----------------------------------|
| 46-3672DPSTS | 46-3066DPSTS | 46-3066LPSTS | 46-3066RPSTS |
| 46-2066SC1 | | | |
| Drawers | W | L | D |
| Box | 12 ³ / ₈ " | 16 ⁷ / ₃₂ " | 3 ²¹ / ₃₂ " |
| File | 12 ³ / ₈ " | 16 ⁷ / ₃₂ " | 8 ²⁹ / ₃₂ " |

| Models | | | |
|----------------|----------------------------------|-----------------------------------|-----------------------------------|
| 46-3672LPSTS | 46-3672RPSTS | | |
| Drawers | W | L | D |
| Box | 15 ³ / ₈ " | 16 ⁷ / ₃₂ " | 3 ²¹ / ₃₂ " |
| File | 15 ³ / ₈ " | 16 ⁷ / ₃₂ " | 8 ²⁹ / ₃₂ " |

| Models | | | |
|----------------|----------------------------------|-----------------------------------|-----------------------------------|
| 46-3672DPSSTS | 46-3066DPSSTS | 46-3066LPSSTS | 46-3066RPSSTS |
| Drawers | W | L | D |
| Tray | 12 ³ / ₈ " | 16 ⁷ / ₃₂ " | 12 ⁷ / ₃₂ " |
| Box | 12 ³ / ₈ " | 16 ⁷ / ₃₂ " | 3 ²¹ / ₃₂ " |
| File | 12 ³ / ₈ " | 16 ⁷ / ₃₂ " | 8 ²⁹ / ₃₂ " |

| Models | | | |
|----------------|----------------------------------|-----------------------------------|-----------------------------------|
| 46-3672LPSSTS | 46-3672RPSSTS | | |
| Drawers | W | L | D |
| Tray | 15 ³ / ₈ " | 16 ⁷ / ₃₂ " | 12 ⁷ / ₃₂ " |
| Box | 15 ³ / ₈ " | 16 ⁷ / ₃₂ " | 3 ²¹ / ₃₂ " |
| File | 15 ³ / ₈ " | 16 ⁷ / ₃₂ " | 8 ²⁹ / ₃₂ " |

| Models | | | |
|----------------|----------------------------------|----------------------------------|-----------------------------------|
| 46-2448LF2STS3 | 46-2448RF2STS3 | | |
| 46-2442LF2STS3 | 46-2442RF2STS3 | | |
| Drawers | W | L | D |
| File | 12 ³ / ₈ " | 12 ⁷ / ₈ " | 8 ²⁹ / ₃₂ " |

| Models | | | |
|----------------|----------------------------------|----------------------------------|-----------------------------------|
| 46-3672RPD1L | 46-3672RPD1R | | |
| Drawers | W | L | D |
| Box | 15 ³ / ₈ " | 19 ³ / ₈ " | 3 ²¹ / ₃₂ " |
| File | 15 ³ / ₈ " | 25 ³ / ₄ " | 8 ²⁹ / ₃₂ " |
| Center | 25 ³ / ₄ " | 19 ³ / ₈ " | 12 ⁷ / ₃₂ " |

| Models | | | |
|----------------|----------------------------------|----------------------------------|-----------------------------------|
| 46-3066RPD1L | 46-3066RPD1R | | |
| Drawers | W | L | D |
| Box | 12 ³ / ₈ " | 19 ³ / ₈ " | 3 ²¹ / ₃₂ " |
| File | 12 ³ / ₈ " | 25 ³ / ₄ " | 8 ²⁹ / ₃₂ " |
| Center | 22 ⁷ / ₈ " | 19 ³ / ₈ " | 12 ⁷ / ₃₂ " |

FILING CAPABILITIES

Drawers with Dimensions:

15³/₈"W x 25³/₄"L

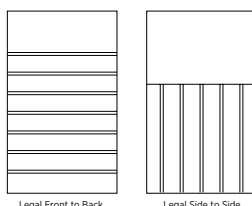

12³/₈"W x 25³/₄"L

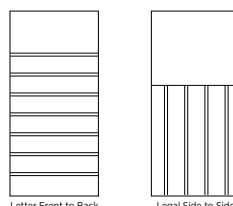

12³/₈"W x 12⁷/₈"L

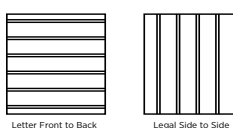

15³/₈"W x 16⁷/₃₂"L

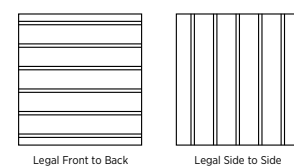

12³/₈"W x 16⁷/₃₂"L

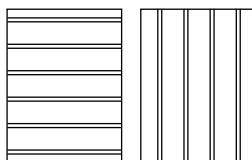

25¹/₂"W x 16⁷/₃₂"L

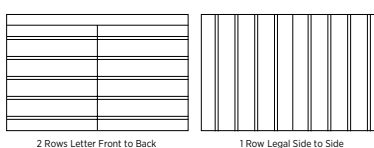

HOW TO ORDER EXAMPLES

DESKS, RETURNS, AND CREDENZAS

| MODEL # | QTY | DESCRIPTION | EXAMPLE |
|------------|-----|----------------------------|---------|
| 46-4284DPS | 1 | Premium or Standard Veneer | PV |
| | | Top Material | P |
| | | Finish/Color | MW |
| | | Pull | JEF |
| | | No Molding | - |
| | | Dictation Slide | DSL |
| | | Drawer Track | SOFT |
| | | Top Grommet Loc./Color | GC/BLK |
| | | Flip Down Center Drawer | LFD |

HEIGHT ADJUSTABLE 3-COLUMN L-UNIT

| | | | |
|--------------|---|----------------------------|------------|
| 46-3672LPSTS | 1 | Premium or Standard Veneer | W |
| | | Top Material | W |
| | | Finish/Color | SKC |
| | | Pull | ALB |
| | | No Molding | NO MOLDING |
| | | Drawer Track | STD |
| | | Leg Configuration | STS3 |
| | | Top Grommet Loc./Color | GC-BOX/SLV |
| | | Control Switch | MSWCH |

| | | | |
|----------------|---|----------------------------|------------|
| 46-2448RF2STS3 | 1 | Premium or Standard Veneer | W |
| | | Top Material | W |
| | | Finish/Color | SKC |
| | | Pull | ALB |
| | | No Molding | NO MOLDING |
| | | Locking Pedestal | LKI-46L |
| | | Drawer Track | STD |
| | | Top Grommet Loc./Color | GC-BOX/SLV |

RECEPTION L-UNIT

| | | | |
|--------------|---|----------------------------|---------------------------|
| 46-3672RPD1L | 1 | Premium or Standard Veneer | W |
| | | Top Material | P |
| | | Finish/Color | GC |
| | | Pull | ARA |
| | | No Molding | - |
| | | Drawer Track | SOFT |
| | | Top Grommet Loc./Color | GC/BLK |
| | | Flip Down Center Drawer | LFD |
| | | Tackboard/Fabric | CF Stinson Nikko Beach |

| | | | |
|--------------|---|----------------------------|--------|
| 46-2448RPD2R | 1 | Premium or Standard Veneer | W |
| | | Top Material | P |
| | | Finish/Color | GC |
| | | Pull | ARA |
| | | No Molding | - |
| | | Drawer Track | SOFT |
| | | Top Grommet Loc./Color | GC/BLK |

PREMIUM AND STANDARD VENEER (W) OPTIONS

Veneer features UVAdvantage, an ultra-violet finish, on all exposed surfaces by utilizing roll-coat UV technology.

| | | | |
|-----|--------------------|-----|---------------------|
| AW | Artisan Walnut | LW | Legacy Walnut |
| CO | Columbian Walnut | MW | Mahogany Walnut |
| DC | Dark Cherry | MTS | Metropolis Sky** |
| DFW | Dark Forest Walnut | PNW | Pinnacle Walnut** |
| EW | Espresso | SCH | Select Cherry |
| GC | Golden Cherry | SKC | Shaker Cherry |
| HW | Harvest Walnut | WC | Williamsburg Cherry |
| HNW | Henna Walnut** | | |

** Available in Standard Veneer Only

HPL (P) TOP OPTIONS

WOODGRAIN

| | | | |
|----|------------------|-----|---------------------|
| CO | Columbian Walnut | PNW | Pinnacle Walnut |
| EF | Espresso | SCH | Select Cherry |
| GC | Golden Cherry | SKC | Shaker Cherry |
| MW | Mahogany Walnut | WC | Williamsburg Cherry |

DRAWER AND DOOR PULL OPTIONS

Units with doors and drawers will feature coordinating pulls however door and drawer pulls cannot be intermixed.

| | | | |
|-----|----------------------------|-----|--------------------------|
| ARA | Arlington A, Antique Brass | JEF | Jefferson, Antique Brass |
| ARB | Arlington B, Antique Brass | ALB | Liberty, Aluminum |
| WLM | Wilmington, Antique Brass | | |



Arlington A (ARA)
Antique Brass - 5/4"



Arlington B (ARB)
Antique Brass - 5/4"



Jefferson (JEF)
Antique Brass - 5/4"



Wilmington (WLM)
Antique Brass - 5/4"



Liberty (ALB)
Aluminum - 4/4"

DRAWER TRACK OPTIONS

Soft close tracks are available on center, tray, box, and file drawers in Jefferson. Soft close drawer tracks have many benefits including reduced stress on the unit, extends the life of the drawer, and ensures a gentle close so fingers don't accidentally get hurt. **File drawers with the soft close option feature front-to-back filing.** Must specify when ordering.

Pricing is per Drawer, not per Model/Unit

| | | | |
|-------|-------------------------|----|----|
| SFTCL | Soft Close Drawer Track | \$ | 34 |
|-------|-------------------------|----|----|

LOCKING FLIP DOWN CENTER DRAWER

Single and double pedestal desks and kneespace credenzas standard with a center drawer have an optional central locking, keyboard flip down drawer. Drawer front is wood veneer with laminate drawer interior.

| | | | |
|-----|---------------------------------------|----|----|
| LFD | Locking Flip Down Front Center Drawer | \$ | 82 |
|-----|---------------------------------------|----|----|

APPROACH SIDE DICTATION SLIDES

Some desk models offer an approach side pull-out dictation slide. Specify DSLD when placing your order and add upcharge. If adding the dictation slide, the center grommet will not be available.

| | | | |
|------|-------------------------------|----|-----|
| NONE | No Approach Dictation Slide | \$ | STD |
| DSL | Approach Side Dictation Slide | \$ | 611 |

MOLDING OPTIONS

All standard, height adjustable, and reception units ship with decorative pencil molding. If you do not want molding, please specify "NO MOLDING" when ordering each model.

Modular components come standard with no molding. To accommodate for flush ends, molding is offered as an option. Specify one of the following codes when ordering.

| | | | |
|-------|--------------------------------------|----|-----|
| STD | No Molding | \$ | STD |
| M46R1 | Molding on Right Side Only | \$ | 85 |
| M46L1 | Molding on Left Side Only | \$ | 85 |
| M46LR | Molding on Both Right and Left Sides | \$ | 170 |

Note: Left or right is determined when facing the front of the unit. Molding features multi-step, hand-finished catalyzed finish

GLASS SHELVES OPTION

Units with beveled glass and mesh grille inserts offer the option of glass shelving.

| | | | |
|-------|-----------------------|----|-----|
| GLSSH | Units with Two Doors | \$ | 104 |
| GLSSH | Units with Four Doors | \$ | 208 |

DOWN LIGHTING OPTION

Select units with beveled glass and mesh grille inserts offer the option of down lighting. See individual models for availability.

| | | | |
|-------|-----------------------|----|-----|
| DNLGT | Units with Two Doors | \$ | 410 |
| DNLGT | Units with Four Doors | \$ | 820 |

LOCKING PEDESTALS ON RETURNS/CREDENZAS

Locking drawers are available on returns and credenzas. Please specify LKI-46L on order and add upcharge. Lock core will coordinate with pull selection.

Returns and single pedestal credenzas will have the lock positioned in the upper right corner of the top pedestal drawer.

| | | | |
|---------|--|----|-----|
| LKI-46L | Return or Single Pedestal Credenza Locking | \$ | 205 |
|---------|--|----|-----|

Double pedestal credenzas will have locks positioned in the upper right corner of both of the top drawers.

| | | | |
|---------|----------------------------------|----|-----|
| LKI-46L | Double Pedestal Credenza Locking | \$ | 410 |
|---------|----------------------------------|----|-----|

LOCKING DOORS

Locking doors are available on specific units, where noted. Specify WITH LOCKING when ordering and add upcharge. Lock core will coordinate with pull selection.

| | | | |
|--------|----------------------------------|----|-----|
| LKT_HU | Two & Four Door Vertical Hutches | \$ | 135 |
| LKT_HU | 72"W to 48"W Units | \$ | 115 |
| LKT_HU | 42"W to 30"W Units | \$ | 91 |
| LKT_HU | 18"W Units | \$ | 69 |

HEIGHT ADJUST LEG CONFIGURATION

The 2-channel leg configuration is standard on height adjustable Desks, Returns, Bridges, and Credenza for one height adjustable worksurface. Desk models offer an optional 3-channel leg configuration for use with 3-channel Returns to allow two worksurfaces to raise and lower simultaneously.

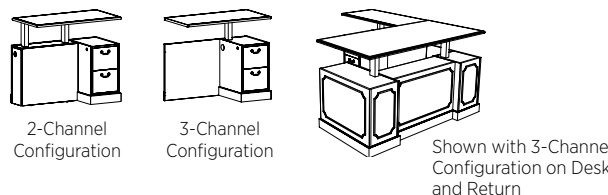

| | | |
|------|---|--------|
| STS2 | 2-Channel Configuration (For one height adjustable worksurface) | STD |
| STS3 | 3-Channel Configuration (For two height adjustable worksurfaces) | \$ N/C |

HEIGHT ADJUST CONTROL OPTIONS

Height adjustable units offer two switch options. The standard switch is a simple up and down switch to move your worksurface from seated to standing height. This comes standard with height adjustable units, unless otherwise noted. The advanced switch features Bluetooth capabilities to connect to smart devices, three stand-up reminder intervals, and height adjustment memory positions, and more.

Please specify desired Control Switch when ordering applicable Height Adjustable units.

| | | | |
|-------|-------------------------------------|----|-----|
| SWCH | Standard Up/Down Switch | \$ | STD |
| MSWCH | Advanced Up/Down with Memory Switch | \$ | 135 |



SWCH (standard) MSWCH

WORKSURFACE GROMMETS FOR STANDARD UNITS & RECEPTION

| | | | |
|----|---|----|----|
| GC | Grommet, Center; Must Specify Black (BLK) or Silver (SLV) | \$ | 52 |
| GL | Grommet, Left; Must Specify Black (BLK) or Silver (SLV) | \$ | 52 |
| GR | Grommet, Right; Must Specify Black (BLK) or Silver (SLV) | \$ | 52 |

Verify Grommet Option is available on the model(s) you are specifying using the location information on Pages 430-431.

Grommets may be ordered in non-standard locations. Call Customer Service to assist with specification. Note additional charges and lead times may apply.

Multiple locations may be selected.

See Grommet Locations on Next Page.

WORKSURFACE GROMMETS FOR STANDARD UNITS & RECEPTION (CONT.)

Models

46-4284DPS 46-4284DP

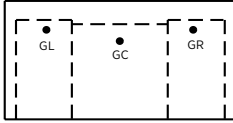

GL/GR: Located 17" from ends and 32" from user side

GC: Located 28" from user side

Models

46-4278DPS 46-4278DP

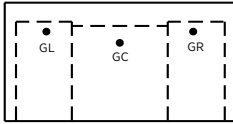

GL/GR: Located 14" from ends and 32" from user side

GC: Located 28" from user side

Models

46-3672CHS 46-3672CH 46-3672LP 46-3672RP
46-3672LPS 46-3672RPS

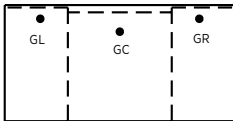

GL/GR: Located 11" from ends and 32" from user side

GC: Located 28" from user side

Models

46-3672DPS 46-3672DP

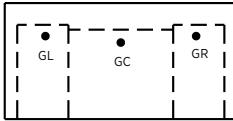

GL/GR: Located 13" from ends and 26" from user side

GC: Located 24" from user side

Models

46-3066DPS 46-3066DP 46-3066LP 46-3066RP
46-3066LPS 46-3066RPS

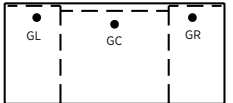

GL/GR: Located 10" from ends and 26" from user side

GC: Located 24" from user side

Models

46-2448UF 46-2448UFH 46-2442UF 46-2442UFH
46-2448LF 46-2448RF 46-2442LF 46-2442RF
46-2448LF2 46-2448RF2 46-2442LF2 46-2442RF2
46-2436CW

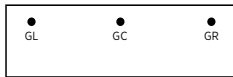

GL/GR: Located 4" from ends and 20" from user side

GC: Located 20" from user side

Models

46-2072KC 46-2072LC 46-2072RC 46-2072LL*
46-2072RL*

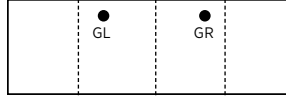

GL/GR: Located 22½" from ends and 17" from user side

* Grommets are only available opposite the pedestal

Models

46-2066KC 46-2066LC 46-2066RC 46-2066LL*
46-2066RL*

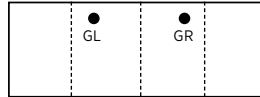

GL/GR: Located 19½" from ends and 17" from user side

* Grommets are only available opposite the pedestal

Models

46-2072KC1 46-2072KC2 46-2066KC2 46-2072LC2
46-2072RC2

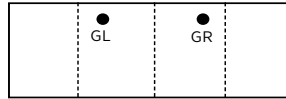

GL/GR: Located 22½" from ends and 17" from user side

Models

46-2066KC1 46-2066LC2 46-2066RC2

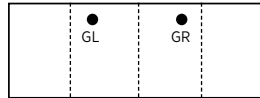

GL/GR: Located 19½" from ends and 17" from user side

Models

46-3672RPD1L 46-3672RPD1R

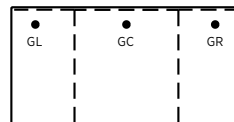

GL/GR: Located 6" from sides and 31¼" from user side

GC: 31¼" from user side

Models

46-3066RPD1L 46-3066RPD1R

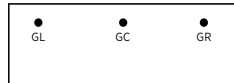

GL/GR: Located 6" from sides and 26%" from user side

GC: 26%" from user side

Models

46-2448RPD2L 46-2448RPD2R 46-2448RUF 46-2442RUF

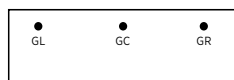

GL/GR: Located 6" from ends and 20" from user side

GC: Located 19" from user side

Models

46-2472RCL 46-2472RCR 46-2466RCL 46-2466RCR

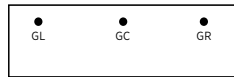

GL/GR: Located 6" from sides and 19" from user

GC: 19" from user side

WORKSURFACE GROMMETS FOR HEIGHT ADJUSTABILITY UNITS

When you select a grommet for use with Height Adjustable worksurfaces, it will automatically come with a wire management sleeve. One grommet per worksurface. Must specify Left, Right, or Center. See below for specific location availability by model. You may also choose to add the Wire Management Box, which will automatically come with a center grommet.

Grommet with Mesh Sleeve \$ 142
Must Specify Grommet Color: Black (BLK) or Silver (SLV)

HA Desks>Returns/Credenzas Choose Left, Right, or Center (See Below)
 HA Bridges Center Only

- GC-MESH Grommet, Center
- GL-MESH Grommet, Left
- GR-MESH Grommet, Right
- GCKS-MESH Grommet, Centered Between Legs



Wire Management Box with Center Grommet \$ 485
Must Specify Black (BLK) or Silver (SLV)

Available on All HA Desks, Returns and Bridges

GC-BOX Grommet, Center

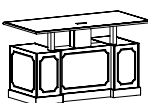

Verify Grommet Option is available on the model(s) you are specifying using the following location information.

Grommets may be ordered in non-standard locations. Call Customer Service to assist with specification. Note additional charges and lead times may apply.

Models

46-3672DPSTS 46-3672DPSSTS

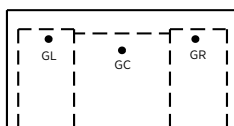

GL or GR: Located 9" from ends and 22½" from user side
 GC: Located 20" from user side

Models

46-3066DPSTS 46-3066DPSSTS 46-3672LPSTS 46-3672RPSTS
 46-3672LPSSTS 46-3672RPSSTS 46-3066LPSTS 46-3672RPSTS
 46-3066LPSSTS 46-3066RPSSTS

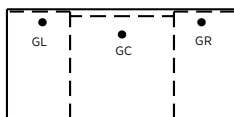

GL or GR: Located 6" from ends and 22½" from user side
 GC: Located 20" from user side

Models

46-2448LF2STS 46-2448RF2STS 46-2442LF2STS 46-2442RF2STS

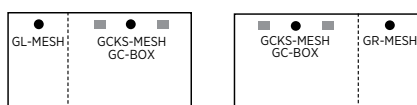

GL or GR: Located 6" from ends and 20" from user side
 CKS: Located 20" from user side

Models

46-2448LF2STS3 46-2448RF2STS3 46-2442LF2STS3 46-2442RF2STS3

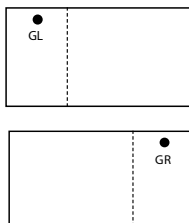

Grommet with Mesh Wire Management Sleeve only available in ped space
 GL-MESH or GR-MESH: Located 6" from ends and 20" from user side

Models

46-2448UFSTS 46-2442UFSTS 46-2448UFSTSL3
 46-2442UFSTSL3 46-2448UFSTSR3 46-2442UFSTSR3

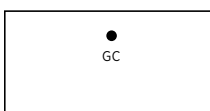

GC: Located 18" from user side

Models

46-2448LF2SR 46-2448RF2SR 46-2442LF2SR 46-2442RF2SR
 46-2448SUFL 46-2448SUFR 46-2442SUFL 46-2442SUFR

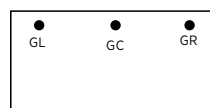

GL/GR: Located 4" from ends and 20" from user side
 GC: Located 20" from user side

HUTCH GROMMET OPTIONS

Select Surface Mount and Vertical Hutches come standard with a lower, center grommet in the back panel. Please specify color: Black (BLK) or Silver (SLV).

Three upper wire management grommets are also available, and are great for use with tasklights. Must specify color option.

WMHUBL Black Lower + 3 Upper Grommets \$ N/C
 WMHUSV Silver Lower + 3 Upper Grommets \$ N/C

CERTIFICATIONS & COMPLIANCE

- Intertek Sustainability Certified
- BIFMA level® Certified
- BIFMA Compliant® Certified
- TSCA Title VI (formerly CARB) Compliance
- Contributes to LEED®, Green Globes®, and WELL® Sustainable Programs

Standard Units + Tables



Double Ped Desks
(See Details)

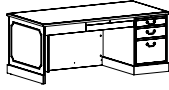

Single Ped Desks
(See Details)

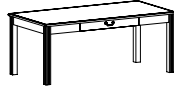
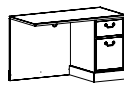
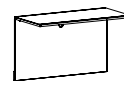

Table Desks
(See Details)



Returns
(See Multiple Unit Details)



Bridges
(See Multiple Unit Details)

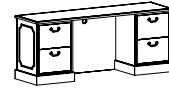

Single Ped, Storage, Kneespace, and Double Lateral Credenzas
(See Multiple Unit Details)

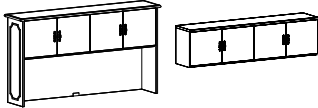

Standard and Tall Surface Mount Hutches and Wall Mount Hutches
(See Multiple Unit Details)

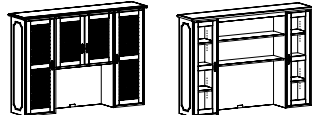

Two and Four Door Vertical Mount Hutches
(See Multiple Unit Details)



Lateral Filing
(See Multiple Unit Details)

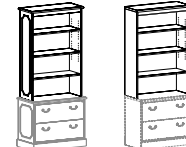

Surface Mount Bookcases with Molding or Flush Ends
(See Multiple Unit Details)



Bookcases with or without Doors
(See Multiple Unit Details)

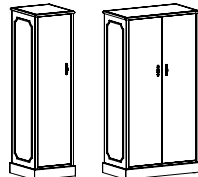

Single and Double Wardrobe/Storage Cabinets
(See Multiple Unit Details)

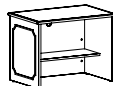

Computer Work Table
(See Details)



Round Tables and Bases
(See Details)

Modular Units

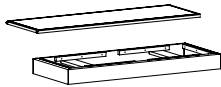

Modular Tops and Bases
(See Multiple Unit Details)
Modular Bookcase Tops and Bases
(See Multiple Unit Details)

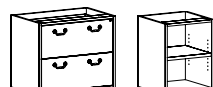

Modular Pedestals
(See Multiple Unit Details)

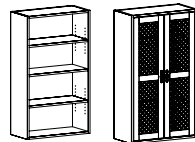

Modular Bookcases
(See Multiple Unit Details)

Occasional Tables



End Tables
(See Details) Lamp Tables
(See Details) Magazine Tables
(See Details)

Height Adjustable (HA) Units

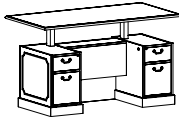

HA Double Ped Desks
(See Multiple Unit Details)

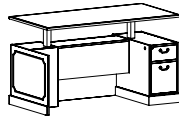

HA Single Ped Desks
(See Multiple Unit Details)



HA Returns
(See Multiple Unit Details)

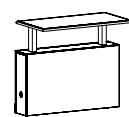

HA Bridges
(See Multiple Unit Details)

Tackboards + Tasklights

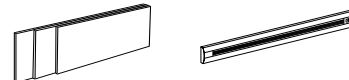

Tackboards
(See Multiple Unit Details)

Tasklights
(See Multiple Unit Details)

Reception Units

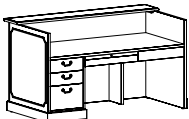

Reception Desks
(See Multiple Unit Details)



Reception Returns
(See Details)

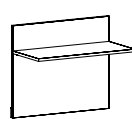

Reception Bridges
(See Multiple Unit Details)

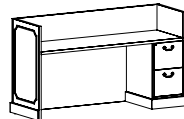

Reception Credenzas
(See Multiple Unit Details)

Kneespace Options + Accessories

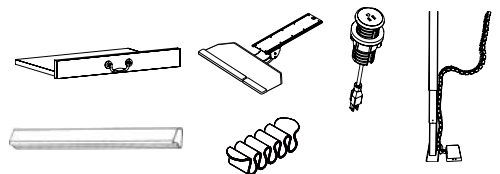

| Item | Model No. | Width | Depth | Height | K | R | Ship Wt | Cubic Ft | List Price | |
|--------|-----------|-------|-------|--------|-----|---|---------|----------|------------|-------|
| L UNIT | 46-20 | 72 | 84 | 30 | 27¾ | - | 480 | 71.8 | W/P\$ | 10661 |
| | | | | | | | | | PV\$ | 11940 |

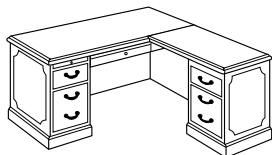

| CONSISTS OF: | | QTY | | | |
|--------------|---|--------------------|-------|------|--|
| 46-3672LP | 1 | Left Pedestal Desk | W/P\$ | 6338 | |
| | | | PV\$ | 7099 | |
| 46-2448RF | 1 | Right Return | W/P\$ | 4323 | |
| | | | PV\$ | 4841 | |

Products are available as left or right, where applicable

| | | | | | | | | | | |
|--------|-------|----|-----|----|---|---|-----|------|-------|-------|
| U UNIT | 46-21 | 72 | 104 | 30 | - | - | 658 | 84.5 | W/P\$ | 13408 |
| | | | | | | | | | PV\$ | 15019 |

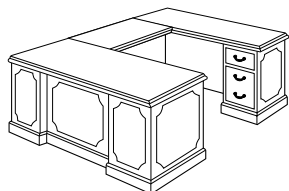

| CONSISTS OF: | | QTY | | | |
|--------------|---|--------------------------|-------|------|--|
| 46-3672LP | 1 | Left Pedestal Desk | W/P\$ | 6338 | |
| | | | PV\$ | 7099 | |
| 46-2448UF | 1 | Bridge with Full Modesty | W/P\$ | 2213 | |
| | | | PV\$ | 2480 | |
| 46-2072RC | 1 | Credenza, Right Pedestal | W/P\$ | 4857 | |
| | | | PV\$ | 5440 | |

Products are available as left or right, where applicable

| | | | | | | | | | | |
|----------------------|------|-----|----|----|---|---|-----|------|-------|-------|
| MODULAR STORAGE UNIT | 46-4 | 88½ | 20 | 83 | - | - | 721 | 88.6 | W/P\$ | 18760 |
| | | | | | | | | | PV\$ | 20739 |



| CONSISTS OF: | | QTY | | | |
|--------------|---|----------------------------------|-------|------|--|
| 46-1589FC | 1 | Modular Cornice Frame | W\$ | 1111 | |
| 46-2952BC | 2 | Modular Bookcases | W\$ | 3600 | |
| | | | PV\$ | 4034 | |
| 46-2952MB | 1 | Modular Bookcase with Mesh Doors | W\$ | 3141 | |
| | | | PV\$ | 3519 | |
| 46-2089TP | 1 | Modular Top | W/P\$ | 1740 | |
| | | | PV\$ | 1948 | |
| 46-1829MU | 2 | Modular Box/Box/File Cabinets | W\$ | 5848 | |
| | | | PV\$ | 6550 | |
| 46-1829MS | 1 | Modular Storage Cabinet | W\$ | 2148 | |
| | | | PV\$ | 2405 | |
| 46-2089BS | 1 | Modular Base | W\$ | 1172 | |

Products are available as left or right, where applicable

| Item | Model No. | Width | Depth | Height | K | R | Ship Wt | Cubic Ft | List Price |
|----------------------|-----------|-------|-------|--------|---|---|---------|----------|---------------------------|
| MODULAR STORAGE UNIT | 46-17 | 88½ | 20 | 83 | - | - | 547 | 62.8 | W/P\$ 16007 PV\$ 17673 |



| CONSIST OF: | QTY | | | |
|-------------|-----|----------------------------------|---------------|--------------|
| 46-1589FC | 1 | Modular Cornice Frame | W\$ | 1111 |
| 46-2952MB | 2 | Modular Bookcase with Mesh Doors | W\$ PV\$ | 6282 7038 |
| 46-2089TP | 1 | Modular Top | W/P\$ PV\$ | 1740 1948 |
| 46-1829MF | 2 | Modular File/File Cabinets | W\$ PV\$ | 5848 6550 |
| 46-2031BS | 2 | Modular Bases | W\$ | 1026 |

Products are available as left or right, where applicable

| | | | | | | | | | |
|---|-------|----|-----|----|---|---|------|-------|---------------------------|
| HEIGHT ADJUSTABLE L UNIT WITH CRENDENZA/HUTCH | 46-22 | 72 | 140 | 83 | - | - | 1207 | 139.9 | W/P\$ 31492 PV\$ 35270 |
|---|-------|----|-----|----|---|---|------|-------|---------------------------|

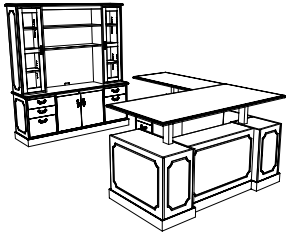

| CONSISTS OF: | QTY | | | |
|----------------|-----|--|---------------|----------------|
| 46-3672RPSTS | 1 | Height Adjustable Right Pedestal Desk | W/P\$ PV\$ | 11552 12936 |
| 46-2448LF2STS3 | 1 | Height Adjustable Left Return for Multiple Surfaces, 3-Channel | W/P\$ PV\$ | 7474 8372 |
| 46-2072SC1 | 1 | Storage Credenza | W/P\$ PV\$ | 6915 7745 |
| 46-1572VHG | 1 | Vertical Open Hutch with Glass Doors | W/P\$ PV\$ | 5551 6217 |

Products are available as left or right, where applicable; Depth is figured with 36" between return and credenza

| | | | | | | | | | |
|------------------|-------|----|-----|----|---|---|-----|-------|---------------------------|
| RECEPTION U-UNIT | 46-23 | 72 | 108 | 42 | - | - | 677 | 104.5 | W/P\$ 17386 PV\$ 19471 |
|------------------|-------|----|-----|----|---|---|-----|-------|---------------------------|

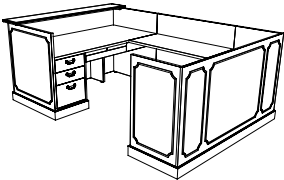

| CONSISTS OF: | QTY | | | |
|--------------|-----|----------------------|---------------|--------------|
| 46-3672RPD1L | 1 | Reception Desk, Left | W/P\$ PV\$ | 8254 9245 |
| 46-2448RUF | 1 | Reception Bridge | W/P\$ PV\$ | 2520 2821 |
| 46-2472RCR | 1 | Reception Credenza | W/P\$ PV\$ | 6612 7405 |

Products are available as left or right, where applicable

[See Jefferson Intro Section for Ordering Options](#)

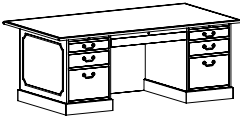
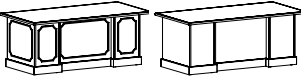
| Item | Model No. | Width | Depth | Height | K | R | Ship Wt | Cubic Ft | List Price | |
|---|--|-------|-------|--------|-----|-----|---------|--------------------------|---------------------------|--|
| DOUBLE PED DESK TRAY/BOX/FILE   Approach Side Shown with Decorative Molding and Optional No Molding | TOP OVERHANG FEATURE | | | | | | | | | |
| | 46-4284DPS | 84 | 42 | 30 | 32½ | 3 | 458 | 67.4 | W/P\$ 11864 PV\$ 13288 | |
| | <i>Chassis 72W x 36D - Legal Ped; Approach Overhang 6", Side Overhang 7"</i> | | | | | | | | | |
| | 46-4278DPS | 78 | 42 | 30 | 32½ | 3 | 408 | 62.6 | W/P\$ 10520 PV\$ 11785 | |
| | <i>Chassis 72W x 36D - Legal Ped; Approach Overhang 6", Side Overhang 4"</i> | | | | | | | | | |
| | 46-3672DPS | 72 | 36 | 30 | 32½ | 3 | 358 | 50.0 | W/P\$ 7118 PV\$ 7973 | |
| <i>Chassis 66W x 30D - Letter Ped; Approach Overhang 6", Side Overhang 4"</i> | | | | | | | | | | |
| STANDARD TOP | | | | | | | | | | |
| 46-3672CHS | 72 | 36 | 30 | 32½ | 3 | 358 | 50.0 | W/P\$ 9942 PV\$ 11132 | | |
| <i>Legal Ped</i> | | | | | | | | | | |
| 46-3066DPS | 66 | 30 | 30 | 32½ | 3 | 300 | 38.7 | W/P\$ 6873 PV\$ 7697 | | |
| <i>Letter Ped</i> | | | | | | | | | | |

Must Specify (in this order):

Model #
 Premium or Standard Veneer
 Top Material
 Finish/Color
 Pull
 No Molding
 Dictation Slide
 Drawer Track
 Top Grommet Location/Color
 Flip Down Center Drawer

Description

- Standard with: Stepped Front, Rectangle Top Profiled on All Sides, Base Molding on All Sides, Decorative Molding on Approach and Both Sides, Central Locking in Center Drawer, Tray/Box/File Peds, Left-to-Right Grain Direction on Top, Pull Out Writing Shelf on Both Sides (Above Tray Drawer), and Dovetail Wood Drawer Construction
- Chassis Available with Premium Veneer (PV) or Standard Veneer (W); Must Specify
- Top Available with Premium/Standard Veneer (PV/W) or HPL (P); Must Specify
- [Height Adjustable Units Available](#)
- Lock Core Color will Coordinate with Pull Selection (Brass Pull with Black Lock, Silver Pull with Silver Lock)
- Additional Options: No Decorative Molding (Specify NO MOLDING); Keyboard Flip Down Center Drawer (Order Separately, [See Center Drawer](#)); Dictation Slide on Approach Side for 36"D and 30"D Units Only ([See Dictation Slide Options](#)); Soft Close Drawer Closure ([See Soft Close Drawer Option](#)); Top Grommet Options ([See Grommet Options](#)); Wire Management + Accessories (Order Separately; [See Multiple Unit Details](#))

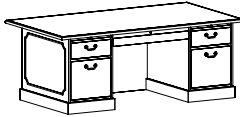
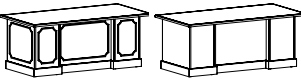
| Item | Model No. | Width | Depth | Height | K | R | Ship Wt | Cubic Ft | List Price | |
|--|--|-------|-------|--------|-----|-----|---------|--------------------------|---------------------------|--|
| DOUBLE PED DESK BOX/FILE   Approach Side Shown with Decorative Molding and Optional No Molding | TOP OVERHANG FEATURE | | | | | | | | | |
| | 46-4284DP | 84 | 42 | 30 | 32½ | 3 | 458 | 67.4 | W/P\$ 10728 PV\$ 12016 | |
| | <i>Chassis 72W x 36D - Legal Ped; Approach Overhang 6", Side Overhang 7"</i> | | | | | | | | | |
| | 46-4278DP | 78 | 42 | 30 | 32½ | 3 | 408 | 62.6 | W/P\$ 9514 PV\$ 10655 | |
| | <i>Chassis 72W x 36D - Legal Ped; Approach Overhang 6", Side Overhang 4"</i> | | | | | | | | | |
| | 46-3672DP | 72 | 36 | 30 | 32½ | 3 | 358 | 50.0 | W/P\$ 6743 PV\$ 7553 | |
| <i>Chassis 66W x 30D - Letter Ped; Approach Overhang 6", Side Overhang 4"</i> | | | | | | | | | | |
| STANDARD TOP | | | | | | | | | | |
| 46-3672CH | 72 | 36 | 30 | 32½ | 3 | 358 | 50.0 | W/P\$ 9167 PV\$ 10268 | | |
| <i>Legal Ped</i> | | | | | | | | | | |
| 46-3066DP | 66 | 30 | 30 | 32½ | 3 | 300 | 38.7 | W/P\$ 6468 PV\$ 7244 | | |
| <i>Letter Ped</i> | | | | | | | | | | |

Must Specify (in this order):

Model #
 Premium or Standard Veneer
 Top Material
 Finish/Color
 Pull
 No Molding
 Dictation Slide
 Drawer Track
 Top Grommet Location/Color
 Flip Down Center Drawer

Description

- Standard with: Stepped Front, Rectangle Top Profiled on All Sides, Base Molding on All Sides, Decorative Molding on Approach and Both Sides, Central Locking in Center Drawer, Box/File Peds, Left-to-Right Grain Direction on Top, Pull Out Writing Shelf on Both Sides (Above Box Drawer), and Dovetail Wood Drawer Construction
- Chassis Available with Premium Veneer (PV) or Standard Veneer (W); Must Specify
- Top Available with Premium/Standard Veneer (PV/W) or HPL (P); Must Specify
- [Height Adjustable Units Available](#)
- Lock Core Color will Coordinate with Pull Selection (Brass Pull with Black Lock, Silver Pull with Silver Lock)
- Additional Options: No Decorative Molding (Specify NO MOLDING); Keyboard Flip Down Center Drawer (Order Separately, [See Center Drawer](#)); Dictation Slide on Approach Side for 36"D and 30"D Units Only ([See Dictation Slide Options](#)); Soft Close Drawer Closure ([See Soft Close Drawer Option](#)); Top Grommet Options ([See Grommet Options](#)); Wire Management + Accessories (Order Separately; [See Multiple Unit Details](#))

P = HPL W = Veneer PV = Premium Veneer

[See Jefferson Intro Section for Ordering Options](#)

| Item | Model No. | Width | Depth | Height | K | R | Ship Wt | Cubic Ft | List Price | |
|--------------------------------------|---------------------------------|------------------|-------|--------|----|-----|---------|----------|------------|-------------------------|
| SINGLE PED DESK TRAY/BOX/FILE | Left Ped | Right Ped | | | | | | | | |
| | 46-3672LPS <i>Legal Ped</i> | 46-3672RPS | 72 | 36 | 30 | 28¼ | 3 | 315 | 50.4 | W/P\$ 6705 PV\$ 7509 |
| | 46-3066LPS <i>Letter Ped</i> | 46-3066RPS | 66 | 30 | 30 | 25¼ | 3 | 262 | 38.7 | W/P\$ 6126 PV\$ 6864 |

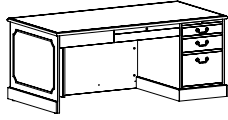

Shown as Right

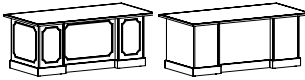

Approach Side Shown with Decorative Molding and Optional No Molding

Must Specify (in this order):

- Model #
- Premium or Standard Veneer
- Top Material
- Finish/Color
- Pull
- No Molding
- Dictation Slide
- Drawer Track
- Top Grommet Location/Color
- Flip Down Center Drawer

Description

- Standard with: Stepped Front, Rectangle Top Profiled on All Sides, Base Molding on All Sides, Decorative Molding on Approach and Both Sides, Central Locking in Center Drawer, Tray/Box/File Ped, Left-to-Right Grain Direction on Top, Pull Out Writing Shelf Above Tray Drawer, and Dovetail Wood Drawer Construction
- Chassis Available with Premium Veneer (PV) or Standard Veneer (W); Must Specify
- Top Available with Premium/Standard Veneer (PV/W) or HPL (P); Must Specify
- [Height Adjustable Units Available](#)
- Lock Core Color will Coordinate with Pull Selection (Brass Pull with Black Lock, Silver Pull with Silver Lock)
- Additional Options: No Decorative Molding (Specify NO MOLDING); Keyboard Flip Down Center Drawer (Order Separately, [See Center Drawer](#)); Dictation Slide on Approach Side for 36"D and 30"D Units Only ([See Dictation Slide Options](#)); Soft Close Drawer Closure ([See Soft Close Drawer Option](#)); Top Grommet Options ([See Grommet Options](#)); Wire Management + Accessories (Order Separately; [See Multiple Unit Details](#))

| Item | Model No. | Width | Depth | Height | K | R | Ship Wt | Cubic Ft | List Price | |
|---------------------------------|--------------------------------|------------------|-------|--------|----|-----|---------|----------|------------|-------------------------|
| SINGLE PED DESK BOX/FILE | Left Ped | Right Ped | | | | | | | | |
| | 46-3672LP <i>Legal Ped</i> | 46-3672RP | 72 | 36 | 30 | 28¼ | 3 | 315 | 50.4 | W/P\$ 6338 PV\$ 7099 |
| | 46-3066LP <i>Letter Ped</i> | 46-3066RP | 66 | 30 | 30 | 25¼ | 3 | 262 | 38.7 | W/P\$ 5760 PV\$ 6451 |

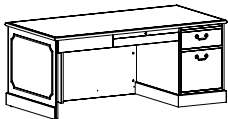

Shown as Right

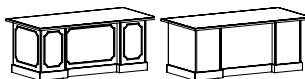

Approach Side Shown with Decorative Molding and Optional No Molding

Must Specify (in this order):

- Model #
- Premium or Standard Veneer
- Top Material
- Finish/Color
- Pull
- No Molding
- Dictation Slide
- Drawer Track
- Top Grommet Location/Color
- Flip Down Center Drawer

Description

- Standard with: Stepped Front, Rectangle Top Profiled on All Sides, Base Molding on All Sides, Decorative Molding on Approach and Both Sides, Central Locking in Center Drawer, Box/File Ped, Left-to-Right Grain Direction on Top, Pull Out Writing Shelf Above Box Drawer, and Dovetail Wood Drawer Construction
- Chassis Available with Premium Veneer (PV) or Standard Veneer (W); Must Specify
- Top Available with Premium/Standard Veneer (PV/W) or HPL (P); Must Specify
- [Height Adjustable Units Available](#)
- Lock Core Color will Coordinate with Pull Selection (Brass Pull with Black Lock, Silver Pull with Silver Lock)
- Additional Options: No Decorative Molding (Specify NO MOLDING); Keyboard Flip Down Center Drawer (Order Separately, [See Center Drawer](#)); Dictation Slide on Approach Side for 36"D and 30"D Units Only ([See Dictation Slide Options](#)); Soft Close Drawer Closure ([See Soft Close Drawer Option](#)); Top Grommet Options ([See Grommet Options](#)); Wire Management + Accessories (Order Separately; [See Multiple Unit Details](#))

P = HPL W = Veneer PV = Premium Veneer

[See Jefferson Intro Section for Ordering Options](#)

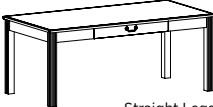
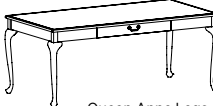
| Item | Model No. | Width | Depth | Height | K | R | Ship Wt | Cubic Ft | List Price | |
|--|-----------------------------|-------|-------|--------|---|---|---------|----------|-------------------------|--|
|  <p>Straight Legs</p>  <p>Queen Anne Legs</p> | WITH STRAIGHT LEGS | | | | | | | | | |
| | 46-3672TD | 72 | 36 | 30 | - | - | 120 | 12.2 | W/P\$ 3975 PV\$ 4453 | |
| | 46-3066TD | 66 | 30 | 30 | - | - | 110 | 9.7 | W/P\$ 3326 PV\$ 3727 | |
| | WITH QUEEN ANNE LEGS | | | | | | | | | |
| | 46-3672TDQ | 72 | 36 | 30 | - | - | 120 | 12.2 | W/P\$ 6327 PV\$ 6804 | |
| | 46-3066TDQ | 66 | 30 | 30 | - | - | 110 | 9.7 | W/P\$ 5678 PV\$ 6079 | |

Must Specify (in this order):

Model #
Top Material
Finish/Color
Pull
Drawer Track

Description

- Standard with: Rectangle Top Profiled on All Sides, Center Drawer with Dovetail Wood Drawer Construction, and Left-to-Right Grain Direction on Top
- Top Available with Premium Veneer (PV), Veneer (W), or HPL (P); Must Specify
- Top and Legs Ship Separately; Some Assembly Required
- Additional Option: Soft Close Drawer Closure ([See Soft Close Drawer Option](#))

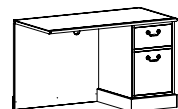
RETURN WITH BOX/FILE

Shown as Right

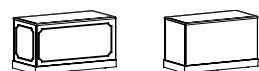

Approach Side Shown with Decorative Molding and Optional No Molding

| | Left Ped | Right Ped | Width | Depth | Height | K | R | Ship Wt | Cubic Ft | List Price |
|--|-----------|-----------|-------|-------|--------|-----|---|---------|----------|-------------------------|
| | 46-2448LF | 46-2448RF | 48 | 24 | 30 | 30¾ | - | 165 | 21.8 | W/P\$ 4323 PV\$ 4841 |
| | 46-2442LF | 46-2442RF | 42 | 24 | 30 | 27¾ | - | 165 | 21.8 | W/P\$ 4271 PV\$ 4786 |

Description

- Standard with: Rectangle Top Profiled on Three Sides with Reverse Profile on Connecting Side, Base Molding on All Sides, Decorative Molding on Approach and Side, Box/File Ped, Grommet in Back Panel, Front-To-Back Grain Direction on Top, and Dovetail Wood Drawer Construction
- Chassis Available with Premium Veneer (PV) or Standard Veneer (W); Must Specify
- Top Available with Premium/Standard Veneer (PV/W) or HPL (P); Must Specify
- [Height Adjustable Units Available](#)
- Grommet in Back Panel; Must Specify: Black (BLK), Silver (SLV), or None (NONE)
- Additional Options: No Decorative Molding (Specify NO MOLDING); Locking Pedestal ([See Locking Options](#)); Kneespace Options (Order Separately, [See Multiple Units](#)); Soft Close Drawer Closure ([See Soft Close Drawer Option](#)); Top Grommet Options ([See Grommet Options](#)); Wire Management + Accessories (Order Separately; [See Multiple Unit Details](#))

Must Specify (in this order):

Model #
Premium or Standard Veneer
Top Material
Finish/Color
Pull
No Molding
Drawer Track
Locking Pedestal
Back Panel Grommet Color
Top Grommet Location/Color
Kneespace Options

P = HPL W = Veneer PV = Premium Veneer

[See Jefferson Intro Section for Ordering Options](#)

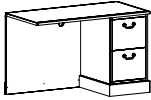
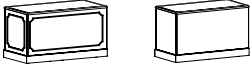
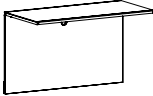
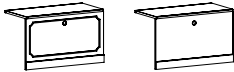
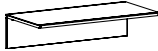
| Item | Model No. | Width | Depth | Height | K | R | Ship Wt | Cubic Ft | List Price | |
|---|-----------------|------------------|-------|--------|-----|-----|---------|----------|------------|-------------------------|
|  <p>Shown as Right</p>  <p>Approach Side Shown with Decorative Molding and Optional No Molding</p> <p><u>Must Specify (in this order):</u> Model # Premium or Standard Veneer Top Material Finish/Color Pull No Molding Drawer Track Locking Pedestal Back Panel Grommet Color Top Grommet Location/Color Kneespace Options</p> | Left Ped | Right Ped | | | | | | | | |
| | 46-2448LF2 | 46-2448RF2 | 48 | 24 | 30 | 30¾ | - | 165 | 21.8 | W/P\$ 4680 PV\$ 5240 |
| | 46-2442LF2 | 46-2442RF2 | 42 | 24 | 30 | 27¾ | - | 165 | 21.8 | W/P\$ 4627 PV\$ 5185 |
| Description | | | | | | | | | | |
| <ul style="list-style-type: none"> Standard with: Rectangle Top Profiled on Three Sides with Reverse Profile on Connecting Side, Base Molding on All Sides, Decorative Molding on Approach and Side, File/File Ped, Grommet in Back Panel, Front-to-Back Grain Direction on Top, and Dovetail Wood Drawer Construction Chassis Available with Premium Veneer (PV) or Standard Veneer (W); Must Specify Top Available with Premium/Standard Veneer (PV/W) or HPL (P); Must Specify Height Adjustable Units Available Grommet in Back Panel; Must Specify: Black (BLK), Silver (SLV), or None (NONE) Additional Options: No Decorative Molding (Specify NO MOLDING); Locking Pedestal (See Locking Options); Kneespace Options (Order Separately, See Multiple Units); Soft Close Drawer Closure (See Soft Close Drawer Option); Top Grommet Options (See Grommet Options); Wire Management + Accessories (Order Separately; See Multiple Unit Details) | | | | | | | | | | |
| BRIDGE WITH FULL MODESTY   <p>Approach Side Shown with Decorative Molding and Optional No Molding</p> <p><u>Must Specify (in this order):</u> Model # Premium or Standard Veneer Top Material Finish/Color No Molding Top Grommet Location/Color</p> | 46-2448UF | | 48 | 24 | 30 | 50 | - | 89 | 5.4 | W/P\$ 2213 PV\$ 2480 |
| | | 46-2442UF | | 42 | 24 | 30 | 42 | - | 85 | 4.6 |
| Description | | | | | | | | | | |
| <ul style="list-style-type: none"> Standard With: Rectangle Top Profiled on Approach and User Side with Reverse Profile on Connecting Sides, Base and Decorative Molding on Approach Side, Grommet in Back Panel, Front-to-Back Grain Direction on Top, and Hinged Back Panel Chassis Available with Premium Veneer (PV) or Standard Veneer (W); Must Specify Top Available with Premium/Standard Veneer (PV/W) or HPL (P); Must Specify Height Adjustable Units Available Grommet in Back Panel; Must Specify: Black (BLK) or Silver (SLV) or None (NONE) Additional Options: No Decorative Molding (Specify No Molding); Kneespace Options (Order Separately, Available for Field Installation Only See Multiple Units); Soft Close Drawer Closure (See Soft Close Drawer Option); Top Grommet Options (See Grommet Options); Wire Management + Accessories (Order Separately; See Multiple Unit Details) | | | | | | | | | | |
| BRIDGE WITH HALF MODESTY  <p><u>Must Specify (in this order):</u> Model # Premium or Standard Veneer Top Material Finish/Color Top Grommet Location/Color</p> | 46-2448UFH | | 48 | 24 | 11½ | 50 | - | 89 | 5.4 | W/P\$ 1939 PV\$ 2170 |
| | | 46-2442UFH | | 42 | 24 | 11½ | 42 | - | 85 | 4.6 |
| Description | | | | | | | | | | |
| <ul style="list-style-type: none"> Standard With: Rectangle Top Profiled on Approach and User Side with Reverse Profile on Connecting Sides, Front-to-Back Grain Direction on Top, and Hinged Back Panel Chassis Available with Premium Veneer (PV) or Standard Veneer (W); Must Specify Top Available with Premium/Standard Veneer (PV/W) or HPL (P); Must Specify No Base or Decorative Molding Additional Options: Top Grommet Options (Starting on Page 429); Kneespace Options (Order Separately, Available for Field Installation Only See Multiple Units); Soft Close Drawer Closure (See Soft Close Drawer Option); Top Grommet Options (See Grommet Options); Wire Management + Accessories (Order Separately; See Multiple Unit Details) | | | | | | | | | | |

P = HPL W = Veneer PV = Premium Veneer

[See Jefferson Intro Section for Ordering Options](#)

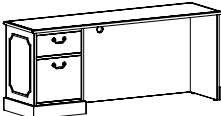
| Item | Model No. | Width | Depth | Height | K | R | Ship Wt | Cubic Ft | List Price | |
|--|--------------------------------|------------------|-------|--------|----|-----|---------|----------|------------|-------------------------|
|  Shown as Left | Left Ped | Right Ped | | | | | | | | |
| | 46-2072LC <i>Legal Ped</i> | 46-2072RC | 72 | 20 | 30 | 28¼ | - | 254 | 29.0 | W/P\$ 4857 PV\$ 5440 |
| | 46-2066LC <i>Letter Ped</i> | 46-2066RC | 66 | 20 | 30 | 25¼ | - | 195 | 26.6 | W/P\$ 4787 PV\$ 5360 |

Description

- Standard With: Rectangle Top Profiled on All Sides, Base Molding on All Sides, Decorative Molding on Back and Both Sides, Box/File Ped, Grommet in Back Panel, Left-to-Right Grain Direction on Top, and Dovetail Wood Drawer Construction
- Chassis Available with Premium Veneer (PV) or Standard Veneer (W); Must Specify
- Top Available with Premium/Standard Veneer (PV/W) or HPL (P); Must Specify
- Grommet in Back Panel; Must Specify: Black (BLK), Silver (SLV), or None (NONE)
- Additional Options: No Decorative Molding (Specify NO MOLDING); Locking Pedestal ([See Locking Options](#)); Soft Close Drawer Closure ([See Soft Close Drawer Option](#)); Top Grommet Options ([See Grommet Options](#)); Wire Management + Accessories (Order Separately; [See Multiple Unit Details](#))

Must Specify (in this order):

- Model #
- Premium or Standard Veneer
- Top Material
- Finish/Color
- Pull
- No Molding
- Drawer Track
- Locking Pedestal
- Back Panel Grommet Color
- Top Grommet Location/Color

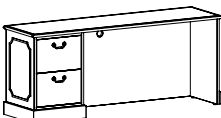
| Item | Model No. | Width | Depth | Height | K | R | Ship Wt | Cubic Ft | List Price | |
|--|---------------------------------|------------------|-------|--------|----|-----|---------|----------|------------|-------------------------|
|  Shown as Left | Left Ped | Right Ped | | | | | | | | |
| | 46-2072LC2 <i>Legal Ped</i> | 46-2072RC2 | 72 | 20 | 30 | 28¼ | - | 254 | 29.0 | W/P\$ 4955 PV\$ 5550 |
| | 46-2066LC2 <i>Letter Ped</i> | 46-2066RC2 | 66 | 20 | 30 | 25¼ | - | 195 | 26.6 | W/P\$ 4866 PV\$ 5449 |

Description

- Standard With: Rectangle Top Profiled on All Sides, Base Molding on All Sides, Decorative Molding on Back and Both Sides, File/File Ped, Grommet in Back Panel, Left-to-Right Grain Direction on Top, and Dovetail Wood Drawer Construction
- Chassis Available with Premium Veneer (PV) or Standard Veneer (W); Must Specify
- Top Available with Premium/Standard Veneer (PV/W) or HPL (P); Must Specify
- Grommet in Back Panel; Must Specify: Black (BLK), Silver (SLV), or None (NONE)
- Additional Options: No Decorative Molding (Specify NO MOLDING); Locking Pedestal ([See Locking Options](#)); Soft Close Drawer Closure ([See Soft Close Drawer Option](#)); Top Grommet Options ([See Grommet Options](#)); Wire Management + Accessories (Order Separately; [See Multiple Unit Details](#))

Must Specify (in this order):

- Model #
- Premium or Standard Veneer
- Top Material
- Finish/Color
- Pull
- No Molding
- Drawer Track
- Locking Pedestal
- Back Panel Grommet Color
- Top Grommet Location/Color

P = HPL W = Veneer PV = Premium Veneer

[See Jefferson Intro Section for Ordering Options](#)

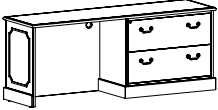
| Item | Model No. | Width | Depth | Height | K | R | Ship Wt | Cubic Ft | List Price | |
|--|-----------------|------------------|-------|--------|----|-----|---------|----------|------------|-------------------------|
| CREDENZA WITH LATERAL/LATERAL FILE  | Left Ped | Right Ped | | | | | | | | |
| | 46-2072LL | 46-2072RL | 72 | 20 | 30 | 28¼ | - | 315 | 50.4 | W/P\$ 5053 PV\$ 5658 |
| | 46-2066LL | 46-2066RL | 66 | 20 | 30 | 25¼ | - | 262 | 38.7 | W/P\$ 4946 PV\$ 5539 |

Shown as Right

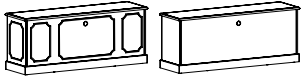

Back Side Shown with Decorative Molding and Optional No Molding

Must Specify (in this order):

- Model #
- Premium or Standard Veneer
- Top Material
- Finish/Color
- Pull
- No Molding
- Back Panel Grommet Color
- Top Grommet Location/Color

Description

- Standard With: Rectangle Top Profiled on All Sides, Base Molding on All Sides, Decorative Molding on Back and Both Sides, Locking Lateral/Lateral File Ped with Legal or Letter Filing, Grommet in Back Panel, Left-to-Right Grain Direction on Top, and Dovetail Wood Drawer Construction
- Chassis Available with Premium Veneer (PV) or Standard Veneer (W); Must Specify
- Top Available with Premium/Standard Veneer (PV/W) or HPL (P); Must Specify
- Grommet in Back Panel; Must Specify: Black (BLK), Silver (SLV), or None (NONE)
- Additional Options: No Decorative Molding (Specify NO MOLDING); Top Grommet Options ([See Grommet Options](#)); Wire Management + Accessories (Order Separately; [See Multiple Unit Details](#))

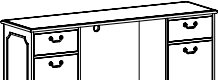
| | | | | | | | | | |
|--|------------------|----|----|----|-----|---|-----|------|-------------------------|
| KNEESPACE CREDENZA WITH BOX/FILE  | 46-2072KC | 72 | 20 | 30 | 32½ | - | 275 | 29.0 | W/P\$ 5794 PV\$ 6489 |
| | <i>Legal Ped</i> | | | | | | | | |
| | 46-2066KC | 66 | 20 | 30 | 32½ | - | 216 | 26.6 | W/P\$ 5262 PV\$ 5893 |

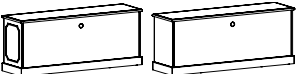

Side Shown with Decorative Molding and Optional No Molding

Must Specify (in this order):

- Model #
- Premium or Standard Veneer
- Top Material
- Finish/Color
- Pull
- No Molding
- Drawer Track
- Locking Pedestal
- Back Panel Grommet Color
- Top Grommet Location/Color

Description

- Standard With: Rectangle Top Profiled on All Sides, Base Molding on All Sides, Decorative Molding on Both Sides, Box/File Peds, Grommet in Back Panel, Left-to-Right Grain Direction on Top, and Dovetail Wood Drawer Construction
- Chassis Available with Premium Veneer (PV) or Standard Veneer (W); Must Specify
- Top Available with Premium/Standard Veneer (PV/W) or HPL (P); Must Specify
- Grommet in Back Panel; Must Specify: Black (BLK), Silver (SLV), or None (NONE)
- Additional Options: No Decorative Molding (Specify NO MOLDING); Locking Pedestal ([See Locking Options](#)); Soft Close Drawer Closure ([See Soft Close Drawer Option](#)); Top Grommet Options ([See Grommet Options](#)); Wire Management + Accessories (Order Separately; [See Multiple Unit Details](#))

P = HPL W = Veneer PV = Premium Veneer

[See Jefferson Intro Section for Ordering Options](#)

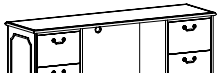
| Item | Model No. | Width | Depth | Height | K | R | Ship Wt | Cubic Ft | List Price |
|---|---------------------------------|-------|-------|--------|-----|---|---------|----------|-------------------------|
| KNEESPACE CREDENZA WITH FILE/FILE  | 46-2072KC2 <i>Legal Ped</i> | 72 | 20 | 30 | 32½ | - | 275 | 29.0 | W/P\$ 6177 PV\$ 6918 |
| | 46-2066KC2 <i>Letter Ped</i> | 66 | 20 | 30 | 32½ | - | 216 | 26.6 | W/P\$ 5645 PV\$ 6324 |

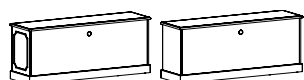

Side Shown with Decorative Molding and
Optional No Molding

Must Specify (in this order):

Model #
Premium or Standard Veneer
Top Material
Finish/Color
Pull
No Molding
Drawer Track
Locking Pedestal
Back Panel Grommet Color
Top Grommet Location/Color

Description

- Standard With: Rectangle Top Profiled on All Sides, Base Molding on All Sides, Decorative Molding on Both Sides, File/File Peds, Grommet in Back Panel, Left-to-Right Grain Direction on Top, and Dovetail Wood Drawer Construction
- Chassis Available with Premium Veneer (PV) or Standard Veneer (W); Must Specify
- Top Available with Premium/Standard Veneer (PV/W) or HPL (P); Must Specify
- Grommet in Back Panel; Must Specify: Black (BLK), Silver (SLV), or None (NONE)
- Additional Options: No Decorative Molding (Specify NO MOLDING); Locking Pedestal ([See Locking Options](#)); Soft Close Drawer Closure ([See Soft Close Drawer Option](#)); Top Grommet Options ([See Grommet Options](#)); Wire Management + Accessories (Order Separately; [See Multiple Unit Details](#))

| | | | | | | | | | |
|--|---------------------------------|----|----|----|-----|---|-----|------|-------------------------|
| KNEESPACE CREDENZA WITH BOX/BOX/FILE  | 46-2072KC1 <i>Legal Ped</i> | 72 | 20 | 30 | 32½ | - | 275 | 29.0 | W/P\$ 6558 PV\$ 7346 |
| | 46-2066KC1 <i>Letter Ped</i> | 66 | 20 | 30 | 32½ | - | 216 | 26.6 | W/P\$ 6028 PV\$ 6749 |

With Decorative Molding

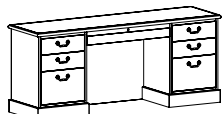

Without Decorative Molding

Must Specify (in this order):

Model #
Premium or Standard Veneer
Top Material
Finish/Color
Pull
No Molding
Drawer Track
Back Panel Grommet Color
Top Grommet Location/Color
Flip Down Center Drawer

Description

- Standard With: Rectangle Top Profiled on All Sides, Central Locking in Center Drawer, Base Molding on All Sides, Decorative Molding on Both Sides, Box/Box/File Peds, Grommet in Back Panel, Left-to-Right Grain Direction on Top, and Dovetail Wood Drawer Construction
- Chassis Available with Premium Veneer (PV) or Standard Veneer (W); Must Specify
- Top Available with Premium/Standard Veneer (PV/W) or HPL (P); Must Specify
- Grommet in Back Panel; Must Specify: Black (BLK), Silver (SLV), or None (NONE)
- Additional Options: No Decorative Molding (Specify NO MOLDING); Soft Close Drawer Closure ([See Soft Close Drawer Option](#)); Top Grommet Options ([See Grommet Options](#)); Wire Management + Accessories (Order Separately; [See Multiple Unit Details](#))

P = HPL W = Veneer PV = Premium Veneer

[See Jefferson Intro Section for Ordering Options](#)

| Item | Model No. | Width | Depth | Height | Ship Wt | Cubic Ft | List Price |
|-------------------------|-----------|-------|-------|--------|---------|----------|-------------------------|
| DOUBLE LATERAL CREDENZA | 46-2072DL | 72 | 20 | 30 | 304 | 29.0 | W/P\$ 7531 PV\$ 8433 |

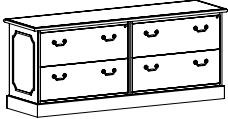

With Decorative Molding

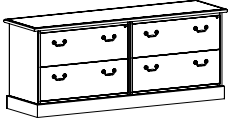

Without Decorative Molding

Description

- Standard With: Rectangle Top Profiled on All Sides, Base Molding on All Sides, Decorative Molding on Both Sides, Dual Locking Double Lateral/Lateral Peds with Legal or Letter Filing, Side-to-Side Grain Direction on Top, Dovetail Wood Drawer Construction, and Anti-Tilt System
- Chassis Available with Premium Veneer (PV) or Standard Veneer (W); Must Specify
- Top Available with Premium/Standard Veneer (PV/W) or HPL (P); Must Specify
- Lock Core Color will Coordinate with Pull Selection (Brass Pull with Black Lock, Silver Pull with Silver Lock)
- Additional Options: No Decorative Molding (Specify NO MOLDING)

Must Specify (in this order):

Model #
Premium or Standard Veneer
Top Material
Finish/Color
Pull
No Molding

| | | | | | | | |
|------------------------------------|-------------------|----|----|----|-----|------|-------------------------|
| STORAGE CREDENZA WITH BOX/BOX/FILE | 46-2072SC1 | 72 | 20 | 30 | 296 | 29.0 | W/P\$ 6915 PV\$ 7745 |
| | <i>Legal Ped</i> | | | | | | |
| | 46-2066SC1 | 66 | 20 | 30 | 296 | 29.0 | W/P\$ 6222 PV\$ 6968 |
| | <i>Letter Ped</i> | | | | | | |

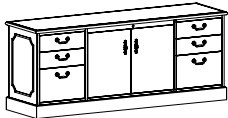

With Decorative Molding

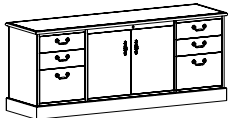

Without Decorative Molding

Description

- Standard With: Rectangle Top Profiled on All Sides, Central Locking, Base Molding on All Sides, Decorative Molding on Both Sides, Box/Box/File Peds with Legal or Letter Filing, One Fixed Shelf Behind Doors, Side-to-Side Grain Direction on Top, and Dovetail Wood Drawer Construction
- Chassis Available with Premium Veneer (PV) or Standard Veneer (W); Must Specify
- Top Available with Premium/Standard Veneer (PV/W) or HPL (P); Must Specify
- Lock Core Color will Coordinate with Pull Selection (Brass Pull with Black Lock, Silver Pull with Silver Lock)
- Additional Options: No Decorative Molding (Specify NO MOLDING); Soft Close Drawer Closure ([See Soft Close Drawer Option](#))

Must Specify (in this order):

Model #
Premium or Standard Veneer
Top Material
Finish/Color
Pull
No Molding
Drawer Track

P = HPL W = Veneer PV = Premium Veneer

[See Jefferson Intro Section for Ordering Options](#)

| Item | Model No. | Width | Depth | Height | Ship Wt | Cubic Ft | List Price |
|---------------------------------------|------------------------------------|-------|-------|--------|---------|----------|-----------------------|
| SURFACE MOUNTED HUTCH WITH WOOD DOORS | 46-1572HU <i>Four (4) Doors</i> | 72 | 15 | 39¾ | 200 | 30.2 | W\$ 6824 PV\$ 7643 |
| | 46-1566HU <i>Four (4) Doors</i> | 66 | 15 | 39¾ | 192 | 26.9 | W\$ 6443 PV\$ 7216 |

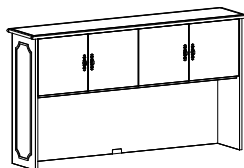

Must Specify (in this order):

Model #
Premium or Standard Veneer
Finish
Pull
No Molding
Tasklights
Upper Grommets
Grommet Color
Locking Door
Tackboard/Fabric

Description

- Standard With: Top Profiled on All Sides, Decorative Molding on Both Sides, Four (4) Soft-Close Doors, and Grommet in Back Panel
- Available in Premium Veneer (PV) or Standard Veneer (W); Must Specify
- Lower, Center Grommet in Back Panel; Must Specify: Black (BLK) or Silver (SLV)
- 20⅞" Clearance Below Doors
- Additional Options: No Decorative Molding (Specify NO MOLDING); Locking Doors ([See Locking Door Options](#)); Factory-Installed Tackboard ([See Sizes](#)); Tasklights ([See Sizes](#)); Upper Wire Management Grommets ([See Grommet Options](#))

| | | | | | | | |
|----------------------------------|-------------------------------------|----|----|----|-----|------|-----------------------|
| WALL MOUNT HUTCH WITH WOOD DOORS | 46-1584WD <i>Five (5) Doors</i> | 84 | 15 | 18 | 138 | 15.2 | W\$ 5380 PV\$ 6028 |
| | 46-1578WD <i>Four (4) Doors</i> | 78 | 15 | 18 | 128 | 14.1 | W\$ 4672 PV\$ 5233 |
| | 46-1572WD <i>Four (4) Doors</i> | 72 | 15 | 18 | 118 | 13.1 | W\$ 4600 PV\$ 5153 |
| | 46-1566WD <i>Four (4) Doors</i> | 66 | 15 | 18 | 105 | 12.0 | W\$ 4498 PV\$ 5038 |
| | 46-1560WD <i>Four (4) Doors</i> | 60 | 15 | 18 | 96 | 11.0 | W\$ 4304 PV\$ 4820 |
| | 46-1554WD <i>Three (3) Doors</i> | 54 | 15 | 18 | 87 | 9.9 | W\$ 4029 PV\$ 4513 |
| | 46-1548WD <i>Three (3) Doors</i> | 48 | 15 | 18 | 77 | 8.9 | W\$ 3751 PV\$ 4200 |
| | 46-1542WD <i>Two (2) Doors</i> | 42 | 15 | 18 | 67 | 7.8 | W\$ 3454 PV\$ 3870 |
| | 46-1536WD <i>Two (2) Doors</i> | 36 | 15 | 18 | 55 | 5.9 | W\$ 3081 PV\$ 3452 |

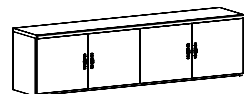

Must Specify (in this order):

Model #
Premium or Standard Veneer
Finish
Pull
Locking Door

Description

- Standard With: Top Profiled on Front Only for Multiple Unit Application, No Molding, Onset Doors with Soft-Close Hinges, and Wall Mounting Brackets
- Available in Premium Veneer (PV) or Standard Veneer (W); Must Specify
- Additional Options: Locking Doors ([See Locking Door Options](#)); Tackboards ([See Sizes](#)); Tasklights ([See Sizes](#))
- Indiana Furniture will not be held liable for wall mount hutches that are not properly installed

W = Veneer PV = Premium Veneer

[See Jefferson Intro Section for Ordering Options](#)

| Item | Model No. | Width | Depth | Height | Ship Wt | Cubic Ft | List Price |
|---|------------------------------|-------|-------|--------|---------|----------|-----------------------|
| TALL SURFACE MOUNTED HUTCH WITH FOUR WOOD DOORS | 46-1572THU <i>4 Doors</i> | 72 | 15 | 51 | 231 | 38.7 | W\$ 8699 PV\$ 9743 |
| | 46-1566THU <i>4 Doors</i> | 66 | 15 | 51 | 226 | 36.0 | W\$ 8218 PV\$ 9204 |

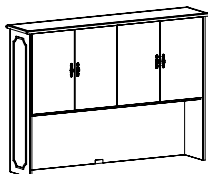

Must Specify (in this order):

Model #
Premium or Standard Veneer
Finish
Pull
No Molding
Tasklights
Upper Grommets
Grommet Color
Locking Door
Tackboard/Fabric

Description

- Standard With: Top Profiled on All Sides, Decorative Molding on Both Sides, Four (4) Soft-Close Doors, One (1) Adjustable Shelf Behind Doors, and Grommet in Back Panel
- Available in Premium Veneer (PV) or Standard Veneer (W); Must Specify
- Lower, Center Grommet in Back Panel; Must Specify: Black (BLK) or Silver (SLV)
- 21½" Clearance Below Doors
- Additional Options: No Decorative Molding (Specify NO MOLDING); Locking Doors ([See Locking Door Options](#)); Factory-Installed Tackboard ([See Sizes](#)); Tasklights ([See Sizes](#)); Upper Wire Management Grommets ([See Grommet Options](#))

| | | | | | | | |
|----------------------------------|-------------|----|----|----|-----|------|-----------------------|
| VERTICAL HUTCH WITH OPEN STORAGE | 46-1572VH4O | 72 | 15 | 51 | 231 | 38.7 | W\$ 4621 PV\$ 5175 |
| | 46-1566VH4O | 66 | 15 | 51 | 185 | 36.0 | W\$ 4394 PV\$ 4920 |

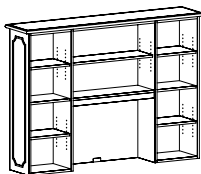

Must Specify (in this order):

Model #
Premium or Standard Veneer
Finish
No Molding
Tasklights
Upper Grommets
Grommet Color
Tackboard/Fabric

Description

- Standard With: Top Profiled on All Sides, Decorative Molding on Both Sides, One (1) Adjustable Shelf and One (1) Fixed Shelf In Center Cabinet, Two (2) Adjustable Shelves and One (1) Fixed Middle Shelf in Each End Cabinet, and Grommet in Back Panel
- Available in Premium Veneer (PV) or Standard Veneer (W); Must Specify
- Lower, Center Grommet in Back Panel; Must Specify: Black (BLK) or Silver (SLV)
- 24½" Clearance Below Center Shelves
- Additional Options: No Decorative Molding (Specify NO MOLDING); Factory-Installed Tackboard ([See Sizes](#)); Tasklights ([See Sizes](#)); Upper Wire Management Grommets ([See Grommet Options](#))

W = Veneer PV = Premium Veneer

[See Jefferson Intro Section for Ordering Options](#)

| Item | Model No. | Width | Depth | Height | Ship Wt | Cubic Ft | List Price |
|--|-------------------------------|-------|-------|--------|---------|----------|-----------------------|
| VERTICAL HUTCH WITH FOUR DOORS AND WOOD DOOR INSERTS | 46-1572VH4W <i>4 Doors</i> | 72 | 15 | 51 | 231 | 38.7 | W\$ 6674 PV\$ 7474 |
| | 46-1566VH4W <i>4 Doors</i> | 66 | 15 | 51 | 226 | 36.0 | W\$ 6445 PV\$ 7217 |

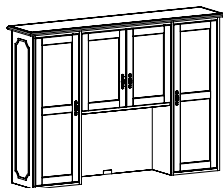

Must Specify (in this order):
 Model #
 Premium or Standard Veneer Finish
 Pull
 No Molding
 Locking Doors
 Tasklights
 Upper Grommets
 Grommet Color
 Tackboard/Fabric

Description

- Standard With: Top Profiled on All Sides, Decorative Molding on Both Sides, Four (4) Wood-Framed Soft-Close Doors with Wood Inserts, One (1) Adjustable Shelf and One (1) Fixed Shelf Behind Center Doors, Two (2) Adjustable Shelves and One (1) Fixed Middle Shelf Behind Each End Door, and Grommet in Back Panel
- Available in Premium Veneer (PV) or Standard Veneer (W); Must Specify
- Lower, Center Grommet in Back Panel; Must Specify: Black (BLK) or Silver (SLV)
- 24 3/8" Clearance Below Center Doors
- Additional Options: No Decorative Molding (Specify NO MOLDING); Locking Doors ([See Locking Door Options](#)); Factory-Installed Tackboard ([See Sizes](#)); Tasklights ([See Sizes](#)); Upper Wire Management Grommets ([See Grommet Options](#))

| | | | | | | | |
|---|-------------------------------|----|----|----|-----|------|-----------------------|
| VERTICAL HUTCH WITH FOUR DOORS AND GLASS DOOR INSERTS | 46-1572VH4G <i>4 Doors</i> | 72 | 15 | 51 | 244 | 38.7 | W\$ 7382 PV\$ 8267 |
| | 46-1566VH4G <i>4 Doors</i> | 66 | 15 | 51 | 231 | 36.0 | W\$ 7145 PV\$ 8004 |

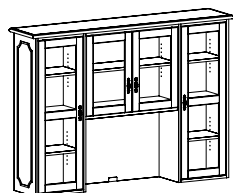

Must Specify (in this order):
 Model #
 Premium or Standard Veneer Finish
 Pull
 Beveled Glass Design
 No Molding
 Locking Doors
 Glass Shelves
 Down Lighting
 Tasklights
 Upper Grommets
 Grommet Color
 Tackboard/Fabric

Description

- Standard With: Top Profiled on All Sides, Decorative Molding on Both Sides, Four (4) Wood-Framed Soft-Close Doors with Glass Inserts, One (1) Adjustable Shelf and One (1) Fixed Shelf Behind Center Doors, Two (2) Adjustable Shelves and One (1) Fixed Middle Shelf Behind Each End Door, and Grommet in Back Panel
- Available in Premium Veneer (PV) or Standard Veneer (W); Must Specify
- Beveled Glass Inserts Available in Clear and Cracked Ice; Must Specify (See Below)
- Lower, Center Grommet in Back Panel; Must Specify: Black (BLK) or Silver (SLV)
- 24 3/8" Clearance Below Center Doors
- Additional Options: No Decorative Molding (Specify NO MOLDING); Locking Doors ([See Locking Door Options](#)); Factory-Installed Tackboard ([See Sizes](#)); Tasklights ([See Sizes](#)); Upper Wire Management Grommets ([See Grommet Options](#))

Beveled Glass Options: Specify & Add

| | | |
|------|----------------------------------|---------|
| 1-CL | Beveled Clear Glass Insert | N/C |
| 1-CR | Beveled Cracked Ice Glass Insert | \$ 1565 |

W = Veneer PV = Premium Veneer

[See Jefferson Intro Section for Ordering Options](#)

| Item | Model No. | Width | Depth | Height | Ship Wt | Cubic Ft | List Price |
|--|-------------------------------|-------|-------|--------|---------|----------|-----------------------|
| VERTICAL HUTCH WITH FOUR DOORS AND MESH DOOR INSERTS | 46-1572VH4M <i>4 Doors</i> | 72 | 15 | 51 | 231 | 38.7 | W\$ 8281 PV\$ 9274 |
| | 46-1566VH4M <i>4 Doors</i> | 66 | 15 | 51 | 226 | 36.0 | W\$ 8050 PV\$ 9014 |

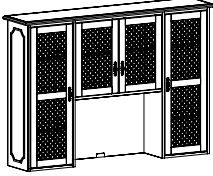

Must Specify (in this order):

- Model #
- Premium or Standard Veneer Finish
- Pull/Mesh Grille Color
- No Molding
- Locking Doors
- Glass Shelves
- Down Lighting
- Tasklights
- Upper Grommets
- Grommet Color
- Tackboard/Fabric

Description

- Standard With: Top Profiled on All Sides, Decorative Molding on Both Sides, Four (4) Wood-Framed Soft-Close Doors with Mesh Inserts, One (1) Adjustable Shelf and One (1) Fixed Shelf Behind Center Doors, Two (2) Adjustable Shelves and One (1) Fixed Middle Shelf Behind Each End Door, and Grommet in Back Panel
- Available in Premium Veneer (PV) or Standard Veneer (W); Must Specify
- Mesh Grille Inserts Available in Antique Brass and Silver; Must Specify (See Below)
- Lower, Center Grommet in Back Panel; Must Specify: Black (BLK) or Silver (SLV)
- 24 $\frac{3}{8}$ " Clearance Below Center Doors
- Additional Options: No Decorative Molding (Specify NO MOLDING); Glass Shelves ([See Glass Shelf Options](#)); Down Lighting ([See Down Lighting Options](#)); Locking Doors ([See Locking Door Options](#)); Factory-Installed Tackboard ([See Sizes](#)); Tasklights ([See Sizes](#)); Upper Wire Management Grommets ([See Grommet Options](#))

Mesh Grille Options: Specify & Add

| | | |
|------|--|---------|
| 1-BM | Antique Brass Mesh Grille Insert <i>Only available when a Brass Pull is specified</i> | N/C |
| 1-AM | Silver Mesh Grille Insert <i>Only available when Liberty Pull (ALB) is specified</i> | \$ 1173 |

| | | | | | | | |
|--|------------------------------|----|----|----|-----|------|-----------------------|
| VERTICAL OPEN HUTCH WITH TWO DOORS AND WOOD DOOR INSERTS | 46-1572VHW <i>2 Doors</i> | 72 | 15 | 51 | 231 | 38.7 | W\$ 5314 PV\$ 5953 |
| | 46-1566VHW <i>2 Doors</i> | 66 | 15 | 51 | 226 | 36.0 | W\$ 5086 PV\$ 5696 |

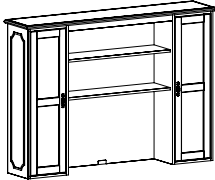

Must Specify (in this order):

- Model #
- Premium or Standard Veneer Finish
- Pull
- No Molding
- Locking Doors
- Grommet Color

Description

- Standard With: Top Profiled on All Sides, Decorative Molding on Both Sides, Two (2) Wood-Framed Soft-Close Doors with Wood Inserts, One (1) Adjustable Shelf and One (1) Fixed Shelf in Center Cabinet, Two (2) Adjustable Shelves and One (1) Fixed Middle Shelf Behind Each End Door, and Grommet in Back Panel
- Available in Premium Veneer (PV) or Standard Veneer (W); Must Specify
- Lower, Center Grommet in Back Panel; Must Specify: Black (BLK) or Silver (SLV)
- 24 $\frac{3}{8}$ " Clearance Below Center
- Additional Options: No Decorative Molding (Specify NO MOLDING); Locking Doors ([See Locking Door Options](#))

W = Veneer PV = Premium Veneer

[See Jefferson Intro Section for Ordering Options](#)

| Item | Model No. | Width | Depth | Height | Ship Wt | Cubic Ft | List Price |
|---|------------------------------|-------|-------|--------|---------|----------|-----------------------|
| VERTICAL OPEN HUTCH WITH TWO DOORS AND GLASS DOOR INSERTS | 46-1572VHG <i>2 Doors</i> | 72 | 15 | 51 | 244 | 38.7 | W\$ 5551 PV\$ 6217 |
| | 46-1566VHG <i>2 Doors</i> | 66 | 15 | 51 | 231 | 36.0 | W\$ 5314 PV\$ 5953 |

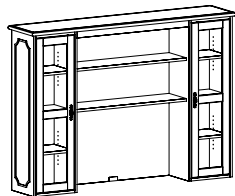

Must Specify (in this order):

- Model #
- Premium or Standard Veneer
- Finish
- Pull
- Beveled Glass Design
- No Molding
- Glass Shelves
- Down Lighting
- Grommet Color

Description

- Standard With: Top Profiled on All Sides, Decorative Molding on Both Sides, Two (2) Wood-Framed Soft-Close Doors with Glass Inserts, One (1) Adjustable Shelf and One (1) Fixed Shelf in Center Cabinet, Two (2) Adjustable Shelves and One (1) Fixed Middle Shelf Behind Each End Door, and Grommet in Back Panel
- Available in Premium Veneer (PV) or Standard Veneer (W); Must Specify
- Beveled Glass Inserts Available in Clear and Cracked Ice; Must Specify (See Below)
- Lower, Center Grommet in Back Panel; Must Specify: Black (BLK) or Silver (SLV)
- 24 $\frac{3}{8}$ " Clearance Below Center
- Additional Options: No Decorative Molding (Specify NO MOLDING); Glass Shelves ([See Glass Shelf Options](#)); Down Lighting ([See Down Lighting Options](#))

Beveled Glass Options: Specify & Add

| | | |
|------|---------------------------|---------|
| 1-CL | Clear Glass Inserts | N/C |
| 1-CR | Cracked Ice Glass Inserts | \$ 1040 |

| | | | | | | | |
|--|------------------------------|----|----|----|-----|------|-----------------------|
| VERTICAL OPEN HUTCH WITH TWO DOORS AND MESH DOOR INSERTS | 46-1572VHM <i>2 Doors</i> | 72 | 15 | 51 | 231 | 38.7 | W\$ 5782 PV\$ 6477 |
| | 46-1566VHM <i>2 Doors</i> | 66 | 15 | 51 | 226 | 36.0 | W\$ 5551 PV\$ 6217 |

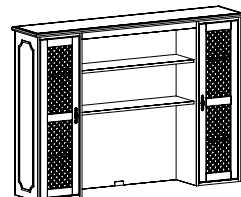

Must Specify (in this order):

- Model #
- Premium or Standard Veneer
- Finish
- Pull/Mesh Grille Color
- No Molding
- Glass Shelves
- Down Lighting
- Grommet Color

Description

- Standard With: Top Profiled on All Sides, Decorative Molding on Both Sides, Two (2) Wood-Framed Soft-Close Doors with Mesh Inserts, One (1) Adjustable Shelf and One (1) Fixed Shelf in Center Cabinet, Two (2) Adjustable Shelves and One (1) Fixed Middle Shelf Behind Each End Door, and Grommet in Back Panel
- Available in Premium Veneer (PV) or Standard Veneer (W); Must Specify
- Mesh Grille Inserts Available in Antique Brass and Silver; Must Specify (See Below)
- Lower, Center Grommet in Back Panel; Must Specify: Black (BLK) or Silver (SLV)
- 24 $\frac{3}{8}$ " Clearance Below Center
- Additional Options: No Decorative Molding (Specify NO MOLDING); Glass Shelves ([See Glass Shelf Options](#)); Down Lighting ([See Down Lighting Options](#))

Mesh Grille Options: Specify & Add

| | | |
|------|--|--------|
| 1-BM | Antique Brass Mesh Grille Insert <i>Only available when a Brass Pull is specified</i> | N/C |
| 1-AM | Silver Mesh Grille Insert <i>Only available when Liberty Pull (ALB) is specified</i> | \$ 782 |

W = Veneer PV = Premium Veneer

[See Jefferson Intro Section for Ordering Options](#)

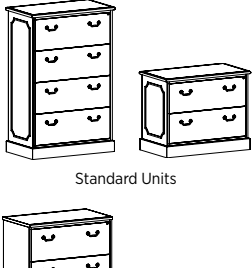
| Item | Model No. | Width | Depth | Height | Ship Wt | Cubic Ft | List Price | |
|--|--|-------|-------|------------------|---------|----------|-------------------------|--|
| LATERAL FILES | | | | | | | | |
| STANDARD: PROFILED ALL SIDES + DECORATIVE MOLDING | | | | | | | | |
|  <p>Standard Units</p> <p>Flush Units</p> | 46-2036L4 | 36 | 20 | 55½ ₂ | 326 | 27.5 | W/P\$ 6407 PV\$ 7176 | |
| | 46-2036L2 | 36 | 20 | 30 | 176 | 14.9 | W/P\$ 3915 PV\$ 4386 | |
| | FLUSH ENDS: PROFILED FRONT SIDE + NO DECORATIVE MOLDING | | | | | | | |
| | 46-2034L4FE | 34¼ | 20 | 55½ ₂ | 326 | 27.5 | W/P\$ 6152 PV\$ 6891 | |
| | 46-2034L2FE | 34¼ | 20 | 30 | 176 | 14.9 | W/P\$ 3762 PV\$ 4212 | |

Description

- Standard With: Central Locking Drawers with Legal or Letter Filing Side-to-Side or Front-to-Back, Dovetail Wood Drawer Construction, and Anti-Tilt System
- For Standard Units, Top Profiled on All Sides, Base Molding on All Sides, Decorative Molding on Both Sides
- For Flush Units, Top Profiled on Front Side, Base Molding on Front Side, No Decorative Molding
- Chassis Available with Premium Veneer (PV) or Standard Veneer (W); Must Specify
- Top Available with Premium/Standard Veneer (PV/W) or HPL (P); Must Specify
- Additional Options: No Decorative Molding (Specify NO MOLDING) on Standard Units

Must Specify (in this order):

Model #
 Premium or Standard Veneer
 Top Material
 Finish/Color
 Pull
 No Molding (if applicable)

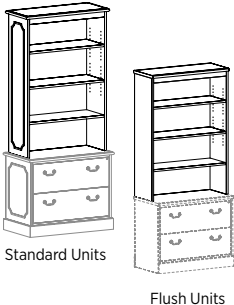
| Item | Model No. | Width | Depth | Height | Ship Wt | Cubic Ft | List Price | |
|--|--|-------------|-------|--------|---------|----------|-----------------------|-----------------------|
| SURFACE MOUNT BOOKCASES | | | | | | | | |
| STANDARD: PROFILED ALL SIDES + DECORATIVE MOLDING | | | | | | | | |
|  <p>Standard Units</p> <p>Flush Units</p> | 46-1534TU | 36 | 15 | 51 | 125 | 19.0 | W\$ 2921 PV\$ 3271 | |
| | <i>For Use with 46-2036L2</i> | | | | | | | |
| | FLUSH ENDS: PROFILED FRONT SIDE + NO DECORATIVE MOLDING | | | | | | | |
| | | 46-1534TUFE | 34¼ | 15 | 51 | 125 | 19.0 | W\$ 2847 PV\$ 3188 |
| <i>For Use with 46-2034L2FE</i> | | | | | | | | |

Description

- Standard With: One (1) Fixed Bottom Shelf with 12" Clearance and Two (2) Adjustable Shelves
- For Standard Units, Top Profiled on All Sides and Decorative Molding on Both Sides
- For Flush Units, Top Profiled on Front Side and No Decorative Molding
- Available in Premium Veneer (PV) or Standard Veneer (W); Must Specify
- Additional Options: No Decorative Molding (Specify NO MOLDING) on Standard Units

Must Specify (in this order):

Model #
 Premium or Standard Veneer
 Finish/Color
 No Molding (if applicable)

P = HPL W = Veneer PV = Premium Veneer

[See Jefferson Intro Section for Ordering Options](#)

| Item | Model No. | Width | Depth | Height | Ship Wt | Cubic Ft | List Price |
|---|--|-------|-------|--------|---------|----------|-----------------------|
| SURFACE MOUNT BOOKCASES WITH DOORS AND WOOD INSERTS | STANDARD: PROFILED ALL SIDES + DECORATIVE MOLDING | | | | | | |
| | 46-1534TUW <i>For Use with 46-2036L2</i> | 36 | 15 | 51 | 125 | 19.0 | W\$ 4334 PV\$ 4854 |
| | FLUSH ENDS: PROFILED FRONT SIDE + NO DECORATIVE MOLDING | | | | | | |
| | 46-1534TUWFE <i>For Use with 46-2034L2FE</i> | 34¼ | 15 | 51 | 125 | 19.0 | W\$ 4258 PV\$ 4769 |

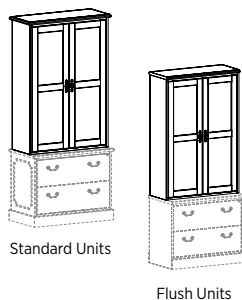

Standard Units

Flush Units

Must Specify (in this order):

- Model #
- Premium or Standard Veneer Finish
- No Molding (if applicable)

Description

- Standard With: Two (2) Wood-Framed Soft-Close Doors with Wood Inserts, One (1) Fixed Bottom Shelf with 12" Clearance, and Two (2) Adjustable Shelves
- For Standard Units, Top Profiled on All Sides and Decorative Molding on Both Sides
- For Flush Units, Top Profiled on Front Side and No Decorative Molding
- Available in Premium Veneer (PV) or Standard Veneer (W); Must Specify
- Additional Options: No Decorative Molding (Specify NO MOLDING) on Standard Units

| | | | | | | | |
|--|--|-----|----|----|-----|------|-----------------------|
| SURFACE MOUNT BOOKCASES WITH DOORS AND GLASS INSERTS | STANDARD: PROFILED ALL SIDES + DECORATIVE MOLDING | | | | | | |
| | 46-1534TUG <i>For Use with 46-2036L2</i> | 36 | 15 | 51 | 125 | 19.0 | W\$ 4563 PV\$ 5112 |
| | FLUSH ENDS: PROFILED FRONT SIDE + NO DECORATIVE MOLDING | | | | | | |
| | 46-1534TUGFE <i>For Use with 46-2034L2FE</i> | 34¼ | 15 | 51 | 125 | 19.0 | W\$ 4525 PV\$ 5068 |

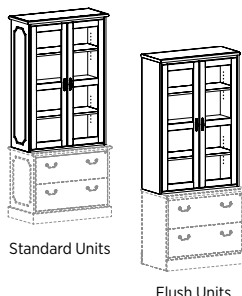

Standard Units

Flush Units

Must Specify (in this order):

- Model #
- Premium or Standard Veneer Finish
- Pull
- Beveled Glass Design
- No Molding (if applicable)
- Glass Shelves
- Down Lighting

Description

- Standard With: Two (2) Wood-Framed Soft-Close Doors with Glass Inserts, One (1) Fixed Bottom Shelf with 12" Clearance, and Two (2) Adjustable Shelves
- For Standard Units, Top Profiled on All Sides and Decorative Molding on Both Sides
- For Flush Units, Top Profiled on Front Side and No Decorative Molding
- Available in Premium Veneer (PV) or Standard Veneer (W); Must Specify
- Beveled Glass Inserts Available in Clear and Cracked Ice; Must Specify (See Below)
- Additional Options: No Decorative Molding (Specify NO MOLDING) on Standard Units; Glass Shelves ([See Glass Shelf Options](#)); Down Lighting ([See Down Lighting Options](#))

Beveled Glass Options: Specify & Add

| | | |
|------|---------------------------|---------|
| 1-CL | Clear Glass Inserts | N/C |
| 1-CR | Cracked Ice Glass Inserts | \$ 1040 |

W = Veneer PV = Premium Veneer

[See Jefferson Intro Section for Ordering Options](#)

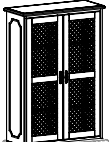
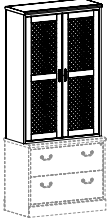
| Item | Model No. | Width | Depth | Height | Ship Wt | Cubic Ft | List Price |
|---|---------------------------------|-------|-------|--------|---------|----------|-----------------------|
| SURFACE MOUNT BOOKCASES WITH DOORS AND MESH INSERTS | | | | | | | |
| STANDARD: PROFILED ALL SIDES + DECORATIVE MOLDING | | | | | | | |
|  Standard Units | 46-1534TUM | 36 | 15 | 51 | 125 | 19.0 | W\$ 4791 PV\$ 5366 |
| | <i>For Use with 46-2036L2</i> | | | | | | |
| FLUSH ENDS: PROFILED FRONT SIDE + NO DECORATIVE MOLDING | | | | | | | |
|  Flush Units | 46-1534TUMFE | 34¼ | 15 | 51 | 125 | 19.0 | W\$ 4718 PV\$ 5283 |
| | <i>For Use with 46-2034L2FE</i> | | | | | | |

Description

- Standard With: Two (2) Wood-Framed Soft-Close Doors with Mesh Inserts, One (1) Fixed Bottom Shelf with 12" Clearance, and Two (2) Adjustable Shelves
- For Standard Units, Top Profiled on All Sides and Decorative Molding on Both Sides
- For Flush Units, Top Profiled on Front Side and No Decorative Molding
- Available in Premium Veneer (PV) or Standard Veneer (W); Must Specify
- Mesh Grille Inserts Available in Antique Brass and Silver; Must Specify (See Below)
- Additional Options: No Decorative Molding (Specify NO MOLDING) on Standard Units; Glass Shelves ([See Glass Shelf Options](#)); Down Lighting ([See Down Lighting Options](#))

Mesh Grille Options: Specify & Add

| | | |
|------|--|--------|
| 1-BM | Antique Brass Mesh Grille Insert <i>Only available when a Brass Pull is specified</i> | N/C |
| 1-AM | Silver Mesh Grille Insert <i>Only available when Liberty Pull (ALB) is specified</i> | \$ 782 |

Must Specify (in this order):
 Model #
 Premium or Standard Veneer
 Finish
 Pull/Mesh Grille Color
 No Molding (if applicable)
 Glass Shelves
 Down Lighting

| BOOKCASE | Model No. | Width | Depth | Height | Ship Wt | Cubic Ft | List Price |
|---|---------------------------------|-------|-------|--------|---------|----------|-------------------------|
|  | 46-3470BC | 34 | 15 | 69½ | 152 | 26.1 | W\$ 3954 PV\$ 4429 |
| | <i>Three Adjustable Shelves</i> | | | | | | |
| | 46-3456BC | 34 | 15 | 55½ | 140 | 20.1 | W/P\$ 3374 PV\$ 3779 |
| | <i>Two Adjustable Shelves</i> | | | | | | |

Description

- Standard With: Top Profiled on All Sides, Decorative Molding on Both Sides, Two (2) or Three (3) 1" Thick Adjustable Shelves (Depending Upon Model, See Above), and One (1) 1" Thick Fixed Shelf (Shaded in Art)
- Available with Premium Veneer (PV) or Standard Veneer (W); 56"H Bookcases Also Available with HPL (P) Tops; Must Specify
- Additional Options: No Decorative Molding (Specify NO MOLDING)

Must Specify (in this order):
 Model #
 Premium or Standard Veneer
 Top Material (for 56"H Only)
 Finish/Color
 No Molding

P = HPL W = Veneer PV = Premium Veneer

[See Jefferson Intro Section for Ordering Options](#)

| Item | Model No. | Width | Depth | Height | Ship Wt | Cubic Ft | List Price |
|--------------------------------------|------------|-------|-------|--------|---------|----------|-------------------------|
| BOOKCASE WITH DOORS AND WOOD INSERTS | 46-3656BCW | 36 | 15 | 55¼ | 140 | 20.1 | W/P\$ 5217 PV\$ 5843 |

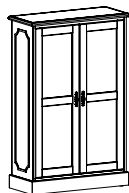

Must Specify (in this order):

Model #
Premium or Standard Veneer
Top Material
Finish/Color
Pull
No Molding
Locking Door

Description

- Standard With: Top Profiled on All Sides, Base Molding on All Sides, Decorative Molding on Both Sides, Two (2) Wood-Framed Soft-Close Doors with Wood Inserts, One (1) 1" Thick Fixed Middle Shelf, and Two (2) 1" Thick Adjustable Shelves
- Chassis Available with Premium Veneer (PV) or Standard Veneer (W); Must Specify
- Top Available with Premium/Standard Veneer (PV/W) or HPL (P); Must Specify
- Additional Options: No Decorative Molding (Specify NO MOLDING); Locking Doors ([See Locking Door Options](#))

| | | | | | | | |
|---------------------------------------|------------|----|----|-----|-----|------|-------------------------|
| BOOKCASE WITH DOORS AND GLASS INSERTS | 46-3656BCG | 36 | 15 | 55¼ | 140 | 20.1 | W/P\$ 5305 PV\$ 5942 |
|---------------------------------------|------------|----|----|-----|-----|------|-------------------------|

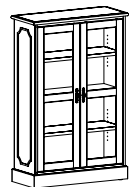

Must Specify (in this order):

Model #
Premium or Standard Veneer
Top Material
Finish/Color
Pull
Beveled Glass Design
No Molding
Locking Door

Description

- Standard With: Top Profiled on All Sides, Base Molding on All Sides, Decorative Molding on Both Sides, Two (2) Wood-Framed Soft-Close Doors with Glass Inserts, One (1) 1" Thick Fixed Middle Shelf, and Two (2) 1" Thick Adjustable Shelves
- Chassis Available with Premium Veneer (PV) or Standard Veneer (W); Must Specify
- Top Available with Premium/Standard Veneer (PV/W) or HPL (P); Must Specify
- Beveled Glass Inserts Available in Clear and Cracked Ice; Must Specify (See Below)
- Additional Options: No Decorative Molding (Specify NO MOLDING); Locking Doors ([See Locking Door Options](#))

Beveled Glass Options: Specify & Add

| | | |
|------|---------------------------|---------|
| 1-CL | Clear Glass Inserts | N/C |
| 1-CR | Cracked Ice Glass Inserts | \$ 1040 |

| | | | | | | | |
|--------------------------------------|------------|----|----|-----|-----|------|-------------------------|
| BOOKCASE WITH DOORS AND MESH INSERTS | 46-3656BCM | 36 | 15 | 55¼ | 140 | 20.1 | W/P\$ 5534 PV\$ 6197 |
|--------------------------------------|------------|----|----|-----|-----|------|-------------------------|

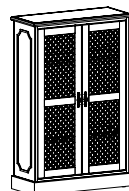

Must Specify (in this order):

Model #
Premium or Standard Veneer
Top Material
Finish
Pull/Mesh Grille Color
No Molding
Locking Door

Description

- Standard With: Top Profiled on All Sides, Base Molding on All Sides, Decorative Molding on Both Sides, Two (2) Wood-Framed Soft-Close Doors with Mesh Grille Inserts, One (1) 1" Thick Fixed Middle Shelf, and Two (2) 1" Thick Adjustable Shelves
- Chassis Available with Premium Veneer (PV) or Standard Veneer (W); Must Specify
- Top Available with Premium/Standard Veneer (PV/W) or HPL (P); Must Specify
- Mesh Grille Inserts Available in Antique Brass and Silver; Must Specify (See Below)
- Additional Options: No Decorative Molding (Specify NO MOLDING); Locking Doors ([See Locking Door Options](#))

Mesh Grille Options: Specify & Add

| | | |
|------|--|--------|
| 1-BM | Antique Brass Mesh Grille Insert <i>Only available when a Brass Pull is specified</i> | N/C |
| 1-AM | Silver Mesh Grille Insert <i>Only available when Liberty Pull (ALB) is specified</i> | \$ 782 |

P = HPL W = Veneer PV = Premium Veneer

[See Jefferson Intro Section for Ordering Options](#)

| Item | Model No. | Width | Depth | Height | Ship Wt | Cubic Ft | List Price |
|-------------------------------------|---------------------|-------|-------|--------|---------|----------|-----------------------|
| SINGLE WARDROBE/ STORAGE CABINET | Left Hinged | | | | | | |
| | Right Hinged | | | | | | |
| | 46-1870WL | 18 | 20 | 69 1/8 | 155 | 17.2 | W\$ 5390 PV\$ 6036 |

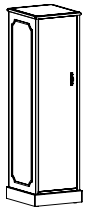

With Decorative Molding

Shown as Left Hinged

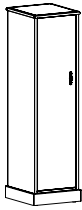

Without Decorative Molding

Must Specify (in this order):

- Model #
- Premium or Standard Veneer
- Finish
- Pull
- No Molding
- Locking Door

Description

- Standard With: Top Profiled on All Sides, Base Molding on All Sides, Decorative Molding on Both Sides, Fixed Top Shelf Behind Door, Coat Rod Under Fixed Shelf, Three (3) Adjustable Shelves Behind Door
- Available in Premium Veneer (PV) or Standard Veneer (W); Must Specify
- Adjustable Shelves Can Be Easily Removed for Wardrobe Application
- Additional Options: No Decorative Molding (Specify NO MOLDING); Locking Doors ([See Locking Door Options](#))

| | | | | | | | |
|-------------------------------------|-----------|----|----|--------|-----|------|------------------------|
| DOUBLE WARDROBE/ STORAGE CABINET | 46-3670WD | 36 | 20 | 69 1/8 | 310 | 34.2 | W\$ 9514 PV\$ 10655 |
| | 46-3270WD | 32 | 24 | 69 1/8 | 310 | 34.2 | W\$ 9769 PV\$ 10943 |

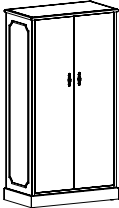

With Decorative Molding

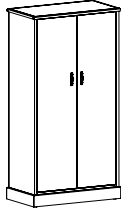

Without Decorative Molding

Must Specify (in this order):

- Model #
- Premium or Standard Veneer
- Finish
- Pull
- No Molding
- Locking Door

Description

- Standard With: Non-Locking, Top Profiled on All Sides, Base Molding on All Sides, Decorative Molding on Both Sides, Fixed Top Shelf Behind Each Door, Coat Rod Under Each Fixed Shelf, Three (3) Adjustable Shelves Behind Each Door
- Available in Premium Veneer (PV) or Standard Veneer (W); Must Specify
- Adjustable Shelves Can Be Easily Removed for Wardrobe Application
- Additional Options: No Decorative Molding (Specify NO MOLDING); Locking Doors ([See Locking Door Options](#))

| | | | | | | | |
|---------------------|--------------------------------------|----|----|--------|-----|------|-------------------------|
| COMPUTER WORK TABLE | 46-2436CW <i>Kneespace 32 1/8</i> | 36 | 24 | 26 3/8 | 115 | 17.6 | W/P\$ 2767 PV\$ 3097 |
|---------------------|--------------------------------------|----|----|--------|-----|------|-------------------------|

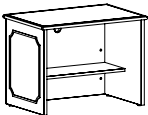

Must Specify (in this order):

- Model #
- Premium or Standard Veneer
- Top Material
- Finish/Color
- No Molding
- Top Grommet Location
- Back Panel Grommet
- Grommet Color
- Kneespace Options
- Casters

Description

- Standard With: Rectangle Top Profiled on All Sides, Decorative Molding on Both Sides, Grommet in Back Panel, Front-to-Back Grain Direction on Top, and Fixed Shelf with 15 7/8" Clearance
- Chassis Available with Premium Veneer (PV) or Standard Veneer (W); Must Specify
- Top Available with Premium/Standard Veneer (PV/W) or HPL (P); Must Specify
- Grommet in Back Panel; Must Specify: Black (BLK), Silver (SLV), or None (NONE)
- Additional Options: Kneespace Options (Order Separately, [See Multiple Units](#)); Casters (See Below); Top Grommet Options ([See Grommet Options](#)); Wire Management + Accessories (Order Separately; [See Multiple Unit Details](#))

Options: Specify & Add

| | | |
|------|---|--------|
| CAST | Optional Black Caster (Increases Height to 30") | \$ 239 |
|------|---|--------|



Braking Casters on User Side/Non-Braking Casters on Approach

P = HPL W = Veneer PV = Premium Veneer

[See Jefferson Intro Section for Ordering Options](#)

| Item | Model No. | Width | Depth | Height | Ship Wt | Cubic Ft | List Price |
|---|---|-------|-------|-------------------|---------|----------|-------------------------|
|  <p>ROUND TOP & BASES</p> <p><u>Top Must Specify (in this order):</u> Model # Top Material Finish/Color</p> <p><u>Base Must Specify (in this order):</u> Model # Premium or Standard Veneer (if applicable) Finish</p> | 46-4848CT <i>Accommodates Five (5) Chairs</i> | 48 | 48 | 13 $\frac{1}{16}$ | 58 | 5.9 | W/P\$ 4287 PV\$ 4801 |
| | 46-4242CT <i>Accommodates Four (4) Chairs</i> | 42 | 42 | 13 $\frac{1}{16}$ | 51 | 4.5 | W/P\$ 3730 PV\$ 4178 |
| | 46-3636CT <i>Accommodates Three (3) Chairs</i> | 36 | 36 | 13 $\frac{1}{16}$ | 43 | 3.3 | W/P\$ 3361 PV\$ 3763 |

Description

- Top Available with Premium/Standard Veneer (PV/W) or HPL (P); Must Specify
- See Below for Base Options, Order Separately; One (1) Required
- Power Options not Available

Base Options: Must Order & Add**Queen Anne Base**

| | | | | | | | |
|-----------|---------------------|----|----|------------------|-----|------|---------|
| 01-0606QB | Must Specify Finish | 24 | 24 | 28 $\frac{3}{4}$ | 136 | 11.1 | \$ 1406 |
|-----------|---------------------|----|----|------------------|-----|------|---------|

Description

- Classic Design Detail on Column
- Queen Anne Base Features Multi-Step, Hand-Finished Catalyzed Finish
- Four Legs with Adjustable Glides

Cylinder Bases

| | | | | | | | |
|-------------------------------|--|----|----|------------------|-----|------|-----------------------|
| 01-2020CB | | 20 | 20 | 28 $\frac{3}{4}$ | 136 | 11.1 | W\$ 1553 PV\$ 1813 |
| For Use with 48" and 42" Tops | | | | | | | |
| 01-1616CB | | 16 | 16 | 28 $\frac{3}{4}$ | 101 | 7.2 | W\$ 1419 PV\$ 1660 |
| For Use with 36" Tops | | | | | | | |

Description

- Premium Veneer (PV) or Standard Veneer (W) Cylinder Base; Weighted for Stability
- Base Features Multi-Step, Hand-Finished Catalyzed Finish
- Two (2) Black Wire Management Grommets at Top and One (1) 8" Wire Management Opening in Bottom

Options: Specify & Add

| | | |
|-------|--|-----|
| GCB1S | Single Grommet at Top Edge (Factory Installed) | N/C |
| NOGC | No Grommet at Top Edge | N/C |

Height Adjustable Pneumatic X-Bases**Maximum Round 42", Maximum Square 36"**

| | | | | | | | |
|--------------|----------|----|----|----|---|-----|---------|
| 01-3232HAXBB | Black | 32 | 32 | 26 | 1 | 0.2 | \$ 1721 |
| 01-3232HAXBA | Aluminum | | | | | | |

Maximum Round 36", Maximum Square 30"

| | | | | | | | |
|--------------|----------|----|----|----|---|-----|---------|
| 01-2626HAXBB | Black | 22 | 22 | 26 | 1 | 0.2 | \$ 1687 |
| 01-2626HAXBA | Aluminum | | | | | | |

Description

- Pre-Drilled Boring Pattern May Not Match Underside of Table Top
- Steel Mounting Plate: 8"x 8"x 1/4"
- Eight (8) Bolts Included for Assembly
- Some Assembly Required

P = HPL W = Veneer PV = Premium Veneer

See Jefferson Intro Section for Ordering Options

| Item | Model No. | Width | Depth | Height | Ship Wt | Cubic Ft | List Price |
|-----------|-----------|-------|-------|----------------------------------|---------|----------|-------------------------|
| END TABLE | 46-1824ET | 24 | 18 | 21 ¹³ / ₁₆ | 25 | 2.0 | W/P\$ 1357 PV\$ 1521 |

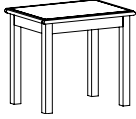

Must Specify (in this order):

Model #
Top Material
Finish/Color

Description

- Available with Premium/Standard Veneer (PV/W) or HPL (P) Top; Must Specify
- Hardwood Legs
- Apron Rails and Panel Legs Feature Multi-Step, Hand-Finished Catalyzed Finish
- Some Assembly Required

| | | | | | | | |
|------------|-----------|----|----|----------------------------------|----|-----|-------------------------|
| LAMP TABLE | 46-2424LT | 24 | 24 | 21 ¹³ / ₁₆ | 37 | 3.3 | W/P\$ 1728 PV\$ 1935 |
|------------|-----------|----|----|----------------------------------|----|-----|-------------------------|

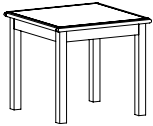

Must Specify (in this order):

Model #
Top Material
Finish/Color

Description

- Available with Premium/Standard Veneer (PV/W) or HPL (P) Top; Must Specify
- Hardwood Legs
- Apron Rails and Panel Legs Feature Multi-Step, Hand-Finished Catalyzed Finish
- Some Assembly Required

| | | | | | | | |
|----------------|-----------|----|----|----|----|-----|-------------------------|
| MAGAZINE TABLE | 46-1847MT | 47 | 18 | 16 | 42 | 3.4 | W/P\$ 1632 PV\$ 1828 |
|----------------|-----------|----|----|----|----|-----|-------------------------|

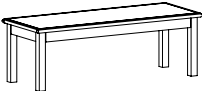

Must Specify (in this order):

Model #
Top Material
Finish/Color
Optional 30"H Leg

Description

- Available with Premium/Standard Veneer (PV/W) or HPL (P) Top; Must Specify
- Hardwood Legs
- Apron Rails and Panel Legs Feature Multi-Step, Hand-Finished Catalyzed Finish
- Optional 30"H Legs, See Below
- Some Assembly Required

Options: Specify & Add

| | | |
|-------|--------------------|--------|
| SH-46 | Optional 30"H Legs | \$ 223 |
|-------|--------------------|--------|

P = HPL W = Veneer PV = Premium Veneer

[See Jefferson Intro Section for Ordering Options](#)

| Item | Model No. | Width | Depth | Height | Ship Wt | Cubic Ft | List Price | |
|--|---|-------|-------|--------|---------|-------------------------|-------------------------|--|
| MODULAR CABINET/ CREDENZA TOPS  Must Specify (in this order): Model # Top Material Finish/Color | FOR 29"W MODULAR UNITS | | | | | | | |
| | 46-2089TP | 88½ | 20 | 1¾ | 43 | 5.8 | W/P\$ 1740 PV\$ 1948 | |
| | <i>Top for Three 29"W Modular Units</i> | | | | | | | |
| | 46-2060TP | 59½ | 20 | 1¾ | 30 | 4.0 | W/P\$ 1145 PV\$ 1281 | |
| | <i>Top for Two 29"W Modular Units</i> | | | | | | | |
| | 46-2031TP | 30½ | 20 | 1¾ | 18 | 2.1 | W/P\$ 650 PV\$ 726 | |
| | <i>Top for One 29" Modular Units</i> | | | | | | | |
| | FOR 18"W MODULAR UNITS | | | | | | | |
| | 46-2038TP | 39¾ | 20 | 1¾ | 21 | 1.7 | W/P\$ 769 PV\$ 862 | |
| | <i>Top for Two 18"W Modular Units</i> | | | | | | | |
| | 46-2020TP | 19½ | 20 | 1¾ | 13 | 1.1 | W/P\$ 462 PV\$ 516 | |
| | <i>Top for One 18" W Modular Units</i> | | | | | | | |
| FOR COMBO OF 18"W and 29"W MODULAR UNITS | | | | | | | | |
| 46-2067TP | 68¾ | 20 | 1¾ | 37 | 4.7 | W/P\$ 1290 PV\$ 1444 | | |
| <i>Top for Two 18" and One 29" Unit</i> | | | | | | | | |
| 46-2049TP | 48½ | 20 | 1¾ | 24 | 2.3 | W/P\$ 957 PV\$ 1071 | | |
| <i>Top for One 18" and One 29" Unit</i> | | | | | | | | |

Description

- Standard With: Rectangle Top Profiled on All Sides
- Available with Premium/Standard Veneer (PV/W) or HPL (P) Top; Must Specify
- **For Use with 18"W and 29"W Modular Storage Units (See Multiple Units)**
- Not For Use on Freestanding Bookcases

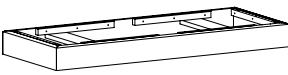
| Item | Model No. | Width | Depth | Height | Ship Wt | Cubic Ft | List Price | |
|---|---------------------------------|-------|-------|--------|---------|----------|------------|--|
| MODULAR CABINET/ CREDENZA BASES  Must Specify (in this order): Model # Finish | FOR 29"W MODULAR UNITS | | | | | | | |
| | 46-2089BS | 88½ | 19½ | 4¼ | 53 | 5.8 | W\$ 1172 | |
| | <i>Base for Three 29" Units</i> | | | | | | | |
| | 46-2060BS | 59½ | 19½ | 4¼ | 38 | 4.0 | W\$ 795 | |
| | <i>Base for Two 29" Units</i> | | | | | | | |
| | 46-2031BS | 30½ | 19½ | 4¼ | 18 | 2.1 | W\$ 513 | |
| | <i>Base for One 29" Units</i> | | | | | | | |
| | FOR 18"W MODULAR UNITS | | | | | | | |
| | 46-2038BS | 38¾ | 19½ | 4¼ | 25 | 2.7 | W\$ 581 | |
| | <i>Base for Two 18" Units</i> | | | | | | | |
| | 46-2020BS | 19½ | 19½ | 4¼ | 16 | 1.5 | W\$ 406 | |
| | <i>Base for One 18" Units</i> | | | | | | | |
| FOR COMBO OF 18"W and 29"W MODULAR UNITS | | | | | | | | |
| 46-2067BS | 66½ | 19½ | 4¼ | 45 | 4.7 | W\$ 885 | | |
| <i>Base for Two 18" and One 29" Units</i> | | | | | | | | |
| 46-2049BS | 48½ | 19½ | 4¼ | 33 | 3.0 | W\$ 687 | | |
| <i>Base for One 18" and One 29" Units</i> | | | | | | | | |

Description

- **For Use with 18"W and 29"W Modular Storage Units (See Multiple Units)**
- Bases Feature Multi-Step, Hand-Finished Catalyzed Finish
- Not For Use with Freestanding Bookcases

P = HPL W = Veneer PV = Premium Veneer

See Jefferson Intro Section for Ordering Options

| Item | Model No. | Width | Depth | Height | Ship Wt | Cubic Ft | List Price |
|---------------------------|-----------|-------|-------|--------|---------|----------|-----------------------|
| MODULAR STORAGE FILE/FILE | 46-1829MF | 29 | 18½ | 24 | 119 | 9.8 | W\$ 2924 PV\$ 3275 |

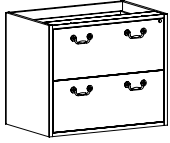

Description

- Standard With: No Molding, Central Locking File/File Ped, Legal-or-Letter Filing Side-to-Side or Letter Filing Front to Back, and Finished Back Panel
- Available with Premium Veneer (PV) or Standard Veneer (W); Must Specify
- **Must Specify Top and Base for Freestanding Applications; Order Separately (See Tops and Bases)**

Molding Options: Specify & Add

| | | |
|-------|--------------------------------|--------|
| M46L1 | Molding on Left Side Only | \$ 85 |
| M46R1 | Molding on Right Side Only | \$ 85 |
| M46LR | Molding on Left and Right Side | \$ 170 |

Must Specify (in this order):

Model #
Premium or Standard Veneer
Finish
Pull
Molding

| | | | | | | | |
|------------------------------|-----------|----|-----|----|-----|-----|-----------------------|
| MODULAR STORAGE BOX/BOX/FILE | 46-1829MU | 29 | 18½ | 24 | 119 | 9.8 | W\$ 2924 PV\$ 3275 |
|------------------------------|-----------|----|-----|----|-----|-----|-----------------------|



Description

- Standard With: No Molding, Central Locking Box/Box/File Ped, Legal-or-Letter Filing Side-to-Side or Letter Filing Front to Back, and Finished Back Panel
- Available with Premium Veneer (PV) or Standard Veneer (W); Must Specify
- **Must Specify Top and Base for Freestanding Applications; Order Separately (See Tops and Bases)**

Molding Options: Specify & Add

| | | |
|-------|--------------------------------|--------|
| M46L1 | Molding on Left Side Only | \$ 85 |
| M46R1 | Molding on Right Side Only | \$ 85 |
| M46LR | Molding on Left and Right Side | \$ 170 |

Must Specify (in this order):

Model #
Premium or Standard Veneer
Finish
Pull
Molding

| | | | | | | | |
|--------------------------|-----------|----|-----|----|----|-----|-----------------------|
| MODULAR STORAGE TWO DOOR | 46-1829MS | 29 | 18½ | 24 | 92 | 9.8 | W\$ 2148 PV\$ 2405 |
|--------------------------|-----------|----|-----|----|----|-----|-----------------------|

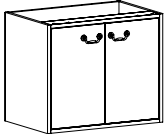

Description

- Standard With: No Molding, Two (2) Soft-Close Doors, One (1) Adjustable Shelf, and Finished Back Panel
- Available with Premium Veneer (PV) or Standard Veneer (W); Must Specify
- **Must Specify Top and Base for Freestanding Applications; Order Separately (See Tops and Bases)**

Molding Options: Specify & Add

| | | |
|-------|--------------------------------|--------|
| M46L1 | Molding on Left Side Only | \$ 85 |
| M46R1 | Molding on Right Side Only | \$ 85 |
| M46LR | Molding on Left and Right Side | \$ 170 |

Must Specify (in this order):

Model #
Premium or Standard Veneer
Finish
Pull
Molding

| | | | | | | | |
|------------------------------|------------|----|-----|----|----|-----|-----------------------|
| MODULAR STORAGE OPEN STORAGE | 46-1829MBC | 29 | 18½ | 24 | 92 | 9.8 | W\$ 1882 PV\$ 2107 |
|------------------------------|------------|----|-----|----|----|-----|-----------------------|

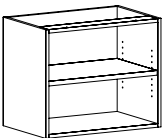

Description

- Standard With: No Molding, One (1) Adjustable 1" Thick Shelf, and Finished Back Panel
- Available with Premium Veneer (PV) or Standard Veneer (W); Must Specify
- **Must Specify Top and Base for Freestanding Applications; Order Separately (See Tops and Bases)**

Molding Options: Specify & Add

| | | |
|-------|--------------------------------|--------|
| M46L1 | Molding on Left Side Only | \$ 85 |
| M46R1 | Molding on Right Side Only | \$ 85 |
| M46LR | Molding on Left and Right Side | \$ 170 |

Must Specify (in this order):

Model #
Premium or Standard Veneer
Finish
Molding

W = Veneer PV = Premium Veneer

[See Jefferson Intro Section for Ordering Options](#)

| Item | Model No. | Width | Depth | Height | Ship Wt | Cubic Ft | List Price |
|----------------------------------|-----------|----------------------------------|-------|--------|---------|----------|-----------------------|
| MODULAR STORAGE FILE/FILE | 46-1818MF | 18 ²⁷ / ₃₂ | 18½ | 24 | 98 | 4.9 | W\$ 2632 PV\$ 2948 |

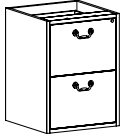

Must Specify (in this order):
Model #
Premium or Standard Veneer
Finish
Pull
Molding

Description

- Standard With: No Molding, Central Locking File/File Ped, Legal-or-Letter Filing Side-to-Side or Letter Filing Front to Back, and Finished Back Panel
- Available with Premium Veneer (PV) or Standard Veneer (W); Must Specify
- **Must Specify Top and Base for Freestanding Applications; Order Separately (See Tops and Bases)**

Molding Options: Specify & Add

| | | |
|-------|--------------------------------|--------|
| M46L1 | Molding on Left Side Only | \$ 85 |
| M46R1 | Molding on Right Side Only | \$ 85 |
| M46LR | Molding on Left and Right Side | \$ 170 |

| | | | | | | | |
|-------------------------------------|-----------|----------------------------------|-----|----|----|-----|-----------------------|
| MODULAR STORAGE BOX/BOX/FILE | 46-1818MU | 18 ²⁷ / ₃₂ | 18½ | 24 | 98 | 4.9 | W\$ 2632 PV\$ 2948 |
|-------------------------------------|-----------|----------------------------------|-----|----|----|-----|-----------------------|

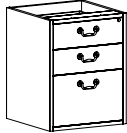

Must Specify (in this order):
Model #
Premium or Standard Veneer
Finish
Pull
Molding

Description

- Standard With: No Molding, Central Locking Box/Box/File Ped, Legal-or-Letter Filing Side-to-Side or Letter Filing Front to Back, and Finished Back Panel
- Available with Premium Veneer (PV) or Standard Veneer (W); Must Specify
- **Must Specify Top and Base for Freestanding Applications; Order Separately (See Tops and Bases)**

Molding Options: Specify & Add

| | | |
|-------|--------------------------------|--------|
| M46L1 | Molding on Left Side Only | \$ 85 |
| M46R1 | Molding on Right Side Only | \$ 85 |
| M46LR | Molding on Left and Right Side | \$ 170 |

| MODULAR STORAGE SINGLE DOOR | Left Hinged | Right Hinged | Width | Depth | Height | Ship Wt | Cubic Ft | List Price |
|-----------------------------|-------------|--------------|----------------------------------|-------|--------|---------|----------|-----------------------|
| | 46-1818MSL | 46-1818MSR | | | | | | |
| | | | 18 ²⁷ / ₃₂ | 18½ | 24 | 80 | 9.2 | W\$ 1933 PV\$ 2165 |

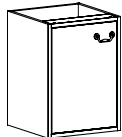

Shown as Left Hinged

Must Specify (in this order):
Model #
Premium or Standard Veneer
Finish
Pull
Molding

Description

- Standard With: No Molding, One (1) Soft-Close Door, One (1) Adjustable Shelf, and Finished Back Panel
- Available with Premium Veneer (PV) or Standard Veneer (W); Must Specify
- **Must Specify Top and Base for Freestanding Applications; Order Separately (See Tops and Bases)**

Molding Options: Specify & Add

| | | |
|-------|--------------------------------|--------|
| M46L1 | Molding on Left Side Only | \$ 85 |
| M46R1 | Molding on Right Side Only | \$ 85 |
| M46LR | Molding on Left and Right Side | \$ 170 |

| | | | | | | | |
|-----------------------------|------------|----------------------------------|-----|----|----|-----|-----------------------|
| MODULAR OPEN STORAGE | 46-1818MBC | 18 ²⁷ / ₃₂ | 18½ | 24 | 45 | 4.6 | W\$ 1693 PV\$ 1896 |
|-----------------------------|------------|----------------------------------|-----|----|----|-----|-----------------------|

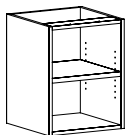

Must Specify (in this order):
Model #
Premium or Standard Veneer
Finish
Molding

Description

- Standard With: No Molding and Finished Back Panel
- Available with Premium Veneer (PV) or Standard Veneer (W); Must Specify
- **Must Specify Top and Base for Freestanding Applications; Order Separately (See Tops and Bases)**

Molding Options: Specify & Add

| | | |
|-------|--------------------------------|--------|
| M46L1 | Molding on Left Side Only | \$ 85 |
| M46R1 | Molding on Right Side Only | \$ 85 |
| M46LR | Molding on Left and Right Side | \$ 170 |

P = HPL W = Veneer PV = Premium Veneer

See Jefferson Intro Section for Ordering Options

| Item | Model No. | Width | Depth | Height | Ship Wt | Cubic Ft | List Price |
|--|---|-------|-------|--------|---------|----------|------------|
| MODULAR OVERHEAD CORNICHE BOOKCASE TOP  | 46-1589FC <i>Cornice for 3 Modular Bookcases</i> | 89 | 15 | 3½ | 30 | 4.5 | W\$ 1111 |
| | 46-1560FC <i>Cornice for 2 Modular Bookcases</i> | 60 | 15 | 3½ | 18 | 3.1 | W\$ 637 |
| | 46-1531FC <i>Cornice for 1 Modular Bookcase</i> | 31 | 15 | 3½ | 10 | 3.1 | W\$ 468 |

Must Specify (in this order):
Model #
Finish

Description

- 46-1589FC Features Insert for Additional Stability
- Recommended for Use Above Line of Sight; Unfinished Open Top
- **For Use with Modular Bookcases (See Multiple Bookcase Units); Not For Use on Standard Bookcases**

| | | | | | | | |
|--|---|-----|----|----|----|-----|-------------------------|
| MODULAR BOOKCASE TOP  | 46-1560TP <i>Top for 2 Modular Bookcases</i> | 59½ | 15 | 1½ | 30 | 3.1 | W/P\$ 1040 PV\$ 1166 |
| | 46-1531TP <i>Top for 1 Modular Bookcase</i> | 30½ | 15 | 1½ | 16 | 1.6 | W/P\$ 633 PV\$ 708 |

Must Specify (in this order):
Model #
Top Material
Finish/Color

Description

- Top Available with Premium/Standard Veneer (W) or HPL (P), Must Specify
- **For Use with Modular Bookcases (See Multiple Bookcase Units); Not For Use on Standard Bookcases**

| | | | | | | | |
|---|-----------------------------------|-----|-----|----|----|-----|---------|
| MODULAR BOOKCASE BASE  | 46-1560BS Base for 2 Bookcases | 59⅞ | 14⅝ | 4¼ | 15 | 3.1 | W\$ 591 |
| | 46-1531BS Base for 1 Bookcase | 30⅞ | 14⅝ | 4¼ | 10 | 1.6 | W\$ 432 |

Must Specify (in this order):
Model #
Finish

Description

- **For Use with Modular Bookcases (See Multiple Bookcase Units); Not For Use on Standard Bookcases**
- Bases Feature Multi-Step, Hand-Finished Catalyzed Finish

P = HPL W = Veneer PV = Premium Veneer

[See Jefferson Intro Section for Ordering Options](#)

| Item | Model No. | Width | Depth | Height | Ship Wt | Cubic Ft | List Price |
|------------------|-----------|-------|-------|--------|---------|----------|-----------------------|
| MODULAR BOOKCASE | 46-2952BC | 29 | 13½ | 50 | 84 | 14.6 | W\$ 1800 PV\$ 2017 |

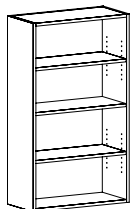

Description

- Standard With: No Molding, One (1) Fixed Shelf, and Two (2) Adjustable Shelves
- Available with Premium Veneer (PV) or Standard Veneer (W); Must Specify
- **Must Specify Top and Base for Freestanding Applications; Order Separately (See Tops and Bases)**
- Additional Options: Molding on One or Both Sides (See Below)
- Recommended for Applications Against a Wall

Molding Options: Specify & Add

| | | |
|-------|--------------------------------|--------|
| M46L1 | Molding on Left Side Only | \$ 85 |
| M46R1 | Molding on Right Side Only | \$ 85 |
| M46LR | Molding on Left and Right Side | \$ 170 |

Must Specify (in this order):

Model #
Premium or Standard Veneer
Finish
Molding

| | | | | | | | |
|--|-----------|----|-----|----|-----|------|-----------------------|
| MODULAR BOOKCASE WITH DOORS AND WOOD INSERTS | 46-2952WB | 29 | 13½ | 50 | 114 | 14.6 | W\$ 3687 PV\$ 4130 |
|--|-----------|----|-----|----|-----|------|-----------------------|

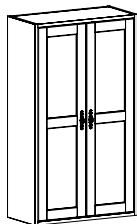

Description

- Standard With: No Molding, Two (2) Wood-Framed Soft-Close Doors with Wood Inserts, One (1) Fixed Shelf, and Two (2) Adjustable Shelves
- Available with Premium Veneer (PV) or Standard Veneer (W); Must Specify
- **Must Specify Top and Base for Freestanding Applications; Order Separately (See Tops and Bases)**
- Additional Options: Molding on One or Both Sides (See Below)
- Recommended for Applications Against a Wall

Molding Options: Specify & Add

| | | |
|-------|--------------------------------|--------|
| M46L1 | Molding on Left Side Only | \$ 85 |
| M46R1 | Molding on Right Side Only | \$ 85 |
| M46LR | Molding on Left and Right Side | \$ 170 |

Must Specify (in this order):

Model #
Premium or Standard Veneer
Finish
Pull
Molding

| Item | Model No. | Width | Depth | Height | Ship Wt | Cubic Ft | List Price |
|---|-----------|-------|-------|--------|---------|----------|-----------------------|
| MODULAR BOOKCASE WITH DOORS AND GLASS INSERTS | 46-2952GB | 29 | 13½ | 50 | 123 | 14.6 | W\$ 3687 PV\$ 4130 |

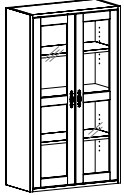

Description

- Standard With: No Molding, Two (2) Wood-Framed Soft-Close Doors with Glass Inserts, One (1) Fixed Shelf, and Two (2) Adjustable Shelves
- Available with Premium Veneer (PV) or Standard Veneer (W); Must Specify
- Beveled Glass Inserts Available in Clear and Cracked Ice; Must Specify (See Below)
- **Must Specify Top and Base for Freestanding Applications; Order Separately (See Tops and Bases)**
- Additional Options: Molding on One or Both Sides (See Below); Glass Shelves ([See Glass Shelf Options](#))
- Recommended for Applications Against a Wall

Beveled Glass Options: Specify & Add

| | | |
|------|---------------------------|---------|
| 1-CL | Clear Glass Inserts | N/C |
| 1-CR | Cracked Ice Glass Inserts | \$ 1040 |

Molding Options: Specify & Add

| | | |
|-------|--------------------------------|--------|
| M46L1 | Molding on Left Side Only | \$ 85 |
| M46R1 | Molding on Right Side Only | \$ 85 |
| M46LR | Molding on Left and Right Side | \$ 170 |

Must Specify (in this order):

- Model #
- Premium or Standard Veneer Finish
- Pull
- Beveled Glass Design
- Molding
- Glass Shelves

| | | | | | | | |
|--|-----------|----|-----|----|----|------|-----------------------|
| MODULAR BOOKCASE WITH DOORS AND MESH INSERTS | 46-2952MB | 29 | 13½ | 50 | 97 | 14.6 | W\$ 3141 PV\$ 3519 |
|--|-----------|----|-----|----|----|------|-----------------------|

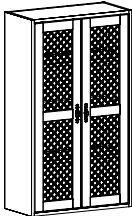

Description

- Standard With: No Molding, Two (2) Wood-Framed Soft-Close Doors with Mesh Inserts, One (1) Fixed Shelf, and Two (2) Adjustable Shelves
- Available in Premium Veneer (PV) or Standard Veneer (W); Must Specify
- Mesh Grille Inserts Available in Antique Brass and Silver; Must Specify (See Below)
- **Must Specify Top and Base for Freestanding Applications; Order Separately (See Tops and Bases)**
- Additional Options: Molding on One or Both Sides (See Below); Glass Shelves ([See Glass Shelf Options](#))
- Recommended for Applications Against a Wall

Mesh Grille Options: Specify & Add

| | | |
|------|--|--------|
| 1-BM | Antique Brass Mesh Grille Insert <i>Only available when a Brass Pull is specified</i> | N/C |
| 1-AM | Silver Mesh Grille Insert <i>Only available when Liberty Pull (ALB) is specified</i> | \$ 782 |

Molding Options: Specify & Add

| | | |
|-------|--------------------------------|--------|
| M46L1 | Molding on Left Side Only | \$ 85 |
| M46R1 | Molding on Right Side Only | \$ 85 |
| M46LR | Molding on Left and Right Side | \$ 170 |

Must Specify (in this order):

- Model #
- Premium or Standard Veneer Finish
- Pull/Mesh Grille Color
- Molding
- Glass Shelves

[See Jefferson Intro Section for Ordering Options](#)

| Item | Model No. | Width | Depth | Height | K | R | Ship Wt | Cubic Ft | List Price |
|---|---|-------|-------|--------|----|---|---------|----------|---------------------------|
| HEIGHT ADJUSTABLE DOUBLE PED DESK TRAY/BOX/FILE | TOP OVERHANG FEATURE | | | | | | | | |
| | 46-3672DPSSTS | 72 | 36 | 30-45 | 16 | 3 | 530 | 50.4 | W/P\$ 12331 PV\$ 13812 |
| | <i>Chassis 66W x 30D - Letter Ped; Approach Overhang 6"; Side Overhang 4"</i> | | | | | | | | |
|  | STANDARD TOP | | | | | | | | |
| | 46-3066DPSSTS | 66 | 30 | 30-45 | 16 | 3 | 495 | 38.7 | W/P\$ 12086 PV\$ 13538 |
| <i>Letter Ped</i> | | | | | | | | | |

Description

- Standard with: Stepped Front, Rectangle Top Profiled on All Sides, Base Molding on All Sides, Decorative Molding on Approach and Both Sides, Locking Tray/Box/File Peds, Left-to-Right Grain Direction on Top, 2-Channel Leg Configuration for Single Surface Height Adjustment, Standard Up/Down Control Switch, and Dovetail Wood Drawer Construction
- Chassis Available with Premium Veneer (PV) or Standard Veneer (W); Must Specify
- Top Available with Premium/Standard Veneer (PV/W) or HPL (P); Must Specify
- Lock Core Color will Coordinate with Pull Selection (Brass Pull with Black Lock, Silver Pull with Silver Lock)
- Wire Management Box Available; Attaches to Bottom Side of Worksurface and Moves Up/Down with Worksurface to Hide Cords/Wires from Top to Chassis ([See Top Grommet Options](#))
- Additional Options: No Decorative Molding (Specify NO MOLDING); Advanced (Memory/Up/Down) Control Switch ([See Switch Options](#)); Soft Close Drawer Closure ([See Soft Close Options](#)); Wire Management + Accessories (Order Separately; [See Multiple Unit Details](#))

Approach Side Shown with Decorative Molding and Optional No Molding

Left Shown with Wire Management Box and Center Grommet

Must Specify (in this order):

- Model #
- Premium or Standard Veneer
- Top Material
- Finish/Color
- Pull
- No Molding
- Drawer Track
- Control Switch
- Top Grommet Location/Color

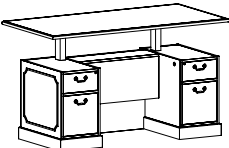
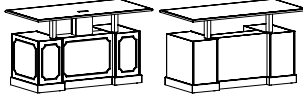
| | | | | | | | | | |
|---|---|----|----|-------|----|---|-----|------|---------------------------|
| HEIGHT ADJUSTABLE DOUBLE PED DESK BOX/FILE | RECESSED MODESTY WITH TOP OVERHANG FEATURE | | | | | | | | |
| | 46-3672DPSTS | 72 | 36 | 30-45 | 16 | 3 | 525 | 50.4 | W/P\$ 11958 PV\$ 13390 |
| | <i>Chassis 66W x 30D - Letter Ped; Approach Overhang 6"; Side Overhang 4"</i> | | | | | | | | |
|  | STANDARD TOP + MODESTY | | | | | | | | |
| | 46-3672CHSTS | 72 | 36 | 30-45 | 16 | 3 | 557 | 50.4 | W/P\$ 14381 PV\$ 16108 |
|  | 46-3066DPSTS | 66 | 30 | 30-45 | 16 | 3 | 490 | 38.7 | W/P\$ 11682 PV\$ 13082 |
| | <i>Letter Ped</i> | | | | | | | | |

Description

- Standard with: Stepped Front, Rectangle Top Profiled on All Sides, Base Molding on All Sides, Decorative Molding on Approach and Both Sides, Locking Box/File Peds, Left-to-Right Grain Direction on Top, 2-Channel Leg Configuration for Single Surface Height Adjustment, Standard Up/Down Control Switch, and Dovetail Wood Drawer Construction
- Chassis Available with Premium Veneer (PV) or Standard Veneer (W); Must Specify
- Top Available with Premium/Standard Veneer (PV/W) or HPL (P); Must Specify
- Lock Core Color will Coordinate with Pull Selection (Brass Pull with Black Lock, Silver Pull with Silver Lock)
- Wire Management Box Available; Attaches to Bottom Side of Worksurface and Moves Up/Down with Worksurface to Hide Cords/Wires from Top to Chassis ([See Top Grommet Options](#))
- Additional Options: No Decorative Molding (Specify NO MOLDING); Advanced (Memory/Up/Down) Control Switch ([See Switch Options](#)); Soft Close Drawer Closure ([See Soft Close Options](#)); Wire Management + Accessories (Order Separately; [See Multiple Unit Details](#))

Approach Side Shown with Decorative Molding and Optional No Molding

Left Shown with Wire Management Box and Center Grommet

Must Specify (in this order):

- Model #
- Premium or Standard Veneer
- Top Material
- Finish/Color
- Pull
- No Molding
- Drawer Track
- Control Switch
- Top Grommet Location/Color

[See Jefferson Intro Section for Ordering Options](#)

| Item | Model No. | Width | Depth | Height | K | R | Ship Wt | Cubic Ft | List Price | |
|--|------------------------------------|------------------|-------|--------|-------|----|---------|----------|------------|---------------------------|
| HEIGHT ADJUSTABLE SINGLE PED DESK TRAY/BOX/FILE | Left Ped | Right Ped | | | | | | | | |
| | 46-3672LPSSTS <i>Legal Ped</i> | 46-3672RPSSTS | 72 | 36 | 30-45 | 16 | 3 | 435 | 50.4 | W/P\$ 11917 PV\$ 13348 |
| | 46-3066LPSSTS <i>Letter Ped</i> | 46-3066RPSSTS | 66 | 30 | 30-45 | 16 | 3 | 285 | 38.7 | W/P\$ 11340 PV\$ 12702 |

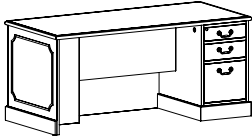

Shown as Right

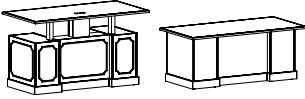

Approach Side Shown with Decorative Molding and Optional No Molding

Left Shown with Wire Management Box and Center Grommet

Must Specify (in this order):

- Model #
- Premium or Standard Veneer
- Top Material
- Finish/Color
- Pull
- No Molding
- Drawer Track
- Leg Configuration
- Control Switch
- Top Grommet Location/Color

Description

- Standard with: Stepped Front, Rectangle Top Profiled on All Sides, Base Molding on All Sides, Decorative Molding on Approach and Both Sides, Locking Tray/Box/File Ped, Left-to-Right Grain Direction on Top, 2-Channel Leg Configuration for Single Surface Height Adjustment, Standard Up/Down Control Switch, and Dovetail Wood Drawer Construction
- Chassis Available with Premium Veneer (PV) or Standard Veneer (W); Must Specify
- Top Available with Premium/Standard Veneer (PV/W) or HPL (P); Must Specify
- Lock Core Color will Coordinate with Pull Selection (Brass Pull with Black Lock, Silver Pull with Silver Lock)
- Stationary Returns and Bridges Available for Use with Single Ped Desks, [See Stationary Return](#) and [Stationary Bridge](#)
- Optional 3-Channel Leg Configuration (STS3) for Use with 3-Channel Returns; [See Option Details](#) and [See 3-Channel Units](#)
- Wire Management Box Available; Attaches to Bottom Side of Worksurface and Moves Up/Down with Worksurface to Hide Cords/Wires from Top to Chassis ([See Top Grommet Options](#))
- Additional Options: No Decorative Molding (Specify NO MOLDING); Advanced (Memory/Up/Down) Control Switch ([See Switch Options](#)); Soft Close Drawer Closure ([See Soft Close Options](#)); Wire Management + Accessories (Order Separately; [See Multiple Unit Details](#))

| Item | Model No. | Width | Depth | Height | K | R | Ship Wt | Cubic Ft | List Price | |
|---|-----------------------------------|------------------|-------|--------|-------|----|---------|----------|------------|---------------------------|
| HEIGHT ADJUSTABLE SINGLE PED DESK BOX/FILE | Left Ped | Right Ped | | | | | | | | |
| | 46-3672LPSTS <i>Legal Ped</i> | 46-3672RPSTS | 72 | 36 | 30-45 | 16 | 3 | 430 | 50.4 | W/P\$ 11552 PV\$ 12936 |
| | 46-3066LPSTS <i>Letter Ped</i> | 46-3066RPSTS | 66 | 30 | 30-45 | 16 | 3 | 280 | 38.7 | W/P\$ 10973 PV\$ 12291 |

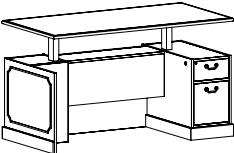

Shown as Right

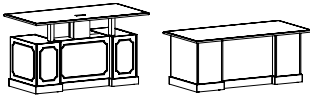

Approach Side Shown with Decorative Molding and Optional No Molding

Left Shown with Wire Management Box and Center Grommet

Must Specify (in this order):

- Model #
- Premium or Standard Veneer
- Top Material
- Finish/Color
- Pull
- No Molding
- Drawer Track
- Leg Configuration
- Control Switch
- Top Grommet Location/Color

Description

- Standard with: Stepped Front, Rectangle Top Profiled on All Sides, Base Molding on All Sides, Decorative Molding on Approach and Both Sides, Locking Box/File Ped, Left-to-Right Grain Direction on Top, 2-Channel Leg Configuration for Single Surface Height Adjustment, Standard Up/Down Control Switch, and Dovetail Wood Drawer Construction
- Chassis Available with Premium Veneer (PV) or Standard Veneer (W); Must Specify
- Top Available with Premium/Standard Veneer (PV/W) or HPL (P); Must Specify
- Lock Core Color will Coordinate with Pull Selection (Brass Pull with Black Lock, Silver Pull with Silver Lock)
- Stationary Returns and Bridges Available for Use with Single Ped Desks, [See Stationary Return](#) and [Stationary Bridge](#)
- Optional 3-Channel Leg Configuration (STS3) for Use with 3-Channel Returns; [See Option Details](#) and [See 3-Channel Units](#)
- Wire Management Box Available; Attaches to Bottom Side of Worksurface and Moves Up/Down with Worksurface to Hide Cords/Wires from Top to Chassis ([See Top Grommet Options](#))
- Additional Options: No Decorative Molding (Specify NO MOLDING); Advanced (Memory/Up/Down) Control Switch ([See Switch Options](#)); Soft Close Drawer Closure ([See Soft Close Options](#)); Wire Management + Accessories (Order Separately; [See Multiple Unit Details](#))

[See Jefferson Intro Section for Ordering Options](#)

| Item | Model No. | Width | Depth | Height | K | R | Ship Wt | Cubic Ft | List Price | |
|---|-----------------|------------------|-------|--------|-------|----|---------|----------|------------|--------------------------|
| HEIGHT ADJUSTABLE RETURN WITH FILE/FILE | Left Ped | Right Ped | | | | | | | | |
| | 46-2448LF2STS | 46-2448RF2STS | 48 | 24 | 30-45 | 13 | - | 237 | 21.8 | W/P\$ 9891 PV\$ 11080 |
| 2-CHANNEL, FOR ONE WORKSURFACE | 46-2442LF2STS | 46-2442RF2STS | 42 | 24 | 30-45 | 13 | - | 237 | 20.4 | W/P\$ 9842 PV\$ 11024 |

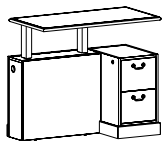

Shown as Right

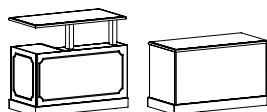

Approach Shown with and without Decorative Molding

Must Specify (in this order):

Model #
 Premium or Standard Veneer
 Top Material
 Finish/Color
 Pull
 No Molding
 Locking
 Drawer Track
 Control Switch
 Top Grommet Location/Color
 Modesty Grommet

Description

- Standard with: Rectangle Top Profiled on All Sides, Base Molding on All Sides, Decorative Molding on Approach and Side, File/File Ped, Worksurface Grommet, Front-To-Back Grain Direction on Top, 2-Channel Leg Configuration for Single Surface Height Adjustment, Standard Up/Down Control Switch, Wire Management from Pedestal to Kneespace, and Dovetail Wood Drawer Construction
- Note: Surface is 1/8" Short on Connecting Side
- Chassis Available with Premium Veneer (PV) or Standard Veneer (W); Must Specify
- Top Available with Premium/Standard Veneer (PV/W) or HPL (P); Must Specify
- Optional Modesty Grommet for Wire Management to Wall; Must Specify: Black (GMBBL), Silver (GMBSV) or None (NONE)
- Wire Management Box Available; Attaches to Bottom Side of Worksurface and Moves Up/Down with Worksurface to Hide Cords/Wires from Top to Chassis ([See Top Grommet Options](#))
- Additional Options: No Decorative Molding (Specify NO MOLDING); Locking Pedestal ([See Locking Options](#)); Advanced (Memory/Up/Down) Control Switch ([See Switch Options](#)); Soft Close Drawer Closure ([See Soft Close Options](#)); Wire Management + Accessories (Order Separately; [See Multiple Unit Details](#))

| Item | Model No. | Width | Depth | Height | K | R | Ship Wt | Cubic Ft | List Price | |
|---|-----------------|------------------|-------|--------|-------|----|---------|----------|------------|-------------------------|
| HEIGHT ADJUSTABLE RETURN WITH FILE/FILE FOR MULTIPLE SURFACES | Left Ped | Right Ped | | | | | | | | |
| | 46-2448LF2STS3 | 46-2448RF2STS3 | 48 | 24 | 30-45 | 22 | - | 237 | 21.8 | W/P\$ 7474 PV\$ 8372 |
| 3-CHANNEL, FOR TWO SIMULTANEOUS WORKSURFACES | 46-2442LF2STS3 | 46-2442RF2STS3 | 42 | 24 | 30-45 | 22 | - | 237 | 20.4 | W/P\$ 7424 PV\$ 8314 |

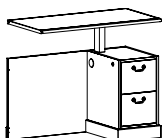

Shown as Right

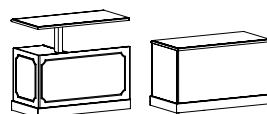

Approach Shown with and without Decorative Molding

Must Specify (in this order):

Model #
 Premium or Standard Veneer
 Top Material
 Finish/Color
 Pull
 No Molding
 Locking
 Drawer Track
 Top Grommet Location/Color
 Modesty Grommet

Description

- Standard with: Rectangle Top Profiled on Approach and User Sides with Reverse Profile on Connecting Side, Base Molding on All Sides, Decorative Molding on Approach and Side, File/File Ped, Front-To-Back Grain Direction on Top, 3-Channel Leg Configuration for Simultaneous Surface Height Adjustment Across Two Units, Wire Management from Pedestal to Kneespace, and Dovetail Wood Drawer Construction
- Chassis Available with Premium Veneer (PV) or Standard Veneer (W); Must Specify
- Top Available with Premium/Standard Veneer (PV/W) or HPL (P); Must Specify
- Must Be Used with Height Adjustable Single Pedestal Desk (Order Separately, [See Single Ped Desks](#))**
- Control Switch Not Included, Will Be On Adjoining Unit
- Optional Modesty Grommet for Wire Management to Wall; Must Specify: Black (GMBBL), Silver (GMBSV) or None (NONE)
- Optional Worksurface Grommet with or without Mesh Wire Management Sleeve Available Over Ped Only; 6" from Ends and 20" from User; Must Specify Location and Color: GL or GL-MESH for Left or GR or GR-MESH for Right; Color Options: Black (BLK) or Silver (SLV); [See Grommet Options](#)
- Monitor Arms not Available on this Unit
- Additional Options: No Decorative Molding (Specify NO MOLDING); Locking Pedestal ([See Locking Options](#)); Soft Close Drawer Closure ([See Soft Close Options](#)); Wire Management + Accessories (Order Separately; [See Multiple Unit Details](#))

| Item | Model No. | Width | Depth | Height | K | R | Ship Wt | Cubic Ft | List Price | |
|----------------------------------|-----------------|------------------|-------|--------|----|----|---------|----------|------------|-------------------------|
| STATIONARY RETURN WITH FILE/FILE | Left Ped | Right Ped | | | | | | | | |
| | 46-2448LF2SR | 46-2448RF2SR | 48 | 24 | 30 | 22 | - | 165 | 21.8 | W/P\$ 4888 PV\$ 5474 |
| | 46-2442LF2SR | 46-2442RF2SR | 42 | 24 | 30 | 22 | - | 110 | 20.4 | W/P\$ 4836 PV\$ 5415 |

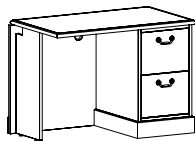

Shown as Right

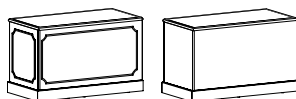

Approach Side Shown with Decorative Molding and Optional No Molding

Must Specify (in this order):

- Model #
- Premium or Standard Veneer
- Top Material
- Finish/Color
- Pull
- No Molding
- Locking
- Drawer Track
- Locking Pedestal
- Top Grommet Location/Color
- Modesty Grommet
- Kneespace Options

Description

- Standard with: Rectangle Top Profiled on All Sides, Base Molding on All Sides, Decorative Molding on Approach and Side, File/File Ped, Front-To-Back Grain Direction on Top, Wire Management from Pedestal to Kneespace, and Dovetail Wood Drawer Construction
- Note: Surface is 1/8" Short on Connecting Side
- Chassis Available with Premium Veneer (PV) or Standard Veneer (W); Must Specify
- Top Available with Premium/Standard Veneer (PV/W) or HPL (P); Must Specify
- **Must Be Used with Height Adjustable Single Pedestal Desk (Order Separately, See Single Ped Desks)**
- Additional Options: No Decorative Molding (Specify NO MOLDING); Kneespace Options (See Multiple Unit Details); Locking Pedestal (See Locking Options); Soft Close Drawer Closure (See Soft Close Options); Top Grommet Options (See Top Grommet Options); Wire Management + Accessories (Order Separately; See Multiple Unit Details)

| | | | | | | | | | |
|--------------------------------|--------------|----|----|-------|----|---|-----|------|-------------------------|
| HEIGHT ADJUSTABLE BRIDGE | 46-2448UFSTS | 48 | 24 | 30-45 | 13 | - | 250 | 24.0 | W/P\$ 7428 PV\$ 8318 |
| 2-CHANNEL, FOR ONE WORKSURFACE | 46-2442UFSTS | 42 | 24 | 30-45 | 13 | - | 230 | 21.8 | W/P\$ 7299 PV\$ 8177 |

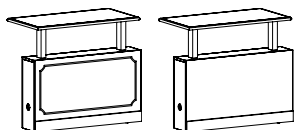
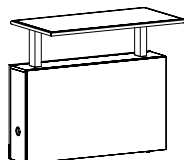

Approach Shown with and without Decorative Molding

Must Specify (in this order):

- Model #
- Premium or Standard Veneer
- Top Material
- Finish/Color
- No Molding
- Top Grommet Location/Color
- Modesty Grommet
- Control Switch
- Kneespace Options

Description

- Standard with: Rectangle Top Profiled on All Sides, Base Molding on Back Side, Decorative Molding on Approach, Front-To-Back Grain Direction on Top, 2-Channel Leg Configuration for Single Surface Height Adjustment, and Standard Up/Down Control Switch (Field Installed)
- Note: Surface is 1/8" Short on Both Connecting Sides to Prevent Contact Between Tops
- Chassis Available with Premium Veneer (PV) or Standard Veneer (W); Must Specify
- Top Available with Premium/Standard Veneer (PV/W) or HPL (P); Must Specify
- Control Switch Standard (Up/Down) or Upgrade to Advanced Switch (MSWCH-Up/Down/Memory); Switch is Field Installed; See Switch Options
- Optional Modesty Grommet for Wire Management to Wall; Must Specify: Black (GMBBL), Silver (GMBSV) or None (NONE)
- Optional Worksurface Grommet with or without Mesh Wire Management Sleeve or Wire Management Box Available On Center Only (See Top Grommet Options)
- Additional Options: No Decorative Molding (Specify NO MOLDING); Kneespace Options (See Multiple Unit Details); Advanced (Memory/Up/Down) Control Switch (See Switch Options); Soft Close Drawer Closure (See Soft Close Options); Wire Management + Accessories (Order Separately; See Multiple Unit Details)

See Jefferson Intro Section for Ordering Options

| Item | Model No. | Width | Depth | Height | K | R | Ship Wt | Cubic Ft | List Price | |
|--|----------------|----------------|-------|--------|-------|----|---------|----------|------------|-------------------------|
| HEIGHT ADJUSTABLE BRIDGE FOR MULTIPLE SURFACES | Left | Right | | | | | | | | |
| | 46-2448UFSTSL3 | 46-2448UFSTSR3 | 48 | 24 | 30-45 | 13 | - | 250 | 24.0 | W/P\$ 6238 PV\$ 7128 |
| 3-CHANNEL, FOR TWO SIMULTANEOUS WORKSURFACES | 46-2442UFSTSL3 | 46-2442UFSTSR3 | 42 | 24 | 30-45 | 13 | - | 230 | 21.8 | W/P\$ 6109 PV\$ 6986 |

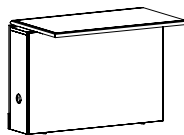

SIN PENDING

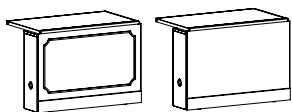

Approach Shown with and without Decorative Molding

Must Specify (in this order):

- Model #
- Premium or Standard Veneer
- Top Material
- Finish/Color
- No Molding
- Top Grommet Location/Color
- Modesty Grommet
- Control Switch
- Kneespace Options

Description

- Standard with: Rectangle Top Profiled on All Sides, Base Molding on Back Side, Decorative Molding on Approach, Front-To-Back Grain Direction on Top, 3-Channel Leg Configuration for Multiple Surface Height Adjustment
- Note: Surface is 1/8" Short on Both Connecting Sides to Prevent Contact Between Tops
- Chassis Available with Premium Veneer (PV) or Standard Veneer (W); Must Specify
- Top Available with Premium/Standard Veneer (PV/W) or HPL (P); Must Specify
- Control Switch Not Included; Control Switch will be on Adjoining Unit
- Optional Modesty Grommet for Wire Management to Wall; Must Specify: Black (GMBBL), Silver (GMBSV) or None (NONE)
- Optional Worksurface Grommet with Mesh Wire Management Sleeve or Wire Management Box Available On Center Only ([See Options](#))
- Additional Options: No Decorative Molding (Specify NO MOLDING); Wire Management + Accessories (Order Separately; [See Multiple Unit Details](#))

STATIONARY BRIDGE FULL MODESTY

| | Left Attachment | Right Attachment | Width | Depth | Height | K | R | Ship Wt | Cubic Ft | List Price |
|--|-----------------|------------------|-------|-------|--------|----|---|---------|----------|-------------------------|
| | 46-2448SUFL | 46-2448SUFR | 48 | 24 | 30 | 22 | - | 89 | 5.5 | W/P\$ 2421 PV\$ 2712 |
| | 46-2442SUFL | 46-2442SUFR | 42 | 24 | 30 | 22 | - | 89 | 5.5 | W/P\$ 2296 PV\$ 2570 |

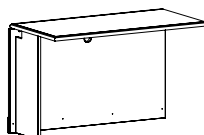

Shown as Right

Must Specify (in this order):

- Model #
- Premium or Standard Veneer
- Top Material
- Finish/Color
- No Molding
- Top Grommet Location/Color

Description

- Standard with: Rectangle Top Profiled on Approach and User Sides with Reverse Profile on Connecting Side (To Credenza), Base Molding on Back Side, Decorative Molding on Approach, and Front-To-Back Grain Direction on Top
- Note: Surface is 1/8" Short on Connecting Side to Prevent Contact Between Tops
- Chassis Available with Premium Veneer (PV) or Standard Veneer (W); Must Specify
- Top Available with Premium/Standard Veneer (PV/W) or HPL (P); Must Specify
- **Must Be Used with Height Adjustable Single Pedestal Desk (Order Separately, [See Single Ped Desks](#))**
- Additional Options: No Decorative Molding (Specify NO MOLDING); Top Grommet Options ([See Top Grommet Options](#)); Kneespace Options (Order Separately; Available for Field Installation Only; [See Multiple Unit Details](#)); Wire Management + Accessories (Order Separately; [See Multiple Unit Details](#))

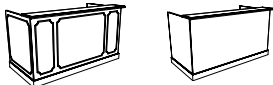
| Item | Model No. | Width | Depth | Height | K | R | Ship Wt | Cubic Ft | List Price | |
|--|--|------------------|-------|--------|----|-----|---------|----------|------------|-------------------------|
| SINGLE PED RECEPTION DESK BOX/BOX/FILE  <p>Shown as Left</p>  <p>Approach Side Shown with Decorative Molding and Optional No Molding</p> | Left Ped | Right Ped | | | | | | | | |
| | 46-3672RPD1L | 46-3672RPD1R | 74 | 39 | 42 | 28¼ | - | 374 | 76.3 | W/P\$ 8254 PV\$ 9245 |
| | <i>Worksurface 70W x 34¾D; Legal Ped</i> | | | | | | | | | |
| | 46-3066RPD1L | 46-3066RPD1R | 68 | 33 | 42 | 25¼ | - | 327 | 59.9 | W/P\$ 7545 PV\$ 8453 |
| <i>Worksurface 64W x 28¾D; Letter Ped</i> | | | | | | | | | | |

Description

- Standard with: Transaction Surface Profiled on All Sides, Rectangle User Surface with Square Profile, Base Molding on All Sides, Decorative Molding on Approach and Both Sides, Central Locking Center Drawer, Box/Box/File Ped, Left-to-Right Grain Direction on Top, and Dovetail Wood Drawer Construction
- Chassis Available with Premium Veneer (PV) or Standard Veneer (W); Must Specify
- Top/Transaction Available with Premium/Standard Veneer (PV/W) or HPL (P); Must Specify
- Lock Core Color will Coordinate with Pull Selection (Brass Pull with Black Lock, Silver Pull with Silver Lock)
- Additional Options: No Decorative Molding (Specify NO MOLDING); Keyboard Flip Down Center Drawer (Order Separately, [See Center Drawer](#)); Factory-Installed Tackboard ([See Tackboards](#)); Soft Close Drawer Closure ([See Soft Close Drawer Option](#)); Top Grommet Options ([See Grommet Options](#)); Wire Management + Accessories (Order Separately; [See Multiple Unit Details](#))

Must Specify (in this order):

- Model #
- Premium or Standard Veneer
- Top Material
- Finish/Color
- Pull
- No Molding
- Drawer Track
- Top Grommet Location/Color
- Flip Down Center Drawer
- Tackboard/Fabric

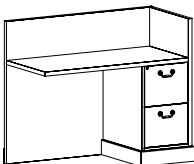
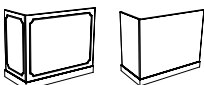
| Item | Model No. | Width | Depth | Height | K | R | Ship Wt | Cubic Ft | List Price | |
|---|--------------------------------|------------------|-------|--------|-----|-----|---------|----------|------------|-------------------------|
| RECEPTION RETURN FILE/FILE  <p>Shown as Right</p>  <p>Approach Side Shown with Decorative Molding and Optional No Molding</p> | Left Ped | Right Ped | | | | | | | | |
| | 46-2448RPD2L | 46-2448RPD2R | 48 | 24 | 40¾ | 28¼ | - | 195 | 33.3 | W/P\$ 5520 PV\$ 6183 |
| | <i>Worksurface 46¼W x 21¾D</i> | | | | | | | | | |

Description

- Standard with: Rectangle Top with Square Profile, Base Molding on All Sides, Decorative Molding on Approach and Side, Locking File/File Ped, Front-To-Back Grain Direction on Top, and Dovetail Wood Drawer Construction
- Chassis Available with Premium Veneer (PV) or Standard Veneer (W); Must Specify
- Top Available with Premium/Standard Veneer (PV/W) or HPL (P); Must Specify
- Additional Options: No Decorative Molding (Specify NO MOLDING); Soft Close Drawer Closure ([See Soft Close Drawer Option](#)); Keyboard Flip Down Center Drawer (Order Separately, [See Center Drawer](#)); Top Grommet Options ([See Grommet Options](#)); Wire Management + Accessories (Order Separately; [See Multiple Unit Details](#))

Must Specify (in this order):

- Model #
- Premium or Standard Veneer
- Top Material
- Finish/Color
- Pull
- No Molding
- Drawer Track
- Top Grommet Location/Color

[See Jefferson Intro Section for Ordering Options](#)

| Item | Model No. | Width | Depth | Height | K | R | Ship Wt | Cubic Ft | List Price |
|------------------|---|-------|-------|--------|----|---|---------|----------|-------------------------|
| RECEPTION BRIDGE | 46-2448RUF <i>Worksurface 48W x 22¼D</i> | 48 | 24 | 40⅞ | 48 | - | 116 | 7.3 | W/P\$ 2520 PV\$ 2821 |
| | 46-2442RUF <i>Worksurface 42W x 22¼D</i> | 42 | 24 | 40⅞ | 42 | - | 104 | 6.3 | W/P\$ 2373 PV\$ 2659 |

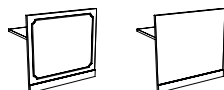
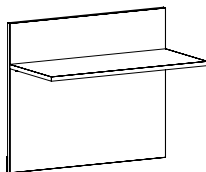

Approach Side Shown with Decorative Molding and Optional No Molding

Must Specify (in this order):

- Model #
- Premium or Standard Veneer
- Top Material
- Finish/Color
- No Molding
- Top Grommet Location/Color

Description

- Standard With: Rectangle Top with Square Profile, Front-to-Back Grain Direction on Top, and Hinged Back Panel
- Chassis Available with Premium Veneer (PV) or Standard Veneer (W); Must Specify
- Top Available with Premium/Standard Veneer (PV/W) or HPL (P); Must Specify
- Additional Options: No Decorative Molding (Specify No Molding); Kneespace Options ([See Multiple Unit Details](#); Available for Field Installation Only); Top Grommet Options ([See Grommet Options](#)); Wire Management + Accessories (Order Separately; [See Multiple Unit Details](#))

| SINGLE PED RECEPTION CREDENZA FILE/FILE | Left Ped | Right Ped | Width | Depth | Height | K | R | Ship Wt | Cubic Ft | List Price |
|---|--|------------|-------|-------|--------|-----|---|---------|----------|-------------------------|
| | Model No. | Model No. | | | | | | | | |
|  | 46-2472RCL <i>Worksurface 70W x 22D; Legal Ped</i> | 46-2472RCR | 72 | 24 | 40⅞ | 32¼ | - | 264 | 46.8 | W/P\$ 6612 PV\$ 7405 |
| | 46-2466RCL <i>Worksurface 64W x 22D; Letter Ped</i> | 46-2466RCR | 66 | 24 | 40⅞ | 26¼ | - | 249 | 43.0 | W/P\$ 6509 PV\$ 7291 |

Shown as Right

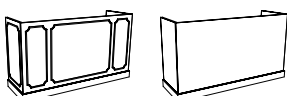



Approach Side Shown with Decorative Molding and Optional No Molding

Must Specify (in this order):

- Model #
- Premium or Standard Veneer
- Top Material
- Finish/Color
- Pull
- Back Panel Grommet Color
- No Molding
- Drawer Track
- Top Grommet Location/Color

Description

- Standard with: Rectangle Top with Square Profile, Base Molding on All Sides, Decorative Molding on Approach and Both Sides, Locking File/File Ped, Left-to-Right Grain Direction on Top, and Dovetail Wood Drawer Construction
- Chassis Available with Premium Veneer (PV) or Standard Veneer (W); Must Specify
- Top Available with Premium/Standard Veneer (PV/W) or HPL (P); Must Specify
- Lock Core Color will Coordinate with Pull Selection (Brass Pull with Black Lock, Silver Pull with Silver Lock)
- Additional Options: No Decorative Molding (Specify NO MOLDING); Soft Close Drawer Closure ([See Soft Close Drawer Option](#)); Kneespace Options ([See Multiple Unit Details](#); Available for Field Installation Only); Top Grommet Options ([See Grommet Options](#)); Wire Management + Accessories (Order Separately; [See Multiple Unit Details](#))

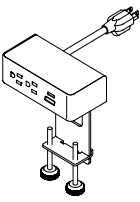
| Item | Model No. | | Width | Depth | Height | Ship Wt | Cubic Ft | List Price |
|--|---------------|--------|--------------------|--------------------|--------|---------|----------|------------|
| ROUND GROMMET COVER  | 01-GRMTBK | Black | 2 $\frac{3}{16}$ " | 2 $\frac{3}{16}$ " | - | 1 | 0.1 | \$ 11 |
| | 01-GRMTSL | Silver | | | | | | |
| <p>OPEN MARKET ONLY (SILVER)</p> <p>Must Specify (in this order): Model # Factory Installed</p> <p>Description</p> <ul style="list-style-type: none"> • 2$\frac{3}{16}$" (60mm) Round Grommet Cover • Field Installed | | | | | | | | |
| SINGLE POWER SAND DOLLAR  | 01-SAND60PW | White | 3 | 3 | 4 | 1 | 0.2 | \$ 98 |
| | 01-SAND60PB | Black | | | | | | |
| | 01-SAND60PS | Silver | | | | | | |
| <p>Description</p> <ul style="list-style-type: none"> • Available on Height Adjustable Desks, Returns and Bridge Units with Wire Management Box in Center Grommet Only (GC-BOX) • Unit is 2" Diameter; Mounts in 60mm Round Grommet • 6' Cord • Single Power Outlet | | | | | | | | |
| DOUBLE USB SAND DOLLAR  | 01-SAND60UW | White | 3 | 3 | 4 | 1 | 0.2 | \$ 277 |
| | 01-SAND60UB | Black | | | | | | |
| | 01-SAND60US | Silver | | | | | | |
| <p>Description</p> <ul style="list-style-type: none"> • Available on Height Adjustable Desks, Returns and Bridge Units with Wire Management Box in Center Grommet Only (GC-BOX) • Unit is 2" Diameter; Mounts in 60mm Round Grommet • 6' Cord • Dual USB Outlets | | | | | | | | |
| DUO CLAMP WITH NEMA PLUG  | 01-DUOCLAMPW | White | 5 $\frac{1}{2}$ " | 3 | 7 | 1 | 0.2 | \$ 572 |
| | 01-DUOCLAMPB | Black | | | | | | |
| | 01-DUOCLAMP S | Silver | | | | | | |
| <p>Description</p> <ul style="list-style-type: none"> • Standard with: Two (2) Power Outlet, One (1) USB Charging Port and One (1) 60-Watt USB-C Power Delivery Port with GaN Technology with 10' Cord • Clamps to Top and Features Silver Metal Trim • Independent USB Circuit Controllers Deliver up to 2.1 Amps to Each Post • All Mounting Hardware Included • FCC Part 15A and UL Approved for Horizontal and Vertical Applications | | | | | | | | |

[See Jefferson Intro Section for Ordering Options](#)

| Item | Model No. | | Width | Depth | Height | Ship Wt | Cubic Ft | List Price |
|------------------------------|---------------|--------|-------|-------|--------|---------|----------|------------|
| TRIO CLAMP WITH NEMA PLUG | 01-TRIOCLAMPW | White | 8 | 3 | 7 | 1 | 0.2 | \$ 671 |
| | 01-TRIOCLAMPB | Black | | | | | | |
| | 01-TRIOCLAMPS | Silver | | | | | | |

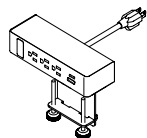

Description

- Standard with: Three (3) Power Outlets, **One (1) USB Charging Port, One (1) 60-Watt USB-C Power Delivery Port with GaN Technology**, One (1) Open Data, and 10' Cord
- Clamps to Top and Features Silver Metal Trim
- Independent USB Circuit Controllers Deliver up to 2.1 Amps to Each Post
- HDMI, VGA, or RJ45 Accessories Sold Separately (See Below)
- All Mounting Hardware Included
- FCC Part 15A and UL Approved for Horizontal and Vertical Applications

| | | | | | | | | |
|-------------------------|------------|--|---|---|---|---|-----|--------|
| VGA DATA PORT ACCESSORY | 01-LCOMVGA | | - | - | - | 1 | 0.2 | \$ 121 |
|-------------------------|------------|--|---|---|---|---|-----|--------|

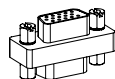

Description

- VGA Port for Trio Clamp Units

| | | | | | | | | |
|--------------------------|-------------|--|---|---|---|---|-----|--------|
| HDMI DATA PORT ACCESSORY | 01-LCOMHDMI | | - | - | - | 1 | 0.2 | \$ 166 |
|--------------------------|-------------|--|---|---|---|---|-----|--------|

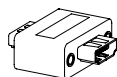

Description

- HDMI Port for Trio Clamp Units

| | | | | | | | | |
|--------------------------|-------------|--|---|---|---|---|-----|-------|
| RJ45 DATA PORT ACCESSORY | 01-LCOMRJ45 | | - | - | - | 1 | 0.2 | \$ 79 |
|--------------------------|-------------|--|---|---|---|---|-----|-------|

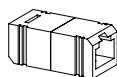



Description

- RJ45 Port for Trio Clamp Units

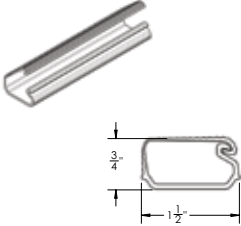
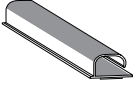
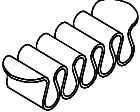
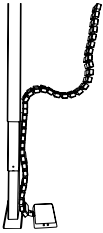
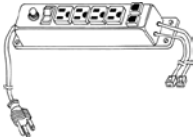
[See Jefferson Intro Section for Ordering Options](#)

| Item | Model No. | | Width | Depth | Height | Ship Wt | Cubic Ft | List Price |
|--|----------------|--------|-------|-------|--------|---------|----------|------------|
| WIRE MANAGEMENT CHANNEL | 01-WMGR4 | | 16 | 1½ | 1 | 1 | - | \$ 116 |
|  <p>Description</p> <ul style="list-style-type: none"> • Set of Four (4) Black Plastic Wire Management Channels • Snap Lock Channel • Attaches with Adhesive Strips • Ships via UPS Only | | | | | | | | |
| WIRE CHANNEL | 01-32125 | | 24 | 1¾ | 1 | .25 | 0.3 | \$ 106 |
|  <p>Description</p> <ul style="list-style-type: none"> • Available in Black • Channels Attach with Two (2) Double-Sided Installation Tape • Open J Channel for Easy Storage of Cables | | | | | | | | |
| CABLE GRIP | 01-WMGRCB | | 5¾ | 2¾ | - | - | - | \$ 17 |
|  <p>Description</p> <ul style="list-style-type: none"> • Under Surface Wire Management • Black | | | | | | | | |
| LINK 360 CABLE MANAGER | 01-0251LINKSLV | Silver | 5¾ | 3¾ | 30-51 | 4 | 3.0 | \$ 390 |
| | 01-0251LINKBLK | Black | 5¾ | 3¾ | 30-51 | 4 | 3.0 | \$ 353 |
|  <p>Description</p> <ul style="list-style-type: none"> • Kit Includes: 50 Link 360™ elements, One (1) Quad Connector, One (1) Dumbbell Connector, One (1) Foot Assembly with Two (2) Magnetic Clips • Can Be Used For Height-Adjustable Mechanisms Up To 51" or Free-Standing Use | | | | | | | | |
| POWER STRIP | 01-PRSP | | 9 | 2 | 2 | 1 | - | \$ 205 |
|  <p>Description</p> <ul style="list-style-type: none"> • Four (4) Outlets and Two (2) Phone Jacks with Rocker Switch • Black Plastic with 10' Power Cord • Suitable for Surface or Recessed Mounting • 13 Amp Circuit Breaker • Two (2) 14 ft. Phone Hook Up Cords • UL and CSA Recognized | | | | | | | | |

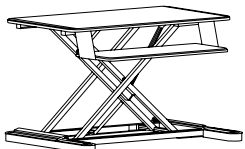
[See Jefferson Intro Section for Ordering Options](#)

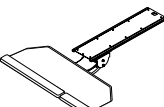
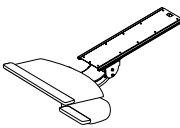
| Item | Model No. | Width | Depth | Height | Ship Wt | Cubic Ft | List Price | | |
|---|--|--------|-------------------|--------|---------|----------|----------------------|--|--|
| HEIGHT ADJUSTABLE WORKSTATION | 01-S2SBLK Black | 35½ | 25 | 6-22 | 49 | 6.5 | \$ 1503 | | |
|  | Description <ul style="list-style-type: none"> • Height Adjustable • Weight Capacity: 35lbs • One-Handed Operation; Platforms Move Simultaneously • Keyboard Platform: 10½"D x 26½"W • Worksurface: 21"D x 35½"W • Can be Used on Worksurface 24"D x 35"W | | | | | | | | |
| KEYBOARD FLIP DOWN CENTER DRAWER | 46-2410FD | 24 | 15 ¾ | 3 ⅙ | 12 | 2.0 | W\$ 988 PV\$ 1106 | | |
|  | Description <ul style="list-style-type: none"> • Flip Down Front • Available with Premium Veneer (PV) or Standard Veneer (W); Must Specify • Does Not Feature Soft Close Hinges • Use on Any Open Kneespace 24" or Larger • Field Installed <p><u>Must Specify (in this order):</u> Model # Premium or Standard Veneer Finish Pull Factory Installed</p> | | | | | | | | |
| ARTICULATING KEYBOARD CORNER PLATFORM | 01-KB2CC | 25 | 10½ | 4½ | 16 | 1.4 | \$ 832 | | |
|  | Description <ul style="list-style-type: none"> • Standard With: +/- 15° Tilt Adjustment , 360° Rotation, Independent Tilt Adjustment, 7" Lift and Lock Height Adjustment, 25" Cut Corner Platform • Keyboard and Mouse on same level; Single Palm Rest for both Left & Right Hands • Works with 17"+ Diagonal Work Surface • Cannot Be Used on 20" or 21" Deep Unit • Not Available with Optional Center Grommet • Track Measures 21" <p>Options: Specify & Add</p> <table border="1"> <tr> <td>KB2CC</td> <td>Factory Installed</td> <td>\$ 208</td> </tr> </table> | KB2CC | Factory Installed | \$ 208 | | | | | |
| KB2CC | Factory Installed | \$ 208 | | | | | | | |
| KEYBOARD MECHANISM WITH KEYBOARD CLAMP | 01-KB3 | 26½ | 14 | 4.5 | 16 | 1.4 | \$ 914 | | |
|  | Description <ul style="list-style-type: none"> • Standard With: 18.75" Platform with Swivel-Below Mouse Platform,+/- 15° Tilt Adjustment, 360° Rotation, 7" Lift and Lock Height Adjustment, Independent Tilt Adjustment, Palm Rest for Mousing Surface • Left or Right Handed Mouse Platform • Cannot Be Used on 20" or 21" Deep Unit • Not Available with Optional Center Grommet • Track Measures 21" <p>Options: Specify & Add</p> <table border="1"> <tr> <td>KB3</td> <td>Factory Installed</td> <td>\$ 208</td> </tr> </table> | KB3 | Factory Installed | \$ 208 | | | | | |
| KB3 | Factory Installed | \$ 208 | | | | | | | |

[See Jefferson Intro Section for Ordering Options](#)

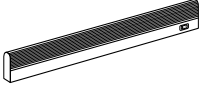
| Item | Model No. | Width | Depth | Height | Ship Wt | Cubic Ft | List Price |
|---|-------------------------------------|-------|-------|--------|---------|----------|------------|
|  | TL-0848 <i>240-LED, 18 Watts</i> | 47½ | 7/8 | 1½ | - | - | \$ 445 |
| | TL-0824 <i>84-LED, 7 Watts</i> | 22½ | 7/8 | 1½ | - | - | \$ 368 |

Description

- Includes the Power Supply and Three (3) Upper Wire Management Grommets
- Rocker Style On/Off Switch with a 10' Power Cord
- Three (3) Upper Wire Management Grommets; Must Specify Color: Black (BLK), Silver (SLV)

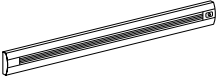
| | | | | | | | |
|---|--|-----|---|---|---|---|---------|
|  | 01-188LED58 <i>96-LED, 33.7 Watts</i> | 57¾ | 2 | ¾ | - | - | \$ 1648 |
| | 01-94LED31 <i>48-LED, 17.6 Watts</i> | 30¾ | 2 | ¾ | - | - | \$ 1195 |
| | 01-47LED17 <i>24-LED, 9.1 Watts</i> | 16¾ | 2 | ¾ | - | - | \$ 690 |

Description

- Includes the Power Supply and Three (3) Upper Wire Management Grommets
- 12' Power Cord
- Three (3) Upper Wire Management Grommets; Must Specify Color: Black (BLK), Silver (SLV)
- Optional Occupancy Sensor Shuts Off After 30 Minutes of Inactivity and Turns On Immediately When Reentering the Detection Area

Options: Specify & Add

| | | |
|---------|------------------|--------|
| 01-OSRP | Occupancy Sensor | \$ 366 |
|---------|------------------|--------|

RECEPTION DESK TACKBOARDS
9" H



| Model # | For Units: | COM YDG | COM, 1, 2, or 3 | GRADES | | | | | | |
|---------|------------|---------|-----------------|--------|-----|-----|------|------|------|------|
| | | | | 4 | 5 | 6 | 7 | 8 | 9 | 10 |
| TB-6172 | 72"W | 2.25 | \$ 256 | 569 | 715 | 864 | 1075 | 1296 | 1552 | 1849 |
| TB-6166 | 66"W | 2.00 | \$ 232 | 510 | 640 | 772 | 960 | 1156 | 1384 | 1648 |

Must Specify (in this order):

Model #
Fabric Vendor, Pattern, and Color

Description

- Coordinates with Reception Desks
- Factory Installed

[See Jefferson Intro Section for Ordering Options](#)

SURFACE MOUNT HUTCH TACKBOARDS
20 1/2" H

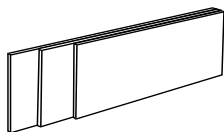

| Model # | For Units: | COM YDG | COM, 1, 2, or 3 | GRADES | | | | | | |
|----------|------------|---------|-----------------|--------|------|------|------|------|------|------|
| | | | | 4 | 5 | 6 | 7 | 8 | 9 | 10 |
| TB-4672H | 72"W | 2.25 | \$ 566 | 879 | 1025 | 1174 | 1385 | 1606 | 1862 | 2159 |
| TB-4666H | 66"W | 2.00 | \$ 533 | 811 | 941 | 1073 | 1261 | 1457 | 1685 | 1949 |

Description

- Coordinates with Standard and Tall Height Surface Mount Hutches
- Factory Installed

Must Specify (in this order):
Model #
Fabric Vendor, Pattern, and Color

VERTICAL HUTCH TACKBOARDS
21 1/2" H

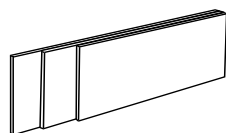

| Model # | For Units: | COM YDG | COM, 1, 2, or 3 | GRADES | | | | | | |
|-----------|------------|---------|-----------------|--------|-----|-----|-----|-----|------|------|
| | | | | 4 | 5 | 6 | 7 | 8 | 9 | 10 |
| TB-4672VH | 72"W | 1.25 | \$ 385 | 559 | 640 | 723 | 840 | 963 | 1105 | 1270 |
| TB-4666VH | 66"W | 1.25 | \$ 377 | 551 | 632 | 715 | 832 | 955 | 1097 | 1262 |

Description

- Coordinates with Vertical Hutches: TB-4672VH is compatible with 46-1572VH4G, 46-1572VH4O, 46-1572VH4W, and 46-1572VH4M; TB-4666VH is compatible with 46-1566VH4G, 46-1566VH4O, 46-1566VH4W, and 46-1566VH4M
- Factory Installed

Must Specify (in this order):
Model #
Fabric Vendor, Pattern, and Color

WALL MOUNT HUTCH TACKBOARDS
21 1/2" H

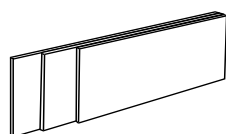

| Model # | For Units: | COM YDG | COM, 1, 2, or 3 | GRADES | | | | | | |
|----------|------------|---------|-----------------|--------|------|------|------|------|------|------|
| | | | | 4 | 5 | 6 | 7 | 8 | 9 | 10 |
| TB-0184W | 84"W | 2.50 | \$ 711 | 1059 | 1221 | 1386 | 1621 | 1866 | 2151 | 2481 |
| TB-0178W | 78"W | 2.50 | \$ 698 | 1046 | 1208 | 1373 | 1608 | 1853 | 2138 | 2468 |
| TB-0172W | 72"W | 2.25 | \$ 642 | 955 | 1101 | 1250 | 1461 | 1682 | 1938 | 2235 |
| TB-0166W | 66"W | 2.00 | \$ 609 | 887 | 1017 | 1149 | 1337 | 1533 | 1761 | 2025 |
| TB-0160W | 60"W | 2.00 | \$ 566 | 844 | 974 | 1106 | 1294 | 1490 | 1718 | 1982 |
| TB-0154W | 54"W | 1.75 | \$ 539 | 782 | 896 | 1012 | 1176 | 1348 | 1547 | 1778 |
| TB-0148W | 48"W | 1.50 | \$ 492 | 701 | 798 | 897 | 1038 | 1185 | 1356 | 1554 |
| TB-0142W | 42"W | 1.25 | \$ 446 | 620 | 701 | 784 | 901 | 1024 | 1166 | 1331 |
| TB-0136W | 36"W | 1.25 | \$ 434 | 608 | 689 | 772 | 889 | 1012 | 1154 | 1319 |

Description

- Coordinates with Wall Mount Hutches
- Factory Installed

Must Specify (in this order):
Model #
Fabric Vendor, Pattern, and Color

VESTA POWER CENTER

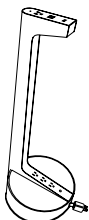

| | | | | | | |
|----------|--------|----|--------|----|-----|---------|
| 01-PDCTR | 10 3/4 | 12 | 28 3/4 | 14 | 2.5 | \$ 1776 |
|----------|--------|----|--------|----|-----|---------|











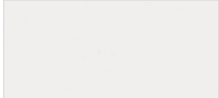

























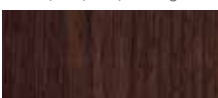
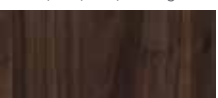

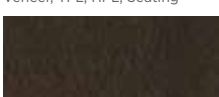
Description

- Top Includes One (1) Power Outlet, Two (2) USB Ports and One (1) USBC Port; Base Includes Three (3) Outlet
- Available in White
- 120" Power Cord
- Built with Weight Distribution for Optimal Stability
- Base is 5" Tall

[See Jefferson Intro Section for Ordering Options](#)

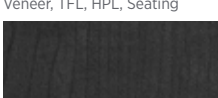
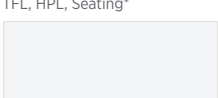
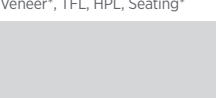
Surface Materials

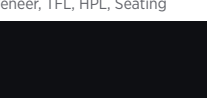
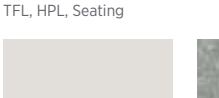
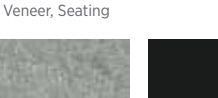
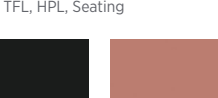
Wood Finishes and Woodgrain, Solid, and 3D Laminates

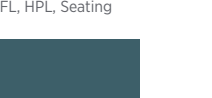
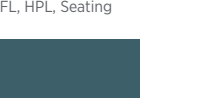
| | | | | | |
|---|---|---|--|---|---|
|  |  |  |  |  |  |
| Aspen White (AWH) SQ1 | White Nebbia (WNB) TFL, HPL, Seating | Beigewood (BW) TFL, HPL, Seating* | Natural Beech (NB) SQ1 | Sugar Maple (SM) Veneer, TFL, HPL, Seating | Oak Riftwood (ORW) Veneer*, TFL, HPL, Seating* |
|  |  |  |  |  |  |
| Kirsche (KHE) TFL, HPL, Seating | Fawn Oak (FO) Veneer*, Seating* | Truffle Rain (TR) SQ1 | River Cherry (RC) TFL, HPL, Seating* | Mesa Sunset (MAS) Veneer*, Seating* | Natural Marrone (NTM) TFL, HPL, Seating* |
|  |  |  |  |  |  |
| Studio Teak (TK) TFL, HPL, Seating | Pinnacle Walnut (PNW) Veneer, TFL, HPL, Seating | Harvest Maple (HVM) TFL, HPL, Seating* | Golden Cherry (GC) Veneer, TFL, HPL, Seating | Legacy Walnut (LW) Veneer, Seating | Artisan Walnut (AW) Veneer, Seating |
|  |  |  |  |  |  |
| Orchard (OR) SQ1 | Shaker Cherry (SKC) Veneer, TFL, HPL, Seating | Select Cherry (SCH) Veneer, TFL, HPL, Seating | Williamsburg Cherry (WC) Veneer, TFL, HPL, Seating | Harvest Walnut (HW) Veneer, Seating | Dark Cherry (DC) Veneer, Seating |
|  |  |  |  |  |  |
| Mahogany Walnut (MW) Veneer, TFL, HPL, Seating | Henna Walnut (HNW) Veneer, Seating | Columbian Walnut (CO) Veneer, TFL, HPL, Seating | Sepia Walnut (SPW) TFL, HPL, Seating* | Florence Walnut (FLW) TFL, HPL, Seating* | Dark Forest Walnut (DFW) Veneer, Seating* |
|  |  |  |  |  |  |
| Ember Gray (EG) SQ1 | Espresso (EW/EF) Veneer, TFL, HPL, Seating | Portico Teak (PTK) TFL, HPL, Seating* | Weathered Ash (WTA) Veneer*, TFL, HPL, Seating* | Smoky Brown Pear (SBP) TFL, HPL, Seating* | Asian Night (AS) Veneer, TFL, HPL, Seating |
|  |  |  |  |  |  |
| Midnight Run (MNR) TFL, HPL, Seating | Metropolis Sky (MTS) Veneer, Seating | Designer White (WH) TFL, HPL, Seating | Fashion Grey (FHG) TFL, HPL | Slate Grey (SG) TFL, HPL | Black (BL) TFL, HPL, Seating |
|  |  |  |  |  |  |
| Matte White (WH3) 3D Laminate (Iconic Only) | Concrete (CR3) 3D Laminate (Iconic Only) | Matte Black (BL3) 3D Laminate (Iconic Only) | Blush (BSH) HPL Accent (Iconic+Plush Only) | First Kiss (FK) HPL Accent (Iconic+Plush Only) | Surfin USA (SUS) HPL Accent (Iconic+Plush Only) |
|  | | | | | |
| Summer Vacation (SV) HPL Accent (Iconic+Plush Only) | | | | | |

* Finish is Low Sheen







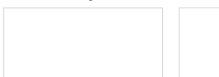

Frosted & High Gloss Acrylics

| | | | | |
|---|---|---|--|---|
|  |  |  |  |  |
| Frosted (FSTA) | White (WHA) | Wired Mercury (WMA) | Graphite (GPA) | Black (BLA) |





Solid Surfaces

| | | | | | |
|---|---|---|--|---|---|
|  |  |  |  |  |  |
| Snow White (SNW) | Pebble Beach (PE) | Sedona (SE) | Arroyo (AR) | Tundra (TN) | Starry Night (SN) |

Metal Options

| | | | | |
|---|---|---|--|---|
|  |  |  |  |  |
| Snow (SNOW) | Oyster White (OYST) | Sugar Cookie (SUGC) | Aluminum (ALUM) | Chrome (CHRM) |
|  |  |  |  | |
| Gold (GOLD) | Platinum (PLAT) | Mist (MIST) | Black (BLK) | |

Glass Options

| | |
|---|---|
|  |  |
| Gloss White (GWHG) (Catalyst + Strut) | Acid Etched White (GWAH) (Catalyst + Strut) |
|  |  |
| Gloss Black (GBLG) (Catalyst + Strut) | Acid Etched Black (GBLA) (Catalyst + Strut) |

Colors represented are high-resolution reproductions and may vary slightly from the actual product. To order samples, please contact our Customer Service team or order online at www.indianafurniture.com. Graining and finish colors may vary, yet will continue to complement, across Veneer, HPL, TFL, and Seating products due to the inherent differences of these materials.

Indiana[®]

FURNITURE

1919 Hospitality Drive, Suite A
PO Box 270
Jasper, Indiana 47547-0270

Tel 812.482.5727

Toll 800.422.5727

Fax 812.482.9035

sales@indianafurniture.com

www.indianafurniture.com

Federal Classification: Small Business

©2024 Indiana Furniture 5/24

