

TABLES + SPACE DIVISION

PRICING EFFECTIVE MAY 13, 2024

Indiana
FURNITURE

Being over a century old hasn't slowed us down! Sure, we are still the reliable, ethical company that was born in southern Indiana, steeped in quality, craftsmanship, and service. But have you seen our latest introductions? We are making a splash with design and challenging the concept of modern offices. Go ahead. Take a look. You know you want to.

Our Pledge to People + Our Planet.

We've been making wood furniture longer than just about anyone...and we want to be doing so for a long time to come. That's a large part of why we take a stewardship approach to our resources. We believe that environmental sustainability and business profits need not be mutually exclusive. They can and should exist side by side in a mutually beneficial relationship. And for more than a century, we've been showing how it's done.

We've proven our commitment to a sustainable future by supporting the standards and programs that protect our home planet and human health. Whether it's local sourcing, reducing contaminants, implementing wellness and safety programs, or diverting waste from landfills, social responsibility is a part of every decision we make at Indiana Furniture.

One of the surest ways to reduce our impact on the planet is to make and buy things that last. And this one's a natural for us. Our products are made with craftsmanship and attention to detail that are a part of our more than a century-long legacy in wood manufacturing. And our products are backed by our 12-year warranty, which facilitates maintenance, servicing and reassembly.

All of our product lines:

- Are manufactured and assembled in the USA,
- Meet or exceed Indoor Air quality standards*,
- Meet or exceed BIFMA level® Sustainability standards and certification*,
- Conform to the BIFMA Compliance standards*,
- Comply with TSCA Title VI (CARB) standards,
- and can contribute to U.S. Green Building's LEED Program.

To learn more, simply go to www.IndianaFurniture.com/resources.



Ease of Specification

Whether you're looking to specify your office spaces or simply to visualize them in the options and surface materials you are desiring, we make it easy. You can find the entire Indiana Furniture portfolio on the following third-party, space-planning platforms.



* Recently launched or new products may still be in testing; Cush Pillows is currently not BIFMA Compliant due to no available compliance test.

<u>General Information + Conditions of Sale</u>	<u>2</u>
<u>Warranty</u>	<u>3</u>
<u>Tables+Storage</u>	<u>5</u>
<u>Arlington (2900 Series)</u>	<u>7</u>
<u>Cameo (9100 Series)</u>	<u>19</u>
<u>Catalyst (8800 Series)</u>	<u>41</u>
<u>Madera (1400/1600 Series)</u>	<u>123</u>
<u>Natta by Pledge (NAT Series)</u>	<u>147</u>
<u>One10 (9600 Series)</u>	<u>149</u>
<u>Phoenix (2100 Series)</u>	<u>179</u>
<u>Strut (8800 Series)</u>	<u>199</u>
<u>Synergy (8200 Series)</u>	<u>263</u>
<u>Tri-One (8500/8600 Series)</u>	<u>275</u>
<u>Occasional Tables</u>	<u>305</u>
<u>General Occasional Tables Information</u>	<u>306</u>
<u>Arlington End, Lamp + Magazine Tables (2900 Series)</u>	<u>307</u>
<u>Bailey End + Cocktail Tables (720 Series)</u>	<u>308</u>
<u>Britta End + Cocktail (230 Series)</u>	<u>313</u>
<u>Canvas End + Magazine Tables (6600 Series)</u>	<u>315</u>
<u>Cicero End, Lamp, Magazine + Console Tables (290 Series)</u>	<u>317</u>
<u>Gesso End + Magazine Tables (6500 Series)</u>	<u>319</u>
<u>Isla End, Lamp + Magazine Tables (370 Series)</u>	<u>321</u>
<u>Jefferson End, Lamp & Magazine Tables (4600 Series)</u>	<u>325</u>
<u>Jot Auxiliary, End, Cocktail + Console Tables (410 Series)</u>	<u>327</u>
<u>Madera End, Lamp + Magazine Tables (1400 Series)</u>	<u>331</u>
<u>Natta Tables by Pledge (NAT Series)</u>	<u>333</u>
<u>Phoenix End + Magazine Tables (2100 Series)</u>	<u>335</u>
<u>Plush Cocktail Tables (620 Series)</u>	<u>337</u>
<u>Spirit Tables by Pledge (S Series)</u>	<u>341</u>
<u>Space Division</u>	<u>343</u>
<u>Screens+Dividers</u>	<u>345</u>
<u>Square One (1700 Series)</u>	<u>355</u>
<u>Synergy (8200 Series)</u>	<u>375</u>

ORDERING INFORMATION

All orders should be emailed to neworders@indianafurniture.com.
Orders can be faxed to 812-482-9035 or mailed to:

Indiana Furniture
P.O. Box 270, 1919 Hospitality Dr., Ste A
Jasper, IN 47547-0270

ORDER PROCEDURE

All orders must include purchase order number, billing address, ship-to address and phone number, and any special instructions.

When ordering casegoods or tables, give complete quantity, model number, finish and any other options.

When ordering seating, give complete quantity, model number, finish, fabric and any other options.

Within each series, an example of "How to Order" is illustrated at the beginning of each series section. For further clarification of order procedure, contact Customer Service.

PRICING

All prices shown are suggested retail prices F.O.B. Point of Origin, freight prepaid and allowed to one continental US destination. Prices, specifications and materials are subject to change without notice. Possession and/or distribution of this price list does not in itself constitute an offer to sell. Orders can be received only from authorized Indiana Furniture dealers. Orders will be billed at prices prevailing at time of shipment, unless acknowledged prior to the effective date of the price change, in which case billing will be at the price acknowledged.

ACKNOWLEDGMENT

All orders will be acknowledged promptly, showing how the order was entered, its approximate shipping date and other pertinent information. This acknowledgment is the final agreement between the customer and Indiana Furniture and is the exclusive statement of the terms thereof. Please examine this acknowledgment carefully and advise Indiana Furniture immediately of any discrepancies.
Note: Shipping fees will not be listed on the acknowledgment.

BUYER'S OBLIGATION: RIGHTS OF SELLER

If Indiana Furniture shall at any time doubt Buyer's financial responsibility, Indiana Furniture may decline to make shipments hereunder except upon receipt of cash payment in advance or security or other proof of responsibility satisfactory to Indiana Furniture. If buyer fails in any way to fulfill the terms and conditions set forth herein, Indiana Furniture may defer shipments until such default is corrected. Remedies provided herein shall be in addition to, and not in lieu of other remedies. Buyer agrees to abide by payment terms as listed on invoice. Buyer shall pay all reasonable costs and expenses, including attorney and collection fees, and late fees, incurred by Seller in connection with any amounts due for goods ordered.

CANCELLATIONS AND CHANGES

Due to immediate production on build-to-order items, all orders are considered firm and are not subject to cancellation or change without approval from Indiana Furniture. All approved changes are subject to additional charges and revised lead times.

PRODUCT DESIGN AND SPECIFICATION CHANGES

Indiana Furniture reserves the right to make changes in design and construction or discontinue products without prior notice.

REPAIR CHARGES

Indiana Furniture will only pay repair charges if Customer Service gives prior written authorization. No repair charge will be paid without advance approval at which time you will be issued a repair authorization number that will allow you to invoice Indiana Furniture for the completed work.

WAREHOUSE STORAGE CHARGES

If a shipment is held beyond 14 calendar days at your request, a **.084% per calendar day** (2.52% per month) storage charge will be assessed. The effective date will be 14 calendar days after the acknowledged ship date. Further, the prices applied to the order will be those in effect at the time of shipment.

DAMAGED MERCHANDISE

The consignee is responsible for filing claims with the carrier for damage and shortages. Claims for both obvious and concealed damage must be filed within 15 calendar days, and the damaged merchandise must not have been moved from the original receiving location. All damaged merchandise, including the cartons and packing materials, must be retained for inspection by either the carrier or by an Indiana Furniture Sales Representative. Indiana Furniture reserves the right to select the most cost effective way to repair or replace the damaged item. Once you have notified the carrier, please contact Customer Service for further assistance.

Obvious Damage/Missing Cartons — Do not refuse merchandise damaged in transit. Indiana Furniture recommends the consignee inspect all merchandise upon arrival. If a shipment is received damaged or short, note all information on carrier's copy and your copy of freight bill and delivery receipt. Notify the delivering carrier and file a claim immediately. Pending the results of your claim, either Indiana Furniture or the carrier will cover 100% of the cost to repair or replace the damaged or missing item.

Concealed Damage — If concealed damage is discovered, notify the delivering carrier at once and request an inspection. This must be done within 15 calendar days of delivery. If the carrier will not perform the inspection, you should prepare an affidavit that you contacted them, noting the time and date, and that they failed to comply with your request. This, along with the other papers in your possession, will support the claim. Pending the results of your claim, the cost to repair or replace the item will be covered 1/3 by the carrier and 2/3 by Indiana Furniture for shipments less than a full truckload and 100% by Indiana Furniture for shipments of full truck loads.

RETURN MERCHANDISE

Merchandise will not be accepted for return without a RGA (Return Goods Authorization) issued by Indiana Furniture. We will consider issuing RGA's for the following reasons:

1. Manufacturing defect (inspected by Indiana Furniture representative)
2. Indiana Furniture order processing error
3. Shipping error
4. Mis-marked cartons
5. Duplicated shipments

If you have any questions as to whether your reason for return qualifies for consideration, please contact your Customer Service Representative. Merchandise must be returned within 60 days of the RGA issued date, or within 60 days upon receipt of replacement product to receive credit. Returns due to mis-marked cartons must also be returned in the original cartoning, with shipping labels intact, to receive credit.

All merchandise being returned must be properly packed and protected to ensure no further damage is incurred during transportation back to an Indiana Furniture facility. Upon receipt, all returned merchandise will be thoroughly inspected and the results compared to the reason for return stated on the RGA. Any discrepancies, such as additional damage, signs of usage, missing parts, etc., will result in an adjustment to the amount of credit issued.

DELIVERY AND FREIGHT CHARGES

All shipments are F.O.B. Point of Origin, Jasper, IN, freight prepaid and allowed dock to dock on 53' trailer. Ownership and responsibility of the merchandise becomes that of the buyer upon delivery to the freight company. Shipments into Alaska, Hawaii, Canada, Mexico, Puerto Rico and other exports are freight prepaid and allowed to port of exit.

Indiana Furniture reserves the right to select the most appropriate carrier and routing on all shipments. Indiana Furniture will attempt to accommodate requests for favored carriers and delivery times. Deliveries requested Monday through Thursday, after 3pm, will be assessed a \$300 per truck after hours fee. Deliveries requested after 3pm on Friday or on weekends, will be assessed a \$600 per truck weekend delivery fee.

Inside delivery and installation services are not included in the pricing shown. Any deviation from dock-to-dock delivery, such as but not limited to, non-dock, residential, or inside delivery must be specified on the order. Should these services be requested or required, all charges incurred will be charged to the "Sold To" of the order.

Shipments totaling less than \$3000 (net value, product only) will be assessed a small order fee of \$300 net per shipment. This fee will be reduced for items shipped via small package carriers. For order shipments of \$100 or less, shipped by small package carrier, the fee is \$18. For order shipments over \$100, shipped by small package carrier, the fee is \$40. All shipping fees will be added at the time of invoicing.

BIFMA AND ANSI TESTING

Indiana Furniture is a member of the Business and Institutional Furniture Manufacturer's Association (BIFMA). Tests developed by the BIFMA and approved by the American National Standards Institute (ANSI) determine the strength and durability of casegoods and seating in its everyday use. Although this testing does not serve as a warranty or guarantee, Indiana Furniture products within this price list have been tested by an independent verifying body and meet or exceed applicable BIFMA and ANSI standards.

Subject to the limitations set forth in this warranty, Indiana Furniture Industries, Inc. (“**Indiana Furniture**”) warrants to the original purchaser all product in this price list (“**Product**”) to be free from defects in material and workmanship given normal use for a 12-year period from the date of manufacture. During the applicable warranty period, Indiana Furniture, as its sole obligation, will repair or replace (in Indiana Furniture’s sole discretion) any Product, part, or component covered by this warranty and sold after May 13, 2024, which fails under normal use as a result of a defect in material or workmanship. Normal use is defined as the equivalent of a single shift, 40-hour work week. Indiana Furniture will repair or replace the defective Product, part, or component with a comparable Product, part, or component.

Warranty periods are limited for certain Products and parts as follows:

12-year Warranty (from the date of manufacture)

- Seating Mechanisms
- Veneers
- Laminates
- Casters and Glides

5-year Warranty (from the date of manufacture)

- Triple Play Series
- Electrical Components
- Pneumatic Cylinders
- Textiles, Foam, and Decorative Trim
- Swivel Arm Pads
- Keyboard Kits
- Lighting
- All Height Adjustable Mechanisms

3-year Warranty (from date of shipment)

- Dock 950 Wireless Charger
- Dock 150 Wireless and USB Charger

THIS WARRANTY DOES NOT COVER:

- Damage caused by a carrier or third party
- Normal or routine wear and tear
- Appearance, durability, quality, behavior, colorfastness, or any other attribute of customer’s own materials or any non-standard Indiana Furniture material (including CF Stinson, Maharam, Momentum, Mayer, UltraFabrics, Architex, and other alliance programs) specified by the customer and applied to a Product
- Color, grain or texture of wood, laminate and other covering materials
- Changes in wood or fabric color due to aging or exposure to light

As the manufacturer of the Product, Indiana Furniture stands behind its craftsmanship and pledges to do everything it can to reasonably resolve, as quickly as possible, any problems you may have with the Product within the terms and conditions of this warranty.

If you encounter a defect covered by the foregoing warranty, contact the dealer from whom you purchased the Product. If the dealer is unable to resolve your warranty issues, you should contact Indiana Furniture. Please ensure that you have all of the pertinent facts when contacting the dealer or Indiana Furniture, including the model number and factory order number from the inspection label attached to the Product.

INDIANA FURNITURE IS NOT PROVIDING, AND SPECIFICALLY DISCLAIMS, ANY OTHER WARRANTIES FOR THE PRODUCTS, EXPRESS OR IMPLIED, INCLUDING ANY IMPLIED WARRANTY OF MERCHANTABILITY OR FITNESS FOR A PARTICULAR PURPOSE. INDIANA FURNITURE SHALL NOT BE LIABLE TO THE PURCHASER OR ANY THIRD PARTY FOR CONSEQUENTIAL, INCIDENTAL, INDIRECT, OR SPECIAL DAMAGES, INCLUDING, WITHOUT LIMITATION, DAMAGES ARISING OUT OF OR RESULTING IN ANY MALFUNCTIONS, DELAYS, LOSS OF PROFIT, INTERRUPTION OF BUSINESS, PERSONAL INJURY, BODILY INJURY, DEATH, DISMEMBERMENT, OR PROPERTY DAMAGE.

Indiana Furniture Industries, Inc.
Attn: Customer Service
1919 Hospitality Dr., Ste A
P.O. Box 270
Jasper, Indiana 47547-0270
800.422.5727
Fax 812.482.9035
custserv@indianafurniture.com



Tables+Storage

Arlington offers all the grace and embellishments associated with traditional styling with an added emphasis on value. Finely crafted in select solids with walnut and cherry veneers and high pressure laminate worksurfaces, Arlington ensures quality and expert craftsmanship with a selection of configurations for today's functional workspaces.

CONSTRUCTION

Arlington features a Veneer chassis with your choice of a Veneer or HPL top. Units ship assembled unless otherwise noted.

VENEER

- Exposed surfaces feature select grade, plain sliced American Black Walnut or Cherry veneers, carefully selected and matched to assure proper balance and consistency

TOPS

- Veneer tops are 5-ply balanced construction and 1 3/16" thick with solid hardwood rims with butt corners
- High Pressure Laminate (HPL) tops are 3-ply balanced construction and 1 3/16" thick with solid hardwood rims with butt corners
- Grain direction runs left to right unless noted

CHASSIS

- Chassis is securely fastened using high quality European fastening systems and heavy-duty, 16-gauge joining brackets to assure maximum strength
- All units ship with heavy-duty, adjustable leveling glides to ensure proper leveling and compensation for uneven floors
- Bases are solid hardwood with mitered corners
- Construction offers tight tolerances and long term durability
- Vertical grain direction on chassis

DRAWERS

- Drawer fronts standard with matched veneer faces
- Drawer sides, back and front are woodgrain vinyl-wrapped, and are 1/2" thick
- 5-sided drawer construction for easy removal of drawer front
- Box and file drawers have 1/8" thick hardboard bottoms and tested for 100lb capacity
- Lateral file drawers feature 1/4" thick bottoms and tested for 200lb capacity
- All drawers feature full extension, progressive action slides with precision steel ball bearings
- All suspensions have a limited lifetime warranty

FILING

- All file drawers are standard with filing systems designed to accommodate a variety of filing requirements
- Letter width file drawers provide letter filing front to back and legal filing side to side
- Lateral file drawers provide legal or letter filing front to back or side to side

STORAGE

- All hinged doors include soft close hinges, unless noted
- One piece hinge and base plate combination
- Soft close hinges reduce stress placed on the cabinet when the door is closed and offers a quiet closure

LOCKING

- See [locking details](#) for locking door and drawer options
- Lock core available in black or silver and will coordinate with pull selection; See [locking details](#)
- Removable lock cylinders allow for units to be re-keyed at a later date if required
- Units are shipped randomly keyed as standard. Keyed alike units available upon request at no additional charge.

CORD MANAGEMENT

- Grommets are available in black or silver, please specify color
- See [optional grommet locations](#)
- Undersurface Wire Managers available for additional cord management; See [Accessories](#)

INTERIOR DRAWER DIMENSIONS & FILING CAPABILITIES

Model

29-2072SC 29-2066SC

Drawers

	W	L	D
Box	15 3/8"	16 1/2"	3 1/2"
File	15 3/8"	16 1/2"	8 29/32"

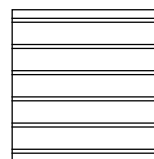

Legal Front to Back

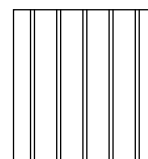

Legal Side to Side

Model

29-2072DL

Drawers

	W	L	D
Lateral File	24 7/8"	16 1/2"	9 7/32"

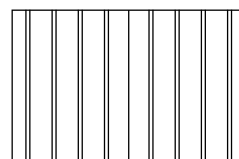

1 Row Letter or Legal Side to Side

HOW TO ORDER EXAMPLES

	QTY	Model No.	Description	Example
TOP/BASE	1	29-4296RT	Top Material	W
			Finish	CO
			Grommet/Power/ Data Location	OC
			Finish	CO
BASES	1	29-2828TB	Finish	CO
PORT	1	01-INTRFCIA		
CREDENZA	1	29-2072SC	Top Material	W
			Finish	CO
			Base Molding	BM3600
			Decorative Molding	M3600
			Pull	ARA
			Locking	LKT-HU
			Drawer Construction	STD

VENEER (W) OPTIONS

Veneer features UVAdvantage, an ultra-violet finish, on all exposed surfaces by utilizing roll-coat UV technology.

Note: Base and decorative molding feature multi-step, hand-finished catalyzed finish.

AW	Artisan Walnut	HW	Harvest Walnut
CO	Columbian Walnut	LW	Legacy Walnut
DC	Dark Cherry	MW	Mahogany Walnut
DFW	Dark Forest Walnut	PNW	Pinnacle Walnut
EW	Espresso	SCH	Select Cherry
GC	Golden Cherry	SKC	Shaker Cherry
HNW	Henna Walnut	WC	Williamsburg Cherry

HPL (P) TOP OPTIONS

WOODGRAIN

CO	Columbian Walnut	PNW	Pinnacle Walnut
EF	Espresso	SCH	Select Cherry
GC	Golden Cherry	SKC	Shaker Cherry
MW	Mahogany Walnut	WC	Williamsburg Cherry

EDGE PROFILES

R Arlington



MOLDING LOCATIONS AND OPTIONS

Base Molding

Arlington and Wilmington Base Molding are skillfully applied on Credenzas to front and both sides with no molding on back for flush wall applications.



Arlington Base Molding



Wilmington Base Molding

Decorative Molding

Optional Decorative Molding is available with the Wilmington Base Molding package. Credenzas will feature decorative molding on the left and right sides only.



Wilmington Decorative Molding



No Decorative Molding

Molding selection must be specified on order.

Arlington Molding

BM2900 Arlington Base Molding \$ N/C

Wilmington Molding

BM3600 Wilmington Base Molding \$ N/C

M3600 Optional Wilmington Decorative Molding \$ 139

Note: Base and Decorative Molding features multi-step, hand-finished catalyzed finish

DRAWER AND DOOR PULL OPTIONS

Units with doors and drawers will feature coordinating pulls however door and drawer pulls cannot be intermixed.

ARA	Arlington A, Antique Brass	JEF	Jefferson, Antique Brass
ARB	Arlington B, Antique Brass	ALB	Liberty, Aluminum
WLM	Wilmington, Antique Brass		



Arlington A (ARA)
Antique Brass - 5/4"



Arlington B (ARB)
Antique Brass - 5/4"



Jefferson (JEF)
Antique Brass - 5/4"



Wilmington (WLM)
Antique Brass - 5/4"



Liberty (ALB)
Aluminum - 4/4"

LOCK CORE OPTIONS

Lock core will be black if Arlington, Wilmington or Jefferson pulls are selected. Lock core will be silver if Liberty Pulls are selected.

BLK	Black
SLV	Silver



Black (BLK)

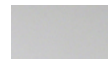

Silver (SLV)

CREDENZA LOCKING DOORS AND DRAWERS

Locking doors and drawers are available on credenzas. Please specify applicable code on order with model/unit and add upcharge.

Storage credenzas offer locking pedestals and locking doors with the lock positioned in the face of the drawer nearest to doors. Door lock is positioned in top right corner of left door.

LKT_P	Double Pedestal Lock	\$ 410
LKT_HU	Double Pedestal and Double Door Locking	\$ 492

LOCKING DOORS

Locking doors are available on specific units, where noted. You must specify WITH LOCKING when ordering and add upcharge.

LKT_HU	36"W to 28"W Units	\$ 91
LKT_HU	18"W Units	\$ 69

DRAWER OPTIONS

Units with drawers come standard with woodgrain vinyl-wrapped drawers with mitered corners. Optional wood dove tail construction for all box, file, and lateral file drawers is available. Must specify when ordering.

Pricing is per Drawer, not per Model/Unit.

MITER	Mitered Fold Construction	STD
DOVE	Wood Dove Tail Construction	\$ 45

CONFERENCE AND MEETING TABLE GROMMET OPTIONS

Arlington Meeting and Conference Tables offer Power/Data and grommets at a variety of locations. Available Power/Data and Grommets may be found on Pages 21 to 23

Must Specify Black (BLK) or Silver (SLV)

Grommet Locations

OC	On Center	CL	5½" Left of Center
EL	24½" from Left End	CR	5½" Right of Center
ER	24½" from Right End	BB	Centered Between Bases

Panel Base Location Availability by Top Size

96"W Tops	OC, EL+ER	
120"W Tops	BB, CL, CR, CL+EL+ER, CR+EL+ER	
144"W Tops	BB, CL, CR, CL+CR, EL+ER, CL+EL+ER, CR+EL+ER	

Power and Grommet Units only available **On Center (OC)** when Queen Anne Bases are selected.



Arlington Work Tables offer grommets at left/right and on center locations.

Must Specify Black (BLK) or Silver (SLV) Grommets

		Per Grommet
Locations Availability by Model		\$ 52
29-3672WT	GL/GR: Grommet Left and Right; 12" from end and 23" from user (Requires 2 grommets)	
	GC: Grommet Center; 23" from user	
29-3060WT	GL/GR: Grommet Left and Right; 9" from end and 23" from user (Requires 2 grommets)	
	GC: Grommet Center; 9" from user	

CERTIFICATIONS & COMPLIANCE

- Intertek Sustainability Certified
- BIFMA level® Certified
- BIFMA Compliant® Certified
- TSCA Title VI (formerly CARB) Compliance
- US Green Building's LEED® Contribution

Tops and Tables



Round Tops
[\(See Details\)](#)



1-Piece Rectangle Tops
[\(See Details\)](#)



2-Piece Rectangle Tops
[\(See Details\)](#)

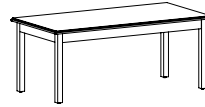

Work Tables
[\(See Details\)](#)

Bases

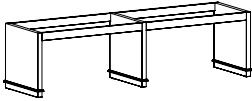

Rectangle Bases
1-Pc Top [\(See Details\)](#)
2-Pc Top [\(See Details\)](#)

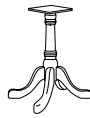

Queen Anne Bases
Round Tops [\(See Details\)](#)
1-Pc Top [\(See Details\)](#)
2-Pc Top [\(See Details\)](#)

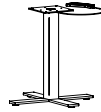

Height Adjustable Pneumatic
X-Bases [\(See Details\)](#)

Storage Components

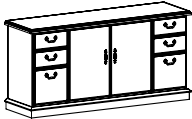

Storage Credenza
[\(See Details\)](#)

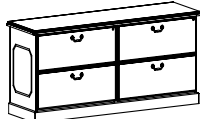

Credenza with Double Lateral
[\(See Details\)](#)



Door Bookcases
[\(See Details\)](#)



Wardrobe/Storage
[\(See Details\)](#)

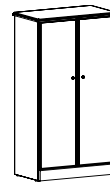

Double Wardrobe/Storage
[\(See Details\)](#)

Wire Management & Power/Data Accessories

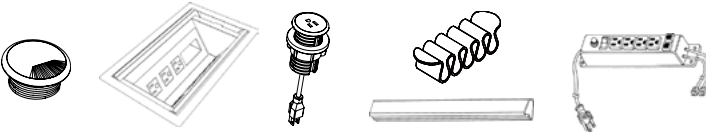

For additional solutions for desking, storage, and accessories, see the [Arlington Casegoods](#) and [Accessories](#) Price Lists.

Item	Model No.	Width	Depth	Height	Ship Wt	Cubic Ft	List Price
	29-4848CT <i>Accommodates Five (5) Chairs</i>	48	48	30	58	5.9	P\$ 2625 W\$ 3083
	29-4242CT <i>Accommodates Four (4) Chairs</i>	42	42	30	51	4.5	P\$ 1829 W\$ 2247
	29-3636CT <i>Accommodates Three (3) Chairs</i>	36	36	30	50	3.3	P\$ 1590 W\$ 1959

Top Must Specify (in this order):

- Model #
- Top Material
- Finish/Color

Base Must Specify (in this order):

- Model #
- Finish/Color

Description

- Available with Veneer (W) or HPL (P) Top, Must Specify
- See Below for Queen Anne Base and Height Adjustable Pneumatic X-Base; Order Separately
- Power Options not Available

Base Options: Must Order Separately

Queen Anne Base

01-0606QB	Optional Queen Anne Base (1 Required)	54	22.4	\$ 1406
-----------	---------------------------------------	----	------	---------



Description

- Queen Anne Base Features Multi-Step, Hand-Finished Catalyzed Finish
- Four Legs with Adjustable Glides

Height Adjustable Pneumatic X-Bases

Maximum Round 42", Maximum Square 36"

01-3232HAXBB	Black	32	32	26-45¾	1	0.2	\$ 1721
01-3232HAXBA	Aluminum						



Maximum Round 36", Maximum Square 30"

01-2626HAXBB	Black	22	22	26-45¾	1	0.2	\$ 1687
01-2626HAXBA	Aluminum						

Description

- Pre-Drilled Boring Pattern May Not Match Underside of Table Top
- Steel Mounting Plate: 8" x 8" x ¼"
- Eight (8) Bolts Included for Assembly
- Some Assembly Required

Item	Model No.	Width	Depth	Height	Ship Wt	Cubic Ft	List Price
	29-4296RT <i>Accommodates Eight (8) Chairs</i>	96	42	30	140	12.5	P\$ 3724 W\$ 4387
	29-3672RT <i>Accommodates Six (6) Chairs</i>	72	36	30	91	6.6	P\$ 3085 W\$ 3596

Must Specify (in this order):

- Model #
- Top Material
- Finish/Color
- Grommet/Power/Data Location
- Base Model #
- Base Finish

Description

- One (1) Piece Top
- Available with Veneer (W) or HPL (P) Top, Must Specify
- Top and Bases Shipped Separately
- Bases Must Specified. Top Price Includes Standard Two (2) Rectangle Bases with Two (2) Stretchers, Optional Queen Anne Bases Available (See Below)
- Queen Anne Base Features Multi-Step, Hand-Finished Catalyzed Finish
- Optional Power/Data/Grommets are Available ([See Details](#)), Must Order Separately

Base Options: Must Specify and Add

29-2828TB	Rectangular Bases (Includes Two (2) Bases and Two (2) Stretchers)	104	7.0	Included
01-0606QB	Queen Anne Base Upgrade (Includes Two (2) Bases)	54	22.4	\$ 943

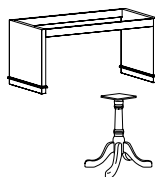

P = HPL W = Veneer

[See Arlington Overview For Ordering Options](#)

Item	Model No.	Width	Depth	Height	Ship Wt	Cubic Ft	List Price
	29-48144RT <i>Accommodates Twelve (12) Chairs</i>	144	48	30	315	22.0	P\$ 7711 W\$ 8820
	29-48120RT <i>Accommodates Ten (10) Chairs</i>	120	48	30	198	22.0	P\$ 4696 W\$ 5584

Must Specify (in this order):

- Model #
- Top Material
- Finish/Color
- Grommet/Power/Data Location
- Base Model #
- Base Finish

Description

- Two (2) Piece Top
- Available with Veneer (W) or HPL (P) Top, Must Specify
- Top and Bases Shipped Separately
- Bases Must Specified. Top Price Includes Standard Two (2) Rectangle Bases with Two (2) Stretchers, Optional Queen Anne Bases Available (See Below)
- Queen Anne Base Features Multi-Step, Hand-Finished Catalyzed Finish
- Optional Power/Data/Grommets are Available ([See Details](#)), Must Order Separately

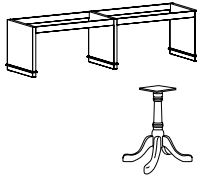

Base Options: Must Specify and Add

29-2828TB	Rectangular Bases (Includes Three (3) Bases and Four (4) Stretchers)	104	7.0	Included
01-0606QB	Queen Anne Base Upgrade (Includes Three (3) Bases)	80	33.6	\$ 1414

Item	Model No.	Width	Depth	Height	Ship Wt	Cubic Ft	List Price
	29-3672WT <i>64" Kneespace</i>	72	36	30	125	11.4	P\$ 2235 W\$ 2636
	29-3060WT <i>52" Kneespace</i>	60	30	30	89	8.0	P\$ 1839 W\$ 2151

Must Specify (in this order):

- Model #
- Top Material
- Finish/Color
- Grommet Location/Color

Description

- Available with Veneer (W) or HPL (P) Top, Must Specify
- Left to Right Grain Direction on Worksurface
- Optional Factory-Installed, Worksurface Grommets Available; See Locations Below, Must Specify Grommet Color: Black (BLK) or Silver (SLV)
- Some Assembly Required
- Optional Wire Management ([See Units](#)), Power/Data/Grommets are Available ([See Details](#)), Must Order Separately

P = HPL W = Veneer

[See Arlington Overview For Ordering Options](#)

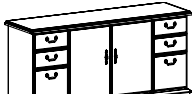
Item	Model No.	Width	Depth	Height	Ship Wt	Cubic Ft	List Price
	29-2072SC	72	20	30	237	30.5	P\$ 4245 W\$ 4607
	29-2066SC	66	20	30	217	30.5	P\$ 3687 W\$ 4032

Shown with Jefferson Drawer and Door Pulls (JEF)

Must Specify (in this order):

Model #
Top Material
Finish/Color
Base Molding
Decorative Molding
Pull
Locking
Drawer Construction

Description

- Standard With: Letter Width Box/Box/File in Pedestals, Left to Right Grain Direction on Worksurface
- Available with Veneer (W) or HPL (P) Top, Must Specify
- Top Profiled on only Three (3) Sides for Flush Wall Application
- Door Pull will Coordinate with Drawer Pull, [See Pull Options](#)
- Base Molding on Sides and User Side, Must Specify: Arlington or Wilmington (See Below)
- Standard with No Decorative Molding; Optional Wilmington Decorative Molding; Must Specify (See Below and [Molding Details](#))
- Optional Locking Pedestals (LKT-P) or Locking Pedestals and Doors (LKT-HU), ([See Details](#))
- Additional Options: Wood Dove Tail Drawers ([See Details](#))

Molding Options: Must Specify and Add

Arlington Molding Options

BM2900	Arlington Base Molding	N/C
--------	------------------------	-----

Wilmington Molding Options

BM3600	Wilmington Base Molding	N/C
M3600	Optional Wilmington Decorative Molding	\$ 139

Note: Wilmington Decorative Molding may only be used with Wilmington Base Molding

CREDENZA WITH DOUBLE LATERAL FILE 	29-2072DL	72	20	30	270	30.5	P\$ 4880 W\$ 5242
---	-----------	----	----	----	-----	------	--------------------------------------

Shown with Jefferson Drawer and Door Pulls (JEF) and Optional Wilmington Decorative Molding

Must Specify (in this order):

Model #
Top Material
Finish/Color
Base Molding
Decorative Molding
Pull
Drawer Construction

Description

- Standard With: Four Locking Lateral File Drawers, Left to Right Grain Direction on Worksurface
- Available with Veneer (W) or HPL (P) Top, Must Specify
- Top Profiled on only Three (3) Sides for Flush Wall Application
- Base Molding on Sides and User Side, Must Specify: Arlington or Wilmington (See Below)
- Standard with No Decorative Molding; Optional Wilmington Decorative Molding; Must Specify (See Below and [Molding Details](#))
- Additional Options: Wood Dove Tail Drawers ([See Details](#))

Molding Options: Must Specify and Add

Arlington Molding Options

BM2900	Arlington Base Molding	N/C
--------	------------------------	-----

Wilmington Molding Options

BM3600	Wilmington Base Molding	N/C
M3600	Optional Wilmington Decorative Molding	\$ 139

Note: Wilmington Decorative Molding may only be used with Wilmington Base Molding

P = HPL W = Veneer

[See Arlington Overview For Ordering Options](#)

Item	Model No.	Width	Depth	Height	Ship Wt	Cubic Ft	List Price
DOOR BOOKCASE	29-2870DB	28	15	70 $\frac{1}{8}$	78	17.8	\$ 2592

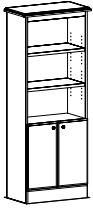

Shown with Arlington (ARB) Door Pull

Description

- Open Bookcase with Two (2) 1" Thick Adjustable Shelves
- Storage Behind Doors; One (1) Adjustable Shelf
- Top Profiled on only Three (3) Sides for Flush Wall Application
- Vertical Woodgrain
- Optional Locking Doors, [See Locking Options](#)

Must Specify (in this order):

- Model #
- Finish
- Pull
- Locking

WARDROBE/STORAGE CABINET	Hinged Left	Hinged Right	Width	Depth	Height	Ship Wt	Cubic Ft	List Price
	Model No.	Model No.						
	29-1870WL	29-1870WR	18	20	70 $\frac{1}{8}$	153	19.2	\$ 3053

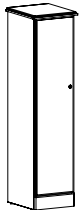

Shown as Left

Description

- Coat Rod Under Top Fixed Shelf and Three (3) Adjustable Shelves
- Adjustable Shelves can be Removed for Wardrobe Application
- Top Profiled on only Three (3) Sides for Flush Wall Application
- Must Specify Door Pull: Arlington B (ARB), Jefferson (JEF), and Liberty (ALB)
- Vertical Woodgrain
- Optional Locking Door, [See Locking Options](#)

Must Specify (in this order):

- Model #
- Finish
- Pull
- Locking

DOUBLE WARDROBE/STORAGE CABINET	29-3670WD	36	20	70 $\frac{1}{8}$	310	34.2	\$ 5391
---------------------------------	-----------	----	----	------------------	-----	------	---------

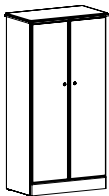

Description

- Three (3) Adjustable Shelves on Both Sides; Coat Rod Under Top Fixed Shelf on Right
- Recommended Against Wall
- Top Profiled on only Three (3) Sides for Flush Wall Application
- Must Specify Door Pull: Arlington B (ARB), Jefferson (JEF), and Liberty (ALB)
- Vertical Woodgrain
- Optional Locking Door, [See Locking Options](#)

Must Specify (in this order):

- Model #
- Finish
- Pull
- Locking

ROUND GROMMET COVER	01-GRMTBK	Black	2 $\frac{3}{8}$	2 $\frac{3}{8}$	-	1	0.1	\$ 11
	01-GRMTSL	Silver						



OPEN MARKET ONLY (SILVER)

Description

- 2 $\frac{3}{8}$ " (60mm) Round Grommet Cover
- Field Installed

[See Arlington Overview For Ordering Options](#)

Item	Model No.		Width	Depth	Height	Ship Wt	Cubic Ft	List Price
SINGLE POWER SAND DOLLAR	01-SAND60PS	Silver	3	3	4	1	0.2	\$ 98
	01-SAND60PW	White						
	01-SAND60PB	Black						

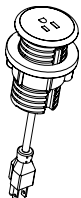

Description

- Mounts in 2 $\frac{3}{8}$ " (60mm) Round Grommet
- Single Power Outlet with 6' Cord

DOUBLE USB SAND DOLLAR	01-SAND60US	Silver	3	3	4	1	0.2	\$ 277
	01-SAND60UW	White						
	01-SAND60UB	Black						

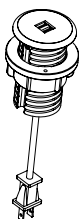

Description

- Mounts in 2 $\frac{3}{8}$ " (60mm) Round Grommet
- Dual USB Outlets with 6' Cord

INTERACT POWER & DATA	01-INTERACTG2A	Aluminum	9	5 $\frac{3}{8}$	2 $\frac{3}{4}$	5	0.2	\$ 891
	01-INTERACTG2B	Black						

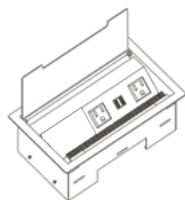

Description

- Includes: Two (2) Power Outlets, Two (2) USB-A Charging Ports, One (1) Telecom Plate Opening; Two (2) Keystone Openings for Voice/Data Jacks
- One (1) Telecom Plates Included with the Unit: One (1) 01-ABLAB Plate (Consists of One (1) RJ45 Cat 6, One (1) RJ11 Cat 3 Phone Jack)
- Convenience Plug on Bottom
- 6' Power Cord
- UL and CSA Recognized
- Additional Telecom Plates, [See Telecom Plate Options](#)

OASIS MINI POWER & DATA	01-OASISMA	Aluminum	14 $\frac{1}{4}$	6 $\frac{3}{8}$	2 $\frac{7}{8}$	11	0.3	\$ 3191
	01-OASISMB	Black						

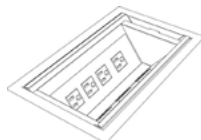

Top View

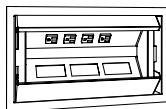

Description

- For Use with Conference Tables
- Plate Includes: Two (2) Data and Four (4) Power Outlets, 9' Power Cord
- Two (2) Telecom Plates Included with the Unit: One (1) 01-ABLAB Plate (Consists of One (1) RJ45 Cat 6, One (1) RJ11 Cat 3 Phone Jack); One (1) 01-ABLB Plate (Consists of One (1) RJ45 Cat 6)
- Soft Touch Hinged Lid
- UL Listed
- Additional Telecom Plates, [See Telecom Plate Options](#)

[See Arlington Overview For Ordering Options](#)

Item	Model No.		Width	Depth	Height	Ship Wt	Cubic Ft	List Price
WORKSURFACE POWER CENTER	01-INTRFCIA	Aluminum	14¼	6½	2⅞	11	0.3	\$ 2064
	01-INTRFCIB	Black						

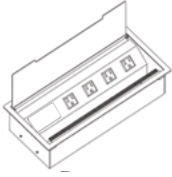

Description

- For Use with Conference Tables
- Four (4) Power Outlets, Three (3) Telecom Plate Openings
- Two (2) Telecom Plates Included with the Unit: One (1) 01-ABLAB Plate (Consists of One (1) RJ45 Cat 6, One (1) RJ11 Cat 3 Phone Jack); One (1) 01-ABLBB Plate (Consists of Two (2) RJ45 Cat 6)
- 6' Power Cord
- Convenience Plug on Bottom
- UL Listed/CSA Certified
- Additional Telecom Plates, [See Telecom Plate Options](#)

DUO CLAMP WITH NEMA PLUG	01-DUOCLAMPS	Silver	5½	3	7	1	0.2	\$ 572
	01-DUOCLAMPW	White						
	01-DUOCLAMPB	Black						

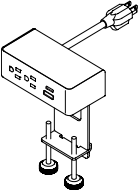

Description

- Standard with: Two (2) Power Outlet, Two (2) USB Ports, 10' Cord
- Clamps to Top and Features Silver Metal Trim
- Independent USB Circuit Controllers Deliver up to 2.1 Amps to Each Post
- All Mounting Hardware Included
- FCC Part 15A and UL Approved for Horizontal and Vertical Applications

WIRE MANAGEMENT CHANNEL	01-WMGR4		16	1½	¾	1	-	\$ 116
-------------------------	----------	--	----	----	---	---	---	--------

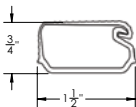

Description

- Set of Four (4) Black Plastic Wire Management Channels
- Snap Lock Channel
- Attaches with Adhesive Strips
- Ships via UPS Only

CABLE GRIP	01-WMGRCB		5¾	2¾	-	-	-	\$ 17
------------	-----------	--	----	----	---	---	---	-------

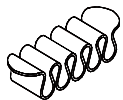

Description

- Under Surface Wire Management
- Black

[See Arlington Overview For Ordering Options](#)

Item	Model No.	Description	List Price
ECA TELECOM PLATES	01-ABL	Telecom Plate, Blank Plate	\$ 41
	01-ABL737373	Telecom Plate, Three (3) RJ45 Cat 5e	\$ 367
	01-ABLAB	Telecom Plate, One (1) RJ45 Cat 6, One (1) RJ11 Cat 3 Phone	\$ 206
	01-ABLAB102	Telecom Plate, One (1) RJ45 Cat 6, One (1) RJ11 Cat 3, One (1) USB W/72" Patch Cord	\$ 320
	01-ABLABB	Telecom Plate, Two (2) RJ45 Cat 6, One (1) RJ11 Cat 3 Phone	\$ 320
	01-ABLB	Telecom Plate, One (1) RJ45 Cat 6	\$ 149
	01-ABLBB	Telecom Plate, Two (2) RJ45 Cat 6	\$ 260
	01-ABLBBB	Telecom Plate, Three (3) RJ45 Cat 6	\$ 367
	01-ABLBBBB	Telecom Plate, (4) RJ45 Cat 6	\$ 476
	01-ABLBBC51	Telecom Plate, Two (2) RJ45 Cat 6, One (1) 15 Pin HD VGA w/72" Patch Cord	\$ 446
	01-ABLBC51L	Telecom Plate, One (1) RJ45 Cat 6, One (1) Mini Stereo Inline, One (1) 15 Pin HD VGA w/72" Patch Cord	\$ 410
	01-ABL3811	Telecom Plate, One (1) RJ45 Cat 6 Data Inline, One (1) RJ11 Cat 3 Phone Inline	\$ 197
	01-ABLC45	Telecom Plate, One (1) HDMI w/36" Patch Cord	\$ 295
	01-ABLC45C51L	Telecom Plate, One (1) Mini Stereo Inline, One (1) HDMI w/36" Patch Cord, One (1) 15 Pin HD VGA w/72" Patch Cord	\$ 558
	01-ABLC51L	Telecom Plate, One (1) 15 Pin HD VGA & One (1) Mini Stereo Inline Jack	\$ 298
	01-ABLCRDM	Telecom Plate, Three (3) Cord Bushings	\$ 96

Compatible with:



Interact Power & Data
01-INTERACTG2A, 01-INTERACTG2B



Power Center
01-INTRFCIA, 01-INTRFCIB

Traditional components echo history and create timeless foundations for meeting rooms that complement our Jefferson and Arlington casegoods collections, and Cameo and Jefferson Reception options. Facilitate presentations with lecterns and visual presentation boards. Mobile serving carts and buffet height credenzas provide additional in-room utility.

CONSTRUCTION

Cameo Tables and Components feature your choice of either a Veneer or HPL top, Veneer bases, and Veneer chassis (where applicable).

VENEERS

- Exposed surfaces are select grade sliced American Black Walnut and **Cherry** veneers carefully selected and matched to assure proper balance and consistency

LAMINATES

- Exposed surfaces are produced from wood grained laminates fused to a particle-board core
- Each laminate offers lasting beauty, superior resistance to normal wear, and easy maintenance

TOPS

- Wood Veneer tops are 5-ply balanced construction and High Pressure Laminate (HPL) tops are 3-ply balanced construction
- Tops are 1 $\frac{3}{16}$ " thick with solid hardwood rims
- All buffets, credenzas, serving carts, video cabinets, and storage/wardrobe cabinets are shaped on user side only
- Grain direction runs left to right unless otherwise noted
- All Veneer tops, as well as Laminate tops up to 144" (12 feet), will have matching woodgrain. Laminate tops sized 156" (13 feet) and longer will have non-matching woodgrain**

CHASSIS

- Tops and end panels are securely fastened using high quality European fastening systems to ensure maximum strength
- All units are equipped with heavy-duty, adjustable glides to ensure proper leveling and compensation for uneven floors

DRAWERS

- All drawer fronts are standard with elegant vertically matched walnut veneer faces
- Drawers feature 5-sided construction with $\frac{3}{4}$ " 3-ply fronts, $\frac{7}{16}$ " thick hardwood sides and $\frac{5}{32}$ " hardboard bottoms
- Units with 36" wide file drawers feature $\frac{1}{4}$ " thick drawer bottoms for maximum storage strength
- Drawer interiors are sanded, sealed, and finished to provide for a smooth, quality feel and appearance
- All drawers feature full extension, progressive action slides with precision steel ball bearings
- Box and file drawers are tested for 100lb capacity
- Lateral files are tested for 200lb capacity
- All suspensions have a limited lifetime warranty

STORAGE

- All hinged doors include soft close hinges, unless otherwise noted
- One piece hinge and base plate combination
- Soft close hinges reduce stress placed on the cabinet when the door is closed and offers a quiet closure

LOCKING

- All units with file drawers feature locking
- Removable lock cylinders allow for units to be re-keyed at a later date if required
- Units are shipped randomly keyed as standard. Keyed alike units available upon request at no additional charge.
- Keyed alike units available upon request at no additional charge
- Lock cores match pull color

INTERIOR DRAWER DIMENSIONS & FILING CAPABILITIES

Models

91-2472BFD 91-2436SV

Drawers

Box **W** **L** **D**
14 $\frac{17}{32}$ " 19 $\frac{1}{4}$ " 3 $\frac{21}{32}$ "

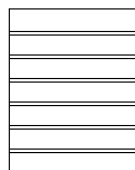

Legal Front to Back

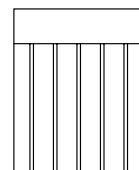

Legal Side to Side

Models

91-2436BF 91-2472BF

Drawers

Box **W** **L** **D**
32 $\frac{9}{16}$ " 19 $\frac{1}{4}$ " 3 $\frac{21}{32}$ "

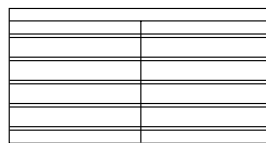

2 Rows Letter or Legal Front to Back

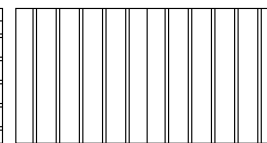

1 Row Letter or Legal Side to Side

Models

91-2472SBF

Drawers

Box **W** **L** **D**
14 $\frac{17}{32}$ " 19 $\frac{1}{4}$ " 3 $\frac{21}{32}$ "

Box **W** **L** **D**
32 $\frac{9}{16}$ " 19 $\frac{1}{4}$ " 3 $\frac{21}{32}$ "

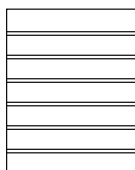

Legal Front to Back

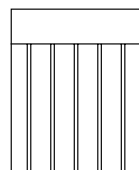

Legal Side to Side

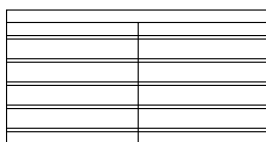

2 Rows Letter or Legal Front to Back

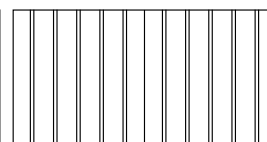

1 Row Letter or Legal Side to Side

HOW TO ORDER EXAMPLES

	QTY	MODEL NO.	DESCRIPTION	EXAMPLE
TOP	1	91-4296RT	Top Material Finish/Color Edge Profile Grommet/Power/ Data Location	W EW C2 EL
BASES	2	01-2028TB	Finish	EW
PORTS	2	01-OASISMA		
TELECOM PLATE	1	01-ABLAB		
MOBILE CART	1	91-2436SV	Top Material Finish/Color Edge Profile Pull Back Panel Grommet Grommet Color	P EW C2 ALB 1-GRMT Black

VENEER (W) OPTIONS

Veneer features UVAdvantage, an ultra-violet finish, on all exposed surfaces by utilizing roll-coat UV technology

AW	Artisan Walnut	LW	Legacy Walnut
CO	Columbian Walnut	MW	Mahogany Walnut
DC	Dark Cherry	MTS	Metropolis Sky
DFW	Dark Forest Walnut	PNW	Pinnacle Walnut
EW	Espresso	SCH	Select Cherry
GC	Golden Cherry	SKC	Shaker Cherry
HW	Harvest Walnut	WC	Williamsburg Cherry
HNW	Henna Walnut		

HPL (P) LAMINATE

WOODGRAIN

CO	Columbian Walnut	PNW	Pinnacle Walnut
EF	Espresso	SCH	Select Cherry
GC	Golden Cherry	SKC	Shaker Cherry
MW	Mahogany Walnut	WC	Williamsburg Cherry

EDGE PROFILES

C2	Jefferson
R	Arlington



Jefferson (C2)



Arlington (R)

PULL OPTIONS

ARA	Arlington A, Brass	ALB	Liberty, Aluminum
ARB	Arlington B, Brass	WLM	Wilmington, Brass
JEF	Jefferson, Brass		



Arlington A (ARA)
Antique Brass - 5/4"



Arlington B (ARB)
Antique Brass - 5/4"



Jefferson (JEF)
Antique Brass - 5/4"



Wilmington (WLM)
Antique Brass - 5/4"



Liberty (ALB)
Aluminum - 4/4"

GROMMET/POWER/DATA OPTIONS & LOCATIONS

See units and options in [accessories section](#) and the [general power and locations information section](#)

LOCKING DOORS

Locking doors are available on specific units, where noted. You must specify WITH LOCKING when ordering and add upcharge.

Lock core will be black if Arlington, Jefferson, and Wilmington brass pulls are selected and silver if Liberty Aluminum pulls are selected.

LKT_HU	72" W - 48" W Units	\$	115
LKT_HU	42" W - 24" W Units	\$	91
LKT_HU	18" W Units	\$	69

CERTIFICATIONS & COMPLIANCE

- Intertek Sustainability Certified
- BIFMA level® Certified
- BIFMA Compliant® Certified
- TSCA Title VI (formerly CARB) Compliance
- US Green Building's LEED® Contribution

Tops/Shapes

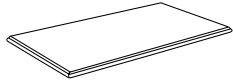

Rectangular [\(See Details\)](#)

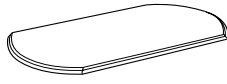

Arc Rectangular [\(See Details\)](#)



Racetrack [\(See Details\)](#)



Boat-Shaped [\(See Details\)](#)

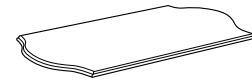

Wave-Rectangular [\(See Details\)](#)

Bases

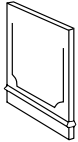

Rectangular [\(See Details\)](#)

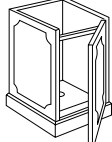

Square [\(See Details\)](#)

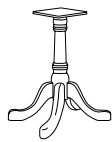

Queen Anne Base [\(See Details\)](#)

Storage Components

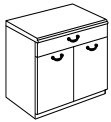

Two Door Buffet w/Drawer [\(See Details\)](#)

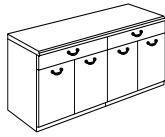

Four Door Buffet w/2 Drawers [\(See Details\)](#)

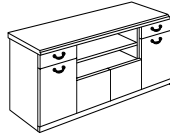

Four Door Buffet w/2 Drawers & Open Storage [\(See Details\)](#)

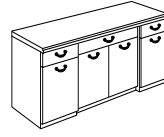

Four Door Buffet w/3 Drawers [\(See Details\)](#)

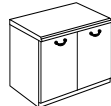

Two Door Credenza [\(See Details\)](#)

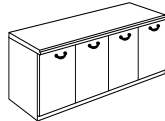

Four Door Credenza [\(See Details\)](#)

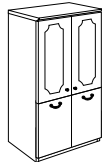

Storage Cabinet Double Doors [\(See Details\)](#)

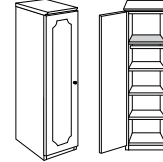

Wardrobe/Storage Cabinet [\(See Details\)](#)



Mobile Serving Cart [\(See Details\)](#)

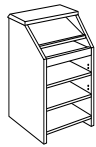

Lectern Stand [\(See Details\)](#)

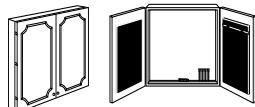

Visual Board [\(See Details\)](#)

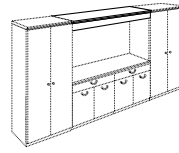

Visor Rail [\(See Details\)](#)

Wire Management & Power/Data Accessories

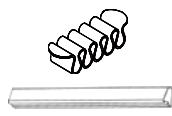

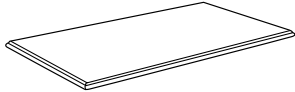
Item	Model No.	W	D	H	Ship Wt	Cubic Ft	List Price	
 <p>RECTANGULAR TOPS</p> <p>Must Specify (in this order): Model # Top Material Finish/Color Edge Profile Grommet/Power/Data Location</p>	192" or 16' - 2 Piece Tops							
	91-48192RT	192	48	1 $\frac{3}{16}$	375	15.5	P\$ 7801 W\$ 9809	
	168" or 14' - 2 Piece Tops							
	91-48168RT	168	48	1 $\frac{3}{16}$	325	13.6	P\$ 7690 W\$ 9140	
	144" or 12' - 2 Piece Tops							
	91-48144RT	144	48	1 $\frac{3}{16}$	275	12.3	P\$ 6468 W\$ 7583	
	120" or 10' - 2 Piece Tops							
	91-48120RT	120	48	1 $\frac{3}{16}$	225	10.3	P\$ 5796 W\$ 6687	
	96" or 8' - 1 Piece Top							
	91-4296RT	96	42	1 $\frac{3}{16}$	180	9.4	P\$ 4349 W\$ 5015	
	72" or 6' - 1 Piece Top							
	91-3672RT	72	36	1 $\frac{3}{16}$	100	6.2	P\$ 2831 W\$ 3341	

Description

- Grain Runs the Width of the Table
- All Veneer Tops, as well as Laminate Tops up to 144" (12 feet), have Matching Woodgrain. Laminate Tops Sized 156" (13 feet) and Longer have Non-Matching Woodgrain
- Heavy-Duty Ganging Mechanisms Connect Two (2) Piece Tops
- See Bases and Number Required For Each Top Size, [See Multiple Base Options](#); Must Order Separately
- Optional Grommets and Power/Data; For Locations See [Power and Locations Information Section](#), See Units and Unit Options in [Accessories Section](#)

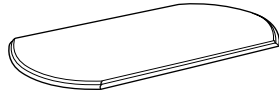
Item	Model No.	W	D	H	Ship Wt	Cubic Ft	List Price	
 <p>ARC RECTANGULAR TOPS</p> <p>Must Specify (in this order): Model # Top Material Finish/Color Edge Profile Grommet/Power/Data Location</p>	192" or 16' - 2 Piece Tops							
	91-48192AR	192	48	1 $\frac{3}{16}$	375	15.5	P\$ 8248 W\$ 10254	
	168" or 14' - 2 Piece Tops							
	91-48168AR	168	48	1 $\frac{3}{16}$	325	13.6	P\$ 8137 W\$ 9586	
	144" or 12' - 2 Piece Tops							
	91-48144AR	144	48	1 $\frac{3}{16}$	275	12.3	P\$ 6911 W\$ 8023	
	120" or 10' - 2 Piece Tops							
	91-48120AR	120	48	1 $\frac{3}{16}$	225	10.3	P\$ 6243 W\$ 7135	
	96" or 8' - 1 Piece Top							
	91-4296AR	96	42	1 $\frac{3}{16}$	180	9.4	P\$ 4904 W\$ 5571	
	72" or 6' - 1 Piece Top							
	91-3672AR	72	36	1 $\frac{3}{16}$	100	6.2	P\$ 3124 W\$ 3633	

Description

- Grain Runs the Width of the Table
- All Veneer Tops, as well as Laminate Tops up to 144" (12 feet), have Matching Woodgrain. Laminate Tops Sized 156" (13 feet) and Longer have Non-Matching Woodgrain
- Heavy-Duty Ganging Mechanisms Connect (2) Piece Tops
- See Bases and Number Required For Each Top Size, [See Multiple Base Options](#); Must Order Separately
- Optional Grommets and Power/Data; For Locations See [Power and Locations Information Section](#), See Units and Unit Options in [Accessories Section](#)

W = Veneer P = HPL

[See Cameo Overview For Ordering Options](#)

Item	Model No.	W	D	H	Ship Wt	Cubic Ft	List Price	
RACETRACK TOPS  <p>Must Specify (in this order): Model # Top Material Finish/Color Edge Profile Grommet/Power/Data Location</p>	192" or 16' - 2 Piece Tops							
	91-48192AT	192	48	1 $\frac{3}{16}$	375	15.5	P\$ 9586 W\$ 11590	
	168" or 14' - 2 Piece Tops							
	91-48168AT	168	48	1 $\frac{3}{16}$	325	13.6	P\$ 9252 W\$ 10700	
	144" or 12' - 2 Piece Tops							
	91-48144AT	144	48	1 $\frac{3}{16}$	275	12.3	P\$ 7914 W\$ 9029	
	120" or 10' - 2 Piece Tops							
	91-48120AT	120	48	1 $\frac{3}{16}$	225	10.3	P\$ 7025 W\$ 7914	
	96" or 8' - 1 Piece Top							
	91-4296AT	96	42	1 $\frac{3}{16}$	180	9.4	P\$ 5347 W\$ 6017	
	72" or 6' - 1 Piece Top							
	91-3672AT	72	36	1 $\frac{3}{16}$	100	6.2	P\$ 3725 W\$ 4233	

Description

- Grain Runs the Width of the Table
- All Veneer Tops, as well as Laminate Tops up to 144" (12 feet), have Matching Woodgrain. Laminate Tops Sized 156" (13 feet) and Longer have Non-Matching Woodgrain
- Heavy-Duty Ganging Mechanisms Connect (2) Piece Tops
- See Bases and Number Required For Each Top Size, [See Multiple Base Options](#); Must Order Separately
- Optional Grommets and Power/Data; For Locations See [Power and Locations Information Section](#), See Units and Unit Options in [Accessories Section](#)

Item	Model No.	W	D	H	Ship Wt	Cubic Ft	List Price	
BOAT-SHAPED TOPS  <p>Must Specify (in this order): Model # Top Material Finish/Color Edge Profile Grommet/Power/Data Location</p>	192" or 16' - 2 Piece Tops							
	91-48192BT	192	48	1 $\frac{3}{16}$	375	15.5	P\$ 9586 W\$ 11590	
	168" or 14' - 2 Piece Tops							
	91-48168BT	168	48	1 $\frac{3}{16}$	325	13.6	P\$ 9252 W\$ 10700	
	144" or 12' - 2 Piece Tops							
	91-48144BT	144	48	1 $\frac{3}{16}$	275	12.3	P\$ 7914 W\$ 9029	
	120" or 10' - 2 Piece Tops							
	91-48120BT	120	48	1 $\frac{3}{16}$	225	10.3	P\$ 7025 W\$ 7914	
	96" or 8' - 1 Piece Top							
	91-4296BT	96	42	1 $\frac{3}{16}$	180	9.4	P\$ 5347 W\$ 6017	
	72" or 6' - 1 Piece Top							
	91-3672BT	72	36	1 $\frac{3}{16}$	100	6.2	P\$ 3725 W\$ 4233	

Description

- Grain Runs the Width of the Table
- All Veneer Tops, as well as Laminate Tops up to 144" (12 feet), have Matching Woodgrain. Laminate Tops Sized 156" (13 feet) and Longer have Non-Matching Woodgrain
- Heavy-Duty Ganging Mechanisms Connect (2) Piece Tops
- See Bases and Number Required For Each Top Size, [See Multiple Base Options](#); Must Order Separately
- Optional Grommets and Power/Data; For Locations See [Power and Locations Information Section](#), See Units and Unit Options in [Accessories Section](#)

W = Veneer P = HPL

[See Cameo Overview For Ordering Options](#)

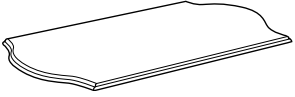
Item	Model No.	W	D	H	Ship Wt	Cubic Ft	List Price
WAVE-RECTANGULAR TOPS 	192" or 16' - 2 Piece Tops						
	91-48192WR	192	48	1 3/16	375	15.5	P\$ 8248 W\$ 10254
	168" or 14' - 2 Piece Tops						
	91-48168WR	168	48	1 3/16	325	13.6	P\$ 8137 W\$ 9586
	144" or 12' - 2 Piece Tops						
	91-48144WR	144	48	1 3/16	275	12.3	P\$ 6911 W\$ 8023
	120" or 10' - 2 Piece Tops						
	91-48120WR	120	48	1 3/16	225	10.3	P\$ 6243 W\$ 7135
	96" or 8' - 1 Piece Top						
	91-4296WR	96	42	1 3/16	180	9.4	P\$ 4904 W\$ 5571
72" or 6' - 1 Piece Top							
91-3672WR	72	36	1 3/16	100	6.2	P\$ 3124 W\$ 3633	

Must Specify (in this order):

- Model #
- Top Material
- Finish/Color
- Edge Profile
- Grommet/Power/Data Location

Description

- Grain Runs the Width of the Table
- All Veneer Tops, as well as Laminate Tops up to 144" (12 feet), have Matching Woodgrain. Laminate Tops Sized 156" (13 feet) and Longer have Non-Matching Woodgrain
- Heavy-Duty Ganging Mechanisms Connect (2) Piece Tops
- See Bases and Number Required For Each Top Size, [See Multiple Base Options](#); Must Order Separately
- Optional Grommets and Power/Data; For Locations See [Power and Locations Information Section](#), See Units and Unit Options in [Accessories Section](#)

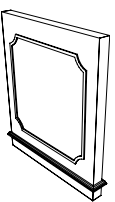
Item	Model No.	W	D	H	Ship Wt	Cubic Ft	List Price	
RECTANGULAR BASE TRADITIONAL 	For Use with 48"D Tops							
	01-2428TB	24	2	28 1/2	38	2.7	W\$ 1489	
For Use with 42"D or Less Tops								
	01-2028TB	20	2	28 1/2	32	2.3	W\$ 1397	
Description								
<ul style="list-style-type: none"> • Veneer Panel Base • Traditional Molding on Outer Side Standard; For No Decorative Molding Option, Must Specify (See Below) • Stretchers are Included in Pricing; Must Specify Model (See Below) 								
Molding Option: Specify								
	NONE	No Decorative Molding					\$	N/C

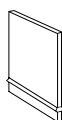

Must Specify (in this order):

- Model # and Quantity
- Finish
- No Molding
- Stretcher Rail

Table Width	72"	96"	120"	144"	168"	192"
Number of Bases Required	2	2	3	3	3	5
Stretcher Rail Needed	01-72STR	01-96STR	01-120STR	01-144STR	01-168STR	01-192STR

Note: Molding is applied to one side of outer extreme bases. If 3 or more bases are required, center bases will not have molding on either side.

W = Veneer P = HPL

[See Cameo Overview For Ordering Options](#)

Item	Model No.	W	D	H	Ship Wt	Cubic Ft	List Price
SQUARE BASE TRADITIONAL	01-2020TSB	20	20	28½	57	8.4	W\$ 2033

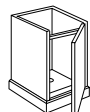
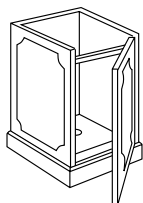
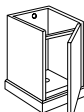
No Molding
OptionGrommet
Option**Description**

- Panel Access Door Features Soft Close Hinges
- Traditional Molding Standard on All Sides; For No Decorative Molding Option, Must Specify (See Below)
- 2" Wire Management Opening Above Door; 2¾" (60mm) Wire Management Opening in Bottom
- Optional Grommet at Top Edge, Must Specify (See Below)

Options: Specify & Add

NONE	No Decorative Molding	\$	N/C
GCB1S	Grommet at Top Edge One (1) - Factory Installed	\$	52

Table Width	72"	96"	120"	144"	168"	192"
Number of Bases Required	2	2	3	3	3	3

Note: Recommended on tables 72"W or Larger. If specified on smaller tables, a ballast must be ordered separately. Contact Customer Service for more information.

Must Specify (in this order):

- Model # and Quantity
- Finish
- No Molding
- Grommet Option

QUEEN ANNE BASE	01-0606QB	24	24	28¾	35	10.8	W\$ 1406
-----------------	-----------	----	----	-----	----	------	----------

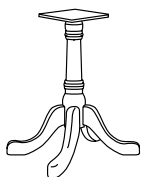
**Description**

- Classic Design Detail on Column
- Queen Anne Base Features Multi-Step, Hand-Finished Catalyzed Finish
- Four (4) Legs with Adjustable Glides

Table Width	72"	96"	120"	144"	168"	192"
Number of Bases Required	2	2	3	3	3	5

Must Specify (in this order):

- Model # and Quantity
- Finish

W = Veneer P = HPL

[See Cameo Overview For Ordering Options](#)

Item	Model No.	W	D	H	Ship Wt	Cubic Ft	List Price
TWO DOOR BUFFET WITH DRAWER	91-2436BF	36	24	36	189	21.7	P\$ 4213 W\$ 4290

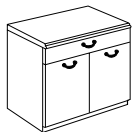
**Description**

- Top Edge Profiled on Approach Side Only ([See Edge Options](#)); Must Specify Edge Selection
- One (1) Drawer and Storage Behind Two (2) Doors with One (1) Adjustable Shelf

Must Specify (in this order):

Model #
Top Material
Finish/Color
Edge Profile
Pull

FOUR DOOR BUFFET WITH TWO DRAWERS	91-2472BF	72	24	36	342	45.6	P\$ 8005 W\$ 8137
-----------------------------------	-----------	----	----	----	-----	------	----------------------

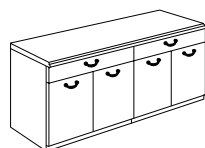
**Description**

- Top Edge Profiled on Approach Side Only ([See Edge Options](#)); Must Specify Edge Selection
- Two (2) Drawers and Storage Behind Four (4) Doors with Two (2) Adjustable Shelves

Must Specify (in this order):

Model #
Top Material
Finish/Color
Edge Profile
Pull

FOUR DOOR BUFFET WITH TWO DRAWERS AND OPEN STORAGE	91-2472BFD	72	24	36	337	45.6	P\$ 9231 W\$ 9366
--	------------	----	----	----	-----	------	----------------------

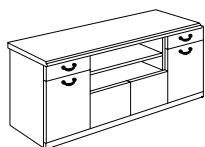
**Description**

- Top Edge Profiled on Approach Side Only ([See Edge Options](#)); Must Specify Edge Selection
- Two (2) Drawers with Open Storage with One (1) Adjustable Shelf
- Left and Right Storage Behind Doors with One (1) Adjustable Shelf
- Storage Behind Center Doors

Must Specify (in this order):

Model #
Top Material
Finish/Color
Edge Profile
Pull

FOUR DOOR BUFFET WITH THREE DRAWERS	91-2472SBF	72	24	36	362	45.6	P\$ 9231 W\$ 9366
-------------------------------------	------------	----	----	----	-----	------	----------------------

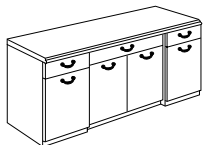
**Description**

- Top Edge Profiled on Approach Side Only ([See Edge Options](#)); Must Specify Edge Selection
- Three (3) Drawers and Storage Behind Four (4) Doors with Three (3) Adjustable Shelves
- Center Section is Stepped Back

Must Specify (in this order):

Model #
Top Material
Finish/Color
Edge Profile
Pull

W = Veneer P = HPL

[See Cameo Overview For Ordering Options](#)

Item	Model No.	W	D	H	Ship Wt	Cubic Ft	List Price
TWO DOOR CREDENZA	91-2436CC	36	24	30	150	17.6	P\$ 3264 W\$ 3341

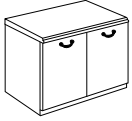

Must Specify (in this order):

Model #
Top Material
Finish/Color
Edge Profile
Pull
Locking Option

Description

- Top Edge Profiled on Approach Side Only ([See Edge Options](#)); Must Specify Edge Selection
- Two (2) Doors with One (1) Adjustable Shelf Behind Doors
- Additional Option: Locking Doors ([See Locking Options](#))

FOUR DOOR CREDENZA	91-2472CC	72	24	30	290	34.2	P\$ 6613 W\$ 6746
--------------------	-----------	----	----	----	-----	------	----------------------

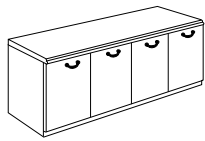

Must Specify (in this order):

Model #
Top Material
Finish/Color
Edge Profile
Pull
Locking Option

Description

- Top Edge Profiled on Approach Side Only ([See Edge Options](#)); Must Specify Edge Selection
- Four (4) Doors with Two (2) Adjustable Shelves Behind Doors
- Additional Option: Locking Doors ([See Locking Options](#))

DOUBLE DOOR STORAGE CABINET	91-3672SUD	36	24	72	285	42.0	W\$ 6784
--------------------------------	------------	----	----	----	-----	------	----------

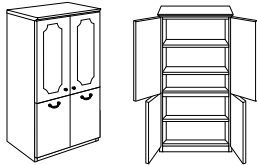

Must Specify (in this order):

Model #
Finish
Edge Profile
Knob
Pull
No Molding

Description

- Top Section has Two (2) Adjustable Shelves; Bottom Section has One (1) Adjustable Shelf
- Two (2) Knobs on Top Doors, Available with Antique Brass (TKN) Door Knob or Aluminum (ALK) Door Knob; Must Specify; Selection of Pulls on Bottom Doors

Options: Specify

NONE	No Decorative Molding	\$	N/C
------	-----------------------	----	-----

WARDROBE/STORAGE CABINET	HINGED LEFT	HINGED RIGHT	W	D	H	Ship Wt	Cubic Ft	List Price
	91-1872WL	91-1872WR	18	24	72	155	22.0	W\$ 5402

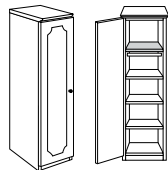

Must Specify (in this order):

Model #
Finish
Edge Profile
Knob
No Molding

Description

- Available with Antique Brass (TKN) Door Knob or Aluminum (ALK) Door Knob; Must Specify
- Fixed Top Shelf; Coat Rod Under Fixed Shelf
- Three (3) Adjustable Shelves Behind Door
- Adjustable Shelves can be Removed for Wardrobe Application

Options: Specify

NONE	No Decorative Molding	\$	N/C
------	-----------------------	----	-----

W = Veneer P = HPL

[See Cameo Overview For Ordering Options](#)

Item	Model No.	W	D	H	Ship Wt	Cubic Ft	List Price
VISOR RAIL	91-2472VR	72	24	5 ³ / ₁₆	100	8.9	W\$ 1394

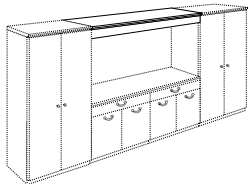

Must Specify (in this order):
Model #
Finish
Projection Screen
Task Light

Description

- Overhead Rail Creates Wall Unit
- For Use with 72" High Cabinets and Credenzas/Bufets (Ordered Separately)

Options: Specify & Add

1-PS	Projection Screen (Requires Field Installation)	\$ 1062
TL-0848	Task Light (Requires Field Installation)	\$ 445

SERVING CART	91-2436SV	36	24	36	149	24.0	P\$ 5052 W\$ 5132
--------------	-----------	----	----	----	-----	------	----------------------

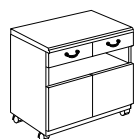

Must Specify (in this order):
Model #
Top Material
Finish/Color
Edge Profile
Pull
Grommet Option

Description

- Top Edge Profiled on Approach Side Only; Must Specify Edge Selection
- Two (2) Box Drawers with Storage Behind Two (2) Doors
- Open Storage
- Locking Casters

Grommet Option: Specify & Add

1-GRMT	Grommet in Back Panel; Must Specify Black or Silver	\$ 52
--------	---	-------

LECTERN STAND	91-2650LS	26	24	50	130	21.9	W\$ 4017
---------------	-----------	----	----	----	-----	------	----------

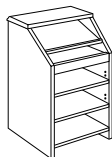

Must Specify (in this order):
Model #
Finish
Edge Profile

Description

- Top Edge Profiled on Approach Side Only; Must Specify Edge Selection
- Fixed Reading Shelf
- Pullout Shelf
- Two (2) Adjustable Storage Shelves in Lower Compartment
- Two (2) Locking and Two (2) Non-Locking Casters
- Wire Management Grommet in Bottom Shelf

VISUAL BOARD	91-4848VB	48	5	48	150	11.0	W\$ 5796
--------------	-----------	----	---	----	-----	------	----------

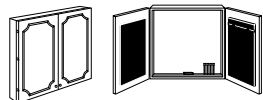

Must Specify (in this order):
Model #
Finish
Project Screen
Tackboard Fabric
Pull

Description

- Tackboard on Each Door Standard in Black Fabric Unless Specified; Price Valid for Grades 1, 2, & 3 (See Other Pricing Below)
- Display Rail with Adjustable Hooks for Flipchart
- Magnetic Door Closure and Porcelain Non-Glare Writing Surface
- Includes Flipchart, Set of Four (4) Dry Erase Markers and Eraser, Mounting Hardware
- Does Not Feature Soft Close Hinges

Options: Specify & Add

	Grade 4	Grade 5	Grade 6	Grade 7	Grade 8	Grade 9	Grade 10
Tackboard Fabric Change	\$ 278	408	540	728	924	1152	1416
1-PS	Projection Screen (Requires Field Installation)						\$ 1062

W = Veneer P = HPL

[See Cameo Overview For Ordering Options](#)

Item	Model No.		W	D	H	Ship Wt	Cubic Ft	List Price
ROUND GROMMET COVER	01-GRMTBK	Black	2 $\frac{3}{8}$	2 $\frac{3}{8}$	-	1	0.1	\$ 11
	01-GRMTSL	Silver						



OPEN MARKET ONLY
(SILVER)

Description

- 2 $\frac{3}{8}$ " (60mm) Round Grommet Cover
- Field Installed

SINGLE POWER SAND DOLLAR	01-SAND60PS	Silver	3	3	4	1	0.2	\$ 98
	01-SAND60PW	White						
	01-SAND60PB	Black						

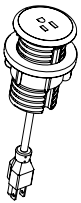

Description

- Mounts in 2 $\frac{3}{8}$ " (60mm) Round Grommet
- Single Power Outlet with 6' Cord

DOUBLE USB SAND DOLLAR	01-SAND60US	Silver	3	3	4	1	0.2	\$ 277
	01-SAND60UW	White						
	01-SAND60UB	Black						

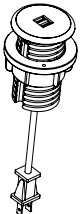

Description

- Mounts in 2 $\frac{3}{8}$ " (60mm) Round Grommet
- Dual USB Outlets with 6' Cord

POWER 440	01-DATA440A	Aluminum	5 $\frac{5}{16}$	4 $\frac{3}{8}$	-	5	0.2	\$ 964
	01-DATA440B	Black						

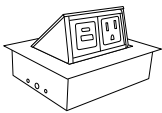

Description

- Two (2) Power Outlets
- Soft Touch Hinged Lid
- 6' Power Cord
- UL and CSA Recognized

[See Cameo Overview For Ordering Options](#)

Item	Model No.		W	D	H	Ship Wt	Cubic Ft	List Price
INTERACT POWER & DATA	01-INTERACTG2A	Aluminum	9	5 $\frac{3}{8}$	2 $\frac{3}{4}$	5	0.2	\$ 891
	01-INTERACTG2B	Black						



Description

- Includes: Two (2) Power Outlets, Two (2) USB-A Charging Ports, One (1) Telecom Plate Opening; Two (2) Keystone Openings for Voice/Data Jacks
- One (1) Telecom Plates Included with the Unit: One (1) 01-ABLAB Plate (Consists of One (1) RJ45 Cat 6, One (1) RJ11 Cat 3 Phone Jack)
- Convenience Plug on Bottom
- 6' Power Cord
- UL and CSA Recognized
- Additional Telecom Plates, [See Telecom Plate Options](#)

TABLE POWER & DATA VAULT	01-CVAULTG2A		4 $\frac{1}{3}$	15 $\frac{7}{8}$	4 $\frac{1}{16}$	10	0.4	\$ 1944
--------------------------	--------------	--	-----------------	------------------	------------------	----	-----	---------



OPEN MARKET ONLY

Description

- Electric Drive Motor Rotates the Surface Technology 180° to the Proper Position
- Photo-Electronic Eye Prevents Rotation When Obstructed
- Two (2) Data Ports, Three (3) Power Outlets, and One (1) HDMI and Two (2) 5V USB
- 6' Power Cord
- UL and CSA Recognized

OASIS MINI POWER & DATA	01-OASISMA	Aluminum	14 $\frac{1}{4}$	6 $\frac{5}{8}$	2 $\frac{7}{8}$	11	0.3	\$ 3191
	01-OASISMB	Black						

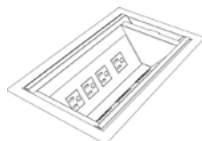

Top View

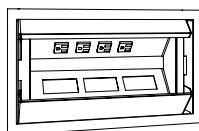

Description

- For Use with Conference Tables
- Soft Touch Hinged Lid
- Four (4) Power Outlets, Three (3) Telecom Plate Openings
- Two (2) Telecom Plates Included with the Unit: One (1) 01-ABLAB Plate (Consists of One (1) RJ45 Cat 6, One (1) RJ11 Cat 3 Phone Jack); One (1) 01-ABLB Plate (Consists of One (1) RJ45 Cat 6)
- 9' Power Cord
- UL Listed
- Additional Telecom Plates, [See Telecom Plate Options](#)

WORKSURFACE POWER CENTER	01-INTRFC1A	Aluminum	14 $\frac{1}{4}$	6 $\frac{5}{8}$	2 $\frac{7}{8}$	11	0.3	\$ 2064
	01-INTRFC1B	Black						

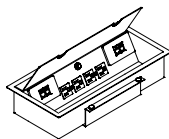

Description

- For Use with Conference Tables
- Four (4) Power Outlets, Three (3) Telecom Plate Openings
- Two (2) Telecom Plates Included with the Unit: One (1) 01-ABLAB Plate (Consists of One (1) RJ45 Cat 6, One (1) RJ11 Cat 3 Phone Jack); One (1) 01-ABLBB Plate (Consists of Two (2) RJ45 Cat 6)
- 6' Power Cord
- Convenience Plug on Bottom
- UL Listed/CSA Certified
- Additional Telecom Plates, [See Telecom Plate Options](#)

[See Cameo Overview For Ordering Options](#)

Item	Model No.		W	D	H	Ship Wt	Cubic Ft	List Price
POWER DATA PORT	01-DPORT4A	Aluminum	8	4	-	7	0.2	\$ 1093
	01-DPORT4B	Black						

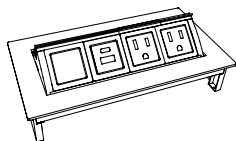
Description

- Retracts into Work Surface to Regain Productive Space; One-Touch Access to Power and Data
- Two (2) Power Outlets and Two (2) Open Ports for Data
- Additional Telecom Plates, [See Telecom Plate Options](#)
- Water-Proof Simplex (Outlets)
- Includes a Voice/Data Adapter Kit to Accept Couplers and Jacks When Required
- 6' Power Cord
- UL and CSA Recognized

USB PORT	01-USBPORT		-	-	-	-	-	\$ 161
----------	------------	--	---	---	---	---	---	--------

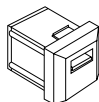
Description

- Passive USB-A Port with Increased Transfer Speed Up to 5 gbs/sec
- Simultaneous Read/Write Capability; Idle Device Power Saving State
- 6' Cord
- Compatible with 01-DPORT4A/B

VOICE COUPLER	01-VOICE1		-	-	-	-	-	\$ 73
---------------	-----------	--	---	---	---	---	---	-------

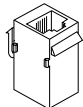
Description

- 6-Pin Modular Plug
- Molded Black; Cord Not included
- Compatible with 01-DPORT4A/B

DATA PORT	01-RJ4DATA		-	-	-	-	-	\$ 167
-----------	------------	--	---	---	---	---	---	--------

Description

- 8-Pin Modular Plug; Cat6 Ethernet Cable; Pre-terminated Cable
- 10' Cord
- Compatible with 01-DPORT4A/B

[See Cameo Overview For Ordering Options](#)

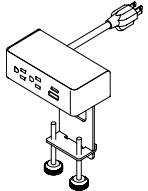
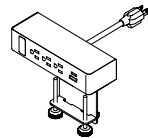
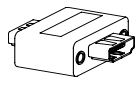
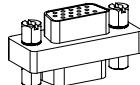
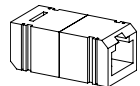
Item	Model No.		W	D	H	Ship Wt	Cubic Ft	List Price
DUO CLAMP WITH NEMA PLUG 	01-DUOCLAMPS	Silver	5½	3	7	1	0.2	\$ 572
	01-DUOCLAMPW	White						
	01-DUOCLAMPB	Black						
	Description <ul style="list-style-type: none"> Clamps to Top and Includes: Two (2) Power One (1) USB Charging Port and One (1) 60-Watt USB-C Power Delivery Port with GaN Technology with 10' Cord Silver Metal Trim Independent USB Circuit Controllers Deliver up to 2.1 Amps to Each Post All Mounting Hardware Included FCC Part 15A and UL Approved for Horizontal and Vertical Applications 							
TRIO CLAMP WITH NEMA PLUG 	01-TRIOCLAMPS	Silver	8	3	7	1	0.2	\$ 671
	01-TRIOCLAMPW	White						
	01-TRIOCLAMPB	Black						
	Description <ul style="list-style-type: none"> Clamps to Top and Includes: Three (3) Power, One (1) USB Charging Port, One (1) 60-Watt USB-C Power Delivery Port with GaN Technology, One (1) Open Data; 10' Cord Silver Metal Trim Independent USB Circuit Controllers Deliver up to 2.1 Amps to Each Post HDMI, VGA, or RJ45 Accessories Sold Separately; See Below All Mounting Hardware Included FCC Part 15A and UL Approved for Horizontal and Vertical Applications 							
HDMI DATA PORT ACCESSORY  <small>OPEN MARKET ONLY</small>	01-LCOMHDMI		-	-	-	1	0.2	\$ 166
Description <ul style="list-style-type: none"> HDMI Port for Trio Clamp Units 								
VGA DATA PORT ACCESSORY 	01-LCOMVGA		-	-	-	1	0.2	\$ 121
Description <ul style="list-style-type: none"> VGA Port for Trio Clamp Units 								
RJ45 DATA PORT ACCESSORY 	01-LCOMRJ45		-	-	-	1	0.2	\$ 79
Description <ul style="list-style-type: none"> RJ45 Port for Trio Clamp Units 								

[See Cameo Overview For Ordering Options](#)

Item	Model No.	W	D	H	Ship Wt	Cubic Ft	List Price
WIRE MANAGERS	01-WMGR4	16	1½	¾	1	-	\$ 116

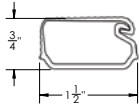
Description

- Four (4) Wire Manager Strips
- Black Plastic
- Snap Lock Channel
- Attaches with Adhesive Strips
- Can be Placed on All Units to Route Wires

CABLE GRIP	01-WMGRCB	5¾	2¾	-	-	-	\$ 17
------------	-----------	----	----	---	---	---	-------

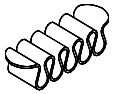
Description

- Under Surface Wire Management
- Black

POWER STRIP	01-PRSP	9	2	2	1	-	\$ 205
-------------	---------	---	---	---	---	---	--------

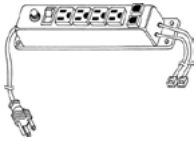
Description

- Includes Four (4) Outlets and Two (2) Phone Jacks
- Black Plastic with Rocker On/Off Switch
- 13 Amp Circuit Breaker
- 10' Power Cord and Two (2) 14' Phone Hook Up Cords
- UL Listed and CSA Certified
- Suitable for Surface or Recessed Mounting
- Ships via UPS Only

VESTA POWER CENTER	01-PDCTR	10¾	12	28¾	14	2.5	\$ 1776
--------------------	----------	-----	----	-----	----	-----	---------

Description

- Top Includes One (1) Power Outlet, Two (2) USB Ports and One (1) USBC Port; Base Includes Three (3) Outlets
- Available in White
- 120" Power Cord
- Built with Weight Distribution for Optimal Stability
- Base is 5" Tall

[See Cameo Overview For Ordering Options](#)

Item	Model No.	Description	List Price
ECA TELECOM PLATES	01-ABL	Telecom Plate, Blank Plate	\$ 41
	01-ABL737373	Telecom Plate, Three (3) RJ45 Cat 5e	\$ 367
	Compatible with:		
	01-ABLAB	Telecom Plate, One (1) RJ45 Cat 6, One (1) RJ11 Cat 3 Phone	\$ 206
	01-ABLAB102	Telecom Plate, One (1) RJ45 Cat 6, One (1) RJ11 Cat 3, One (1) USB W/72" Patch Cord	\$ 320
	01-ABLABB	Telecom Plate, Two (2) RJ45 Cat 6, One (1) RJ11 Cat 3 Phone	\$ 320
	01-ABLB	Telecom Plate, One (1) RJ45 Cat 6	\$ 149
	01-ABLB	Telecom Plate, Two (2) RJ45 Cat 6	\$ 260
	01-ABLB	Telecom Plate, Three (3) RJ45 Cat 6	\$ 367
	01-ABLB	Telecom Plate, Four (4) RJ45 Cat 6	\$ 476
	01-ABLBB	Telecom Plate, Two (2) RJ45 Cat 6, One (1) 15 Pin HD VGA w/72" Patch Cord	\$ 446
	01-ABLBBB	Telecom Plate, One (1) RJ45 Cat 6, One (1) Mini Stereo Inline, One (1) 15 Pin HD VGA w/72" Patch Cord	\$ 410
	01-ABLBBB	Telecom Plate, One (1) RJ45 Cat 6 Data Inline, One (1) RJ11 Cat 3 Phone Inline	\$ 197
	01-ABLBBB	Telecom Plate, One (1) HDMI w/36" Patch Cord	\$ 295
	01-ABLBBB	Telecom Plate, One (1) Mini Stereo Inline, One (1) HDMI w/36" Patch Cord, One (1) 15 Pin HD VGA w/72" Patch Cord	\$ 558
	01-ABLBBB	Telecom Plate, One (1) 15 Pin HD VGA & One (1) Mini Stereo Inline Jack	\$ 298
	01-ABLBBB	Telecom Plate, Three (3) Cord Bushings	\$ 96

Compatible with:



Oasis Mini Power & Data
01-OASISMA, 01-OASISMB



Interact Power & Data
01-INTERACTG2A, 01-INTERACTG2B



Power Center
01-INTRFCIA, 01-INTRFCIB

Standard Cutout Types & General Location Information

- Grommets can be specified, at an upcharge, add \$11 for a field installed grommet cover or add \$50 for a factory installed grommet (unless otherwise noted).
- Power/Data Modules can be specified in standard locations at no additional charge.
- The selection of both the Power/Data Module and Base will determine cutout locations for each table size, as well as placement over or between bases.
- [See exact measurements of Module locations.](#)
- For specific locations available by table size see series pages, [see Cameo locations.](#)

Cutout Locations Available

OC = On Center
BB = Between Bases (*requires 2 modules*)
CL = Left of Center
CR = Right of Center
EL = End Left
ER = End Right
ML = Middle Left
MR = Middle Right

General Location of Cutouts

*For Tables with **Two (2) Bases** and **One (1) Location**:*

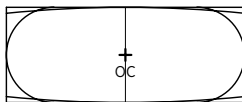

On Center
(OC)



One End
(EL)

*For Tables with **Two (2) Bases** and **Two (2) Locations**:*

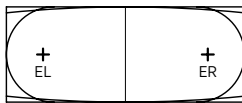

Both Ends
(EL + ER)

*For Tables with **Three (3) Bases** and **One (1) Location**:*

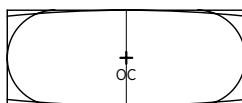

On Center
(OC)

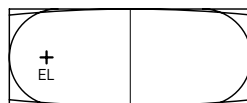

One End
(EL)

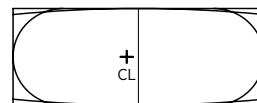

Off Center
(CL)

*For Tables with **Three (3) Bases** and **Two (2) Locations**:*

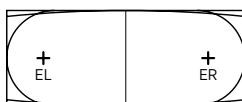

Both Ends
(EL + ER)

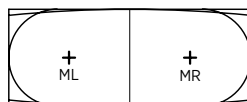

Middle of Each End
(ML + MR)

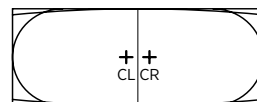

Off Center Left and Right
(CL + CR)

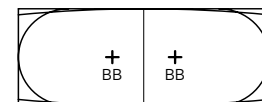

Between the Bases
(BB, Slightly Off Center Between Bases)

*For Tables with **Three (3) Bases** and **Three (3) Locations**:*

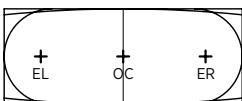

On Center and Both Ends
(OC + EL + ER)

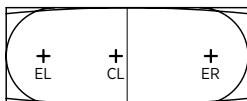

Left of Center and Both Ends
(CL + EL + ER)

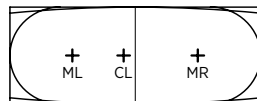

Off Center and Middle of Each End
(CL + ML + MR)

Continued on Next Page.

[See Cameo Overview For Ordering Options](#)

Standard Cutout Types & General Location Information (Continued)

- Grommets can be specified, at an upcharge, add \$11 for a field installed grommet cover or add \$50 for a factory installed grommet (unless otherwise noted).
- Power/Data Modules can be specified in standard locations at no additional charge.
- The selection of both the Power/Data Module and Base will determine cutout locations for each table size, as well as placement over or between bases.
- [See exact measurements of Module locations.](#)
- For specific locations available by table size see series pages, [see Cameo locations.](#)

Cutout Locations Available

OC = On Center
BB = Between Bases (*requires 2 modules*)
CL = Left of Center
CR = Right of Center
EL = End Left
ER = End Right
ML = Middle Left
MR = Middle Right

General Location of Cutouts

Continued from Previous Page

*For Tables with **Three (3) Bases** and **Four (4) Locations**:*

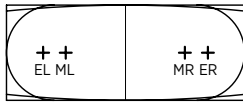

Middle of Each End and Both Ends
(ML + MR + EL + ER)

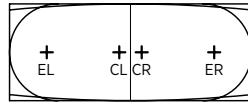

Off Center and Both Ends
(CL + CR + EL + ER)

*For Tables with **Five (5) Bases** and **One (1) Location**:*

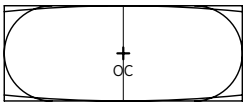

On Center
(OC)



One End
(EL)

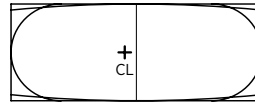

Off Center
(CL)

*For Tables with **Five (5) Bases** and **Two (2) Locations**:*

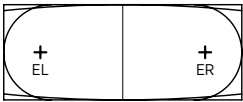

Both Ends
(EL + ER)

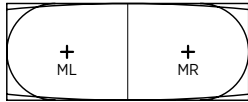

Middle of Each End
(ML + MR)

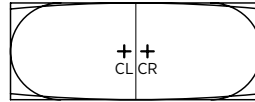

Off Center Left and Right
(CL + CR)

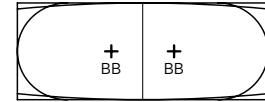

Between the Bases
(BB, Slightly Off Center Between Bases)

*For Tables with **Five (5) Bases** and **Three (3) Locations**:*

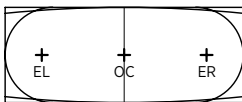

On Center and Both Ends
(OC + EL + ER)

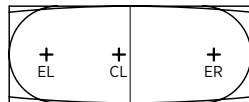

Left of Center and Both Ends
(CL + EL + ER)

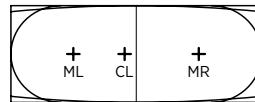

Off Center and Middle of Each End
(CL + ML + MR)

*For Tables with **Five (5) Bases** and **Four (4) Locations**:*

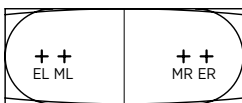

Middle of Each End and Both Ends
(ML + MR + EL + ER)

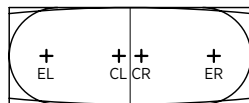







Off Center and Both Ends
(CL + CR + EL + ER)

[See Cameo Overview For Ordering Options](#)

Location Measurements By Module



	72" Tops	96" Tops	120", 144" & 168" Tops	192" Tops
	OC On Center BB Between Bases (requires 2 modules)		CL Left of Center CR Right of Center	EL End Left ER End Right ML Middle Left MR Middle Right
GROMMET 	OC Center of Table	OC Center of Table EL, EL + ER 24½" from end	CL, CL + CR 5½" from center EL, EL + ER 24½" from end CL + EL + ER, 5½" from center and CL + CR + EL + ER 24½" from end BB Slightly off centered between bases	CL, CL + CR 5½" from center EL, EL + ER 24½" from end CL + EL + ER, 5½" from center and CL + CR + EL + ER 24½" from end BB Slightly off centered between bases ML + MR 48" from end CL + ML + MR, 5½" from center and CL + CR + ML + MR 48" from end
POWER 440  INTERACT 	OC Center of Table	OC Center of Table EL, EL + ER 25" from end	OC Splits seam in center of bases EL, EL + ER 25" from end CL, CL + CR 5" from center CL + EL + ER, 5" from center and CL + CR + EL + ER 25" from end BB Slightly off centered between bases	OC Splits seam in center of bases EL, EL + ER 25" from end CL, CL + CR 5" from center CL + EL + ER, 5" from center and CL + CR + EL + ER 25" from end BB Slightly off centered between bases ML + MR 48" from end CL + ML + MR, 5" from center and CL + CR + ML + MR 48" from end
DPORT 4A  OASIS MINI,  INTRFC1  POWER & DATA VAULT 	OC Center of Table	OC Center of Table EL, EL + ER 29" from end	OC Splits seam in center of bases EL, EL + ER 29" from end CL + EL + ER, 9½" from center and CL + CR + EL + ER 29" from end CL, CL + CR 9½" from center BB Slightly off centered between bases	OC Splits seam in center of bases EL, EL + ER 29" from end CL + EL + ER, 9½" from center and CL + CR + EL + ER 29" from end CL, CL + CR 9½" from center BB Slightly off centered between bases ML + MR 48" from end OC+ EL + ER Splits center seam and 29" from end OC+ ML + MR Splits center seam and 48" from end CL + ML + MR, 9½" from center and CL + CR + ML + MR 48" from end

[See Cameo Overview For Ordering Options](#)



36"x72" & 42"x96" TOPS

For General Location Information, [See Cut Out Locations](#); For Exact Measurements of Locations, [See Details](#).

TOP LOCATIONS AVAILABLE BY BASE & MODULE COMBINATION

OC On Center

BB Between Bases (requires 2 modules)

CL Left of Center















CR Right of Center

EL End Left

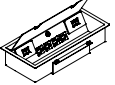
ER End Right

ML Middle Left

MR Middle Right

36x72				42x96			
	RECTANGLE	SQUARE	QUEEN ANNE		RECTANGLE	SQUARE	QUEEN ANNE
GROMMET 	OC	OC	OC	GROMMET 	OC EL EL + ER	OC EL EL + ER	OC
POWER & DATA VAULT 	OC			POWER & DATA VAULT 	OC EL EL + ER	OC EL EL + ER	OC
OASIS MINI 	OC			OASIS MINI 	OC EL EL + ER	OC EL EL + ER	OC
INTERACT 	OC			INTERACT 	OC EL EL + ER	OC EL EL + ER	OC
INTRFC1 	OC			INTRFC1 	OC EL EL + ER	OC EL EL + ER	OC
POWER 440 	OC	OC	OC	POWER 440 	OC EL EL + ER	OC EL EL + ER	OC
DPORT4A 	OC	OC	OC	DPORT4A 	OC EL EL + ER	OC EL EL + ER	OC

[See Cameo Overview For Ordering Options](#)

















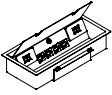



48"x120" & 48"x144" TOPS

For General Location Information, [See Cut Out Locations](#); For Exact Measurements of Locations, [See Details](#).

TOP LOCATIONS AVAILABLE BY BASE & MODULE COMBINATION

OC On Center **CL** Left of Center **EL** End Left **ML** Middle Left
BB Between Bases (requires 2 modules) **CR** Right of Center **ER** End Right **MR** Middle Right

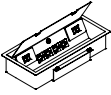
	48x120		
	RECTANGLE 	SQUARE 	QUEEN ANNE 
GROMMET 	BB, CL or EL CL + CR EL + ER CL + EL + ER CL + CR + EL + ER	BB, CL or EL CL + CR EL + ER CL + EL + ER CL + CR + EL + ER	BB
POWER & DATA VAULT 	BB, CL or EL CL + CR EL + ER CL + EL + ER CL + CR + EL + ER	OC EL EL + ER OC + EL + ER	
OASIS MINI 	BB, CL or EL CL + CR EL + ER CL + EL + ER CL + CR + EL + ER	OC EL EL + ER OC + EL + ER	
INTERACT 	BB, CL or EL CL + CR EL + ER CL + EL + ER CL + CR + EL + ER	OC EL EL + ER OC + EL + ER	BB
INTRFC1 	BB, CL or EL CL + CR EL + ER CL + EL + ER CL + CR + EL + ER	OC EL EL + ER OC + EL + ER	BB
POWER 440 	BB, CL or EL CL + CR EL + ER CL + EL + ER CL + CR + EL + ER	BB, CL or EL CL + CR EL + ER CL + EL + ER CL + CR + EL + ER	BB
DPORT4A 	BB, CL or EL CL + CR EL + ER CL + EL + ER CL + CR + EL + ER	OC EL EL + ER OC + EL + ER	BB

	48x144		
	RECTANGLE 	SQUARE 	QUEEN ANNE 
GROMMET 	BB, CL or EL CL + CR EL + ER CL + EL + ER CL + CR + EL + ER	BB, CL or EL CL + CR EL + ER CL + EL + ER CL + CR + EL + ER	BB
POWER & DATA VAULT 	BB, CL or EL CL + CR EL + ER CL + EL + ER CL + CR + EL + ER	OC BB EL EL + ER OC + EL + ER	BB
OASIS MINI 	BB, CL or EL CL + CR EL + ER CL + EL + ER CL + CR + EL + ER	OC BB EL EL + ER OC + EL + ER	BB
INTERACT 	BB, CL or EL CL + CR EL + ER CL + EL + ER CL + CR + EL + ER	OC BB EL EL + ER OC + EL + ER	BB
POWER CENTER 	BB, CL or EL CL + CR EL + ER CL + EL + ER CL + CR + EL + ER	OC BB EL EL + ER OC + EL + ER	BB
POWER 440 	BB, CL or EL CL + CR EL + ER CL + EL + ER CL + CR + EL + ER	BB, CL or EL CL + CR EL + ER CL + EL + ER CL + CR + EL + ER	BB
DPORT4A 	BB, CL or EL CL + CR EL + ER CL + EL + ER CL + CR + EL + ER	OC BB EL EL + ER OC + EL + ER	BB

[See Cameo Overview For Ordering Options](#)



48" x 168" & 48" x 192" TOPS

For General Location Information, [See Cut Out Locations](#); For Exact Measurements of Locations, [See Details](#).

TOP LOCATIONS AVAILABLE BY BASE & MODULE COMBINATION

OC On Center

BB Between Bases (requires 2 modules)

CL Left of Center

CR Right of Center

EL End Left

ER End Right

ML Middle Left

MR Middle Right

48x168			
	RECTANGLE	SQUARE	QUEEN ANNE
	BB, CL or EL CL + CR EL + ER CL + EL + ER CL + CR + EL + ER	BB, CL or EL CL + CR EL + ER CL + EL + ER CL + CR + EL + ER	BB
	BB, CL or EL CL + CR EL + ER CL + EL + ER CL + CR + EL + ER	OC, BB or EL EL + ER OC + EL + ER	BB
	BB, CL or EL CL + CR EL + ER CL + EL + ER CL + CR + EL + ER	OC, BB or EL EL + ER OC + EL + ER	BB
	BB, CL or EL CL + CR EL + ER CL + EL + ER CL + CR + EL + ER	OC, BB or EL EL + ER OC + EL + ER	BB
	BB, CL or EL CL + CR EL + ER CL + EL + ER CL + CR + EL + ER	OC, BB or EL EL + ER OC + EL + ER	BB
	BB, CL or EL CL + CR EL + ER CL + EL + ER CL + CR + EL + ER	BB, CL or EL CL + CR EL + ER CL + EL + ER CL + CR + EL + ER	BB
	BB, CL or EL CL + CR EL + ER CL + EL + ER CL + CR + EL + ER	OC, BB or EL EL + ER OC + EL + ER	BB

48x192			
	RECTANGLE	SQUARE	QUEEN ANNE
	CL or EL CL + CR EL + ER ML + MR CL + EL + ER CL + ML + MR CL + CR + EL + ER CL + CR + ML + MR	BB, CL or EL CL + CR EL + ER ML + MR CL + EL + ER CL + ML + MR CL + CR + EL + ER CL + CR + ML + MR	BB ML + MR
	CL or EL CL + CR EL + ER ML + MR CL + EL + ER CL + ML + MR CL + CR + EL + ER CL + CR + ML + MR	OC, BB or EL EL + ER ML + MR OC + EL + ER OC + ML + MR	BB ML + MR
	CL or EL CL + CR EL + ER ML + MR CL + EL + ER CL + ML + MR CL + CR + EL + ER CL + CR + ML + MR	OC, BB or EL EL + ER ML + MR OC + EL + ER OC + ML + MR	BB ML + MR
	CL or EL CL + CR EL + ER ML + MR CL + EL + ER CL + ML + MR CL + CR + EL + ER CL + CR + ML + MR	OC, BB or EL EL + ER ML + MR OC + EL + ER OC + ML + MR	BB ML + MR
	CL or EL CL + CR EL + ER ML + MR CL + EL + ER CL + ML + MR CL + CR + EL + ER CL + CR + ML + MR	OC, BB or EL EL + ER ML + MR OC + EL + ER OC + ML + MR	BB ML + MR
	CL or EL CL + CR EL + ER ML + MR CL + EL + ER CL + ML + MR CL + CR + EL + ER CL + CR + ML + MR	BB, CL or EL CL + CR EL + ER ML + MR CL + EL + ER CL + ML + MR CL + CR + EL + ER CL + CR + ML + MR	BB ML + MR
	CL or EL CL + CR EL + ER ML + MR CL + EL + ER CL + ML + MR CL + CR + EL + ER CL + CR + ML + MR	OC, BB or EL EL + ER ML + MR OC + EL + ER OC + ML + MR	BB ML + MR

[See Cameo Overview For Ordering Options](#)

Catalyst Tables blend desired aesthetics, functionality, and technology to deliver a comprehensive solution for all types of meeting needs and spaces. The line boasts a broad selection of veneers, laminates, and glass with a variety of top shapes, and a vast range of sizes spanning from 36”D to 60”D and 36”W to 240”W, integrated power/data, and a variety of heights, including work, counter, and bar. Buffets, Credenzas, Waste Bins, and more will help to complete your space.

CONSTRUCTION

veneer

- Exposed surfaces feature select grade plain-sliced hardwood veneers in Cherry, Maple, American Black Walnut, or composite veneers. Veneers are carefully selected and matched to assure proper balance and consistency
- Veneer features UVAdvantage, an ultra-violet finish, on all exposed surfaces by utilizing roll-coat UV technology

LAMINATE

- Thermally-Fused Laminate (TFL) and High-Pressure Laminate (HPL) are made of woodgrain and solid color laminates fused to particleboard core; each laminate offers lasting beauty, superior resistance to normal wear, and easy maintenance

TOPS

- Veneer (W) or HPL (P) Tops available in five shapes: Rectangle, Boat, Modern Rectangle, Square and Round with woodgrain patterns following the depth (short) of Veneer (W) table tops while grain patterns follow the width (long) of HPL (P) table tops
- Tops are shaped on all four sides and are available in two thicknesses and five edge profiles
- Double Kerf (F), Duo (G) and Square (Y) available in Veneer (W) and HPL (P) tops with 3-ply balanced construction, 1 $\frac{3}{16}$ ” thick and matching 3mm wood or PVC edge bands on profiled edges; Designer White, Sugar Maple, and Williamsburg Cherry feature ABS edge bands
- Knife (K) edge profile tops are 1 $\frac{3}{16}$ ” thick with solid wood rims available on both Veneer (W) or HPL (P) tops
- Vertical Square (H) edge profile tops are 1 $\frac{1}{2}$ ” thick with 1.5mm wood edge band on Veneer (W) tops and 1mm PVC edge band on HPL (P) tops; Designer White, Sugar Maple, and Williamsburg Cherry feature ABS edge bands
- Credenzas, buffets, and other ancillary support models are available in Square (Y), Double Kerf (F), Duo (G), and Vertical Square (H) edge profiles and profiled on approach side only
- All Veneer tops, as well as Laminate tops up to 144” (12 feet), will have matching woodgrain. Laminate tops sized 156” (13 feet) and longer will have non-matching woodgrain
- All surfaces feature reverse slip matched pattern
- Back Painted, Tempered Glass Tops are 1/4” thick and are attached to a substrate topped with black paper covering
- Tempered glass top has a 1/8” overhang from the sub-top

LOCKING

- All box drawers feature locking
- Removable lock cylinders allow for units to be re-keyed at a later date, if required
- Units are shipped randomly keyed as standard
- Keyed alike units available upon request at no additional charge
- Lock core is predetermined by pull color. Black lock cores are used with black and gold pulls while silver lock cores are used with chrome and aluminum pulls
- Optional locking doors available on buffets and credenzas

BASES

- All rectangle bases are available in TFL (T) or Veneer (W), feature vertical grain direction and include L-bracket hardware for easy installation

BASES CON'T

- Rectangle box bases include removable access panel and wire management and support trough
- Rectangle Accent bases feature 5/16” metal accent available in four colors including Aluminum, Black, Gold, and Platinum
- All units ship with heavy-duty, adjustable leveling glides to ensure proper leveling and compensation for uneven floors

CHASSIS

- All credenzas are available in TFL (T) or Veneer (W) with vertical grain direction
- Chassis for storage units are securely fastened using high quality European fastening systems and heavy-duty 16-gauge joining brackets to assure maximum strength
- All units ship with heavy-duty, adjustable leveling glides to ensure proper leveling and compensation for uneven floors

DRAWERS

- Drawers feature 5-sided drawer construction allowing for easy removal of drawer fronts; All drawer fronts are standard with elegant vertically matched faces
- Drawer sides, back, and front are woodgrain vinyl-wrapped 1/2” thick with 1/8” thick hardboard bottoms
- Drawer interiors are dovetail construction with 7/16” thick hardwood sides and backs, and 5/32” thick hardboard bottoms
- All drawers feature full extension, progressive action slides with precision steel ball bearings
- Box drawers are tested for 100lb capacity
- All suspensions have a limited lifetime warranty

STORAGE

- All hinged doors are soft-close with one piece hinge and base plate combination
- Soft close hinges reduce stress placed on the cabinet when the door is closed and offers a quiet closure
- All Credenzas feature a 2”W wire management channel along back of the interior cabinet for easy accessibility to wall outlets

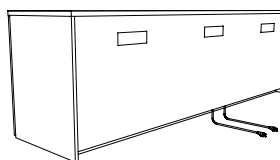

2”W wire management channel

INTERIOR DRAWER DIMENSIONS

Models

88-2496BF

	W	L	D
Box Drawers	15 $\frac{3}{4}$ "	16 $\frac{3}{8}$ "	3 $\frac{2}{32}$ "

Models

88-2484BF

	W	L	D
Box Drawers	30"	16 $\frac{3}{8}$ "	3 $\frac{2}{32}$ "
	13 $\frac{3}{8}$ "	16 $\frac{3}{8}$ "	3 $\frac{2}{32}$ "

Models

88-2472BF

88-2436BF

	W	L	D
Box Drawers	32 $\frac{3}{16}$ "	16 $\frac{3}{8}$ "	3 $\frac{2}{32}$ "

Models

88-2460BF

	W	L	D
Box Drawers	16 $\frac{1}{2}$ "	16 $\frac{3}{8}$ "	3 $\frac{2}{32}$ "

Models

88-2448BF

	W	L	D
Box Drawers	20 $\frac{15}{16}$ "	16 $\frac{3}{8}$ "	3 $\frac{2}{32}$ "

INTERIOR CABINET DIMENSIONS

Models

88-2496BF

	W	D	H
Double Door	36 $\frac{3}{4}$ "	22 $\frac{3}{8}$ "	23 $\frac{1}{2}$ "
Single Door with Waste Bin	18"	22 $\frac{3}{8}$ "	23 $\frac{1}{2}$ "

Models

88-2484BF

	W	D	H
Double Door	32"	22 $\frac{3}{8}$ "	23 $\frac{1}{2}$ "
Single Door with Waste Bin	15 $\frac{1}{2}$ "	22 $\frac{3}{8}$ "	23 $\frac{1}{2}$ "

Models

88-2472BF

88-2436BF

	W	D	H
Double Door	34 $\frac{3}{8}$ "	22 $\frac{3}{8}$ "	23 $\frac{1}{2}$ "
Single Door with Waste Bin	16 $\frac{3}{4}$ "	22 $\frac{3}{8}$ "	23 $\frac{1}{2}$ "

Models

88-2460BF

	W	D	H
Single Door	18 $\frac{3}{8}$ "	22 $\frac{3}{8}$ "	23 $\frac{1}{2}$ "

Models

88-2448BF

	W	D	H
Double Door	46 $\frac{3}{8}$ "	22 $\frac{3}{8}$ "	23 $\frac{1}{2}$ "
Single Door with Waste Bin	22 $\frac{3}{4}$ "	22 $\frac{3}{8}$ "	23 $\frac{1}{2}$ "

Models

88-2496CC

	W	D	H
Double Door	36 $\frac{3}{4}$ "	22 $\frac{3}{8}$ "	24 $\frac{3}{8}$ "
Single Door with Waste Bin	18"	22 $\frac{3}{8}$ "	24 $\frac{3}{8}$ "

Models

88-2484CC

	W	D	H
Double Door	32"	22 $\frac{3}{8}$ "	24 $\frac{3}{8}$ "
Single Door with Waste Bin	15 $\frac{1}{2}$ "	22 $\frac{3}{8}$ "	24 $\frac{3}{8}$ "

Models

88-2472CC

88-2436BF

	W	D	H
Double Door	34 $\frac{3}{8}$ "	22 $\frac{3}{8}$ "	24 $\frac{3}{8}$ "
Single Door with Waste Bin	16 $\frac{3}{4}$ "	22 $\frac{3}{8}$ "	24 $\frac{3}{8}$ "

Models

88-2460CC

	W	D	H
Single Door with Waste Bin	18 $\frac{3}{8}$ "	22 $\frac{3}{8}$ "	24 $\frac{3}{8}$ "

Models

88-2448CC

	W	D	H
Double Door	46 $\frac{3}{8}$ "	22 $\frac{3}{8}$ "	24 $\frac{3}{8}$ "
Single Door with Waste Bin	22 $\frac{3}{4}$ "	22 $\frac{3}{8}$ "	24 $\frac{3}{8}$ "

Models

88-2096CC

	W	D	H
Double Door	36 $\frac{3}{4}$ "	18 $\frac{3}{8}$ "	24 $\frac{3}{8}$ "
Single Door	17 $\frac{3}{8}$ "	18 $\frac{3}{8}$ "	24 $\frac{3}{8}$ "

Models

88-2084CC

	W	D	H
Double Door	32"	18 $\frac{3}{8}$ "	24 $\frac{3}{8}$ "
Single Door	15 $\frac{1}{2}$ "	18 $\frac{3}{8}$ "	24 $\frac{3}{8}$ "

INTERIOR CABINET DIMENSIONS CONTINUED

Models

88-2072CC	88-2036CC		
	W	D	H
Single Door	34 ³ / ₈ "	18 ³ / ₈ "	24 ³ / ₈ "

Models

88-2060CC			
	W	D	H
Single Door	18 ³ / ₈ "	18 ³ / ₈ "	24 ³ / ₈ "

Models

88-2048CC			
	W	D	H
Double Door	46 ³ / ₈ "	18 ³ / ₈ "	24 ³ / ₈ "

HOW TO ORDER EXAMPLES

SQUARE MEETING TABLE

	QTY	MODEL NO.		EXAMPLE
TOP	1	88-4848SQ	Top/Edge Material Finish/Color Edge Profile Glass Top Glass Color/Surface Finish Power/Data Location	P FO 3MMW/F Y GBLG OC
BASE	1	08-2642LXB		
POWER	1	01-DUOBEZELS		

MODERN RECTANGLE MEETING TABLES

	QTY	MODEL NO.		EXAMPLE
TOP	1	88-54192MR	Top/Edge Material Top/Edge Finish/Color Edge Profile Glass Top Glass Color/Surface Finish Grommet/Power/Data Type Grommet/Power/Data Location	W MAS 3MMW/F Y GBLG DPORTA OC
BASES	1	88-2415406RAB	Base Material Base Finish/Color Accent Finish/Color Metal Accent Color	W MAS BL GLD
POWER	1	DPORTA		

STORAGE & ACCESSORIES

Buffet Credenza			
QTY	MODEL NO.		EXAMPLE
1	88-2472BF	Top/Edge Material Finish/Color Edge Profile Chassis Finish/Color Glass Top Glass Color/Surface Finish Studio Pull Color Locking Drawer Construction Drawer Track Vent Waste Bin	W MAS 3MMW/F ORW Y GBLG GST LKT_BFD DOVE SFTCL VENT WBL

VENEER (W) OPTIONS ON TOPS / EDGES, BASES, AND ACCENT PANELS

Veneer features UVAdvantage, an ultra-violet finish, on all exposed surfaces or our Catalyzed finish (where noted), which is a multi-step, finish process that provides years of lasting beauty.

AW	Artisan Walnut	MW	Mahogany Walnut
AS	Asian Night	MAS	Mesa Sunset*
CO	Columbian Walnut	MTS	Metropolis Sky
DC	Dark Cherry	ORW	Oak Riftwood*
DFW	Dark Forest Walnut	PNW	Pinnacle Walnut
EW	Espresso	SCH	Select Cherry
FO	Fawn Oak*	SKC	Shaker Cherry
GC	Golden Cherry	SM	Sugar Maple
HW	Harvest Walnut	WTA	Weathered Ash*
HNW	Henna Walnut	WC	Williamsburg Cherry
LW	Legacy Walnut		

* Finish is Low Sheen

TFL (T) OPTIONS FOR BASES / ACCENT PANELS AND HPL (P) LAMINATE OPTIONS ON TOPS / EDGES

WOODGRAIN			
AS	Asian Night	PNW	Pinnacle Walnut
BW	Beigewood	PTK	Portico Teak
CO	Columbian Walnut	RC	River Cherry
EF	Espresso	SPW	Sepia Walnut
FLW	Florence Walnut	SKC	Shaker Cherry
GC	Golden Cherry	SCH	Select Cherry
HVM	Harvest Maple	SBP	Smoky Brown Pear
KHE	Kirsche	TK	Studio Teak
MW	Mahogany Walnut	SM	Sugar Maple
MNR	Midnight Run	WTA	Weathered Ash
NTM	Natural Marrone	WNB	White Nebbia
ORW	Oak Riftwood	WC	Williamsburg Cherry
SOLID			
BL	Black	FHG	Fashion Grey
WH	Designer White	SG	Slate Grey

BASE METAL ACCENT COLOR OPTIONS

6" and 10" Rectangle Accent Bases feature 5/16" metal trim. Must specify color

ALUM	Aluminum	PLAT	Platinum
BLK	Black	GLD	Gold

EDGE PROFILES

Double Kerf (F), Duo (G), Square (Y) and Knife (K) edge profiles are 1 3/16" thick and available in Veneer (W) and HPL (P) tops. Vertical Square (H) edge profile available is 1 1/2" thick and also available Veneer (W) and HPL (P) tops. Must specify edge profile.

Knife (K) edge not available on buffet and credenzas

Laminate (P) Top Edges

3MMP/F	Double Kerf (1 3/16" H)	3MMP/Y	Square (1 3/16" H)
3MMP/G	Duo (1 3/16" H)	RIMP/K	Knife (1 3/16" H)
3MMP/X	Fluted (1 3/16" H)	HP	Vertical Square (1 1/2" H)

Veneer (W) Top Edges

3MMW/F	Double Kerf (1 3/16" H)	3MMW/Y	Square (1 3/16" H)
3MMW/G	Duo (1 3/16" H)	RIMW/K	Knife (1 3/16" H)
3MMW/X	Fluted (1 3/16" H)	HW	Vertical Square (1 1/2" H)



Double Kerf (F) 1 3/16" H Duo (G) 1 3/16" H Fluted (X) 1 3/16" H Square (Y) 1 3/16" H



Knife (K) 1 3/16" H Vertical Square (H) 1 1/2" H

PULL OPTIONS

Buffets and Credenzas available with pulls on doors. Must specify and select color.

Lock core color is predetermined by pull color.

AST	Studio, Aluminum	CST	Studio, Chrome
BST	Studio, Black	GST	Studio, Gold



Studio (AST) Aluminum - 13" Studio (BST) Black - 13" Studio (CST) Chrome - 13"



Studio (GST) Gold - 13"

GLASS OPTIONS ON TOPS

Back painted tempered glass tops are 1/4" thick and available in Black or White with Gloss or Acid Etched finish. Glass top sits 1/16" on top of substrate top. Must specify color and finish.

GWHG	White Gloss	GBLG	Black Gloss
GWHA	White Acid Etched	GBLA	Black Acid Etched



White Gloss (GWHG) White Acid Etched (GWHA) Black Gloss (GBLG) Black Acid Etched (GBLA)

LOCK CORE COLOR OPTIONS

BLK	Black (Used with Black and Gold Pulls)
SLV	Silver (Used with Aluminum and Chrome Pulls)



Black (BLK) Silver (SLV)

GROMMET & POWER UNIT OPTIONS

Power units and grommets are available on Rectangle, Modern Rectangle, and Boat shaped tops. Each unit is sold separately and must be specified separately with surface mount location. Multiple locations may be selected. Only one unit per location.

Power units and Grommets Available in Table Surfaces (See Units)

Grommet	\$ 52
Specify Color: Black = BLK and Silver = SLV	

DUO/TRIO BEZEL

01-DUOBEZEL	Available in Black (B), Silver (S), or White (W)
01-TRIOBEZEL	Available in Black (B), Silver (S), or White (W)

DOCK 950, DOCK 800 and DOCK 150

DOCK950	Available in Black or White
DOCK150	Available in Black or White
DOCK800	Available in Black or Silver

Other Power Units

DPORT4	Available in Aluminum or Black
ELLORA	Available in Aluminum or Black
E2X	Available in Aluminum or Black
INTERACTG	Available in Aluminum or Black
OASISM	Available in Aluminum or Black

Power/Data Location Information:

- Designate unit and location when specifying the top model. Power/Data Module need to be ordered separately.
- Power/Data Modules specified at the time of order will be routed for field installation.

E1	Unit on One End
E2	Unit on Each End
OC	Unit on Center

- All power units available **On Center (OC)** only when paired with two (2) or more of the following bases:

Cylinder Base	Square Base
X-Base	Disc
Tubular X-Base	

Grommets and Power Units may be ordered in non-standard locations. Call Customer Service to assist with specification and/or please attach a drawing to the PO showing the location of the grommet. Note additional charges and lead times may apply.

Top Locations

Power units available on Each End (E1 and E2) and On Center (OC) unless otherwise noted, when paired with any Rectangle Panel Base, Rectangle Box Base or Rectangle Accent Box Base.

Power units centered at locations below:

36" Tops	Centered 18"D	54" Tops	Centered 27"D
42" Tops	Centered 21"D	60" Tops	Centered 30"D
48" Tops	Centered 24"D		

GROMMET OPTIONS & POWER UNIT OPTIONS CONTINUED

Top Locations Continued

- 72: OC 36" from end (available with OC Only)
- 84: OC 42" from end (available with OC Only)
- 96: OC 48" from end; E1/E2 29" from end
- 108: OC 54" from end; E1/E2 29" from end
- 120: OC 60" from end; E1/E2 29" from end
- 132: OC 66" from end; E1/E2 29" from end
- 144: OC 72" from end; E1/E2 29" from end
- 156: OC 78" from end; E1/E2 29" from end
- 168: OC 84" from end; E1/E2 29" from end
- 180: OC 90" from end; E1/E2 36" from end
- 192: OC 96" from end; E1/E2 36" from end
- 204: OC 102" from end; E1/E2 36" from end
- 216: OC 108" from end; E1/E2 36" from end
- 228: OC 114" from end; E1/E2 36" from end
- 240: OC 120" from end; E1/E2 36" from end

Example: 60x204 Modern Rectangle

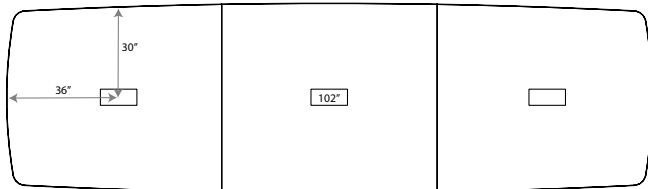

DRAWER TRACK OPTIONS

Soft close tracks are available on box drawers. Soft close drawer tracks have many benefits including reduced stress on the unit, extends the life of the drawer, and ensures a gentle close so fingers don't accidentally get pinched. Must specify when ordering.

Pricing is per Drawer, not per Model/Unit

SFTCL	Soft Close Drawer Track	\$ 34
-------	-------------------------	-------

VENT OPTION FOR CREDENZAS

Buffets and Credenzas feature optional ventilation grommets. Includes one vent per compartment.

Vents are 10" Down from top surface on Buffet Credenzas and 2 7/8" on Credenzas.

NONE	No Vent Grommet	
VENT	Vented back panel	\$ 68

Number of vents per unit:

36"	1 vent
72" / 48"	2 vents
96" / 84" / 60"	3 vents

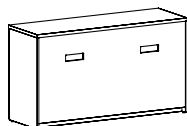

WASTE BIN OPTIONS

Buffet and 24" Credenzas are available with two (2) 41-quart beige waste bins in a pull out cabinet with silver hardware and divider panel. Adjacent cabinet features one (1) adjustable shelf. Studio pulls applied centered on doors when waste bin is selected. Locking not available.

WBL	Waste Bin on Left	\$ 510
WBR	Waste Bin on Right	\$ 510

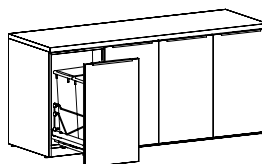

Shown as Left

LOCKING DOORS

Locking doors are available on Buffets and Credenzas. You must specify WITH LOCKING when ordering and add upcharge.

Note: When locking is selected with optional waste bin, locking will not apply to waste bin door.

LKT_BFD	96"W to 84"W Units	\$ 135
LKT_BFD	72"W to 48"W Units	\$ 115
LKT_BFD	36"W Units	\$ 91

CERTIFICATIONS & COMPLIANCE

- Intertek Sustainability Certified
- BIFMA level® Certified
- BIFMA Compliant® Certified
- TSCA Title VI (Formerly CARB) Compliance
- US Green Building's LEED® Contribution

Tops/Shapes



Square ([See Details](#))

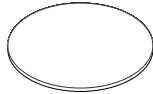

Round ([See Details](#))



Rectangular ([See Details](#))



Modern Rectangular ([See Details](#))



Boat ([See Details](#))

Bases

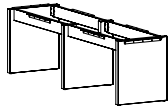

Rectangular Panel Bases with Trough ([See Details](#))

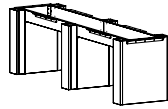

6" Rectangular Bases with Trough ([See Details](#))

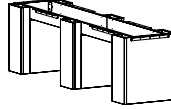

10" Rectangular Bases with Trough ([See Details](#))

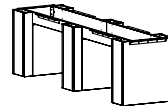

6" Rectangular Accent Bases with Trough ([See Details](#))

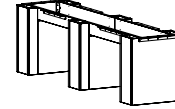

10" Rectangular Accent Bases with Trough ([See Details](#))

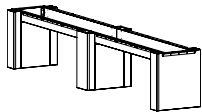

6" + 10" Combo Rectangular Bases with Trough ([See Details](#))

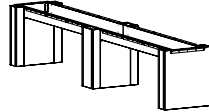

6" + 10" Combo Rectangular Accent Bases with Trough ([See Details](#))



Metal ([See Details](#))

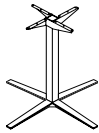

X-Base ([See Details](#))

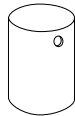

Cylinder ([See Details](#))



Disc Base ([See Details](#))

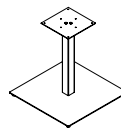

Square Base ([See Details](#))

Storage Components + Accessories

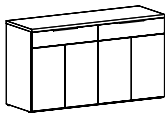

Buffet with Doors + Drawers ([See Details](#))

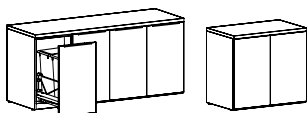

24" + 20" Credenzas with Doors ([See Details](#))

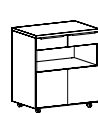

Mobile Serving Cart ([See Details](#))

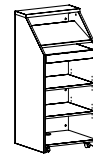

Lectern Stand ([See Details](#))

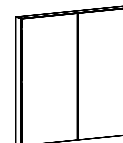

Visual Board ([See Details](#))

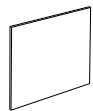
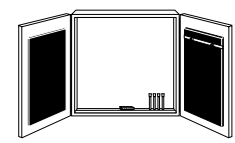

Marker Boards ([See Multiple Unit Details](#))



Marker, Eraser and Magnet Sets ([See Details](#))

Wire Management & Power/Data Accessories ([See Details](#))

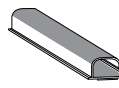
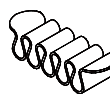
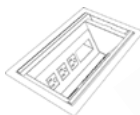
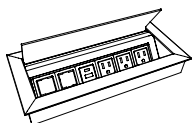

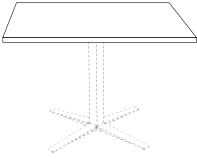

Item	Model No.		W	D	H	Ship Wt	Cubic Ft	Edge Profile + Material	List Price
SQUARE - 1 PIECE TOP  88-3636SQ shown with 08-2036SXB (Metal X-Base) BASES SOLD SEPARATELY Must Specify (in this order): Model # Top/Edge Material Top/Edge Finish/Color Edge Profile Glass (Y/N) Glass Color + Surface Finish	88-4848SQ	Laminate	48	48	1 ³ / ₁₆	82	7.2	F, G, X, Y / P\$	850
					1 ³ / ₁₆			K / P\$	1398
					1 ¹ / ₂			H / P\$	948
		Veneer	1 ³ / ₁₆	F, G, X, Y / W\$	967				
			1 ³ / ₁₆	K / W\$	1620				
			1 ¹ / ₂	H / W\$	1146				
	Glass	1/4	Acid Etched Glass Top \$	5455					
		1/4	Gloss Glass Top \$	4541					
	88-4242SQ	Laminate	42	42	1 ³ / ₁₆	70	3.4	F, G, X, Y / P\$	757
					1 ³ / ₁₆			K / P\$	1215
					1 ¹ / ₂			H / P\$	875
			Veneer	1 ³ / ₁₆	F, G, X, Y / W\$	866			
1 ³ / ₁₆				K / W\$	1468				
1 ¹ / ₂				H / W\$	962				
Glass		1/4	Acid Etched Glass Top \$	4396					
		1/4	Gloss Glass Top \$	3695					
88-3636SQ		Laminate	36	36	1 ³ / ₁₆	37	2.5	F, G, X, Y / P\$	648
					1 ³ / ₁₆			K / P\$	968
					1 ¹ / ₂			H / P\$	748
			Veneer	1 ³ / ₁₆	F, G, X, Y / W\$	827			
	1 ³ / ₁₆			K / W\$	1255				
	1 ¹ / ₂			H / W\$	885				
	Glass	1/4	Acid Etched Glass Top \$	3394					
		1/4	Gloss Glass Top \$	2879					
	88-3030SQ	Laminate	30	30	1 ³ / ₁₆	30	2.3	F, G, X, Y / P\$	550
					1 ³ / ₁₆			K / P\$	824
					1 ¹ / ₂			H / P\$	620
			Veneer	1 ³ / ₁₆	F, G, X, Y / W\$	632			
1 ³ / ₁₆				K / W\$	976				
1 ¹ / ₂				H / W\$	676				
Glass		1/4	Acid Etched Glass Top \$	2597					
		1/4	Gloss Glass Top \$	2238					

Description

- Tops Feature a 1-piece, 1³/₁₆" or 1¹/₂" Thick Top in Veneer (W) or HPL (P)
- Must Specify Edge Profile: 1³/₁₆" Thick/Double Kerf (F), Duo (G), Fluted (X), Square (Y), and Knife (K) Edge Profiles or 1¹/₂" Thick/Vertical Square (H)
- Due to Top Sizes and Base Placement, Power is Not Available on Square Tops
- Available with Back Painted Tempered Glass Top; Must Specify Color and Finish; [See Options](#)
- Bases Sold Separately, See [Multiple Base Options](#)



Double Kerf (F) 1³/₁₆" Duo (G) 1³/₁₆" Fluted (X) 1³/₁₆" Square (Y) 1³/₁₆" Knife (K) 1³/₁₆" Vertical Square (H) 1¹/₂"

P = HPL W = Veneer

[See Catalyst Overview For Ordering Options](#)

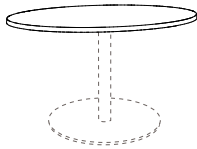
Item	Model No.		W	D	H	Ship Wt	Cubic Ft	Edge Profile + Material	List Price
ROUND - 1 PIECE TOP  88-4848CT shown with 01-3230DBB (Disc Base) BASES SOLD SEPARATELY Must Specify (in this order): Model # Top/Edge Material Top/Edge Finish/Color Edge Profile Glass (Y/N) Glass Color + Surface Finish	88-6060CT	Laminate	60	60	1 3/16	143	8.4	F, G, X, Y / P\$	1037
					1 3/16			K / P\$	2195
					1 1/2			H / P\$	1085
		Veneer	1 3/16	F, G, X, Y / W\$	1406				
			1 3/16	K / W\$	2461				
			1 1/2	H / W\$	1662				
	Glass	1/4	Acid Etched Glass Top \$	8681					
		1/4	Gloss Glass Top \$	7210					
	88-5454CT	Laminate	54	54	1 3/16	114	6.8	F, G, X, Y / P\$	997
					1 3/16			K / P\$	2003
					1 1/2			H / P\$	1033
			Veneer	1 3/16	F, G, X, Y / W\$	1248			
1 3/16				K / W\$	2190				
1 1/2				H / W\$	1460				
Glass		1/4	Acid Etched Glass Top \$	7267					
		1/4	Gloss Glass Top \$	6073					
88-4848CT		Laminate	48	48	1 3/16	90	5.5	F, G, X, Y / P\$	904
					1 3/16			K / P\$	1894
					1 1/2			H / P\$	930
			Veneer	1 3/16	F, G, X, Y / W\$	1024			
	1 3/16			K / W\$	2130				
	1 1/2			H / W\$	1195				
	Glass	1/4	Acid Etched Glass Top \$	6064					
		1/4	Gloss Glass Top \$	5122					
	88-4242CT	Laminate	42	42	1 3/16	70	3.4	F, G, X, Y / P\$	806
					1 3/16			K / P\$	1632
					1 1/2			H / P\$	870
			Veneer	1 3/16	F, G, X, Y / W\$	923			
1 3/16				K / W\$	1895				
1 1/2				H / W\$	1008				
Glass		1/4	Acid Etched Glass Top \$	4890					
		1/4	Gloss Glass Top \$	4174					

Additional Round Tops on Next Page.



Double Kerf (F) 1 3/16" Duo (G) 1 3/16" Fluted (X) 1 3/16" Square (Y) 1 3/16" Knife (K) 1 3/16" Vertical Square (H) 1 1/2"

P = HPL W = Veneer

[See Catalyst Overview For Ordering Options](#)

Item	Model No.		W	D	H	Ship Wt	Cubic Ft	Edge Profile + Material	List Price	
<i>CONTINUED FROM PREVIOUS PAGE</i>	88-3636CT	Laminate	36	36	1 3/16"	37	2.5	F, G, X, Y / P\$	700	
					1 3/16"			K / P\$	1439	
					1 1/2"			H / P\$	794	
					Veneer			1 3/16"	F, G, X, Y / W\$	881
								1 3/16"	K / W\$	1720
								1 1/2"	H / W\$	893
	Glass	1/4"	Acid Etched Glass Top \$	3903						
		1/4"	Gloss Glass Top \$	3373						
	88-3030CT	Laminate	30	30	1 3/16"	30	2.3	F, G, X, Y / P\$	610	
					1 3/16"			K / P\$	1196	
					1 1/2"			H / P\$	638	
					Veneer			1 3/16"	F, G, X, Y / W\$	684
1 3/16"								K / W\$	1332	
1 1/2"								H / W\$	736	
Glass	1/4"	Acid Etched Glass Top \$	3463							
	1/4"	Gloss Glass Top \$	3094							

Must Specify (in this order):

- Model #
- Top/Edge Material
- Top/Edge Finish/Color
- Edge Profile
- Glass (Y/N)
- Glass Color + Surface Finish

Description

- Tops Feature a 1-piece, 1 3/16" or 1 1/2" Thick Top in Veneer (W) or HPL (P)
- Must Specify Edge Profile: 1 3/16" Thick/Double Kerf (F), Duo (G), Fluted (X), Square (Y), and Knife (K) Edge Profiles or 1 1/2" Thick/Vertical Square (H)
- 60" and 54" Tops Feature Catalyzed Finish
- Due to Top Sizes and Base Placement, Power is Not Available on Round Tops
- Available with Back Painted Tempered Glass Top; Must Specify Color and Finish; [See Options](#)
- Bases Sold Separately, See [Multiple Base Options](#)



Double Kerf (F)
1 3/16"



Duo (G)
1 3/16"



Fluted (X)
1 3/16"



Square (Y)
1 3/16"



Knife (K)
1 3/16"



Vertical Square (H)
1 1/2"

P = HPL W = Veneer C = Combination of Wood/Laminate

[See Catalyst Overview For Ordering Options](#)

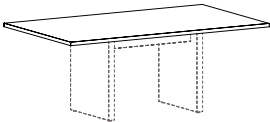
Item	Model No.		W	D	H	Ship Wt	Cubic Ft	Edge Profile + Material	List Price	
RECTANGLE SHAPE MEETING TOP 36"D  88-3672RT shown with 88-2034RPB (Rectangle Panel Base) BASES SOLD SEPARATELY	36"D x 96"W or 8' - 1 Piece Rectangle Top									
	88-3696RT	Laminate	96	36	1 3/16	142	12.9	F, G, X, Y / P\$	1364	
					1 3/16			K / P\$	2150	
					1 1/2			H / P\$	1547	
		Veneer			1 3/16			F, G, X, Y / W\$	1544	
					1 3/16			K / W\$	2556	
					1 1/2			H / W\$	1858	
		Glass			1/4			Acid Etched Glass Top \$	8134	
					1/4			Gloss Glass Top \$	6806	
	36"D x 84"W or 7' - 1 Piece Rectangle Top									
	88-3684RT	Laminate	84	36	1 3/16	126	11.3	F, G, X, Y / P\$	1299	
					1 3/16			K / P\$	2006	
				1 1/2			H / P\$	1489		
	Veneer			1 3/16			F, G, X, Y / W\$	1462		
				1 3/16			K / W\$	2437		
				1 1/2			H / W\$	1707		
	Glass			1/4			Acid Etched Glass Top \$	7313		
				1/4			Gloss Glass Top \$	6151		
36"D x 72"W or 6' - 1 Piece Rectangle Top										
88-3672RT	Laminate	72	36	1 3/16	109	10.3	F, G, X, Y / P\$	1052		
				1 3/16			K / P\$	1695		
				1 1/2			H / P\$	1188		
	Veneer			1 3/16			F, G, X, Y / W\$	1238		
				1 3/16			K / W\$	1957		
				1 1/2			H / W\$	1478		
	Glass			1/4			Acid Etched Glass Top \$	6321		
				1/4			Gloss Glass Top \$	5324		

Must Specify (in this order):

- Model #
- Top/Edge Material
- Top/Edge Finish/Color
- Edge Profile
- Glass (Y/N)
- Glass Color + Surface Finish
- Power/Data Type
- Power/Data Location

Description

- Tops Available with Veneer (W) or HPL (P) Top in 1 3/16" and 1 1/2" Thicknesses
- Must Specify Edge Profile: 1 3/16" Thick/Double Kerf (F), Duo (G), **Fluted (X)**, Square (Y), and Knife (K) Edge Profiles or 1 1/2" Thick/Vertical Square (H)
- Veneer (W) Top Grain Runs Depth of Top and HPL (P) Top Grain Runs Width of Top
- Available with Back Painted Tempered Glass Top; Must Specify Color and Finish; [See Options](#)
- Power and Data Options Available; Sold Separately, [See Multiple Power Unit Details](#)
- Bases Sold Separately, See [Multiple Base Options](#)



Double Kerf (F)
1 3/16"



Duo (G)
1 3/16"



Fluted (X)
1 3/16"



Square (Y)
1 3/16"



Knife (K)
1 3/16"



Vertical Square (H)
1 1/2"

P = HPL W = Veneer

[See Catalyst Overview For Ordering Options](#)

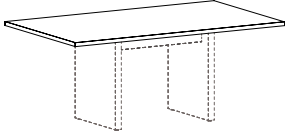
Item	Model No.		W	D	H	Ship Wt	Cubic Ft	Edge Profile + Material	List Price	
RECTANGLE SHAPE MEETING TOP 42"D  88-4272RT shown with 88-2034RPB (Rectangle Panel Base) BASES SOLD SEPARATELY	42"D x 120"W or 10' - 2 Piece Rectangle Top									
	88-42120RT	Laminate	120	42	1 3/16"	268	27.0	F, G, X, Y / P\$	1892	
					1 3/16"			K / P\$	3077	
					1 1/2"			H / P\$	2162	
		Veneer			1 3/16"			F, G, X, Y / W\$	2200	
					1 3/16"			K / W\$	3492	
					1 1/2"			H / W\$	2645	
		Glass			1/4"			Acid Etched Glass Top \$	11225	
					1/4"			Gloss Glass Top \$	9288	
	42"D x 108"W or 9' - 2 Piece Rectangle Top									
	88-42108RT	Laminate	108	42	1 3/16"	260	27.0	F, G, X, Y / P\$	1853	
					1 3/16"			K / P\$	2899	
				1 1/2"			H / P\$	2097		
	Veneer			1 3/16"			F, G, X, Y / W\$	2062		
				1 3/16"			K / W\$	3359		
				1 1/2"			H / W\$	2465		
	Glass			1/4"			Acid Etched Glass Top \$	10270		
				1/4"			Gloss Glass Top \$	8527		
42"D x 96"W or 8' - 1 Piece Rectangle Top										
88-4296RT	Laminate	96	42	1 3/16"	164	15.0	F, G, X, Y / P\$	1393		
				1 3/16"			K / P\$	2337		
				1 1/2"			H / P\$	1608		
	Veneer			1 3/16"			F, G, X, Y / W\$	1685		
				1 3/16"			K / W\$	2697		
				1 1/2"			H / W\$	2042		
	Glass			1/4"			Acid Etched Glass Top \$	8955		
				1/4"			Gloss Glass Top \$	7405		
42"D x 84"W or 7' - 1 Piece Rectangle Top										
88-4284RT	Laminate	84	42	1 3/16"	145	13.1	F, G, X, Y / P\$	1355		
				1 3/16"			K / P\$	2174		
				1 1/2"			H / P\$	1542		
	Veneer			1 3/16"			F, G, X, Y / W\$	1551		
				1 3/16"			K / W\$	2567		
				1 1/2"			H / W\$	1867		
	Glass			1/4"			Acid Etched Glass Top \$	8002		
				1/4"			Gloss Glass Top \$	6647		

Additional 42" Rectangle Shaped Tops on Next Page



Double Kerf (F) 1 3/16" Duo (G) 1 3/16" Fluted (X) 1 3/16" Square (Y) 1 3/16" Knife (K) 1 3/16" Vertical Square (H) 1 1/2"

P = HPL W = Veneer

[See Catalyst Overview For Ordering Options](#)

Item	Model No.		W	D	H	Ship Wt	Cubic Ft	Edge Profile + Material	List Price
42"D x 72"W or 6' - 1 Piece Rectangle Top									
<i>CONTINUED FROM PREVIOUS PAGE</i>	88-4272RT	Laminate	72	42	1 ³ / ₁₆	126	11.3	F, G, X, Y / P\$	1125
					1 ³ / ₁₆			K / P\$	1906
					1 ¹ / ₂			H / P\$	1285
		Veneer			1 ³ / ₁₆			F, G, X, Y / W\$	1408
					1 ³ / ₁₆			K / W\$	2134
					1 ¹ / ₂			H / W\$	1681
			Glass			1/4		Acid Etched Glass Top \$	7015
					1/4		Gloss Glass Top \$	5853	

Must Specify (in this order):

- Model #
- Top/Edge Material
- Top/Edge Finish/Color
- Edge Profile
- Glass (Y/N)
- Glass Color + Surface Finish
- Power/Data Type
- Power/Data Location

Description

- Tops Available with Veneer (W) or HPL (P) Top in 1³/₁₆" and 1¹/₂" Thicknesses
- Must Specify Edge Profile: 1³/₁₆" Thick/Double Kerf (F), Duo (G), Fluted (X), Square (Y), and Knife (K) Edge Profiles or 1¹/₂" Thick/Vertical Square (H)
- Veneer (W) Top Grain Runs Depth of Top and HPL (P) Top Grain Runs Width of Top
- Available with Back Painted Tempered Glass Top; Must Specify Color and Finish; [See Options](#)
- Power and Data Options Available; Sold Separately, [See Multiple Power Unit Details](#)
- Bases Sold Separately, See [Multiple Base Options](#)



Double Kerf (F)
1³/₁₆"



Duo (G)
1³/₁₆"



Fluted (X)
1³/₁₆"



Square (Y)
1³/₁₆"



Knife (K)
1³/₁₆"



Vertical Square (H)
1¹/₂"

P = HPL W = Veneer

[See Catalyst Overview For Ordering Options](#)

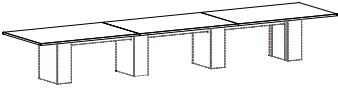
Item	Model No.		W	D	H	Ship Wt	Cubic Ft	Edge Profile + Material	List Price	
RECTANGLE SHAPE MEETING TOP 48" D  <p>88-48216RT shown with 88-2417810RB (10" Rectangle Base) BASES SOLD SEPARATELY</p> <p>Must Specify (in this order): Model # Top/Edge Material Top/Edge Finish/Color Edge Profile Glass (Y/N) Glass Color + Surface Finish Power/Data Type Power/Data Location</p>	48"D x 240"W or 20' - 3 Piece Rectangle Top									
	88-48240RT	Laminate	240	48	1 3/16	460	28.5	F, G, X, Y / P\$	4463	
					1 3/16				K / P\$	7279
					1 1/2				H / P\$	5088
		Veneer			1 3/16				F, G, X, Y / W\$	6000
					1 3/16				K / W\$	8081
					1 1/2				H / W\$	6974
		Glass			1/4				Acid Etched Glass Top \$	24958
					1/4				Gloss Glass Top \$	20531
	48"D x 228"W or 19' - 3 Piece Rectangle Top									
	88-48228RT	Laminate	228	48	1 3/16	438	27.0	F, G, X, Y / P\$	4419	
					1 3/16				K / P\$	7144
				1 1/2				H / P\$	5015	
	Veneer			1 3/16				F, G, X, Y / W\$	5743	
				1 3/16				K / W\$	7825	
				1 1/2				H / W\$	6670	
	Glass			1/4				Acid Etched Glass Top \$	23871	
				1/4				Gloss Glass Top \$	19666	
48"D x 216"W or 18' - 3 Piece Rectangle Top										
88-48216RT	Laminate	216	48	1 3/16	416	25.5	F, G, X, Y / P\$	3513		
				1 1/2				K / P\$	5875	
				1 3/16				H / P\$	4077	
	Veneer			1 3/16				F, G, X, Y / W\$	5081	
				1 3/16				K / W\$	6624	
				1 1/2				H / W\$	5961	
	Glass			1/4				Acid Etched Glass Top \$	22339	
				1/4				Gloss Glass Top \$	18355	
48"D x 204"W or 17' - 3 Piece Rectangle Top										
88-48204RT	Laminate	204	48	1 3/16	394	24.0	F, G, X, Y / P\$	3470		
				1 3/16				K / P\$	5739	
				1 1/2				H / P\$	4002	
	Veneer			1 3/16				F, G, X, Y / P\$	4824	
				1 3/16				K / W\$	6599	
				1 1/2				H / W\$	5657	
	Glass			1/4				Acid Etched Glass Top \$	21427	
				1/4				Gloss Glass Top \$	17664	

Additional 48" Rectangle Shaped Tops on Next Page



Double Kerf (F) 1 3/16" Duo (G) 1 3/16" Fluted (X) 1 3/16" Square (Y) 1 3/16" Knife (K) 1 3/16" Vertical Square (H) 1 1/2"

P = HPL W = Veneer

[See Catalyst Overview For Ordering Options](#)

Item	Model No.		W	D	H	Ship Wt	Cubic Ft	Edge Profile + Material	List Price	
48"D x 192"W or 16' - 2 Piece Rectangle Top										
<i>CONTINUED FROM PREVIOUS PAGE</i>	88-48192RT	Laminate	192	48	1 ³ / ₁₆	372	31.2	F, G, X, Y / P\$	3002	
					1 ³ / ₁₆			K / P\$	5173	
					1 ¹ / ₂			H / P\$	3500	
	Veneer	1 ³ / ₁₆	F, G, X, Y / W\$	4079						
		1 ³ / ₁₆	K / W\$	5673						
		1 ¹ / ₂	H / W\$	4861						
	Glass		1 ¹ / ₄	Acid Etched Glass Top \$	19497					
			1 ¹ / ₄	Gloss Glass Top \$	15957					
	48"D x 180"W or 15' - 2 Piece Rectangle Top									
	Must Specify (in this order): Model # Top/Edge Material Top/Edge Finish/Color Edge Profile Glass (Y/N) Glass Color + Surface Finish Power/Data Power/Data Location	88-48180RT	Laminate	180	48	1 ³ / ₁₆	350	31.2	F, G, X, Y / P\$	2959
						1 ³ / ₁₆			K / P\$	4936
						1 ¹ / ₂			H / P\$	3427
Veneer		1 ³ / ₁₆	F, G, X, Y / W\$	3910						
		1 ³ / ₁₆	K / W\$	5556						
		1 ¹ / ₂	H / W\$	4646						
Glass			1 ¹ / ₄	Acid Etched Glass Top \$	18411					
			1 ¹ / ₄	Gloss Glass Top \$	15091					
48"D x 168"W or 14' - 2 Piece Rectangle Top										
		88-48168RT	Laminate	168	48	1 ³ / ₁₆	328	31.2	F, G, X, Y / P\$	2808
						1 ³ / ₁₆			K / P\$	4653
						1 ¹ / ₂			H / P\$	3245
	Veneer	1 ³ / ₁₆	F, G, X, Y / W\$	3604						
		1 ³ / ₁₆	K / W\$	5242						
		1 ¹ / ₂	H / W\$	4292						
	Glass		1 ¹ / ₄	Acid Etched Glass Top \$	17213					
			1 ¹ / ₄	Gloss Glass Top \$	14114					
	48"D x 156"W or 13' - 2 Piece Rectangle Top									
		88-48156RT	Laminate	156	48	1 ³ / ₁₆	306	31.2	F, G, X, Y / P\$	2766
						1 ³ / ₁₆			K / P\$	4505
						1 ¹ / ₂			H / P\$	3171
Veneer		1 ³ / ₁₆	F, G, X, Y / W\$	3435						
		1 ³ / ₁₆	K / W\$	5043						
		1 ¹ / ₂	H / W\$	4077						
Glass			1 ¹ / ₄	Acid Etched Glass Top \$	16126					
			1 ¹ / ₄	Gloss Glass Top \$	13249					

Additional 48" Rectangle Shaped Tops on Next Page



Double Kerf (F)
1³/₁₆"



Duo (G)
1³/₁₆"



Fluted (X)
1³/₁₆"



Square (Y)
1³/₁₆"



Knife (K)
1³/₁₆"



Vertical Square (H)
1¹/₂"

P = HPL W = Veneer

[See Catalyst Overview For Ordering Options](#)

Item	Model No.		W	D	H	Ship Wt	Cubic Ft	Edge Profile + Material	List Price		
<i>CONTINUED FROM PREVIOUS PAGE</i>	48"D x 144"W or 12' - 2 Piece Rectangle Top										
	88-48144RT	Laminate	144	48	1 3/16	284	23.5	F, G, X, Y / P\$	2304		
					1 3/16			K / P\$	3924		
					1 1/2			H / P\$	2678		
		Veneer			1 3/16			F, G, X, Y / W\$	3197		
					1 3/16			K / W\$	4389		
					1 1/2			H / W\$	3792		
		Glass			1/4			Acid Etched Glass Top \$	15016		
					1/4			Gloss Glass Top \$	12360		
		48"D x 132"W or 11' - 2 Piece Rectangle Top									
	88-48132RT	Laminate	132	48	1 3/16	262	23.5	F, G, X, Y / P\$	2248		
					1 3/16			K / P\$	3775		
					1 1/2			H / P\$	2591		
		Veneer			1 3/16			F, G, X, Y / W\$	2975		
					1 3/16			K / W\$	4144		
					1 1/2			H / W\$	3522		
		Glass			1/4			Acid Etched Glass Top \$	13917		
					1/4			Gloss Glass Top \$	11481		
	48"D x 120"W or 10' - 2 Piece Rectangle Top										
88-48120RT	Laminate	120	48	1 3/16	240	23.5	F, G, X, Y / P\$	2183			
				1 3/16			K / P\$	3529			
				1 1/2			H / P\$	2493			
	Veneer			1 3/16			F, G, X, Y / W\$	2741			
				1 3/16			K / W\$	3975			
				1 1/2			H / W\$	3241			
	Glass			1/4			Acid Etched Glass Top \$	12806			
				1/4			Gloss Glass Top \$	10593			
	48"D x 108"W or 9' - 2 Piece Rectangle Top										
88-48108RT	Laminate	108	48	1 3/16	218	23.5	F, G, X, Y / P\$	2126			
				1 3/16			K / P\$	3361			
				1 1/2			H / P\$	2406			
	Veneer			1 3/16			F, G, X, Y / W\$	2518			
				1 3/16			K / W\$	3756			
				1 1/2			H / W\$	2970			
	Glass			1/4			Acid Etched Glass Top \$	11706			
				1/4			Gloss Glass Top \$	9715			

Must Specify (in this order):

- Model #
- Top/Edge Material
- Top/Edge Finish/Color
- Edge Profile
- Glass (Y/N)
- Glass Color + Surface Finish
- Power/Data Type
- Power/Data Location

Additional 48" Rectangle Shaped Tops on Next Page



Double Kerf (F)
1 3/16"



Duo (G)
1 3/16"



Fluted (X)
1 3/16"



Square (Y)
1 3/16"



Knife (K)
1 3/16"



Vertical Square (H)
1 1/2"

P = HPL W = Veneer

[See Catalyst Overview For Ordering Options](#)

Item	Model No.		W	D	H	Ship Wt	Cubic Ft	Edge Profile + Material	List Price	
48"D x 96"W or 8' - 1 Piece Rectangle Top										
<i>CONTINUED FROM PREVIOUS PAGE</i>	88-4896RT	Laminate	96	48	1 3/16	196	11.3	F, G, X, Y / P\$	1469	
					1 3/16			K / P\$	2549	
					1 1/2			H / P\$	1715	
		Veneer			1 3/16			F, G, X, Y / W\$	1883	
					1 3/16			K / W\$	2867	
					1 1/2			H / W\$	2284	
		Glass			1/4			Acid Etched Glass Top \$	10062	
					1/4			Gloss Glass Top \$	8291	
	48"D x 84"W or 7' - 1 Piece Rectangle Top									
		88-4884RT	Laminate	84	48	1 3/16	174	10.0	F, G, X, Y / P\$	1426
					1 3/16			K / P\$	2299	
					1 1/2			H / P\$	1640	
		Veneer			1 3/16			F, G, X, Y / W\$	1658	
					1 3/16			K / W\$	2650	
					1 1/2			H / W\$	2013	
		Glass			1/4			Acid Etched Glass Top \$	8910	
					1/4			Gloss Glass Top \$	7361	
48"D x 72"W or 6' - 1 Piece Rectangle Top										
		88-4872RT	Laminate	72	48	1 3/16	152	8.6	F, G, X, Y / P\$	1192
					1 3/16			K / P\$	2048	
					1 1/2			H / P\$	1376	
		Veneer			1 3/16			F, G, X, Y / W\$	1569	
					1 3/16			K / W\$	2307	
					1 1/2			H / W\$	1876	
		Glass			1/4			Acid Etched Glass Top \$	7859	
					1/4			Gloss Glass Top \$	6531	

Must Specify (in this order):

- Model #
- Top/Edge Material
- Top/Edge Finish/Color
- Edge Profile
- Glass (Y/N)
- Glass Color + Surface Finish
- Power/Data
- Power/Data Location

Description

- Tops Available with Veneer (W) or HPL (P) Top in 1 3/16" and 1 1/2" Thicknesses
- Must Specify Edge Profile: 1 3/16" Thick/Double Kerf (F), Duo (G), Fluted (X), Square (Y), and Knife (K) Edge Profiles or 1 1/2" Thick/Vertical Square (H)
- Veneer (W) Top Grain Runs Depth of Top and HPL (P) Top Grain Runs Width of Top
- All Veneer Tops, as well as Laminate Tops up to 144" (12 feet), have Matching Woodgrain. Laminate Tops Sized 156" (13 feet) and Longer have Non-Matching Woodgrain
- Available with Back Painted Tempered Glass Top; Must Specify Color and Finish; [See Options](#)
- Power and Data Options Available; Sold Separately, [See Multiple Power Unit Details](#)
- Dock800, Oasis, and E2X Power Units Available on Ends Only (E2 and E2) for 108"D - 156"D and 204"D-240"D Tops Bases Sold Separately, See [Multiple Base Options](#)



Double Kerf (F)
1 3/16"



Duo (G)
1 3/16"



Fluted (X)
1 3/16"



Square (Y)
1 3/16"



Knife (K)
1 3/16"



Vertical Square (H)
1 1/2"

P = HPL W = Veneer

[See Catalyst Overview For Ordering Options](#)

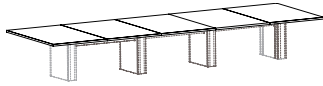
Item	Model No.		W	D	H	Ship Wt	Cubic Ft	Edge Profile + Material	List Price	
RECTANGLE SHAPE MEETING TOP 54"D  88-54204RT shown in Veneer with 88-2416606RAB (6" Rectangle Accent Base) BASES SOLD SEPARATELY	54"D x 240"W or 20' - 5 Piece Veneer (W) and 3 Piece HPL (P) Rectangle Top									
	88-54240RT	Laminate	240	54	1 3/16"	519	24.0	F, G, X, Y / P\$	4515	
					1 3/16"			K / P\$	7566	
					1 1/2"			H / P\$	5221	
		Veneer			1 3/16"			F, G, X, Y / W\$	7573	
					1 3/16"			K / W\$	9727	
					1 1/2"			H / W\$	8862	
		Glass			1/4"			Acid Etched Glass Top \$	27961	
					1/4"			Gloss Glass Top \$	22981	
	54"D x 228"W or 19' - 5 Piece Veneer (W) and 3 Piece HPL (P) Rectangle Top									
	88-54228RT	Laminate	228	54	1 3/16"	495	23.0	F, G, X, Y / P\$	4467	
					1 3/16"			K / P\$	7418	
				1 1/2"			H / P\$	5139		
	Veneer			1 3/16"			F, G, X, Y / W\$	7340		
				1 3/16"			K / W\$	9434		
				1 1/2"			H / W\$	8576		
	Glass			1/4"			Acid Etched Glass Top \$	26742		
				1/4"			Gloss Glass Top \$	22011		
54"D x 216"W or 18' - 5 Piece Veneer (W) and 3 Piece HPL (P) Rectangle Top										
88-54216RT	Laminate	216	54	1 3/16"	470	22.0	F, G, X, Y / P\$	3873		
				1 3/16"			K / P\$	6460		
				1 1/2"			H / P\$	4508		
	Veneer			1 3/16"			F, G, X, Y / W\$	7107		
				1 3/16"			K / W\$	9142		
				1 1/2"			H / W\$	8291		
	Glass			1/4"			Acid Etched Glass Top \$	25472		
				1/4"			Gloss Glass Top \$	20991		
54"D x 204"W or 17' - 5 Piece Veneer (W) and 3 Piece HPL (P) Rectangle Top										
88-54204RT	Laminate	204	54	1 3/16"	445	21.0	F, G, X, Y / P\$	3826		
				1 3/16"			K / P\$	6312		
				1 1/2"			H / P\$	4427		
	Veneer			1 3/16"			F, G, X, Y / W\$	6874		
				1 3/16"			K / W\$	8849		
				1 1/2"			H / W\$	8007		
	Glass			1/4"			Acid Etched Glass Top \$	24254		
				1/4"			Gloss Glass Top \$	20021		

Additional 54" Rectangle Shaped Tops on Next Page



Double Kerf (F) 1 3/16" Duo (G) 1 3/16" Fluted (X) 1 3/16" Square (Y) 1 3/16" Knife (K) 1 3/16" Vertical Square (H) 1 1/2"

P = HPL W = Veneer

[See Catalyst Overview For Ordering Options](#)

Item	Model No.		W	D	H	Ship Wt	Cubic Ft	Edge Profile + Material	List Price	
54"D x 192"W or 16' - 4 Piece Veneer (W) and 2 Piece HPL (P) Rectangle Top										
<i>CONTINUED FROM PREVIOUS PAGE</i>	88-54192RT	Laminate	192	54	1 3/16	408	19.0	F, G, X, Y / P\$	3168	
					1 3/16			K / P\$	5542	
					1 1/2			H / P\$	3732	
		Veneer			1 3/16			F, G, X, Y / W\$	5654	
					1 3/16			K / W\$	7438	
					1 1/2			H / W\$	6532	
		Glass			1/4			Acid Etched Glass Top \$	22145	
					1/4			Gloss Glass Top \$	18160	
	54"D x 180"W or 15' - 4 Piece Veneer (W) and 2 Piece HPL (P) Rectangle Top									
	<i>Must Specify (in this order):</i> Model # Top/Edge Material Top/Edge Finish/Color Edge Profile Glass (Y/N) Glass Color + Surface Finish Power/Data Type Power/Data Location	88-54180RT	Laminate	180	54	1 3/16	384	18.0	F, G, X, Y / P\$	3122
					1 3/16			K / P\$	5393	
					1 1/2			H / P\$	3649	
		Veneer			1 3/16			F, G, X, Y / W\$	5440	
					1 3/16			K / W\$	7163	
					1 1/2			H / W\$	6265	
		Glass			1/4			Acid Etched Glass Top \$	20926	
					1/4			Gloss Glass Top \$	17191	
54"D x 168"W or 14' - 4 Piece Veneer (W) and 2 Piece HPL (P) Rectangle Top										
		88-54168RT	Laminate	168	54	1 3/16	359	17.0	F, G, X, Y / P\$	3075
					1 3/16			K / P\$	5245	
					1 1/2			H / P\$	3568	
		Veneer			1 3/16			F, G, X, Y / W\$	5226	
					1 3/16			K / W\$	6889	
					1 1/2			H / W\$	5998	
		Glass			1/4			Acid Etched Glass Top \$	19707	
					1/4			Gloss Glass Top \$	16222	
	54"D x 156"W or 13' - 4 Piece Veneer (W) and 2 Piece HPL (P) Rectangle Top									
		88-54156RT	Laminate	156	54	1 3/16	334	16.0	F, G, X, Y / P\$	3028
					1 3/16			K / P\$	5096	
					1 1/2			H / P\$	3485	
		Veneer			1 3/16			F, G, X, Y / W\$	5011	
					1 3/16			K / W\$	6615	
					1 1/2			H / W\$	5732	
		Glass			1/4			Acid Etched Glass Top \$	18489	
					1/4			Gloss Glass Top \$	15253	

Additional 54" Rectangle Shaped Tops on Next Page



Double Kerf (F)
1 3/16"



Duo (G)
1 3/16"



Fluted (X)
1 3/16"



Square (Y)
1 3/16"



Knife (K)
1 3/16"



Vertical Square (H)
1 1/2"

P = HPL W = Veneer

[See Catalyst Overview For Ordering Options](#)

Item	Model No.		W	D	H	Ship Wt	Cubic Ft	Edge Profile + Material	List Price		
<i>CONTINUED FROM PREVIOUS PAGE</i>	54"D x 144"W or 12' - 3 Piece Veneer (W) and 2 Piece HPL (P) Rectangle Top										
	88-54144RT	Laminate	144	54	1 3/16	309	15.0	F, G, X, Y / P\$	2557		
					1 3/16			K / P\$	4349		
					1 1/2			H / P\$	2980		
		Veneer			1 3/16			F, G, X, Y / W\$	4061		
					1 3/16			K / W\$	5474		
					1 1/2			H / W\$	4724		
		Glass			1/4			Acid Etched Glass Top \$	17401		
					1/4			Gloss Glass Top \$	14413		
		54"D x 132"W or 11' - 3 Piece Veneer (W) and 2 Piece HPL (P) Rectangle Top									
	88-54132RT	Laminate	132	54	1 3/16	285	13.2	F, G, X, Y / P\$	2497		
					1 3/16			K / P\$	4188		
				1 1/2			H / P\$	2884			
	Veneer			1 3/16			F, G, X, Y / W\$	3866			
				1 3/16			K / W\$	5218			
				1 1/2			H / W\$	4476			
	Glass			1/4			Acid Etched Glass Top \$	16170			
				1/4			Gloss Glass Top \$	13430			
	54"D x 120"W or 10' - 3 Piece Veneer (W) and 2 Piece HPL (P) Rectangle Top										
88-54120RT	Laminate	120	54	1 3/16	260	12.1	F, G, X, Y / P\$	2436			
				1 3/16			K / P\$	4026			
				1 1/2			H / P\$	2788			
	Veneer			1 3/16			F, G, X, Y / W\$	3670			
				1 3/16			K / W\$	4963			
				1 1/2			H / W\$	4229			
	Glass			1/4			Acid Etched Glass Top \$	14938			
				1/4			Gloss Glass Top \$	12448			

Must Specify (in this order):

- Model #
- Top/Edge Material
- Top/Edge Finish/Color
- Edge Profile
- Glass (Y/N)
- Glass Color + Surface Finish
- Power/Data
- Power/Data Location

Description

- Tops Available with Veneer (W) or HPL (P) Top in 1 3/16" and 1 1/2" Thicknesses
- Must Specify Edge Profile: 1 3/16" Thick/Double Kerf (F), Duo (G), Fluted (X), Square (Y), and Knife (K) Edge Profiles or 1 1/2" Thick/Vertical Square (H)
- Veneer (W) Top Grain Runs Depth of Top and HPL (P) Top Grain Runs Width of Top
- All Veneer Tops, as well as Laminate Tops up to 144" (12 feet), have Matching Woodgrain. Laminate Tops Sized 156" (13 feet) and Longer have Non-Matching Woodgrain
- Available with Back Painted Tempered Glass Top; Must Specify Color and Finish; [See Options](#)
- Power and Data Options Available; Sold Separately, [See Multiple Power Unit Details](#)
- Bases Sold Separately, See [Multiple Base Options](#)



Double Kerf (F)
1 3/16"



Duo (G)
1 3/16"



Fluted (X)
1 3/16"



Square (Y)
1 3/16"



Knife (K)
1 3/16"



Vertical Square (H)
1 1/2"

P = HPL W = Veneer

[See Catalyst Overview For Ordering Options](#)

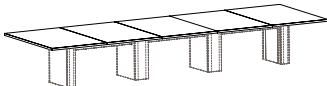
Item	Model No.		W	D	H	Ship Wt	Cubic Ft	Edge Profile + Material	List Price	
RECTANGLE SHAPE MEETING TOP 60"D  88-60204RT Shown in Veneer with 88-24166C610RAB (6" + 10" Combo Rectangle Accent Base) BASES SOLD SEPARATELY	60"D x 240"W or 20' - 5 Piece Veneer (W) and 3 Piece HPL (P) Rectangle Top									
	88-60240RT	Laminate	240	60	1 3/16"	574	26.3	F, G, X, Y / P\$	4603	
					1 3/16"			K / P\$	7839	
					1 1/2"			H / P\$	5390	
	Veneer				1 3/16"			F, G, X, Y / W\$	8087	
					1 3/16"			K / W\$	10324	
					1 1/2"			H / W\$	9485	
	Glass				1/4"			Acid Etched Glass Top \$	30611	
					1/4"			Gloss Glass Top \$	25078	
	60"D x 228"W or 19' - 5 Piece Veneer (W) and 3 Piece HPL (P) Rectangle Top									
	88-60228RT	Laminate	228	60	1 3/16"	547	25.0	F, G, X, Y / P\$	4552	
					1 3/16"			K / P\$	7678	
				1 1/2"			H / P\$	5300		
Veneer				1 3/16"			F, G, X, Y / W\$	7830		
				1 3/16"			K / W\$	10003		
				1 1/2"			H / W\$	9168		
Glass				1/4"			Acid Etched Glass Top \$	29260		
				1/4"			Gloss Glass Top \$	24005		
60"D x 216"W or 18' - 5 Piece Veneer (W) and 3 Piece HPL (P) Rectangle Top										
88-60216RT	Laminate	216	60	1 3/16"	519	23.7	F, G, X, Y / P\$	3953		
				1 3/16"			K / P\$	6708		
				1 1/2"			H / P\$	4662		
Veneer				1 3/16"			F, G, X, Y / W\$	7571		
				1 3/16"			K / W\$	9681		
				1 1/2"			H / W\$	8852		
Glass				1/4"			Acid Etched Glass Top \$	27859		
				1/4"			Gloss Glass Top \$	22880		
60"D x 204"W or 17' - 5 Piece Veneer (W) and 3 Piece HPL (P) Rectangle Top										
88-60204RT	Laminate	204	60	1 3/16"	492	22.4	F, G, X, Y / P\$	3902		
				1 3/16"			K / P\$	6547		
				1 1/2"			H / P\$	4572		
Veneer				1 3/16"			F, G, X, Y / W\$	7313		
				1 3/16"			K / W\$	9361		
				1 1/2"			H / W\$	8537		
Glass				1/4"			Acid Etched Glass Top \$	26509		
				1/4"			Gloss Glass Top \$	21806		

Additional 60" Rectangle Shaped Tops on Next Page



Double Kerf (F) 1 3/16" Duo (G) 1 3/16" Fluted (X) 1 3/16" Square (Y) 1 3/16" Knife (K) 1 3/16" Vertical Square (H) 1 1/2"

P = HPL W = Veneer

[See Catalyst Overview For Ordering Options](#)

Item	Model No.		W	D	H	Ship Wt	Cubic Ft	Edge Profile + Material	List Price		
<i>CONTINUED FROM PREVIOUS PAGE</i>	60"D x 192"W or 16' - 4 Piece Veneer (W) and 2 Piece HPL (P) Rectangle Top										
	88-60192RT	Laminate	192	60	1 3/16"	458	21.1	F, G, X, Y / P\$	3241		
					1 3/16"			K / P\$	5763		
					1 1/2"			H / P\$	3868		
		Veneer			1 3/16"			F, G, X, Y / W\$	6033		
					1 3/16"			K / W\$	7886		
					1 1/2"			H / W\$	6997		
		Glass			1/4"			Acid Etched Glass Top \$	24267		
					1/4"			Gloss Glass Top \$	19841		
		60"D x 180"W or 15' - 4 Piece Veneer (W) and 2 Piece HPL (P) Rectangle Top									
	88-60180RT	Laminate	180	60	1 3/16"	430	19.8	F, G, X, Y / P\$	3190		
					1 3/16"			K / P\$	5602		
					1 1/2"			H / P\$	3778		
		Veneer			1 3/16"			F, G, X, Y / W\$	5796		
					1 3/16"			K / W\$	7584		
				1 1/2"			H / W\$	6702			
	Glass			1/4"			Acid Etched Glass Top \$	22917			
				1/4"			Gloss Glass Top \$	18768			
	60"D x 168"W or 14' - 4 Piece Veneer (W) and 2 Piece HPL (P) Rectangle Top										
88-60168RT	Laminate	168	60	1 3/16"	403	18.5	F, G, X, Y / P\$	3138			
				1 3/16"			K / P\$	5441			
				1 1/2"			H / P\$	3688			
	Veneer			1 3/16"			F, G, X, Y / W\$	5558			
				1 3/16"			K / W\$	7283			
				1 1/2"			H / W\$	6407			
	Glass			1/4"			Acid Etched Glass Top \$	21567			
				1/4"			Gloss Glass Top \$	17694			
	60"D x 156"W or 13' - 4 Piece Veneer (W) and 2 Piece HPL (P) Rectangle Top										
88-60156RT	Laminate	156	60	1 3/16"	376	17.2	F, G, X, Y / P\$	3087			
				1 3/16"			K / P\$	5280			
				1 1/2"			H / P\$	3597			
	Veneer			1 3/16"			F, G, X, Y / W\$	5320			
				1 3/16"			K / W\$	6982			
				1 1/2"			H / W\$	6112			
	Glass			1/4"			Acid Etched Glass Top \$	20218			
				1/4"			Gloss Glass Top \$	16621			

Must Specify (in this order):
 Model #
 Top/Edge Material
 Top/Edge Finish/Color
 Edge Profile
 Glass (Y/N)
 Glass Color + Surface Finish
 Power/Data Type
 Power/Data Location

Additional 60" Rectangle Shaped Tops on Next Page



Double Kerf (F) 1 3/16" Duo (G) 1 3/16" Fluted (X) 1 3/16" Square (Y) 1 3/16" Knife (K) 1 3/16" Vertical Square (H) 1 1/2"

P = HPL W = Veneer

[See Catalyst Overview For Ordering Options](#)

Item	Model No.		W	D	H	Ship Wt	Cubic Ft	Edge Profile + Material	List Price	
60"D x 144"W or 12' - 3 Piece Veneer (W) and 2 Piece HPL (P) Rectangle Top										
<i>CONTINUED FROM PREVIOUS PAGE</i>	88-60144RT	Laminate	144	60	1 3/16"	342	16.0	F, G, X, Y / P\$	2612	
					1 3/16"			K / P\$	4520	
					1 1/2"			H / P\$	3083	
		Veneer			1 3/16"			F, G, X, Y / W\$	4320	
					1 3/16"			K / W\$	5789	
					1 1/2"			H / W\$	5050	
		Glass			1/4"			Acid Etched Glass Top \$	18997	
					1/4"			Gloss Glass Top \$	15678	
	60"D x 132"W or 11' - 3 Piece Veneer (W) and 2 Piece HPL (P) Rectangle Top									
		88-60132RT	Laminate	132	60	1 3/16"	323	14.6	F, G, X, Y / P\$	2548
					1 3/16"			K / P\$	4345	
					1 1/2"			H / P\$	2979	
		Veneer			1 3/16"			F, G, X, Y / W\$	4104	
					1 3/16"			K / W\$	5508	
					1 1/2"			H / W\$	4775	
	Glass				1/4"			Acid Etched Glass Top \$	17634	
					1/4"			Gloss Glass Top \$	14591	
60"D x 120"W or 10' - 3 Piece Veneer (W) and 2 Piece HPL (P) Rectangle Top										
	88-60120RT	Laminate	120	60	1 3/16"	287	13.3	F, G, X, Y / P\$	2484	
					1 3/16"			K / P\$	4170	
					1 1/2"			H / P\$	2875	
		Veneer			1 3/16"			F, G, X, Y / W\$	3886	
					1 3/16"			K / W\$	5228	
					1 1/2"			H / W\$	4500	
	Glass				1/4"			Acid Etched Glass Top \$	16271	
					1/4"			Gloss Glass Top \$	13505	

Must Specify (in this order):

- Model #
- Top/Edge Material
- Top/Edge Finish/Color
- Edge Profile
- Glass (Y/N)
- Glass Color + Surface Finish
- Power/Data Type
- Power/Data Location

Description

- Tops Available with Veneer (W) or HPL (P) Top in 1 3/16" and 1 1/2" Thicknesses
- Must Specify Edge Profile: 1 3/16" Thick/Double Kerf (F), Duo (G), Fluted (X), Square (Y), and Knife (K) Edge Profiles or 1 1/2" Thick/Vertical Square (H)
- Veneer (W) Top Grain Runs Depth of Top and HPL (P) Top Grain Runs Width of Top
- All Veneer Tops, as well as Laminate Tops up to 144" (12 feet), have Matching Woodgrain. Laminate Tops Sized 156" (13 feet) and Longer have Non-Matching Woodgrain
- Available with Back Painted Tempered Glass Top; Must Specify Color and Finish; [See Options](#)
- Power and Data Options Available; Sold Separately, [See Multiple Power Unit Details](#)
- Bases Sold Separately, See [Multiple Base Options](#)



Double Kerf (F)
1 3/16"



Duo (G)
1 3/16"



Fluted (X)
1 3/16"



Square (Y)
1 3/16"



Knife (K)
1 3/16"



Vertical Square (H)
1 1/2"

P = HPL W = Veneer

[See Catalyst Overview For Ordering Options](#)

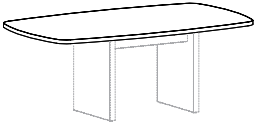
Item	Model No.		W	D	H	Ship Wt	Cubic Ft	Edge Profile + Material	List Price	
MODERN RECTANGLE SHAPE MEETING TOP 36"D  88-3672MR shown with 88-2034RPB (Rectangle Panel Base) BASES SOLD SEPARATELY	36"D x 96"W or 8' - 1 Piece Modern Rectangle Top									
	88-3696MR	Laminate	96	36	1 3/16	142	12.9	F, G, X, Y / P\$	1424	
					1 3/16			K / P\$	2821	
					1 1/2			H / P\$	1606	
		Veneer			1 3/16			F, G, X, Y / W\$	1613	
					1 3/16			K / W\$	3163	
					1 1/2			H / W\$	1921	
		Glass			1/4			Acid Etched Glass Top \$	8724	
					1/4			Gloss Glass Top \$	7396	
	36"D x 84"W or 7' - 1 Piece Modern Rectangle Top									
		88-3684MR	Laminate	84	36	1 3/16	126	11.3	F, G, X, Y / P\$	1357
						1 3/16			K / P\$	2583
					1 1/2			H / P\$	1547	
		Veneer			1 3/16			F, G, X, Y / W\$	1529	
					1 3/16			K / W\$	2958	
					1 1/2			H / W\$	1768	
		Glass			1/4			Acid Etched Glass Top \$	7821	
					1/4			Gloss Glass Top \$	6659	
36"D x 72"W or 6' - 1 Piece Modern Rectangle Top										
	88-3672MR	Laminate	72	36	1 3/16	109	10.3	F, G, X, Y / P\$	1108	
					1 3/16			K / P\$	2236	
					1 1/2			H / P\$	1245	
		Veneer			1 3/16			F, G, X, Y / W\$	1302	
					1 3/16			K / W\$	2518	
					1 1/2			H / W\$	1537	
		Glass			1/4			Acid Etched Glass Top \$	6829	
					1/4			Gloss Glass Top \$	5832	

Must Specify (in this order):

- Model #
- Top/Edge Material
- Top/Edge Finish/Color
- Edge Profile
- Glass (Y/N)
- Glass Color + Surface Finish
- Power/Data
- Power/Data Location

Description

- Tops Available with Veneer (W) or HPL (P) Top in 1 3/16" and 1 1/2" Thicknesses
- Must Specify Edge Profile: 1 3/16" Thick/Double Kerf (F), Duo (G), Fluted (X), Square (Y), and Knife (K) Edge Profiles or 1 1/2" Thick/Vertical Square (H)
- Veneer (W) Top Grain Runs Depth of Top and HPL (P) Top Grain Runs Width of Top
- Available with Back Painted Tempered Glass Top; Must Specify Color and Finish; [See Options](#)
- Power and Data Options Available; Sold Separately, [See Multiple Power Unit Details](#)
- Bases Sold Separately, See [Multiple Base Options](#)



Double Kerf (F)
1 3/16"



Duo (G)
1 3/16"



Fluted (X)
1 3/16"



Square (Y)
1 3/16"



Knife (K)
1 3/16"



Vertical Square (H)
1 1/2"

P = HPL W = Veneer

[See Catalyst Overview For Ordering Options](#)

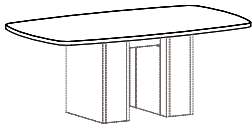
Item	Model No.		W	D	H	Ship Wt	Cubic Ft	Edge Profile + Material	List Price	
MODERN RECTANGLE SHAPE MEETING TOP 42"D  88-42108MR shown with 88-203406GRAB (Rectangle Panel Base) BASES SOLD SEPARATELY	42"D x 120"W or 10' - 2 Piece Modern Rectangle Top									
	88-42120MR	Laminate	120	42	1 3/16	268	27.0	F, G, X, Y / P\$	2008	
					1 3/16			K / P\$	3846	
					1 1/2			H / P\$	2278	
		Veneer			1 3/16			F, G, X, Y / W\$	2330	
					1 3/16			K / W\$	4333	
					1 1/2			H / W\$	2769	
		Glass			1/4			Acid Etched Glass Top \$	12215	
					1/4			Gloss Glass Top \$	10279	
	42"D x 108"W or 9' - 2 Piece Modern Rectangle Top									
	88-42108MR	Laminate	108	42	1 3/16	260	27.0	F, G, X, Y / P\$	1970	
					1 3/16			K / P\$	3630	
				1 1/2			H / P\$	2213		
	Veneer			1 3/16			F, G, X, Y / W\$	2192		
				1 3/16			K / W\$	4063		
				1 1/2			H / W\$	2590		
	Glass			1/4			Acid Etched Glass Top \$	11182		
				1/4			Gloss Glass Top \$	9439		
42"D x 96"W or 8' - 1 Piece Modern Rectangle Top										
88-4296MR	Laminate	96	42	1 3/16	164	15.0	F, G, X, Y / P\$	1453		
				1 3/16			K / P\$	2984		
				1 1/2			H / P\$	1667		
	Veneer			1 3/16			F, G, X, Y / W\$	1752		
				1 3/16			K / W\$	3361		
				1 1/2			H / W\$	2104		
	Glass			1/4			Acid Etched Glass Top \$	9818		
				1/4			Gloss Glass Top \$	8269		
42"D x 84"W or 7' - 1 Piece Modern Rectangle Top										
88-4284MR	Laminate	84	42	1 3/16	145	13.1	F, G, X, Y / P\$	1414		
				1 3/16			K / P\$	2769		
				1 1/2			H / P\$	1600		
	Veneer			1 3/16			F, G, X, Y / W\$	1618		
				1 3/16			K / W\$	3102		
				1 1/2			H / W\$	1928		
	Glass			1/4			Acid Etched Glass Top \$	8786		
				1/4			Gloss Glass Top \$	7430		

Additional 42" Modern Rectangle Shaped Tops on Next Page



Double Kerf (F)
1 3/16"



Duo (G)
1 3/16"



Fluted (X)
1 3/16"



Square (Y)
1 3/16"



Knife (K)
1 3/16"



Vertical Square (H)
1 1/2"

P = HPL W = Veneer

[See Catalyst Overview For Ordering Options](#)

Item	Model No.		W	D	H	Ship Wt	Cubic Ft	Edge Profile + Material	List Price
<i>CONTINUED FROM PREVIOUS PAGE</i>	42"D x 72"W or 6' - 1 Piece Modern Rectangle Top								
	88-4272MR	Laminate	72	42	1 3/16	126	11.3	F, G, X, Y / P\$	1182
					1 3/16			K / P\$	2467
					1 1/2			H / P\$	1341
		Veneer			1 3/16			F, G, X, Y / W\$	1473
					1 3/16			K / W\$	2710
					1 1/2			H / W\$	1741
		Glass			1/4			Acid Etched Glass Top \$	7725
					1/4			Gloss Glass Top \$	6563

Must Specify (in this order):

- Model #
- Top/Edge Material
- Top/Edge Finish/Color
- Edge Profile
- Glass (Y/N)
- Glass Color + Surface Finish
- Power/Data
- Power/Data Location

Description

- Tops Available with Veneer (W) or HPL (P) Top in 1 3/16" and 1 1/2" Thicknesses
- Must Specify Edge Profile: 1 3/16" Thick/Double Kerf (F), Duo (G), Fluted (X), Square (Y), and Knife (K) Edge Profiles or 1 1/2" Thick/Vertical Square (H)
- Veneer (W) Top Grain Runs Depth of Top and HPL (P) Top Grain Runs Width of Top
- Available with Back Painted Tempered Glass Top; Must Specify Color and Finish; [See Options](#)
- Power and Data Options Available; Sold Separately, [See Multiple Power Unit Details](#)
- Bases Sold Separately, See [Multiple Base Options](#)



Double Kerf (F)
1 3/16"



Duo (G)
1 3/16"



Fluted (X)
1 3/16"



Square (Y)
1 3/16"



Knife (K)
1 3/16"



Vertical Square (H)
1 1/2"

P = HPL W = Veneer

[See Catalyst Overview For Ordering Options](#)

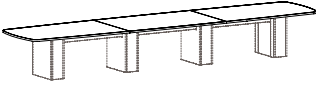
Item	Model No.		W	D	H	Ship Wt	Cubic Ft	Edge Profile + Material	List Price	
MODERN RECTANGLE SHAPE MEETING TOP 48"D  88-48216MR shown in HPL with 88-24178C610RAB (10" Rectangle Accent Base) BASES SOLD SEPARATELY	48"D x 240"W or 20' - 3 Piece Modern Rectangle Top									
	88-48240MR	Laminate	240	48	1 3/16	460	48.9	F, G, X, Y / P\$	4638	
					1 3/16			K / P\$	8499	
					1 1/2			H / P\$	5257	
		Veneer			1 3/16			F, G, X, Y / W\$	6301	
					1 3/16			K / W\$	9571	
					1 1/2			H / W\$	7153	
		Glass			1/4			Acid Etched Glass Top \$	26634	
					1/4			Gloss Glass Top \$	22207	
	48"D x 228"W or 19' - 3 Piece Modern Rectangle Top									
	88-48228MR	Laminate	228	48	1 3/16	438	48.9	F, G, X, Y / P\$	4594	
					1 3/16			K / P\$	8284	
					1 1/2			H / P\$	5182	
		Veneer			1 3/16			F, G, X, Y / W\$	6037	
					1 3/16			K / W\$	9216	
				1 1/2			H / W\$	6849		
	Glass			1/4			Acid Etched Glass Top \$	25468		
				1/4			Gloss Glass Top \$	21263		
48"D x 216"W or 18' - 3 Piece Modern Rectangle Top										
88-48216MR	Laminate	216	48	1 3/16	416	48.9	F, G, X, Y / P\$	3687		
				1 3/16			K / P\$	7182		
				1 1/2			H / P\$	4244		
	Veneer			1 3/16			F, G, X, Y / W\$	5369		
				1 3/16			K / W\$	8456		
				1 1/2			H / W\$	6139		
	Glass			1/4			Acid Etched Glass Top \$	23917		
				1/4			Gloss Glass Top \$	19933		
48"D x 204"W or 17' - 3 Piece Modern Rectangle Top										
88-48204MR	Laminate	204	48	1 3/16	394	48.9	F, G, X, Y / P\$	3643		
				1 3/16			K / P\$	6968		
				1 1/2			H / P\$	4169		
	Veneer			1 3/16			F, G, X, Y / W\$	5106		
				1 3/16			K / W\$	8101		
				1 1/2			H / W\$	5834		
	Glass			1/4			Acid Etched Glass Top \$	22751		
				1/4			Gloss Glass Top \$	18988		

Must Specify (in this order):
 Model #
 Top/Edge Material
 Top/Edge Finish/Color
 Edge Profile
 Glass (Y/N)
 Glass Color + Surface Finish
 Power/Data
 Power/Data Location

Additional 48" Modern Rectangle Shaped Tops on Next Page



Double Kerf (F)
1 3/16"



Duo (G)
1 3/16"



Fluted (X)
1 3/16"



Square (Y)
1 3/16"



Knife (K)
1 3/16"



Vertical Square (H)
1 1/2"

P = HPL W = Veneer

[See Catalyst Overview For Ordering Options](#)

Item	Model No.		W	D	H	Ship Wt	Cubic Ft	Edge Profile + Material	List Price	
48"D x 192"W or 16' - 2 Piece Modern Rectangle Top										
<i>CONTINUED FROM PREVIOUS PAGE</i>	88-48192MR	Laminate	192	48	1 3/16	372	31.2	F, G, X, Y / P\$	3125	
					1 3/16			K / P\$	6249	
					1 1/2			H / P\$	3621	
	Veneer							F, G, X, Y / W\$	4215	
								1 3/16	K / W\$	6996
								1 1/2	H / W\$	4991
	Glass							Acid Etched Glass Top \$	21073	
									Gloss Glass Top \$	17531
	48"D x 180"W or 15' - 2 Piece Modern Rectangle Top									
	<i>Must Specify (in this order):</i> Model # Top/Edge Material Top/Edge Finish/Color Edge Profile Glass (Y/N) Glass Color + Surface Finish Power/Data Power/Data Location	88-48180MR	Laminate	180	48	1 3/16	350	31.2	F, G, X, Y / P\$	3080
1 3/16						K / P\$			6034	
1 1/2						H / P\$			3547	
Veneer								F, G, X, Y / W\$	4045	
								1 3/16	K / W\$	6679
								1 1/2	H / W\$	4773
Glass								Acid Etched Glass Top \$	19906	
									Gloss Glass Top \$	16586
48"D x 168"W or 14' - 2 Piece Modern Rectangle Top										
		88-48168MR	Laminate	168	48	1 3/16	328	31.2	F, G, X, Y / P\$	2928
	1 3/16					K / P\$			5708	
	1 1/2					H / P\$			3363	
	Veneer							F, G, X, Y / W\$	3736	
								1 3/16	K / W\$	6223
								1 1/2	H / W\$	4418
	Glass							Acid Etched Glass Top \$	18629	
									Gloss Glass Top \$	15530
	48"D x 156"W or 13' - 2 Piece Modern Rectangle Top									
		88-48156MR	Laminate	156	48	1 3/16	306	31.2	F, G, X, Y / P\$	2885
1 3/16						K / P\$			5363	
1 1/2						H / P\$			3288	
Veneer								F, G, X, Y / W\$	3567	
								1 3/16	K / W\$	6039
								1 1/2	H / W\$	4202
Glass								Acid Etched Glass Top \$	17463	
									Gloss Glass Top \$	14585

Additional 48" Modern Rectangle Shaped Tops on Next Page

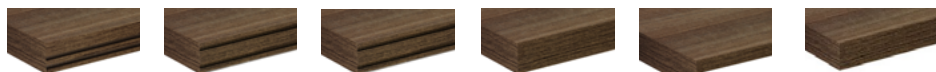

Double Kerf (F) 1 3/16" Duo (G) 1 3/16" Fluted (X) 1 3/16" Square (Y) 1 3/16" Knife (K) 1 3/16" Vertical Square (H) 1 1/2"

P = HPL W = Veneer

[See Catalyst Overview For Ordering Options](#)

Item	Model No.		W	D	H	Ship Wt	Cubic Ft	Edge Profile + Material	List Price		
48"D x 144"W or 12' - 2 Piece Modern Rectangle Top											
<i>CONTINUED FROM PREVIOUS PAGE</i>	88-48144MR	Laminate	144	48	1 3/16	284	23.5	F, G, X, Y / P\$	2421		
					1 3/16			K / P\$	4847		
					1 1/2			H / P\$	2793		
					Veneer			1 3/16	F, G, X, Y / W\$	3328	
								1 3/16	K / W\$	5521	
								1 1/2	H / W\$	3915	
		Glass	1/4	Acid Etched Glass Top \$	16201						
			1/4	Gloss Glass Top \$	13544						
		48"D x 132"W or 11' - 2 Piece Modern Rectangle Top									
		<i>Must Specify (in this order):</i> Model # Top/Edge Material Top/Edge Finish/Color Edge Profile Glass (Y/N) Glass Color + Surface Finish Power/Data Power/Data Location	88-48132MR	Laminate	132	48	1 3/16	262	23.5	F, G, X, Y / P\$	2365
							1 3/16			K / P\$	4619
							1 1/2			H / P\$	2705
Veneer	1 3/16						F, G, X, Y / W\$			3105	
	1 3/16						K / W\$			5178	
	1 1/2						H / W\$			3645	
Glass	1/4			Acid Etched Glass Top \$	15022						
	1/4			Gloss Glass Top \$	12588						
48"D x 120"W or 10' - 2 Piece Modern Rectangle Top											
	88-48120MR			Laminate	120	48	1 3/16	240	23.5	F, G, X, Y / P\$	2299
							1 3/16			K / P\$	4383
							1 1/2			H / P\$	2609
		Veneer	1 3/16				F, G, X, Y / W\$			2870	
			1 3/16				K / W\$			4823	
			1 1/2				H / W\$			3364	
		Glass	1/4	Acid Etched Glass Top \$	13835						
			1/4	Gloss Glass Top \$	11622						
		48"D x 108"W or 9' - 2 Piece Modern Rectangle Top									
			88-48108MR	Laminate	108	48	1 3/16	218	23.5	F, G, X, Y / P\$	2243
							1 3/16			K / P\$	4063
							1 1/2			H / P\$	2522
Veneer	1 3/16						F, G, X, Y / W\$			2648	
	1 3/16						K / W\$			4575	
	1 1/2						H / W\$			3095	
Glass	1/4			Acid Etched Glass Top \$	12657						
	1/4			Gloss Glass Top \$	10665						

Additional 48" Modern Rectangle Shaped Tops on Next Page

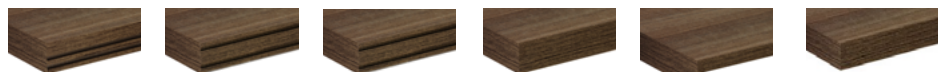

Double Kerf (F) 1 3/16" Duo (G) 1 3/16" Fluted (X) 1 3/16" Square (Y) 1 3/16" Knife (K) 1 3/16" Vertical Square (H) 1 1/2"

P = HPL W = Veneer

[See Catalyst Overview For Ordering Options](#)

Item	Model No.		W	D	H	Ship Wt	Cubic Ft	Edge Profile + Material	List Price	
<i>CONTINUED FROM PREVIOUS PAGE</i>	48"D x 96"W or 8' - 1 Piece Modern Rectangle Top									
	88-4896MR	Laminate	96	48	1 3/16	315	18.0	F, G, X, Y / P\$	1529	
					1 3/16			K / P\$	3258	
					1 1/2			H / P\$	1774	
		Veneer			1 3/16			F, G, X, Y / W\$	1951	
					1 3/16			K / W\$	3558	
					1 1/2			H / W\$	2347	
		Glass			1/4			Acid Etched Glass Top \$	10965	
					1/4			Gloss Glass Top \$	9194	
	48"D x 84"W or 7' - 1 Piece Modern Rectangle Top									
	88-4884MR	Laminate	84	48	1 3/16	164	15.0	F, G, X, Y / P\$	1484	
					1 3/16			K / P\$	2899	
					1 1/2			H / P\$	1698	
		Veneer			1 3/16			F, G, X, Y / W\$	1724	
					1 3/16			K / W\$	3266	
					1 1/2			H / W\$	2074	
		Glass			1/4			Acid Etched Glass Top \$	9732	
					1/4			Gloss Glass Top \$	8184	
48"D x 72"W or 6' - 1 Piece Modern Rectangle Top										
88-4872MR	Laminate	72	48	1 3/16	142	12.8	F, G, X, Y / P\$	1249		
				1 3/16			K / P\$	2637		
				1 1/2			H / P\$	1432		
	Veneer			1 3/16			F, G, X, Y / W\$	1633		
				1 3/16			K / W\$	2948		
				1 1/2			H / W\$	1935		
	Glass			1/4			Acid Etched Glass Top \$	8608		
				1/4			Gloss Glass Top \$	7280		

Must Specify (in this order):

- Model #
- Top/Edge Material
- Top/Edge Finish/Color
- Edge Profile
- Glass (Y/N)
- Glass Color + Surface Finish
- Power/Data
- Power/Data Location

Description

- Tops Available with Veneer (W) or HPL (P) Top in 1 3/16" and 1 1/2" Thicknesses
- Must Specify Edge Profile: 1 3/16" Thick/Double Kerf (F), Duo (G), Fluted (X), Square (Y), and Knife (K) Edge Profiles or 1 1/2" Thick/Vertical Square (H)
- Veneer (W) Top Grain Runs Depth of Top and HPL (P) Top Grain Runs Width of Top
- All Veneer Tops, as well as Laminate Tops up to 144" (12 feet), have Matching Woodgrain. Laminate Tops Sized 156" (13 feet) and Longer have Non-Matching Woodgrain
- Available with Back Painted Tempered Glass Top; Must Specify Color and Finish; [See Options](#)
- Power and Data Options Available; Sold Separately, [See Multiple Power Unit Details](#)
- Bases Sold Separately, See [Multiple Base Options](#)



Double Kerf (F) 1 3/16" Duo (G) 1 3/16" Fluted (X) 1 3/16" Square (Y) 1 3/16" Knife (K) 1 3/16" Vertical Square (H) 1 1/2"

P = HPL W = Veneer

[See Catalyst Overview For Ordering Options](#)

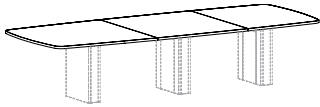
Item	Model No.		W	D	H	Ship Wt	Cubic Ft	Edge Profile + Material	List Price	
MODERN RECTANGLE SHAPE MEETING TOP 54"D  88-54156MR shown in HPL with 88-2411806RAB (6" Rectangle Accent Base) BASES SOLD SEPARATELY Must Specify (in this order): Model # Top/Edge Material Top/Edge Finish/Color Edge Profile Glass (Y/N) Glass Color + Surface Finish Power/Data Power/Data Location	54"D x 240"W or 20' - 5 Piece Veneer (W) and 3 Piece HPL (P) Modern Rectangle Top									
	88-54240MR	Laminate	240	54	1 3/16	519	24.0	F, G, X, Y / P\$	4690	
					1 3/16				K / P\$	8773
					1 1/2				H / P\$	5389
	Veneer				1 3/16			F, G, X, Y / W\$	7844	
					1 3/16				K / W\$	11557
					1 1/2				H / W\$	8912
	Glass				1/4			Acid Etched Glass Top \$	29666	
					1/4			Gloss Glass Top \$	24687	
	54"D x 228"W or 19' - 5 Piece Veneer (W) and 3 Piece HPL (P) Modern Rectangle Top									
	88-54228MR	Laminate	228	54	1 3/16	495	23.0	F, G, X, Y / P\$	4642	
					1 3/16				K / P\$	8545
				1 1/2				H / P\$	5306	
Veneer				1 3/16			F, G, X, Y / W\$	7602		
				1 3/16				K / W\$	11159	
				1 1/2				H / W\$	8619	
Glass				1/4			Acid Etched Glass Top \$	28369		
				1/4			Gloss Glass Top \$	23639		
54"D x 216"W or 18' - 5 Piece Veneer (W) and 3 Piece HPL (P) Modern Rectangle Top										
88-54216MR	Laminate	216	54	1 3/16	470	22.0	F, G, X, Y / P\$	4047		
				1 3/16				K / P\$	7755	
				1 1/2				H / P\$	4676	
Veneer				1 3/16			F, G, X, Y / W\$	7361		
				1 3/16				K / W\$	10761	
				1 1/2				H / W\$	8327	
Glass				1/4			Acid Etched Glass Top \$	27037		
				1/4			Gloss Glass Top \$	22556		
54"D x 204"W or 17' - 5 Piece Veneer (W) and 3 Piece HPL (P) Modern Rectangle Top										
88-54204MR	Laminate	204	54	1 3/16	445	21.0	F, G, X, Y / P\$	3999		
				1 3/16				K / P\$	7528	
				1 1/2				H / P\$	4593	
Veneer				1 3/16			F, G, X, Y / W\$	7119		
				1 3/16				K / W\$	10364	
				1 1/2				H / W\$	8034	
Glass				1/4			Acid Etched Glass Top \$	25741		
				1/4			Gloss Glass Top \$	21509		

Additional 54" Modern Rectangle Shaped Tops on Next Page



Double Kerf (F)
1 3/16"



Duo (G)
1 3/16"



Fluted (X)
1 3/16"



Square (Y)
1 3/16"



Knife (K)
1 3/16"



Vertical Square (H)
1 1/2"

P = HPL W = Veneer

[See Catalyst Overview For Ordering Options](#)

Item	Model No.		W	D	H	Ship Wt	Cubic Ft	Edge Profile + Material	List Price	
<i>CONTINUED FROM PREVIOUS PAGE</i>	54"D x 192"W or 16' - 4 Piece Veneer (W) and 2 Piece HPL (P) Modern Rectangle Top									
	88-54192MR	Laminate	192	54	1 3/16	408	19.0	F, G, X, Y / P\$	3291	
					1 3/16			K / P\$	6606	
					1 1/2			H / P\$	3852	
		Veneer			1 3/16			F, G, X, Y / W\$	5874	
					1 3/16			K / W\$	8938	
					1 1/2			H / W\$	6734	
		Glass			1/4			Acid Etched Glass Top \$	23748	
					1/4			Gloss Glass Top \$	19764	
		54"D x 180"W or 15' - 4 Piece Veneer (W) and 2 Piece HPL (P) Modern Rectangle Top								
	88-54180MR	Laminate	180	54	1 3/16	384	18.0	F, G, X, Y / P\$	3244	
					1 3/16			K / P\$	6379	
					1 1/2			H / P\$	3769	
		Veneer			1 3/16			F, G, X, Y / W\$	5652	
					1 3/16			K / W\$	8560	
					1 1/2			H / W\$	6460	
		Glass			1/4			Acid Etched Glass Top \$	22451	
					1/4			Gloss Glass Top \$	18716	
	54"D x 168"W or 14' - 4 Piece Veneer (W) and 2 Piece HPL (P) Modern Rectangle Top									
88-54168MR	Laminate	168	54	1 3/16	359	17.0	F, G, X, Y / P\$	3195		
				1 3/16			K / P\$	6151		
				1 1/2			H / P\$	3687		
	Veneer			1 3/16			F, G, X, Y / W\$	5431		
				1 3/16			K / W\$	8182		
				1 1/2			H / W\$	6188		
	Glass			1/4			Acid Etched Glass Top \$	21154		
				1/4			Gloss Glass Top \$	17668		
	54"D x 156"W or 13' - 4 Piece Veneer (W) and 2 Piece HPL (P) Modern Rectangle Top									
88-54156MR	Laminate	156	54	1 3/16	334	16.0	F, G, X, Y / P\$	3147		
				1 3/16			K / P\$	5923		
				1 1/2			H / P\$	3603		
	Veneer			1 3/16			F, G, X, Y / W\$	5209		
				1 3/16			K / W\$	7802		
				1 1/2			H / W\$	5915		
	Glass			1/4			Acid Etched Glass Top \$	19856		
				1/4			Gloss Glass Top \$	16619		

Must Specify (in this order):
 Model #
 Top/Edge Material
 Top/Edge Finish/Color
 Edge Profile
 Glass (Y/N)
 Glass Color + Surface Finish
 Power/Data
 Power/Data Location

Additional 54" Modern Rectangle Shaped Tops on Next Page



Double Kerf (F) 1 3/16" Duo (G) 1 3/16" Fluted (X) 1 3/16" Square (Y) 1 3/16" Knife (K) 1 3/16" Vertical Square (H) 1 1/2"

P = HPL W = Veneer

[See Catalyst Overview For Ordering Options](#)

Item	Model No.		W	D	H	Ship Wt	Cubic Ft	Edge Profile + Material	List Price	
54"D x 144"W or 12' - 3 Piece Veneer (W) and 2 Piece HPL (P) Modern Rectangle Top										
CONTINUED FROM PREVIOUS PAGE	88-54144MR	Laminate	144	54	1 3/16	309	15.0	F, G, X, Y / P\$	2675	
					1 3/16			K / P\$	5261	
					1 1/2			H / P\$	3097	
		Veneer			1 3/16			F, G, X, Y / W\$	4300	
					1 3/16			K / W\$	6645	
					1 1/2			H / W\$	6645	
		Glass			1/4			Acid Etched Glass Top \$	18228	
					1/4			Gloss Glass Top \$	15240	
	54"D x 132"W or 11' - 3 Piece Veneer (W) and 2 Piece HPL (P) Modern Rectangle Top									
	Must Specify (in this order): Model # Top/Edge Material Top/Edge Finish/Color Edge Profile Glass (Y/N) Glass Color + Surface Finish Power/Data Power/Data Location	88-54132MR	Laminate	132	54	1 3/16	285	13.2	F, G, X, Y / P\$	2614
					1 3/16			K / P\$	5021	
					1 1/2			H / P\$	3000	
		Veneer			1 3/16			F, G, X, Y / W\$	4090	
					1 3/16			K / W\$	6285	
					1 1/2			H / W\$	4624	
		Glass			1/4			Acid Etched Glass Top \$	16918	
					1/4			Gloss Glass Top \$	14180	
54"D x 120"W or 10' - 3 Piece Veneer (W) and 2 Piece HPL (P) Modern Rectangle Top										
		88-54120MR	Laminate	120	54	1 3/16	260	12.1	F, G, X, Y / P\$	2553
					1 3/16			K / P\$	4780	
					1 1/2			H / P\$	2904	
		Veneer			1 3/16			F, G, X, Y / W\$	3880	
					1 3/16			K / W\$	5927	
					1 1/2			H / W\$	4370	
		Glass			1/4			Acid Etched Glass Top \$	15612	
					1/4			Gloss Glass Top \$	13122	

Description

- Tops Available with Veneer (W) or HPL (P) Top in 1 3/16" and 1 1/2" Thicknesses
- Must Specify Edge Profile: 1 3/16" Thick/Double Kerf (F), Duo (G), Fluted (X), Square (Y), and Knife (K) Edge Profiles or 1 1/2" Thick/Vertical Square (H)
- Veneer (W) Top Grain Runs Depth of Top and HPL (P) Top Grain Runs Width of Top
- All Veneer Tops, as well as Laminate Tops up to 144" (12 feet), have Matching Woodgrain. Laminate Tops Sized 156" (13 feet) and Longer have Non-Matching Woodgrain
- Available with Back Painted Tempered Glass Top; Must Specify Color and Finish; [See Options](#)
- Power and Data Options Available; Sold Separately, [See Multiple Power Unit Details](#)
- Bases Sold Separately, See [Multiple Base Options](#)



Double Kerf (F)
1 3/16"



Duo (G)
1 3/16"



Fluted (X)
1 3/16"



Square (Y)
1 3/16"



Knife (K)
1 3/16"



Vertical Square (H)
1 1/2"

P = HPL W = Veneer

[See Catalyst Overview For Ordering Options](#)

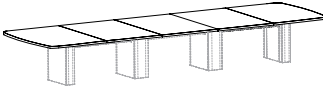
Item	Model No.		W	D	H	Ship Wt	Cubic Ft	Edge Profile + Material	List Price	
MODERN RECTANGLE SHAPE MEETING TOP 60"D  88-60204MR shown in Veneer with 88-24166C6I06RAB (6" + 10" Combo Rectangle Accent Base) BASES SOLD SEPARATELY	60"D x 240"W or 20' - 5 Piece Veneer (W) and 3 Piece HPL (P) Modern Rectangle Top									
	88-60240MR	Laminate	240	60	1 3/16	574	26.3	F, G, X, Y / P\$	4779	
					1 3/16			K / P\$	9084	
					1 1/2			H / P\$	5559	
		Veneer			1 3/16			F, G, X, Y / W\$	8359	
					1 3/16			K / W\$	12204	
					1 1/2			H / W\$	9534	
		Glass			1/4			Acid Etched Glass Top \$	32356	
					1/4			Gloss Glass Top \$	26823	
	60"D x 228"W or 19' - 5 Piece Veneer (W) and 3 Piece HPL (P) Modern Rectangle Top									
	88-60228MR	Laminate	228	60	1 3/16	547	25.0	F, G, X, Y / P\$	4727	
					1 3/16			K / P\$	8844	
					1 1/2			H / P\$	5468	
		Veneer			1 3/16			F, G, X, Y / W\$	8092	
					1 3/16			K / W\$	11776	
				1 1/2			H / W\$	9210		
	Glass			1/4			Acid Etched Glass Top \$	30928		
				1/4			Gloss Glass Top \$	25671		
60"D x 216"W or 18' - 5 Piece Veneer (W) and 3 Piece HPL (P) Modern Rectangle Top										
88-60216MR	Laminate	216	60	1 3/16	519	23.7	F, G, X, Y / P\$	4127		
				1 3/16			K / P\$	8042		
				1 1/2			H / P\$	4829		
	Veneer			1 3/16			F, G, X, Y / W\$	7825		
				1 3/16			K / W\$	11350		
				1 1/2			H / W\$	8888		
	Glass			1/4			Acid Etched Glass Top \$	29463		
				1/4			Gloss Glass Top \$	24483		
60"D x 204"W or 17' - 5 Piece Veneer (W) and 3 Piece HPL (P) Modern Rectangle Top										
88-60204MR	Laminate	204	60	1 3/16	492	22.4	F, G, X, Y / P\$	4075		
				1 3/16			K / P\$	7802		
				1 1/2			H / P\$	4738		
	Veneer			1 3/16			F, G, X, Y / W\$	7558		
				1 3/16			K / W\$	10922		
				1 1/2			H / W\$	8564		
	Glass			1/4			Acid Etched Glass Top \$	28035		
				1/4			Gloss Glass Top \$	23332		

Must Specify (in this order):
 Model #
 Top/Edge Material
 Top/Edge Finish/Color
 Edge Profile
 Glass (Y/N)
 Glass Color + Surface Finish
 Power/Data Type
 Power/Data Location

Additional 60" Modern Rectangle Shaped Tops on Next Page



Double Kerf (F) 1 3/16" Duo (G) 1 3/16" Fluted (X) 1 3/16" Square (Y) 1 3/16" Knife (K) 1 3/16" Vertical Square (H) 1 1/2"

P = HPL W = Veneer

[See Catalyst Overview For Ordering Options](#)

Item	Model No.		W	D	H	Ship Wt	Cubic Ft	Edge Profile + Material	List Price		
60"D x 192"W or 16' - 4 Piece Veneer (W) and 2 Piece HPL (P) Modern Rectangle Top											
<i>CONTINUED FROM PREVIOUS PAGE</i>	88-60192MR	Laminate	192	60	1 3/16	458	21.1	F, G, X, Y / P\$	3364		
					1 3/16			K / P\$	6866		
					1 1/2			H / P\$	3989		
	Veneer								F, G, X, Y / W\$	6252	
									1 3/16	K / W\$	9435
									1 1/2	H / W\$	7199
	Glass								Acid Etched Glass Top \$	25909	
										Gloss Glass Top \$	21482
	60"D x 180"W or 15' - 4 Piece Veneer (W) and 2 Piece HPL (P) Modern Rectangle Top										
	<i>Must Specify (in this order):</i> Model # Top/Edge Material Top/Edge Finish/Color Edge Profile Glass (Y/N) Glass Color + Surface Finish Power/Data Power/Data Location	88-60180MR	Laminate	180	60	1 3/16	431	19.8	F, G, X, Y / P\$	3311	
						1 3/16			K / P\$	6625	
						1 1/2			H / P\$	3898	
Veneer									F, G, X, Y / W\$	6007	
									1 3/16	K / W\$	9030
									1 1/2	H / W\$	6898
Glass									Acid Etched Glass Top \$	24481	
										Gloss Glass Top \$	20332
60"D x 168"W or 14' - 4 Piece Veneer (W) and 2 Piece HPL (P) Modern Rectangle Top											
		88-60168MR	Laminate	168	60	1 3/16	403	18.5	F, G, X, Y / P\$	3259	
						1 3/16			K / P\$	6385	
						1 1/2			H / P\$	3806	
	Veneer								F, G, X, Y / W\$	5762	
									1 3/16	K / W\$	8625
									1 1/2	H / W\$	6596
	Glass								Acid Etched Glass Top \$	23053	
										Gloss Glass Top \$	19180
	60"D x 156"W or 13' - 4 Piece Veneer (W) and 2 Piece HPL (P) Modern Rectangle Top										
		88-60156MR	Laminate	156	60	1 3/16	376	17.2	F, G, X, Y / P\$	3206	
						1 3/16			K / P\$	6145	
						1 1/2			H / P\$	3715	
Veneer									F, G, X, Y / W\$	5518	
									1 3/16	K / W\$	8220
									1 1/2	H / W\$	6295
Glass									Acid Etched Glass Top \$	21624	
										Gloss Glass Top \$	18028

Additional 60" Modern Rectangle Shaped Tops on Next Page



Double Kerf (F)
1 3/16"



Duo (G)
1 3/16"



Fluted (X)
1 3/16"



Square (Y)
1 3/16"



Knife (K)
1 3/16"



Vertical Square (H)
1 1/2"

P = HPL W = Veneer

[See Catalyst Overview For Ordering Options](#)

Item	Model No.		W	D	H	Ship Wt	Cubic Ft	Edge Profile + Material	List Price		
<i>CONTINUED FROM PREVIOUS PAGE</i>	60"D x 144"W or 12' - 3 Piece Veneer (W) and 2 Piece HPL (P) Modern Rectangle Top										
	88-60144MR	Laminate	144	60	1 3/16"	342	16.0	F, G, X, Y / P\$	2731		
					1 3/16"			K / P\$	5470		
					1 1/2"			H / P\$	3200		
		Veneer			1 3/16"			F, G, X, Y / W\$	4568		
					1 3/16"			K / W\$	7008		
					1 1/2"			H / W\$	5205		
		Glass			1/4"			Acid Etched Glass Top \$	19864		
					1/4"			Gloss Glass Top \$	16543		
		60"D x 132"W or 11' - 3 Piece Veneer (W) and 2 Piece HPL (P) Modern Rectangle Top									
	88-60132MR	Laminate	132	60	1 3/16"	323	14.6	F, G, X, Y / P\$	2666		
					1 3/16"			K / P\$	5216		
					1 1/2"			H / P\$	3096		
		Veneer			1 3/16"			F, G, X, Y / W\$	4336		
					1 3/16"			K / W\$	6621		
				1 1/2"			H / W\$	4922			
	Glass			1/4"			Acid Etched Glass Top \$	18421			
				1/4"			Gloss Glass Top \$	15378			
	60"D x 120"W or 10' - 3 Piece Veneer (W) and 2 Piece HPL (P) Modern Rectangle Top										
88-60120MR	Laminate	120	60	1 3/16"	287	13.3	F, G, X, Y / P\$	2601			
				1 3/16"			K / P\$	4964			
				1 1/2"			H / P\$	2991			
	Veneer			1 3/16"			F, G, X, Y / W\$	4104			
				1 3/16"			K / W\$	6237			
				1 1/2"			H / W\$	4641			
	Glass			1/4"			Acid Etched Glass Top \$	16980			
				1/4"			Gloss Glass Top \$	14214			

Must Specify (in this order):
 Model #
 Top/Edge Material
 Top/Edge Finish/Color
 Edge Profile
 Glass (Y/N)
 Glass Color + Surface Finish
 Power/Data Type
 Power/Data Location

Description

- Tops Available with Veneer (W) or HPL (P) Top in 1 3/16" and 1 1/2" Thicknesses
- Must Specify Edge Profile: 1 3/16" Thick/Double Kerf (F), Duo (G), Fluted (X), Square (Y), and Knife (K) Edge Profiles or 1 1/2" Thick/Vertical Square (H)
- Veneer (W) Top Grain Runs Depth of Top and HPL (P) Top Grain Runs Width of Top
- All Veneer Tops, as well as Laminate Tops up to 144" (12 feet), have Matching Woodgrain. Laminate Tops Sized 156" (13 feet) and Longer have Non-Matching Woodgrain
- Available with Back Painted Tempered Glass Top; Must Specify Color and Finish; [See Options](#)
- Power and Data Options Available; Sold Separately, [See Multiple Power Unit Details](#)
- Bases Sold Separately, See [Multiple Base Options](#)



Double Kerf (F) 1 3/16" Duo (G) 1 3/16" Fluted (X) 1 3/16" Square (Y) 1 3/16" Knife (K) 1 3/16" Vertical Square (H) 1 1/2"

P = HPL W = Veneer

[See Catalyst Overview For Ordering Options](#)

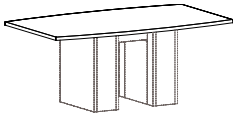
Item	Model No.		W	D	H	Ship Wt	Cubic Ft	Edge Profile + Material	List Price	
BOAT SHAPE MEETING TOP 36"D  88-3696BT shown with 88-203406RAB (6" Rectangle Accent Base) BASES SOLD SEPARATELY	36"D x 96"W or 8' - 1 Piece Boat Top									
	88-3696BT	Laminate	96	36-30	1 3/16	142	12.9	F, G, X, Y / P\$	1424	
					1 3/16			K / P\$	2821	
					1 1/2			H / P\$	1606	
		Veneer			1 3/16			F, G, X, Y / W\$	1613	
					1 3/16			K / W\$	3163	
					1 1/2			H / W\$	1921	
		Glass			1/4			Acid Etched Glass Top \$	8724	
					1/4			Gloss Glass Top \$	7396	
	36"D x 84"W or 7' - 1 Piece Boat Top									
		88-3684BT	Laminate	84	36-30	1 3/16	126	11.3	F, G, X, Y / P\$	1357
					1 3/16			K / P\$	2583	
				1 1/2			H / P\$	1547		
	Veneer			1 3/16			F, G, X, Y / W\$	1529		
				1 3/16			K / W\$	2958		
				1 1/2			H / W\$	1768		
	Glass			1/4			Acid Etched Glass Top \$	7821		
				1/4			Gloss Glass Top \$	6659		
36"D x 72"W or 6' - 1 Piece Boat Top										
	88-3672BT	Laminate	72	36-30	1 3/16	109	10.3	F, G, X, Y / P\$	1108	
				1 3/16			K / P\$	2236		
				1 1/2			H / P\$	1245		
	Veneer			1 3/16			F, G, X, Y / W\$	1302		
				1 3/16			K / W\$	2518		
				1 1/2			H / W\$	1537		
	Glass			1/4			Acid Etched Glass Top \$	6829		
				1/4			Gloss Glass Top \$	5832		

Must Specify (in this order):

- Model #
- Top/Edge Material
- Top/Edge Finish/Color
- Edge Profile
- Glass (Y/N)
- Glass Color + Surface Finish
- Power/Data
- Power/Data Location

Description

- Tops Available with Veneer (W) or HPL (P) Top in 1 3/16" and 1 1/2" Thicknesses
- Must Specify Edge Profile: 1 3/16" Thick/Double Kerf (F), Duo (G), Fluted (X), Square (Y), and Knife (K) Edge Profiles or 1 1/2" Thick/Vertical Square (H)
- Veneer (W) Top Grain Runs Depth of Top and HPL (P) Top Grain Runs Width of Top
- Available with Back Painted Tempered Glass Top; Must Specify Color and Finish; [See Options](#)
- Power and Data Options Available; Sold Separately, [See Multiple Power Unit Details](#)
- Bases Sold Separately, See [Multiple Base Options](#)



Double Kerf (F)
1 3/16"



Duo (G)
1 3/16"



Fluted (X)
1 3/16"



Square (Y)
1 3/16"



Knife (K)
1 3/16"



Vertical Square (H)
1 1/2"

P = HPL W = Veneer

[See Catalyst Overview For Ordering Options](#)

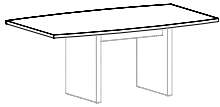
Item	Model No.		W	D	H	Ship Wt	Cubic Ft	Edge Profile + Material	List Price	
BOAT SHAPE MEETING TOP 42"D  88-4272BT shown with 88-2034RPB (Rectangle Panel Base) BASES SOLD SEPARATELY	42"D x 120"W or 10' - 2 Piece Boat Top									
	88-42120BT	Laminate	120	42-36	1 3/16	268	27.0	F, G, X, Y / P\$	2008	
					1 3/16			K / P\$	3846	
					1 1/2			H / P\$	2278	
		Veneer			1 3/16			F, G, X, Y / W\$	2330	
					1 3/16			K / W\$	4333	
					1 1/2			H / W\$	2769	
		Glass			1/4			Acid Etched Glass Top \$	12215	
					1/4			Gloss Glass Top \$	10279	
	42"D x 108"W or 9' - 2 Piece Boat Top									
	88-42108BT	Laminate	108	42-36	1 3/16	260	27.0	F, G, X, Y / P\$	1970	
					1 3/16			K / P\$	3630	
					1 1/2			H / P\$	2213	
		Veneer			1 3/16			F, G, X, Y / W\$	2192	
					1 3/16			K / W\$	4063	
				1 1/2			H / W\$	2590		
	Glass			1/4			Acid Etched Glass Top \$	11182		
				1/4			Gloss Glass Top \$	9439		
42"D x 96"W or 8' - 1 Piece Boat Top										
88-4296BT	Laminate	96	42-36	1 3/16	164	15.0	F, G, X, Y / P\$	1453		
				1 3/16			K / P\$	2984		
				1 1/2			H / P\$	1667		
	Veneer			1 3/16			F, G, X, Y / W\$	1752		
				1 3/16			K / W\$	3361		
				1 1/2			H / W\$	2104		
	Glass			1/4			Acid Etched Glass Top \$	9818		
				1/4			Gloss Glass Top \$	8269		
42"D x 84"W or 7' - 1 Piece Boat Top										
88-4284BT	Laminate	84	42-36	1 3/16	145	13.1	F, G, X, Y / P\$	1414		
				1 3/16			K / P\$	2769		
				1 1/2			H / P\$	1600		
	Veneer			1 3/16			F, G, X, Y / W\$	1618		
				1 3/16			K / W\$	3102		
				1 1/2			H / W\$	1928		
	Glass			1/4			Acid Etched Glass Top \$	8786		
				1/4			Gloss Glass Top \$	7430		

Must Specify (in this order):
 Model #
 Top/Edge Material
 Top/Edge Finish/Color
 Edge Profile
 Glass (Y/N)
 Glass Color + Surface Finish
 Power/Data
 Power/Data Location

Additional 42" Boat Shaped Tops on Next Page

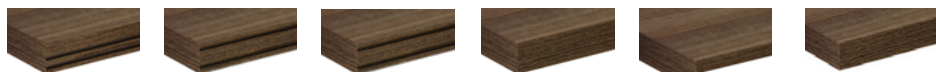

Double Kerf (F) 1 3/16" Duo (G) 1 3/16" Fluted (X) 1 3/16" Square (Y) 1 3/16" Knife (K) 1 3/16" Vertical Square (H) 1 1/2"

P = HPL W = Veneer

[See Catalyst Overview For Ordering Options](#)

Item	Model No.		W	D	H	Ship Wt	Cubic Ft	Edge Profile + Material	List Price	
<i>CONTINUED FROM PREVIOUS PAGE</i>	42"D x 72"W or 6' - 1 Piece Boat Top									
	88-4272BT	Laminate	72	42-36	1 3/16	164	15.0	F, G, X, Y / P\$	1182	
					1 3/16			K / P\$	2467	
					1 1/2			H / P\$	1341	
		Veneer			1 3/16			F, G, X, Y / W\$	1473	
					1 3/16			K / W\$	2710	
					1 1/2			H / W\$	1741	
		Glass			1/4			Acid Etched Glass Top \$	7725	
					1/4			Gloss Glass Top \$	6563	

Must Specify (in this order):

- Model #
- Top/Edge Material
- Top/Edge Finish/Color
- Edge Profile
- Glass (Y/N)
- Glass Color + Surface Finish
- Power/Data
- Power/Data Location

Description

- Tops Available with Veneer (W) or HPL (P) Top in 1 3/16" and 1 1/2" Thicknesses
- Must Specify Edge Profile: 1 3/16" Thick/Double Kerf (F), Duo (G), Fluted (X), Square (Y), and Knife (K) Edge Profiles or 1 1/2" Thick/Vertical Square (H)
- Veneer (W) Top Grain Runs Depth of Top and HPL (P) Top Grain Runs Width of Top
- Available with Back Painted Tempered Glass Top; Must Specify Color and Finish; [See Options](#)
- Power and Data Options Available; Sold Separately, [See Multiple Power Unit Details](#)
- Bases Sold Separately, See [Multiple Base Options](#)



Double Kerf (F)
1 3/16"



Duo (G)
1 3/16"



Fluted (X)
1 3/16"



Square (Y)
1 3/16"



Knife (K)
1 3/16"



Vertical Square (H)
1 1/2"

P = HPL W = Veneer

[See Catalyst Overview For Ordering Options](#)

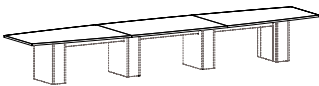
Item	Model No.		W	D	H	Ship Wt	Cubic Ft	Edge Profile + Material	List Price	
BOAT SHAPE MEETING TOP 48"D  88-48216BT shown with 88-2417810RAB (10" Rectangle Accent Base) BASES SOLD SEPARATELY	48"D x 240"W or 20' - 3 Piece Boat Top									
	88-48240BT	Laminate	240	48-36	1 3/16	460	48.9	F, G, X, Y / P\$	4638	
					1 3/16			K / P\$	8499	
					1 1/2			H / P\$	5257	
		Veneer			1 3/16			F, G, X, Y / W\$	6301	
					1 3/16			K / W\$	9571	
					1 1/2			H / W\$	7153	
		Glass			1/4			Acid Etched Glass Top \$	26634	
					1/4			Gloss Glass Top \$	22207	
	48"D x 228"W or 19' - 3 Piece Boat Top									
	88-48228BT	Laminate	228	48-36	1 3/16	438	48.9	F, G, X, Y / P\$	4594	
					1 3/16			K / P\$	8284	
					1 1/2			H / P\$	5182	
		Veneer			1 3/16			F, G, X, Y / W\$	6037	
					1 3/16			K / W\$	9216	
				1 1/2			H / W\$	6849		
	Glass			1/4			Acid Etched Glass Top \$	25468		
				1/4			Gloss Glass Top \$	21263		
48"D x 216"W or 18' - 3 Piece Boat Top										
88-48216BT	Laminate	216	48-36	1 3/16	416	48.9	F, G, X, Y / P\$	3687		
				1 3/16			K / P\$	7182		
				1 1/2			H / P\$	4244		
	Veneer			1 3/16			F, G, X, Y / W\$	5369		
				1 3/16			K / W\$	8456		
				1 1/2			H / W\$	6139		
	Glass			1/4			Acid Etched Glass Top \$	23917		
				1/4			Gloss Glass Top \$	19933		
48"D x 204"W or 17' - 3 Piece Boat Top										
88-48204BT	Laminate	204	48-36	1 3/16	394	48.9	F, G, X, Y / P\$	3643		
				1 3/16			K / P\$	6968		
				1 1/2			H / P\$	4169		
	Veneer			1 3/16			F, G, X, Y / W\$	5106		
				1 3/16			K / W\$	8101		
				1 1/2			H / W\$	5834		
	Glass			1/4			Acid Etched Glass Top \$	22751		
				1/4			Gloss Glass Top \$	18988		

Must Specify (in this order):
 Model #
 Top/Edge Material
 Top/Edge Finish/Color
 Edge Profile
 Glass (Y/N)
 Glass Color + Surface Finish
 Power/Data
 Power/Data Location

Additional 48" Boat Shaped Tops on Next Page



Double Kerf (F) 1 3/16" Duo (G) 1 3/16" Fluted (X) 1 3/16" Square (Y) 1 3/16" Knife (K) 1 3/16" Vertical Square (H) 1 1/2"

P = HPL W = Veneer

[See Catalyst Overview For Ordering Options](#)

Item	Model No.		W	D	H	Ship Wt	Cubic Ft	Edge Profile + Material	List Price	
48"D x 192"W or 16' - 2 Piece Boat Top										
<i>CONTINUED FROM PREVIOUS PAGE</i>	88-48192BT	Laminate	192	48-36	1 3/16"	372	31.2	F, G, X, Y / P\$	3125	
					1 3/16"			K / P\$	6249	
					1 1/2"			H / P\$	3621	
	Veneer	1 3/16"	F, G, X, Y / W\$	4215						
		1 3/16"	K / W\$	6996						
		1 1/2"	H / W\$	4991						
	Glass		1/4"	Acid Etched Glass Top \$	21073					
			1/4"	Gloss Glass Top \$	17531					
	48"D x 180"W or 15' - 2 Piece Boat Top									
	<i>Must Specify (in this order):</i> Model # Top/Edge Material Top/Edge Finish/Color Edge Profile Glass (Y/N) Glass Color + Surface Finish Power/Data Power/Data Location	88-48180BT	Laminate	180	48-36	1 3/16"	350	31.2	F, G, X, Y / P\$	3080
						1 3/16"			K / P\$	6034
						1 1/2"			H / P\$	3547
Veneer		1 3/16"	F, G, X, Y / W\$	4045						
		1 3/16"	K / W\$	6679						
		1 1/2"	H / W\$	4773						
Glass			1/4"	Acid Etched Glass Top \$	19906					
			1/4"	Gloss Glass Top \$	16586					
48"D x 168"W or 14' - 2 Piece Boat Top										
		88-48168BT	Laminate	168	48-36	1 3/16"	328	31.2	F, G, X, Y / P\$	2928
						1 3/16"			K / P\$	5708
						1 1/2"			H / P\$	3363
	Veneer	1 3/16"	F, G, X, Y / W\$	3736						
		1 3/16"	K / W\$	6223						
		1 1/2"	H / W\$	4418						
	Glass		1/4"	Acid Etched Glass Top \$	18629					
			1/4"	Gloss Glass Top \$	15530					
	48"D x 156"W or 13' - 2 Piece Boat Top									
		88-48156BT	Laminate	156	48-36	1 3/16"	306	31.2	F, G, X, Y / P\$	2885
						1 3/16"			K / P\$	5363
						1 1/2"			H / P\$	3288
Veneer		1 3/16"	F, G, X, Y / W\$	3567						
		1 3/16"	K / W\$	6039						
		1 1/2"	H / W\$	4202						
Glass			1/4"	Acid Etched Glass Top \$	17463					
			1/4"	Gloss Glass Top \$	14585					

Additional 48" Boat Shaped Tops on Next Page



Double Kerf (F)
1 3/16"



Duo (G)
1 3/16"



Fluted (X)
1 3/16"



Square (Y)
1 3/16"



Knife (K)
1 3/16"



Vertical Square (H)
1 1/2"

P = HPL W = Veneer

[See Catalyst Overview For Ordering Options](#)

Item	Model No.		W	D	H	Ship Wt	Cubic Ft	Edge Profile + Material	List Price		
<i>CONTINUED FROM PREVIOUS PAGE</i>	48"D x 144"W or 12' - 2 Piece Boat Top										
	88-48144BT	Laminate	144	48-36	1 3/16	284	23.5	F, G, X, Y / P\$	2421		
					1 3/16			K / P\$	4847		
					1 1/2			H / P\$	2793		
		Veneer			1 3/16			F, G, X, Y / W\$	3328		
					1 3/16			K / W\$	5521		
					1 1/2			H / W\$	3915		
		Glass			1/4			Acid Etched Glass Top \$	16201		
					1/4			Gloss Glass Top \$	13544		
		48"D x 132"W or 11' - 2 Piece Boat Top									
	88-48132BT	Laminate	132	48-36	1 3/16	262	23.5	F, G, X, Y / P\$	2365		
					1 3/16			K / P\$	4619		
					1 1/2			H / P\$	2705		
		Veneer			1 3/16			F, G, X, Y / W\$	3105		
					1 3/16			K / W\$	5178		
					1 1/2			H / W\$	3645		
		Glass			1/4			Acid Etched Glass Top \$	15022		
					1/4			Gloss Glass Top \$	12588		
	48"D x 120"W or 10' - 2 Piece Boat Top										
88-48120BT	Laminate	120	48-36	1 3/16	240	23.5	F, G, X, Y / P\$	2299			
				1 3/16			K / P\$	4383			
				1 1/2			H / P\$	2609			
	Veneer			1 3/16			F, G, X, Y / W\$	2870			
				1 3/16			K / W\$	4823			
				1 1/2			H / W\$	3364			
	Glass			1/4			Acid Etched Glass Top \$	13835			
				1/4			Gloss Glass Top \$	11622			
	48"D x 108"W or 9' - 2 Piece Boat Top										
88-48108BT	Laminate	108	48-36	1 3/16	218	23.5	F, G, X, Y / P\$	2243			
				1 3/16			K / P\$	4063			
				1 1/2			H / P\$	2522			
	Veneer			1 3/16			F, G, X, Y / W\$	2648			
				1 3/16			K / W\$	4575			
				1 1/2			H / W\$	3095			
	Glass			1/4			Acid Etched Glass Top \$	12657			
				1/4			Gloss Glass Top \$	10665			

Must Specify (in this order):
 Model #
 Top/Edge Material
 Top/Edge Finish/Color
 Edge Profile
 Glass (Y/N)
 Glass Color + Surface Finish
 Power/Data
 Power/Data Location

Additional 48" Boat Shaped Tops on Next Page



Double Kerf (F) 1 3/16" Duo (G) 1 3/16" Fluted (X) 1 3/16" Square (Y) 1 3/16" Knife (K) 1 3/16" Vertical Square (H) 1 1/2"

P = HPL W = Veneer

[See Catalyst Overview For Ordering Options](#)

Item	Model No.		W	D	H	Ship Wt	Cubic Ft	Edge Profile + Material	List Price	
48"D x 96"W or 8' - 1 Piece Boat Top										
<i>CONTINUED FROM PREVIOUS PAGE</i>	88-4896BT	Laminate	96	48-36	1 ³ / ₁₆	295	27.0	F, G, X, Y / P\$	1529	
					1 ³ / ₁₆			K / P\$	3258	
					1 ¹ / ₂			H / P\$	1774	
	Veneer	1 ³ / ₁₆	F, G, X, Y / W\$	1951						
		1 ³ / ₁₆	K / W\$	3558						
		1 ¹ / ₂	H / W\$	2347						
	Glass		1 ⁴ / ₄	Acid Etched Glass Top \$	10965					
			1 ⁴ / ₄	Gloss Glass Top \$	9194					
	48"D x 84"W or 7' - 1 Piece Boat Top									
	Must Specify (in this order): Model # Top/Edge Material Top/Edge Finish/Color Edge Profile Glass (Y/N) Glass Color + Surface Finish Power/Data Power/Data Location	88-4884BT	Laminate	84	48-36	1 ³ / ₁₆	164	15.0	F, G, X, Y / P\$	1484
1 ³ / ₁₆						K / P\$			2899	
1 ¹ / ₂						H / P\$			1698	
Veneer		1 ³ / ₁₆	F, G, X, Y / W\$	1724						
		1 ³ / ₁₆	K / W\$	3266						
		1 ¹ / ₂	H / W\$	2074						
Glass			1 ⁴ / ₄	Acid Etched Glass Top \$	9732					
			1 ⁴ / ₄	Gloss Glass Top \$	8184					
48"D x 72"W or 6' - 1 Piece Boat Top										
		88-4872BT	Laminate	72	48-36	1 ³ / ₁₆	142	12.8	F, G, X, Y / P\$	1249
	1 ³ / ₁₆					K / P\$			2637	
	1 ¹ / ₂					H / P\$			1432	
	Veneer	1 ³ / ₁₆	F, G, X, Y / W\$	1633						
		1 ³ / ₁₆	K / W\$	2948						
		1 ¹ / ₂	H / W\$	1935						
	Glass		1 ⁴ / ₄	Acid Etched Glass Top \$	8608					
			1 ⁴ / ₄	Gloss Glass Top \$	7280					

Description

- Tops Available with Veneer (W) or HPL (P) Top in 1³/₁₆" and 1¹/₂" Thicknesses
- Must Specify Edge Profile: 1³/₁₆" Thick/Double Kerf (F), Duo (G), Fluted (X), Square (Y), and Knife (K) Edge Profiles or 1¹/₂" Thick/Vertical Square (H)
- Veneer (W) Top Grain Runs Depth of Top and HPL (P) Top Grain Runs Width of Top
- All Veneer Tops, as well as Laminate Tops up to 144" (12 feet), have Matching Woodgrain. Laminate Tops Sized 156" (13 feet) and Longer have Non-Matching Woodgrain
- Available with Back Painted Tempered Glass Top; Must Specify Color and Finish; [See Options](#)
- Power and Data Options Available; Sold Separately, [See Multiple Power Unit Details](#)
- Bases Sold Separately, See [Multiple Base Options](#)



Double Kerf (F)
1³/₁₆"



Duo (G)
1³/₁₆"



Fluted (X)
1³/₁₆"



Square (Y)
1³/₁₆"



Knife (K)
1³/₁₆"



Vertical Square (H)
1¹/₂"

P = HPL W = Veneer

[See Catalyst Overview For Ordering Options](#)

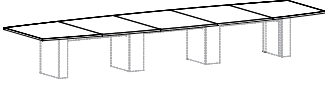
Item	Model No.		W	D	H	Ship Wt	Cubic Ft	Edge Profile + Material	List Price	
BOAT SHAPE MEETING TOP 54"D  88-54204BT shown in Veneer with 88-241661ORB (10" Rectangle Base) BASES SOLD SEPARATELY	54"D x 240"W or 20' - 5 Piece Veneer (W) and 3 Piece HPL (P) Boat Top									
	88-54240BT	Laminate	240	54-42	1 3/16	519	24.0	F, G, X, Y / P\$	4690	
					1 3/16			K / P\$	8773	
					1 1/2			H / P\$	5389	
		Veneer			1 3/16			F, G, X, Y / W\$	7844	
					1 3/16			K / W\$	11557	
					1 1/2			H / W\$	8912	
		Glass			1/4			Acid Etched Glass Top \$	29666	
					1/4			Gloss Glass Top \$	24687	
	54"D x 228"W or 19' - 5 Piece Veneer (W) and 3 Piece HPL (P) Boat Top									
	88-54228BT	Laminate	228	54-42	1 3/16	495	23.0	F, G, X, Y / P\$	4642	
					1 3/16			K / P\$	8545	
				1 1/2			H / P\$	5306		
	Veneer			1 3/16			F, G, X, Y / W\$	7602		
				1 3/16			K / W\$	11159		
				1 1/2			H / W\$	8619		
	Glass			1/4			Acid Etched Glass Top \$	28369		
				1/4			Gloss Glass Top \$	23639		
54"D x 216"W or 18' - 5 Piece Veneer (W) and 3 Piece HPL (P) Boat Top										
88-54216BT	Laminate	216	54-42	1 3/16	470	22.0	F, G, X, Y / P\$	4047		
				1 3/16			K / P\$	7755		
				1 1/2			H / P\$	4676		
	Veneer			1 3/16			F, G, X, Y / W\$	7361		
				1 3/16			K / W\$	10761		
				1 1/2			H / W\$	8327		
	Glass			1/4			Acid Etched Glass Top \$	27037		
				1/4			Gloss Glass Top \$	22556		
54"D x 204"W or 17' - 5 Piece Veneer (W) and 3 Piece HPL (P) Boat Top										
88-54204BT	Laminate	204	54-42	1 3/16	445	21.0	F, G, X, Y / P\$	3999		
				1 3/16			K / P\$	7528		
				1 1/2			H / P\$	4593		
	Veneer			1 3/16			F, G, X, Y / W\$	7119		
				1 3/16			K / W\$	10364		
				1 1/2			H / W\$	8034		
	Glass			1/4			Acid Etched Glass Top \$	25741		
				1/4			Gloss Glass Top \$	21509		

Must Specify (in this order):

- Model #
- Top/Edge Material
- Top/Edge Finish/Color
- Edge Profile
- Glass (Y/N)
- Glass Color + Surface Finish
- Power/Data
- Power/Data Location

Additional 54" Boat Shaped Tops on Next Page



Double Kerf (F) 1 3/16" Duo (G) 1 3/16" Fluted (X) 1 3/16" Square (Y) 1 3/16" Knife (K) 1 3/16" Vertical Square (H) 1 1/2"

P = HPL W = Veneer

[See Catalyst Overview For Ordering Options](#)

Item	Model No.		W	D	H	Ship Wt	Cubic Ft	Edge Profile + Material	List Price		
54"D x 192"W or 16' - 4 Piece Veneer (W) and 2 Piece HPL (P) Boat Top											
<i>CONTINUED FROM PREVIOUS PAGE</i>	88-54192BT	Laminate	192	54-42	1 ³ / ₁₆	408	19.0	F, G, X, Y / P\$	3291		
					1 ³ / ₁₆			K / P\$	6606		
					1 ¹ / ₂			H / P\$	3852		
	Veneer								F, G, X, Y / W\$	5874	
									1 ³ / ₁₆	K / W\$	8938
									1 ¹ / ₂	H / W\$	6734
	Glass								Acid Etched Glass Top \$	23748	
									1 ¹ / ₂	Gloss Glass Top \$	19764
	54"D x 180"W or 15' - 4 Piece Veneer (W) and 2 Piece HPL (P) Boat Top										
	<i>Must Specify (in this order):</i> Model # Top/Edge Material Top/Edge Finish/Color Edge Profile Glass (Y/N) Glass Color + Surface Finish Power/Data Power/Data Location	88-54180BT	Laminate	180	54-42	1 ³ / ₁₆	384	18.0	F, G, X, Y / P\$	3244	
1 ³ / ₁₆						K / P\$			6379		
1 ¹ / ₂						H / P\$			3769		
Veneer									F, G, X, Y / W\$	5652	
									1 ³ / ₁₆	K / W\$	8560
									1 ¹ / ₂	H / W\$	6460
Glass									Acid Etched Glass Top \$	22451	
									1 ¹ / ₂	Gloss Glass Top \$	18716
54"D x 168"W or 14' - 4 Piece Veneer (W) and 2 Piece HPL (P) Boat Top											
		88-54168BT	Laminate	168	54-42	1 ³ / ₁₆	359	17.0	F, G, X, Y / P\$	3195	
	1 ³ / ₁₆					K / P\$			6151		
	1 ¹ / ₂					H / P\$			3687		
	Veneer								F, G, X, Y / W\$	5431	
									1 ³ / ₁₆	K / W\$	8182
									1 ¹ / ₂	H / W\$	6188
	Glass								Acid Etched Glass Top \$	21154	
									1 ¹ / ₂	Gloss Glass Top \$	17668
	54"D x 156"W or 13' - 4 Piece Veneer (W) and 2 Piece HPL (P) Boat Top										
		88-54156BT	Laminate	156	54-42	1 ³ / ₁₆	334	16.0	F, G, X, Y / P\$	3147	
1 ³ / ₁₆						K / P\$			5923		
1 ¹ / ₂						H / P\$			3603		
Veneer									F, G, X, Y / W\$	5209	
									1 ³ / ₁₆	K / W\$	7802
									1 ¹ / ₂	H / W\$	5915
Glass									Acid Etched Glass Top \$	19856	
									1 ¹ / ₂	Gloss Glass Top \$	16619

Additional 54" Boat Shaped Tops on Next Page



Double Kerf (F)
1³/₁₆"



Duo (G)
1³/₁₆"



Fluted (X)
1³/₁₆"



Square (Y)
1³/₁₆"



Knife (K)
1³/₁₆"



Vertical Square (H)
1¹/₂"

P = HPL W = Veneer

[See Catalyst Overview For Ordering Options](#)

Item	Model No.		W	D	H	Ship Wt	Cubic Ft	Edge Profile + Material	List Price	
<i>CONTINUED FROM PREVIOUS PAGE</i>	54"D x 144"W or 12' - 3 Piece Veneer (W) and 2 Piece HPL (P) Boat Top									
	88-54144BT	Laminate	144	54-42	1 3/16"	309	15.0	F, G, X, Y / P\$	2675	
					1 3/16"			K / P\$	5261	
					1 1/2"			H / P\$	3097	
		Veneer			1 3/16"			F, G, X, Y / W\$	4300	
					1 3/16"			K / W\$	6645	
					1 1/2"			H / W\$	4880	
		Glass			1/4"			Acid Etched Glass Top \$	18228	
					1/4"			Gloss Glass Top \$	15240	
		54"D x 132"W or 11' - 3 Piece Veneer (W) and 2 Piece HPL (P) Boat Top								
	88-54132BT	Laminate	132	54-42	1 3/16"	285	13.2	F, G, X, Y / P\$	2614	
					1 3/16"			K / P\$	5021	
					1 1/2"			H / P\$	3000	
		Veneer			1 3/16"			F, G, X, Y / W\$	4090	
					1 3/16"			K / W\$	6285	
					1 1/2"			H / W\$	4624	
		Glass			1/4"			Acid Etched Glass Top \$	16918	
					1/4"			Gloss Glass Top \$	14180	
	54"D x 120"W or 10' - 3 Piece Veneer (W) and 2 Piece HPL (P) Boat Top									
88-54120BT	Laminate	120	54-42	1 3/16"	260	12.1	F, G, X, Y / P\$	2553		
				1 3/16"			K / P\$	4780		
				1 1/2"			H / P\$	2904		
	Veneer			1 3/16"			F, G, X, Y / W\$	3880		
				1 3/16"			K / W\$	5927		
				1 1/2"			H / W\$	4370		
	Glass			1/4"			Acid Etched Glass Top \$	15612		
				1/4"			Gloss Glass Top \$	13122		

Must Specify (in this order):
 Model #
 Top/Edge Material
 Top/Edge Finish/Color
 Edge Profile
 Glass (Y/N)
 Glass Color + Surface Finish
 Power/Data
 Power/Data Location

Description

- Tops Available with Veneer (W) or HPL (P) Top in 1 3/16" and 1 1/2" Thicknesses
- Must Specify Edge Profile: 1 3/16" Thick/Double Kerf (F), Duo (G), Fluted (X), Square (Y), and Knife (K) Edge Profiles or 1 1/2" Thick/Vertical Square (H)
- Veneer (W) Top Grain Runs Depth of Top and HPL (P) Top Grain Runs Width of Top
- All Veneer Tops, as well as Laminate Tops up to 144" (12 feet), have Matching Woodgrain. Laminate Tops Sized 156" (13 feet) and Longer have Non-Matching Woodgrain
- Available with Back Painted Tempered Glass Top; Must Specify Color and Finish; [See Options](#)
- Power and Data Options Available; Sold Separately, [See Multiple Power Unit Details](#)
- Bases Sold Separately, See [Multiple Base Options](#)



Double Kerf (F) 1 3/16" Duo (G) 1 3/16" Fluted (X) 1 3/16" Square (Y) 1 3/16" Knife (K) 1 3/16" Vertical Square (H) 1 1/2"

P = HPL W = Veneer

[See Catalyst Overview For Ordering Options](#)

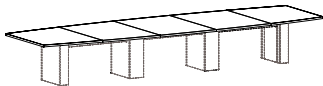
Item	Model No.		W	D	H	Ship Wt	Cubic Ft	Edge Profile + Material	List Price	
BOAT SHAPE MEETING TOP 60"D  88-60204BT shown in Veneer with 88-24166C610RB (6" + 10" Combo Rectangle Base) BASES SOLD SEPARATELY	60"D x 240"W or 20' - 5 Piece Veneer (W) and 3 Piece HPL (P) Boat Top									
	88-60240BT	Laminate	240	60-48	1 3/16"	574	26.3	F, G, X, Y / P\$	4779	
					1 3/16"			K / P\$	9084	
					1 1/2"			H / P\$	5559	
	Veneer				1 3/16"			F, G, X, Y / W\$	8359	
					1 3/16"			K / W\$	12204	
					1 1/2"			H / W\$	9534	
	Glass				1/4"			Acid Etched Glass Top \$	32356	
					1/4"			Gloss Glass Top \$	26823	
	60"D x 228"W or 19' - 5 Piece Veneer (W) and 3 Piece HPL (P) Boat Top									
	88-60228BT	Laminate	228	60-48	1 3/16"	547	25.0	F, G, X, Y / P\$	4727	
					1 3/16"			K / P\$	8844	
				1 1/2"			H / P\$	5468		
Veneer				1 3/16"			F, G, X, Y / W\$	8092		
				1 3/16"			K / W\$	11776		
				1 1/2"			H / W\$	9210		
Glass				1/4"			Acid Etched Glass Top \$	30928		
				1/4"			Gloss Glass Top \$	25671		
60"D x 216"W or 18' - 5 Piece Veneer (W) and 3 Piece HPL (P) Boat Top										
88-60216BT	Laminate	216	60-48	1 3/16"	519	23.7	F, G, X, Y / P\$	4127		
				1 3/16"			K / P\$	8042		
				1 1/2"			H / P\$	4829		
Veneer				1 3/16"			F, G, X, Y / W\$	7825		
				1 3/16"			K / W\$	11350		
				1 1/2"			H / W\$	8888		
Glass				1/4"			Acid Etched Glass Top \$	29463		
				1/4"			Gloss Glass Top \$	24483		
60"D x 204"W or 17' - 5 Piece Veneer (W) and 3 Piece HPL (P) Boat Top										
88-60204BT	Laminate	204	60-48	1 3/16"	492	22.4	F, G, X, Y / P\$	4075		
				1 3/16"			K / P\$	7802		
				1 1/2"			H / P\$	4738		
Veneer				1 3/16"			F, G, X, Y / W\$	7558		
				1 3/16"			K / W\$	10922		
				1 1/2"			H / W\$	8564		
Glass				1/4"			Acid Etched Glass Top \$	28035		
				1/4"			Gloss Glass Top \$	23332		

Must Specify (in this order):

- Model #
- Top/Edge Material
- Top/Edge Finish/Color
- Edge Profile
- Glass (Y/N)
- Glass Color + Surface Finish
- Power/Data
- Power/Data Location

Additional 60" Boat Shaped Tops on Next Page



Double Kerf (F)
1 3/16"



Duo (G)
1 3/16"



Fluted (X)
1 3/16"



Square (Y)
1 3/16"



Knife (K)
1 3/16"



Vertical Square (H)
1 1/2"

P = HPL W = Veneer

[See Catalyst Overview For Ordering Options](#)

Item	Model No.		W	D	H	Ship Wt	Cubic Ft	Edge Profile + Material	List Price	
<i>CONTINUED FROM PREVIOUS PAGE</i>	60"D x 192"W or 16' - 4 Piece Veneer (W) and 2 Piece HPL (P) Boat Top									
	88-60192BT	Laminate	192	60-48	1 3/16	458	21.1	F, G, X, Y / P\$	3364	
					1 3/16			K / P\$	6866	
					1 1/2			H / P\$	3989	
		Veneer			1 3/16			F, G, X, Y / W\$	6252	
					1 3/16			K / W\$	9435	
					1 1/2			H / W\$	7199	
		Glass			1/4			Acid Etched Glass Top \$	25909	
					1/4			Gloss Glass Top \$	21482	
	60"D x 180"W or 15' - 4 Piece Veneer (W) and 2 Piece HPL (P) Boat Top									
	88-60180BT	Laminate	180	60-48	1 3/16	431	19.8	F, G, X, Y / P\$	3311	
					1 3/16			K / P\$	6625	
					1 1/2			H / P\$	3898	
		Veneer			1 3/16			F, G, X, Y / W\$	6007	
					1 3/16			K / W\$	9030	
					1 1/2			H / W\$	6898	
		Glass			1/4			Acid Etched Glass Top \$	24481	
					1/4			Gloss Glass Top \$	20332	
60"D x 168"W or 14' - 4 Piece Veneer (W) and 2 Piece HPL (P) Boat Top										
88-60168BT	Laminate	168	60-48	1 3/16	403	18.5	F, G, X, Y / P\$	3259		
				1 3/16			K / P\$	6385		
				1 1/2			H / P\$	3806		
	Veneer			1 3/16			F, G, X, Y / W\$	5762		
				1 3/16			K / W\$	8625		
				1 1/2			H / W\$	6596		
	Glass			1/4			Acid Etched Glass Top \$	23053		
				1/4			Gloss Glass Top \$	19180		
60"D x 156"W or 13' - 4 Piece Veneer (W) and 2 Piece HPL (P) Boat Top										
88-60156BT	Laminate	156	60-48	1 3/16	376	17.2	F, G, X, Y / P\$	3206		
				1 3/16			K / P\$	6145		
				1 1/2			H / P\$	3715		
	Veneer			1 3/16			F, G, X, Y / W\$	5518		
				1 3/16			K / W\$	8220		
				1 1/2			H / W\$	6295		
	Glass			1/4			Acid Etched Glass Top \$	21624		
				1/4			Gloss Glass Top \$	18028		

Must Specify (in this order):

- Model #
- Top/Edge Material
- Top/Edge Finish/Color
- Edge Profile
- Glass (Y/N)
- Glass Color + Surface Finish
- Power/Data
- Power/Data Location

Additional 60" Boat Shaped Tops on Next Page



Double Kerf (F)
1 3/16"



Duo (G)
1 3/16"



Fluted (X)
1 3/16"



Square (Y)
1 3/16"



Knife (K)
1 3/16"



Vertical Square (H)
1 1/2"

P = HPL W = Veneer

[See Catalyst Overview For Ordering Options](#)

Item	Model No.		W	D	H	Ship Wt	Cubic Ft	Edge Profile + Material	List Price	
60"D x 144"W or 12' - 3 Piece Veneer (W) and 2 Piece HPL (P) Boat Top										
<i>CONTINUED FROM PREVIOUS PAGE</i>	88-60144BT	Laminate	144	60-48	1 3/16"	342	16.0	F, G, X, Y / P\$	2731	
					1 3/16"			K / P\$	5470	
					1 1/2"			H / P\$	3200	
	Veneer	1 3/16"	F, G, X, Y / W\$	4568						
		1 3/16"	K / W\$	7008						
		1 1/2"	H / W\$	5205						
	Glass		1/4"	Acid Etched Glass Top \$	19864					
			1/4"	Gloss Glass Top \$	16543					
	60"D x 132"W or 11' - 3 Piece Veneer (W) and 2 Piece HPL (P) Boat Top									
	<u>Must Specify (in this order):</u> Model # Top/Edge Material Top/Edge Finish/Color Edge Profile Glass (Y/N) Glass Color + Surface Finish Power/Data Power/Data Location	88-60132BT	Laminate	132	60-48	1 3/16"	323	14.6	F, G, X, Y / P\$	2666
1 3/16"						K / P\$			5216	
1 1/2"						H / P\$			3096	
Veneer		1 3/16"	F, G, X, Y / W\$	4336						
		1 3/16"	K / W\$	6621						
		1 1/2"	H / W\$	4922						
Glass			1/4"	Acid Etched Glass Top \$	18421					
			1/4"	Gloss Glass Top \$	15378					
60"D x 120"W or 10' - 3 Piece Veneer (W) and 2 Piece HPL (P) Boat Top										
88-60120BT		Laminate	120	60-48	1 3/16"	287	13.3	F, G, X, Y / P\$	2601	
	1 3/16"				K / P\$			4964		
	1 1/2"				H / P\$			2991		
	Veneer	1 3/16"	F, G, X, Y / W\$	4104						
		1 3/16"	K / W\$	6237						
		1 1/2"	H / W\$	4641						
	Glass		1/4"	Acid Etched Glass Top \$	16980					
			1/4"	Gloss Glass Top \$	14214					

Description

- Tops Available with Veneer (W) or HPL (P) Top in 1 3/16" and 1 1/2" Thicknesses
- Must Specify Edge Profile: 1 3/16" Thick/Double Kerf (F), Duo (G), Fluted (X), Square (Y), and Knife (K) Edge Profiles or 1 1/2" Thick/Vertical Square (H)
- Veneer (W) Top Grain Runs Depth of Top and HPL (P) Top Grain Runs Width of Top
- All Veneer Tops, as well as Laminate Tops up to 144" (12 feet), have Matching Woodgrain. Laminate Tops Sized 156" (13 feet) and Longer have Non-Matching Woodgrain
- Available with Back Painted Tempered Glass Top; Must Specify Color and Finish; [See Options](#)
- Power and Data Options Available; Sold Separately, [See Multiple Power Unit Details](#)
- Bases Sold Separately, See [Multiple Base Options](#)



Double Kerf (F)
1 3/16"



Duo (G)
1 3/16"



Fluted (X)
1 3/16"



Square (Y)
1 3/16"



Knife (K)
1 3/16"



Vertical Square (H)
1 1/2"

P = HPL W = Veneer

[See Catalyst Overview For Ordering Options](#)

Item	Model No.		W	D	H	Ship Wt	Cubic Ft	List Price	
RECTANGLE PANEL BASES WITH TROUGH 24"W	Four (4) Panel Bases - For Use With 60" / 54" / 48" x 240" Surfaces								
	88-24202RPB	Laminate	24	202	28¾	159	14.3	T\$	4441
		Veneer						W\$	4500
	Four (4) Panel Bases - For Use With 60" / 54" / 48" x 228" Surfaces								
	88-24190RPB	Laminate	24	190	28¾	158	14.3	T\$	4395
		Veneer						W\$	4446
	Four (4) Panel Bases - For Use With 60" / 54" / 48" x 216" Surfaces								
	88-24178RPB	Laminate	24	178	28¾	156	14.3	T\$	4363
		Veneer						W\$	4414
	Four (4) Panel Bases - For Use With 60" / 54" / 48" x 204" Surfaces								
	88-24166RPB	Laminate	24	166	28¾	155	14.3	T\$	4315
		Veneer						W\$	4360
	Three (3) Panel Bases - For Use With 60" / 54" / 48" x 192" Surfaces								
	88-24154RPB	Laminate	24	154	28¾	122	13.8	T\$	3450
		Veneer						W\$	3675
	Three (3) Panel Bases - For Use With 60" / 54" / 48" x 180" Surfaces								
	88-24142RPB	Laminate	24	142	28¾	120	13.8	T\$	3135
		Veneer						W\$	3171
	Three (3) Panel Bases - For Use With 60" / 54" / 48" x 168" Surfaces								
	88-24130RPB	Laminate	24	130	28¾	119	13.8	T\$	3110
		Veneer						W\$	3134
	Three (3) Panel Bases - For Use With 60" / 54" / 48" x 156" Surfaces								
	88-24118RPB	Laminate	24	118	28¾	118	13.8	T\$	3071
		Veneer						W\$	3097
	Three (3) Panel Bases - For Use With 60" / 54" / 48" x 144" Surfaces								
	88-24106RPB	Laminate	24	106	28¾	116	13.8	T\$	3000
		Veneer						W\$	3059
	Three (3) Panel Bases - For Use With 60" / 54" / 48" x 132" Surfaces								
	88-2494RPB	Laminate	24	94	28¾	115	13.8	T\$	2666
		Veneer						W\$	2781
	Two (2) Panel Bases - For Use With 60" / 54" / 48" x 120" Surfaces								
	88-2482RPB	Laminate	24	82	28¾	90	6.9	T\$	2150
		Veneer						W\$	2201

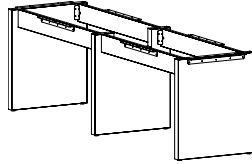

Shown: 88-2494RPB

TOPS SOLD SEPARATELY

Must Specify (in this order):

Model #
Material
Finish / Color

Additional Rectangle Panel Bases on Next Page

T = TFL W = Veneer

[See Catalyst Overview For Ordering Options](#)

Item	Model No.		W	D	H	Ship Wt	Cubic Ft	List Price	
CONTINUED FROM PREVIOUS PAGE RECTANGLE PANEL BASES WITH TROUGH 24" + 20"W	24"W Bases Continued								
	Two (2) Panel Bases - For Use With 48" x 108" Surfaces								
	88-2470RPB	Laminate	24	70	28¾	87	6.9	T\$	1919
		Veneer						W\$	1991
	Two (2) Panel Bases - For Use With 48" x 96" Surfaces								
	88-2458RPB	Laminate	24	58	28¾	84	6.9	T\$	1880
		Veneer						W\$	1954
	Two (2) Panel Bases - For Use With 48" x 84" Surfaces								
	88-2446RPB	Laminate	24	46	28¾	81	6.9	T\$	1677
		Veneer						W\$	1797
	Two (2) Panel Bases - For Use With 48" x 72" Surfaces								
	88-2434RPB	Laminate	24	34	28¾	78	6.9	T\$	1602
		Veneer						W\$	1758
	20"W Bases								
	Two (2) Panel Bases - For Use With 42" x 120" Surfaces								
	88-2082RPB	Laminate	20	82	28¾	78	6.7	T\$	2132
		Veneer						W\$	2175
	Two (2) Panel Bases - For Use With 42" x 108" Surfaces								
88-2070RPB	Laminate	20	70	28¾	75	6.7	T\$	1892	
	Veneer						W\$	1975	
Two (2) Panel Bases - For Use With 36" / 42" x 96" Surfaces									
88-2058RPB	Laminate	20	58	28¾	72	6.7	T\$	1853	
	Veneer						W\$	1938	
Two (2) Panel Bases - For Use With 36" / 42" x 84" Surfaces									
88-2046RPB	Laminate	20	46	28¾	69	6.7	T\$	1651	
	Veneer						W\$	1779	
Two (2) Panel Bases - For Use With 36" / 42" x 72" Surfaces									
88-2034RPB	Laminate	20	34	28¾	66	6.7	T\$	1575	
	Veneer						W\$	1742	

Must Specify (in this order):

Model #

Material

Finish / Color

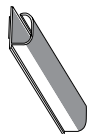

Wire Management
Channel

Description

- 2" Panel Bases with Trough, Stretcher Rails, and L-Bracket Hardware Included
- Available with TFL (T) or Veneer (W)
- Vertical Grain Direction on Bases
- Wire Management Channel Included; Two (2) Base Units Include One (1) Wire Management Channel and Three (3) Base Units Includes Two (2) Wire Management Channel
- Bases Require Some Assembly; Attachment Hardware Included
- Tops Sold Separately, [See Multiple Unit Details](#)

T = TFL W = Veneer

[See Catalyst Overview For Ordering Options](#)

Item	Model No.		W	D	H	Ship Wt	Cubic Ft	List Price	
6" RECTANGLE BASES WITH TROUGH AND REMOVABLE PANEL 24"W	Four (4) 6" Rectangle Bases - For Use With 60" / 54" / 48" x 240" Surfaces								
	88-2420206RB	Laminate	24	202	28¾	158	26.3	T\$	6570
		Veneer						W\$	8938
	Four (4) 6" Rectangle Bases - For Use With 60" / 54" / 48" x 228" Surfaces								
	88-2419006RB	Laminate	24	190	28¾	156	26.3	T\$	6523
		Veneer						W\$	8899
	Four (4) 6" Rectangle Bases - For Use With 60" / 54" / 48" x 216" Surfaces								
	88-2417806RB	Laminate	24	178	28¾	154	26.3	T\$	6490
		Veneer						W\$	8867
	Four (4) 6" Rectangle Bases - For Use With 60" / 54" / 48" x 204" Surfaces								
	88-2416606RB	Laminate	24	166	28¾	152	26.3	T\$	6444
		Veneer						W\$	8813
	Three (3) 6" Rectangle Bases - For Use With 60" / 54" / 48" x 192" Surfaces								
	88-2415406RB	Laminate	24	154	28¾	114	19.6	T\$	5110
		Veneer						W\$	7101
	Three (3) 6" Rectangle Bases - For Use With 60" / 54" / 48" x 180" Surfaces								
	88-2414206RB	Laminate	24	142	28¾	112	19.6	T\$	5073
		Veneer						W\$	6856
	Three (3) 6" Rectangle Bases - For Use With 60" / 54" / 48" x 168" Surfaces								
	88-2413006RB	Laminate	24	130	28¾	110	19.6	T\$	4794
		Veneer						W\$	6536
	Three (3) 6" Rectangle Bases - For Use With 60" / 54" / 48" x 156" Surfaces								
	88-2411806RB	Laminate	24	118	28¾	108	19.6	T\$	4757
		Veneer						W\$	6497
	Three (3) 6" Rectangle Bases - For Use With 60" / 54" / 48" x 144" Surfaces								
	88-2410606RB	Laminate	24	106	28¾	106	19.6	T\$	4720
		Veneer						W\$	6457
	Three (3) 6" Rectangle Bases - For Use With 60" / 54" / 48" x 132" Surfaces								
	88-249406RB	Laminate	24	94	28¾	102	12.9	T\$	4442
		Veneer						W\$	6092
	Two (2) 6" Rectangle Bases - For Use With 60" / 54" / 48" x 120" Surfaces								
	88-248206RB	Laminate	24	82	28¾	99	12.9	T\$	3219
		Veneer						W\$	4449

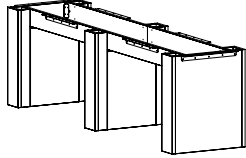

Shown: 88-249406RB

TOPS SOLD SEPARATELY

Must Specify (in this order):

Model #

Material

Finish / Color

Additional 6" Rectangle Panel Bases on Next Page

T = TFL W = Veneer

[See Catalyst Overview For Ordering Options](#)

Item	Model No.		W	D	H	Ship Wt	Cubic Ft	List Price	
CONTINUED FROM PREVIOUS PAGE -	24"W Bases Continued								
	Two (2) 6" Rectangle Bases - For Use With 48" x 108" Surfaces								
6" RECTANGLE BASES WITH TROUGH AND REMOVABLE PANEL 24" + 20"W	88-247006RB	Laminate	24	70	28¾	96	12.9	T\$	3062
		Veneer						W\$	4160
	Two (2) 6" Rectangle Bases - For Use With 48" x 96" Surfaces								
	88-245806RB	Laminate	24	58	28¾	93	12.9	T\$	3023
		Veneer						W\$	4128
	Two (2) 6" Rectangle Bases - For Use With 48" x 84" Surfaces								
	88-244606RB	Laminate	24	46	28¾	90	12.9	T\$	2866
		Veneer						W\$	3925
	Two (2) 6" Rectangle Bases - For Use With 48" x 72" Surfaces								
	88-243406RB	Laminate	24	34	28¾	87	12.9	T\$	2829
		Veneer						W\$	3850
<u>Must Specify (in this order):</u>	20"W Bases								
Model #	Two (2) 6" Rectangle Bases - For Use With 42" x 120" Surfaces								
Material	88-208206RB	Laminate	20	82	28¾	89	12.9	T\$	3167
Finish / Color		Veneer						W\$	4419
	Two (2) 6" Rectangle Bases - For Use With 42" x 108" Surfaces								
	88-207006RB	Laminate	20	70	28¾	86	12.9	T\$	3009
		Veneer						W\$	4130
	Two (2) 6" Rectangle Bases - For Use With 36" / 42" x 96" Surfaces								
	88-205806RB	Laminate	20	58	28¾	82	12.9	T\$	2971
		Veneer						W\$	4098
	Two (2) 6" Rectangle Bases - For Use With 36" / 42" x 84" Surfaces								
	88-204606RB	Laminate	20	46	28¾	79	12.9	T\$	2814
		Veneer						W\$	3895
	Two (2) 6" Rectangle Bases - For Use With 36" / 42" x 72" Surfaces								
	88-203406RB	Laminate	20	34	28¾	76	12.9	T\$	2777
		Veneer						W\$	3820

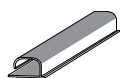
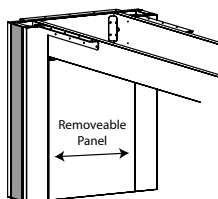

Wire Management Channel

Description

- 6" Rectangle Bases with Trough, Stretcher Rails, and L-Bracket Hardware Included
- Available with TFL (T) or Veneer (W)
- Vertical Grain Direction on Bases
- Bases Include Interior Removable Panel for Wire Management Access; Removable Panel is 15⅞"W for 24" Bases and 11⅞"W for 20" Bases
- Wire Management Channel Included; Two (2) Base Units Include One (1) Wire Management Channel and Three (3) Base Units Includes Two (2) Wire Management Channel
- Removable Panels Attached with Z Brackets.
- Bases Require Some Assembly; Attachment Hardware Included
- Tops Sold Separately, [See Multiple Unit Details](#)

T = TFL W = Veneer

[See Catalyst Overview For Ordering Options](#)

Item	Model No.		W	D	H	Ship Wt	Cubic Ft	List Price	
10" RECTANGLE BASES WITH TROUGH AND REMOVABLE PANEL 24"W	Four (4) 10" Rectangle Bases - For Use With 60" / 54" / 48" x 240" Surfaces								
	88-242021ORB	Laminate	24	202	28¾	205	24.6	T\$	6731
		Veneer						W\$	9062
	Four (4) 10" Rectangle Bases - For Use With 60" / 54" / 48" x 228" Surfaces								
	88-241901ORB	Laminate	24	190	28¾	202	24.6	T\$	6684
		Veneer						W\$	9023
	Four (4) 10" Rectangle Bases - For Use With 60" / 54" / 48" x 216" Surfaces								
	88-241781ORB	Laminate	24	178	28¾	198	24.6	T\$	6651
		Veneer						W\$	8991
	Four (4) 10" Rectangle Bases - For Use With 60" / 54" / 48" x 204" Surfaces								
	88-241661ORB	Laminate	24	166	28¾	195	24.6	T\$	6604
		Veneer						W\$	8937
	Three (3) 10" Rectangle Bases - For Use With 60" / 54" / 48" x 192" Surfaces								
	88-241541ORB	Laminate	24	154	28¾	155	18.2	T\$	5231
		Veneer						W\$	7194
	Three (3) 10" Rectangle Bases - For Use With 60" / 54" / 48" x 180" Surfaces								
	88-241421ORB	Laminate	24	142	28¾	151	18.2	T\$	5193
		Veneer						W\$	6949
	Three (3) 10" Rectangle Bases - For Use With 60" / 54" / 48" x 168" Surfaces								
	88-241301ORB	Laminate	24	130	28¾	148	18.2	T\$	4915
		Veneer						W\$	6629
	Three (3) 10" Rectangle Bases - For Use With 60" / 54" / 48" x 156" Surfaces								
	88-241181ORB	Laminate	24	118	28¾	144	18.2	T\$	4878
		Veneer						W\$	6590
	Three (3) 10" Rectangle Bases - For Use With 60" / 54" / 48" x 144" Surfaces								
	88-241061ORB	Laminate	24	106	28¾	141	18.2	T\$	4841
		Veneer						W\$	6551
	Three (3) 10" Rectangle Bases - For Use With 60" / 54" / 48" x 132" Surfaces								
	88-24941ORB	Laminate	24	94	28¾	137	18.2	T\$	4562
		Veneer						W\$	6185
	Two (2) 10" Rectangle Bases - For Use With 60" / 54" / 48" x 120" Surfaces								
	88-24821ORB	Laminate	24	82	28¾	96	12.0	T\$	3300
		Veneer						W\$	4512

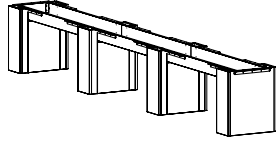

Shown: 88-241901ORB

TOPS SOLD SEPARATELY

Must Specify (in this order):

Model #
Material
Finish / Color

Additional 10" Rectangle Panel Bases on Next Page

T = TFL W = Veneer

[See Catalyst Overview For Ordering Options](#)

Item	Model No.		W	D	H	Ship Wt	Cubic Ft	List Price	
<i>CONTINUED FROM PREVIOUS PAGE</i>		24"W Bases Continued							
10" RECTANGLE BASES WITH TROUGH AND REMOVABLE PANEL 24" + 20"W		Two (2) 10" Rectangle Bases - For Use With 48" x 108" Surfaces							
	88-24701ORB	Laminate	24	70	28¾	93	12.0	T\$	3141
		Veneer						W\$	4222
		Two (2) 10" Rectangle Bases - For Use With 48" x 96" Surfaces							
	88-24581ORB	Laminate	24	58	28¾	89	12.0	T\$	3104
		Veneer						W\$	4190
		Two (2) 10" Rectangle Bases - For Use With 48" x 84" Surfaces							
	88-24461ORB	Laminate	24	46	28¾	86	12.0	T\$	2947
		Veneer						W\$	3987
		Two (2) 10" Rectangle Bases - For Use With 48" x 72" Surfaces							
	88-24341ORB	Laminate	24	34	28¾	82	12.0	T\$	2843
		Veneer						W\$	3832
		20"W Bases							
		Two (2) 10" Rectangle Bases - For Use With 42" x 120" Surfaces							
	88-20821ORB	Laminate	20	82	28¾	86	10.0	T\$	3247
		Veneer						W\$	4482
		Two (2) 10" Rectangle Bases - For Use With 42" x 108" Surfaces							
	88-20701ORB	Laminate	20	70	28¾	82	10.0	T\$	3089
		Veneer						W\$	4192
		Two (2) 10" Rectangle Bases - For Use With 36" / 42" x 96" Surfaces							
	88-20581ORB	Laminate	20	58	28¾	79	10.0	T\$	3052
		Veneer						W\$	4160
		Two (2) 10" Rectangle Bases - For Use With 36" / 42" x 84" Surfaces							
	88-20461ORB	Laminate	20	46	28¾	75	10.0	T\$	2894
		Veneer						W\$	3957
		Two (2) 10" Rectangle Bases - For Use With 36" / 42" x 72" Surfaces							
	88-20341ORB	Laminate	20	34	28¾	72	10.0	T\$	2857
		Veneer						W\$	3882

Must Specify (in this order):

Model #

Material

Finish / Color

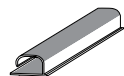
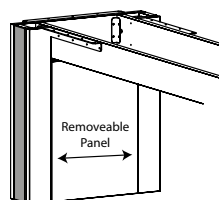

Wire Management Channel

Description

- 10" Rectangle Bases with Trough and Stretcher Rails
- Available with TFL (T) or Veneer (W)
- Vertical Grain Direction on Bases
- Bases Include Interior Removable Panel for Wire Management Access; Removable Panel is 15⅞"W for 24" Bases and 11⅞"W for 20" Bases
- Wire Management Channel Included; Two (2) Base Units Include One (1) Wire Management Channel and Three (3) Base Units Includes Two (2) Wire Management Channel
- Removable Panels Attached with Z Brackets.
- Bases Require Some Assembly; Attachment Hardware Included
- Tops Sold Separately, [See Multiple Unit Details](#)

T = TFL W = Veneer

[See Catalyst Overview For Ordering Options](#)

Item	Model No.		W	D	H	Ship Wt	Cubic Ft	List Price
6" + 10" COMBO RECTANGLE BASES WITH TROUGH AND REMOVABLE PANEL 24"W	Four (4) Bases Total: Two (2) 6" and Two (2) 10" Rectangle Bases - For Use With 60" / 54" / 48" x 240" Surfaces							
	88-24202C610RB	Laminate	24	202	28¾	205	24.6	T\$ 6650
		Veneer						W\$ 9015
	Four (4) Bases Total: Two (2) 6" and Two (2) 10" Rectangle Bases - For Use With 60" / 54" / 48" x 228" Surfaces							
	88-24190C610RB	Laminate	24	190	28¾	202	24.6	T\$ 6603
		Veneer						W\$ 8961
	Four (4) Bases Total: Two (2) 6" and Two (2) 10" Rectangle Bases - For Use With 60" / 54" / 48" x 216" Surfaces							
	88-24178C610RB	Laminate	24	178	28¾	198	24.6	T\$ 6570
		Veneer						W\$ 8929
	Four (4) Bases Total: Two (2) 6" and Two (2) 10" Rectangle Bases - For Use With 60" / 54" / 48" x 204" Surfaces							
	88-24166C610RB	Laminate	24	166	28¾	195	24.6	T\$ 6524
		Veneer						W\$ 8875
	Three (3) Bases Total: Two (2) 6" and One (1) 10" Rectangle Bases - For Use With 60" / 54" / 48" x 192" Surfaces							
	88-24154C610RB	Laminate	24	154	28¾	155	18.2	T\$ 5544
		Veneer						W\$ 7616
	Three (3) Bases Total: Two (2) 6" and One (1) 10" Rectangle Bases - For Use With 60" / 54" / 48" x 180" Surfaces							
	88-24142C610RB	Laminate	24	142	28¾	151	18.2	T\$ 5113
		Veneer						W\$ 6887
	Three (3) Bases Total: Two (2) 6" and One (1) 10" Rectangle Bases - For Use With 60" / 54" / 48" x 168" Surfaces							
	88-24130C610RB	Laminate	24	130	28¾	148	18.2	T\$ 4834
		Veneer						W\$ 6567
	Three (3) Bases Total: Two (2) 6" and One (1) 10" Rectangle Bases - For Use With 60" / 54" / 48" x 156" Surfaces							
	88-24118C610RB	Laminate	24	118	28¾	144	18.2	T\$ 4797
		Veneer						W\$ 6528
	Three (3) Bases Total: Two (2) 6" and One (1) 10" Rectangle Bases - For Use With 60" / 54" / 48" x 144" Surfaces							
	88-24106C610RB	Laminate	24	106	28¾	141	18.2	T\$ 4760
		Veneer						W\$ 6488
	Three (3) Bases Total: Two (2) 6" and One (1) 10" Rectangle Bases - For Use With 60" / 54" / 48" x 132" Surfaces							
	88-2494C610RB	Laminate	24	94	28¾	137	18.2	T\$ 4482
		Veneer						W\$ 6123

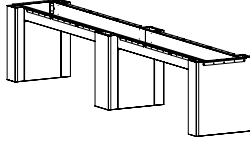

Shown: 88-24142C610RB

TOPS SOLD SEPARATELY

Must Specify (in this order):

Model #

Material

Finish / Color

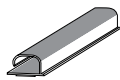
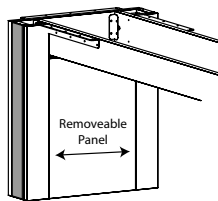

Wire Management Channel

Description

- 6" + 10" Rectangle Bases with Trough and Stretcher Rails; 6" Bases on Exterior and 10" Bases on Interior
- Available with TFL (T) or Veneer (W)
- Vertical Grain Direction on Bases
- Wire Management Channel Included; Two (2) Base Units Include One (1) Wire Management Channel and Three (3) Base Units Includes Two (2) Wire Management Channel
- Bases Include Interior Removable Panel for Wire Management. Removable Panel is 15⅞"W and Attaches with Z Brackets.
- Bases Require Some Assembly; Attachment Hardware Included
- Tops Sold Separately, [See Multiple Unit Details](#)

T = TFL W = Veneer

[See Catalyst Overview For Ordering Options](#)

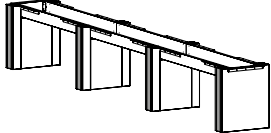
Item	Model No.		W	D	H	Ship Wt	Cubic Ft	List Price	
6" RECTANGLE ACCENT BASES WITH TROUGH AND REMOVABLE PANEL 24"W	Four (4) 6" Rectangle Bases - For Use With 60" / 54" / 48" x 240" Surfaces								
	88-2420206RAB	Laminate	24	202	28¾	158	26.3	T\$	7463
		Veneer						W\$	9887
	Four (4) 6" Rectangle Bases - For Use With 60" / 54" / 48" x 228" Surfaces								
	88-2419006RAB	Laminate	24	190	28¾	156	26.3	T\$	7417
		Veneer						W\$	9847
Shown: 88-2419006RAB	Four (4) 6" Rectangle Bases - For Use With 60" / 54" / 48" x 216" Surfaces								
	88-2417806RAB	Laminate	24	178	28¾	154	26.3	T\$	7384
TOPS SOLD SEPARATELY		Veneer						W\$	9815
Must Specify (in this order):	Four (4) 6" Rectangle Bases - For Use With 60" / 54" / 48" x 204" Surfaces								
	88-2416606RAB	Laminate	24	166	28¾	152	26.3	T\$	7337
Model #		Veneer						W\$	9762
Base Finish/Color	Three (3) 6" Rectangle Bases - For Use With 60" / 54" / 48" x 192" Surfaces								
Metal Accent Color	88-2415406RAB	Laminate	24	154	28¾	114	19.6	T\$	5785
Accent Panel Finish/Color		Veneer						W\$	7817
	Three (3) 6" Rectangle Bases - For Use With 60" / 54" / 48" x 180" Surfaces								
	88-2414206RAB	Laminate	24	142	28¾	112	19.6	T\$	5747
		Veneer						W\$	7571
	Three (3) 6" Rectangle Bases - For Use With 60" / 54" / 48" x 168" Surfaces								
	88-2413006RAB	Laminate	24	130	28¾	110	19.6	T\$	5469
		Veneer						W\$	7252
	Three (3) 6" Rectangle Bases - For Use With 60" / 54" / 48" x 156" Surfaces								
	88-2411806RAB	Laminate	24	118	28¾	108	19.6	T\$	5432
		Veneer						W\$	7213
	Three (3) 6" Rectangle Bases - For Use With 60" / 54" / 48" x 144" Surfaces								
	88-2410606RAB	Laminate	24	106	28¾	106	19.6	T\$	5394
		Veneer						W\$	7174
	Three (3) 6" Rectangle Bases - For Use With 60" / 54" / 48" x 132" Surfaces								
	88-249406RAB	Laminate	24	94	28¾	102	12.9	T\$	5117
		Veneer						W\$	6808
	Two (2) 6" Rectangle Bases - For Use With 60" / 54" / 48" x 120" Surfaces								
	88-248206RAB	Laminate	24	82	28¾	99	12.9	T\$	4745
		Veneer						W\$	6436

Additional 6" Rectangle Accent Bases on Next Page.

T = TFL W = Veneer

[See Catalyst Overview For Ordering Options](#)

Item	Model No.		W	D	H	Ship Wt	Cubic Ft	List Price		
6" RECTANGLE ACCENT BASES WITH TROUGH AND REMOVABLE PANEL 24" + 20"W Must Specify (in this order): Model # Base Finish/Color Metal Accent Color Accent Panel Finish/Color	24"W Bases Continued									
	Two (2) 6" Rectangle Bases - For Use With 48" x 108" Surfaces									
	88-247006RAB	Laminate	24	70	28 ³ / ₄	96	12.9	T\$	3517	
		Veneer						W\$	4642	
	Two (2) 6" Rectangle Bases - For Use With 48" x 96" Surfaces									
	88-245806RAB	Laminate	24	58	28 ³ / ₄	93	12.9	T\$	3480	
		Veneer						W\$	4610	
	Two (2) 6" Rectangle Bases - For Use With 48" x 84" Surfaces									
	88-244606RAB	Laminate	24	46	28 ³ / ₄	90	12.9	T\$	3322	
		Veneer						W\$	4408	
	Two (2) 6" Rectangle Bases - For Use With 48" x 72" Surfaces									
	88-243406RAB	Laminate	24	34	28 ³ / ₄	87	12.9	T\$	3284	
		Veneer						W\$	4333	
	20"W Bases									
	Two (2) 6" Rectangle Bases - For Use With 42" x 120" Surfaces									
	88-208206RAB	Laminate	20	82	28 ³ / ₄	89	12.9	T\$	3623	
		Veneer						W\$	4902	
	Two (2) 6" Rectangle Bases - For Use With 42" x 108" Surfaces									
	88-207006RAB	Laminate	20	70	28 ³ / ₄	86	12.9	T\$	3465	
		Veneer						W\$	4612	
	Two (2) 6" Rectangle Bases - For Use With 36" / 42" x 96" Surfaces									
	88-205806RAB	Laminate	20	58	28 ³ / ₄	82	12.9	T\$	3428	
		Veneer						W\$	4580	
	Two (2) 6" Rectangle Bases - For Use With 36" / 42" x 84" Surfaces									
88-204606RAB	Laminate	20	46	28 ³ / ₄	79	12.9	T\$	3270		
	Veneer						W\$	4378		
Two (2) 6" Rectangle Bases - For Use With 36" / 42" x 72" Surfaces										
88-203406RAB	Laminate	20	34	28 ³ / ₄	76	12.9	T\$	3232		
	Veneer						W\$	4302		

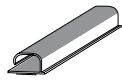
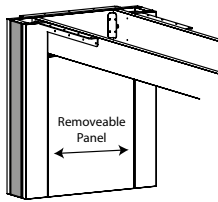

Wire Management Channel

Description

- 6" Rectangle Bases with Trough and Stretcher Rails
- Available with TFL (T) or Veneer (W)
- ⁵/₁₆" Metal Accent Available in Four (4) Colors: Aluminum, Black, Gold, and Platinum; Must Specify Color
- Vertical Grain Direction on Bases
- Bases Include Interior Removable Panel for Wire Management Access; Removable Panel is 15¹/₈"W for 24" Bases and 11⁷/₈"W for 20" Bases
- Wire Management Channel Included; Two (2) Base Units Include One (1) Wire Management Channel and Three (3) Base Units Includes Two (2) Wire Management Channel
- Removable Panels Attached with Z Brackets.
- Bases Require Some Assembly; Attachment Hardware Included
- Tops Sold Separately, [See Multiple Unit Details](#)

T = TFL W = Veneer

[See Catalyst Overview For Ordering Options](#)

Item	Model No.		W	D	H	Ship Wt	Cubic Ft	List Price	
10" RECTANGLE ACCENT BASES WITH TROUGH AND REMOVABLE PANEL 24"W	Four (4) 10" Rectangle Bases - For Use With 60" / 54" / 48" x 240" Surfaces								
	88-242021ORAB	Laminate	24	202	28¾	205	24.6	T\$	7556
		Veneer						W\$	10002
	Four (4) 10" Rectangle Bases - For Use With 60" / 54" / 48" x 228" Surfaces								
	88-241901ORAB	Laminate	24	190	28¾	202	24.6	T\$	7509
		Veneer						W\$	9963
	Four (4) 10" Rectangle Bases - For Use With 60" / 54" / 48" x 216" Surfaces								
	88-241781ORAB	Laminate	24	178	28¾	198	24.6	T\$	7477
		Veneer						W\$	9931
	Four (4) 10" Rectangle Bases - For Use With 60" / 54" / 48" x 204" Surfaces								
	88-241661ORAB	Laminate	24	166	28¾	195	24.6	T\$	7429
		Veneer						W\$	9877
	Three (3) 10" Rectangle Bases - For Use With 60" / 54" / 48" x 192" Surfaces								
	88-241541ORAB	Laminate	24	154	28¾	155	18.2	T\$	5852
		Veneer						W\$	7902
	Three (3) 10" Rectangle Bases - For Use With 60" / 54" / 48" x 180" Surfaces								
	88-241421ORAB	Laminate	24	142	28¾	151	18.2	T\$	5815
		Veneer						W\$	7656
	Three (3) 10" Rectangle Bases - For Use With 60" / 54" / 48" x 168" Surfaces								
	88-241301ORAB	Laminate	24	130	28¾	148	18.2	T\$	5536
		Veneer						W\$	7337
	Three (3) 10" Rectangle Bases - For Use With 60" / 54" / 48" x 156" Surfaces								
	88-241181ORAB	Laminate	24	118	28¾	144	18.2	T\$	5499
		Veneer						W\$	7298
	Three (3) 10" Rectangle Bases - For Use With 60" / 54" / 48" x 144" Surfaces								
	88-241061ORAB	Laminate	24	106	28¾	141	18.2	T\$	5462
		Veneer						W\$	7258
	Three (3) 10" Rectangle Bases - For Use With 60" / 54" / 48" x 132" Surfaces								
	88-24941ORAB	Laminate	24	94	28¾	137	18.2	T\$	5183
		Veneer						W\$	6892
	Two (2) 10" Rectangle Bases - For Use With 60" / 54" / 48" x 120" Surfaces								
	88-24821ORAB	Laminate	24	82	28¾	96	12.0	T\$	3717
		Veneer						W\$	4986

Additional 10" Rectangle Accent Bases on Next Page.

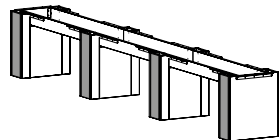

Shown: 88-241901ORAB
Shown with Gray Accent Panel

TOPS SOLD SEPARATELY

Must Specify (in this order):

- Model #
- Base Finish/Color
- Metal Accent Color
- Accent Panel Finish/Color

T = TFL W = Veneer

[See Catalyst Overview For Ordering Options](#)

Item	Model No.		W	D	H	Ship Wt	Cubic Ft	List Price	
CONTINUED FROM PREVIOUS PAGE	24"W Bases Continued								
	Two (2) 10" Rectangle Bases - For Use With 48" x 108" Surfaces								
	10" RECTANGLE ACCENT BASES WITH TROUGH AND REMOVABLE PANEL 24" + 20"W	88-247010RAB	Laminate	24	70	28¾	93	12.0	T\$ 3558
			Veneer						W\$ 4696
	Two (2) 10" Rectangle Bases - For Use With 48" x 96" Surfaces								
		88-245810RAB	Laminate	24	58	28¾	89	12.0	T\$ 3521
			Veneer						W\$ 4664
	Two (2) 10" Rectangle Bases - For Use With 48" x 84" Surfaces								
		88-244610RAB	Laminate	24	46	28¾	86	12.0	T\$ 3364
			Veneer						W\$ 4461
	Two (2) 10" Rectangle Bases - For Use With 48" x 72" Surfaces								
		88-243410RAB	Laminate	24	34	28¾	82	12.0	T\$ 3260
		Veneer						W\$ 4306	
Must Specify (in this order): Model # Base Finish/Color Metal Accent Color Accent Panel Finish/Color	20"W Bases								
	Two (2) 10" Rectangle Bases - For Use With 42" x 120" Surfaces								
		88-208210RAB	Laminate	20	82	28¾	86	10.0	T\$ 3664
			Veneer						W\$ 4956
	Two (2) 10" Rectangle Bases - For Use With 42" x 108" Surfaces								
		88-207010RAB	Laminate	20	70	28¾	82	10.0	T\$ 3507
			Veneer						W\$ 4666
	Two (2) 10" Rectangle Bases - For Use With 36" / 42" x 96" Surfaces								
		88-205810RAB	Laminate	20	58	28¾	79	10.0	T\$ 3469
			Veneer						W\$ 4634
	Two (2) 10" Rectangle Bases - For Use With 36" / 42" x 84" Surfaces								
		88-204610RAB	Laminate	20	46	28¾	75	10.0	T\$ 3311
		Veneer						W\$ 4431	
Two (2) 10" Rectangle Bases - For Use With 36" / 42" x 72" Surfaces									
	88-203410RAB	Laminate	20	34	28¾	72	10.0	T\$ 3209	
		Veneer						W\$ 4276	

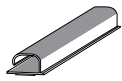
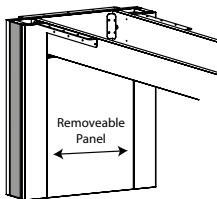

Wire Management
Channel

Description

- 10" Rectangle Bases with Trough and Stretcher Rails
- Available with TFL (T) or Veneer (W)
- 5/16" Metal Accent Available in Four (4) Colors: Aluminum, Black, Gold, and Platinum; Must Specify Color
- Vertical Grain Direction on Bases
- Bases Include Interior Removable Panel for Wire Management Access; Removable Panel is 15 7/8"W for 24" Bases and 11 7/8"W for 20" Bases
- Wire Management Channel Included; Two (2) Base Units Include One (1) Wire Management Channel and Three (3) Base Units Includes Two (2) Wire Management Channel
- Removable Panels Attached with Z Brackets.
- Bases Require Some Assembly; Attachment Hardware Included
- Tops Sold Separately, [See Multiple Unit Details](#)

T = TFL W = Veneer

[See Catalyst Overview For Ordering Options](#)

Item	Model No.		W	D	H	Ship Wt	Cubic Ft	List Price	
6" + 10" COMBO RECTANGLE ACCENT BASES WITH TROUGH AND REMOVABLE PANEL 24"W	Four (4) Bases Total: Two (2) 6" and Two (2) 10" Rectangle Bases - For Use With 60" / 54" / 48" x 240" Surfaces								
	88-24202C610RAB	Laminate	24	202	28¾	205	24.6	T\$	7514
		Veneer						W\$	9964
	Four (4) Bases Total: Two (2) 6" and Two (2) 10" Rectangle Bases - For Use With 60" / 54" / 48" x 228" Surfaces								
	88-24190C610RAB	Laminate	24	190	28¾	202	24.6	T\$	7468
		Veneer						W\$	9909
	Four (4) Bases Total: Two (2) 6" and Two (2) 10" Rectangle Bases - For Use With 60" / 54" / 48" x 216" Surfaces								
	88-24178C610RAB	Laminate	24	178	28¾	198	24.6	T\$	7434
		Veneer						W\$	9877
	Four (4) Bases Total: Two (2) 6" and Two (2) 10" Rectangle Bases - For Use With 60" / 54" / 48" x 204" Surfaces								
	88-24166C610RAB	Laminate	24	166	28¾	195	24.6	T\$	7388
		Veneer						W\$	9824
	Three (3) Bases Total: Two (2) 6" and One (1) 10" Rectangle Bases - For Use With 60" / 54" / 48" x 192" Surfaces								
	88-24154C610RAB	Laminate	24	154	28¾	155	18.2	T\$	5810
		Veneer						W\$	7848
	Three (3) Bases Total: Two (2) 6" and One (1) 10" Rectangle Bases - For Use With 60" / 54" / 48" x 180" Surfaces								
	88-24142C610RAB	Laminate	24	142	28¾	151	18.2	T\$	5773
		Veneer						W\$	7602
	Three (3) Bases Total: Two (2) 6" and One (1) 10" Rectangle Bases - For Use With 60" / 54" / 48" x 168" Surfaces								
	88-24130C610RAB	Laminate	24	130	28¾	148	18.2	T\$	5495
		Veneer						W\$	7283
	Three (3) Bases Total: Two (2) 6" and One (1) 10" Rectangle Bases - For Use With 60" / 54" / 48" x 156" Surfaces								
	88-24118C610RAB	Laminate	24	118	28¾	144	18.2	T\$	5458
		Veneer						W\$	7244
	Three (3) Bases Total: Two (2) 6" and One (1) 10" Rectangle Bases - For Use With 60" / 54" / 48" x 144" Surfaces								
	88-24106C610RAB	Laminate	24	106	28¾	141	18.2	T\$	5420
		Veneer						W\$	7205
	Three (3) Bases Total: Two (2) 6" and One (1) 10" Rectangle Bases - For Use With 60" / 54" / 48" x 132" Surfaces								
	88-2494C610RAB	Laminate	24	94	28¾	137	18.2	T\$	5142
		Veneer						W\$	6839

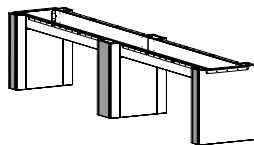

Shown: 88-24142C610RAB
Shown with Gray Accent Panel

TOPS SOLD SEPARATELY

Must Specify (in this order):

- Model #
- Base Finish/Color
- Metal Accent Color
- Accent Panel Finish/Color

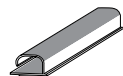
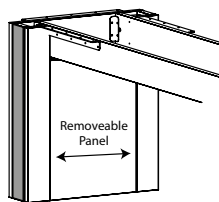

Wire Management Channel

Description

- 6" + 10" Rectangle Accent Bases with Trough and Stretcher Rails; 6" Bases on Exterior and 10" Bases on Interior
- Available with TFL (T) or Veneer (W)
- 5/16" Metal Accent Available in Four (4) Colors: Aluminum, Black, Gold, and Platinum; Must Specify Color
- Vertical Grain Direction on Bases
- Bases Include Interior Removable Panel for Wire Management. Removable Panel is 15 7/8" W and Attaches with Z Brackets.
- Wire Management Channel Included; Two (2) Base Units Include One (1) Wire Management Channel and Three (3) Base Units Includes Two (2) Wire Management Channel
- Bases Require Some Assembly; Attachment Hardware Included
- Tops Sold Separately, [See Multiple Unit Details](#)

T = TFL W = Veneer

[See Catalyst Overview For Ordering Options](#)

Item	Model No.		W	D	H	Ship Wt	Cubic Ft	List Price
DISC BASE 	Heavy Duty For Use With Round Tops: 54" + 60" Square Tops: 48"							
	01-2432HDBB	Black	32	32	27 $\frac{3}{4}$	42	4.1	\$ 2523
	01-2432HDBA	Aluminum						
	For Use With Round Tops: 48" Square Tops: 42" Top Surfaces: 48"x96", 48"x84", 48"x72", 42"x96", 42"x84", 42"x72"							
	01-3230DBB	Black	32	32	27 $\frac{3}{4}$	32	3.2	\$ 1842
	01-3230DBA	Aluminum						
	For Use With Round Tops: 30", 36", 42" Square Tops: 36" Top Surfaces: 36"x96", 36"x84", 36"x72"							
	01-2430DBB	Black	24	24	27 $\frac{3}{4}$	32	3.2	\$ 1535
	01-2430DBA	Aluminum						

Description

- 4" Diameter 14 Gauge Steel Column with 12"x12" Mounting Plate at Top of Column
- $\frac{1}{4}$ " Thick Disc Plate with 5 Levelers
- Stiffener Bar Not Included; Must Order Separately ([See Stiffener Bars](#))
- See Number of Bases Required Per Top Width Below
- Power Units Available On Center When Using Two or More Disc Bases
- Some Assembly Required

Table Widths	Round+Square	72"	84"	96"
Number of Bases Required	1	2	2	2

SQUARE BASE

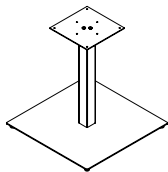

For Use With Round Tops: 48" Square Tops: 42" Top Surfaces: 48"x96", 48"x84", 48"x72", 42"x96", 42"x84", 42"x72"							
01-2630SBB	Black	26	26	27 $\frac{3}{4}$	32	3.2	\$ 1163
01-2630SBA	Aluminum						
For Use With Round Tops: 42" Square Tops: 36" Top Surfaces: 36"x96", 36"x84", 36"x72"							
01-2030SBB	Black	20	20	27 $\frac{3}{4}$	32	3.2	\$ 956
01-2030SBA	Aluminum						
For Use With Round Tops: 36" Square Tops: 30"							
01-1630SBB	Black	16	16	27 $\frac{3}{4}$	32	3.2	\$ 898
01-1630SBA	Aluminum						

Description

- 2 $\frac{3}{4}$ " Diameter Column with 12"x12" Mounting Plate at Top of Column
- Stiffener Bar Not Included; Must Order Separately ([See Stiffener Bars](#))
- See Number of Bases Required Per Top Width Below
- Power Units Available On Center When Using Two or More Square Bases
- Some Assembly Required

Table Widths	Round+Square	72"	84"	96"
Number of Bases Required	1	2	2	2

[See Catalyst Overview For Ordering Options](#)

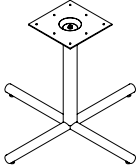
Item	Model No.		W	D	H	Ship Wt	Cubic Ft	List Price		
TUBULAR X-BASE 	For Use With Round Tops: 48" Square Tops: 42" Top Surfaces: 48"x96", 48"x84", 48"x72", 42"x96", 42"x84", 42"x72"									
	01-3830TXB	Black	38	38	27 $\frac{3}{4}$	40	4.2	\$	699	
	01-3830TXA	Aluminum								
	For Use With Round Tops: 36" + 42" Square Tops: 36" Top Surfaces: 36"x96", 36"x84", 36"x72"									
	01-3230TXB	Black	32	32	27 $\frac{3}{4}$	32	3.2	\$	633	
	01-3230TXA	Aluminum								
	Description <ul style="list-style-type: none"> • 3" Diameter Column • See Number of Bases Required Per Top Width Below • Stiffener Bar Not Included; Must Order Separately (See Stiffener Bars) • Power Units Available On Center When Using Two or More Tubular X-Bases • Some Assembly Required 									
	Table Widths						Round+Square	72"	84"	96"
	Number of Bases Required						1	2	2	2

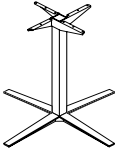
METAL X-BASE 	For Use With Round + Square Tops: 42" + 48" Top Surfaces: 48"x96", 48"x84", 48"x72", 42"x96", 42"x84", 42"x72"									
	08-2642LXBB	Black	35 $\frac{1}{2}$	35 $\frac{1}{2}$	40	33	20.0	\$	1322	
	08-2642LXBA	Aluminum								
	<i>For 42"H Tables</i>									
	08-2636LXBB	Black	35 $\frac{1}{2}$	35 $\frac{1}{2}$	34	30	17.2	\$	1275	
	08-2636LXBA	Aluminum								
	<i>For 36"H Tables</i>									
	08-2630LXBB	Black	35 $\frac{1}{2}$	35 $\frac{1}{2}$	28	27	14.5	\$	1219	
	08-2630LXBA	Aluminum								
	<i>For 30"H Tables</i>									
	For Use With Round + Square Tops: 30" + 36" Top Surfaces: 36"x96", 36"x84", 36"x72"									
	08-2042SXBB	Black	29	29	40	27	15.9	\$	1235	
	08-2042SXBA	Aluminum								
	<i>For 42"H Tables</i>									
	08-2036SXBB	Black	29	29	34	24	13.7	\$	1185	
	08-2036SXBA	Aluminum								
<i>For 36"H Tables</i>										
08-2030SXBB	Black	29	29	28	21	11.6	\$	1139		
08-2030SXBA	Aluminum									
<i>For 30"H Tables</i>										
Description <ul style="list-style-type: none"> • See Number of Bases Required Per Top Width Below • Not Available to be Sold Separately • Stiffener Bar Not Included; Must Order Separately (See Stiffener Bars) • Power Units Available On Center When Using Two or More Metal X-Bases • Ships Assembled 										
Table Widths						Round+Square	72"	84"	96"	
Number of Bases Required						1	2	2	2	

[See Catalyst Overview For Ordering Options](#)

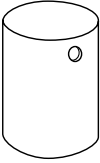
Item	Model No.	W	D	H	Ship Wt	Cubic Ft	List Price
CYLINDER BASE 	For Use With Round Tops: 54" + 60" Square Tops: 48"						
	01-3030CB	30	30	28½	136	10.9	W\$ 3924
	For Use With Round Tops: 42" + 48" Square Tops: 36" + 42" Top Surfaces: 48"x96", 48"x84", 48"x72", 42"x96", 42"x84", 42"x72"						
	01-2020CB	20	20	28½	136	10.9	W\$ 1553
	For Use With Round Tops: 36" Square Tops: 30" Top Surfaces: 36"x96", 36"x84", 36"x72"						
	01-1616CB	16	16	28½	101	7.2	W\$ 1419

Must Specify (in this order):
 Model # and Quantity
 Finish
 Grommet Options

Description

- Veneer Cylinder Base Features Multi-Step, Hand-Finished Catalyzed Finish
- Weighted for Stability
- Two (2) Wire Management Black Grommets Standard at Top Edge; 8" Wire Management Opening Standard at Bottom
- See Number of Bases Required Per Top Width Below
- Power Units Available On Center When Using Two or More Cylinder Bases

Additional Grommet Options: Specify & Add

GCB1S	Only One (1) Grommet At Top Edge	\$	N/C
NOGC	No Grommets At Top Edge	\$	N/C

Table Widths	Round+Square	72"	84"	96"
Number of Bases Required	1	2	2	2

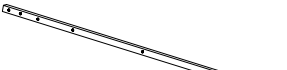
STIFFENER BAR 	01-00060SB	60	1¾	¾	8	0.3	\$ 129
	01-00048SB	48	1¾	¾	5	0.3	\$ 121

Description

- Reinforce Worksurfaces with Large Kneespace Widths
- Includes End Caps to Cover Sharp Edges
- Recommended in Kneespaces 60" or Greater
- Field Installed

[See Catalyst Overview For Ordering Options](#)

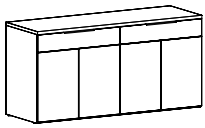
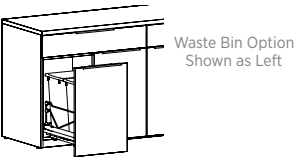
Item	Model No.		W	D	H	Ship Wt	Cubic Ft	Edge Profile + Material	List Price
BUFFET CREDENZA WITH DRAWERS  Shown: 88-2472BF  Waste Bin Option Shown as Left Must Specify (in this order): Model # Top/Edge Material Top/Edge Finish/Color Edge Profile Chassis Color Glass (Y/N) Glass Color + Surface Finish Pull Locking Drawer Track Vent Waste Bin	88-2496BF	TFL+HPL	96	24	36	466	56.0	F, G, X, Y / T+P\$	5839
								H / T+P\$	5952
		Veneer+HPL						F, G, X, Y / W+P\$	8909
								H / W+P\$	9078
		Veneer						F, G, X, Y / W\$	9242
								H / W\$	9379
		Glass+TFL						Acid Etched Glass Top +T\$	9417
								Gloss Glass Top +T\$	8532
		Glass+Veneer						Acid Etched Glass Top +W\$	12818
								Gloss Glass Top +W\$	11934
	88-2484BF	TFL+HPL	84	24	36	404	49.2	F, G, X, Y / T+P\$	5109
								H / T+P\$	5208
	Veneer+HPL						F, G, X, Y / W+P\$	7679	
							H / W+P\$	7828	
	Veneer						F, G, X, Y / W\$	8015	
							H / W\$	8136	
	Glass+TFL						Acid Etched Glass Top +T\$	8204	
							Gloss Glass Top +T\$	7430	
	Glass+Veneer						Acid Etched Glass Top +W\$	11111	
							Gloss Glass Top +W\$	10336	
88-2472BF	TFL+HPL	72	24	36	342	42.3	F, G, X, Y / T+P\$	4098	
							H / T+P\$	4183	
	Veneer+HPL						F, G, X, Y / W+P\$	6292	
							H / W+P\$	6420	
	Veneer						F, G, X, Y / W\$	6450	
							H / W\$	6556	
	Glass+TFL						Acid Etched Glass Top +T\$	6853	
							Gloss Glass Top +T\$	6189	
	Glass+Veneer						Acid Etched Glass Top +W\$	9205	
							Gloss Glass Top +W\$	8541	
88-2460BF	TFL+HPL	60	24	36	280	34.5	F, G, X, Y / T+P\$	3940	
							H / T+P\$	4012	
	Veneer+HPL						F, G, X, Y / W+P\$	5833	
							H / W+P\$	5942	
	Veneer						F, G, X, Y / W\$	5996	
							H / W\$	6084	
	Glass+TFL						Acid Etched Glass Top +T\$	6213	
							Gloss Glass Top +T\$	5659	
	Glass+Veneer						Acid Etched Glass Top +W\$	8269	
							Gloss Glass Top +W\$	7715	

T= TFL P = HPL W = Veneer

Additional Buffet Credenzas on Next Page

[See Catalyst Overview For Ordering Options](#)

Item	Model No.		W	D	H	Ship Wt	Cubic Ft	Edge Profile + Material	List Price
<i>CONTINUED FROM PREVIOUS PAGE</i>	88-2448BF <i>Two Doors + Two Drawers</i>	TFL+HPL	48	24	36	209	28.6	F, G, X, Y / T+P\$	2783
								H / T+P\$	2841
		Veneer+HPL						F, G, X, Y / W+P\$	4296
								H / W+P\$	4385
		Veneer						F, G, X, Y / W\$	4463
								H / W\$	4534
		Glass+TFL						Acid Etched Glass Top +T\$	4574
								Gloss Glass Top +T\$	4131
		Glass+Veneer						Acid Etched Glass Top +W\$	6253
								Gloss Glass Top +W\$	5812
<i>Must Specify (in this order):</i> Model # Top/Edge Material Top/Edge Finish/Color Edge Profile Chassis Color Glass (Y/N) Glass Color + Surface Finish Pull Drawer Track Vent Waste Bin	88-2436BF <i>Two Doors + One Drawer</i>	TFL+HPL	36	24	36	209	28.6	F, G, X, Y / T+P\$	2323
								H / T+P\$	2367
		Veneer+HPL						F, G, X, Y / W+P\$	3424
								H / W+P\$	3492
		Veneer						F, G, X, Y / W\$	3594
								H / W\$	3648
		Glass+TFL						Acid Etched Glass Top +T\$	3631
								Gloss Glass Top +T\$	3299
		Glass+Veneer						Acid Etched Glass Top +W\$	4903
								Gloss Glass Top +W\$	4571

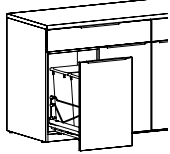

Waste Bin Option Shown as Left

Description

- Standard with: Touch Latch Doors with One (1) Adjustable Shelf Behind Doors, Top Profile on Approach Side, 2" Wire Management Channel Along Back of Interior Cabinet, Reverse Slip Matched Pattern on Top Surface, and Vertical Grain Direction on Chassis
- Available with Veneer (W), HPL (P), or Back Painted Tempered Glass (Black or White with Gloss or Acid Etched Finish) Top with Veneer (W) or HPL (P) Chassis
- When Selecting Back Painted Tempered Glass Top; Must Specify Glass Color, Gloss or Acid Etched Finish and Edge Profile; [See Options](#)
- Tops and Chassis Available in Contrasting Colors; Must Specific Color of Each Component
- Studio Pull Centered on Drawer Fronts Standard; Must Specify Pull Color ([See Color Options](#))
- Touch Latch Doors Standard Without Pulls, Optional Studio Pulls; Must Specify Pull Color ([See Color Options](#))
- Studio Pulls Will be Added and Centered on Top of Doors When Waste Bin is Selected; Must Specify Pull Color ([See Color Options](#)) and Optional Waste Bin ([See Options](#))
- Knife Edge not Available
- Additional Options: Locking Doors ([See Options Details](#)); Pull Out Waste Bin ([See Options Details](#)); Back Panel Vent ([See Options Details](#)); Soft Close Drawers ([See Soft Close Option](#))



Double Kerf (F) 1 3/16" Duo (G) 1 3/16" Fluted (X) 1 3/16" Square (Y) 1 3/16" Vertical Square (H) 1 1/2"

T= TFL P= HPL W= Veneer

[See Catalyst Overview For Ordering Options](#)

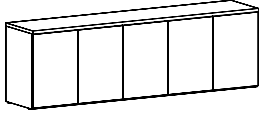
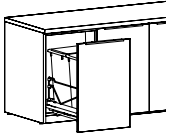
Item	Model No.		W	D	H	Ship Wt	Cubic Ft	Edge Profile + Material	List Price	
24"D CREDENZA  Shown: 88-2496CC  Waste Bin Option Shown as Left	88-2496CC <i>Five Doors</i>	TFL+HPL	96	24	30	415	47.2	F, G, X, Y / T+P\$	4591	
									H / T+P\$	4704
		Veneer+HPL							F, G, X, Y / W+P\$	7195
									H / W+P\$	7365
		Veneer							F, G, X, Y / W\$	7528
									H / W\$	7666
	88-2484CC <i>Five Doors</i>	Glass+TFL							Acid Etched Glass Top +T\$	8169
									Gloss Glass Top +T\$	7283
		Glass+Veneer							Acid Etched Glass Top +W\$	11106
									Gloss Glass Top +W\$	10220
		88-2472CC <i>Four Doors</i>	TFL+HPL	84	24	30	353	41.4	F, G, X, Y / T+P\$	4189
										H / T+P\$
Veneer+HPL								F, G, X, Y / W+P\$	6418	
								H / W+P\$	6567	
Veneer								F, G, X, Y / W\$	6754	
								H / W\$	6876	
88-2460CC <i>Three Doors</i>	Glass+TFL							Acid Etched Glass Top +T\$	7284	
								Gloss Glass Top +T\$	6510	
	Glass+Veneer							Acid Etched Glass Top +W\$	9850	
								Gloss Glass Top +W\$	9075	
	TFL+HPL	72	24	30	260	35.6	F, G, X, Y / T+P\$	3384		
								H / T+P\$	3470	
88-2472CC <i>Four Doors</i>	Veneer+HPL							F, G, X, Y / W+P\$	5268	
								H / W+P\$	5396	
	Veneer							F, G, X, Y / W\$	5427	
								H / W\$	5531	
	Glass+TFL							Acid Etched Glass Top +T\$	6140	
								Gloss Glass Top +T\$	5475	
88-2460CC <i>Three Doors</i>	Glass+Veneer							Acid Etched Glass Top +W\$	8182	
								Gloss Glass Top +W\$	7517	
	TFL+HPL	60	24	30	240	29.9	F, G, X, Y / T+P\$	2983		
								H / T+P\$	3055	
	Veneer+HPL							F, G, X, Y / W+P\$	4623	
								H / W+P\$	4732	
88-2460CC <i>Three Doors</i>	Veneer							F, G, X, Y / W\$	4786	
								H / W\$	4874	
	Glass+TFL							Acid Etched Glass Top +T\$	5256	
								Gloss Glass Top +T\$	4702	
	Glass+Veneer							Acid Etched Glass Top +W\$	7059	
								Gloss Glass Top +W\$	6505	

Must Specify (in this order):

- Model #
- Top/Edge Material
- Top/Edge Finish/Color
- Edge Profile
- Chassis Color
- Glass (Y/N)
- Glass Color + Surface Finish
- Pull
- Locking
- Vent
- Waste Bin

T= TFL P = HPL W = Veneer

Additional 24" Credenzas on Next Page

[See Catalyst Overview For Ordering Options](#)

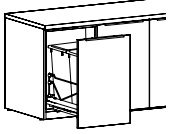
Item	Model No.		W	D	H	Ship Wt	Cubic Ft	Edge Profile + Material	List Price	
CONTINUED FROM PREVIOUS PAGE  <p>Waste Bin Option Shown as Left</p> <p>Must Specify (in this order): Model # Top/Edge Material Top/Edge Finish/Color Edge Profile Chassis Color Glass (Y/N) Glass Color + Surface Finish Pull Vent Waste Bin</p>	88-2448CC <i>Two Doors</i>	TFL+HPL	48	24	30	185	20.4	F, G, X, Y / T+P\$ H / T+P\$	2258 2316	
		Veneer+HPL						F, G, X, Y / W+P\$ H / W+P\$	3546 3634	
		Veneer						F, G, X, Y / W\$ H / W\$	3713 3784	
		Glass+TFL						Acid Etched Glass Top +T\$ Gloss Glass Top +T\$	4049 3606	
		Glass+Veneer						Acid Etched Glass Top +W\$ Gloss Glass Top +W\$	5503 5060	
		88-2436CC <i>Two Doors</i>	TFL+HPL	36	24	30	150	18.3	F, G, X, Y / T+P\$ H / T+P\$	1909 1953
			Veneer+HPL						F, G, X, Y / W+P\$ H / W+P\$	2846 2915
			Veneer						F, G, X, Y / W\$ H / W\$	3017 3072
			Glass+TFL						Acid Etched Glass Top +T\$ Gloss Glass Top +T\$	3217 2886
			Glass+Veneer						Acid Etched Glass Top +W\$ Gloss Glass Top +W\$	4325 3994

Description

- Standard with: One (1) Adjustable Shelf Behind Touch Latch Doors, Top Profile on Approach Side, 2" Wire Management Channel Along Back of Interior Cabinet, Reverse Slip Matched Pattern on Top Surface, and Vertical Grain Direction on Chassis
- Available with Veneer (W), HPL (P), or Back Painted Tempered Glass (Black or White with Gloss or Acid Etched Finish) Top
- When Selecting Back Painted Tempered Glass Top; Must Specify Glass Color, Gloss or Acid Etched Finish and Edge Profile; [See Options](#)
- Tops and Chassis Available in Contrasting Colors; Must Specific Color of Each Component
- Touch Latch Doors Standard Without Pulls, Optional Studio Pulls; Must Specify Pull Color ([See Color Options](#))
- Studio Pulls Will be Added and Centered on Top of Doors When Waste Bin is Selected; Must Specify Pull Color ([See Color Options](#)) and Optional Waste Bin ([See Options](#))
- Knife Edge not Available
- Additional Options: Locking Doors ([See Options Details](#)); Pull Out Waste Bin Available ([See Options Details](#)); Back Panel Vent ([See Options Details](#))



Double Kerf (F) 1 3/16" Duo (G) 1 3/16" Fluted (X) 1 3/16" Square (Y) 1 3/16" Vertical Square (H) 1 1/2"

T = TFL P = HPL W = Veneer

[See Catalyst Overview For Ordering Options](#)

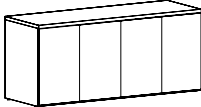
Item	Model No.		W	D	H	Ship Wt	Cubic Ft	Edge Profile + Material	List Price	
20" D CREDENZA 	88-2096CC <i>Five Doors</i>	TFL+HPL	96	20	30	398	39.9	F, G, X, Y / T+P\$	4283	
									H / T+P\$	4378
		Veneer+HPL							F, G, X, Y / W+P\$	6753
									H / W+P\$	6900
		Veneer							F, G, X, Y / W\$	7094
									H / W\$	7210
			Glass+TFL						Acid Etched Glass Top +T\$	7218
									Gloss Glass Top +T\$	6480
			Glass+Veneer						Acid Etched Glass Top +W\$	10029
									Gloss Glass Top +W\$	9291
		88-2084CC <i>Five Doors</i>	TFL+HPL	84	20	30	338	35.1	F, G, X, Y / T+P\$	3909
										H / T+P\$
Veneer+HPL									F, G, X, Y / W+P\$	6026
									H / W+P\$	6155
Veneer									F, G, X, Y / W\$	6369
									H / W\$	6472
		Glass+TFL						Acid Etched Glass Top +T\$	6443	
								Gloss Glass Top +T\$	5797	
		Glass+Veneer						Acid Etched Glass Top +W\$	8903	
								Gloss Glass Top +W\$	8257	
	88-2072CC <i>Four Doors</i>	TFL+HPL	72	20	30	260	35.6	F, G, X, Y / T+P\$	3141	
									H / T+P\$	3214
Veneer+HPL									F, G, X, Y / W+P\$	4928
									H / W+P\$	5039
Veneer									F, G, X, Y / W\$	5093
									H / W\$	5181
		Glass+TFL						Acid Etched Glass Top +T\$	5414	
								Gloss Glass Top +T\$	4860	
		Glass+Veneer						Acid Etched Glass Top +W\$	7366	
								Gloss Glass Top +W\$	6812	
	88-2060CC <i>Three Doors</i>	TFL+HPL	60	20	30	220	25.3	F, G, X, Y / T+P\$	2753	
									H / T+P\$	2813
Veneer+HPL									F, G, X, Y / W+P\$	4259
									H / W+P\$	4353
Veneer									F, G, X, Y / W\$	4427
									H / W\$	4501
		Glass+TFL						Acid Etched Glass Top +T\$	4623	
								Gloss Glass Top +T\$	4163	
		Glass+Veneer						Acid Etched Glass Top +W\$	6298	
								Gloss Glass Top +W\$	5837	

T= TFL P = HPL W = Veneer

Additional 20" Credenzas on Next Page

[See Catalyst Overview For Ordering Options](#)

Item	Model No.		W	D	H	Ship Wt	Cubic Ft	Edge Profile + Material	List Price
<i>CONTINUED FROM PREVIOUS PAGE</i>	88-2048CC <i>Two Doors</i>	TFL+HPL	48	20	30	165	24.1	F, G, X, Y / T+P\$	2103
								H / T+P\$	2153
			Veneer+HPL					F, G, X, Y / W+P\$	3329
								H / W+P\$	3405
			Veneer					F, G, X, Y / W\$	3499
								H / W\$	3559
			Glass+TFL					Acid Etched Glass Top +T\$	3573
								Gloss Glass Top +T\$	3203
			Glass+Veneer					Acid Etched Glass Top +W\$	4969
								Gloss Glass Top +W\$	4600
	88-2036CC <i>Two Doors</i>	TFL+HPL	36	20	30	135	15.5	F, G, X, Y / T+P\$	1792
								H / T+P\$	1830
			Veneer+HPL					F, G, X, Y / W+P\$	2688
								H / W+P\$	2747
			Veneer					F, G, X, Y / W\$	2862
								H / W\$	2907
			Glass+TFL					Acid Etched Glass Top +T\$	2860
								Gloss Glass Top +T\$	2582
			Glass+Veneer					Acid Etched Glass Top +W\$	3929
								Gloss Glass Top +W\$	3653

Must Specify (in this order):

- Model #
- Top/Edge Material
- Top/Edge Finish/Color
- Edge Profile
- Chassis Color
- Glass (Y/N)
- Glass Color + Surface Finish
- Pull
- Vent

Description

- Standard with: One (1) Adjustable Shelf Behind Touch Latch Doors, Top Profile on Approach Side, 2" Wire Management Channel Along Back of Interior Cabinet, Reverse Slip Matched Pattern on Top Surface, and Vertical Grain Direction on Chassis
- Available with Veneer (W), HPL (P), or Back Painted Tempered Glass (Black or White with Gloss or Acid Etched Finish) Top
- When Selecting Back Painted Tempered Glass Top; Must Specify Glass Color, Gloss or Acid Etched Finish and Edge Profile; [See Options](#)
- Tops and Chassis Available in Contrasting Colors; Must Specific Color of Each Component
- Touch Latch Doors Standard Without Pulls, Optional Studio Pulls; Must Specify Color
- Knife Edge not Available
- Additional Options: Locking Doors ([See Options Details](#)); Back Panel Vent ([See Options Details](#))



Double Kerf (F)
1 3/16"



Duo (G)
1 3/16"



Fluted (X)
1 3/16"



Square (Y)
1 3/16"



Vertical Square (H)
1 1/2"

T= TFL P= HPL W= Veneer

[See Catalyst Overview For Ordering Options](#)

Item	Model No.		W	D	H	Ship Wt	Cubic Ft		List Price
MOBILE SERVING CART 	88-2436SV	TFL+HPL	36	24	36	260	35.6	F, G, X, Y / T+P\$	2585
								H / T+P\$	2631
		Veneer+HPL						F, G, X, Y / W+P\$	3852
								H / W+P\$	3921
		Veneer						F, G, X, Y / W\$	4023
								H / W\$	4078

Must Specify (in this order):

- Model #
- Top/Edge Material
- Top/Edge Finish/Color
- Edge Profile
- Optional Grommet

Description

- Top Edge Profiled on Approach Side Only (See Edge Options); Must Specify Edge Selection ([See Edge Details](#))
- Two (2) Box Drawers, Open Storage, and Storage Behind Two (2) Doors
- Locking Casters

Grommet Option: Specify & Add

1-GRMT	Grommet in Back Panel; Must Specify Black or Silver	\$ 52
--------	---	-------

Item	Model No.	Color	W	D	H	Ship Wt	Cubic Ft		List Price
ROUND GROMMET COVER FIELD INSTALLED 	01-GRMTBK	Black	-	-	-	-	-		\$ 11
	01-GRMTSL	Silver							

Description

- 60mm Round Grommet Cover
- Field Installed

OPEN MARKET ONLY
(SILVER)

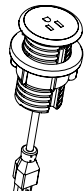
Item	Model No.	Color	W	D	H	Ship Wt	Cubic Ft		List Price
SINGLE POWER SAND DOLLAR 	01-SAND60PS	Silver	3	3	4	1	0.2		\$ 98
	01-SAND60PW	White							
	01-SAND60PB	Black							

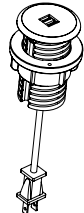

Description

- Mounts in 2 3/8" (60mm) Round Grommet
- Single Power Outlet with 6' Cord

Item	Model No.	Color	W	D	H	Ship Wt	Cubic Ft		List Price
DOUBLE USB SAND DOLLAR 	01-SAND60US	Silver	3	3	4	1	0.2		\$ 277
	01-SAND60UW	White							
	01-SAND60UB	Black							

Description

- Mounts in 2 3/8" (60mm) Round Grommet
- Dual USB Outlets with 6' Cord

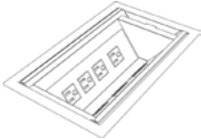
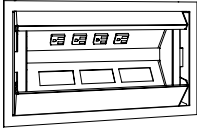
Item	Model No.		W	D	H	Ship Wt	Cubic Ft	List Price
DOCK 950 WIRELESS CHARGER	01-DOCK950W	White	3 $\frac{3}{10}$	3 $\frac{3}{10}$	-	1	0.2	\$ 265
	01-DOCK950B	Black						
 OPEN MARKET ONLY	Description <ul style="list-style-type: none"> • For Use with Wireless Charging Enabled Devices • 5 Watts Maximum Output with a Direct Current of 5V 2A and 10 Watts Maximum with Quick Charge 2.0 • LED will Confirm Pairing with Device and Begin Wireless Charging 							
WIRELESS AND USB CHARGER	01-DOCK150W	White	3	3	$\frac{3}{4}$ "	1	0.2	\$ 405
	01-DOCK150B	Black						
 OPEN MARKET ONLY	Description <ul style="list-style-type: none"> • For Use with Wireless Charging Enabled Devices and USB Charging Devices • 5 Watt Maximum Output with a Direct Current Input of 5V 6A (Wireless Fast Charge) • Pop-Up is $\frac{3}{4}$"H and Includes Three (3) USB Ports; One (1) 12 Watt Maximum with 2.4A (USB Fast Charge) and Two (2) 5 Watt with 1A (USB Standard Charge) • LED Light will Confirm Pairing with Device and Begin Wireless Charging • UL and cUL Certified 							
INTERACT POWER & DATA	01-INTERACTG2A	Aluminum	9	5 $\frac{5}{8}$	2 $\frac{3}{4}$	5	0.2	\$ 891
	01-INTERACTG2B	Black						
	Description <ul style="list-style-type: none"> • Includes: Two (2) Power Outlets, Two (2) USB-A Charging Ports, One (1) Telecom Plate Opening; Two (2) Keystone Openings for Voice/Data Jacks • One (1) Telecom Plates Included with the Unit: One (1) 01-ABLAB Plate (Consists of One (1) RJ45 Cat 6, One (1) RJ11 Cat 3 Phone Jack) • Convenience Plug on Bottom • 6' Power Cord • UL and CSA Recognized • Additional Telecom Plates, See ECA Telecom Plate Options 							
OASIS MINI POWER & DATA	01-OASISMA	Aluminum	15	9	5	11	0.3	\$ 3191
	01-OASISMB	Black						
 Top View 	Description <ul style="list-style-type: none"> • For Use with Conference Tables • Soft Touch Hinged Lid • Four (4) Power Outlets, Three (3) Telecom Plate Openings • Two (2) Telecom Plates Included with the Unit: One (1) 01-ABLAB Plate (Consists of One (1) RJ45 Cat 6, One (1) RJ11 Cat 3 Phone Jack); One (1) 01-ABLB Plate (Consists of One (1) RJ45 Cat 6) • 9' Power Cord • UL Listed • Additional Telecom Plates, See ECA Telecom Plate Options 							

[See Catalyst Overview For Ordering Options](#)

Item	Model No.		W	D	H	Ship Wt	Cubic Ft	List Price
DOCK800	01-DOCK800S	Silver	14	9	-			\$ 2047
	01-DOCK800B	Black						

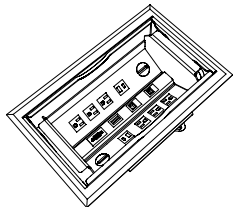

OPEN MARKET ONLY

Description

- Stylish Aluminum Housing with Beveled Edges; Soft Touch Access and Closure
- Includes: Six (6) Power Outlets, Two (2) USB-A 5V Ports, Two (2) USB-C Charging Ports, One (1) RJ45 Ethernet Port, One (1) RJ11 Port, One (1) HDMI Port, and One (1) VGA Port
- 10' Power Cord
- UL and cUL Certified

DPORT	01-DPORT4A	Aluminum	8	4	-	7	0.2	\$ 1093
	01-DPORT4B	Black						

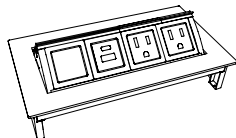
**Description**





- Retracts into Work Surface to Regain Productive Space; One-Touch Access to Power and Data
- Two (2) Power Outlets, One (1) USB A+C, and One (1) Open Port
- Optional Telecom Port Components, [See Compatible Units](#)
- Water-Proof Simplex (Outlets)
- Includes a Voice/Data Adapter Kit to Accept Couplers and Jacks When Required
- 10' Power Cord
- UL Recognized

E2X	01-E2X6A	Aluminum	11	9 ¹³ / ₁₆	-	6	0.7	\$ 1625
	01-E2X6B	Black						
	01-E2X4A	Aluminum	8	9 ¹³ / ₁₆	-	5	0.5	\$ 1494
	01-E2X4B	Black						

01-E2X4
SIN PENDING**Description**

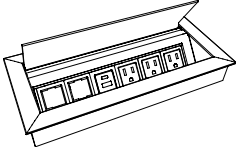
- In Surface, Dual Side Application; Soft Touch Access to Power and Data
- Each Side has the Following: 11" Unit Includes Three (3) Power Outlets, One (1) USB A+C, and Two (2) Open Port on Each Side; 8" Unit Includes Two (2) Power Outlets, One (1) USB A+C, and One (1) Open Port
- Optional Telecom Port Components, [See Compatible Units](#)
- 6' Power Cord
- UL Listed

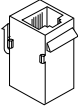
[See Catalyst Overview For Ordering Options](#)

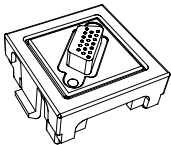
Item	Model No.		W	D	H	Ship Wt	Cubic Ft	Edge Profile + Material	List Price
 <p>01-ELLORA6 SIN PENDING</p>	01-ELLORA6A	Aluminum	11	5	-	6	0.7	\$	852
	01-ELLORA6B	Black							
	01-ELLORA4A	Aluminum	8	5	-	5	0.5	\$	792
	01-ELLORA4B	Black							
<p>Description</p> <ul style="list-style-type: none"> In Surface Application; Soft Touch Access to Power and Data 11" Includes Three (3) Power Outlets, One (1) USB A+C, and Two (2) Open Port; 8" Includes Two (2) Power Outlets, One (1) USB A+C, and One (1) Open Port Optional Telecom Port Components, See Below for Compatible Units 6' Power Cord UL Recognized 									
USB PORT	01-USBPORT		-	-	-	-	-	\$	161
	<p>Description</p> <ul style="list-style-type: none"> Passive USB-A Port with Increased Transfer Speed Up to 5 gbs/sec Simultaneous Read/Write Capability; Idle Device Power Saving State 6' Cord Compatible with 01-DPORT4A, 01-DPORT4B, ELLORA4A, ELLORA4B, ELLORA6A, ELLORA6B, E2X4A, E2X4B, E2X6A, and E2X6B 								
VOICE COUPLER	01-VOICE1		-	-	-	-	-	\$	73
	<p>Description</p> <ul style="list-style-type: none"> 6-Pin Modular Plug Molded Black; Cord Not included Compatible with 01-DPORT4A, 01-DPORT4B, ELLORA4A, ELLORA4B, ELLORA6A, ELLORA6B, E2X4A, E2X4B, E2X6A, and E2X6B 								
DATA PORT	01-RJ4DATA		-	-	-	-	-	\$	167
	<p>Description</p> <ul style="list-style-type: none"> 8-Pin Modular Plug; Cat6 Ethernet Cable; Pre-terminated Cable 10' Cord Compatible with 01-DPORT4A, 01-DPORT4B, ELLORA4A, ELLORA4B, ELLORA6A, ELLORA6B, E2X4A, E2X4B, E2X6A, and E2X6B 								
VGA CONNECTOR ACCESSORY	01-VGACON		-	-	-	1	0.2	\$	149
	<p>Description</p> <ul style="list-style-type: none"> VGA Port for 01-DPORT4A, 01-DPORT4B, ELLORA4A, ELLORA4B, ELLORA6A, ELLORA6B, E2X4A, E2X4B, E2X6A, and E2X6B Enables Devices to Remote Display on Monitors 10' Cord Male/Female Connector 								

[See Catalyst Overview For Ordering Options](#)

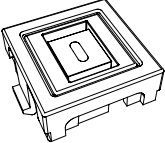
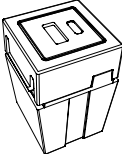
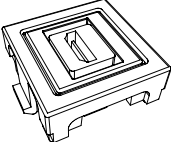
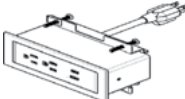
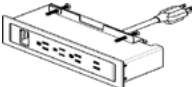
Item	Model No.		W	D	H	Ship Wt	Cubic Ft	List Price
PASSIVE USB-C ACCESSORY	01-PUSBC		-	-	-	1	0.2	\$ 95
	Description	<ul style="list-style-type: none"> Passive USB-C Port ; Unit Provides Data Connection to Transfer Data Only, No Charging Capabilities Compatible with 01-DPORT4A, 01-DPORT4B, ELLORA4A, ELLORA4B, ELLORA6A, ELLORA6B, E2X4A, E2X4B, E2X6A, and E2X6B Male/Female Connector 						
CHARGING USB-A+C ACCESSORY	01-USBAC		-	-	-	1	0.2	\$ 283
	Description	<ul style="list-style-type: none"> For Charging Devices 20 Watt Power Supply USB+C Charging Port for 01-DPORT4A, 01-DPORT4B, ELLORA4A, ELLORA4B, ELLORA6A, ELLORA6B, E2X4A, E2X4B, E2X6A, and E2X6B 						
HDMI CONNECTOR ACCESSORY	01-HDMICON		-	-	-	1	0.2	\$ 124
	Description	<ul style="list-style-type: none"> HDMI Port for 01-DPORT4A, 01-DPORT4B, ELLORA4A, ELLORA4B, ELLORA6A, ELLORA6B, E2X4A, E2X4B, E2X6A, and E2X6B Connects to High Definition Displays Female/Female Connector 18" Cord 						
DUO BEZEL WITH NEMA PLUG	01-DUOBEZELW	White	6½	2½	3¼	1	0.2	\$ 675
	01-DUOBEZELB	Black						
	01-DUOBEZELS	Silver						
	Description	<ul style="list-style-type: none"> Sits on Table Top and Includes: Two (2) Power, One (1) USB Charging Port and One (1) 60-Watt USB-C Power Delivery Port with GaN Technology, 10' Cord, and All Mounting Hardware Independent USB Circuit Controllers Deliver up to 2.1 Amps to Each Post FCC Part 15A, UL Recognized for Horizontal and Vertical Applications 						
TRIO BEZEL WITH NEMA PLUG	01-TRIOBEZELW	White	9	2½	3	1	0.2	\$ 725
	01-TRIOBEZELB	Black						
	01-TRIOBEZELS	Silver						
	Description	<ul style="list-style-type: none"> Sits on Table Top and Includes: Three (3) Power Outlets, One (1) USB Charging Port, One (1) 60-Watt USB-C Power Delivery Port with GaN Technology, One (1) Open Data Port, 10' Cord, and All Mounting Hardware HDMI, VGA, and RJ45 Accessories for Open Data Port; Sold Separately, See Accessories Independent USB Circuit Controllers Deliver up to 2.1 Amps to Each Post FCC Part 15A, UL Recognized for Horizontal and Vertical Applications 						

[See Catalyst Overview For Ordering Options](#)

Item	Model No.		W	D	H	Ship Wt	Cubic Ft	List Price
DUO BEZEL WITH DAISY CHAIN PLUG	01-PDUOBEZELW	White	6½	2½	3	1	0.2	\$ 668
	01-PDUOBEZELB	Black						
	01-PDUOBEZELS	Silver						

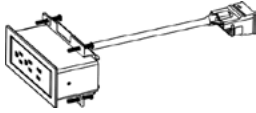

Description

- Sits on Table Top and Includes: Two (2) Power, **One (1) USB Charging Port and One (1) 60-Watt USB-C Power Delivery Port with GaN Technology**, 12" Cord, and All Mounting Hardware
- Requires Daisy Chain Power Box; Sold Separately, [See Power Box Details](#)
- Non-Sequential System Allows up to Eight (8) Modules to be Connected with Jumper Cord, [See Jumper Cord Details](#)
- Independent USB Circuit Controllers Deliver up to 2.1 Amps to Each Post
- FCC Part 15A, RU Listed and UL Recognized for Horizontal and Vertical Applications

TRIO BEZEL WITH DAISY CHAIN PLUG	01-PTRIOBEZELW	White	9	2½	3	1	0.2	\$ 715
	01-PTRIOBEZELB	Black						
	01-PTRIOBEZELS	Silver						

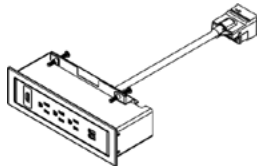

Description

- Sits on Table Top and Includes: Three (3) Power Outlets, **One (1) USB Charging Port, One (1) 60-Watt USB-C Power Delivery Port with GaN Technology**, One (1) Open Data Port, 12" Cord, and All Mounting Hardware
- HDMI, VGA, or RJ45 Accessory for Open Data Port; Sold Separately, [See Accessories](#)
- Requires Daisy Chain Power Box, Specified Separately, See Below
- Non-Sequential System Allows up to Eight (8) Modules to be Connected with Jumper Cord, See Below
- Independent USB Circuit Controllers Deliver up to 2.1 Amps to Each Post
- FCC Part 15A, RU Listed and UL Recognized for Horizontal and Vertical Applications

DAISY CHAIN POWER BOX	01-PPOWER		-	-	-	1	0.2	\$ 775
		<i>76" Perimeter, 36" Power Cord</i>						
	01-PPOWER2		-	-	-	1	0.2	\$ 796
		<i>24" Perimeter, 144" Power Cord</i>						

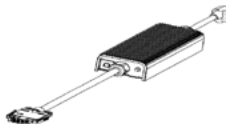

Description

- Powers up to Eight (8) Duo and Trio Daisy Chain Units
- One Nema Plug and One Daisy Chain Plug
- 12-Amp System Rating
- 15-Amp Over-Current Protection

DAISY CHAIN JUMPER CORD	01-6JUMP	<i>72" Long</i>	-	-	-	1	0.2	\$ 299
	01-5JUMP	<i>60" Long</i>	-	-	-	1	0.2	\$ 284
	01-4JUMP	<i>48" Long</i>	-	-	-	1	0.2	\$ 240
	01-2JUMP	<i>24" Long</i>	-	-	-	1	0.2	\$ 220

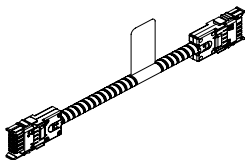

Description

- Connects Duo and Trio Daisy Chain Units
- Non-Sequential System Allows up to Eight (8) Modules to be Connected

[See Catalyst Overview For Ordering Options](#)

Item	Model No.	W	D	H	Ship Wt	Cubic Ft	List Price
HDMI DATA PORT ACCESSORY	01-LCOMHDMI	-	-	-	1	0.2	\$ 166

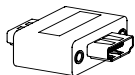

OPEN MARKET ONLY

Description

- HDMI Port for Trio Bezel Units

VGA DATA PORT ACCESSORY	01-LCOMVGA	-	-	-	1	0.2	\$ 121
-------------------------	------------	---	---	---	---	-----	--------

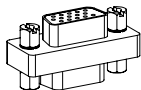
**Description**

- VGA Port for Trio Bezel Units

RJ45 DATA PORT ACCESSORY	01-LCOMRJ45	-	-	-	1	0.2	\$ 79
--------------------------	-------------	---	---	---	---	-----	-------

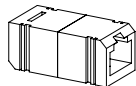
**Description**

- RJ45 Port for Trio Bezel Units

WIRE MANAGEMENT CHANNEL	01-WMGR4	16	1½	¾	1	-	\$ 116
-------------------------	----------	----	----	---	---	---	--------

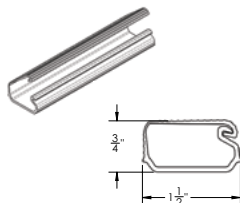
**Description**

- Set of Four (4) Black Plastic Wire Management Channels
- Snap Lock Channel
- Attaches with Adhesive Strips
- Ships via UPS Only

WIRE CHANNEL	01-32125	24	1½	1	.25	0.3	\$ 106
--------------	----------	----	----	---	-----	-----	--------

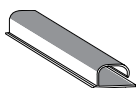
**Description**

- Available in Black
- Channels Attach with Two (2) Double-Sided Installation Tape
- Open J Channel for Easy Storage of Cables

CABLE GRIP	01-WMGRCB	5%	2½	-	-	-	\$ 17
------------	-----------	----	----	---	---	---	-------

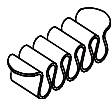
**Description**

- Under Surface Wire Management
- Black

[See Catalyst Overview For Ordering Options](#)

Item	Model No.	W	D	H	Ship Wt	Cubic Ft	List Price
MAGNETIC GLASS MARKER BOARD FOR USE WITH 30"H CREDENZA AND SHELVING	GMB-4048W	48	½	40⅞	67	11.0	\$ 3128
	GMB-4042W	42	½	40⅞	58	9.9	\$ 2644
	GMB-4036W	36	½	40⅞	50	8.8	\$ 2285
	GMB-4030W	30	½	40⅞	42	7.7	\$ 1924

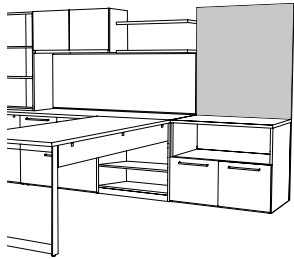

Description

- Available in Black (BLMKR) or White (WHMKR), Must Specify
- Tempered Glass Magnetic Marker Boards Include Mounting Brackets
- For Use over 30"H Desks and Credenzas with Wall Mount Hutches or Shelving
- For Rare Earth Magnets, Marker and Eraser Sets; [See Set Options](#)

Must Specify (in this order):

Model #
Color



Rare Earth Magnets, Marker and Eraser set available; [See Set Options](#)

MAGNETIC GLASS MARKER BOARD FOR USE WITH 30"H CREDENZA AND SHELVING	GMB-5248W	48	½	52⅞	86	13.5	\$ 3988
	GMB-5242W	42	½	52⅞	76	12.2	\$ 3369
	GMB-5236W	36	½	52⅞	65	10.8	\$ 2904
	GMB-5230W	30	½	52⅞	54	9.5	\$ 2441

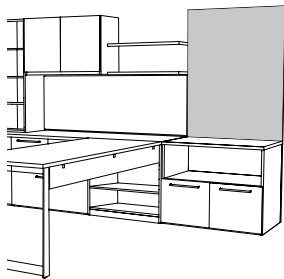

Description

- Available in Black (BLMKR) or White (WHMKR), Must Specify
- Tempered Glass Magnetic Marker Boards Include Mounting Brackets
- For Use Next to Tall Surface or Wall Mount Hutches
- For Rare Earth Magnets, Marker and Eraser Sets; [See Set Options](#)

Must Specify (in this order):

Model #
Color



Rare Earth Magnets, Marker and Eraser set available; [See Set Options](#)

[See Catalyst Overview For Ordering Options](#)

Item	Model No.	W	D	H	Ship Wt	Cubic Ft	List Price
MAGNETIC GLASS MARKER BOARD	GMB-8236W	36	½	82⅞	102	15.8	\$ 4453
FOR USE FROM FLOOR TO TOP OF UNIT	GMB-7036W	36	½	70⅞	87	13.8	\$ 3834
	GMB-5136W	36	½	51⅞	63	10.6	\$ 2802
	GMB-8230W	30	½	82⅞	85	13.8	\$ 3730
	GMB-7030W	30	½	70⅞	72	12.1	\$ 3215
	GMB-5130W	30	½	51⅞	53	9.3	\$ 2354

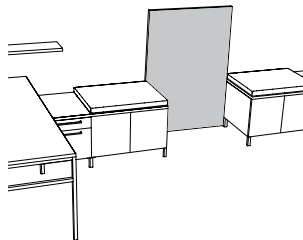

Must Specify (in this order):

Model #

Color

Description

- Available in Black (BLMKR) or White (WHMKR), Must Specify
- Tempered Glass Magnetic Marker Boards Are One (1) Piece with No Seams
- Mounting Brackets Included
- For Use From Floor to Top of Unit
- For Rare Earth Magnets, Marker and Eraser Sets; See Below



Rare Earth Magnets, Marker and Eraser set available; See Below

MARKER AND ERASER SET	01-MRKRSETBL	For Use with Black Marker Boards and Black Glass Doors	\$ 123
	01-MRKRSETWH	For Use with White Marker Boards and White Glass Doors	

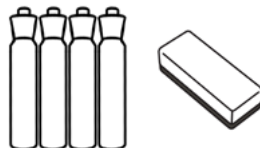

Description

- 01-MRKRSETWH May Also be Used with Dry Erase Doors and Boards
- Includes 4 Markers and an Eraser

RARE EARTH MAGNET SET	01-MAGBL	For Use with White Marker Boards	\$ 114
	01-MAGWH	For Use with Black Marker Boards	



Description

- Includes Set of Five (5) Rare Earth Magnets
- To be Used with Tempered Glass Magnetic Marker Boards
- Comfort Grip with Stylish Protective Plastic Coating

[See Catalyst Overview For Ordering Options](#)

Item	Model No.		W	D	H	Ship Wt	Cubic Ft	List Price	
VISUAL BOARD	88-4848VB	TFL	48	5	48	150	11.0	T\$	2956
		Veneer						W\$	4908

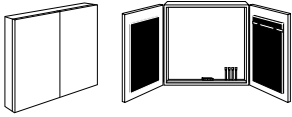

Must Specify (in this order):

- Model #
- Color
- Projection Screen
- Tackboard Fabric

Description

- Tackboard on Each Door Standard in Black Fabric Unless Specified; Price Valid for Grades 1, 2, & 3 (See Other Pricing Below)
- Display Rail with Adjustable Hooks for Flipchart
- Magnetic Porcelain Non-Glare Writing Surface
- Includes Flipchart, Set of Four (4) Dry Erase Markers and Eraser, Mounting Hardware
- Does Not Feature Soft Close Hinges

Options: Specify & Add

	Grade 4	Grade 5	Grade 6	Grade 7	Grade 8	Grade 9	Grade 10
Tackboard Fabric Change	\$ 278	408	540	728	924	1152	1416
1-PS Projection Screen (Requires Field Installation)						\$	1062

LECTERN STAND	88-2650LS	TFL+HPL	26	24	50	130	21.9	F, G, X, Y / T+P\$	1911
								H / T+P\$	1921
		Veneer+HPL						F, G, X, Y / W+P\$	3451
								H / W+P\$	3477
		Veneer						F, G, X, Y / W\$	3587
							H / W\$	3601	

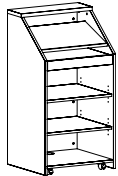

Must Specify (in this order):

- Model #
- Top/Edge Material
- Top/Edge Finish/Color
- Edge Profile

Description

- Top Edge Profiled on Approach Side Only (See Edge Options); Must Specify Edge Selection
- Fixed Shelf Angled for User Comfort, One (1) Pullout Shelf, and Two (2) Adjustable Shelves
- Two (2) Locking and Two (2) Non-Locking Casters
- Wire Management Grommet on Bottom Shelf

[See Catalyst Overview For Ordering Options](#)

Item	Model No.	Description	List Price
ECA TELECOM PLATES			
	01-ABL	Telecom Plate, Blank Plate	\$ 41
	01-ABL737373	Telecom Plate, Three (3) RJ45 Cat 5e	\$ 367
Compatible with:	01-ABLAB	Telecom Plate, One (1) RJ45 Cat 6, One (1) RJ11 Cat 3 Phone	\$ 206
	01-ABLAB102	Telecom Plate, One (1) RJ45 Cat 6, One (1) RJ11 Cat 3, One (1) USB W/72" Patch Cord	\$ 320
	01-ABLABB	Telecom Plate, Two (2) RJ45 Cat 6, One (1) RJ11 Cat 3 Phone	\$ 320
Oasis Mini Power & Data 01-OASISMA, 01-OASISMB	01-ABLB	Telecom Plate, One (1) RJ45 Cat 6	\$ 149
	01-ABLBB	Telecom Plate, Two (2) RJ45 Cat 6	\$ 260
Interact Power & Data 01-INTERACTG2A, 01-INTERACTG2B	01-ABLBBB	Telecom Plate, Three (3) RJ45 Cat 6	\$ 367
	01-ABLBBBB	Telecom Plate, Four (4) RJ45 Cat 6	\$ 476
Power Center 01-INTRFCIA, 01-INTRFCIB	01-ABLBBC51	Telecom Plate, Two (2) RJ45 Cat 6, One (1) 15 Pin HD VGA w/72" Patch Cord	\$ 446
	01-ABLBC51L	Telecom Plate, One (1) RJ45 Cat 6, One (1) Mini Stereo Inline, One (1) 15 Pin HD VGA w/72" Patch Cord	\$ 410
	01-ABL3811	Telecom Plate, One (1) RJ45 Cat 6 Data Inline, One (1) RJ11 Cat 3 Phone Inline	\$ 197
	01-ABL45	Telecom Plate, One (1) HDMI w/36" Patch Cord	\$ 295
	01-ABL45C51L	Telecom Plate, One (1) Mini Stereo Inline, One (1) HDMI w/36" Patch Cord, One (1) 15 Pin HD VGA w/72" Patch Cord	\$ 558
	01-ABL51L	Telecom Plate, One (1) 15 Pin HD VGA & One (1) Mini Stereo Inline Jack	\$ 298
	01-ABLCRDM	Telecom Plate, Three (3) Cord Bushings	\$ 96

Madera creates a variety of looks from rich, refined transitional to fresh, modern contemporary by offering an abundance of options, including premium veneer. Finely crafted in select Cherry, Maple, Walnut, and Oak veneers, Madera features a UV topcoat on all exposed surfaces adding unsurpassed hardness and extreme durability for long lasting office applications.

CONSTRUCTION

Madera features a Veneer chassis with your choice of either a Veneer or HPL top. Units ship assembled unless otherwise noted.

VENEER

- Choose from premium veneer or select veneer on exposed surfaces in American Black Walnut, White Oak, Cherry, or Maple species
- The American Black Walnut, White Oak, and Cherry veneers are book matched veneer faces, while the Maple is a slip-matched veneer face
- These veneers are carefully selected and matched to assure proper balance and consistency

TOPS

- Wood Veneer tops have a 5-ply balanced construction while High Pressure Laminate (HPL) tops have a 3-ply balanced construction, 1 $\frac{3}{16}$ " thick, with hardwood rims
- Tops featuring the Bullnose (D), Tri-Round (E), Flute (X), and Square (Y) edge profiles have vertical profiles
- Tops featuring the Radius (A) and Bevel (B) edge profiles have the same construction, but provide a matching reverse profile on connecting edge
- Grain direction runs left to right unless otherwise noted

CHASSIS

- Tops, end panels, and modesty panels are securely fastened using high quality European style fastening systems and heavy-duty, 16-gauge joining brackets to assure maximum strength
- All units are equipped with heavy-duty, adjustable glides to ensure proper leveling and compensation for uneven floors

DRAWERS

- All drawer fronts are standard with matched faces
- All drawers feature 5-sided construction allowing for easy removal of drawer fronts
- Fronts are 3-ply construction and are $\frac{3}{4}$ " thick with matched grain
- Drawer interiors are dovetail construction with $\frac{7}{16}$ " thick hardwood sides and backs and $\frac{5}{32}$ " thick hardboard bottoms
- The drawer interiors are sanded, sealed, and finished to provide a smooth, quality feel and appearance
- All drawers feature full extension, progressive action slides with precision steel ball bearings
- Box and file drawers are tested for 100lb capacity
- Lateral files are tested for 200lb capacity
- All suspensions have a limited lifetime warranty

FILING

- All file drawers are standard with filing systems designed to accommodate a variety of filing requirements
- Letter width file drawers provide letter filing front to back and legal filing side to side
- Lateral file drawers provide legal or letter filing front to back or side to side

STORAGE

- All hinged doors include soft close hinges, unless noted
- One piece hinge and base plate combination
- Soft close hinges reduce stress placed on the cabinet when the door is closed and offers a quiet closure

LOCKING

- All credenzas feature locking file drawers; optional locking doors is available on select units
- Removable lock cylinders allow for units to be re-keyed at a later date, if required
- Units are shipped randomly keyed as standard
- Keyed alike units available upon request at no additional charge
- Lock core will match pull color

CORD MANAGEMENT

- Grommets are available in black or silver, please specify color

INTERIOR DRAWER DIMENSIONS & FILING CAPABILITIES

Models

16-2472SC 16-2072SC

Drawers

File

W

15 $\frac{1}{32}$ "

L

16 $\frac{1}{4}$ "

D

8 $\frac{29}{32}$ "

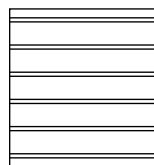

Legal Front to Back

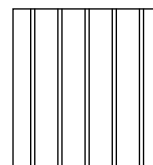

Legal Side to Side

Models

16-2466SC

Drawers

File

W

12 $\frac{1}{32}$ "

L

16 $\frac{1}{4}$ "

D

8 $\frac{29}{32}$ "

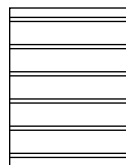

Letter Front to Back

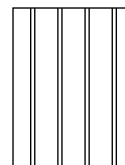

Legal Side to Side

Models

14-2072SC

Drawers

Box

W

15 $\frac{1}{32}$ "

L

16 $\frac{1}{4}$ "

D

3 $\frac{21}{32}$ "

File

15 $\frac{1}{32}$ "

16 $\frac{1}{4}$ "

8 $\frac{29}{32}$ "

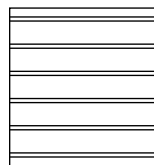

Legal Front to Back

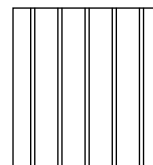

Legal Side to Side

PULL OPTIONS

Note: Lock Core will match Pull Color

AAC Arc, Aluminum	AEL Elite, Aluminum
BAC Arc, Black	BEL Elite, Black
ABM Beam, Aluminum	FPL Finger
BBM Beam, Black	AFL Flair, Aluminum
BBT Bow Tie, Black	CFL Flair, Chrome
NBT Bow Tie, Nickel	AFC Focus, Aluminum
ABU Buckle, Aluminum	BFC Focus, Black
BBU Buckle, Black	AQD Quadra, Aluminum
	BQD Quadra, Black

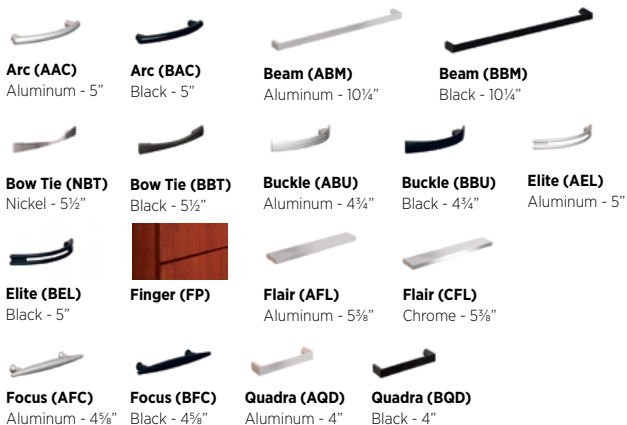

EDGE PROFILES

B Bevel	A Radius
D Bullnose	Y Square
X Flute	E Tri-Round

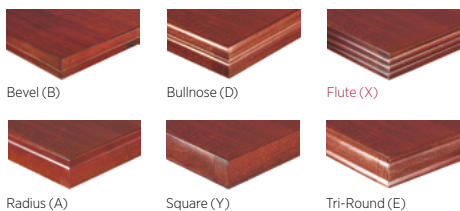

TABLE GROMMET & POWER UNIT OPTIONS

Power units and grommets are sold separately and must be specified separately with surface mount location. Multiple locations may be selected. Only one unit per location.

Power units and Grommets Available in Table Surfaces (See Units)

Grommet Specify Color: Black = BLK and Silver = SLV

DUO/TRIO BEZEL

01-DUOBEZEL	Available in Black (B), Silver (S), or White (W)
01-TRIOBEZEL	Available in Black (B), Silver (S), or White (W)

DOCK 950, DOCK 800 and DOCK 150

DOCK950	Available in Black or White
DOCK150	Available in Black or White
DOCK800	Available in Black or Silver

TABLE GROMMET & POWER UNIT OPTIONS CONTINUE

Other Power Units

DPORT4	Available in Aluminum or Black
INTERACTG	Available in Aluminum or Black
OASISM	Available in Aluminum or Black

Power/Data Location Information:

- Designate unit and location when specifying the top model. Power/Data Module need to be ordered separately.
- Power/Data Modules specified at the time of order will be routed for field installation.

E1	Unit on One End
E2	Unit on Each End
OC	Unit on Center

- All power units available **On Center (OC) only** when paired with two (2) or more of the following bases:

Cylinder Base	Square Base
X-Base	Disc
Tubular X-Base	

Grommets and Power Units may be ordered in non-standard locations. Call Customer Service to assist with specification and/or please attach a drawing to the PO showing the location of the grommet. Note additional charges and lead times may apply.

Top Locations

Power units available on Each End (E1 and E2) and On Center (OC) unless otherwise noted, when paired with any Rectangle Panel Base, Rectangle Box Base or Rectangle Accent Box Base. ([See Unit Details](#))

Power units centered at locations below:

36" Tops	centered 18"D	48" Tops	centered 24"D
42" Tops	centered 21"D		

72: OC 36" from end (available with OC Only)

96: OC 48" from end; E1/E2 29" from end

120: OC 60" from end; E1/E2 29" from end

144: OC 72" from end; E1/E2 29" from end

LOCKING DOORS

Locking doors are available on select units. You must specify WITH LOCKING when ordering and add upcharge.

LKT_HU	36"W Units	\$ 91
LKT_HU	18"W Units	\$ 69

CERTIFICATIONS & COMPLIANCE

- Intertek Sustainability Certified
- BIFMA level® Certified
- BIFMA Compliant® Certified
- TSCA Title VI (Formerly CARB) Compliance
- US Green Building's LEED® Contribution

Tops and Tables



Round Tops
[\(See Details\)](#)



Rectangle Tops
[\(See Details\)](#)



Boat Tops
[\(See Details\)](#)

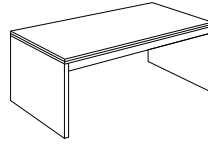

Work/Landing Tables
[\(See Details\)](#)

Bases

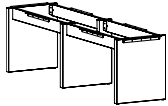

Rectangular Panel
Bases with Trough
[\(See Details\)](#)

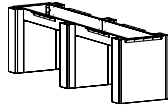

6" Rectangular Bases
with Trough
[\(See Details\)](#)

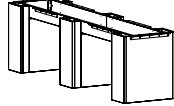

10" Rectangular
Bases with Trough
[\(See Details\)](#)

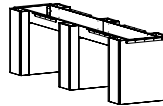

6" Rectangular Accent
Bases with Trough
[\(See Details\)](#)

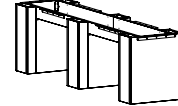

10" Rectangular Accent
Bases with Trough
[\(See Details\)](#)

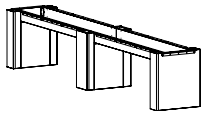

6" + 10" Combo Rectangular
Bases with Trough
[\(See Details\)](#)

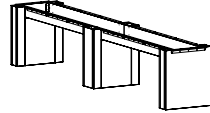

6" + 10" Combo Rectangular
Accent Bases with Trough
[\(See Details\)](#)



Disc Bases
[\(See Details\)](#)

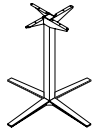

Small and Large X
Bases [\(See Details\)](#)



HA Pneumatic X Bases
[\(See Details\)](#)



Metal Bases
[\(See Details\)](#)

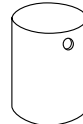

Cylinder Bases
[\(See Details\)](#)

Storage Components

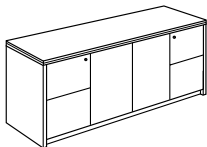

[Full & 3/4 Ped Storage Credenzas](#)

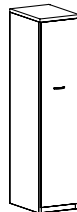
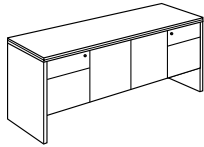

[Wardrobe/Storage](#)

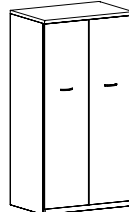

[Double Wardrobe/Storage](#)

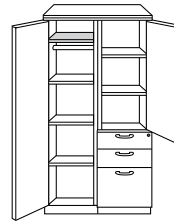

Wire Management & Power/Data Accessories [\(See Multiple Units\)](#)

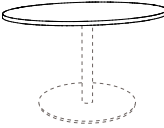

For additional solutions for deskings, storage, and accessories, see the [Madera Casegoods](#) and [Accessories](#) Price Lists.

Item	Model No.	Width	Depth	Height	Ship Wt	Cubic Ft	List Price		
 <p>14-4242CT shown with 01-2430DBA (Disc Base) BASES SOLD SEPARATELY</p>	14-4848CT	<i>Accommodates Five (5) Chairs</i>		48	48	30	60	5.7	W/P\$ 2876 PV\$ 3363
	14-4242CT	<i>Accommodates Four (4) Chairs</i>		42	42	30	40	4.4	W/P\$ 2608 PV\$ 3053
	14-3636CT	<i>Accommodates Three (3) to Four (4) Chairs</i>		36	36	30	35	3.4	W/P\$ 2289 PV\$ 2678

Description

- Available with Premium/Standard Veneer (PV/W) or HPL (P) Top, Must Specify
- Single Base Required; Ordered Separately, [See Details](#)
- Bases Sold Separately
- Power Options not Available

Must Specify (in this order):

Model #
Top Material
Finish/Color
Edge Profile

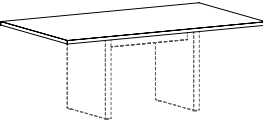
RECTANGULAR TOP	144" or 12' - 2 Piece Tops						
 <p>14-3672RT shown with 88-2034RPB (Rectangle Panel Base) BASES SOLD SEPARATELY</p>	14-48144RT	144	48	1 $\frac{3}{16}$	275	12.3	W/P\$ 2323 PV\$ 2717
	120" or 10' - 2 Piece Tops						
	14-48120RT	120	48	1 $\frac{3}{16}$	225	10.3	W/P\$ 2134 PV\$ 2497
	96" or 8' - 1 Piece Top						
14-4896RT	96	48	1 $\frac{3}{16}$	180	9.4	W/P\$ 2039 PV\$ 2386	
72" or 6' - 1 Piece Top							
14-3672RT	72	36	1 $\frac{3}{16}$	100	6.2	W/P\$ 1282 PV\$ 1501	

Description

- Grain Runs the Width of the Table
- Available with Veneer (PV/W) or HPL (P) Top; Must Specify
- Heavy-Duty Ganging Mechanisms Connect Two (2) Piece Tops
- See Bases/Legs and Number Required For Each Top Size, Must Order Bases Separately
- Optional Grommets and Power/Data Units; [See Location Options](#), [See Power Units Available](#)

P = HPL W = Veneer PV = Premium Veneer

[See Madera Overview For Ordering Options](#)

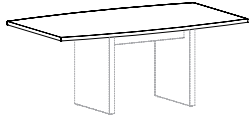
Item	Model No.	Width	Depth	Height	Ship Wt	Cubic Ft	List Price	
 <p>14-3672BT shown with 88-2034RPB (Rectangle Panel Base) BASES SOLD SEPARATELY</p> <p>Must Specify (in this order): Model # Top Material Finish/Color Edge Profile</p>	BOAT TOP							
	144" or 12' - 2 Piece Tops							
	14-48144BT		144	48	1 $\frac{3}{16}$	275	12.3	W/P\$ 4380
	14-48144BT							PV\$ 5124
	120" or 10' - 2 Piece Tops							
	14-48120BT		120	48	1 $\frac{3}{16}$	225	10.3	W/P\$ 3980
	14-48120BT							PV\$ 4656
	96" or 8' - 1 Piece Top							
	14-4896BT		96	48	1 $\frac{3}{16}$	180	9.4	W/P\$ 3228
	14-4896BT							PV\$ 3777
	72" or 6' - 1 Piece Top							
	14-3672BT		72	36	1 $\frac{3}{16}$	100	6.2	W/P\$ 1865
14-3672BT							PV\$ 2182	

Description

- Grain Runs the Width of the Table
- Available with Veneer (PV/W) or HPL (P) Top; Must Specify
- Heavy-Duty Ganging Mechanisms Connect Two (2) Piece Tops
- See Bases/Legs and Number Required For Each Top Size, Must Order Bases Separately
- Optional Grommets and Power/Data Units; [See Location Options](#), [See Power Units Available](#)

RECTANGLE PANEL BASES WITH TROUGH

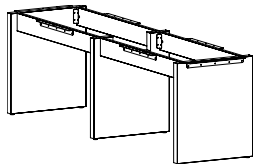

Three (3) Panel Bases - For Use With 48" x 144" Surfaces							
88-24106RPB	Laminate	24	106	28 $\frac{3}{4}$	116	13.8	T\$ 3000
	Veneer						W\$ 3059
Two (2) Panel Bases - For Use With 48" x 120" Surfaces							
88-2482RPB	Laminate	24	82	28 $\frac{3}{4}$	90	6.9	T\$ 2150
	Veneer						W\$ 2201
Two (2) Panel Bases - For Use With 48" x 96" Surfaces							
88-2458RPB	Laminate	24	58	28 $\frac{3}{4}$	84	6.9	T\$ 1880
	Veneer						W\$ 1954
Two (2) Panel Bases - For Use With 36" x 72" Surfaces							
88-2034RPB	Laminate	20	34	28 $\frac{3}{4}$	66	6.7	T\$ 1575
	Veneer						W\$ 1742

Must Specify (in this order):

- Model #
- Material
- Finish / Color

Description

- 2" Panel Bases with Trough, Stretcher Rails, and L-Bracket Hardware Included
- Available with TFL (T) or Veneer (W)
- Vertical Grain Direction on Bases
- Bases Require Some Assembly; Attachment Hardware Included
- Tops Sold Separately

[See Madera Overview For Ordering Options](#)

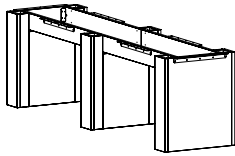
Item	Model No.		Width	Depth	Height	Ship Wt	Cubic Ft	List Price
6" RECTANGLE BASES WITH TROUGH AND REMOVABLE PANEL 	Three (3) 6" Rectangle Bases - For Use With 48" x 144" Surfaces							
	88-2410606RB	Laminate	24	106	28¾	106	19.6	T\$ 4720
		Veneer						W\$ 6457
	Two (2) 6" Rectangle Bases - For Use With 48" x 120" Surfaces							
	88-248206RB	Laminate	24	82	28¾	99	12.9	T\$ 3219
		Veneer						W\$ 4449
	Two (2) 6" Rectangle Bases - For Use With 48" x 96" Surfaces							
	88-245806RB	Laminate	24	58	28¾	93	12.9	T\$ 3023
		Veneer						W\$ 4128
	Two (2) 6" Rectangle Bases - For Use With 36" x 72" Surfaces							
	88-203406RB	Laminate	20	34	28¾	76	12.9	T\$ 2777
		Veneer						W\$ 3820

Must Specify (in this order):

- Model #
- Material
- Finish / Color

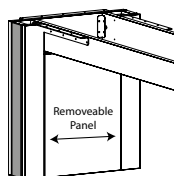

Description

- 6" Rectangle Bases with Trough and Stretcher Rails
- Available with TFL (T) or Veneer (W)
- Vertical Grain Direction on Bases
- Bases Include Interior Removable Panel for Wire Management Access; Removable Panel is 15⅞"W for 24" Bases and 11⅞"W for 20" Bases
- Removable Panels Attached with Z Brackets
- Bases Require Some Assembly; Attachment Hardware Included
- Tops Sold Separately

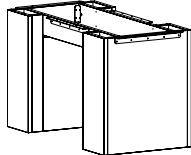
10" RECTANGLE BASES WITH TROUGH AND REMOVABLE PANEL 	Three (3) 10" Rectangle Bases - For Use With 48" x 144" Surfaces							
	88-2410610RB	Laminate	24	106	28¾	141	18.2	T\$ 4841
		Veneer						W\$ 6551
	Two (2) 10" Rectangle Bases - For Use With 48" x 120" Surfaces							
	88-248210RB	Laminate	24	82	28¾	96	12.0	T\$ 3300
		Veneer						W\$ 4512
	Two (2) 10" Rectangle Bases - For Use With 48" x 96" Surfaces							
	88-245810RB	Laminate	24	58	28¾	89	12.0	T\$ 3104
		Veneer						W\$ 4190
	Two (2) 10" Rectangle Bases - For Use With 36" x 72" Surfaces							
	88-203410RB	Laminate	20	34	28¾	72	10.0	T\$ 2857
		Veneer						W\$ 3882

Must Specify (in this order):

- Model #
- Material
- Finish / Color

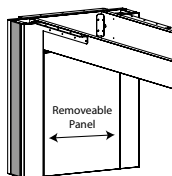

Description

- 10" Rectangle Bases with Trough and Stretcher Rails
- Available with TFL (T) or Veneer (W)
- Vertical Grain Direction on Bases
- Bases Include Interior Removable Panel for Wire Management Access; Removable Panel is 15⅞"W for 24" Bases and 11⅞"W for 20" Bases
- Removable Panels Attached with Z Brackets
- Bases Require Some Assembly; Attachment Hardware Included
- Tops Sold Separately

Item	Model No.		Width	Depth	Height	Ship Wt	Cubic Ft	List Price
6" + 10" COMBO RECTANGLE BASES WITH TROUGH AND REMOVABLE PANEL	Three (3) Bases Total: Two (2) 6" and One (1) 10" Rectangle Bases - For Use With 60" / 54" / 48" x 144" Surfaces							
	88-24106C610RB	Laminate	24	106	28¾	141	18.2	T\$ 4760
		Veneer						W\$ 6488

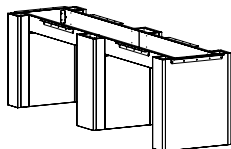

Must Specify (in this order):

- Model #
- Material
- Finish / Color

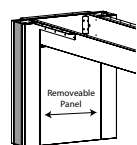

Description

- 6" + 10" Rectangle Bases with Trough and Stretcher Rails; 6" Bases on Exterior and 10" Base on Interior
- Available with TFL (T) or Veneer (W)
- Vertical Grain Direction on Bases
- Bases Include Interior Removable Panel for Wire Management; Removable Panel is 15⅞"W and Attaches with Z Brackets.
- Bases Require Some Assembly; Attachment Hardware Included
- Tops Sold Separately

6" RECTANGLE ACCENT BASES WITH TROUGH AND REMOVABLE PANEL

6" RECTANGLE ACCENT BASES WITH TROUGH AND REMOVABLE PANEL	Three (3) 6" Rectangle Bases - For Use With 48" x 144" Surfaces							
	88-24106O6RAB	Laminate	24	106	28¾	106	19.6	T\$ 5394
		Veneer						W\$ 7174
	Two (2) 6" Rectangle Bases - For Use With 48" x 120" Surfaces							
	88-248206RAB	Laminate	24	82	28¾	99	12.9	T\$ 4745
		Veneer						W\$ 6436
	Two (2) 6" Rectangle Bases - For Use With 48" x 96" Surfaces							
	88-245806RAB	Laminate	24	58	28¾	93	12.9	T\$ 3480
		Veneer						W\$ 4610
	Two (2) 6" Rectangle Bases - For Use With 36" x 72" Surfaces							
	88-203406RAB	Laminate	20	34	28¾	76	12.9	T\$ 3232
		Veneer						W\$ 4302

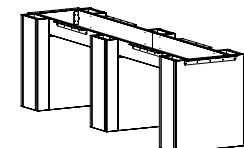

Must Specify (in this order):

- Model #
- Base Finish/Color
- Metal Accent Color
- Accent Panel Finish/Color

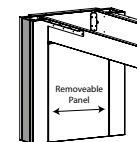

Description

- 6" Rectangle Bases with Trough and Stretcher Rails
- Available with TFL (T) or Veneer (W)
- ⅝" Metal Accent Available in Four (4) Colors: Aluminum, Black, Gold, and Platinum; Must Specify Color
- Vertical Grain Direction on Bases
- Bases Include Interior Removable Panel for Wire Management Access; Removable Panel is 15⅞"W for 24" Bases and 11⅞"W for 20" Bases
- Removable Panels Attached with Z Brackets
- Bases Require Some Assembly; Attachment Hardware Included
- Tops Sold Separately

[See Madera Overview For Ordering Options](#)

Item	Model No.		Width	Depth	Height	Ship Wt	Cubic Ft	List Price
10" RECTANGLE ACCENT BASES WITH TROUGH AND REMOVABLE PANEL	Three (3) 10" Rectangle Bases - For Use With 48" x 144" Surfaces							
	88-241061ORAB	Laminate	24	106	28¾	141	18.2	T\$ 5462
		Veneer						W\$ 7258
	Two (2) 10" Rectangle Bases - For Use With 48" x 120" Surfaces							
	88-248210RAB	Laminate	24	82	28¾	96	12.0	T\$ 3717
		Veneer						W\$ 4986
	Two (2) 10" Rectangle Bases - For Use With 48" x 96" Surfaces							
	88-245810RAB	Laminate	24	58	28¾	89	12.0	T\$ 3521
		Veneer						W\$ 4664
	Two (2) 10" Rectangle Bases - For Use With 36" x 72" Surfaces							
	88-203410RAB	Laminate	20	34	28¾	72	10.0	T\$ 3209
		Veneer						W\$ 4276

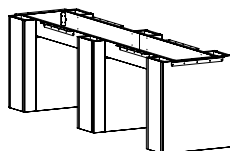

Must Specify (in this order):

- Model #
- Base Finish/Color
- Metal Accent Color
- Accent Panel Finish/Color

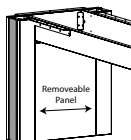

Description

- 10" Rectangle Bases with Trough and Stretcher Rails
- Available with TFL (T) or Veneer (W)
- 5/16" Metal Accent Available in Four (4) Colors: Aluminum, Black, Gold, and Platinum; Must Specify Color
- Vertical Grain Direction on Bases
- Bases Include Interior Removable Panel for Wire Management Access; Removable Panel is 15 7/8"W for 24" Bases and 11 7/8"W for 20" Bases
- Removable Panels Attached with Z Brackets
- Bases Require Some Assembly; Attachment Hardware Included
- Tops Sold Separately

6" + 10" COMBO RECTANGLE ACCENT BASES WITH TROUGH AND REMOVABLE PANEL	Three (3) Bases Total: Two (2) 6" and One (1) 10" Rectangle Bases - For Use With 60" / 54" / 48" x 144" Surfaces							
	88-24106C610RAB	Laminate	24	106	28¾	141	18.2	T\$ 5420
		Veneer						W\$ 7205

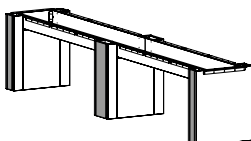

Must Specify (in this order):

- Model #
- Base Finish/Color
- Metal Accent Color
- Accent Panel Finish/Color

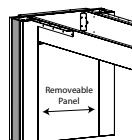

Description

- 6" + 10" Rectangle Accent Bases with Trough and Stretcher Rails; 6" Bases on Exterior and 10" Bases on Interior
- Available with TFL (T) or Veneer (W)
- 5/16" Metal Accent Available in Four (4) Colors: Aluminum, Black, Gold, and Platinum; Must Specify Color
- Vertical Grain Direction on Bases
- Bases Include Interior Removable Panel for Wire Management; Removable Panel is 15 7/8"W and Attaches with Z Brackets
- Bases Require Some Assembly; Attachment Hardware Included
- Tops Sold Separately

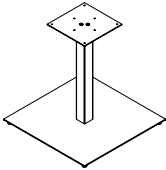
Item	Model No.		Width	Depth	Height	Ship Wt	Cubic Ft	List Price
	For Use With Round Tops: 48" Top Surfaces: 48"x96"							
	01-2630SBB	Black	26	26	27¾	32	3.2	\$ 1163
	01-2630SBA	Aluminum						
	For Use With Round Tops: 42" Top Surfaces: 36"x72"							
	01-2030SBB	Black	20	20	27¾	32	3.2	\$ 956
	01-2030SBA	Aluminum						
	For Use With Round Tops: 36"							
	01-1630SBB	Black	16	16	27¾	32	3.2	\$ 898
	01-1630SBA	Aluminum						

Description

- 2¾" Diameter Column
- 12"x12" Mounting Plate at Top of Column
- Stiffener Bar Not Included; Must Order Separately (See Stiffener Bars)
- See Number of Bases Required Per Top Width Below
- Power Units Available On Center When Using Two or More Square Bases
- Some Assembly Required

Table Widths	Round	72"	96"
Number of Bases Required	1	2	2

TUBULAR X-BASE

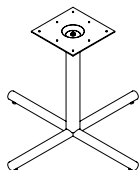

OPEN MARKET ONLY

For Use With Round Tops: 48" Top Surfaces: 48"x96"							
01-3830TXB	Black	38	38	27¾	40	4.2	\$ 699
01-3830TXA	Aluminum						
For Use With Round Tops: 36", 42" Top Surfaces: 36"x72"							
01-3230TXB	Black	32	32	27¾	32	3.2	\$ 633
01-3230TXA	Aluminum						

Description

- 3" Diameter Column
- See Number of Bases Required Per Top Width Below
- Power Units Available On Center When Using Two or More Tubular X-Bases
- Some Assembly Required

Table Widths	Round	72"	96"
Number of Bases Required	1	2	2

[See Madera Overview For Ordering Options](#)

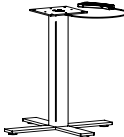
Item	Model No.	Width	Depth	Height	Ship Wt	Cubic Ft	List Price	
HEIGHT ADJUSTABLE PNEUMATIC X-BASE 	Maximum Round 42"							
	01-3232HAXBB	Black	32	32	26-45¾	1	0.2	\$ 1721
	01-3232HAXBA	Aluminum						
	Maximum Round 36"							
	01-2626HAXBB	Black	22	22	26-45¾	1	0.2	\$ 1687
	01-2626HAXBA	Aluminum						

Description

- Pre-Drilled Boring Pattern May Not Match Underside of Table Top
- Steel Mounting Plate: 8"x 8"x ¼"
- Eight (8) Bolts Included for Assembly
- Some Assembly Required

METAL X-BASE

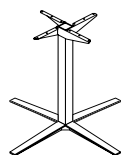

For Use With							
Round Tops: 42" + 48"							
Top Surfaces: 48"x96"							
08-2642LXBB	Black	35½	35½	40	33	20.0	\$ 1322
08-2642LXBA	Aluminum						
<i>For 42"H Tables</i>							
08-2636LXBB	Black	35½	35½	34	30	17.2	\$ 1275
08-2636LXBA	Aluminum						
<i>For 36"H Tables</i>							
08-2630LXBB	Black	35½	35½	28	27	14.5	\$ 1219
08-2630LXBA	Aluminum						
<i>For 30"H Tables</i>							
For Use With							
Round: 36"							
Top Surfaces: 36"x72"							
08-2042SXBB	Black	29	29	40	27	15.9	\$ 1235
08-2042SXBA	Aluminum						
<i>For 42"H Tables</i>							
08-2036SXBB	Black	29	29	34	24	13.7	\$ 1185
08-2036SXBA	Aluminum						
<i>For 36"H Tables</i>							
08-2030SXBB	Black	29	29	28	21	11.6	\$ 1139
08-2030SXBA	Aluminum						
<i>For 30"H Tables</i>							

Description

- See Number of Bases Required Per Top Width Below
- Not Available to be Sold Separately
- Power Units Available On Center When Using Two or More Metal X-Bases
- Ships Assembled

Table Widths	Round	72"	96"
Number of Bases Required	1	2	2

Item	Model No.		Width	Depth	Height	Ship Wt	Cubic Ft	List Price
DISC BASE 	For 48" Round Tops							
	01-3230DBB	Black	30	30	27¾	42	4.1	\$ 1842
	01-3230DBA	Aluminum	30	30	27¾	42	4.1	\$ 1842
	For 36" and 42" Round Tops							
	01-2430DBB	Black	24	24	27¾	32	3.2	\$ 1535
	01-2430DBA	Aluminum	24	24	27¾	32	3.2	\$ 1535
Description								
<ul style="list-style-type: none"> • 4" Diameter 14 Gauge Steel Column • 12"x12" Mounting Plate at Top of Column • ¼" Thick Disc Plate with 5 Levelers • Some Assembly Required 								
Table Widths						Round	72"	96"
Number of Bases Required						1	4	4

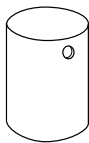
CYLINDER BASE 	01-2020CB		20	20	28½	136	11.1	W\$ 1553
		<i>For Use With 42" or 48" Round Top</i>						PV\$ 1813
	01-1616CB		16	16	28½	101	7.2	W\$ 1419
	<i>For Use With 36" Round Top</i>							PV\$ 1660
Description								
<ul style="list-style-type: none"> • Veneer Cylinder Base Features Multi-Step, Hand-Finished Catalyzed Finish • Weighted for Stability • Two (2) Wire Management Black Grommets Standard at Top with 8" Opening Standard in Bottom 								
Options: Specify & Add								
GCB1S	Single Grommet at Top Edge							N/C
NOGC	No Grommets							N/C

Must Specify (in this order):

Model
Finish/Color
Grommet
Grommet Color

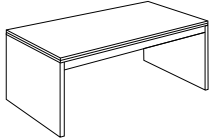
WORK TABLE SEATED HEIGHT 	14-3672WT		72	36	30	195	50.0	W/P\$ 3199
		Kneespace - 69 ¹ / ₁₆						PV\$ 3742
	14-3060WT		60	30	30	134	35.5	W/P\$ 2503
	Kneespace - 57 ¹ / ₁₆							PV\$ 2932
Description								
<ul style="list-style-type: none"> • Solid End Panels with Apron Rail • Available with Premium Veneer (PV), Standard Veneer (W) or HPL (P) Tops with Veneer Chassis; Must Specify • Ships Fully Assembled 								
Must Specify (in this order):								
Model # Premium or Standard Veneer Top Material Finish/Color Edge Profile								

P = HPL W = Veneer PV = Premium Veneer

[See Madera Overview For Ordering Options](#)

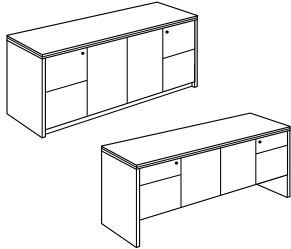
Item	Model No.	Width	Depth	Height	Ship Wt	Cubic Ft	List Price
STORAGE CREDENZA		Full Pedestals					
	16-2472SC	72	24	30	285	35.6	W/P\$ 6020 PV\$ 5758
	16-2466SC	66	24	30	261	32.7	W/P\$ 5509 PV\$ 5758
	16-2072SC	72	20	30	270	30.5	W/P\$ 5682 PV\$ 5758
		¾ Pedestals					
	14-2072SC	72	20	30	227	30.5	W/P\$ 4919 PV\$ 5758

Must Specify (in this order):

Model #
Premium or Standard Veneer
Top Material
Finish/Color
Edge Profile
Pull

Description

- Legal Width, Locking File/File Pedestals (Full) and Legal Width, Locking Box/File Pedestals (¾)
- Fixed Storage Shelf Behind Doors
- Available with Premium Veneer (PV), Standard Veneer (W) or HPL (P) Tops with Veneer Chassis; Must Specify
- Lock Core will Coordinate with Pull Selection

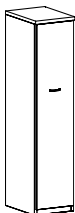
WARDROBE/STORAGE CABINET	Left Hinged	Right Hinged	Width	Depth	Height	Ship Wt	Cubic Ft	List Price
	14-1870WL	14-1870WR	18	24	69¾	153	19.2	W\$ 5263 PV\$ 6159
	14-1870CL	14-1870CR	18	20	69¾	150	18.6	W\$ 4454 PV\$ 5209

Shown as Left

Must Specify (in this order):

Model #
Premium or Standard Veneer
Finish/Color
Edge Profile
Pull
Locking Door

Description

- Standard with: Fixed Top Shelf, Coat Rod, Three Adjustable/Removable Shelves
- Available in Premium Veneer (PV) or Standard Veneer (W); Must Specify
- Knob Pull will be Substituted for Finger Pull
- Optional Locking Door ([See Locking Options](#))

DOUBLE WARDROBE/STORAGE CABINET	14-3670WD	36	24	69¾	290	42.0	W\$ 9291 PV\$ 10875
--	-----------	----	----	-----	-----	------	------------------------

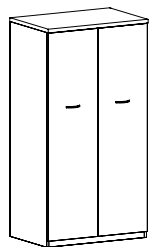
**Must Specify (in this order):**

Model #
Premium or Standard Veneer
Finish/Color
Edge Profile
Pull
Locking Door

Description

- Standard with: Fixed Top Shelf Behind Each Door, Coat Rod, Three Adjustable/Removable Shelves on Each Side
- Available in Premium Veneer (PV) or Standard Veneer (W); Must Specify
- Knob Pull will be Substituted for Finger Pull
- Optional Locking Door ([See Locking Options](#))

P = HPL W = Veneer PV = Premium Veneer

[See Madera Overview For Ordering Options](#)

Item	Model No.	Width	Depth	Height	Ship Wt	Cubic Ft	List Price
DOUBLE WARDROBE/STORAGE CABINET WITH FILE/FILE	Left Drawers	Right Drawers					
	14-3670WD2L	14-3670WD2R	36	24	69%	315	42.0

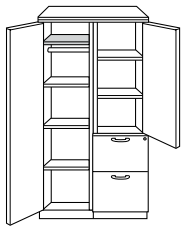

Shown as Right

Description

- One Side - Shaded Fixed Top Shelf, Coat Rod, and Three Adjustable Shelves
- One Side - Top Storage with Two Adjustable Shelves, Bottom Locking File/File
- Available in Premium Veneer (PV) or Standard Veneer (W); Must Specify
- Pedestal Determines Left or Right Handed Unit
- Finger Pull Not Available
- Optional Locking Door ([See Locking Options](#))

Must Specify (in this order):

Model #
Premium or Standard Veneer
Finish/Color
Edge Profile
Pull
Locking Door

DOUBLE WARDROBE/STORAGE CABINET WITH BOX/BOX/FILE	Left Drawers	Right Drawers					
	14-3670WD1L	14-3670WD1R	36	24	69%	315	42.0



Shown as Right

Description

- One Side - Shaded Fixed Top Shelf, Coat Rod, and Three Adjustable Shelves
- One Side - Top Storage with Two Adjustable Shelves, Bottom Locking Box/Box/File
- Available in Premium Veneer (PV) or Standard Veneer (W); Must Specify
- Pedestal Determines Left or Right Handed Unit
- Finger Pull Not Available
- Optional Locking Door ([See Locking Options](#))

Must Specify (in this order):

Model #
Premium or Standard Veneer
Finish/Color
Edge Profile
Pull
Locking Door

STORAGE CABINET WITH LATERAL FILE DRAWERS	14-3670SU2	36	24	69%	298	42.0	W\$ 10170 PV\$ 11899
---	------------	----	----	-----	-----	------	-------------------------

**Description**

- Standard with: Two 170° Hinged Doors, Two Adjustable Shelves on Top, Two Locking Lateral File Drawers on Bottom
- Lateral Drawers Provide Letter or Legal Filing Capabilities
- Available in Premium Veneer (PV) or Standard Veneer (W); Must Specify
- Finger Pull Not Available
- Optional Locking Door ([See Locking Options](#))

Must Specify (in this order):

Model #
Premium or Standard Veneer
Finish/Color
Edge Profile
Pull
Locking Door

P = HPL W = Veneer PV = Premium Veneer

[See Madera Overview For Ordering Options](#)

Item	Model No.		W	D	H	Ship Wt	Cubic Ft	List Price
ROUND GROMMET COVER FIELD INSTALLED	01-GRMTBK	Black	-	-	-	-	-	\$ 11
	01-GRMTSL	Silver						



OPEN MARKET ONLY
(SILVER)

Description

- 60mm Round Grommet Cover
- Field Installed

SINGLE POWER SAND DOLLAR	01-SAND60PS	Silver	3	3	4	1	0.2	\$ 98
	01-SAND60PW	White						
	01-SAND60PB	Black						

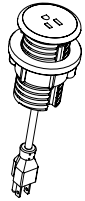

Description

- Mounts in 2 $\frac{3}{8}$ " (60mm) Round Grommet
- Single Power Outlet with 6' Cord

DOUBLE USB SAND DOLLAR	01-SAND60US	Silver	3	3	4	1	0.2	\$ 277
	01-SAND60UW	White						
	01-SAND60UB	Black						

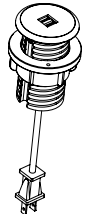

Description

- Mounts in 2 $\frac{3}{8}$ " (60mm) Round Grommet
- Dual USB Outlets with 6' Cord

DOCK 950 WIRELESS CHARGER	01-DOCK950W	White	3 $\frac{1}{2}$ "	3 $\frac{1}{2}$ "	-	1	0.2	\$ 265
	01-DOCK950B	Black						



OPEN MARKET ONLY

Description

- For Use with Wireless Charging Enabled Devices
- 5 Watts Maximum Output with a Direct Current of 5V 2A and 10 Watts Maximum with Quick Charge 2.0
- LED will Confirm Pairing with Device and Begin Wireless Charging

WIRELESS AND USB CHARGER	01-DOCK150W	White	3	3	$\frac{3}{4}$ "	1	0.2	\$ 405
	01-DOCK150B	Black						







OPEN MARKET ONLY

Description

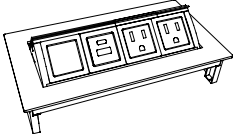
- For Use with Wireless Charging Enabled Devices and USB Charging Devices
- 5 Watt Maximum Output with a Direct Current Input of 5V 6A (Wireless Fast Charge)
- Pop-Up is $\frac{3}{4}$ "H and Includes Three (3) USB Ports; One (1) 12 Watt Maximum with 2.4A (USB Fast Charge) and Two (2) 5 Watt with 1A (USB Standard Charge)
- LED Light will Confirm Pairing with Device and Begin Wireless Charging
- UL and cUL Certified

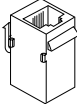
[See Madera Overview For Ordering Options](#)

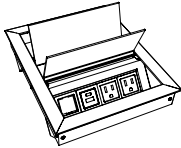
Item	Model No.		W	D	H	Ship Wt	Cubic Ft	List Price
	01-DPORT4A	Aluminum	8	4	-	7	0.2	\$ 1093
	01-DPORT4B	Black						
Description								
<ul style="list-style-type: none"> Retracts into Work Surface to Regain Productive Space; One-Touch Access to Power and Data Two (2) Power Outlets, One (1) USB A+C, and One (1) Open Port Optional Telecom Port Components, See Options Water-Proof Simplex (Outlets) Includes a Voice/Data Adapter Kit to Accept Couplers and Jacks When Required 10' Power Cord UL Recognized 								
USB PORT	01-USBPORT		-	-	-	-	-	\$ 161
	Description							
<ul style="list-style-type: none"> Passive USB-A Port with Increased Transfer Speed Up to 5 gbs/sec Simultaneous Read/Write Capability; Idle Device Power Saving State 6' Cord Compatible with 01-DPORT4A, 01-DPORT4B 								
VOICE COUPLER	01-VOICE1		-	-	-	-	-	\$ 73
	Description							
<ul style="list-style-type: none"> 6-Pin Modular Plug Molded Black; Cord Not included Compatible with 01-DPORT4A, 01-DPORT4B 								
DATA PORT	01-RJ4DATA		-	-	-	-	-	\$ 167
	Description							
<ul style="list-style-type: none"> 8-Pin Modular Plug; Cat6 Ethernet Cable; Pre-terminated Cable 10' Cord Compatible with 01-DPORT4A, 01-DPORT4B 								
 <p>01-E2X4 SIN PENDING</p>	01-E2X6A	Aluminum	11	9 ³ / ₁₆	-	6	0.7	\$ 1625
	01-E2X6B	Black						
	01-E2X4A	Aluminum	8	9 ³ / ₁₆	-	5	0.5	\$ 1494
	01-E2X4B	Black						
Description								
<ul style="list-style-type: none"> In Surface, Dual Side Application; Soft Touch Access to Power and Data 11" Unit Includes Three (3) Power Outlets, One (1) USB A+C, and Two (2) Open Port on Each Side; 8" Unit Includes Two (2) Power Outlets, One (1) USB A+C, and One (1) Open Port on Each Side Optional Telecom Port Components, See Compatible Units 6' Power Cord UL Listed 								

[See Madera Overview For Ordering Options](#)

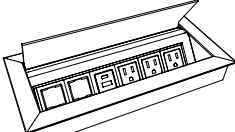
Item	Model No.		W	D	H	Ship Wt	Cubic Ft	List Price
	01-ELLORA6A	Aluminum	11	5	-	6	0.7	\$ 852
	01-ELLORA6B	Black						
	01-ELLORA4A	Aluminum	8	5	-	5	0.5	\$ 792
	01-ELLORA4B	Black						

01-ELLORA6

SIN PENDING

Description

- In Surface Application; Soft Touch Access to Power and Data
- 11" Includes Three (3) Power Outlets, One (1) USB A+C, and Two (2) Open Port; 8" Includes Two (2) Power Outlets, One (1) USB A+C, and One (1) Open Port
- Optional Telecom Port Components, See Below for Compatible Units
- 6' Power Cord
- UL Recognized

VGA CONNECTOR ACCESSORY	01-VGACON		-	-	-	1	0.2	\$ 149
-------------------------	-----------	--	---	---	---	---	-----	--------

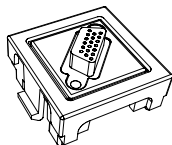
**Description**

- VGA Port for 01-DPORT4A, 01-DPORT4B, ELLORA4A, ELLORA4B, ELLORA6A, ELLORA6B, E2X4A, E2X4B, E2X6A, and E2X6B
- Enables Devices to Remote Display on Monitors
- 10' Cord
- Male/Female Connector

PASSIVE USB-C ACCESSORY	01-PUSBC		-	-	-	1	0.2	\$ 95
-------------------------	----------	--	---	---	---	---	-----	-------

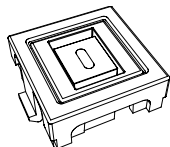
**Description**

- Passive USB-C Port ; Unit Provides Data Connection to Transfer Data Only, No Charging Capabilities
- Compatible with 01-DPORT4A, 01-DPORT4B, ELLORA4A, ELLORA4B, ELLORA6A, ELLORA6B, E2X4A, E2X4B, E2X6A, and E2X6B
- Male/Female Connector

CHARGING USB-A+C ACCESSORY	01-USBAC		-	-	-	1	0.2	\$ 283
----------------------------	----------	--	---	---	---	---	-----	--------

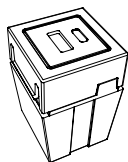
**Description**

- For Charging Devices
- 20 Watt Power Supply
- USB+C Charging Port for 01-DPORT4A, 01-DPORT4B, ELLORA4A, ELLORA4B, ELLORA6A, ELLORA6B, E2X4A, E2X4B, E2X6A, and E2X6B

Item	Model No.		W	D	H	Ship Wt	Cubic Ft	List Price
HDMI CONNECTOR ACCESSORY	01-HDMICON		-	-	-	1	0.2	\$ 124

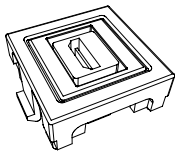

Description

- HDMI Port for 01-DPORT4A, 01-DPORT4B, ELLORA4A, ELLORA4B, ELLORA6A, ELLORA6B, E2X4A, E2X4B, E2X6A, and E2X6B
- Connects to High Definition Displays
- Female/Female Connector
- 18" Cord

INTERACT POWER & DATA	01-INTERACTG2A	Aluminum	9	5 $\frac{3}{8}$	2 $\frac{3}{4}$	5	0.2	\$ 891
	01-INTERACTG2B	Black						



Description

- Includes: Two (2) Power Outlets, Two (2) USB-A Charging Ports, One (1) Telecom Plate Opening; Two (2) Keystone Openings for Voice/Data Jacks
- One (1) Telecom Plates Included with the Unit: One (1) 01-ABLAB Plate (Consists of One (1) RJ45 Cat 6, One (1) RJ11 Cat 3 Phone Jack)
- Convenience Plug on Bottom
- 6' Power Cord
- UL and CSA Recognized
- Additional Telecom Plates, [See ECA Telecom Plate Options](#)

OASIS MINI POWER & DATA	01-OASISMA	Aluminum	15	9	5	11	0.3	\$ 3191
	01-OASISMB	Black						



Top View

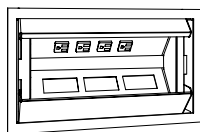

Description

- Soft Touch Hinged Lid
- Four (4) Power Outlets, Three (3) Telecom Plate Openings
- Two (2) Telecom Plates Included with the Unit: One (1) 01-ABLAB Plate (Consists of One (1) RJ45 Cat 6, One (1) RJ11 Cat 3 Phone Jack); One (1) 01-ABLB Plate (Consists of One (1) RJ45 Cat 6)
- 9' Power Cord
- UL Listed
- Additional Telecom Plates, [See ECA Telecom Plate Options](#)

DOCK800	01-DOCK800S	Silver	14	9	-			\$ 2047
	01-DOCK800B	Black						

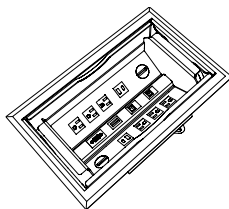

Description

- Stylish Aluminum Housing with Beveled Edges; Soft Touch Access and Closure
- Includes: Six (6) Power Outlets, Two (2) USB-A 5V Ports, Two (2) USB-C Charging Ports, One (1) RJ45 Ethernet Port, One (1) RJ11 Port, One (1) HDMI Port, and One (1) VGA Port
- 10' Power Cord
- UL and cUL Certified

OPEN MARKET ONLY

[See Madera Overview For Ordering Options](#)

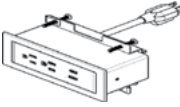
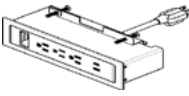
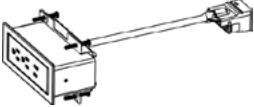
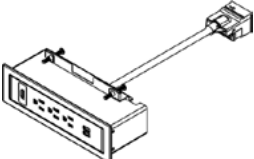
Item	Model No.		W	D	H	Ship Wt	Cubic Ft	List Price
DUO BEZEL WITH NEMA PLUG 	01-DUOBEZELW	White	6½	2½	3¼	1	0.2	\$ 675
	01-DUOBEZELB	Black						
	01-DUOBEZELS	Silver						
	Description <ul style="list-style-type: none"> Sits on Table Top and Includes: Two (2) Power, One (1) USB Charging Port and One (1) 60-Watt USB-C Power Delivery Port with GaN Technology, 10' Cord, and All Mounting Hardware Independent USB Circuit Controllers Deliver up to 2.1 Amps to Each Post FCC Part 15A, UL Recognized for Horizontal and Vertical Applications 							
TRIO BEZEL WITH NEMA PLUG 	01-TRIOBEZELW	White	9	2½	3	1	0.2	\$ 725
	01-TRIOBEZELB	Black						
	01-TRIOBEZELS	Silver						
	Description <ul style="list-style-type: none"> Sits on Table Top and Includes: Three (3) Power Outlets, One (1) USB Charging Port, One (1) 60-Watt USB-C Power Delivery Port with GaN Technology, One (1) Open Data Port, 10' Cord, and All Mounting Hardware HDMI, VGA, and RJ45 Accessories for Open Data Port; Sold Separately, See Accessories Independent USB Circuit Controllers Deliver up to 2.1 Amps to Each Post FCC Part 15A, UL Recognized for Horizontal and Vertical Applications 							
DUO BEZEL WITH DAISY CHAIN PLUG 	01-PDUOBEZELW	White	6½	2½	3	1	0.2	\$ 668
	01-PDUOBEZELB	Black						
	01-PDUOBEZELS	Silver						
	Description <ul style="list-style-type: none"> Sits on Table Top and Includes: Two (2) Power, One (1) USB Charging Port and One (1) 60-Watt USB-C Power Delivery Port with GaN Technology 12" Cord, and All Mounting Hardware Requires Daisy Chain Power Box; Sold Separately, See Power Box Details Non-Sequential System Allows up to Eight (8) Modules to be Connected with Jumper Cord, See Jumper Cord Details Independent USB Circuit Controllers Deliver up to 2.1 Amps to Each Post FCC Part 15A, RU Listed and UL Recognized for Horizontal and Vertical Applications 							
TRIO BEZEL WITH DAISY CHAIN PLUG 	01-PTRIOBEZELW	White	9	2½	3	1	0.2	\$ 715
	01-PTRIOBEZELB	Black						
	01-PTRIOBEZELS	Silver						
	Description <ul style="list-style-type: none"> Sits on Table Top and Includes: Three (3) Power Outlets, One (1) USB Charging Port, One (1) 60-Watt USB-C Power Delivery Port with GaN Technology, One (1) Open Data Port, 12" Cord, and All Mounting Hardware HDMI, VGA, or RJ45 Accessory for Open Data Port; Sold Separately, See Accessories Requires Daisy Chain Power Box, Specified Separately, See Next Page Non-Sequential System Allows up to Eight (8) Modules to be Connected with Jumper Cord, See Jumper Cord Details Independent USB Circuit Controllers Deliver up to 2.1 Amps to Each Post FCC Part 15A, RU Listed and UL Recognized for Horizontal and Vertical Applications 							

[See Madera Overview For Ordering Options](#)

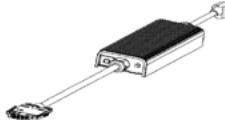
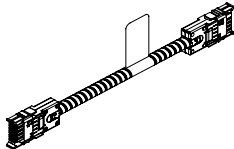
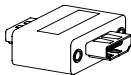
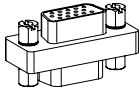
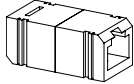
Item	Model No.		W	D	H	Ship Wt	Cubic Ft	List Price
DAISY CHAIN POWER BOX 	01-PPOWER	76" Perimeter, 36" Power Cord	-	-	-	1	0.2	\$ 775
	01-PPOWER2	24" Perimeter, 144" Power Cord	-	-	-	1	0.2	\$ 796
Description								
<ul style="list-style-type: none"> • Powers up to Eight (8) Duo and Trio Daisy Chain Units • One Nema Plug and One Daisy Chain Plug • 12-Amp System Rating • 15-Amp Over-Current Protection 								
DAISY CHAIN JUMPER CORD 	01-6JUMP	72" Long	-	-	-	1	0.2	\$ 299
	01-5JUMP	60" Long	-	-	-	1	0.2	\$ 284
	01-4JUMP	48" Long	-	-	-	1	0.2	\$ 240
	01-2JUMP	24" Long	-	-	-	1	0.2	\$ 220
Description								
<ul style="list-style-type: none"> • Connects Duo and Trio Daisy Chain Units • Non-Sequential System Allows up to Eight (8) Modules to be Connected 								
HDMI DATA PORT ACCESSORY 	01-LCOMHDMI		-	-	-	1	0.2	\$ 166
Description								
<ul style="list-style-type: none"> • HDMI Port for Trio Bezel Units 								
OPEN MARKET ONLY								
VGA DATA PORT ACCESSORY 	01-LCOMVGA		-	-	-	1	0.2	\$ 121
Description								
<ul style="list-style-type: none"> • VGA Port for Trio Bezel Units 								
RJ45 DATA PORT ACCESSORY 	01-LCOMRJ45		-	-	-	1	0.2	\$ 79
Description								
<ul style="list-style-type: none"> • RJ45 Port for Trio Bezel Units 								

[See Madera Overview For Ordering Options](#)

Item	Model No.	Width	Depth	Height	Ship Wt	Cubic Ft	List Price
WIRE MANAGEMENT CHANNEL	01-WMGR4	16	1½	¾	1	-	\$ 116

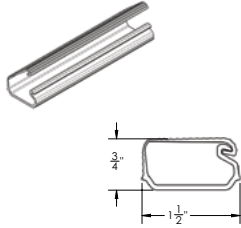

Description

- Set of Four (4) Black Plastic Wire Management Channels
- Snap Lock Channel
- Attaches with Adhesive Strips
- Ships via UPS Only

WIRE CHANNEL	01-32125	24	1½	1	.25	0.3	\$ 106
--------------	----------	----	----	---	-----	-----	--------

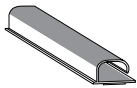

Description



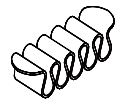

- Available in Black
- Channels Attach with Two (2) Double-Sided Installation Tape
- Open J Channel for Easy Storage of Cables

CABLE GRIP	01-WMGRCB	5¾	2¾	-	-	-	\$ 17
------------	-----------	----	----	---	---	---	-------



Description

- Under Surface Wire Management
- Black

Item	Model No.	Description	List Price
ECA TELECOM PLATES	01-ABL	Telecom Plate, Blank Plate	\$ 41
Compatible with:	01-ABL737373	Telecom Plate, Three (3) RJ45 Cat 5e	\$ 367
	01-ABLAB	Telecom Plate, One (1) RJ45 Cat 6, One (1) RJ11 Cat 3 Phone	\$ 206
	01-ABLAB102	Telecom Plate, One (1) RJ45 Cat 6, One (1) RJ11 Cat 3, One (1) USB W/72" Patch Cord	\$ 320
Oasis Mini Power & Data 01-OASISMA, 01-OASISMB	01-ABLABB	Telecom Plate, Two (2) RJ45 Cat 6, One (1) RJ11 Cat 3 Phone	\$ 320
	01-ABLB	Telecom Plate, One (1) RJ45 Cat 6	\$ 149
Interact Power & Data 01-INTERACTG2A, 01-INTERACTG2B	01-ABLBB	Telecom Plate, Two (2) RJ45 Cat 6	\$ 260
	01-ABLBBB	Telecom Plate, Three (3) RJ45 Cat 6	\$ 367
Power Center 01-INTRFCIA, 01-INTRFCIB	01-ABLBBB	Telecom Plate, Four (4) RJ45 Cat 6	\$ 476
	01-ABLBBBC51	Telecom Plate, Two (2) RJ45 Cat 6, One (1) 15 Pin HD VGA w/72" Patch Cord	\$ 446
	01-ABLBC51L	Telecom Plate, One (1) RJ45 Cat 6, One (1) Mini Stereo Inline, One (1) 15 Pin HD VGA w/72" Patch Cord	\$ 410
	01-ABLC3811	Telecom Plate, One (1) RJ45 Cat 6 Data Inline, One (1) RJ11 Cat 3 Phone Inline	\$ 197
	01-ABLC45	Telecom Plate, One (1) HDMI w/36" Patch Cord	\$ 295
	01-ABLC45C51L	Telecom Plate, One (1) Mini Stereo Inline, One (1) HDMI w/36" Patch Cord, One (1) 15 Pin HD VGA w/72" Patch Cord	\$ 558
	01-ABLC51L	Telecom Plate, One (1) 15 Pin HD VGA & One (1) Mini Stereo Inline Jack	\$ 298
	01-ABLCRDM	Telecom Plate, Three (3) Cord Bushings	\$ 96

[See Madera Overview For Ordering Options](#)

Natta offers an agile solution for a variety of community spaces and meeting applications. With its simplicity of form, it can achieve a subtle effect and still provide an excellent solution for any meeting and breakout environment.

CONSTRUCTION

TOPS

- NAT-1 and NAT-2 Tops are High Pressure Laminate (HPL) and 3-ply balanced construction, 1½" thick with 1 mm PVC edge band and vertical square edge profile
- NAT-3 and NAT-4 Tops have 1½" thick HPL surface with 1mm PVC edge band Square edge profile
- Designer White, Sugar Maple, and Williamsburg Cherry feature ABS edge bands
- Grain direction runs left to right unless otherwise noted

CHASSIS

- All frames are made of solid European Beech with double-doweled or mortised and tenoned joints
- NAT-3 and NAT-4 Frames are individually hand assembled and sanded prior to being finished; Legs are 9¾"H on the rectangular table and 14"H on the square table and include non-marring nylon glides
- NAT-1 and NAT-2 units are equipped with heavy-duty, adjustable glides to ensure proper leveling and compensation for uneven floors
- All table units ship fully assembled with tops installed

HOW TO ORDER EXAMPLE

Model No.	Description	Example
NAT-1	Top Color Leg Finish	SBP SBP
MMIT-2	Top Color Leg Finish	WH BW

HPL (P) LAMINATE OPTIONS ON TOPS

WOODGRAIN

AS	Asian Night	PTK	Portico Teak
BW	Beigewood	RC	River Cherry
CO	Columbian Walnut	SCH	Select Cherry
EF	Espresso	SPW	Sepia Walnut
FLW	Florence Walnut	SKC	Shaker Cherry
GC	Golden Cherry	SBP	Smoky Brown Pear
KHE	Kirsche	TK	Studio Teak
MW	Mahogany Walnut	SM	Sugar Maple
MNR	Midnight Run	WTA	Weathered Ash
NTM	Natural Marrone	WNB	White Nebbia
ORW	Oak Riftwood	WC	Williamsburg Cherry
PNW	Pinnacle Walnut		

SOLID

BL	Black	FHG	Fashion Grey
WH	Designer White	SG	Slate Grey

WOOD FINISHES AVAILABLE ON BASE/LEGS

Indiana Furniture uses a multi-step, hand finishing process on all exposed wood frames.

Tables feature a catalyzed varnish finish which offers durability, lasting beauty, and resistance to normal wear.

AW	Artisan Walnut	MAS	Mesa Sunset*
AS	Asian Night	MTS	Metropolis Sky
BW	Beigewood*	MNR	Midnight Run
BL	Black	NTM	Natural Marrone*
CO	Columbian Walnut	ORW	Oak Riftwood*
DC	Dark Cherry	PNW	Pinnacle Walnut
DFW	Dark Forest Walnut*	PTK	Portico Teak*
WH	Designer White	RC	River Cherry*
EF	Espresso	SCH	Select Cherry
FO	Fawn Oak*	SPW	Sepia Walnut*
FLW	Florence Walnut*	SKC	Shaker Cherry
GC	Golden Cherry	SBP	Smoky Brown Pear*
HW	Harvest Walnut	TK	Studio Teak
HNW	Henna Walnut	SM	Sugar Maple
KHE	Kirsche	WTA	Weathered Ash*
LW	Legacy Walnut	WNB	White Nebbia
MW	Mahogany Walnut	WC	Williamsburg Cherry

* Finish is Low Sheen

TABLE EDGE PROFILE



Vertical Square

CERTIFICATIONS & COMPLIANCE

- Intertek Sustainability Certified
- BIFMA level® Certified
- BIFMA Compliant Certified
- TSCA Title VI (Formerly CARB) Compliance
- US Green Building's LEED Contribution

STATEMENT OF LINE

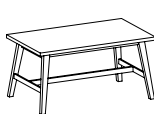

NAT-1: 30"H Table



NAT-2: 42"H Table

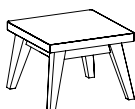

NAT-3:
Square Table

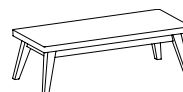

NAT-4:
Rectangle Table

See Next Page
For All Products

MEETING, COLLABORATIVE + LOUNGE TABLES (NAT SERIES)

Item	Model No.	W	D	H	Ship Wt	Cubic Ft	List Price
30"H MEETING TABLE	NAT-1	61½	35½	30½	106	43.7	\$ 2445

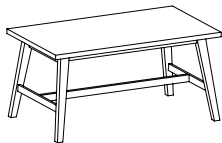

Description

- Features Square Edge Profile
- Available with Contrasting Top and Leg Color

Must Specify (in this order):

Model #
Top Color
Leg Finish

42"H MEETING TABLE	NAT-2	63	39	43	115	64.0	\$ 3023
--------------------	-------	----	----	----	-----	------	---------

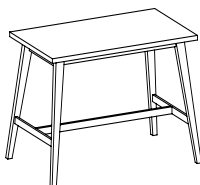

Description

- Features Square Edge Profile
- Available in Contrasting Top and Leg Color

Must Specify (in this order):

Model #
Top Color
Leg Finish

SQUARE TABLE	NAT-3	22	22	16	31	10.8	\$ 1013
--------------	-------	----	----	----	----	------	---------

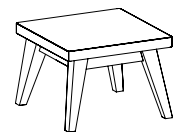

Description

- Features Square Edge Profile
- Available with Contrasting Top and Leg Color

Must Specify (in this order):

Model #
Top Color
Leg Finish

RECTANGLE TABLE	NAT-4	51	22	16	66	25.9	\$ 1381
-----------------	-------	----	----	----	----	------	---------

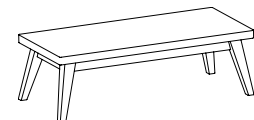

Description

- Features Square Edge Profile
- Available in Contrasting Surface and Leg Color

Must Specify (in this order):

Model #
Top Color
Leg Finish

[See Natta Overview For Ordering Options](#)

One10 Conference provides a scalable aesthetic with a versatile range of tables that provide solutions for casual to formal meetings that can support individual technology, the sharing of personal technology, or communal technology equipment. From conference tables, meeting tables, and TV stands, the collection provides flexibility for tailored applications, virtually anywhere.

CONSTRUCTION

VENEER

- Exposed surfaces feature select grade plain-sliced hardwood veneers in Cherry, Maple, American Black Walnut, or composite veneers. Veneers are carefully selected and matched to assure proper balance and consistency
- Veneer features either our UVAdvantage, an ultra-violet finish, or our Catalyzed finish (where noted)

LAMINATE

- High-Pressure Laminates (HPL) are made of woodgrain and solid color laminates fused to particleboard core; each laminate offers lasting beauty, superior resistance to normal wear, and easy maintenance

TOPS

- Tops with the Block Edge are 1½" thick while tops with the Knife Edge are 1¾" thick
- Veneer tops offer 3-ply balanced construction with 1.5mm wood edge band; Laminate tops offer 3-ply balanced construction with 1mm PVC edge band; Designer White, Sugar Maple, and Williamsburg Cherry feature ABS edge bands
- Credenza tops are ¾" thick, 3-ply balanced construction with 0.5mm wood edge-banded rims on Veneer options and 1mm PVC edge-banded rims on Laminate options
- Veneer accent tops are ¾" thick, 3-ply construction with 0.5mm wood edge band while Laminate accent tops are ¾" thick, 3-ply construction with 1mm PVC edge band; Designer White, Sugar Maple, and Williamsburg Cherry feature ABS edge bands
- Grain direction runs left-to-right, unless noted
- The Block Edge profile will be used with Block Bases only, while the Knife Edge profile will be used with Blade Bases only



Block Edge Profile

Knife Edge Profile

CHASSIS

- Chassis for storage units are securely fastened using high quality European fastening systems and heavy-duty 16-gauge joining brackets to assure maximum strength
- All units ship with heavy-duty, adjustable leveling glides to ensure proper leveling and compensation for uneven floors

DRAWERS

- All drawer fronts are ¾" thick, 3-ply construction with vertical grain direction
- Drawer sides, back, and front are woodgrain vinyl-wrapped ½" thick with ⅛" thick hardboard bottoms
- 5-sided drawer construction allows for easy removal of drawer fronts; All drawer fronts are standard with elegant vertically matched faces
- All drawers feature full extension, progressive action slides with precision steel ball bearings
- Box and file drawers are tested for 100lb capacity
- All suspensions have a limited lifetime warranty

STORAGE

- All hinged doors are soft-close, unless otherwise noted
- One piece hinge and base plate combination
- Soft close hinges reduce stress placed on the cabinet when the door is closed and offers a quiet closure

HOW TO ORDER EXAMPLES

SMALL MEETING TABLES

Single Column Table

	QTY	MODEL NO.	DESCRIPTION	EXAMPLE
TOP	1	95-6060SQV	Finish/Color	FO
			Power/Data Location	OC
BASE	1	95-3630BB	Finish/Color	FO
POWER	1	01-DUOBEZELS		

STANDARD MEETING TABLES

Rectangle Shaped with Center Inlay, Block Edge, and Block Bases

	QTY	MODEL NO.	DESCRIPTION	EXAMPLE
TOP	1	96-60192RTV5	Primary Finish/Color	WTA
			Accent Finish/Color	FHG
BASES	2	96-2428BB	Primary Finish/Color	WTA
			Accent Finish/Color	FHG
	1	96-2428MSL	Primary Finish/Color	WTA
			Accent Finish/Color	FHG
POWER	10	01-DUOS		
	2	01-TRIOS		
	2	LCOMHDMI		

STORAGE & ACCESSORIES

Media Credenza

	QTY	MODEL NO.	DESCRIPTION	EXAMPLE
	1	95-1872OMC	Finish/Color	SBP

VENEER (W) OPTIONS ON TOPS, BASES, AND ACCENTS

Veneer features UVAdvantage, an ultra-violet finish, on all exposed surfaces or our Catalyzed finish (where noted), which is a multi-step, finish process that provides years of lasting beauty.

AW	Artisan Walnut	MW	Mahogany Walnut
AS	Asian Night	MAS	Mesa Sunset*
CO	Columbian Walnut	MTS	Metropolis Sky
DC	Dark Cherry	ORW	Oak Riftwood*
DFW	Dark Forest Walnut	PNW	Pinnacle Walnut
EW	Espresso	SCH	Select Cherry
FO	Fawn Oak*	SKC	Shaker Cherry
GC	Golden Cherry	SM	Sugar Maple
HW	Harvest Walnut	WTA	Weathered Ash*
HNW	Henna Walnut	WC	Williamsburg Cherry
LW	Legacy Walnut		

* Finish is Low Sheen

HPL (P) LAMINATE OPTIONS ON TOPS, BASES, AND ACCENTS AND TFL (T) FOR BASE ACCENTS

WOODGRAIN

AS	Asian Night	PNW	Pinnacle Walnut
BW	Beigewood	PTK	Portico Teak
CO	Columbian Walnut	RC	River Cherry
EF	Espresso	SCH	Select Cherry
FLW	Florence Walnut	SPW	Sepia Walnut
GC	Golden Cherry	SKC	Shaker Cherry
HVM	Harvest Maple	SBP	Smoky Brown Pear
KHE	Kirsche	TK	Studio Teak
MW	Mahogany Walnut	SM	Sugar Maple
MNR	Midnight Run	WTA	Weathered Ash
NTM	Natural Marrone	WNB	White Nebbia
ORW	Oak Riftwood	WC	Williamsburg Cherry

SOLID

BL	Black*	FHG	Fashion Grey*
WH	Designer White	SG	Slate Grey*

* Available as Laminate Accent Only.

POWER/DATA UNITS & LOCATIONS

Square & Round Shaped Tops with Blade Bases

Models:

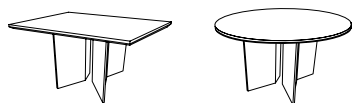

Modules Available (See Unit Details):

01-DUOBEZEL	Available in Black (B), Silver (S), or White (W)
01-TRIOBEZEL	Available in Black (B), Silver (S), or White (W)
01-PDUOBEZEL	Available in Black (B), Silver (S), or White (W)
01-PTRIOBEZEL	Available in Black (B), Silver (S), or White (W)

Note: Only one Power/Data Module Per Top.

Power/Data Location:

- All Power/Data Modules will be placed **On Center (OC)** of top.
- Designate "OC" when specifying the top model. Power/Data Module will need to be ordered separately.
- Power/Data Modules specified at the time of order will be routed for field installation.

Square & Rectangular Tops for Single and Dual Column Bases

Models:

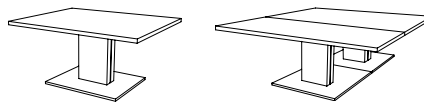

Modules Available (See Unit Details):

01-DUOBEZEL	Available in Black (B), Silver (S), or White (W)
01-TRIOBEZEL	Available in Black (B), Silver (S), or White (W)

Note: Only one Power/Data Module Per Top. Must Order Two (2) Power/Data Modules for Dual Column Tables.

Power/Data Location:

- All Power/Data Modules will be placed **On Center (OC)** of each top and installed directly over the base.
- Designate "OC" when specifying the top model. Power/Data Module will need to be ordered separately.
- Power/Data Modules specified at the time of order will be routed for field installation.

Rectangular 1 or 2 Piece Tops with Block or Blade Bases

Models:

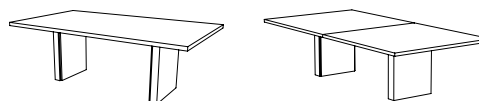

Modules Available (See Unit Details):

Available in Table Surface:

01-DUOBEZEL	Available in Black (B), Silver (S), or White (W)
01-TRIOBEZEL	Available in Black (B), Silver (S), or White (W)
01-PDUOBEZEL	Available in Black (B), Silver (S), or White (W)
01-PTRIOBEZEL	Available in Black (B), Silver (S), or White (W)

Available Under Table Surface:

01-DUO	Available in Black (B), Silver (S), or White (W)
01-TRIO	Available in Black (B), Silver (S), or White (W)
01-PDUO	Available in Black (B), Silver (S), or White (W)
01-PTRIO	Available in Black (B), Silver (S), or White (W)

Power/Data Location:

- Power/Data Modules specified at the time of order will be routed for field installation.
- Modules to be mounted under the table surface may be placed anywhere during field installation - No need to specify location when ordering top.

E1	29" Off One End
ELR	29" Off Each End
OC	On Center
OCELR	29" Off Each End and On Center

OCELR Not Available on Tables 96"W or Less

Rectangular and Boat Shaped Tops with Center Inlay

Modules Available (See Unit Details):

- 01-DUO Available in Black (B), Silver (S), or White (W)
- 01-TRIO Available in Black (B), Silver (S), or White (W)

Power/Data Location:

- All troughs, included as standard with the tops, have pre-drilled peck-hole locations from the bottom side of the trough for easy field installation. No need to specify location when ordering top.
- Desired Power/Data Modules will need to be ordered separately.
- Field install Power/Data Modules by selecting any or all of the desired pre-marked locations and drill the hole through.

Locations For: 48"x192" & 60"x192" Models with Center Inlay

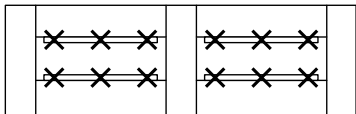

31", 52", and 73" off each end

Locations For: 48"x168" & 60"x168" Models with Center Inlay

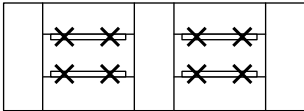

37" and 58" off each end

Locations For: 48"x144" & 60"x144" Models with Center Inlay

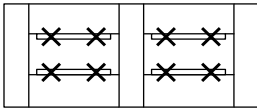

29" and 50" off each end

Locations For: 48"x120" & 60"x120" Models with Center Inlay

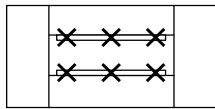

39" and 60" off each end

Locations For: 48"x108" & 60"x108" Models with Center Inlay

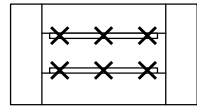

33" and 54" off each end

Locations For: 48"x96" & 60"x96" Models with Center Inlay

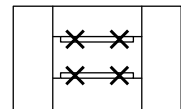

37½" off each end

CERTIFICATIONS & SUSTAINABILITY

- Intertek Sustainability Certified
- BIFMA level® Certified
- BIFMA Compliant® Certified
- TSCA Title VI (formerly CARB) Compliance
- US Green Building's LEED® Contribution

Small Meeting Tables



Square with Knife Edge and Blade Bases
[\(See Details\)](#)



Round with Knife Edge and Blade Bases
[\(See Details\)](#)

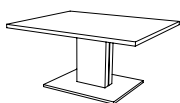

Square/Rectangle with Block or Knife Edge and Single Column
[\(See Details\)](#)

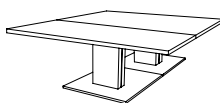

Square w/Block or Knife Edge and Dual Columns
[\(See Details\)](#)

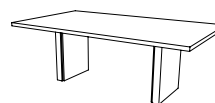

Rectangle with Block Edge and Block Bases
[\(See Details\)](#)

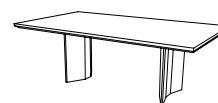

Rectangle with Knife Edge and Blade Bases
[\(See Details\)](#)

Standard Meeting Tables

Select from a variety of tops featuring solid, channels, or inlays in your choice of Block or Knife Edge

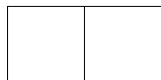

Solid 1 or 2 Piece

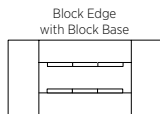

Block Edge with Block Base

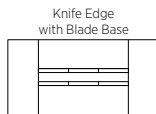

Knife Edge with Blade Base

Center Inlay

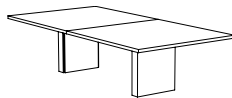

Rectangular with Block Edge and Block Bases
[\(See Details\)](#)



Rectangular with Knife Edge and Blade Bases
[\(See Details\)](#)



Boat Shaped with Block Edge and Block Bases
[\(See Details\)](#)

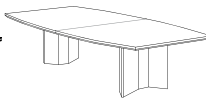

Boat Shaped with Knife Edge and Blade Bases
[\(See Details\)](#)

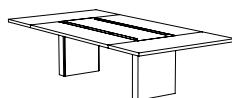

Rectangle with Center Inlay, Block Edge, and Block Bases
[\(See Details\)](#)

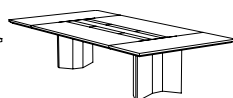

Rectangle with Center Inlay, Knife Edge, and Blade Bases
[\(See Details\)](#)

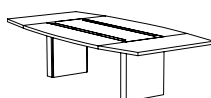

Boat Shaped with Center Inlay, Block Edge, and Block Bases
[\(See Details\)](#)



Boat Shaped with Center Inlay, Knife Edge, and Blade Bases
[\(See Details\)](#)

Wire Management & Power/Data Accessories [\(See Multiple Unit Details\)](#)

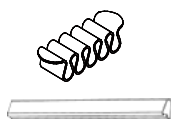
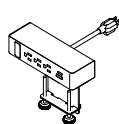

Storage & Accessories

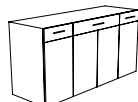

Buffet
[\(See Details\)](#)

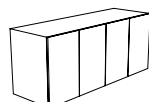

Credenza
[\(See Details\)](#)

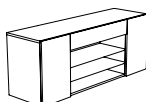

Media Credenza
[\(See Details\)](#)

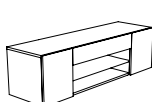

Low Media Credenza
[\(See Details\)](#)

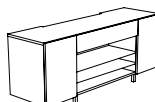

Footed Media Credenza
[\(See Details\)](#)

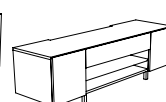

Low Footed Media Credenza
[\(See Details\)](#)



Flat Panel Monitor Stand
[\(See Details\)](#)



Lectern
[\(See Details\)](#)

Item	Model No.		W	D	H	Ship Wt	Cubic Ft	List Price
SMALL MEETING TABLES	96-6060SQK	HPL	60	60	1¾	143	8.4	P\$ 2336
	95-6060SQK	Veneer						W\$ 3346
SQUARE TOP BLADE BASE SET KNIFE EDGE	96-5454SQK	HPL	54	54	1¾	114	6.8	P\$ 2141
	95-5454SQK	Veneer						W\$ 3068
	96-4848SQK	HPL	48	48	1¾	90	5.5	P\$ 1856
	95-4848SQK	Veneer						W\$ 2742



Must Specify (in this order):
 Model #
 Finish/Color
 Power/Data Location

Description

- Veneer Tops Feature UV Finish on 48"D and Catalyzed Finish on 54"D and 60"D
- Requires One (1) Blade Base Set; Sold Separately, See Below
- Outer Panel can be Specified in a Contrasting Finish/Color from Top Finish/Color
- Power and Data Options Available; Sold Separately, [See Multiple Power Unit Details](#); Unit Will Be Routed On Center. [See Location Details](#)

BLADE BASE SET

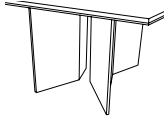

Must Specify (in this order):
 Model #
 Finish/Color

Blade Base Set with Stretchers - Requires One (1) Set								
96-2711BL	HPL		27	10½	28	45	1.9	P\$ 4039
95-2711BL	Veneer							W\$ 5080

Description

- Tops Require One (1) Blade Base Set; Sold Separately, See Below
- Outer Panel Features Vertical Grain Direction and can be Specified in a Contrasting Finish/Color from Top Finish/Color

SMALL MEETING TABLES	96-6060CTK	HPL	60	60	1¾	143	8.4	P\$ 2340
	95-6060CTK	Veneer						W\$ 3408
ROUND TOP BLADE BASE SET KNIFE EDGE	96-5454CTK	HPL	54	54	1¾	114	6.8	P\$ 2149
	95-5454CTK	Veneer						W\$ 3133
	96-4848CTK	HPL	48	48	1¾	90	5.5	P\$ 1870
	95-4848CTK	Veneer						W\$ 2797



Must Specify (in this order):
 Model #
 Finish/Color
 Power/Data Location

Description

- Veneer Tops Feature UV Finish on 48"D and Catalyzed Finish on 54"D and 60"D
- Requires One (1) Blade Base Set; Sold Separately, See Below
- Outer Panel can be Specified in a Contrasting Finish/Color from Top Finish/Color
- Power and Data Options Available; Sold Separately, [See Multiple Power Unit Details](#); Unit Will Be Routed On Center. [See Location Details](#)

BLADE BASE SET

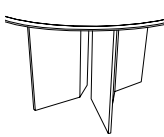

Must Specify (in this order):
 Model #
 Finish/Color

Blade Base Set with Stretchers								
96-2711BL	HPL		27	10½	28	45	1.9	P\$ 4039
95-2711BL	Veneer							W\$ 5080

Description

- Tops Require One (1) Blade Base Set; Sold Separately, See Below
- Outer Panel Features Vertical Grain Direction and can be Specified in a Contrasting Finish/Color from Top Finish/Color

P = HPL W = Veneer

[See One10 Overview For Ordering Options](#)

Item	Model No.		W	D	H	Ship Wt	Cubic Ft	List Price
------	-----------	--	---	---	---	---------	----------	------------

SMALL MEETING TABLES

**SQUARE/RECTANGULAR
1 PIECE TOP
SEATING OR STANDING HEIGHT
SINGLE COLUMN BASE
BLOCK OR KNIFE EDGE**

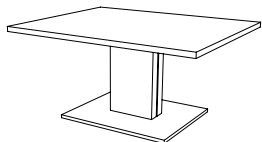

Must Specify (in this order):

- Model #
- Finish/Color
- Power/Data Location

Block Edge								
<i>Square Tops</i>								
96-6060SQV	HPL	60	60	1½	143	8.4	P\$	2004
95-6060SQV	Veneer						W\$	2668
96-5454SQV	HPL	54	54	1½	114	6.8	P\$	1839
95-5454SQV	Veneer						W\$	2381
96-4848SQV	HPL	48	48	1½	90	5.5	P\$	1597
95-4848SQV	Veneer						W\$	1987
<i>Rectangular Tops</i>								
96-4896RTVBB	HPL	48	96	1½	205	17.7	P\$	2020
95-4896RTVBB	Veneer						W\$	2772
96-4884RTV	HPL	48	84	1½	158	9.3	P\$	1960
95-4884RTV	Veneer						W\$	2491
96-4872RTV	HPL	48	72	1½	135	8.1	P\$	1869
95-4872RTV	Veneer						W\$	2220
96-4860RTV	HPL	48	60	1½	112	6.8	P\$	1779
95-4860RTV	Veneer						W\$	1983
Knife Edge								
<i>Square Tops</i>								
96-6060SQK	HPL	60	60	1⅜	143	8.4	P\$	2336
95-6060SQK	Veneer						W\$	3346
96-5454SQK	HPL	54	54	1⅜	114	6.8	P\$	2141
95-5454SQK	Veneer						W\$	3068
96-4848SQK	HPL	48	48	1⅜	90	5.5	P\$	1856
95-4848SQK	Veneer						W\$	2742
<i>Rectangular Tops</i>								
96-4896RTKBB	HPL	48	96	1⅜	180	11.4	P\$	2389
95-4896RTKBB	Veneer						W\$	3281
96-4884RTKBB	HPL	48	84	1⅜	158	10.0	P\$	2316
95-4884RTKBB	Veneer						W\$	2912
96-4872RTKBB	HPL	48	72	1⅜	135	8.1	P\$	2208
95-4872RTKBB	Veneer						W\$	2596
96-4860RTKBB	HPL	48	60	1⅜	112	6.8	P\$	2110
95-4860RTKBB	Veneer						W\$	2333

Description

- All Models Feature a 1-piece, 1⅜" Thick Top
- Veneer Tops Feature UV Finish on 48"D and Catalyzed Finish on 54"D and 60"D
- Metal Frame Column Bases For Seated Height or Standing Height Tables; Sold Separately, See Below
- Power and Data Options Available; Sold Separately, [See Multiple Power Unit Details](#); Unit Will Be Routed On Center. [See Location Details](#)

METAL FRAME COLUMN BASES

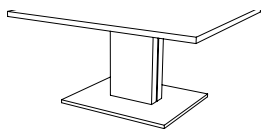

Must Specify (in this order):

- Model #
- Finish/Color

Bases for Tables ≤72"D								
96-3630TBB	42" Standing Height	36	30	40	178	30.4	P\$	3008
95-3630TBB							W\$	3526
96-3630BB	30" Seated Height	36	30	28	168	26.2	P\$	2847
95-3630BB							W\$	3137
Bases for Tables ≥84"D								
96-6030TBB	42" Standing Height	60	30	40	257	49.5	P\$	3908
95-6030TBB							W\$	4382
96-6030BB	30" Seated Height	60	30	28	211	35.7	P\$	3774
95-6030BB							W\$	4060

Description

- Aluminum Base Platform and Aluminum Detail Continues Up the Column for Design Appeal
- Base Features Horizontal Grain Direction
- Column Accommodates Wire Management with Removable Panel for Power and Data
- Adjustable Levelers

P = HPL W = Veneer

[See One10 Overview For Ordering Options](#)

Item	Model No.		W	D	H	Ship Wt	Cubic Ft	List Price	
SMALL MEETING TABLES									
Block Edge - 2 Piece Top									
SQUARE SHAPED 2 PIECE TOP SEATING OR STANDING HEIGHT DUAL COLUMN BASE BLOCK OR KNIFE EDGE	96-9696SQV	HPL	96	96	1½	379	21.2	P\$ 4881	
	95-9696SQV	Veneer						W\$ 5066	
	96-8484SQV	HPL	84	84	1½	294	21.2	P\$ 4494	
	95-8484SQV	Veneer						W\$ 4664	
	Knife Edge - 2 Piece Top								
	96-9696SQK	HPL	96	96	1⅝	287	21.2	P\$ 5066	
	95-9696SQK	Veneer						W\$ 6691	
	96-8484SQK	HPL	84	84	1⅝	224	21.2	P\$ 4664	
95-8484SQK	Veneer						W\$ 6120		

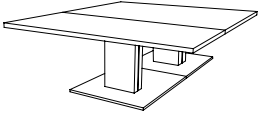

Must Specify (in this order):

- Model #
- Finish/Color
- Power/Data Location

Description

- All Models Feature a 2-piece, 1½" Thick Top
- Veneer Tops Feature Catalyzed Finish
- Requires Two (2) Metal Frame Column Bases For Seated Height or Standing Height Tables; Sold Separately, See Below
- Power and Data Options Available; Sold Separately, [See Multiple Power Unit Details](#); If Ordering, Must Order Two (2) as Units Will Be Routed On Center of Each Top, Directly Above the Bases. [See Location Details](#)

METAL FRAME COLUMN BASES

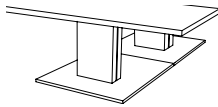

Two (2) Bases Required								
96-6030TBB	42" Standing Height		60	30	40	257	49.5	P\$ 3908
95-6030TBB								W\$ 4382
96-6030BB	30" Seated Height		60	30	28	211	35.7	P\$ 3774
95-6030BB								W\$ 4060

Description

- Two (2) Bases Required
- Aluminum Base Platform and Aluminum Detail Continues Up the Column for Design Appeal
- Base Features Horizontal Grain Direction
- Column Accommodates Wire Management with Removable Panel for Power and Data
- Adjustable Levelers

Must Specify (in this order):

- Model #
- Finish/Color

P = HPL W = Veneer

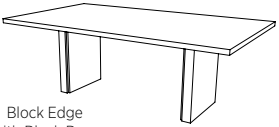
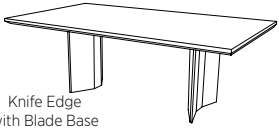
Item	Model No.		W	D	H	Ship Wt	Cubic Ft	List Price	
SMALL MEETING TABLES									
Block Edge (Use with Block Base Only)									
<i>48"W Tops</i>									
RECTANGULAR SHAPE 1 PIECE TOP BLOCK EDGE W/BLOCK BASE OR KNIFE EDGE W/BLADE BASE  Block Edge with Block Base  Knife Edge with Blade Base	96-4884RTV	HPL	48	84	1½	158	9.3	P\$ 1960	
	95-4884RTV	Veneer						W\$ 2491	
	96-4872RTV	HPL	48	72	1½	135	8.1	P\$ 1869	
	95-4872RTV	Veneer						W\$ 2220	
	<i>42"W Tops</i>								
	96-4296RTV	HPL	42	96	1½	158	9.1	P\$ 1869	
	95-4296RTV	Veneer						W\$ 2605	
	96-4284RTV	HPL	42	84	1½	138	8.1	P\$ 1791	
	95-4284RTV	Veneer						W\$ 2459	
	96-4272RTV	HPL	42	72	1½	119	7.1	P\$ 1709	
95-4272RTV	Veneer						W\$ 2003		
<i>36"W Tops</i>									
96-3696RTV	HPL	36	96	1½	135	8.1	P\$ 1796		
95-3696RTV	Veneer						W\$ 2394		
96-3684RTV	HPL	36	84	1½	119	7.1	P\$ 1726		
95-3684RTV	Veneer						W\$ 2092		
96-3672RTV	HPL	36	72	1½	102	6.2	P\$ 1683		
95-3672RTV	Veneer						W\$ 1898		
Knife Edge (Use with Blade Base Only)									
<i>48"W Tops</i>									
96-4884RTK	HPL	48	84	1¾	158	9.3	P\$ 4270		
95-4884RTK	Veneer						W\$ 5553		
96-4872RTK	HPL	48	72	1¾	135	8.1	P\$ 4047		
95-4872RTK	Veneer						W\$ 4956		
<i>42"W Tops</i>									
96-4296RTK	HPL	42	96	1¾	158	9.1	P\$ 4541		
95-4296RTK	Veneer						W\$ 5786		
96-4284RTK	HPL	42	84	1¾	138	8.1	P\$ 4093		
95-4284RTK	Veneer						W\$ 5281		
96-4272RTK	HPL	42	72	1¾	119	7.1	P\$ 3875		
95-4272RTK	Veneer						W\$ 4909		
<i>36"W Tops</i>									
96-3696RTK	HPL	36	96	1¾	135	8.1	P\$ 4389		
95-3696RTK	Veneer						W\$ 5682		
96-3684RTK	HPL	36	84	1¾	119	7.1	P\$ 3990		
95-3684RTK	Veneer						W\$ 5094		
96-3672RTK	HPL	36	72	1¾	102	6.2	P\$ 3790		
95-3672RTK	Veneer						W\$ 4791		

Must Specify (in this order):

- Model #
- Finish/Color
- Power/Data Location

Continued on next page.

P = HPL W = Veneer C = Combination of Wood/Laminate

[See One10 Overview For Ordering Options](#)

Item	Model No.	W	D	H	Ship Wt	Cubic Ft	List Price
------	-----------	---	---	---	---------	----------	------------

Continued from
Previous Page

What You Get:

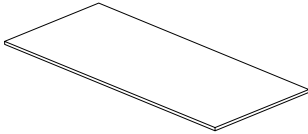

Top

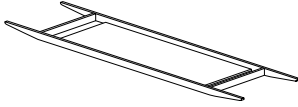

Trough
(on Knife Edge with Blade Bases Only)

Description

- 1½" Thick Rectangular Top with Block Edge or 1⅜" Thick Rectangular Top with Knife Edge
- All Models Feature a 1 Piece Top
- Veneer Tops Feature Catalyzed Finish
- Requires Two (2) Block Bases (Block Edge Only) or Blade Bases (Knife Edge Only); Sold Separately, See Below
- Block Bases Require Stretcher Rails; Sold Separately, See Below
- Blade Bases come with Trough to Reinforce and Support Top
- Power and Data Options Available; Sold Separately, [See Multiple Power Unit Details](#); [See Location Options](#)
- Assembly Required

Top Grain Direction

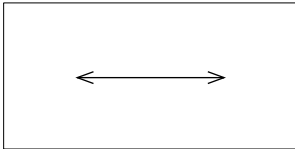

BASES & STRETCHERS

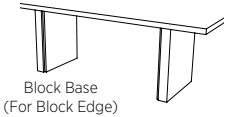

Block Base
(For Block Edge)

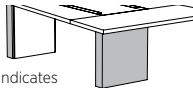

Shaded Indicates
Accent Area
(Vertical Grain Direction)

Must Specify (in this order):

- Standard Base Model #
- Stretchers (If needed)
- Primary Finish/Color
- Accent Material
- Accent Finish/Color

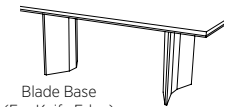

Blade Base
(For Knife Edge)

Must Specify (in this order):

- Standard Base Model #
- Stretchers (If needed)
- Primary Finish/Color

Block Bases; Must Order - Two (2) Required							
96-2228BB	HPL	22	5¼	28	45	1.9	P\$ 1485
95-2228BB	Veneer						W\$ 2039
95-2228BB	Veneer/TFL						C\$ 2312
Stretcher Sets For Block Bases; Must Order - One (1) Set Required							
<i>For 96"D Tables</i>							
96-0496STR	HPL	54⅞	¾	4⅝	9.2	0.5	P\$ 720
95-0496STR	Veneer						W\$ 865
<i>For 84"D Tables</i>							
96-0484STR	HPL	42⅜	¾	4⅝	7.2	0.4	P\$ 642
95-0484STR	Veneer						W\$ 768
<i>For 72"D Tables</i>							
96-0472STR	HPL	30⅞	¾	4⅝	5.2	0.3	P\$ 597
95-0472STR	Veneer						W\$ 698
Blade Bases; Must Order - Two (2) Required							
96-2828BD	HPL	28	10½	28	52	2.4	P\$ 1290
95-2828BD	Veneer						W\$ 1776

Description

- All Tables with a Block Edge Require Two (2) Block Bases and One (1) Set of Stretchers; All Tables with a Knife Edge Require Two (2) Blade Bases
- Bases are Constructed with Removable Interior Panel for Wire Management Installation
- Block Bases Feature Horizontal Grain Direction on Primary Panels and Vertical Grain on Accent Panels
- Block Base Outer Accent Panel can be Specified in a Contrasting Finish/Color from Top Finish/Color
- Blade Bases Feature Vertical Grain Direction
- Adjustable Glides Included

P = HPL W = Veneer C = Combination of Wood/TFL Accent

[See One10 Overview For Ordering Options](#)

Item	Model No.		W	D	H	Ship Wt	Cubic Ft	List Price	
STANDARD TABLES		60"D Tops							
		<i>192"W: 2 Piece Top</i>							
RECTANGULAR SHAPE 1 OR 2 PIECE TOP BLOCK EDGE BLOCK BASE	96-60192RTV	HPL	192	60	1½	482	28.2	P\$ 9270	
	95-60192RTV	Veneer						W\$ 10051	
	<i>168"W: 2 Piece Top</i>								
	96-60168RTV	HPL	168	60	1½	449	24.8	P\$ 8628	
	95-60168RTV	Veneer						W\$ 9306	
	<i>144"W: 2 Piece Top</i>								
	96-60144RTV	HPL	144	60	1½	388	21.4	P\$ 7220	
	95-60144RTV	Veneer						W\$ 8676	
	<i>120"W: 2 Piece Top</i>								
	96-60120RTV	HPL	120	60	1½	332	18.0	P\$ 6083	
95-60120RTV	Veneer						W\$ 7165		
<i>108"W: 1 Piece Top</i>									
96-60108RTV	HPL	108	60	1½	301	16.3	P\$ 5320		
95-60108RTV	Veneer						W\$ 7076		
<i>96"W: 1 Piece Top</i>									
96-6096RTV	HPL	96	60	1½	262	14.6	P\$ 4929		
95-6096RTV	Veneer						W\$ 5889		
		48"D Tops							
		<i>192"W: 2 Piece Top</i>							
Must Specify (in this order): Model # Finish/Color Power/Data Location	96-48192RTV	HPL	192	48	1½	426	22.7	P\$ 7815	
	95-48192RTV	Veneer						W\$ 9078	
	<i>168"W: 2 Piece Top</i>								
	96-48168RTV	HPL	168	48	1½	368	19.9	P\$ 7427	
	95-48168RTV	Veneer						W\$ 8522	
	<i>144"W: 2 Piece Top</i>								
	96-48144RTV	HPL	144	48	1½	318	17.1	P\$ 6109	
	95-48144RTV	Veneer						W\$ 7892	
	<i>120"W: 2 Piece Top</i>								
	96-48120RTV	HPL	120	48	1½	269	14.3	P\$ 5266	
95-48120RTV	Veneer						W\$ 6194		
<i>108"W: 1 Piece Top</i>									
96-48108RTV	HPL	108	48	1½	234	12.9	P\$ 4909		
95-48108RTV	Veneer						W\$ 5921		
<i>96"W: 1 Piece Top</i>									
96-4896RTV	HPL	96	48	1½	205	11.5	P\$ 3849		
95-4896RTV	Veneer						W\$ 5124		

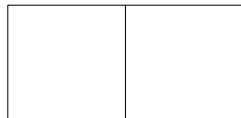
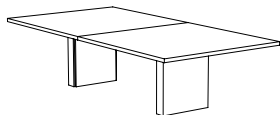

Rectangular 1 or 2-Piece Top available with a Knife Edge and coordinating Blade Base.

[See Details.](#)

Continued on next page.

P = HPL W = Veneer

[See One10 Overview For Ordering Options](#)

Item	Model No.	W	D	H	Ship Wt	Cubic Ft	List Price
------	-----------	---	---	---	---------	----------	------------

Continued from
Previous Page

What You Get:

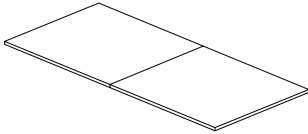

Top

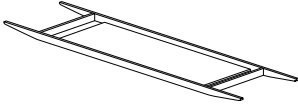

Trough

Description

- 1½” Thick Rectangular Top with Block Edge
- Veneer Tops Feature UV Finish on 48”D and Catalyzed Finish on 60”D
- Trough Reinforces and Supports Top
- Requires Two (2) Block Bases; Tables 144”W or Larger Also Require Middle Block Base; Sold Separately, See Below
- Power and Data Options Available; Sold Separately, [See Multiple Power Unit Details](#); [See Location Options](#)
- Assembly Required

Top Grain Direction

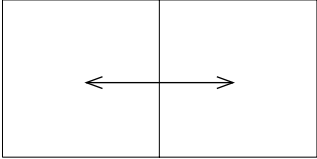

BLOCK BASES

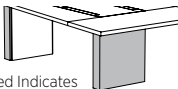
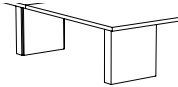

Shaded Indicates
Accent Area
(Vertical Grain Direction)

Block Base Options; Must Order							
Standard Block Base - Two (2) Required							
96-2428BB	HPL	24	6	28	52	2.4	P\$ 1580
95-2428BB	Veneer						W\$ 2170
95-2428BB	Veneer/TFL						C\$ 2430
Middle Block Base - Required for Tops 144”W or Larger							
96-2428MSL	HPL	24	7½	28	72	2.8	P\$ 1930
95-2428MSL	Veneer						W\$ 2511
95-2428MSL	Veneer/TFL						C\$ 2859



Description

- All Tops Require Two (2) Block Bases; Tables 144”W or Larger Also Require Middle Block Base
- Bases are Constructed with Removable Interior Panel for Wire Management Installation
- Block Bases Feature Horizontal Grain Direction on Primary Panels and Vertical Grain on Accent Panels
- Block Base Outer Accent Panel can be Specified in a Contrasting Finish/Color from Top Finish/Color
- Middle Base Feature Horizontal Grain Direction on Primary Panels and Vertical Grain on Accent Panels
- Adjustable Glides Included

Must Specify (in this order):

- Standard Base Model #
- Primary Finish/Color
- Accent Material
- Accent Finish/Color
- Middle Base Model # (If needed)
- Middle Base Primary Finish/Color
- Middle Base Accent Material
- Middle Base Accent Finish/Color

P = HPL W = Veneer C = Combination of Wood/TFL Accent

Item	Model No.		W	D	H	Ship Wt	Cubic Ft	List Price	
STANDARD TABLES		60"D Tops							
		<i>192"W: 2 Piece Top</i>							
RECTANGULAR SHAPE 1 OR 2 PIECE TOP KNIFE EDGE BLADE BASE	96-60192RTK	HPL	192	60	1 3/16	482	28.2	P\$ 10386	
	95-60192RTK	Veneer						W\$ 11257	
		<i>168"W: 2 Piece Top</i>							
	96-60168RTK	HPL	168	60	1 3/16	449	24.8	P\$ 9661	
	95-60168RTK	Veneer						W\$ 10422	
		<i>144"W: 2 Piece Top</i>							
	96-60144RTK	HPL	144	60	1 3/16	388	21.4	P\$ 8087	
	95-60144RTK	Veneer						W\$ 9721	
		<i>120"W: 2 Piece Top</i>							
	96-60120RTK	HPL	120	60	1 3/16	332	18.0	P\$ 6814	
	95-60120RTK	Veneer						W\$ 8024	
		<i>108"W: 1 Piece Top</i>							
	96-60108RTK	HPL	108	60	1 3/16	301	16.3	P\$ 5960	
	95-60108RTK	Veneer						W\$ 7930	
		<i>96"W: 1 Piece Top</i>							
Must Specify (in this order): Model # Finish/Color Power/Data Location	96-6096RTK	HPL	96	60	1 3/16	262	14.6	P\$ 5521	
	95-6096RTK	Veneer						W\$ 6595	
		48"D Tops							
		<i>192"W: 2 Piece Top</i>							
	96-48192RTK	HPL	192	48	1 3/16	426	22.7	P\$ 8751	
	95-48192RTK	Veneer						W\$ 10169	
		<i>168"W: 2 Piece Top</i>							
	96-48168RTK	HPL	168	48	1 3/16	368	19.9	P\$ 8318	
	95-48168RTK	Veneer						W\$ 9546	
		<i>144"W: 2 Piece Top</i>							
Rectangular 1 or 2-Piece Top available with a Block Edge and coordinating Block Base.	96-48144RTK	HPL	144	48	1 3/16	318	17.1	P\$ 6842	
	95-48144RTK	Veneer						W\$ 8837	
		<i>120"W: 2 Piece Top</i>							
	96-48120RTK	HPL	120	48	1 3/16	269	14.3	P\$ 5901	
	95-48120RTK	Veneer						W\$ 6939	
		<i>108"W: 1 Piece Top</i>							
	96-48108RTK	HPL	108	48	1 3/16	234	12.9	P\$ 5498	
	95-48108RTK	Veneer						W\$ 6632	
		<i>96"W: 1 Piece Top</i>							
	96-4896RTK	HPL	96	48	1 3/16	205	11.5	P\$ 4311	
	95-4896RTK	Veneer						W\$ 5743	

Continued on next page.

P = HPL W = Veneer

[See One10 Overview For Ordering Options](#)

Item	Model No.	W	D	H	Ship Wt	Cubic Ft	List Price
------	-----------	---	---	---	---------	----------	------------

Continued from
Previous Page

What You Get:

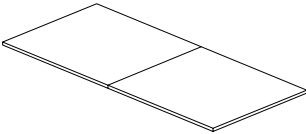

Top

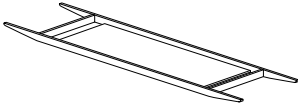

Trough

Description

- 1³/₁₆" Rectangular Top with Knife Edge
- Veneer Tops Feature UV Finish on 48"D and Catalyzed Finish on 60"D
- Trough Reinforces and Supports Top
- Requires Two (2) Blade Bases; Tables 144"W or Larger Also Require Middle Blade Base; Sold Separately, See Below
- Power and Data Options Available; Sold Separately, [See Multiple Power Unit Details](#); [See Location Options](#)
- Assembly Required

Top Grain Direction

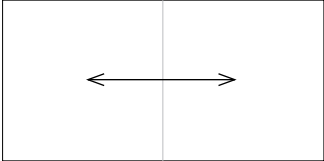

BLADE BASES

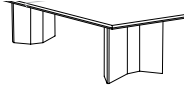

Blade Base Options; Must Order							
<i>Standard Blade Base - Two (2) Required</i>							
96-2828BD	HPL	28	10½	28	52	2.4	P\$ 1290
95-2828BD	Veneer						W\$ 1776
<i>Middle Blade Base - Required for Tops 144"W or Larger</i>							
96-2818MBD	Aluminum	18	3 ³ / ₈	28	72	2.8	\$ 1708
95-2818MBD	Aluminum						\$ 1708

Description

- All Tops Require Two (2) Blade Bases; Tables 144"W or Larger Also Require Middle Blade Base
- Bases are Constructed with Removable Interior Aluminum Panel for Wire Management Installation
- Aluminum Middle Blade Base Features Two (2) Aluminum Doors for Wire Management
- Blade Base Outer Panel Feature Vertical Grain Direction and can be Specified in a Contrasting Finish/Color from Top Finish/Color
- Adjustable Glides Included

Must Specify (in this order):

- Standard Base Model #
- Primary Finish/Color
- Middle Base Model # (If needed)

P = HPL W = Veneer

[See One10 Overview For Ordering Options](#)

Item	Model No.		W	D	H	Ship Wt	Cubic Ft	List Price	
STANDARD TABLES									
60"D Tops									
<i>192"W: 2 Piece Top</i>									
BOAT SHAPED 1 OR 2 PIECE TOP BLOCK EDGE BLOCK BASE	96-60192BTV	HPL	192	60 - 48	1½	482	28.2	P\$ 9736	
	95-60192BTV	Veneer						W\$ 10854	
<i>168"W: 2 Piece Top</i>									
	96-60168BTV	HPL	168	60 - 48	1½	449	24.8	P\$ 9059	
	95-60168BTV	Veneer						W\$ 10051	
<i>144"W: 2 Piece Top</i>									
	96-60144BTV	HPL	144	60 - 48	1½	388	21.4	P\$ 7583	
	95-60144BTV	Veneer						W\$ 9372	
<i>120"W: 2 Piece Top</i>									
	96-60120BTV	HPL	120	60 - 48	1½	332	18.0	P\$ 6385	
	95-60120BTV	Veneer						W\$ 7520	
<i>108"W: 1 Piece Top</i>									
	96-60108BTV	HPL	108	60 - 48	1½	301	16.3	P\$ 5586	
	95-60108BTV	Veneer						W\$ 7432	
<i>96"W: 1 Piece Top</i>									
	96-6096BTV	HPL	96	60 - 48	1½	262	14.6	P\$ 5174	
	95-6096BTV	Veneer						W\$ 6183	
48"D Tops									
<i>192"W: 2 Piece Top</i>									
	96-48192BTV	HPL	192	48 - 36	1½	426	22.7	P\$ 8208	
	95-48192BTV	Veneer						W\$ 9531	
<i>168"W: 2 Piece Top</i>									
	96-48168BTV	HPL	168	48 - 36	1½	368	19.9	P\$ 7796	
	95-48168BTV	Veneer						W\$ 8952	
<i>144"W: 2 Piece Top</i>									
Boat-Shaped 1 or 2-Piece Top available with a Knife Edge and coordinating Blade Base.	96-48144BTV	HPL	144	48 - 36	1½	318	17.1	P\$ 6416	
	95-48144BTV	Veneer						W\$ 8287	
<i>120"W: 2 Piece Top</i>									
	96-48120BTV	HPL	120	48 - 36	1½	269	14.3	P\$ 5530	
	95-48120BTV	Veneer						W\$ 6506	
<i>108"W: 1 Piece Top</i>									
	96-48108BTV	HPL	108	48 - 36	1½	234	12.9	P\$ 5156	
	95-48108BTV	Veneer						W\$ 6217	
<i>96"W: 1 Piece Top</i>									
	96-4896BTV	HPL	96	48 - 36	1½	205	11.5	P\$ 4042	
	95-4896BTV	Veneer						W\$ 5382	

Must Specify (in this order):

- Model #
- Finish/Color
- Power/Data Location

Boat-Shaped 1 or 2-Piece
Top available with a
Knife Edge and
coordinating Blade Base.

[See Details.](#)

Continued on next page.

P = HPL W = Veneer

[See One10 Overview For Ordering Options](#)

Item	Model No.	W	D	H	Ship Wt	Cubic Ft	List Price
------	-----------	---	---	---	---------	----------	------------

Continued from
Previous Page

What You Get:

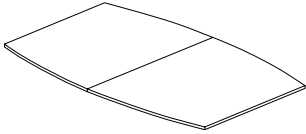

Top

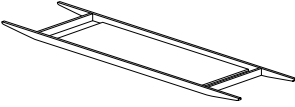

Trough

Description

- 1½” Thick Boat-Shaped Top with Block Edge
- Veneer Tops Feature UV Finish on 48”D and Catalyzed Finish on 60”D
- Trough Reinforces and Supports Top
- Requires Two (2) Block Bases; Tables 144”W or Larger Also Require Middle Block Base; Sold Separately, See Below
- Power and Data Options Available; Sold Separately, [See Multiple Power Unit Details](#); [See Location Options](#)
- Assembly Required

Top Grain Direction

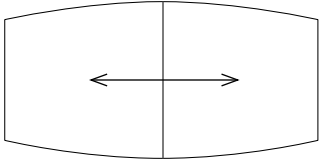

BLOCK BASES

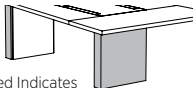
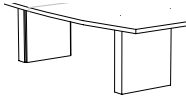

Shaded Indicates
Accent Area
(Vertical Grain Direction)

Block Base Options; Must Order							
Standard Block Base - Two (2) Required							
96-2428BB	HPL	24	6	28	52	2.4	P\$ 1580
95-2428BB	Veneer						W\$ 2170
95-2428BB	Veneer/TFL						C\$ 2430
Middle Block Base - Required for Tops 144”W or Larger							
96-2428MSL	HPL	24	7½	28	72	2.8	P\$ 1930
95-2428MSL	Veneer						W\$ 2511
95-2428MSL	Veneer/TFL						C\$ 2859

Description

- All Tops Require Two (2) Block Bases; Tables 144”W or Larger Also Require Middle Block Base
- Bases are Constructed with Removable Interior Panel for Wire Management Installation
- Block Bases Feature Horizontal Grain Direction on Primary Panels and Vertical Grain on Accent Panels
- Block Base Outer Accent Panel can be Specified in a Contrasting Finish/Color from Top Finish/Color
- Middle Base Feature Horizontal Grain Direction on Primary Panels and Vertical Grain on Accent Panels
- Adjustable Glides Included

Must Specify (in this order):

- Standard Base Model #
- Primary Finish/Color
- Accent Material
- Accent Finish/Color
- Middle Base Model # (If needed)
- Middle Base Primary Finish/Color
- Middle Base Accent Material
- Middle Base Accent Finish/Color

P = HPL W = Veneer C = Combination of Wood/TFL Accent

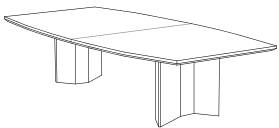
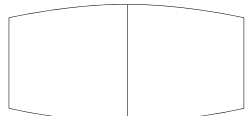
Item	Model No.		W	D	H	Ship Wt	Cubic Ft	List Price	
STANDARD TABLES		60"D Tops							
		<i>192"W: 2 Piece Top</i>							
BOAT SHAPED 1 OR 2 PIECE TOP KNIFE EDGE BLADE BASE	96-60192BTK	HPL	192	60 - 48	1¾	482	28.2	P\$ 10904	
	95-60192BTK	Veneer						W\$ 11820	
		<i>168"W: 2 Piece Top</i>							
	96-60168BTK	HPL	168	60 - 48	1¾	449	24.8	P\$ 10144	
	95-60168BTK	Veneer						W\$ 10943	
		<i>144"W: 2 Piece Top</i>							
	96-60144BTK	HPL	144	60 - 48	1¾	388	21.4	P\$ 8491	
	95-60144BTK	Veneer						W\$ 10204	
		<i>120"W: 2 Piece Top</i>							
	96-60120BTK	HPL	120	60 - 48	1¾	332	18.0	P\$ 7153	
	95-60120BTK	Veneer						W\$ 8425	
		<i>108"W: 1 Piece Top</i>							
	96-60108BTK	HPL	108	60 - 48	1¾	301	16.3	P\$ 6258	
	95-60108BTK	Veneer						W\$ 8323	
		<i>96"W: 1 Piece Top</i>							
	96-6096BTK	HPL	96	60 - 48	1¾	262	14.6	P\$ 5797	
	95-6096BTK	Veneer						W\$ 6922	
		48"D Tops							
		<i>192"W: 2 Piece Top</i>							
	96-48192BTK	HPL	192	48 - 36	1¾	426	22.7	P\$ 9191	
	95-48192BTK	Veneer						W\$ 10679	
		<i>168"W: 2 Piece Top</i>							
	96-48168BTK	HPL	168	48 - 36	1¾	368	19.9	P\$ 8732	
	95-48168BTK	Veneer						W\$ 10022	
		<i>144"W: 2 Piece Top</i>							
Boat-Shaped 1 or 2-Piece Top available with a Block Edge and coordinating Block Base.	96-48144BTK	HPL	144	48 - 36	1¾	318	17.1	P\$ 7181	
	95-48144BTK	Veneer						W\$ 9282	
		<i>120"W: 2 Piece Top</i>							
	96-48120BTK	HPL	120	48 - 36	1¾	269	14.3	P\$ 6194	
	95-48120BTK	Veneer						W\$ 7284	
		<i>108"W: 1 Piece Top</i>							
	96-48108BTK	HPL	108	48 - 36	1¾	234	12.9	P\$ 5775	
	95-48108BTK	Veneer						W\$ 6966	
		<i>96"W: 1 Piece Top</i>							
	96-4896BTK	HPL	96	48 - 36	1¾	205	11.5	P\$ 4527	
	95-4896BTK	Veneer						W\$ 6033	

Must Specify (in this order):

- Model #
- Finish/Color
- Power/Data Location

[See Details.](#)

Continued on next page.

P = HPL W = Veneer

[See One10 Overview For Ordering Options](#)

Item	Model No.	W	D	H	Ship Wt	Cubic Ft	List Price
------	-----------	---	---	---	---------	----------	------------

Continued from
Previous Page

What You Get:

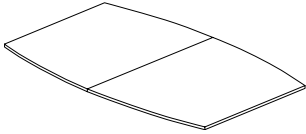

Top

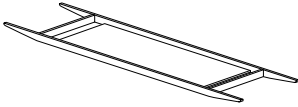

Trough

Description

- 1 $\frac{3}{16}$ " Rectangular Top with Knife Edge
- Veneer Tops Feature UV Finish on 48"D and Catalyzed Finish on 60"D
- Trough Reinforces and Supports Top
- Requires Two (2) Blade Bases; Tables 144"W or Larger Also Require Middle Blade Base; Sold Separately, See Below
- Power and Data Options Available; Sold Separately, [See Multiple Power Unit Details](#); [See Location Options](#)
- Assembly Required

Top Grain Direction

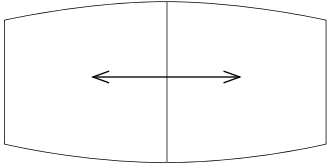

BLADE BASES

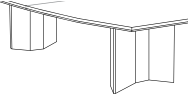

Blade Base Options; Must Order							
<i>Standard Blade Base - Two (2) Required</i>							
96-2828BD	HPL	28	10 $\frac{1}{2}$	28	52	2.4	P\$ 1290
95-2828BD	Veneer						W\$ 1776
<i>Middle Blade Base - Required for Tops 144"W or Larger</i>							
96-2818MBD	Aluminum	18	3 $\frac{3}{8}$	28	72	2.8	\$ 1708
95-2818MBD	Aluminum						\$ 1708

Must Specify (in this order):
Standard Base Model #
Primary Finish/Color
Middle Base Model # (If needed)

Description

- All Tops Require Two (2) Blade Bases; Tables 144"W or Larger Also Require Middle Blade Base
- Bases are Constructed with Removable Interior Aluminum Panel for Wire Management Installation
- Aluminum Middle Blade Base Features Two (2) Aluminum Doors for Wire Management
- Blade Base Outer Panel Feature Vertical Grain Direction and can be Specified in a Contrasting Finish/Color from Top Finish/Color
- Adjustable Glides Included

P = HPL W = Veneer

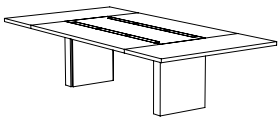
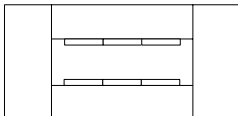
Item	Model No.		W	D	H	Ship Wt	Cubic Ft	List Price	
STANDARD TABLES		60"D Tops							
		<i>192"W: 9 Piece Top - 12 Accent Doors</i>							
RECTANGULAR TOP CENTER INLAY BLOCK EDGE BLOCK BASE	96-60192RTV5	HPL	192	60	1½	435	25.3	P\$ 16291	
	95-60192RTV5	Veneer						W\$ 19254	
	95-60192RTV5	Veneer/HPL						C\$ 19536	
		<i>168"W: 9 Piece Top - 8 Accent Doors</i>							
	96-60168RTV5	HPL	168	60	1½	407	24.9	P\$ 14747	
	95-60168RTV5	Veneer						W\$ 17116	
	95-60168RTV5	Veneer/HPL						C\$ 17563	
		<i>144"W: 9 Piece Top - 8 Accent Doors</i>							
	96-60144RTV5	HPL	144	60	1½	379	24.4	P\$ 14158	
	95-60144RTV5	Veneer						W\$ 16250	
	95-60144RTV5	Veneer/HPL						C\$ 16665	
		<i>120"W: 5 Piece Top - 6 Accent Doors</i>							
	96-60120RTV5	HPL	120	60	1½	339	24.0	P\$ 9227	
	95-60120RTV5	Veneer						W\$ 10922	
	95-60120RTV5	Veneer/HPL						C\$ 11061	
		<i>108"W: 5 Piece Top - 6 Accent Doors</i>							
<u>Must Specify (in this order):</u> Model # Primary Finish/Color Accent Material Accent Finish/Color	96-60108RTV5	HPL	108	60	1½	310	23.6	P\$ 8958	
	95-60108RTV5	Veneer						W\$ 10544	
	95-60108RTV5	Veneer/HPL						C\$ 10667	
		<i>96"W: 5 Piece Top - 4 Accent Doors</i>							
	96-6096RTV5	HPL	96	60	1½	282	23.0	P\$ 8229	
	95-6096RTV5	Veneer						W\$ 9765	
	95-6096RTV5	Veneer/HPL						C\$ 10022	
		48"D Tops							
		<i>192"W: 9 Piece Top - 12 Accent Doors</i>							
Rectangular Table With Center Inlay also available with a Knife Edge and coordinating Blade Base.	96-48192RTV5	HPL	192	48	1½	345	23.9	P\$ 15111	
	95-48192RTV5	Veneer						W\$ 17447	
	95-48192RTV5	Veneer/HPL						C\$ 18184	
		<i>168"W: 9 Piece Top - 8 Accent Doors</i>							
See Details.	96-48168RTV5	HPL	168	48	1½	328	23.7	P\$ 13604	
	95-48168RTV5	Veneer						W\$ 14970	
	95-48168RTV5	Veneer/HPL						C\$ 15737	
		<i>144"W: 9 Piece Top - 8 Accent Doors</i>							
	96-48144RTV5	HPL	144	48	1½	311	23.4	P\$ 13099	
	95-48144RTV5	Veneer						W\$ 14449	
	95-48144RTV5	Veneer/HPL						C\$ 15197	
		<i>120"W: 5 Piece Top - 6 Accent Doors</i>							
	96-48120RTV5	HPL	120	48	1½	282	23.2	P\$ 8491	
	95-48120RTV5	Veneer						W\$ 9682	
	95-48120RTV5	Veneer/HPL						C\$ 10082	
		<i>108"W: 5 Piece Top - 6 Accent Doors</i>							
	96-48108RTV5	HPL	108	48	1½	260	22.8	P\$ 8219	
	95-48108RTV5	Veneer						W\$ 9403	
	95-48108RTV5	Veneer/HPL						C\$ 9789	
		<i>96"W: 5 Piece Top - 4 Accent Doors</i>							
	96-4896RTV5	HPL	96	48	1½	237	23.0	P\$ 7543	
	95-4896RTV5	Veneer						W\$ 8275	
	95-4896RTV5	Veneer/HPL						C\$ 8706	

Continued on next page.

P = HPL W = Veneer C = Combination of Wood/HPL

[See One10 Overview For Ordering Options](#)

Item	Model No.	W	D	H	Ship Wt	Cubic Ft	List Price
------	-----------	---	---	---	---------	----------	------------

Continued from
Previous Page

What You Get:

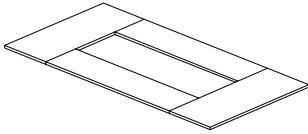

Outer Piece Top

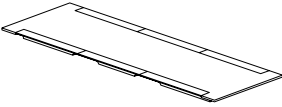

Center Inlay Top

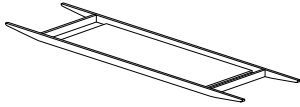

Trough

Description

- 1½” Thick Rectangular Top with Block Edge
- Veneer Tops Feature UV Finish
- Center Inlay Includes Aluminum Accent Doors for Wire Management
- Center Inlay Available in Contrasting Laminate or Veneer
- Trough Reinforces and Supports Top
- Requires Two (2) Block Bases; Tables 144”W or Larger Also Require Middle Block Base; Sold Separately, See Below
- Silver Grommet Included for Optional Polycrom Installation
- Power and Data Options Available; Sold Separately, [See Multiple Power Unit Details](#); [See Location Options](#)
- Assembly Required

Top Grain Direction

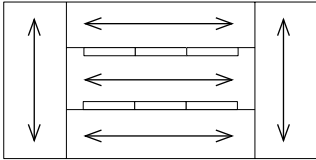

BLOCK BASES

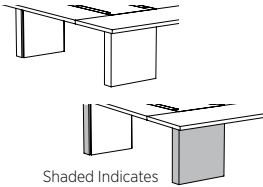

Shaded Indicates
Accent Area
(Vertical Grain Direction)

Block Base Options; Must Order								
<i>Standard Block Base - Two (2) Required</i>								
96-2428BB	HPL	24	6	28	52	2.4	P\$	1580
95-2428BB	Veneer						W\$	2170
95-2428BB	Veneer/TFL						C\$	2430
<i>Middle Block Base - Required for Tops 144”W or Larger</i>								
96-2428MSL	HPL	24	7½	28	72	2.8	P\$	1930
95-2428MSL	Veneer						W\$	2511
95-2428MSL	Veneer/TFL						C\$	2859

Description

- All Tops Require Two (2) Block Bases; Tables 144”W or Larger Also Require Middle Block Base
- Bases are Constructed with Removable Interior Panel for Wire Management Installation
- Block Bases Feature Horizontal Grain Direction on Primary Panels and Vertical Grain on Accent Panels
- Block Base Outer Accent Panel can be Specified in a Contrasting Finish/Color from Top Finish/Color
- Middle Base Feature Horizontal Grain Direction on Primary Panels and Vertical Grain on Accent Panels Adjustable Glides Included

Must Specify (in this order):

- Standard Base Model #
- Primary Finish/Color
- Accent Material
- Accent Finish/Color
- Middle Base Model # (If needed)
- Middle Base Primary Finish/Color
- Middle Base Accent Material
- Middle Base Accent Finish/Color

P = HPL W = Veneer C = Combination of Wood/TFL Accent

[See One10 Overview For Ordering Options](#)

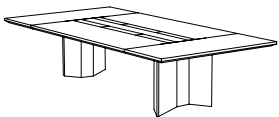
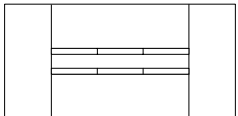
Item	Model No.		W	D	H	Ship Wt	Cubic Ft	List Price	
STANDARD TABLES		60"D Tops							
		<i>192"W: 9 Piece Top - 12 Accent Doors</i>							
RECTANGULAR TOP CENTER INLAY KNIFE EDGE BLADE BASE	96-60192RTK5	HPL	192	60	1 3/16	435	25.3	P\$ 18248	
	95-60192RTK5	Veneer						W\$ 21563	
	95-60192RTK5	Veneer/HPL						C\$ 21930	
		<i>168"W: 9 Piece Top - 8 Accent Doors</i>							
	96-60168RTK5	HPL	168	60	1 3/16	407	24.9	P\$ 16517	
	95-60168RTK5	Veneer						W\$ 19169	
	95-60168RTK5	Veneer/HPL						C\$ 19689	
		<i>144"W: 9 Piece Top - 8 Accent Doors</i>							
	96-60144RTK5	HPL	144	60	1 3/16	379	24.4	P\$ 15856	
	95-60144RTK5	Veneer						W\$ 18202	
	95-60144RTK5	Veneer/HPL						C\$ 18687	
		<i>120"W: 5 Piece Top - 6 Accent Doors</i>							
	96-60120RTK5	HPL	120	60	1 3/16	339	24.0	P\$ 10332	
	95-60120RTK5	Veneer						W\$ 12233	
	95-60120RTK5	Veneer/HPL						C\$ 12420	
		<i>108"W: 5 Piece Top - 6 Accent Doors</i>							
<u>Must Specify (in this order):</u> Model # Primary Finish/Color Accent Material Accent Finish/Color	96-60108RTK5	HPL	108	60	1 3/16	310	23.6	P\$ 10032	
	95-60108RTK5	Veneer						W\$ 11805	
	95-60108RTK5	Veneer/HPL						C\$ 11976	
		<i>96"W: 5 Piece Top - 4 Accent Doors</i>							
	96-6096RTK5	HPL	96	60	1 3/16	282	23.0	P\$ 9216	
	95-6096RTK5	Veneer						W\$ 10935	
	95-6096RTK5	Veneer/HPL						C\$ 11236	
		48"D Tops							
		<i>192"W: 9 Piece Top - 12 Accent Doors</i>							
Rectangular Table With Center Inlay also available with a Block Edge and coordinating Block Base.	96-48192RTK5	HPL	192	48	1 3/16	345	23.9	P\$ 16925	
	95-48192RTK5	Veneer						W\$ 19539	
	95-48192RTK5	Veneer/HPL						C\$ 20352	
		<i>168"W: 9 Piece Top - 8 Accent Doors</i>							
See Details.	96-48168RTK5	HPL	168	48	1 3/16	328	23.7	P\$ 15237	
	95-48168RTK5	Veneer						W\$ 16767	
	95-48168RTK5	Veneer/HPL						C\$ 17596	
		<i>144"W: 9 Piece Top - 8 Accent Doors</i>							
	96-48144RTK5	HPL	144	48	1 3/16	311	23.4	P\$ 14674	
	95-48144RTK5	Veneer						W\$ 16181	
	95-48144RTK5	Veneer/HPL						C\$ 16994	
		<i>120"W: 5 Piece Top - 6 Accent Doors</i>							
	96-48120RTK5	HPL	120	48	1 3/16	282	23.2	P\$ 9511	
	95-48120RTK5	Veneer						W\$ 10845	
	95-48120RTK5	Veneer/HPL						C\$ 11289	
		<i>108"W: 5 Piece Top - 6 Accent Doors</i>							
	96-48108RTK5	HPL	108	48	1 3/16	260	22.8	P\$ 9204	
	95-48108RTK5	Veneer						W\$ 10530	
	95-48108RTK5	Veneer/HPL						C\$ 10957	
		<i>96"W: 5 Piece Top - 4 Accent Doors</i>							
	96-4896RTK5	HPL	96	48	1 3/16	237	23.0	P\$ 8450	
	95-4896RTK5	Veneer						W\$ 9269	
	95-4896RTK5	Veneer/HPL						C\$ 9733	

Continued on next page.

P = HPL W = Veneer C = Combination of Wood/HPL

[See One10 Overview For Ordering Options](#)

Item	Model No.	W	D	H	Ship Wt	Cubic Ft	List Price
------	-----------	---	---	---	---------	----------	------------

Continued from
Previous Page

What You Get:

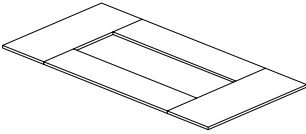

Outer Piece Top

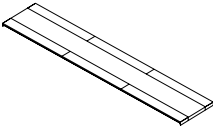

Center Inlay Top

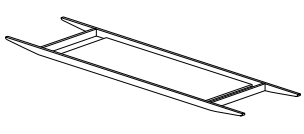

Trough

Description

- 1 $\frac{3}{16}$ " Rectangular Top with Knife Edge
- Veneer Tops Feature UV Finish
- Center Inlay Includes Aluminum Accent Doors for Wire Management
- Center Inlay Available in Contrasting Laminate or Veneer
- Trough Reinforces and Supports Top
- Requires Two (2) Blade Bases; Tables 144"W or Larger Also Require Middle Blade Base; Sold Separately, See Below
- Silver Grommet Included for Optional Polycrom Installation
- Power and Data Options Available; Sold Separately, [See Multiple Power Unit Details](#); [See Location Options](#)
- Assembly Required

Top Grain Direction

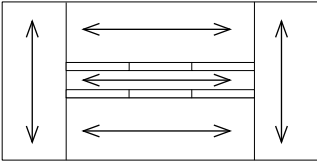

BLADE BASES

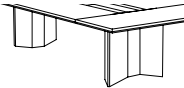

Blade Base Options; Must Order							
<i>Standard Blade Base - Two (2) Required</i>							
96-2828BD	HPL	28	10 $\frac{1}{2}$	28	52	2.4	P\$ 1290
95-2828BD	Veneer						W\$ 1776
<i>Middle Blade Base - Required for Tops 144"W or Larger</i>							
96-2818MBD	Aluminum	18	3 $\frac{7}{8}$	28	72	2.8	\$ 1708
95-2818MBD	Aluminum						\$ 1708

Description

- All Tops Require Two (2) Blade Bases; Tables 144"W or Larger Also Require Middle Blade Base
- Bases are Constructed with Removable Interior Aluminum Panel for Wire Management Installation
- Aluminum Middle Blade Base Features Two (2) Aluminum Doors for Wire Management
- Blade Base Outer Panel Feature Vertical Grain Direction and can be Specified in a Contrasting Finish/Color from Top Finish/Color
- Adjustable Glides Included

Must Specify (in this order):

- Standard Base Model #
- Primary Finish/Color
- Middle Base Model # (If needed)

P = HPL W = Veneer

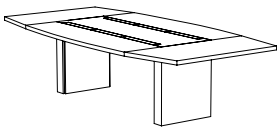
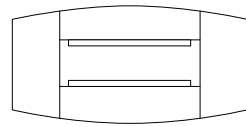
Item	Model No.		W	D	H	Ship Wt	Cubic Ft	List Price	
STANDARD TABLES		60"D Tops							
		<i>192"W: 9 Piece Top - 12 Accent Doors</i>							
BOAT-SHAPED TOP CENTER INLAY BLOCK EDGE BLOCK BASE	96-60192BTV5	HPL	192	60 - 48	1½	435	25.3	P\$ 17103	
	95-60192BTV5	Veneer						W\$ 20215	
	95-60192BTV5	Veneer/HPL						C\$ 20512	
		<i>168"W: 9 Piece Top - 8 Accent Doors</i>							
	96-60168BTV5	HPL	168	60 - 48	1½	407	24.9	P\$ 15486	
	95-60168BTV5	Veneer						W\$ 17972	
	95-60168BTV5	Veneer/HPL						C\$ 18440	
		<i>144"W: 9 Piece Top - 8 Accent Doors</i>							
	96-60144BTV5	HPL	144	60 - 48	1½	379	24.4	P\$ 14867	
	95-60144BTV5	Veneer						W\$ 17062	
	95-60144BTV5	Veneer/HPL						C\$ 17498	
		<i>120"W: 5 Piece Top - 6 Accent Doors</i>							
	96-60120BTV5	HPL	120	60 - 48	1½	339	24.0	P\$ 9689	
	95-60120BTV5	Veneer						W\$ 11469	
	95-60120BTV5	Veneer/HPL						C\$ 11616	
		<i>108"W: 5 Piece Top - 6 Accent Doors</i>							
Must Specify (in this order): Model # Primary Finish/Color Accent Material Accent Finish/Color	96-60108BTV5	HPL	108	60 - 48	1½	310	23.6	P\$ 9407	
	95-60108BTV5	Veneer						W\$ 11071	
	95-60108BTV5	Veneer/HPL						C\$ 11201	
		<i>96"W: 5 Piece Top - 4 Accent Doors</i>							
	96-6096BTV5	HPL	96	60 - 48	1½	282	23.0	P\$ 8640	
	95-6096BTV5	Veneer						W\$ 10253	
	95-6096BTV5	Veneer/HPL						C\$ 10522	
		48"D Tops							
		<i>192"W: 9 Piece Top - 12 Accent Doors</i>							
Boat-Shaped Table With Center Inlay also available with a Knife Edge and coordinating Blade Base.	96-48192BTV5	HPL	192	48 - 36	1½	345	23.9	P\$ 15871	
	95-48192BTV5	Veneer						W\$ 18316	
	95-48192BTV5	Veneer/HPL						C\$ 19091	
		<i>168"W: 9 Piece Top - 8 Accent Doors</i>							
See Details.	96-48168BTV5	HPL	168	48 - 36	1½	328	23.7	P\$ 14284	
	95-48168BTV5	Veneer						W\$ 15716	
	95-48168BTV5	Veneer/HPL						C\$ 16523	
		<i>144"W: 9 Piece Top - 8 Accent Doors</i>							
	96-48144BTV5	HPL	144	48 - 36	1½	311	23.4	P\$ 13756	
	95-48144BTV5	Veneer						W\$ 15169	
	95-48144BTV5	Veneer/HPL						C\$ 15957	
		<i>120"W: 5 Piece Top - 6 Accent Doors</i>							
	96-48120BTV5	HPL	120	48 - 36	1½	282	23.2	P\$ 8915	
	95-48120BTV5	Veneer						W\$ 10167	
	95-48120BTV5	Veneer/HPL						C\$ 10587	
		<i>108"W: 5 Piece Top - 6 Accent Doors</i>							
	96-48108BTV5	HPL	108	48 - 36	1½	260	22.8	P\$ 8631	
	95-48108BTV5	Veneer						W\$ 9872	
	95-48108BTV5	Veneer/HPL						C\$ 10281	
		<i>96"W: 5 Piece Top - 4 Accent Doors</i>							
	96-4896BTV5	HPL	96	48 - 36	1½	237	23.0	P\$ 7922	
	95-4896BTV5	Veneer						W\$ 8692	
	95-4896BTV5	Veneer/HPL						C\$ 9141	

Continued on next page.

P = HPL W = Veneer C = Combination of Wood/HPL

[See One10 Overview For Ordering Options](#)

Item	Model No.	W	D	H	Ship Wt	Cubic Ft	List Price
------	-----------	---	---	---	---------	----------	------------

Continued from Previous Page

What You Get:

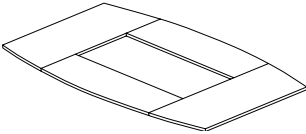

Outer Piece Top

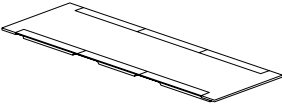

Center Inlay Top

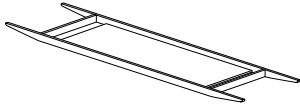

Trough

Description

- 1½” Thick Boat-Shaped Top with Block Edge
- Veneer Tops Feature UV Finish
- Center Inlay Includes Aluminum Accent Doors for Wire Management
- Center Inlay Available in Contrasting Laminate or Veneer
- Trough Reinforces and Supports Top
- Requires Two (2) Block Bases; Tables 144”W or Larger Also Require Middle Block Base; Sold Separately, See Below
- Silver Grommet Included for Optional Polycrom Installation
- Power and Data Options Available; Sold Separately, [See Multiple Power Unit Details](#); [See Location Options](#)
- Assembly Required

Top Grain Direction

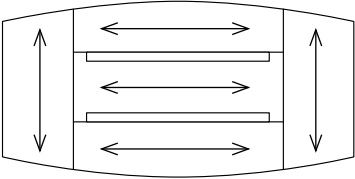

BLOCK BASES

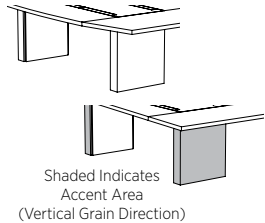

Block Base Options; Must Order							
<i>Standard Block Base - Two (2) Required</i>							
96-2428BB	HPL	24	6	28	52	2.4	P\$ 1580
95-2428BB	Veneer						W\$ 2170
95-2428BB	Veneer/TFL						C\$ 2430
<i>Middle Block Base - Required for Tops 144”W or Larger</i>							
96-2428MSL	HPL	24	7½	28	72	2.8	P\$ 1930
95-2428MSL	Veneer						W\$ 2511
95-2428MSL	Veneer/TFL						C\$ 2859

Must Specify (in this order):

- Standard Base Model #
- Primary Finish/Color
- Accent Material
- Accent Finish/Color
- Middle Base Model # (If needed)
- Middle Base Primary Finish/Color
- Middle Base Accent Material
- Middle Base Accent Finish/Color

Description

- All Tops Require Two (2) Block Bases; Tables 144”W or Larger Also Require Middle Block Base
- Bases are Constructed with Removable Interior Panel for Wire Management Installation
- Block Bases Feature Horizontal Grain Direction on Primary Panels and Vertical Grain on Accent Panels
- Block Base Outer Accent Panel can be Specified in a Contrasting Finish/Color from Top Finish/Color
- Middle Base Feature Horizontal Grain Direction on Primary Panels and Vertical Grain on AccentAdjustable Glides Included

P = HPL W = Veneer C = Combination of Wood/TFL Accent

[See One10 Overview For Ordering Options](#)

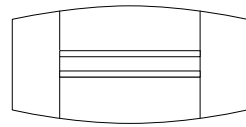
Item	Model No.		W	D	H	Ship Wt	Cubic Ft	List Price	
STANDARD TABLES		60"D Tops							
		<i>192"W: 9 Piece Top - 12 Accent Doors</i>							
BOAT-SHAPED TOP CENTER INLAY KNIFE EDGE BLADE BASE	96-60192BTK5	HPL	192	60 - 48	1 3/16	435	25.3	P\$ 19158	
	95-60192BTK5	Veneer						W\$ 22640	
	95-60192BTK5	Veneer/HPL						C\$ 23024	
		<i>168"W: 9 Piece Top - 8 Accent Doors</i>							
	96-60168BTK5	HPL	168	60 - 48	1 3/16	407	24.9	P\$ 17341	
	95-60168BTK5	Veneer						W\$ 20128	
	95-60168BTK5	Veneer/HPL						C\$ 20674	
		<i>144"W: 9 Piece Top - 8 Accent Doors</i>							
	96-60144BTK5	HPL	144	60 - 48	1 3/16	379	24.4	P\$ 16650	
	95-60144BTK5	Veneer						W\$ 19111	
	95-60144BTK5	Veneer/HPL						C\$ 19623	
		<i>120"W: 5 Piece Top - 6 Accent Doors</i>							
	96-60120BTK5	HPL	120	60 - 48	1 3/16	339	24.0	P\$ 10850	
	95-60120BTK5	Veneer						W\$ 12843	
	95-60120BTK5	Veneer/HPL						C\$ 13041	
		<i>108"W: 5 Piece Top - 6 Accent Doors</i>							
<u>Must Specify (in this order):</u> Model # Primary Finish/Color Accent Material Accent Finish/Color	96-60108BTK5	HPL	108	60 - 48	1 3/16	310	23.6	P\$ 10535	
	95-60108BTK5	Veneer						W\$ 12398	
	95-60108BTK5	Veneer/HPL						C\$ 12576	
		<i>96"W: 5 Piece Top - 4 Accent Doors</i>							
	96-6096BTK5	HPL	96	60 - 48	1 3/16	282	23.0	P\$ 9678	
	95-6096BTK5	Veneer						W\$ 11482	
	95-6096BTK5	Veneer/HPL						C\$ 11797	
		48"D Tops							
		<i>192"W: 9 Piece Top - 12 Accent Doors</i>							
Boat-Shaped Table With Center Inlay also available with a Block Edge and coordinating Block Base.	96-48192BTK5	HPL	192	48 - 36	1 3/16	345	23.9	P\$ 17775	
	95-48192BTK5	Veneer						W\$ 20518	
	95-48192BTK5	Veneer/HPL						C\$ 21371	
		<i>168"W: 9 Piece Top - 8 Accent Doors</i>							
See Details.	96-48168BTK5	HPL	168	48 - 36	1 3/16	328	23.7	P\$ 15998	
	95-48168BTK5	Veneer						W\$ 17604	
	95-48168BTK5	Veneer/HPL						C\$ 18474	
		<i>144"W: 9 Piece Top - 8 Accent Doors</i>							
	96-48144BTK5	HPL	144	48 - 36	1 3/16	311	23.4	P\$ 15405	
	95-48144BTK5	Veneer						W\$ 16994	
	95-48144BTK5	Veneer/HPL						C\$ 17844	
		<i>120"W: 5 Piece Top - 6 Accent Doors</i>							
	96-48120BTK5	HPL	120	48 - 36	1 3/16	282	23.2	P\$ 9987	
	95-48120BTK5	Veneer						W\$ 11387	
	95-48120BTK5	Veneer/HPL						C\$ 11854	
		<i>108"W: 5 Piece Top - 6 Accent Doors</i>							
	96-48108BTK5	HPL	108	48 - 36	1 3/16	260	22.8	P\$ 9667	
	95-48108BTK5	Veneer						W\$ 11056	
	95-48108BTK5	Veneer/HPL						C\$ 11507	
		<i>96"W: 5 Piece Top - 4 Accent Doors</i>							
	96-4896BTK5	HPL	96	48 - 36	1 3/16	237	23.0	P\$ 8870	
	95-4896BTK5	Veneer						W\$ 9731	
	95-4896BTK5	Veneer/HPL						C\$ 10219	

Continued on next page.

P = HPL W = Veneer C = Combination of Wood/HPL

[See One10 Overview For Ordering Options](#)

Item	Model No.	W	D	H	Ship Wt	Cubic Ft	List Price
------	-----------	---	---	---	---------	----------	------------

Continued from
Previous Page

What You Get:

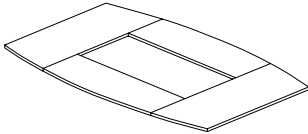

Outer Piece Top

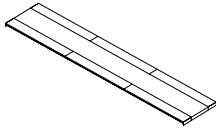

Center Inlay Top

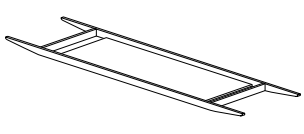

Trough

Description

- 1 $\frac{3}{16}$ " Boat-Shaped Top with Knife Edge
- Veneer Tops Feature UV Finish
- Center Inlay Includes Aluminum Accent Doors for Wire Management
- Center Inlay Available in Contrasting Laminate or Veneer
- Trough Reinforces and Supports Top
- Requires Two (2) Blade Bases; Tables 144"W or Larger Also Require Middle Blade Base; Sold Separately, See Below
- Silver Grommet Included for Optional Polycrom Installation
- Power and Data Options Available; Sold Separately, [See Multiple Power Unit Details](#); [See Location Options](#)
- Assembly Required

Top Grain Direction

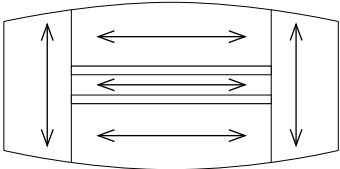

BLADE BASES

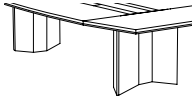

Blade Base Options; Must Order							
<i>Standard Blade Base - Two (2) Required</i>							
96-2828BD	HPL	28	10 $\frac{1}{2}$	28	52	2.4	P\$ 1290
95-2828BD	Veneer						W\$ 1776
<i>Middle Blade Base - Required for Tops 144"W or Larger</i>							
96-2818MBD	Aluminum	18	3 $\frac{7}{8}$	28	72	2.8	\$ 1708
95-2818MBD	Aluminum						\$ 1708

Description

- All Tops Require Two (2) Blade Bases; Tables 144"W or Larger Also Require Middle Blade Base
- Bases are Constructed with Removable Aluminum Interior Panel for Wire Management Installation
- Aluminum Middle Blade Base Features Two (2) Aluminum Doors for Wire Management
- Blade Base Outer Panel Feature Vertical Grain Direction and can be Specified in a Contrasting Finish/Color from Top Finish/Color
- Adjustable Glides Included

Must Specify (in this order):
Standard Base Model #
Primary Finish/Color
Middle Base Model # (If needed)

P = HPL W = Veneer

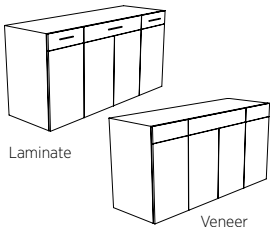
Item	Model No.		W	D	H	Ship Wt	Cubic Ft	List Price	
BUFFET WITH DRAWERS									
	4 DOORS & 3 DRAWERS								
	96-2460BF2	HPL	60	24	36	275	34.2	P\$	6095
	95-2460BF2	Veneer						W\$	7757
	4 DOORS & 2 DRAWERS								
	96-2460BF1	HPL	60	24	36	275	34.2	P\$	5290
	95-2460BF1	Veneer						W\$	6689
2 DOORS & 1 DRAWER									
96-2430BF	HPL	30	24	36	150	17.6	P\$	2785	
95-2430BF	Veneer						W\$	3624	

Description

- Standard with: Touch Latch Doors, Vertical Grain Direction, Finished Back, Adjustable Glides
- Laminate Unit features Aluminum Beam Pull on Drawers While Veneer Unit Features Finger Pull
- Storage Behind Doors with Adjustable Shelves (Shelves will Match Material Specified)

Must Specify (in this order):

Model #
Finish/Color

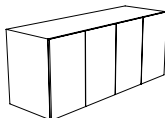
Item	Model No.		W	D	H	Ship Wt	Cubic Ft	List Price	
CREDENZA									
	4 DOORS								
	96-2472C	HPL	72	24	30	290	28.0	P\$	4756
	95-2472C	Veneer						W\$	6453
	96-2460C	HPL	60	24	30	250	23.4	P\$	4444
	95-2460C	Veneer						W\$	5688
	3 DOORS								
	96-2448C	HPL	48	24	30	210	19.5	P\$	3264
	95-2448C	Veneer						W\$	4311
	2 DOORS								
	96-2436C	HPL	36	24	30	150	17.6	P\$	2441
95-2436C	Veneer						W\$	3289	

Description

- Standard with: Vertical Grain Direction, Finished Back, Adjustable Glides
- Touch Latch Doors, Veneer Units Also Feature Finger Pulls
- Storage Behind Doors with Adjustable Shelves

Must Specify (in this order):

Model #
Finish/Color

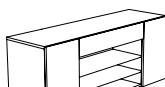
Item	Model No.		W	D	H	Ship Wt	Cubic Ft	List Price	
MEDIA CREDENZA									
	96-1872OMC	HPL	72	18	36	175	24.0	P\$	4422
	95-1872OMC	Veneer						W\$	5679
	96-1860OMC	HPL	60	18	36	155	19.5	P\$	4083
	95-1860OMC	Veneer						W\$	5142

Description

- Standard with: Vertical Grain Direction, Adjustable Glides
- Touch Latch Closure; Veneer Units Also Feature Finger Pulls
- Storage Behind Two (2) Doors with Adjustable Laminate Shelves
- Open Storage with Two (2) Adjustable Metal Shelves in Middle Section Below Flip Down Door
- Flip Down Door (Does Not Feature Soft Close Hinges)
- Finished Back is Recessed and Open 2" Below Worksurface for Wire Management

Must Specify (in this order):

Model #
Finish/Color

P = HPL W = Veneer

[See One10 Overview For Ordering Options](#)

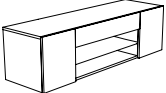
Item	Model No.		W	D	H	Ship Wt	Cubic Ft	List Price	
	96-1872LOMC	HPL	72	18	24	145	24.0	P\$	4061
	95-1872LOMC	Veneer						W\$	5295
	96-1860LOMC	HPL	60	18	24	125	19.5	P\$	3799
	95-1860LOMC	Veneer						W\$	4848

Description

- Standard with: Vertical Grain Direction, Adjustable Glides
- Touch Latch Doors; Veneer Units Also Feature Finger Pulls
- Storage Behind Two (2) Doors with Adjustable Veneer Shelves
- Open Storage with Adjustable Metal Shelf in Middle Section Below Flip Down Door
- Flip Down Door (Does Not Feature Soft Close Hinges)
- Finished Back is Recessed and Open 2" Below Worksurface for Wire Management

Must Specify (in this order):

Model #
Finish/Color

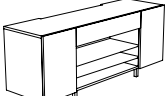
Item	Model No.		W	D	H	Ship Wt	Cubic Ft	List Price	
	96-1872FMC	HPL	72	18	36	175	24.0	P\$	4256
	95-1872FMC	Veneer						W\$	5586
	96-1860FMC	HPL	60	18	36	155	19.5	P\$	4019
	95-1860FMC	Veneer						W\$	5152

Description

- Standard with: Vertical Grain Direction, Aluminum Post Legs with Adjustable Glides
- Touch Latch Doors; Veneer Units Also Feature Finger Pulls
- Storage Behind Two (2) Doors with Adjustable Shelves (Shelves will Match Material Specified)
- Open Storage with Two (2) Adjustable Metal Shelves in Middle Section Below Flip Down Door
- Flip Down Door (Does Not Feature Soft Close Hinges)
- Finished Back is Recessed and Open 2" Below Worksurface for Wire Management
- Top is Routed to Accommodate Wire Management or Flat Panel Monitor Stand ([See Flat Panel Monitor Stand](#))
- Doors are Hinged from the Inside of the Cabinet and Swing in to Accommodate the Meeting Table

Must Specify (in this order):

Model #
Finish/Color

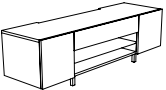
Item	Model No.		W	D	H	Ship Wt	Cubic Ft	List Price	
	96-1872LFMC	HPL	72	18	24	145	24.0	P\$	3782
	95-1872LFMC	Veneer						W\$	4652
	96-1860LFMC	HPL						P\$	3584
	95-1860LFMC	Veneer	60	18	24	125	19.5	W\$	4377

Description

- Standard with: Vertical Grain Direction, Aluminum Post Legs with Adjustable Glides
- Storage Behind Two (2) Doors with Adjustable Shelves (Shelves will Match Material Specified)
- Open Storage with Adjustable Metal Shelf in Middle Section Below Flip Down Door
- Flip Down Door (Does Not Feature Soft Close Hinges)
- Finished Back is Recessed and Open 2" Below Worksurface for Wire Management
- Top is Routed to Accommodate Wire Management or Flat Panel Monitor Stand ([See Flat Panel Monitor Stand](#))
- Touch Latch Doors; Veneer Units Also Feature Finger Pulls
- Doors are Hinged from the Inside of the Cabinet and Swing in to Accommodate the Meeting Table

Must Specify (in this order):

Model #
Finish/Color

P = HPL W = Veneer

[See One10 Overview For Ordering Options](#)

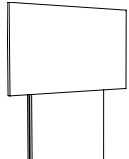
Item	Model No.		W	D	H	Ship Wt	Cubic Ft	List Price	
FLAT PANEL MONITOR STAND  Shown with Monitor (Not Included)	COORDINATES WITH ≥60" MEETING TABLES 42" TALL AND FOOTED MEDIA CRENZAS 36"H								
	96-3067FP	HPL	30½	14	67½	140	16.7	P\$	2238
	95-3067FP	Veneer						W\$	2808
	COORDINATES WITH ≥60" MEETING TABLES 42" TALL AND LOW FOOTED MEDIA CRENZAS 24"H								
	96-3055FP	HPL	30½	14	55½	123	13.8	P\$	2048
	95-3055FP	Veneer						W\$	2522

Description

- Standard with: Vertical Grain Direction, Aluminum Metal Base
- Not Freestanding; Must be Used with a Coordinating Product
- Finished Back is Removable for Wire Management
- Accommodates 200, 300, and 400mm VESA Patterns
- Check the Monitor Manufacturer's Specifications for Compliance
- Mounting Hardware Not Included
- Not Responsible for Monitors Improperly Installed or Any Attempt To Use As A Freestanding Unit

Must Specify (in this order):

- Model #
- Finish/Color

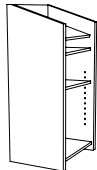
LECTERN STAND 	96-2650LS	HPL	24	23	49	130	21.9	P\$	1920
	95-2650LS	Veneer						W\$	3219

Description

- Standard with: Vertical Grain Direction, Two (2) Fixed Shelves and One (1) Adjustable Shelf, Two (2) Locking and Two (2) Non-Locking Casters, Top Fixed Shelf Angled for User Comfort
- Wire Management Grommet on Second and Bottom Shelf, Middle Shelf Features Wire Management Grommet Cut Out

Must Specify (in this order):

- Model #
- Finish/Color

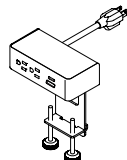
DUO CLAMP WITH NEMA PLUG 	01-DUOCLAMPW	White	5½	3	7	1	0.2	\$	572
	01-DUOCLAMPB	Black							
	01-DUOCLAMPS	Silver							

Description

- Clamps to Table Top and Includes: Two (2) Power, **One (1) USB Charging Port and One (1) 60-Watt USB-C Power Delivery Port with GaN Technology with 10' Cord**, and All Mounting Hardware
- Silver Metal Trim on All Color Options
- Independent USB Circuit Controllers Deliver up to 2.1 Amps to Each Post
- FCC Part 15A, UL Recognized for Horizontal and Vertical Applications

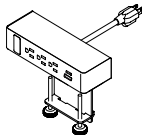
TRIO CLAMP WITH NEMA PLUG 	01-TRIOCLAMPW	White	8	3	7	1	0.2	\$	671
	01-TRIOCLAMPB	Black							
	01-TRIOCLAMPS	Silver							

Description

- Clamps to Table Top and Includes: Three (3) Power Outlets, **One (1) USB Charging Port, One (1) 60-Watt USB-C Power Delivery Port with GaN Technology, One (1) Open Data Port, 10' Cord**, and All Mounting Hardware
- HDMI, VGA, and RJ45 Accessories for Open Data Port; Sold Separately, [See Accessories](#)
- Silver Metal Trim on All Color Options
- Independent USB Circuit Controllers Deliver up to 2.1 Amps to Each Post
- FCC Part 15A, UL Recognized for Horizontal and Vertical Applications

P = HPL W = Veneer

[See One10 Overview For Ordering Options](#)

Item	Model No.		W	D	H	Ship Wt	Cubic Ft	List Price
DUO BEZEL WITH NEMA PLUG	01-DUOBEZELW	White	6½	2¼	3¼	1	0.2	\$ 675
	01-DUOBEZELB	Black						
	01-DUOBEZELS	Silver						

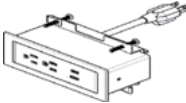

Description

- Sits on Table Top and Includes: Two (2) Power, **One (1) USB Charging Port and One (1) 60-Watt USB-C Power Delivery Port with GaN Technology with 10' Cord**, and All Mounting Hardware
- Independent USB Circuit Controllers Deliver up to 2.1 Amps to Each Post
- FCC Part 15A, UL Recognized for Horizontal and Vertical Applications
- Works with One10 Small Meeting Tables, Standard Tables, and Single Column Meeting Tables

TRIO BEZEL WITH NEMA PLUG	01-TRIOBEZELW	White	9	2¼	3	1	0.2	\$ 725
	01-TRIOBEZELB	Black						
	01-TRIOBEZELS	Silver						

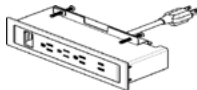

Description

- Sits on Table Top and Includes: Three (3) Power Outlets, **One (1) USB Charging Port, One (1) 60-Watt USB-C Power Delivery Port with GaN Technology**, One (1) Open Data Port, 10' Cord, and All Mounting Hardware
- HDMI, VGA, and RJ45 Accessories for Open Data Port; Sold Separately, [See Accessories](#)
- Independent USB Circuit Controllers Deliver up to 2.1 Amps to Each Post
- FCC Part 15A, UL Recognized for Horizontal and Vertical Applications
- Works with One10 Small Meeting Tables, Standard Tables, and Single Column Meeting Tables

DUO WITH NEMA PLUG	01-DUOW	White	5½	2	3¼	1	0.2	\$ 711
	01-DUOB	Black						
	01-DUOS	Silver						

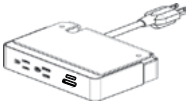

Description

- Sits Between Worksurfaces or Below the Worksurface and Includes: Two (2) Power, **One (1) USB Charging Port and One (1) 60-Watt USB-C Power Delivery Port with GaN Technology with 10' Cord**, and All Mounting Hardware
- Independent USB Circuit Controllers Deliver up to 2.1 Amps to Each Post
- FCC Part 15A, UL Recognized for Horizontal and Vertical Applications
- Works with One10 Small Meeting Tables and Standard Tables with Center Inlay

TRIO WITH NEMA PLUG	01-TRIOW	White	8	2	3	1	0.2	\$ 733
	01-TRIOB	Black						
	01-TRIOS	Silver						



Description

- Sits Between Worksurfaces or Below the Worksurface and Includes: Three (3) Power Outlets, **One (1) USB Charging Port, One (1) 60-Watt USB-C Power Delivery Port with GaN Technology**, One (1) Open Data Port, 10' Cord, and All Mounting Hardware
- HDMI, VGA, and RJ45 Accessories for Open Data Port; Sold Separately, [See Accessories](#)
- Independent USB Circuit Controllers Deliver up to 2.1 Amps to Each Post
- FCC Part 15A, UL Recognized for Horizontal and Vertical Applications
- Works with One10 Small Meeting Tables and Standard Tables with Center Inlay

Item	Model No.		W	D	H	Ship Wt	Cubic Ft	List Price
DUO BEZEL WITH DAISY CHAIN PLUG	01-PDUOBEZELW	White	6½	2½	3	1	0.2	\$ 668
	01-PDUOBEZELB	Black						
	01-PDUOBEZELS	Silver						

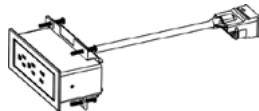

Description

- Sits on Table Top and Includes: Two (2) Power, **One (1) USB Charging Port and One (1) 60-Watt USB-C Power Delivery Port with GaN Technology with 12" Cord**, and All Mounting Hardware
- Requires Daisy Chain Power Box; Sold Separately, [See Power Box Details](#)
- Non-Sequential System Allows up to Eight (8) Modules to be Connected with Jumper Cord, [See Jumper Cord Details](#)
- Independent USB Circuit Controllers Deliver up to 2.1 Amps to Each Post
- FCC Part 15A, RU Listed and UL Recognized for Horizontal and Vertical Applications
- Works with One10 Small Meeting Tables, Standard Tables, and Single Column Meeting Tables

TRIO BEZEL WITH DAISY CHAIN PLUG	01-PTRIOBEZELW	White	9	2½	3	1	0.2	\$ 715
	01-PTRIOBEZELB	Black						
	01-PTRIOBEZELS	Silver						

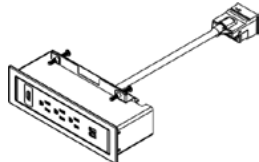

Description

- Sits on Table Top and Includes: Three (3) Power Outlets, **One (1) USB Charging Port, One (1) 60-Watt USB-C Power Delivery Port with GaN Technology**, One (1) Open Data Port, 12" Cord, and All Mounting Hardware
- HDMI, VGA, or RJ45 Accessory for Open Data Port; Sold Separately, [See Accessories](#)
- Requires Daisy Chain Power Box, Specified Separately, See Next Page
- Non-Sequential System Allows up to Eight (8) Modules to be Connected with Jumper Cord, [See Jumper Cord Details](#)
- Independent USB Circuit Controllers Deliver up to 2.1 Amps to Each Post
- FCC Part 15A, RU Listed and UL Recognized for Horizontal and Vertical Applications
- Works with One10 Small Meeting Tables, Standard Tables, and Single Column Meeting Tables

DUO WITH DAISY CHAIN PLUG	01-PDUOW	White	5½	2	3	1	0.2	\$ 705
	01-PDUOB	Black						
	01-PDUOS	Silver						

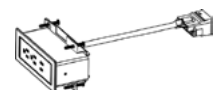

Description

- Sits Between Worksurfaces or Below the Worksurface and Includes: Two (2) Power, **One (1) USB Charging Port and One (1) 60-Watt USB-C Power Delivery Port with GaN Technology with 12" Cord**, and All Mounting Hardware
- Requires Daisy Chain Power Box; Sold Separately, [See Power Box Details](#)
- Non-Sequential System Allows up to Eight (8) Modules to be Connected with Jumper Cord, [See Jumper Cord Details](#)
- Independent USB Circuit Controllers Deliver up to 2.1 Amps to Each Post
- FCC Part 15A, RU Listed and UL Recognized for Horizontal and Vertical Applications
- Works with One10 Small Meeting Tables and Standard Tables with Center Inlay

[See One10 Overview For Ordering Options](#)

Item	Model No.		W	D	H	Ship Wt	Cubic Ft	List Price
TRIO WITH DAISY CHAIN PLUG	01-PTRIOW	White	8	2	3	1	0.2	\$ 725
	01-PTRIOB	Black						
	01-PTRIOS	Silver						

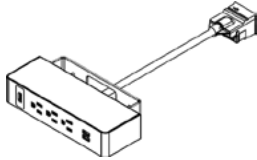

Description

- Sits on Table Top and Includes: Three (3) Power Outlets, **One (1) USB Charging Port, One (1) 60-Watt USB-C Power Delivery Port with GaN Technology**, One (1) Open Data Port, 12" Cord, and All Mounting Hardware
- HDMI, VGA, or RJ45 Accessory for Open Data Port; Sold Separately, See Accessories Below
- Requires Daisy Chain Power Box; Sold Separately, See Details Below
- Non-Sequential System Allows up to Eight (8) Modules to be Connected with Jumper Cord, [See Jumper Cord Details](#)
- Independent USB Circuit Controllers Deliver up to 2.1 Amps to Each Post
- FCC Part 15A, RU Listed and UL Recognized for Horizontal and Vertical Applications
- Works with One10 Small Meeting Tables and Standard Tables with Center Inlay

HDMI DATA PORT ACCESSORY	01-LCOMHDMI		-	-	-	1	0.2	\$ 166
--------------------------	-------------	--	---	---	---	---	-----	--------

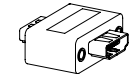

OPEN MARKET ONLY

Description

- HDMI Port for Trio, Trio Clamp and Trio Bezel Units

VGA DATA PORT ACCESSORY	01-LCOMVGA		-	-	-	1	0.2	\$ 121
-------------------------	------------	--	---	---	---	---	-----	--------

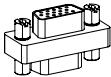

Description

- VGA Port for Trio, Trio Clamp and Trio Bezel Units

RJ45 DATA PORT ACCESSORY	01-LCOMRJ45		-	-	-	1	0.2	\$ 79
--------------------------	-------------	--	---	---	---	---	-----	-------

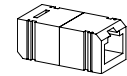

Description

- RJ45 Port for Trio, Trio Clamp and Trio Bezel Units

DAISY CHAIN POWER BOX	01-PPOWER		-	-	-	1	0.2	\$ 775
		<i>76" Perimeter, 36" Power Cord</i>						
	01-PPOWER2		-	-	-	1	0.2	\$ 796
		<i>24" Perimeter, 144" Power Cord</i>						

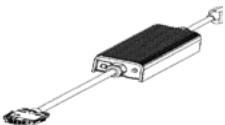

Description

- Powers up to Eight (8) Duo and Trio Daisy Chain Units
- One Nema Plug and One Daisy Chain Plug
- 12-Amp System Rating
- 15-Amp Over-Current Protection

[See One10 Overview For Ordering Options](#)

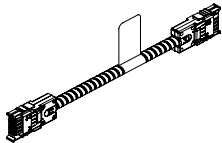
Item	Model No.		W	D	H	Ship Wt	Cubic Ft	List Price
DAISY CHAIN JUMPER CORD 	01-6JUMP	72" Long	-	-	-	1	0.2	\$ 299
	01-5JUMP	60" Long	-	-	-	1	0.2	\$ 284
	01-4JUMP	48" Long	-	-	-	1	0.2	\$ 240
	01-2JUMP	24" Long	-	-	-	1	0.2	\$ 220

Description

- Connects Duo and Trio Daisy Chain Units
- Non-Sequential System Allows up to Eight (8) Modules to be Connected

WIRE MANAGERS	01-WMGR4		16	1½	¾	1	-	\$ 116
---------------	----------	--	----	----	---	---	---	--------

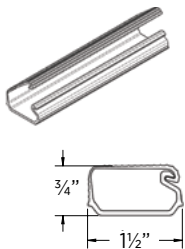
**Description**

- Four (4) Wire Manager Strips
- Black Plastic
- Snap Lock Channel
- Attaches with Adhesive Strips
- Can be Placed on All Units to Route Wires

CABLE GRIP	01-WMGRCB		5⅞	2⅝	-	-	-	\$ 17
------------	-----------	--	----	----	---	---	---	-------

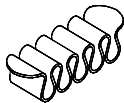
**Description**

- Under Surface Wire Management
- Black

POWER STRIP	01-PRSP		9	2	2	1	-	\$ 205
-------------	---------	--	---	---	---	---	---	--------

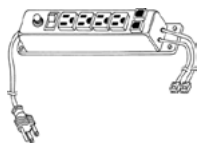
**Description**

- Includes Four (4) Outlets and Two (2) Phone Jacks
- Black Plastic with Rocker On/Off Switch
- 13 Amp Circuit Breaker
- 10' Power Cord and Two (2) 14' Phone Hook Up Cords
- UL and CSA Recognized
- Suitable for Surface or Recessed Mounting
- Ships via UPS Only

VESTA POWER CENTER	01-PDCTR		10¾	12	28¼	14	2.5	\$ 1776
--------------------	----------	--	-----	----	-----	----	-----	---------

**Description**

- Top Includes One (1) Power Outlet, Two (2) USB Ports and One (1) USBC Port; Base Includes Three (3) Outlet
- Available in White
- 120" Power Cord
- Built with Weight Distribution for Optimal Stability
- Base is 5" Tall

[See One10 Overview For Ordering Options](#)

FLUSH FEATURE OPTION

Select units feature multiple flush options allowing units to be placed next to each other. See specific units for details. Must specify when placing ordering.

- FL Flush Left
- FR Flush Right
- FLR Flush Left and Right

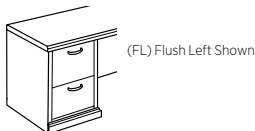

PULL OPTIONS

Note: Lock Core will match Pull Color

- | | |
|----------------------|----------------------|
| AAC Arc, Aluminum | AEL Elite, Aluminum |
| BAC Arc, Black | BEL Elite, Black |
| ABM Beam, Aluminum | AFL Flair, Aluminum |
| BBM Beam, Black | CFL Flair, Chrome |
| BBT Bow Tie, Black | AFC Focus, Aluminum |
| NBT Bow Tie, Nickel | BFC Focus, Black |
| ABU Buckle, Aluminum | AQD Quadra, Aluminum |
| BBU Buckle, Black | BQD Quadra, Black |



TABLE GROMMET & POWER UNIT OPTIONS

Power units and grommets are sold separately and must be specified separately with surface mount location. Multiple locations may be selected. Only one unit per location.

Power units and Grommets Available in Table Surfaces (See Units)

Grommet Specify Color: Black = BLK and Silver = SLV

DUO/TRIO BEZEL

- 01-DUOBEZEL Available in Black (B), Silver (S), or White (W)
- 01-TRIOBEZEL Available in Black (B), Silver (S), or White (W)

DOCK 950, DOCK 800 and DOCK 150

- DOCK950 Available in Black or White
- DOCK150 Available in Black or White
- DOCK800 Available in Black or Silver

Other Power Units

- DPORT4 Available in Aluminum or Black
- INTERACTG Available in Aluminum or Black
- OASISM Available in Aluminum or Black

TABLE GROMMET & POWER UNIT OPTIONS CONTINUED

Power/Data Location Information:

- Designate unit and location when specifying the top model. Power/Data Module need to be ordered separately.
- Power/Data Modules specified at the time of order will be routed for field installation.
 - E1 Unit on One End
 - E2 Unit on Each End
 - OC Unit on Center

- All power units available **On Center (OC) only** when paired with two (2) or more of the following bases:

- Cylinder Base Square Base
- X-Base Disc
- Tubular X-Base

Grommets and Power Units may be ordered in non-standard locations. Call Customer Service to assist with specification and/or please attach a drawing to the PO showing the location of the grommet. Note additional charges and lead times may apply.

Top Locations

Power units available on Each End (E1 and E2) and On Center (OC) unless otherwise noted, when paired with any Rectangle Panel Base, Rectangle Box Base or Rectangle Accent Box Base. (See Unit Details)

Power units centered at locations below:

- 36" Tops centered 18"D 48" Tops centered 24"D
- 42" Tops centered 21"D

- 72: OC 36" from end (available with OC Only)
- 96: OC 48" from end; E1/E2 29" from end
- 120: OC 60" from end; E1/E2 29" from end
- 144: OC 72" from end; E1/E2 29" from end

LOCKING DOORS

Locking doors are available on Wardrobes. You must specify WITH LOCKING when ordering and add upcharge.

- | | | | |
|--------|-------------------|----|----|
| LKT_HU | 36"W - 30"W Units | \$ | 91 |
| LKT_HU | 18"W Units | \$ | 69 |

LOCK CORE OPTIONS

Lock core will coordinate with pull color unless otherwise noted.

- BLK Black
- SLV Silver



CERTIFICATIONS & COMPLIANCE

- Intertek Sustainability Certified
- BIFMA level® Certified
- BIFMA Compliant Certified
- TSCA Title VI (formerly CARB) Compliance
- US Green Building's LEED Contribution

Tops and Bases



Round Tops
[\(See Details\)](#)



Rectangle Tops
[\(See Details\)](#)



Boat Tops
[\(See Details\)](#)

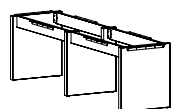

Rectangular Panel
Bases with Trough
[\(See Details\)](#)

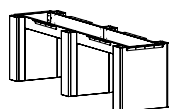

6" Rectangular Bases
with Trough
[\(See Details\)](#)

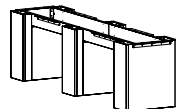

10" Rectangular
Bases with Trough
[\(See Details\)](#)

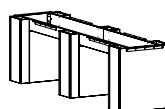

6" Rectangular Accent
Bases with Trough
[\(See Details\)](#)

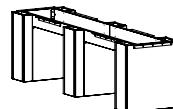

10" Rectangular Accent
Bases with Trough
[\(See Details\)](#)

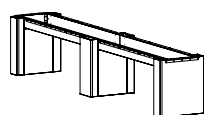

6" + 10" Combo Rectangular
Bases with Trough
[\(See Details\)](#)

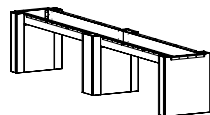

6" + 10" Combo Rectangular
Accent Bases with Trough
[\(See Details\)](#)



Disc Bases
[\(See Details\)](#)

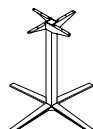

Small and Large X
Bases [\(See Details\)](#)

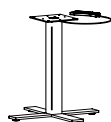

HA Pneumatic X
[\(See Details\)](#)



Metal Bases
[\(See Details\)](#)

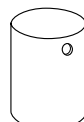

Cylinder
[\(See Details\)](#)



Queen Anne
[\(See Details\)](#)

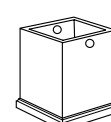

Square
[\(See Details\)](#)

Storage Components

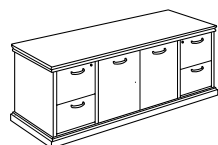

Storage Credenzas
[\(See Details\)](#)

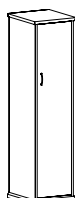

Wardrobe/Storage
[\(See Details\)](#)

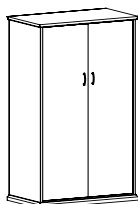

Double Wardrobe/ Storage
[\(See Details\)](#)

Wire Management & Power/Data Accessories

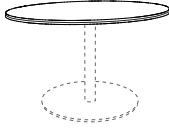

For additional solutions for desking, storage, and accessories, see the [Phoenix Caseloads](#) and [Accessories](#) Price Lists.

Item	Model No.		Width	Depth	Height	Ship Wt	Cubic Ft	List Price
	21-4848CT	<i>Accommodates Five (5) Chairs</i>	48	48	30	60	5.7	P\$ 1587 W\$ 2048
	21-4242CT	<i>Accommodates Four (4) Chairs</i>	42	42	30	40	4.4	P\$ 1471 W\$ 1891
	21-3636CT	<i>Accommodates Three (3) to Four (4) Chairs</i>	36	36	30	35	3.4	P\$ 1363 W\$ 1735

21-4242CT shown with 01-2430DBA
(Disc Base)
BASES SOLD SEPARATELY

Must Specify (in this order):

Model #
Top Material
Finish/Color
Edge Profile

Description

- Available with Premium/Standard Veneer (PV/W) or HPL (P) Top, Must Specify
- Single Base Required; Ordered Separately, [See Details](#)
- Power Options not Available

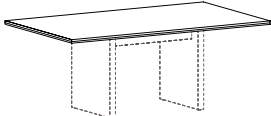
RECTANGULAR TOP	144" or 12' - 2 Piece Tops							
	21-48144RT		144	48	1 $\frac{5}{16}$	275	12.3	P\$ 4423 W\$ 4724
	120" or 10' - 2 Piece Tops							
	21-48120RT		120	48	1 $\frac{5}{16}$	225	10.3	P\$ 4043 W\$ 4270
	96" or 8' - 1 Piece Top							
	21-4896RT		96	48	1 $\frac{5}{16}$	180	9.4	P\$ 2564 W\$ 2805
	72" or 6' - 1 Piece Top							
	21-3672RT		72	36	1 $\frac{5}{16}$	100	6.2	P\$ 1679 W\$ 1778

21-3672RT shown with 88-2034RPB
(Rectangle Panel Base)
BASES SOLD SEPARATELY

Description

- Grain Runs the Width of the Table
- Available with Veneer (PV/W) or HPL (P) Top; Must Specify
- Heavy-Duty Ganging Mechanisms Connect Two (2) Piece Tops
- See Bases/Legs and Number Required For Each Top Size, [See Multiple Base Options](#); Must Order Separately
- Optional Grommets and Power/Data Units; [See Location Options](#), [See Power Units Available](#)

[See Phoenix Overview For Ordering Options](#)

Item	Model No.	Width	Depth	Height	Ship Wt	Cubic Ft	List Price
 <p>21-3672BT shown with 88-2034RPB (Rectangle Panel Base) BASES SOLD SEPARATELY</p>	144" or 12' - 2 Piece Tops						
	21-48144BT	144	48	1 $\frac{3}{16}$	275	12.3	P\$ 5141 W\$ 5533
	120" or 10' - 2 Piece Tops						
	21-48120BT	120	48	1 $\frac{3}{16}$	225	10.3	P\$ 4680 W\$ 4986
	96" or 8' - 1 Piece Top						
	21-4896BT	96	48	1 $\frac{3}{16}$	180	9.4	P\$ 3737 W\$ 4041
	72" or 6' - 1 Piece Top						
	21-3672BT	72	36	1 $\frac{3}{16}$	100	6.2	P\$ 2279 W\$ 2357

Description

- Grain Runs the Width of the Table
- Available with Veneer (PV/W) or HPL (P) Top; Must Specify
- Heavy-Duty Ganging Mechanisms Connect Two (2) Piece Tops
- See Bases/Legs and Number Required For Each Top Size, See Below for Multiple Base Options; Must Order Separately
- Optional Grommets and Power/Data Units; [See Location Options](#), [See Power Units Available](#)

RECTANGLE PANEL BASES WITH TROUGH

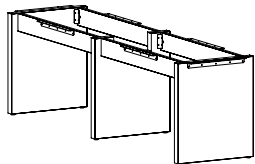

Must Specify (in this order):

Model #
Material
Finish / Color

Three (3) Panel Bases - For Use With 48" x 144" Surfaces							
88-24106RPB	Laminate	24	106	28 $\frac{3}{4}$	116	13.8	T\$ 3000
	Veneer						W\$ 3059
Two (2) Panel Bases - For Use With 48" x 120" Surfaces							
88-2482RPB	Laminate	24	82	28 $\frac{3}{4}$	90	6.9	T\$ 2150
	Veneer						W\$ 2201
Two (2) Panel Bases - For Use With 48" x 96" Surfaces							
88-2458RPB	Laminate	24	58	28 $\frac{3}{4}$	84	6.9	T\$ 1880
	Veneer						W\$ 1954
Two (2) Panel Bases - For Use With 36" x 72" Surfaces							
88-2034RPB	Laminate	20	34	28 $\frac{3}{4}$	66	6.7	T\$ 1575
	Veneer						W\$ 1742

Description

- 2" Panel Bases with Trough, Stretcher Rails, and L-Bracket Hardware Included
- Available with TFL (T) or Veneer (W)
- Vertical Grain Direction on Bases
- Bases Require Some Assembly; Attachment Hardware Included
- Tops Sold Separately

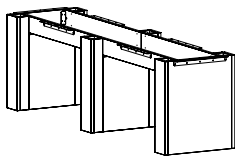
Item	Model No.		Width	Depth	Height	Ship Wt	Cubic Ft	List Price
6" RECTANGLE BASES WITH TROUGH AND REMOVABLE PANEL 	Three (3) 6" Rectangle Bases - For Use With 48" x 144" Surfaces							
	88-2410606RB	Laminate	24	106	28¾	106	19.6	T\$ 4720
		Veneer						W\$ 6457
	Two (2) 6" Rectangle Bases - For Use With 48" x 120" Surfaces							
	88-248206RB	Laminate	24	82	28¾	99	12.9	T\$ 3219
		Veneer						W\$ 4449
	Two (2) 6" Rectangle Bases - For Use With 48" x 96" Surfaces							
	88-245806RB	Laminate	24	58	28¾	93	12.9	T\$ 3023
		Veneer						W\$ 4128
	Two (2) 6" Rectangle Bases - For Use With 36" x 72" Surfaces							
	88-203406RB	Laminate	20	34	28¾	76	12.9	T\$ 2777
		Veneer						W\$ 3820

Must Specify (in this order):

- Model #
- Material
- Finish / Color

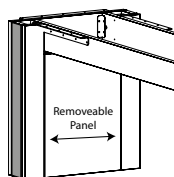

Description

- 6" Rectangle Bases with Trough and Stretcher Rails
- Available with TFL (T) or Veneer (W)
- 5/8" Metal Accent Available in Four (4) Colors: Aluminum, Black, Gold, and Platinum; Must Specify Color
- Vertical Grain Direction on Bases
- Bases Include Interior Removable Panel for Wire Management Access. Removable Panel is 15 7/8"W for 24" Bases and 11 7/8"W for 20" Bases
- Removable Panels Attached with Z Brackets
- Bases Require Some Assembly; Attachment Hardware Included
- Tops Sold Separately

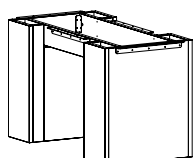
10" RECTANGLE BASES WITH TROUGH AND REMOVABLE PANEL 	Three (3) 10" Rectangle Bases - For Use With 48" x 144" Surfaces							
	88-2410610RB	Laminate	24	106	28¾	141	18.2	T\$ 4841
		Veneer						W\$ 6551
	Two (2) 10" Rectangle Bases - For Use With 48" x 120" Surfaces							
	88-248210RB	Laminate	24	82	28¾	96	12.0	T\$ 3300
		Veneer						W\$ 4512
	Two (2) 10" Rectangle Bases - For Use With 48" x 96" Surfaces							
	88-245810RB	Laminate	24	58	28¾	89	12.0	T\$ 3104
		Veneer						W\$ 4190
	Two (2) 10" Rectangle Bases - For Use With 36" x 72" Surfaces							
	88-203410RB	Laminate	20	34	28¾	72	10.0	T\$ 2857
		Veneer						W\$ 3882

Must Specify (in this order):

- Model #
- Material
- Finish / Color

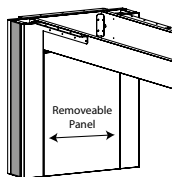

Description

- 6" Rectangle Bases with Trough and Stretcher Rails
- Available with TFL (T) or Veneer (W)
- 5/8" Metal Accent Available in Four (4) Colors: Aluminum, Black, Gold, and Platinum; Must Specify Color
- Vertical Grain Direction on Bases
- Bases Include Interior Removable Panel for Wire Management Access. Removable Panel is 15 7/8"W for 24" Bases and 11 7/8"W for 20" Bases
- Removable Panels Attached with Z Brackets
- Bases Require Some Assembly; Attachment Hardware Included
- Tops Sold Separately

[See Phoenix Overview For Ordering Options](#)

Item	Model No.		Width	Depth	Height	Ship Wt	Cubic Ft	List Price
6" + 10" COMBO RECTANGLE BASES WITH TROUGH AND REMOVABLE PANEL	Three (3) Bases Total: Two (2) 6" and One (1) 10" Rectangle Bases - For Use With 60" / 54" / 48" x 144" Surfaces							
	88-24106C610RB	Laminate	24	106	28¾	141	18.2	T\$ 4760
		Veneer						W\$ 6488

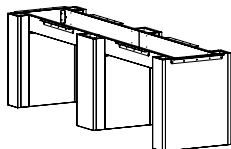

Must Specify (in this order):

- Model #
- Material
- Finish / Color

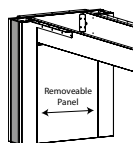

Description

- 6" + 10" Rectangle Bases with Trough and Stretcher Rails; 6" Bases on Exterior and 10" Bases on Interior
- Available with TFL (T) or Veneer (W)
- Vertical Grain Direction on Bases
- Bases Include Interior Removable Panel for Wire Management. Removable Panel is 15½"W and Attaches with Z Brackets.
- Bases Require Some Assembly; Attachment Hardware Included
- Tops Sold Separately

6" RECTANGLE ACCENT BASES WITH TROUGH AND REMOVABLE PANEL

6" RECTANGLE ACCENT BASES WITH TROUGH AND REMOVABLE PANEL	Three (3) 6" Rectangle Bases - For Use With 48" x 144" Surfaces							
	88-2410606RAB	Laminate	24	106	28¾	106	19.6	T\$ 5394
		Veneer						W\$ 7174
	Two (2) 6" Rectangle Bases - For Use With 48" x 120" Surfaces							
	88-248206RAB	Laminate	24	82	28¾	99	12.9	T\$ 4745
		Veneer						W\$ 6436
	Two (2) 6" Rectangle Bases - For Use With 48" x 96" Surfaces							
	88-245806RAB	Laminate	24	58	28¾	93	12.9	T\$ 3480
		Veneer						W\$ 4610
	Two (2) 6" Rectangle Bases - For Use With 36" x 72" Surfaces							
	88-203406RAB	Laminate	20	34	28¾	76	12.9	T\$ 3232
		Veneer						W\$ 4302

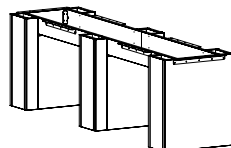

Must Specify (in this order):

- Model #
- Base Finish/Color
- Metal Accent Color
- Accent Panel Finish/Color

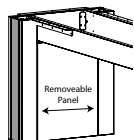

Description

- 6" Rectangle Bases with Trough and Stretcher Rails
- Available with TFL (T) or Veneer (W)
- 5/16" Metal Accent Available in Four (4) Colors: Aluminum, Black, Gold, and Platinum; Must Specify Color
- Vertical Grain Direction on Bases
- Bases Include Interior Removable Panel for Wire Management Access. Removable Panel is 15½"W for 24" Bases and 11½"W for 20" Bases
- Removable Panels Attached with Z Brackets
- Bases Require Some Assembly; Attachment Hardware Included
- Tops Sold Separately

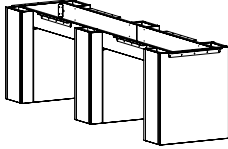
Item	Model No.		Width	Depth	Height	Ship Wt	Cubic Ft	List Price	
10" RECTANGLE ACCENT BASES WITH TROUGH AND REMOVABLE PANEL 	Three (3) 10" Rectangle Bases - For Use With 48" x 144" Surfaces								
	88-2410610RAB	Laminate	24	106	28¾	141	18.2	T\$ 5462	
		Veneer						W\$ 7258	
	Two (2) 10" Rectangle Bases - For Use With 48" x 120" Surfaces								
	88-248210RAB	Laminate	24	82	28¾	96	12.0	T\$ 3717	
		Veneer						W\$ 4986	
	Two (2) 10" Rectangle Bases - For Use With 48" x 96" Surfaces								
	88-245810RAB	Laminate	24	58	28¾	89	12.0	T\$ 3521	
		Veneer						W\$ 4664	
	Two (2) 10" Rectangle Bases - For Use With 36" x 72" Surfaces								
	88-203410RAB	Laminate	20	34	28¾	72	10.0	T\$ 3209	
		Veneer						W\$ 4276	

Must Specify (in this order):

- Model #
- Base Finish/Color
- Metal Accent Color
- Accent Panel Finish/Color

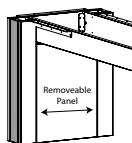

Description

- 10" Rectangle Bases with Trough and Stretcher Rails
- Available with TFL (T) or Veneer (W)
- 5/16" Metal Accent Available in Four (4) Colors: Aluminum, Black, Gold, and Platinum; Must Specify Color
- Vertical Grain Direction on Bases
- Bases Include Interior Removable Panel for Wire Management Access. Removable Panel is 15 7/8"W for 24" Bases and 11 7/8"W for 20" Bases
- Removable Panels Attached with Z Brackets
- Bases Require Some Assembly; Attachment Hardware Included
- Tops Sold Separately

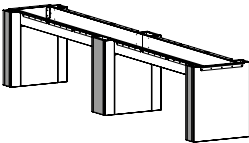
6" + 10" COMBO RECTANGLE ACCENT BASES WITH TROUGH AND REMOVABLE PANEL 	Three (3) Bases Total: Two (2) 6" and One (1) 10" Rectangle Bases - For Use With 60" / 54" / 48" x 144" Surfaces								
	88-24106C610RAB	Laminate	24	106	28¾	141	18.2	T\$ 5420	
		Veneer						W\$ 7205	

Must Specify (in this order):

- Model #
- Base Finish/Color
- Metal Accent Color
- Accent Panel Finish/Color

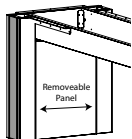

Description

- 6" + 10" Rectangle Accent Bases with Trough and Stretcher Rails; 6" Bases on Exterior and 10" Bases on Interior
- Available with TFL (T) or Veneer (W)
- 5/16" Metal Accent Available in Four (4) Colors: Aluminum, Black, Gold, and Platinum; Must Specify Color
- Vertical Grain Direction on Bases
- Bases Include Interior Removable Panel for Wire Management. Removable Panel is 15 7/8"W and Attaches with Z Brackets
- Bases Require Some Assembly; Attachment Hardware Included
- Tops Sold Separately

[See Phoenix Overview For Ordering Options](#)

Item	Model No.		Width	Depth	Height	Ship Wt	Cubic Ft	List Price
DISC BASE 	For 48" Round Tops							
	01-3230DBB	Black	30	30	27¾	42	4.1	\$ 1842
	01-3230DBA	Aluminum						
	For 36" and 42" Round Tops							
	01-2430DBB	Black	24	24	27¾	32	3.2	\$ 1535
	01-2430DBA	Aluminum						

Description

- 4" Diameter 14 Gauge Steel Column
- 12"x12" Mounting Plate at Top of Column
- ¼" Thick Disc Plate with 5 Levelers
- Some Assembly Required

Table Widths	Round	72"	96"
Number of Bases Required	1	2	2

METAL X-BASE

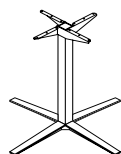

For Use With								
Round Tops: 42" + 48"								
Top Surfaces: 48"x96"								
08-2642LXBB	Black	35½	35½	40	33	20.0	\$	1322
08-2642LXBA	Aluminum							
<i>For 42"H Tables</i>								
08-2636LXBB	Black	35½	35½	34	30	17.2	\$	1275
08-2636LXBA	Aluminum							
<i>For 36"H Tables</i>								
08-2630LXBB	Black	35½	35½	28	27	14.5	\$	1219
08-2630LXBA	Aluminum							
<i>For 30"H Tables</i>								
For Use With								
Round: 36"								
Top Surfaces: 36"x72"								
08-2042SXBB	Black	29	29	40	27	15.9	\$	1235
08-2042SXBA	Aluminum							
<i>For 42"H Tables</i>								
08-2036SXBB	Black	29	29	34	24	13.7	\$	1185
08-2036SXBA	Aluminum							
<i>For 36"H Tables</i>								
08-2030SXBB	Black	29	29	28	21	11.6	\$	1139
08-2030SXBA	Aluminum							
<i>For 30"H Tables</i>								

Description

- See Number of Bases Required Per Top Width Below
- Not Available to be Sold Separately
- Power Units Available On Center When Using Two or More Metal X-Bases
- Ships Assembled

Table Widths	Round	72"	96"
Number of Bases Required	1	2	2

P = HPL W = Veneer

For ordering options, see overview at the beginning of this section.

[See Phoenix Overview For Ordering Options](#)

Item	Model No.		Width	Depth	Height	Ship Wt	Cubic Ft	List Price	
HEIGHT ADJUSTABLE PNEUMATIC X-BASE 	Maximum Round 42"								
	01-3232HAXBB	Black	32	32	26-45¾	1	0.2	\$ 1721	
	01-3232HAXBA	Aluminum							
	Maximum Round 36"								
	01-2626HAXBB	Black	22	22	26-45¾	1	0.2	\$ 1687	
	01-2626HAXBA	Aluminum							

Description

- Pre-Drilled Boring Pattern May Not Match Underside of Table Top
- Steel Mounting Plate: 8"x 8"x ¼"
- Eight (8) Bolts Included for Assembly
- Some Assembly Required

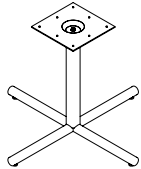
TUBULAR X-BASE 	For Use With Round Tops: 48" Top Surfaces: 48"x96"								
	01-3830TXB	Black	38	38	27¾	40	4.2	\$ 699	
	01-3830TXA	Aluminum							
	For Use With Round Tops: 36", 42" Top Surfaces: 36"x72"								
	01-3230TXB	Black	32	32	27¾	32	3.2	\$ 633	
	01-3230TXA	Aluminum							

Description

- 3" Diameter Column
- See Number of Bases Required Per Top Width Below
- Power Units Available On Center When Using Two or More Tubular X-Bases
- Some Assembly Required

Table Widths	Round	72"	84"	96"
Number of Bases Required	1	2	2	2

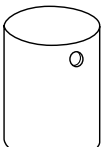
CYLINDER BASE 	For Tables 42"D to 48"D							
	01-2020CB		20	20	28½	136	10.9	W\$ 1553
	For Tables 36"D							
01-1616CB		16	16	28½	101	7.2	W\$ 1419	

Description

- Veneer Base Features Multi-Step, Hand-Finished Catalyzed Finish
- Weighted for Stability
- Two (2) Wire Management Black Grommets Standard at Top Edge; 8" Opening Standard at Bottom

Additional Grommet Options: Specify & Add

GCB1S	Only One (1) Grommet At Top Edge	\$	N/C
NOGC	No Grommets At Top Edge	\$	N/C

Must Specify (in this order):

- Model #
- Finish
- Grommet Options

[See Phoenix Overview For Ordering Options](#)

Item	Model No.	Width	Depth	Height	Ship Wt	Cubic Ft	List Price
QUEEN ANNE BASE	01-0606QB	24	24	28¾	136	11.1	W\$ 1406

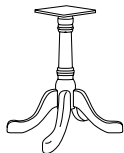

Description

- Classic Design Detail on Column
- Base Features Multi-Step, Hand-Finished Catalyzed Finish
- Four (4) Legs with Adjustable Glides

Must Specify (in this order):

Model #
Finish

SQUARE BASE	21-2020SB	20	20	28¾	57	8.4	W\$ 1183
-------------	-----------	----	----	-----	----	-----	----------

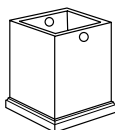

For Use with 48" or 42" Tops

	21-1616SB	16	16	28¾	41	6.0	W\$ 1100
--	-----------	----	----	-----	----	-----	----------

For Use with 36" Top

Description

- Veneer Base
- Two (2) Wire Management Black Grommets Standard at Top and 8" Wire Management Opening in Bottom

Must Specify (in this order):

Model #
Finish
Grommet Options



Options: Specify & Add

NOGC	No Grommet at Top Edge	\$	N/C
------	------------------------	----	-----

Item	Model No.	Width	Depth	Height	Ship Wt	Cubic Ft	List Price
STORAGE CREDENZA	21-2072SC	72	20 ⁷ / ₁₆	30	349	29.0	P\$ 4360 W\$ 4754
	21-2066SC	66	20 ⁷ / ₁₆	30	320	26.6	P\$ 4206 W\$ 4589

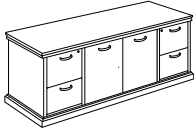

Must Specify (in this order):

- Model #
- Top Material
- Finish/Color
- Pull
- Flush Feature

Description

- Letter Width Locking File/File Pedestals
- Available with Veneer (W) or HPL (P) Top, Must Specify
- Fixed Storage Shelf Behind Doors
- Profiles on Three (3) Sides for Flush Wall Application Standard
- Flush Feature Available; Must Specify: Flush Left (FL), Flush Right (FR) or Flush Left and Right (FLR)
- Flush Option Reduces Unit by 3/4" Per Side and 1 1/2" for Both Flush Sides

WARDROBE/STORAGE CABINET	Hinged Left	Hinged Right	Width	Depth	Height	Ship Wt	Cubic Ft	List Price
	21-1872WL	21-1872WR						

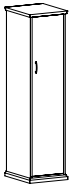

Shown as Right

Must Specify (in this order):

- Model #
- Finish
- Pull
- Locking Doors
- Flush Feature

Description

- Coat Rod Under Top Fixed Shelf
- Three (3) Adjustable Shelves; Adjustable Shelves can be Removed for Wardrobe Application
- Profiles on Three (3) Sides for Flush Wall Application Standard
- Flush Feature Available; Must Specify: Flush Left (FL), Flush Right (FR) or Flush on Both Sides (FLR)
- Flush Option Reduces Unit by 3/4" Per Side and 1 1/2" if Both Sides Are Selected to be Flush
- Optional Locking Doors ([See Locking Options](#)), Lock Core will Coordinate with Pull Color

DOUBLE WARDROBE/STORAGE	21-3672WC	36	20 ⁷ / ₁₆	70 ⁷ / ₈	290	42.0	W\$ 4139
	21-3072WC	30	20 ⁷ / ₁₆	70 ⁷ / ₈	240	35.7	W\$ 4030

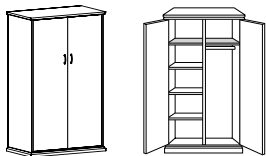

Must Specify (in this order):

- Model #
- Finish
- Pull
- Locking Doors
- Flush Feature

Description

- Fixed Top Shelf Behind Each Door
- Three (3) Adjustable Shelves on Left Side; Coat Rod Under Fixed Shelf on Right Side
- Profiled on Three (3) Sides for Flush Wall Applications Standard
- Flush Feature Available; Must Specify: Flush Left (FL), Flush Right (FR) or Flush on Both Sides (FLR)
- Flush Option Reduces Unit by 3/4" Per Side and 1 1/2" if Both Sides Are Selected to be Flush
- Optional Locking Doors ([See Locking Options](#)), Lock Core will Coordinate with Pull Color

P = HPL W = Veneer

[See Phoenix Overview For Ordering Options](#)

Item	Model No.		Width	Depth	Height	Ship Wt	Cubic Ft	List Price
ROUND GROMMET COVER FIELD INSTALLED	01-GRMTBK	Black	-	-	-	-	-	\$ 11
	01-GRMTSL	Silver						



OPEN MARKET ONLY
(SILVER)

Description

- 60mm Round Grommet Cover
- Field Installed

SINGLE POWER SAND DOLLAR	01-SAND60PS	Silver	3	3	4	1	0.2	\$ 98
	01-SAND60PW	White						\$ 98
	01-SAND60PB	Black						\$ 98

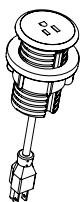

Description

- Mounts in 2 $\frac{3}{8}$ " (60mm) Round Grommet
- Single Power Outlet with 6' Cord

DOUBLE USB SAND DOLLAR	01-SAND60US	Silver	3	3	4	1	0.2	\$ 277
	01-SAND60UW	White						\$ 277
	01-SAND60UB	Black						\$ 277

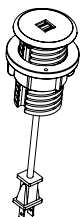

Description

- Mounts in 2 $\frac{3}{8}$ " (60mm) Round Grommet
- Dual USB Outlets with 6' Cord

DOCK 950 WIRELESS CHARGER	01-DOCK950W	White	3 $\frac{1}{10}$	3 $\frac{1}{10}$	-	1	0.2	\$ 265
	01-DOCK950B	Black						\$ 265



OPEN MARKET ONLY

Description

- For Use with Wireless Charging Enabled Devices
- 5 Watts Maximum Output with a Direct Current of 5V 2A and 10 Watts Maximum with Quick Charge 2.0
- LED will Confirm Pairing with Device and Begin Wireless Charging



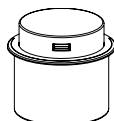

WIRELESS AND USB CHARGER	01-DOCK150W	White	3	3	$\frac{3}{4}$ "	1	0.2	\$ 405
	01-DOCK150B	Black						\$ 405

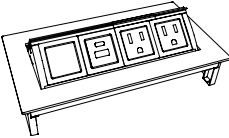

OPEN MARKET ONLY

Description

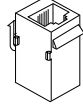
- For Use with Wireless Charging Enabled Devices and USB Charging Devices
- 5 Watt Maximum Output with a Direct Current Input of 5V 6A (Wireless Fast Charge)
- Pop-Up is $\frac{3}{4}$ "H and Includes Three (3) USB Ports; One (1) 12 Watt Maximum with 2.4A (USB Fast Charge) and Two (2) 5 Watt with 1A (USB Standard Charge)
- LED Light will Confirm Pairing with Device and Begin Wireless Charging
- UL and cUL Certified

Item	Model No.		Width	Depth	Height	Ship Wt	Cubic Ft	List Price
	01-DPORT4A	Aluminum	8	4	-	7	0.2	\$ 1093
	01-DPORT4B	Black						
Description <ul style="list-style-type: none"> Retracts into Work Surface to Regain Productive Space; One-Touch Access to Power and Data Two (2) Power Outlets, One (1) USB A+C, and One (1) Open Port Optional Telecom Port Components, See Below Water-Proof Simplex (Outlets) Includes a Voice/Data Adapter Kit to Accept Couplers and Jacks When Required 10' Power Cord UL Recognized 								
USB PORT	01-USBPORT		-	-	-	-	-	\$ 161
	Description <ul style="list-style-type: none"> Passive USB-A Port with Increased Transfer Speed Up to 5 gbs/sec Simultaneous Read/Write Capability; Idle Device Power Saving State 6' Cord Compatible with 01-DPORT4A, 01-DPORT4B 							
VOICE COUPLER	01-VOICE1		-	-	-	-	-	\$ 73
	Description <ul style="list-style-type: none"> 6-Pin Modular Plug Molded Black; Cord Not included Compatible with 01-DPORT4A, 01-DPORT4B 							
DATA PORT	01-RJ4DATA		-	-	-	-	-	\$ 167
	Description <ul style="list-style-type: none"> 8-Pin Modular Plug; Cat6 Ethernet Cable; Pre-terminated Cable 10' Cord Compatible with 01-DPORT4A, 01-DPORT4B 							
 <p>01-E2X4 SIN PENDING</p>	01-E2X6A	Aluminum	11	9 ¹³ / ₁₆	-	6	0.7	\$ 1625
	01-E2X6B	Black						
	01-E2X4A	Aluminum	8	9 ¹³ / ₁₆	-	5	0.5	\$ 1494
	01-E2X4B	Black						
Description <ul style="list-style-type: none"> In Surface, Dual Side Application; Soft Touch Access to Power and Data 11" Unit Includes Three (3) Power Outlets, One (1) USB A+C, and Two (2) Open Port on Each Side; 8" Unit Includes Two (2) Power Outlets, One (1) USB A+C, and One (1) Open Port on Each Side Optional Telecom Port Components, See Compatible Units 6' Power Cord UL Listed 								

[See Phoenix Overview For Ordering Options](#)

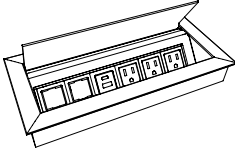
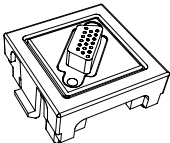
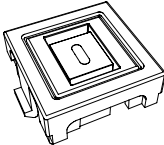
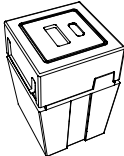
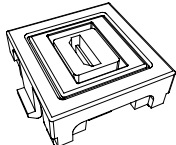
Item	Model No.		Width	Depth	Height	Ship Wt	Cubic Ft	List Price
 <p>01-ELLORA6 SIN PENDING</p>	01-ELLORA6A	Aluminum	11	5	-	6	0.7	\$ 852
	01-ELLORA6B	Black						
	01-ELLORA4A	Aluminum	8	5	-	5	0.5	\$ 792
	01-ELLORA4B	Black						
Description								
<ul style="list-style-type: none"> In Surface Application; Soft Touch Access to Power and Data 11" Includes Three (3) Power Outlets, One (1) USB A+C, and Two (2) Open Port; 8" Includes Two (2) Power Outlets, One (1) USB A+C, and One (1) Open Port Optional Telecom Port Components, See Below for Compatible Units 6' Power Cord UL Recognized 								
VGA CONNECTOR ACCESSORY	01-VGACON		-	-	-	1	0.2	\$ 149
	Description							
	<ul style="list-style-type: none"> VGA Port for 01-DPORT4A, 01-DPORT4B, ELLORA4A, ELLORA4B, ELLORA6A, ELLORA6B, E2X4A, E2X4B, E2X6A, and E2X6B Enables Devices to Remote Display on Monitors 10' Cord Male/Female Connector 							
PASSIVE USB-C ACCESSORY	01-PUSBC		-	-	-	1	0.2	\$ 95
	Description							
	<ul style="list-style-type: none"> Passive USB-C Port ; Unit Provides Data Connection to Transfer Data Only, No Charging Capabilities Compatible with 01-DPORT4A, 01-DPORT4B, ELLORA4A, ELLORA4B, ELLORA6A, ELLORA6B, E2X4A, E2X4B, E2X6A, and E2X6B Male/Female Connector 							
CHARGING USB-A+C ACCESSORY	01-USBAC		-	-	-	1	0.2	\$ 283
	Description							
	<ul style="list-style-type: none"> For Charging Devices 20 Watt Power Supply USB+C Charging Port for 01-DPORT4A, 01-DPORT4B, ELLORA4A, ELLORA4B, ELLORA6A, ELLORA6B, E2X4A, E2X4B, E2X6A, and E2X6B 							
HDMI CONNECTOR ACCESSORY	01-HDMICON		-	-	-	1	0.2	\$ 124
	Description							
	<ul style="list-style-type: none"> HDMI Port for 01-DPORT4A, 01-DPORT4B, ELLORA4A, ELLORA4B, ELLORA6A, ELLORA6B, E2X4A, E2X4B, E2X6A, and E2X6B Connects to High Definition Displays Female/Female Connector 18" Cord 							

[See Phoenix Overview For Ordering Options](#)

Item	Model No.		Width	Depth	Height	Ship Wt	Cubic Ft	List Price
INTERACT POWER & DATA	01-INTERACTG2A	Aluminum	9	5½	2¾	5	0.2	\$ 891
	01-INTERACTG2B	Black						



Description

- Includes: Two (2) Power Outlets, Two (2) USB-A Charging Ports, One (1) Telecom Plate Opening; Two (2) Keystone Openings for Voice/Data Jacks
- One (1) Telecom Plates Included with the Unit: One (1) 01-ABLAB Plate (Consists of One (1) RJ45 Cat 6, One (1) RJ11 Cat 3 Phone Jack)
- Convenience Plug on Bottom
- 6' Power Cord
- UL and CSA Recognized
- Additional Telecom Plates, [See ECA Telecom Plate Options](#)

OASIS MINI POWER & DATA	01-OASISMA	Aluminum	15	9	5	11	0.3	\$ 3191
	01-OASISMB	Black						

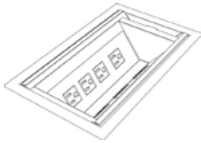

Top View

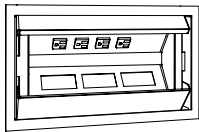

Description

- For Use with Conference Tables
- Soft Touch Hinged Lid
- Four (4) Power Outlets, Three (3) Telecom Plate Openings
- Two (2) Telecom Plates Included with the Unit: One (1) 01-ABLAB Plate (Consists of One (1) RJ45 Cat 6, One (1) RJ11 Cat 3 Phone Jack); One (1) 01-ABLB Plate (Consists of One (1) RJ45 Cat 6)
- 9' Power Cord
- UL Listed
- Additional Telecom Plates, [See ECA Telecom Plate Options](#)

DOCK800	01-DOCK800S	Silver	14	9	-			\$ 2047
	01-DOCK800B	Black						

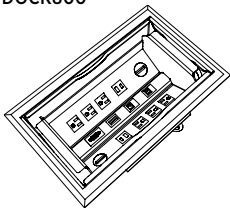

OPEN MARKET ONLY

Description

- Stylish Aluminum Housing with Beveled Edges; Soft Touch Access and Closure
- Includes: Six (6) Power Outlets, Two (2) USB-A 5V Ports, Two (2) USB-C Charging Ports, One (1) RJ45 Ethernet Port, One (1) RJ11 Port, One (1) HDMI Port, and One (1) VGA Port
- 10' Power Cord
- UL and cUL Certified

[See Phoenix Overview For Ordering Options](#)

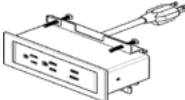
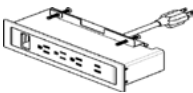
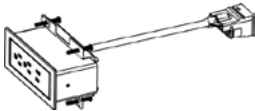
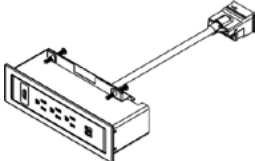
Item	Model No.		Width	Depth	Height	Ship Wt	Cubic Ft	List Price
DUO BEZEL WITH NEMA PLUG 	01-DUOBEZELW	White	6½	2½	3¼	1	0.2	\$ 675
	01-DUOBEZELB	Black						
	01-DUOBEZELS	Silver						
	Description <ul style="list-style-type: none"> Sits on Table Top and Includes: Two (2) Power, One (1) USB Charging Port and One (1) 60-Watt USB-C Power Delivery Port with GaN Technology, 10' Cord, and All Mounting Hardware Independent USB Circuit Controllers Deliver up to 2.1 Amps to Each Post FCC Part 15A, UL Recognized for Horizontal and Vertical Applications 							
TRIO BEZEL WITH NEMA PLUG 	01-TRIOBEZELW	White	9	2½	3	1	0.2	\$ 725
	01-TRIOBEZELB	Black						
	01-TRIOBEZELS	Silver						
	Description <ul style="list-style-type: none"> Sits on Table Top and Includes: Three (3) Power Outlets, One (1) USB Charging Port, One (1) 60-Watt USB-C Power Delivery Port with GaN Technology, One (1) Open Data Port, 10' Cord, and All Mounting Hardware HDMI, VGA, and RJ45 Accessories for Open Data Port; Sold Separately, See Accessories Independent USB Circuit Controllers Deliver up to 2.1 Amps to Each Post FCC Part 15A, UL Recognized for Horizontal and Vertical Applications 							
DUO BEZEL WITH DAISY CHAIN PLUG 	01-PDUOBEZELW	White	6½	2½	3	1	0.2	\$ 668
	01-PDUOBEZELB	Black						
	01-PDUOBEZELS	Silver						
	Description <ul style="list-style-type: none"> Sits on Table Top and Includes: Two (2) Power, One (1) USB Charging Port and One (1) 60-Watt USB-C Power Delivery Port with GaN Technology, 12" Cord, and All Mounting Hardware Requires Daisy Chain Power Box; Sold Separately, See Power Box Details Non-Sequential System Allows up to Eight (8) Modules to be Connected with Jumper Cord, See Jumper Cord Details Independent USB Circuit Controllers Deliver up to 2.1 Amps to Each Post FCC Part 15A, RU Listed and UL Recognized for Horizontal and Vertical Applications 							
TRIO BEZEL WITH DAISY CHAIN PLUG 	01-PTRIOBEZELW	White	9	2½	3	1	0.2	\$ 715
	01-PTRIOBEZELB	Black						
	01-PTRIOBEZELS	Silver						
	Description <ul style="list-style-type: none"> Sits on Table Top and Includes: Three (3) Power Outlets, One (1) USB Charging Port, One (1) 60-Watt USB-C Power Delivery Port with GaN Technology, One (1) Open Data Port, 12" Cord, and All Mounting Hardware HDMI, VGA, or RJ45 Accessory for Open Data Port; Sold Separately, See Accessories Requires Daisy Chain Power Box, Specified Separately, See Next Page Non-Sequential System Allows up to Eight (8) Modules to be Connected with Jumper Cord, See Jumper Cord Details Independent USB Circuit Controllers Deliver up to 2.1 Amps to Each Post FCC Part 15A, RU Listed and UL Recognized for Horizontal and Vertical Applications 							

[See Phoenix Overview For Ordering Options](#)

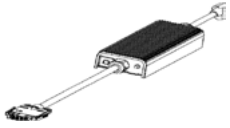
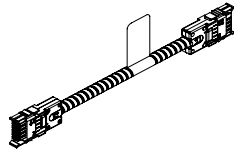
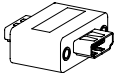
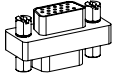
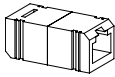
Item	Model No.		Width	Depth	Height	Ship Wt	Cubic Ft	List Price
DAISY CHAIN POWER BOX 	01-PPOWER	<i>76" Perimeter, 36" Power Cord</i>	-	-	-	1	0.2	\$ 775
	01-PPOWER2	<i>24" Perimeter, 144" Power Cord</i>	-	-	-	1	0.2	\$ 796
Description <ul style="list-style-type: none"> • Powers up to Eight (8) Duo and Trio Daisy Chain Units • One Nema Plug and One Daisy Chain Plug • 12-Amp System Rating • 15-Amp Over-Current Protection 								
DAISY CHAIN JUMPER CORD 	01-6JUMP	<i>72" Long</i>	-	-	-	1	0.2	\$ 299
	01-5JUMP	<i>60" Long</i>	-	-	-	1	0.2	\$ 284
	01-4JUMP	<i>48" Long</i>	-	-	-	1	0.2	\$ 240
	01-2JUMP	<i>24" Long</i>	-	-	-	1	0.2	\$ 220
Description <ul style="list-style-type: none"> • Connects Duo and Trio Daisy Chain Units • Non-Sequential System Allows up to Eight (8) Modules to be Connected 								
HDMI DATA PORT ACCESSORY 	01-LCOMHDMI		-	-	-	1	0.2	\$ 166
Description <ul style="list-style-type: none"> • HDMI Port for Trio Bezel Units • See Additional Accessories on next page 								
OPEN MARKET ONLY								
VGA DATA PORT ACCESSORY 	01-LCOMVGA		-	-	-	1	0.2	\$ 121
Description <ul style="list-style-type: none"> • VGA Port for Trio Bezel Units 								
RJ45 DATA PORT ACCESSORY 	01-LCOMRJ45		-	-	-	1	0.2	\$ 79
Description <ul style="list-style-type: none"> • RJ45 Port for Trio Bezel Units 								

[See Phoenix Overview For Ordering Options](#)

Item	Model No.	Width	Depth	Height	Ship Wt	Cubic Ft	List Price
WIRE MANAGEMENT CHANNEL	01-WMGR4	16	1½	¾	1	-	\$ 116

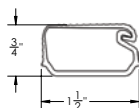
Description

- Set of Four (4) Black Plastic Wire Management Channels
- Snap Lock Channel
- Attaches with Adhesive Strips
- Ships via UPS Only

WIRE CHANNEL	01-32125	24	1%	1	.25	0.3	\$ 106
--------------	----------	----	----	---	-----	-----	--------

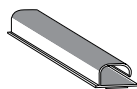
Description

- Available in Black
- Channels Attach with Two (2) Double-Sided Installation Tape
- Open J Channel for Easy Storage of Cables

CABLE GRIP	01-WMGRCB	5%	2%	-	-	-	\$ 17
------------	-----------	----	----	---	---	---	-------

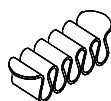
Description

- Under Surface Wire Management
- Black

Item	Model No.	Width	Depth	Height	Ship Wt	Cubic Ft	List Price	
ECA TELECOM PLATES	01-ABL	Telecom Plate, Blank Plate						\$ 41
	01-ABL737373	Telecom Plate, Three (3) RJ45 Cat 5e						\$ 367
	Compatible with:	01-ABLAB	Telecom Plate, One (1) RJ45 Cat 6, One (1) RJ11 Cat 3 Phone					\$ 206
		01-ABLAB102	Telecom Plate, One (1) RJ45 Cat 6, One (1) RJ11 Cat 3, One (1) USB W/72" Patch Cord					\$ 320
		01-ABLABB	Telecom Plate, Two (2) RJ45 Cat 6, One (1) RJ11 Cat 3 Phone					\$ 320
	Oasis Mini Power & Data 01-OASISMA, 01-OASISMB	01-ABLB	Telecom Plate, One (1) RJ45 Cat 6					\$ 149
		01-ABLBB	Telecom Plate, Two (2) RJ45 Cat 6					\$ 260
	Interact Power & Data 01-INTERACTG2A, 01-INTERACTG2B	01-ABLBBB	Telecom Plate, Three (3) RJ45 Cat 6					\$ 367
		01-ABLBBB	Telecom Plate, Four (4) RJ45 Cat 6					\$ 476
		01-ABLBBBC51	Telecom Plate, Two (2) RJ45 Cat 6, One (1) 15 Pin HD VGA w/72" Patch Cord					\$ 446
		01-ABLBC51L	Telecom Plate, One (1) RJ45 Cat 6, One (1) Mini Stereo Inline, One (1) 15 Pin HD VGA w/72" Patch Cord					\$ 410
		01-ABLC3811	Telecom Plate, One (1) RJ45 Cat 6 Data Inline, One (1) RJ11 Cat 3 Phone Inline					\$ 197
		01-ABLC45	Telecom Plate, One (1) HDMI w/36" Patch Cord					\$ 295
	Power Center 01-INTRFCIA, 01-INTRFCIB	01-ABLC45C51L	Telecom Plate, One (1) Mini Stereo Inline, One (1) HDMI w/36" Patch Cord, One (1) 15 Pin HD VGA w/72" Patch Cord					\$ 558
		01-ABLC51L	Telecom Plate, One (1) 15 Pin HD VGA & One (1) Mini Stereo Inline Jack					\$ 298
		01-ABLCRDM	Telecom Plate, Three (3) Cord Bushings					\$ 96

[See Phoenix Overview For Ordering Options](#)

Dress up a casual drop-in meeting room or add prestige to an executive suite. Strut Tables are designed with precision minimalist lines and angles to establish modern sensibility in any space. With tops available in round, square, rectangle, modern rectangle, and boat shapes, in a range of veneer, laminate, and glass options, and in sizes ranging from 3.5 square feet to 5 by 20 feet, Strut can accommodate small meeting spaces, cafes, private offices, or even large board rooms.

CONSTRUCTION

VENEER

- Exposed surfaces feature select grade plain-sliced hardwood veneers in Cherry, Maple, American Black Walnut, or composite veneers. Veneers are carefully selected and matched to assure proper balance and consistency
- Veneer features UVA Advantage, an ultra-violet finish, on all exposed surfaces by utilizing roll-coat UV technology

LAMINATE

- Thermally-Fused Laminate (TFL) and High-Pressure Laminate (HPL) are made of woodgrain and solid color laminates fused to particleboard core; each laminate offers lasting beauty, superior resistance to normal wear, and easy maintenance,

TOPS

- Veneer (W) or HPL (P) Tops available in five shapes: Rectangle, Boat, Modern Rectangle, Square and Round with woodgrain patterns following the depth (short) of Veneer (W) table tops while grain patterns follow the width (long) of HPL (P) table tops
- Tops are shaped on all four sides and are available in two thicknesses and six edge profiles
- Double Kerf (F), Duo (G), **Fluted (X)** and Square (Y) available in Veneer (W) and HPL (P) tops with 3-ply balanced construction, 1 $\frac{3}{16}$ " thick and matching 3mm wood or PVC edge bands on profiled edges; Designer White, Sugar Maple, and Williamsburg Cherry feature ABS edge bands
- Knife (K) edge profile tops are 1 $\frac{3}{16}$ " thick with solid wood rims available on both Veneer (W) or HPL (P) tops
- Vertical Square (H) edge profile tops are 1 $\frac{1}{2}$ " thick with 1.5mm wood edge band on Veneer (W) tops and 1mm PVC edge band on HPL (P) tops; Designer White, Sugar Maple, and Williamsburg Cherry feature ABS edge bands
- Tops will include with holes bored on bottom to ensure proper leg placement
- Credenzas, buffets, and other ancillary support models are available in Square (Y), Double Kerf (F), Duo (G), and Vertical Square (H) edge profiles and profiled on approach side only
- All Veneer tops, as well as Laminate tops up to 144" (12 feet), will have matching woodgrain. Laminate tops sized 156" (13 feet) and longer will have non-matching woodgrain**
- All surfaces feature reverse slip matched pattern
- Back Painted, Tempered Glass Tops are 1/4" thick and are attached to a substrate topped with black paper covering
- Tempered glass top has a 1/16" overhang from the sub-top

LOCKING

- All units with file drawers feature locking
- Removable lock cylinders allow for units to be re-keyed at a later date, if required Units are shipped randomly keyed as standard
- Keyed alike units available upon request at no additional charge Lock core is predetermined by pull color. Black lock cores are used with black and gold pulls while silver lock cores are used with chrome and aluminum pulls
- Optional locking doors available on buffets and credenzas

LEGS

- Available in aluminum (ALUM) or black (BLK)
- Integrated wire management inside of leg to keep your space clean and free of wires
- Each leg has adjustable glides

CHASSIS

- All credenzas are available in TFL (T) or Veneer (W) with vertical grain direction
- Chassis for storage units are securely fastened using high quality European fastening systems and heavy-duty 16-gauge joining brackets to assure maximum strength
- All units ship with heavy-duty, adjustable leveling glides to ensure proper leveling and compensation for uneven floors

DRAWERS

- Drawers feature 5-sided drawer construction allowing for easy removal of drawer fronts; All drawer fronts are standard with elegant vertically matched faces
- Drawer sides, back, and front are woodgrain vinyl-wrapped 1/2" thick with 1/8" thick hardboard bottoms
- Drawer interiors are dovetail construction with 7/16" thick hardwood sides and backs, and 5/32" thick hardboard bottoms
- All drawers feature full extension, progressive action slides with precision steel ball bearings
- Box drawers are tested for 100lb capacity
- All suspensions have a limited lifetime warranty

STORAGE

- All hinged doors are soft-close with one piece hinge and base plate combination
- Soft close hinges reduce stress placed on the cabinet when the door is closed and offers a quiet closure
- All Credenzas feature a 2" W wire management channel along back of the interior cabinet for easy accessibility to wall outlets

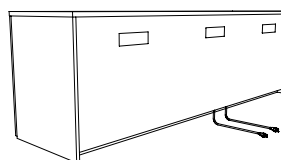

2" wire management channel

INTERIOR DRAWER DIMENSIONS

Models

88-2496BF

	W	L	D
Box Drawers	15 $\frac{3}{4}$ "	16 $\frac{3}{8}$ "	3 $\frac{2}{32}$ "

Models

88-2484BF

	W	L	D
Box Drawers	30"	16 $\frac{3}{8}$ "	3 $\frac{2}{32}$ "
	13 $\frac{3}{8}$ "	16 $\frac{3}{8}$ "	3 $\frac{2}{32}$ "

Models

88-2472BF

88-2436BF

	W	L	D
Box Drawers	32 $\frac{3}{16}$ "	16 $\frac{3}{8}$ "	3 $\frac{2}{32}$ "

Models

88-2460BF

	W	L	D
Box Drawers	16 $\frac{1}{2}$ "	16 $\frac{3}{8}$ "	3 $\frac{2}{32}$ "

Models

88-2448BF

	W	L	D
Box Drawers	20 $\frac{15}{16}$ "	16 $\frac{3}{8}$ "	3 $\frac{2}{32}$ "

INTERIOR CABINET DIMENSIONS

Models

88-2496BF

	W	D	H
Double Door	36 $\frac{3}{4}$ "	22 $\frac{3}{8}$ "	23 $\frac{1}{2}$ "
Single Door with Waste Bin	18"	22 $\frac{3}{8}$ "	23 $\frac{1}{2}$ "

Models

88-2484BF

	W	D	H
Double Door	32"	22 $\frac{3}{8}$ "	23 $\frac{1}{2}$ "
Single Door with Waste Bin	15 $\frac{1}{2}$ "	22 $\frac{3}{8}$ "	23 $\frac{1}{2}$ "

Models

88-2472BF

88-2436BF

	W	D	H
Double Door	34 $\frac{3}{8}$ "	22 $\frac{3}{8}$ "	23 $\frac{1}{2}$ "
Single Door with Waste Bin	16 $\frac{3}{4}$ "	22 $\frac{3}{8}$ "	23 $\frac{1}{2}$ "

Models

88-2460BF

	W	D	H
Single Door	18 $\frac{3}{8}$ "	22 $\frac{3}{8}$ "	23 $\frac{1}{2}$ "

Models

88-2448BF

	W	D	H
Double Door	46 $\frac{3}{8}$ "	22 $\frac{3}{8}$ "	23 $\frac{1}{2}$ "
Single Door with Waste Bin	22 $\frac{3}{4}$ "	22 $\frac{3}{8}$ "	23 $\frac{1}{2}$ "

Models

88-2496CC

	W	D	H
Double Door	36 $\frac{3}{4}$ "	22 $\frac{3}{8}$ "	24 $\frac{3}{8}$ "
Single Door with Waste Bin	18"	22 $\frac{3}{8}$ "	24 $\frac{3}{8}$ "

Models

88-2484CC

	W	D	H
Double Door	32"	22 $\frac{3}{8}$ "	24 $\frac{3}{8}$ "
Single Door with Waste Bin	15 $\frac{1}{2}$ "	22 $\frac{3}{8}$ "	24 $\frac{3}{8}$ "

Models

88-2472CC

88-2436BF

	W	D	H
Double Door	34 $\frac{3}{8}$ "	22 $\frac{3}{8}$ "	24 $\frac{3}{8}$ "
Single Door with Waste Bin	16 $\frac{3}{4}$ "	22 $\frac{3}{8}$ "	24 $\frac{3}{8}$ "

Models

88-2460CC

	W	D	H
Single Door with Waste Bin	18 $\frac{3}{8}$ "	22 $\frac{3}{8}$ "	24 $\frac{3}{8}$ "

Models

88-2448CC

	W	D	H
Double Door	46 $\frac{3}{8}$ "	22 $\frac{3}{8}$ "	24 $\frac{3}{8}$ "
Single Door with Waste Bin	22 $\frac{3}{4}$ "	22 $\frac{3}{8}$ "	24 $\frac{3}{8}$ "

Models

88-2096CC

	W	D	H
Double Door	36 $\frac{3}{4}$ "	18 $\frac{3}{8}$ "	24 $\frac{3}{8}$ "
Single Door	17 $\frac{3}{8}$ "	18 $\frac{3}{8}$ "	24 $\frac{3}{8}$ "

Models

88-2084CC

	W	D	H
Double Door	32"	18 $\frac{3}{8}$ "	24 $\frac{3}{8}$ "
Single Door	15 $\frac{1}{2}$ "	18 $\frac{3}{8}$ "	24 $\frac{3}{8}$ "

INTERIOR CABINET DIMENSIONS CONTINUED

Models

	88-2072CC	88-2036CC			
			W	D	H
Single Door			34 $\frac{3}{8}$ "	18 $\frac{3}{8}$ "	24 $\frac{3}{8}$ "

Models

	88-2060CC				
			W	D	H
Single Door			18 $\frac{3}{8}$ "	18 $\frac{3}{8}$ "	24 $\frac{3}{8}$ "

Models

	88-2048CC				
			W	D	H
Double Door			46 $\frac{3}{8}$ "	18 $\frac{3}{8}$ "	24 $\frac{3}{8}$ "

HOW TO ORDER EXAMPLES

SQUARE MEETING TABLE

	QTY	MODEL NO.		EXAMPLE
TOP	1	88-4848SQ	Top/Edge Material Finish/Color Edge Profile Glass Top Glass Color/Surface Finish Power/Data Location	P FO 3MMW/F Y GBLG OC
BASE	1	01-2228STR4	Strut Legs (4 legs) Leg Color	ALUM
POWER	1	01-DUOBEZELS		

MODERN RECTANGLE MEETING TABLES

	QTY	MODEL NO.		EXAMPLE
TOP	1	88-54192MR	Top/Edge Material Top/Edge Finish/Color Edge Profile Glass Top Glass Color/Surface Finish Grommet/Power/Data Type Grommet/Power/Data Location	W MAS 3MMW/F Y GBLG DPORTA OC
BASES	2	01-2228STR4	Strut Legs (4 legs) Leg Color	BLK
POWER	1	DPORTA		

STORAGE & ACCESSORIES

Buffet Credenza

	QTY	MODEL NO.		EXAMPLE
	1	88-2472BF	Top/Edge Material Finish/Color Edge Profile Chassis Finish/Color Glass Top Glass Color/Surface Finish Studio Pull Color Locking Drawer Construction Drawer Track Vent Waste Bin	W MAS 3MMW/F ORW Y GBLG GST LKT_BFD DOVE SFTCL VENT WBL

VENEER (W) OPTIONS ON TOPS / EDGES

Veneer features UVAdvantage, an ultra-violet finish, on all exposed surfaces or our Catalyzed finish (where noted), which is a multi-step, finish process that provides years of lasting beauty.

AW	Artisan Walnut	MW	Mahogany Walnut
AS	Asian Night	MAS	Mesa Sunset*
CO	Columbian Walnut	MTS	Metropolis Sky
DC	Dark Cherry	ORW	Oak Riftwood*
DFW	Dark Forest Walnut	PNW	Pinnacle Walnut
EW	Espresso	SCH	Select Cherry
FO	Fawn Oak*	SKC	Shaker Cherry
GC	Golden Cherry	SM	Sugar Maple
HVM	Harvest Walnut	WTA	Weathered Ash*
HNW	Henna Walnut	WC	Williamsburg Cherry
LW	Legacy Walnut		

* Finish is Low Sheen

TFL (T) OPTIONS FOR CREDENZA TOPS AND HPL (P) LAMINATE OPTIONS ON TOPS / EDGES

WOODGRAIN

AS	Asian Night	PNW	Pinnacle Walnut
BW	Beigewood	PTK	Portico Teak
CO	Columbian Walnut	RC	River Cherry
EF	Espresso	SPW	Seppia Walnut
FLW	Florence Walnut	SKC	Shaker Cherry
GC	Golden Cherry	SCH	Select Cherry
HVM	Harvest Maple	SBP	Smoky Brown Pear
KHE	Kirsche	TK	Studio Teak
MW	Mahogany Walnut	SM	Sugar Maple
MNR	Midnight Run	WTA	Weathered Ash
NTM	Natural Marrone	WC	Williamsburg Cherry
ORW	Oak Riftwood	WNB	White Nebbia

SOLID

BL	Black	FHG	Fashion Grey
WH	Designer White	SG	Slate Grey

EDGE PROFILES

Double Kerf (F), Duo (G), **Fluted (X)**, Square (Y) and Knife (K) edge profiles is 1 3/16" thick and available in Veneer (W) and HPL (P) tops. Vertical Square (H) edge profile available is 1 1/2" thick and also available Veneer (W) and HPL (P) tops. Knife (K) edge not available on buffet and credenzas.

Must specify edge profile.

Laminate (P) Top Edges

3MMP/F	Double Kerf (1 3/16" H)	3MMP/Y	Square (1 3/16" H)
3MMP/G	Duo (1 3/16" H)	RIMP/K	Knife (1 3/16" H)
3MMP/X	Fluted (1 3/16" H)	HP	Vertical Square (1 1/2" H)

Veneer (W) Top Edges

3MMW/F	Double Kerf (1 3/16" H)	3MMW/Y	Square (1 3/16" H)
3MMW/G	Duo (1 3/16" H)	RIMW/K	Knife (1 3/16" H)
3MMW/X	Fluted (1 3/16" H)	HW	Vertical Square (1 1/2" H)

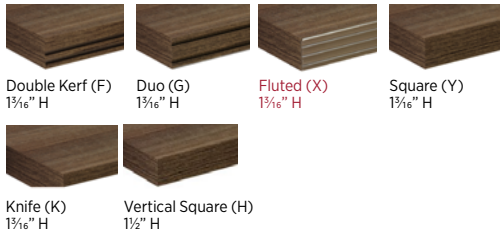

PULL OPTIONS

Buffets and Credenzas available with pulls on doors. Must specify and select color.

Lock core color is predetermined by pull color.

AST	Studio, Aluminum	CST	Studio, Chrome
BST	Studio, Black	GST	Studio, Gold

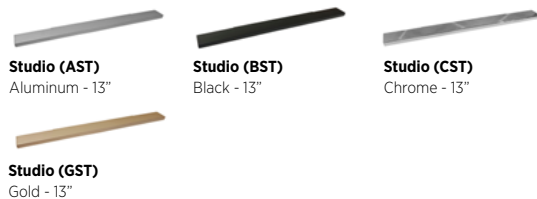

GLASS OPTIONS ON TOPS

Back painted tempered glass tops are 1/4" thick and available in Black or White with Gloss or Acid Etched finish. Glass top sits 1/16" on top of substrate top.

GWHG	White Gloss	GBLG	Black Gloss
GWHA	White Acid Etched	GBLA	Black Acid Etched



White Gloss (GWHG)



Black Gloss (GBLG)

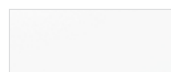

White Acid Etched (GWHA)



Black Acid Etched (GBLA)

LOCK CORE COLOR OPTIONS

BLK	Black (Used with Black and Gold Pulls)
SLV	Silver (Used with Aluminum and Chrome Pulls)

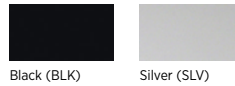

GROMMET & POWER UNIT OPTIONS

Power units and grommets are available on Rectangle, Modern Rectangle, and Boat shaped tops. Each unit is sold separately and must be specified separately with surface mount location. Multiple locations may be selected. Only one unit per location.

Power units and Grommets Available in Table Surfaces (See Units)

Grommet	\$ 52
---------	-------

Specify Color: Black = BLK and Silver = SLV

DUO/TRIO BEZEL

01-DUOBEZEL	Available in Black (B), Silver (S), or White (W)
01-TRIOBEZEL	Available in Black (B), Silver (S), or White (W)

DOCK 950, DOCK 800 and DOCK 150

DOCK950	Available in Black or White
DOCK150	Available in Black or White
DOCK800	Available in Black or Silver

Other Power Units

DPORT4	Available in Aluminum or Black
ELLORA	Available in Aluminum or Black
E2X	Available in Aluminum or Black
INTERACTG	Available in Aluminum or Black
OASISM	Available in Aluminum or Black

Power/Data Location Information:

- Designate unit and location when specifying the top model. Power/Data Module need to be ordered separately.
- Power/Data Modules specified at the time of order will be routed for field installation.

E1	Unit on One End
E2	Unit on Each End
OC	Unit on Center

- 72"W tops available with power units **On Center (OC) only**

Grommets and Power Units may be ordered in non-standard locations. Call Customer Service to assist with specification and/or please attach a drawing to the PO showing the location of the grommet. Note additional charges and lead times may apply.

Top Locations

Power units available on Each End (E1 and E2) and On Center (OC) unless otherwise noted.

Power units centered at locations below:

36" Tops	Centered 18"D	54" Tops	Centered 27"D
42" Tops	Centered 21"D	60" Tops	Centered 30"D
48" Tops	Centered 24"D		

GROMMET OPTIONS & POWER UNIT OPTIONS CONTINUED

Top Locations Continued

- 72: OC 36" from end (available with OC Only)
- 84: OC 42" from end (available with OC Only)
- 96: OC 48" from end; E1/E2 29" from end
- 108 OC 54" from end; E1/E2 29" from end
- 120: OC 60" from end; E1/E2 29" from end
- 132: OC 66" from end; E1/E2 29" from end
- 144: OC 72" from end; E1/E2 29" from end
- 156: OC 78" from end; E1/E2 29" from end
- 168: OC 84" from end; E1/E2 29" from end
- 180: OC 90" from end; E1/E2 36" from end
- 192: OC 96" from end; E1/E2 36" from end
- 204: OC 102" from end; E1/E2 36" from end
- 216: OC 108" from end; E1/E2 36" from end
- 228: OC 114" from end; E1/E2 36" from end
- 240: OC 120" from end; E1/E2 36" from end

Example: 60x204 Modern Rectangle

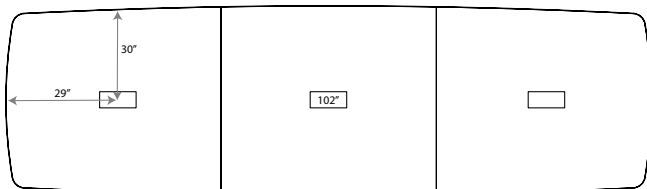

DRAWER TRACK OPTIONS

Soft close tracks are available on box drawers only. Soft close drawer tracks have many benefits including reduced stress on the unit, extends the life of the drawer, and ensures a gentle close so fingers don't accidentally get pinched. Must specify when ordering. **Pricing is per Drawer, not per Model/Unit**

SFTCL	Soft Close Drawer Track	\$	34
-------	-------------------------	----	----

WASTE BIN OPTIONS

Buffet and 24" Credenzas are available with two (2) 41-quart beige waste bins in a pull out cabinet with silver hardware and divider panel. Adjacent cabinet features one (1) adjustable shelf. Studio pulls applied centered on doors when waste bin is selected. Locking not available.

WBL	Waste Bin on Left	\$	510
WBR	Waste Bin on Right	\$	510

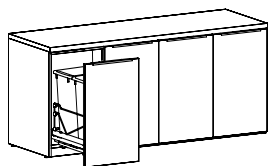

Shown as Left

VENT OPTION FOR CREDENZAS

Buffets and Credenzas feature optional ventilation grommets. Includes one vent per compartment.

Vents are 10" Down from top surface on Buffet Credenzas and 2 7/8" on Credenzas.

NONE	No Vent Grommet		
VENT	Vented back panel	\$	68

Number of vents per unit:

36"	1 vent
72" / 48"	2 vents
96" / 84" / 60"	3 vents

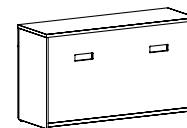

LOCKING DOORS

Locking doors are available on Buffets and Credenzas. You must specify WITH LOCKING when ordering and add upcharge.

Note: When locking is selected with optional waste bin, locking will not apply to waste bin door.

LKT_BFD	96"W to 84"W Units	\$	135
LKT_BFD	72"W to 48"W Units	\$	115
LKT_BFD	36"W Units	\$	91

BASE METAL ACCENT COLOR OPTIONS

6" and 10" Rectangle Accent Bases feature 5/16" metal trim. Must specify color

ALUM	Aluminum	PLAT	Platinum
BLK	Black	GLD	Gold

Tops/Shapes + Bases



Square ([See Details](#))

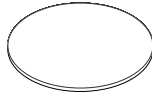

Round ([See Details](#))



Rectangular ([See Details](#))



Modern Rectangular ([See Details](#))



Boat ([See Details](#))

Strut Legs ([See Details](#))

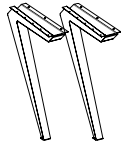

Set of 2 legs

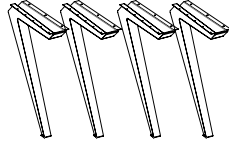

Set of 4 legs

Storage Components + Accessories

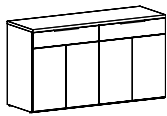

Buffet with Doors + Drawers
([See Details](#))

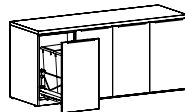

24" + 20" Credenzas with Doors
([See Details](#))

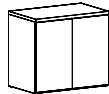

Mobile Serving Cart
([See Details](#))

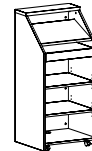

Lectern Stand
([See Details](#))

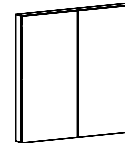

Visual Board
([See Details](#))

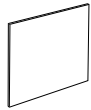
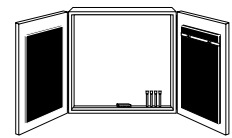

Marker Boards
([See Multiple Unit Details](#))



Marker, Eraser and Magnet
Sets ([See Details](#))

Wire Management + Power/Data Accessories ([See Details](#))

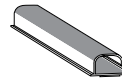
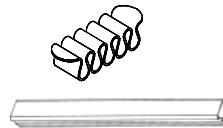
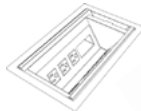
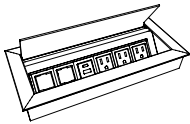

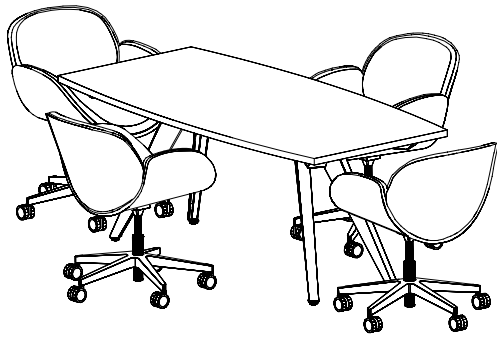
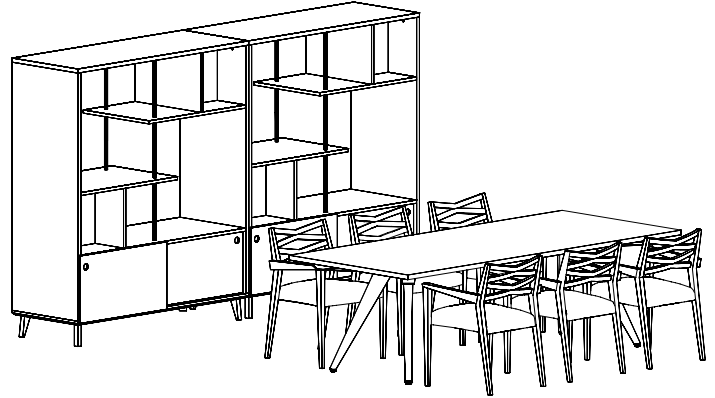
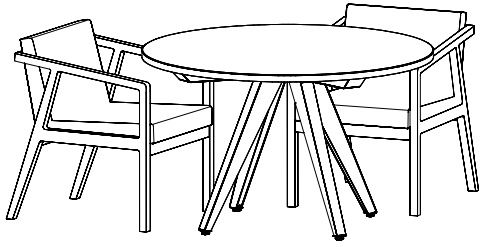

Item	Model No.		W	D	H	Ship Wt	Cubic Ft	Edge Profile + Material	List Price
 <p>88-4242SQ Shown BASES SOLD SEPARATELY</p> <p><u>Must Specify (in this order):</u> Model # Top/Edge Material Top/Edge Finish/Color Edge Profile Glass (Y/N) Glass Color + Surface Finish Power/Data Power/Data Location</p>	88-4848SQ	Laminate	48	48	1 ³ / ₁₆	82	7.2	F, G, X, Y / P\$	850
					1 ³ / ₁₆			K / P\$	1398
					1 ¹ / ₂			H / P\$	948
		Veneer	1 ³ / ₁₆	F, G, X, Y / W\$	967				
			1 ³ / ₁₆	K / W\$	1620				
			1 ¹ / ₂	H / W\$	1146				
	Glass	1 ¹ / ₄	Acid Etched Glass Top \$	5455					
		1 ¹ / ₄	Gloss Glass Top \$	4541					
	88-4242SQ	Laminate	42	42	1 ³ / ₁₆	70	3.4	F, G, X, Y / P\$	757
					1 ³ / ₁₆			K / P\$	1215
					1 ¹ / ₂			H / P\$	875
		Veneer	1 ³ / ₁₆	F, G, X, Y / W\$	866				
1 ³ / ₁₆			K / W\$	1468					
1 ¹ / ₂			H / W\$	962					
Glass	1 ¹ / ₄	Acid Etched Glass Top \$	4396						
	1 ¹ / ₄	Gloss Glass Top \$	3695						

Description

- Tops Feature a 1-piece, 1³/₁₆" or 1¹/₂" Thick Top in Veneer (W) or HPL (P)
- Must Specify Edge Profile: 1³/₁₆" Thick/Double Kerf (F), Duo (G), Fluted (X), Square (Y), and Knife (K) Edge Profiles or 1¹/₂" Thick/Vertical Square (H)
- Due to Top Sizes and Base Placement, Power is Not Available on Square Tops
- Available with Back Painted Tempered Glass Top; Must Specify Color and Finish; [See Options](#)
- Strut Legs Sold Separately, See [Multiple Base Options](#)



Double Kerf (F)
1³/₁₆"



Duo (G)
1³/₁₆"



Fluted (X)
1³/₁₆"



Square (Y)
1³/₁₆"



Knife (K)
1³/₁₆"



Vertical Square (H)
1¹/₂"

P = HPL W = Veneer

[See Strut Overview For Ordering Options](#)

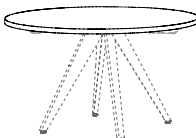
Item	Model No.		W	D	H	Ship Wt	Cubic Ft	Edge Profile + Material	List Price		
 <p>88-4848CT Shown BASES SOLD SEPARATELY</p>	88-6060CT	Laminate	60	60	1 $\frac{3}{16}$ "	143	8.4	F, G, X, Y / P\$	1037		
					1 $\frac{3}{16}$ "			K / P\$	2195		
					1 $\frac{1}{2}$ "			H / P\$	1085		
		Veneer	1 $\frac{3}{16}$ "	F, G, X, Y / W\$	1406						
			1 $\frac{3}{16}$ "	K / W\$	2461						
			1 $\frac{1}{2}$ "	H / W\$	1662						
			Glass	1 $\frac{1}{4}$ "	Acid Etched Glass Top \$	8681					
				1 $\frac{1}{4}$ "	Gloss Glass Top \$	7210					
			<p><u>Must Specify (in this order):</u> Model # Top/Edge Material Top/Edge Finish/Color Edge Profile Glass (Y/N) Glass Color + Surface Finish Power/Data Type Power/Data Location</p>	88-5454CT	Laminate	54	54	1 $\frac{3}{16}$ "	114	6.8	F, G, X, Y / P\$
		1 $\frac{3}{16}$ "						K / P\$			2003
1 $\frac{1}{2}$ "	H / P\$	1033									
Veneer	1 $\frac{3}{16}$ "	F, G, X, Y / W\$			1248						
	1 $\frac{3}{16}$ "	K / W\$			2190						
	1 $\frac{1}{2}$ "	H / W\$			1460						
	Glass	1 $\frac{1}{4}$ "			Acid Etched Glass Top \$	7267					
		1 $\frac{1}{4}$ "			Gloss Glass Top \$	6073					
	88-4848CT	Laminate			48	48	1 $\frac{3}{16}$ "	90	5.5	F, G, X, Y / P\$	904
1 $\frac{3}{16}$ "							K / P\$			1894	
1 $\frac{1}{2}$ "			H / P\$	930							
Veneer		1 $\frac{3}{16}$ "	F, G, X, Y / W\$	1024							
		1 $\frac{3}{16}$ "	K / W\$	2130							
		1 $\frac{1}{2}$ "	H / W\$	1195							
		Glass	1 $\frac{1}{4}$ "	Acid Etched Glass Top \$	6064						
			1 $\frac{1}{4}$ "	Gloss Glass Top \$	5122						

Description

- Tops Feature a 1-piece, 1 $\frac{3}{16}$ " or 1 $\frac{1}{2}$ " Thick Top in Veneer (W) or HPL (P)
- Must Specify Edge Profile: 1 $\frac{3}{16}$ " Thick/Double Kerf (F), Duo (G), **Fluted (X)**, Square (Y), and Knife (K) Edge Profiles or 1 $\frac{1}{2}$ " Thick/Vertical Square (H)
- Due to Top Sizes and Base Placement, Power is Not Available on Round Tops
- Available with Back Painted Tempered Glass Top; Must Specify Color and Finish; [See Options](#)
- 60" and 54" Tops Feature Catalyzed Finish
- Strut Legs Sold Separately, See [Multiple Base Options](#)



Double Kerf (F)
1 $\frac{3}{16}$ "



Duo (G)
1 $\frac{3}{16}$ "



Fluted (X)
1 $\frac{3}{16}$ "



Square (Y)
1 $\frac{3}{16}$ "



Knife (K)
1 $\frac{3}{16}$ "



Vertical Square (H)
1 $\frac{1}{2}$ "

P = HPL W = Veneer

[See Strut Overview For Ordering Options](#)

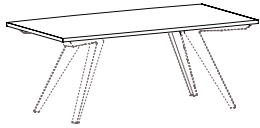
Item	Model No.		W	D	H	Ship Wt	Cubic Ft	Edge Profile + Material	List Price	
RECTANGLE SHAPE MEETING TOP 36"D  88-3672RT Shown BASES SOLD SEPARATELY	36"D x 96"W or 8' - 1 Piece Rectangle Top									
	88-3696RT	Laminate	96	36	1 3/16"	142	12.9	F, G, X, Y / P\$	1364	
					1 3/16"			K / P\$	2150	
					1 1/2"			H / P\$	1547	
		Veneer			1 3/16"			F, G, X, Y / W\$	1544	
					1 3/16"			K / W\$	2556	
					1 1/2"			H / W\$	1858	
		Glass			1/4"			Acid Etched Glass Top \$	8134	
					1/4"			Gloss Glass Top \$	6806	
	36"D x 84"W or 7' - 1 Piece Rectangle Top									
	88-3684RT	Laminate	84	36	1 3/16"	126	11.3	F, G, X, Y / P\$	1299	
					1 3/16"			K / P\$	2006	
					1 1/2"			H / P\$	1489	
		Veneer			1 3/16"			F, G, X, Y / W\$	1462	
					1 3/16"			K / W\$	2437	
				1 1/2"			H / W\$	1707		
	Glass			1/4"			Acid Etched Glass Top \$	7313		
				1/4"			Gloss Glass Top \$	6151		
36"D x 72"W or 6' - 1 Piece Rectangle Top										
88-3672RT	Laminate	72	36	1 3/16"	109	10.3	F, G, X, Y / P\$	1052		
				1 3/16"			K / P\$	1695		
				1 1/2"			H / P\$	1188		
	Veneer			1 3/16"			F, G, X, Y / W\$	1238		
				1 3/16"			K / W\$	1957		
				1 1/2"			H / W\$	1478		
	Glass			1/4"			Acid Etched Glass Top \$	6321		
				1/4"			Gloss Glass Top \$	5324		

Description

- Tops Available with Veneer (W) or HPL (P) Top in 1 3/16" and 1 1/2" Thicknesses
- Must Specify Edge Profile: 1 3/16" Thick/Double Kerf (F), Duo (G), **Fluted (X)**, Square (Y), and Knife (K) Edge Profiles or 1 1/2" Thick/Vertical Square (H)
- Veneer (W) Top Grain Runs Depth of Top and HPL (P) Top Grain Runs Width of Top
- Available with Back Painted Tempered Glass Top; Must Specify Color and Finish; [See Options](#)
- Strut Legs Sold Separately, [See Strut Legs](#)



Double Kerf (F)
1 3/16"



Duo (G)
1 3/16"



Fluted (X)
1 3/16"



Square (Y)
1 3/16"



Knife (K)
1 3/16"



Vertical Square (H)
1 1/2"

P = HPL W = Veneer

[See Strut Overview For Ordering Options](#)

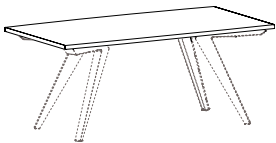
Item	Model No.		W	D	H	Ship Wt	Cubic Ft	Edge Profile + Material	List Price	
RECTANGLE SHAPE MEETING TOP 42"D  88-4272RT Shown BASES SOLD SEPARATELY	42"D x 96"W or 8' - 1 Piece Rectangle Top									
	88-4296RT	Laminate	96	42	1 3/16	164	15.0	F, G, X, Y / P\$	1393	
					1 3/16			K / P\$	2337	
					1 1/2			H / P\$	1608	
		Veneer			1 3/16			F, G, X, Y / W\$	1685	
					1 3/16			K / W\$	2697	
					1 1/2			H / W\$	2042	
		Glass			1/4			Acid Etched Glass Top \$	8955	
					1/4			Gloss Glass Top \$	7405	
	42"D x 84"W or 7' - 1 Piece Rectangle Top									
	88-4284RT	Laminate	84	42	1 3/16	145	13.1	F, G, X, Y / P\$	1355	
					1 3/16			K / P\$	2174	
				1 1/2			H / P\$	1542		
	Veneer			1 3/16			F, G, X, Y / W\$	1551		
				1 3/16			K / W\$	2567		
				1 1/2			H / W\$	1867		
	Glass			1/4			Acid Etched Glass Top \$	8002		
				1/4			Gloss Glass Top \$	6647		
42"D x 72"W or 6' - 1 Piece Rectangle Top										
88-4272RT	Laminate	72	42	1 3/16	126	11.3	F, G, X, Y / P\$	1125		
				1 3/16			K / P\$	1906		
				1 1/2			H / P\$	1285		
	Veneer			1 3/16			F, G, X, Y / W\$	1408		
				1 3/16			K / W\$	2134		
				1 1/2			H / W\$	1681		
	Glass			1/4			Acid Etched Glass Top \$	7015		
				1/4			Gloss Glass Top \$	5853		

Must Specify (in this order):

- Model #
- Top/Edge Material
- Top/Edge Finish/Color
- Edge Profile
- Glass (Y/N)
- Glass Color + Surface Finish
- Power/Data Type
- Power/Data Location

Description

- Tops Available with Veneer (W) or HPL (P) Top in 1 3/16" and 1 1/2" Thicknesses
- Must Specify Edge Profile: 1 3/16" Thick/Double Kerf (F), Duo (G), **Fluted (X)**, Square (Y), and Knife (K) Edge Profiles or 1 1/2" Thick/Vertical Square (H)
- Veneer (W) Top Grain Runs Depth of Top and HPL (P) Top Grain Runs Width of Top
- Available with Back Painted Tempered Glass Top; Must Specify Color and Finish; [See Options](#)
- Power and Data Options Available; Sold Separately, [See Multiple Power Unit Details](#)
- Strut Legs Sold Separately, [See Strut Legs](#)



Double Kerf (F)
1 3/16"



Duo (G)
1 3/16"



Fluted (X)
1 3/16"



Square (Y)
1 3/16"



Knife (K)
1 3/16"



Vertical Square (H)
1 1/2"

P = HPL W = Veneer

[See Strut Overview For Ordering Options](#)

Item	Model No.		W	D	H	Ship Wt	Cubic Ft	Edge Profile + Material	List Price	
RECTANGLE SHAPE MEETING TOP 48" D  <p>88-48216RT Shown BASES SOLD SEPARATELY</p>	48"D x 240"W or 20' - 3 Piece Rectangle Top									
	88-48240RT	Laminate	240	48	1 3/16	460	28.5	F, G, X, Y / P\$	4463	
					1 3/16			K / P\$	7279	
					1 1/2			H / P\$	5088	
		Veneer			1 3/16			F, G, X, Y / W\$	6000	
					1 3/16			K / W\$	8081	
					1 1/2			H / W\$	6974	
		Glass			1/4			Acid Etched Glass Top \$	24958	
					1/4			Gloss Glass Top \$	20531	
	48"D x 228"W or 19' - 3 Piece Rectangle Top									
	88-48228RT	Laminate	228	48	1 3/16	438	27.0	F, G, X, Y / P\$	4419	
					1 3/16			K / P\$	7144	
				1 1/2			H / P\$	5015		
	Veneer			1 3/16			F, G, X, Y / W\$	5743		
				1 3/16			K / W\$	7825		
				1 1/2			H / W\$	6670		
	Glass			1/4			Acid Etched Glass Top \$	23871		
				1/4			Gloss Glass Top \$	19666		
48"D x 216"W or 18' - 3 Piece Rectangle Top										
88-48216RT	Laminate	216	48	1 3/16	416	25.5	F, G, X, Y / P\$	3513		
				1 1/2			K / P\$	5875		
				1 3/16			H / P\$	4077		
	Veneer			1 3/16			F, G, X, Y / W\$	5081		
				1 3/16			K / W\$	6624		
				1 1/2			H / W\$	5961		
	Glass			1/4			Acid Etched Glass Top \$	22339		
				1/4			Gloss Glass Top \$	18355		
48"D x 204"W or 17' - 3 Piece Rectangle Top										
88-48204RT	Laminate	204	48	1 3/16	394	24.0	F, G, X, Y / P\$	3470		
				1 3/16			K / P\$	5739		
				1 1/2			H / P\$	4002		
	Veneer			1 3/16			F, G, X, Y / W\$	4824		
				1 3/16			K / W\$	6599		
				1 1/2			H / W\$	5657		
	Glass			1/4			Acid Etched Glass Top \$	21427		
				1/4			Gloss Glass Top \$	17664		

Additional 48" Rectangle Shaped Tops on Next Page

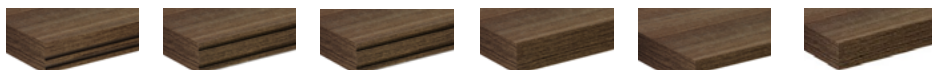

Double Kerf (F) 1 3/16" Duo (G) 1 3/16" Fluted (X) 1 3/16" Square (Y) 1 3/16" Knife (K) 1 3/16" Vertical Square (H) 1 1/2"

P = HPL W = Veneer

[See Strut Overview For Ordering Options](#)

Item	Model No.		W	D	H	Ship Wt	Cubic Ft	Edge Profile + Material	List Price	
48"D x 192"W or 16' - 2 Piece Rectangle Top										
<i>CONTINUED FROM PREVIOUS PAGE</i>	88-48192RT	Laminate	192	48	1 ³ / ₁₆	372	31.2	F, G, X, Y / P\$	3002	
					1 ³ / ₁₆			K / P\$	5173	
					1 ¹ / ₂			H / P\$	3500	
	Veneer	1 ³ / ₁₆	F, G, X, Y / W\$	4079						
		1 ³ / ₁₆	K / W\$	5673						
		1 ¹ / ₂	H / W\$	4861						
	Glass		1 ¹ / ₄	Acid Etched Glass Top \$	19497					
			1 ¹ / ₄	Gloss Glass Top \$	15957					
	48"D x 180"W or 15' - 2 Piece Rectangle Top									
	<i>Must Specify (in this order):</i> Model # Top/Edge Material Top/Edge Finish/Color Edge Profile Glass (Y/N) Glass Color + Surface Finish Power/Data Power/Data Location	88-48180RT	Laminate	180	48	1 ³ / ₁₆	350	31.2	F, G, X, Y / P\$	2959
						1 ³ / ₁₆			K / P\$	4936
						1 ¹ / ₂			H / P\$	3427
Veneer		1 ³ / ₁₆	F, G, X, Y / W\$	3910						
		1 ³ / ₁₆	K / W\$	5556						
		1 ¹ / ₂	H / W\$	4646						
Glass			1 ¹ / ₄	Acid Etched Glass Top \$	18411					
			1 ¹ / ₄	Gloss Glass Top \$	15091					
48"D x 168"W or 14' - 2 Piece Rectangle Top										
		88-48168RT	Laminate	168	48	1 ³ / ₁₆	328	31.2	F, G, X, Y / P\$	2808
						1 ³ / ₁₆			K / P\$	4653
						1 ¹ / ₂			H / P\$	3245
	Veneer	1 ³ / ₁₆	F, G, X, Y / W\$	3604						
		1 ³ / ₁₆	K / W\$	5242						
		1 ¹ / ₂	H / W\$	4292						
	Glass		1 ¹ / ₄	Acid Etched Glass Top \$	17213					
			1 ¹ / ₄	Gloss Glass Top \$	14114					
	48"D x 156"W or 13' - 2 Piece Rectangle Top									
		88-48156RT	Laminate	156	48	1 ³ / ₁₆	306	31.2	F, G, X, Y / P\$	2766
						1 ³ / ₁₆			K / P\$	4505
						1 ¹ / ₂			H / P\$	3171
Veneer		1 ³ / ₁₆	F, G, X, Y / W\$	3435						
		1 ³ / ₁₆	K / W\$	5043						
		1 ¹ / ₂	H / W\$	4077						
Glass			1 ¹ / ₄	Acid Etched Glass Top \$	16126					
			1 ¹ / ₄	Gloss Glass Top \$	13249					

Additional 48" Rectangle Shaped Tops on Next Page



Double Kerf (F)
1³/₁₆"



Duo (G)
1³/₁₆"



Fluted (X)
1³/₁₆"



Square (Y)
1³/₁₆"



Knife (K)
1³/₁₆"



Vertical Square (H)
1¹/₂"

P = HPL W = Veneer

[See Strut Overview For Ordering Options](#)

Item	Model No.		W	D	H	Ship Wt	Cubic Ft	Edge Profile + Material	List Price	
<i>CONTINUED FROM PREVIOUS PAGE</i>	48"D x 144"W or 12' - 2 Piece Rectangle Top									
	88-48144RT	Laminate	144	48	1 3/16	284	23.5	F, G, X, Y / P\$	2304	
					1 3/16			K / P\$	3924	
					1 1/2			H / P\$	2678	
		Veneer			1 3/16			F, G, X, Y / W\$	3197	
					1 3/16			K / W\$	4389	
					1 1/2			H / W\$	3792	
		Glass			1/4			Acid Etched Glass Top \$	15016	
					1/4			Gloss Glass Top \$	12360	
	48"D x 132"W or 11' - 2 Piece Rectangle Top									
	88-48132RT	Laminate	132	48	1 3/16	262	23.5	F, G, X, Y / P\$	2248	
					1 3/16			K / P\$	3775	
					1 1/2			H / P\$	2591	
		Veneer			1 3/16			F, G, X, Y / W\$	2975	
					1 3/16			K / W\$	4144	
					1 1/2			H / W\$	3522	
		Glass			1/4			Acid Etched Glass Top \$	13917	
					1/4			Gloss Glass Top \$	11481	
48"D x 120"W or 10' - 2 Piece Rectangle Top										
88-48120RT	Laminate	120	48	1 3/16	240	23.5	F, G, X, Y / P\$	2183		
				1 3/16			K / P\$	3529		
				1 1/2			H / P\$	2493		
	Veneer			1 3/16			F, G, X, Y / W\$	2741		
				1 3/16			K / W\$	3975		
				1 1/2			H / W\$	3241		
	Glass			1/4			Acid Etched Glass Top \$	12806		
				1/4			Gloss Glass Top \$	10593		
48"D x 108"W or 9' - 2 Piece Rectangle Top										
88-48108RT	Laminate	108	48	1 3/16	218	23.5	F, G, X, Y / P\$	2126		
				1 3/16			K / P\$	3361		
				1 1/2			H / P\$	2406		
	Veneer			1 3/16			F, G, X, Y / W\$	2518		
				1 3/16			K / W\$	3756		
				1 1/2			H / W\$	2970		
	Glass			1/4			Acid Etched Glass Top \$	11706		
				1/4			Gloss Glass Top \$	9715		

Additional 48" Rectangle Shaped Tops on Next Page

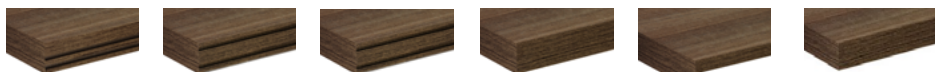

Double Kerf (F) 1 3/16" Duo (G) 1 3/16" Fluted (X) 1 3/16" Square (Y) 1 3/16" Knife (K) 1 3/16" Vertical Square (H) 1 1/2"

P = HPL W = Veneer

[See Strut Overview For Ordering Options](#)

Item	Model No.		W	D	H	Ship Wt	Cubic Ft	Edge Profile + Material	List Price	
48"D x 96"W or 8' - 1 Piece Rectangle Top										
CONTINUED FROM PREVIOUS PAGE	88-4896RT	Laminate	96	48	1 3/16"	196	11.3	F, G, X, Y / P\$	1469	
					1 3/16"			K / P\$	2549	
					1 1/2"			H / P\$	1715	
	Veneer	1 3/16"	F, G, X, Y / W\$	1883						
		1 3/16"	K / W\$	2867						
		1 1/2"	H / W\$	2284						
	Glass	1/4"	Acid Etched Glass Top \$	10062						
		1/4"	Gloss Glass Top \$	8291						
	48"D x 84"W or 7' - 1 Piece Rectangle Top									
		88-4884RT	Laminate	84	48	1 3/16"	174	10.0	F, G, X, Y / P\$	1426
1 3/16"						K / P\$			2299	
1 1/2"						H / P\$			1640	
Veneer		1 3/16"	F, G, X, Y / W\$	1658						
		1 3/16"	K / W\$	2650						
		1 1/2"	H / W\$	2013						
Glass		1/4"	Acid Etched Glass Top \$	8910						
		1/4"	Gloss Glass Top \$	7361						
48"D x 72"W or 6' - 1 Piece Rectangle Top										
		88-4872RT	Laminate	72	48	1 3/16"	152	8.6	F, G, X, Y / P\$	1192
	1 3/16"					K / P\$			2048	
	1 1/2"					H / P\$			1376	
	Veneer	1 3/16"	F, G, X, Y / W\$	1569						
		1 3/16"	K / W\$	2307						
		1 1/2"	H / W\$	1876						
	Glass	1/4"	Acid Etched Glass Top \$	7859						
		1/4"	Gloss Glass Top \$	6531						

Must Specify (in this order):

- Model #
- Top/Edge Material
- Top/Edge Finish/Color
- Edge Profile
- Glass (Y/N)
- Glass Color + Surface Finish
- Power/Data
- Power/Data Location

Description

- Tops Available with Veneer (W) or HPL (P) Top in 1 3/16" and 1 1/2" Thicknesses
- Must Specify Edge Profile: 1 3/16" Thick/Double Kerf (F), Duo (G), Fluted (X), Square (Y), and Knife (K) Edge Profiles or 1 1/2" Thick/Vertical Square (H)
- Veneer (W) Top Grain Runs Depth of Top and HPL (P) Top Grain Runs Width of Top
- All Veneer Tops, as well as Laminate Tops up to 144" (12 feet), have Matching Woodgrain. Laminate Tops Sized 156" (13 feet) and Longer have Non-Matching Woodgrain
- Available with Back Painted Tempered Glass Top; Must Specify Color and Finish; [See Options](#)
- Power and Data Options Available; Sold Separately, [See Multiple Power Unit Details](#)
- Dock800, Oasis, and E2X Power Units Available on Ends Only (E1 and E2) for 108"D - 156"D and 204"D-240"D Tops
- Strut Legs Sold Separately, [See Strut Legs](#)



Double Kerf (F)
1 3/16"



Duo (G)
1 3/16"



Fluted (X)
1 3/16"



Square (Y)
1 3/16"



Knife (K)
1 3/16"



Vertical Square (H)
1 1/2"

P = HPL W = Veneer

[See Strut Overview For Ordering Options](#)

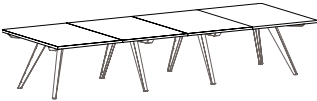
Item	Model No.		W	D	H	Ship Wt	Cubic Ft	Edge Profile + Material	List Price	
RECTANGLE SHAPE MEETING TOP 54"D  88-54156RT Shown in Veneer BASES SOLD SEPARATELY	54"D x 240"W or 20' - 5 Piece Veneer (W) and 3 Piece HPL (P) Rectangle Top									
	88-54240RT	Laminate	240	54	1 3/16	519	24.0	F, G, X, Y / P\$	4515	
					1 3/16			K / P\$	7566	
					1 1/2			H / P\$	5221	
		Veneer			1 3/16			F, G, X, Y / W\$	7573	
					1 3/16			K / W\$	9727	
					1 1/2			H / W\$	8862	
		Glass			1/4			Acid Etched Glass Top \$	27961	
					1/4			Gloss Glass Top \$	22981	
	54"D x 228"W or 19' - 5 Piece Veneer (W) and 3 Piece HPL (P) Rectangle Top									
	88-54228RT	Laminate	228	54	1 3/16	495	23.0	F, G, X, Y / P\$	4467	
					1 3/16			K / P\$	7418	
				1 1/2			H / P\$	5139		
	Veneer			1 3/16			F, G, X, Y / W\$	7340		
				1 3/16			K / W\$	9434		
				1 1/2			H / W\$	8576		
	Glass			1/4			Acid Etched Glass Top \$	26742		
				1/4			Gloss Glass Top \$	22011		
54"D x 216"W or 18' - 5 Piece Veneer (W) and 3 Piece HPL (P) Rectangle Top										
88-54216RT	Laminate	216	54	1 3/16	470	22.0	F, G, X, Y / P\$	3873		
				1 3/16			K / P\$	6460		
				1 1/2			H / P\$	4508		
	Veneer			1 3/16			F, G, X, Y / W\$	7107		
				1 3/16			K / W\$	9142		
				1 1/2			H / W\$	8291		
	Glass			1/4			Acid Etched Glass Top \$	25472		
				1/4			Gloss Glass Top \$	20991		
54"D x 204"W or 17' - 5 Piece Veneer (W) and 3 Piece HPL (P) Rectangle Top										
88-54204RT	Laminate	204	54	1 3/16	445	21.0	F, G, X, Y / P\$	3826		
				1 3/16			K / P\$	6312		
				1 1/2			H / P\$	4427		
	Veneer			1 3/16			F, G, X, Y / W\$	6874		
				1 3/16			K / W\$	8849		
				1 1/2			H / W\$	8007		
	Glass			1/4			Acid Etched Glass Top \$	24254		
				1/4			Gloss Glass Top \$	20021		

Additional 54" Rectangle Shaped Tops on Next Page



Double Kerf (F)
1 3/16"



Duo (G)
1 3/16"



Fluted (X)
1 3/16"



Square (Y)
1 3/16"



Knife (K)
1 3/16"



Vertical Square (H)
1 1/2"

P = HPL W = Veneer

[See Strut Overview For Ordering Options](#)

Item	Model No.		W	D	H	Ship Wt	Cubic Ft	Edge Profile + Material	List Price		
<i>CONTINUED FROM PREVIOUS PAGE</i>	54"D x 192"W or 16' - 4 Piece Veneer (W) and 2 Piece HPL (P) Rectangle Top										
	88-54192RT	Laminate	192	54	1 3/16"	408	19.0	F, G, X, Y / P\$	3168		
					1 3/16"			K / P\$	5542		
					1 1/2"			H / P\$	3732		
		Veneer			1 3/16"			F, G, X, Y / W\$	5654		
					1 3/16"			K / W\$	7438		
					1 1/2"			H / W\$	6532		
		Glass			1/4"			Acid Etched Glass Top \$	22145		
					1/4"			Gloss Glass Top \$	18160		
		54"D x 180"W or 15' - 4 Piece Veneer (W) and 2 Piece HPL (P) Rectangle Top									
	88-54180RT	Laminate	180	54	1 3/16"	384	18.0	F, G, X, Y / P\$	3122		
					1 3/16"			K / P\$	5393		
					1 1/2"			H / P\$	3649		
		Veneer			1 3/16"			F, G, X, Y / W\$	5440		
					1 3/16"			K / W\$	7163		
					1 1/2"			H / W\$	6265		
		Glass			1/4"			Acid Etched Glass Top \$	20926		
					1/4"			Gloss Glass Top \$	17191		
	54"D x 168"W or 14' - 4 Piece Veneer (W) and 2 Piece HPL (P) Rectangle Top										
88-54168RT	Laminate	168	54	1 3/16"	359	17.0	F, G, X, Y / P\$	3075			
				1 3/16"			K / P\$	5245			
				1 1/2"			H / P\$	3568			
	Veneer			1 3/16"			F, G, X, Y / W\$	5226			
				1 3/16"			K / W\$	6889			
				1 1/2"			H / W\$	5998			
	Glass			1/4"			Acid Etched Glass Top \$	19707			
				1/4"			Gloss Glass Top \$	16222			
	54"D x 156"W or 13' - 4 Piece Veneer (W) and 2 Piece HPL (P) Rectangle Top										
88-54156RT	Laminate	156	54	1 3/16"	334	16.0	F, G, X, Y / P\$	3028			
				1 3/16"			K / P\$	5096			
				1 1/2"			H / P\$	3485			
	Veneer			1 3/16"			F, G, X, Y / W\$	5011			
				1 3/16"			K / W\$	6615			
				1 1/2"			H / W\$	5732			
	Glass			1/4"			Acid Etched Glass Top \$	18489			
				1/4"			Gloss Glass Top \$	15253			

Must Specify (in this order):
 Model #
 Top/Edge Material
 Top/Edge Finish/Color
 Edge Profile
 Glass (Y/N)
 Glass Color + Surface Finish
 Power/Data Type
 Power/Data Location

Additional 54" Rectangle Shaped Tops on Next Page



Double Kerf (F)
1 3/16"



Duo (G)
1 3/16"



Fluted (X)
1 3/16"



Square (Y)
1 3/16"



Knife (K)
1 3/16"



Vertical Square (H)
1 1/2"

P = HPL W = Veneer

[See Strut Overview For Ordering Options](#)

Item	Model No.		W	D	H	Ship Wt	Cubic Ft	Edge Profile + Material	List Price	
<i>CONTINUED FROM PREVIOUS PAGE</i>	54"D x 144"W or 12' - 3 Piece Veneer (W) and 2 Piece HPL (P) Rectangle Top									
	88-54144RT	Laminate	144	54	1 3/16	309	15.0	F, G, X, Y / P\$	2557	
					1 3/16			K / P\$	4349	
					1 1/2			H / P\$	2980	
		Veneer			1 3/16			F, G, X, Y / W\$	4061	
					1 3/16			K / W\$	5474	
					1 1/2			H / W\$	4724	
		Glass			1/4			Acid Etched Glass Top \$	17401	
					1/4			Gloss Glass Top \$	14413	
		54"D x 132"W or 11' - 3 Piece Veneer (W) and 2 Piece HPL (P) Rectangle Top								
	88-54132RT	Laminate	132	54	1 3/16	285	13.2	F, G, X, Y / P\$	2497	
					1 3/16			K / P\$	4188	
				1 1/2			H / P\$	2884		
	Veneer			1 3/16			F, G, X, Y / W\$	3866		
				1 3/16			K / W\$	5218		
				1 1/2			H / W\$	4476		
	Glass			1/4			Acid Etched Glass Top \$	16170		
				1/4			Gloss Glass Top \$	13430		
	54"D x 120"W or 10' - 3 Piece Veneer (W) and 2 Piece HPL (P) Rectangle Top									
88-54120RT	Laminate	120	54	1 3/16	260	12.1	F, G, X, Y / P\$	2436		
				1 3/16			K / P\$	4026		
				1 1/2			H / P\$	2788		
	Veneer			1 3/16			F, G, X, Y / W\$	3670		
				1 3/16			K / W\$	4963		
				1 1/2			H / W\$	4229		
	Glass			1/4			Acid Etched Glass Top \$	14938		
				1/4			Gloss Glass Top \$	12448		

Must Specify (in this order):

- Model #
- Top/Edge Material
- Top/Edge Finish/Color
- Edge Profile
- Glass (Y/N)
- Glass Color + Surface Finish
- Power/Data
- Power/Data Location

Description

- Tops Available with Veneer (W) or HPL (P) Top in 1 3/16" and 1 1/2" Thicknesses
- Must Specify Edge Profile: 1 3/16" Thick/Double Kerf (F), Duo (G), Fluted (X), Square (Y), and Knife (K) Edge Profiles or 1 1/2" Thick/Vertical Square (H)
- Veneer (W) Top Grain Runs Depth of Top and HPL (P) Top Grain Runs Width of Top
- All Veneer Tops, as well as Laminate Tops up to 144" (12 feet), have Matching Woodgrain. Laminate Tops Sized 156" (13 feet) and Longer have Non-Matching Woodgrain
- Available with Back Painted Tempered Glass Top; Must Specify Color and Finish; [See Options](#)
- Power and Data Options Available; Sold Separately, [See Multiple Power Unit Details](#)
- Strut Legs Sold Separately, [See Strut Legs](#)



Double Kerf (F)
1 3/16"



Duo (G)
1 3/16"



Fluted (X)
1 3/16"



Square (Y)
1 3/16"



Knife (K)
1 3/16"



Vertical Square (H)
1 1/2"

P = HPL W = Veneer

[See Strut Overview For Ordering Options](#)

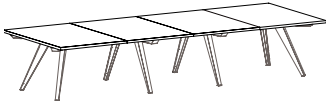
Item	Model No.		W	D	H	Ship Wt	Cubic Ft	Edge Profile + Material	List Price
RECTANGLE SHAPE MEETING TOP 60"D  88-60156RT Shown in Veneer BASES SOLD SEPARATELY	60"D x 240"W or 20' - 5 Piece Veneer (W) and 3 Piece HPL (P) Rectangle Top								
	88-60240RT	Laminate	240	60	1 3/16	574	26.3	F, G, X, Y / P\$	4603
					1 3/16			K / P\$	7839
					1 1/2			H / P\$	5390
	Veneer				1 3/16			F, G, X, Y / W\$	8087
					1 3/16			K / W\$	10324
					1 1/2			H / W\$	9485
	Glass				1/4			Acid Etched Glass Top \$	30611
					1/4			Gloss Glass Top \$	25078
	60"D x 228"W or 19' - 5 Piece Veneer (W) and 3 Piece HPL (P) Rectangle Top								
	88-60228RT	Laminate	228	60	1 3/16	547	25.0	F, G, X, Y / P\$	4552
					1 3/16			K / P\$	7678
					1 1/2			H / P\$	5300
	Veneer				1 3/16			F, G, X, Y / W\$	7830
					1 3/16			K / W\$	10003
				1 1/2			H / W\$	9168	
Glass				1/4			Acid Etched Glass Top \$	29260	
				1/4			Gloss Glass Top \$	24005	
60"D x 216"W or 18' - 5 Piece Veneer (W) and 3 Piece HPL (P) Rectangle Top									
88-60216RT	Laminate	216	60	1 3/16	519	23.7	F, G, X, Y / P\$	3953	
				1 3/16			K / P\$	6708	
				1 1/2			H / P\$	4662	
Veneer				1 3/16			F, G, X, Y / W\$	7571	
				1 3/16			K / W\$	9681	
				1 1/2			H / W\$	8852	
Glass				1/4			Acid Etched Glass Top \$	27859	
				1/4			Gloss Glass Top \$	22880	
60"D x 204"W or 17' - 5 Piece Veneer (W) and 3 Piece HPL (P) Rectangle Top									
88-60204RT	Laminate	204	60	1 3/16	492	22.4	F, G, X, Y / P\$	3902	
				1 3/16			K / P\$	6547	
				1 1/2			H / P\$	4572	
Veneer				1 3/16			F, G, X, Y / W\$	7313	
				1 3/16			K / W\$	9361	
				1 1/2			H / W\$	8537	
Glass				1/4			Acid Etched Glass Top \$	26509	
				1/4			Gloss Glass Top \$	21806	

Additional 60" Rectangle Shaped Tops on Next Page

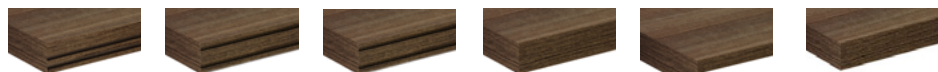

Double Kerf (F) 1 3/16" Duo (G) 1 3/16" Fluted (X) 1 3/16" Square (Y) 1 3/16" Knife (K) 1 3/16" Vertical Square (H) 1 1/2"

P = HPL W = Veneer

[See Strut Overview For Ordering Options](#)

Item	Model No.		W	D	H	Ship Wt	Cubic Ft	Edge Profile + Material	List Price	
<i>CONTINUED FROM PREVIOUS PAGE</i>	60"D x 192"W or 16' - 4 Piece Veneer (W) and 2 Piece HPL (P) Rectangle Top									
	88-60192RT	Laminate	192	60	1 3/16	458	21.1	F, G, X, Y / P\$	3241	
					1 3/16			K / P\$	5763	
					1 1/2			H / P\$	3868	
		Veneer			1 3/16			F, G, X, Y / W\$	6033	
					1 3/16			K / W\$	7886	
					1 1/2			H / W\$	6997	
		Glass			1/4			Acid Etched Glass Top \$	24267	
					1/4			Gloss Glass Top \$	19841	
	60"D x 180"W or 15' - 4 Piece Veneer (W) and 2 Piece HPL (P) Rectangle Top									
	88-60180RT	Laminate	180	60	1 3/16	430	19.8	F, G, X, Y / P\$	3190	
					1 3/16			K / P\$	5602	
					1 1/2			H / P\$	3778	
		Veneer			1 3/16			F, G, X, Y / W\$	5796	
					1 3/16			K / W\$	7584	
					1 1/2			H / W\$	6702	
		Glass			1/4			Acid Etched Glass Top \$	22917	
					1/4			Gloss Glass Top \$	18768	
60"D x 168"W or 14' - 4 Piece Veneer (W) and 2 Piece HPL (P) Rectangle Top										
88-60168RT	Laminate	168	60	1 3/16	403	18.5	F, G, X, Y / P\$	3138		
				1 3/16			K / P\$	5441		
				1 1/2			H / P\$	3688		
	Veneer			1 3/16			F, G, X, Y / W\$	5558		
				1 3/16			K / W\$	7283		
				1 1/2			H / W\$	6407		
	Glass			1/4			Acid Etched Glass Top \$	21567		
				1/4			Gloss Glass Top \$	17694		
60"D x 156"W or 13' - 4 Piece Veneer (W) and 2 Piece HPL (P) Rectangle Top										
88-60156RT	Laminate	156	60	1 3/16	376	17.2	F, G, X, Y / P\$	3087		
				1 3/16			K / P\$	5280		
				1 1/2			H / P\$	3597		
	Veneer			1 3/16			F, G, X, Y / W\$	5320		
				1 3/16			K / W\$	6982		
				1 1/2			H / W\$	6112		
	Glass			1/4			Acid Etched Glass Top \$	20218		
				1/4			Gloss Glass Top \$	16621		

Must Specify (in this order):
 Model #
 Top/Edge Material
 Top/Edge Finish/Color
 Edge Profile
 Glass (Y/N)
 Glass Color + Surface Finish
 Power/Data Type
 Power/Data Location

Additional 60" Rectangle Shaped Tops on Next Page



Double Kerf (F) 1 3/16" Duo (G) 1 3/16" Fluted (X) 1 3/16" Square (Y) 1 3/16" Knife (K) 1 3/16" Vertical Square (H) 1 1/2"

P = HPL W = Veneer

[See Strut Overview For Ordering Options](#)

Item	Model No.		W	D	H	Ship Wt	Cubic Ft	Edge Profile + Material	List Price	
60"D x 144"W or 12' - 3 Piece Veneer (W) and 2 Piece HPL (P) Rectangle Top										
<i>CONTINUED FROM PREVIOUS PAGE</i>	88-60144RT	Laminate	144	60	1 3/16	342	16.0	F, G, X, Y / P\$	2612	
					1 3/16			K / P\$	4520	
					1 1/2			H / P\$	3083	
		Veneer			1 3/16			F, G, X, Y / W\$	4320	
					1 3/16			K / W\$	5789	
					1 1/2			H / W\$	5050	
		Glass			1/4			Acid Etched Glass Top \$	18997	
					1/4			Gloss Glass Top \$	15678	
	60"D x 132"W or 11' - 3 Piece Veneer (W) and 2 Piece HPL (P) Rectangle Top									
		88-60132RT	Laminate	132	60	1 3/16	323	14.6	F, G, X, Y / P\$	2548
					1 3/16			K / P\$	4345	
					1 1/2			H / P\$	2979	
		Veneer			1 3/16			F, G, X, Y / W\$	4104	
					1 3/16			K / W\$	5508	
					1 1/2			H / W\$	4775	
		Glass			1/4			Acid Etched Glass Top \$	17634	
					1/4			Gloss Glass Top \$	14591	
60"D x 120"W or 10' - 3 Piece Veneer (W) and 2 Piece HPL (P) Rectangle Top										
	88-60120RT	Laminate	120	60	1 3/16	287	13.3	F, G, X, Y / P\$	2484	
					1 3/16			K / P\$	4170	
					1 1/2			H / P\$	2875	
		Veneer			1 3/16			F, G, X, Y / W\$	3886	
					1 3/16			K / W\$	5228	
					1 1/2			H / W\$	4500	
		Glass			1/4			Acid Etched Glass Top \$	16271	
					1/4			Gloss Glass Top \$	13505	

Must Specify (in this order):

- Model #
- Top/Edge Material
- Top/Edge Finish/Color
- Edge Profile
- Glass (Y/N)
- Glass Color + Surface Finish
- Power/Data Type
- Power/Data Location

Description

- Tops Available with Veneer (W) or HPL (P) Top in 1 3/16" and 1 1/2" Thicknesses
- Must Specify Edge Profile: 1 3/16" Thick/Double Kerf (F), Duo (G), Fluted (X), Square (Y), and Knife (K) Edge Profiles or 1 1/2" Thick/Vertical Square (H)
- Veneer (W) Top Grain Runs Depth of Top and HPL (P) Top Grain Runs Width of Top
- All Veneer Tops, as well as Laminate Tops up to 144" (12 feet), have Matching Woodgrain. Laminate Tops Sized 156" (13 feet) and Longer have Non-Matching Woodgrain
- Available with Back Painted Tempered Glass Top; Must Specify Color and Finish; [See Options](#)
- Power and Data Options Available; Sold Separately, [See Multiple Power Unit Details](#)
- Strut Legs Sold Separately, [See Strut Legs](#)



Double Kerf (F)
1 3/16"



Duo (G)
1 3/16"



Fluted (X)
1 3/16"



Square (Y)
1 3/16"



Knife (K)
1 3/16"



Vertical Square (H)
1 1/2"

P = HPL W = Veneer

[See Strut Overview For Ordering Options](#)

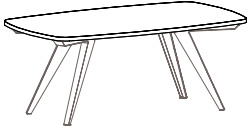
Item	Model No.		W	D	H	Ship Wt	Cubic Ft	Edge Profile + Material	List Price	
MODERN RECTANGLE SHAPE MEETING TOP 36"D  88-3672MR Shown BASES SOLD SEPARATELY	36"D x 96"W or 8' - 1 Piece Modern Rectangle Top									
	88-3696MR	Laminate	96	36	1 3/16	142	12.9	F, G, X, Y / P\$	1424	
					1 3/16			K / P\$	2821	
					1 1/2			H / P\$	1606	
		Veneer			1 3/16			F, G, X, Y / W\$	1613	
					1 3/16			K / W\$	3163	
					1 1/2			H / W\$	1921	
		Glass			1/4			Acid Etched Glass Top \$	8724	
					1/4			Gloss Glass Top \$	7396	
	36"D x 84"W or 7' - 1 Piece Modern Rectangle Top									
		88-3684MR	Laminate	84	36	1 3/16	126	11.3	F, G, X, Y / P\$	1357
						1 3/16			K / P\$	2583
					1 1/2			H / P\$	1547	
		Veneer			1 3/16			F, G, X, Y / W\$	1529	
					1 3/16			K / W\$	2958	
					1 1/2			H / W\$	1768	
		Glass			1/4			Acid Etched Glass Top \$	7821	
					1/4			Gloss Glass Top \$	6659	
36"D x 72"W or 6' - 1 Piece Modern Rectangle Top										
	88-3672MR	Laminate	72	36	1 3/16	109	10.3	F, G, X, Y / P\$	1108	
					1 3/16			K / P\$	2236	
					1 1/2			H / P\$	1245	
		Veneer			1 3/16			F, G, X, Y / W\$	1302	
					1 3/16			K / W\$	2518	
					1 1/2			H / W\$	1537	
		Glass			1/4			Acid Etched Glass Top \$	6829	
					1/4			Gloss Glass Top \$	5832	

Must Specify (in this order):

- Model #
- Top/Edge Material
- Top/Edge Finish/Color
- Edge Profile
- Glass (Y/N)
- Glass Color + Surface Finish
- Power/Data
- Power/Data Location

Description

- Tops Available with Veneer (W) or HPL (P) Top in 1 3/16" and 1 1/2" Thicknesses
- Must Specify Edge Profile: 1 3/16" Thick/Double Kerf (F), Duo (G), Fluted (X), Square (Y), and Knife (K) Edge Profiles or 1 1/2" Thick/Vertical Square (H)
- Veneer (W) Top Grain Runs Depth of Top and HPL (P) Top Grain Runs Width of Top
- Available with Back Painted Tempered Glass Top; Must Specify Color and Finish; [See Options](#)
- Power and Data Options Available; Sold Separately, [See Multiple Power Unit Details](#)
- Strut Legs Sold Separately, [See Strut Legs](#)



Double Kerf (F)
1 3/16"



Duo (G)
1 3/16"



Fluted (X)
1 3/16"



Square (Y)
1 3/16"



Knife (K)
1 3/16"



Vertical Square (H)
1 1/2"

P = HPL W = Veneer

[See Strut Overview For Ordering Options](#)

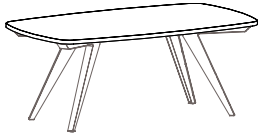
Item	Model No.		W	D	H	Ship Wt	Cubic Ft	Edge Profile + Material	List Price	
MODERN RECTANGLE SHAPE MEETING TOP 42"D  88-4272MR Shown BASES SOLD SEPARATELY	42"D x 96"W or 8' - 1 Piece Modern Rectangle Top									
	88-4296MR	Laminate	96	42	1 3/16	164	15.0	F, G, X, Y / P\$	1453	
					1 3/16			K / P\$	2984	
					1 1/2			H / P\$	1667	
		Veneer			1 3/16			F, G, X, Y / W\$	1752	
					1 3/16			K / W\$	3361	
					1 1/2			H / W\$	2104	
		Glass			1/4			Acid Etched Glass Top \$	9818	
					1/4			Gloss Glass Top \$	8269	
	42"D x 84"W or 7' - 1 Piece Modern Rectangle Top									
	88-4284MR	Laminate	84	42	1 3/16	145	13.1	F, G, X, Y / P\$	1414	
					1 3/16			K / P\$	2769	
				1 1/2			H / P\$	1600		
	Veneer			1 3/16			F, G, X, Y / W\$	1618		
				1 3/16			K / W\$	3102		
				1 1/2			H / W\$	1928		
	Glass			1/4			Acid Etched Glass Top \$	8786		
				1/4			Gloss Glass Top \$	7430		
42"D x 72"W or 6' - 1 Piece Modern Rectangle Top										
88-4272MR	Laminate	72	42	1 3/16	126	11.3	F, G, X, Y / P\$	1182		
				1 3/16			K / P\$	2467		
				1 1/2			H / P\$	1341		
	Veneer			1 3/16			F, G, X, Y / W\$	1473		
				1 3/16			K / W\$	2710		
				1 1/2			H / W\$	1741		
	Glass			1/4			Acid Etched Glass Top \$	7725		

Must Specify (in this order):

- Model #
- Top/Edge Material
- Top/Edge Finish/Color
- Edge Profile
- Glass (Y/N)
- Glass Color + Surface Finish
- Power/Data
- Power/Data Location

Description

- Tops Available with Veneer (W) or HPL (P) Top in 1 3/16" and 1 1/2" Thicknesses
- Must Specify Edge Profile: 1 3/16" Thick/Double Kerf (F), Duo (G), Fluted (X), Square (Y), and Knife (K) Edge Profiles or 1 1/2" Thick/Vertical Square (H)
- Veneer (W) Top Grain Runs Depth of Top and HPL (P) Top Grain Runs Width of Top
- Available with Back Painted Tempered Glass Top; Must Specify Color and Finish; [See Options](#)
- Power and Data Options Available; Sold Separately, [See Multiple Power Unit Details](#)
- Strut Legs Sold Separately, [See Strut Legs](#)



Double Kerf (F) 1 3/16" Duo (G) 1 3/16" Fluted (X) 1 3/16" Square (Y) 1 3/16" Knife (K) 1 3/16" Vertical Square (H) 1 1/2"

P = HPL W = Veneer

[See Strut Overview For Ordering Options](#)

Item	Model No.		W	D	H	Ship Wt	Cubic Ft	Edge Profile + Material	List Price	
MODERN RECTANGLE SHAPE MEETING TOP 48"D  88-48216MR Shown BASES SOLD SEPARATELY	48"D x 240"W or 20' - 3 Piece Modern Rectangle Top									
	88-48240MR	Laminate	240	48	1 3/16	460	48.9	F, G, X, Y / P\$	4638	
					1 3/16			K / P\$	8499	
					1 1/2			H / P\$	5257	
		Veneer			1 3/16			F, G, X, Y / W\$	6301	
					1 3/16			K / W\$	9571	
					1 1/2			H / W\$	7153	
		Glass			1/4			Acid Etched Glass Top \$	26634	
					1/4			Gloss Glass Top \$	22207	
	48"D x 228"W or 19' - 3 Piece Modern Rectangle Top									
	88-48228MR	Laminate	228	48	1 3/16	438	48.9	F, G, X, Y / P\$	4594	
					1 3/16			K / P\$	8284	
					1 1/2			H / P\$	5182	
		Veneer			1 3/16			F, G, X, Y / W\$	6037	
					1 3/16			K / W\$	9216	
				1 1/2			H / W\$	6849		
	Glass			1/4			Acid Etched Glass Top \$	25468		
				1/4			Gloss Glass Top \$	21263		
48"D x 216"W or 18' - 3 Piece Modern Rectangle Top										
88-48216MR	Laminate	216	48	1 3/16	416	48.9	F, G, X, Y / P\$	3687		
				1 3/16			K / P\$	7182		
				1 1/2			H / P\$	4244		
	Veneer			1 3/16			F, G, X, Y / W\$	5369		
				1 3/16			K / W\$	8456		
				1 1/2			H / W\$	6139		
	Glass			1/4			Acid Etched Glass Top \$	23917		
				1/4			Gloss Glass Top \$	19933		
48"D x 204"W or 17' - 3 Piece Modern Rectangle Top										
88-48204MR	Laminate	204	48	1 3/16	394	48.9	F, G, X, Y / P\$	3643		
				1 3/16			K / P\$	6968		
				1 1/2			H / P\$	4169		
	Veneer			1 3/16			F, G, X, Y / W\$	5106		
				1 3/16			K / W\$	8101		
				1 1/2			H / W\$	5834		
	Glass			1/4			Acid Etched Glass Top \$	22751		
				1/4			Gloss Glass Top \$	18988		

Additional 48" Modern Rectangle Shaped Tops on Next Page



Double Kerf (F) 1 3/16" Duo (G) 1 3/16" Fluted (X) 1 3/16" Square (Y) 1 3/16" Knife (K) 1 3/16" Vertical Square (H) 1 1/2"

P = HPL W = Veneer

[See Strut Overview For Ordering Options](#)

Item	Model No.		W	D	H	Ship Wt	Cubic Ft	Edge Profile + Material	List Price	
48"D x 192"W or 16' - 2 Piece Modern Rectangle Top										
<i>CONTINUED FROM PREVIOUS PAGE</i>	88-48192MR	Laminate	192	48	1 3/16"	372	31.2	F, G, X, Y / P\$	3125	
					1 3/16"			K / P\$	6249	
					1 1/2"			H / P\$	3621	
	Veneer	1 3/16"	F, G, X, Y / W\$	4215						
		1 3/16"	K / W\$	6996						
		1 1/2"	H / W\$	4991						
	Glass		1/4"	Acid Etched Glass Top \$	21073					
			1/4"	Gloss Glass Top \$	17531					
	48"D x 180"W or 15' - 2 Piece Modern Rectangle Top									
	<i>Must Specify (in this order):</i> Model # Top/Edge Material Top/Edge Finish/Color Edge Profile Glass (Y/N) Glass Color + Surface Finish Power/Data Power/Data Location	88-48180MR	Laminate	180	48	1 3/16"	350	31.2	F, G, X, Y / P\$	3080
						1 3/16"			K / P\$	6034
						1 1/2"			H / P\$	3547
Veneer		1 3/16"	F, G, X, Y / W\$	4045						
		1 3/16"	K / W\$	6679						
		1 1/2"	H / W\$	4773						
Glass			1/4"	Acid Etched Glass Top \$	19906					
			1/4"	Gloss Glass Top \$	16586					
48"D x 168"W or 14' - 2 Piece Modern Rectangle Top										
		88-48168MR	Laminate	168	48	1 3/16"	328	31.2	F, G, X, Y / P\$	2928
						1 3/16"			K / P\$	5708
						1 1/2"			H / P\$	3363
	Veneer	1 3/16"	F, G, X, Y / W\$	3736						
		1 3/16"	K / W\$	6223						
		1 1/2"	H / W\$	4418						
	Glass		1/4"	Acid Etched Glass Top \$	18629					
			1/4"	Gloss Glass Top \$	15530					
	48"D x 156"W or 13' - 2 Piece Modern Rectangle Top									
		88-48156MR	Laminate	156	48	1 3/16"	306	31.2	F, G, X, Y / P\$	2885
						1 3/16"			K / P\$	5363
						1 1/2"			H / P\$	3288
Veneer		1 3/16"	F, G, X, Y / W\$	3567						
		1 3/16"	K / W\$	6039						
		1 1/2"	H / W\$	4202						
Glass			1/4"	Acid Etched Glass Top \$	17463					
			1/4"	Gloss Glass Top \$	14585					

Additional 48" Modern Rectangle Shaped Tops on Next Page



Double Kerf (F) 1 3/16" Duo (G) 1 3/16" Fluted (X) 1 3/16" Square (Y) 1 3/16" Knife (K) 1 3/16" Vertical Square (H) 1 1/2"

P = HPL W = Veneer

[See Strut Overview For Ordering Options](#)

Item	Model No.		W	D	H	Ship Wt	Cubic Ft	Edge Profile + Material	List Price	
<i>CONTINUED FROM PREVIOUS PAGE</i>	48"D x 144"W or 12' - 2 Piece Modern Rectangle Top									
	88-48144MR	Laminate	144	48	1 3/16	284	23.5	F, G, X, Y / P\$	2421	
					1 3/16			K / P\$	4847	
					1 1/2			H / P\$	2793	
		Veneer			1 3/16			F, G, X, Y / W\$	3328	
					1 3/16			K / W\$	5521	
					1 1/2			H / W\$	3915	
		Glass			1/4			Acid Etched Glass Top \$	16201	
					1/4			Gloss Glass Top \$	13544	
	48"D x 132"W or 11' - 2 Piece Modern Rectangle Top									
	88-48132MR	Laminate	132	48	1 3/16	262	23.5	F, G, X, Y / P\$	2365	
					1 3/16			K / P\$	4619	
					1 1/2			H / P\$	2705	
		Veneer			1 3/16			F, G, X, Y / W\$	3105	
					1 3/16			K / W\$	5178	
					1 1/2			H / W\$	3645	
		Glass			1/4			Acid Etched Glass Top \$	15022	
					1/4			Gloss Glass Top \$	12588	
48"D x 120"W or 10' - 2 Piece Modern Rectangle Top										
88-48120MR	Laminate	120	48	1 3/16	240	23.5	F, G, X, Y / P\$	2299		
				1 3/16			K / P\$	4383		
				1 1/2			H / P\$	2609		
	Veneer			1 3/16			F, G, X, Y / W\$	2870		
				1 3/16			K / W\$	4823		
				1 1/2			H / W\$	3364		
	Glass			1/4			Acid Etched Glass Top \$	13835		
				1/4			Gloss Glass Top \$	11622		
48"D x 108"W or 9' - 2 Piece Modern Rectangle Top										
88-48108MR	Laminate	108	48	1 3/16	218	23.5	F, G, X, Y / P\$	2243		
				1 3/16			K / P\$	4063		
				1 1/2			H / P\$	2522		
	Veneer			1 3/16			F, G, X, Y / W\$	2648		
				1 3/16			K / W\$	4575		
				1 1/2			H / W\$	3095		
	Glass			1/4			Acid Etched Glass Top \$	12657		
				1/4			Gloss Glass Top \$	10665		

Must Specify (in this order):
 Model #
 Top/Edge Material
 Top/Edge Finish/Color
 Edge Profile
 Glass (Y/N)
 Glass Color + Surface Finish
 Power/Data
 Power/Data Location

Additional 48" Modern Rectangle Shaped Tops on Next Page



Double Kerf (F)
1 3/16"



Duo (G)
1 3/16"



Fluted (X)
1 3/16"



Square (Y)
1 3/16"



Knife (K)
1 3/16"



Vertical Square (H)
1 1/2"

P = HPL W = Veneer

[See Strut Overview For Ordering Options](#)

Item	Model No.		W	D	H	Ship Wt	Cubic Ft	Edge Profile + Material	List Price	
48"D x 96"W or 8' - 1 Piece Modern Rectangle Top										
<i>CONTINUED FROM PREVIOUS PAGE</i>	88-4896MR	Laminate	96	48	1 3/16"	315	18.0	F, G, X, Y / P\$	1529	
					1 3/16"			K / P\$	3258	
					1 1/2"			H / P\$	1774	
	Veneer	1 3/16"	F, G, X, Y / W\$	1951						
		1 3/16"	K / W\$	3558						
		1 1/2"	H / W\$	2347						
	Glass		1/4"	Acid Etched Glass Top \$	10965					
			1/4"	Gloss Glass Top \$	9194					
	48"D x 84"W or 7' - 1 Piece Modern Rectangle Top									
	<i>Must Specify (in this order):</i>	88-4884MR	Laminate	84	48	1 3/16"	164	15.0	F, G, X, Y / P\$	1484
1 3/16"						K / P\$			2899	
1 1/2"						H / P\$			1698	
Veneer		1 3/16"	F, G, X, Y / W\$	1724						
		1 3/16"	K / W\$	3266						
		1 1/2"	H / W\$	2074						
Glass			1/4"	Acid Etched Glass Top \$	9732					
			1/4"	Gloss Glass Top \$	8184					
48"D x 72"W or 6' - 1 Piece Modern Rectangle Top										
		88-4872MR	Laminate	72	48	1 3/16"	142	12.8	F, G, X, Y / P\$	1249
	1 3/16"					K / P\$			2637	
	1 1/2"					H / P\$			1432	
	Veneer	1 3/16"	F, G, X, Y / W\$	1633						
		1 3/16"	K / W\$	2948						
		1 1/2"	H / W\$	1935						
	Glass		1/4"	Acid Etched Glass Top \$	8608					
			1/4"	Gloss Glass Top \$	7280					

Description

- Tops Available with Veneer (W) or HPL (P) Top in 1 3/16" and 1 1/2" Thicknesses
- Must Specify Edge Profile: 1 3/16" Thick/Double Kerf (F), Duo (G), Fluted (X), Square (Y), and Knife (K) Edge Profiles or 1 1/2" Thick/Vertical Square (H)
- Veneer (W) Top Grain Runs Depth of Top and HPL (P) Top Grain Runs Width of Top
- All Veneer Tops, as well as Laminate Tops up to 144" (12 feet), have Matching Woodgrain. Laminate Tops Sized 156" (13 feet) and Longer have Non-Matching Woodgrain
- Available with Back Painted Tempered Glass Top; Must Specify Color and Finish; [See Options](#)
- Power and Data Options Available; Sold Separately, [See Multiple Power Unit Details](#)
- Dock800, Oasis, and E2X Power Units Available on Ends Only (E1 and E2) for 108"D - 156"D and 204"D-240"D Tops
- Strut Legs Sold Separately, [See Strut Legs](#)



Double Kerf (F)
1 3/16"



Duo (G)
1 3/16"



Fluted (X)
1 3/16"



Square (Y)
1 3/16"



Knife (K)
1 3/16"



Vertical Square (H)
1 1/2"

P = HPL W = Veneer

[See Strut Overview For Ordering Options](#)

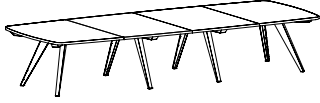
Item	Model No.		W	D	H	Ship Wt	Cubic Ft	Edge Profile + Material	List Price	
MODERN RECTANGLE SHAPE MEETING TOP 54"D  88-54156MR Shown in Veneer BASES SOLD SEPARATELY	54"D x 240"W or 20' - 5 Piece Veneer (W) and 3 Piece HPL (P) Modern Rectangle Top									
	88-54240MR	Laminate	240	54	1 3/16	519	24.0	F, G, X, Y / P\$	4690	
					1 3/16			K / P\$	8773	
					1 1/2			H / P\$	5389	
		Veneer			1 3/16			F, G, X, Y / W\$	7844	
					1 3/16			K / W\$	11557	
					1 1/2			H / W\$	8912	
		Glass			1/4			Acid Etched Glass Top \$	29666	
					1/4			Gloss Glass Top \$	24687	
	54"D x 228"W or 19' - 5 Piece Veneer (W) and 3 Piece HPL (P) Modern Rectangle Top									
	88-54228MR	Laminate	228	54	1 3/16	495	23.0	F, G, X, Y / P\$	4642	
					1 3/16			K / P\$	8545	
				1 1/2			H / P\$	5306		
	Veneer			1 3/16			F, G, X, Y / W\$	7602		
				1 3/16			K / W\$	11159		
				1 1/2			H / W\$	8619		
	Glass			1/4			Acid Etched Glass Top \$	28369		
				1/4			Gloss Glass Top \$	23639		
54"D x 216"W or 18' - 5 Piece Veneer (W) and 3 Piece HPL (P) Modern Rectangle Top										
88-54216MR	Laminate	216	54	1 3/16	470	22.0	F, G, X, Y / P\$	4047		
				1 3/16			K / P\$	7755		
				1 1/2			H / P\$	4676		
	Veneer			1 3/16			F, G, X, Y / W\$	7361		
				1 3/16			K / W\$	10761		
				1 1/2			H / W\$	8327		
	Glass			1/4			Acid Etched Glass Top \$	27037		
				1/4			Gloss Glass Top \$	22556		
54"D x 204"W or 17' - 5 Piece Veneer (W) and 3 Piece HPL (P) Modern Rectangle Top										
88-54204MR	Laminate	204	54	1 3/16	445	21.0	F, G, X, Y / P\$	3999		
				1 3/16			K / P\$	7528		
				1 1/2			H / P\$	4593		
	Veneer			1 3/16			F, G, X, Y / W\$	7119		
				1 3/16			K / W\$	10364		
				1 1/2			H / W\$	8034		
	Glass			1/4			Acid Etched Glass Top \$	25741		
				1/4			Gloss Glass Top \$	21509		

Must Specify (in this order):
 Model #
 Top/Edge Material
 Top/Edge Finish/Color
 Edge Profile
 Glass (Y/N)
 Glass Color + Surface Finish
 Power/Data
 Power/Data Location

Additional 54" Modern Rectangle Shaped Tops on Next Page

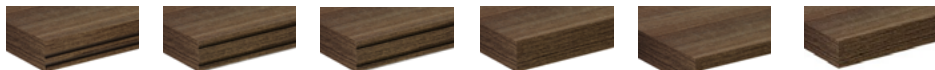

Double Kerf (F) 1 3/16" Duo (G) 1 3/16" Fluted (X) 1 3/16" Square (Y) 1 3/16" Knife (K) 1 3/16" Vertical Square (H) 1 1/2"

P = HPL W = Veneer

[See Strut Overview For Ordering Options](#)

Item	Model No.		W	D	H	Ship Wt	Cubic Ft	Edge Profile + Material	List Price	
54"D x 192"W or 16' - 4 Piece Veneer (W) and 2 Piece HPL (P) Modern Rectangle Top										
<i>CONTINUED FROM PREVIOUS PAGE</i>	88-54192MR	Laminate	192	54	1 3/16	408	19.0	F, G, X, Y / P\$	3291	
					1 3/16			K / P\$	6606	
					1 1/2			H / P\$	3852	
		Veneer			1 3/16			F, G, X, Y / W\$	5874	
					1 3/16			K / W\$	8938	
					1 1/2			H / W\$	6734	
		Glass			1/4			Acid Etched Glass Top \$	23748	
					1/4			Gloss Glass Top \$	19764	
	54"D x 180"W or 15' - 4 Piece Veneer (W) and 2 Piece HPL (P) Modern Rectangle Top									
	Must Specify (in this order): Model # Top/Edge Material Top/Edge Finish/Color Edge Profile Glass (Y/N) Glass Color + Surface Finish Power/Data Power/Data Location	88-54180MR	Laminate	180	54	1 3/16	384	18.0	F, G, X, Y / P\$	3244
					1 3/16			K / P\$	6379	
					1 1/2			H / P\$	3769	
		Veneer			1 3/16			F, G, X, Y / W\$	5652	
					1 3/16			K / W\$	8560	
					1 1/2			H / W\$	6460	
		Glass			1/4			Acid Etched Glass Top \$	22451	
					1/4			Gloss Glass Top \$	18716	
54"D x 168"W or 14' - 4 Piece Veneer (W) and 2 Piece HPL (P) Modern Rectangle Top										
		88-54168MR	Laminate	168	54	1 3/16	359	17.0	F, G, X, Y / P\$	3195
					1 3/16			K / P\$	6151	
					1 1/2			H / P\$	3687	
		Veneer			1 3/16			F, G, X, Y / W\$	5431	
					1 3/16			K / W\$	8182	
					1 1/2			H / W\$	6188	
		Glass			1/4			Acid Etched Glass Top \$	21154	
					1/4			Gloss Glass Top \$	17668	
	54"D x 156"W or 13' - 4 Piece Veneer (W) and 2 Piece HPL (P) Modern Rectangle Top									
		88-54156MR	Laminate	156	54	1 3/16	334	16.0	F, G, X, Y / P\$	3147
					1 3/16			K / P\$	5923	
					1 1/2			H / P\$	3603	
		Veneer			1 3/16			F, G, X, Y / W\$	5209	
					1 3/16			K / W\$	7802	
					1 1/2			H / W\$	5915	
		Glass			1/4			Acid Etched Glass Top \$	19856	
					1/4			Gloss Glass Top \$	16619	

Additional 54" Modern Rectangle Shaped Tops on Next Page



Double Kerf (F)
1 3/16"



Duo (G)
1 3/16"



Fluted (X)
1 3/16"



Square (Y)
1 3/16"



Knife (K)
1 3/16"



Vertical Square (H)
1 1/2"

P = HPL W = Veneer

[See Strut Overview For Ordering Options](#)

Item	Model No.		W	D	H	Ship Wt	Cubic Ft	Edge Profile + Material	List Price		
<i>CONTINUED FROM PREVIOUS PAGE</i>	54"D x 144"W or 12' - 3 Piece Veneer (W) and 2 Piece HPL (P) Modern Rectangle Top										
	88-54144MR	Laminate	144	54	1 3/16	309	15.0	F, G, X, Y / P\$	2675		
					1 3/16			K / P\$	5261		
					1 1/2			H / P\$	3097		
		Veneer			1 3/16			F, G, X, Y / W\$	4300		
					1 3/16			K / W\$	6645		
					1 1/2			H / W\$	6645		
		Glass			1/4			Acid Etched Glass Top \$	18228		
					1/4			Gloss Glass Top \$	15240		
		54"D x 132"W or 11' - 3 Piece Veneer (W) and 2 Piece HPL (P) Modern Rectangle Top									
	88-54132MR	Laminate	132	54	1 3/16	285	13.2	F, G, X, Y / P\$	2614		
					1 3/16			K / P\$	5021		
				1 1/2			H / P\$	3000			
	Veneer			1 3/16			F, G, X, Y / W\$	4090			
				1 3/16			K / W\$	6285			
				1 1/2			H / W\$	4624			
	Glass			1/4			Acid Etched Glass Top \$	16918			
				1/4			Gloss Glass Top \$	14180			
	54"D x 120"W or 10' - 3 Piece Veneer (W) and 2 Piece HPL (P) Modern Rectangle Top										
88-54120MR	Laminate	120	54	1 3/16	260	12.1	F, G, X, Y / P\$	2553			
				1 3/16			K / P\$	4780			
				1 1/2			H / P\$	2904			
	Veneer			1 3/16			F, G, X, Y / W\$	3880			
				1 3/16			K / W\$	5927			
				1 1/2			H / W\$	4370			
	Glass			1/4			Acid Etched Glass Top \$	15612			
				1/4			Gloss Glass Top \$	13122			

Must Specify (in this order):
 Model #
 Top/Edge Material
 Top/Edge Finish/Color
 Edge Profile
 Glass (Y/N)
 Glass Color + Surface Finish
 Power/Data
 Power/Data Location

Description

- Tops Available with Veneer (W) or HPL (P) Top in 1 3/16" and 1 1/2" Thicknesses
- Must Specify Edge Profile: 1 3/16" Thick/Double Kerf (F), Duo (G), Fluted (X), Square (Y), and Knife (K) Edge Profiles or 1 1/2" Thick/Vertical Square (H)
- Veneer (W) Top Grain Runs Depth of Top and HPL (P) Top Grain Runs Width of Top
- All Veneer Tops, as well as Laminate Tops up to 144" (12 feet), have Matching Woodgrain. Laminate Tops Sized 156" (13 feet) and Longer have Non-Matching Woodgrain
- Available with Back Painted Tempered Glass Top; Must Specify Color and Finish; [See Options](#)
- Power and Data Options Available; Sold Separately, [See Multiple Power Unit Details](#)
- Strut Legs Sold Separately, [See Strut Legs](#)



Double Kerf (F) 1 3/16" Duo (G) 1 3/16" Fluted (X) 1 3/16" Square (Y) 1 3/16" Knife (K) 1 3/16" Vertical Square (H) 1 1/2"

P = HPL W = Veneer

[See Strut Overview For Ordering Options](#)

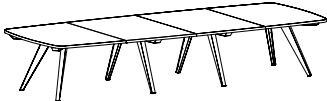
Item	Model No.		W	D	H	Ship Wt	Cubic Ft	Edge Profile + Material	List Price	
MODERN RECTANGLE SHAPE MEETING TOP 60"D  88-60156MR Shown in Veneer BASES SOLD SEPARATELY	60"D x 240"W or 20' - 5 Piece Veneer (W) and 3 Piece HPL (P) Modern Rectangle Top									
	88-60240MR	Laminate	240	60	1 3/16	574	26.3	F, G, X, Y / P\$	4779	
					1 3/16			K / P\$	9084	
					1 1/2			H / P\$	5559	
		Veneer			1 3/16			F, G, X, Y / W\$	8359	
					1 3/16			K / W\$	12204	
					1 1/2			H / W\$	9534	
		Glass			1/4			Acid Etched Glass Top \$	32356	
					1/4			Gloss Glass Top \$	26823	
	60"D x 228"W or 19' - 5 Piece Veneer (W) and 3 Piece HPL (P) Modern Rectangle Top									
	88-60228MR	Laminate	228	60	1 3/16	547	25.0	F, G, X, Y / P\$	4727	
					1 3/16			K / P\$	8844	
				1 1/2			H / P\$	5468		
	Veneer			1 3/16			F, G, X, Y / W\$	8092		
				1 3/16			K / W\$	11776		
				1 1/2			H / W\$	9210		
	Glass			1/4			Acid Etched Glass Top \$	30928		
				1/4			Gloss Glass Top \$	25671		
60"D x 216"W or 18' - 5 Piece Veneer (W) and 3 Piece HPL (P) Modern Rectangle Top										
88-60216MR	Laminate	216	60	1 3/16	519	23.7	F, G, X, Y / P\$	4127		
				1 3/16			K / P\$	8042		
				1 1/2			H / P\$	4829		
	Veneer			1 3/16			F, G, X, Y / W\$	7825		
				1 3/16			K / W\$	11350		
				1 1/2			H / W\$	8888		
	Glass			1/4			Acid Etched Glass Top \$	29463		
				1/4			Gloss Glass Top \$	24483		
60"D x 204"W or 17' - 5 Piece Veneer (W) and 3 Piece HPL (P) Modern Rectangle Top										
88-60204MR	Laminate	204	60	1 3/16	492	22.4	F, G, X, Y / P\$	4075		
				1 3/16			K / P\$	7802		
				1 1/2			H / P\$	4738		
	Veneer			1 3/16			F, G, X, Y / W\$	7558		
				1 3/16			K / W\$	10922		
				1 1/2			H / W\$	8564		
	Glass			1/4			Acid Etched Glass Top \$	28035		
				1/4			Gloss Glass Top \$	23332		

Additional 60" Modern Rectangle Shaped Tops on Next Page

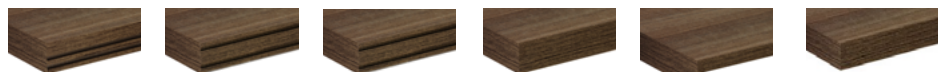

Double Kerf (F) 1 3/16" Duo (G) 1 3/16" Fluted (X) 1 3/16" Square (Y) 1 3/16" Knife (K) 1 3/16" Vertical Square (H) 1 1/2"

P = HPL W = Veneer

[See Strut Overview For Ordering Options](#)

Item	Model No.		W	D	H	Ship Wt	Cubic Ft	Edge Profile + Material	List Price		
<i>CONTINUED FROM PREVIOUS PAGE</i>	60"D x 192"W or 16' - 4 Piece Veneer (W) and 2 Piece HPL (P) Modern Rectangle Top										
	88-60192MR	Laminate	192	60	1 3/16	458	21.1	F, G, X, Y / P\$	3364		
					1 3/16			K / P\$	6866		
					1 1/2			H / P\$	3989		
		Veneer			1 3/16			F, G, X, Y / W\$	6252		
					1 3/16			K / W\$	9435		
					1 1/2			H / W\$	7199		
		Glass			1/4			Acid Etched Glass Top \$	25909		
					1/4			Gloss Glass Top \$	21482		
		60"D x 180"W or 15' - 4 Piece Veneer (W) and 2 Piece HPL (P) Modern Rectangle Top									
	88-60180MR	Laminate	180	60	1 3/16	431	19.8	F, G, X, Y / P\$	3311		
					1 3/16			K / P\$	6625		
					1 1/2			H / P\$	3898		
		Veneer			1 3/16			F, G, X, Y / W\$	6007		
					1 3/16			K / W\$	9030		
					1 1/2			H / W\$	6898		
		Glass			1/4			Acid Etched Glass Top \$	24481		
					1/4			Gloss Glass Top \$	20332		
	60"D x 168"W or 14' - 4 Piece Veneer (W) and 2 Piece HPL (P) Modern Rectangle Top										
88-60168MR	Laminate	168	60	1 3/16	403	18.5	F, G, X, Y / P\$	3259			
				1 3/16			K / P\$	6385			
				1 1/2			H / P\$	3806			
	Veneer			1 3/16			F, G, X, Y / W\$	5762			
				1 3/16			K / W\$	8625			
				1 1/2			H / W\$	6596			
	Glass			1/4			Acid Etched Glass Top \$	23053			
				1/4			Gloss Glass Top \$	19180			
	60"D x 156"W or 13' - 4 Piece Veneer (W) and 2 Piece HPL (P) Modern Rectangle Top										
88-60156MR	Laminate	156	60	1 3/16	376	17.2	F, G, X, Y / P\$	3206			
				1 3/16			K / P\$	6145			
				1 1/2			H / P\$	3715			
	Veneer			1 3/16			F, G, X, Y / W\$	5518			
				1 3/16			K / W\$	8220			
				1 1/2			H / W\$	6295			
	Glass			1/4			Acid Etched Glass Top \$	21624			
				1/4			Gloss Glass Top \$	18028			

Must Specify (in this order):
 Model #
 Top/Edge Material
 Top/Edge Finish/Color
 Edge Profile
 Glass (Y/N)
 Glass Color + Surface Finish
 Power/Data
 Power/Data Location

Additional 60" Modern Rectangle Shaped Tops on Next Page

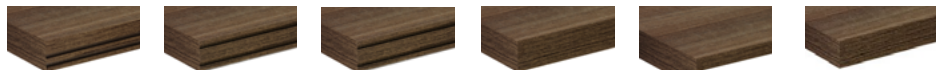

Double Kerf (F) 1 3/16" Duo (G) 1 3/16" Fluted (X) 1 3/16" Square (Y) 1 3/16" Knife (K) 1 3/16" Vertical Square (H) 1 1/2"

P = HPL W = Veneer

[See Strut Overview For Ordering Options](#)

Item	Model No.		W	D	H	Ship Wt	Cubic Ft	Edge Profile + Material	List Price	
<i>CONTINUED FROM PREVIOUS PAGE</i>	60"D x 144"W or 12' - 3 Piece Veneer (W) and 2 Piece HPL (P) Modern Rectangle Top									
	88-60144MR	Laminate	144	60	1 3/16"	342	16.0	F, G, X, Y / P\$	2731	
					1 3/16"			K / P\$	5470	
					1 1/2"			H / P\$	3200	
		Veneer			1 3/16"			F, G, X, Y / W\$	4568	
					1 3/16"			K / W\$	7008	
					1 1/2"			H / W\$	5205	
		Glass			1/4"			Acid Etched Glass Top \$	19864	
					1/4"			Gloss Glass Top \$	16543	
	60"D x 132"W or 11' - 3 Piece Veneer (W) and 2 Piece HPL (P) Modern Rectangle Top									
	88-60132MR	Laminate	132	60	1 3/16"	323	14.6	F, G, X, Y / P\$	2666	
					1 3/16"			K / P\$	5216	
					1 1/2"			H / P\$	3096	
		Veneer			1 3/16"			F, G, X, Y / W\$	4336	
					1 3/16"			K / W\$	6621	
					1 1/2"			H / W\$	4922	
		Glass			1/4"			Acid Etched Glass Top \$	18421	
					1/4"			Gloss Glass Top \$	15378	
60"D x 120"W or 10' - 3 Piece Veneer (W) and 2 Piece HPL (P) Modern Rectangle Top										
88-60120MR	Laminate	120	60	1 3/16"	287	13.3	F, G, X, Y / P\$	2601		
				1 3/16"			K / P\$	4964		
				1 1/2"			H / P\$	2991		
	Veneer			1 3/16"			F, G, X, Y / W\$	4104		
				1 3/16"			K / W\$	6237		
				1 1/2"			H / W\$	4641		
	Glass			1/4"			Acid Etched Glass Top \$	16980		
				1/4"			Gloss Glass Top \$	14214		

Must Specify (in this order):
 Model #
 Top/Edge Material
 Top/Edge Finish/Color
 Edge Profile
 Glass (Y/N)
 Glass Color + Surface Finish
 Power/Data Type
 Power/Data Location

Description

- Tops Available with Veneer (W) or HPL (P) Top in 1 3/16" and 1 1/2" Thicknesses
- Must Specify Edge Profile: 1 3/16" Thick/Double Kerf (F), Duo (G), Fluted (X), Square (Y), and Knife (K) Edge Profiles or 1 1/2" Thick/Vertical Square (H)
- Veneer (W) Top Grain Runs Depth of Top and HPL (P) Top Grain Runs Width of Top
- All Veneer Tops, as well as Laminate Tops up to 144" (12 feet), have Matching Woodgrain. Laminate Tops Sized 156" (13 feet) and Longer have Non-Matching Woodgrain
- Available with Back Painted Tempered Glass Top; Must Specify Color and Finish; [See Options](#)
- Power and Data Options Available; Sold Separately, [See Multiple Power Unit Details](#)
- Strut Legs Sold Separately, [See Strut Legs](#)



Double Kerf (F)
1 3/16"



Duo (G)
1 3/16"



Fluted (X)
1 3/16"



Square (Y)
1 3/16"



Knife (K)
1 3/16"



Vertical Square (H)
1 1/2"

P = HPL W = Veneer

[See Strut Overview For Ordering Options](#)

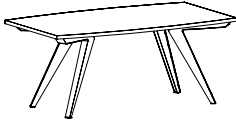
Item	Model No.		W	D	H	Ship Wt	Cubic Ft	Edge Profile + Material	List Price	
BOAT SHAPE MEETING TOP 36"D  88-3696BT Shown BASES SOLD SEPARATELY	36"D x 96"W or 8' - 1 Piece Boat Top									
	88-3696BT	Laminate	96	36-30	1 3/16	142	12.9	F, G, X, Y / P\$	1424	
					1 3/16			K / P\$	2821	
					1 1/2			H / P\$	1606	
		Veneer			1 3/16			F, G, X, Y / W\$	1613	
					1 3/16			K / W\$	3163	
					1 1/2			H / W\$	1921	
		Glass			1/4			Acid Etched Glass Top \$	8724	
					1/4			Gloss Glass Top \$	7396	
	36"D x 84"W or 7' - 1 Piece Boat Top									
	88-3684BT	Laminate	84	36-30	1 3/16	126	11.3	F, G, X, Y / P\$	1357	
					1 3/16			K / P\$	2583	
					1 1/2			H / P\$	1547	
		Veneer			1 3/16			F, G, X, Y / W\$	1529	
					1 3/16			K / W\$	2958	
				1 1/2			H / W\$	1768		
	Glass			1/4			Acid Etched Glass Top \$	7821		
				1/4			Gloss Glass Top \$	6659		
36"D x 72"W or 6' - 1 Piece Boat Top										
88-3672BT	Laminate	72	36-30	1 3/16	109	10.3	F, G, X, Y / P\$	1108		
				1 3/16			K / P\$	2236		
				1 1/2			H / P\$	1245		
	Veneer			1 3/16			F, G, X, Y / W\$	1302		
				1 3/16			K / W\$	2518		
				1 1/2			H / W\$	1537		
	Glass			1/4			Acid Etched Glass Top \$	6829		
				1/4			Gloss Glass Top \$	5832		

Must Specify (in this order):

- Model #
- Top/Edge Material
- Top/Edge Finish/Color
- Edge Profile
- Glass (Y/N)
- Glass Color + Surface Finish
- Power/Data
- Power/Data Location

Description

- Tops Available with Veneer (W) or HPL (P) Top in 1 3/16" and 1 1/2" Thicknesses
- Must Specify Edge Profile: 1 3/16" Thick/Double Kerf (F), Duo (G), Fluted (X), Square (Y), and Knife (K) Edge Profiles or 1 1/2" Thick/Vertical Square (H)
- Veneer (W) Top Grain Runs Depth of Top and HPL (P) Top Grain Runs Width of Top
- Available with Back Painted Tempered Glass Top; Must Specify Color and Finish; [See Options](#)
- Power and Data Options Available; Sold Separately, [See Multiple Power Unit Details](#)
- Strut Legs Sold Separately, [See Strut Legs](#)



Double Kerf (F)
1 3/16"



Duo (G)
1 3/16"



Fluted (X)
1 3/16"



Square (Y)
1 3/16"



Knife (K)
1 3/16"



Vertical Square (H)
1 1/2"

P = HPL W = Veneer

[See Strut Overview For Ordering Options](#)

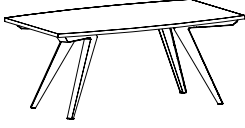
Item	Model No.		W	D	H	Ship Wt	Cubic Ft	Edge Profile + Material	List Price	
BOAT SHAPE MEETING TOP 42"D  <p>88-3696BT Shown BASES SOLD SEPARATELY</p>	42"D x 96"W or 8' - 1 Piece Boat Top									
	88-4296BT	Laminate	96	42-36	1 3/16	164	15.0	F, G, X, Y / P\$	1453	
					1 3/16			K / P\$	2984	
					1 1/2			H / P\$	1667	
		Veneer			1 3/16			F, G, X, Y / W\$	1752	
					1 3/16			K / W\$	3361	
					1 1/2			H / W\$	2104	
		Glass			1/4			Acid Etched Glass Top \$	9818	
					1/4			Gloss Glass Top \$	8269	
	42"D x 84"W or 7' - 1 Piece Boat Top									
	88-4284BT	Laminate	84	42-36	1 3/16	145	13.1	F, G, X, Y / P\$	1414	
					1 3/16			K / P\$	2769	
				1 1/2			H / P\$	1600		
	Veneer			1 3/16			F, G, X, Y / W\$	1618		
				1 3/16			K / W\$	3102		
				1 1/2			H / W\$	1928		
	Glass			1/4			Acid Etched Glass Top \$	8786		
				1/4			Gloss Glass Top \$	7430		
42"D x 72"W or 6' - 1 Piece Boat Top										
88-4272BT	Laminate	72	42-36	1 3/16	164	15.0	F, G, X, Y / P\$	1182		
				1 3/16			K / P\$	2467		
				1 1/2			H / P\$	1341		
	Veneer			1 3/16			F, G, X, Y / W\$	1473		
				1 3/16			K / W\$	2710		
				1 1/2			H / W\$	1741		
	Glass			1/4			Acid Etched Glass Top \$	7725		
				1/4			Gloss Glass Top \$	6563		

Must Specify (in this order):

- Model #
- Top/Edge Material
- Top/Edge Finish/Color
- Edge Profile
- Glass (Y/N)
- Glass Color + Surface Finish
- Power/Data
- Power/Data Location

Description

- Tops Available with Veneer (W) or HPL (P) Top in 1 3/16" and 1 1/2" Thicknesses
- Must Specify Edge Profile: 1 3/16" Thick/Double Kerf (F), Duo (G), **Fluted (X)**, Square (Y), and Knife (K) Edge Profiles or 1 1/2" Thick/Vertical Square (H)
- Veneer (W) Top Grain Runs Depth of Top and HPL (P) Top Grain Runs Width of Top
- Available with Back Painted Tempered Glass Top; Must Specify Color and Finish; [See Options](#)
- Power and Data Options Available; Sold Separately, [See Multiple Power Unit Details](#)
- Strut Legs Sold Separately, [See Strut Legs](#)



Double Kerf (F) 1 3/16" Duo (G) 1 3/16" **Fluted (X)** 1 3/16" Square (Y) 1 3/16" Knife (K) 1 3/16" Vertical Square (H) 1 1/2"

P = HPL W = Veneer

[See Strut Overview For Ordering Options](#)

Item	Model No.		W	D	H	Ship Wt	Cubic Ft	Edge Profile + Material	List Price	
BOAT SHAPE MEETING TOP 48"D  88-48216BT Shown BASES SOLD SEPARATELY	48"D x 240"W or 20' - 3 Piece Boat Top									
	88-48240BT	Laminate	240	48-36	1 3/16	460	48.9	F, G, X, Y / P\$	4638	
					1 3/16			K / P\$	8499	
					1 1/2			H / P\$	5257	
		Veneer			1 3/16			F, G, X, Y / W\$	6301	
					1 3/16			K / W\$	9571	
					1 1/2			H / W\$	7153	
		Glass			1/4			Acid Etched Glass Top \$	26634	
					1/4			Gloss Glass Top \$	22207	
	48"D x 228"W or 19' - 3 Piece Boat Top									
	88-48228BT	Laminate	228	48-36	1 3/16	438	48.9	F, G, X, Y / P\$	4594	
					1 3/16			K / P\$	8284	
					1 1/2			H / P\$	5182	
		Veneer			1 3/16			F, G, X, Y / W\$	6037	
					1 3/16			K / W\$	9216	
					1 1/2			H / W\$	6849	
		Glass			1/4			Acid Etched Glass Top \$	25468	
					1/4			Gloss Glass Top \$	21263	
48"D x 216"W or 18' - 3 Piece Boat Top										
88-48216BT	Laminate	216	48-36	1 3/16	416	48.9	F, G, X, Y / P\$	3687		
				1 3/16			K / P\$	7182		
				1 1/2			H / P\$	4244		
	Veneer			1 3/16			F, G, X, Y / W\$	5369		
				1 3/16			K / W\$	8456		
				1 1/2			H / W\$	6139		
	Glass			1/4			Acid Etched Glass Top \$	23917		
				1/4			Gloss Glass Top \$	19933		
48"D x 204"W or 17' - 3 Piece Boat Top										
88-48204BT	Laminate	204	48-36	1 3/16	394	48.9	F, G, X, Y / P\$	3643		
				1 3/16			K / P\$	6968		
				1 1/2			H / P\$	4169		
	Veneer			1 3/16			F, G, X, Y / W\$	5106		
				1 3/16			K / W\$	8101		
				1 1/2			H / W\$	5834		
	Glass			1/4			Acid Etched Glass Top \$	22751		
				1/4			Gloss Glass Top \$	18988		

Additional 48" Boat Shaped Tops on Next Page



Double Kerf (F) 1 3/16" Duo (G) 1 3/16" Fluted (X) 1 3/16" Square (Y) 1 3/16" Knife (K) 1 3/16" Vertical Square (H) 1 1/2"

P = HPL W = Veneer

[See Strut Overview For Ordering Options](#)

Item	Model No.		W	D	H	Ship Wt	Cubic Ft	Edge Profile + Material	List Price		
<i>CONTINUED FROM PREVIOUS PAGE</i>	48"D x 192"W or 16' - 2 Piece Boat Top										
	88-48192BT	Laminate	192	48-36	1 3/16	372	31.2	F, G, X, Y / P\$	3125		
					1 3/16			K / P\$	6249		
					1 1/2			H / P\$	3621		
		Veneer			1 3/16			F, G, X, Y / W\$	4215		
					1 3/16			K / W\$	6996		
					1 1/2			H / W\$	4991		
		Glass			1/4			Acid Etched Glass Top \$	21073		
					1/4			Gloss Glass Top \$	17531		
		48"D x 180"W or 15' - 2 Piece Boat Top									
	88-48180BT	Laminate	180	48-36	1 3/16	350	31.2	F, G, X, Y / P\$	3080		
					1 3/16			K / P\$	6034		
					1 1/2			H / P\$	3547		
		Veneer			1 3/16			F, G, X, Y / W\$	4045		
					1 3/16			K / W\$	6679		
				1 1/2			H / W\$	4773			
	Glass			1/4			Acid Etched Glass Top \$	19906			
				1/4			Gloss Glass Top \$	16586			
	48"D x 168"W or 14' - 2 Piece Boat Top										
88-48168BT	Laminate	168	48-36	1 3/16	328	31.2	F, G, X, Y / P\$	2928			
				1 3/16			K / P\$	5708			
				1 1/2			H / P\$	3363			
	Veneer			1 3/16			F, G, X, Y / W\$	3736			
				1 3/16			K / W\$	6223			
				1 1/2			H / W\$	4418			
	Glass			1/4			Acid Etched Glass Top \$	18629			
				1/4			Gloss Glass Top \$	15530			
	48"D x 156"W or 13' - 2 Piece Boat Top										
88-48156BT	Laminate	156	48-36	1 3/16	306	31.2	F, G, X, Y / P\$	2885			
				1 3/16			K / P\$	5363			
				1 1/2			H / P\$	3288			
	Veneer			1 3/16			F, G, X, Y / W\$	3567			
				1 3/16			K / W\$	6039			
				1 1/2			H / W\$	4202			
	Glass			1/4			Acid Etched Glass Top \$	17463			
				1/4			Gloss Glass Top \$	14585			

Must Specify (in this order):

- Model #
- Top/Edge Material
- Top/Edge Finish/Color
- Edge Profile
- Glass (Y/N)
- Glass Color + Surface Finish
- Power/Data
- Power/Data Location

Additional 48" Boat Shaped Tops on Next Page



Double Kerf (F)
1 3/16"



Duo (G)
1 3/16"



Fluted (X)
1 3/16"



Square (Y)
1 3/16"



Knife (K)
1 3/16"



Vertical Square (H)
1 1/2"

P = HPL W = Veneer

[See Strut Overview For Ordering Options](#)

Item	Model No.		W	D	H	Ship Wt	Cubic Ft	Edge Profile + Material	List Price		
<i>CONTINUED FROM PREVIOUS PAGE</i>	48"D x 144"W or 12' - 2 Piece Boat Top										
	88-48144BT	Laminate	144	48-36	1 3/16	284	23.5	F, G, X, Y / P\$	2421		
					1 3/16			K / P\$	4847		
					1 1/2			H / P\$	2793		
		Veneer			1 3/16			F, G, X, Y / W\$	3328		
					1 3/16			K / W\$	5521		
					1 1/2			H / W\$	3915		
		Glass			1/4			Acid Etched Glass Top \$	16201		
					1/4			Gloss Glass Top \$	13544		
		48"D x 132"W or 11' - 2 Piece Boat Top									
	88-48132BT	Laminate	132	48-36	1 3/16	262	23.5	F, G, X, Y / P\$	2365		
					1 3/16			K / P\$	4619		
					1 1/2			H / P\$	2705		
		Veneer			1 3/16			F, G, X, Y / W\$	3105		
					1 3/16			K / W\$	5178		
					1 1/2			H / W\$	3645		
		Glass			1/4			Acid Etched Glass Top \$	15022		
					1/4			Gloss Glass Top \$	12588		
	48"D x 120"W or 10' - 2 Piece Boat Top										
88-48120BT	Laminate	120	48-36	1 3/16	240	23.5	F, G, X, Y / P\$	2299			
				1 3/16			K / P\$	4383			
				1 1/2			H / P\$	2609			
	Veneer			1 3/16			F, G, X, Y / W\$	2870			
				1 3/16			K / W\$	4823			
				1 1/2			H / W\$	3364			
	Glass			1/4			Acid Etched Glass Top \$	13835			
				1/4			Gloss Glass Top \$	11622			
	48"D x 108"W or 9' - 2 Piece Boat Top										
88-48108BT	Laminate	108	48-36	1 3/16	218	23.5	F, G, X, Y / P\$	2243			
				1 3/16			K / P\$	4063			
				1 1/2			H / P\$	2522			
	Veneer			1 3/16			F, G, X, Y / W\$	2648			
				1 3/16			K / W\$	4575			
				1 1/2			H / W\$	3095			
	Glass			1/4			Acid Etched Glass Top \$	12657			
				1/4			Gloss Glass Top \$	10665			

Must Specify (in this order):
 Model #
 Top/Edge Material
 Top/Edge Finish/Color
 Edge Profile
 Glass (Y/N)
 Glass Color + Surface Finish
 Power/Data
 Power/Data Location

Additional 48" Boat Shaped Tops on Next Page



Double Kerf (F)
1 3/16"



Duo (G)
1 3/16"



Fluted (X)
1 3/16"



Square (Y)
1 3/16"



Knife (K)
1 3/16"



Vertical Square (H)
1 1/2"

P = HPL W = Veneer

[See Strut Overview For Ordering Options](#)

Item	Model No.		W	D	H	Ship Wt	Cubic Ft	Edge Profile + Material	List Price	
48"D x 96"W or 8' - 1 Piece Boat Top										
<i>CONTINUED FROM PREVIOUS PAGE</i>	88-4896BT	Laminate	96	48-36	1 ³ / ₁₆	295	27.0	F, G, X, Y / P\$	1529	
					1 ³ / ₁₆			K / P\$	3258	
					1 ¹ / ₂			H / P\$	1774	
	Veneer	1 ³ / ₁₆	F, G, X, Y / W\$	1951						
		1 ³ / ₁₆	K / W\$	3558						
		1 ¹ / ₂	H / W\$	2347						
	Glass		1 ¹ / ₄	Acid Etched Glass Top \$	10965					
			1 ¹ / ₄	Gloss Glass Top \$	9194					
	48"D x 84"W or 7' - 1 Piece Boat Top									
	Must Specify (in this order): Model # Top/Edge Material Top/Edge Finish/Color Edge Profile Glass (Y/N) Glass Color + Surface Finish Power/Data Power/Data Location	88-4884BT	Laminate	84	48-36	1 ³ / ₁₆	164	15.0	F, G, X, Y / P\$	1484
1 ³ / ₁₆						K / P\$			2899	
1 ¹ / ₂						H / P\$			1698	
Veneer		1 ³ / ₁₆	F, G, X, Y / W\$	1724						
		1 ³ / ₁₆	K / W\$	3266						
		1 ¹ / ₂	H / W\$	2074						
Glass			1 ¹ / ₄	Acid Etched Glass Top \$	9732					
			1 ¹ / ₄	Gloss Glass Top \$	8184					
48"D x 72"W or 6' - 1 Piece Boat Top										
		88-4872BT	Laminate	72	48-36	1 ³ / ₁₆	142	12.8	F, G, X, Y / P\$	1249
	1 ³ / ₁₆					K / P\$			2637	
	1 ¹ / ₂					H / P\$			1432	
	Veneer	1 ³ / ₁₆	F, G, X, Y / W\$	1633						
		1 ³ / ₁₆	K / W\$	2948						
		1 ¹ / ₂	H / W\$	1935						
	Glass		1 ¹ / ₄	Acid Etched Glass Top \$	8608					
			1 ¹ / ₄	Gloss Glass Top \$	7280					

Description

- Tops Available with Veneer (W) or HPL (P) Top in 1³/₁₆" and 1¹/₂" Thicknesses
- Must Specify Edge Profile: 1³/₁₆" Thick/Double Kerf (F), Duo (G), **Fluted (X)**, Square (Y), and Knife (K) Edge Profiles or 1¹/₂" Thick/Vertical Square (H)
- Veneer (W) Top Grain Runs Depth of Top and HPL (P) Top Grain Runs Width of Top
- **All Veneer Tops, as well as Laminate Tops up to 144" (12 feet), have Matching Woodgrain. Laminate Tops Sized 156" (13 feet) and Longer have Non-Matching Woodgrain**
- Available with Back Painted Tempered Glass Top; Must Specify Color and Finish; [See Options](#)
- Power and Data Options Available; Sold Separately, [See Multiple Power Unit Details](#)
- Dock800, Oasis, and E2X Power Units Available on Ends Only (E1 and E2) for 108"D - 156"D and 204"D-240"D Tops
- Strut Legs Sold Separately, [See Strut Legs](#)



Double Kerf (F)
1³/₁₆"



Duo (G)
1³/₁₆"



Fluted (X)
1³/₁₆"



Square (Y)
1³/₁₆"



Knife (K)
1³/₁₆"



Vertical Square (H)
1¹/₂"

P = HPL W = Veneer

[See Strut Overview For Ordering Options](#)

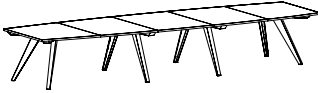
Item	Model No.		W	D	H	Ship Wt	Cubic Ft	Edge Profile + Material	List Price	
BOAT SHAPE MEETING TOP 54"D  88-54204BT shown in Veneer BASES SOLD SEPARATELY	54"D x 240"W or 20' - 5 Piece Veneer (W) and 3 Piece HPL (P) Boat Top									
	88-54240BT	Laminate	240	54-42	1 3/16	519	24.0	F, G, X, Y / P\$	4690	
					1 3/16			K / P\$	8773	
					1 1/2			H / P\$	5389	
		Veneer			1 3/16			F, G, X, Y / W\$	7844	
					1 3/16			K / W\$	11557	
					1 1/2			H / W\$	8912	
		Glass			1/4			Acid Etched Glass Top \$	29666	
					1/4			Gloss Glass Top \$	24687	
	54"D x 228"W or 19' - 5 Piece Veneer (W) and 3 Piece HPL (P) Boat Top									
		88-54228BT	Laminate	228	54-42	1 3/16	495	23.0	F, G, X, Y / P\$	4642
						1 3/16			K / P\$	8545
					1 1/2			H / P\$	5306	
		Veneer			1 3/16			F, G, X, Y / W\$	7602	
					1 3/16			K / W\$	11159	
					1 1/2			H / W\$	8619	
		Glass			1/4			Acid Etched Glass Top \$	28369	
					1/4			Gloss Glass Top \$	23639	
54"D x 216"W or 18' - 5 Piece Veneer (W) and 3 Piece HPL (P) Boat Top										
	88-54216BT	Laminate	216	54-42	1 3/16	470	22.0	F, G, X, Y / P\$	4047	
					1 3/16			K / P\$	7755	
					1 1/2			H / P\$	4676	
		Veneer			1 3/16			F, G, X, Y / W\$	7361	
					1 3/16			K / W\$	10761	
					1 1/2			H / W\$	8327	
		Glass			1/4			Acid Etched Glass Top \$	27037	
					1/4			Gloss Glass Top \$	22556	
54"D x 204"W or 17' - 5 Piece Veneer (W) and 3 Piece HPL (P) Boat Top										
	88-54204BT	Laminate	204	54-42	1 3/16	445	21.0	F, G, X, Y / P\$	3999	
					1 3/16			K / P\$	7528	
					1 1/2			H / P\$	4593	
		Veneer			1 3/16			F, G, X, Y / W\$	7119	
					1 3/16			K / W\$	10364	
					1 1/2			H / W\$	8034	
		Glass			1/4			Acid Etched Glass Top \$	25741	
					1/4			Gloss Glass Top \$	21509	

Must Specify (in this order):

- Model #
- Top/Edge Material
- Top/Edge Finish/Color
- Edge Profile
- Glass (Y/N)
- Glass Color + Surface Finish
- Power/Data
- Power/Data Location

Additional 54" Boat Shaped Tops on Next Page



Double Kerf (F)
1 3/16"



Duo (G)
1 3/16"



Fluted (X)
1 3/16"



Square (Y)
1 3/16"



Knife (K)
1 3/16"



Vertical Square (H)
1 1/2"

P = HPL W = Veneer

[See Strut Overview For Ordering Options](#)

Item	Model No.		W	D	H	Ship Wt	Cubic Ft	Edge Profile + Material	List Price		
<i>CONTINUED FROM PREVIOUS PAGE</i>	54"D x 192"W or 16' - 4 Piece Veneer (W) and 2 Piece HPL (P) Boat Top										
	88-54192BT	Laminate	192	54-42	1 3/16"	408	19.0	F, G, X, Y / P\$	3291		
					1 3/16"			K / P\$	6606		
					1 1/2"			H / P\$	3852		
		Veneer			1 3/16"			F, G, X, Y / W\$	5874		
					1 3/16"			K / W\$	8938		
					1 1/2"			H / W\$	6734		
		Glass			1/4"			Acid Etched Glass Top \$	23748		
					1/4"			Gloss Glass Top \$	19764		
		54"D x 180"W or 15' - 4 Piece Veneer (W) and 2 Piece HPL (P) Boat Top									
	88-54180BT	Laminate	180	54-42	1 3/16"	384	18.0	F, G, X, Y / P\$	3244		
					1 3/16"			K / P\$	6379		
					1 1/2"			H / P\$	3769		
		Veneer			1 3/16"			F, G, X, Y / W\$	5652		
					1 3/16"			K / W\$	8560		
					1 1/2"			H / W\$	6460		
		Glass			1/4"			Acid Etched Glass Top \$	22451		
					1/4"			Gloss Glass Top \$	18716		
	54"D x 168"W or 14' - 4 Piece Veneer (W) and 2 Piece HPL (P) Boat Top										
88-54168BT	Laminate	168	54-42	1 3/16"	359	17.0	F, G, X, Y / P\$	3195			
				1 3/16"			K / P\$	6151			
				1 1/2"			H / P\$	3687			
	Veneer			1 3/16"			F, G, X, Y / W\$	5431			
				1 3/16"			K / W\$	8182			
				1 1/2"			H / W\$	6188			
	Glass			1/4"			Acid Etched Glass Top \$	21154			
				1/4"			Gloss Glass Top \$	17668			
	54"D x 156"W or 13' - 4 Piece Veneer (W) and 2 Piece HPL (P) Boat Top										
88-54156BT	Laminate	156	54-42	1 3/16"	334	16.0	F, G, X, Y / P\$	3147			
				1 3/16"			K / P\$	5923			
				1 1/2"			H / P\$	3603			
	Veneer			1 3/16"			F, G, X, Y / W\$	5209			
				1 3/16"			K / W\$	7802			
				1 1/2"			H / W\$	5915			
	Glass			1/4"			Acid Etched Glass Top \$	19856			
				1/4"			Gloss Glass Top \$	16619			

Must Specify (in this order):

- Model #
- Top/Edge Material
- Top/Edge Finish/Color
- Edge Profile
- Glass (Y/N)
- Glass Color + Surface Finish
- Power/Data
- Power/Data Location

Additional 54" Boat Shaped Tops on Next Page

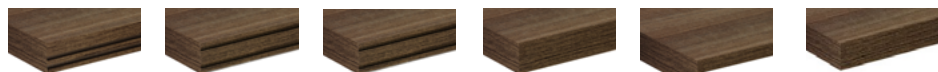

Double Kerf (F) 1 3/16" Duo (G) 1 3/16" Fluted (X) 1 3/16" Square (Y) 1 3/16" Knife (K) 1 3/16" Vertical Square (H) 1 1/2"

P = HPL W = Veneer

[See Strut Overview For Ordering Options](#)

Item	Model No.		W	D	H	Ship Wt	Cubic Ft	Edge Profile + Material	List Price	
<i>CONTINUED FROM PREVIOUS PAGE</i>	54"D x 144"W or 12' - 3 Piece Veneer (W) and 2 Piece HPL (P) Boat Top									
	88-54144BT	Laminate	144	54-42	1 3/16"	309	15.0	F, G, X, Y / P\$	2675	
					1 3/16"			K / P\$	5261	
					1 1/2"			H / P\$	3097	
		Veneer			1 3/16"			F, G, X, Y / W\$	4300	
					1 3/16"			K / W\$	6645	
					1 1/2"			H / W\$	4880	
		Glass			1/4"			Acid Etched Glass Top \$	18228	
					1/4"			Gloss Glass Top \$	15240	
		54"D x 132"W or 11' - 3 Piece Veneer (W) and 2 Piece HPL (P) Boat Top								
	88-54132BT	Laminate	132	54-42	1 3/16"	285	13.2	F, G, X, Y / P\$	2614	
					1 3/16"			K / P\$	5021	
					1 1/2"			H / P\$	3000	
		Veneer			1 3/16"			F, G, X, Y / W\$	4090	
					1 3/16"			K / W\$	6285	
					1 1/2"			H / W\$	4624	
		Glass			1/4"			Acid Etched Glass Top \$	16918	
					1/4"			Gloss Glass Top \$	14180	
	54"D x 120"W or 10' - 3 Piece Veneer (W) and 2 Piece HPL (P) Boat Top									
88-54120BT	Laminate	120	54-42	1 3/16"	260	12.1	F, G, X, Y / P\$	2553		
				1 3/16"			K / P\$	4780		
				1 1/2"			H / P\$	2904		
	Veneer			1 3/16"			F, G, X, Y / W\$	3880		
				1 3/16"			K / W\$	5927		
				1 1/2"			H / W\$	4370		
	Glass			1/4"			Acid Etched Glass Top \$	15612		
				1/4"			Gloss Glass Top \$	13122		

Must Specify (in this order):

- Model #
- Top/Edge Material
- Top/Edge Finish/Color
- Edge Profile
- Glass (Y/N)
- Glass Color + Surface Finish
- Power/Data
- Power/Data Location

Description

- Tops Available with Veneer (W) or HPL (P) Top in 1 3/16" and 1 1/2" Thicknesses
- Must Specify Edge Profile: 1 3/16" Thick/Double Kerf (F), Duo (G), **Fluted (X)**, Square (Y), and Knife (K) Edge Profiles or 1 1/2" Thick/Vertical Square (H)
- Veneer (W) Top Grain Runs Depth of Top and HPL (P) Top Grain Runs Width of Top
- **All Veneer Tops, as well as Laminate Tops up to 144" (12 feet), have Matching Woodgrain. Laminate Tops Sized 156" (13 feet) and Longer have Non-Matching Woodgrain**
- Available with Back Painted Tempered Glass Top; Must Specify Color and Finish; [See Options](#)
- Power and Data Options Available; Sold Separately, [See Multiple Power Unit Details](#)
- Strut Legs Sold Separately, [See Strut Legs](#)



Double Kerf (F)
1 3/16"



Duo (G)
1 3/16"



Fluted (X)
1 3/16"



Square (Y)
1 3/16"



Knife (K)
1 3/16"



Vertical Square (H)
1 1/2"

P = HPL W = Veneer

[See Strut Overview For Ordering Options](#)

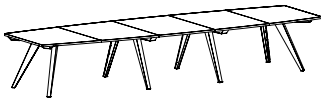
Item	Model No.		W	D	H	Ship Wt	Cubic Ft	Edge Profile + Material	List Price
BOAT SHAPE MEETING TOP 60"D  88-60204BT shown in Veneer BASES SOLD SEPARATELY	60"D x 240"W or 20' - 5 Piece Veneer (W) and 3 Piece HPL (P) Boat Top								
	88-60240BT	Laminate	240	60-48	1 3/16	574	26.3	F, G, X, Y / P\$	4779
					1 3/16			K / P\$	9084
					1 1/2			H / P\$	5559
	Veneer				1 3/16			F, G, X, Y / W\$	8359
					1 3/16			K / W\$	12204
					1 1/2			H / W\$	9534
	Glass				1/4			Acid Etched Glass Top \$	32356
					1/4			Gloss Glass Top \$	26823
	60"D x 228"W or 19' - 5 Piece Veneer (W) and 3 Piece HPL (P) Boat Top								
	88-60228BT	Laminate	228	60-48	1 3/16	547	25.0	F, G, X, Y / P\$	4727
					1 3/16			K / P\$	8844
				1 1/2			H / P\$	5468	
Veneer				1 3/16			F, G, X, Y / W\$	8092	
				1 3/16			K / W\$	11776	
				1 1/2			H / W\$	9210	
Glass				1/4			Acid Etched Glass Top \$	30928	
				1/4			Gloss Glass Top \$	25671	
60"D x 216"W or 18' - 5 Piece Veneer (W) and 3 Piece HPL (P) Boat Top									
88-60216BT	Laminate	216	60-48	1 3/16	519	23.7	F, G, X, Y / P\$	4127	
				1 3/16			K / P\$	8042	
				1 1/2			H / P\$	4829	
Veneer				1 3/16			F, G, X, Y / W\$	7825	
				1 3/16			K / W\$	11350	
				1 1/2			H / W\$	8888	
Glass				1/4			Acid Etched Glass Top \$	29463	
				1/4			Gloss Glass Top \$	24483	
60"D x 204"W or 17' - 5 Piece Veneer (W) and 3 Piece HPL (P) Boat Top									
88-60204BT	Laminate	204	60-48	1 3/16	492	22.4	F, G, X, Y / P\$	4075	
				1 3/16			K / P\$	7802	
				1 1/2			H / P\$	4738	
Veneer				1 3/16			F, G, X, Y / W\$	7558	
				1 3/16			K / W\$	10922	
				1 1/2			H / W\$	8564	
Glass				1/4			Acid Etched Glass Top \$	28035	
				1/4			Gloss Glass Top \$	23332	

Additional 60" Boat Shaped Tops on Next Page



Double Kerf (F)
1 3/16"



Duo (G)
1 3/16"



Fluted (X)
1 3/16"



Square (Y)
1 3/16"



Knife (K)
1 3/16"



Vertical Square (H)
1 1/2"

P = HPL W = Veneer

[See Strut Overview For Ordering Options](#)

Item	Model No.		W	D	H	Ship Wt	Cubic Ft	Edge Profile + Material	List Price		
<i>CONTINUED FROM PREVIOUS PAGE</i>	60"D x 192"W or 16' - 4 Piece Veneer (W) and 2 Piece HPL (P) Boat Top										
	88-60192BT	Laminate	192	60-48	1 3/16"	458	21.1	F, G, X, Y / P\$	3364		
					1 3/16"			K / P\$	6866		
					1 1/2"			H / P\$	3989		
		Veneer			1 3/16"			F, G, X, Y / W\$	6252		
					1 3/16"			K / W\$	9435		
					1 1/2"			H / W\$	7199		
		Glass			1/4"			Acid Etched Glass Top \$	25909		
					1/4"			Gloss Glass Top \$	21482		
		60"D x 180"W or 15' - 4 Piece Veneer (W) and 2 Piece HPL (P) Boat Top									
		88-60180BT	Laminate	180	60-48	1 3/16"	431	19.8	F, G, X, Y / P\$	3311	
						1 3/16"			K / P\$	6625	
						1 1/2"			H / P\$	3898	
			Veneer			1 3/16"			F, G, X, Y / W\$	6007	
						1 3/16"			K / W\$	9030	
						1 1/2"			H / W\$	6898	
			Glass			1/4"			Acid Etched Glass Top \$	24481	
						1/4"			Gloss Glass Top \$	20332	
		60"D x 168"W or 14' - 4 Piece Veneer (W) and 2 Piece HPL (P) Boat Top									
		88-60168BT	Laminate	168	60-48	1 3/16"	403	18.5	F, G, X, Y / P\$	3259	
						1 3/16"			K / P\$	6385	
					1 1/2"			H / P\$	3806		
		Veneer			1 3/16"			F, G, X, Y / W\$	5762		
					1 3/16"			K / W\$	8625		
					1 1/2"			H / W\$	6596		
		Glass			1/4"			Acid Etched Glass Top \$	23053		
					1/4"			Gloss Glass Top \$	19180		
	60"D x 156"W or 13' - 4 Piece Veneer (W) and 2 Piece HPL (P) Boat Top										
	88-60156BT	Laminate	156	60-48	1 3/16"	376	17.2	F, G, X, Y / P\$	3206		
					1 3/16"			K / P\$	6145		
					1 1/2"			H / P\$	3715		
		Veneer			1 3/16"			F, G, X, Y / W\$	5518		
					1 3/16"			K / W\$	8220		
					1 1/2"			H / W\$	6295		
		Glass			1/4"			Acid Etched Glass Top \$	21624		
					1/4"			Gloss Glass Top \$	18028		

Must Specify (in this order):

- Model #
- Top/Edge Material
- Top/Edge Finish/Color
- Edge Profile
- Glass (Y/N)
- Glass Color + Surface Finish
- Power/Data
- Power/Data Location

Additional 60" Boat Shaped Tops on Next Page



Double Kerf (F)
1 3/16"



Duo (G)
1 3/16"



Fluted (X)
1 3/16"



Square (Y)
1 3/16"



Knife (K)
1 3/16"



Vertical Square (H)
1 1/2"

P = HPL W = Veneer

[See Strut Overview For Ordering Options](#)

Item	Model No.		W	D	H	Ship Wt	Cubic Ft	Edge Profile + Material	List Price		
<i>CONTINUED FROM PREVIOUS PAGE</i>	60"D x 144"W or 12' - 3 Piece Veneer (W) and 2 Piece HPL (P) Boat Top										
	88-60144BT	Laminate	144	60-48	1 3/16"	342	16.0	F, G, X, Y / P\$	2731		
					1 3/16"			K / P\$	5470		
					1 1/2"			H / P\$	3200		
		Veneer			1 3/16"			F, G, X, Y / W\$	4568		
					1 3/16"			K / W\$	7008		
					1 1/2"			H / W\$	5205		
		Glass			1/4"			Acid Etched Glass Top \$	19864		
					1/4"			Gloss Glass Top \$	16543		
		60"D x 132"W or 11' - 3 Piece Veneer (W) and 2 Piece HPL (P) Boat Top									
	88-60132BT	Laminate	132	60-48	1 3/16"	323	14.6	F, G, X, Y / P\$	2666		
					1 3/16"			K / P\$	5216		
					1 1/2"			H / P\$	3096		
		Veneer			1 3/16"			F, G, X, Y / W\$	4336		
					1 3/16"			K / W\$	6621		
				1 1/2"			H / W\$	4922			
	Glass			1/4"			Acid Etched Glass Top \$	18421			
				1/4"			Gloss Glass Top \$	15378			
	60"D x 120"W or 10' - 3 Piece Veneer (W) and 2 Piece HPL (P) Boat Top										
88-60120BT	Laminate	120	60-48	1 3/16"	287	13.3	F, G, X, Y / P\$	2601			
				1 3/16"			K / P\$	4964			
				1 1/2"			H / P\$	2991			
	Veneer			1 3/16"			F, G, X, Y / W\$	4104			
				1 3/16"			K / W\$	6237			
				1 1/2"			H / W\$	4641			
	Glass			1/4"			Acid Etched Glass Top \$	16980			
				1/4"			Gloss Glass Top \$	14214			

Must Specify (in this order):

- Model #
- Top/Edge Material
- Top/Edge Finish/Color
- Edge Profile
- Glass (Y/N)
- Glass Color + Surface Finish
- Power/Data
- Power/Data Location

Description

- Tops Available with Veneer (W) or HPL (P) Top in 1 3/16" and 1 1/2" Thicknesses
- Must Specify Edge Profile: 1 3/16" Thick/Double Kerf (F), Duo (G), **Fluted (X)**, Square (Y), and Knife (K) Edge Profiles or 1 1/2" Thick/Vertical Square (H)
- Veneer (W) Top Grain Runs Depth of Top and HPL (P) Top Grain Runs Width of Top
- **All Veneer Tops, as well as Laminate Tops up to 144" (12 feet), have Matching Woodgrain. Laminate Tops Sized 156" (13 feet) and Longer have Non-Matching Woodgrain**
- Available with Back Painted Tempered Glass Top; Must Specify Color and Finish; [See Options](#)
- Power and Data Options Available; Sold Separately, [See Multiple Power Unit Details](#)
- Strut Legs Sold Separately, [See Strut Legs](#)



Double Kerf (F)
1 3/16"



Duo (G)
1 3/16"



Fluted (X)
1 3/16"



Square (Y)
1 3/16"



Knife (K)
1 3/16"



Vertical Square (H)
1 1/2"

P = HPL W = Veneer

[See Strut Overview For Ordering Options](#)

Item	Model No.		W	D	H	Ship Wt	Cubic Ft	List Price
STRUT TABLE LEGS	01-2228STR2	1 Pair (2 Legs)	1½	22½	28⅞	32	4.5	\$ 1278
	01-2228STR4	2 Pair (4 Legs)	1½	22½	28⅞	64	9.0	\$ 2556

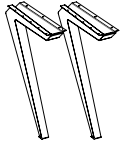

Must Specify (in this order):

Model # and Quantity
Color

Description

- Available in Aluminum (ALUM) or Black (BLK); Must Specify Color
- Integrated Wire Management Inside of Legs to Keep Your Space Clean and Free of Wires
- Stiffener Bars Included with Top for Additional Support
- Each Leg has Adjustable Glides
- Legs not Available To Be Sold Separately

Table Widths	42" - 96"	108" - 144"	156" - 192"	204" - 240"
Number of Legs Required	4	6	8	10
Quantity and Model #	(1) 01-2228STR4	(1) 01-2228STR4 + (1) 01-2228STR2	(2) 01-2228STR4	(2) 01-2228STR4 + (1) 01-2228STR2

T = TFL W = Veneer

[See Strut Overview For Ordering Options](#)

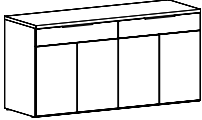
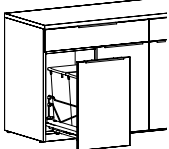
Item	Model No.		W	D	H	Ship Wt	Cubic Ft	Edge Profile + Material	List Price	
BUFFET CREDENZA WITH DRAWERS  Shown: 88-2472BF  Waste Bin Option Shown as Left	88-2496BF <i>Five Doors + Five Drawers</i>	TFL+HPL	96	24	36	466	56.0	F, G, X, Y / T+P\$	5839	
									H / T+P\$	5952
		Veneer+HPL							F, G, X, Y / W+P\$	8909
									H / W+P\$	9078
		Veneer							F, G, X, Y / W\$	9242
									H / W\$	9379
		Glass+TFL							Acid Etched Glass Top +T\$	9417
									Gloss Glass Top +T\$	8532
		Glass+Veneer							Acid Etched Glass Top +W\$	12818
									Gloss Glass Top +W\$	11934
		88-2484BF <i>Five Doors + Three Drawers</i>	TFL+HPL	84	24	36	404	49.2	F, G, X, Y / T+P\$	5109
										H / T+P\$
Veneer+HPL								F, G, X, Y / W+P\$	7679	
								H / W+P\$	7828	
Veneer								F, G, X, Y / W\$	8015	
								H / W\$	8136	
Glass+TFL								Acid Etched Glass Top +T\$	8204	
								Gloss Glass Top +T\$	7430	
Glass+Veneer								Acid Etched Glass Top +W\$	11111	
								Gloss Glass Top +W\$	10336	
88-2472BF <i>Four Doors + Two Drawers</i>	TFL+HPL			72	24	36	342	42.3	F, G, X, Y / T+P\$	4098
										H / T+P\$
		Veneer+HPL						F, G, X, Y / W+P\$	6292	
								H / W+P\$	6420	
		Veneer						F, G, X, Y / W\$	6450	
								H / W\$	6556	
		Glass+TFL						Acid Etched Glass Top +T\$	6853	
								Gloss Glass Top +T\$	6189	
		Glass+Veneer						Acid Etched Glass Top +W\$	9205	
								Gloss Glass Top +W\$	8541	
		88-2460BF <i>Three Doors + Three Drawers</i>	TFL+HPL	60	24	36	280	34.5	F, G, X, Y / T+P\$	3940
										H / T+P\$
Veneer+HPL								F, G, X, Y / W+P\$	5833	
								H / W+P\$	5942	
Veneer								F, G, X, Y / W\$	5996	
								H / W\$	6084	
Glass+TFL								Acid Etched Glass Top +T\$	6213	
								Gloss Glass Top +T\$	5659	
Glass+Veneer								Acid Etched Glass Top +W\$	8269	
								Gloss Glass Top +W\$	7715	

T= TFL P = HPL W = Veneer

Additional Buffet Credenzas on Next Page

[See Strut Overview For Ordering Options](#)

Item	Model No.		W	D	H	Ship Wt	Cubic Ft	Edge Profile + Material	List Price
<i>CONTINUED FROM PREVIOUS PAGE</i>	88-2448BF <i>Two Doors + Two Drawers</i>	TFL+HPL	48	24	36	209	28.6	F, G, X, Y / T+P\$	2783
								H / T+P\$	2841
		Veneer+HPL						F, G, X, Y / W+P\$	4296
								H / W+P\$	4385
		Veneer						F, G, X, Y / W\$	4463
								H / W\$	4534
		Glass+TFL						Acid Etched Glass Top +T\$	4574
								Gloss Glass Top +T\$	4131
		Glass+Veneer						Acid Etched Glass Top +W\$	6253
								Gloss Glass Top +W\$	5812
<i>Must Specify (in this order):</i> Model # Top/Edge Material Top/Edge Finish/Color Edge Profile Chassis Color Glass (Y/N) Glass Color + Surface Finish Pull Drawer Track Vent Waste Bin	88-2436BF <i>Two Doors + One Drawer</i>	TFL+HPL	36	24	36	209	28.6	F, G, X, Y / T+P\$	2323
								H / T+P\$	2367
		Veneer+HPL						F, G, X, Y / W+P\$	3424
								H / W+P\$	3492
		Veneer						F, G, X, Y / W\$	3594
								H / W\$	3648
		Glass+TFL						Acid Etched Glass Top +T\$	3631
								Gloss Glass Top +T\$	3299
		Glass+Veneer						Acid Etched Glass Top +W\$	4903
								Gloss Glass Top +W\$	4571

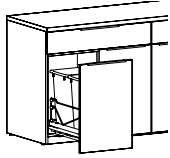

Waste Bin Option Shown as Left

Description

- Standard with: Touch Latch Doors with One (1) Adjustable Shelf Behind Doors, Top Profile on Approach Side, 2" Wire Management Channel Along Back of Interior Cabinet, Reverse Slip Matched Pattern on Top Surface, and Vertical Grain Direction on Chassis
- Available with Veneer (W), HPL (P), or Back Painted Tempered Glass (Black or White with Gloss or Acid Etched Finish) Top with Veneer (W) or HPL (P) Chassis
- When Selecting Back Painted Tempered Glass Top; Must Specify Glass Color, Gloss or Acid Etched Finish and Edge Profile; [See Options](#)
- Tops and Chassis Available in Contrasting Colors; Must Specific Color of Each Component
- Studio Pull Centered on Drawer Fronts Standard; Must Specify Pull Color ([See Color Options](#))
- Touch Latch Doors Standard Without Pulls, Optional Studio Pulls; Must Specify Pull Color ([See Color Options](#))
- Studio Pulls Will be Added and Centered on Top of Doors When Waste Bin is Selected; Must Specify Pull Color ([See Color Options](#)) and Optional Waste Bin ([See Options](#))
- Knife Edge not Available
- Additional Options: Locking Doors ([See Options Details](#)); Pull Out Waste Bin ([See Options Details](#)); Back Panel Vent ([See Options Details](#)); Soft Close Drawers ([See Soft Close Option](#))



Double Kerf (F)
1 3/16"



Duo (G)
1 3/16"



Fluted (X)
1 3/16"



Square (Y)
1 3/16"



Vertical Square (H)
1 1/2"

T= TFL P= HPL W= Veneer

[See Strut Overview For Ordering Options](#)

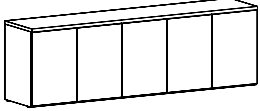
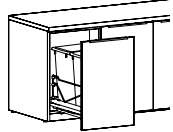
Item	Model No.		W	D	H	Ship Wt	Cubic Ft	Edge Profile + Material	List Price		
24"D CREDENZA  Shown: 88-2496CC  Waste Bin Option Shown as Left	88-2496CC <i>Five Doors</i>	TFL+HPL	96	24	30	415	47.2	F, G, X, Y / T+P\$	4591		
									H / T+P\$	4704	
		Veneer+HPL							F, G, X, Y / W+P\$	7195	
									H / W+P\$	7365	
		Veneer							F, G, X, Y / W\$	7528	
									H / W\$	7666	
		Glass+TFL							Acid Etched Glass Top +T\$	8169	
									Gloss Glass Top +T\$	7283	
		Glass+Veneer							Acid Etched Glass Top +W\$	11106	
									Gloss Glass Top +W\$	10220	
		88-2484CC <i>Five Doors</i>	88-2484CC <i>Five Doors</i>	TFL+HPL	84	24	30	353	41.4	F, G, X, Y / T+P\$	4189
											H / T+P\$
Veneer+HPL									F, G, X, Y / W+P\$	6418	
									H / W+P\$	6567	
Veneer									F, G, X, Y / W\$	6754	
									H / W\$	6876	
Glass+TFL									Acid Etched Glass Top +T\$	7284	
									Gloss Glass Top +T\$	6510	
Glass+Veneer									Acid Etched Glass Top +W\$	9850	
									Gloss Glass Top +W\$	9075	
88-2472CC <i>Four Doors</i>	88-2472CC <i>Four Doors</i>			TFL+HPL	72	24	30	260	35.6	F, G, X, Y / T+P\$	3384
											H / T+P\$
		Veneer+HPL							F, G, X, Y / W+P\$	5268	
									H / W+P\$	5396	
		Veneer							F, G, X, Y / W\$	5427	
									H / W\$	5531	
		Glass+TFL							Acid Etched Glass Top +T\$	6140	
									Gloss Glass Top +T\$	5475	
		Glass+Veneer							Acid Etched Glass Top +W\$	8182	
									Gloss Glass Top +W\$	7517	
		88-2460CC <i>Three Doors</i>	88-2460CC <i>Three Doors</i>	TFL+HPL	60	24	30	240	29.9	F, G, X, Y / T+P\$	2983
											H / T+P\$
Veneer+HPL									F, G, X, Y / W+P\$	4623	
									H / W+P\$	4732	
Veneer									F, G, X, Y / W\$	4786	
									H / W\$	4874	
Glass+TFL									Acid Etched Glass Top +T\$	5256	
									Gloss Glass Top +T\$	4702	
Glass+Veneer									Acid Etched Glass Top +W\$	7059	
									Gloss Glass Top +W\$	6505	

Must Specify (in this order):

- Model #
- Top/Edge Material
- Top/Edge Finish/Color
- Edge Profile
- Chassis Color
- Glass (Y/N)
- Glass Color + Surface Finish
- Pull
- Vent
- Waste Bin

T= TFL P = HPL W = Veneer

Additional 24" Credenzas on Next Page

[See Strut Overview For Ordering Options](#)

Item	Model No.		W	D	H	Ship Wt	Cubic Ft	Edge Profile + Material	List Price
<i>CONTINUED FROM PREVIOUS PAGE</i>	88-2448CC <i>Two Doors</i>	TFL+HPL	48	24	30	185	20.4	F, G, X, Y / T+P\$ H / T+P\$	2258 2316
		Veneer+HPL						F, G, X, Y / W+P\$ H / W+P\$	3546 3634
		Veneer						F, G, X, Y / W\$ H / W\$	3713 3784
		Glass+TFL						Acid Etched Glass Top +T\$ Gloss Glass Top +T\$	4049 3606
		Glass+Veneer						Acid Etched Glass Top +W\$ Gloss Glass Top +W\$	5503 5060
		TFL+HPL	36	24	30	150	18.3	F, G, X, Y / T+P\$ H / T+P\$	1909 1953
		Veneer+HPL						F, G, X, Y / W+P\$ H / W+P\$	2846 2915
		Veneer						F, G, X, Y / W\$ H / W\$	3017 3072
		Glass+TFL						Acid Etched Glass Top +T\$ Gloss Glass Top +T\$	3217 2886
		Glass+Veneer						Acid Etched Glass Top +W\$ Gloss Glass Top +W\$	4325 3994

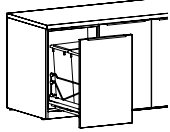

Waste Bin Option
Shown as Left

Must Specify (in this order):

- Model #
- Top/Edge Material
- Top/Edge Finish/Color
- Edge Profile
- Chassis Color
- Glass (Y/N)
- Glass Color + Surface Finish
- Pull
- Vent
- Waste Bin

Description

- Standard with: One (1) Adjustable Shelf Behind Touch Latch Doors, Top Profile on Approach Side, 2" Wire Management Channel Along Back of Interior Cabinet, Reverse Slip Matched Pattern on Top Surface, and Vertical Grain Direction on Chassis
- Available with Veneer (W), HPL (P), or Back Painted Tempered Glass (Black or White with Gloss or Acid Etched Finish) Top
- When Selecting Back Painted Tempered Glass Top; Must Specify Glass Color, Gloss or Acid Etched Finish and Edge Profile; [See Options](#)
- Tops and Chassis Available in Contrasting Colors; Must Specific Color of Each Component
- Studio Pull Centered on Drawer Fronts Standard; Must Specify Pull Color ([See Color Options](#))
- Touch Latch Doors Standard Without Pulls, Optional Studio Pulls; Must Specify Pull Color ([See Color Options](#))
- Studio Pulls Will be Added and Centered on Top of Doors When Waste Bin is Selected; Must Specify Pull Color ([See Color Options](#)) and Optional Waste Bin ([See Options](#))
- Knife Edge not Available
- Additional Options: Locking Doors ([See Options Details](#)); Pull Out Waste Bin ([See Options Details](#)); Back Panel Vent ([See Options Details](#)); Soft Close Drawers ([See Soft Close Option](#))



Double Kerf (F)
1 3/16"



Duo (G)
1 3/16"



Fluted (X)
1 3/16"



Square (Y)
1 3/16"



Vertical Square (H)
1 1/2"

T = TFL P = HPL W = Veneer

[See Strut Overview For Ordering Options](#)

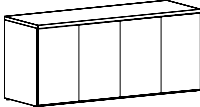
Item	Model No.		W	D	H	Ship Wt	Cubic Ft	Edge Profile + Material	List Price	
	88-2096CC <i>Five Doors</i>	TFL+HPL	96	20	30	398	39.9	F, G, X, Y / T+P\$	4283	
									H / T+P\$	4378
		Veneer+HPL							F, G, X, Y / W+P\$	6753
									H / W+P\$	6900
		Veneer							F, G, X, Y / W\$	7094
									H / W\$	7210
	88-2084CC <i>Five Doors</i>	Glass+TFL							Acid Etched Glass Top +T\$	7218
									Gloss Glass Top +T\$	6480
		Glass+Veneer							Acid Etched Glass Top +W\$	10029
									Gloss Glass Top +W\$	9291
		TFL+HPL	84	20	30	338	35.1	F, G, X, Y / T+P\$	3909	
									H / T+P\$	3993
88-2072CC <i>Four Doors</i>	Veneer+HPL							F, G, X, Y / W+P\$	6026	
								H / W+P\$	6155	
	Veneer							F, G, X, Y / W\$	6369	
								H / W\$	6472	
	Glass+TFL							Acid Etched Glass Top +T\$	6443	
								Gloss Glass Top +T\$	5797	
88-2060CC <i>Three Doors</i>	Glass+Veneer							Acid Etched Glass Top +W\$	8903	
								Gloss Glass Top +W\$	8257	
	TFL+HPL	72	20	30	260	35.6	F, G, X, Y / T+P\$	3141		
								H / T+P\$	3214	
	Veneer+HPL							F, G, X, Y / W+P\$	4928	
								H / W+P\$	5039	
88-2060CC <i>Three Doors</i>	Veneer							F, G, X, Y / W\$	5093	
								H / W\$	5181	
	Glass+TFL							Acid Etched Glass Top +T\$	5414	
								Gloss Glass Top +T\$	4860	
	Glass+Veneer							Acid Etched Glass Top +W\$	7366	
								Gloss Glass Top +W\$	6812	
88-2060CC <i>Three Doors</i>	TFL+HPL	60	20	30	220	25.3	F, G, X, Y / T+P\$	2753		
								H / T+P\$	2813	
	Veneer+HPL							F, G, X, Y / W+P\$	4259	
								H / W+P\$	4353	
	Veneer							F, G, X, Y / W\$	4427	
								H / W\$	4501	
88-2060CC <i>Three Doors</i>	Glass+TFL							Acid Etched Glass Top +T\$	4623	
								Gloss Glass Top +T\$	4163	
	Glass+Veneer							Acid Etched Glass Top +W\$	6298	
								Gloss Glass Top +W\$	5837	

T= TFL P = HPL W = Veneer

Additional 20" Credenzas on Next Page

[See Strut Overview For Ordering Options](#)

Item	Model No.		W	D	H	Ship Wt	Cubic Ft	Edge Profile + Material	List Price
<i>CONTINUED FROM PREVIOUS PAGE</i>	88-2048CC <i>Two Doors</i>	TFL+HPL	48	20	30	165	24.1	F, G, X, Y / T+P\$	2103
								H / T+P\$	2153
		Veneer+HPL						F, G, X, Y / W+P\$	3329
								H / W+P\$	3405
		Veneer						F, G, X, Y / W\$	3499
								H / W\$	3559
		Glass+TFL						Acid Etched Glass Top +T\$	3573
								Gloss Glass Top +T\$	3203
		Glass+Veneer						Acid Etched Glass Top +W\$	4969
								Gloss Glass Top +W\$	4600
<i>Must Specify (in this order):</i> Model # Top/Edge Material Top/Edge Finish/Color Edge Profile Chassis Color Glass (Y/N) Glass Color + Surface Finish Pull Drawer Track Vent	88-2036CC <i>Two Doors</i>	TFL+HPL	36	20	30	135	15.5	F, G, X, Y / T+P\$	1792
								H / T+P\$	1830
		Veneer+HPL						F, G, X, Y / W+P\$	2688
								H / W+P\$	2747
		Veneer						F, G, X, Y / W\$	2862
								H / W\$	2907
		Glass+TFL						Acid Etched Glass Top +T\$	2860
								Gloss Glass Top +T\$	2582
		Glass+Veneer						Acid Etched Glass Top +W\$	3929
								Gloss Glass Top +W\$	3653

Description

- Standard with: One (1) Adjustable Shelf Behind Touch Latch Doors, Top Profile on Approach Side, 2" Wire Management Channel Along Back of Interior Cabinet, Reverse Slip Matched Pattern on Top Surface, and Vertical Grain Direction on Chassis
- Available with Veneer (W), HPL (P), or Back Painted Tempered Glass (Black or White with Gloss or Acid Etched Finish) Top
- When Selecting Back Painted Tempered Glass Top; Must Specify Glass Color, Gloss or Acid Etched Finish and Edge Profile; [See Options](#)
- Tops and Chassis Available in Contrasting Colors; Must Specific Color of Each Component
- Touch Latch Doors Standard Without Pulls, Optional Studio Pulls; Must Specify Pull Color ([See Color Options](#))
- Studio Pulls Will be Added and Centered on Top of Doors When Waste Bin is Selected; Must Specify Pull Color ([See Color Options](#)) and Optional Waste Bin ([See Options](#))
- Knife Edge not Available
- Additional Options: Locking Doors ([See Options Details](#)); Pull Out Waste Bin Available ([See Options Details](#)); Back Panel Vent ([See Options Details](#))



Double Kerf (F)
1 3/16"



Duo (G)
1 3/16"



Fluted (X)
1 3/16"



Square (Y)
1 3/16"



Vertical Square (H)
1 1/2"

T = TFL P = HPL W = Veneer

[See Strut Overview For Ordering Options](#)

Item	Model No.		W	D	H	Ship Wt	Cubic Ft		List Price
	88-2436SV	TFL+HPL	36	24	36	260	35.6	F, G, X, Y / T+P\$	2585
									H / T+P\$
		Veneer+HPL						F, G, X, Y / W+P\$	3852
								H / W+P\$	3921
		Veneer						F, G, X, Y / W\$	4023
								H / W\$	4078

Must Specify (in this order):

Model #
 Top/Edge Material
 Top/Edge Finish/Color
 Edge Profile
 Optional Grommet

Description

- Top Edge Profiled on Approach Side Only (See Edge Options); Must Specify Edge Selection ([See Edge Details](#))
- Two (2) Box Drawers, Open Storage, and Storage Behind Two (2) Doors
- Locking Casters

Grommet Option: Specify & Add

1-GRMT Grommet in Back Panel; Must Specify Black or Silver \$ 52

ROUND GROMMET COVER FIELD INSTALLED	01-GRMTBK	Black	-	-	-	-	-	\$	11
	01-GRMTSL	Silver							

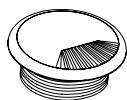

OPEN MARKET ONLY
(SILVER)

Description

- 60mm Round Grommet Cover
- Field Installed

SINGLE POWER SAND DOLLAR	01-SAND60PS	Silver	3	3	4	1	0.2	\$	98
	01-SAND60PW	White							
	01-SAND60PB	Black							

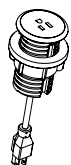

Description

- Mounts in 2 $\frac{3}{8}$ " (60mm) Round Grommet
- Single Power Outlet with 6' Cord

DOUBLE USB SAND DOLLAR	01-SAND60US	Silver	3	3	4	1	0.2	\$	277
	01-SAND60UW	White							
	01-SAND60UB	Black							

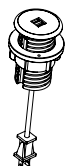

Description

- Mounts in 2 $\frac{3}{8}$ " (60mm) Round Grommet
- Dual USB Outlets with 6' Cord

DOCK 950 WIRELESS CHARGER	01-DOCK950W	White	3 $\frac{3}{16}$	3 $\frac{3}{16}$	-	1	0.2	\$	265
	01-DOCK950B	Black							



OPEN MARKET ONLY

Description

- For Use with Wireless Charging Enabled Devices
- 5 Watts Maximum Output with a Direct Current of 5V 2A and 10 Watts Maximum with Quick Charge 2.0
- LED will Confirm Pairing with Device and Begin Wireless Charging

[See Strut Overview For Ordering Options](#)

Item	Model No.		W	D	H	Ship Wt	Cubic Ft	List Price
WIRELESS AND USB CHARGER	01-DOCK150W	White	3	3	¾"	1	0.2	\$ 405
	01-DOCK150B	Black						



OPEN MARKET ONLY

Description

- For Use with Wireless Charging Enabled Devices and USB Charging Devices
- 5 Watt Maximum Output with a Direct Current Input of 5V 6A (Wireless Fast Charge)
- Pop-Up is ¾"H and Includes Three (3) USB Ports; One (1) 12 Watt Maximum with 2.4A (USB Fast Charge) and Two (2) 5 Watt with 1A (USB Standard Charge)
- LED Light will Confirm Pairing with Device and Begin Wireless Charging
- UL and cUL Certified

DPORT	01-DPORT4A	Aluminum	8	4	-	7	0.2	\$ 1093
	01-DPORT4B	Black						

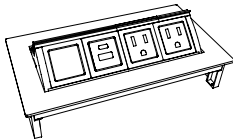
**Description**

- Retracts into Work Surface to Regain Productive Space; One-Touch Access to Power and Data
- Two (2) Power Outlets, One (1) USB A+C, and One (1) Open Port with 10' Power Cord
- Optional Telecom Port Components, [See Compatible Units](#)
- Water-Proof Simplex (Outlets)
- Includes a Voice/Data Adapter Kit to Accept Couplers and Jacks When Required
- UL Recognized

E2X	01-E2X6A	Aluminum	11	9 ³ / ₁₆	-	6	0.7	\$ 1625
	01-E2X6B	Black						
	01-E2X4A	Aluminum	8	9 ³ / ₁₆	-	5	0.5	\$ 1494
	01-E2X4B	Black						

01-E2X4
SIN PENDING**Description**

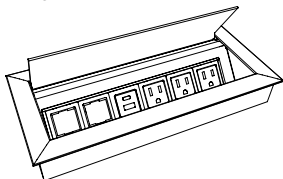

- In Surface Application; Soft Touch Access to Power and Data
- Each Side has the Following: 11" Includes Three (3) Power Outlets, One (1) USB A+C, and Two (2) Open Port; 8" Includes Two (2) Power Outlets, One (1) USB A+C, and One (1) Open Port with 6' Power Cord
- Optional Telecom Port Components, [See Compatible Units](#)
- UL Listed

ELLORA	01-ELLORA6A	Aluminum	11	5	-	6	0.7	\$ 852
	01-ELLORA6B	Black						
	01-ELLORA4A	Aluminum	8	5	-	5	0.5	\$ 792
	01-ELLORA4B	Black						

01-ELLORA6
SIN PENDING**Description**

- In Surface Application; Soft Touch Access to Power and Data
- 11" Includes Three (3) Power Outlets, One (1) USB A+C, and Two (2) Open Port; 8" Includes Two (2) Power Outlets, One (1) USB A+C, and One (1) Open Port with 6' Power Cord
- Optional Telecom Port Components, See Below for Compatible Units
- UL Recognized

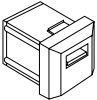
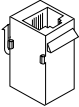
[See Strut Overview For Ordering Options](#)

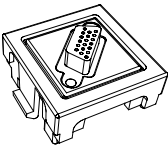
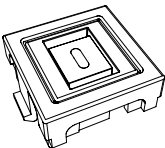
Item	Model No.	W	D	H	Ship Wt	Cubic Ft	List Price
USB PORT	01-USBPORT	-	-	-	-	-	\$ 161
	<p>Description</p> <ul style="list-style-type: none"> • Passive USB-A Port with Increased Transfer Speed Up to 5 gbs/sec • Simultaneous Read/Write Capability; Idle Device Power Saving State • 6' Cord • Compatible with 01-DPORT4A, 01-DPORT4B, ELLORA4A, ELLORA4B, ELLORA6A, ELLORA6B, E2X4A, E2X4B, E2X6A, and E2X6B 						
VOICE COUPLER	01-VOICE1	-	-	-	-	-	\$ 73
	<p>Description</p> <ul style="list-style-type: none"> • 6-Pin Modular Plug • Molded Black; Cord Not included • Compatible with 01-DPORT4A, 01-DPORT4B, ELLORA4A, ELLORA4B, ELLORA6A, ELLORA6B, E2X4A, E2X4B, E2X6A, and E2X6B 						
DATA PORT	01-RJ4DATA	-	-	-	-	-	\$ 167
	<p>Description</p> <ul style="list-style-type: none"> • 8-Pin Modular Plug; Cat6 Ethernet Cable; Pre-terminated Cable • 10' Cord • Compatible with 01-DPORT4A, 01-DPORT4B, ELLORA4A, ELLORA4B, ELLORA6A, ELLORA6B, E2X4A, E2X4B, E2X6A, and E2X6B 						
VGA CONNECTOR ACCESSORY	01-VGACON	-	-	-	1	0.2	\$ 149
	<p>Description</p> <ul style="list-style-type: none"> • VGA Port for 01-DPORT4A, 01-DPORT4B, ELLORA4A, ELLORA4B, ELLORA6A, ELLORA6B, E2X4A, E2X4B, E2X6A, and E2X6B • Enables Devices to Remote Display on Monitors • 10' Cord • Male/Female Connector 						
PASSIVE USB-C ACCESSORY	01-PUSBC	-	-	-	1	0.2	\$ 95
	<p>Description</p> <ul style="list-style-type: none"> • Passive USB-C Port ; Unit Provides Data Connection to Transfer Data Only, No Charging Capabilities • Compatible with 01-DPORT4A, 01-DPORT4B, ELLORA4A, ELLORA4B, ELLORA6A, ELLORA6B, E2X4A, E2X4B, E2X6A, and E2X6B • Male/Female Connector 						

[See Strut Overview For Ordering Options](#)

Item	Model No.	W	D	H	Ship Wt	Cubic Ft	List Price
CHARGING USB-A+C ACCESSORY	01-USBAC	-	-	-	1	0.2	\$ 283

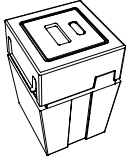
Description

- For Charging Devices
- 20 Watt Power Supply
- USB+C Charging Port for 01-DPORT4A, 01-DPORT4B, ELLORA4A, ELLORA4B, ELLORA6A, ELLORA6B, E2X4A, E2X4B, E2X6A, and E2X6B

HDMI CONNECTOR ACCESSORY	01-HDMICON	-	-	-	1	0.2	\$ 124
--------------------------	------------	---	---	---	---	-----	--------

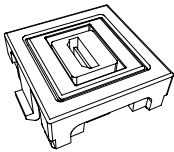
Description

- HDMI Port for 01-DPORT4A, 01-DPORT4B, ELLORA4A, ELLORA4B, ELLORA6A, ELLORA6B, E2X4A, E2X4B, E2X6A, and E2X6B
- Connects to High Definition Displays
- Female/Female Connector
- 18" Cord

INTERACT POWER & DATA	01-INTERACTG2A	Aluminum	9	5 $\frac{3}{4}$	2 $\frac{3}{4}$	5	0.2	\$ 891
	01-INTERACTG2B	Black						



Description

- Includes: Two (2) Power Outlets, Two (2) USB-A Charging Ports, One (1) Telecom Plate Opening; Two (2) Keystone Openings for Voice/Data Jacks
- One (1) Telecom Plates Included with the Unit: One (1) 01-ABLAB Plate (Consists of One (1) RJ45 Cat 6, One (1) RJ11 Cat 3 Phone Jack)
- Convenience Plug on Bottom
- 6' Power Cord
- UL and CSA Recognized
- Additional Telecom Plates, [See ECA Telecom Plate Options](#)

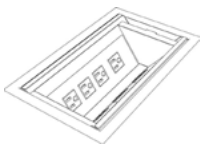
OASIS MINI POWER & DATA	01-OASISMA	Aluminum	15	9	5	11	0.3	\$ 3191
	01-OASISMB	Black						

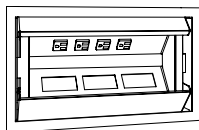

Top View

Description

- For Use with Conference Tables
- Soft Touch Hinged Lid
- Four (4) Power Outlets, Three (3) Telecom Plate Openings
- Two (2) Telecom Plates Included with the Unit: One (1) 01-ABLAB Plate (Consists of One (1) RJ45 Cat 6, One (1) RJ11 Cat 3 Phone Jack); One (1) 01-ABLB Plate (Consists of One (1) RJ45 Cat 6)
- 9' Power Cord
- UL Listed
- Additional Telecom Plates, [See ECA Telecom Plate Options](#)

[See Strut Overview For Ordering Options](#)

Item	Model No.	W	D	H	Ship Wt	Cubic Ft	List Price
DOCK800	01-DOCK800S	Silver	14	9	-		\$ 2047
	01-DOCK800B	Black					

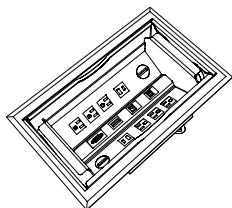

OPEN MARKET ONLY

Description

- Stylish Aluminum Housing with Beveled Edges; Soft Touch Access and Closure
- Includes: Six (6) Power Outlets, Two (2) USB-A 5V Ports, Two (2) USB-C Charging Ports, One (1) RJ45 Ethernet Port, One (1) RJ11 Port, One (1) HDMI Port, and One (1) VGA Port
- 10' Power Cord
- UL and cUL Certified

DUO BEZEL WITH NEMA PLUG	01-DUOBEZELW	White	6½	2¼	3	1	0.2	\$ 675
	01-DUOBEZELB	Black						
	01-DUOBEZELS	Silver						

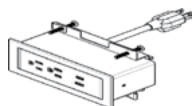
**Description**

- Sits On Top of the Worksurface and Includes: Two (2) Power, **One (1) USB Charging Port and One (1) 60-Watt USB-C Power Delivery Port with GaN Technology with 10' Cord**
- Independent USB Circuit Controllers Deliver up to 2.1 Amps to Each Post
- All Mounting Hardware Included
- FCC Part 15A and UL Approved for Horizontal and Vertical Applications

TRIO BEZEL WITH NEMA PLUG	01-TRIOBEZELW	White	9	2¼	3	1	0.2	\$ 725
	01-TRIOBEZELB	Black						
	01-TRIOBEZELS	Silver						

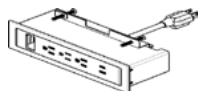
**Description**

- Sits On Top of the Worksurface and Includes: Three (3) Power, **One (1) USB Charging Port and One (1) 60-Watt USB-C Power Delivery Port with GaN Technology**, One (1) Open Data, and 10' Cord
- Independent USB Circuit Controllers Deliver up to 2.1 Amps to Each Post
- HDMI, VGA, or RJ45 Sold Separately; [See Accessories](#)
- All Mounting Hardware Included
- FCC Part 15A and UL Approved for Horizontal and Vertical Applications

DUO BEZEL WITH DAISY CHAIN PLUG	01-PDUOBEZELW	White	6½	2¼	3	1	0.2	\$ 668
	01-PDUOBEZELB	Black						
	01-PDUOBEZELS	Silver						

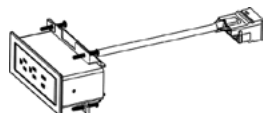
**Description**

- Sits On Top of the Worksurface and Includes: Two (2) Power, **One (1) USB Charging Port and One (1) 60-Watt USB-C Power Delivery Port with GaN Technology with 12" Cord**
- Independent USB Circuit Controllers Deliver up to 2.1 Amps to Each Post
- All Mounting Hardware Included
- FCC Part 15A, RU Listed and UL Recognized for Horizontal and Vertical Applications
- Non Sequential System Allows Up to Eight (8) Modules To Be Connected With Jumper Cord
- Requires Power Box, See Below; See Jumper Cable on Next Page

[See Strut Overview For Ordering Options](#)

Item	Model No.		W	D	H	Ship Wt	Cubic Ft	List Price
TRIO BEZEL WITH DAISY CHAIN PLUG	01-PTRIOBEZELW	White	9	2½	3	1	0.2	\$ 715
	01-PTRIOBEZELB	Black						
	01-PTRIOBEZELS	Silver						

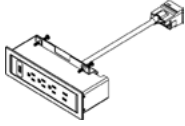

Description

- Sits On Top of the Worksurface and Includes: Three (3) Power, **One (1) USB Charging Port, One (1) 60-Watt USB-C Power Delivery Port with GaN Technology**, and One (1) Open Data with 12" Cord
- HDMI, VGA, or RJ45 Sold Separately; [See Accessories](#)
- All Mounting Hardware Included
- FCC Part 15A, RU Listed and UL Recognized for Horizontal and Vertical Applications
- Non Sequential System Allows Up to Eight (8) Modules To Be Connected With Jumper Cord
- Requires Power Box, See Below; See Jumper Cable on Next Page

DAISY CHAIN POWER BOX	01-PPOWER		-	-	-	1	0.2	\$ 775
		<i>76" Perimeter, 36" Power Cord</i>						
	01-PPOWER2		-	-	-	1	0.2	\$ 796
		<i>24" Perimeter, 144" Power Cord</i>						

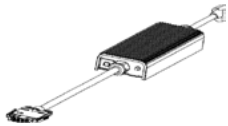

Description

- Powers up to Eight (8) Duo and Trio Daisy Chain Units
- One Nema Plug and One Daisy Chain Plug
- 12-Amp System Rating
- 15-Amp Over-Current Protection

DAISY CHAIN JUMPER CORD	01-6JUMP	<i>72" Long</i>	-	-	-	1	0.2	\$ 299
	01-5JUMP	<i>60" Long</i>	-	-	-	1	0.2	\$ 284
	01-4JUMP	<i>48" Long</i>	-	-	-	1	0.2	\$ 240
	01-2JUMP	<i>24" Long</i>	-	-	-	1	0.2	\$ 220

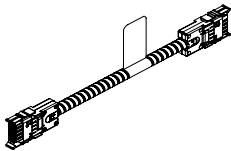

Description

- Connects Duo and Trio Daisy Chain Units
- Non-Sequential System Allows up to Eight (8) Modules to be Connected

HDMI DATA PORT ACCESSORY	01-LCOMHDMI		-	-	-	1	0.2	\$ 166
--------------------------	-------------	--	---	---	---	---	-----	--------

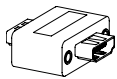

OPEN MARKET ONLY

Description

- HDMI Port for Trio Bezel Units

[See Strut Overview For Ordering Options](#)

Item	Model No.	W	D	H	Ship Wt	Cubic Ft	List Price
VGA DATA PORT ACCESSORY	01-LCOMVGA	-	-	-	1	0.2	\$ 121

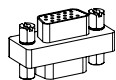
Description

- VGA Port for Trio Bezel Units

RJ45 DATA PORT ACCESSORY	01-LCOMRJ45	-	-	-	1	0.2	\$ 79
--------------------------	-------------	---	---	---	---	-----	-------

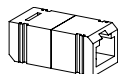
Description

- RJ45 Port for Trio Bezel Units

WIRE MANAGEMENT CHANNEL	01-WMGR4	16	1½	¾	1	-	\$ 116
-------------------------	----------	----	----	---	---	---	--------

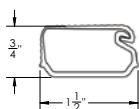
Description

- Set of Four (4) Black Plastic Wire Management Channels
- Snap Lock Channel
- Attaches with Adhesive Strips
- Ships via UPS Only

WIRE CHANNEL	01-32125	24	1½	1	.25	0.3	\$ 106
--------------	----------	----	----	---	-----	-----	--------

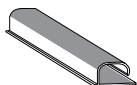
Description

- Available in Black
- Channels Attach with Two (2) Double-Sided Installation Tape
- Open J Channel for Easy Storage of Cables

CABLE GRIP	01-WMGRCB	5¾	2¾	-	-	-	\$ 17
------------	-----------	----	----	---	---	---	-------

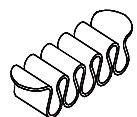
Description

- Under Surface Wire Management
- Black

Item	Model No.	W	D	H	Ship Wt	Cubic Ft	Edge Profile + Material	List Price
MAGNETIC GLASS MARKER BOARD FOR USE WITH 30"H CREDENZA AND SHELVING	GMB-4048W	48	½	40⅞	67	11.0	\$	3128
	GMB-4042W	42	½	40⅞	58	9.9	\$	2644
	GMB-4036W	36	½	40⅞	50	8.8	\$	2285
	GMB-4030W	30	½	40⅞	42	7.7	\$	1924

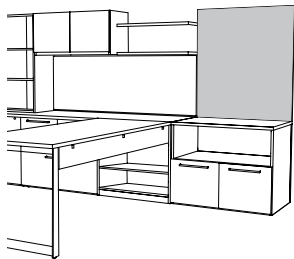

Description

- Available in Black (BLMKR) or White (WHMKR), Must Specify
- Tempered Glass Magnetic Marker Boards Include Mounting Brackets
- For Use over 30"H Desks and Credenzas with Wall Mount Hutches or Shelving
- For Rare Earth Magnets, Marker and Eraser Sets; [See Set Options](#)

Must Specify (in this order):

Model #
Color



Rare Earth Magnets, Marker and Eraser set available; [See Set Options](#)

MAGNETIC GLASS MARKER BOARD FOR USE WITH 30"H CREDENZA AND SHELVING	GMB-5248W	48	½	52⅞	86	13.5	\$	3988
	GMB-5242W	42	½	52⅞	76	12.2	\$	3369
	GMB-5236W	36	½	52⅞	65	10.8	\$	2904
	GMB-5230W	30	½	52⅞	54	9.5	\$	2441

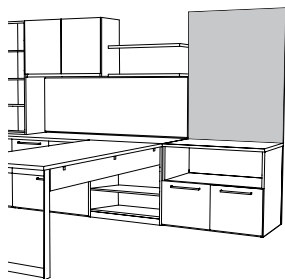

Description

- Available in Black (BLMKR) or White (WHMKR), Must Specify
- Tempered Glass Magnetic Marker Boards Include Mounting Brackets
- For Use Next to Tall Surface or Wall Mount Hutches
- For Rare Earth Magnets, Marker and Eraser Sets; [See Set Options](#)

Must Specify (in this order):

Model #
Color



Rare Earth Magnets, Marker and Eraser set available; [See Set Options](#)

[See Strut Overview For Ordering Options](#)

Item	Model No.	W	D	H	Ship Wt	Cubic Ft	List Price
MAGNETIC GLASS MARKER BOARD	GMB-8236W	36	½	82⅞	102	15.8	\$ 4453
FOR USE FROM FLOOR TO TOP OF UNIT	GMB-7036W	36	½	70⅞	87	13.8	\$ 3834
	GMB-5136W	36	½	51⅞	63	10.6	\$ 2802
	GMB-8230W	30	½	82⅞	85	13.8	\$ 3730
	GMB-7030W	30	½	70⅞	72	12.1	\$ 3215
	GMB-5130W	30	½	51⅞	53	9.3	\$ 2354

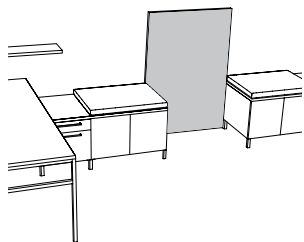

Must Specify (in this order):

Model #

Color

Description

- Available in Black (BLMKR) or White (WHMKR), Must Specify
- Tempered Glass Magnetic Marker Boards Are One (1) Piece with No Seams
- Mounting Brackets Included
- For Use From Floor to Top of Unit
- For Rare Earth Magnets, Marker and Eraser Sets; [See Set Options](#)



Rare Earth Magnets, Marker and Eraser set available; [See Set Options](#)

MARKER AND ERASER SET	01-MRKRSETBL	For Use with Black Marker Boards and Black Glass Doors	\$ 123
	01-MRKRSETWH	For Use with White Marker Boards and White Glass Doors	

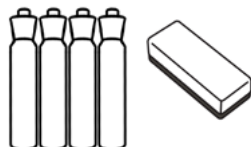

Description

- 01-MRKRSETWH May Also be Used with Dry Erase Doors and Boards
- Includes 4 Markers and an Eraser

RARE EARTH MAGNET SET	01-MAGBL	For Use with White Marker Boards	\$ 114
	01-MAGWH	For Use with Black Marker Boards	



Description

- Includes Set of Five (5) Rare Earth Magnets
- To be Used with Tempered Glass Magnetic Marker Boards
- Comfort Grip with Stylish Protective Plastic Coating

Item	Model No.		W	D	H	Ship Wt	Cubic Ft	List Price
VISUAL BOARD	88-4848VB	TFL	48	5	48	150	11.0	T\$ 2956
		Veneer						W\$ 4908

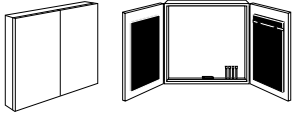

Must Specify (in this order):

- Model #
- Color
- Projection Screen
- Tackboard Fabric

Description

- Tackboard on Each Door Standard in Black Fabric Unless Specified; Price Valid for Grades 1, 2, & 3 (See Other Pricing Below)
- Display Rail with Adjustable Hooks for Flipchart
- Magnetic Porcelain Non-Glare Writing Surface
- Includes Flipchart, Set of Four (4) Dry Erase Markers and Eraser, Mounting Hardware
- Does Not Feature Soft Close Hinges

Options: Specify & Add

	Grade 4	Grade 5	Grade 6	Grade 7	Grade 8	Grade 9	Grade 10
Tackboard Fabric Change	\$ 278	408	540	728	924	1152	1416
1-PS Projection Screen (Requires Field Installation)							\$ 1062

LECTERN STAND	88-2650LS	TFL+HPL	26	24	50	130	21.9	F, G, X, Y / T+P\$	1911
								H / T+P\$	1921
		Veneer+HPL						F, G, X, Y / W+P\$	3451
								H / W+P\$	3477
		Veneer						F, G, X, Y / W\$	3587
							H / W\$	3601	

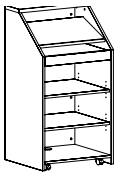





Must Specify (in this order):

- Model #
- Top/Edge Material
- Top/Edge Finish/Color
- Edge Profile

Description

- Top Edge Profiled on Approach Side Only (See Edge Options); Must Specify Edge Selection
- Fixed Shelf Angled for User Comfort, One (1) Pullout Shelf, and Two (2) Adjustable Shelves
- Two (2) Locking and Two (2) Non-Locking Casters
- Wire Management Grommet on Bottom Shelf

[See Strut Overview For Ordering Options](#)

Item	Model No.	Description	List Price
ECA TELECOM PLATES			
	01-ABL	Telecom Plate, Blank Plate	\$ 41
	01-ABL737373	Telecom Plate, Three (3) RJ45 Cat 5e	\$ 367
Compatible with:	01-ABLAB	Telecom Plate, One (1) RJ45 Cat 6, One (1) RJ11 Cat 3 Phone	\$ 206
	01-ABLAB102	Telecom Plate, One (1) RJ45 Cat 6, One (1) RJ11 Cat 3, One (1) USB W/72" Patch Cord	\$ 320
	01-ABLABB	Telecom Plate, Two (2) RJ45 Cat 6, One (1) RJ11 Cat 3 Phone	\$ 320
Oasis Mini Power & Data 01-OASISMA, 01-OASISMB	01-ABLB	Telecom Plate, One (1) RJ45 Cat 6	\$ 149
	01-ABLBB	Telecom Plate, Two (2) RJ45 Cat 6	\$ 260
Interact Power & Data 01-INTERACTG2A, 01-INTERACTG2B	01-ABLBBB	Telecom Plate, Three (3) RJ45 Cat 6	\$ 367
	01-ABLBBBB	Telecom Plate, Four (4) RJ45 Cat 6	\$ 476
Power Center 01-INTRFCIA, 01-INTRFCIB	01-ABLBBC51	Telecom Plate, Two (2) RJ45 Cat 6, One (1) 15 Pin HD VGA w/72" Patch Cord	\$ 446
	01-ABLBC51L	Telecom Plate, One (1) RJ45 Cat 6, One (1) Mini Stereo Inline, One (1) 15 Pin HD VGA w/72" Patch Cord	\$ 410
	01-ABLC3811	Telecom Plate, One (1) RJ45 Cat 6 Data Inline, One (1) RJ11 Cat 3 Phone Inline	\$ 197
	01-ABLC45	Telecom Plate, One (1) HDMI w/36" Patch Cord	\$ 295
	01-ABLC45C51L	Telecom Plate, One (1) Mini Stereo Inline, One (1) HDMI w/36" Patch Cord, One (1) 15 Pin HD VGA w/72" Patch Cord	\$ 558
	01-ABLC51L	Telecom Plate, One (1) 15 Pin HD VGA & One (1) Mini Stereo Inline Jack	\$ 298
	01-ABLCRDM	Telecom Plate, Three (3) Cord Bushings	\$ 96

The Synergy Collection has partitions, tables, and seating to create spaces in an impromptu way without the need for complex architecture. Synergy Tables are a component of this thoughtful portfolio with soft rectangle and view-shaped seated, counter, and standing height tables, available as freestanding or with casters.

CONSTRUCTION

TABLES

- Table legs are 2"D, crafted from European Beech, and individually hand sanded prior to being finished with non-marring fixed nylon glides when casters are not selected
- Table tops have 1" thick Thermally-Fused Laminate (TFL) or High Pressure Laminate (HPL) surface with 3mm PVC edge band and Square edge profile; Designer White, Sugar Maple, and Williamsburg Cherry feature ABS edge bands



Square (Y)

- Tables require some assembly

POWER/DATA/CORD MANAGEMENT

- Table top grommets and power/data units are available on center
- Table tops feature undersurface a 2"H metal accent to conceal wires and additional cord management is available for order; [See Accessories](#)
- Power/Data units available for in-surface mounting and comply with FCC Part 15A and UL
- Partitions with TV mount include a black grommet below TV mount, center wire channel, and grommet in bottom of unit for a clean and easy access to power.

HOW TO ORDER EXAMPLES

MODEL	QTY	DESCRIPTION	EXAMPLE
82-3672BRT	1	Top Material	T
		TFL Top Color	NTM
		Metal Accent	ALUM
		Leg Color	ORW
		Leg Glide or Caster	BSC60 (Caster)
POWER	1	Grommet/Power	C
		Duo Bezel Nema Plug	01-DUOBEZELS
82-3672CVT	1	Top Material	T
		TFL Top Color	RC
		Metal Accent	ALUM
		Leg Color	RC
		Leg Glide or Caster	GLIDES
POWER	1	Grommet/Power	C
		Dock 950	01-DOCK950B

TFL (T) OR HPL (P) FOR TABLE TOP

WOODGRAIN

AS	Asian Night	PNW	Pinnacle Walnut
BW	Beigewood	PTK	Portico Teak
CO	Columbian Walnut	RC	River Cherry
EF	Espresso	SCH	Select Cherry
FLW	Florence Walnut	SPW	Sepia Walnut
GC	Golden Cherry	SKC	Shaker Cherry
HVM	Harvest Maple	SBP	Smoky Brown Pear
KHE	Kirsche	TK	Studio Teak
MW	Mahogany Walnut	SM	Sugar Maple
MNR	Midnight Run	WTA	Weathered Ash
NTM	Natural Marrone	WNB	White Nebbia
ORW	Oak Riftwood	WC	Williamsburg Cherry

SOLID

BL	Black	FHG	Fashion Grey
WH	Designer White	SG	Slate Grey

TABLE LEG WOOD FINISHES

Indiana Furniture uses a multi-step, hand finishing process on all exposed wood frames.

Units feature a catalyzed varnish finish which offers durability, lasting beauty, and resistance to normal wear.

AW	Artisan Walnut	MAS	Mesa Sunset*
AS	Asian Night	MTS	Metropolis Sky
BW	Beigewood*	MNR	Midnight Run
BL	Black	NTM	Natural Marrone*
CO	Columbian Walnut	ORW	Oak Riftwood*
DC	Dark Cherry	PNW	Pinnacle Walnut
DFW	Dark Forest Walnut*	PTK	Portico Teak*
WH	Designer White	RC	River Cherry*
EF	Espresso	SCH	Select Cherry
FO	Fawn Oak*	SPW	Sepia Walnut*
FLW	Florence Walnut*	SKC	Shaker Cherry
GC	Golden Cherry	SBP	Smoky Brown Pear*
HVM	Harvest Maple*	TK	Studio Teak
HW	Harvest Walnut	SM	Sugar Maple
HNW	Henna Walnut	WTA	Weathered Ash*
KHE	Kirsche	WNB	White Nebbia
LW	Legacy Walnut	WC	Williamsburg Cherry
MW	Mahogany Walnut		* Finish is Low Sheen

TABLE METAL ACCENT COLORS

Metal accents are featured on tables in three colors. Must specify color.

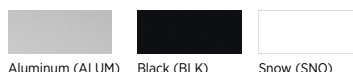

ALUM	Aluminum	SNO	Snow
BLK	Black		



Aluminum (ALUM) Black (BLK) Snow (SNO)

TABLE GLIDE OR CASTER OPTIONS

Tables available with casters or glides. Must specify.

	GLIDES	Fixed Glides	N/C
	BSC60	60mm Soft Caster	\$ 117

GROMMET & POWER/DATA UNIT OPTIONS & LOCATIONS

Grommets and Power/Data units available in center of table tops. Specify Center (C) location on order. Grommet and power/data units must be ordered separately. Tops may also be ordered without grommet/power units by specifying NO GROMMET on order.

Only one grommet/power/data unit per top. [See Product Details](#)

LOCATION OPTION

C On Center

GROMMET OPTIONS

GC Grommet, Center \$ 52

POWER/DATA UNIT OPTIONS [See Product Details and Pricing](#)

- DUO CLAMP Available in Black (B), Silver (S), or White (W)
- TRIO CLAMP Available in Black (B), Silver (S), or White (W)
- DUO BEZEL Available in Black (B), Silver (S), or White (W)
- TRIO BEZEL Available in Black (B), Silver (S), or White (W)
- DPORT4 Available in Aluminum or Black
- DOCK950 Available in Black or White
- DOCK150 Available in Black or White

CERTIFICATIONS & COMPLIANCE

- Intertek Sustainability Certified
- BIFMA Compliant® Certified
- TSCA Title VI (formerly CARB) Compliance
- Contributes to LEED®, Green Globes®, and WELL® Sustainable Programs

STATEMENT OF LINE

Synergy is a collection of partitions, tables, and seating to create spaces in an impromptu way without the need for complex architecture. See the entire Synergy Collection in the Space Division section.

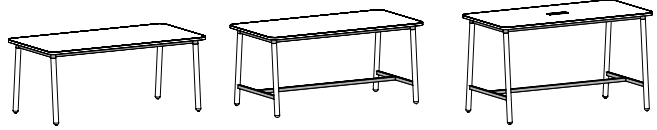

Seated Height Tables [\(See Details\)](#)

Counter Height Tables [\(See Details\)](#)

Standing Height Tables [\(See Details\)](#)

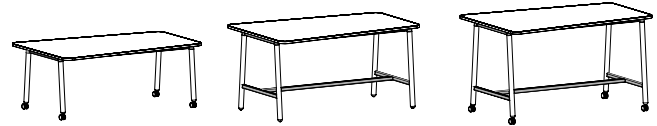

Seated Height View Tables [\(See Details\)](#)

Counter Height View Tables [\(See Details\)](#)

Standing Height View Tables [\(See Details\)](#)

Wire Management & Power/Data Accessories

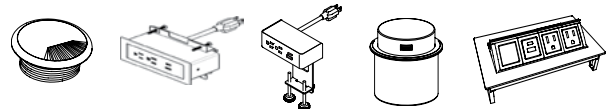

Power Options [\(See Multiple Unit Details\)](#)



Wire Management & Other Accessories [\(See Multiple Unit Details\)](#)

SYNERGY

MULTI-USE TABLES (8200 SERIES)

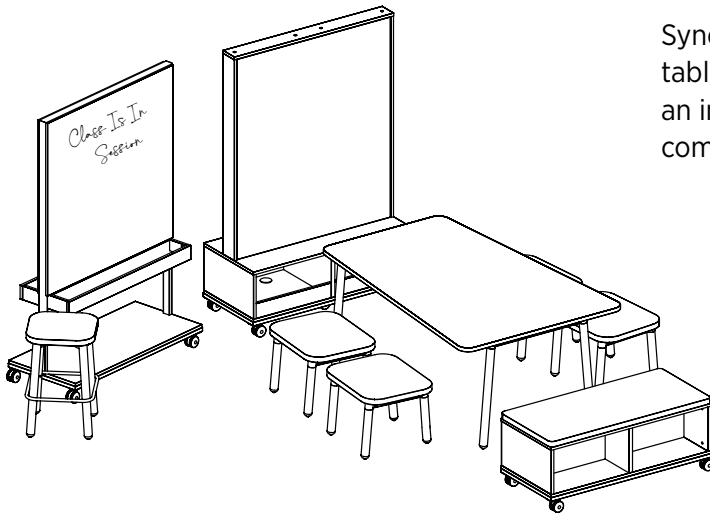

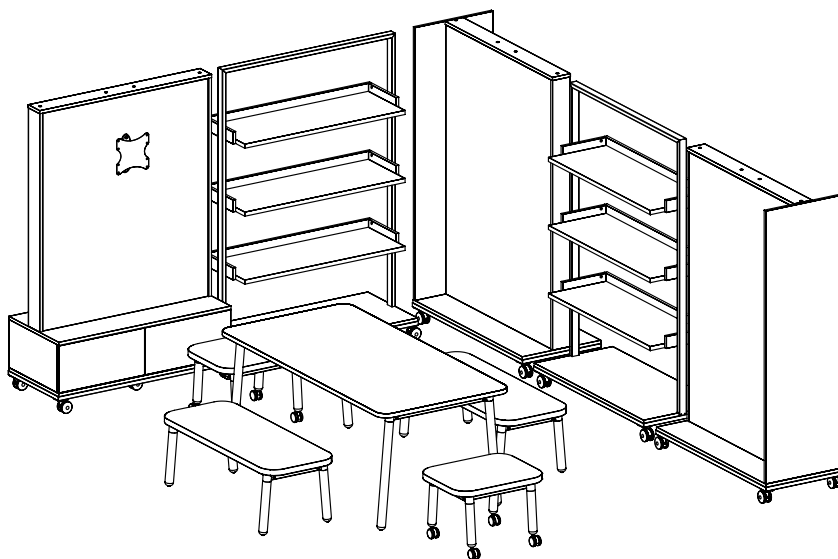
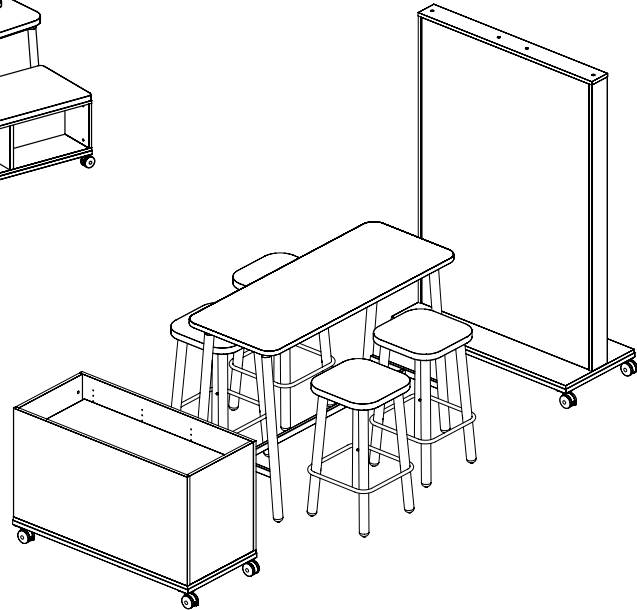

Synergy is a collection of partitions, tables, and seating to create spaces in an impromptu way without the need for complex architecture.

Synergy promotes flexibility to adapt to different interactions, forming areas to gather, separate, and then gather again...all in personalized ways, and all within the same open space.

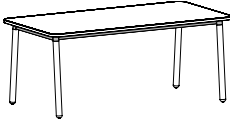

See the entire [Synergy Collection](#) under Space Division in this Price List.

Item	Model No.	W	D	H	Ship Wt	Cubic Ft	List Price
  <p>Top Shape</p>	82-4296RT	96	42	30	141	25.5	T\$ 2824 P\$ 3177
	82-4284RT	84	42	30	127	22.4	T\$ 2725 P\$ 3142
	82-4272RT	72	42	30	115	19.3	T\$ 2626 P\$ 2715
	82-3696RT	96	36	30	126	22.7	T\$ 2716 P\$ 3142
	82-3684RT	84	36	30	115	19.9	T\$ 2630 P\$ 3111
	82-3672RT	72	36	30	103	17.1	T\$ 2491 P\$ 2551
	82-3660RT	60	36	30	90	14.4	T\$ 2345 P\$ 2460
	82-3072RT	72	30	30	86	13.3	T\$ 2313 P\$ 2428
	82-3060RT	60	30	30	76	11.1	T\$ 2180 P\$ 2218
	82-2472RT	72	24	30	76	12	T\$ 2231 P\$ 2286
	82-2460RT	60	24	30	67	10	T\$ 2111 P\$ 2195

Must Specify (in this order):

- Model #
- Top Material
- Top Color
- Metal Accent Color
- Leg Color
- Leg Glide or Casters
- Grommet/Power





Use the Black Undermount Hook For Purses, Bags, Etc. [\(See Details\)](#)

Description

- TFL and HPL Tops; [See TFL and HPL Colors and Specify](#)
- Undermount Metal Accents Measure 2"H, 1" Thick, and is Available in Black (BLK), Aluminum (ALUM), or Snow (SNO); Must Specify Color, [See Details](#)
- Top and Legs Available in Contrasting Colors; [See Leg Color Options](#)
- Legs Available with Fixed Glides (GLIDES) or Four (4) 60mm Casters (BSC60), Two (2) Locking and Two (2) Non-Locking; [See Details and Specify](#)
- Some Assembly Required
- Power and Grommet Available on Center Only; [See Options](#)

T= TFL P= HPL

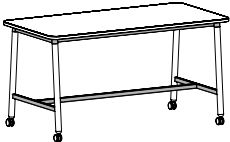
[See Synergy Overview For Ordering Options](#)

Item	Model No.	W	D	H	Ship Wt	Cubic Ft	List Price
COUNTER HEIGHT TABLE  Table Shown with Casters  Top Shape Must Specify (in this order): Model # Top Material Top Color Metal Accent Color Leg Color Leg Glide or Casters Grommet/Power	82-4296CRT	96	42	36	152	25.5	T\$ 3205 P\$ 3558
	82-4284CRT	84	42	36	139	22.4	T\$ 3106 P\$ 3523
	82-4272CRT	72	42	36	126	19.3	T\$ 3007 P\$ 3096
	82-3696CRT	96	36	36	137	22.7	T\$ 3097 P\$ 3523
	82-3684CRT	84	36	36	126	19.9	T\$ 3011 P\$ 3492
	82-3672CRT	72	36	36	115	17.1	T\$ 2873 P\$ 2932
	82-3660CRT	60	36	36	101	14.4	T\$ 2861 P\$ 2976
	82-3072CRT	72	30	36	98	13.3	T\$ 2669 P\$ 2784
	82-3060CRT	60	30	36	85	11.1	T\$ 2671 P\$ 2709
	82-2472CRT	72	24	36	86	12	T\$ 2587 P\$ 2642
	82-2460CRT	60	24	36	76	10	T\$ 2602 P\$ 2686

Description



- TFL and HPL Tops; [See TFL and HPL Colors and Specify](#)
- Undermount and Lower Metal Accents Measure 2"H, 1" Thick, and is Available in Black (BLK), Aluminum (ALUM), or Snow (SNO); Must Specify Color, [See Details](#)
- Top and Legs Available in Contrasting Colors; [See Leg Color Options](#)
- Legs Available with Fixed Glides (GLIDES) or Four (4) 60mm Casters (BSC60), Two (2) Locking and Two (2) Non-Locking; [See Details and Specify](#)
- Some Assembly Required
- Power and Grommet Available on Center Only; [See Options](#)



Use the Black Undermount Hook For Purses, Bags, Etc. ([See Details](#))

T= TFL P= HPL

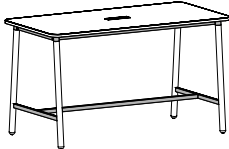
[See Synergy Overview For Ordering Options](#)

Item	Model No.	W	D	H	Ship Wt	Cubic Ft	List Price	
 <p>Table Shown with TRIO on Center</p>  <p>Top Shape</p> <p><u>Must Specify (in this order):</u> Model # Top Material Top Color Metal Accent Color Leg Color Leg Glide or Casters Grommet/Power</p>	82-4296BRT	96	42	42	154	25.5	T\$	3411
							P\$	3763
	82-4284BRT	84	42	42	141	22.4	T\$	3311
							P\$	3728
	82-4272BRT	72	42	42	128	19.3	T\$	3212
							P\$	3301
	82-3696BRT	96	36	42	139	22.7	T\$	3302
							P\$	3729
	82-3684BRT	84	36	42	128	19.9	T\$	3216
							P\$	3697
	82-3672BRT	72	36	42	117	17.1	T\$	3078
							P\$	3138
82-3660BRT	60	36	42	103	14.4	T\$	2905	
						P\$	3020	
82-3072BRT	72	30	42	100	13.3	T\$	2861	
						P\$	2975	
82-3060BRT	60	30	42	86	11.1	T\$	2701	
						P\$	2739	
82-2472BRT	72	24	42	88	12	T\$	2779	
						P\$	2833	
82-2460BRT	60	24	42	77	10	T\$	2632	
						P\$	2716	

Description

- TFL and HPL Tops; [See TFL and HPL Colors and Specify](#)
- Undermount and Lower Metal Accents Measure 2”H, 1” Thick, and is Available in Black (BLK), Aluminum (ALUM), or Snow (SNO); Must Specify Color, [See Details](#)
- Top and Legs Available in Contrasting Colors; [See Leg Color Options](#)
- Legs Available with Fixed Glides (GLIDES) or Four (4) 60mm Casters (BSC60), Two (2) Locking and Two (2) Non-Locking; [See Details and Specify](#)
- Some Assembly Required
- Power and Grommet Available on Center Only; [See Options](#)

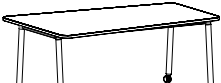
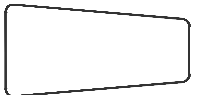

Use the Black Undermount Hook For Purses, Bags, Etc. [\(See Details\)](#)

Item	Model No.	W	D	H	Ship Wt	Cubic Ft	List Price	
 <p>Table Shown with Casters</p>  <p>Top Shape</p> <p><u>Must Specify (in this order):</u> Model # Top Material Top Color Metal Accent Color Leg Color Leg Glide or Casters Grommet/Power</p>	82-3672VT	72	36-48	30	118	21	T\$	2704
							P\$	2738
	82-2472VT	72	24-36	30	90	17.1	T\$	2405
							P\$	2465

Description

- TFL and HPL Tops; [See TFL and HPL Colors and Specify](#)
- Undermount Metal Accents Measure 2”H, 1” Thick, and is Available in Black (BLK), Aluminum (ALUM), or Snow (SNO); Must Specify Color, [See Details](#)
- Top and Legs Available in Contrasting Colors; [See Leg Color Options](#)
- Legs Available with Fixed Glides (GLIDES) or Four (4) 60mm Casters (BSC60), Two (2) Locking and Two (2) Non-Locking; [See Details and Specify](#)
- Some Assembly Required
- Power and Grommet Available on Center Only; [See Options](#)



Use the Black Undermount Hook For Purses, Bags, Etc. [\(See Details\)](#)

T= TFL P= HPL

[See Synergy Overview For Ordering Options](#)

Item	Model No.	W	D	H	Ship Wt	Cubic Ft	List Price	
COUNTER HEIGHT VIEW TABLE	82-3672CVT	72	36-48	36	129	21	T\$	3085
							P\$	3119
	82-2472CVT	72	24-36	36	100	17.1	T\$	2761
							P\$	2821

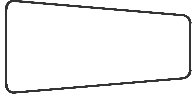
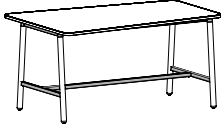

Top Shape

Must Specify (in this order):

- Model #
- Top Material
- Top Color
- Metal Accent Color
- Leg Color
- Leg Glide or Casters
- Grommet/Power



Use the Black Undermount Hook For Purses, Bags, Etc. [\(See Details\)](#)

Description

- TFL and HPL Tops; [See TFL and HPL Colors and Specify](#)
- Undermount and Lower Metal Accents Measure 2”H, 1” Thick, and is Available in Black (BLK), Aluminum (ALUM), or Snow (SNO); Must Specify Color, [See Details](#)
- Top and Legs Available in Contrasting Colors; [See Leg Color Options](#)
- Legs Available with Fixed Glides (GLIDES) or Four (4) 60mm Casters (BSC60), Two (2) Locking and Two (2) Non-Locking; [See Details and Specify](#)
- Two (2) Cubbies on Each Side; Each Cubby is 22½”W x 10¼”D x 12”H
- Some Assembly Required
- Power and Grommet Available on Center Only; [See Options](#)

STANDING HEIGHT VIEW TABLE	82-3672BVT	72	36-48	42	131	21	T\$	3291
							P\$	3325
	82-2472BVT	72	24-36	42	102	17.1	T\$	2952
							P\$	3012

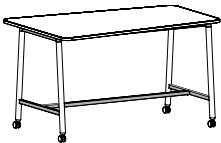
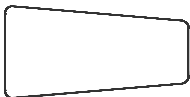

Table Shown with Casters



Top Shape

Must Specify (in this order):

- Model #
- Top Material
- Top Color
- Metal Accent Color
- Leg Color
- Leg Glide or Casters
- Grommet/Power





Use the Black Undermount Hook For Purses, Bags, Etc. [\(See Details\)](#)

Description

- TFL and HPL Tops; [See TFL and HPL Colors and Specify](#)
- Undermount and Lower Metal Accents Measure 2”H, 1” Thick, and is Available in Black (BLK), Aluminum (ALUM), or Snow (SNO); Must Specify Color, [See Details](#)
- Top and Legs Available in Contrasting Colors; [See Leg Color Options](#)
- Legs Available with Fixed Glides (GLIDES) or Four (4) 60mm Casters (BSC60), Two (2) Locking and Two (2) Non-Locking; [See Details and Specify](#)
- Some Assembly Required
- Power and Grommet Available on Center Only; [See Options](#)

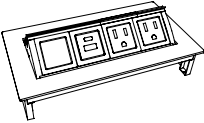

T= TFL P= HPL

[See Synergy Overview For Ordering Options](#)

Item	Model No.		W	D	H	Ship Wt	Cubic Ft	List Price
ROUND GROMMET COVER	01-GRMTB	Black	2 $\frac{3}{8}$	2 $\frac{3}{8}$	-	1	0.1	\$ 11
	01-GRMTSL	Silver						
 OPEN MARKET ONLY (SILVER)	Description <ul style="list-style-type: none"> • 2$\frac{3}{8}$" (60mm) Round Grommet Cover • Field Installed 							
DOCK 950 WIRELESS CHARGER	01-DOCK950W	White	3 $\frac{3}{16}$	3 $\frac{3}{16}$	-	1	0.2	\$ 265
	01-DOCK950B	Black						
 OPEN MARKET ONLY	Description <ul style="list-style-type: none"> • For Use with Wireless Charging Enabled Devices • 5 Watts Maximum Output with a Direct Current of 5V 2A and 10 Watts Maximum with Quick Charge 2.0 • Mounts in 76mm Round Cut-Out • LED will Confirm Pairing with Device and Begin Wireless Charging 							
DOCK 150 WIRELESS AND USB CHARGER	01-DOCK150W	White	3	3	$\frac{3}{4}$	1	0.2	\$ 405
	01-DOCK150B	Black						
 OPEN MARKET ONLY	Description <ul style="list-style-type: none"> • For Use with Wireless Charging Enabled Devices and USB Charging Devices • 5 Watt Maximum Output with a Direct Current Input of 5V 6A (Wireless Fast Charge) • Mounts in 76mm Round Cut-Out • Pop-Up is $\frac{3}{4}$"H and Includes Three (3) USB Ports; One (1) 12 Watt Maximum with 2.4A (USB Fast Charge) and Two (2) 5 Watt with 1A (USB Standard Charge) • LED Light will Confirm Pairing with Device and Begin Wireless Charging • UL and cUL Certified 							
POWER DATA PORT	01-DPORT4A	Aluminum	8	4	-	7	0.2	\$ 1093
	01-DPORT4B	Black						
	Description <ul style="list-style-type: none"> • Retracts into Work Surface to Regain Productive Space • One-Touch Access to Power and Data • Two (2) Water-Proof Simplex Power Outlets, One (1) USB A+C, and One (1) Open Port • Optional Telecom Port Components, Following Page • Includes a Voice/Data Adapter Kit to Accept Couplers and Jacks When Required • 10' Power Cord 							

T= TFL P= HPL

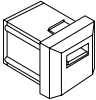
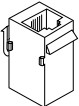
[See Synergy Overview For Ordering Options](#)

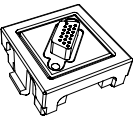
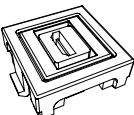
Item	Model No.	W	D	H	Ship Wt	Cubic Ft	List Price
USB PORT	01-USBPORT	-	-	-	-	-	\$ 161
	<p>Description</p> <ul style="list-style-type: none"> • For Use with 01-DPORT4A and 01-DPORT4B • Passive USB-A Port with Increased Transfer Speed Up to 5 gbs/sec • Simultaneous Read/Write Capability • Idle Device Power Saving State • 6' Cord • See Voice Coupler and Data Port on Next Page 						
VOICE COUPLER	01-VOICE1	-	-	-	-	-	\$ 73
	<p>Description</p> <ul style="list-style-type: none"> • For Use with 01-DPORT4A and 01-DPORT4B • 6-Pin Modular Plug • Molded Black • Cord Not included 						
DATA PORT	01-RJ4DATA	-	-	-	-	-	\$ 167
 OPEN MARKET ONLY	<p>Description</p> <ul style="list-style-type: none"> • For Use with 01-DPORT4A and 01-DPORT4B • 8-Pin Modular Plug; Cat6 Ethernet Cable; Pre-terminated Cable • 10' Cord 						
VGA CONNECTOR ACCESSORY	01-VGACON	-	-	-	1	0.2	\$ 149
	<p>Description</p> <ul style="list-style-type: none"> • VGA Port for 01-DPORT4A and 01-DPORT4B • Enables Devices to Remote Display on Monitors • 10' Cord • Male/Female Connector 						
HDMI CONNECTOR ACCESSORY	01-HDMICON	-	-	-	1	0.2	\$ 124
	<p>Description</p> <ul style="list-style-type: none"> • HDMI Port for 01-DPORT4A and 01-DPORT4B • Connects to High Definition Displays • Female/Female Connector • 18" Cord 						

T= TFL P= HPL

[See Synergy Overview For Ordering Options](#)

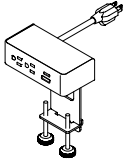
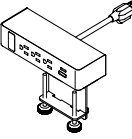
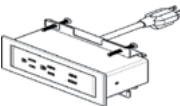
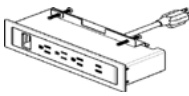
Item	Model No.		W	D	H	Ship Wt	Cubic Ft	List Price
DUO CLAMP WITH NEMA PLUG 	01-DUOCLAMPW	White	6½	3	7	1	0.2	\$ 572
	01-DUOCLAMPB	Black						
	01-DUOCLAMP S	Silver						
	Description <ul style="list-style-type: none"> • Standard with: Two (2) Power Outlet, One (1) USB Charging Port and One (1) 60-Watt USB-C Power • Delivery Port with GaN Technology with 10' Cord • Clamps to Top and Features Silver Metal Trim • Independent USB Circuit Controllers Deliver up to 2.1 Amps to Each Post • All Mounting Hardware Included • FCC Part 15A and UL Approved for Horizontal and Vertical Applications 							
TRIO CLAMP WITH NEMA PLUG 	01-TRIOCLAMPW	White	9	3	7	1	0.2	\$ 671
	01-TRIOCLAMPB	Black						
	01-TRIOCLAMP S	Silver						
	Description <ul style="list-style-type: none"> • Standard with: Three (3) Power Outlets, One (1) USB Charging Port, One (1) 60-Watt USB-C Power • Delivery Port with GaN Technology, One (1) Open Data with 10' Cord • Clamps to Top and Features Silver Metal Trim • Independent USB Circuit Controllers Deliver up to 2.1 Amps to Each Post • HDMI, VGA, or RJ45 Sold Separately; See Accessories • All Mounting Hardware Included • FCC Part 15A and UL Approved for Horizontal and Vertical Applications 							
DUO BEZEL WITH NEMA PLUG 	01-DUOBEZELW	White	6½	2½	3¼	1	0.2	\$ 675
	01-DUOBEZELB	Black						
	01-DUOBEZEL S	Silver						
	Description <ul style="list-style-type: none"> • Sits On Top of the Worksurface and Includes: Two (2) Power, One (1) USB Charging Port and One (1) 60-Watt USB-C Power Delivery Port with GaN Technology with 10' Cord • Independent USB Circuit Controllers Deliver up to 2.1 Amps to Each Post • All Mounting Hardware Included • FCC Part 15A and UL Approved for Horizontal and Vertical Applications 							
TRIO BEZEL WITH NEMA PLUG 	01-TRIOBEZELW	White	9	2½	3	1	0.2	\$ 725
	01-TRIOBEZELB	Black						
	01-TRIOBEZEL S	Silver						
	Description <ul style="list-style-type: none"> • Sits On Top of the Worksurface and Includes: Three (3) Power, One (1) USB Charging Port and One (1) 60-Watt USB-C Power Delivery Port with GaN Technology, One (1) Open Data, and 10' Cord • Independent USB Circuit Controllers Deliver up to 2.1 Amps to Each Post • HDMI, VGA, or RJ45 Sold Separately; See Accessories • All Mounting Hardware Included • FCC Part 15A and UL Approved for Horizontal and Vertical Applications 							

[See Synergy Overview For Ordering Options](#)

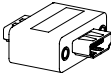
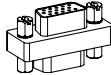
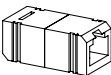
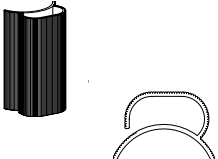
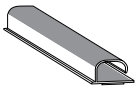
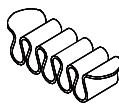
Item	Model No.	W	D	H	Ship Wt	Cubic Ft	List Price
HDMI DATA PORT ACCESSORY	01-LCOMHDMI	-	-	-	1	0.2	\$ 166
	<p>Description</p> <ul style="list-style-type: none"> HDMI Port for Undermount Trio Clamp and Trio Bezel Units 						
OPEN MARKET ONLY							
VGA DATA PORT ACCESSORY	01-LCOMVGA	-	-	-	1	0.2	\$ 121
	<p>Description</p> <ul style="list-style-type: none"> VGA Port for Undermount Trio Clamp and Trio Bezel Units 						
RJ45 DATA PORT ACCESSORY	01-LCOMRJ45	-	-	-	1	0.2	\$ 79
	<p>Description</p> <ul style="list-style-type: none"> RJ45 Port for Undermount Trio Clamp and Trio Bezel Units 						
3" WIRE MANAGER FOR ROUND LEGS	01-0302WM	3	2	3/4	0.25	0.13	\$ 31
	<p>Description</p> <ul style="list-style-type: none"> Black Vinyl Wire Management With Adhesive for Round Leg Quantity of Three (3) Attaches with Adhesive Strips Field Installed 						
WIRE CHANNEL	01-32125	24	1 1/2	1	.25	0.3	\$ 106
	<p>Description</p> <ul style="list-style-type: none"> Available in Black Channel Attaches with Two (2) Double-Sided Installation Tape to Flat Surfaces Open J Channel for Easy Storage of Cables Field Installed 						
CABLE GRIP	01-WMGRCB	5 3/8	2 5/8	-	-	-	\$ 17
	<p>Description</p> <ul style="list-style-type: none"> Black Under Surface Wire Management Cable Grip Attaches with Four (4) Screws, Hardware Included Field Installed 						

[See Synergy Overview For Ordering Options](#)

Item	Model No.	W	D	H	Ship Wt	Cubic Ft	List Price
BLACK UNDERMOUNT HOOK FOR TABLES	01-HOOK	2	1¾	2½ ₅			\$ 79

**Description**

- Black Hook Includes Mounting Hardware
- For Undermount Applications on Tables
- Field Installed

BLACK HOOK FOR VERTICAL SURFACES	01-ACCHOOKB	2	1¾	2½ ₅			\$ 64
-------------------------------------	-------------	---	----	-----------------	--	--	-------

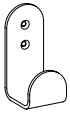
**Description**

- Black Hook Includes Mounting Hardware
- For Use on Vertical Surfaces
- 20lbs Weight Capacity
- Field Installed

[See Synergy Overview For Ordering Options](#)

Designers Jim Contois and Ramsey Madsen complement existing products with the Tri-One Table Collection. A full offering of training, meeting, and modular tables are available in flexible models that is sure to meet every expectation with integrated power and data capabilities.

CONSTRUCTION

LAMINATE

- Thermally-Fused Laminate (TFL) and High-Pressure Laminate (HPL) are made of woodgrain and solid color laminates fused to particleboard core; each laminate offers lasting beauty, superior resistance to normal wear, and easy maintenance

VENEER

- Surfaces feature select-grade, plain-sliced hardwood Cherry, Maple, American Black Walnut, White Oak, and composite veneers; Veneers are carefully selected and matched to assure proper balance and consistency
- Veneer features UV Advantage, an ultra-violet finish, on all exposed surfaces by utilizing roll-coat UV technology

TOPS

- Tops with the Square (Y) edge profile are 1" thick TFL or 1 3/16" HPL with a 3mm PVC rim; or 1 3/16" Veneer with 1.5mm edge banding
- Tops with the Knife (K) edge profile are 1 3/16" HPL with a 3mm PVC rim or 1 3/16" Veneer with 1 1/2 mm edge banding
- Laminate colors Designer White, Sugar Maple, and Williamsburg Cherry feature ABS edge bands
- Training and Modular tops feature shaped profiles on the user side while Meeting tops are shaped on all four sides
- Tops are pre-drilled for the specified base assembly and for ganging where applicable
- Grain direction runs left-to-right, unless noted



Knife (K)



Square (Y)

LEGS/BASES

- The Envy and Vantage leg/base styles are powder-coated Aluminum and include a 5mm steel mounting plate
- Envy style legs are aluminum extrusions while Vantage style legs are welded steel
- All legs and bases come standard with adjustable glides

GANGING

- All Modular and Training tops are pre-drilled with threaded inserts for ganging applications
- Ganging brackets include quick release thumb screws for ease of use; No tools required

NESTING

- Training tables offer an exclusive flip mechanism which can be accessed from any position to allow easier nesting of tables
- Optional flip mechanisms are factory installed and must be specified at the time of order

POWER/DATA/CORD MANAGEMENT

- Grommets are available in tops, where noted
- Grommets are 2 3/8" in diameter and available in black or silver
- Power/Data units available for under-surface mount, routed into tops, or for use in standard grommet holes (e.g., Sand Dollar)
- Power/Data Units comply with FCC Part 15A and UL
- Standard Power/Data plugs and daisy-chain connections are available; daisy chains are non-sequential; connect up to 8 modules

HOW TO ORDER EXAMPLES

MODULAR TABLE	QTY	MODEL NO.	EXAMPLE	
TOP	4	85-3084MCT	Finish	FO
LEG	4	08-0227APL4		
GANGING	3	08-1505GB		
MODESTY	4	85-0884MD	Finish	FO
GROMMET/POWER/DATA	4	01-DUOBEZELS		PDC-L

FLEXIBLE SIZE TOP	QTY	MODEL NO.	EXAMPLE	
TOP	4	86-FLEXMCT30	Width	79
			Color	WH
LEG	4	08-0227SPL4		
GANGING	3	08-1505GB		
MODESTY		No Modesty		
GROMMET/POWER/DATA		No Grommet		

MEETING TABLE	QTY	MODEL NO.	EXAMPLE	
TOP	1	86-4296MTKH	Color	WTA
LEG	1	08-2828YLG84	Finish	BLK
GROMMET/POWER/DATA	1	GC	Color	BLK

TRAINING TABLE	QTY	MODEL NO.	EXAMPLE	
TOP	6	86-2472TTKH	Color	PTM
LEG	6	08-2427TLC72	Casters	SOFT
GANGING	5	08-1505GB		
NESTING	6	08-FLIP		
MODESTY	6	86-0865HMD	Color	PTM
GROMMET/POWER/DATA	6	01-PDUOBEZELW		PDC-C

TFL (T) & HPL (P) LAMINATE OPTIONS

Tops with Knife Edge Profile available in HPL Only.

WOODGRAIN

AS	Asian Night	PNW	Pinnacle Walnut
BW	Beigewood	PTK	Portico Teak
CO	Columbian Walnut	RC	River Cherry
EF	Espresso	SCH	Select Cherry
FLW	Florence Walnut	SPW	Sepia Walnut
GC	Golden Cherry	SKC	Shaker Cherry
HVM	Harvest Maple	SBP	Smoky Brown Pear
KHE	Kirsche	TK	Studio Teak
MW	Mahogany Walnut	SM	Sugar Maple
MNR	Midnight Run	WTA	Weathered Ash
NTM	Natural Marrone	WNB	White Nebbia
ORW	Oak Riftwood	WC	Williamsburg Cherry

SOLID

BL	Black	FHG	Fashion Grey
WH	Designer White	SG	Slate Grey

VENEER (W) OPTIONS

Veneer features UVAdvantage, an ultra-violet finish, on all exposed surfaces by utilizing roll-coat UV technology

AW Artisan Walnut	MW Mahogany Walnut
AS Asian Night	MAS Mesa Sunset*
CO Columbian Walnut	MTS Metropolis Sky
DC Dark Cherry	ORW Oak Riftwood*
DFW Dark Forest Walnut	PNW Pinnacle Walnut
EW Espresso	SCH Select Cherry
FO Fawn Oak*	SKC Shaker Cherry
GC Golden Cherry	SM Sugar Maple
HW Harvest Walnut	WTA Weathered Ash*
HNW Henna Walnut	WC Williamsburg Cherry
LW Legacy Walnut	

* Finish is Low Sheen

GROMMET OPTIONS & POWER/DATA UNIT LOCATIONS

Grommets are available in modular, meeting, and training tops. Tops may also be ordered without grommets at no additional charge. Please specify NO GROMMET on order.

Power/Data units must be specified separately with surface mount location. Specify location on order, as well as the power/data unit. Routed for field placement at no additional charge.

Grommets are available in standard locations. Please specify using info below. Multiple locations may be selected. Only one grommet/power/data unit per location.

GROMMET LOCATIONS (Black = BLK and Silver = SLV)

GC	Grommet, Center - Must Specify BLK or SLV	\$	52
GL	Grommet, Left - Must Specify BLK or SLV	\$	52
GR	Grommet, Right - Must Specify BLK or SLV	\$	52

DUO/TRIO BEZEL LOCATIONS (Starting on Page 200)

PDC-C	Bezel, Center
PDC-L	Bezel, Left
PDC-R	Bezel, Right

Grommets and Power/Data Units may be ordered in non-standard locations. Call Customer Service to assist with specification and/or please attach a drawing to the PO showing the location of the grommet. Note additional charges and lead times may apply.

24" Modular Tops

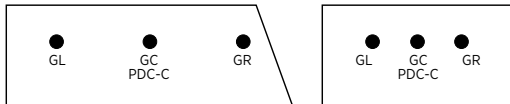

GL/GR: Located 10" from end based on widest dimension, 13 3/8" from user side
GC/PDC-C: Located 13 3/8" from user side

30" Modular Tops

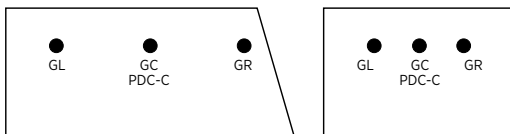

GL/GR: Located 10" from end based on widest dimension, 19 3/8" from user side
GC/PDC-C: Located 19 3/8" from user side

Meeting Tops (Where Applicable)

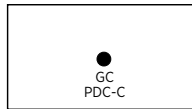

PDC-C: On Center, front to back

18" Training Tables

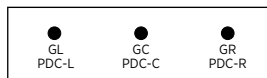

GL/GR/PDC-L/PDC-R: Located 10" from end, 12" from user side
GC/PDC-C: Located 12" from user side

24" Training Tables

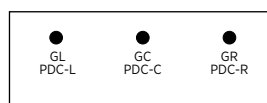

GL/GR: Located 10" from end, 16 1/2" from user side
GC: Located 16 1/2" from user side

30" Training Tables

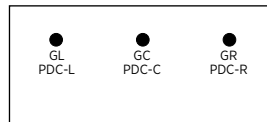

GL/GR: Located 10" from end, 20" from user side
GC: Located 20" from user side

CERTIFICATIONS & COMPLIANCE

- Intertek Sustainability Certified
- BIFMA level® Certified
- BIFMA Compliant® Certified
- TSCA Title VI (formerly CARB) Compliance
- Contributes to LEED®, Green Globes®, and WELL® Sustainable Programs

Modular Tops & Legs

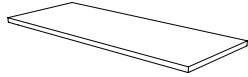

Rectangular Modular Tops in Standard Sizes [\(See Details\)](#)
Flexible Sizes [\(See Details\)](#)



Trapezoid Modular Tops in Standard [\(See Multiple Unit Details\)](#)
Flexible Sizes [\(See Multiple Unit Details\)](#)



Pentagon Ganging Tops [\(See Details\)](#)

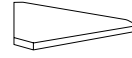

Bridge Ganging Tops [\(See Multiple Unit Details\)](#)



Envy Post Leg [\(See Details\)](#)



Vantage Post Leg [\(See Details\)](#)

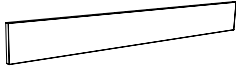

Modesty Panels [\(See Multiple Unit Details\)](#)

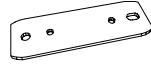

Ganging Brackets [\(See Details\)](#)



Grommets, Power/Data, and Accessories [\(See Multiple Unit Details\)](#)



Meeting Tops & Legs

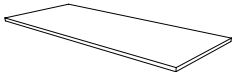

Rectangular Meeting Tops [\(See Details\)](#)

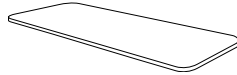

Soft Rectangular Meeting Tops [\(See Details\)](#)



Soft View Meeting Tops [\(See Details\)](#)



Ellipse Meeting Tops* [\(See Details\)](#)

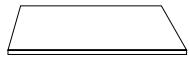

Square Meeting Tops [\(See Details\)](#)

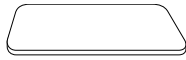

Soft Square Meeting Tops [\(See Details\)](#)



Round Meeting Tops [\(See Details\)](#)



Grommets, Power/Data, and Accessories [\(See Multiple Unit Details\)](#)

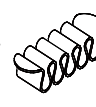

Bases and Legs [\(See Multiple Base Options\)](#)



Y-Bases [\(See Details\)](#)

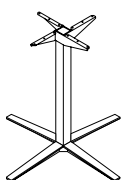

X-Bases [\(See Details\)](#)

* The Ellipse Meeting Tops will use the Envy Post or Vantage Post Legs

Training Tops & Legs

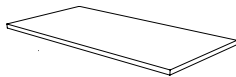

Rectangular Training Tops [\(See Details\)](#)

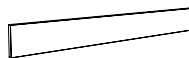

Modesty Panels [\(See Details\)](#)



Grommets, Power/Data, and Accessories [\(See Multiple Unit Details\)](#)

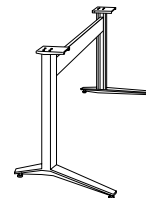

Envy C-Legs [\(See Details\)](#)

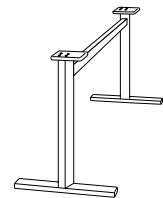

Vantage T-Legs [\(See Details\)](#)

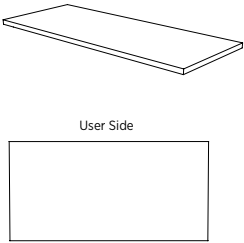
Item	Model No.		W	D	H	Ship Wt	Cubic Ft	List Price
RECTANGULAR MODULAR TOPS								
	Square Edge							
	86-3084MCT	TFL	84	30	-	76.4	6.0	T\$ 1014
	86-3084MCTH	HPL						P\$ 1373
	85-3084MCT	Veneer						W\$ 2034
	86-3072MCT	TFL	72	30	-	65.5	5.1	T\$ 819
	86-3072MCTH	HPL						P\$ 1111
	85-3072MCT	Veneer						W\$ 1647
	86-3060MCT	TFL	60	30	-	54.6	4.3	T\$ 738
	86-3060MCTH	HPL						P\$ 999
	85-3060MCT	Veneer						W\$ 1477
	86-3048MCT	TFL	48	30	-	43.7	3.5	T\$ 550
	86-3048MCTH	HPL						P\$ 747
	85-3048MCT	Veneer						W\$ 1107
	86-2484MCT	TFL	84	24	-	61.1	4.9	T\$ 940
	86-2484MCTH	HPL						P\$ 1277
	85-2484MCT	Veneer						W\$ 1889
	86-2472MCT	TFL	72	24	-	52.4	4.2	T\$ 758
	86-2472MCTH	HPL						P\$ 1026
	85-2472MCT	Veneer						W\$ 1518
	86-2460MCT	TFL	60	24	-	43.7	3.5	T\$ 690
86-2460MCTH	HPL						P\$ 932	
85-2460MCT	Veneer						W\$ 1379	
86-2448MCT	TFL	48	24	-	34.9	2.8	T\$ 510	
86-2448MCTH	HPL						P\$ 693	
85-2448MCT	Veneer						W\$ 1023	
Knife Edge								
	86-3084MCTKH	HPL	84	30	-	76.4	6.0	P\$ 1798
	85-3084MCTK	Veneer						W\$ 2479
	86-3072MCTKH	HPL	72	30	-	65.5	5.1	P\$ 1457
	85-3072MCTK	Veneer						W\$ 2007
	86-3060MCTKH	HPL	60	30	-	54.6	4.3	P\$ 1309
	85-3060MCTK	Veneer						W\$ 1804
	86-3048MCTKH	HPL	48	30	-	43.7	3.5	P\$ 980
	85-3048MCTK	Veneer						W\$ 1352
	86-2484MCTKH	HPL	84	24	-	61.1	4.9	P\$ 1675
	85-2484MCTK	Veneer						W\$ 2303
	86-2472MCTKH	HPL	72	24	-	52.4	4.2	P\$ 1346
	85-2472MCTK	Veneer						W\$ 1855
	86-2460MCTKH	HPL	60	24	-	43.7	3.5	P\$ 1219
	85-2460MCTK	Veneer						W\$ 1681
	86-2448MCTKH	HPL	48	24	-	34.9	2.8	P\$ 903
	85-2448MCTK	Veneer						W\$ 1247

Must Specify (in this order):
 Model #
 Top Finish/Color
 Leg Model #
 Ganging Brackets
 Modesty Model # and Finish/Color
 Grommet/Power/Data Location



Must Order Envy or Vantage Post Legs. [See Leg Options.](#)

Description

- Profile on User Side Only
- Flexible Sizes Available, [See Next Page](#)
- Tops 60" or Larger Include Stiffener Bar for Additional Support
- Legs Required (Assembly Required); Sold Separately, [See Leg Options](#)
- Pre-Drilled for Optional Ganging Brackets; Sold Separately, [See Details](#)
- Fixed Modesty Panel Options Available; Sold Separately, [See Modesty Options](#)
- Power & Data Options Available; Sold Separately, [See Multiple Units](#) and [See Locations](#)

T = TFL P = HPL W = Veneer

[See Tri-One Overview For Ordering Options](#)

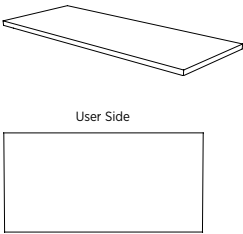
Item	Model No.		W	D	H	Ship Wt	Cubic Ft	List Price	
RECTANGULAR MODULAR TOPS FLEXIBLE SIZES 	Square Edge								
	86-FLEXMCT30	TFL	84-73	30	-	76.4	6.0	T\$ 1014	
	86-FLEXMCTH30	HPL						P\$ 1373	
	85-FLEXMCT30	Veneer						W\$ 2034	
			72-61	30	-	65.5	5.1	T\$ 819	
								P\$ 1111	
								W\$ 1647	
			60-49	30	-	54.6	4.3	T\$ 738	
								P\$ 999	
								W\$ 1477	
			48-36	30	-	43.7	3.5	T\$ 550	
								P\$ 747	
								W\$ 1107	
		86-FLEXMCT24	TFL	84-73	24	-	61.1	4.9	T\$ 940
		86-FLEXMCTH24	HPL						P\$ 1277
	85-FLEXMCT24	Veneer						W\$ 1889	
			72-61	24	-	52.4	4.2	T\$ 758	
								P\$ 1026	
								W\$ 1518	
			60-49	24	-	43.7	3.5	T\$ 690	
								P\$ 932	
								W\$ 1379	
			48-36	24	-	34.9	2.8	T\$ 510	
								P\$ 693	
								W\$ 1023	
	Knife Edge								
	86-FLEXMCTKH30	HPL	84-73	30	-	76.4	6.0	P\$ 1798	
	85-FLEXMCTK30	Veneer						W\$ 2479	
			72-61	30	-	65.5	5.1	P\$ 1457	
								W\$ 2007	
			60-49	30	-	54.6	4.3	P\$ 1309	
								W\$ 1804	
			48-36	30	-	43.7	3.5	P\$ 980	
								W\$ 1352	
	86-FLEXMCTKH24	HPL	84-73	24	-	61.1	4.9	P\$ 1675	
	85-FLEXMCTK24	Veneer						W\$ 2303	
			72-61	24	-	52.4	4.2	P\$ 1346	
								W\$ 1855	
			60-49	24	-	43.7	3.5	P\$ 1219	
								W\$ 1681	
			48-36	24	-	34.9	2.8	P\$ 903	
								W\$ 1247	

Must Specify (in this order):
 Model #
 Top Width Measurement
 Top Finish/Color
 Leg Model #
 Ganging Brackets
 Modesty Model # and Finish/Color
 Grommet/Power/Data Location



Must Order Envy or Vantage Post Legs. [See Leg Options.](#)

Description

- Profile on User Side Only
- Must Specify Width In One Inch Increments from 36" to 84"
- Tops 60" or Larger Include Stiffener Bar for Additional Support
- Legs Required (Assembly Required); Sold Separately, [See Leg Options](#)
- Pre-Drilled for Optional Ganging Brackets; Sold Separately, [See Details](#)
- Fixed Modesty Panel Options Available; Sold Separately, [See Modesty Options](#)
- Power & Data Options Available; Sold Separately, [See Multiple Units](#) and [See Locations](#)

T = TFL P = HPL W = Veneer

[See Tri-One Overview For Ordering Options](#)

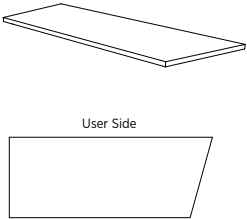
Item	Model No.		W	D	H	Ship Wt	Cubic Ft	List Price
LEFT TRAPEZOID MODULAR TOPS								
Square Edge								
 <p>User Side</p>	86-3084LMCT	TFL	84	30	-	76.4	6.0	T\$ 974
	86-3084LMCTH	HPL						P\$ 1319
	85-3084LMCT	Veneer						W\$ 1952
	86-3072LMCT	TFL	72	30	-	65.5	5.1	T\$ 788
	86-3072LMCTH	HPL						P\$ 1066
	85-3072LMCT	Veneer						W\$ 1577
	86-3060LMCT	TFL	60	30	-	54.6	4.3	T\$ 708
	86-3060LMCTH	HPL						P\$ 962
	85-3060LMCT	Veneer						W\$ 1422
	86-3048LMCT	TFL	48	30	-	43.7	3.5	T\$ 530
	86-3048LMCTH	HPL						P\$ 718
	85-3048LMCT	Veneer						W\$ 1062
	86-2484LMCT	TFL	84	24	-	61.1	4.9	T\$ 903
	86-2484LMCTH	HPL						P\$ 1229
	85-2484LMCT	Veneer						W\$ 1818
	86-2472LMCT	TFL	72	24	-	52.4	4.2	T\$ 725
	86-2472LMCTH	HPL						P\$ 983
	85-2472LMCT	Veneer						W\$ 1456
	86-2460LMCT	TFL	60	24	-	43.7	3.5	T\$ 661
	86-2460LMCTH	HPL						P\$ 894
	85-2460LMCT	Veneer						W\$ 1327
	86-2448LMCT	TFL	48	24	-	34.9	2.8	T\$ 486
	86-2448LMCTH	HPL						P\$ 659
	85-2448LMCT	Veneer						W\$ 976
Knife Edge								
	86-3084LMCTKH	HPL	84	30	-	76.4	6.0	P\$ 1729
	85-3084LMCTK	Veneer						W\$ 2383
	86-3072LMCTKH	HPL	72	30	-	65.5	5.1	P\$ 1395
	85-3072LMCTK	Veneer						W\$ 1924
	86-3060LMCTKH	HPL	60	30	-	54.6	4.3	P\$ 1258
	85-3060LMCTK	Veneer						W\$ 1734
	86-3048LMCTKH	HPL	48	30	-	43.7	3.5	P\$ 939
	85-3048LMCTK	Veneer						W\$ 1294
	86-2484LMCTKH	HPL	84	24	-	61.1	4.9	P\$ 1605
	85-2484LMCTK	Veneer						W\$ 2215
	86-2472LMCTKH	HPL	72	24	-	52.4	4.2	P\$ 1290
	85-2472LMCTK	Veneer						W\$ 1777
	86-2460LMCTKH	HPL	60	24	-	43.7	3.5	P\$ 1173
	85-2460LMCTK	Veneer						W\$ 1618
	86-2448LMCTKH	HPL	48	24	-	34.9	2.8	P\$ 864
	85-2448LMCTK	Veneer						W\$ 1192

Must Specify (in this order):
 Model #
 Top Finish/Color
 Leg Model #
 Ganging Brackets
 Modesty Model # and Finish/Color
 Grommet/Power/Data Location

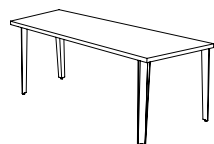

Must Order Envy or Vantage Post Legs. [See Leg Options.](#)

Description

- Profile on User Side Only
- Flexible Sizes Available, [See Next Page](#)
- Tops 60" or Larger Include Stiffener Bar for Additional Support
- Legs Required (Assembly Required); Legs Sold Separately, [See Leg Options](#)
- Pre-Drilled for Optional Ganging Brackets; Sold Separately, [See Details](#)
- For Ganging Applications, the Angled End of a Trapezoid Modular Top Must Connect with the Angled End of Another Trapezoid Modular Top; Please Specify a Left and a Right to Gang Tops
- Trapezoid Modular Tops Only Connect to Rectangular Modular Tops on Straight End
- Fixed Modesty Panel Options Available; Sold Separately, [See Modesty Options](#)
- Power & Data Options Available; Sold Separately, [See Multiple Units](#) and [See Locations](#)

T = TFL P = HPL W = Veneer

[See Tri-One Overview For Ordering Options](#)

Item	Model No.		W	D	H	Ship Wt	Cubic Ft	List Price	
LEFT TRAPEZOID MODULAR TOPS FLEXIBLE SIZES	Square Edge								
	86-FLEXLMCT30	TFL	84-73	30	-	76.4	6.0	T\$ 974	
	86-FLEXLMCTH30	HPL						P\$ 1319	
	85-FLEXLMCT30	Veneer						W\$ 1952	
			72-61	30	-	65.5	5.1	T\$ 788	
								P\$ 1066	
								W\$ 1577	
			60-49	30	-	54.6	4.3	T\$ 708	
								P\$ 962	
								W\$ 1422	
			48-36	30	-	43.7	3.5	T\$ 530	
								P\$ 718	
								W\$ 1062	
		86-FLEXLMCT24	TFL	84-73	24	-	61.1	4.9	T\$ 903
		86-FLEXLMCTH24	HPL						P\$ 1229
	85-FLEXLMCT24	Veneer						W\$ 976	
			72-61	24	-	52.4	4.2	T\$ 725	
								P\$ 983	
								W\$ 1456	
			60-49	24	-	43.7	3.5	T\$ 661	
								P\$ 894	
								W\$ 1327	
			48-36	24	-	34.9	2.8	T\$ 486	
								P\$ 659	
								W\$ 976	
	Knife Edge								
	86-FLEXLMCTKH30	HPL	84-73	30	-	76.4	6.0	P\$ 1729	
	85-FLEXLMCTK30	Veneer						W\$ 2383	
			72-61	30	-	65.5	5.1	P\$ 1395	
								W\$ 1924	
			60-49	30	-	54.6	4.3	P\$ 1258	
								W\$ 1734	
			48-36	30	-	43.7	3.5	P\$ 939	
								W\$ 1294	
	86-FLEXLMCTKH24	HPL	84-73	24	-	61.1	4.9	P\$ 1605	
	85-FLEXLMCTK24	Veneer						W\$ 2215	
			72-61	24	-	52.4	4.2	P\$ 1290	
								W\$ 1777	
			60-49	24	-	43.7	3.5	P\$ 1173	
								W\$ 1618	
			48-36	24	-	34.9	2.8	P\$ 864	
								W\$ 1192	

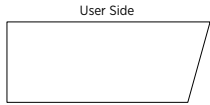
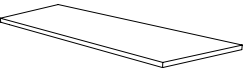

Must Specify (in this order):

- Model #
- Top Width Measurement
- Top Finish/Color
- Leg Model #
- Ganging Brackets
- Modesty Model # and Finish/Color
- Grommet/Power/Data Location

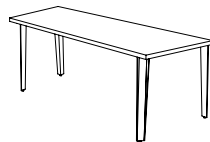

Must Order Envy or Vantage Post Legs. See Leg Options.

Description

- Profile on User Side Only
- Tops 60" or Larger Include Stiffener Bar for Additional Support
- Legs Required (Assembly Required); Sold Separately, [See Leg Options](#)
- Pre-Drilled for Optional Ganging Brackets; Sold Separately, [See Details](#)
- For Ganging Applications, the Angled End of a Trapezoid Modular Top Must Connect with the Angled End of Another Trapezoid Modular Top; Please Specify a Left and a Right to Gang Tops
- Trapezoid Modular Tops Only Connect to Rectangular Modular Tops on Straight End
- Fixed Modesty Panel Options Available; Sold Separately, [See Modesty Options](#)
- Power & Data Options Available; Sold Separately, [See Multiple Units](#) and [See Locations](#)

T = TFL P = HPL W = Veneer

[See Tri-One Overview For Ordering Options](#)

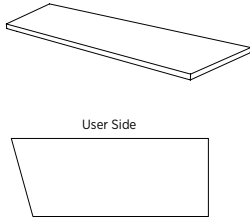
Item	Model No.		W	D	H	Ship Wt	Cubic Ft	List Price
RIGHT TRAPEZOID MODULAR TOPS								
Square Edge								
 <p>User Side</p>	86-3084RMCT	TFL	84	30	-	76.4	6.0	T\$ 974
	86-3084RMCTH	HPL						P\$ 1319
	85-3084RMCT	Veneer						W\$ 1952
	86-3072RMCT	TFL	72	30	-	65.5	5.1	T\$ 788
	86-3072RMCTH	HPL						P\$ 1066
	85-3072RMCT	Veneer						W\$ 1577
	86-3060RMCT	TFL	60	30	-	54.6	4.3	T\$ 708
	86-3060RMCTH	HPL						P\$ 962
	85-3060RMCT	Veneer						W\$ 1422
	86-3048RMCT	TFL	48	30	-	43.7	3.5	T\$ 530
	86-3048RMCTH	HPL						P\$ 718
	85-3048RMCT	Veneer						W\$ 1062
	86-2484RMCT	TFL	84	24	-	61.1	4.9	T\$ 903
	86-2484RMCTH	HPL						P\$ 1229
	85-2484RMCT	Veneer						W\$ 1818
	86-2472RMCT	TFL	72	24	-	52.4	4.2	T\$ 725
	86-2472RMCTH	HPL						P\$ 983
	85-2472RMCT	Veneer						W\$ 1456
86-2460RMCT	TFL	60	24	-	43.7	3.5	T\$ 661	
86-2460RMCTH	HPL						P\$ 894	
85-2460RMCT	Veneer						W\$ 1327	
86-2448RMCT	TFL	48	24	-	34.9	2.8	T\$ 486	
86-2448RMCTH	HPL						P\$ 659	
85-2448RMCT	Veneer						W\$ 976	
Knife Edge								
	86-3084RMCTKH	HPL	84	30	-	76.4	6.0	P\$ 1729
	85-3084RMCTK	Veneer						W\$ 2383
	86-3072RMCTKH	HPL	72	30	-	65.5	5.1	P\$ 1395
	85-3072RMCTK	Veneer						W\$ 1924
	86-3060RMCTKH	HPL	60	30	-	54.6	4.3	P\$ 1258
	85-3060RMCTK	Veneer						W\$ 1734
	86-3048RMCTKH	HPL	48	30	-	43.7	3.5	P\$ 939
	85-3048RMCTK	Veneer						W\$ 1294
	86-2484RMCTKH	HPL	84	24	-	61.1	4.9	P\$ 1605
	85-2484RMCTK	Veneer						W\$ 2215
	86-2472RMCTKH	HPL	72	24	-	52.4	4.2	P\$ 1290
	85-2472RMCTK	Veneer						W\$ 1777
	86-2460RMCTKH	HPL	60	24	-	43.7	3.5	P\$ 1173
	85-2460RMCTK	Veneer						W\$ 1618
	86-2448RMCTKH	HPL	48	24	-	34.9	2.8	P\$ 864
	85-2448RMCTK	Veneer						W\$ 1192

Must Specify (in this order):
 Model #
 Top Finish/Color
 Leg Model #
 Ganging Brackets
 Modesty Model # and Finish/Color
 Grommet/Power/Data Location

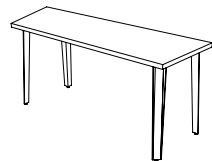

Must Order Envy or Vantage Post Legs. [See Leg Options.](#)

Description

- Profile on User Side Only
- Flexible Sizes Available, [See Next Page](#)
- Tops 60" or Larger Include Stiffener Bar for Additional Support
- Legs Required (Assembly Required); Sold Separately, [See Leg Options](#)
- Pre-Drilled for Optional Ganging Brackets; Sold Separately, [See Details](#)
- For Ganging Applications, the Angled End of a Trapezoid Modular Top Must Connect with the Angled End of Another Trapezoid Modular Top; Please Specify a Left and a Right to Gang Tops
- Trapezoid Modular Tops Only Connect to Rectangular Modular Tops on Straight End
- Fixed Modesty Panel Options Available; Sold Separately, [See Modesty Options](#)
- Power & Data Options Available; Sold Separately, [See Multiple Units](#) and [See Locations](#)

T = TFL P = HPL W = Veneer

[See Tri-One Overview For Ordering Options](#)

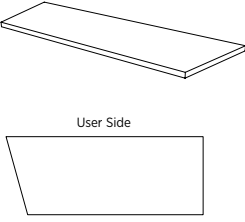
Item	Model No.		W	D	H	Ship Wt	Cubic Ft	List Price	
RIGHT TRAPEZOID MODULAR TOPS			Square Edge						
FLEXIBLE SIZES									
 <p>User Side</p>	86-FLEXRMCT30	TFL	84-73	30	-	76.4	6.0	T\$ 974	
	86-FLEXRMCTH30	HPL						P\$ 1319	
	85-FLEXRMCT30	Veneer						W\$ 1952	
				72-61	30	-	65.5	5.1	T\$ 788
									P\$ 1066
									W\$ 1577
				60-49	30	-	54.6	4.3	T\$ 708
									P\$ 962
									W\$ 1422
				48-36	30	-	43.7	3.5	T\$ 530
									P\$ 718
									W\$ 1062
	86-FLEXRMCT24	TFL	84-73	24	-	61.1	4.9	T\$ 903	
	86-FLEXRMCTH24	HPL						P\$ 1229	
	85-FLEXRMCT24	Veneer						W\$ 1818	
			72-61	24	-	52.4	4.2	T\$ 725	
								P\$ 983	
								W\$ 1456	
			60-49	24	-	43.7	3.5	T\$ 661	
								P\$ 894	
								W\$ 1327	
			48-36	24	-	34.9	2.8	T\$ 486	
								P\$ 659	
								W\$ 976	
			Knife Edge						
	86-FLEXRMCTKH30	HPL	84-73	30	-	76.4	6.0	P\$ 1729	
	85-FLEXRMCTK30	Veneer						W\$ 2383	
			72-61	30	-	65.5	5.1	P\$ 1395	
								W\$ 1924	
			60-49	30	-	54.6	4.3	P\$ 1258	
								W\$ 1734	
			48-36	30	-	43.7	3.5	P\$ 939	
								W\$ 1294	
	86-FLEXRMCTKH24	HPL	84-73	24	-	61.1	4.9	P\$ 1605	
	85-FLEXRMCTK24	Veneer						W\$ 2215	
			72-61	24	-	52.4	4.2	P\$ 1290	
								W\$ 1777	
			60-49	24	-	43.7	3.5	P\$ 1173	
								W\$ 1618	
			48-36	24	-	34.9	2.8	P\$ 864	
								W\$ 1192	

Must Specify (in this order):
 Model #
 Top Width Measurement
 Top Finish/Color
 Ganging Brackets
 Ganging Model #
 Modesty Model # and Finish/Color
 Grommet/Power/Data Location

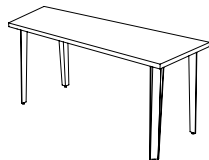

Must Order Envy or Vantage Post Legs. [See Leg Options.](#)

Description

- Profile on User Side Only
- Tops 60" or Larger Include Stiffener Bar for Additional Support
- Legs Required (Assembly Required); Sold Separately, [See Leg Options](#)
- Pre-Drilled for Optional Ganging Brackets; Sold Separately, [See Details](#)
- For Ganging Applications, the Angled End of a Trapezoid Modular Top Must Connect with the Angled End of Another Trapezoid Modular Top; Please Specify a Left and a Right to Gang Tops
- Trapezoid Modular Tops Only Connect to Rectangular Modular Tops on Straight End
- Fixed Modesty Panel Options Available; Sold Separately, [See Modesty Options](#)
- Power & Data Options Available; Sold Separately, [See Multiple Units](#) and [See Locations](#)

T = TFL P = HPL W = Veneer

[See Tri-One Overview For Ordering Options](#)

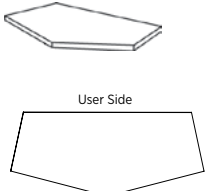
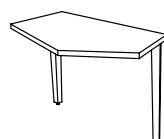
Item	Model No.		W	D	H	Ship Wt	Cubic Ft	List Price	
PENTAGON MODULAR TOPS									
 <p>User Side</p> <p>Must Specify (in this order): Model # Top Finish/Color Leg Model # Ganging Brackets</p>  <p>Must Order Envy or Vantage Post Legs. See Leg Options.</p>	Square Edge								
	<i>For Use with 30"D Modular Tops:</i>								
	86-30MCTP	TFL	58-48 $\frac{5}{8}$	18-25	-	44	3.6	T\$	619
	86-30MCTPH	HPL						P\$	837
	85-30MCTP	Veneer						W\$	1240
	<i>For Use with 24"D Modular Tops:</i>								
	86-24MCTP	TFL	46 $\frac{1}{3}$ -37	18-23 $\frac{1}{2}$	-	33.7	3.6	T\$	545
	86-24MCTPH	HPL						P\$	739
	85-24MCTP	Veneer						W\$	1095
	Knife Edge								
	<i>For Use with 30"D Modular Tops:</i>								
	86-30MCTPKH	HPL	58-48 $\frac{5}{8}$	18-25	-	44	3.6	P\$	1099
	85-30MCTPK	Veneer						W\$	1509
	<i>For Use with 24"D Modular Tops:</i>								
	86-24MCTPKH	HPL	46 $\frac{1}{3}$ -37	18-23 $\frac{1}{2}$	-	33.7	3.6	P\$	966
85-24MCTPK	Veneer						W\$	1334	
Description									
<ul style="list-style-type: none"> • Profile on User Side Only • Not a Freestanding Unit • Legs Required (Assembly Required); See Leg Options • 24" Tops Require Set of 2 Legs; 30" Tops Require Set of 4 Legs • Pre-Drilled for Required Ganging Brackets 									
Specify & Add: Ganging Brackets - Requires 2 Sets									
08-1505GB	Ganging Bracket Kit - Set of 2 with Thumb Screws							\$	82

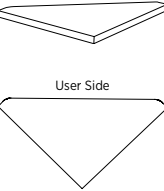
90° BRIDGE MODULAR TOPS									
 <p>User Side</p> <p>Must Specify (in this order): Model # Top Finish/Color Ganging Brackets</p>	Square Edge								
	<i>For Use with 30"D Modular Tops:</i>								
	86-3090MCTB	TFL	42 $\frac{2}{5}$	30	-	18.2	2.0	T\$	691
	86-3090MCTBH	HPL						P\$	934
	85-3090MCTB	Veneer						W\$	1382
	<i>For Use with 24"D Modular Tops:</i>								
	86-2490MCTB	TFL	34	24	-	11.6	1.3	T\$	486
	86-2490MCTBH	HPL						P\$	659
	85-2490MCTB	Veneer						W\$	976
	Knife Edge								
	<i>For Use with 30"D Modular Tops:</i>								
	86-3090MCTBKH	HPL	42 $\frac{2}{5}$	30	-	18.2	2.0	P\$	1223
	85-3090MCTBK	Veneer						W\$	1686
	<i>For Use with 24"D Modular Tops:</i>								
	86-2490MCTBKH	HPL	34	24	-	11.6	1.3	P\$	864
85-2490MCTBK	Veneer						W\$	1192	
Description									
<ul style="list-style-type: none"> • Profile on User Side Only • 90° Bridge to Connect Two Table Tops • Not a Freestanding Unit • Pre-Drilled for Required Ganging Brackets 									
Specify & Add: Ganging Brackets - Requires 2 Sets									
08-1505GB	Ganging Bracket Kit - Set of 2 with Thumb Screws							\$	82

T = TFL P = HPL W = Veneer

[See Tri-One Overview For Ordering Options](#)

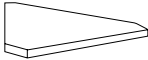
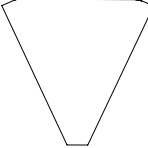
Item	Model No.		W	D	H	Ship Wt	Cubic Ft	List Price	
45° BRIDGE MODULAR TOPS									
Square Edge									
<i>For Use with 30"D Modular Tops:</i>									
 User Side 	86-3045MCTB	TFL	27 ¹ / ₈	30	-	16.1	2.0	T\$ 500	
	86-3045MCTBH	HPL						P\$ 678	
	85-3045MCTB	Veneer						W\$ 1005	
<i>For Use with 24"D Modular Tops:</i>									
	86-2445MCTB	TFL	22 ² / ₈	24	-	10.8	1.4	T\$ 447	
	86-2445MCTBH	HPL						P\$ 608	
	85-2445MCTB	Veneer						W\$ 894	
Knife Edge									
<i>For Use with 30"D Modular Tops:</i>									
	86-3045MCTBKH	HPL	27 ¹ / ₈	30	-	16.1	2.0	P\$ 889	
	85-3045MCTBK	Veneer						W\$ 1223	
<i>For Use with 24"D Modular Tops:</i>									
	86-2445MCTBKH	HPL	22 ² / ₈	24	-	10.8	1.4	P\$ 794	
	85-2445MCTBK	Veneer						W\$ 1094	
Description									
<ul style="list-style-type: none"> • Profile on User Side Only • 45° Bridge to Connect Two Table Tops • Not a Freestanding Unit • Pre-Drilled for Required Ganging Brackets 									
Specify & Add: Ganging Brackets - Requires 2 Sets									
	08-1505GB	Ganging Bracket Kit - Set of 2 with Thumb Screws							\$ 82

Must Specify (in this order):

- Model #
- Top Finish/Color
- Ganging Brackets

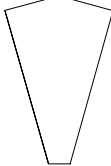
Item	Model No.		W	D	H	Ship Wt	Cubic Ft	List Price	
30° BRIDGE MODULAR TOPS									
Square Edge									
<i>For Use with 30"D Modular Tops:</i>									
 User Side 	86-3030MCTB	TFL	19 ³ / ₄	30	-	11.4	1.5	T\$ 470	
	86-3030MCTBH	HPL						P\$ 635	
	85-3030MCTB	Veneer						W\$ 939	
<i>For Use with 24"D Modular Tops:</i>									
	86-2430MCTB	TFL	16 ² / ₃	24	-	8.6	1.1	T\$ 427	
	86-2430MCTBH	HPL						P\$ 659	
	85-2430MCTB	Veneer						W\$ 850	
Knife Edge									
<i>For Use with 30"D Modular Tops:</i>									
	86-3030MCTBKH	HPL	19 ³ / ₄	30	-	11.4	1.5	P\$ 833	
	85-3030MCTBK	Veneer						W\$ 1145	
<i>For Use with 24"D Modular Tops:</i>									
	86-2430MCTBKH	HPL	16 ² / ₃	24	-	8.6	1.1	P\$ 756	
	85-2430MCTBK	Veneer						W\$ 1037	
Description									
<ul style="list-style-type: none"> • Profile on User Side Only • 30° Bridge to Connect Two Table Tops • Not a Freestanding Unit • Pre-Drilled for Required Ganging Brackets 									
Specify & Add: Ganging Brackets - Requires 2 Sets									
	08-1505GB	Ganging Bracket Kit - Set of 2 with Thumb Screws							\$ 82

Must Specify (in this order):

- Model #
- Top Finish/Color
- Ganging Brackets

T = TFL P = HPL W = Veneer

Item	Model No.	Ship Wt	Cubic Ft	List Price
ENVY POST LEG FOR MODULAR TOPS 	08-0227APL2 <i>Set of 2: For Use with 24" Pentagon Modular Tops Only</i>	10	0.8	\$ 498
	08-0227APL4 <i>Set of 4</i>	20	1.6	\$ 864
Description				
<ul style="list-style-type: none"> • Available in Aluminum • Each Leg has Adjustable Glides • Must Specify with Modular Top; Legs Are Not Available To Be Sold Separately 				

VANTAGE POST LEG FOR MODULAR TOPS 	08-0227SPL2 <i>Set of 2: For Use with 24" Pentagon Modular Tops Only</i>	10	0.8	\$ 413
	08-0227SPL4 <i>Set of 4</i>	20	1.6	\$ 699
Description				
<ul style="list-style-type: none"> • Available in Aluminum • Each Leg has Adjustable Glides • Must Specify with Modular Top; Legs Are Not Available To Be Sold Separately 				

GANGING BRACKET FOR MODULAR TOPS 	08-1505GB <i>Set of 2 with Thumb Screws</i>	2	0.5	\$ 82
---	--	---	-----	-------

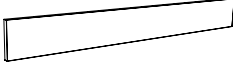
FIXED MODESTY PANEL FOR RECTANGULAR MODULAR TOPS  <small>Must Specify (in this order): Model # Finish/Color</small>	For 84"W TOPS			
	86-0884MD	TFL		T\$ 506
	86-0884MDH	HPL		P\$ 691
	85-0884MD	Veneer		W\$ 1022
	For 72"W TOPS			
	86-0872MD	TFL		T\$ 495
	86-0872MDH	HPL		P\$ 670
	85-0872MD	Veneer		W\$ 992
	For 60"W Tops			
	86-0860MD	TFL		T\$ 468
	86-0860MDH	HPL		P\$ 629
	85-0860MD	Veneer		W\$ 934
	For 48"W Tops			
	86-0848MD	TFL		T\$ 451
	86-0848MDH	HPL		P\$ 612
85-0848MD	Veneer		W\$ 903	

Description

- Modesty Panels are 8"H
- Must Specify Color; See [HPL/TFL Colors](#) and [Veneer Finishes](#)

T = TFL P = HPL W = Veneer

[See Tri-One Overview For Ordering Options](#)

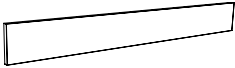
Item	Model No.	Ship Wt	Cubic Ft	List Price
FIXED MODESTY PANEL FOR RECTANGULAR MODULAR TOPS WITH FLEXIBLE SIZES  Must Specify (in this order): Model # Finish/Color	For 84"-73"W TOPS			
	86-FLEXMD84	TFL		T\$ 506
	86-FLEXMDH84	HPL		P\$ 691
	85-FLEXMD84	Veneer		W\$ 1022
	For 72"-61"W TOPS			
	86-FLEXMD72	TFL		T\$ 495
	86-FLEXMDH72	HPL		P\$ 670
	85-FLEXMD72	Veneer		W\$ 992
	For 60"-49"W Tops			
	86-FLEXMD60	TFL		T\$ 468
	86-FLEXMDH60	HPL		P\$ 629
	85-FLEXMD60	Veneer		W\$ 934
	For 48"-36"W Tops			
	86-FLEXMD48	TFL		T\$ 451
	86-FLEXMDH48	HPL		P\$ 612
85-FLEXMD48	Veneer		W\$ 903	

Description

- Modesty Panels are 8"H
- Must Specify Color; See [HPL/TFL Colors](#) and [Veneer Finishes](#)

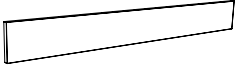
FIXED MODESTY PANEL FOR LEFT & RIGHT TRAPEZOID MODULAR TOPS  Must Specify (in this order): Model # Finish/Color	For 30"D TRAPEZOID TOPS			
	For 84"W TOPS			
	86-0884MDT30	TFL		T\$ 538
	86-0884MDTH30	HPL		P\$ 726
	85-0884MDT30	Veneer		W\$ 1075
	For 72"W TOPS			
	86-0872MDT30	TFL		T\$ 485
	86-0872MDTH30	HPL		P\$ 658
	85-0872MDT30	Veneer		W\$ 974
	For 60"W Tops			
	86-0860MDT30	TFL		T\$ 455
	86-0860MDTH30	HPL		P\$ 619
	85-0860MDT30	Veneer		W\$ 917
	For 48"W Tops			
	86-0848MDT30	TFL		T\$ 431
	86-0848MDTH30	HPL		P\$ 581
	85-0848MDT30	Veneer		W\$ 861
	For 24"D TRAPEZOID TOPS			
	For 84"W TOPS			
	86-0884MDT24	TFL		T\$ 527
	86-0884MDTH24	HPL		P\$ 714
	85-0884MDT24	Veneer		W\$ 1056
	For 72"W TOPS			
	86-0872MDT24	TFL		T\$ 474
86-0872MDTH24	HPL		P\$ 642	
85-0872MDT24	Veneer		W\$ 949	
For 60"W Tops				
86-0860MDT24	TFL		T\$ 447	
86-0860MDTH24	HPL		P\$ 608	
85-0860MDT24	Veneer		W\$ 894	
For 48"W Tops				
86-0848MDT24	TFL		T\$ 416	
86-0848MDTH24	HPL		P\$ 569	
85-0848MDT24	Veneer		W\$ 842	

Description

- Modesty Panels are 8"H
- Must Specify Color; See [HPL/TFL Colors](#) and [Veneer Finishes](#)

T = TFL P = HPL W = Veneer

[See Tri-One Overview For Ordering Options](#)

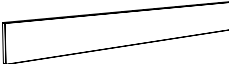
Item	Model No.	Ship Wt	Cubic Ft	List Price
FIXED MODESTY PANEL FOR LEFT & RIGHT TRAPEZOID MODULAR TOPS WITH FLEXIBLE SIZES 	For 30"D TRAPEZOID TOPS			
	For 84"W-73"W TOPS			
	86-FLEXMDTRP3084	TFL		T\$ 538
	86-FLEXMDTRP30H84	HPL		P\$ 726
	85-FLEXMDTRP3084	Veneer		W\$ 1075
	For 72"W-61"W TOPS			
	86-FLEXMDTRP3072	TFL		T\$ 485
	86-FLEXMDTRP30H72	HPL		P\$ 658
	85-FLEXMDTRP3072	Veneer		W\$ 974
	For 60"W-49"W Tops			
	86-FLEXMDTRP3060	TFL		T\$ 455
	86-FLEXMDTRP30H60	HPL		P\$ 619
	85-FLEXMDTRP3060	Veneer		W\$ 917
	For 48"W-36"W Tops			
	86-FLEXMDTRP3048	TFL		T\$ 431
	86-FLEXMDTRP30H48	HPL		P\$ 581
	85-FLEXMDTRP3048	Veneer		W\$ 861
	For 24"D TRAPEZOID TOPS			
	For 84"W-73"W TOPS			
	86-FLEXMDTRP2484	TFL		T\$ 527
	86-FLEXMDTRP24H84	HPL		P\$ 714
	85-FLEXMDTRP2484	Veneer		W\$ 1056
	For 72"W-61"W TOPS			
	86-FLEXMDTRP2472	TFL		T\$ 474
	86-FLEXMDTRP24H72	HPL		P\$ 642
	85-FLEXMDTRP2472	Veneer		W\$ 949
	For 60"W-49"W Tops			
	86-FLEXMDTRP2460	TFL		T\$ 447
	86-FLEXMDTRP24H60	HPL		P\$ 608
	85-FLEXMDTRP2460	Veneer		W\$ 894
For 48"W-36"W Tops				
86-FLEXMDTRP2448	TFL		T\$ 416	
86-FLEXMDTRP24H48	HPL		P\$ 569	
85-FLEXMDTRP2448	Veneer		W\$ 842	

Must Specify (in this order):

Model #
Finish/Color

Description

- Modesty Panels are 8"H
- Must Specify Color; See [HPL/TFL Colors](#) and [Veneer Finishes](#)

T = TFL P = HPL W = Veneer

[See Tri-One Overview For Ordering Options](#)

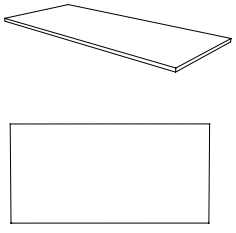
Item	Model No.		Kneespace	W	D	H	Ship Wt	Cubic Ft	List Price
RECTANGULAR MEETING TOPS									
Square Edge									
	86-4296MT	TFL	55	96	42	-	122.2	9.4	T\$ 1166
	86-4296MTH	HPL							P\$ 1580
	85-4296MT	Veneer							W\$ 2341
	86-4284MT	TFL	47	84	42	-	106.9	8.2	T\$ 1096
	86-4284MTH	HPL							P\$ 1485
	85-4284MT	Veneer							W\$ 2196
	86-4272MT	TFL	39	72	42	-	91.7	7.1	T\$ 974
	86-4272MTH	HPL							P\$ 1319
	85-4272MT	Veneer							W\$ 1952
	86-4260MT	TFL	31½	60	42	-	76.4	5.7	T\$ 892
	86-4260MTH	HPL							P\$ 1210
	85-4260MT	Veneer							W\$ 1792
	86-3696MT	TFL	55	96	36	-	104.8	8.1	T\$ 1054
	86-3696MTH	HPL							P\$ 1425
	85-3696MT	Veneer							W\$ 2113
	86-3684MT	TFL	47	84	36	-	92	7.1	T\$ 980
	86-3684MTH	HPL							P\$ 1328
	85-3684MT	Veneer							W\$ 1965
86-3672MT	TFL	39	72	36	-	78.6	6.1	T\$ 891	
86-3672MTH	HPL							P\$ 1207	
85-3672MT	Veneer							W\$ 1788	
86-3660MT	TFL	31½	60	36	-	65.5	5.1	T\$ 818	
86-3660MTH	HPL							P\$ 1110	
85-3660MT	Veneer							W\$ 1645	
Knife Edge									
86-4296MTKH	HPL	55	96	42	-	122.2	9.4	P\$ 2071	
85-4296MTK	Veneer							W\$ 2855	
86-4284MTKH	HPL	47	84	42	-	106.9	8.2	P\$ 1944	
85-4284MTK	Veneer							W\$ 2679	
86-4272MTKH	HPL	39	72	42	-	91.7	7.1	P\$ 1729	
85-4272MTK	Veneer							W\$ 2383	
86-4260MTKH	HPL	31½	60	42	-	76.4	5.7	P\$ 1587	
85-4260MTK	Veneer							W\$ 2182	
86-3696MTKH	HPL	55	96	36	-	104.8	8.1	P\$ 1869	
85-3696MTK	Veneer							W\$ 2577	
86-3684MTKH	HPL	47	84	36	-	92	7.1	P\$ 1736	
85-3684MTK	Veneer							W\$ 2399	
86-3672MTKH	HPL	39	72	36	-	78.6	6.1	P\$ 1585	
85-3672MTK	Veneer							W\$ 2181	
86-3660MTKH	HPL	31½	60	36	-	65.5	5.1	P\$ 1455	
85-3660MTK	Veneer							W\$ 2004	

Must Specify (in this order):
 Model #
 Top Finish/Color
 Leg Model # and Color (if applicable)
 Grommet/Power/Data Location



Must Order X-Base or Y-Base Separately [See Base/Leg Options.](#)

- Description**
- Profiled on All Four Sides
 - Seated Height Base/Legs Required (Assembly Required); Sold Separately, [See Base/Legs Options](#)
 - Power & Data Options Available; Sold Separately, [See Multiple Units](#) and [See Locations](#)

T = TFL P = HPL W = Veneer

[See Tri-One Overview For Ordering Options](#)

Item	Model No.		Kneespace	W	D	H	Ship Wt	Cubic Ft	List Price
SOFT RECTANGULAR MEETING TOPS									
Square Edge									
	86-4296SMT	TFL	55	96	42	-	122.2	9.4	T\$ 1127
	86-4296SMTH	HPL							P\$ 1527
	85-4296SMT	Veneer							W\$ 2260
	86-4284SMT	TFL	47	84	42	-	106.9	8.2	T\$ 1061
	86-4284SMTH	HPL							P\$ 1436
	85-4284SMT	Veneer							W\$ 2126
	86-4272SMT	TFL	39	72	42	-	91.7	7.1	T\$ 940
	86-4272SMTH	HPL							P\$ 1277
	85-4272SMT	Veneer							W\$ 1889
	86-4260SMT	TFL	31½	60	42	-	76.4	5.7	T\$ 865
	86-4260SMTH	HPL							P\$ 1173
	85-4260SMT	Veneer							W\$ 1735
86-3696SMT	TFL	55	96	36	-	104.8	8.1	T\$ 1015	
86-3696SMTH	HPL							P\$ 1379	
85-3696SMT	Veneer							W\$ 2035	
86-3684SMT	TFL	47	84	36	-	92	7.1	T\$ 947	
86-3684SMTH	HPL							P\$ 1281	
85-3684SMT	Veneer							W\$ 1898	
86-3672SMT	TFL	39	72	36	-	78.6	6.1	T\$ 863	
86-3672SMTH	HPL							P\$ 1169	
85-3672SMT	Veneer							W\$ 1731	
86-3660SMT	TFL	31½	60	36	-	65.5	5.1	T\$ 795	
86-3660SMTH	HPL							P\$ 1075	
85-3660SMT	Veneer							W\$ 1595	
Knife Edge									
86-4296SMTKH	HPL	55	96	42	-	122.2	9.4	P\$ 2001	
85-4296SMTK	Veneer							W\$ 2756	
86-4284SMTKH	HPL	47	84	42	-	106.9	8.2	P\$ 1883	
85-4284SMTK	Veneer							W\$ 2594	
86-4272SMTKH	HPL	39	72	42	-	91.7	7.1	P\$ 1675	
85-4272SMTK	Veneer							W\$ 2303	
86-4260SMTKH	HPL	31½	60	42	-	76.4	5.7	P\$ 1537	
85-4260SMTK	Veneer							W\$ 2120	
86-3696SMTKH	HPL	55	96	36	-	104.8	8.1	P\$ 1803	
85-3696SMTK	Veneer							W\$ 2480	
86-3684SMTKH	HPL	47	84	36	-	92	7.1	P\$ 1680	
85-3684SMTK	Veneer							W\$ 2314	
86-3672SMTKH	HPL	39	72	36	-	78.6	6.1	P\$ 1530	
85-3672SMTK	Veneer							W\$ 2111	
86-3660SMTKH	HPL	31½	60	36	-	65.5	5.1	P\$ 1412	
85-3660SMTK	Veneer							W\$ 1944	

Must Specify (in this order):
 Model #
 Top Finish/Color
 Leg Model # and Color (if applicable)
 Grommet/Power/Data Location

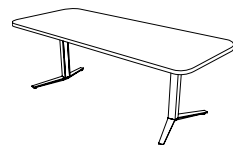

Must Order X-Base or Y-Base Separately [See Base/Leg Options.](#)

Description

- Profiled on All Four Sides
- Seated Height Base/Legs Required (Assembly Required); Sold Separately, [See Base/Legs Options](#)
- Power & Data Options Available; Sold Separately, [See Multiple Units](#) and [See Locations](#)

T = TFL P = HPL W = Veneer

[See Tri-One Overview For Ordering Options](#)

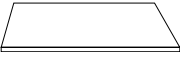
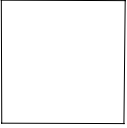
Item	Model No.		W	D	H	Ship Wt	Cubic Ft	List Price	
SQUARE MEETING TOPS		Square Edge							
	86-4242SQ	TFL	42	42	-	70	3.3	T\$ 686	
	86-4242SQH	HPL						P\$ 928	
	85-4242SQ	Veneer						W\$ 1373	
	86-3636SQ	TFL	36	36	-	37	2.5	T\$ 583	
	86-3636SQH	HPL						P\$ 794	
	85-3636SQ	Veneer						W\$ 1173	
	86-3030SQ	TFL	30	30	-	30	2.2	T\$ 514	
	86-3030SQH	HPL						P\$ 698	
	85-3030SQ	Veneer						W\$ 1029	

Must Specify (in this order):

- Model #
- Top Finish/Color
- Leg Model # and Color (if applicable)



Must Order X-Base Separately.
[See Base/Leg Options.](#)

		Knife Edge							
	86-4242SQKH	HPL	42	42	-	70	3.3	P\$ 1213	
	85-4242SQQ	Veneer						W\$ 1677	
	86-3636SQKH	HPL	36	36	-	37	2.5	P\$ 1037	
	85-3636SQQ	Veneer						W\$ 1429	
	86-3030SQKH	HPL	30	30	-	30	2.2	P\$ 914	
	85-3030SQQ	Veneer						W\$ 1255	

Description

- Profiled on All Four Sides
- Base/Legs Required (Assembly Required); Sold Separately, [See Base/Legs Options](#)

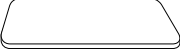
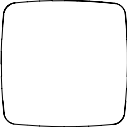
SOFT SQUARE MEETING TOPS		Square Edge							
	86-4242SSQ	TFL	42	42	-	70	3.3	T\$ 662	
	86-4242SSQH	HPL						P\$ 895	
	85-4242SSQ	Veneer						W\$ 1373	
	86-3636SSQ	TFL	36	36	-	37	2.5	T\$ 569	
	86-3636SSQH	HPL						P\$ 768	
	85-3636SSQ	Veneer						W\$ 1139	
	86-3030SSQ	TFL	30	30	-	30	2.2	T\$ 501	
	86-3030SSQH	HPL						P\$ 680	
	85-3030SSQ	Veneer						W\$ 1009	

Must Specify (in this order):

- Model #
- Top Finish/Color
- Leg Model # and Color (if applicable)





Must Order X-Base Separately.
[See Base/Leg Options.](#)

		Knife Edge							
	86-4242SSQKH	HPL	42	42	-	70	3.3	P\$ 1174	
	85-4242SSQQ	Veneer						W\$ 1620	
	86-3636SSQKH	HPL	36	36	-	37	2.5	P\$ 1008	
	85-3636SSQQ	Veneer						W\$ 1389	
	86-3030SSQKH	HPL	30	30	-	30	2.2	P\$ 892	
	85-3030SSQQ	Veneer						W\$ 1232	

Description

- Profiled on All Four Sides
- Base/Legs Required (Assembly Required); Sold Separately, [See Base/Legs Options](#)

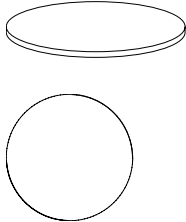
T = TFL P = HPL W = Veneer



Item	Model No.		W	D	H	Ship Wt	Cubic Ft	List Price	
ROUND MEETING TOPS		Square Edge							
	86-4848CT	TFL	48	48	-	95	4.3	T\$ 741	
	86-4848CTH	HPL						P\$ 1005	
	85-4848CT	Veneer						W\$ 1486	
	86-4242CT	TFL	42	42	-	70	3.3	T\$ 643	
	86-4242CTH	HPL						P\$ 873	
	85-4242CT	Veneer						W\$ 1290	
	86-3636CT	TFL	36	36	-	37	2.5	T\$ 563	
	86-3636CTH	HPL						P\$ 762	
	85-3636CT	Veneer						W\$ 1128	
	86-3030CT	TFL	30	30	-	30	2.2	T\$ 498	
	86-3030CTH	HPL						P\$ 673	
	85-3030CT	Veneer						W\$ 997	
		Knife Edge							
	86-4848CTKH	HPL	48	48	-	95	4.3	P\$ 1315	
	85-4848CTK	Veneer						W\$ 1812	
	86-4242CTKH	HPL	42	42	-	70	3.3	P\$ 1142	
	85-4242CTK	Veneer						W\$ 1573	
	86-3636CTKH	HPL	36	36	-	37	2.5	P\$ 999	
	85-3636CTK	Veneer						W\$ 1378	
	86-3030CTKH	HPL	30	30	-	30	2.2	P\$ 883	
	85-3030CTK	Veneer						W\$ 1215	

Must Specify (in this order):
 Model #
 Top Finish/Color
 Leg Model # and Color (if applicable)

Must Order X-Base Separately. [See Base/Leg Options.](#)

Description

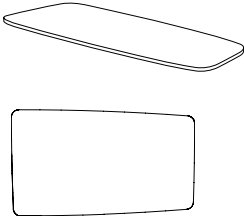
- Profiled on All Sides
- Base/Legs Required (Assembly Required); Sold Separately, [See Base/Leg Options](#)

Item	Model No.		W	D	H	Ship Wt	Cubic Ft	List Price	
SOFT VIEW MEETING TOPS		Square Edge							
	86-4296SVT	TFL	96	42-36	-	122.2	9.4	T\$ 1122	
	86-4296SVTH	HPL						P\$ 1517	
	85-4296SVT	Veneer						W\$ 2247	
	86-4284SVT	TFL	84	42-36	-	106.9	8.2	T\$ 1014	
	86-4284SVTH	HPL						P\$ 1373	
	85-4284SVT	Veneer						W\$ 2034	
	86-4272SVT	TFL	72	42-36	-	91.7	7.1	T\$ 939	
	86-4272SVTH	HPL						P\$ 1276	
	85-4272SVT	Veneer						W\$ 1887	
			Knife Edge						
	86-4296SVTKH	HPL	96	42-36	-	122.2	9.4	P\$ 1989	
	85-4296SVTK	Veneer						W\$ 2743	
	86-4284SVTKH	HPL	84	42-36	-	106.9	8.2	P\$ 1798	
	85-4284SVTK	Veneer						W\$ 2479	
	86-4272SVTKH	HPL	72	42-36	-	91.7	7.1	P\$ 1672	
	85-4272SVTK	Veneer						W\$ 2302	

Must Specify (in this order):
 Model #
 Top Finish/Color
 Leg Model # and Color (if applicable)
 Grommet/Power/Data Location

Must Order X-Base Separately. [See Base/Leg Options.](#)

Description

- Profiled on All Four Sides
- Base/Legs Required (Assembly Required); Sold Separately, [See Base/Leg Options](#)
- Power & Data Options Available; Sold Separately, [See Multiple Units](#) and [See Locations](#)

T = TFL P = HPL W = Veneer

[See Tri-One Overview For Ordering Options](#)

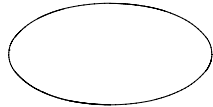
Item	Model No.		W	D	H	Ship Wt	Cubic Ft	List Price
ELLIPSE MEETING TOPS								
Square Edge								
	86-4284EMT	TFL	84	42	-	106.9	8.2	T\$ 1053
	86-4284EMTH	HPL						P\$ 1423
	85-4284EMT	Veneer						W\$ 2108
	86-3672EMT	TFL	72	36	-	78.6	6.1	T\$ 853
	86-3672EMTH	HPL						P\$ 1158
	85-3672EMT	Veneer						W\$ 1714
Knife Edge								
	86-4284EMTKH	HPL	84	42	-	106.9	8.2	P\$ 1864
	85-4284EMTK	Veneer						W\$ 2568
	86-3672EMTKH	HPL	72	36	-	78.6	6.1	P\$ 1515
	85-3672EMTK	Veneer						W\$ 2089

Must Specify (in this order):
 Model #
 Top Finish/Color
 Leg Model #
 Grommet/Power/Data Location

Description

- Includes Stiffener Bar for Additional Support
- Profiled on All Four Sides
- Legs Required (Assembly Required); Sold Separately, See Below
- Power & Data Options Available; Sold Separately, [See Multiple Units](#) and [See Locations](#)

Specify & Add: Your Choice Of Legs

08-0227APL4	Envy Post Leg (Set of 4)		20	1.6		\$ 864
	<ul style="list-style-type: none"> • Available in Aluminum • Each Leg has Adjustable Glides • Legs Are Not Available To Be Sold Separately 					
08-0227SPL4	Vantage Post Leg (Set of 4)		20	1.6		\$ 699
	<ul style="list-style-type: none"> • Available in Aluminum • Each Leg has Adjustable Glides • Legs Are Not Available To Be Sold Separately 					



Must Order Envy or Vantage Post Legs.

T = TFL P = HPL W = Veneer

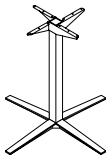
Item	Model No.	Ship Wt	Cubic Ft	List Price	
	X-BASES FOR MEETING TOPS				
	Large X-Base: For Use with 42"D and 48"D Tops				
	08-2642LXBA		33	20.0	\$ 1322
	<i>For 42"H Tables; Square, Soft Square, and Round Tops Only</i>				
	08-2636LXBA		30	17.2	\$ 1275
	<i>For 36"H Tables; Square, Soft Square, and Round Tops Only</i>				
	08-2630LXBA		27	14.5	\$ 1219
	<i>For 30"H Tables</i>				
	Small X-Base: For Use with 30"D and 36"D Tops				
08-2042SXBA		27	15.9	\$ 1235	
<i>For 42"H Tables; Square, Soft Square, and Round Tops Only</i>					
08-2036SXBA		24	13.7	\$ 1185	
<i>For 36"H Tables; Square, Soft Square, and Round Tops Only</i>					
08-2030SXBA		21	11.6	\$ 1139	
<i>For 30"H Tables</i>					

Description

- Available in Aluminum
- Square, Soft Square, and Round Tops Require One (1) Base; All Other Meeting Tops Require Two (2) Seated Height (30"H) Bases
- Bases Are Not Available To Be Sold Separately

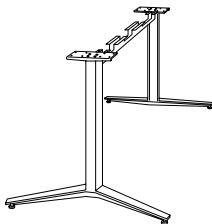
	Y-BASES FOR MEETING TOPS				
	08-2828YLG96		47	6.5	\$ 1736
	<i>For Use with 96"W Meeting Tops</i>				
	08-2828YLG84		43	5.4	\$ 1713
	<i>For Use with 84"W Meeting Tops</i>				
08-2828YLG72		39	4.3	\$ 1676	
<i>For Use with 72"W Meeting Tops</i>					
08-2828YLG60		35	3.2	\$ 1607	
<i>For Use with 60"W Meeting Tops</i>					

Description

- Available in Aluminum
- Y-Base Includes Trough with Removable Panels for Wire Management
- Bases Are Not Available To Be Sold Separately

T = TFL P = HPL W = Veneer

[See Tri-One Overview For Ordering Options](#)

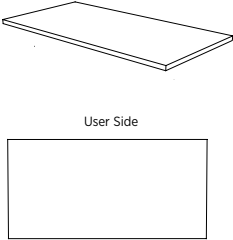
Item	Model No.	Kneespace	W	D	H	Ship Wt	Cubic Ft	List Price
RECTANGULAR TRAINING TOPS								
Square Edge								
 <p>User Side</p>	86-3072TT	65½	72	30	-	75.5	5.2	T\$ 737
	86-3072TTH							P\$ 997
	86-3060TT	53¾	60	30	-	64.6	4.3	T\$ 656
	86-3060TTH							P\$ 889
	86-3048TT	41½	48	30	-	53.7	3.5	T\$ 598
	86-3048TTH							P\$ 810
	86-2472TT	65½	72	24	-	62.4	4.2	T\$ 671
	86-2472TTH							P\$ 914
	86-2460TT	53¾	60	24	-	53.7	3.5	T\$ 605
	86-2460TTH							P\$ 815
	86-2448TT	41½	48	24	-	44.9	2.8	T\$ 554
	86-2448TTH							P\$ 749
	86-1872TT	65½	72	18	-	49.3	3.2	T\$ 608
	86-1872TTH							P\$ 819
	86-1860TT	53¾	60	18	-	43.7	2.7	T\$ 546
	86-1860TTH							P\$ 741
	86-1848TT	41½	48	18	-	36.2	2.2	T\$ 505
	86-1848TTH							P\$ 690
Knife Edge								
	86-3072TTKH	65½	72	30	-	75.5	5.2	P\$ 1307
	86-3060TTKH	53¾	60	30	-	64.6	4.3	P\$ 1165
	86-3048TTKH	41½	48	30	-	53.7	3.5	P\$ 1061
	86-2472TTKH	65½	72	24	-	62.4	4.2	P\$ 1195
	86-2460TTKH	53¾	60	24	-	53.7	3.5	P\$ 1070
	86-2448TTKH	41½	48	24	-	44.9	2.8	P\$ 982
	86-1872TTKH	65½	72	18	-	49.3	3.2	P\$ 1075
	86-1860TTKH	53¾	60	18	-	42.7	2.7	P\$ 969
	86-1848TTKH	41½	48	18	-	36.2	2.2	P\$ 900

Must Specify (in this order):

- Model #
- Top Finish/Color
- Leg Model #
- Ganging Model #
- Nesting Model #
- Grommet/Power/Data Location

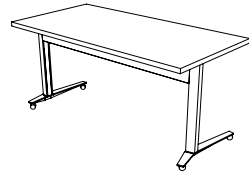

Must Order Envy C-Leg or Vantage T-Leg Base. See [Envy Details](#) and [Vantage Details](#).

Description

- Profile on User Side Only
- Legs Required (Assembly Required); Sold Separately, See [Envy](#) and [Vantage](#) Details
- Leg Assemblies available with Glides or Casters
- 18"D Tops Available with Envy C-Leg Base Only
- Pre-Drilled for Optional Ganging Brackets, See Below
- Optional Flip Mechanism for Nesting is Available, See Below
- Modesty Panel Standard on Envy C-Leg Base and Optional on Vantage T-Leg Base; Sold Separately, See [Envy C-Leg Base Details](#) and [Vantage T-Leg Base Details](#)
- Power & Data Options Available; Sold Separately, [See Multiple Units](#) and [See Locations](#)

Options: Specify & Add

GANGING

08-1505GB	Ganging Bracket Kit	\$ 82
	<ul style="list-style-type: none"> • Set of 2 with Thumb Screws • Tops Are Pre-Drilled 	

NESTING

08-FLIP	Flip Mechanism for Nesting (Factory Installed)	\$ 503
---------	--	--------

T = TFL P = HPL W = Veneer

[See Tri-One Overview For Ordering Options](#)

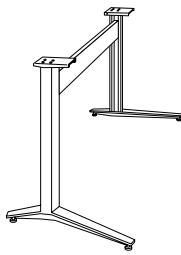
Item	Model No.	Ship Wt	Cubic Ft	List Price
ENVY C-LEG BASE ASSEMBLY FOR TRAINING TOPS 	Large C-Leg Base Assembly: For Use with 24"D and 30"D Tops			
	With Casters: Also Specify Soft Wheel (SOFT) or Hard Wheel (CAST)			
	08-2428CLC72 For 72"W Tops	40	4.3	\$ 1540
	08-2428CLC60 For 60"W Tops	36	3.2	\$ 1483
	08-2428CLC48 For 48"W Tops	32	2.9	\$ 1433
	With Glides:			
	08-2428CLG72 For 72"W Tops	39	4.3	\$ 1406
	08-2428CLG60 For 60"W Tops	35	3.2	\$ 1351
	08-2428CLG48 For 48"W Tops	31	2.9	\$ 1302
	Small C-Leg Base Assembly: For Use with 18"D Tops			
	With Casters: Also Specify Soft Wheel (SOFT) or Hard Wheel (CAST)			
	08-1828CLC72 For 72"W Tops	36	4.3	\$ 1417
	08-1828CLC60 For 60"W Tops	32	3.2	\$ 1362
	08-1828CLC48 For 48"W Tops	28	2.9	\$ 1311
	With Glides:			
08-1828CLG72 For 72"W Tops	35	4.3	\$ 1283	
08-1828CLG60 For 60"W Tops	31	3.2	\$ 1231	
08-1828CLG48 For 48"W Tops	27	2.9	\$ 1179	

Must Specify (in this order):

Model #

Caster Type (if applicable)

Description

- Available in Aluminum
- Includes Trough/Modesty
- Legs Feature Removable Panel for Wire Management
- When Casters are Specified, Must Choose Soft Wheel (SOFT) or Hard Wheel (Hard)
- Caster Option Features Two Locking Casters and Two Non-Locking Casters
- Bases Are Not Available To Be Sold Separately

T = TFL P = HPL W = Veneer

[See Tri-One Overview For Ordering Options](#)

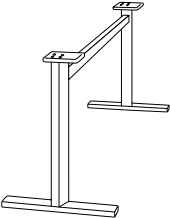
Item	Model No.	Ship Wt	Cubic Ft	List Price	
VANTAGE T-LEG BASE ASSEMBLY FOR TRAINING TOPS  Must Specify (in this order): Model # Caster Type (if applicable) Optional Modesty Optional Modesty Color	Large T-Leg Base Assembly: For Use with 24"D and 30"D Tops				
	With Casters: Also Specify Soft Wheel (SOFT) or Hard Wheel (CAST)				
		08-2428TLC72 For 72"W Tops	36	4.3	\$ 738
		08-2428TLC60 For 60"W Tops	32	3.2	\$ 705
		08-2428TLC48 For 48"W Tops	28	2.9	\$ 676
	With Glides:				
		08-2428TLG72 For 72"W Tops	35	4.3	\$ 708
		08-2428TLG60 For 60"W Tops	31	3.2	\$ 676
		08-2428TLG48 For 48"W Tops	27	2.9	\$ 651

Description

- Available in Aluminum
- Not Available for Use on 18"D Tops
- Includes Stretcher Rail
- When Casters are Specified, Must Choose Soft Wheel (SOFT) or Hard Wheel (Hard)
- Caster Option Features Two Locking Casters and Two Non-Locking Casters
- Optional 12"H Modesty Panel, See Below
- Bases Are Not Available To Be Sold Separately

Optional Modesty Panels: Specify & Add

FIXED MODESTY: Used on Standard, Non-Nesting Tables

86-0872MD	TFL	For 72"W Tops	T\$ 495
86-0872MDH	HPL		P\$ 670
86-0860MD	TFL	For 60"W Tops	T\$ 468
86-0860MDH	HPL		P\$ 629
86-0848MD	TFL	For 48" Tops	T\$ 451
86-0848MDH	HPL		P\$ 612

HINGED MODESTY: Used on Nesting Tables with Flip Mechanism

86-0865HMD	TFL	For 72"W Tops	T\$ 495
86-0865HMDH	HPL		P\$ 670
86-0853HMD	TFL	For 60"W Tops	T\$ 469
86-0853HMDH	HPL		P\$ 634
86-0841HMD	TFL	For 48" Tops	T\$ 453
86-0841HMDH	HPL		P\$ 616

T = TFL P = HPL W = Veneer

[See Tri-One Overview For Ordering Options](#)

Item	Model No.		W	D	H	Ship Wt	Cubic Ft	List Price
ROUND GROMMET COVER	01-GRMTB	Black	2 ³ / ₈	2 ³ / ₈	-	1	0.1	\$ 11
	01-GRMTSL	Silver						



OPEN MARKET ONLY
(SILVER)

Description

- 2³/₈" (60mm) Round Grommet Cover
- Field Installed

SINGLE POWER SAND DOLLAR	01-SAND60PW	White	3	3	4	1	0.2	\$ 98
	01-SAND60PB	Black						
	01-SAND60PS	Silver						

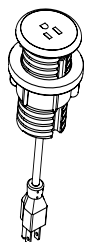

Description

- Unit is 2³/₈" Diameter; Mounts in 60mm Round Grommet
- 6' Cord
- Single Power Outlet

DOUBLE USB SAND DOLLAR	01-SAND60UW	White	3	3	4	1	0.2	\$ 277
	01-SAND60UB	Black						
	01-SAND60US	Silver						

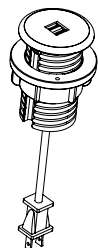

Description

- Unit is 2³/₈" Diameter; Mounts in 60mm Round Grommet
- 6' Cord
- Dual USB Outlets

DUO CLAMP WITH NEMA PLUG	01-DUOCLAMPW	White	6 ¹ / ₂	3	7	1	0.2	\$ 572
	01-DUOCLAMPB	Black						
	01-DUOCLAMP S	Silver						

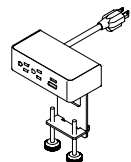

Description

- Clamps to Table Top and Includes: Two (2) Power, **One (1) USB Charging Port and One (1) 60-Watt USB-C Power Delivery Port with GaN Technology with 10' Cord** and All Mounting Hardware
- Silver Metal Trim on All Color Options
- Independent USB Circuit Controllers Deliver up to 2.1 Amps to Each Post
- FCC Part 15A, UL Approved for Horizontal and Vertical Applications
- Works with Tri-One Modular, Meeting, and Training Tables

[See Tri-One Overview For Ordering Options](#)

Item	Model No.		W	D	H	Ship Wt	Cubic Ft	List Price
TRIO CLAMP WITH NEMA PLUG	01-TRIOCLAMPW	White	9	3	7	1	0.2	\$ 671
	01-TRIOCLAMPB	Black						
	01-TRIOCLAMPS	Silver						

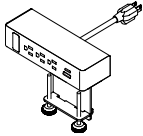

Description

- Clamps to Table Top and Includes: Three (3), Power, **One (1) USB Charging Port, One (1) 60-Watt USB-C Power Delivery Port with GaN Technology**, One (1) Open Data, 10' Cord, and All Mounting Hardware
- HDMI, VGA, or RJ45 Accessory for Open Data Port Specified Separately, [See Data Port Options](#)
- Silver Metal Trim on All Color Options
- Independent USB Circuit Controllers Deliver up to 2.1 Amps to Each Post
- FCC Part 15A, UL Approved for Horizontal and Vertical Applications
- Works with Tri-One Modular, Meeting, and Training Tables

UNDERMOUNT DUO WITH NEMA PLUG	01-DUOUNDERW	White	6½	2½	3	1	0.2	\$ 546
	01-DUOUNDERB	Black						
	01-DUOUNDEERS	Silver						

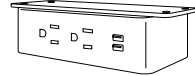

Description

- Sits Under Table Top and Includes: Two (2) Power, Two (2) USB, 10' Cord, and All Mounting Hardware
- Independent USB Circuit Controllers Deliver up to 2.1 Amps to Each Post
- FCC Part 15A, UL Approved for Horizontal and Vertical Applications
- Works with Tri-One Modular, Meeting, and Training Tables

UNDERMOUNT TRIO WITH NEMA PLUG	01-TRIOUNDERW	White	9	2½	3	1	0.2	\$ 655
	01-TRIOUNDERB	Black						
	01-TRIOUNDERS	Silver						

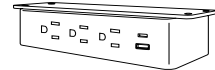

Description

- Sits Under Table Top and Includes: Three (3), Power, **One (1) USB Charging Port, One (1) 60-Watt USB-C Power Delivery Port with GaN Technology**, One (1) Open Data, 10' Cord, and All Mounting Hardware
- HDMI, VGA, or RJ45 Accessory for Open Data Port Specified Separately, [See Data Port Options](#)
- Independent USB Circuit Controllers Deliver up to 2.1 Amps to Each Post
- FCC Part 15A, UL Approved for Horizontal and Vertical Applications
- Works with Tri-One Modular, Meeting, and Training Tables

UNDERMOUNT DUO WITH DAISY CHAIN PLUG	01-PDUOUNDERW	White	6½	2½	3	1	0.2	\$ 539
	01-PDUOUNDERB	Black						
	01-PDUOUNDEERS	Silver						

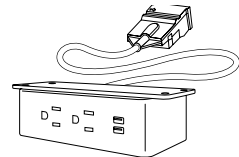

Description

- Sits Under Table Top and Includes: Two (2) Power, **One (1) USB Charging Port and One (1) 60-Watt USB-C Power Delivery Port with GaN Technology with 12" Cord**, and All Mounting Hardware
- Requires Daisy Chain Power Box, Specified Separately, [See Details](#)
- Non-Sequential System Allows up to 8 Modules to be Connected with Jumper Cord, [See Details](#)
- Independent USB Circuit Controllers Deliver up to 2.1 Amps to Each Post
- FCC Part 15A, RU Listed and UL Recognized for Horizontal Applications
- Works with Tri-One Modular, Meeting, and Training Tables

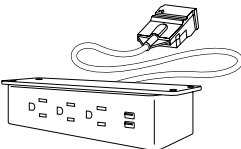
Item	Model No.		W	D	H	Ship Wt	Cubic Ft	List Price
UNDERMOUNT TRIO WITH DAISY CHAIN PLUG 	01-PTRIOUNDERW	White	9	2½	3	1	0.2	\$ 646
	01-PTRIOUNDERB	Black						
	01-PTRIOUNDERS	Silver						

Description

- Sits Under Table Top and Includes: Three (3), Power, **One (1) USB Charging Port, One (1) 60-Watt USB-C Power Delivery Port with GaN Technology**, One (1) Open Data, 12" Cord, and All Mounting Hardware
- HDMI, VGA, or RJ45 Accessory for Open Data Port Specified Separately, [See Data Port Options](#)
- Requires Daisy Chain Power Box, Specified Separately, [See Details](#)
- Non-Sequential System Allows up to Eight (8) Modules to be Connected with Jumper Cord, [See Details](#)
- Independent USB Circuit Controllers Deliver up to 2.1 Amps to Each Post
- FCC Part 15A, RU Listed and UL Recognized for Horizontal Applications
- Works with Tri-One Modular, Meeting, and Training Tables

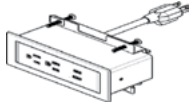
DUO BEZEL WITH NEMA PLUG 	01-DUOBEZELW	White	6½	2½	3¼	1	0.2	\$ 675
	01-DUOBEZELB	Black						
	01-DUOBEZELS	Silver						

Description

- Sits on Table Top and Includes: Two (2) Power, **One (1) USB Charging Port and One (1) 60-Watt USB-C Power Delivery Port with GaN Technology with 10' Cord**, and All Mounting Hardware
- Independent USB Circuit Controllers Deliver up to 2.1 Amps to Each Post
- FCC Part 15A, UL Approved for Horizontal and Vertical Applications
- Works with Tri-One Modular, Meeting, and Training Tables

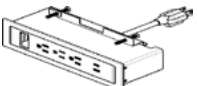
TRIO BEZEL WITH NEMA PLUG 	01-TRIOBEZELW	White	9	2½	3	1	0.2	\$ 725
	01-TRIOBEZELB	Black						
	01-TRIOBEZELS	Silver						

Description

- Sits on Table Top and Includes: Three (3), Power, **One (1) USB Charging Port, One (1) 60-Watt USB-C Power Delivery Port with GaN Technology**, One (1) Open Data, 10' Cord, and All Mounting Hardware
- HDMI, VGA, or RJ45 Accessory for Open Data Port Specified Separately, [See Data Port Options](#)
- Independent USB Circuit Controllers Deliver up to 2.1 Amps to Each Post
- FCC Part 15A, UL Approved for Horizontal and Vertical Applications
- Works with Tri-One Modular, Meeting, and Training Tables

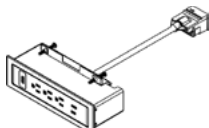
DUO BEZEL WITH DAISY CHAIN PLUG 	01-PDUOBEZELW	White	6½	2½	3	1	0.2	\$ 668
	01-PDUOBEZELB	Black						
	01-PDUOBEZELS	Silver						

Description

- Sits on Table Top and Includes: Two (2) Power, **One (1) USB Charging Port and One (1) 60-Watt USB-C Power Delivery Port with GaN Technology with 12" Cord**, and All Mounting Hardware
- Requires Daisy Chain Power Box, Specified Separately, [See Details](#)
- Non-Sequential System Allows up to 8 Modules to be Connected with Jumper Cord, [See Details](#)
- Independent USB Circuit Controllers Deliver up to 2.1 Amps to Each Post
- FCC Part 15A, RU Listed and UL Recognized for Horizontal and Vertical Applications
- Works with Tri-One Modular, Meeting, and Training Tables

[See Tri-One Overview For Ordering Options](#)

Item	Model No.		W	D	H	Ship Wt	Cubic Ft	List Price
TRIO BEZEL WITH DAISY CHAIN PLUG	01-PTRIOBEZELW	White	9	2 1/2	3	1	0.2	\$ 715
	01-PTRIOBEZELB	Black						
	01-PTRIOBEZELS	Silver						

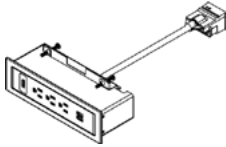

Description

- Sits on Table Top and Includes: Three (3), Power, **One (1) USB Charging Port**, **One (1) 60-Watt USB-C Power Delivery Port with GaN Technology**, One (1) Open Data, 12" Cord, and All Mounting Hardware
- HDMI, VGA, or RJ45 Accessory for Open Data Port Specified Separately, See Below
- Requires Daisy Chain Power Box, Specified Separately, [See Details](#)
- Non-Sequential System Allows up to Eight (8) Modules to be Connected with Jumper Cord, [See Details](#)
- Independent USB Circuit Controllers Deliver up to 2.1 Amps to Each Post
- FCC Part 15A, RU Listed and UL Recognized for Horizontal and Vertical Applications
- Works with Tri-One Modular, Meeting, and Training Tables

HDMI DATA PORT ACCESSORY	01-LCOMHDMI		-	-	-	1	0.2	\$ 166
--------------------------	-------------	--	---	---	---	---	-----	--------

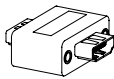

OPEN MARKET ONLY

Description

- HDMI Port for Undermount Trio, Trio Clamp and Trio Bezel Units

VGA DATA PORT ACCESSORY	01-LCOMVGA		-	-	-	1	0.2	\$ 121
-------------------------	------------	--	---	---	---	---	-----	--------

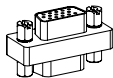

Description

- VGA Port for Undermount Trio, Trio Clamp and Trio Bezel Units

RJ45 DATA PORT ACCESSORY	01-LCOMRJ45		-	-	-	1	0.2	\$ 79
--------------------------	-------------	--	---	---	---	---	-----	-------

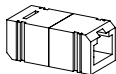

Description

- RJ45 Port for Undermount Trio, Trio Clamp and Trio Bezel Units

DAISY CHAIN POWER BOX	01-PPOWER		-	-	-	1	0.2	\$ 775
		<i>76" Perimeter, 36" Power Cord</i>						
	01-PPOWER2		-	-	-	1	0.2	\$ 796
		<i>24" Perimeter, 144" Power Cord</i>						

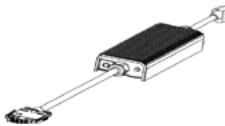

Description

- Powers up to Eight (8) Duo and Trio Daisy Chain Units
- One (1) Nema Plug and One (1) Daisy Chain Plug
- 12-Amp System Rating
- 15-Amp Over-Current Protection

[See Tri-One Overview For Ordering Options](#)

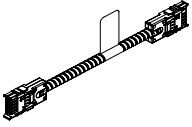
Item	Model No.		W	D	H	Ship Wt	Cubic Ft	List Price
DAISY CHAIN JUMPER CORD 	01-6JUMP	<i>72" Long</i>	-	-	-	1	0.2	\$ 299
	01-5JUMP	<i>60" Long</i>	-	-	-	1	0.2	\$ 284
	01-4JUMP	<i>48" Long</i>	-	-	-	1	0.2	\$ 240
	01-2JUMP	<i>24" Long</i>	-	-	-	1	0.2	\$ 220

Description

- Connects Duo and Trio Daisy Chain Units
- Non-Sequential System Allows up to 8 Modules to be Connected

POWER STRIP	01-PRSP		9	2	2	1	-	\$ 205
-------------	---------	--	---	---	---	---	---	--------

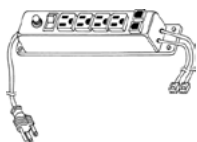
**Description**

- Includes Four (4) Outlets and Two (2) Phone Jacks
- Black Plastic with Rocker On/Off Switch
- 13 Amp Circuit Breaker
- 10' Power Cord and Two (2) 14' Phone Hook Up Cords
- UL and CSA Recognized
- Suitable for Surface or Recessed Mounting
- Ships via UPS Only

WIRE MANAGEMENT CHANNEL	01-WMGR4		16	1½	¾	1	-	\$ 116
-------------------------	----------	--	----	----	---	---	---	--------

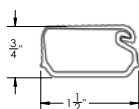
**Description**

- Set of Four (4) Black Plastic Wire Management Channels
- Snap Lock Channel
- Attaches with Adhesive Strips
- Ships via UPS Only

CABLE GRIP	01-WMGRCB		5%	2%	-	-	-	\$ 17
------------	-----------	--	----	----	---	---	---	-------

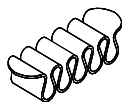
**Description**

- Under Surface Wire Management
- Black

[See Tri-One Overview For Ordering Options](#)



Occasional Tables

SURFACE MATERIAL DIGITAL IMAGES & BROCHURE

The finishes represented on Indiana Furniture's Surface Material Finish Brochure were reproduced using the finest technology available. Samples of our finishes and laminates are available for order through our Collateral Store. Please verify your desired finish before ordering as such orders are not subject to return to Indiana Furniture.

Contact your local Indiana Furniture Sales Representative or our Customer Service team should you need assistance.

GLIDES

All tables ship with non-marring glides, some series offering leveling glides as standard. See pricing pages for each series for more information.

FINISH

Indiana Furniture standard occasional table finishes correspond to casegoods and conferencing finishes and laminates. Minor variations in finish color and value may occur due to the natural characteristics of wood. Consult this price list for specific finish availability within each series.

Special Finishes: Indiana Furniture is able to accommodate our customer's needs for specific finish matches. Please submit a 3"x5" sample panel to Customer Service for quotation and lead time.

An overview of our finishes and laminate options can be found on the inside of the back cover of this price list.

Arlington offers all the grace and embellishments associated with traditional styling with an added emphasis on value. Finely crafted in select solids with walnut and cherry veneers and high pressure laminate worksurfaces, Arlington ensures quality and expert craftsmanship with a selection of configurations for today's functional workspaces.

CONSTRUCTION

- Veneers on exposed surfaces feature select grade, plain sliced American Black Walnut or Cherry veneers, carefully selected and matched to assure proper balance and consistency
- Veneer tops have a 5-ply balanced construction, 1 3/16" thick with solid hardwood rims with butt corners
- HPL tops have a 3-ply balanced construction, 1 3/16" thick, with solid hardwood rims with butt corners
- Grain direction runs left to right
- All units ship with heavy duty, adjustable leveling glides to ensure proper leveling and compensation for uneven floors
- Some Assembly Required

HOW TO ORDER EXAMPLE

Model No.	Description	Example
29-2124ET	Top Material Finish	W CO

VENEER (W) OPTIONS

Veneer features UVAdvantage, an ultra-violet finish, on all exposed surfaces by utilizing roll-coat UV technology. Apron rails and table legs use a multi-step, hand finished process with a catalyzed finish

AW	Artisan Walnut	HW	Harvest Walnut
CO	Columbian Walnut	LW	Legacy Walnut
DC	Dark Cherry	MW	Mahogany Walnut
DFW	Dark Forest Walnut	PNW	Pinnacle Walnut
EW	Espresso	SCH	Select Cherry
GC	Golden Cherry	SKC	Shaker Cherry
HNW	Henna Walnut	WC	Williamsburg Cherry

HPL (P) TOP OPTIONS

WOODGRAIN

CO	Columbian Walnut	PNW	Pinnacle Walnut
EF	Espresso	SCH	Select Cherry
GC	Golden Cherry	SKC	Shaker Cherry
MW	Mahogany Walnut	WC	Williamsburg Cherry

TABLE EDGE PROFILE



Arlington

CERTIFICATIONS & COMPLIANCE

- Intertek Sustainability Certified
- BIFMA level® Certified
- BIFMA Compliant® Certified
- TSCA Title VI (CARB) Compliance
- US Green Building's LEED® Contribution

STATEMENT OF LINE



29-2124ET:
End Table
[\(See Details\)](#)

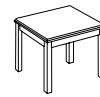

29-2424LT:
Lamp Table
[\(See Details\)](#)

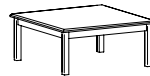

29-3636MT:
Square Magazine
Table
[\(See Details\)](#)

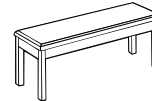

29-1847MT:
Magazine Table
[\(See Details\)](#)

Item	Model No.	W	D	H	Ship Wt	Cubic Ft	List Price	
END TABLE	29-2124ET	21	24	21½	25	2.0	P\$ 1027	W\$ 1197

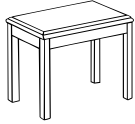

Must Specify (in this order):
Model #
Top Material
Finish/Color

Description

- Available with Veneer (W) or HPL (P) Top, Must Specify
- Hardwood Legs
- Some Assembly Required

LAMP TABLE	29-2424LT	24	24	21½	25	2.0	P\$ 1149	W\$ 1233
------------	-----------	----	----	-----	----	-----	----------	----------

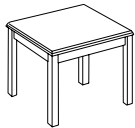

Must Specify (in this order):
Model #
Top Material
Finish/Color

Description

- Available with Veneer (W) or HPL (P) Top, Must Specify
- Hardwood Legs
- Some Assembly Required

MAGAZINE TABLE	29-1847MT	47	18	16	47	3.4	P\$ 1233	W\$ 1438
----------------	-----------	----	----	----	----	-----	----------	----------

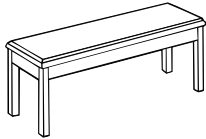

Must Specify (in this order):
Model #
Top Material
Finish/Color
Leg

Description

- Available with Veneer (W) or HPL (P) Top, Must Specify
- Left to Right Grain Direction on Worksurface
- Hardwood Legs
- Some Assembly Required
- Optional 30" Legs; See Below

Desk Base Molding Options: Must Specify and Add

SH-36	Optional 30" H Legs	\$ 223
-------	---------------------	--------

SQUARE MAGAZINE TABLE	29-3636MT	36	36	16	60	5.5	P\$ 1317	W\$ 1538
-----------------------	-----------	----	----	----	----	-----	----------	----------

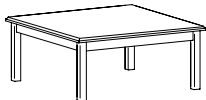

Must Specify (in this order):
Model #
Top Material
Finish/Color

Description

- Available with Veneer (W) or HPL (P) Top, Must Specify
- Hardwood Legs
- Some Assembly Required



Wilmington/Arlington

P = HPL W = Veneer

[See Intro Overview For Ordering Options](#)

From lounge areas, to private office, to conference settings, the Bailey Collection can make a statement. Bailey tables are offered in square and rectangular cocktail tables, as well as end tables, in a wide range of veneers and laminates with two edge profiles. Pair Bailey tables with the collection's chairs, settees, sofas, and ottomans.

CONSTRUCTION

- Bases for tables are manufactured using steel frames with a chrome finish
- The wood veneer tops are made of select grade sliced Black Walnut, Cherry, Maple, or composite veneers for maximum grain and color consistency
- Veneer tops are 1" with 1mm veneer edge bands
- Laminate tops are 1" with 1mm PVC edge bands; laminate tops are ¾" with 1mm PVC edge bands; Designer White, Sugar Maple, and Williamsburg Cherry feature ABS edge bands
- Ships fully assembled

HOW TO ORDER EXAMPLE

Model No.	Description	Example
720-3030SQ	Finish	TK

TFL (T) AND HPL (P) LAMINATE OPTIONS

WOODGRAIN

AS	Asian Night	PNW	Pinnacle Walnut
BW	Beigewood	SCH	Select Cherry
CO	Columbian Walnut	SKC	Shaker Cherry
EF	Espresso	SBP	Smoky Brown Pear
GC	Golden Cherry	TK	Studio Teak
HVM	Harvest Maple	SM	Sugar Maple
MW	Mahogany Walnut	WTA	Weathered Ash
ORW	Oak Riftwood	WC	Williamsburg Cherry

SOLID

BL	Black	PPD	Pepperdust
WH	Designer White	SG	Slate Grey
FHG	Fashion Grey	WHS	White Sand

VENEER (W) OPTIONS AVAILABLE

Veneer tops feature UVAdvantage, an ultra-violet finish, on all exposed surfaces by utilizing roll-coat UV technology.

AW	Artisan Walnut	MW	Mahogany Walnut
AS	Asian Night	ORW	Oak Riftwood*
CO	Columbian Walnut	SCH	Select Cherry
DC	Dark Cherry	SKC	Shaker Cherry
DFW	Dark Forest Walnut	SBP	Smoky Brown Pear
EF	Espresso	SM	Sugar Maple
FO	Fawn Oak*	SW	Sunglow Walnut
GC	Golden Cherry	WTA	Weathered Ash*
HW	Harvest Walnut	WC	Williamsburg Cherry
LW	Legacy Walnut		

* Finish is Low Sheen

TABLE EDGE PROFILES

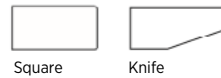

Square

Knife

CERTIFICATIONS & COMPLIANCE

- Intertek Sustainability Certified
- BIFMA level® Certified
- BIFMA Compliant® Certified
- TSCA Title VI (CARB) Compliance
- US Green Building's LEED® Contribution

STATEMENT OF LINE

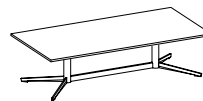

Rectangular
Cocktail Tables
[\(See Details\)](#)

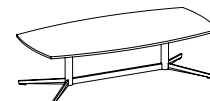

Soft Rectangular
Cocktail Tables
[\(See Details\)](#)



Square
Cocktail Tables
[\(See Details\)](#)



Soft Square
Cocktail Tables
[\(See Details\)](#)



Square
End Tables
[\(See Details\)](#)

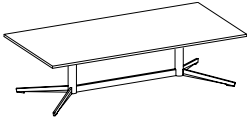
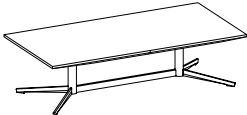

Soft Square
End Tables
[\(See Details\)](#)

Item	Model No.		W	D	H	Ship Wt	Cubic Ft	List Price		
RECTANGULAR COCKTAIL TABLE  	SQUARE EDGE									
	720-2550RT	TFL	25	50	14	34.9	3.2	T\$	1440	
	720-2550RTH	HPL	25	50	14	34.9	3.2	P\$	1691	
	719-2550RT	Wood	25	50	14	34.9	3.2	W\$	2045	
	KNIFE EDGE									
	720-2550RTKH	HPL	25	50	14	34.9	3.2	P\$	2096	
719-2550RTK	Wood	25	50	14	34.9	3.2	W\$	2195		

Must Specify (in this order):

Model #
Finish/Color

Description

- Standard with: Chrome Base
- Table Ships Fully Assembled

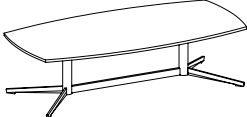
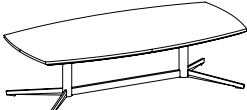
SOFT RECTANGULAR COCKTAIL TABLE  	SQUARE EDGE									
	720-2550SRT	TFL	25	50	14	34.9	3.2	T\$	1440	
	720-2550SRTH	HPL	25	50	14	34.9	3.2	P\$	1691	
	719-2550SRT	Wood	25	50	14	34.9	3.2	W\$	2045	
	KNIFE EDGE									
	720-2550SRTKH	HPL	25	50	14	34.9	3.2	P\$	2096	
719-2550SRTK	Wood	25	50	14	34.9	3.2	W\$	2195		

Must Specify (in this order):

Model #
Finish/Color

Description

- Standard with: Chrome Base
- Table Ships Fully Assembled





Square



Knife

T = TFL P = HPL W = Veneer

[See Intro Overview For Ordering Options](#)



Item	Model No.		W	D	H	Ship Wt	Cubic Ft	List Price		
SQUARE COCKTAIL TABLE  	SQUARE EDGE									
	720-3030SQ	TFL	30	30	14	29.7	2.80	T\$	893	
	720-3030SQH	HPL	30	30	14	29.7	2.80	P\$	1212	
	719-3030SQ	Wood	30	30	14	29.7	2.80	W\$	1407	
	KNIFE EDGE									
	720-3030SQKH	HPL	30	30	14	29.7	2.80	P\$	1528	
	719-3030SQK	Wood	30	30	14	29.7	2.80	W\$	1530	

Must Specify (in this order):

Model #
Finish/Color

Description

- Standard with: Chrome Base
- Table Ships Fully Assembled

Item	Model No.		W	D	H	Ship Wt	Cubic Ft	List Price		
SOFT SQUARE COCKTAIL TABLE  	SQUARE EDGE									
	720-3030SSQ	TFL	30	30	14	29.7	2.80	T\$	893	
	720-3030SSQH	HPL	30	30	14	29.7	2.80	P\$	1212	
	719-3030SSQ	Wood	30	30	14	29.7	2.80	W\$	1407	
	KNIFE EDGE									
	720-3030SSQKH	HPL	30	30	14	29.7	2.80	P\$	1528	
	719-3030SSQK	Wood	30	30	14	29.7	2.80	W\$	1530	

Must Specify (in this order):

Model #
Finish/Color

Description

- Standard with: Chrome Base
- Table Ships Fully Assembled



Square



Knife

T = TFL P = HPL W = Veneer

[See Intro Overview For Ordering Options](#)

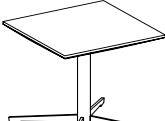
Item	Model No.		W	D	H	Ship Wt	Cubic Ft	List Price	
	SQUARE EDGE								
	720-2020ET	TFL	20	20	20	20	2.0	T\$	976
	720-2020ETH	HPL	20	20	20	20	2.0	P\$	1211
	719-2020ET	Wood	20	20	20	20	2.0	W\$	1284
	KNIFE EDGE								
	720-2020ETKH	HPL	20	20	20	20	2.0	P\$	1349
	719-2020ETK	Wood	20	20	20	20	2.0	W\$	1411

Description

- Standard with: Chrome Base
- Table Ships Fully Assembled

Must Specify (in this order):
Model #
Finish/Color

Item	Model No.		W	D	H	Ship Wt	Cubic Ft	List Price	
	SQUARE EDGE								
	720-2020SET	TFL	20	20	20	20	2.0	T\$	976
	720-2020SETH	HPL	20	20	20	20	2.0	P\$	1211
	719-2020SET	Wood	20	20	20	20	2.0	W\$	1284
	KNIFE EDGE								
	720-2020SETKH	HPL	20	20	20	20	2.0	P\$	1349
	719-2020SETK	Wood	20	20	20	20	2.0	W\$	1411

Description

- Standard with: Chrome Base
- Table Ships Fully Assembled

Must Specify (in this order):
Model #
Finish/Color

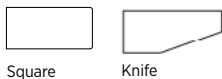

T = TFL P = HPL W = Veneer

[See Intro Overview For Ordering Options](#)

The Britta Collection showcases a Mid-Century Scandinavian aesthetic with an appealing contemporary feel. Available in two edge styles and a broad range of finishes to create an inviting space with warm and energetic sensibility. Pair Britta tables with the collection's guest, single lounge, and settee options, which all feature a wall-saver design, to create an entire setting.

CONSTRUCTION

- The wood veneer table tops are 1" thick and are made of select grade sliced Walnut, Cherry, or Maple veneers for maximum grain and color consistency
- The knife edge profile features a 5-ply balanced construction with a solid hardwood rim; the square edge profile features a 3-ply balanced construction with a 3mm veneer edge band
- The aprons and legs are solid maple hardwood and ship with adjustable glides
- Ships fully assembled

HOW TO ORDER EXAMPLE

Model No.	Description	Example
231-1818ET	Finish Edge Profile	DFW K

VENEER (W) OPTIONS

Veneer tops feature UVAdvantage, an ultra-violet finish, on all exposed surfaces by utilizing roll-coat UV technology. Apron rails and table legs use a multi-step, hand finished process with a catalyzed finish.

AW	Artisan Walnut	LW	Legacy Walnut
CO	Columbian Walnut	MW	Mahogany Walnut
DC	Dark Cherry	MTS	Metropolis Sky
DFW	Dark Forest Walnut	SCH	Select Cherry
EF	Espresso	SKC	Shaker Cherry
GC	Golden Cherry	SM	Sugar Maple
HW	Harvest Walnut	WC	Williamsburg Cherry
HNW	Henna Walnut	PNW	Pinnacle Walnut

TABLE EDGE PROFILE

- Y Square Edge
- K Knife Edge



Square



Knife

CERTIFICATIONS & COMPLIANCE

- Intertek Sustainability Certified
- BIFMA level® Certified
- BIFMA Compliant® Certified
- TSCA Title VI (CARB) Compliance
- US Green Building's LEED® Contribution

STATEMENT OF LINE



231-1818ET: Square
End Table
[\(See Details\)](#)

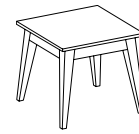

231-2323SCT: Square
Cocktail Table
[\(See Details\)](#)

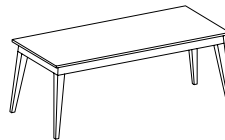

231-4723RCT: Rectangular
Cocktail Table
[\(See Details\)](#)

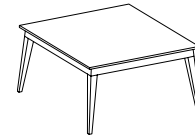

231-3535SCT: Square
Cocktail Table
[\(See Details\)](#)

Item	Model No.		W	D	H	Ship Wt	Cubic Ft	List Price	
END TABLE	231-1818ET	Square Edge	18	18	20	18	10.8	Y\$	1438
		Knife Edge						K\$	No Match!



Must Specify (in this order):

Model #
Finish
Edge

Description

- Standard with: Adjustable Glides
- Available with [Square \(Y\)](#) or [Knife \(K\)](#) Edge; Must Specify
- Ships Fully Assembled

SMALL SQUARE COCKTAIL TABLE	231-2323SCT	Square Edge	23	23	16	21	10.8	Y\$	1470
		Knife Edge						K\$	No Match!



Must Specify (in this order):

Model #
Finish
Edge

Description

- Standard with: Adjustable Glides
- Available with [Square \(Y\)](#) or [Knife \(K\)](#) Edge; Must Specify
- Ships Fully Assembled

SQUARE COCKTAIL TABLE	231-3535SCT	Square Edge	34 $\frac{7}{8}$	34 $\frac{7}{8}$	16	45	25.7	Y\$	1762
		Knife Edge						K\$	No Match!

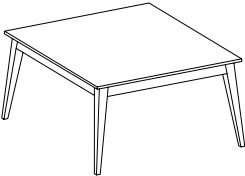

Must Specify (in this order):

Model #
Finish
Edge

Description

- Standard with: Adjustable Glides
- Available with [Square \(Y\)](#) or [Knife \(K\)](#) Edge; Must Specify
- Ships Fully Assembled

RECTANGULAR COCKTAIL TABLE	231-4723RCT	Square Edge	46 $\frac{7}{8}$	23	16	36	23.1	Y\$	1724
		Knife Edge						K\$	No Match!

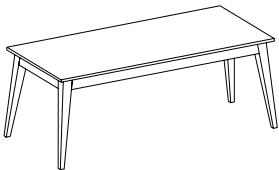

Must Specify (in this order):

Model #
Finish
Edge

Description

- Standard with: Adjustable Glides
- Available with [Square \(Y\)](#) or [Knife \(K\)](#) Edge; Must Specify
- Ships Fully Assembled



Square



Knife

[See Intro Overview For Ordering Options](#)

Always stylish, comfortable and effortlessly adaptable, Canvas enlivens environments with refined aesthetics. Project a fresh, polished attitude with our enhanced selection of multidimensional components. Your creation of an ultra-functional workspace is limited only by your imagination.

CONSTRUCTION

- Exposed surfaces are produced from wood-grained or solid color laminates fused to a particle-board core.
- TFL chassis are fastened by screws and heavy-duty metal fasteners
- Tops are 1" thick Thermally-Fused (TFL) or High-Pressure (HPL) laminate using 3mm PVC rims on profiled edges Grain direction runs left to right; Designer White, Sugar Maple, and Williamsburg Cherry feature ABS edge bands
- Slab ends come standard with adjustable levelers
- Ships fully assembled

HOW TO ORDER EXAMPLE

Model No.	Description	Example
66-2424ET	Top Material	T
	Top Color	FHG
	Edge Profile	F
	Chassis Color	WTA

TFL (T) AND HPL (P) LAMINATE OPTIONS

WOODGRAIN

AS	Asian Night	PNW	Pinnacle Walnut
BW	Beigewood	PTK	Portico Teak
CO	Columbian Walnut	RC	River Cherry
EF	Espresso	SCH	Select Cherry
FLW	Florence Walnut	SPW	Sepia Walnut
GC	Golden Cherry	SKC	Shaker Cherry
HVM	Harvest Maple	SBP	Smoky Brown Pear
KHE	Kirsche	TK	Studio Teak
MW	Mahogany Walnut	SM	Sugar Maple
MNR	Midnight Run	WTA	Weathered Ash
NTM	Natural Marrone	WC	Williamsburg Cherry
ORW	Oak Riftwood	WNB	White Nebbia

SOLID

BL	Black	FHG	Fashion Grey
WH	Designer White	SG	Slate Grey

TABLE EDGE PROFILE

F	Double Kerf	Y	Square
G	Duo		
X	Fluted		

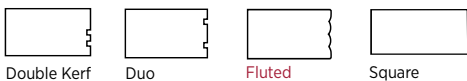

CERTIFICATIONS & COMPLIANCE

- Intertek Sustainability Certified
- BIFMA level® Certified
- BIFMA Compliant® Certified
- TSCA Title VI (CARB) Compliance
- US Green Building's LEED® Contribution

STATEMENT OF LINE

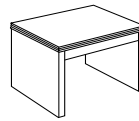

66-2424ET:
End Table
[\(See Details\)](#)

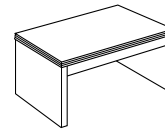

66-2442MT:
Magazine Table
[\(See Details\)](#)

Item	Model No.		W	D	H	Ship Wt	Cubic Ft	List Price	
END TABLE	66-2424ET	TFL	24	24	22	65	9.4	T\$	921
		HPL						P\$	1057

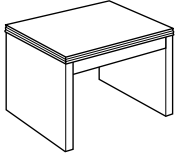

Must Specify (in this order):

- Model #
- Top Material
- Top Color
- Edge
- Chassis Color

Description

- Standard with: TFL Slab Ends and Apron Rail, with Adjustable Glides
- Available in Contrasting Top and Chassis Color
- Choose from TFL (T) or HPL (P) Top
- Ships Fully Assembled

MAGAZINE TABLE	66-2442MT	TFL	42	24	16	70	11.9	T\$	970
		HPL						P\$	1136

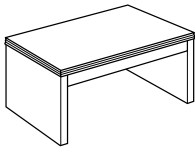

Must Specify (in this order):

- Model #
- Top Material
- Top Color
- Edge
- Chassis Color

Description

- Standard with: TFL Slab Ends and Apron Rail, with Adjustable Glides
- Available in Contrasting Top and Chassis Color
- Choose from TFL (T) or HPL (P) Top
- Ships Fully Assembled



Double Kerf



Duo



Square

T=TFL P=HPL

[See Intro Overview For Ordering Options](#)

Carefully matched select veneer tops with solid hardwood legs and aprons form a collection of beautiful wood tables suitable for nearly any application.

CONSTRUCTION

- Constructed of a 5-ply veneer top, 1½" thick
- Legs are solid Maple hardwood and ship with nylon glides
- Aprons are steam bent with Maple veneer faces
- Grain direction runs left to right
- Elliptical Magazine and Rounded End Tables ship fully assembled; all other models require some assembly

HOW TO ORDER EXAMPLE

Model No.	Description	Example
294-4222EMT	Finish	HW

VENEER (W) OPTIONS

Veneer tops feature UVAAdvantage, an ultra-violet finish, on all exposed surfaces by utilizing roll-coat UV technology. Apron rails and table legs use a multi-step, hand finished process with a catalyzed finish

AW	Artisan Walnut	LW	Legacy Walnut
CO	Columbian Walnut	MW	Mahogany Walnut
DC	Dark Cherry	MTS	Metropolis Sky
DFW	Dark Forest Walnut	SCH	Select Cherry
EF	Espresso	SKC	Shaker Cherry
GC	Golden Cherry	SM	Sugar Maple
HW	Harvest Walnut	WC	Williamsburg Cherry
HNW	Henna Walnut	PNW	Pinnacle Walnut

TABLE EDGE PROFILE

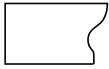

Phoenix

CERTIFICATIONS & COMPLIANCE

- Intertek Sustainability Certified
- BIFMA level® Certified
- BIFMA Compliant® Certified
- TSCA Title VI (CARB) Compliance
- US Green Building's LEED® Contribution

STATEMENT OF LINE

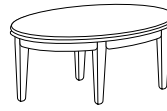

294-4222EMT:
Elliptical
Magazine Table
[\(See Details\)](#)

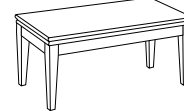

294-4222MT:
Magazine Table
[\(See Details\)](#)



294-2222LT:
Lamp Table
[\(See Details\)](#)



294-2622ET:
End Table
[\(See Details\)](#)



294-2222RET:
Rounded End Table
[\(See Details\)](#)

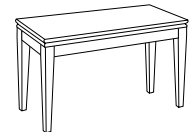

294-4216CT:
Console Table
[\(See Details\)](#)

Item	Model No.	W	D	H	Ship Wt	Cubic Ft	List Price
ELLIPTICAL MAGAZINE TABLE	294-4222EMT	42	22	16	48	14.4	\$ 2993

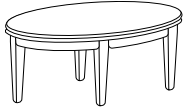
**Description**

- Ships Assembled

Must Specify (in this order):

Model #
Finish

MAGAZINE TABLE	294-4222MT	42	22	16	33	3.7	\$ 1930
----------------	------------	----	----	----	----	-----	---------

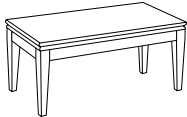
**Description**

- Some Assembly Required

Must Specify (in this order):

Model #
Finish

LAMP TABLE	294-2222LT	22	22	22	27	2.4	\$ 1473
------------	------------	----	----	----	----	-----	---------

**Description**

- Some Assembly Required

Must Specify (in this order):

Model #
Finish

END TABLE	294-2622ET	26	22	22	36	2.8	\$ 1553
-----------	------------	----	----	----	----	-----	---------

**Description**

- Some Assembly Required

Must Specify (in this order):

Model #
Finish

ROUNDED END TABLE	294-2222RET	22	22	22	24	2.4	\$ 2044
-------------------	-------------	----	----	----	----	-----	---------

**Description**

- Ships Assembled

Must Specify (in this order):

Model #
Finish

CONSOLE TABLE	294-4216CT	42	16	30	36	3.9	\$ 1840
---------------	------------	----	----	----	----	-----	---------

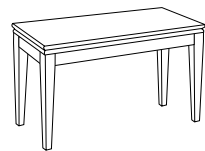
**Description**

- Some Assembly Required

Must Specify (in this order):

Model #
Finish

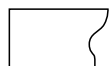

Phoenix

[See Intro Overview For Ordering Options](#)

A foundational suite of casegoods and tables primed to evolve with your needs. Gesso allows you to combine luxurious veneers, top grade laminates and other materials to create stylish, reconfigurable work spaces.

CONSTRUCTION

- Exposed surfaces feature select grade plain sliced hardwood veneers in Cherry, Maple, American Black Walnut, White Oak, or composite veneers
- Veneer and standard high pressure laminate tops are 3-ply balanced construction and 1 $\frac{3}{8}$ " thick, with 3mm wood edge-banded rims contoured to the selected profile
- Grain direction runs left to right
- All units ship with heavy duty, adjustable leveling glides to ensure proper leveling and compensation for uneven floors
- Ships fully assembled

HOW TO ORDER EXAMPLE

Model No.	Description	Example
65-2424ET	Top Material	W
	Finish	LW
	Edge Profile	G

VENEER (W) OPTIONS

Veneer tops feature UVAdvantage, an ultra-violet finish, on all exposed surfaces by utilizing roll-coat UV technology.

AW	Artisan Walnut	MW	Mahogany Walnut
AS	Asian Night	MAS	Mesa Sunset
CO	Columbian Walnut	MTS	Metropolis Sky
DC	Dark Cherry	PNW	Pinnacle Walnut
DFW	Dark Forest Walnut	ORW	Oak Riftwood*
EW	Espresso	SCH	Select Cherry
FO	Fawn Oak*	SKC	Shaker Cherry
GC	Golden Cherry	SM	Sugar Maple
HW	Harvest Walnut	WTA	Weathered Ash*
HNW	Henna Walnut	WC	Williamsburg Cherry
LW	Legacy Walnut		

* Finish is Low Sheen

HPL (P) LAMINATE OPTIONS

WOODGRAIN

AS	Asian Night	SCH	Select Cherry
CO	Columbian Walnut	SKC	Shaker Cherry
EF	Espresso	SBP	Smoky Brown Pear
GC	Golden Cherry	SM	Sugar Maple
MW	Mahogany Walnut	WTA	Weathered Ash
ORW	Oak Riftwood	WC	Williamsburg Cherry
PNW	Pinnacle Walnut		

SOLID

BL	Black	FHG	Fashion Grey
WH	Designer White	SG	Slate Grey

TABLE EDGE PROFILE

F	Double Kerf	Y	Square
G	Duo		
X	Fluted		

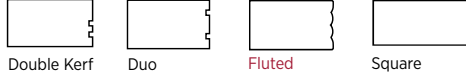

CERTIFICATIONS & COMPLIANCE

- Intertek Sustainability Certified
- BIFMA level® Certified
- BIFMA Compliant® Certified
- TSCA Title VI (CARB) Compliance
- US Green Building's LEED® Contribution

STATEMENT OF LINE

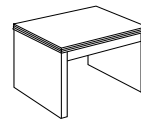

65-2424ET:
End Table
([See Details](#))

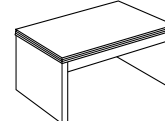

65-2442MT:
Magazine Table
([See Details](#))

Item	Model No.	W	D	H	Ship Wt	Cubic Ft	List Price
END TABLE	65-2424ET	24	24	22	65	9.4	W/P\$ 1632

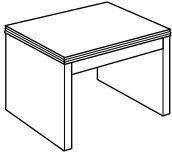

Description

- Standard with: Veneer Slab Ends and Apron Rail, with Adjustable Glides
- Choose from HPL (P) or Veneer (W) Top; Must Specify
- Ships Fully Assembled

Must Specify (in this order):

Model #
Top Material
Finish/Color
Edge

MAGAZINE TABLE	65-2442MT	42	24	16	70	11.9	W/P\$ 1718
----------------	-----------	----	----	----	----	------	------------

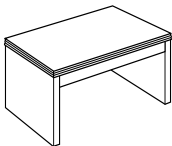

Description

- Standard with: Veneer Slab Ends and Apron Rail, with Adjustable Glides
- Choose from HPL (P) or Veneer (W) Top; Must Specify
- Ships Fully Assembled

Must Specify (in this order):

Model #
Top Material
Finish/Color
Edge



Double Kerf



Duo



Square

P = HPL W = Veneer

[See Intro Overview For Ordering Options](#)

Open spaces really come together with Isla Lounge & Tables Collection. Create conversation settings or private areas by mixing components to fit the space and needs of the environment. Power and data options keep everyone working on-the-go.

CONSTRUCTION

- External wood parts are kiln-dried hardwoods; internal parts are structurally engineered plywood; European Beech on legs
- Joints are double-doweled or mortised and tenoned, screwed, and glued for maximum strength and durability
- Tops are ¾" thick on occasional tables, 1" thick on Laminate tops, and 1⅜" on Veneer tops
- Non-marring adjustable nylon guides included in each leg at floor level
- Ships fully assembled

HOW TO ORDER EXAMPLES

378-1626ET	Top Material	T
	Finish	AS
	Upholstery	Mayer Fedora Topaz
	Leg	WLEG, AS
	Power	PWRUSBA

TFL (T) LAMINATE TABLE TOP OPTIONS

WOODGRAIN

AS	Asian Night	PNW	Pinnacle Walnut
BW	Beigewood	PTK	Portico Teak
CO	Columbian Walnut	RC	River Cherry
EF	Espresso	SPW	Sepia Walnut
FLW	Florence Walnut	SCH	Select Cherry
GC	Golden Cherry	SKC	Shaker Cherry
HVM	Harvest Maple	SBP	Smoky Brown Pear
KHE	Kirsche	TK	Studio Teak
MW	Mahogany Walnut	SM	Sugar Maple
MNR	Midnight Run	WTA	Weathered Ash
NTM	Natural Marrone	WC	Williamsburg Cherry
ORW	Oak Riftwood	WNB	White Nebbia

SOLID

BL	Black	FHG	Fashion Grey
WH	Designer White	SG	Slate Grey

VENEER (W) TABLE TOP OPTIONS

Veneer tops feature UVAdvantage, an ultra-violet finish, on all exposed surfaces by utilizing roll-coat UV technology.

AW	Artisan Walnut	MW	Mahogany Walnut
AS	Asian Night	MAS	Mesa Sunset
CO	Columbian Walnut	MTS	Metropolis Sky
DC	Dark Cherry	ORW	Oak Riftwood*
DFW	Dark Forest Walnut	PNW	Pinnacle Walnut
EF	Espresso	SCH	Select Cherry
FO	Fawn Oak*	SKC	Shaker Cherry
GC	Golden Cherry	SM	Sugar Maple
HW	Harvest Walnut	WTA	Weathered Ash*
HNW	Henna Walnut	WC	Williamsburg Cherry
LW	Legacy Walnut		

* Finish is Low Sheen

SOLID SURFACE (S) TABLE TOP OPTIONS

AR	Arroyo	SNW	Snow White
PE	Pebble Beach	SN	Starry Night
SE	Sedona	TN	Tundra

SOLID SURFACE EDGE PROFILE OPTIONS

SI Straight



LEG OPTIONS

WLEG	Wood Leg, Specify Finish		Std
CLEG	Chrome Leg		\$ N/C
PLEG	Aluminum Leg		\$ 216
	ALUM Aluminum	BLK Black	
	MIST Mist	OYST Oyster	
	SUGC Sugar Cookie		

LEG WOOD FINISHES

Indiana Furniture uses a multi-step, hand-finishing process on all exposed wood frames. Legs feature a catalyzed varnish finish offering durability, lasting beauty, and resistance to normal wear.

AW	Artisan Walnut	MAS	Mesa Sunset
AS	Asian Night	MTS	Metropolis Sky
BW	Beigewood*	MNR	Midnight Run
BL	Black	NTM	Natural Marrone
CO	Columbian Walnut	ORW	Oak Riftwood*
DC	Dark Cherry	PNW	Pinnacle Walnut
DFW	Dark Forest Walnut*	PTK	Portico Teak
WH	Designer White	RC	River Cherry
EF	Espresso	SCH	Select Cherry
FO	Fawn Oak*	SPW	Sepia Walnut
FLW	Florence Walnut	SKC	Shaker Cherry
GC	Golden Cherry	SBP	Smoky Brown Pear
HW	Harvest Walnut	TK	Studio Teak
HNW	Henna Walnut	SM	Sugar Maple
KHE	Kirsche	WTA	Weathered Ash*
LW	Legacy Walnut	WNB	White Nebbia
MW	Mahogany Walnut	WC	Williamsburg Cherry

* Finish is Low Sheen

UPHOLSTERY OPTIONS

Available in single upholstery in a wide variety of graded-in or contract options, including fabric, vinyl, and leather.

POWER OPTIONS

PWRUSBA	Power and Two USB Ports, Aluminum	\$ 884
---------	-----------------------------------	--------

CERTIFICATIONS & COMPLIANCE

- CAL 117-2013 Compliance
- Intertek Sustainability Certified
- BIFMA level® Certified
- BIFMA Compliant® Certified
- TSCA Title VI (CARB) Compliance
- US Green Building's LEED® Contribution

Freestanding Tables (Upholstered Chassis with TFL, Veneer, or Solid Surface Top)

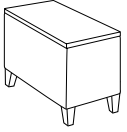

End Table:
378-1626ET
[\(See Details\)](#)

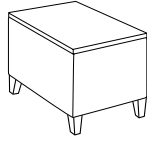

Lamp Table:
378-2226ET
[\(See Details\)](#)

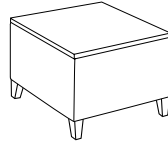

Magazine Table:
378-2626MT
[\(See Details\)](#)

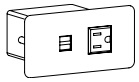

1 Electrical Power
and 2 USB Outlets

Item	Model No.		W	D	H	Ship Wt	Cubic Ft	List Price	
END TABLE	378-1626ET	TFL	16	26½	15½	42	11.0	T\$	958
		Veneer						W\$	1067
		Solid Surface						S\$	1755

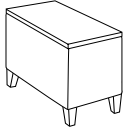

Must Specify (in this order):

- Model #
- Top Material
- Finish/Color
- Fabric
- Leg/Color
- Power

Description

- Standard with: Upholstered Chassis and Wood Legs
- Choose TFL (T), Veneer (W), or Solid Surface (S) Top
- Add Upholstery Grade Pricing to Top Material Price
- Optional Leg and Power

Add List Price/Grade	Yards	COM/1	2	3	4	5	6	7	8	9	10	L1	L2
Single Upholstery	1.00	\$ 0	52	96	139	204	270	364	462	576	708	330	471

LAMP TABLE	378-2226ET	TFL	22	26½	15½	48	12.0	T\$	1005
		Veneer						W\$	1235
		Solid Surface						S\$	2079

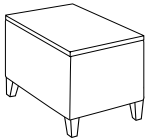

Must Specify (in this order):

- Model #
- Top Material
- Finish/Color
- Fabric
- Leg/Color
- Power

Description

- Standard with: Upholstered Chassis and Wood Legs
- Choose TFL (T), Veneer (W), or Solid Surface (S) Top
- Add Upholstery Grade Pricing to Top Material Price
- Optional Leg and Power

Add List Price/Grade	Yards	COM/1	2	3	4	5	6	7	8	9	10	L1	L2
Single Upholstery	1.00	\$ 0	52	96	139	364	270	364	462	576	708	330	471

MAGAZINE TABLE	378-2626MT	TFL	26½	26½	15½	57	15.0	T\$	1064
		Veneer						W\$	1308
		Solid Surface						S\$	2364

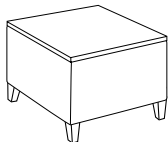

Must Specify (in this order):

- Model #
- Top Material
- Finish/Color
- Fabric
- Leg/Color
- Power

Description

- Standard with: Upholstered Chassis and Ganging Hardware
- Choose TFL (T), Veneer (W), or Solid Surface (S) Top
- Add Upholstery Grade Pricing to Top Material Price
- Optional Leg and Power

Add List Price/Grade	Yards	COM/1	2	3	4	5	6	7	8	9	10	L1	L2
Single Upholstery	1.00	\$ 0	52	96	139	204	270	364	462	576	708	330	471

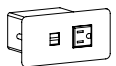

1 Electrical Power and 2 USB Outlets

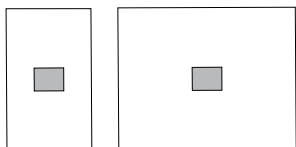

Power is centered into End, Lamp, and Magazine Tables, as shown above

T = TFL W = Veneer S = Solid Surface

[See Intro Overview For Ordering Options](#)

Jefferson echoes history and creates a timeless foundation for today's sophisticated work place. Finely crafted in select solids with walnut veneers, the tailored details of this collection accentuate our expert craftsmanship and perfect attention to detail.

CONSTRUCTION

- Veneers on exposed surfaces are select grade sliced American Black Walnut and Cherry are carefully selected and matched to assure proper balance and consistency
- Veneer and HPL tops featuring the C2 tops are 5-ply balanced construction, 1 $\frac{3}{16}$ " thick, with solid hardwood mitered rims
- Grain direction runs left to right
- All units ship with heavy duty, adjustable leveling glides to ensure proper leveling and compensation for uneven floors
- Some assembly required

HOW TO ORDER EXAMPLE

Model No.	Description	Example
46-1824ET	Top Material	W
	Finish	LW

VENEER (W) AND PREMIUM VENEER (PV) OPTIONS

Veneer tops feature UVAdvantage, an ultra-violet finish, on all exposed surfaces by utilizing roll-coat UV technology. Apron rails and table legs use a multi-step, hand finished process with a catalyzed finish.

AW	Artisan Walnut	LW	Legacy Walnut
CO	Columbian Walnut	MW	Mahogany Walnut
DC	Dark Cherry	MTS	Metropolis Sky
DFW	Dark Forest Walnut	PNW	Pinnacle Walnut
EW	Espresso	SCH	Select Cherry
GC	Golden Cherry	SKC	Shaker Cherry
HNW	Henna Walnut	WC	Williamsburg Cherry
HW	Harvest Walnut		

HPL (P) TOP OPTIONS

WOODGRAIN

CO	Columbian Walnut	PNW	Pinnacle Walnut
EF	Espresso	SCH	Select Cherry
GC	Golden Cherry	SKC	Shaker Cherry
MW	Mahogany Walnut	WC	Williamsburg Cherry

TABLE EDGE PROFILE



C2

CERTIFICATIONS & COMPLIANCE

- Intertek Sustainability Certified
- BIFMA level® Certified
- BIFMA Compliant® Certified
- TSCA Title VI (CARB) Compliance
- US Green Building's LEED® Contribution

STATEMENT OF LINE

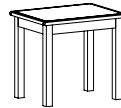

46-1824ET:
End Table
[\(See Details\)](#)

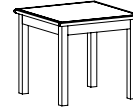

46-2424LT:
Lamp Table
[\(See Details\)](#)

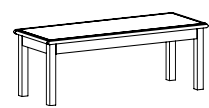

46-1847MT:
Magazine Table
[\(See Details\)](#)

Item	Model No.	W	D	H	Ship Wt	Cubic Ft	List Price	
END TABLE	46-1824ET	24	18	21 ¹³ / ₁₆	25	2.0	W/P\$	1357
							PV\$	1521

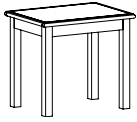

Description

- Available with Premium/Standard Veneer (PV/W) or HPL (P) Top; Must Specify
- Hardwood Legs
- Some Assembly Required

Must Specify (in this order):

- Model #
- Top Material
- Finish/Color

LAMP TABLE	46-2424LT	24	24	21 ¹³ / ₁₆	37	3.3	W/P\$	1728
							PV\$	1935

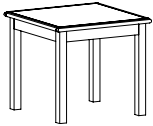

Description

- Available with Premium/Standard Veneer (PV/W) or HPL (P) Top; Must Specify
- Hardwood Legs
- Some Assembly Required

Must Specify (in this order):

- Model #
- Top Material
- Finish/Color

MAGAZINE TABLE	46-1847MT	47	18	16	42	3.4	W/P\$	1632
							PV\$	1828

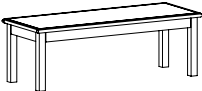

Description

- Available with Premium/Standard Veneer (PV/W) or HPL (P) Top; Must Specify
- Hardwood Legs
- Optional 30"H Legs
- Some Assembly Required

Must Specify (in this order):

- Model #
- Top Material
- Finish/Color
- Optional 30"H Leg

Options: Specify & Add

SH-46	Optional 30"H Legs	\$	223
-------	--------------------	----	-----



C2

P = HPL W = Veneer

[See Intro Overview For Ordering Options](#)

Discover the perfect table collection that goes anywhere. With a mix of materials, Jot complements a diverse range of interiors from ultra modern to classic. Its metal base, available in five refreshed colors, supports tops in solid surface, veneer, or laminate. Scaled for a perfect fit, Jot makes a great first impression front and center or corner-tucked for convenient storage. Jot's UV Advantage finish features a crystal clear topcoat developed for durability in high traffic areas.

CONSTRUCTION

- Veneer tops are ¾" thick with veneer edge bands; made of select grade, sliced Black Walnut, Cherry, Maple, or Composite species
- TFL tops are ¾" thick with a 1mm PVC edge band; Designer White, Sugar Maple, and Williamsburg Cherry feature ABS edge bands
- Solid surface tops are ¾" thick and are available in six colors and two edge profiles
- Bases are manufactured using ¾" steel frames and powder coated in your choice of five standard colors
- Joints on bases are mitered and fully welded for maximum strength and durability
- Tops are securely fastened to the bases with metal screws
- Ships fully assembled

HOW TO ORDER EXAMPLES

410-1412AT	Top Material	T
	Finish	TK
	Edge Detail (if applicable)	-
	Metal Base Color	ALUM

TFL (T) LAMINATE TABLE TOP OPTIONS

WOODGRAIN

AS	Asian Night	PNW	Pinnacle Walnut
BW	Beigewood	PTK	Portico Teak
CO	Columbian Walnut	RC	River Cherry
EF	Espresso	SCH	Select Cherry
FLW	Florence Walnut	SPW	Sepia Walnut
GC	Golden Cherry	SKC	Shaker Cherry
HVM	Harvest Maple	SBP	Smoky Brown Pear
KHE	Kirsche	TK	Studio Teak
MW	Mahogany Walnut	SM	Sugar Maple
MNR	Midnight Run	WTA	Weathered Ash
NTM	Natural Marrone	WC	Williamsburg Cherry
ORW	Oak Riftwood	WNB	White Nebbia

SOLID

BL	Black	FHG	Fashion Grey
WH	Designer White	SG	Slate Grey

VENEER (W) TABLE TOP OPTIONS

Tops feature UV Advantage, an ultra-violet finish, on all exposed surfaces by utilizing roll-coat UV technology.

AW	Artisan Walnut	MW	Mahogany Walnut
AS	Asian Night	MAS	Mesa Sunset
CO	Columbian Walnut	MTS	Metropolis Sky
DC	Dark Cherry	ORW	Oak Riftwood*
DFW	Dark Forest Walnut	PNW	Pinnacle Walnut
EF	Espresso	SCH	Select Cherry
FO	Fawn Oak*	SKC	Shaker Cherry
GC	Golden Cherry	SM	Sugar Maple
HW	Harvest Walnut	WTA	Weathered Ash*
HNW	Henna Walnut	WC	Williamsburg Cherry
LW	Legacy Walnut		

* Finish is Low Sheen

SOLID SURFACE (S) TABLE TOP OPTIONS

AR	Arroyo	SNW	Snow White
PE	Pebble Beach	SN	Starry Night
SE	Sedona	TN	Tundra

SOLID SURFACE EDGE PROFILE OPTIONS

S1	Straight
S2	Roman

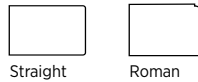

METAL BASE OPTIONS

ALUM	Aluminum	OYST	Oyster
BLK	Black	SUGC	Sugar Cookie
MIST	Mist		

CERTIFICATIONS & COMPLIANCE

- Intertek Sustainability Certified
- BIFMA level® Certified
- BIFMA Compliant® Certified
- TSCA Title VI (CARB) Compliance
- US Green Building's LEED® Contribution

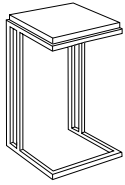

410-1412AT:
Auxiliary Table
[\(See Details\)](#)

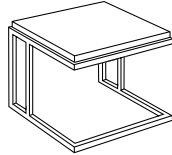

Square End Tables
410-1818ET: 18"
410-2424ET: 24"
[\(See Details\)](#)

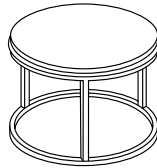

410-2020CT:
Circular End Table
[\(See Details\)](#)

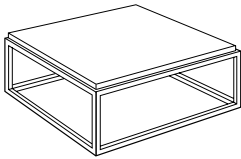

410-3636SQ:
Square Cocktail
Table
[\(See Details\)](#)

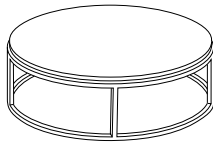

410-3636CT:
Circular Cocktail
Table
[\(See Details\)](#)

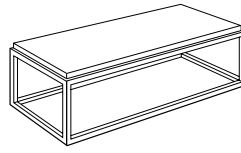

410-2248MT:
Rectangular Cocktail
Table
[\(See Details\)](#)

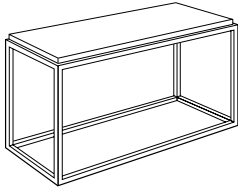

410-1848ST:
Console Table
[\(See Details\)](#)

Item	Model No.		W	D	H	Ship Wt	Cubic Ft	List Price
AUXILIARY TABLE	410-1412AT	TFL	12½	14	26½	46	8.6	T\$ 1299
		Veneer						W\$ 1459
		Solid Surface						S\$ 2369

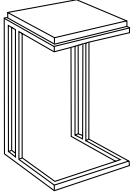

Must Specify (in this order):

Model #
Top Material
Finish/Color
Edge Profile (if applicable)
Base Color

Description

- Standard with: Decorative Metal Base and Nylon Glides
- Select Your Choice of TFL (T), Veneer (W), or Solid Surface (S) Top
- [See Top Options, Base Color Options and Specify](#)

Item	Model No.		W	D	H	Ship Wt	Cubic Ft	List Price
SQUARE END TABLE	410-2424ET	TFL	24	24	20	46	8.6	T\$ 1281
		Veneer						W\$ 1565
		Solid Surface						S\$ 2771
	410-1818ET	TFL	18	18	20	34	5.1	T\$ 1196
		Veneer						W\$ 1411
		Solid Surface						S\$ 2304

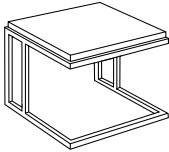

Must Specify (in this order):

Model #
Top Material
Finish/Color
Edge Profile (if applicable)
Base Color

Description

- Standard with: Decorative Metal Base and Nylon Glides
- Select Your Choice of TFL (T), Veneer (W), or Solid Surface (S) Top
- [See Top Options, Base Color Options and Specify](#)

Item	Model No.		W	D	H	Ship Wt	Cubic Ft	List Price
CIRCULAR END TABLE	410-2020CT	TFL	20	20	20	36	6.2	T\$ 1162
		Veneer						W\$ 1484
		Solid Surface						S\$ 4329

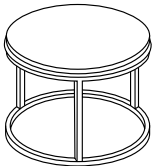

Must Specify (in this order):

Model #
Top Material
Finish/Color
Edge Profile (if applicable)
Base Color

Description

- Standard with: Decorative Metal Base and Adjustable Levelers
- Select Your Choice of TFL (T), Veneer (W), or Solid Surface (S) Top
- [See Top Options, Base Color Options and Specify](#)

Item	Model No.		W	D	H	Ship Wt	Cubic Ft	List Price
SQUARE COCKTAIL TABLE	410-3636SQ	TFL	36	36	15	68	13.4	T\$ 1535
		Veneer						W\$ 1857
		Solid Surface						S\$ 4594

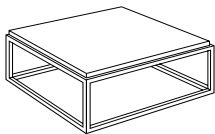

Must Specify (in this order):

Model #
Top Material
Finish/Color
Edge Profile (if applicable)
Base Color

Description

- Standard with: Decorative Metal Base and Nylon Glides
- Select Your Choice of TFL (T), Veneer (W), or Solid Surface (S) Top
- [See Top Options, Base Color Options and Specify](#)

T = TFL W = Veneer S = Solid Surface

[See Intro Overview For Ordering Options](#)

Item	Model No.		W	D	H	Ship Wt	Cubic Ft	List Price
RECTANGULAR COCKTAIL TABLE	410-2248MT	TFL	48	22	15	92	11.0	T\$ 1462
		Veneer						W\$ 1731
		Solid Surface						S\$ 3759

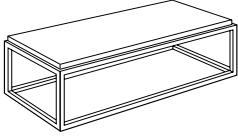

Must Specify (in this order):

Model #
Top Material
Finish/Color
Edge Profile (if applicable)
Base Color

Description

- Standard with: Decorative Metal Base and Nylon Glides
- Select Your Choice of TFL (T), Veneer (W), or Solid Surface (S) Top
- [See Top Options, Base Color Options and Specify](#)

CIRCULAR COCKTAIL TABLE	410-3636CT	TFL	36	36	15	68	13.4	T\$ 1451
		Veneer						W\$ 1844
		Solid Surface						S\$ 6617

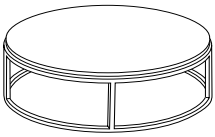

Must Specify (in this order):

Model #
Top Material
Finish/Color
Edge Profile (if applicable)
Base Color

Description

- Standard with: Decorative Metal Base and Adjustable Levelers
- Select Your Choice of TFL (T), Veneer (W), or Solid Surface (S) Top
- [See Top Options, Base Color Options and Specify](#)

CONSOLE TABLE	410-1848ST	TFL	48	18	28	86	17.4	T\$ 1573
		Veneer						W\$ 1871
		Solid Surface						S\$ 3562

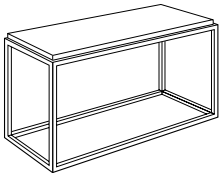

Must Specify (in this order):

Model #
Top Material
Finish/Color
Edge Profile (if applicable)
Base Color

Description

- Standard with: Decorative Metal Base and Adjustable Levelers
- Select Your Choice of TFL (T), Veneer (W), or Solid Surface (S) Top
- [See Top Options, Base Color Options and Specify](#)

T = TFL W = Veneer S = Solid Surface

[See Intro Overview For Ordering Options](#)

Create a variety of looks from refined transitional to clean contemporary with an abundance of finishes and edge details. Madera features ultra violet finish for long lasting beauty in corporate environments, as well as a premium veneer option, which offers a grade of veneer exceeding the general commercial market standards.

CONSTRUCTION

- Choose from premium veneer or select veneer on exposed surfaces in American Black Walnut, White Oak, Cherry, or Maple species
- Veneer tops are available in the 6 edge profiles and have a 5-ply balanced construction, 1 $\frac{3}{16}$ " thick, with hardwood rims
- High pressure laminate (HPL) tops have a 3-ply balanced construction, 1 $\frac{3}{16}$ " thick, with solid hardwood rims
- Grain direction runs left to right
- All units ship with heavy duty, adjustable leveling glides to ensure proper leveling and compensation for uneven floors
- Ships fully assembled

HOW TO ORDER EXAMPLE

Model No.	Description	Example
14-1824ET	Top Material	W
	Finish	AW
	Edge Profile	X

VENEER (W) AND PREMIUM VENEER (PV) OPTIONS

Veneer tops feature UVAdvantage, an ultra-violet finish, on all exposed surfaces by utilizing roll-coat UV technology.

AS	Asian Night	MW	Mahogany Walnut
AW	Artisan Walnut	MAS	Mesa Sunset
CO	Columbian Walnut	MTS	Metropolis Sky
DC	Dark Cherry	ORW	Oak Riftwood
DFW	Dark Forest Walnut	PNW	Pinnacle Walnut
EW	Espresso	SCH	Select Cherry
FO	Fawn Oak*	SKC	Shaker Cherry
GC	Golden Cherry	SM	Sugar Maple
HW	Harvest Walnut	WC	Williamsburg Cherry
HNW	Henna Walnut	WTA	Weathered Ash
LW	Legacy Walnut		

* Finish is Low Sheen

HPL (P) LAMINATE OPTIONS

AS	Asian Night	PNW	Pinnacle Walnut
CO	Columbian Walnut	SCH	Select Cherry
EF	Espresso	SKC	Shaker Cherry
GC	Golden Cherry	SM	Sugar Maple
MW	Mahogany Walnut	WC	Williamsburg Cherry
ORW	Oak Riftwood	WTA	Weathered Ash

TABLE EDGE PROFILE

B	Bevel	A	Radius
D	Bullnose	Y	Square
X	Fluted	E	Tri-Round



Bevel



Bullnose



Fluted



Radius



Square



Tri-Round

CERTIFICATIONS & COMPLIANCE

- Intertek Sustainability Certified
- BIFMA level® Certified
- BIFMA Compliant® Certified
- TSCA Title VI (CARB) Compliance
- US Green Building's LEED® Contribution

STATEMENT OF LINE

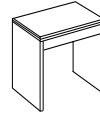

End Table:
14-1824ET
[\(See Details\)](#)

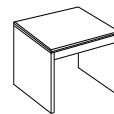

Lamp Table:
14-2828LT
[\(See Details\)](#)

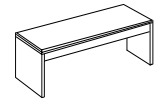

Magazine Table:
14-1847MT
[\(See Details\)](#)

Item	Model No.		W	D	H	Ship Wt	Cubic Ft	List Price	
END TABLE	14-1824ET	Veneer or HPL	24	18	21 $\frac{1}{16}$	48	7.6	W/P\$	1365
		Premium Veneer						PV\$	1599

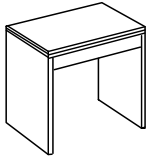

Description

- Standard with: Left to Right Grain Direction on Worksurface, Vertical Grain Direction on Solid End Panels
- Available in Premium Veneer (PV) or Standard Veneer (W); Must Specify
- Available with Veneer (PV/W) or HPL (P) Top; Must Specify
- Ships Assembled

Must Specify (in this order):

- Model
- Premium or Standard Veneer
- Chassis
- Top Material
- Finish/Color
- Edge Profile

LAMP TABLE	14-2828LT	Veneer or HPL	28	28	21 $\frac{1}{16}$	56	12.3	W/P\$	1768
		Premium Veneer						PV\$	2072

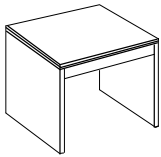

Description

- Standard with: Left to Right Grain Direction on Worksurface, Vertical Grain Direction on Solid End Panels
- Available in Premium Veneer (PV) or Standard Veneer (W); Must Specify
- Available with Veneer (PV/W) or HPL (P) Top; Must Specify
- Ships Assembled

Must Specify (in this order):

- Model
- Premium or Standard Veneer
- Chassis
- Top Material
- Finish/Color
- Edge Profile

MAGAZINE TABLE	14-1847MT	Veneer or HPL	47	18	15 $\frac{1}{16}$	75	9.9	W/P\$	1492
		Premium Veneer						PV\$	1747

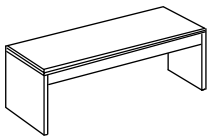

Description

- Standard with: Left to Right Grain Direction on Worksurface, Vertical Grain Direction on Solid End Panels
- Available in Premium Veneer (PV) or Standard Veneer (W); Must Specify
- Available with Veneer (PV/W) or HPL (P) Top; Must Specify
- Ships Assembled

Must Specify (in this order):

- Model #
- Top Material
- Finish/Color
- Edge Profile

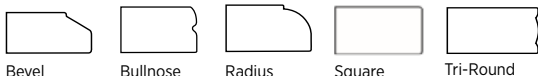

Bevel Bullnose Radius Square Tri-Round

P = HPL W = Veneer PV = Premium Veneer

See Intro Overview For Ordering Options

Natta offers an agile solution for a variety of community spaces and meeting applications. With its simplicity of form, it can achieve a subtle effect and still provide an excellent solution for any meeting and breakout environment.

CONSTRUCTION

- Exposed parts are manufactured using European Beech
- Joints are double-doweled or mortised and tenoned, screwed, and glued for maximum strength and durability
- Frames are individually hand assembled and sanded prior to being finished; Legs are 9¾"H on the rectangular table and 14"H on the square table
- Non-marring nylon glides included in each leg at floor level
- Tables have 1½" thick HPL surface with 1mm PVC edge band Square edge profile; Designer White, Sugar Maple, and Williamsburg Cherry feature ABS edge bands
- Ships fully assembled

HOW TO ORDER EXAMPLE

Model No.	Description	Example
MMIT-2	Leg Finish	BW
	Top Color	WH

HPL (P) LAMINATE OPTIONS ON TABLES TOPS

WOODGRAIN

AS	Asian Night	PNW	Pinnacle Walnut
BW	Beigewood	PTK	Portico Teak
CO	Columbian Walnut	RC	River Cherry
EF	Espresso	SCH	Select Cherry
FLW	Florence Walnut	SPW	Sepia Walnut
GC	Golden Cherry	SKC	Shaker Cherry
HVM	Harvest Maple	SBP	Smoky Brown Pear
KHE	Kirsche	TK	Studio Teak
MW	Mahogany Walnut	SM	Sugar Maple
MNR	Midnight Run	WTA	Weathered Ash
NTM	Natural Marrone	WNB	White Nebbia
ORW	Oak Riftwood	WC	Williamsburg Cherry

SOLID

BL	Black	FHG	Fashion Grey
WH	Designer White	SG	Slate Grey

WOOD FINISHES AVAILABLE ON LEGS

AW	Artisan Walnut	MAS	Mesa Sunset*
AS	Asian Night	MTS	Metropolis Sky
BW	Beigewood*	MNR	Midnight Run
BL	Black	NTM	Natural Marrone*
CO	Columbian Walnut	ORW	Oak Riftwood*
DC	Dark Cherry	PNW	Pinnacle Walnut
DFW	Dark Forest Walnut*	PTK	Portico Teak*
WH	Designer White	RC	River Cherry*
EF	Espresso	SCH	Select Cherry
FO	Fawn Oak*	SPW	Sepia Walnut*
FLW	Florence Walnut*	SKC	Shaker Cherry
GC	Golden Cherry	SBP	Smoky Brown Pear*
HW	Harvest Walnut	TK	Studio Teak
HNW	Henna Walnut	SM	Sugar Maple
KHE	Kirsche	WTA	Weathered Ash*
LW	Legacy Walnut	WNB	White Nebbia
MW	Mahogany Walnut	WC	Williamsburg Cherry

* Finish is Low Sheen

TABLE EDGE PROFILE



Square

CERTIFICATIONS & COMPLIANCE

- Intertek Sustainability Certified
- BIFMA level® Certified
- BIFMA Compliant® Certified
- TSCA Title VI (CARB) Compliance
- US Green Building's LEED® Contribution

STATEMENT OF LINE

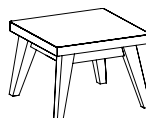

Square Table:
NAT-3
[\(See Details\)](#)

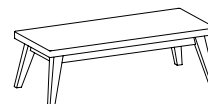

Rectangle Table:
NAT-2
[\(See Details\)](#)

Item	Model No.	W	D	H	Ship Wt	Cubic Ft	List Price
SQUARE TABLE	NAT-3	22	22	16	31	10.8	\$ 1013

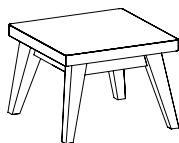

Description

- Features Square Edge Profile
- Available with Contrasting Top and Leg Color; [See Colors and Specify](#)

Must Specify (in this order):

Model #
Leg Finish
Top Color

RECTANGLE TABLE	NAT-4	51	22	16	66	25.9	\$ 1381
-----------------	-------	----	----	----	----	------	---------

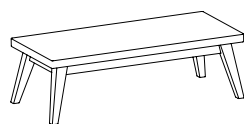

Description

- Features Square Edge Profile
- Available in Contrasting Surface and Leg Color; [See Colors and Specify](#)

Must Specify (in this order):

Model #
Leg Finish
Top Color

Crafted in American veneers, Phoenix's clean, transitional styling is at ease in both contemporary and traditional settings. It is a perfect choice for value-minded companies who want a sophisticated, yet uncomplicated, solution.

CONSTRUCTION

- Veneers on exposed surfaces are select grade sliced American Black Walnut and Cherry, and are carefully selected and matched to assure proper balance and consistency
- Veneer tops are 5-ply balanced construction and 1 $\frac{1}{32}$ " thick. High pressure laminate (HPL) tops are 3-ply balanced construction and 1 $\frac{1}{32}$ " thick
- Grain direction runs left to right
- All units ship with heavy duty, adjustable leveling glides to ensure proper leveling and compensation for uneven floors
- Some assembly required

HOW TO ORDER EXAMPLE

Model No.	Description	Example
21-1847MT	Top Material	P
	Finish	SKC

VENEER (W) OPTIONS

Veneer features UVAdvantage, an ultra-violet finish, on all exposed surfaces by utilizing roll-coat UV technology. Apron rails and table legs use a multi-step, hand finished process with a catalyzed finish.

AW	Artisan Walnut	LW	Legacy Walnut
CO	Columbian Walnut	MW	Mahogany Walnut
DC	Dark Cherry	MTS	Metropolis Sky
DFW	Dark Forest Walnut	PNW	Pinnacle Walnut
EW	Espresso	SCH	Select Cherry
GC	Golden Cherry	SKC	Shaker Cherry
HW	Harvest Walnut	WC	Williamsburg Cherry
HNW	Henna Walnut		

HPL (P) TOP OPTIONS

CO	Columbian Walnut	PNW	Pinnacle Walnut
EF	Espresso	SCH	Select Cherry
GC	Golden Cherry	SKC	Shaker Cherry
MW	Mahogany Walnut	WC	Williamsburg Cherry

TABLE EDGE PROFILE



Phoenix

CERTIFICATIONS & COMPLIANCE

- Intertek Sustainability Certified
- BIFMA level® Certified
- BIFMA Compliant® Certified
- TSCA Title VI (CARB) Compliance
- US Green Building's LEED® Contribution

STATEMENT OF LINE

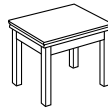

21-1824ET:
End Table
([See Details](#))

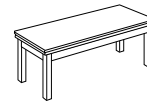

21-1847MT:
Magazine Table
([See Details](#))

Item	Model No.		W	D	H	Ship Wt	Cubic Ft	List Price
END TABLE	21-1824ET	HPL Veneer	18	24	22	25	2.0	P\$ 928 W\$ 980

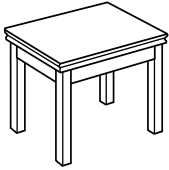

Description

- Available with Veneer (W) or HPL (P) Top, Must Specify
- Some Assembly Required

Must Specify (in this order):

Model #
Top Material
Finish/Color

MAGAZINE TABLE	21-1847MT	HPL Veneer	47	18	16	42	3.4	P\$ 1210 W\$ 980
----------------	-----------	---------------	----	----	----	----	-----	---------------------

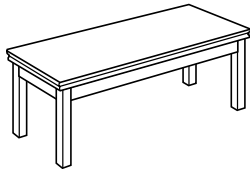

Description

- Available with Veneer (W) or HPL (P) Top, Must Specify
- Some Assembly Required
- Optional 30" Leg; See Below

Leg Option: Specify & Add

30H-2SQ	30"H Legs					20	0.9	\$ 223
---------	-----------	--	--	--	--	----	-----	--------

Must Specify (in this order):

Model #
Top Material
Finish/Color
Leg



Phoenix

P = HPL W = Veneer

[See Intro Overview For Ordering Options](#)

Plush Lounge seamlessly brings together the endurance needed for commercial spaces with the relaxed comforts of home. Introducing a smart range of freestanding and modular seating components, along with coordinating tables, that provide the flexibility and comfort needed in today's ever-changing environments.

CONSTRUCTION

- Exposed wood parts are kiln-dried hardwoods, selected from the highest grades of plain sliced hardwood veneers and are free of spirits, discoloration, pits, shakes, and wormholes
- Joints are mortised and tenoned, screwed, and glued for maximum strength and durability
- Maple Wood Legs are 2"Wx2½Dx6"H; Metal Legs are 2"Wx2"Dx6"H
- Non-marring adjustable nylon glides included at floor level
- Table tops are ¾" thick and feature a vertical square profiled edge



- Ships fully assembled

HOW TO ORDER EXAMPLES

TABLE

620-2445CT	Top Material	W
	Finish/Color	ORW
	Cabinet Accent	CAPPD
	Leg	PLALUM
	Leg Finish	-
	Power Location	C
	Power	01-DUOBEZELS

TABLE LEG OPTIONS

Plush cocktail table comes standard with Black or Aluminum Metal legs. Optional Wood Leg matches our Iconic Caseloads Collection. Must Specify Leg and Color.

PLBLK	Black Metal Leg	STD
PLALUM	Aluminum Metal Leg	STD
ICON	Wood Leg (<i>Matches the Iconic Collection</i>)	\$ 328

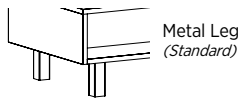

LEG WOOD FINISHES

Indiana Furniture uses a multi-step, hand finishing process on all exposed wood. Table legs feature a catalyzed varnish finish which offers durability, lasting beauty, and resistance to normal wear.

AW	Artisan Walnut	MAS	Mesa Sunset*
AS	Asian Night	MTS	Metropolis Sky
BW	Beigewood*	MNR	Midnight Run
BL	Black	NTM	Natural Marrone*
CO	Columbian Walnut	ORW	Oak Riftwood*
DC	Dark Cherry	PNW	Pinnacle Walnut
DFW	Dark Forest Walnut*	PTK	Portico Teak*
WH	Designer White	RC	River Cherry*
EF	Espresso	SCH	Select Cherry
FO	Fawn Oak*	SPW	Sepia Walnut*
FLW	Florence Walnut*	SKC	Shaker Cherry
GC	Golden Cherry	SBP	Smoky Brown Pear*
HVM	Harvest Maple	TK	Studio Teak
HW	Harvest Walnut	SM	Sugar Maple
HNW	Henna Walnut	WTA	Weathered Ash*
KHE	Kirsche	WNB	White Nebbia
LW	Legacy Walnut	WC	Williamsburg Cherry
MW	Mahogany Walnut		

*Finish is Low Sheen

VENEER TABLES WITH VENEER (W) OR HPL (P) TOP OPTIONS

Veneer tables feature UVAdvantage, an ultra-violet finish, on all exposed surfaces by utilizing roll-coat UV technology.

Veneer tables available with Veneer (W) or HPL (P) Top. Must specify Top Material and Finish Color. Tables are available with contrasting chassis and leg colors.

AW	Artisan Walnut	MW	Mahogany Walnut
AS	Asian Night^	MAS	Mesa Sunset*
CO	Columbian Walnut^	MTS	Metropolis Sky
DC	Dark Cherry	ORW	Oak Riftwood*^
DFW	Dark Forest Walnut	PNW	Pinnacle Walnut^
EF	Espresso^	SCH	Select Cherry
FO	Fawn Oak*	SKC	Shaker Cherry^
GC	Golden Cherry	SM	Sugar Maple^
HW	Harvest Walnut	WTA	Weathered Ash*^
HNW	Henna Walnut	WC	Williamsburg Cherry^
LW	Legacy Walnut		

*Finish is Low Sheen

^HPL Color Options with Veneer Tables

TFL TABLES WITH TFL (T) OR HPL (P) TOP OPTIONS

TFL tables available with TFL (T) or HPL (P) Top. Must specify Top Material and Color.

WOODGRAIN

AS	Asian Night	PNW	Pinnacle Walnut
BW	Beigewood	PTK	Portico Teak
CO	Columbian Walnut	RC	River Cherry
EF	Espresso	SCH	Select Cherry
FLW	Florence Walnut	SKC	Shaker Cherry
GC	Golden Cherry	SPW	Sepia Walnut
HVM	Harvest Maple	SBP	Smoky Brown Pear
KHE	Kirsche	TK	Studio Teak
MW	Mahogany Walnut	SM	Sugar Maple
MNR	Midnight Run	WTA	Weathered Ash
NTM	Natural Marrone	WNB	White Nebbia
ORW	Oak Riftwood	WC	Williamsburg Cherry

SOLID

BL	Black	WH	Designer White
----	-------	----	----------------

INTERIOR CABINET TABLE ACCENT HPL (P) OPTIONS

Select Veneer tables feature an optional interior HPL accent color. See specific veneer tables for details.

CABL	Black	CAFK	First Kiss
CABSH	Blush	CASG	Slate Grey
CAWH	Designer White	CASV	Summer Vacation
CAFHG	Fashion Grey	CASUS	Surfin USA

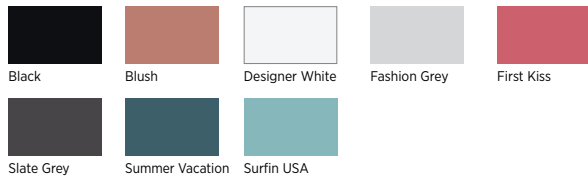

TABLE POWER OPTIONS

Power Options + Locations: Specify the grommet, power, and location.





Grommet	<i>Specify</i>		\$ 52
Black	GBR60		
Silver	GSR60		
D150 Wireless Charger			\$ 405
Wireless & Three (3) USB Ports			
Black	01-DOCK150B		
White	01-DOCK150W		
D950 Wireless & USB Charger			\$ 265
Wireless Charging			
Black	01-DOCK950B		
White	01-DOCK950W		
ECA Cove			\$ 975
One (1) Electrical Power and Two (2) USB Outlets			
Black	01-COVIUBL		
Silver	01-COVIUAL		

TABLE POWER OPTIONS CONTINUE



DUOBEZEL			\$ 675
Two (2) Power, One (1) USB, and One (1) USB-C Outlets			
Black	01-DUOBEZELB		
White	01-DUOBEZELS		
Silver	01-DUOBEZELW		
TRIOBEZEL			\$ 725
Three (3) Electrical Power, One (1) USB, One (1) USB-C Outlets, and One (1) Open Data Port			
Black	01-TRIOBEZELB		
White	01-TRIOBEZELS		
Silver	01-TRIOBEZELW		
<i>Open Port Options for TRIOBEZEL</i>			
VGA Data Port	01-LCOMVGA		\$ 121
HDMI Data Port (Open Market Only)	01-LCOMHDMI		\$ 166
RJ45 Data Port	01-LCOMRJ45		\$ 79
DPORT4			\$ 1093
Two (2) USB Outlets, and Two (2) Open Data Port			
Aluminum	01-DPORT4A		
Black	01-DPORT4B		
<i>Port Options for DPORTS</i>			
USB Port	01-USBPORT		\$ 161
Voice Coupler	01-VOICE1		\$ 73
Data Port	01-RJ4DATA		\$ 167

TABLE POWER LOCATIONS

NONE	None	LC	Left and Centered
C	Centered	RC	Right and Centered
R	Right	LR	Left and Right
L	Left	LCR	Left, Right and Centered

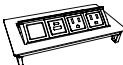
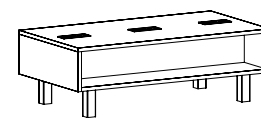

L/R: 6" from ends and 12" from front
C: 22 1/2" from ends and 12" from front

Cocktail Table Shown with Metal Leg and Three TRIOBEZEL on Left and Right and Center

All power options available in Left, Right and Center.

CERTIFICATIONS & COMPLIANCE

- CAL 117-2013 Compliance
- Intertek Sustainability Certified
- BIFMA level® Certified
- BIFMA Compliant® Certified
- TSCA Title VI (CARB) Compliance
- US Green Building's LEED® Contribution

Item	Model No.		W	D	H	Ship Wt	Cubic Ft	List Price	
 COCKTAIL TABLE	620-2445CT	Veneer/HPL	45	24	15	77	9.4	W/P\$	2169
		Veneer Chassis							
	620-2445CTT	TFL	45	24	15	77	9.4	T\$	1325
		TFL Chassis						P\$	1447

Shown with Metal Leg

Must Specify (in this order):

- Model #
- Top Material
- Finish/Color
- Cabinet Accent Color (Veneer Only)
- Leg
- Leg Finish/Color
- Power Location
- Power

Description

- Standard with: Metal Legs
- Chassis Available in Veneer (W) or TFL (T)
- Top Available with Veneer (W), TFL (T) or HPL (P), Must Specify
- Primary Finish and Wood Legs Available in Contrasting Finish Colors
- 9"D Cubby Area on Both Sides of the Table
- Optional Cabinet Interior Accent Color on Veneer Tables Only; Must Specify Color, [See Color Options](#)
- Optional Wood Leg ([See Color Options](#)) and Power ([See Power Options](#))

Veneer Table Cabinet Accent Option: Specify Color & Add

Interior Cabinet Table Accent Color	Available on Veneer Tables Only; See Color Options	\$	191
-------------------------------------	--	----	-----

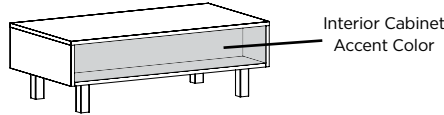

In partnership with Edge Design, a UK-based company, we welcome Spirit.

Spirit has a refined and inviting form, and capitalizes on versatility and comfort. Complete your waiting area, welcoming lobby, or office space with Spirit tables.

CONSTRUCTION

- Non-marring nylon glides included in each leg at floor level
- Tables have 1" TFL or 1½" HPL surface thickness with 1mm PVC edge band and Square edge profile; Designer White, Sugar Maple, and Williamsburg Cherry feature ABS edge bands
- Bases are comprised of bent wire frames or hardwood legs securely attached to a metal substructure.
- Black or Aluminum Powder Coat, and Chrome wireframes
- Ships fully assembled

HOW TO ORDER EXAMPLE

Model No.	Description	Example
ST11C	Top Color	WTA
	Base	STWFA

TFL (T) AND HPL (P) LAMINATE TABLE OPTIONS

WOODGRAIN

AS	Asian Night	PNW	Pinnacle Walnut
BW	Beigewood	PTK	Portico Teak
CO	Columbian Walnut	RC	River Cherry
EF	Espresso	SCH	Select Cherry
FLW	Florence Walnut	SPW	Sepia Walnut
GC	Golden Cherry	SKC	Shaker Cherry
HVM	Harvest Maple	SBP	Smoky Brown Pear
KHE	Kirsche	TK	Studio Teak
MW	Mahogany Walnut	SM	Sugar Maple
MNR	Midnight Run	WTA	Weathered Ash
NTM	Natural Marrone	WNB	White Nebbia
ORW	Oak Riftwood	WC	Williamsburg Cherry

SOLID

BL	Black	FHG	Fashion Grey
WH	Designer White	SG	Slate Grey

TABLE BASE OPTIONS

Not all bases are available on each model. Check availability on pricing pages.

STWFA	Wireframe, Aluminum	N/C
STWFB	Wireframe, Black	N/C
STWFC	Wireframe, Chrome	\$ 59
SLBO	4-Star Wood Base, Blonde Oak	N/C
SLSPW	4-Star Wood Base, Spiced Walnut	N/C

TABLE EDGE PROFILE



Square

CERTIFICATIONS & COMPLIANCE

- Intertek Sustainability Certified
- BIFMA level® Certified
- BIFMA Compliant® Certified
- TSCA Title VI (CARB) Compliance
- US Green Building's LEED® Contribution

STATEMENT OF LINE



Spirit Square Table

ST11C: TFL
ST11CH: HPL
[\(See Details\)](#)

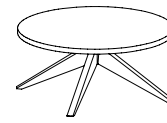

Spirit Round Table

SLT-1W: TFL
SLT-1WH: HPL
[\(See Details\)](#)

Item	Model No.		W	D	H	Ship Wt	Cubic Ft	List Price	
SPIRIT SQUARE TABLE	ST11C	TFL	27	27	17	31	11.4	T\$	850
	ST11CH	HPL	27	27	17	31	11.4	P\$	1026

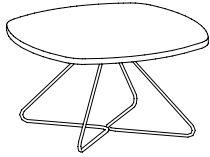

Must Specify (in this order):

- Model #
- Top Color
- Base Color

Description

- Standard with: 1" TFL Top or 1½" HPL Top and Wireframe Base; Must Specify Color
- Features Square Edge Profile

Leg Option: Specify & Add

STWFA	Wireframe, Aluminum	N/C
STWFB	Wireframe, Black	N/C
STWFC	Wireframe, Chrome	\$ 59

SPIRIT ROUND TABLE	SLT-1W	TFL	31½	31½	14½	31	11.4	T\$	1498
	SLT-1WH	HPL	31½	31½	14½	31	11.4	P\$	1660

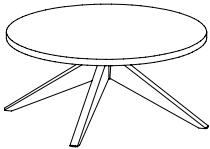

Must Specify (in this order):

- Model #
- Top Color
- Base Color

Description

- Standard with: 1" TFL Top or 1½" HPL Top and 4-Star Swivel Wood Base (Select Blonde Oak or Spiced Walnut)
- Features Square Edge Profile



Square

T = TFL P = HPL

[See Intro Overview For Ordering Options](#)

PLEDGE

Space Division

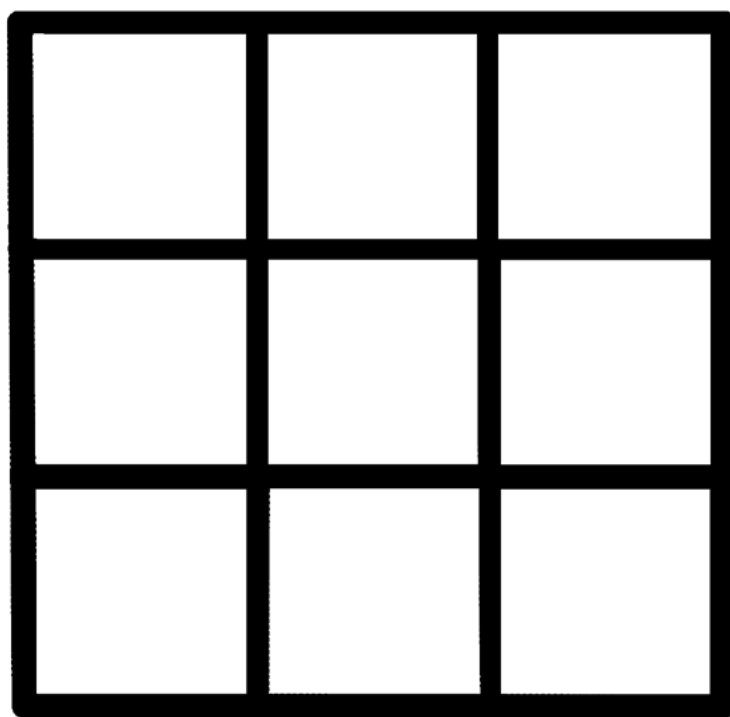

Our functional range of screens and dividers make it easy to create space division within any environment, on nearly any product. Simply add screens to your worksurface, training table, and/or reception desk to create privacy, add protection, or further define personal space.

CONSTRUCTION

- ACRYLIC PANELS/SCREENS/DIVIDERS**
- Clear and Frosted Acrylics are ¼” thick, while High Gloss Acrylics are ¾” thick; cut to size and machined for a clean finish
- TFL PANELS/SCREENS/DIVIDERS**
- Made of woodgrain and solid color laminates fused to particle-board core
 - Privacy Panels and Above/Below Screens are ¾” thick
 - Gallery Screens are 1” thick
 - Each laminate offers lasting beauty, superior resistance to normal wear, and easy maintenance
- VENEER PANELS/SCREENS/DIVIDERS**
- Made of select-grade, plain sliced hardwood Cherry, Maple, American Black Walnut, White Oak, or composite veneers; selected and matched to assure proper balance and consistency
 - Privacy Panels and Above/Below Screens are ¾” thick
 - Gallery Screens are 1” thick
 - Veneers feature Indiana Furniture’s sustainable UVAdvantage, an ultra-violet topcoat finish, on all exposed surfaces by utilizing roll-coat UV technology
- WIRE MANAGEMENT**
- Grommets may be specified for 51”H Straight Floorstanding Gallery Screens, and are available in black or silver

CERTIFICATIONS & COMPLIANCE

- CAL 117-2013 Compliance
- Intertek Sustainability Certified
- BIFMA level® Certified
- BIFMA Compliant Certified
- TSCA Title VI (CARB) Compliance
- Contributes to LEED®, Green Globes®, and WELL® Sustainable Programs

HOW TO ORDER EXAMPLES

SCREEN	QTY	MODEL NO.	DESCRIPTION	EXAMPLE
DIVIDER	2	01-4224SDCA		
ABOVE & BELOW	QTY	MODEL NO.	DESCRIPTION	EXAMPLE
	1	01-6235ABA	Hardware	ALUM
PRIVACY PANEL	QTY	MODEL NO.	DESCRIPTION	EXAMPLE
	4	01-5624PPA	Hardware	CHRM
GALLERY SCREEN	QTY	MODEL NO.	DESCRIPTION	EXAMPLE
	4	65-5173GS	Finish	WTA
			Grommet	DGL, BL
			Grommet	DGR, BL
			Grommet	DGC, BL

SUPPORT BLOCKS/ATTACHMENT HARDWARE COLOR OPTIONS

- ALUM Aluminum
CHRM Chrome

TFL (T) LAMINATE OPTIONS

WOODGRAIN

AS Asian Night	PNW Pinnacle Walnut
BW Beigewood	PTK Portico Teak
CO Columbian Walnut	RC River Cherry
EF Espresso	SCH Select Cherry
FLW Florence Walnut	SPW Sepia Walnut
GC Golden Cherry	SKC Shaker Cherry
HVM Harvest Maple	SBP Smoky Brown Pear
KHE Kirsche	TK Studio Teak
MW Mahogany Walnut	SM Sugar Maple
MNR Midnight Run	WTA Weathered Ash
NTM Natural Marrone	WC Williamsburg Cherry
ORW Oak Riftwood	WNB White Nebbia

SOLID

BL Black	FHG Fashion Grey
WH Designer White	SG Slate Grey

VENEER (W) OPTIONS

AW Artisan Walnut	MW Mahogany Walnut
AS Asian Night	MAS Mesa Sunset*
CO Columbian Walnut	MTS Metropolis Sky
DC Dark Cherry	PNW Pinnacle Walnut
DFW Dark Forest Walnut	ORW Oak Riftwood*
EW Espresso	SCH Select Cherry
FO Fawn Oak*	SKC Shaker Cherry
GC Golden Cherry	SM Sugar Maple
HW Harvest Walnut	WTA Weathered Ash*
HNW Henna Walnut	WC Williamsburg Cherry
LW Legacy Walnut	

* Finish is Low Sheen

HIGH GLOSS ACRYLIC OPTIONS

- BLA Black High Gloss Acrylic
GPA Graphite High Gloss Acrylic (upcharge)
WHA White High Gloss Acrylic

GALLERY SCREEN GROMMET OPTIONS & LOCATIONS

Multiple grommets may be ordered for each screen.
Must Specify Model and Color: Black (BLK) or Silver (SLV).

51”H Gallery Screens

DGL Desk Height Left; 6” from end, 5¼” from bottom	\$ 52
DGR Desk Height Right; 6” from end, 25¼” from bottom	\$ 52
DGC Desk Height Center; 25¼” from bottom	\$ 52
BGL Bench Height Left; 6” from end, 15” from bottom	\$ 52
BGR Bench Height Right; 6” from end, 15” from bottom	\$ 52
BGC Bench Height Center; 15” from bottom	\$ 52

Grommets may be ordered in non-standard locations. Call Customer Service to assist with specification. Note additional charges and lead times may apply.

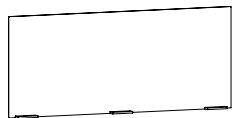

24" H Privacy Panels
Available in Clear and Frosted Acrylic
[\(See Details\)](#)



12" H Privacy Panels
Available in Frosted and High Gloss Acrylic, TFL, and Veneer
[\(See Details\)](#)

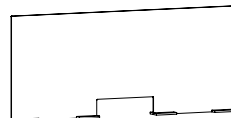

24" H Privacy Panels with Transaction Slot
Available in Clear Acrylic
[\(See Details\)](#)



24" H Screen Dividers
Available in Clear and Frosted Acrylic
[\(See Details\)](#)

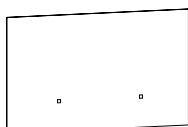

33" H Above & Below Screens
Available in Frosted Acrylic
[\(See Details\)](#)

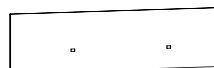

21" H Above & Below Screen
Available in Frosted and High Gloss Acrylic, TFL, and Veneer
[\(See Details\)](#)



20" H Above & Below Screens
Available in Frosted and High Gloss Acrylic, Tackboard, TFL, and Veneer
[\(See Details\)](#)



17" H Above & Below Screens
Available in Frosted and High Gloss Acrylic, Tackboard, TFL, and Veneer
[\(See Details\)](#)



2-Way & 3-Way Connector Clips
Corner, T, and Straight Connectors for Clear and Frosted Acrylic Options
[\(See Details\)](#)

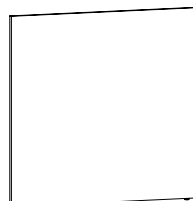

51" H Straight Gallery Screens
Available in TFL and Veneer
[\(See Details\)](#)

SCREENS+DIVIDERS

IDEA STARTERS

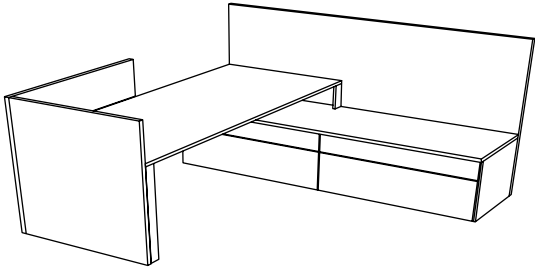
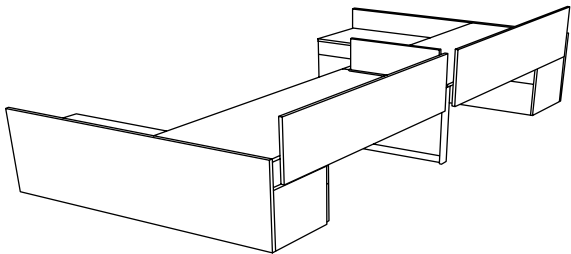
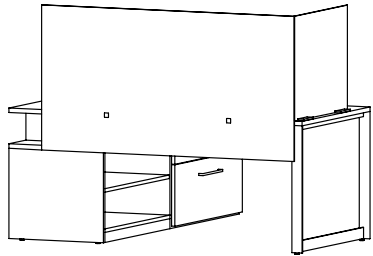
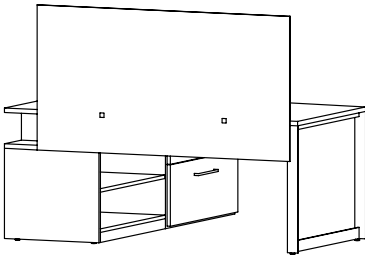
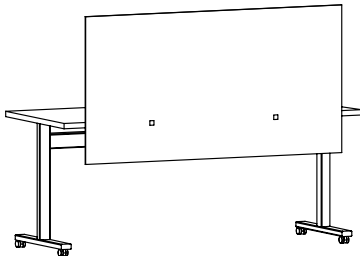
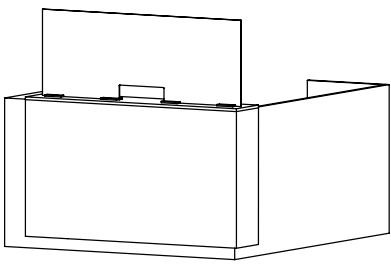
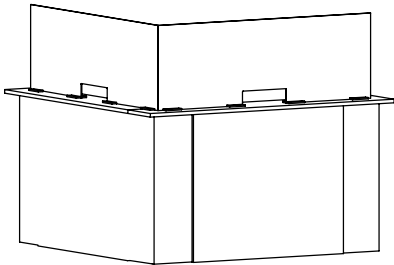
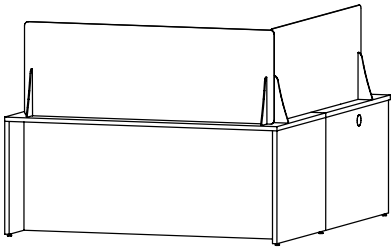
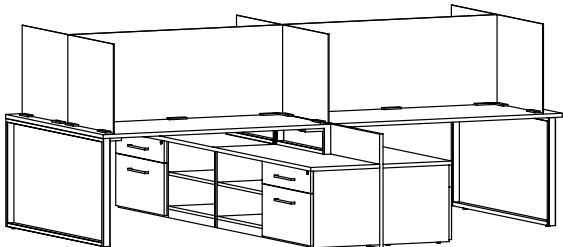

Item	Model No.		W	D	H	Ship Wt	Cubic Ft	List Price
24"H PRIVACY PANELS 	01-6224PPCA	Clear	62	¼	23½	13.9	2.1	C\$ 1162
	01-6224PPA	Frosted						F\$ 1457
	01-5624PPCA	Clear	56	¼	23½	11.5	1.9	C\$ 1088
	01-5624PPA	Frosted						F\$ 1359
	01-2824PPCA	Clear	28	¼	23½	5.8	1.4	C\$ 686
	01-2824PPA	Frosted						F\$ 831
	01-2224PPCA	Clear	22	¼	23½	4.8	1.2	C\$ 614
	01-2224PPA	Frosted						F\$ 733

Description

- Sets on Surface; Comes with Non-Marring, Removable Adhesive Strip for Surface Attachment
- Available in Clear or Frosted Acrylic
- Acrylic Connector Clips are Recommended for Support on 90° Corner, T Shaped and Straight Applications, [See Connector Clip Details](#)
- Decorative Support Blocks; Must Specify: Aluminum (ALUM) or Chrome (CHRM)
- Some Assembly Required

Item	Model No.		W	D	H	Ship Wt	Cubic Ft	List Price
12"H PRIVACY PANELS 	66-6812PPA	Frosted	68	¼	12	8	2.2	F\$ 982
	66-6812PPGA	High Gloss	68	¾	12	25	2.3	HG\$ 1051
	66-6812PPGA	High Gloss Graphite	68	¾	12	25	2.3	GR\$ 1233
	66-6812PP	TFL	68	¾	12	26	2.2	T\$ 430
	65-6812PP	Veneer	68	¾	12	26	2.2	W\$ 761
	66-6212PPA	Frosted	62	¼	12	7	2.0	F\$ 925
	66-6212PPGA	High Gloss	62	¾	12	23	2.1	HG\$ 979
	66-6212PPGA	High Gloss Graphite	62	¾	12	23	2.1	GR\$ 1154
	66-6212PP	TFL	62	¾	12	25	2.0	T\$ 419
	65-6212PP	Veneer	62	¾	12	25	2.0	W\$ 745
	66-5612PPA	Frosted	56	¼	12	6	1.8	F\$ 854
	66-5612PPGA	High Gloss	56	¾	12	22	1.9	HG\$ 886
	66-5612PPGA	High Gloss Graphite	56	¾	12	22	1.9	GR\$ 1073
	66-5612PP	TFL	56	¾	12	23	1.8	T\$ 408
	65-5612PP	Veneer	56	¾	12	23	1.8	W\$ 723
	66-2812PPA	Frosted	28	¼	12	8	0.7	F\$ 580
	66-2812PPGA	High Gloss	28	¾	12	13	0.9	HG\$ 609
	66-2812PPGA	High Gloss Graphite	28	¾	12	13	0.9	GR\$ 686
	66-2812PP	TFL	28	¾	12	12	0.9	T\$ 355
	65-2812PP	Veneer	28	¾	12	12	0.9	W\$ 626
	66-2212PPA	Frosted	22	¼	12	7	0.6	F\$ 523
	66-2212PPGA	High Gloss	22	¾	12	11	0.7	HG\$ 546
	66-2212PPGA	High Gloss Graphite	22	¾	12	11	0.7	GR\$ 605
	66-2212PP	TFL	22	¾	12	10	0.7	T\$ 345
	65-2212PP	Veneer	22	¾	12	10	0.7	W\$ 612

Description

- Sets on Surface
- Available in Frosted or High Gloss Acrylic, TFL, or Veneer; Must Specify; See [TFL Colors](#) or [Veneer Finish](#), and See [High Gloss Acrylic Colors](#)
- Decorative Support Blocks; Must Specify: Aluminum (ALUM) or Chrome (CHRM)
- Some Assembly Required

Pricing Codes: C=Clear F=Frosted HG=High Gloss GR=High Gloss Graphite T=TFL W=Veneer

[For ordering options, see overview at the beginning of section.](#)

SCREENS+DIVIDERS
MULTI-USE SPACE DIVISION

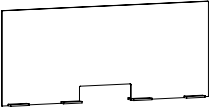
Item	Model No.		W	D	H	Ship Wt	Cubic Ft	List Price
24"H PRIVACY PANELS WITH TRANSACTION SLOT 	01-6224PPSCA	Clear	62	¼	23½	13.9	2.1	\$ 1229
	01-5624PPSCA	Clear	56	¼	23½	11.5	1.9	\$ 1154
	01-5024PPSCA	Clear	50	¼	23½	9.1	1.7	\$ 949
	01-4424PPSCA	Clear	44	¼	23½	6.7	1.5	\$ 877
	01-3824PPSCA	Clear	38	¼	23½	4.3	1.2	\$ 806

Description

- Sets on Surface; Comes with Non-Marring Adhesive Strip for Additional Surface Attachment
- Available in Clear Acrylic
- Decorative Support Blocks; Must Specify: Aluminum (ALUM) or Chrome (CHRM)
- Transaction Slot (14"Wx4"H) Always Centered On Panel Along Bottom Edge
- Some Assembly Required

Item	Model No.		W	D	H	Ship Wt	Cubic Ft	List Price
24"H SCREEN DIVIDERS 	01-6624SDCA	Clear	66	¼	23½	11.8	4.7	C\$ 1172
	01-6624SDA	Frosted						F\$ 1424
	01-6024SDCA	Clear	60	¼	23½	10.8	4.2	C\$ 1095
	01-6024SDA	Frosted						F\$ 1327
	01-5424SDCA	Clear	54	¼	23½	9.8	3.7	C\$ 1018
	01-5424SDA	Frosted						F\$ 1228
	01-4824SDCA	Clear	48	¼	23½	8.8	3.2	C\$ 939
	01-4824SDA	Frosted						F\$ 1126
	01-4224SDCA	Clear	42	¼	23½	7.8	2.7	C\$ 864
	01-4224SDA	Frosted						F\$ 1026
	01-3624SDCA	Clear	36	¼	23½	6.8	2.2	C\$ 762
	01-3624SDA	Frosted						F\$ 895
	01-3024SDCA	Clear	30	¼	23½	5.8	1.7	C\$ 709
	01-3024SDA	Frosted						F\$ 830
	01-2424SDCA	Clear	24	¼	23½	4.8	1.2	C\$ 598
	01-2424SDA	Frosted						F\$ 732

Description

- Freestanding on Surface
- Available in Clear and Frosted Acrylic
- Supports Constructed of Acrylic; Will Match Screen
- Some Assembly Required

Pricing Codes: C=Clear F= Frosted

[For ordering options, see overview at the beginning of section.](#)

Item	Model No.		W	D	H	Ship Wt	Cubic Ft	List Price
33"H ABOVE AND BELOW SCREENS	01-6233ABA	Frosted	62	¼	33	13	3.5	\$ 1792
	01-5633ABA	Frosted	56	¼	33	12	2.9	\$ 1658
	01-5033ABA	Frosted	50	¼	33	11	2.3	\$ 1524
	01-4433ABA	Frosted	44	¼	33	10	1.7	\$ 1389

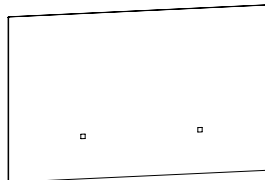
**Description**

- Mounts to Surface
- Available in Frosted Acrylic
- Provides Privacy 24" Above Surface and Modesty 8" Below Surface
- Decorative Attachment Hardware; Must Specify: Aluminum (ALUM) or Chrome (CHRM)

Item	Model No.		W	D	H	Ship Wt	Cubic Ft	List Price
21"H ABOVE AND BELOW SCREENS	66-6821ABA	Frosted	68	¼	21	14	3.3	F\$ 1352
	66-6821ABGA	High Gloss	68	¾	21	44	3.3	HG\$ 1447
	66-6821ABGA	High Gloss Graphite	68	¾	21	44	3.3	GR\$ 1886
	66-6821AB	TFL	68	¾	21	41	3.3	T\$ 471
	65-6821AB	Veneer	68	¾	21	41	3.3	W\$ 840
	66-6221ABA	Frosted	62	¼	21	12	2.8	F\$ 1265
	66-6221ABGA	High Gloss	62	¾	21	41	3	HG\$ 1344
	66-6221ABGA	High Gloss Graphite	62	¾	21	41	3	GR\$ 1747
	66-6221AB	TFL	62	¾	21	39	3	T\$ 459
	65-6221AB	Veneer	62	¾	21	39	3	W\$ 814
	66-5621ABA	Frosted	56	¼	21	10	2.6	F\$ 1177
	66-5621ABGA	High Gloss	56	¾	21	38	2.7	HG\$ 1246
	66-5621ABGA	High Gloss Graphite	56	¾	21	38	2.7	GR\$ 1606
	66-5621AB	TFL	56	¾	21	36	2.7	T\$ 441
	65-5621AB	Veneer	56	¾	21	36	2.7	W\$ 782
	66-5021ABA	Frosted	50	¼	21	9	2.2	F\$ 1088
	66-5021ABGA	High Gloss	50	¾	21	36	2.4	HG\$ 1147
	66-5021ABGA	High Gloss Graphite	50	¾	21	36	2.4	GR\$ 1470
	66-5021AB	TFL	50	¾	21	34	2.4	T\$ 425
	65-5021AB	Veneer	50	¾	21	34	2.4	W\$ 755
	66-4421ABA	Frosted	44	¼	21	8	1.2	F\$ 998
	66-4421ABGA	High Gloss	44	¾	21	33	2.2	HG\$ 1051
	66-4421ABGA	High Gloss Graphite	44	¾	21	33	2.2	GR\$ 1333
	66-4421AB	TFL	44	¾	21	31	2.2	T\$ 408
	65-4421AB	Veneer	44	¾	21	31	2.2	W\$ 723

**Description**

- Mounts to Surface
- Available in Frosted or High Gloss Acrylic, TFL, or Veneer; Must Specify; See [TFL Colors](#) or [Veneer Finish](#), and See [High Gloss Acrylic Colors](#)
- Provides Privacy 12" Above Surface and Modesty 8" Below Surface
- Decorative Attachment Hardware on Frosted Acrylic; Must Specify: Aluminum (ALUM) or Chrome (CHRM)

Pricing Codes: F= Frosted HG= High Gloss GR= High Gloss Graphite T = TFL W = Veneer

[For ordering options, see overview at the beginning of section.](#)

SCREENS+DIVIDERS

MULTI-USE SPACE DIVISION

Item	Model No.		W	D	H	Ship Wt	Cubic Ft	List Price
20"H ABOVE AND BELOW SCREENS 	PS-5720FA	Frosted	57	¼	20	20	2.2	F\$ 1163
	PS-5720HGA	High Gloss	57	¾	20	36	2.7	HG\$ 1230
	PS-5720HGA	High Gloss Graphite	57	¾	20	36	2.7	GR\$ 1586
	PS-5720TB	Tackboard	57	⅝	20	14	2.2	U\$ see below
	66-5720PS	TFL	57	¾	20	36	2.7	T\$ 438
	65-5720PS	Veneer	57	¾	20	36	2.7	W\$ 768
	PS-5120FA	Frosted	51	¼	20	19	2.1	F\$ 1075
	PS-5120HGA	High Gloss	51	¾	20	34	2.5	HG\$ 1131
	PS-5120HGA	High Gloss Graphite	51	¾	20	34	2.5	GR\$ 1451
	PS-5120TB	Tackboard	51	⅝	20	13	2.2	U\$ see below
	66-5120PS	TFL	51	¾	20	34	2.5	T\$ 420
	65-5120PS	Veneer	51	¾	20	34	2.5	W\$ 742
	PS-4520FA	Frosted	45	¼	20	19	2.0	F\$ 988
	PS-4520HGA	High Gloss	45	¾	20	32	2.3	HG\$ 1032
	PS-4520HGA	High Gloss Graphite	45	¾	20	32	2.3	GR\$ 1313
	PS-4520TB	Tackboard	45	⅝	20	12	2.0	U\$ see below
	66-4520PS	TFL	45	¾	20	32	2.3	T\$ 405
	65-4520PS	Veneer	45	¾	20	32	2.3	W\$ 714
	PS-4120FA	Frosted	41	¼	20	18	1.9	F\$ 951
	PS-4120HGA	High Gloss	41	¾	20	30	2.2	HG\$ 990
PS-4120HGA	High Gloss Graphite	41	¾	20	30	2.2	GR\$ 1261	
PS-4120TB	Tackboard	41	⅝	20	12	1.8	U\$ see below	
66-4120PS	TFL	41	¾	20	30	2.2	T\$ 389	
65-4120PS	Veneer	41	¾	20	30	2.2	W\$ 687	
PS-3920FA	Frosted	39	¼	20	18	1.8	F\$ 918	
PS-3920HGA	High Gloss	39	¾	20	29	2.2	HG\$ 960	
PS-3920HGA	High Gloss Graphite	39	¾	20	29	2.2	GR\$ 1219	
PS-3920TB	Tackboard	39	⅝	20	11	1.8	U\$ see below	
66-3920PS	TFL	39	¾	20	29	2.2	T\$ 375	
65-3920PS	Veneer	39	¾	20	29	2.2	W\$ 662	
PS-3520FA	Frosted	35	¼	20	17	1.7	F\$ 881	
PS-3520HGA	High Gloss	35	¾	20	29	2.2	HG\$ 922	
PS-3520HGA	High Gloss Graphite	35	¾	20	29	2.2	GR\$ 1174	
PS-3520TB	Tackboard	35	⅝	20	11	1.5	U\$ see below	
66-3520PS	TFL	35	¾	20	28	2.1	T\$ 362	
65-3520PS	Veneer	35	¾	20	28	2.1	W\$ 638	
PS-3320FA	Frosted	33	¼	20	17	1.6	F\$ 849	
PS-3320HGA	High Gloss	33	¾	20	27	2.1	HG\$ 889	
PS-3320HGA	High Gloss Graphite	33	¾	20	27	2.1	GR\$ 1133	
PS-3320TB	Tackboard	33	⅝	20	10	1.5	U\$ see below	
66-3320PS	TFL	33	¾	20	27	2.1	T\$ 348	
65-3320PS	Veneer	33	¾	20	27	2.1	W\$ 614	
PS-2920FA	Frosted	29	¼	20	16	1.5	F\$ 814	
PS-2920HGA	High Gloss	29	¾	20	26	1.9	HG\$ 851	
PS-2920HGA	High Gloss Graphite	29	¾	20	26	1.9	GR\$ 1087	
PS-2920TB	Tackboard	29	⅝	20	10	1.5	U\$ see below	
66-2920PS	TFL	29	¾	20	26	1.9	T\$ 335	
65-2920PS	Veneer	29	¾	20	26	1.9	W\$ 589	

Description

- Mounts to Surface; Provides Privacy 12" Above Surface and Modesty 7" Below Surface
- Available in Frosted or High Gloss Acrylic, Tackboard, TFL, or Veneer; Must Specify; See [TFL Colors](#) or [Veneer Finish](#), See [High Gloss Acrylic Colors](#), For Upholstery, See Below
- Decorative Hardware on Frosted Acrylic & Tackboards; Must Specify: Aluminum (ALUM) or Chrome (CHRM)
- Great option for Canvas and Gesso Modular Height-Adjustable units

Tackboards - Must Specify: Model# & Fabric/Grade

Model	Ydg	COM/Grades 1, 2, 3	Grade 4	Grade 5	Grade 6	Grade 7	Grade 8	Grade 9	Grade 10
PS-5720TB	2.00	\$ 623	\$ 901	\$ 1031	\$ 1163	\$ 1351	\$ 1547	\$ 1775	\$ 2039
PS-5120TB	2.00	\$ 578	\$ 856	\$ 986	\$ 1118	\$ 1306	\$ 1502	\$ 1730	\$ 1994
PS-4520TB	1.75	\$ 513	\$ 756	\$ 870	\$ 986	\$ 1150	\$ 1322	\$ 1521	\$ 1752
PS-4120TB	1.50	\$ 473	\$ 682	\$ 779	\$ 878	\$ 1019	\$ 1166	\$ 1337	\$ 1535
PS-3920TB	1.50	\$ 459	\$ 668	\$ 765	\$ 864	\$ 1005	\$ 1152	\$ 1323	\$ 1521
PS-3520TB	1.50	\$ 443	\$ 652	\$ 749	\$ 848	\$ 989	\$ 1136	\$ 1307	\$ 1505
PS-3320TB	1.25	\$ 404	\$ 578	\$ 659	\$ 742	\$ 859	\$ 982	\$ 1124	\$ 1289
PS-2920TB	1.25	\$ 383	\$ 557	\$ 638	\$ 721	\$ 838	\$ 961	\$ 1103	\$ 1268

For ordering options, see overview at the beginning of section.

SCREENS+DIVIDERS

MULTI-USE SPACE DIVISION

Item	Model No.		W	D	H	Ship Wt	Cubic Ft	List Price
17"H ABOVE AND BELOW SCREENS 	PS-6817FA	Frosted	68	¼	17	14	3.3	F\$ 1196
	PS-6817HGA	High Gloss	68	¾	17	24	3.3	HG\$ 1260
	PS-6817HGA	High Gloss Graphite	68	¾	17	24	3.3	GR\$ 1627
	PS-6817TB	Tackboard	68	⅝	17	15	2.5	U\$ see below
	66-6817PS	TFL	68	¾	17	24	3.3	T\$ 450
	65-6817PS	Veneer	68	¾	17	24	3.3	W\$ 791
	PS-6217FA	Frosted	62	¼	17	14	3.1	F\$ 1160
	PS-6217HGA	High Gloss	62	¾	17	22	3.1	HG\$ 1223
	PS-6217HGA	High Gloss Graphite	62	¾	17	22	3.1	GR\$ 1579
	PS-6217TB	Tackboard	62	⅝	17	14	2.5	U\$ see below
	66-6217PS	TFL	62	¾	17	22	3.1	T\$ 437
	65-6217PS	Veneer	62	¾	17	22	3.1	W\$ 767
	PS-5617FA	Frosted	56	¼	17	13	2.9	F\$ 1121
	PS-5617HGA	High Gloss	56	¾	17	20	2.7	HG\$ 1180
	PS-5617HGA	High Gloss Graphite	56	¾	17	20	2.7	GR\$ 1521
	PS-5617TB	Tackboard	56	⅝	17	13	2.2	U\$ see below
	66-5617PS	TFL	56	¾	17	20	2.7	T\$ 419
	65-5617PS	Veneer	56	¾	17	20	2.7	W\$ 741
	PS-5017FA	Frosted	50	¼	17	13	2.7	F\$ 1036
	PS-5017HGA	High Gloss	50	¾	17	18	2.5	HG\$ 1088
	PS-5017HGA	High Gloss Graphite	50	¾	17	18	2.5	GR\$ 1395
	PS-5017TB	Tackboard	50	⅝	17	12	2.0	U\$ see below
	66-5017PS	TFL	50	¾	17	18	2.5	T\$ 405
	65-5017PS	Veneer	50	¾	17	18	2.5	W\$ 714
	PS-4417FA	Frosted	44	¼	17	12	2.5	F\$ 954
	PS-4417HGA	High Gloss	44	¾	17	16	2.3	HG\$ 995
	PS-4417HGA	High Gloss Graphite	44	¾	17	16	2.3	GR\$ 1267
	PS-4417TB	Tackboard	44	⅝	17	11	1.8	U\$ see below
66-4417PS	TFL	44	¾	17	16	2.3	T\$ 390	
65-4417PS	Veneer	44	¾	17	16	2.3	W\$ 690	

Description

- Mounts to Surface
- Decorative Attachment Hardware on Frosted Acrylic & Tackboards; Must Specify: Aluminum (ALUM) or Chrome (CHRM)
- Available in Frosted or High Gloss Acrylic, Tackboard, TFL, or Veneer; Must Specify; See [TFL Colors](#) or [Veneer Finish](#), See [High Gloss Acrylic Colors](#), For Upholstery, See Below
- Provides Privacy 12" Above Surface and Modesty 4" Below Surface
- Great option for Canvas and Gesso Modular Height-Adjustable units

Tackboards - Must Specify: Model# & Fabric/Grade

Model	Ydg	COM/Grades 1, 2, 3	Grade 4	Grade 5	Grade 6	Grade 7	Grade 8	Grade 9	Grade 10
PS-6817TB	2.00	\$ 642	\$ 920	\$ 1050	\$ 1182	\$ 1370	\$ 1566	\$ 1794	\$ 2058
PS-6217TB	2.00	\$ 602	\$ 880	\$ 1010	\$ 1142	\$ 1330	\$ 1526	\$ 1754	\$ 2018
PS-5617TB	2.00	\$ 549	\$ 827	\$ 957	\$ 1089	\$ 1277	\$ 1473	\$ 1701	\$ 1965
PS-5017TB	2.00	\$ 520	\$ 798	\$ 928	\$ 1060	\$ 1248	\$ 1444	\$ 1672	\$ 1936
PS-4417TB	1.75	\$ 468	\$ 711	\$ 825	\$ 941	\$ 1105	\$ 1277	\$ 1476	\$ 1707

Pricing Codes: C=Clear F= Frosted HG= High Gloss GR= High Gloss Graphite U=Tackboard T = TFL W = Veneer

[For ordering options, see overview at the beginning of section.](#)

SCREENS+DIVIDERS
MULTI-USE SPACE DIVISION

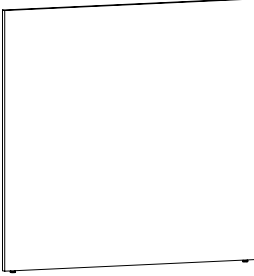

Item	Model No.		W	D	H	Ship Wt	Cubic Ft	List Price
51" GALLERY SCREEN STRAIGHT FLOORSTANDING 	66-5173GS	TFL	73	1	51¼	110	7.9	T\$ 1147
	65-5173GS	Veneer						W\$ 2036
	66-5172GS	TFL	72	1	51¼	110	7.9	T\$ 1139
	65-5172GS	Veneer						W\$ 2021
	66-5167GS	TFL	67	1	51¼	104	7.3	T\$ 1103
	65-5167GS	Veneer						W\$ 1955
	66-5166GS	TFL	66	1	51¼	104	7.3	T\$ 1096
	65-5166GS	Veneer						W\$ 1943
	66-5161GS	TFL	61	1	51¼	98	6.7	T\$ 1057
	65-5161GS	Veneer						W\$ 1874
	66-5160GS	TFL	60	1	51¼	98	6.7	T\$ 1051
	65-5160GS	Veneer						W\$ 1861
	66-5155GS	TFL	55	1	51¼	92	6.1	T\$ 1010
	65-5155GS	Veneer						W\$ 1792
	66-5154GS	TFL	54	1	51¼	92	6.1	T\$ 1003
	65-5154GS	Veneer						W\$ 1778
	66-5149GS	TFL	49	1	51¼	86	5.4	T\$ 964
	65-5149GS	Veneer						W\$ 1711
	66-5148GS	TFL	48	1	51¼	86	5.4	T\$ 957
	65-5148GS	Veneer						W\$ 1695
	66-5143GS	TFL	43	1	51¼	80	4.7	T\$ 920
	65-5143GS	Veneer						W\$ 1632
	66-5142GS	TFL	42	1	51¼	80	4.7	T\$ 913
	65-5142GS	Veneer						W\$ 1620
	66-5137GS	TFL	37	1	51¼	60	4.1	T\$ 795
	65-5137GS	Veneer						W\$ 1413
	66-5136GS	TFL	36	1	51¼	60	4.1	T\$ 772
	65-5136GS	Veneer						W\$ 1369
	66-5131GS	TFL	31	1	51¼	54	3.5	T\$ 724
	65-5131GS	Veneer						W\$ 1283
	66-5130GS	TFL	30	1	51¼	54	3.5	T\$ 713
	65-5130GS	Veneer						W\$ 1266
66-5125GS	TFL	25	1	51¼	48	2.8	T\$ 662	
65-5125GS	Veneer						W\$ 1173	
66-5124GS	TFL	24	1	51¼	48	2.8	T\$ 652	
65-5124GS	Veneer						W\$ 1154	
66-5119GS	TFL	19	1	51¼	42	2.2	T\$ 613	
65-5119GS	Veneer						W\$ 1085	
66-5118GS	TFL	18	1	51¼	42	2.2	T\$ 603	
65-5118GS	Veneer						W\$ 1070	

Description

- Horizontal Woodgrain
- Mounts to Back of Modular Credenza for Space Division
- Available in TFL and Veneer; Must Specify Finish/Color, [See Color and Finish Options](#)
- Extend up to 24" Beyond Workstation without Additional Support
- Includes Leveling Glides
- Six (6) Wire Management Grommet Location Options; Must Specify Location/Color, [See Grommet Locations](#)

Pricing Codes: T = TFL W = Veneer

[For ordering options, see overview at the beginning of section.](#)

Item	Model No.	W	D	H	Ship Wt	Cubic Ft	List Price
ACRYLIC CONNECTOR CLIPS   	01-2WAY90	1¼	1¼	7⁄8	0.1	0.8	\$ 34
	<i>For Use with 2-Way, 90° Corner Connections</i>						
	01-3WAY90	2	1½	7⁄8	0.1	0.8	\$ 26
<i>For Use with 3-Way, T-Connections</i>							
	01-2WAY180	1⅞	7⁄8	13⁄16	0.1	0.8	\$ 21
<i>For Use with 2-Way, 180° Straight Connections</i>							

Description

- Constructed of Metal with a Chrome Finish
- For Use with ¼" Thick Clear and Frosted Acrylics
- Provides a Clean Connection For Adjacent Panels and Screens

Pricing Codes: T = TFL W = Veneer

[For ordering options, see overview at the beginning of section.](#)

STEP 1: PLANNING FOR SQUARE ONE

Planning for Square One is based on configuring 12"x24" and 24"x24" blocks in nearly any manner to create space dividing walls, coves, work zones, and more within open environments.

Idea Starters/Typicals:

When you select one of our pre-configured Typicals, everything you need comes specified together, including the blocks, caps and posts, hardware, glides, and more.

- Select the typical number (e.g., 17-4), then specify the finish and hardware color.
- Add optional accessories (see Step #5).

Make Your Own Typicals:

There are endless opportunities with Square One, giving you the ability to create unique setups to meet the specific needs of your customers.

- We recommend utilizing our Specification/Drawing Services team, who can help in bringing your vision to life and ensure all the necessary components are included. To get started, just send us a drawing. You can use our easy online request form: [Design Request Form](#)
- Steps #2 - #5 outline the process for specifying your own typical. Please provide a drawing with the order to ensure accuracy.

STEP 2: SPECIFYING BLOCKS

When making your own typical, choose the quantity of blocks needed to create your design. We offer single blocks in two styles: 24"x24" and 12"x24".

- Blocks can go up to four high (8') and do runs of five wide (10') without a supporting wall or anchor to create stability.
- We recommend using single 12" x 24" blocks on the top or ends. If placing on the bottom or in the center of the design, using two of them together will ensure alignment with the holes bored on attachment items like End Caps, Corner Posts, etc.
- When creating an "L" or "T" design, we suggest going a minimum of three blocks wide to ensure stability without additional support.

STEP 3: CAPS, POSTS, CONNECTORS, AND SPANNERS

Next, determine what Caps, Posts, Connectors, and Spanners are needed to complete the design.

- End and Top Caps are necessary to ensure a clean and balanced aesthetic (as they hide the attachment hardware/ensure no empty holes are showing where attachments would have been).
- Square One offers connection beams to create 90° turns (Corner Posts), three walls (T-Connectors), four walls (X-Connectors), and span doorways or other openings (Horizontal Beam Spanners).
- End Caps, Posts, and Connectors should always be specified to run longer (taller) than the unit so that the end of the top cap or horizontal rail will not be seen (there are only a few exceptions).

STEP 4: HARDWARE, LEVELING, AND GENERAL ASSEMBLY

Whether connecting square to square or square to post, individual components come with the necessary hardware. Should you need more, we offer separate Bolt Kits to provide proper installation.

We offer heavy-duty, adjustable leveling glides to compensate for uneven floors. A tool (6mm allen driver bit) is also available to insert the glide nuts. The glides must be ordered separately from the blocks.

We do not offer connection methods to anchor to the floor or wall. We recommend discussing this with the building's facility manager for proper connection. Indiana Furniture will not be liable for wall or floor mounts that are not properly installed.

Assembly Instructions may be found on our website.

STEP 5: ACCESSORIES

Add function without sacrificing beauty. Acrylic Inserts, Tackable and Acoustical Panels, Dry Erase Boards, and TV mounts can give your space the ability for more privacy, collaboration, or brainstorming.

- Dry Erase Boards and Tackable Panels have onset installation.
- Dry Erase Boards can be mounted either vertically or horizontally.
- Acoustical Panels are either specified onset or inset, and Acrylic Inserts are inset.
- Tackable Panels are fully upholstered, so a clean aesthetic is seen from both sides of the blocks.
- Acrylic Inserts lock into insert retainers which are installed on top of the hardware, inside of the block, allowing for a quick and tight-fitting installation.
- Frosted Acrylic Inserts can be customized with a logo or image, giving you freedom to create a personal touch. Provide a .CDR, .AI, or .EPS file. Extended lead times may apply.
- We offer the Vesta Power Data Center and other similar items to add power within your Square One spaces created.



**Space Division.
Redefined.**

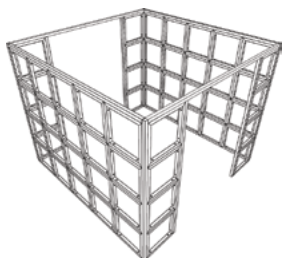

17-1 (Approximately 10' X 10' X 8')

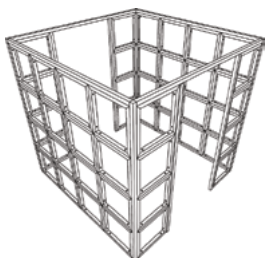

17-2 (Approximately 8' X 8' X 8')

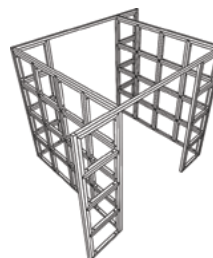

17-3 (Approximately 12' X 8' X 8')

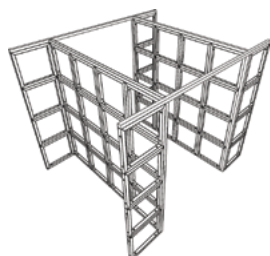

17-4 (Approximately 10' X 8' X 8')

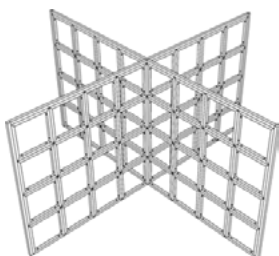

17-5 (Approximately 16' X 16' X 8')

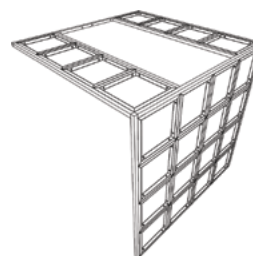

17-6 (Approximately 8' X 8' X 8')



17-7 (Approximately 8' X 8')

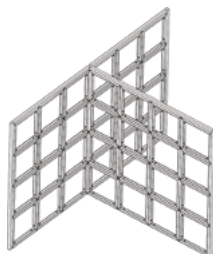

17-8 (Approximately 12' X 8' X 8')

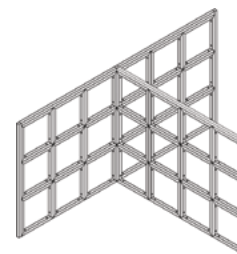

17-9 (Approximately 12' X 8' X 6')

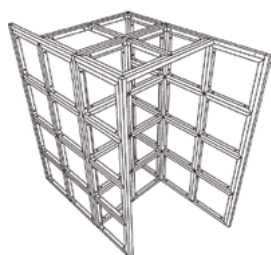

17-10 (Approximately 4' X 8' X 8')



17-11 (Approximately 4' X 4' X 8')



17-12 (Approximately 2' X 4' X 8')

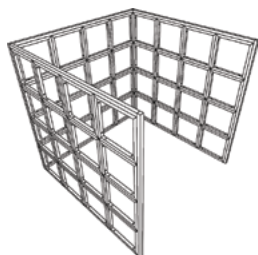

17-13 (Approximately 8' X 8' X 8')

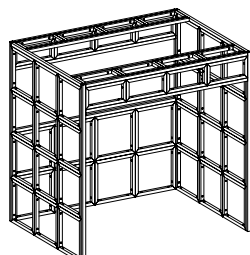

17-14 (Approximately 8' X 6' X 8')

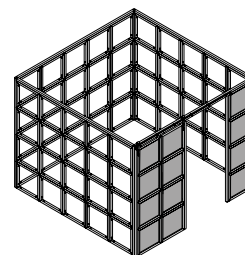

17-15 (Approximately 10' X 10' X 8')

Space Division. Redefined.

Square One is the clean, simple way to provide space division, functionality, and architectural design to any zone within the working environment. With individual building blocks that securely connect to one another and accessories like dry erase boards, barn doors, planter boxes, acrylic inserts, and tackable and acoustical panels, your personalization of Square One is only limited to your imagination. Square One is made of solid wood, providing a sustainable material for the workplace and bringing warmth and beauty to any space.

CONSTRUCTION

BLOCKS

- Blocks are manufactured using kiln-dried, solid European Beech and are attached using hardware, available in your choice of nickel or black, for durability and strength

FINISH

- Indiana Furniture uses a multi-step hand finishing process
- Blocks are pre-sanded for smoothness, then stained and finished with a catalyzed varnish finish which offers durability, lasting beauty, and resistance to normal wear
- Square One finishes were selected to complement casegoods, tables, and seating finishes which allows for easy blending of furniture components

END & TOP CAPS

- Measure 1¾"W and 1¾"D and come in a variety of lengths
- Used vertically and horizontally to provide a clean, balanced aesthetic by hiding the attachment hardware
- Caps are constructed of kiln-dried, solid European Beech and include blind threaded inserts for installation

CORNER POSTS

- Measure 1¾"W and 1¾"D and come in a variety of heights
- Used to create 90° turns
- Corner posts are constructed of kiln-dried, solid European Beech and include blind threaded inserts for installation

T-CONNECTORS

- Measure 1¾"W and 1¾"D and come in a variety of heights
- Used vertically and horizontally to create an intersection for three wall runs
- T-Connectors are constructed of kiln-dried, solid European Beech and include blind threaded inserts for installation

X-CONNECTORS

- Measure 1¾"W and 1¾"D and come in a variety of heights
- Used vertically to create an intersection for four wall runs
- X-Connectors are constructed of kiln-dried, solid European Beech and include blind threaded inserts for installation

HORIZONTAL BEAM SPANNERS

- Measure 1¾"D and 1¾"H and come in a variety of widths
- Used horizontally to provide structural support for doorways and other designed openings
- Spanners are constructed of kiln-dried, solid European Beech and include blind threaded inserts for installation

DRY ERASE BOARDS

- Available in 22½" or 46½" heights and multiple widths
- Installed onset, either vertically or horizontally
- Installation brackets are included; longer bolts for installation on-site are also included

ACOUSTICAL PANELS

- Constructed of 100% polyester made from up to 50% recycled materials without the use of adhesive or other bonding agents, Acoustical Panels are 100% recyclable
- Panels are ½" (12mm) thick and are available in multiple widths and lengths
- Sound absorption is average NRC 0.75 (50mm air gap) 1.0 NRC in mid-high frequencies
- Panels are installed inset with tabs or onset with dual-lock connectors

TACKABLE PANELS

- Tackable Panels are constructed of 7/16" corkboard and then covered, on both sides, in the textile of your choice
- Highly-skilled upholsterers hand tailor each unit to meet individual specifications
- Upholstery options include a broad range of styles, all pre-graded in this price list for ease of use
- Panels are installed onset with dual-lock connectors

ACRYLIC INSERTS

- Acrylic inserts are manufactured using high performance engineering resins and provide translucency, strength, clarity, and versatility
- Inserts are 20½"W and are available in 8½" and 20½" lengths
- Inserts are inset within the blocks with retainers for a tight-fitting installation
- Frosted acrylic options can be customized with logos and other designs as requested

LEVELING GLIDES

- Heavy-duty, adjustable leveling glides are available in black or nickel and are recommended to ensure proper leveling and compensation for uneven floors
- A tool (6mm allen driver bit) to install glides is also available to ensure proper installation

BARN DOOR HARDWARE

- Sliding system tracks are constructed of black powder coated steel
- Hardware includes tracks, hangers, track stops, screws, inserts, bracket, and sliding system
- Installation hardware will be shipped attached to components

PLANTER BOXES

- The planter box is made of ¾" thick thermally-fused laminate (TFL) fused particle-board core
- Grain direction runs horizontal
- Planter boxes are fastened together with screws and heavy-duty metal fasteners
- Optional insert is made of lightweight, fade-resistant, recyclable plastic

HOW TO ORDER EXAMPLES

IDEA STARTERS/TYPICALS

Model No.	Description	Example
17-1	Finish	EF
	Hardware Color	BLK

BLOCKS & RAILS

Model No.	Description	Example
17-2424BL	Finish	NB
	Hardware Color	NCKL

ACRYLIC INSERTS

Model No.	Description	Example
AI-2020AC	Acrylic Color	FSTA

PLANTER BOXES

Model No.	Description	Example
01-1909PL	TFL Color	AS
	Hardware Color	BLK
	Optional Insert	PBI

veneer (W) OPTIONS

Indiana Furniture uses a multi-step, hand finishing process on all exposed wood frames.

Square One models feature a catalyzed varnish finish which offers durability, lasting beauty, and resistance to normal wear.

AW	Artisan Walnut	MAS	Mesa Sunset*
AS	Asian Night	MTS	Metropolis Sky
AWH	Aspen White	MNR	Midnight Run
BW	Beigewood*	NTM	Natural Marrone*
BL	Black	NB	Natural Beech
CO	Columbian Walnut	ORW	Oak Riftwood*
DC	Dark Cherry	OR	Orchard
DFW	Dark Forest Walnut*	PNW	Pinnacle Walnut
WH	Designer White	PTK	Portico Teak*
EG	Ember Gray	RC	River Cherry*
EF	Espresso	SCH	Select Cherry
FO	Fawn Oak*	SPW	Sepia Walnut*
FLW	Florence Walnut*	SKC	Shaker Cherry
GC	Golden Cherry	SBP	Smoky Brown Pear*
HVM	Harvest Maple*	TK	Studio Teak
HW	Harvest Walnut	SM	Sugar Maple
HNW	Henna Walnut	TR	Truffle Rain
KHE	Kirsche	WTA	Weathered Ash*
LW	Legacy Walnut	WNB	White Nebbia
MW	Mahogany Walnut	WC	Williamsburg Cherry

* Finish is Low Sheen

TFL (T) LAMINATE OPTIONS ON PLANTER BOXES

WOODGRAIN

AS	Asian Night	PNW	Pinnacle Walnut
BW	Beigewood	PTK	Portico Teak
CO	Columbian Walnut	RC	River Cherry
EF	Espresso	SCH	Select Cherry
FLW	Florence Walnut	SPW	Sepia Walnut
GC	Golden Cherry	SKC	Shaker Cherry
HVM	Harvest Maple	SBP	Smoky Brown Pear
KHE	Kirsche	TK	Studio Teak
MW	Mahogany Walnut	SM	Sugar Maple
MNR	Midnight Run	WTA	Weathered Ash
NTM	Natural Marrone	WNB	White Nebbia
ORW	Oak Riftwood	WC	Williamsburg Cherry

SOLID

BL	Black	FHG	Fashion Grey
WH	Designer White	SG	Slate Grey

HARDWARE/LEVELING GLIDES COLOR OPTIONS

BLK	Black	NCKL	Nickel
-----	-------	------	--------



Black (BLK)

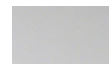

Nickel (NCKL)

ACOUSTICAL PANEL OPTIONS

ASH	Ash	MLK	Milky
BLK	Black	TPE	Taupe
GRY	Grey		



Ash (ASH)



Black (BLK)



Grey (GRY)



Milky (MLK)

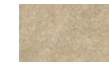

Taupe (TPE)

ACRYLIC INSERT OPTIONS

FSTA	Frosted	TGWA	Twigwork
RAFA	Raffia	TNSA	Tinsel
WOVA	Woven		

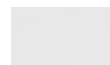

Frosted (FSTA)



Raffia (RAFA)



Woven (WOVA)



Twigwork (TGWA)



Tinsel (TNSA)

TACKABLE PANEL OPTIONS

Available in single upholstery in a wide variety of graded-in or contract options.

CERTIFICATIONS & COMPLIANCE

- CAL 117-2013 Compliance
- Intertek Sustainability Certified
- BIFMA level® Certified
- BIFMA Compliant® Certified
- TSCA Title VI (CARB) Compliance
- Contributes to LEED®, Green Globes®, and WELL® Sustainable Programs

Building Blocks

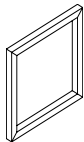

24" x 24" Block
[\(See Details\)](#)

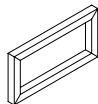

24" x 12" Block
[\(See Details\)](#)

Hardware

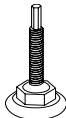

Leveling Glide Kits
[\(See Details\)](#)

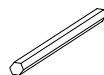

Allen Driver Bit
[\(See Details\)](#)

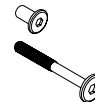

Bolt & Nut Kits
[\(See Details\)](#)

Connectors

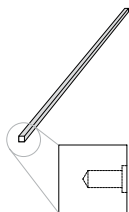

End Caps
[\(See Details\)](#)

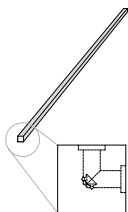

Corner Posts
[\(See Details\)](#)

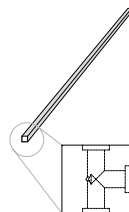

T-Connector Beams
[\(See Details\)](#)

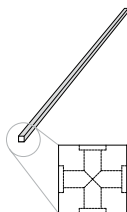

X-Connector Beams
[\(See Details\)](#)

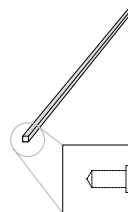

Horizontal Beam Spanners
[\(See Details\)](#)

Accessories

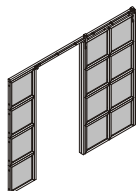

Barn Door Wall
[\(See Details\)](#)

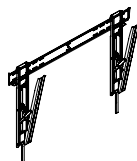

TV Mounts
[\(See Details\)](#)

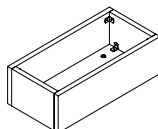

Planter Boxes
[\(See Details\)](#)



Tic-Tac-Toe Foam Game
[\(See Details\)](#)



Vesta Power Center
[\(See Details\)](#)

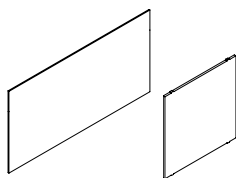

Onset & Inset Acoustical Panels
[\(See Details\)](#)

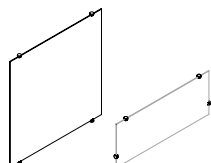

Acrylic Inset Panels
[\(See Details\)](#)



Dry Erase Boards
[\(See Details\)](#)

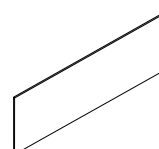

Tackable Panels
[\(See Details\)](#)

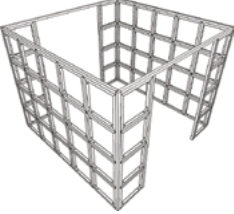
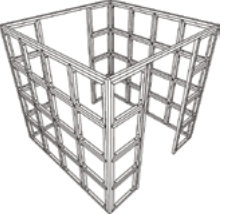
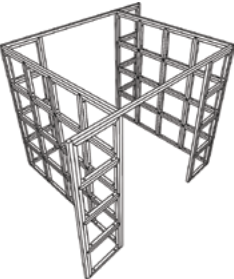
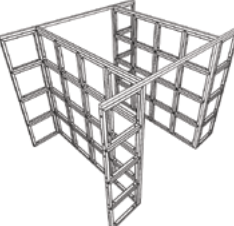
Item	Model No.	Qty	Description	List Price
HUDDLE (APPROXIMATELY 10' X 10' X 8')	17-1_1701			\$ 22036
	Consists of:			
	17-2424BL	56	Single Block, 24" x 24"	\$ 16464
	17-17596EC	4	End Cap, 96" (used vertically)	\$ 1576
	17-175120EC	2	End Cap, 120" (used horizontally)	\$ 860
	17-17597CP	4	Corner Post, 97¾"	\$ 1588
	17-175120HBS	2	Horizontal Beam Spanner, 120"	\$ 820
	17-LEVKIT	14	Leveler Kit, (2) Levelers	\$ 728
HUDDLE (APPROXIMATELY 8' X 8' X 8')	17-2			\$ 19442
	Consists of:			
	17-2424BL	48	Single Block, 24" x 24"	\$ 14112
	17-17596EC	6	End Cap, 96" (4 used vertically, 2 used horizontally)	\$ 2364
	17-17597CP	4	Corner Post, 97¾"	\$ 1588
	17-17596HBS	2	Horizontal Beam Spanner, 96"	\$ 754
	17-LEVKIT	12	Leveler Kit, (2) Levelers	\$ 624
HUDDLE (APPROXIMATELY 12' X 8' X 8')	17-3			\$ 19508
	Consists of:			
	17-2424BL	48	Single Block, 24" x 24"	\$ 14112
	17-17596EC	4	End Cap, 96" (2 used vertically, 2 used horizontally)	\$ 1576
	17-17597EC	2	End Cap, 97¾" (used vertically)	\$ 788
	17-17596CP	2	Corner Post, 96"	\$ 794
	17-17597CP	2	Corner Post, 97¾"	\$ 794
	17-175120HBS	2	Horizontal Beam Spanner, 120"	\$ 820
	17-LEVKIT	12	Leveler Kit, (2) Levelers	\$ 624
H-CONFIGURATION (APPROXIMATELY 10' X 8' X 8')	17-4			\$ 19508
	Consists of:			
	17-2424BL	48	Single Block, 24" x 24"	\$ 14112
	17-17596EC	2	End Cap, 96" (used horizontally)	\$ 788
	17-17597EC	4	End Cap, 97¾" (used vertically)	\$ 1576
	17-17596CP	4	Corner Post, 96"	\$ 1588
	17-175120HBS	2	Horizontal Beam Spanner, 120"	\$ 820
	17-LEVKIT	12	Leveler Kit, (2) Levelers	\$ 624

[See Overview for Square One Ordering Options.](#)

Item	Model No.	Qty	Description	List Price
QUAD-CONFIGURATION (APPROXIMATELY 16' X 16' X 8')	17-5			\$ 23204

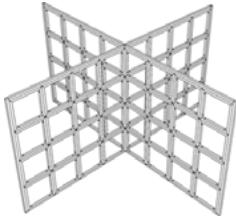
**Consists of:**

17-2424BL	64	Single Block, 24" x 24"	\$ 18816
17-17596EC	4	End Cap, 96" (used horizontally)	\$ 1576
17-17597EC	4	End Cap, 97¾" (used vertically)	\$ 1576
17-17597XB	1	X-Connector Beam, 97¾"	\$ 404
17-LEVKIT	16	Leveler Kit, (2) Levelers	\$ 832

WALL COVE (APPROXIMATELY 8' X 8' X 8')	17-6			\$ 10457
---	------	--	--	----------

**Consists of:**

17-2424BL	24	Single Block, 24" x 24"	\$ 7056
17-17596EC	3	End Cap, 96" (used horizontally)	\$ 1182
17-17597EC	4	End Cap, 97¾" (2 used vertically, 2 used horizontally)	\$ 1576
17-17596CP	1	Corner Post, 96" (used horizontally)	\$ 397
17-LEVKIT	4	Leveler Kit, (2) Levelers	\$ 208
17-12MMBOLTKIT	1	12mm Bolt Kit, qty 8	\$ 38

** This typical is not design for freestanding applications. This unit must be secured at the top to a rigid structure. Attachment hardware not included.*

SINGLE WALL (APPROXIMATELY 8' X 8')	17-7			\$ 6094
--	------	--	--	---------

**Consists of:**

17-2424BL	16	Single Block, 24" x 24"	\$ 4704
17-17596EC	1	End Cap, 96" (used horizontally)	\$ 394
17-17597EC	2	End Cap, 97¾" (used vertically)	\$ 788
17-LEVKIT	4	Leveler Kit, (2) Levelers	\$ 208

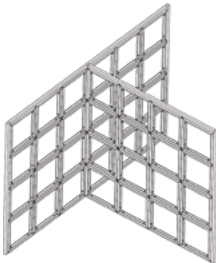

** This typical is not design for freestanding applications. This unit must be secured at the top to a rigid structure. Attachment hardware not included.*

T-CONFIGURATION (APPROXIMATELY 12' X 8' X 8')	17-8_1708			\$ 15021
--	-----------	--	--	----------

**Consists of:**

17-2424BL	40	Single Block, 24" x 24"	\$ 11760
17-17572EC	2	End Cap, 72" (used horizontally)	\$ 764
17-17596EC	1	End Cap, 96" (used horizontally)	\$ 394
17-17597EC	3	End Cap, 97¾" (used vertically)	\$ 1182
17-17597TCB	1	T-Connector Beam, 97¾"	\$ 401
17-LEVKIT	10	Leveler Kit, (2) Levelers	\$ 520

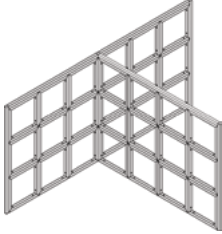
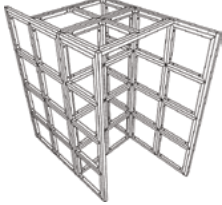
[See Overview for Square One Ordering Options.](#)

Item	Model No.	Qty	Description	List Price
T-CONFIGURATION (APPROXIMATELY 12' X 8' X 6')	17-9			\$ 12032
	Consists of:			
	17-2424BL	30	Single Block, 24" x 24"	\$ 8820
	17-17572EC	2	End Cap, 72" (used horizontally)	\$ 764
	17-17573EC	3	End Cap, 73¾" (used vertically)	\$ 1146
	17-17596EC	1	End Cap, 96" (used horizontally)	\$ 394
	17-17573TCB	1	T-Connector Beam, 73¾"	\$ 388
	17-LEVKIT	10	Leveler Kit, (2) Levelers	\$ 520
OFFSET DUAL BOOTH (APPROXIMATELY 4' X 8' X 8')	17-10			\$ 15610
	Consists of:			
	17-2424BL	36	Single Block, 24" x 24"	\$ 10584
	17-17548EC	2	End Cap, 48" (used horizontally)	\$ 630
	17-17597EC	4	End Cap, 97¾" (used vertically)	\$ 1576
	17-17524CP	2	Corner Post, 24" (used horizontally)	\$ 612
	17-17548CP	2	Corner Post, 48" (used horizontally)	\$ 634
	17-17548TCB	1	T-Connector Beam, 48"	\$ 318
	17-17596TCB	2	T-Connector Beam, 96"	\$ 802
	17-LEVKIT	8	Leveler Kit, (2) Levelers	\$ 416
	17-12MMBOLTKIT	1	12mm Bolt Kit, qty 8	\$ 38
DUAL BOOTH (APPROXIMATELY 4' X 4' X 8')	17-11			\$ 11273
	Consists of:			
	17-2424BL	24	Single Block, 24" x 24"	\$ 7056
	17-17524EC1711	4	End Cap, 24" (used horizontally)	\$ 1212
	17-17548EC1711	1	End Cap, 48" (used horizontally)	\$ 315
	17-17597EC1711	4	End Cap, 97¾" (used vertically)	\$ 1576
	17-17597TCB1711	2	T-Connector Beam, 97¾"	\$ 802
	17-LEVKIT	6	Leveler Kit, (2) Levelers	\$ 312
L COVE (APPROXIMATELY 2' X 4' X 8')	17-12			\$ 5487
	Consists of:			
	17-2424BL	12	Single Block, 24" x 24"	\$ 3528
	17-17524EC	1	End Cap, 24" (used horizontally)	\$ 303
	17-17548EC	1	End Cap, 48" (used horizontally)	\$ 315
	17-17597EC	2	End Cap, 97¾" (used vertically)	\$ 788
	17-17597CP	1	Corner Post, 97¾"	\$ 397
	17-LEVKIT	3	Leveler Kit, (2) Levelers	\$ 156

[See Overview for Square One Ordering Options.](#)

Item	Model No.	Qty	Description	List Price
C-CONFIGURATION (APPROXIMATELY 8' X 8' X 8')	17-13			\$ 17500

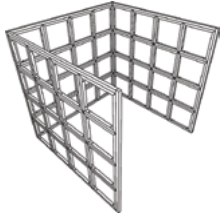
**Consists of:**

17-2424BL	48	Single Block, 24" x 24"	\$ 14112
17-17596EC	3	End Cap, 96" (used horizontally)	\$ 1182
17-17597EC	2	End Cap, 97¾" (used vertically)	\$ 788
17-17597CP	2	Corner Post, 97¾"	\$ 794
17-LEVKIT	12	Leveler Kit, (2) Levelers	\$ 624

GATEWAY COVE (APPROXIMATELY 8' X 6' X 8')	17-14			\$ 19278
--	-------	--	--	----------

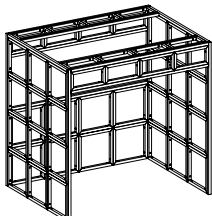
**Consists of:**

17-2424BL	32	Single Block, 24" x 24"	\$ 9408
17-2412BL	16	Single Block, 24" x 12"	\$ 4112
17-17596EC	5	End Cap, 96" (used horizontally)	\$ 1970
17-17572CP	2	Corner Post, 72" (used horizontally)	\$ 772
17-17596CP	2	Corner Post, 96" (used horizontally)	\$ 794
17-17597CP	4	Corner Post, 97¾" (used vertically)	\$ 1588
17-LEVKIT	10	Leveler Kit, (2) Levelers	\$ 520
17-12MMBOLTKit	3	12mm Bolt Kit, qty 8	\$ 114

MEETING ROOM WITH BARN DOOR (APPROXIMATELY 10' X 10' X 8')	17-15			\$ 30773
---	-------	--	--	----------

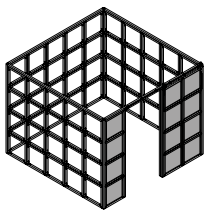
**Consists of:**

17-2424BL	60	Single Block, 24" x 24"	\$ 17640
17-175120EC	3	End Cap, 120" (used horizontally)	\$ 1290
17-17597CP	4	Corner Post, 97¾"	\$ 1588
17-4896BDBR	1	Barn Door Wall, Right	\$ 9475
17-LEVKIT	15	Leveler Kit, (2) Levelers	\$ 780

** Must Specify Acrylic and/or Acoustical Inserts for Use in Barn Door Wall (Total 20 Inserts);
Note: List Price Shown Above Does NOT Include These Required Inserts Due to Variance in Pricing. See
Page 307 for Acrylic and Acoustical Insert options.*

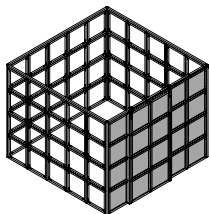

Shown as Right Barn Door

[See Overview for Square One Ordering Options.](#)

Item	Model No.	W	D	H	Ship Wt	Cubic Ft	List Price
SINGLE BLOCK 24" X 24"	17-2424BL	24	1¾	24	12	1.5	\$ 294

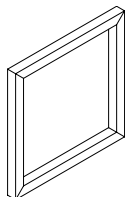

Description

- Includes Four (4) Bolts and Nuts for Installation

Must Specify (in this order):

Model # and Quantity
Finish
Hardware Color

SINGLE BLOCK 24" X 12"	17-2412BL	24	1¾	12	8	1.0	\$ 257
---------------------------	-----------	----	----	----	---	-----	--------

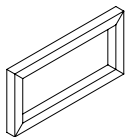

Description

- Includes Three (3) Bolts and Nuts for Installation
- Can Be Used Vertically or Horizontally
- Recommended for Use on Top or End of Configuration, Unless Used in Pairs
- We Recommend Using Single 12" x 24" Blocks on the Top or Ends. If Placing on the Bottom or In the Center of the Design, Using Two of Them Together Will Ensure Alignment with the Holes Bored on Attachment Items Like End Caps, Corner Posts, Etc.

Must Specify (in this order):

Model # and Quantity
Finish
Hardware Color

[See Overview for Square One Ordering Options.](#)

Item	Model No.	W	D	H	Ship Wt	Cubic Ft	List Price
END CAPS	17-175120EC	1¾	1¾	120	14	0.3	\$ 430
	17-175108EC	1¾	1¾	108	13	0.3	\$ 427
	17-17597EC <i>Vertical Use Only</i>	1¾	1¾	97¾	13	0.3	\$ 394
	17-17596EC	1¾	1¾	96	12	0.3	\$ 394
	17-17585EC <i>Vertical Use Only</i>	1¾	1¾	85¾	12	0.3	\$ 386
	17-17584EC	1¾	1¾	84	11	0.3	\$ 386
	17-17573EC <i>Vertical Use Only</i>	1¾	1¾	73¾	11	0.3	\$ 382
	17-17572EC	1¾	1¾	72	11	0.3	\$ 382
	17-17561EC <i>Vertical Use Only</i>	1¾	1¾	61¾	10	0.2	\$ 374
	17-17560EC	1¾	1¾	60	10	0.2	\$ 374
	17-17549EC <i>Vertical Use Only</i>	1¾	1¾	49¾	9	0.1	\$ 315
	17-17548EC	1¾	1¾	48	9	0.1	\$ 315
	17-17537EC <i>Vertical Use Only</i>	1¾	1¾	37¾	8	0.1	\$ 308
	17-17536EC	1¾	1¾	36	8	0.1	\$ 308
	17-17525EC <i>Vertical Use Only</i>	1¾	1¾	25¾	7	0.1	\$ 303
	17-17524EC	1¾	1¾	24	7	0.1	\$ 303
	17-17522EC	1¾	1¾	22¾	7	0.1	\$ 298

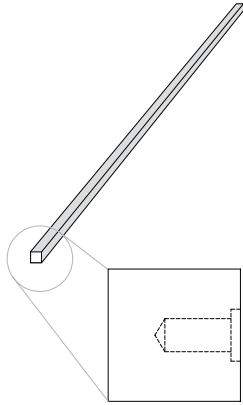

Must Specify (in this order):

Model # and Quantity
Finish
Hardware Color

Description

- Used Vertically and Horizontally to Provide a Clean, Balanced Aesthetic by Hiding Attachment Hardware
- Includes Bolts for Installation
- Blind-Threaded Insert for Installation

[See Overview for Square One Ordering Options.](#)

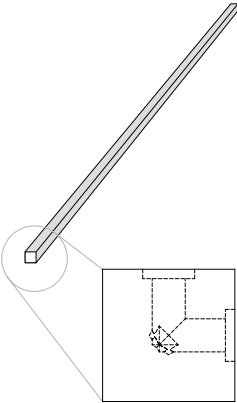
Item	Model No.	W	D	H	Ship Wt	Cubic Ft	List Price
	17-17597CP	1¾	1¾	97¾	13	0.3	\$ 397
	17-17596CP	1¾	1¾	96	12	0.3	\$ 397
	17-17585CP	1¾	1¾	85¾	12	0.2	\$ 390
	17-17584CP	1¾	1¾	84	11	0.2	\$ 390
	17-17573CP	1¾	1¾	73¾	11	0.2	\$ 386
	17-17572CP	1¾	1¾	72	11	0.2	\$ 386
	17-17561CP	1¾	1¾	61¾	10	0.2	\$ 381
	17-17560CP	1¾	1¾	60	10	0.2	\$ 381
	17-17549CP	1¾	1¾	49¾	9	0.1	\$ 317
	17-17548CP	1¾	1¾	48	9	0.1	\$ 317
	17-17537CP	1¾	1¾	37¾	8	0.1	\$ 311
	17-17536CP	1¾	1¾	36	8	0.1	\$ 311
	17-17525CP	1¾	1¾	25¾	7	0.1	\$ 306
	17-17524CP	1¾	1¾	24	7	0.1	\$ 306
	17-17522CP	1¾	1¾	22¾	7	0.1	\$ 299

Must Specify (in this order):

Model # and Quantity

Finish

Hardware Color

Description

- Used Vertically to make 90° Turns
- Includes Bolts for Installation
- Blind-Threaded Insert for Installation

[See Overview for Square One Ordering Options.](#)

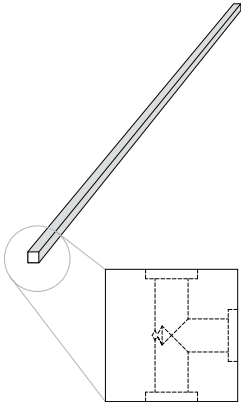
Item	Model No.	W	D	H	Ship Wt	Cubic Ft	List Price
	T-CONNECTOR BEAMS						
	17-17597TCB	1¾	1¾	97¾	13	0.3	\$ 401
	17-17596TCB	1¾	1¾	96	12	0.3	\$ 401
	17-17585TCB	1¾	1¾	85¾	12	0.2	\$ 396
	17-17584TCB	1¾	1¾	84	11	0.2	\$ 396
	17-17573TCB	1¾	1¾	73¾	11	0.2	\$ 388
	17-17572TCB	1¾	1¾	72	11	0.2	\$ 388
	17-17561TCB	1¾	1¾	61¾	10	0.2	\$ 385
	17-17560TCB	1¾	1¾	60	10	0.2	\$ 385
	17-17549TCB	1¾	1¾	49¾	9	0.1	\$ 318
	17-17548TCB	1¾	1¾	48	9	0.1	\$ 318
	17-17537TCB	1¾	1¾	37¾	8	0.1	\$ 314
	17-17536TCB	1¾	1¾	36	8	0.1	\$ 314
	17-17525TCB	1¾	1¾	25¾	7	0.1	\$ 308
	17-17524TCB	1¾	1¾	24	7	0.1	\$ 308
17-17522TCB	1¾	1¾	22¾	7	0.1	\$ 303	

Must Specify (in this order):

Model # and Quantity

Finish

Hardware Color

Description

- Used Vertically to Connect Three (3) Walls
- Includes Bolts for Installation
- Blind-Threaded Insert for Installation

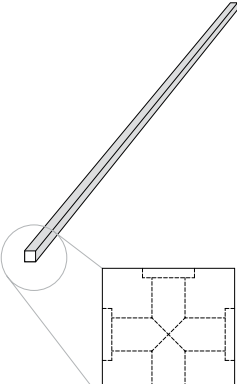
Item	Model No.	W	D	H	Ship Wt	Cubic Ft	List Price
	17-17597XB	1¾	1¾	97¾	13	0.3	\$ 404
	17-17585XB	1¾	1¾	85¾	12	0.2	\$ 400
	17-17573XB	1¾	1¾	73¾	11	0.2	\$ 395
	17-17561XB	1¾	1¾	61¾	10	0.2	\$ 388
	17-17549XB	1¾	1¾	49¾	9	0.1	\$ 320
	17-17537XB	1¾	1¾	37¾	8	0.1	\$ 316
	17-17525XB	1¾	1¾	25¾	7	0.1	\$ 309
	17-17522XB	1¾	1¾	22¾	7	0.1	\$ 306

Description

- Used Vertically to Connect Four (4) Wall Runs
- Includes Bolts for Installation
- Blind-Threaded Insert for Installation

Must Specify (in this order):

Model # and Quantity
Finish
Hardware Color

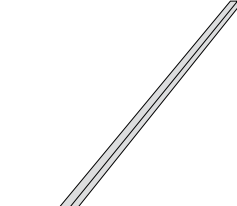
Item	Model No.	W	D	H	Ship Wt	Cubic Ft	List Price
	17-175120HBS	120	1¾	1¾	14	0.3	\$ 410
	17-175108HBS	108	1¾	1¾	12	0.3	\$ 390
	17-17596HBS	96	1¾	1¾	12	0.3	\$ 377
	17-17584HBS	84	1¾	1¾	11	0.2	\$ 357
	17-17572HBS	72	1¾	1¾	11	0.2	\$ 347

Description

- Used Horizontally to Provide Structural Support for Doorways and Other Openings
- Includes Bolts for Installation
- Blind-Threaded Insert for Installation
- Holes Bored Only on Ends to Accommodate Attachment

Must Specify (in this order):

Model # and Quantity
Finish
Hardware Color

[See Overview for Square One Ordering Options.](#)

Item	Model No.	W	D	H	Ship Wt	Cubic Ft	List Price
BARN DOOR WALL	Left	Right					
	17-4896BDBL	17-4896BDBR	120	4	103	289	271

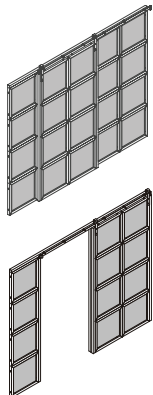

Shown as Right Barn Door

Must Specify (in this order):

Model #
Finish
Hardware Color
Acrylic or Acoustic Panels/Color

Description

- Standard with: Blocks, Beam Spanner, Four (4) End Caps, and Hardware to Create An *Approximately* 10"W x 8½"H Wall with Barn Door, including Leveling Glides
- Barn Door Features Soft Open and Soft Close to Avoid Door Slamming
- Must Specify Finish and Hardware Color (Door Track Available in Black Only)
- Must Specify Acrylic and/or Acoustical Inserts for Use in Barn Door Wall (Total 20 Inserts); Note: List Price Shown Above Does NOT Include These Required Inserts Due to Variance in Pricing

Must Specify Insert Options: 20 Acrylic and/or Acoustical Inserts (any combination)

AP-2020AP	Acoustic Insert - Must Specify Color Option and Add; See Acoustic Color Options		
MLK	Milky		\$ 260
TPE	Taupe		\$ 260
GRY	Grey		\$ 260
ASH	Ash		\$ 260
BLK	Black		\$ 260
AI-2020AC	Acrylic Insert - Must Specify Color Option and Add; See Acrylic Color Options		
FSTA	Frosted		\$ 303
TGWA	Twigwork		\$ 582
WOVA	Woven		\$ 582
RAFA	Raffia		\$ 582
TNSA	Tinsel		\$ 582

PLANTER BOX	01-1909PL	19¼	9½	6	16	2.0	\$ 569
-------------	-----------	-----	----	---	----	-----	--------

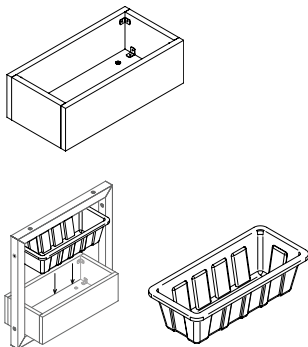
**Description**

- Material is TFL. Must Specify TFL (T) Color; [See Color Options](#)
- Planter Will Ship with Attachment Hardware: Two (2) Black and Two (2) Nickel Bolts
- Horizontal Grain
- Planter Boxes Cannot be Installed on Both Sides of a Corner
- Optional Planter Box Insert Sold Separately

Option: Specify & Add

PBI	Planter Box Insert, Black Plastic		\$ 52
-----	-----------------------------------	--	-------

Must Specify (in this order):

Model #
TFL Color
Optional Planter Insert

[See Overview for Square One Ordering Options.](#)

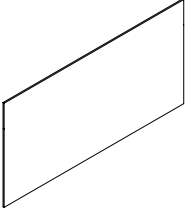
Item	Model No.	W	D	H	Ship Wt	Cubic Ft	List Price
ACOUSTICAL PANEL ONSET INSTALLATION 	46"H Panels						
	AP-4670AP	70¼	½	46¼	13	7.6	\$ 1246
	AP-4658AP	58¼	½	46¼	12	6.3	\$ 1054
	AP-4646AP	46¼	½	46¼	10	5.1	\$ 892
	22"H Panels						
	AP-2270AP	70¼	½	22¼	9	4.1	\$ 628
	AP-2258AP	58¼	½	22¼	8	3.4	\$ 525
	AP-2246AP	46¼	½	22¼	8	2.8	\$ 442
	AP-2234AP	34¼	½	22¼	7	2.1	\$ 368
	AP-2222AP	22¼	½	22¼	6	1.4	\$ 260

Must Specify (in this order):

Model #

Color

Description

- Onset Application, Installed with 9" Dual-Lock Connectors
- Sound Absorption Rating Average NRC 0.75 (50 mm Air Gap) 1.0 NRC in Mid-High Frequencies
- Cannot be Used on Same Side as TV Mount
- For Space Planning with Furniture, Note the Onset Application Will Add ½" to the Square One Blocks

Color Options: Must Specify; [See Color Options](#)

MLK Milky

TPE Taupe

GRY Grey

ASH Ash

BLK Black

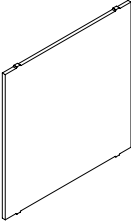
ACOUSTICAL PANEL INSET INSTALLATION 	For 24" Blocks						
	AP-2020AP	20¼	½	20¼	6	1.4	\$ 260
	For 12" Blocks						
	AP-0820AP	20¼	½	8¼	3	0.8	\$ 225

Description

- Inset Application; Includes Tabs to Secure in Place
- Sound Absorption Rating Average NRC 0.75 (50 mm Air Gap) 1.0 NRC in Mid-High Frequencies
- Cannot be Used with TV Mount

Color Options: Must Specify; [See Color Options](#)

MLK Milky

TPE Taupe

GRY Grey

ASH Ash

BLK Black

Must Specify (in this order):

Model #

Color

[See Overview for Square One Ordering Options.](#)

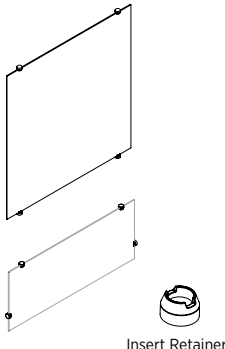
Item	Model No.	W	D	H	Ship Wt	Cubic Ft	List Price	
ACRYLIC INSERTS								
For 24" Blocks								
	AI-2020AC	20¼	½	20¼	7	2.0	\$ See Below	
	For 12" Blocks							
	AI-2008AC	8¾	½	20¼	6	2.0	\$ See Below	
	<i>Vertical Insert Applications</i>							
	AI-0820AC	20¼	½	8¾	6	2.0	\$ See Below	
	<i>Horizontal Insert Applications</i>							
Description								
<ul style="list-style-type: none"> Inserted Into 24" or 12" Blocks with Insert Retainers (Included) Raffia's Linear Pattern will be Installed Vertically on Both AI-2008AC (Vertical) and AI-0820AC (Horizontal) Frosted Acrylic Inserts can be customized with a logo or design using one of the following file types: .CDR, .AI, or .EPS. Email the image to customproduct@indianafurniture.com for a quote. Additional costs and lead times may apply. Note this as a special on your order when submitting. 								

Must Specify (in this order):

Model #

Color

Special Custom Logo

Color Options: Must Specify; See Color Options

FSTA	Frosted	24" \$	303
		12" \$	197
TGWA	Twigwork	24" \$	582
		12" \$	316
WOVA	Woven	24" \$	582
		12" \$	316
RAFA	Raffia	24" \$	582
		12" \$	316
TNSA	Tinsel	24" \$	582
		12" \$	316

For 12" Blocks



Raffia (RAFA)
Vertical Installation
Standard

DRY ERASE BOARDS



Must Specify (in this order):

Model #

Color

46"H Panels							
17-4670DEB	70¼	¾	46¼	11	0.2	\$	1749
17-4658DEB	58¼	¾	46¼	11	0.2	\$	1451
17-4646DEB	46¼	¾	46¼	11	0.2	\$	1151
22"H Panels							
17-2270DEB	70¼	¾	22¼	11	0.2	\$	1181
17-2258DEB	58¼	¾	22¼	11	0.2	\$	954
17-2246DEB	46¼	¾	22¼	11	0.2	\$	759

Description

- Nuts and Bolts Included for Onset Attachment
- May be Applied Horizontally or Vertically
- For Space Planning with Furniture, Note the Onset Application Will Add ¾" to the Square One Blocks

[See Overview for Square One Ordering Options.](#)

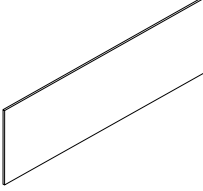
Item	Model No.	W	D	H	YARDS		GRADE COM/1/2/3	GRADE 4	GRADE 5	GRADE 6	GRADE 7	GRADE 8	GRADE 9	GRADE 10	
 <p>Must Specify (in this order): Model # Fabric Vendor/Pattern/Color</p>	TACKABLE PANELS														
	46"H Panels (2 pieces)														
	TB-4670TB	70¼	⅝	46¼	8.75	\$	2158	3374	3943	4521	5343	6201	7198	8353	
	TB-4658TB	58¼	⅝	46¼	7.25	\$	1903	2911	3382	3861	4542	5253	6079	7036	
	TB-4646TB	46¼	⅝	46¼	6.00	\$	1647	2481	2871	3267	3831	4419	5103	5895	
	22"H Panels (1 piece)														
	TB-2270TB	70¼	⅝	22¼	4.50	\$	1191	1817	2109	2406	2829	3270	3783	4377	
	TB-2258TB	58¼	⅝	22¼	3.75	\$	1034	1555	1799	2047	2399	2767	3194	3689	
	TB-2246TB	46¼	⅝	22¼	3.00	\$	871	1288	1483	1681	1963	2257	2599	2995	
	TB-2234TB	34¼	⅝	22¼	2.50	\$	711	1059	1221	1386	1621	1866	2151	2481	
	TB-2222TB	22¼	⅝	22¼	1.75	\$	545	788	902	1018	1182	1354	1553	1784	

Description

- Installed with 9" Dual-Lock Connectors
- Tackable Panels are Fully Upholstered on Both Sides.
- For Space Planning with Furniture, Note the Onset Application Will Add ⅝" to the Square One Blocks

Item	Model No.	W	D	H	Ship Wt	Cubic Ft	List Price
TV BRACKET	01-TVBR	3½	4	3	1	1.0	\$ 139

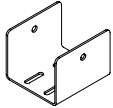

Description

- Black Metal
- Coordinates with TV Mount

TV MOUNT	01-TVMT	35¾	⅞	21⅝	15	0.5	\$ 1094
----------	---------	-----	---	-----	----	-----	---------

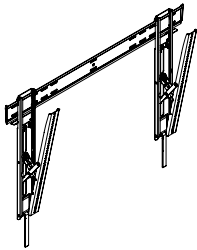

OPEN MARKET ONLY

Description

- Available in Black; Provides 12° of Smooth, Fingertip Tilt
- Compatible with Ultra-Thin TVs 2" (51 mm) Deep or Less; Typical Screen Sizes: 37" - 63"
- Weight Capacity: 100 lbs (45.4 kg)
- Can be Installed in Landscape Mode Only
- Must Order Two (2) 01-TVBR to Mount TV
- Not Compatible with Acrylic or Acoustical Inserts; Can be Used with Onset Acoustical Panels when Used on Opposite Sides

LEVELER KIT	17-LEVKIT				1	1.0	\$ 52
-------------	-----------	--	--	--	---	-----	-------

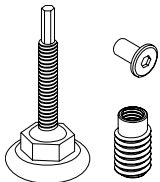

Description

- Includes Two (2) Levelers, Two (2) Insert Nuts and Two (2) Cap Nuts
- Must Specify Black (BLK) or Nickel (NCKL)

Must Specify (in this order):

Model # and Quantity
Hardware Color

[See Overview for Square One Ordering Options.](#)

Item	Model No.	W	D	H	Ship Wt	Cubic Ft	List Price
ALLEN DRIVER BIT	17-TOOL	-	-	-	1	1.0	\$ 59

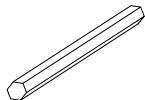
Description

- Used for Inserting Glide Insert Nuts for Levelers
- 6mm Allen Driver Bit

80MM BOLT AND NUT KIT	17-80MMBOLTKIT	-	-	-	1	1.0	\$ 50
-----------------------	----------------	---	---	---	---	-----	-------

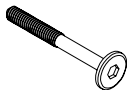

Description

- Quantity of Eight (8)
- For Connecting Block to Block
- Must Specify Black (BLK) or Nickel (NCKL)

Must Specify (in this order):

Model # and Quantity
Hardware Color

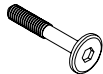
60MM BOLT AND NUT KIT	17-60MMBOLTKIT	-	-	-	1	1.0	\$ 39
-----------------------	----------------	---	---	---	---	-----	-------

Description

- Quantity of Eight (8)
- For Connecting Block to Beam, Post, or End Cap
- Must Specify Black (BLK) or Nickel (NCKL)

Must Specify (in this order):

Model # and Quantity
Hardware Color

12MM BOLT AND NUT KIT	17-12MMBOLTKIT	-	-	-	1	1.0	\$ 38
-----------------------	----------------	---	---	---	---	-----	-------

Description

- Quantity of Eight (8)
- For Covering Exposed Holes in Rails Only
- Must Specify Black (BLK) or Nickel (NCKL)

Must Specify (in this order):

Model # and Quantity
Hardware Color

[See Overview for Square One Ordering Options.](#)

Item	Model No.	W	D	H	Ship Wt	Cubic Ft	List Price
VESTA POWER CENTER	01-PDCTR	10¾	12	28¾	14	2.5	\$ 1776



Description

- Top Includes One (1) Power Outlet, Two (2) USB Ports and One (1) USBC Port; Base Includes Three (3) Outlet
- Available in White
- 120" Power Cord
- Built with Weight Distribution for Optimal Stability
- Base is 5" Tall

TIC-TAC-TOE FOAM GAME SET	17-XOSET	20¾	2	20¾	6	3.0	\$ 361
------------------------------	----------	-----	---	-----	---	-----	--------



Description

- Set Includes Five (5) Xs (Charcoal Gray) and Four (4) Os (Light Gray)
- Constructed of Polyurethane Foam

[See Overview for Square One Ordering Options.](#)

Synergy is a collection of partitions, tables, and seating to create spaces in an impromptu way without the need for complex architecture. This line promotes flexibility to adapt to different interactions, forming areas to gather, separate, and then gather again...all in personalized ways, and all within the same open space.

CONSTRUCTION

PARTITIONS

- Internal wood components are manufactured using plywood
- Partitions require some assembly including 75mm casters that are field installed
- Partitions Chassis consists of TFL frame, shelves (if applicable) and bottom panel

TABLES

- Table legs are 2"D, crafted from European Beech, and individually hand sanded prior to being finished with non-marring fixed nylon glides when casters are not selected
- Table tops have 1" thick Thermally-Fused Laminate (TFL) or High Pressure Laminate (HPL) surface with 3mm PVC edge band and Square edge profile; Designer White, Sugar Maple, and Williamsburg Cherry feature ABS edge bands



Square (Y)

- Tables require some assembly

SEATING

- All bench and stool joints are precisely fit with lag bolt connections for maximum strength and durability
- Stools and benches are rated for users up to 275lbs, ship fully assembled and feature 1½" thick High Grade Polyurethane Foam on the stools and bench seats
- Stool legs are 2"D, crafted from European Beech, and individually hand sanded prior to being finished with non-marring fixed nylon glides when casters are not selected

STORAGE

- Media Low Storage Partition on Casters includes soft close, touch latch hinged doors
- Soft close hinges reduce stress placed on the cabinet when the door is closed and offers a quiet closure
- Media Low Storage and Open Storage Partitions feature two (2) black grommets within the storage

PLANTER BOXES

- The planter box is made of ¾" thick thermally-fused laminate (TFL) particle-board core
- Grain direction runs horizontal
- Planter boxes are fastened together with screws and heavy-duty metal fasteners
- Optional Planter Insert is made of lightweight, fade-resistant, recyclable plastic

POWER/DATA/CORD MANAGEMENT

- Table top grommets and power/data units are available on center
- Table tops feature undersurface a 2"H metal accent to conceal wires and additional cord management is available for order; [See Accessories](#)
- Power/Data units available for in-surface mounting and comply with FCC Part 15A and UL
- Partitions with TV mount include a black grommet below TV mount, center wire channel, and grommet in bottom of unit for a clean and easy access to power.

HOW TO ORDER EXAMPLES

MODEL	QTY	DESCRIPTION	EXAMPLE		
PARTITIONS					
82-4872PT	1	TFL Chassis Color	NTM		
		Metal Accent	ALUM		
		Side A Panel	TKBP (Tackable Panel)		
		Tackable Upholstery	Mayer Fabrics Strata Cliff		
		TV Mount Option	TVSA		
		Side B Panel	TFLP (TFL Panel)		
82-4872CPT	1	TFL Panel Color	ORW		
		Hook Option	HKSB		
		TFL Chassis Color	KHE		
		Metal Accent	ALUM		
		Side A Panel	WHBP (Dry Erase Panel)		
		TV Mount Option	TVSA		
82-4872CPT	1	Side B Panel	TFLP (TFL Panel)		
		TFL Panel Color	CO		
		Hook Option	HKSB		
		PLANTER			
		82-4830PL	2	TFL Color	NTM
				Metal Accent	ALUM
TABLE					
82-3672BRT	1	Top Material	T		
		TFL Top Color	NTM		
		Metal Accent	ALUM		
		Leg Color	ORW		
		Leg Glide or Caster	BSC60 (Caster)		
		Grommet/Power	C		
POWER					
821	1	Duo Bezel Nema Plug	01-DUOBEZELS		
STOOLS					
821	4	Upholstery	CF Stinson Drift Tidepool		
		Leg Color	ORW		
		Foot Ring Metal Accent	ALUM		

PARTITION PANEL OPTIONS

Each side of a partition with panels can be personalized to meet the needs of your space; referred to as Side A Panel and Side B Panel. Select from TFL, Tackable Upholstery, or Dry Erase. Dry Erase Partitions also offer Glass Magnetic Marker Board Panels.

When a TFL Panel or Tackable Upholstery Panel is selected for both Side A and Side B, the same TFL color, or the same upholstery, will be used on both sides for a cohesive aesthetic.

Must specify Side A and Side B panel selection on order.

TFLP	TFL Panel
TKBP	Tackable Upholstered Panel
WHBP	Dry Erase Panel
BLMMB	Black Glass Magnetic Marker Board (82-4872PDE Only)
WHMMB	White Glass Magnetic Marker Board (82-4872PDE Only)

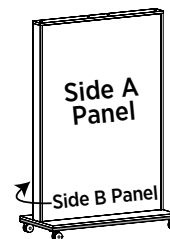

CONTRASTING TFL OPTIONS

Chassis, door fronts, and TFL panels available in contrasting colors. Must specify color of each component with order.

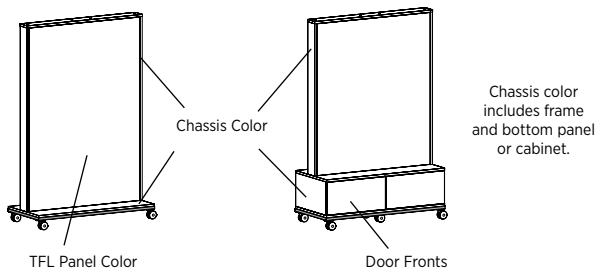

TFL (T) OR HPL (P) FOR TABLE TOP / TFL (T) OPTIONS FOR PARTITION CHASSIS AND PLANTER BOXES

WOODGRAIN

AS Asian Night	PNW Pinnacle Walnut
BW Beigewood	PTK Portico Teak
CO Columbian Walnut	RC River Cherry
EF Espresso	SCH Select Cherry
FLW Florence Walnut	SPW Sepia Walnut
GC Golden Cherry	SKC Shaker Cherry
HVM Harvest Maple	SBP Smoky Brown Pear
KHE Kirsche	TK Studio Teak
MW Mahogany Walnut	SM Sugar Maple
MNR Midnight Run	WTA Weathered Ash
NTM Natural Marrone	WNB White Nebbia
ORW Oak Riftwood	WC Williamsburg Cherry

SOLID

BL Black	FHG Fashion Grey
WH Designer White	SG Slate Grey

SEATING AND TABLE LEG WOOD FINISHES

Indiana Furniture uses a multi-step, hand finishing process on all exposed wood frames.

Units feature a catalyzed varnish finish which offers durability, lasting beauty, and resistance to normal wear.

AW Artisan Walnut	MAS Mesa Sunset*
AS Asian Night	MTS Metropolis Sky
BW Beigewood*	MNR Midnight Run
BL Black	NTM Natural Marrone*
CO Columbian Walnut	ORW Oak Riftwood*
DC Dark Cherry	PNW Pinnacle Walnut
DFW Dark Forest Walnut*	PTK Portico Teak*
WH Designer White	RC River Cherry*
EF Espresso	SCH Select Cherry
FO Fawn Oak*	SPW Sepia Walnut*
FLW Florence Walnut*	SKC Shaker Cherry
GC Golden Cherry	SBP Smoky Brown Pear*
HVM Harvest Maple*	TK Studio Teak
HW Harvest Walnut	SM Sugar Maple
HNW Henna Walnut	WTA Weathered Ash*
KHE Kirsche	WNB White Nebbia
LW Legacy Walnut	WC Williamsburg Cherry
MW Mahogany Walnut	

* Finish is Low Sheen

PARTITION, TABLE, AND FOOT RING METAL ACCENT COLORS

Metal accents are featured on tables, partitions, and stools in three colors. Must specify color.

ALUM	Aluminum	SNO	Snow
BLK	Black		

Aluminum (ALUM) Black (BLK) Snow (SNO)

TV MOUNT OPTIONS

TV Mounts are available on one side only. TFL or Tackable Upholstered Panels may be selected with TV Mount. When a TV Mount is specified, a black grommet and channel to the bottom chassis is provided for cord management. TV mount bracket coordinates with 42" TVs or smaller and cannot exceed 50lbs. Must specify and add when ordering.

TVSA	TV Mount Side A	\$ 196
TVSB	TV Mount Side B	\$ 196
NONE	No TV Mount	

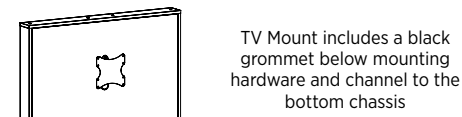

HOOK OPTIONS

A set of four (4) black hooks are available on TFL, Tackable Upholstery, and Dry Erase Panels. Hooks can be selected for both sides and will be factory installed 6" from each end and 12" between each hook. Hooks feature a 20lbs weight capacity. Must specify and add when ordering. Hooks may be purchased individually for use on vertical surfaces. [See Product Details.](#)

HKSA	Four (4) Black Hooks on Side A	\$ 152
HKSB	Four (4) Black Hooks on Side B	\$ 152
NONE	No Hooks	

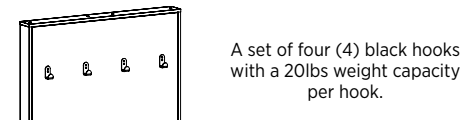

LOCKING DOOR OPTION

Locking doors are available on the Media Low Storage Partition on Casters. Must specify and add when ordering.

LKT-DB2	Locking Doors	\$ 91
---------	---------------	-------

TABLE GLIDE OR CASTER OPTIONS

Tables available with casters or glides. Must specify.

	GLIDES	Fixed Glides	N/C
	BSC60	60mm Soft Caster	\$ 117

GROMMET & POWER/DATA UNIT OPTIONS & LOCATIONS

Grommets and Power/Data units available in center of table tops. Specify Center (C) location on order. Grommet and power/data units must be ordered separately. Tops may also be ordered without grommet/power units by specifying NO GROMMET on order.

Only one grommet/power/data unit per top. [See Product Details](#)

LOCATION OPTION

C On Center

GROMMET OPTIONS

GC Grommet, Center \$ 52

POWER/DATA UNIT OPTIONS [See Product Details and Pricing](#)

DUO CLAMP Available in Black (B), Silver (S), or White (W)

TRIO CLAMP Available in Black (B), Silver (S), or White (W)

DUO BEZEL Available in Black (B), Silver (S), or White (W)

TRIO BEZEL Available in Black (B), Silver (S), or White (W)

DPORT4 Available in Aluminum or Black

DOCK950 Available in Black or White

DOCK150 Available in Black or White

CERTIFICATIONS & COMPLIANCE

- Intertek Sustainability Certified
- BIFMA Compliant® Certified
- TSCA Title VI (formerly CARB) Compliance
- Contributes to LEED®, Green Globes®, and WELL® Sustainable Programs

Partitions

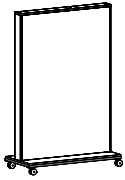

Partition on Casters [\(See Details\)](#)

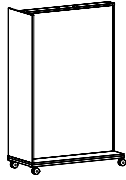

Corner Partition on Casters [\(See Details\)](#)

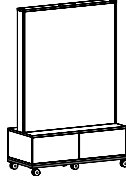

Media Low Storage Partition on Casters [\(See Details\)](#)

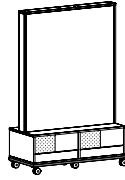

Media Low Open Storage Partition on Casters [\(See Details\)](#)

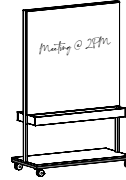

Dry Erase Partition on Casters [\(See Details\)](#)

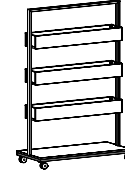

Planter Box Partition on Casters [\(See Details\)](#)

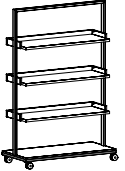

Shelf Partition on Casters [\(See Details\)](#)

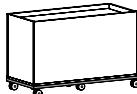

Planter on Casters [\(See Details\)](#)

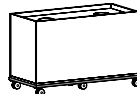

Recycle Bin on Casters [\(See Details\)](#)

Tables

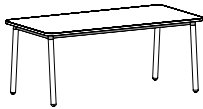

Seated Height Tables [\(See Details\)](#)

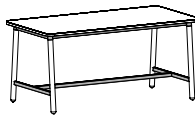

Counter Height Tables [\(See Details\)](#)

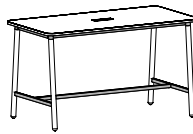

Standing Height Tables [\(See Details\)](#)

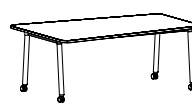

Seated Height View Tables [\(See Details\)](#)

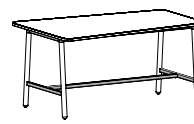

Counter Height View Tables [\(See Details\)](#)

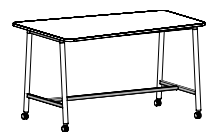

Standing Height View Tables [\(See Details\)](#)

Seating

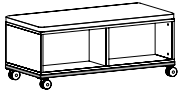

Cubby Bench With Casters [\(See Details\)](#)

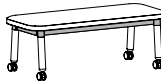

Team Bench With Casters [\(See Details\)](#)

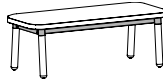

Team Bench With Glides [\(See Details\)](#)



Stool With Casters [\(See Details\)](#)



Stool With Glides [\(See Details\)](#)



Counter Height Stool With Glides [\(See Details\)](#)



Bar Height Stool With Glides [\(See Details\)](#)

Wire Management & Power/Data Accessories

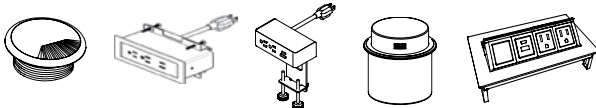

Power Options [\(See Multiple Unit Details\)](#)

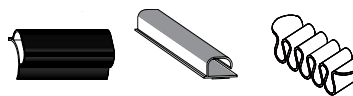

Wire Management [\(See Multiple Unit Details\)](#)



Accessories [\(See Details\)](#)

IDEA STARTERS

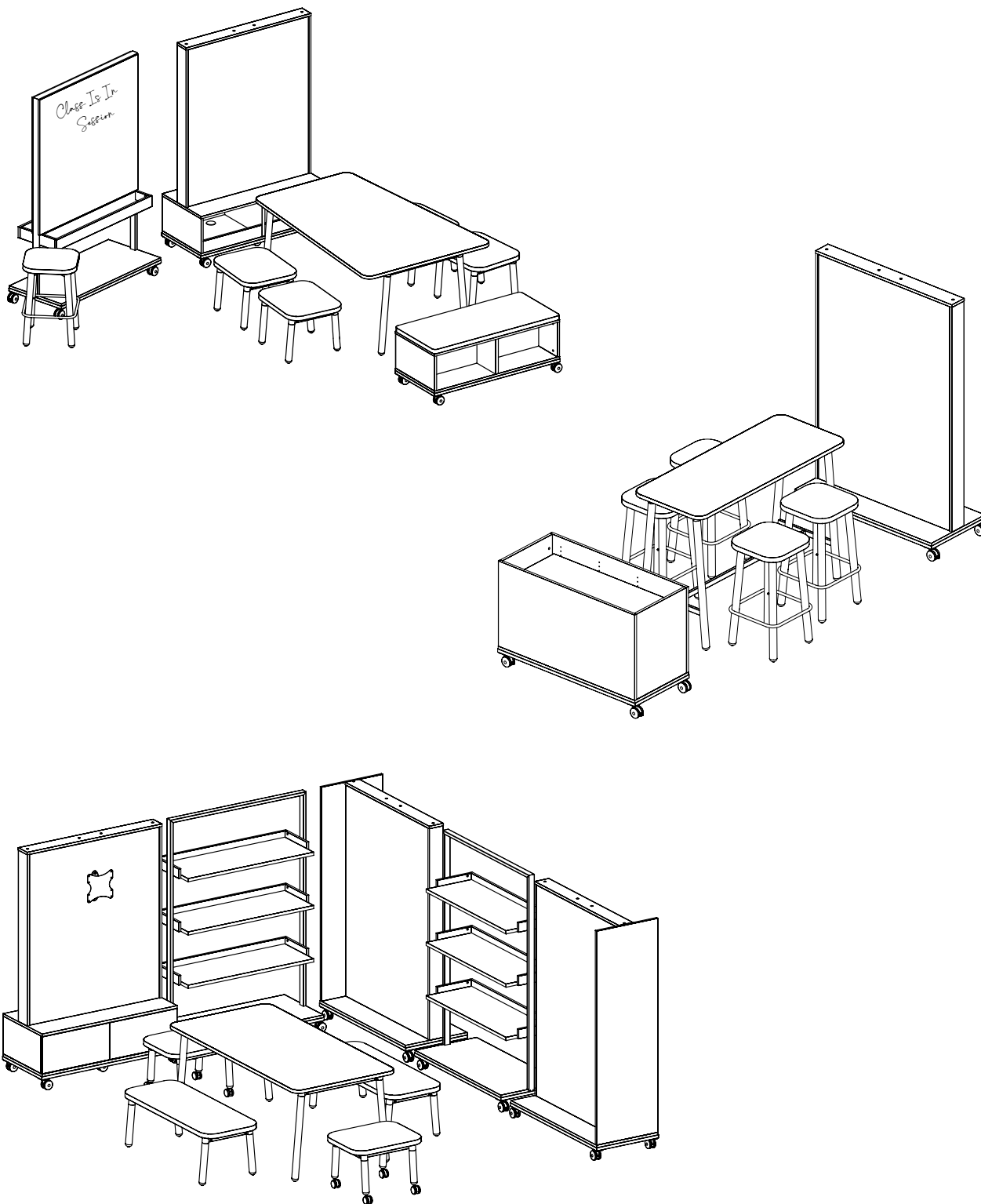

Item	Model No.	W	D	H	Ship Wt	Cubic Ft	List Price
PARTITION ON CASTERS	82-4872PT	48	22	73	290	48.6	T\$ 2991

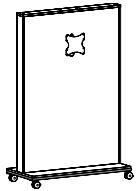

Side A Shown with TFL Panel and TV Mount

Must Specify (in this order):

- Model #
- TFL Chassis Color
- Metal Accent Finish
- Side A Panel Options
 - TFL Panel Color (If Applicable)
 - Tackable Upholstery (If Applicable)
 - TV Mount
 - Hook Options
- Side B Panel Options
 - TFL Panel Color (If Applicable)
 - Tackable Upholstery (If Applicable)
 - TV Mount
 - Hook Options

Description

- Standard with: Four (4) 75mm Casters are Field Installed; Two (2) Locking on Side A, Two (2) Non-Locking on Side B
- Must Specify TFL Chassis Color; [See TFL Colors and Specify](#)
- Chassis and TFL Panels (TFLP) Available in Contrasting Colors
- Metal Accent Color; Must Specify Black (BLK), Aluminum (ALUM), or Snow (SNO), [See Details](#)
- Panels for Side A and Side B Available with TFL Panel (TFLP), Tackable Upholstered Panel (TKBP), Dry Erase Panels (WHBP); See Option Details Below
- When TFL Panels (TFLP) are Selected for Both Side A and B, Choose One Color
- When Tackable Upholstered Panels (TKBP) are Selected for Both Side A and B, Choose One Fabric
- Optional TV Mount and Black Grommet Available on One Side; Must Specify Side A (TVSA), Side B (TVSB), or No TV Mount (NONE), See Below
- Optional Hooks Available, Four (4) Black Hooks Included, Must Specify Hooks Side A (HKSA), Hooks Side B (HKSB), or No Hooks (NONE), See Below

Side A Specify & Add:

Side A Panel Options:

TFLP	TFL Panel	N/C
TKBP	Tackable Upholstered Panel	See Pricing Below
WHBP	Dry Erase Panels	\$ 285

Side A Panel Accessories Options: (Choose One)

TVSA	TV Mount Side A (Available on One Side Only)	\$ 196
HKSA	Four (4) Black Hooks Side A	\$ 152
NONE	No Accessories	N/C

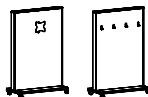

Side A (TKBP) Tackable Upholstered Panel Pricing

List Price/Grade	Yards	COM/1	2	3	4	5	6	7	8	9	10
Tackable Panel	2.00	\$ 285	389	477	563	693	825	1013	1209	1437	1701

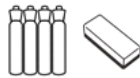

Take Notes or Set Action Items with Dry Erase Panels and the Marker/Erase Sets [\(See Sets\)](#)

Side B Specify & Add:

Side B Panel Options:

TFLP	TFL Panel	N/C
TKBP	Tackable Upholstered Panel	See Pricing Below
WHBP	Dry Erase Panels	\$ 285

Side B Panel Accessories Options: (Choose One)

TVSB	TV Mount Side B (Available on One Side Only)	\$ 196
HKSB	Four (4) Black Hooks Side B	\$ 152
NONE	No Accessories	N/C

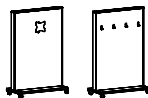

Side B (TKBP) Tackable Upholstered Panel Pricing - Must Match Side A

List Price/Grade	Yards	COM/1	2	3	4	5	6	7	8	9	10
Tackable Panel	2.00	\$ 285	389	477	563	693	825	1013	1209	1437	1701

Item	Model No.	W	D	H	Ship Wt	Cubic Ft	List Price
CORNER PARTITION ON CASTERS	82-4872CPT	48	22	73	311	48.6	T\$ 3089

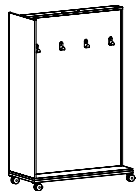

Side A Shown with Dry Erase Panel and Hooks

Must Specify (in this order):

- Model #
- TFL Chassis Color
- Metal Accent Finish
- Side A Panel Options
 - TFL Panel Color (If Applicable)
 - Tackable Upholstery (If Applicable)
 - TV Mount
 - Hook Options
- Side B Panel Options
 - TFL Panel Color (If Applicable)
 - Tackable Upholstery (If Applicable)
 - TV Mount
 - Hook Options

Description

- Corner Panel on Left When Facing Side A
- Standard with: Four (4) 75mm Casters are Field Installed; Two (2) Locking on Side A, Two (2) Non-Locking on Side B
- Must Specify TFL Chassis Color; [See TFL Colors and Specify](#)
- Chassis and TFL Panel Available in Contrasting Colors
- Metal Accent Color; Must Specify Black (BLK), Aluminum (ALUM), or Snow (SNO); [See Details](#)
- Panels for Side A and Side B Available with TFL Panel (TFLP), Tackable Upholstered Panel (TKBP), Dry Erase Panels (WHBP); See Option Details Below
- When TFL Panels (TFLP) are Selected for Both Side A and B, Choose One Color
- When Tackable Upholstered Panels (TKBP) are Selected for Both Side A and B, Choose One Fabric
- Optional TV Mount and Black Grommet Available on One Side; Must Specify Side A (TVSA), Side B (TVSB), or No TV Mount (NONE), See Below
- Optional Hooks Available, Four (4) Black Hooks Included, Must Specify Hooks Side A (HKSA), Hooks Side B (HKSB), or No Hooks (NONE), See Below

Side A Specify & Add:

Side A Panel Options:		
TFLP	TFL Panel	N/C
TKBP	Tackable Upholstered Panel	See Pricing Below
WHBP	Dry Erase Panels	\$ 285

Side A Panel Accessories Options: (Choose One)

TVSA	TV Mount Side A (Available on One Side Only)	\$ 196
HKSA	Four (4) Black Hooks Side A	\$ 152
NONE	No Accessories	N/C

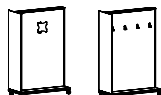

Side A (TKBP) Tackable Upholstered Panel Pricing

List Price/Grade	Yards	COM/1	2	3	4	5	6	7	8	9	10
Tackable Panel	2.00	\$ 285	389	477	563	693	825	1013	1209	1437	1701



Take Notes or Set Action Items with Dry Erase Panels and the Marker/Erase Sets [\(See Sets\)](#)

Side B Specify & Add:

Side B Panel Options:		
TFLP	TFL Panel	N/C
TKBP	Tackable Upholstered Panel	See Pricing Below
WHBP	Dry Erase Panels	\$ 285

Side B Panel Accessories Options: (Choose One)

TVSB	TV Mount Side B (Available on One Side Only)	\$ 196
HKSB	Four (4) Black Hooks Side B	\$ 152
NONE	No Accessories	N/C

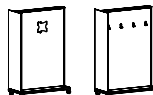

Side B (TKBP) Tackable Upholstered Panel Pricing - Must Match Side A

List Price/Grade	Yards	COM/1	2	3	4	5	6	7	8	9	10
Tackable Panel	2.00	\$ 285	389	477	563	693	825	1013	1209	1437	1701

Item	Model No.	W	D	H	Ship Wt	Cubic Ft	List Price
MEDIA LOW STORAGE PARTITION ON CASTERS	82-4872PMLS	48	22	73	290	48.6	T\$ 3507

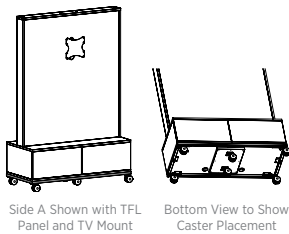

Description

- Standard with: Six (6) 75mm Casters are Field Installed; Two (2) Locking on Side A, Two (2) Non-Locking on Side B, and Two (2) Non-Locking in Center of Bottom
- Two (2) Black Grommets on Side A for Easy Accessibility to Power
- Must Specify TFL Chassis Color; [See TFL Colors and Specify](#)
- Chassis, Doors, and TFL Panel(s) Available in Contrasting Colors
- Metal Accent Color; Must Specify Black (BLK), Aluminum (ALUM), or Snow (SNO), [See Details](#)
- Panels for Side A and Side B Available with TFL Panel (TFLP), Tackable Upholstered Panel (TKBP), Dry Erase Panels (WHBP); See Option Details Below
- When TFL Panels (TFLP) are Selected for Both Side A and B, Choose One Color
- When Tackable Upholstered Panels (TKBP) are Selected for Both Side A and B, Choose One Fabric
- Optional TV Mount Available on One Side; Must Specify Side A (TVSA), Side B (TVSB), or No TV Mount (NONE), See Below
- Optional Hooks Available, Four (4) Black Hooks Included, Must Specify Hooks Side A (HKSA), Hooks Side B (HKSB), or No Hooks (NONE), See Below
- Non-Locking, Touch Latch, Soft Close Doors Standard with Optional Locking, [See Details](#)
- Safely Write on Optional Black and White Glass Magnetic Marker Panel With Marker and Eraser, [Sets See Set Details](#)
- Rare Earth Magnets Easily Work on Glass Magnetic Marker Panels; [See Set Details](#)

Must Specify (in this order):

- Model #
- TFL Chassis Color
- Metal Accent Finish
- Side A Panel Options
 - TFL Panel Color (If Applicable)
 - Tackable Upholstery (If Applicable)
 - TV Mount
 - Hook Options
- Side B Panel Options
 - TFL Panel Color (If Applicable)
 - Tackable Upholstery (If Applicable)
 - TV Mount
 - Hook Options
- Door Color
- Locking Door Option

Side A Specify & Add:

Side A Panel Options:

TFLP	TFL Panel	N/C
TKBP	Tackable Upholstered Panel	See Pricing Below
WHBP	Dry Erase Panels	\$ 285

Side A Panel Accessories Options: (Choose One)

TVSA	TV Mount Side A (Available on One Side Only)	\$ 196
HKSA	Four (4) Black Hooks Side A	\$ 152
NONE	No Accessories	N/C

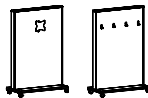

Side A (TKBP) Tackable Upholstered Panel Pricing

List Price/Grade	Yards	COM/1	2	3	4	5	6	7	8	9	10
Tackable Panel	1.75	\$ 252	343	420	495	609	725	889	1061	1260	1491



Take Notes or Set Action Items with Dry Erase Panels and the Marker/Eraser Sets ([See Sets](#))

Side B Specify & Add:

Side B Panel Options:

TFLP	TFL Panel	N/C
TKBP	Tackable Upholstered Panel	See Pricing Below
WHBP	Dry Erase Panels	\$ 285

Side B Panel Accessories Options: (Choose One)

TVSB	TV Mount Side B (Available on One Side Only)	\$ 196
HKSB	Four (4) Black Hooks Side B	\$ 152
NONE	No Accessories	N/C

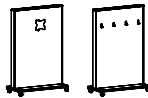

Side B (TKBP) Tackable Upholstered Panel Pricing - Must Match Side A

List Price/Grade	Yards	COM/1	2	3	4	5	6	7	8	9	10
Tackable Panel	1.75	\$ 252	343	420	495	609	725	889	1061	1260	1491

P = HPL W = Veneer

[See Synergy Overview For Ordering Options](#)

Item	Model No.	W	D	H	Ship Wt	Cubic Ft	List Price
MEDIA LOW OPEN STORAGE PARTITION ON CASTERS	82-4872PML0S	48	22	73	311	48.6	T\$ 3365

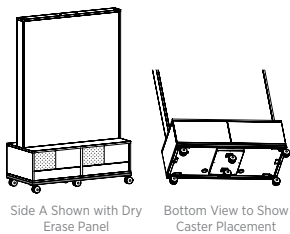

Side A Shown with Dry Erase Panel Bottom View to Show Caster Placement

Description

- Standard with: Six (6) 75mm Casters are Field Installed; Two (2) Locking on Side A, Two (2) Non-Locking on Side B, and Two (2) Non-Locking in Center of Bottom
- Two (2) Black Grommets Included, One (1) Black Grommet Inside Each Cubby for Easy Accessibility to Power
- Two (2) Open Storage Cubbies Per Unit; 22½"W x 20"D x 12"H with an 8" Opening in Front and 4" Guard to Contain Stored Items when Unit is Moved. Patterned Portion of Art Shows Back Panel
- Must Specify TFL Chassis Color; [See TFL Colors and Specify](#)
- Chassis and TFL Panel Available in Contrasting Colors
- Metal Accent Color; Must Specify Black (BLK), Aluminum (ALUM), or Snow (SNO), [See Details](#)
- Panels for Side A and Side B Available with TFL Panel (TFLP), Tackable Upholstered Panel (TKBP), Dry Erase Panels (WHBP); See Option Details Below
- When TFL Panels (TFLP) are Selected for Both Side A and B, Choose One Color
- When Tackable Upholstered Panels (TKBP) are Selected for Both Side A and B, Choose One Fabric
- Optional TV Mount Available on One Side; Must Specify Side A (TVSA), Side B (TVSB), or No TV Mount(NONE), See Below
- Optional Hooks Available, Four (4) Black Hooks Included, Must Specify Hooks Side A (HKSA), Hooks Side B (HKSB), or No Hooks (NONE), See Below
- Safely Write on Optional Black and White Glass Magnetic Marker Panel With Marker and Eraser, [Sets See Set Details](#)
- Rare Earth Magnets Easily Work on Glass Magnetic Marker Panels; [See Set Details](#)

Must Specify (in this order):

- Model #
- TFL Chassis Color
- Metal Accent Finish
- Side A Panel Options
 - TFL Panel Color (If Applicable)
 - Tackable Upholstery (If Applicable)
 - TV Mount
 - Hook Options
- Side B Panel Options
 - TFL Panel Color (If Applicable)
 - Tackable Upholstery (If Applicable)
 - TV Mount
 - Hook Options

Side A Specify & Add:

Side A Panel Options:

TFLP	TFL Panel	N/C
TKBP	Tackable Upholstered Panel	See Pricing Below
WHBP	Dry Erase Panels	\$ 285

Side A Panel Accessories Options: (Choose One)

TVSA	TV Mount Side A (Available on One Side Only)	\$ 196
HKSA	Four (4) Black Hooks Side A	\$ 152
NONE	No Accessories	N/C

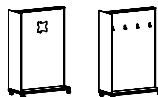

Side A (TKBP) Tackable Upholstered Panel Pricing

List Price/Grade	Yards	COM/1	2	3	4	5	6	7	8	9	10
Tackable Panel	1.75	\$ 252	343	420	495	609	725	889	1061	1260	1491



Take Notes or Set Action Items with Dry Erase Panels and the Marker/Eraser Sets ([See Sets](#))

Side B Specify & Add:

Side B Panel Options:

TFLP	TFL Panel	N/C
TKBP	Tackable Upholstered Panel	See Pricing Below
WHBP	Dry Erase Panels	\$ 285

Side B Panel Accessories Options: (Choose One)

TVSB	TV Mount Side B (Available on One Side Only)	\$ 196
HKSB	Four (4) Black Hooks Side B	\$ 152
NONE	No Accessories	N/C

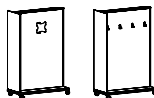

Side B (TKBP) Tackable Upholstered Panel Pricing - Must Match Side A

List Price/Grade	Yards	COM/1	2	3	4	5	6	7	8	9	10
Tackable Panel	1.75	\$ 252	343	420	495	609	725	889	1061	1260	1491

P = HPL W = Veneer

[See Synergy Overview For Ordering Options](#)

Item	Model No.	W	D	H	Ship Wt	Cubic Ft	List Price
DRY ERASE PARTITION ON CASTERS	82-4872PDE	48	22	73	290	48.6	WHBP \$ 4138
							BLMMB \$ 10885
							WHMMB \$ 10885

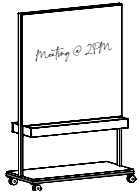

Shown with Dry Erase Panels

Description

- Standard with: Four (4) 75mm Casters are Field Installed; Two (2) Locking on Side A, Two (2) Non-Locking on Side B
- Must Specify TFL Chassis Color; [See TFL Colors and Specify](#)
- Metal Accent Color; Must Specify Black (BLK), Aluminum (ALUM), or Snow (SNO), [See Details](#)
- Panels Available with Dry Erase Panels (WHBP), Black Glass Magnetic Marker Panels (BLMMB), or White Glass Magnetic Marker Panels (WHMMB)
- Safely Write on Optional Black and White Glass Magnetic Marker Panel With Marker and Eraser Sets [See Set Details](#)
- Pin a Note with the Rare Earth Magnets on Glass Magnetic Marker Panels; [See Set Details](#)

Must Specify (in this order):

- Model #
- TFL Chassis Color
- Metal Accent Finish
- Panel Options



Take Notes or Set Action Items with the Marker/Eraser and Magnet Sets ([See Sets](#))

PLANTER BOX PARTITION ON CASTERS	82-4872PPB	48	22	73	160	48.6	T\$ 3650
----------------------------------	------------	----	----	----	-----	------	----------

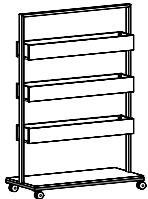

Description

- Standard with: Three Planter Boxes, Four (4) 75mm Casters are Field Installed; Two (2) Locking on Side A, Two (2) Non-Locking on Side B
- Planter Boxes are 9"D x 6"H
- Must Specify TFL Chassis Color; [See TFL Colors and Specify](#)
- Metal Accent Color; Must Specify Black (BLK), Aluminum (ALUM), or Snow (SNO), [See Details](#)
- We Recommend Using Optional Planter Inserts (See Below) to Protect Planter Boxes from Water

Must Specify (in this order):

- Model #
- TFL Chassis Color
- Metal Accent Finish
- Planter Inserts



Option: Specify & Add

PBI6	Planter Box Insert, Six (6) Black Plastic Inserts	\$ 284
------	---	--------

Item	Model No.	W	D	H	Ship Wt	Cubic Ft	List Price
SHELF PARTITION ON CASTERS	82-4872PSP	48	22	73	105	48.6	T\$ 3712

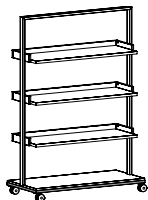

Description

- Standard with: Four (4) 75mm Casters are Field Installed; Two (2) Locking on Side A, Two (2) Non-Locking on Side B
- Shelves are 44½"W x 16"D with 16⅞" Between Each Shelf
- Shelves Feature 100lb Weight Capacity
- Must Specify TFL Chassis Color; [See TFL Colors and Specify](#)
- Metal Accent Color; Must Specify Black (BLK), Aluminum (ALUM), or Snow (SNO), [See Details](#)

Must Specify (in this order):

Model #
TFL Chassis Color
Metal Accent Finish

PLANTER ON CASTERS	82-4830PL	48	22	31	178	19.6	T\$ 2115
--------------------	-----------	----	----	----	-----	------	----------

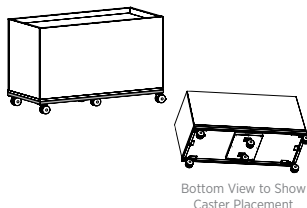

Description

- Standard with: Six (6) 75mm Casters are Field Installed; Two (2) Locking on Side A, Two (2) Non-Locking on Side B, and Two (2) Non-Locking in Center of Bottom
- Top Shelf is 1" Smaller for Easy Removal and Adjusts From 1⅞" to 8⅞" Deep to Accommodate Different Sized Flower Pots
- **Shelf Feature 100lb Weight Capacity**
- Must specify TFL Chassis; [See TFL Colors and Specify](#)
- Metal Accent Color; Must Specify Black (BLK), Aluminum (ALUM), or Snow (SNO), [See Details](#)
- Flower Pots or Planters Not Included

Must Specify (in this order):

Model #
TFL Chassis Color
Metal Accent Finish

RECYCLE BIN ON CASTERS	82-4830RB	48	22	31	183	19.6	T\$ 2375
------------------------	-----------	----	----	----	-----	------	----------

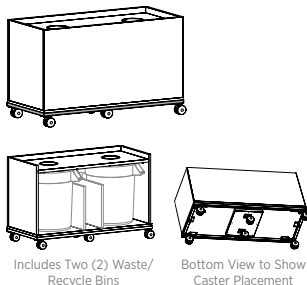



Description

- Standard with: Two (2) 20 Gallon Waste/Recycle Bins, Six (6) 75mm Casters are Field Installed; Two (2) Locking on Side A, Two (2) Non-Locking on Side B, and Two (2) Non-Locking in Center of Bottom
- Top Shelf 1" Smaller for Easy Removal to Access Recycle Bins; Fixed Side Panels
- Must Specify TFL Chassis; [See TFL Colors and Specify](#)
- Metal Accent Color; Must Specify Black (BLK), Aluminum (ALUM), or Snow (SNO), [See Details](#)

Must Specify (in this order):

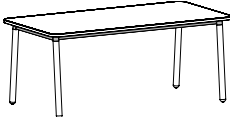
Model #
TFL Chassis Color
Metal Accent Finish

Item	Model No.	W	D	H	Ship Wt	Cubic Ft	List Price
  <p>Top Shape</p>	82-4296RT	96	42	30	141	25.5	T\$ 2824 P\$ 3177
	82-4284RT	84	42	30	127	22.4	T\$ 2725 P\$ 3142
	82-4272RT	72	42	30	115	19.3	T\$ 2626 P\$ 2715
	82-3696RT	96	36	30	126	22.7	T\$ 2716 P\$ 3142
	82-3684RT	84	36	30	115	19.9	T\$ 2630 P\$ 3111
	82-3672RT	72	36	30	103	17.1	T\$ 2491 P\$ 2551
	82-3660RT	60	36	30	90	14.4	T\$ 2345 P\$ 2460
	82-3072RT	72	30	30	86	13.3	T\$ 2313 P\$ 2428
	82-3060RT	60	30	30	76	11.1	T\$ 2180 P\$ 2218
	82-2472RT	72	24	30	76	12	T\$ 2231 P\$ 2286
	82-2460RT	60	24	30	67	10	T\$ 2111 P\$ 2195

Must Specify (in this order):

- Model #
- Top Material
- Top Color
- Metal Accent Color
- Leg Color
- Leg Glide or Casters
- Grommet/Power





Use the Black Undermount Hook For Purses, Bags, Etc. [\(See Details\)](#)

Description

- TFL and HPL Tops; [See TFL and HPL Colors and Specify](#)
- Undermount Metal Accents Measure 2”H, 1” Thick, and is Available in Black (BLK), Aluminum (ALUM), or Snow (SNO); Must Specify Color, [See Details](#)
- Top and Legs Available in Contrasting Colors; [See Leg Color Options](#)
- Legs Available with Fixed Glides (GLIDES) or Four (4) 60mm Casters (BSC60), Two (2) Locking and Two (2) Non-Locking; [See Details and Specify](#)
- Some Assembly Required
- Power and Grommet Available on Center Only; [See Options](#)

T= TFL P= HPL

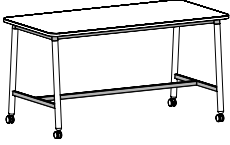
[See Synergy Overview For Ordering Options](#)

Item	Model No.	W	D	H	Ship Wt	Cubic Ft	List Price
 <p>Table Shown with Casters</p>  <p>Top Shape</p> <p>Must Specify (in this order): Model # Top Material Top Color Metal Accent Color Leg Color Leg Glide or Casters Grommet/Power</p>	82-4296CRT	96	42	36	152	25.5	T\$ 3205 P\$ 3558
	82-4284CRT	84	42	36	139	22.4	T\$ 3106 P\$ 3523
	82-4272CRT	72	42	36	126	19.3	T\$ 3007 P\$ 3096
	82-3696CRT	96	36	36	137	22.7	T\$ 3097 P\$ 3523
	82-3684CRT	84	36	36	126	19.9	T\$ 3011 P\$ 3492
	82-3672CRT	72	36	36	115	17.1	T\$ 2873 P\$ 2932
	82-3660CRT	60	36	36	101	14.4	T\$ 2861 P\$ 2976
	82-3072CRT	72	30	36	98	13.3	T\$ 2669 P\$ 2784
	82-3060CRT	60	30	36	85	11.1	T\$ 2671 P\$ 2709
	82-2472CRT	72	24	36	86	12	T\$ 2587 P\$ 2642
	82-2460CRT	60	24	36	76	10	T\$ 2602 P\$ 2686

Description



- TFL and HPL Tops; [See TFL and HPL Colors and Specify](#)
- Undermount and Lower Metal Accents Measure 2"H, 1" Thick, and is Available in Black (BLK), Aluminum (ALUM), or Snow (SNO); Must Specify Color, [See Details](#)
- Top and Legs Available in Contrasting Colors; [See Leg Color Options](#)
- Legs Available with Fixed Glides (GLIDES) or Four (4) 60mm Casters (BSC60), Two (2) Locking and Two (2) Non-Locking; [See Details and Specify](#)
- Some Assembly Required
- Power and Grommet Available on Center Only; [See Options](#)



Use the Black Undermount Hook For Purses, Bags, Etc. [\(See Details\)](#)

T= TFL P= HPL

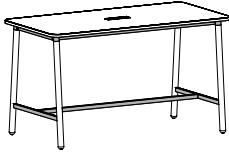
[See Synergy Overview For Ordering Options](#)

Item	Model No.	W	D	H	Ship Wt	Cubic Ft	List Price
 <p>Table Shown with TRIO on Center</p>  <p>Top Shape</p> <p><u>Must Specify (in this order):</u> Model # Top Material Top Color Metal Accent Color Leg Color Leg Glide or Casters Grommet/Power</p>	82-4296BRT	96	42	42	154	25.5	T\$ 3411 P\$ 3763
	82-4284BRT	84	42	42	141	22.4	T\$ 3311 P\$ 3728
	82-4272BRT	72	42	42	128	19.3	T\$ 3212 P\$ 3301
	82-3696BRT	96	36	42	139	22.7	T\$ 3302 P\$ 3729
	82-3684BRT	84	36	42	128	19.9	T\$ 3216 P\$ 3697
	82-3672BRT	72	36	42	117	17.1	T\$ 3078 P\$ 3138
	82-3660BRT	60	36	42	103	14.4	T\$ 2905 P\$ 3020
	82-3072BRT	72	30	42	100	13.3	T\$ 2861 P\$ 2975
	82-3060BRT	60	30	42	86	11.1	T\$ 2701 P\$ 2739
	82-2472BRT	72	24	42	88	12	T\$ 2779 P\$ 2833
	82-2460BRT	60	24	42	77	10	T\$ 2632 P\$ 2716

Description

- TFL and HPL Tops; [See TFL and HPL Colors and Specify](#)
- Undermount and Lower Metal Accents Measure 2"H, 1" Thick, and is Available in Black (BLK), Aluminum (ALUM), or Snow (SNO); Must Specify Color, [See Details](#)
- Top and Legs Available in Contrasting Colors; [See Leg Color Options](#)
- Legs Available with Fixed Glides (GLIDES) or Four (4) 60mm Casters (BSC60), Two (2) Locking and Two (2) Non-Locking; [See Details and Specify](#)
- Some Assembly Required
- Power and Grommet Available on Center Only; [See Options](#)

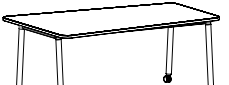
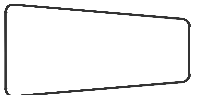

Use the Black Undermount Hook For Purses, Bags, Etc. ([See Details](#))

Item	Model No.	W	D	H	Ship Wt	Cubic Ft	List Price
 <p>Table Shown with Casters</p>  <p>Top Shape</p> <p><u>Must Specify (in this order):</u> Model # Top Material Top Color Metal Accent Color Leg Color Leg Glide or Casters Grommet/Power</p>	82-3672VT	72	36-48	30	118	21	T\$ 2704 P\$ 2738
	82-2472VT	72	24-36	30	90	17.1	T\$ 2405 P\$ 2465

Description

- TFL and HPL Tops; [See TFL and HPL Colors and Specify](#)
- Undermount Metal Accents Measure 2"H, 1" Thick, and is Available in Black (BLK), Aluminum (ALUM), or Snow (SNO); Must Specify Color, [See Details](#)
- Top and Legs Available in Contrasting Colors; [See Leg Color Options](#)
- Legs Available with Fixed Glides (GLIDES) or Four (4) 60mm Casters (BSC60), Two (2) Locking and Two (2) Non-Locking; [See Details and Specify](#)
- Some Assembly Required
- Power and Grommet Available on Center Only; [See Options](#)



Use the Black Undermount Hook For Purses, Bags, Etc. ([See Details](#))

T= TFL P= HPL

[See Synergy Overview For Ordering Options](#)

Item	Model No.	W	D	H	Ship Wt	Cubic Ft	List Price
COUNTER HEIGHT VIEW TABLE	82-3672CVT	72	36-48	36	129	21	T\$ 3085 P\$ 3119
	82-2472CVT	72	24-36	36	100	17.1	T\$ 2761 P\$ 2821

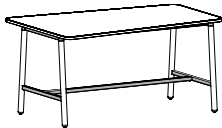

Top Shape

Must Specify (in this order):

- Model #
- Top Material
- Top Color
- Metal Accent Color
- Leg Color
- Leg Glide or Casters
- Grommet/Power



Use the Black Undermount Hook For Purses, Bags, Etc. [\(See Details\)](#)

Description

- TFL and HPL Tops; [See TFL and HPL Colors and Specify](#)
- Undermount and Lower Metal Accents Measure 2"H, 1" Thick, and is Available in Black (BLK), Aluminum (ALUM), or Snow (SNO); Must Specify Color, [See Details](#)
- Top and Legs Available in Contrasting Colors; [See Leg Color Options](#)
- Legs Available with Fixed Glides (GLIDES) or Four (4) 60mm Casters (BSC60), Two (2) Locking and Two (2) Non-Locking; [See Details and Specify](#)
- Two (2) Cubbies on Each Side; Each Cubby is 22½"W x 10¼"D x 12"H
- Some Assembly Required
- Power and Grommet Available on Center Only; [See Options](#)

STANDING HEIGHT VIEW TABLE	82-3672BVT	72	36-48	42	131	21	T\$ 3291 P\$ 3325
	82-2472BVT	72	24-36	42	102	17.1	T\$ 2952 P\$ 3012

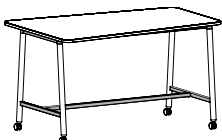

Table Shown with Casters



Top Shape

Must Specify (in this order):

- Model #
- Top Material
- Top Color
- Metal Accent Color
- Leg Color
- Leg Glide or Casters
- Grommet/Power



Use the Black Undermount Hook For Purses, Bags, Etc. [\(See Details\)](#)

Description

- TFL and HPL Tops; [See TFL and HPL Colors and Specify](#)
- Undermount and Lower Metal Accents Measure 2"H, 1" Thick, and is Available in Black (BLK), Aluminum (ALUM), or Snow (SNO); Must Specify Color, [See Details](#)
- Top and Legs Available in Contrasting Colors; [See Leg Color Options](#)
- Legs Available with Fixed Glides (GLIDES) or Four (4) 60mm Casters (BSC60), Two (2) Locking and Two (2) Non-Locking; [See Details and Specify](#)
- Some Assembly Required
- Power and Grommet Available on Center Only; [See Options](#)

T= TFL P= HPL

[See Synergy Overview For Ordering Options](#)

Item	Model No.	Seat Width	Seat Depth	Seat Height	Ship Wt	Cubic Ft
CUBBY BENCH	820-4822MCB	48	19	17½	47	9.2

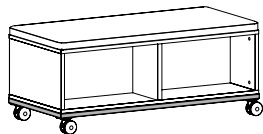

Must Specify (in this order):
 Model #
 Upholstery
 Chassis Finish
 Metal Accent Color

Description

- Standard with: Four (4) 75mm Non-Locking Casters
- Two (2) Cubbies on Each Side, Four (4) Cubbies Total; Each Cubby is 22½"W x 10¼"D x 12"H
- Cushion is One Piece
- Must Specify TFL Chassis; [See TFL Colors and Specify](#)
- Metal Accent Measures 1" Square, Available in Black (BLK), Aluminum (ALUM), or Snow (SNO); Must Specify Color, [See Details](#)

List Price/Grade	Yards	COM/1	2	3	4	5	6	7	8	9	10	L1	L2
Single Upholstery	1.50	\$ 1880	1958	2024	2089	2186	2285	2426	2573	2744	2942	2375	2587

Item	Model No.	Seat Width	Seat Depth	Seat Height	Ship Wt	Cubic Ft
TEAM BENCH WITH CASTERS	820-4819MTB	48	19	17½	47	9.2

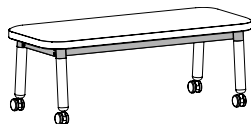

Must Specify (in this order):
 Model #
 Upholstery
 Leg Finish
 Metal Accent Color

Description

- Standard with 60mm Non-Locking Casters
- Legs are 2"D, Must Specify Color; [See Leg Color Options](#)
- Metal Accent Measures 2"H and 1" Thick, Available in Black (BLK), Aluminum (ALUM), or Snow (SNO); Must Specify Color, [See Details](#)

List Price/Grade	Yards	COM/1	2	3	4	5	6	7	8	9	10	L1	L2
Single Upholstery	1.50	\$ 1906	1984	2050	2115	2212	2311	2452	2599	2770	2968	2401	2613

Item	Model No.	Seat Width	Seat Depth	Seat Height	Ship Wt	Cubic Ft
TEAM BENCH WITH GLIDES	820-4819TB	48	19	17½	47	9.2

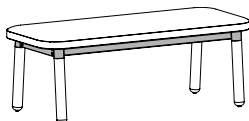

Must Specify (in this order):
 Model #
 Upholstery
 Leg Finish
 Metal Accent Color

Description

- Standard with Fixed Glides
- Legs are 2"D Feature Fixed Glides, Must Specify Color; [See Leg Color Options](#)
- Metal Accent Measures 2"H and 1" Thick, Available in Black (BLK), Aluminum (ALUM), or Snow (SNO); Must Specify Color, [See Details](#)

List Price/Grade	Yards	COM/1	2	3	4	5	6	7	8	9	10	L1	L2
Single Upholstery	1.50	\$ 1799	1877	1943	2008	2105	2204	2345	2492	2663	2861	2294	2506

[See Synergy Overview For Ordering Options](#)

Item	Model No.	Seat Width	Seat Depth	Seat Height	Ship Wt	Cubic Ft
STOOL WITH CASTERS	820-2419MFS	24	19	17½	29	4.6

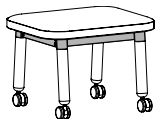

Stool Shown with Casters

Description

- Standard with 60mm Non-Locking Casters
- Legs are 2”D, Must Specify Color; [See Leg Color Options](#).
- Metal Accent Measures 2”H and 1” Thick, Available in Black (BLK), Aluminum (ALUM), or Snow (SNO); Must Specify Color, [See Details](#)

Must Specify (in this order):

- Model #
- Upholstery
- Leg Finish
- Metal Accent Color

List Price/Grade	Yards	COM/1	2	3	4	5	6	7	8	9	10	L1	L2
Single Upholstery	1.00	\$ 1652	1704	1748	1791	1856	1922	2016	2114	2228	2360	1982	2123

Item	Model No.	Seat Width	Seat Depth	Seat Height	Ship Wt	Cubic Ft
STOOL WITH GLIDES	820-2419FS	24	19	17½	29	4.6

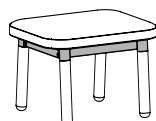

Stool Shown with Casters

Description

- Standard with Fixed Glides
- Legs are 2”D, Must Specify Color; [See Leg Color Options](#).
- Metal Accent Measures 2”H and 1” Thick, Available in Black (BLK), Aluminum (ALUM), or Snow (SNO); Must Specify Color, [See Details](#)

Must Specify (in this order):

- Model #
- Upholstery
- Leg Finish
- Metal Accent Color

List Price/Grade	Yards	COM/1	2	3	4	5	6	7	8	9	10	L1	L2
Single Upholstery	1.00	\$ 1545	1597	1641	1684	1749	1815	1909	2007	2121	2253	1875	2016

Item	Model No.	Seat Width	Seat Depth	Seat Height	Ship Wt	Cubic Ft
COUNTER HEIGHT STOOL	821	16¾	16¾	31½	23	5.1

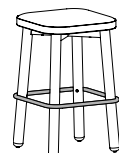

Description

- Standard with Fixed Glides
- Legs are 2”D, Must Specify Color; [See Leg Color Options](#).
- Foot Ring Available in Black (BLK), Aluminum (ALUM), or Snow (SNO), Must Specify Color, [See Details](#)

Must Specify (in this order):

- Model #
- Upholstery
- Leg Finish
- Foot Ring Color

List Price/Grade	Yards	COM/1	2	3	4	5	6	7	8	9	10	L1	L2
Single Upholstery	1.00	\$ 1386	1438	1482	1525	1590	1656	1750	1848	1962	2094	1716	1386

Item	Model No.	Seat Width	Seat Depth	Seat Height	Ship Wt	Cubic Ft
BAR HEIGHT STOOL	822	16¾	16¾	27½	22	4.5

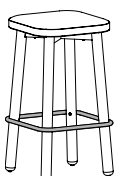

Description



- Standard with Fixed Glides
- Legs are 2”D, Must Specify Color; [See Leg Color Options](#).
- Foot Ring Available in Black (BLK), Aluminum (ALUM), or Snow (SNO), Must Specify Color, [See Details](#)

Must Specify (in this order):

- Model #
- Upholstery
- Leg Finish
- Foot Ring Color

List Price/Grade	Yards	COM/1	2	3	4	5	6	7	8	9	10	L1	L2
Single Upholstery	1.00	\$ 1421	1473	1517	1560	1625	1691	1785	1883	1997	2129	1751	1421

[See Synergy Overview For Ordering Options](#)

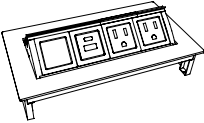
Item	Model No.		W	D	H	Ship Wt	Cubic Ft	List Price
ROUND GROMMET COVER	01-GRMTB	Black	2 $\frac{3}{8}$	2 $\frac{3}{8}$	-	1	0.1	\$ 11
	01-GRMTSL	Silver						
 OPEN MARKET ONLY (SILVER)	Description <ul style="list-style-type: none"> • 2$\frac{3}{8}$" (60mm) Round Grommet Cover • Field Installed 							
DOCK 950 WIRELESS CHARGER	01-DOCK950W	White	3 $\frac{3}{16}$	3 $\frac{3}{16}$	-	1	0.2	\$ 265
	01-DOCK950B	Black						
 OPEN MARKET ONLY	Description <ul style="list-style-type: none"> • For Use with Wireless Charging Enabled Devices • 5 Watts Maximum Output with a Direct Current of 5V 2A and 10 Watts Maximum with Quick Charge 2.0 • Mounts in 76mm Round Cut-Out • LED will Confirm Pairing with Device and Begin Wireless Charging 							
DOCK 150 WIRELESS AND USB CHARGER	01-DOCK150W	White	3	3	$\frac{3}{4}$	1	0.2	\$ 405
	01-DOCK150B	Black						
 OPEN MARKET ONLY	Description <ul style="list-style-type: none"> • For Use with Wireless Charging Enabled Devices and USB Charging Devices • 5 Watt Maximum Output with a Direct Current Input of 5V 6A (Wireless Fast Charge) • Mounts in 76mm Round Cut-Out • Pop-Up is $\frac{3}{4}$"H and Includes Three (3) USB Ports; One (1) 12 Watt Maximum with 2.4A (USB Fast Charge) and Two (2) 5 Watt with 1A (USB Standard Charge) • LED Light will Confirm Pairing with Device and Begin Wireless Charging • UL and cUL Certified 							
POWER DATA PORT	01-DPORT4A	Aluminum	8	4	-	7	0.2	\$ 1093
	01-DPORT4B	Black						
	Description <ul style="list-style-type: none"> • Retracts into Work Surface to Regain Productive Space • One-Touch Access to Power and Data • Two (2) Water-Proof Simplex Power Outlets, One (1) USB A+C, and One (1) Open Port • Optional Telecom Port Components, Following Page • Includes a Voice/Data Adapter Kit to Accept Couplers and Jacks When Required • 10' Power Cord 							

[See Synergy Overview For Ordering Options](#)

Item	Model No.	W	D	H	Ship Wt	Cubic Ft	List Price
USB PORT	01-USBPORT	-	-	-	-	-	\$ 161

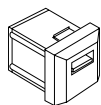
**Description**

- For Use with 01-DPORT4A and 01-DPORT4B
- Passive USB-A Port with Increased Transfer Speed Up to 5 gbs/sec
- Simultaneous Read/Write Capability
- Idle Device Power Saving State
- 6' Cord
- See Voice Coupler and Data Port on Next Page

VOICE COUPLER	01-VOICE1	-	-	-	-	-	\$ 73
---------------	-----------	---	---	---	---	---	-------

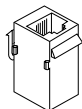
**Description**

- For Use with 01-DPORT4A and 01-DPORT4B
- 6-Pin Modular Plug
- Molded Black
- Cord Not included

DATA PORT	01-RJ4DATA	-	-	-	-	-	\$ 167
-----------	------------	---	---	---	---	---	--------



OPEN MARKET ONLY

Description

- For Use with 01-DPORT4A and 01-DPORT4B
- 8-Pin Modular Plug; Cat6 Ethernet Cable; Pre-terminated Cable
- 10' Cord

VGA CONNECTOR ACCESSORY	01-VGACON	-	-	-	1	0.2	\$ 149
-------------------------	-----------	---	---	---	---	-----	--------

**Description**

- VGA Port for 01-DPORT4A and 01-DPORT4B
- Enables Devices to Remote Display on Monitors
- 10' Cord
- Male/Female Connector

HDMI CONNECTOR ACCESSORY	01-HDMICON	-	-	-	1	0.2	\$ 124
--------------------------	------------	---	---	---	---	-----	--------

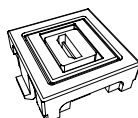
**Description**

- HDMI Port for 01-DPORT4A and 01-DPORT4B
- Connects to High Definition Displays
- Female/Female Connector
- 18" Cord

[See Synergy Overview For Ordering Options](#)

Item	Model No.		W	D	H	Ship Wt	Cubic Ft	List Price
DUO CLAMP WITH NEMA PLUG	01-DUOCLAMPW	White	6½	3	7	1	0.2	\$ 572
	01-DUOCLAMPB	Black						
	01-DUOCLAMP S	Silver						

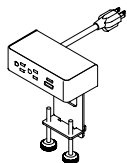

Description

- Standard with: Two (2) Power Outlet, One (1) USB Charging Port and One (1) 60-Watt USB-C Power
- Delivery Port with GaN Technology with 10' Cord
- Clamps to Top and Features Silver Metal Trim
- Independent USB Circuit Controllers Deliver up to 2.1 Amps to Each Post
- All Mounting Hardware Included
- FCC Part 15A and UL Approved for Horizontal and Vertical Applications

TRIO CLAMP WITH NEMA PLUG	01-TRIOCLAMPW	White	9	3	7	1	0.2	\$ 671
	01-TRIOCLAMPB	Black						
	01-TRIOCLAMP S	Silver						

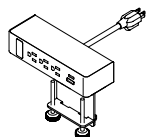

Description

- Standard with: Three (3) Power Outlets, One (1) USB Charging Port, One (1) 60-Watt USB-C Power
- Delivery Port with GaN Technology, One (1) Open Data with 10' Cord
- Clamps to Top and Features Silver Metal Trim
- Independent USB Circuit Controllers Deliver up to 2.1 Amps to Each Post
- HDMI, VGA, or RJ45 Sold Separately; [See Accessories](#)
- All Mounting Hardware Included
- FCC Part 15A and UL Approved for Horizontal and Vertical Applications

DUO BEZEL WITH NEMA PLUG	01-DUOBEZELW	White	6½	2½	3¼	1	0.2	\$ 675
	01-DUOBEZELB	Black						
	01-DUOBEZEL S	Silver						

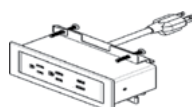

Description

- Sits On Top of the Worksurface and Includes: Two (2) Power, One (1) USB Charging Port and One (1)
- 60-Watt USB-C Power Delivery Port with GaN Technology with 10' Cord
- Independent USB Circuit Controllers Deliver up to 2.1 Amps to Each Post
- All Mounting Hardware Included
- FCC Part 15A and UL Approved for Horizontal and Vertical Applications

TRIO BEZEL WITH NEMA PLUG	01-TRIOBEZELW	White	9	2½	3	1	0.2	\$ 725
	01-TRIOBEZELB	Black						
	01-TRIOBEZEL S	Silver						

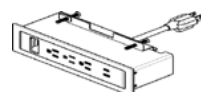

Description

- Sits On Top of the Worksurface and Includes: Three (3) Power, One (1) USB Charging Port and One (1)
- 60-Watt USB-C Power Delivery Port with GaN Technology, One (1) Open Data, and 10' Cord
- Independent USB Circuit Controllers Deliver up to 2.1 Amps to Each Post
- HDMI, VGA, or RJ45 Sold Separately; [See Accessories](#)
- All Mounting Hardware Included
- FCC Part 15A and UL Approved for Horizontal and Vertical Applications

[See Synergy Overview For Ordering Options](#)

Item	Model No.	W	D	H	Ship Wt	Cubic Ft	List Price
HDMI DATA PORT ACCESSORY	01-LCOMHDMI	-	-	-	1	0.2	\$ 166

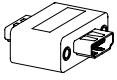
**Description**

- HDMI Port for Undermount Trio Clamp and Trio Bezel Units

OPEN MARKET ONLY

VGA DATA PORT ACCESSORY	01-LCOMVGA	-	-	-	1	0.2	\$ 121
-------------------------	------------	---	---	---	---	-----	--------

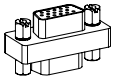
**Description**

- VGA Port for Undermount Trio Clamp and Trio Bezel Units

RJ45 DATA PORT ACCESSORY	01-LCOMRJ45	-	-	-	1	0.2	\$ 79
--------------------------	-------------	---	---	---	---	-----	-------

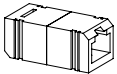
**Description**

- RJ45 Port for Undermount Trio Clamp and Trio Bezel Units

MARKER AND ERASER SET	01-MRKRSETBL	For Use with Black Glass Magnetic Marker Panels	\$ 123
	01-MRKRSETWH	For Use with White Glass Magnetic Marker Panels	

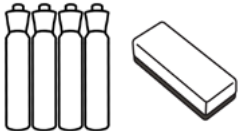
**Description**



- 01-MRKRSETWH May Also be Used with Dry Erase Panels
- Includes 4 Markers and an Eraser

RARE EARTH MAGNET SET	01-MAGBL	Black Magnets	\$ 114
	01-MAGWH	White Magnets	

**Description**

- Includes Set of Five (5) Rare Earth Magnets
- To be Used with Black and White Glass Magnetic Marker Panels
- Comfort Grip with Stylish Protective Plastic Coating

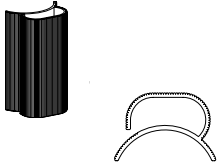
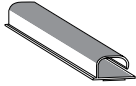
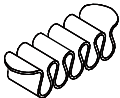

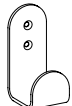







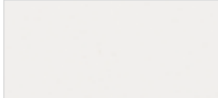

























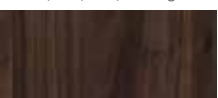

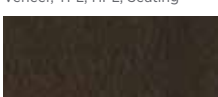



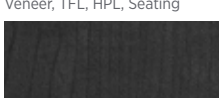
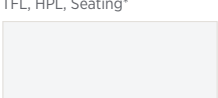
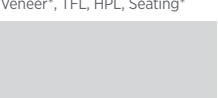

[See Synergy Overview For Ordering Options](#)

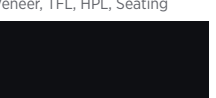
Item	Model No.	W	D	H	Ship Wt	Cubic Ft	List Price
3" WIRE MANAGER FOR ROUND LEGS	01-0302WM	3	2	¾	0.25	0.13	\$ 31
	Description	<ul style="list-style-type: none"> • Black Vinyl Wire Management With Adhesive for Round Leg • Quantity of Three (3) • Attaches with Adhesive Strips • Field Installed 					
WIRE CHANNEL	01-32125	24	1½	1	.25	0.3	\$ 106
	Description	<ul style="list-style-type: none"> • Available in Black • Channel Attaches with Two (2) Double-Sided Installation Tape to Flat Surfaces • Open J Channel for Easy Storage of Cables • Field Installed 					
CABLE GRIP	01-WMGRCB	5%	2%	-	-	-	\$ 17
	Description	<ul style="list-style-type: none"> • Black Under Surface Wire Management • Cable Grip Attaches with Four (4) Screws, Hardware Included • Field Installed 					
BLACK UNDERMOUNT HOOK FOR TABLES	01-HOOK	2	1¾	2½			\$ 79
	Description	<ul style="list-style-type: none"> • Black Hook Includes Mounting Hardware • For Undermount Applications on Tables • Field Installed 					
BLACK HOOK FOR VERTICAL SURFACES	01-ACCHOOKB	2	1¾	2½			\$ 64
	Description	<ul style="list-style-type: none"> • Black Hook Includes Mounting Hardware • For Use on Vertical Surfaces • 20lbs Weight Capacity • Field Installed 					

[See Synergy Overview For Ordering Options](#)



Surface Materials

Wood Finishes and Woodgrain, Solid, and 3D Laminates





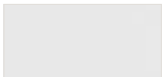

						
Aspen White (AWH) SQ1	White Nebbia (WNB) TFL, HPL, Seating	Beigewood (BW) TFL, HPL, Seating*	Natural Beech (NB) SQ1	Sugar Maple (SM) Veneer, TFL, HPL, Seating	Oak Riftwood (ORW) Veneer*, TFL, HPL, Seating*	
						
Kirsche (KHE) TFL, HPL, Seating	Fawn Oak (FO) Veneer*, Seating*	Truffle Rain (TR) SQ1	River Cherry (RC) TFL, HPL, Seating*	Mesa Sunset (MAS) Veneer*, Seating*	Natural Marrone (NTM) TFL, HPL, Seating*	
						
Studio Teak (TK) TFL, HPL, Seating	Pinnacle Walnut (PNW) Veneer, TFL, HPL, Seating	Harvest Maple (HVM) TFL, HPL, Seating*	Golden Cherry (GC) Veneer, TFL, HPL, Seating	Legacy Walnut (LW) Veneer, Seating	Artisan Walnut (AW) Veneer, Seating	
						
Orchard (OR) SQ1	Shaker Cherry (SKC) Veneer, TFL, HPL, Seating	Select Cherry (SCH) Veneer, TFL, HPL, Seating	Williamsburg Cherry (WC) Veneer, TFL, HPL, Seating	Harvest Walnut (HW) Veneer, Seating	Dark Cherry (DC) Veneer, Seating	
						
Mahogany Walnut (MW) Veneer, TFL, HPL, Seating	Henna Walnut (HNW) Veneer, Seating	Columbian Walnut (CO) Veneer, TFL, HPL, Seating	Sepia Walnut (SPW) TFL, HPL, Seating*	Florence Walnut (FLW) TFL, HPL, Seating*	Dark Forest Walnut (DFW) Veneer, Seating*	
						
Ember Gray (EG) SQ1	Espresso (EW/EF) Veneer, TFL, HPL, Seating	Portico Teak (PTK) TFL, HPL, Seating*	Weathered Ash (WTA) Veneer*, TFL, HPL, Seating*	Smoky Brown Pear (SBP) TFL, HPL, Seating*	Asian Night (AS) Veneer, TFL, HPL, Seating	
						
Midnight Run (MNR) TFL, HPL, Seating	Metropolis Sky (MTS) Veneer, Seating	Designer White (WH) TFL, HPL, Seating	Fashion Grey (FHG) TFL, HPL	Slate Grey (SG) TFL, HPL	Black (BL) TFL, HPL, Seating	
						
Matte White (WH3) 3D Laminate (Iconic Only)	Concrete (CR3) 3D Laminate (Iconic Only)	Matte Black (BL3) 3D Laminate (Iconic Only)	Blush (BSH) HPL Accent (Iconic+Plush Only)	First Kiss (FK) HPL Accent (Iconic+Plush Only)	Surfin USA (SUS) HPL Accent (Iconic+Plush Only)	Summer Vacation (SV) HPL Accent (Iconic+Plush Only)

* Finish is Low Sheen

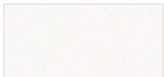







Frosted & High Gloss Acrylics

				
Frosted (FSTA)	White (WHA)	Wired Mercury (WMA)	Graphite (GPA)	Black (BLA)

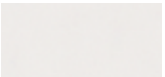

Solid Surfaces

					
Snow White (SNW)	Pebble Beach (PE)	Sedona (SE)	Arroyo (AR)	Tundra (TN)	Starry Night (SN)

Metal Options

				
Snow (SNOW)	Oyster White (OYST)	Sugar Cookie (SUGC)	Aluminum (ALUM)	Chrome (CHRM)
				
Gold (GOLD)	Platinum (PLAT)	Mist (MIST)	Black (BLK)	

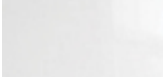
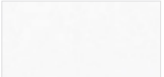
Glass Options

	
Gloss White (GWHG) (Catalyst + Strut)	Acid Etched White (GWHA) (Catalyst + Strut)
	
Gloss Black (GBLG) (Catalyst + Strut)	Acid Etched Black (GBLA) (Catalyst + Strut)

Colors represented are high-resolution reproductions and may vary slightly from the actual product. To order samples, please contact our Customer Service team or order online at www.indianafurniture.com. Graining and finish colors may vary, yet will continue to complement, across Veneer, HPL, TFL, and Seating products due to the inherent differences of these materials.

Indiana[®]

FURNITURE

1919 Hospitality Drive, Suite A
PO Box 270
Jasper, Indiana 47547-0270

Tel 812.482.5727

Toll 800.422.5727

Fax 812.482.9035

sales@indianafurniture.com

www.indianafurniture.com

Federal Classification: Small Business

©2024 Indiana Furniture 5/24

