

TABLES + SPACE DIVISION

PRICING EFFECTIVE MAY 13, 2024

Indiana
FURNITURE

Being over a century old hasn't slowed us down! Sure, we are still the reliable, ethical company that was born in southern Indiana, steeped in quality, craftsmanship, and service. But have you seen our latest introductions? We are making a splash with design and challenging the concept of modern offices. Go ahead. Take a look. You know you want to.

Our Pledge to People + Our Planet.

We've been making wood furniture longer than just about anyone...and we want to be doing so for a long time to come. That's a large part of why we take a stewardship approach to our resources. We believe that environmental sustainability and business profits need not be mutually exclusive. They can and should exist side by side in a mutually beneficial relationship. And for more than a century, we've been showing how it's done.

We've proven our commitment to a sustainable future by supporting the standards and programs that protect our home planet and human health. Whether it's local sourcing, reducing contaminants, implementing wellness and safety programs, or diverting waste from landfills, social responsibility is a part of every decision we make at Indiana Furniture.

One of the surest ways to reduce our impact on the planet is to make and buy things that last. And this one's a natural for us. Our products are made with craftsmanship and attention to detail that are a part of our more than a century-long legacy in wood manufacturing. And our products are backed by our 12-year warranty, which facilitates maintenance, servicing and reassembly.

All of our product lines:

- Are manufactured and assembled in the USA,
- Meet or exceed Indoor Air quality standards*,
- Meet or exceed BIFMA level® Sustainability standards and certification*,
- Conform to the BIFMA Compliance standards*,
- Comply with TSCA Title VI (CARB) standards,
- and can contribute to U.S. Green Building's LEED Program.

To learn more, simply go to www.IndianaFurniture.com/resources.



Ease of Specification

Whether you're looking to specify your office spaces or simply to visualize them in the options and surface materials you are desiring, we make it easy. You can find the entire Indiana Furniture portfolio on the following third-party, space-planning platforms.



* Recently launched or new products may still be in testing; Cush Pillows is currently not BIFMA Compliant due to no available compliance test.

Synergy is a collection of partitions, tables, and seating to create spaces in an impromptu way without the need for complex architecture. This line promotes flexibility to adapt to different interactions, forming areas to gather, separate, and then gather again...all in personalized ways, and all within the same open space.

CONSTRUCTION

PARTITIONS

- Internal wood components are manufactured using plywood
- Partitions require some assembly including 75mm casters that are field installed
- Partitions Chassis consists of TFL frame, shelves (if applicable) and bottom panel

TABLES

- Table legs are 2"D, crafted from European Beech, and individually hand sanded prior to being finished with non-marring fixed nylon glides when casters are not selected
- Table tops have 1" thick Thermally-Fused Laminate (TFL) or High Pressure Laminate (HPL) surface with 3mm PVC edge band and Square edge profile; Designer White, Sugar Maple, and Williamsburg Cherry feature ABS edge bands



Square (Y)

- Tables require some assembly

SEATING

- All bench and stool joints are precisely fit with lag bolt connections for maximum strength and durability
- Stools and benches are rated for users up to 275lbs, ship fully assembled and feature 1½" thick High Grade Polyurethane Foam on the stools and bench seats
- Stool legs are 2"D, crafted from European Beech, and individually hand sanded prior to being finished with non-marring fixed nylon glides when casters are not selected

STORAGE

- Media Low Storage Partition on Casters includes soft close, touch latch hinged doors
- Soft close hinges reduce stress placed on the cabinet when the door is closed and offers a quiet closure
- Media Low Storage and Open Storage Partitions feature two (2) black grommets within the storage

PLANTER BOXES

- The planter box is made of ¾" thick thermally-fused laminate (TFL) particle-board core
- Grain direction runs horizontal
- Planter boxes are fastened together with screws and heavy-duty metal fasteners
- Optional Planter Insert is made of lightweight, fade-resistant, recyclable plastic

POWER/DATA/CORD MANAGEMENT

- Table top grommets and power/data units are available on center
- Table tops feature undersurface a 2"H metal accent to conceal wires and additional cord management is available for order; [See Accessories](#)
- Power/Data units available for in-surface mounting and comply with FCC Part 15A and UL
- Partitions with TV mount include a black grommet below TV mount, center wire channel, and grommet in bottom of unit for a clean and easy access to power.

HOW TO ORDER EXAMPLES

MODEL	QTY	DESCRIPTION	EXAMPLE		
PARTITIONS					
82-4872PT	1	TFL Chassis Color	NTM		
		Metal Accent	ALUM		
		Side A Panel	TKBP (Tackable Panel)		
		Tackable Upholstery	Mayer Fabrics Strata Cliff		
		TV Mount Option	TVSA		
		Side B Panel	TFLP (TFL Panel)		
82-4872CPT	1	TFL Panel Color	ORW		
		Hook Option	HKSB		
		TFL Chassis Color	KHE		
		Metal Accent	ALUM		
		Side A Panel	WHBP (Dry Erase Panel)		
		TV Mount Option	TVSA		
82-4872CPT	1	Side B Panel	TFLP (TFL Panel)		
		TFL Panel Color	CO		
		Hook Option	HKSB		
		PLANTER			
		82-4830PL	2	TFL Color	NTM
				Metal Accent	ALUM
TABLE					
82-3672BRT	1	Top Material	T		
		TFL Top Color	NTM		
		Metal Accent	ALUM		
		Leg Color	ORW		
		Leg Glide or Caster	BSC60 (Caster)		
		Grommet/Power	C		
POWER					
821	1	Duo Bezel Nema Plug	01-DUOBEZELS		
STOOLS					
821	4	Upholstery	CF Stinson Drift Tidepool		
		Leg Color	ORW		
		Foot Ring Metal Accent	ALUM		

PARTITION PANEL OPTIONS

Each side of a partition with panels can be personalized to meet the needs of your space; referred to as Side A Panel and Side B Panel. Select from TFL, Tackable Upholstery, or Dry Erase. Dry Erase Partitions also offer Glass Magnetic Marker Board Panels.

When a TFL Panel or Tackable Upholstery Panel is selected for both Side A and Side B, the same TFL color, or the same upholstery, will be used on both sides for a cohesive aesthetic.

Must specify Side A and Side B panel selection on order.

TFLP	TFL Panel
TKBP	Tackable Upholstered Panel
WHBP	Dry Erase Panel
BLMMB	Black Glass Magnetic Marker Board (82-4872PDE Only)
WHMMB	White Glass Magnetic Marker Board (82-4872PDE Only)

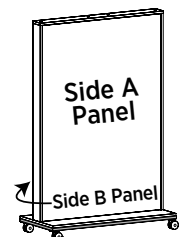

CONTRASTING TFL OPTIONS

Chassis, door fronts, and TFL panels available in contrasting colors. Must specify color of each component with order.

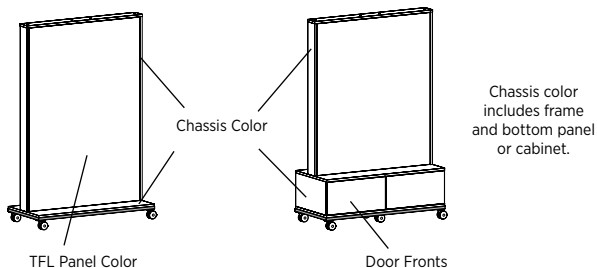

TFL (T) OR HPL (P) FOR TABLE TOP / TFL (T) OPTIONS FOR PARTITION CHASSIS AND PLANTER BOXES

WOODGRAIN

AS Asian Night	PNW Pinnacle Walnut
BW Beigewood	PTK Portico Teak
CO Columbian Walnut	RC River Cherry
EF Espresso	SCH Select Cherry
FLW Florence Walnut	SPW Sepia Walnut
GC Golden Cherry	SKC Shaker Cherry
HVM Harvest Maple	SBP Smoky Brown Pear
KHE Kirsche	TK Studio Teak
MW Mahogany Walnut	SM Sugar Maple
MNR Midnight Run	WTA Weathered Ash
NTM Natural Marrone	WNB White Nebbia
ORW Oak Riftwood	WC Williamsburg Cherry

SOLID

BL Black	FHG Fashion Grey
WH Designer White	SG Slate Grey

SEATING AND TABLE LEG WOOD FINISHES

Indiana Furniture uses a multi-step, hand finishing process on all exposed wood frames.

Units feature a catalyzed varnish finish which offers durability, lasting beauty, and resistance to normal wear.

AW Artisan Walnut	MAS Mesa Sunset*
AS Asian Night	MTS Metropolis Sky
BW Beigewood*	MNR Midnight Run
BL Black	NTM Natural Marrone*
CO Columbian Walnut	ORW Oak Riftwood*
DC Dark Cherry	PNW Pinnacle Walnut
DFW Dark Forest Walnut*	PTK Portico Teak*
WH Designer White	RC River Cherry*
EF Espresso	SCH Select Cherry
FO Fawn Oak*	SPW Sepia Walnut*
FLW Florence Walnut*	SKC Shaker Cherry
GC Golden Cherry	SBP Smoky Brown Pear*
HVM Harvest Maple*	TK Studio Teak
HW Harvest Walnut	SM Sugar Maple
HNW Henna Walnut	WTA Weathered Ash*
KHE Kirsche	WNB White Nebbia
LW Legacy Walnut	WC Williamsburg Cherry
MW Mahogany Walnut	

* Finish is Low Sheen

PARTITION, TABLE, AND FOOT RING METAL ACCENT COLORS

Metal accents are featured on tables, partitions, and stools in three colors. Must specify color.

ALUM	Aluminum	SNO	Snow
BLK	Black		

TV MOUNT OPTIONS

TV Mounts are available on one side only. TFL or Tackable Upholstered Panels may be selected with TV Mount. When a TV Mount is specified, a black grommet and channel to the bottom chassis is provided for cord management. TV mount bracket coordinates with 42" TVs or smaller and cannot exceed 50lbs. Must specify and add when ordering.

TVSA	TV Mount Side A	\$ 196
TVSB	TV Mount Side B	\$ 196
NONE	No TV Mount	



HOOK OPTIONS

A set of four (4) black hooks are available on TFL, Tackable Upholstery, and Dry Erase Panels. Hooks can be selected for both sides and will be factory installed 6" from each end and 12" between each hook. Hooks feature a 20lbs weight capacity. Must specify and add when ordering. Hooks may be purchased individually for use on vertical surfaces. [See Product Details.](#)

HKSA	Four (4) Black Hooks on Side A	\$ 152
HKSB	Four (4) Black Hooks on Side B	\$ 152
NONE	No Hooks	

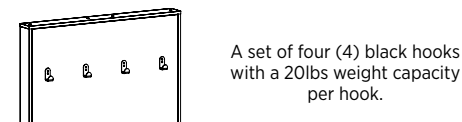

LOCKING DOOR OPTION

Locking doors are available on the Media Low Storage Partition on Casters. Must specify and add when ordering.

LKT-DB2	Locking Doors	\$ 91
---------	---------------	-------

TABLE GLIDE OR CASTER OPTIONS

Tables available with casters or glides. Must specify.

	GLIDES	Fixed Glides	N/C
	BSC60	60mm Soft Caster	\$ 117

GROMMET & POWER/DATA UNIT OPTIONS & LOCATIONS

Grommets and Power/Data units available in center of table tops. Specify Center (C) location on order. Grommet and power/data units must be ordered separately. Tops may also be ordered without grommet/power units by specifying NO GROMMET on order.

Only one grommet/power/data unit per top. [See Product Details](#)

LOCATION OPTION

C On Center

GROMMET OPTIONS

GC Grommet, Center \$ 52

POWER/DATA UNIT OPTIONS [See Product Details and Pricing](#)

DUO CLAMP Available in Black (B), Silver (S), or White (W)

TRIO CLAMP Available in Black (B), Silver (S), or White (W)

DUO BEZEL Available in Black (B), Silver (S), or White (W)

TRIO BEZEL Available in Black (B), Silver (S), or White (W)

DPORT4 Available in Aluminum or Black

DOCK950 Available in Black or White

DOCK150 Available in Black or White

CERTIFICATIONS & COMPLIANCE

- Intertek Sustainability Certified
- TSCA Title VI (formerly CARB) Compliance
- Contributes to LEED®, Green Globes®, and WELL® Sustainable Programs

Partitions

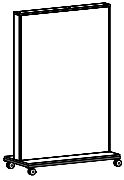

Partition on Casters
[\(See Details\)](#)

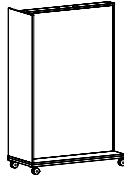

Corner Partition on Casters
[\(See Details\)](#)

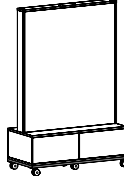

Media Low Storage Partition on Casters
[\(See Details\)](#)

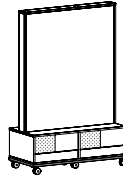

Media Low Open Storage Partition on Casters
[\(See Details\)](#)

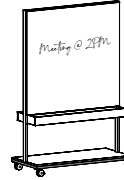

Dry Erase Partition on Casters
[\(See Details\)](#)

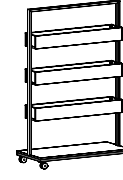

Planter Box Partition on Casters
[\(See Details\)](#)



Shelf Partition on Casters
[\(See Details\)](#)

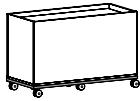

Planter on Casters
[\(See Details\)](#)

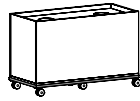

Recycle Bin on Casters
[\(See Details\)](#)

Tables

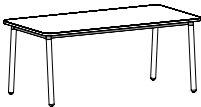

Seated Height Tables
[\(See Details\)](#)

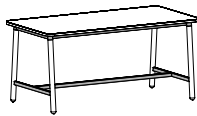

Counter Height Tables
[\(See Details\)](#)

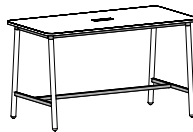

Bar Height Tables
[\(See Details\)](#)

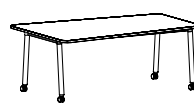

Seated Height View Tables
[\(See Details\)](#)

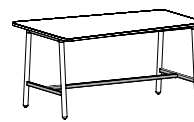

Counter Height View Tables
[\(See Details\)](#)

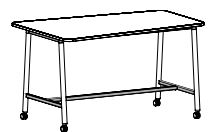

Bar Height View Tables
[\(See Details\)](#)

Seating

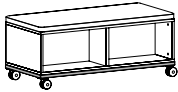

Cubby Bench With Casters
[\(See Details\)](#)

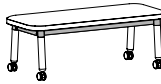

Team Bench With Casters
[\(See Details\)](#)

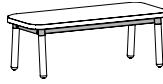

Team Bench With Glides
[\(See Details\)](#)



Stool With Casters
[\(See Details\)](#)



Stool With Glides
[\(See Details\)](#)



Counter Height Stool With Glides
[\(See Details\)](#)



Bar Height Stool With Glides
[\(See Details\)](#)

Wire Management & Power/Data Accessories

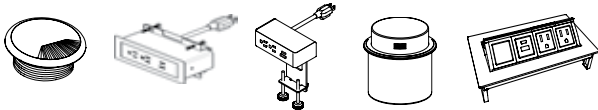

Power Options [\(See Multiple Unit Details\)](#)

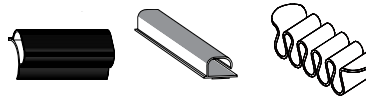

Wire Management [\(See Multiple Unit Details\)](#)



Accessories [\(See Details\)](#)

IDEA STARTERS

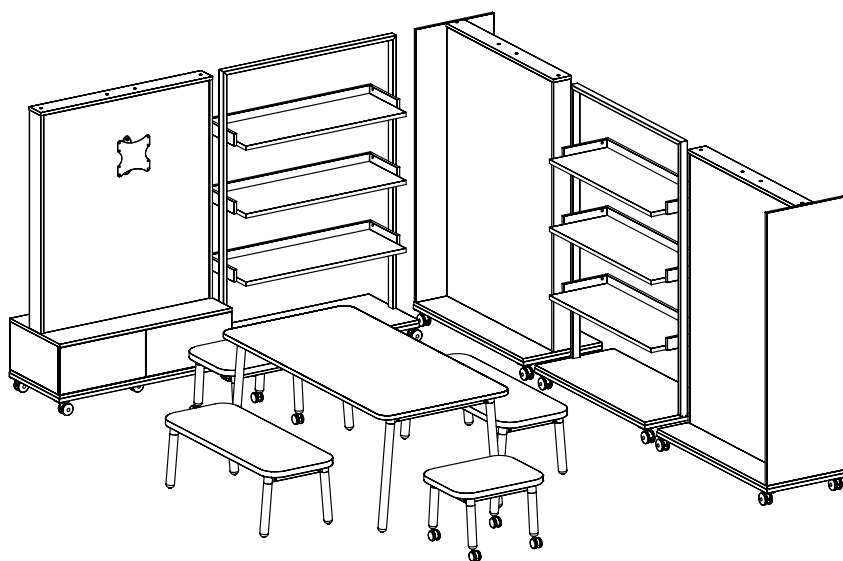
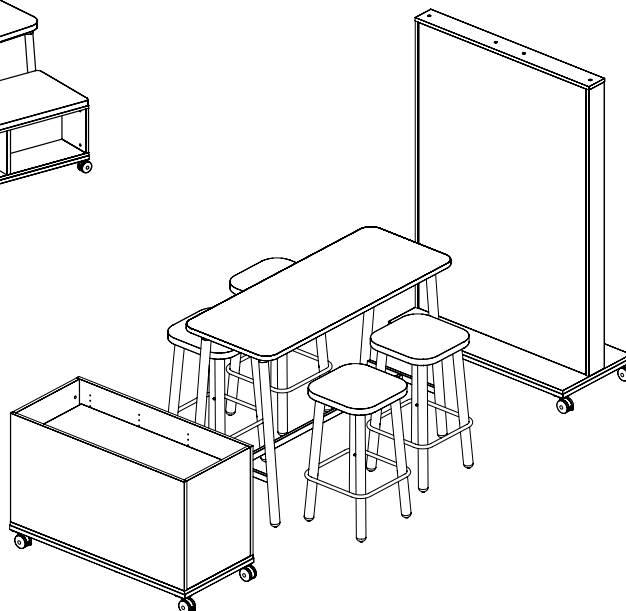
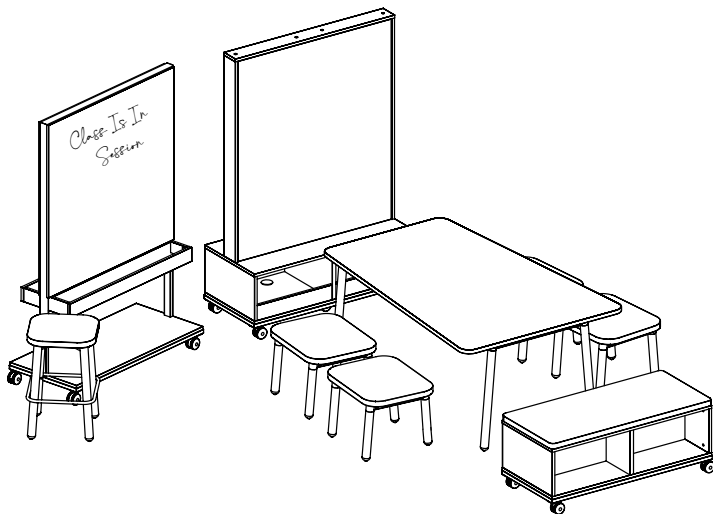

Item	Model No.	W	D	H	Ship Wt	Cubic Ft	List Price
PARTITION ON CASTERS	82-4872PT	48	22	73	290	48.6	T\$ 2991

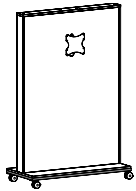

Side A Shown with TFL Panel and TV Mount

Must Specify (in this order):

- Model #
- TFL Chassis Color
- Metal Accent Finish
- Side A Panel Options
 - TFL Panel Color (If Applicable)
 - Tackable Upholstery (If Applicable)
 - TV Mount
 - Hook Options
- Side B Panel Options
 - TFL Panel Color (If Applicable)
 - Tackable Upholstery (If Applicable)
 - TV Mount
 - Hook Options

Description

- Standard with: Four (4) 75mm Casters are Field Installed; Two (2) Locking on Side A, Two (2) Non-Locking on Side B
- Must Specify TFL Chassis Color; [See TFL Colors and Specify](#)
- Chassis and TFL Panels (TFLP) Available in Contrasting Colors
- Metal Accent Color; Must Specify Black (BLK), Aluminum (ALUM), or Snow (SNO), [See Details](#)
- Panels for Side A and Side B Available with TFL Panel (TFLP), Tackable Upholstered Panel (TKBP), Dry Erase Panels (WHBP); See Option Details Below
- When TFL Panels (TFLP) are Selected for Both Side A and B, Choose One Color
- When Tackable Upholstered Panels (TKBP) are Selected for Both Side A and B, Choose One Fabric
- Optional TV Mount and Black Grommet Available on One Side; Must Specify Side A (TVSA), Side B (TVSB), or No TV Mount (NONE), See Below
- Optional Hooks Available, Four (4) Black Hooks Included, Must Specify Hooks Side A (HKSA), Hooks Side B (HKSB), or No Hooks (NONE), See Below

Side A Specify & Add:

Side A Panel Options:

TFLP	TFL Panel	N/C
TKBP	Tackable Upholstered Panel	See Pricing Below
WHBP	Dry Erase Panels	\$ 285

Side A Panel Accessories Options: (Choose One)

TVSA	TV Mount Side A (Available on One Side Only)	\$ 196
HKSA	Four (4) Black Hooks Side A	\$ 152
NONE	No Accessories	N/C

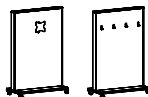

Side A (TKBP) Tackable Upholstered Panel Pricing

List Price/Grade	Yards	COM/1	2	3	4	5	6	7	8	9	10
Tackable Panel	2.00	\$ 285	389	477	563	693	825	1013	1209	1437	1701



Take Notes or Set Action Items with Dry Erase Panels and the Marker/Erase Sets [\(See Sets\)](#)

Side B Specify & Add:

Side B Panel Options:

TFLP	TFL Panel	N/C
TKBP	Tackable Upholstered Panel	See Pricing Below
WHBP	Dry Erase Panels	\$ 285

Side B Panel Accessories Options: (Choose One)

TVSB	TV Mount Side B (Available on One Side Only)	\$ 196
HKSB	Four (4) Black Hooks Side B	\$ 152
NONE	No Accessories	N/C

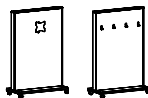

Side B (TKBP) Tackable Upholstered Panel Pricing - Must Match Side A

List Price/Grade	Yards	COM/1	2	3	4	5	6	7	8	9	10
Tackable Panel	2.00	\$ 285	389	477	563	693	825	1013	1209	1437	1701

Item	Model No.	W	D	H	Ship Wt	Cubic Ft	List Price
CORNER PARTITION ON CASTERS	82-4872CPT	48	22	73	311	48.6	T\$ 3089

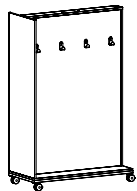

Side A Shown with Dry Erase Panel and Hooks

Must Specify (in this order):

- Model #
- TFL Chassis Color
- Metal Accent Finish
- Side A Panel Options
 - TFL Panel Color (If Applicable)
 - Tackable Upholstery (If Applicable)
 - TV Mount
 - Hook Options
- Side B Panel Options
 - TFL Panel Color (If Applicable)
 - Tackable Upholstery (If Applicable)
 - TV Mount
 - Hook Options

Description

- Corner Panel on Left When Facing Side A
- Standard with: Four (4) 75mm Casters are Field Installed; Two (2) Locking on Side A, Two (2) Non-Locking on Side B
- Must Specify TFL Chassis Color; [See TFL Colors and Specify](#)
- Chassis and TFL Panel Available in Contrasting Colors
- Metal Accent Color; Must Specify Black (BLK), Aluminum (ALUM), or Snow (SNO); [See Details](#)
- Panels for Side A and Side B Available with TFL Panel (TFLP), Tackable Upholstered Panel (TKBP), Dry Erase Panels (WHBP); See Option Details Below
- When TFL Panels (TFLP) are Selected for Both Side A and B, Choose One Color
- When Tackable Upholstered Panels (TKBP) are Selected for Both Side A and B, Choose One Fabric
- Optional TV Mount and Black Grommet Available on One Side; Must Specify Side A (TVSA), Side B (TVSB), or No TV Mount (NONE), See Below
- Optional Hooks Available, Four (4) Black Hooks Included, Must Specify Hooks Side A (HKSA), Hooks Side B (HKSB), or No Hooks (NONE), See Below

Side A Specify & Add:

Side A Panel Options:

TFLP	TFL Panel	N/C
TKBP	Tackable Upholstered Panel	See Pricing Below
WHBP	Dry Erase Panels	\$ 285

Side A Panel Accessories Options: (Choose One)

TVSA	TV Mount Side A (Available on One Side Only)	\$ 196
HKSA	Four (4) Black Hooks Side A	\$ 152
NONE	No Accessories	N/C

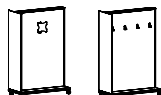

Side A (TKBP) Tackable Upholstered Panel Pricing

List Price/Grade	Yards	COM/1	2	3	4	5	6	7	8	9	10
Tackable Panel	2.00	\$ 285	389	477	563	693	825	1013	1209	1437	1701



Take Notes or Set Action Items with Dry Erase Panels and the Marker/Eraser Sets [\(See Sets\)](#)

Side B Specify & Add:

Side B Panel Options:

TFLP	TFL Panel	N/C
TKBP	Tackable Upholstered Panel	See Pricing Below
WHBP	Dry Erase Panels	\$ 285

Side B Panel Accessories Options: (Choose One)

TVSB	TV Mount Side B (Available on One Side Only)	\$ 196
HKSB	Four (4) Black Hooks Side B	\$ 152
NONE	No Accessories	N/C

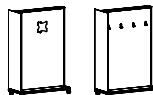

Side B (TKBP) Tackable Upholstered Panel Pricing - Must Match Side A

List Price/Grade	Yards	COM/1	2	3	4	5	6	7	8	9	10
Tackable Panel	2.00	\$ 285	389	477	563	693	825	1013	1209	1437	1701

Item	Model No.	W	D	H	Ship Wt	Cubic Ft	List Price
MEDIA LOW STORAGE PARTITION ON CASTERS	82-4872PMLS	48	22	73	290	48.6	T\$ 3507

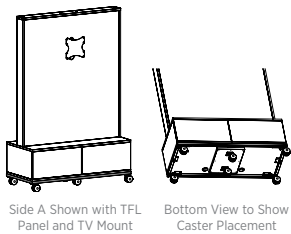

Description

- Standard with: Six (6) 75mm Casters are Field Installed; Two (2) Locking on Side A, Two (2) Non-Locking on Side B, and Two (2) Non-Locking in Center of Bottom
- Two (2) Black Grommets on Side A for Easy Accessibility to Power
- Must Specify TFL Chassis Color; [See TFL Colors and Specify](#)
- Chassis, Doors, and TFL Panel(s) Available in Contrasting Colors
- Metal Accent Color; Must Specify Black (BLK), Aluminum (ALUM), or Snow (SNO), [See Details](#)
- Panels for Side A and Side B Available with TFL Panel (TFLP), Tackable Upholstered Panel (TKBP), Dry Erase Panels (WHBP); See Option Details Below
- When TFL Panels (TFLP) are Selected for Both Side A and B, Choose One Color
- When Tackable Upholstered Panels (TKBP) are Selected for Both Side A and B, Choose One Fabric
- Optional TV Mount Available on One Side; Must Specify Side A (TVSA), Side B (TVSB), or No TV Mount (NONE), See Below
- Optional Hooks Available, Four (4) Black Hooks Included, Must Specify Hooks Side A (HKSA), Hooks Side B (HKSB), or No Hooks (NONE), See Below
- Non-Locking, Touch Latch, Soft Close Doors Standard with Optional Locking, [See Details](#)
- Safely Write on Optional Black and White Glass Magnetic Marker Panel With Marker and Eraser, [Sets See Set Details](#)
- Rare Earth Magnets Easily Work on Glass Magnetic Marker Panels; [See Set Details](#)

Must Specify (in this order):

- Model #
- TFL Chassis Color
- Metal Accent Finish
- Side A Panel Options
 - TFL Panel Color (If Applicable)
 - Tackable Upholstery (If Applicable)
 - TV Mount
 - Hook Options
- Side B Panel Options
 - TFL Panel Color (If Applicable)
 - Tackable Upholstery (If Applicable)
 - TV Mount
 - Hook Options
- Door Color
- Locking Door Option

Side A Specify & Add:

Side A Panel Options:

TFLP	TFL Panel	N/C
TKBP	Tackable Upholstered Panel	See Pricing Below
WHBP	Dry Erase Panels	\$ 285

Side A Panel Accessories Options: (Choose One)

TVSA	TV Mount Side A (Available on One Side Only)	\$ 196
HKSA	Four (4) Black Hooks Side A	\$ 152
NONE	No Accessories	N/C

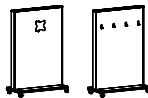

Side A (TKBP) Tackable Upholstered Panel Pricing

List Price/Grade	Yards	COM/1	2	3	4	5	6	7	8	9	10
Tackable Panel	2.00	\$ 252	343	420	495	609	725	889	1061	1260	1491



Take Notes or Set Action Items with Dry Erase Panels and the Marker/Eraser Sets ([See Sets](#))

Side B Specify & Add:

Side B Panel Options:

TFLP	TFL Panel	N/C
TKBP	Tackable Upholstered Panel	See Pricing Below
WHBP	Dry Erase Panels	\$ 285

Side B Panel Accessories Options: (Choose One)

TVSB	TV Mount Side B (Available on One Side Only)	\$ 196
HKSB	Four (4) Black Hooks Side B	\$ 152
NONE	No Accessories	N/C

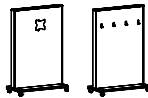

Side B (TKBP) Tackable Upholstered Panel Pricing - Must Match Side A

List Price/Grade	Yards	COM/1	2	3	4	5	6	7	8	9	10
Tackable Panel	2.00	\$ 252	343	420	495	609	725	889	1061	1260	1491

Item	Model No.	W	D	H	Ship Wt	Cubic Ft	List Price
MEDIA LOW OPEN STORAGE PARTITION ON CASTERS	82-4872PML0S	48	22	73	311	48.6	T\$ 3365

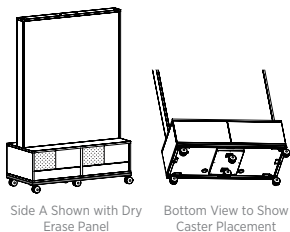

Description

- Standard with: Six (6) 75mm Casters are Field Installed; Two (2) Locking on Side A, Two (2) Non-Locking on Side B, and Two (2) Non-Locking in Center of Bottom
- Two (2) Black Grommets Included, One (1) Black Grommet Inside Each Cubby for Easy Accessibility to Power
- Two (2) Open Storage Cubbies Per Unit; 22½"W x 20"D x 12"H with an 8" Opening in Front and 4" Guard to Contain Stored Items when Unit is Moved. Patterned Portion of Art Shows Back Panel
- Must Specify TFL Chassis Color; [See TFL Colors and Specify](#)
- Chassis and TFL Panel Available in Contrasting Colors
- Metal Accent Color; Must Specify Black (BLK), Aluminum (ALUM), or Snow (SNO), [See Details](#)
- Panels for Side A and Side B Available with TFL Panel (TFLP), Tackable Upholstered Panel (TKBP), Dry Erase Panels (WHBP); See Option Details Below
- When TFL Panels (TFLP) are Selected for Both Side A and B, Choose One Color
- When Tackable Upholstered Panels (TKBP) are Selected for Both Side A and B, Choose One Fabric
- Optional TV Mount Available on One Side; Must Specify Side A (TVSA), Side B (TVSB), or No TV Mount(NONE), See Below
- Optional Hooks Available, Four (4) Black Hooks Included, Must Specify Hooks Side A (HKSA), Hooks Side B (HKSB), or No Hooks (NONE), See Below
- Safely Write on Optional Black and White Glass Magnetic Marker Panel With Marker and Eraser, [Sets See Set Details](#)
- Rare Earth Magnets Easily Work on Glass Magnetic Marker Panels; [See Set Details](#)

Must Specify (in this order):

- Model #
- TFL Chassis Color
- Metal Accent Finish
- Side A Panel Options
 - TFL Panel Color (If Applicable)
 - Tackable Upholstery (If Applicable)
 - TV Mount
 - Hook Options
- Side B Panel Options
 - TFL Panel Color (If Applicable)
 - Tackable Upholstery (If Applicable)
 - TV Mount
 - Hook Options

Side A Specify & Add:

Side A Panel Options:

TFLP	TFL Panel	N/C
TKBP	Tackable Upholstered Panel	See Pricing Below
WHBP	Dry Erase Panels	\$ 285

Side A Panel Accessories Options: (Choose One)

TVSA	TV Mount Side A (Available on One Side Only)	\$ 196
HKSA	Four (4) Black Hooks Side A	\$ 152
NONE	No Accessories	N/C

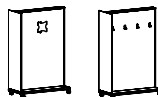

Side A (TKBP) Tackable Upholstered Panel Pricing

List Price/Grade	Yards	COM/1	2	3	4	5	6	7	8	9	10
Tackable Panel	2.00	\$ 252	343	420	495	609	725	889	1061	1260	1491



Take Notes or Set Action Items with Dry Erase Panels and the Marker/Eraser Sets ([See Sets](#))

Side B Specify & Add:

Side B Panel Options:

TFLP	TFL Panel	N/C
TKBP	Tackable Upholstered Panel	See Pricing Below
WHBP	Dry Erase Panels	\$ 285

Side B Panel Accessories Options: (Choose One)

TVSB	TV Mount Side B (Available on One Side Only)	\$ 196
HKSB	Four (4) Black Hooks Side B	\$ 152
NONE	No Accessories	N/C

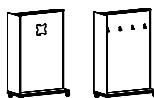

Side B (TKBP) Tackable Upholstered Panel Pricing - Must Match Side A

List Price/Grade	Yards	COM/1	2	3	4	5	6	7	8	9	10
Tackable Panel	2.00	\$ 252	343	420	495	609	725	889	1061	1260	1491

Item	Model No.	W	D	H	Ship Wt	Cubic Ft	List Price
DRY ERASE PARTITION ON CASTERS	82-4872PDE	48	22	73	290	48.6	WHBP \$ 4138
							BLMMB \$ 10885
							WHMMB \$ 10885

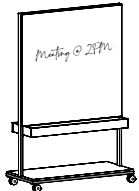

Shown with Dry Erase Panels

Description

- Standard with: Four (4) 75mm Casters are Field Installed; Two (2) Locking on Side A, Two (2) Non-Locking on Side B
- Must Specify TFL Chassis Color; [See TFL Colors and Specify](#)
- Metal Accent Color; Must Specify Black (BLK), Aluminum (ALUM), or Snow (SNO), [See Details](#)
- Panels Available with Dry Erase Panels (WHBP), Black Glass Magnetic Marker Panels (BLMMB), or White Glass Magnetic Marker Panels (WHMMB)
- Safely Write on Optional Black and White Glass Magnetic Marker Panel With Marker and Eraser Sets [See Set Details](#)
- Pin a Note with the Rare Earth Magnets on Glass Magnetic Marker Panels; [See Set Details](#)

Must Specify (in this order):

- Model #
- TFL Chassis Color
- Metal Accent Finish
- Panel Options



Take Notes or Set Action Items with the Marker/Eraser and Magnet Sets ([See Sets](#))

PLANTER BOX PARTITION ON CASTERS	82-4872PPB	48	22	73	160	48.6	T\$ 1014
----------------------------------	------------	----	----	----	-----	------	----------

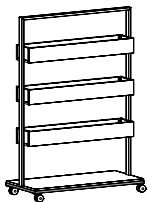

Description

- Standard with: Three Planter Boxes, Four (4) 75mm Casters are Field Installed; Two (2) Locking on Side A, Two (2) Non-Locking on Side B
- Planter Boxes are 9"D x 6"H
- Must Specify TFL Chassis Color; [See TFL Colors and Specify](#)
- Metal Accent Color; Must Specify Black (BLK), Aluminum (ALUM), or Snow (SNO), [See Details](#)
- We Recommend Using Optional Planter Inserts (See Below) to Protect Planter Boxes from Water

Must Specify (in this order):

- Model #
- TFL Chassis Color
- Metal Accent Finish
- Planter Inserts

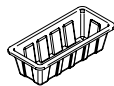

Option: Specify & Add

PBI6	Planter Box Insert, Six (6) Black Plastic Inserts	\$ 52
------	---	-------

Item	Model No.	W	D	H	Ship Wt	Cubic Ft	List Price
SHELF PARTITION ON CASTERS	82-4872PSP	48	22	73	105	48.6	T\$ 3712

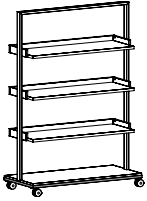

Description

- Standard with: Four (4) 75mm Casters are Field Installed; Two (2) Locking on Side A, Two (2) Non-Locking on Side B
- Shelves are 44½"W x 16"D with 16⅞" Between Each Shelf
- Must Specify TFL Chassis Color; [See TFL Colors and Specify](#)
- Metal Accent Color; Must Specify Black (BLK), Aluminum (ALUM), or Snow (SNO), [See Details](#)

Must Specify (in this order):

Model #
TFL Chassis Color
Metal Accent Finish

PLANTER ON CASTERS	82-4830PL	48	22	31	178	19.6	T\$ 2115
--------------------	-----------	----	----	----	-----	------	----------

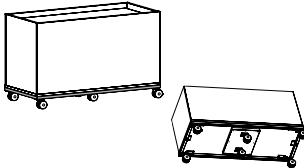

Bottom View to Show
Caster Placement

Description

- Standard with: Six (6) 75mm Casters are Field Installed; Two (2) Locking on Side A, Two (2) Non-Locking on Side B, and Two (2) Non-Locking in Center of Bottom
- Top Shelf is 1" Smaller for Easy Removal and Adjustable to Accommodate Different Sized Flower Pots
- Must Specify TFL Chassis; [See TFL Colors and Specify](#)
- Metal Accent Color; Must Specify Black (BLK), Aluminum (ALUM), or Snow (SNO), [See Details](#)
- Flower Pots or Planters Not Included

Must Specify (in this order):

Model #
TFL Chassis Color
Metal Accent Finish

RECYCLE BIN ON CASTERS	82-4830RB	48	22	31	183	19.6	T\$ 2375
------------------------	-----------	----	----	----	-----	------	----------

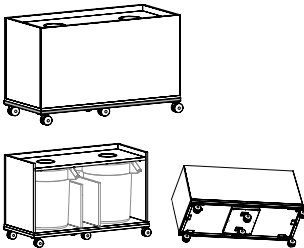

Includes Two (2) Waste/
Recycle Bins



Bottom View to Show
Caster Placement

Description

- Standard with: Two (2) 20 Gallon Waste/Recycle Bins, Six (6) 75mm Casters are Field Installed; Two (2) Locking on Side A, Two (2) Non-Locking on Side B, and Two (2) Non-Locking in Center of Bottom
- Top Shelf 1" Smaller for Easy Removal to Access Recycle Bins; Fixed Side Panels
- Must Specify TFL Chassis; [See TFL Colors and Specify](#)
- Metal Accent Color; Must Specify Black (BLK), Aluminum (ALUM), or Snow (SNO), [See Details](#)

Must Specify (in this order):

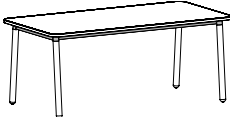
Model #
TFL Chassis Color
Metal Accent Finish

Item	Model No.	W	D	H	Ship Wt	Cubic Ft	List Price
  <p>Top Shape</p>	82-4296RT	96	42	30	141	25.5	T\$ 2824 P\$ 3177
	82-4284RT	84	42	30	127	22.4	T\$ 2725 P\$ 3142
	82-4272RT	72	42	30	115	19.3	T\$ 2626 P\$ 2715
	82-3696RT	96	36	30	126	22.7	T\$ 2716 P\$ 3142
	82-3684RT	84	36	30	115	19.9	T\$ 2630 P\$ 3111
	82-3672RT	72	36	30	103	17.1	T\$ 2491 P\$ 2551
	82-3660RT	60	36	30	90	14.4	T\$ 2345 P\$ 2460
	82-3072RT	72	30	30	86	13.3	T\$ 2313 P\$ 2428
	82-3060RT	60	30	30	76	11.1	T\$ 2180 P\$ 2218
	82-2472RT	72	24	30	76	12	T\$ 2231 P\$ 2286
	82-2460RT	60	24	30	67	10	T\$ 2111 P\$ 2195

Must Specify (in this order):

Model #
 Top Material
 Top Color
 Metal Accent Color
 Leg Color
 Leg Glide or Casters
 Grommet/Power





Use the Black Undermount Hook For Purses, Bags, Etc. [\(See Details\)](#)

Description

- TFL and HPL Tops; [See TFL and HPL Colors and Specify](#)
- Undermount Metal Accents Measure 2"H, 1" Thick, and is Available in Black (BLK), Aluminum (ALUM), or Snow (SNO); Must Specify Color, [See Details](#)
- Top and Legs Available in Contrasting Colors; [See Leg Color Options](#)
- Legs Available with Fixed Glides (GLIDES) or Four (4) 60mm Casters (BSC60), Two (2) Locking and Two (2) Non-Locking; [See Details and Specify](#)
- Some Assembly Required
- Power and Grommet Available on Center Only; [See Options](#)

T= TFL P= HPL

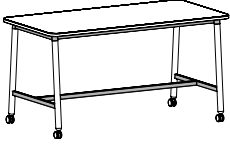
[See Synergy Overview For Ordering Options](#)

Item	Model No.	W	D	H	Ship Wt	Cubic Ft	List Price
<p>COUNTER HEIGHT TABLE</p>  <p>Table Shown with Casters</p>  <p>Top Shape</p> <p>Must Specify (in this order): Model # Top Material Top Color Metal Accent Color Leg Color Leg Glide or Casters Grommet/Power</p>	82-4296CRT	96	42	36	152	25.5	T\$ 3205 P\$ 3558
	82-4284CRT	84	42	36	139	22.4	T\$ 3106 P\$ 3523
	82-4272CRT	72	42	36	126	19.3	T\$ 3007 P\$ 3096
	82-3696CRT	96	36	36	137	22.7	T\$ 3097 P\$ 3523
	82-3684CRT	84	36	36	126	19.9	T\$ 3011 P\$ 3492
	82-3672CRT	72	36	36	115	17.1	T\$ 2873 P\$ 2932
	82-3660CRT	60	36	36	101	14.4	T\$ 2861 P\$ 2976
	82-3072CRT	72	30	36	98	13.3	T\$ 2669 P\$ 2784
	82-3060CRT	60	30	36	85	11.1	T\$ 2671 P\$ 2709
	82-2472CRT	72	24	36	86	12	T\$ 2587 P\$ 2642
	82-2460CRT	60	24	36	76	10	T\$ 2602 P\$ 2686

Description



- TFL and HPL Tops; [See TFL and HPL Colors and Specify](#)
- Undermount and Lower Metal Accents Measure 2"H, 1" Thick, and is Available in Black (BLK), Aluminum (ALUM), or Snow (SNO); Must Specify Color, [See Details](#)
- Top and Legs Available in Contrasting Colors; [See Leg Color Options](#)
- Legs Available with Fixed Glides (GLIDES) or Four (4) 60mm Casters (BSC60), Two (2) Locking and Two (2) Non-Locking; [See Details and Specify](#)
- Some Assembly Required
- Power and Grommet Available on Center Only; [See Options](#)



Use the Black
[Undermount Hook](#)
 For Purses, Bags, Etc.
[\(See Details\)](#)

T= TFL P= HPL

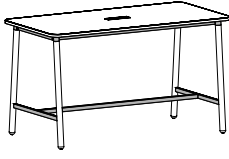
[See Synergy Overview For Ordering Options](#)

Item	Model No.	W	D	H	Ship Wt	Cubic Ft	List Price
 <p>Table Shown with TRIO on Center</p>  <p>Top Shape</p> <p><u>Must Specify (in this order):</u> Model # Top Material Top Color Metal Accent Color Leg Color Leg Glide or Casters Grommet/Power</p>	82-4296BRT	96	42	42	154	25.5	T\$ 3411 P\$ 3763
	82-4284BRT	84	42	42	141	22.4	T\$ 3311 P\$ 3728
	82-4272BRT	72	42	42	128	19.3	T\$ 3212 P\$ 3301
	82-3696BRT	96	36	42	139	22.7	T\$ 3302 P\$ 3729
	82-3684BRT	84	36	42	128	19.9	T\$ 3216 P\$ 3697
	82-3672BRT	72	36	42	117	17.1	T\$ 3078 P\$ 3138
	82-3660BRT	60	36	42	103	14.4	T\$ 2905 P\$ 3020
	82-3072BRT	72	30	42	100	13.3	T\$ 2861 P\$ 2975
	82-3060BRT	60	30	42	86	11.1	T\$ 2701 P\$ 2739
	82-2472BRT	72	24	42	88	12	T\$ 2779 P\$ 2833
	82-2460BRT	60	24	42	77	10	T\$ 2632 P\$ 2716

Description

- TFL and HPL Tops; [See TFL and HPL Colors and Specify](#)
- Undermount and Lower Metal Accents Measure 2”H, 1” Thick, and is Available in Black (BLK), Aluminum (ALUM), or Snow (SNO); Must Specify Color, [See Details](#)
- Top and Legs Available in Contrasting Colors; [See Leg Color Options](#)
- Legs Available with Fixed Glides (GLIDES) or Four (4) 60mm Casters (BSC60), Two (2) Locking and Two (2) Non-Locking; [See Details and Specify](#)
- Some Assembly Required
- Power and Grommet Available on Center Only; [See Options](#)

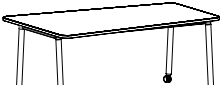
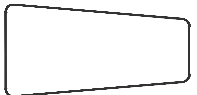

Use the Black Undermount Hook For Purses, Bags, Etc. [\(See Details\)](#)

Item	Model No.	W	D	H	Ship Wt	Cubic Ft	List Price
 <p>Table Shown with Casters</p>  <p>Top Shape</p> <p><u>Must Specify (in this order):</u> Model # Top Material Top Color Metal Accent Color Leg Color Leg Glide or Casters Grommet/Power</p>	82-3672VT	72	36-48	30	118	21	T\$ 2704 P\$ 2738
	82-2472VT	72	24-36	30	90	17.1	T\$ 2405 P\$ 2465

Description

- TFL and HPL Tops; [See TFL and HPL Colors and Specify](#)
- Undermount Metal Accents Measure 2”H, 1” Thick, and is Available in Black (BLK), Aluminum (ALUM), or Snow (SNO); Must Specify Color, [See Details](#)
- Top and Legs Available in Contrasting Colors; [See Leg Color Options](#)
- Legs Available with Fixed Glides (GLIDES) or Four (4) 60mm Casters (BSC60), Two (2) Locking and Two (2) Non-Locking; [See Details and Specify](#)
- Some Assembly Required
- Power and Grommet Available on Center Only; [See Options](#)



Use the Black Undermount Hook For Purses, Bags, Etc. [\(See Details\)](#)

T= TFL P= HPL

[See Synergy Overview For Ordering Options](#)

Item	Model No.	W	D	H	Ship Wt	Cubic Ft	List Price
COUNTER HEIGHT VIEW TABLE	82-3672CVT	72	36-48	36	129	21	T\$ 3085 P\$ 3119
	82-2472CVT	72	24-36	36	100	17.1	T\$ 2761 P\$ 2821

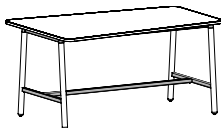

Top Shape

Must Specify (in this order):

- Model #
- Top Material
- Top Color
- Metal Accent Color
- Leg Color
- Leg Glide or Casters
- Grommet/Power

Description

- TFL and HPL Tops; [See TFL and HPL Colors and Specify](#)
- Undermount and Lower Metal Accents Measure 2"H, 1" Thick, and is Available in Black (BLK), Aluminum (ALUM), or Snow (SNO); Must Specify Color, [See Details](#)
- Top and Legs Available in Contrasting Colors; [See Leg Color Options](#)
- Legs Available with Fixed Glides (GLIDES) or Four (4) 60mm Casters (BSC60), Two (2) Locking and Two (2) Non-Locking; [See Details and Specify](#)
- Two (2) Cubbies on Each Side; Each Cubby is 22½"W x 10¼"D x 12"H
- Some Assembly Required
- Power and Grommet Available on Center Only; [See Options](#)



Use the Black Undermount Hook For Purses, Bags, Etc. [\(See Details\)](#)

STANDING HEIGHT VIEW TABLE	82-3672BVT	72	36-48	42	131	21	T\$ 3291 P\$ 3325
	82-2472BVT	72	24-36	42	102	17.1	T\$ 2952 P\$ 3012

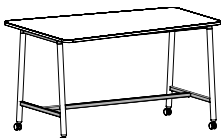

Table Shown with Casters



Top Shape

Must Specify (in this order):

- Model #
- Top Material
- Top Color
- Metal Accent Color
- Leg Color
- Leg Glide or Casters
- Grommet/Power

Description

- TFL and HPL Tops; [See TFL and HPL Colors and Specify](#)
- Undermount and Lower Metal Accents Measure 2"H, 1" Thick, and is Available in Black (BLK), Aluminum (ALUM), or Snow (SNO); Must Specify Color, [See Details](#)
- Top and Legs Available in Contrasting Colors; [See Leg Color Options](#)
- Legs Available with Fixed Glides (GLIDES) or Four (4) 60mm Casters (BSC60), Two (2) Locking and Two (2) Non-Locking; [See Details and Specify](#)
- Some Assembly Required
- Power and Grommet Available on Center Only; [See Options](#)



Use the Black Undermount Hook For Purses, Bags, Etc. [\(See Details\)](#)

T= TFL P= HPL

[See Synergy Overview For Ordering Options](#)

Item	Model No.	Seat Width	Seat Depth	Seat Height	Ship Wt	Cubic Ft
CUBBY BENCH	820-4822MCB	48	19	17½	47	9.2

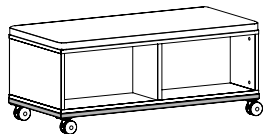

Must Specify (in this order):
 Model #
 Upholstery
 Chassis Finish
 Metal Accent Color

Description

- Standard with: Four (4) 75mm Non-Locking Casters
- Two (2) Cubbies on Each Side, Four (4) Cubbies Total; Each Cubby is 22½"W x 10¼"D x 12"H
- Cushion is One Piece
- Must Specify TFL Chassis; [See TFL Colors and Specify](#)
- Metal Accent Measures 1" Square, Available in Black (BLK), Aluminum (ALUM), or Snow (SNO); Must Specify Color, [See Details](#)

List Price/Grade	Yards	COM/1	2	3	4	5	6	7	8	9	10	L1	L2
Single Upholstery	1.50	\$ 1880	1958	2024	2089	2186	2285	2426	2573	2744	2942	2375	2587

Item	Model No.	Seat Width	Seat Depth	Seat Height	Ship Wt	Cubic Ft
TEAM BENCH WITH CASTERS	820-4819MTB	48	19	17½	47	9.2

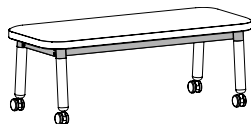

Must Specify (in this order):
 Model #
 Upholstery
 Leg Finish
 Metal Accent Color

Description

- Standard with 60mm Non-Locking Casters
- Legs are 2"D, Must Specify Color; [See Leg Color Options](#)
- Metal Accent Measures 2"H and 1" Thick, Available in Black (BLK), Aluminum (ALUM), or Snow (SNO); Must Specify Color, [See Details](#)

List Price/Grade	Yards	COM/1	2	3	4	5	6	7	8	9	10	L1	L2
Single Upholstery	1.50	\$ 1906	1984	2050	2115	2212	2311	2452	2599	2770	2968	2401	2613

Item	Model No.	Seat Width	Seat Depth	Seat Height	Ship Wt	Cubic Ft
TEAM BENCH WITH GLIDES	820-4819TB	48	19	17½	47	9.2

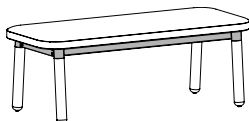

Must Specify (in this order):
 Model #
 Upholstery
 Leg Finish
 Metal Accent Color

Description

- Standard with Fixed Glides
- Legs are 2"D Feature Fixed Glides, Must Specify Color; [See Leg Color Options](#)
- Metal Accent Measures 2"H and 1" Thick, Available in Black (BLK), Aluminum (ALUM), or Snow (SNO); Must Specify Color, [See Details](#)

List Price/Grade	Yards	COM/1	2	3	4	5	6	7	8	9	10	L1	L2
Single Upholstery	1.50	\$ 1799	1877	1943	2008	2105	2204	2345	2492	2663	2861	2294	2506

[See Synergy Overview For Ordering Options](#)

Item	Model No.	Seat Width	Seat Depth	Seat Height	Ship Wt	Cubic Ft
STOOL WITH CASTERS	820-2419MFS	24	19	17½	29	4.6

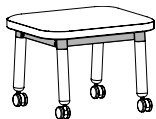

Stool Shown with Casters

Description

- Standard with 60mm Non-Locking Casters
- Legs are 2”D, Must Specify Color; [See Leg Color Options](#).
- Metal Accent Measures 2”H and 1” Thick, Available in Black (BLK), Aluminum (ALUM), or Snow (SNO); Must Specify Color, [See Details](#)

Must Specify (in this order):

- Model #
- Upholstery
- Leg Finish
- Metal Accent Color

List Price/Grade	Yards	COM/1	2	3	4	5	6	7	8	9	10	L1	L2
Single Upholstery	1.00	\$ 1652	1704	1748	1791	1856	1922	2016	2114	2228	2360	1982	2123

Item	Model No.	Seat Width	Seat Depth	Seat Height	Ship Wt	Cubic Ft
STOOL WITH GLIDES	820-2419FS	24	19	17½	29	4.6

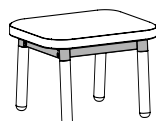

Stool Shown with Casters

Description

- Standard with Fixed Glides
- Legs are 2”D, Must Specify Color; [See Leg Color Options](#).
- Metal Accent Measures 2”H and 1” Thick, Available in Black (BLK), Aluminum (ALUM), or Snow (SNO); Must Specify Color, [See Details](#)

Must Specify (in this order):

- Model #
- Upholstery
- Leg Finish
- Metal Accent Color

List Price/Grade	Yards	COM/1	2	3	4	5	6	7	8	9	10	L1	L2
Single Upholstery	1.00	\$ 1652	1704	1748	1791	1856	1922	2016	2114	2228	2360	1982	2123

Item	Model No.	Seat Width	Seat Depth	Seat Height	Ship Wt	Cubic Ft
COUNTER HEIGHT STOOL	821	16¾	16¾	31½	23	5.1

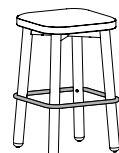

Description

- Standard with Fixed Glides
- Legs are 2”D, Must Specify Color; [See Leg Color Options](#).
- Foot Ring Available in Black (BLK), Aluminum (ALUM), or Snow (SNO), Must Specify Color, [See Details](#)

Must Specify (in this order):

- Model #
- Upholstery
- Leg Finish
- Foot Ring Color

List Price/Grade	Yards	COM/1	2	3	4	5	6	7	8	9	10	L1	L2
Single Upholstery	1.00	\$ 1386	1438	1482	1525	1590	1656	1750	1848	1962	2094	1716	1386

Item	Model No.	Seat Width	Seat Depth	Seat Height	Ship Wt	Cubic Ft
BAR HEIGHT STOOL	822	16¾	16¾	27½	22	4.5

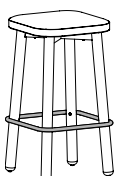

Description



- Standard with Fixed Glides
- Legs are 2”D, Must Specify Color; [See Leg Color Options](#).
- Foot Ring Available in Black (BLK), Aluminum (ALUM), or Snow (SNO), Must Specify Color, [See Details](#)

Must Specify (in this order):

- Model #
- Upholstery
- Leg Finish
- Foot Ring Color

List Price/Grade	Yards	COM/1	2	3	4	5	6	7	8	9	10	L1	L2
Single Upholstery	1.00	\$ 1421	1473	1517	1560	1625	1691	1785	1883	1997	2129	1751	1421

[See Synergy Overview For Ordering Options](#)

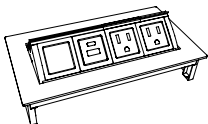
Item	Model No.		W	D	H	Ship Wt	Cubic Ft	List Price
ROUND GROMMET COVER	01-GRMTB	Black	2 $\frac{3}{8}$	2 $\frac{3}{8}$	-	1	0.1	\$ 11
	01-GRMTSL	Silver						
 OPEN MARKET ONLY (SILVER)	Description <ul style="list-style-type: none"> • 2$\frac{3}{8}$" (60mm) Round Grommet Cover • Field Installed 							
DOCK 950 WIRELESS CHARGER	01-DOCK950W	White	3 $\frac{3}{16}$	3 $\frac{3}{16}$	-	1	0.2	\$ 265
	01-DOCK950B	Black						
 OPEN MARKET ONLY	Description <ul style="list-style-type: none"> • For Use with Wireless Charging Enabled Devices • 5 Watts Maximum Output with a Direct Current of 5V 2A and 10 Watts Maximum with Quick Charge 2.0 • Mounts in 76mm Round Cut-Out • LED will Confirm Pairing with Device and Begin Wireless Charging 							
DOCK 150 WIRELESS AND USB CHARGER	01-DOCK150W	White	3	3	$\frac{3}{4}$	1	0.2	\$ 405
	01-DOCK150B	Black						
 OPEN MARKET ONLY	Description <ul style="list-style-type: none"> • For Use with Wireless Charging Enabled Devices and USB Charging Devices • 5 Watt Maximum Output with a Direct Current Input of 5V 6A (Wireless Fast Charge) • Mounts in 76mm Round Cut-Out • Pop-Up is $\frac{3}{4}$"H and Includes Three (3) USB Ports; One (1) 12 Watt Maximum with 2.4A (USB Fast Charge) and Two (2) 5 Watt with 1A (USB Standard Charge) • LED Light will Confirm Pairing with Device and Begin Wireless Charging • UL and cUL Certified 							
POWER DATA PORT	01-DPORT4A	Aluminum	8	4	-	7	0.2	\$ 1093
	01-DPORT4B	Black						
	Description <ul style="list-style-type: none"> • Retracts into Work Surface to Regain Productive Space • One-Touch Access to Power and Data • Two (2) Water-Proof Simplex Power Outlets, One (1) USB A+C, and One (1) Open Port • Optional Telecom Port Components, Following Page • Includes a Voice/Data Adapter Kit to Accept Couplers and Jacks When Required • 10' Power Cord 							

[See Synergy Overview For Ordering Options](#)

Item	Model No.	W	D	H	Ship Wt	Cubic Ft	List Price
USB PORT	01-USBPORT	-	-	-	-	-	\$ 161

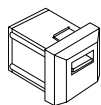
**Description**

- For Use with 01-DPORT4A and 01-DPORT4B
- Passive USB-A Port with Increased Transfer Speed Up to 5 gbs/sec
- Simultaneous Read/Write Capability
- Idle Device Power Saving State
- 6' Cord
- See Voice Coupler and Data Port on Next Page

VOICE COUPLER	01-VOICE1	-	-	-	-	-	\$ 73
---------------	-----------	---	---	---	---	---	-------

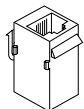
**Description**

- For Use with 01-DPORT4A and 01-DPORT4B
- 6-Pin Modular Plug
- Molded Black
- Cord Not included

DATA PORT	01-RJ4DATA	-	-	-	-	-	\$ 167
-----------	------------	---	---	---	---	---	--------



OPEN MARKET ONLY

Description

- For Use with 01-DPORT4A and 01-DPORT4B
- 8-Pin Modular Plug; Cat6 Ethernet Cable; Pre-terminated Cable
- 10' Cord

VGA CONNECTOR ACCESSORY	01-VGACON	-	-	-	1	0.2	\$ 149
-------------------------	-----------	---	---	---	---	-----	--------

**Description**

- VGA Port for 01-DPORT4A and 01-DPORT4B
- Enables Devices to Remote Display on Monitors
- 10' Cord
- Male/Female Connector

HDMI CONNECTOR ACCESSORY	01-HDMICON	-	-	-	1	0.2	\$ 124
--------------------------	------------	---	---	---	---	-----	--------

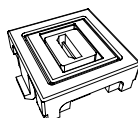
**Description**

- HDMI Port for 01-DPORT4A and 01-DPORT4B
- Connects to High Definition Displays
- Female/Female Connector
- 18" Cord

[See Synergy Overview For Ordering Options](#)

Item	Model No.		W	D	H	Ship Wt	Cubic Ft	List Price
DUO CLAMP WITH NEMA PLUG	01-DUOCLAMPW	White	6½	3	7	1	0.2	\$ 572
	01-DUOCLAMPB	Black						
	01-DUOCLAMP S	Silver						

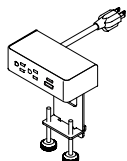

Description

- Standard with: Two (2) Power Outlet, One (1) USB Charging Port and One (1) 60-Watt USB-C Power
- Delivery Port with GaN Technology with 10' Cord
- Clamps to Top and Features Silver Metal Trim
- Independent USB Circuit Controllers Deliver up to 2.1 Amps to Each Post
- All Mounting Hardware Included
- FCC Part 15A and UL Approved for Horizontal and Vertical Applications

TRIO CLAMP WITH NEMA PLUG	01-TRIOCLAMPW	White	9	3	7	1	0.2	\$ 671
	01-TRIOCLAMPB	Black						
	01-TRIOCLAMP S	Silver						

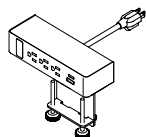

Description

- Standard with: Three (3) Power Outlets, One (1) USB Charging Port, One (1) 60-Watt USB-C Power
- Delivery Port with GaN Technology, One (1) Open Data with 10' Cord
- Clamps to Top and Features Silver Metal Trim
- Independent USB Circuit Controllers Deliver up to 2.1 Amps to Each Post
- HDMI, VGA, or RJ45 Sold Separately; [See Accessories](#)
- All Mounting Hardware Included
- FCC Part 15A and UL Approved for Horizontal and Vertical Applications

DUO BEZEL WITH NEMA PLUG	01-DUOBEZELW	White	6½	2½	3¼	1	0.2	\$ 675
	01-DUOBEZELB	Black						
	01-DUOBEZEL S	Silver						



Description

- Sits On Top of the Worksurface and Includes: Two (2) Power, One (1) USB Charging Port and One (1)
- 60-Watt USB-C Power Delivery Port with GaN Technology with 10' Cord
- Independent USB Circuit Controllers Deliver up to 2.1 Amps to Each Post
- All Mounting Hardware Included
- FCC Part 15A and UL Approved for Horizontal and Vertical Applications

TRIO BEZEL WITH NEMA PLUG	01-TRIOBEZELW	White	9	2½	3	1	0.2	\$ 725
	01-TRIOBEZELB	Black						
	01-TRIOBEZEL S	Silver						

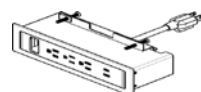

Description

- Sits On Top of the Worksurface and Includes: Three (3) Power, One (1) USB Charging Port and One (1)
- 60-Watt USB-C Power Delivery Port with GaN Technology, One (1) Open Data, and 10' Cord
- Independent USB Circuit Controllers Deliver up to 2.1 Amps to Each Post
- HDMI, VGA, or RJ45 Sold Separately; [See Accessories](#)
- All Mounting Hardware Included
- FCC Part 15A and UL Approved for Horizontal and Vertical Applications

[See Synergy Overview For Ordering Options](#)

Item	Model No.	W	D	H	Ship Wt	Cubic Ft	List Price
HDMI DATA PORT ACCESSORY	01-LCOMHDMI	-	-	-	1	0.2	\$ 166

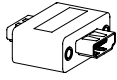
**Description**

- HDMI Port for Undermount Trio Clamp and Trio Bezel Units

OPEN MARKET ONLY

VGA DATA PORT ACCESSORY	01-LCOMVGA	-	-	-	1	0.2	\$ 121
-------------------------	------------	---	---	---	---	-----	--------

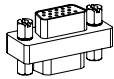
**Description**

- VGA Port for Undermount Trio Clamp and Trio Bezel Units

RJ45 DATA PORT ACCESSORY	01-LCOMRJ45	-	-	-	1	0.2	\$ 79
--------------------------	-------------	---	---	---	---	-----	-------

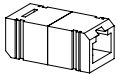
**Description**

- RJ45 Port for Undermount Trio Clamp and Trio Bezel Units

MARKER AND ERASER SET	01-MRKRSETBL	For Use with Black Glass Magnetic Marker Panels	\$ 123
	01-MRKRSETWH	For Use with White Glass Magnetic Marker Panels	

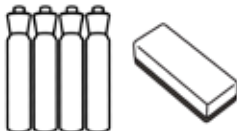
**Description**



- 01-MRKRSETWH May Also be Used with Dry Erase Panels
- Includes 4 Markers and an Eraser

RARE EARTH MAGNET SET	01-MAGBL	Black Magnets	\$ 114
	01-MAGWH	White Magnets	

**Description**

- Includes Set of Five (5) Rare Earth Magnets
- To be Used with Black and White Glass Magnetic Marker Panels
- Comfort Grip with Stylish Protective Plastic Coating

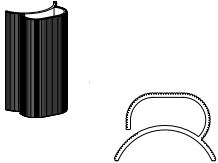
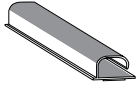
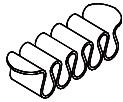
[See Synergy Overview For Ordering Options](#)

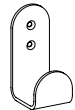
Item	Model No.	W	D	H	Ship Wt	Cubic Ft	List Price
3" WIRE MANAGER FOR ROUND LEGS	01-0302WM	3	2	¾	0.25	0.13	\$ 31
	Description	<ul style="list-style-type: none"> • Black Vinyl Wire Management With Adhesive for Round Leg • Quantity of Three (3) • Attaches with Adhesive Strips • Field Installed 					
WIRE CHANNEL	01-32125	24	1½	1	.25	0.3	\$ 106
	Description	<ul style="list-style-type: none"> • Available in Black • Channel Attaches with Two (2) Double-Sided Installation Tape to Flat Surfaces • Open J Channel for Easy Storage of Cables • Field Installed 					
CABLE GRIP	01-WMGRCB	5%	2%	-	-	-	\$ 17
	Description	<ul style="list-style-type: none"> • Black Under Surface Wire Management • Cable Grip Attaches with Four (4) Screws, Hardware Included • Field Installed 					
BLACK UNDERMOUNT HOOK FOR TABLES	01-HOOK	2	1¾	2½			\$ 79
	Description	<ul style="list-style-type: none"> • Black Hook Includes Mounting Hardware • For Undermount Applications on Tables • Field Installed 					
BLACK HOOK FOR VERTICAL SURFACES	01-ACCHOOKB	2	1¾	2½			\$ 64
	Description	<ul style="list-style-type: none"> • Black Hook Includes Mounting Hardware • For Use on Vertical Surfaces • 20lbs Weight Capacity • Field Installed 					

[See Synergy Overview For Ordering Options](#)

ORDERING INFORMATION

All orders should be emailed to neworders@indianafurniture.com. Orders can be faxed to 812-482-9035 or mailed to:

Indiana Furniture
P.O. Box 270, 1919 Hospitality Dr., Ste. A
Jasper, IN 47547-0270

ORDER PROCEDURE

All orders must include purchase order number, billing address, ship-to address and phone number, and any special instructions.

When ordering casegoods or tables, give complete quantity, model number, finish and any other options.

When ordering seating, give complete quantity, model number, finish, fabric and any other options.

Within each series, an example of "How to Order" is illustrated at the beginning of each series section. For further clarification of order procedure, contact Customer Service.

PRICING

All prices shown are suggested retail prices F.O.B. Point of Origin, freight prepaid and allowed to one continental US destination. Prices, specifications and materials are subject to change without notice. Possession and/or distribution of this price list does not in itself constitute an offer to sell. Orders can be received only from authorized Indiana Furniture dealers. Orders will be billed at prices prevailing at time of shipment, unless acknowledged prior to the effective date of the price change, in which case billing will be at the price acknowledged.

ACKNOWLEDGMENT

All orders will be acknowledged promptly, showing how the order was entered, its approximate shipping date and other pertinent information. This acknowledgment is the final agreement between the customer and Indiana Furniture and is the exclusive statement of the terms thereof. Please examine this acknowledgment carefully and advise Indiana Furniture immediately of any discrepancies. Note: Shipping fees will not be listed on the acknowledgment.

BUYER'S OBLIGATION: RIGHTS OF SELLER

If Indiana Furniture shall at any time doubt Buyer's financial responsibility, Indiana Furniture may decline to make shipments hereunder except upon receipt of cash payment in advance or security or other proof of responsibility satisfactory to Indiana Furniture. If buyer fails in any way to fulfill the terms and conditions set forth herein, Indiana Furniture may defer shipments until such default is corrected. Remedies provided herein shall be in addition to, and not in lieu of other remedies. Buyer agrees to abide by payment terms as listed on invoice. Buyer shall pay all reasonable costs and expenses, including attorney and collection fees, and late fees, incurred by Seller in connection with any amounts due for goods ordered.

CANCELLATIONS AND CHANGES

Due to immediate production on build-to-order items, all orders are considered firm and are not subject to cancellation or change without approval from Indiana Furniture. All approved changes are subject to additional charges and revised lead times.

PRODUCT DESIGN AND SPECIFICATION CHANGES

Indiana Furniture reserves the right to make changes in design and construction or discontinue products without prior notice.

REPAIR CHARGES

Indiana Furniture will only pay repair charges if Customer Service gives prior written authorization. No repair charge will be paid without advance approval at which time you will be issued a repair authorization number that will allow you to invoice Indiana Furniture for the completed work.

WAREHOUSE STORAGE CHARGES

If a shipment is held beyond 14 calendar days at your request, a **.084% per calendar day** (2.52% per month) storage charge will be assessed. The effective date will be 14 calendar days after the acknowledged ship date. Further, the prices applied to the order will be those in effect at the time of shipment.

DAMAGED MERCHANDISE

The consignee is responsible for filing claims with the carrier for damage and shortages. Claims for both obvious and concealed damage must be filed within 15 calendar days, and the damaged merchandise must not have been moved from the original receiving location. All damaged merchandise, including the cartons and packing materials, must be retained for inspection by either the carrier or by an Indiana Furniture Sales Representative. Indiana Furniture reserves the right to select the most cost effective way to repair or replace the damaged item. Once you have notified the carrier, please contact Customer Service for further assistance.

Obvious Damage/Missing Cartons — Do not refuse merchandise damaged in transit. Indiana Furniture recommends the consignee inspect all merchandise upon arrival. If a shipment is received damaged or short, note all information on carrier's copy and your copy of freight bill and delivery receipt. Notify the delivering carrier and file a claim immediately. Pending the results of your claim, either Indiana Furniture or the carrier will cover 100% of the cost to repair or replace the damaged or missing item.

Concealed Damage — If concealed damage is discovered, notify the delivering carrier at once and request an inspection. This must be done within 15 calendar days of delivery. If the carrier will not perform the inspection, you should prepare an affidavit that you contacted them, noting the time and date, and that they failed to comply with your request. This, along with the other papers in your possession, will support the claim. Pending the results of your claim, the cost to repair or replace the item will be covered 1/3 by the carrier and 2/3 by Indiana Furniture for shipments less than a full truckload and 100% by Indiana Furniture for shipments of full truck loads.

RETURN MERCHANDISE

Merchandise will not be accepted for return without a RGA (Return Goods Authorization) issued by Indiana Furniture. We will consider issuing RGA's for the following reasons:

1. Manufacturing defect (inspected by Indiana Furniture representative)
2. Indiana Furniture order processing error
3. Shipping error
4. Mis-marked cartons
5. Duplicated shipments

If you have any questions as to whether your reason for return qualifies for consideration, please contact your Customer Service Representative. Merchandise must be returned within 60 days of the RGA issued date, or within 60 days upon receipt of replacement product to receive credit. Returns due to mis-marked cartons must also be returned in the original cartoning, with shipping labels intact, to receive credit.

All merchandise being returned must be properly packed and protected to ensure no further damage is incurred during transportation back to an Indiana Furniture facility. Upon receipt, all returned merchandise will be thoroughly inspected and the results compared to the reason for return stated on the RGA. Any discrepancies, such as additional damage, signs of usage, missing parts, etc., will result in an adjustment to the amount of credit issued.

DELIVERY AND FREIGHT CHARGES

All shipments are F.O.B. Point of Origin, Jasper, IN, freight prepaid and allowed dock to dock on 53' trailer. Ownership and responsibility of the merchandise becomes that of the buyer upon delivery to the freight company. Shipments into Alaska, Hawaii, Canada, Mexico, Puerto Rico and other exports are freight prepaid and allowed to port of exit.

Indiana Furniture reserves the right to select the most appropriate carrier and routing on all shipments. Indiana Furniture will attempt to accommodate requests for favored carriers and delivery times. Deliveries requested Monday through Thursday, after 3pm, will be assessed a \$300 per truck after hours fee. Deliveries requested after 3pm on Friday or on weekends, will be assessed a \$600 per truck weekend delivery fee.

Inside delivery and installation services are not included in the pricing shown. Any deviation from dock-to-dock delivery, such as but not limited to, non-dock, residential, or inside delivery must be specified on the order. Should these services be requested or required, all charges incurred will be charged to the "Sold To" of the order.

Shipments totaling less than \$3000 (net value, product only) will be assessed a small order fee of \$300 net per shipment. This fee will be reduced for items shipped via small package carriers. For order shipments of \$100 or less, shipped by small package carrier, the fee is \$18. For order shipments over \$100, shipped by small package carrier, the fee is \$40. All shipping fees will be added at the time of invoicing.

BIFMA AND ANSI TESTING

Indiana Furniture is a member of the Business and Institutional Furniture Manufacturer's Association (BIFMA). Tests developed by the BIFMA and approved by the American National Standards Institute (ANSI) determine the strength and durability of casegoods and seating in its everyday use. Although this testing does not serve as a warranty or guarantee, Indiana Furniture products within this price list have been tested by an independent verifying body and meet or exceed applicable BIFMA and ANSI standards.

Subject to the limitations set forth in this warranty, Indiana Furniture Industries, Inc. (“**Indiana Furniture**”) warrants to the original purchaser all product in this price list (“**Product**”) to be free from defects in material and workmanship given normal use for a 12-year period from the date of manufacture. During the applicable warranty period, Indiana Furniture, as its sole obligation, will repair or replace (in Indiana Furniture’s sole discretion) any Product, part, or component covered by this warranty and sold after May 13, 2024, which fails under normal use as a result of a defect in material or workmanship. Normal use is defined as the equivalent of a single shift, 40-hour work week. Indiana Furniture will repair or replace the defective Product, part, or component with a comparable Product, part, or component.

Warranty periods are limited for certain Products and parts as follows:

12-year Warranty (from the date of manufacture)

- Seating Mechanisms
- Veneers
- Laminates
- Casters and Glides

5-year Warranty (from the date of manufacture)

- Triple Play Series
- Electrical Components
- Pneumatic Cylinders
- Textiles, Foam, and Decorative Trim
- Swivel Arm Pads
- Keyboard Kits
- Lighting
- All Height Adjustable Mechanisms

3-year Warranty (from date of shipment)

- Dock 950 Wireless Charger
- Dock 150 Wireless and USB Charger

THIS WARRANTY DOES NOT COVER:

- Damage caused by a carrier or third party
- Normal or routine wear and tear
- Appearance, durability, quality, behavior, colorfastness, or any other attribute of customer’s own materials or any non-standard Indiana Furniture material (including CF Stinson, Maharam, Momentum, Mayer, UltraFabrics, Architex, and other alliance programs) specified by the customer and applied to a Product
- Color, grain or texture of wood, laminate and other covering materials
- Changes in wood or fabric color due to aging or exposure to light

As the manufacturer of the Product, Indiana Furniture stands behind its craftsmanship and pledges to do everything it can to reasonably resolve, as quickly as possible, any problems you may have with the Product within the terms and conditions of this warranty.

If you encounter a defect covered by the foregoing warranty, contact the dealer from whom you purchased the Product. If the dealer is unable to resolve your warranty issues, you should contact Indiana Furniture. Please ensure that you have all of the pertinent facts when contacting the dealer or Indiana Furniture, including the model number and factory order number from the inspection label attached to the Product.

INDIANA FURNITURE IS NOT PROVIDING, AND SPECIFICALLY DISCLAIMS, ANY OTHER WARRANTIES FOR THE PRODUCTS, EXPRESS OR IMPLIED, INCLUDING ANY IMPLIED WARRANTY OF MERCHANTABILITY OR FITNESS FOR A PARTICULAR PURPOSE. INDIANA FURNITURE SHALL NOT BE LIABLE TO THE PURCHASER OR ANY THIRD PARTY FOR CONSEQUENTIAL, INCIDENTAL, INDIRECT, OR SPECIAL DAMAGES, INCLUDING, WITHOUT LIMITATION, DAMAGES ARISING OUT OF OR RESULTING IN ANY MALFUNCTIONS, DELAYS, LOSS OF PROFIT, INTERRUPTION OF BUSINESS, PERSONAL INJURY, BODILY INJURY, DEATH, DISMEMBERMENT, OR PROPERTY DAMAGE.

Indiana Furniture Industries, Inc.
Attn: Customer Service
1919 Hospitality Dr., Ste A
P.O. Box 270
Jasper, Indiana
47547-0270
800.422.5727
Fax 812.482.9035
custserv@indianafurniture.com

Surface Materials

Wood Finishes and Woodgrain, Solid, and 3D Laminates



White Nebbia (WNB)
TFL, HPL, Seating



Beigewood (BW)
TFL, HPL, Seating*



Sugar Maple (SM)
Veneer, TFL, HPL, Seating



Oak Riftwood (ORW)
Veneer*, TFL, HPL, Seating*



Kirsche (KHE)
TFL, HPL, Seating



Fawn Oak (FO)
Veneer*, Seating*



River Cherry (RC)
TFL, HPL, Seating*



Mesa Sunset (MAS)
Veneer*, Seating*



Natural Marrone (NTM)
TFL, HPL, Seating*



Studio Teak (TK)
TFL, HPL, Seating



Pinnacle Walnut (PNW)
Veneer, TFL, HPL, Seating



Golden Cherry (GC)
Veneer, HPL, Seating



Legacy Walnut (LW)
Veneer, Seating



Artisan Walnut (AW)
Veneer, Seating



Shaker Cherry (SKC)
Veneer, TFL, HPL, Seating



Select Cherry (SCH)
Veneer, HPL, Seating



Williamsburg Cherry (WC)
Veneer, TFL, HPL, Seating



Harvest Walnut (HW)
Veneer, Seating



Dark Cherry (DC)
Veneer, Seating



Mahogany Walnut (MW)
Veneer, HPL, Seating



Henna Walnut (HNW)
Veneer, Seating



Columbian Walnut (CO)
Veneer, TFL, HPL, Seating



Sepia Walnut (SPW)
TFL, HPL, Seating*



Florence Walnut (FLW)
TFL, HPL, Seating*



Dark Forest Walnut (DFW)
Veneer, Seating*



Espresso (EW/EF)
Veneer, TFL, HPL, Seating



Portico Teak (PTK)
TFL, HPL, Seating*



Weathered Ash (WTA)
Veneer*, TFL, HPL, Seating*



Smoky Brown Pear (SBP)
TFL, HPL, Seating*



Asian Night (AS)
Veneer, TFL, HPL, Seating



Midnight Run (MNR)
TFL, HPL, Seating



Metropolis Sky (MTS)
Veneer, Seating

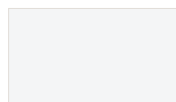

Designer White (WH)
TFL, HPL, Seating



Fashion Grey (FHG)
TFL, HPL



Slate Grey (SG)
TFL, HPL



Black (BL)
TFL, HPL, Seating



Matte White (WH3)
3D Laminate (Iconic Only)



Concrete (CR3)
3D Laminate (Iconic Only)



Matte Black (BL3)
3D Laminate (Iconic Only)



Enamel (ENL)
HPL Accent (Iconic Only)



Blush (BSH)
HPL Accent (Iconic Only)



First Kiss (FK)
HPL Accent (Iconic Only)



Surfin USA (SUS)
HPL Accent (Iconic Only)



Summer Vacation (SV)
HPL Accent (Iconic Only)

* Finish is Low Sheen

Frosted & High Gloss Acrylics

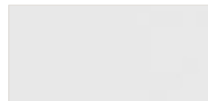

Frosted (FSTA)

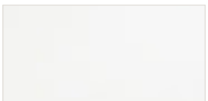

White (WHA)



Wired Mercury (WMA)



Graphite (GPA)



Black (BLA)

Solid Surfaces

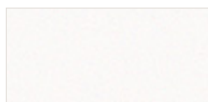

Snow White (SNW)

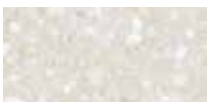

Pebble Beach (PE)



Sedona (SE)



Arroyo (AR)



Tundra (TN)



Starry Night (SN)

Metal Options

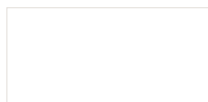

Oyster White (OYST)

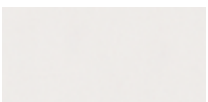

Sugar Cookie (SUGC)



Aluminum (ALUM)



Chrome (CHRM)



Mist (MIST)



Black (BLK)

Colors represented are high-resolution reproductions and may vary slightly from the actual product. To order samples, please contact our Customer Service team or order online at www.indianafurniture.com. Graining and finish colors may vary yet will continue to complement, across Veneer, HPL, TFL, and Seating products due to the inherent differences of these materials.

Indiana[®]

FURNITURE

1919 Hospitality Drive, Suite A
PO Box 270
Jasper, Indiana 47547-0270

Tel 812.482.5727

Toll 800.422.5727

Fax 812.482.9035

sales@indianafurniture.com

www.indianafurniture.com

Federal Classification: Small Business

©2024 Indiana Furniture 5/24

