

Indiana
FURNITURE

CASEGOODS + RECEPTION

PRICING EFFECTIVE MAY 13, 2024

Being over a century old hasn't slowed us down! Sure, we are still the reliable, ethical company that was born in southern Indiana, steeped in quality, craftsmanship, and service. But have you seen our latest introductions? We are making a splash with design and challenging the concept of modern offices. Go ahead. Take a look. You know you want to.

Our Pledge to People + Our Planet.

We've been making wood furniture longer than just about anyone...and we want to be doing so for a long time to come. That's a large part of why we take a stewardship approach to our resources. We believe that environmental sustainability and business profits need not be mutually exclusive. They can and should exist side by side in a mutually beneficial relationship. And for more than a century, we've been showing how it's done.

We've proven our commitment to a sustainable future by supporting the standards and programs that protect our home planet and human health. Whether it's local sourcing, reducing contaminants, implementing wellness and safety programs, or diverting waste from landfills, social responsibility is a part of every decision we make at Indiana Furniture.

One of the surest ways to reduce our impact on the planet is to make and buy things that last. And this one's a natural for us. Our products are made with craftsmanship and attention to detail that are a part of our more than a century-long legacy in wood manufacturing. And our products are backed by our 12-year warranty, which facilitates maintenance, servicing and reassembly.

All of our product lines:

- Are manufactured and assembled in the USA,
- Meet or exceed Indoor Air quality standards*,
- Meet or exceed BIFMA level® Sustainability standards and certification*,
- Conform to the BIFMA Compliance standards*,
- Comply with TSCA Title VI (CARB) standards,
- and can contribute to U.S. Green Building's LEED Program.

To learn more, simply go to www.IndianaFurniture.com/resources.



Ease of Specification

Whether you're looking to specify your office spaces or simply to visualize them in the options and surface materials you are desiring, we make it easy. You can find the entire Indiana Furniture portfolio on the following third-party, space-planning platforms.



* Recently launched or new products may still be in testing; Cush Pillows is currently not BIFMA Compliant due to no available compliance test.

| | |
|--|-------------------|
| <u>General Information + Conditions of Sale</u> | <u>2</u> |
| <u>Warranty</u> | <u>3</u> |
| <u>Casegoods</u> | <u>4</u> |
| <u>Arlington (2900 Series)</u> | <u>7</u> |
| <u>Canvas (6600/6800 Series)</u> | <u>49</u> |
| <u>Gesso (6500/6700 Series)</u> | <u>211</u> |
| <u>Iconic (5000 Series)</u> | <u>369</u> |
| <u>Jefferson (4600 Series)</u> | <u>416</u> |
| <u>Madera (1400/1600 Series)</u> | <u>466</u> |
| <u>Phoenix (2100 Series)</u> | <u>528</u> |
| | |
| <u>Reception</u> | <u>568</u> |
| <u>Aura (6200 Series)</u> | <u>570</u> |
| <u>Cameo (6100 Series)</u> | <u>586</u> |
| <u>Canvas (6400 Series)</u> | <u>598</u> |
| <u>Jefferson (4600 Series)</u> | <u>632</u> |
| | |
| <u>Accessories</u> | <u>644</u> |

ORDERING INFORMATION

All orders should be emailed to neworders@indianafurniture.com.
Orders can be faxed to 812-482-9035 or mailed to:

Indiana Furniture
P.O. Box 270, 1919 Hospitality Dr., Ste. A
Jasper, IN 47547-0270

ORDER PROCEDURE

All orders must include purchase order number, billing address, ship-to address and phone number, and any special instructions.

When ordering casegoods or tables, give complete quantity, model number, finish and any other options.

When ordering seating, give complete quantity, model number, finish, fabric and any other options.

Within each series, an example of "How to Order" is illustrated at the beginning of each series section. For further clarification of order procedure, contact Customer Service.

PRICING

All prices shown are suggested retail prices F.O.B. Point of Origin, freight prepaid and allowed to one continental US destination. Prices, specifications and materials are subject to change without notice. Possession and/or distribution of this price list does not in itself constitute an offer to sell. Orders can be received only from authorized Indiana Furniture dealers. Orders will be billed at prices prevailing at time of shipment, unless acknowledged prior to the effective date of the price change, in which case billing will be at the price acknowledged.

ACKNOWLEDGMENT

All orders will be acknowledged promptly, showing how the order was entered, its approximate shipping date and other pertinent information. This acknowledgment is the final agreement between the customer and Indiana Furniture and is the exclusive statement of the terms thereof. Please examine this acknowledgment carefully and advise Indiana Furniture immediately of any discrepancies.
Note: Shipping fees will not be listed on the acknowledgment.

BUYER'S OBLIGATION: RIGHTS OF SELLER

If Indiana Furniture shall at any time doubt Buyer's financial responsibility, Indiana Furniture may decline to make shipments hereunder except upon receipt of cash payment in advance or security or other proof of responsibility satisfactory to Indiana Furniture. If buyer fails in any way to fulfill the terms and conditions set forth herein, Indiana Furniture may defer shipments until such default is corrected. Remedies provided herein shall be in addition to, and not in lieu of other remedies. Buyer agrees to abide by payment terms as listed on invoice. Buyer shall pay all reasonable costs and expenses, including attorney and collection fees, and late fees, incurred by Seller in connection with any amounts due for goods ordered.

CANCELLATIONS AND CHANGES

Due to immediate production on build-to-order items, all orders are considered firm and are not subject to cancellation or change without approval from Indiana Furniture. All approved changes are subject to additional charges and revised lead times.

PRODUCT DESIGN AND SPECIFICATION CHANGES

Indiana Furniture reserves the right to make changes in design and construction or discontinue products without prior notice.

REPAIR CHARGES

Indiana Furniture will only pay repair charges if Customer Service gives prior written authorization. No repair charge will be paid without advance approval at which time you will be issued a repair authorization number that will allow you to invoice Indiana Furniture for the completed work.

WAREHOUSE STORAGE CHARGES

If a shipment is held beyond 14 calendar days at your request, a **.084% per calendar day** (2.52% per month) storage charge will be assessed. The effective date will be 14 calendar days after the acknowledged ship date. Further, the prices applied to the order will be those in effect at the time of shipment.

DAMAGED MERCHANDISE

The consignee is responsible for filing claims with the carrier for damage and shortages. Claims for both obvious and concealed damage must be filed within 15 calendar days, and the damaged merchandise must not have been moved from the original receiving location. All damaged merchandise, including the cartons and packing materials, must be retained for inspection by either the carrier or by an Indiana Furniture Sales Representative. Indiana Furniture reserves the right to select the most cost effective way to repair or replace the damaged item. Once you have notified the carrier, please contact Customer Service for further assistance.

Obvious Damage/Missing Cartons — Do not refuse merchandise damaged in transit. Indiana Furniture recommends the consignee inspect all merchandise upon arrival. If a shipment is received damaged or short, note all information on carrier's copy and your copy of freight bill and delivery receipt. Notify the delivering carrier and file a claim immediately. Pending the results of your claim, either Indiana Furniture or the carrier will cover 100% of the cost to repair or replace the damaged or missing item.

Concealed Damage — If concealed damage is discovered, notify the delivering carrier at once and request an inspection. This must be done within 15 calendar days of delivery. If the carrier will not perform the inspection, you should prepare an affidavit that you contacted them, noting the time and date, and that they failed to comply with your request. This, along with the other papers in your possession, will support the claim. Pending the results of your claim, the cost to repair or replace the item will be covered 1/3 by the carrier and 2/3 by Indiana Furniture for shipments less than a full truckload and 100% by Indiana Furniture for shipments of full truck loads.

RETURN MERCHANDISE

Merchandise will not be accepted for return without a RGA (Return Goods Authorization) issued by Indiana Furniture. We will consider issuing RGA's for the following reasons:

1. Manufacturing defect (inspected by Indiana Furniture representative)
2. Indiana Furniture order processing error
3. Shipping error
4. Mis-marked cartons
5. Duplicated shipments

If you have any questions as to whether your reason for return qualifies for consideration, please contact your Customer Service Representative. Merchandise must be returned within 60 days of the RGA issued date, or within 60 days upon receipt of replacement product to receive credit. Returns due to mis-marked cartons must also be returned in the original cartoning, with shipping labels intact, to receive credit.

All merchandise being returned must be properly packed and protected to ensure no further damage is incurred during transportation back to an Indiana Furniture facility. Upon receipt, all returned merchandise will be thoroughly inspected and the results compared to the reason for return stated on the RGA. Any discrepancies, such as additional damage, signs of usage, missing parts, etc., will result in an adjustment to the amount of credit issued.

DELIVERY AND FREIGHT CHARGES

All shipments are F.O.B. Point of Origin, Jasper, IN, freight prepaid and allowed dock to dock on 53' trailer. Ownership and responsibility of the merchandise becomes that of the buyer upon delivery to the freight company. Shipments into Alaska, Hawaii, Canada, Mexico, Puerto Rico and other exports are freight prepaid and allowed to port of exit.

Indiana Furniture reserves the right to select the most appropriate carrier and routing on all shipments. Indiana Furniture will attempt to accommodate requests for favored carriers and delivery times. Deliveries requested Monday through Thursday, after 3pm, will be assessed a \$300 per truck after hours fee. Deliveries requested after 3pm on Friday or on weekends, will be assessed a \$600 per truck weekend delivery fee.

Inside delivery and installation services are not included in the pricing shown. Any deviation from dock-to-dock delivery, such as but not limited to, non-dock, residential, or inside delivery must be specified on the order. Should these services be requested or required, all charges incurred will be charged to the "Sold To" of the order.

Shipments totaling less than \$3000 (net value, product only) will be assessed a small order fee of \$300 net per shipment. This fee will be reduced for items shipped via small package carriers. For order shipments of \$100 or less, shipped by small package carrier, the fee is \$18. For order shipments over \$100, shipped by small package carrier, the fee is \$40. All shipping fees will be added at the time of invoicing.

BIFMA AND ANSI TESTING

Indiana Furniture is a member of the Business and Institutional Furniture Manufacturer's Association (BIFMA). Tests developed by the BIFMA and approved by the American National Standards Institute (ANSI) determine the strength and durability of casegoods and seating in its everyday use. Although this testing does not serve as a warranty or guarantee, Indiana Furniture products within this price list have been tested by an independent verifying body and meet or exceed applicable BIFMA and ANSI standards.

Subject to the limitations set forth in this warranty, Indiana Furniture Industries, Inc. (“**Indiana Furniture**”) warrants to the original purchaser all product in this price list (“**Product**”) to be free from defects in material and workmanship given normal use for a 12-year period from the date of manufacture. During the applicable warranty period, Indiana Furniture, as its sole obligation, will repair or replace (in Indiana Furniture’s sole discretion) any Product, part, or component covered by this warranty and sold after May 13, 2024, which fails under normal use as a result of a defect in material or workmanship. Normal use is defined as the equivalent of a single shift, 40-hour work week. Indiana Furniture will repair or replace the defective Product, part, or component with a comparable Product, part, or component.

Warranty periods are limited for certain Products and parts as follows:

12-year Warranty (from the date of manufacture)

- Seating Mechanisms
- Veneers
- Laminates
- Casters and Glides

5-year Warranty (from the date of manufacture)

- Triple Play Series
- Electrical Components
- Pneumatic Cylinders
- Textiles, Foam, and Decorative Trim
- Swivel Arm Pads
- Keyboard Kits
- Lighting
- All Height Adjustable Mechanisms

3-year Warranty (from date of shipment)

- Dock 950 Wireless Charger
- Dock 150 Wireless and USB Charger

THIS WARRANTY DOES NOT COVER:

- Damage caused by a carrier or third party
- Normal or routine wear and tear
- Appearance, durability, quality, behavior, colorfastness, or any other attribute of customer’s own materials or any non-standard Indiana Furniture material (including CF Stinson, Maharam, Momentum, Mayer, UltraFabrics, Architex, and other alliance programs) specified by the customer and applied to a Product
- Color, grain or texture of wood, laminate and other covering materials
- Changes in wood or fabric color due to aging or exposure to light

As the manufacturer of the Product, Indiana Furniture stands behind its craftsmanship and pledges to do everything it can to reasonably resolve, as quickly as possible, any problems you may have with the Product within the terms and conditions of this warranty.

If you encounter a defect covered by the foregoing warranty, contact the dealer from whom you purchased the Product. If the dealer is unable to resolve your warranty issues, you should contact Indiana Furniture. Please ensure that you have all of the pertinent facts when contacting the dealer or Indiana Furniture, including the model number and factory order number from the inspection label attached to the Product.

INDIANA FURNITURE IS NOT PROVIDING, AND SPECIFICALLY DISCLAIMS, ANY OTHER WARRANTIES FOR THE PRODUCTS, EXPRESS OR IMPLIED, INCLUDING ANY IMPLIED WARRANTY OF MERCHANTABILITY OR FITNESS FOR A PARTICULAR PURPOSE. INDIANA FURNITURE SHALL NOT BE LIABLE TO THE PURCHASER OR ANY THIRD PARTY FOR CONSEQUENTIAL, INCIDENTAL, INDIRECT, OR SPECIAL DAMAGES, INCLUDING, WITHOUT LIMITATION, DAMAGES ARISING OUT OF OR RESULTING IN ANY MALFUNCTIONS, DELAYS, LOSS OF PROFIT, INTERRUPTION OF BUSINESS, PERSONAL INJURY, BODILY INJURY, DEATH, DISMEMBERMENT, OR PROPERTY DAMAGE.

Indiana Furniture Industries, Inc.
Attn: Customer Service
1919 Hospitality Dr., Ste A
P.O. Box 270
Jasper, Indiana
47547-0270
800.422.5727
Fax 812.482.9035
custserv@indianafurniture.com

Casegoods

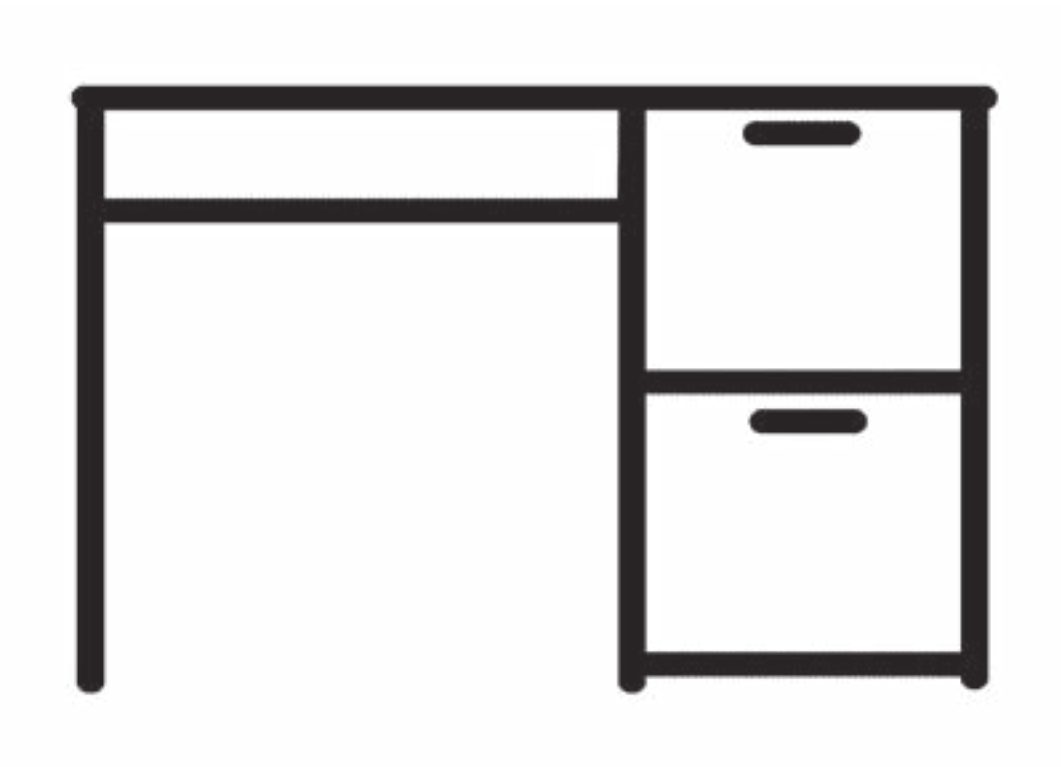

Arlington ensures quality and expert craftsmanship with a selection of configurations for today's functional workspaces including new Height Adjustable options. Providing all the grace and embellishments associated with traditional styling, Arlington features multiple worksurface materials and hand placed decorative and base molding to create a value driven collection with high end elegance.

CONSTRUCTION

Arlington features a Veneer chassis with your choice of a Veneer or HPL top. Units ship assembled unless otherwise noted.

VENEER

- Exposed surfaces feature select grade, plain sliced American Black Walnut or Cherry veneers, carefully selected and matched to assure proper balance and consistency

TOPS

- Veneer tops are 5-ply balanced construction and 1 3/16" thick with solid hardwood rims with butt corners
- High Pressure Laminate (HPL) tops are 3-ply balanced construction and 1 3/16" thick with solid hardwood rims with butt corners
- Grain direction runs left to right unless noted

CHASSIS

- Chassis is securely fastened using high quality European fastening systems and heavy-duty, 16-gauge joining brackets to assure maximum strength
- All units ship with heavy-duty, adjustable leveling glides to ensure proper leveling and compensation for uneven floors
- Bases are solid hardwood with mitered corners
- Construction offers tight tolerances and long term durability
- Vertical grain direction on chassis

DRAWERS

- Drawer fronts standard with matched veneer faces
- Drawer sides, back and front are woodgrain vinyl-wrapped, and are 1/2" thick
- 5-sided drawer construction for easy removal of drawer fronts
- Box and file drawers are tested for 100lb capacity
- Lateral files feature 1/4" thick bottoms. Drawers are tested for 200lb of equally distributed weight (ex: hanging file folders) and 65lbs of bottom load weight (ex: stacked catalogs)
- All drawers feature full extension, progressive action slides with precision steel ball bearings
- All suspensions have a limited lifetime warranty

FILING

- All file drawers are standard with filing systems designed to accommodate a variety of filing requirements
- Letter width file drawers provide letter filing front to back and legal filing side to side
- Lateral file drawers provide legal or letter filing front to back or side to side

STORAGE

- All hinged doors include soft close hinges, unless noted
- One piece hinge and base plate combination
- Soft close hinges reduce stress placed on the cabinet when the door is closed and offers a quiet closure

LOCKING

- Central locking is standard on all desks and optional for credenzas and returns; one key in the lock cylinder locks all drawers in the desk
- Lock core available in black or silver and will coordinate with pull selection; [See option details](#)
- Removable lock cylinders allow for units to be re-keyed at a later date if required

LOCKING CON'T

- Units are shipped randomly keyed as standard. Keyed alike units available upon request at no additional charge

CORD MANAGEMENT

- Grommets are standard in back panels of returns, bridge units, credenzas, and hutch units
- Grommets may be ordered in the tops of desks, returns, bridge units, and credenzas
- Grommets are 2 3/8" in diameter and available in black or silver, please specify color
- [See all grommet options and locations](#)
- Undersurface Wire Manager (O1-WMGR4) is available for additional cord management; See Accessories

HEIGHT ADJUSTABILITY

- Electric-powered height adjustable mechanisms are offered in 2-channel for single surface height adjustment and 3-channel for simultaneous, two surface height adjustment
- Height adjustable legs available in black finish only
- Height adjustment range 30"H to 45"H
- 5-year warranty
- Recommended load capacity of 180lbs
- Two control switches are available, including an up/down switch (standard with product, unless noted) and an advanced switch with Bluetooth capabilities, position memory, three stand up reminder intervals, and more; gently adjust worksurface with a one second stop at each memory position
- The standard control switch is factory installed on all units except bridges and 3-channel units
- Bridges and returns will not have a standard grommet on the back panel
- New wire management mesh wrap included when worksurface grommet is selected
- Grommets and one wire management channel provided within kneespace to manage wires from switch and control box; two wire management channels will be shipped with desk shells

INTERIOR DRAWER DIMENSIONS

Models

| | | | |
|--------------|--------------|-----------|--------------|
| 29-3672DP | 29-3072DP | 29-3066DP | 29-3066DPSTS |
| 29-3672DPSTS | 29-3072DPSTS | | |

Drawers

| | W | L | D |
|--------|---------|---------|----------|
| Box | 12 3/8" | 19 1/2" | 3 21/32" |
| File | 12 3/8" | 19 1/2" | 8 29/32" |
| Center | 29 5/8" | 19 1/2" | 1 29/32" |

Models

| | | | |
|--------------|--------------|--------------|--------------|
| 29-3672LP | 29-3672RP | 29-3072LP | 29-3072RP |
| 29-3672LPSTS | 29-3672RPSTS | 29-3072LPSTS | 29-3072RPSTS |

Drawers

| | W | L | D |
|--------|---------|---------|----------|
| Box | 12 3/8" | 19 1/2" | 3 21/32" |
| File | 12 3/8" | 19 1/2" | 8 29/32" |
| Center | 27 5/8" | 19 1/2" | 1 29/32" |

INTERIOR DRAWER DIMENSIONS (CONTINUED)

| Models | | | |
|---------------|-----------|--------------|--------------|
| 29-3066LP | 29-3066RP | 29-3066LPSTS | 29-3066RPSTS |

| Drawers | W | L | D |
|----------------|----------------------------------|-----------------------------------|-----------------------------------|
| Box | 12 ³ / ₈ " | 19 ⁹ / ₃₂ " | 3 ²¹ / ₃₂ " |
| File | 12 ³ / ₈ " | 19 ⁹ / ₃₂ " | 8 ²⁹ / ₃₂ " |
| Center | 21 ¹ / ₈ " | 19 ⁹ / ₃₂ " | 1 ²⁹ / ₃₂ " |

| Models | | | |
|---------------|--------------|--|--|
| 29-3060DP | 29-3060DPSTS | | |

| Drawers | W | L | D |
|----------------|----------------------------------|-----------------------------------|-----------------------------------|
| Box | 12 ³ / ₈ " | 19 ⁹ / ₃₂ " | 3 ²¹ / ₃₂ " |
| File | 12 ³ / ₈ " | 19 ⁹ / ₃₂ " | 8 ²⁹ / ₃₂ " |
| Center | 23 ⁵ / ₈ " | 19 ⁹ / ₃₂ " | 1 ²⁹ / ₃₂ " |

| Models | | | |
|---------------|-----------|--------------|--------------|
| 29-3060LP | 29-3060RP | 29-3060LPSTS | 29-3060RPSTS |

| Drawers | W | L | D |
|----------------|----------------------------------|-----------------------------------|-----------------------------------|
| Box | 12 ³ / ₈ " | 19 ⁹ / ₃₂ " | 3 ²¹ / ₃₂ " |
| File | 12 ³ / ₈ " | 19 ⁹ / ₃₂ " | 8 ²⁹ / ₃₂ " |
| Center | 18 ⁵ / ₈ " | 19 ⁹ / ₃₂ " | 1 ²⁹ / ₃₂ " |

| Models | | | |
|---------------|--------------|--------------|--------------|
| 29-2448LF | 29-2448RF | 29-2442LF | 29-2442RF |
| 29-2448LFSTS | 29-2448RFSTS | 29-2442LFSTS | 29-2442RFSTS |

| Drawers | W | L | D |
|----------------|----------------------------------|-----------------------------------|-----------------------------------|
| Box | 12 ³ / ₈ " | 16 ⁵ / ₃₂ " | 3 ²¹ / ₃₂ " |
| File | 12 ³ / ₈ " | 16 ⁵ / ₃₂ " | 8 ²⁹ / ₃₂ " |

| Models | | | |
|---------------|---------------|---------------|---------------|
| 29-2448LF2 | 29-2448RF2 | 29-2442LF2 | 29-2442RF2 |
| 29-2448LF2STS | 29-2448RF2STS | 29-2442LF2STS | 29-2442RF2STS |
| 29-2448LF2SR | 29-2448RF2SR | 29-2442LF2SR | 29-2442RF2SR |

| Drawers | W | L | D |
|----------------|----------------------------------|-----------------------------------|-----------------------------------|
| File | 12 ³ / ₈ " | 16 ⁵ / ₃₂ " | 8 ²⁹ / ₃₂ " |

| Models | | | |
|----------------|----------------|----------------|----------------|
| 29-2448LF2STS3 | 29-2448RF2STS3 | 29-2442LF2STS3 | 29-2442RF2STS3 |

| Drawers | W | L | D |
|----------------|----------------------------------|----------------------------------|-----------------------------------|
| File | 12 ³ / ₈ " | 12 ⁷ / ₈ " | 8 ²⁹ / ₃₂ " |

| Models | | | |
|---------------|-----------|-----------|-----------|
| 29-2072SC | 29-2072KC | 29-2072LC | 29-2072RC |
| 29-2066SC | 29-2066KC | 29-2066LC | 29-2066RC |
| 29-2060LC | 29-2060RC | 29-2060KC | |

| Drawers | W | L | D |
|----------------|----------------------------------|-----------------------------------|-----------------------------------|
| Box | 15 ³ / ₈ " | 16 ⁵ / ₃₂ " | 3 ²¹ / ₃₂ " |
| File | 15 ³ / ₈ " | 16 ⁵ / ₃₂ " | 8 ²⁹ / ₃₂ " |

| Models | | | |
|---------------|------------|------------|------------|
| 29-2072LC2 | 29-2072RC2 | 29-2066LC2 | 29-2066RC2 |
| 29-2060LC2 | 29-2060RC2 | | |

| Drawers | W | L | D |
|----------------|----------------------------------|-----------------------------------|-----------------------------------|
| File | 15 ³ / ₈ " | 16 ⁵ / ₃₂ " | 8 ²⁹ / ₃₂ " |

| Models | | | |
|---------------|-----------|-----------|-----------|
| 29-2036L4 | 29-2036L2 | 29-2072DL | 29-2072LL |
| 29-2072RL | | | |

| Drawers | W | L | D |
|----------------|----------------------------------|-----------------------------------|-----------------------------------|
| File | 30 ³ / ₄ " | 16 ⁵ / ₃₂ " | 8 ¹³ / ₃₂ " |

| Models | | | |
|---------------|-----------|--|--|
| 29-2448LP | 29-2448RP | | |

| Drawers | W | L | D |
|----------------|----------------------------------|-----------------------------------|-----------------------------------|
| Box | 12 ³ / ₈ " | 19 ⁹ / ₃₂ " | 3 ²¹ / ₃₂ " |
| File | 12 ³ / ₈ " | 19 ⁹ / ₃₂ " | 8 ²⁹ / ₃₂ " |

FILING CAPABILITIES

Drawers with Dimensions: 12³/₈"W x 12⁷/₈"L

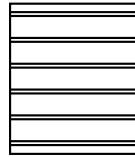

Letter Front to Back

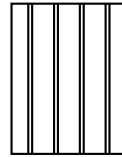

Legal Side to Side

Drawers with Dimensions: 12³/₈"W x 19⁹/₃₂"L

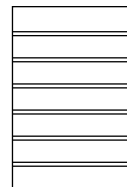

Letter Front to Back

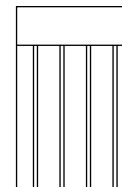

Legal Side to Side

Drawers with Dimensions: 12³/₈"W x 16⁵/₃₂"L

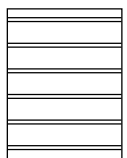

Letter Front to Back

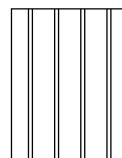

Legal Side to Side

FILING CAPABILITIES (CONTINUED)

Drawers with Dimensions: 15³/₈"W x 16⁵/₂"L

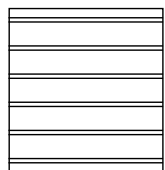

Legal Front to Back

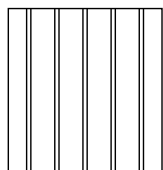

Legal Side to Side

Drawers with Dimensions: 30³/₄"W x 16⁵/₂"L

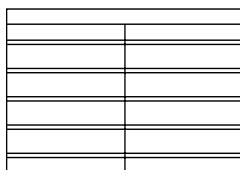

2 Rows Letter Front to Back

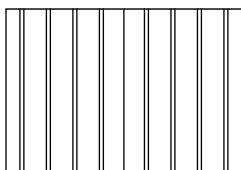

1 Row Letter or Legal Side to Side

HOW TO ORDER EXAMPLES

| Model No. | Description | Example |
|-----------|--------------------------------|---------------------------|
| 29-3672DP | Top Material | W |
| | Finish | CO |
| | Base Molding | BM3600 |
| | Decorative Molding | M3600 |
| | Pull | ARA |
| | Drawer Construction | STD |
| | Surface Grommet Location/Color | GC, BLK |
| 29-2448LF | Top Material | HPL |
| | Finish | CO |
| | Base Molding | BM2900 |
| | Decorative Molding | - |
| | Pull | ARA |
| | Locking | LKT |
| | Drawer Construction | DOVE |
| | Surface Grommet Location | GR |
| | Back Panel Grommet | YES |
| | Grommet Color | BLK |
| 29-1572HU | Finish | CO |
| | Door Pull | ARA |
| | Locking | NO |
| | Tackboard | Momentum/Marathon/Caravel |
| | Tasklight | TL-0848 |
| | Grommets/Color | WMHU, BLK |

VENEER (W) OPTIONS

Veneer features UVAdvantage, an ultra-violet finish, on all exposed surfaces by utilizing roll-coat UV technology.

| | | | |
|-----|--------------------|-----|---------------------|
| AW | Artisan Walnut | HW | Harvest Walnut |
| CO | Columbian Walnut | LW | Legacy Walnut |
| DC | Dark Cherry | MW | Mahogany Walnut |
| DFW | Dark Forest Walnut | PNW | Pinnacle Walnut |
| EW | Espresso | SCH | Select Cherry |
| GC | Golden Cherry | SKC | Shaker Cherry |
| HNW | Henna Walnut | WC | Williamsburg Cherry |

HPL (P) TOP OPTIONS

WOODGRAIN

| | | | |
|----|------------------|-----|---------------------|
| CO | Columbian Walnut | PNW | Pinnacle Walnut |
| EF | Espresso | SCH | Select Cherry |
| GC | Golden Cherry | SKC | Shaker Cherry |
| MW | Mahogany Walnut | WC | Williamsburg Cherry |

EDGE PROFILES

R Arlington



MOLDING LOCATIONS AND OPTIONS

Styles of Base Molding and Decorative Molding cannot be intermixed. For example, when Arlington Base Molding is selected, only the Arlington Decorative may be ordered, while Wilmington Base Molding must also be ordered with Wilmington Decorative Molding.

Base Molding

Arlington and Wilmington Base Molding are skillfully applied on the approach, sides, and user side of Desks and Returns. Lateral Files and Credenzas feature molding on front and both sides with no molding on back for flush wall applications. Bridges will feature molding on approach. Storage Cabinets, Bookcases and Wardrobe/Storage Cabinets will feature base molding on front of unit only.

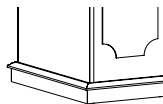

Arlington Base Molding



Wilmington Base Molding

Decorative Molding

Units come standard with no decorative molding. See below for details and locations of optional Arlington or Wilmington Decorative Molding. See next page for ordering options and pricing.

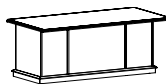

No Decorative Molding Standard

See next page for additional molding information

MOLDING LOCATIONS AND OPTIONS CONTINUED

Arlington Decorative Molding will be featured on the approach side of Desks only and is not available on Bridges, Returns, Lateral Files, and Credenzas.

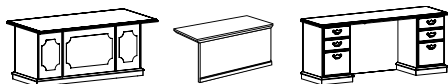

Arlington Molding

Wilmington Decorative Molding will be on the approach and sides of Desks. Returns and Bridges will have decorative molding on the approach side. Credenzas will feature decorative molding on left and right sides only

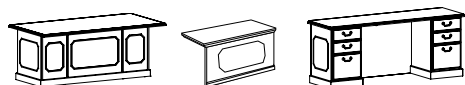

Wilmington Molding

Surface Mount Hutches, Wall Mount Hutches, Freestanding Bookcases, and Surface Mount Bookcases have no decorative molding. See next page for ordering options and pricing.

Molding selection must be specified on order. *Note: Base and Decorative Molding feature multi-step, hand-finished catalyzed finish*

Arlington Molding

| | | | |
|--------|---------------------------------------|----|-----|
| BM2900 | Arlington Base Molding | \$ | N/C |
| M2900 | Optional Arlington Decorative Molding | \$ | 83 |

Wilmington Molding

| | | | |
|--------|--|----|-----|
| BM3600 | Wilmington Base Molding | \$ | N/C |
| M3600 | Optional Wilmington Decorative Molding | \$ | 139 |

DRAWER AND DOOR PULL OPTIONS

Units with doors and drawers will feature coordinating pulls however door and drawer pulls cannot be intermixed.

| | | | |
|-----|----------------------------|-----|--------------------------|
| ARA | Arlington A, Antique Brass | JEF | Jefferson, Antique Brass |
| ARB | Arlington B, Antique Brass | ALB | Liberty, Aluminum |
| WLM | Wilmington, Antique Brass | | |



Arlington A (ARA)
Antique Brass - 5 1/4"



Arlington B (ARB)
Antique Brass - 5 1/4"



Jefferson (JEF)
Antique Brass - 5 1/4"



Wilmington (WLM)
Antique Brass - 5 1/4"



Liberty (ALB)
Aluminum - 4 1/4"

LOCK CORE OPTIONS

Lock core will be black if Arlington, Wilmington or Jefferson pulls are selected. Lock core will be silver if Liberty Pulls are selected.

| | | | |
|-----|-------|-----|--------|
| BLK | Black | SLV | Silver |
|-----|-------|-----|--------|



Black (BLK)



Silver (SLV)

LOCKING PEDESTALS ON RETURNS/CREDENZAS

Locking doors and drawers are available on returns and credenzas. Please specify applicable code on order with model/unit and add upcharge.

| | | | |
|-------|---|----|-----|
| LKT-P | Single Pedestal or Return Lock | \$ | 205 |
| | <i>Lock positioned in drawer face nearest the kneespace</i> | | |

| | | | |
|-------|---|----|-----|
| LKT-P | Double Pedestal Credenza Lock | \$ | 410 |
| | <i>Lock positioned in drawer face nearest the kneespace or in drawer face nearest to doors on Storage Credenzas</i> | | |

| | | | |
|--------|---|----|-----|
| LKT-HU | Double Pedestal and Double Door Credenza Locking | \$ | 492 |
| | <i>Drawer lock is positioned in drawer face nearest to doors and door lock is in top right corner of left door.</i> | | |

LOCKING DOORS

Locking is available on select doors. You must specify LKT_HU when ordering and add upcharge.

| | | | |
|--------|--------------------|----|-----|
| LKT_HU | 72"W to 48"W Units | \$ | 115 |
| LKT_HU | 42"W to 24"W Units | \$ | 91 |
| LKT_HU | 18"W Units | \$ | 69 |

DRAWER OPTIONS

Units with drawers come standard with woodgrain vinyl-wrapped drawers with mitered corners. Optional dove tail construction for all center, box, file, and lateral file drawers is available. Must specify when ordering.

Pricing is per Drawer, not per Model/Unit.

| | | | |
|-------|-----------------------------|----|-----|
| MITER | Mitered Fold Construction | | STD |
| DOVE | Wood Dove Tail Construction | \$ | 45 |

HEIGHT ADJUST LEG CONFIGURATION

The 2-channel leg configuration is standard on height adjustable Desks, Returns, and Bridges for one height adjustable worksurface. Desk models offer an optional 3-channel leg configuration for use with 3-channel Return to allow two worksurfaces to raise and lower simultaneously.

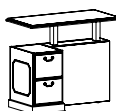

2-Channel Configuration

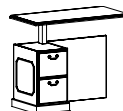

3-Channel Configuration

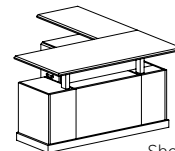

Shown with 3-Channel Configuration on Desk and Return

| | | |
|------|---|-----|
| STS2 | 2-Channel Configuration (For one height adjustable worksurface) | STD |
| STS3 | 3-Channel Configuration (For two height adjustable worksurfaces) | N/C |

HEIGHT ADJUSTABLE CONTROL OPTIONS

Height adjustable units offer two switch options. The standard switch is a simple up and down switch to move your worksurface from seated to standing height. This comes standard with height adjustable units, unless otherwise noted. The advanced switch features Bluetooth capabilities to connect to smart devices, three stand-up reminder intervals, height adjustment memory positions, and more.

Please specify desired Control Switch when ordering applicable Height Adjustable units.

| | | | |
|-------|-------------------------------------|----|-----|
| SWCH | Standard Up/Down Switch | \$ | STD |
| MSWCH | Advanced Up/Down with Memory Switch | \$ | 135 |



SWCH (standard)

MSWCH

GROMMET OPTIONS & LOCATIONS

| | | | |
|----|--------------------------------------|----|----|
| GC | Grommet, Center - Specify BLK or SLV | \$ | 52 |
| GL | Grommet, Left - Specify BLK or SLV | \$ | 52 |
| GR | Grommet, Right - Specify BLK or SLV | \$ | 52 |

Verify Grommet Option is available on the model(s) you are specifying using the following location information. Grommets may be ordered in non-standard locations. Call Customer Service to assist with specification. Note additional charges and lead times may apply.

Multiple locations may be selected.

Models

| | | | |
|-----------|-----------|-----------|-----------|
| 29-3672DP | 29-3672LP | 29-3672RP | 29-3072DP |
| 29-3072LP | 29-3072RP | 29-3672WT | |

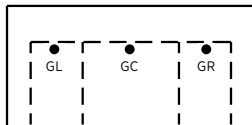

GL/GR: Located 12" from ends and 23" from user side

GC: Located 23" from user side

Models

| | | |
|-----------|-----------|-----------|
| 29-3066DP | 29-3066LP | 29-3066RP |
|-----------|-----------|-----------|

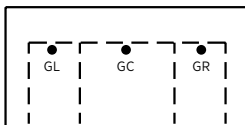

GL/GR: Located 9" from ends and 23" from user side

GC: Located 23" from user side

Models

| | | | |
|-----------|-----------|-----------|-----------|
| 29-3060DP | 29-3060LP | 29-3060RP | 29-3060WT |
|-----------|-----------|-----------|-----------|

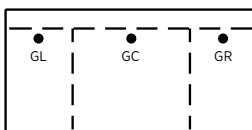

GL/GR: Located 9" from ends and 23" from user side

GC: Located 23" from user side

GROMMET OPTIONS & LOCATIONS (CONTINUED)

Models

| | | | |
|-----------|------------|-----------|------------|
| 29-2448UF | 29-2448UFH | 29-2442UF | 29-2442UFH |
|-----------|------------|-----------|------------|

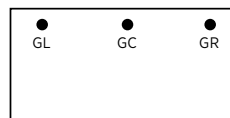

GL/GR: Located 4" from ends and 19½" from user side

GC: Located 19½" from user side

Models

| | | | |
|------------|------------|-----------|-----------|
| 29-2448LF2 | 29-2448RF2 | 29-2448LF | 29-2448RF |
| 29-2448LP | 29-2448RP | | |

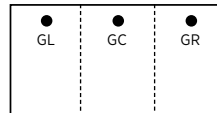

GL/GR: Located 5" from ends and 20" from user side

GC: Located 20" from user side

Models

| | | | |
|------------|------------|-----------|-----------|
| 29-2442LF2 | 29-2442RF2 | 29-2442LF | 29-2442RF |
|------------|------------|-----------|-----------|

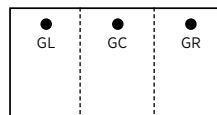

GL/GR: Located 5" from ends and 17" from user side

GC: Located 17" from user side

Models

| | | | |
|------------|------------|------------|------------|
| 29-2072KC | 29-2072LC | 29-2072RC | 29-2072LL* |
| 29-2072RL* | 29-2072LC2 | 29-2072RC2 | 29-2066KC |
| 29-2066LC | 29-2066RC | 29-2066LC2 | 29-2066RC2 |
| 29-2060KC | 29-2060LC | 29-2060RC | 29-2060LC2 |
| 29-2060RC2 | | | |

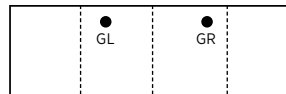

GL/GR: Located 22½" from ends and 17½" from user side

* Grommets are only available on opposite side of pedestal

WORKSURFACE GROMMETS FOR HEIGHT ADJUSTABILITY UNITS

When you select a grommet for use with Height Adjustable worksurfaces, it will automatically come with a wire management sleeve. One grommet per worksurface. Must specify Left, Right, or Center. See below for specific location availability by model. You may also choose to add the Wire Management Box, which will automatically come with a center grommet.

Grommet with Mesh Wire Management Sleeve \$ 142
Specify Black (BLK) or Silver (SLV) and Location

| | |
|------------------|---|
| HA Desks>Returns | Choose Left, Right, or Center (See Below) |
| HA Bridges | Center Only |

| | |
|-----------|--------------------------------|
| GC-MESH | Grommet, Center |
| GL-MESH | Grommet, Left |
| GR-MESH | Grommet, Right |
| GCKS-MESH | Grommet, Centered Between Legs |



Black wire management mesh sleeve

Wire Management Box with Center Grommet \$ 485

Available on All HA Desks, Returns and Bridges

| | |
|--------|--|
| GC-BOX | Grommet, Center; Specify Black (BLK) or Silver (SLV) |
|--------|--|

See next page for additional grommet information.

WORKSURFACE GROMMETS FOR HEIGHT ADJUSTABILITY UNITS (CONT'D)

Verify Grommet Option is available on the model(s) you are specifying using the following location information.

Grommets may be ordered in non-standard locations. Call Customer Service to assist with specification. Note additional charges and lead times may apply.

Models

29-3672DPSTS 29-3072DPSTS

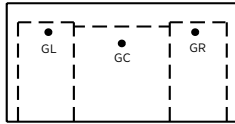

GL or GR: Located 9" from ends and 22½" from user side
GC: Located 20" from user side

Models

29-3066DPSTS 29-3060DPSTS 29-3672LPSTS 29-3672RPSTS
29-3072LPSTS 29-3072RPSTS 29-3066LPSTS 29-3066RPSTS
29-3060LPSTS 29-3060RPSTS

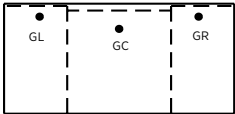

GL or GR: Located 6" from ends and 22½" from user side
GC: Located 20" from user side

Models

29-2448LF2STS 29-2448RF2STS 29-2448LFSTS 29-2448RFSTS
29-2448LP 29-2448RP

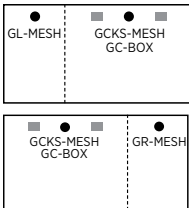

GL or GR: Located 6" from ends and 20" from user side
CKS: Located 18" from user side

Models

29-2442LF2STS3 29-2442RF2STS3
29-2442LFSTS3 29-2442RFSTS3

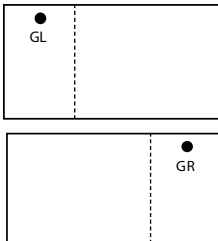

Grommet with Mesh Wire Management Sleeve only available in ped space

GL-MESH or GR-MESH: Located 6" from ends and 20" from user side

Models

29-2448SUFL 29-2448SUFR 29-2442SUFL 29-2442SUFR

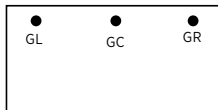

GL/GR: Located 4" from ends and 20" from user side
GC: Located 20" from user side

Models

29-2448UFSTS 29-2442UFSTS 29-2448UFSTSL3
29-2448UFSTSR3 29-2442UFSTSL3 29-2442UFSTSR3

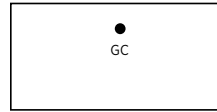

GC: Located 18" from user side

HUTCH GROMMET OPTIONS

Surface Mount Hutches come standard with one center grommet at workstation level on back panel. Three upper wire management grommets also are available. One grommet located on right, center and left. Must specify with color selection.

WMHUBL Black Lower Grommet + Three Upper Grommets N/C
WMHUSV Silver Lower Grommet + Three Upper Grommets N/C

CONFERENCE AND MEETING TABLE GROMMET OPTIONS

Arlington Meeting and Conference Tables offer power and grommet locations at multiple locations.

Must Specify Black (BLK) or Silver (SLV)

Grommet Locations

OC On Center CL 5½" Left of Center
EL 24½" from Left End CR 5½" Right of Center
ER 24½" from Right End BB Centered Between Bases

Location Availability by Top Size

96"W Tops OC, EL+ER
120"W Tops BB, CL, CR, CL+EL+ER, CR+EL+ER
144"W Tops BB, CL, CR, CL+CR, EL+ER, CL+EL+ER, CR+EL+ER

CERTIFICATIONS & COMPLIANCE

- Intertek Sustainability Certified
- BIFMA level® Certified
- BIFMA Compliant® Certified
- TSCA Title VI (formerly CARB) Compliance
- US Green Building's LEED® Contribution

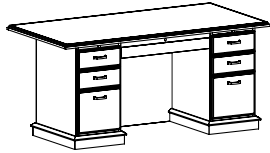

Double Ped Desks
(See Multiple Unit Details)

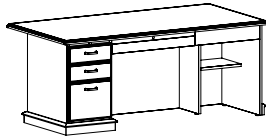

Single Ped Desks
(See Multiple Unit Details)

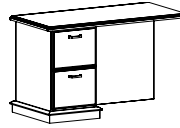

Returns
(See Multiple Unit Details)



Bridges
(See Multiple Unit Details)

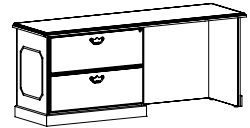

Kneespace, Storage, and Single Ped Credenzas
(See Multiple Unit Details)

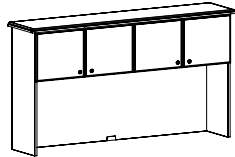

Surface Mount and Wall Mount Hutches
(See Multiple Unit Details)

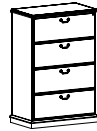

Filing
(See Multiple Unit Details)

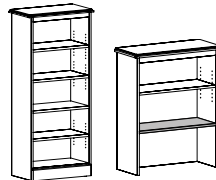

Bookcases
(See Multiple Unit Details)

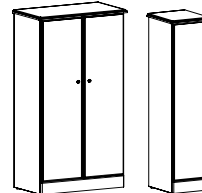

Wardrobe/Storage
(See Multiple Unit Details)

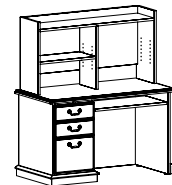

Computer Desks with Hutches
(See Multiple Unit Details)

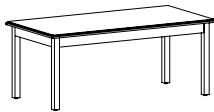

Work Tables
(See Details)

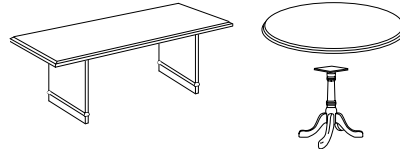

Conference and Round Tables
(See Multiple Unit Details)

Occasional Tables

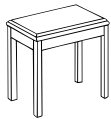

End Tables
(See Details)

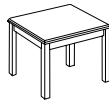

Lamp Tables
(See Details)

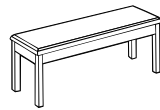

Magazine Tables
(See Details)

Height Adjustable (HA) Units

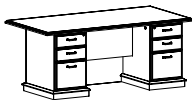

HA Double Ped Desks
(See Details)

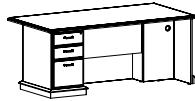

HA Single Ped Desks
(See Details)



HA & Stationary Returns
(See Multiple Unit Details)

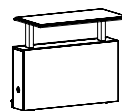

HA Bridges
(See Multiple Unit Details)

Tackboards + Tasklights

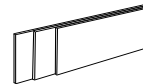

Tackboards
(See Details)



Tasklights
(See Details)

Accessories

Keyboard Accessories *(See Details)*

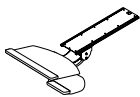

Power Options *(See Multiple Unit Details)*

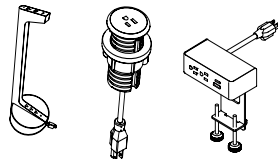

Accessories and Wire Management
(See Multiple Unit Details)



| Item | Model No. | Width | Depth | Height | Ship Wt | Cubic Ft | List Price |
|--------|-----------|-------|-------|--------|---------|----------|----------------------|
| L UNIT | 29-1 | 72 | 84 | 30 | 440 | 73.3 | P\$ 6802 W\$ 7474 |

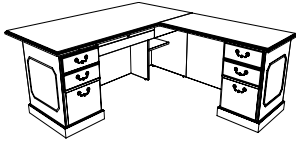

Shown with Wilmington Base and Decorative Molding

| CONSIST OF: | QTY | | | |
|-------------|-----|-----------------------|----------|----------|
| 29-3672LP | 1 | Single Ped Desk, Left | P\$ 3945 | W\$ 4349 |
| 29-2448RF | 1 | Return, Right | P\$ 2857 | W\$ 3125 |

Products are available as left or right, where applicable
List prices do not include optional Wilmington decorative molding

| | | | | | | | |
|--------|------|----|-----|----|-----|------|----------------------|
| U UNIT | 29-3 | 72 | 104 | 30 | 540 | 87.1 | P\$ 8886 W\$ 9920 |
|--------|------|----|-----|----|-----|------|----------------------|

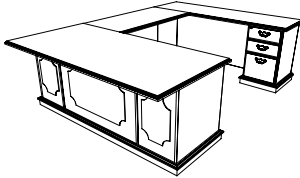

Shown with Arlington Base and Decorative Molding

| CONSIST OF: | QTY | | | |
|-------------|-----|-----------------------|----------|----------|
| 29-3672LP | 1 | Single Ped Desk, Left | P\$ 3945 | W\$ 4349 |
| 29-2448UF | 1 | Bridge | P\$ 1530 | W\$ 1797 |
| 29-2072RC | 1 | Credenza, Right | P\$ 3411 | W\$ 3774 |

Products are available as left or right, where applicable
List prices do not include optional Arlington decorative molding

| | | | | | | | |
|--------|------|----|-------------------|----|-----|------|------------------------|
| U UNIT | 29-4 | 66 | 91 $\frac{1}{16}$ | 30 | 401 | 72.9 | P\$ 11912 W\$ 12855 |
|--------|------|----|-------------------|----|-----|------|------------------------|

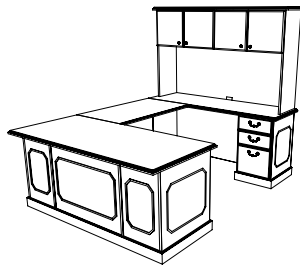

| CONSIST OF: | QTY | | | |
|-------------|-----|-----------------------|----------|----------|
| 29-3066LP | 1 | Single Ped Desk, Left | P\$ 3444 | W\$ 3777 |
| 29-2442UF | 1 | Bridge | P\$ 1458 | W\$ 1722 |
| 29-2066RC | 1 | Credenza, Right | P\$ 3022 | W\$ 3368 |
| 29-1566HU | 1 | Hutch | \$ 3988 | |

Products are available as left or right, where applicable
List prices do not include optional Wilmington decorative molding

Pricing Codes:
P = HPL Top
W = Veneer Top

[See Arlington Intro Section for Ordering Options](#)

| Item | Model No. | Width | Depth | Height | Ship Wt | Cubic Ft | List Price |
|----------------------------------|-----------|----------|---------|--------|---------|----------|------------------------|
| HEIGHT ADJUSTABLE PRIVATE OFFICE | 29-9 | 140 7/16 | 98 7/16 | 70 7/8 | 975 | 146.8 | P\$ 21724 W\$ 22848 |

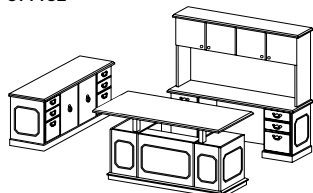

Shown with Wilmington Base and Decorative Molding

| CONSIST OF: | QTY | | | |
|--------------|-----|-----------------------------------|----------------------|--|
| 29-3672DPSTS | 1 | Height Adjustable Double Ped Desk | P\$ 9226 W\$ 9629 | |
| 29-1572HU | 1 | Surface Mount Hutch | \$ 4461 | |
| 29-2072KC | 1 | Kneespace Credenza | P\$ 3792 W\$ 4151 | |
| 29-2072SC | 1 | Storage Credenza | P\$ 4245 W\$ 4607 | |

*Products are available as left or right, where applicable
Width includes 48" between Desk and Storage Credenza
Depth includes 42" between Desk and Kneespace Credenza
List prices do not include optional Wilmington decorative molding*

| | | | | | | | |
|--------------------------|-------|----------|----------|--------|------|-------|------------------------|
| HEIGHT ADJUSTABLE U UNIT | 29-10 | 140 7/16 | 104 7/16 | 70 7/8 | 1178 | 170.8 | P\$ 28021 W\$ 29416 |
|--------------------------|-------|----------|----------|--------|------|-------|------------------------|

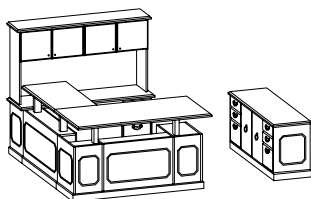

Shown with Wilmington Base and Decorative Molding

| CONSIST OF: | QTY | | | |
|--------------|-----|---|----------------------|--|
| 29-3672LPSTS | 1 | Height Adjustable Single Ped Desk, Left | P\$ 9160 W\$ 9563 | |
| 29-2448UFSTS | 1 | Height Adjustable Bridge | P\$ 6744 W\$ 7011 | |
| 29-2072RC2 | 1 | Credenza, Right | P\$ 3411 W\$ 3774 | |
| 29-1572HU | 1 | Surface Mount Hutch | \$ 4461 | |
| 29-2072SC | 1 | Storage Credenza | P\$ 4245 W\$ 4607 | |

*Products are available as left or right, where applicable
Width includes 48" between Desk and Storage Credenza
List prices do not include optional Wilmington decorative molding*

| | | | | | | | |
|--------------------------|-------|-----|-----|--------|------|-------|------------------------|
| HEIGHT ADJUSTABLE L UNIT | 29-11 | 108 | 146 | 70 7/8 | 1178 | 170.8 | P\$ 29357 W\$ 30391 |
|--------------------------|-------|-----|-----|--------|------|-------|------------------------|

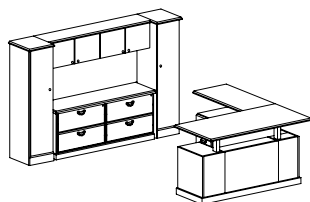

Shown with Arlington Base Molding

| CONSIST OF: | QTY | | | |
|----------------|-----|--|----------------------|--|
| 29-3672RPSTS | 1 | Height Adjustable Single Ped Desk, Right | P\$ 9160 W\$ 9563 | |
| 29-2448LF2STS3 | 1 | Height Adjustable Return, Left | P\$ 5651 W\$ 5920 | |
| 29-2072DL | 1 | Credenza with Double Lateral File | P\$ 4880 W\$ 5242 | |
| 29-1572WD | 1 | Wall Mounted Hutch | \$ 3560 | |
| 29-1870WL | 1 | Wardrobe/Storage Cabinet, Left | \$ 3053 | |
| 29-1870WR | 1 | Wardrobe/Storage Cabinet, Right | \$ 3053 | |

*Products are available as left or right, where applicable
Depth includes 42" between Return and Wardrobe*

[See Arlington Intro Section for Ordering Options](#)

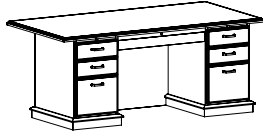
| Item | Model No. | Width | Depth | Height | K | Ship Wt | Cubic Ft | List Price |
|---|--|-------|-------|--------|-----|---------|----------|----------------------|
|  | 29-3672DP | 72 | 36 | 30 | 31½ | 266 | 51.7 | P\$ 4013 W\$ 4414 |
| | Chassis 64W x 24D, 10" Approach Overhang | | | | | | | |
| | 29-3072DP | 72 | 30 | 30 | 31½ | 255 | 43.9 | P\$ 3980 W\$ 4334 |
| | Chassis 64W x 24D, 4" Approach Overhang | | | | | | | |
| | 29-3066DP | 66 | 30 | 30 | 31½ | 249 | 40.3 | P\$ 3945 W\$ 4276 |
| | Chassis 64W x 24D, 4" Approach Overhang | | | | | | | |
| | 29-3060DP | 60 | 30 | 30 | 25½ | 241 | 35.3 | P\$ 3772 W\$ 4083 |
| | Chassis 58W x 24D, 4" Approach Overhang | | | | | | | |

Must Specify (in this order):

- Model #
- Surface Material
- Finish/Color
- Base Molding
- Decorative Molding
- Drawer Pull
- Drawer Construction
- Worksurface Grommet Location
- Grommet Color

Description

- Standard with: Rectangle Top, Central Locking, Letter Width Locking Box/Box/File Pedestals, Left to Right Grain Direction on Worksurface, Pull Out Writing Shelves on User Side and Center Drawer with Pen Tray
- Available with Veneer (W) or HPL (P) Top, Must Specify
- Top Profiled on All 4 Sides
- Lock Core Color will Coordinate with Pull Selection, [See Option Details](#)
- Base Molding on Approach, Sides and User Side. Must Specify: Arlington or Wilmington (See Below)
- Standard with No Decorative Molding; Optional Decorative Molding, [See Option Details](#); Must Specify (See Below)
- [Height Adjustable Units Available](#)
- Additional Options: Dove Tail Drawer Construction ([See Construction Details](#)); Grommet Options ([See Option Details](#)); Glass Marker Boards ([See Sizes and Details](#))

Molding Options: Must Specify and Add

Arlington Molding Options

| | | |
|--------|---------------------------------------|-------|
| BM2900 | Arlington Base Molding | N/C |
| M2900 | Optional Arlington Decorative Molding | \$ 83 |

Wilmington Molding Options

| | | |
|--------|--|--------|
| BM3600 | Wilmington Base Molding | N/C |
| M3600 | Optional Wilmington Decorative Molding | \$ 139 |

Note: Arlington Decorative Molding may only be used with Arlington Base Molding and Wilmington Decorative Molding may only be used with Wilmington Base Molding

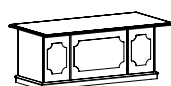

Approach View for all Double and Single Ped Desks with Arlington Molding

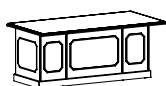

Approach View for all Double and Single Ped Desks with Wilmington Molding

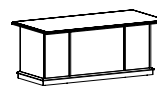

Approach View for all Double and Single Ped Desks with No Molding

Pricing Codes:
P = HPL Top
W = Veneer Top

[See Arlington Intro Section for Ordering Options](#)

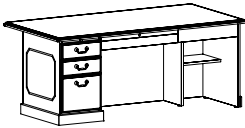
| Item | Model No. | Width | Depth | Height | K | Ship Wt | Cubic Ft | List Price | |
|--|--|------------------|-------|--------|----|---------|----------|----------------------|--|
|  Shown as Left | Left Ped | Right Ped | | | | | | | |
| | 29-3672LP | 29-3672RP | 72 | 36 | 30 | 30¾ | 315 | P\$ 3945 W\$ 4349 | |
| | Chassis 70W x 24D, 10" Approach Overhang | | | | | | | | |
| | 29-3072LP | 29-3072RP | 72 | 30 | 30 | 30¾ | 189 | P\$ 3696 W\$ 4050 | |
| | Chassis 70W x 24D, 4" Approach Overhang | | | | | | | | |
| | 29-3066LP | 29-3066RP | 66 | 30 | 30 | 24¾ | 189 | P\$ 3444 W\$ 3777 | |
| | Chassis 64W x 24D, 4" Approach Overhang | | | | | | | | |
| | 29-3060LP | 29-3060RP | 60 | 30 | 30 | 18¾ | 186 | P\$ 3195 W\$ 3506 | |
| | Chassis 58W x 24D, 4" Approach Overhang | | | | | | | | |

Must Specify (in this order):

- Model #
- Surface Material
- Finish/Color
- Base Molding
- Decorative Molding
- Drawer Pull
- Drawer Construction
- Worksurface Grommet Location
- Grommet Color

Description

- Standard with: Rectangle Top, Central Locking, Letter Width Locking Box/Box/File Pedestal, Left to Right Grain Direction on Worksurface, Pull Out Writing Shelf on User Side and Center Drawer with Pen Tray
- Available with Veneer (W) or HPL (P) Top, Must Specify
- Top Profiled on All 4 Sides
- Lock Core Color will Coordinate with Pull Selection, [See Option Details](#)
- Base Molding on Approach, Sides and User Side. Must Specify: Arlington or Wilmington (See Below)
- Standard with No Decorative Molding; Optional Decorative Molding, [See Option Details](#); Must Specify (See Below)
- [Height Adjustable Units Available](#)
- Additional Options: Dove Tail Drawer Construction ([See Construction Details](#)); Grommet Options ([See Option Details](#)); Glass Marker Boards ([See Sizes and Details](#))

Molding Options: Must Specify and Add

| Arlington Molding Options | | |
|----------------------------|--|--------|
| BM2900 | Arlington Base Molding | N/C |
| M2900 | Optional Arlington Decorative Molding | \$ 83 |
| Wilmington Molding Options | | |
| BM3600 | Wilmington Base Molding | N/C |
| M3600 | Optional Wilmington Decorative Molding | \$ 139 |

Note: Arlington Decorative Molding may only be used with Arlington Base Molding and Wilmington Decorative Molding may only be used with Wilmington Base Molding

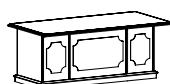

Approach View for all Double and Single Ped Desks with Arlington Molding

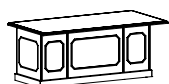

Approach View for all Double and Single Ped Desks with Wilmington Molding

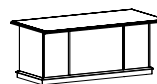

Approach View for all Double and Single Ped Desks with No Molding

[See Arlington Intro Section for Ordering Options](#)

| Item | Model No. | Width | Depth | Height | K | Ship Wt | Cubic Ft | List Price | |
|---|-----------------|------------------|-------|--------|----|---------|----------|------------|----------------------|
|  | Left Ped | Right Ped | | | | | | | |
| | 29-2448LF2 | 29-2448RF2 | 48 | 24 | 30 | 30¼ | 125 | 22.9 | P\$ 2857 W\$ 3125 |
| | 29-2442LF2 | 29-2442RF2 | 42 | 24 | 30 | 26¼ | 113 | 18.8 | P\$ 2477 W\$ 2738 |

Shown as Left with
Optional Locking

Must Specify (in this order):

- Model #
- Surface Material
- Finish/Color
- Base Molding
- Decorative Molding
- Drawer Pull
- Locking
- Drawer Construction
- Worksurface Grommet Location
- Back Panel Grommet
- Grommet Color

Description

- Standard With: Letter Width File/File in Pedestal, Front to Back Grain Direction on Worksurface
- Top Profiled on 3 Sides with Reverse Profile on Connecting Edge
- Available with Veneer (W) or HPL (P) Top, Must Specify
- Grommet in Back Panel; Must Specify: Black (BLK), Silver (SLV) or No Back Panel Grommet (NONE)
- Base Molding on Approach, Side, and User Side. Must Specify: Arlington or Wilmington (See Below)
- Standard with No Decorative Molding; Optional Decorative Molding, [See Option Details](#); Must Specify (See Below)
- [Height Adjustable Units Available](#)
- Additional Options: Locking Pedestal ([See Locking Details](#)); Dove Tail Drawer Construction ([See Construction Details](#)); Worksurface Grommet Options ([See Option Details](#))

Molding Options: Must Specify and Add

Arlington Molding Options

| | | |
|--------|------------------------|-----|
| BM2900 | Arlington Base Molding | N/C |
|--------|------------------------|-----|

Wilmington Molding Options

| | | |
|--------|--|--------|
| BM3600 | Wilmington Base Molding | N/C |
| M3600 | Optional Wilmington Decorative Molding | \$ 139 |



Note: Wilmington Decorative Molding may only be used with Wilmington Base Molding

| Item | Model No. | Width | Depth | Height | K | Ship Wt | Cubic Ft | List Price | |
|---|-----------------|------------------|-------|--------|----|---------|----------|------------|----------------------|
|  | Left Ped | Right Ped | | | | | | | |
| | 29-2448LF | 29-2448RF | 48 | 24 | 30 | 30¼ | 125 | 22.9 | P\$ 2857 W\$ 3125 |
| | 29-2442LF | 29-2442RF | 42 | 24 | 30 | 26¼ | 113 | 18.8 | P\$ 2477 W\$ 2738 |

Shown as Left with
Optional Locking

Must Specify (in this order):

- Model #
- Surface Material
- Finish/Color
- Base Molding
- Decorative Molding
- Drawer Pull
- Locking
- Drawer Construction
- Worksurface Grommet Location
- Back Panel Grommet
- Grommet Color

Description

- Standard With: Letter Width Box/Box/File in Pedestal, Front to Back Grain Direction on Worksurface
- Top Profiled on 3 Sides with Reverse Profile on Connecting Edge
- Available with Veneer (W) or HPL (P) Top, Must Specify
- Grommet in Back Panel; Must Specify: Black (BLK) or Silver (SLV) or No Back Panel Grommet (NONE)
- Base Molding on Approach, Side, and User Side. Must Specify: Arlington or Wilmington (See Below)
- Standard with No Decorative Molding; Optional Decorative Molding, [See Option Details](#); Must Specify (See Below)
- [Height Adjustable Units Available](#)
- Additional Options: Locking Pedestal ([See Locking Details](#)); Dove Tail Drawer Construction ([See Construction Details](#)); Worksurface Grommet Options ([See Option Details](#))

Molding Options: Must Specify and Add

Arlington Molding Options

| | | |
|--------|------------------------|-----|
| BM2900 | Arlington Base Molding | N/C |
|--------|------------------------|-----|

Wilmington Molding Options

| | | |
|--------|--|--------|
| BM3600 | Wilmington Base Molding | N/C |
| M3600 | Optional Wilmington Decorative Molding | \$ 139 |



Note: Wilmington Decorative Molding may only be used with Wilmington Base Molding

Pricing Codes:
P = HPL Top
W = Veneer Top

[See Arlington Intro Section for Ordering Options](#)

| Item | Model No. | Width | Depth | Height | K | Ship Wt | Cubic Ft | List Price |
|--------------------------|-----------|-------|-------|--------|------------------|---------|----------|----------------------|
| BRIDGE WITH FULL MODESTY | 29-2448UF | 48 | 24 | 30 | 46 $\frac{7}{8}$ | 75 | 6.2 | P\$ 1530 W\$ 1797 |
| | 29-2442UF | 42 | 24 | 30 | 40 $\frac{7}{8}$ | 73 | 4.7 | P\$ 1458 W\$ 1722 |

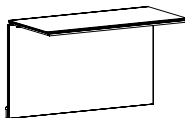

Must Specify (in this order):

Model #
Surface Material
Finish/Color
Base Molding
Decorative Molding
Worksurface Grommet Location
Back Panel Grommet
Grommet Color

Description

- Standard With: Hinged Back Panel, Front to Back Grain Direction on Worksurface
- Available with Veneer (W) or HPL (P) Top, Must Specify
- Grommet in Back Panel; Must Specify: Black (BLK) or Silver (SLV) or No Back Panel Grommet (NONE)
- Base Molding on Approach, Must Specify: Arlington or Wilmington (See Below)
- Standard with No Decorative Molding; Optional Decorative Molding, [See Option Details](#); Must Specify (See Below)
- [Height Adjustable Units Available](#)
- Additional Options: Worksurface Grommet Options ([See Option Details](#))
- Keyboard Accessories Cannot be Factory Installed but are Available for Field Installation (Sold Separately, [See 01-KB3 for Details](#))

Molding Options: Must Specify and Add

Arlington Molding Options

| | | |
|--------|------------------------|-----|
| BM2900 | Arlington Base Molding | N/C |
|--------|------------------------|-----|

Wilmington Molding Options

| | | |
|--------|--|--------|
| BM3600 | Wilmington Base Molding | N/C |
| M3600 | Optional Wilmington Decorative Molding | \$ 139 |

Note: Wilmington Decorative Molding may only be used with Wilmington Base Molding

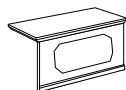

| Item | Model No. | Width | Depth | Height | K | Ship Wt | Cubic Ft | List Price |
|--------------------------|------------|-------|-------|------------------|------------------|---------|----------|----------------------|
| BRIDGE WITH HALF MODESTY | 29-2448UFH | 48 | 24 | 11 $\frac{1}{2}$ | 46 $\frac{7}{8}$ | 89 | 5.4 | P\$ 1350 W\$ 1618 |
| | 29-2442UFH | 42 | 24 | 11 $\frac{1}{2}$ | 40 $\frac{7}{8}$ | 85 | 4.6 | P\$ 1285 W\$ 1548 |

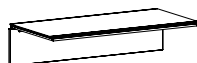

Must Specify (in this order):

Model #
Surface Material
Finish / Color
Worksurface Grommet Location
Grommet Color

Description

- Standard With: Hinged Back Panel, Front to Back Grain Direction on Worksurface
- Available with Veneer (W) or HPL (P) Top, Must Specify
- Keyboard Accessories Cannot be Factory Installed but are Available for Field Installation (Sold Separately, [See 01-KB3 for Details](#))
- No Base or Decorative Molding

[See Arlington Intro Section for Ordering Options](#)

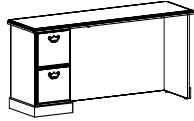
| Item | Model No. | Width | Depth | Height | K | Ship Wt | Cubic Ft | List Price | |
|--|-----------------|------------------|-------|---------------------------------|----|--------------------------------|----------|------------|----------------------|
|  <p>Shown as Left with Optional Locking</p> | Left Ped | Right Ped | | | | | | | |
| | 29-2072LC2 | 29-2072RC2 | 72 | 20 ⁷ / ₁₆ | 30 | 52 ¹ / ₄ | 150 | 30.5 | P\$ 3411 W\$ 3774 |
| | 29-2066LC2 | 29-2066RC2 | 66 | 20 ⁷ / ₁₆ | 30 | 46 ¹ / ₄ | 139 | 27.9 | P\$ 3022 W\$ 3368 |
| | 29-2060LC2 | 29-2060RC2 | 60 | 20 ⁷ / ₁₆ | 30 | 40 ¹ / ₄ | 129 | 25.3 | P\$ 2978 W\$ 3303 |

Description

- Standard With: Letter Width File/File in Pedestal, Left to Right Grain Direction on Worksurface
- Available with Veneer (W) or HPL (P) Top, Must Specify
- Grommet in Back Panel; Must Specify: Black (BLK) or Silver (SLV) or No Back Panel Grommet (NONE)
- Top Profiled on only Three (3) Sides for Flush Wall Application
- Base Molding on Sides and User Side, Must Specify: Arlington or Wilmington (See Below)
- Standard with No Decorative Molding; Optional Decorative Molding, [See Option Details](#); Must Specify (See Below)
- Additional Options: Locking Pedestal ([See Locking Details](#)); Dove Tail Drawer Construction ([See Construction Details](#)); Grommet Options ([See Option Details](#)); Glass Marker Boards ([See Sizes and Details](#))

Must Specify (in this order):

- Model #
- Surface Material
- Finish/Color
- Base Molding
- Decorative Molding
- Drawer Pull
- Locking
- Drawer Construction
- Worksurface Grommet Location
- Back Panel Grommet
- Grommet Color

Molding Options: Must Specify and Add

Arlington Molding Options

| | | |
|--------|------------------------|-----|
| BM2900 | Arlington Base Molding | N/C |
|--------|------------------------|-----|

Wilmington Molding Options

| | | |
|--------|--|--------|
| BM3600 | Wilmington Base Molding | N/C |
| M3600 | Optional Wilmington Decorative Molding | \$ 139 |

Note: Wilmington Decorative Molding may only be used with Wilmington Base Molding

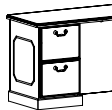

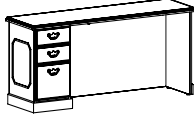
| Item | Model No. | Width | Depth | Height | K | Ship Wt | Cubic Ft | List Price | |
|---|-----------------|------------------|-------|---------------------------------|----|--------------------------------|----------|------------|----------------------|
|  <p>Shown as Left with Optional Locking and Optional Wilmington Decorative Molding</p> | Left Ped | Right Ped | | | | | | | |
| | 29-2072LC | 29-2072RC | 72 | 20 ⁷ / ₁₆ | 30 | 52 ¹ / ₄ | 150 | 30.5 | P\$ 3411 W\$ 3774 |
| | 29-2066LC | 29-2066RC | 66 | 20 ⁷ / ₁₆ | 30 | 46 ¹ / ₄ | 139 | 27.9 | P\$ 3022 W\$ 3368 |
| | 29-2060LC | 29-2060RC | 60 | 20 ⁷ / ₁₆ | 30 | 40 ¹ / ₄ | 129 | 25.3 | P\$ 2978 W\$ 3303 |

Description

- Standard With: Letter Width Box/Box/File in Pedestal, Left to Right Grain Direction on Worksurface
- Available with Veneer (W) or HPL (P) Top, Must Specify
- Grommet in Back Panel; Must Specify: Black (BLK) or Silver (SLV) or No Back Panel Grommet (NONE)
- Top Profiled on only Three (3) Sides for Flush Wall Application
- Base Molding on Sides and User Side, Must Specify: Arlington or Wilmington (See Below)
- Standard with No Decorative Molding; Optional Wilmington Decorative Molding, [See Option Details](#) for Details; Must Specify (See Below)
- Additional Options: Locking Pedestal ([See Locking Details](#)); Dove Tail Drawer Construction ([See Construction Details](#)); Grommet Options ([See Option Details](#)); Glass Marker Boards ([See Sizes and Details](#)); Kneespace Options (Sold Separately, [See 01-KB3 for Details](#))

Must Specify (in this order):

- Model #
- Surface Material
- Finish/Color
- Base Molding
- Decorative Molding
- Drawer Pull
- Locking
- Drawer Construction
- Worksurface Grommet Location
- Back Panel Grommet
- Grommet Color

Molding Options: Must Specify and Add

Arlington Molding Options

| | | |
|--------|------------------------|-----|
| BM2900 | Arlington Base Molding | N/C |
|--------|------------------------|-----|

Wilmington Molding Options

| | | |
|--------|--|--------|
| BM3600 | Wilmington Base Molding | N/C |
| M3600 | Optional Wilmington Decorative Molding | \$ 139 |

Note: Wilmington Decorative Molding may only be used with Wilmington Base Molding



Pricing Codes:
P = HPL Top
W = Veneer Top

[See Arlington Intro Section for Ordering Options](#)

| Item | Model No. | Width | Depth | Height | K | Ship Wt | Cubic Ft | List Price | |
|-------------------------------|------------------|-----------|-------|---------------------------------|----|--------------------------------|----------|------------|----------------------|
| CREDENZA WITH LATERAL/LATERAL | Left Ped | | | | | | | | |
| | Right Ped | | | | | | | | |
| | 29-2072LL | 29-2072RL | 72 | 20 ⁷ / ₁₆ | 30 | 32 ² / ₃ | 182 | 30.5 | P\$ 3608 W\$ 3970 |

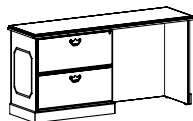

Shown as Left with Optional Locking and Optional Wilmington Decorative Molding

Must Specify (in this order):

- Model #
- Surface Material
- Finish/Color
- Base Molding
- Decorative Molding
- Drawer Pull
- Drawer Construction
- Worksurface Grommet Location
- Back Panel Grommet
- Grommet Color



Description

- Standard With: Two (2) Locking Lateral Files in Pedestal, Left to Right Grain Direction on Worksurface
- Available with Veneer (W) or HPL (P) Top, Must Specify
- Grommet in Back Panel; Must Specify: Black (BLK) or Silver (SLV) or No Back Panel Grommet (NONE)
- Top Profiled on only Three (3) Sides for Flush Wall Application
- Lock Core Color will Coordinate with Pull Selection, [See Option Details](#)
- Legal or Letter Filing Side to Side or Front to Back
- Base Molding on Sides and User Side, Must Specify: Arlington or Wilmington (See Below)
- Standard with No Decorative Molding; Optional Wilmington Decorative Molding, [See Option Details](#) for Details; Must Specify (See Below)
- Additional Options: Dove Tail Drawer Construction ([See Construction Details](#)); Grommet Options ([See Option Details](#)); Glass Marker Boards ([See Sizes and Details](#))

Molding Options: Must Specify and Add

Arlington Molding Options

| | | |
|--------|------------------------|-----|
| BM2900 | Arlington Base Molding | N/C |
|--------|------------------------|-----|

Wilmington Molding Options

| | | |
|--------|--|--------|
| BM3600 | Wilmington Base Molding | N/C |
| M3600 | Optional Wilmington Decorative Molding | \$ 139 |

Note: Wilmington Decorative Molding may only be used with Wilmington Base Molding

| Item | Model No. | Width | Depth | Height | K | Ship Wt | Cubic Ft | List Price | |
|--------------------|-----------|-------|-------|---------------------------------|----|--------------------------------|----------|------------|----------------------|
| KNEESPACE CREDENZA | 29-2072KC | | 72 | 20 ⁷ / ₁₆ | 30 | 34 ¹ / ₂ | 197 | 30.5 | P\$ 3792 W\$ 4151 |
| | 29-2066KC | | 66 | 20 ⁷ / ₁₆ | 30 | 28 ¹ / ₂ | 185 | 27.9 | P\$ 3444 W\$ 3793 |
| | 29-2060KC | | 60 | 20 ⁷ / ₁₆ | 30 | 22 ¹ / ₂ | 173 | 25.3 | P\$ 3419 W\$ 3745 |

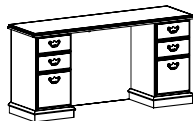

Shown with Optional Locking

Must Specify (in this order):

- Model #
- Surface Material
- Finish/Color
- Base Molding
- Decorative Molding
- Drawer Pull
- Locking
- Drawer Construction
- Worksurface Grommet Location
- Back Panel Grommet
- Grommet Color



Description

- Standard With: Letter Width Box/Box/File in Pedestals, Left to Right Grain Direction on Worksurface
- Available with Veneer (W) or HPL (P) Top, Must Specify
- Grommet in Back Panel; Must Specify: Black (BLK) or Silver (SLV) or No Back Panel Grommet (NONE)
- Top Profiled on only Three (3) Sides for Flush Wall Application
- Base Molding on Sides and User Side, Must Specify: Arlington or Wilmington (See Below)
- Standard with No Decorative Molding; Optional Wilmington Decorative Molding, [See Option Details](#) for Details; Must Specify (See Below)
- Additional Options: Locking Pedestal ([See Locking Details](#)); Dove Tail Drawer Construction ([See Construction Details](#)); Grommet Options ([See Option Details](#)); Glass Marker Boards ([See Sizes and Details](#))

Molding Options: Must Specify and Add

Arlington Molding Options

| | | |
|--------|------------------------|-----|
| BM2900 | Arlington Base Molding | N/C |
|--------|------------------------|-----|

Wilmington Molding Options

| | | |
|--------|--|--------|
| BM3600 | Wilmington Base Molding | N/C |
| M3600 | Optional Wilmington Decorative Molding | \$ 139 |

Note: Wilmington Decorative Molding may only be used with Wilmington Base Molding

[See Arlington Intro Section for Ordering Options](#)

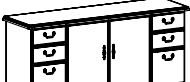
| Item | Model No. | Width | Depth | Height | Ship Wt | Cubic Ft | List Price |
|---|-----------|-------|---------------------------------|--------|---------|----------|----------------------|
|  | 29-2072SC | 72 | 20 ⁷ / ₁₆ | 30 | 237 | 30.5 | P\$ 4245 W\$ 4607 |
| | 29-2066SC | 66 | 20 ⁷ / ₁₆ | 30 | 217 | 30.5 | P\$ 3687 W\$ 4032 |

Shown with Jefferson Drawer and Door Pulls (JEF)

Must Specify (in this order):

- Model #
- Surface Material
- Finish/Color
- Base Molding
- Decorative Molding
- Drawer / Door Pull
- Locking
- Drawer Construction

Description

- Standard With: Letter Width Box/Box/File in Pedestals, Left to Right Grain Direction on Worksurface
- Available with Veneer (W) or HPL (P) Top, Must Specify
- Top Profiled on only Three (3) Sides for Flush Wall Application
- Door Pull will Coordinate with Drawer Pull, [See Pull Details](#)
- Base Molding on Sides and User Side, Must Specify: Arlington or Wilmington (See Below)
- Standard with No Decorative Molding; Optional Wilmington Decorative Molding, [See Option Details](#) for Details; Must Specify (See Below)
- Optional Locking Pedestals (LKT-P) or Locking Pedestals and Doors (LKT-HU), [See Locking Details](#)
- Additional Options: Dove Tail Drawer Construction ([See Construction Details](#))

Molding Options: Must Specify and Add

Arlington Molding Options

| | | |
|--------|------------------------|-----|
| BM2900 | Arlington Base Molding | N/C |
|--------|------------------------|-----|

Wilmington Molding Options

| | | |
|--------|--|--------|
| BM3600 | Wilmington Base Molding | N/C |
| M3600 | Optional Wilmington Decorative Molding | \$ 139 |

Note: Wilmington Decorative Molding may only be used with Wilmington Base Molding



| | | | | | | | |
|---|-----------|----|---------------------------------|----|-----|------|----------------------|
| CREDENZA WITH DOUBLE LATERAL FILE  | 29-2072DL | 72 | 20 ⁷ / ₁₆ | 30 | 270 | 30.5 | P\$ 4880 W\$ 5242 |
|---|-----------|----|---------------------------------|----|-----|------|----------------------|

Shown with Jefferson Drawer and Door Pulls (JEF) and Optional Wilmington Decorative Molding

Must Specify (in this order):

- Model #
- Surface Material
- Finish/Color
- Base Molding
- Decorative Molding
- Drawer Pull
- Drawer Construction

Description

- Standard With: Four (4) Locking Lateral File Drawers, Left to Right Grain Direction on Worksurface
- Available with Veneer (W) or HPL (P) Top, Must Specify
- Top Profiled on only Three (3) Sides for Flush Wall Application
- Legal or Letter Filing Side to Side or Front to Back
- Base Molding on Sides and User Side, Must Specify: Arlington or Wilmington (See Below)
- Standard with No Decorative Molding; Optional Wilmington Decorative Molding, [See Option Details](#) for Details; Must Specify (See Below)
- Additional Options: Dove Tail Drawer Construction ([See Construction Details](#))

Molding Options: Must Specify and Add

Arlington Molding Options

| | | |
|--------|------------------------|-----|
| BM2900 | Arlington Base Molding | N/C |
|--------|------------------------|-----|

Wilmington Molding Options

| | | |
|--------|--|--------|
| BM3600 | Wilmington Base Molding | N/C |
| M3600 | Optional Wilmington Decorative Molding | \$ 139 |

Note: Wilmington Decorative Molding may only be used with Wilmington Base Molding

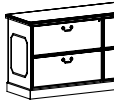

Pricing Codes:
P = HPL Top
W = Veneer Top

[See Arlington Intro Section for Ordering Options](#)

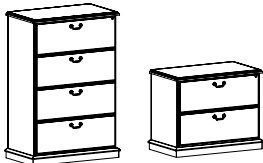
| Item | Model No. | Width | Depth | Height | Ship Wt | Cubic Ft | List Price |
|---|--------------------------------------|-------|-------------------|--------|---------|----------|----------------------|
| LATERAL FILE  | 29-2036L4 <i>Four (4) Drawers</i> | 36 | 20 $\frac{1}{16}$ | 54 | 224 | 27.3 | P\$ 5112 W\$ 5307 |
| | 29-2036L2 <i>Two (2) Drawers</i> | 36 | 20 $\frac{1}{16}$ | 30 | 135 | 15.9 | P\$ 2934 W\$ 3131 |

Description

- Central Locking Lateral File Drawers provide Legal or Letter Filing Front to Back or Side to Side
- Anti-Tilt Mechanism
- Available with Veneer (W) or HPL (P) Top, Must Specify
- Top Profiled on only Three (3) Sides for Flush Wall Application
- Base Molding on Sides and User Side, Must Specify: Arlington or Wilmington (See Below)
- No Decorative Molding Available
- Additional Options: Dove Tail Drawer Construction ([See Construction Details](#))

Base Molding Options: Must Specify

| | | |
|--------|------------------------------|-----|
| BM2900 | Arlington Base Molding Only | N/C |
| BM3600 | Wilmington Base Molding Only | N/C |

Must Specify (in this order):

Model #
Surface Material
Finish/Color
Base Molding
Drawer Pull
Drawer Construction

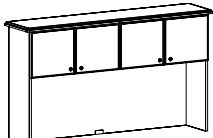
| Item | Model No. | Width | Depth | Height | Ship Wt | Cubic Ft | List Price |
|--|------------------------------------|-------|-------|------------------|---------|----------|------------|
| SURFACE MOUNT HUTCH  | 29-1572HU <i>Four (4) Doors</i> | 72 | 15 | 40 $\frac{1}{8}$ | 203 | 34.1 | \$ 4461 |
| | 29-1566HU <i>Four (4) Doors</i> | 66 | 15 | 40 $\frac{1}{8}$ | 166 | 32.1 | \$ 3988 |
| | 29-1560HU <i>Four (4) Doors</i> | 60 | 15 | 40 $\frac{1}{8}$ | 129 | 28.4 | \$ 3831 |

Description

- Standard with: Soft-Close Hinged Wood Doors, Vertical Grain Direction,
- 25 $\frac{3}{4}$ " Clearance Below Doors
- Top Profiled on Three (3) Sides for Flush Wall Application Standard
- Lower, Center Grommet on Back Panel Standard; Must Specify: Black (BLK) or Silver (SLV)
- Additional Options: Locking Doors ([See Option Details](#)); Three (3) Upper Wire Management Grommets ([See Option Details](#)); Factory-Installed Tackboard ([See Unit Details](#)); Tasklights ([See Multiple Units Details](#))

Must Specify (in this order):

Model #
Finish
Door Pull
Locking
Tackboard Fabric
Tasklight
Grommet Color

[See Arlington Intro Section for Ordering Options](#)

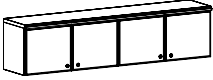
| Item | Model No. | Width | Depth | Height | Ship Wt | Cubic Ft | List Price |
|--|-------------------------------------|-------|-------|-------------------|---------|----------|------------|
| WALL MOUNT HUTCH  | 29-1572WD <i>Four (4) Doors</i> | 72 | 15 | 17 $\frac{3}{16}$ | 118 | 13.1 | \$ 3560 |
| | 29-1566WD <i>Four (4) Doors</i> | 66 | 15 | 17 $\frac{3}{16}$ | 105 | 12.0 | \$ 3483 |
| | 29-1560WD <i>Four (4) Doors</i> | 60 | 15 | 17 $\frac{3}{16}$ | 96 | 11.0 | \$ 3333 |
| | 29-1554WD <i>Three (3) Doors</i> | 54 | 15 | 17 $\frac{3}{16}$ | 87 | 9.9 | \$ 3118 |
| | 29-1548WD <i>Three (3) Doors</i> | 48 | 15 | 17 $\frac{3}{16}$ | 77 | 8.9 | \$ 2904 |
| | 29-1542WD <i>Two (2) Doors</i> | 42 | 15 | 17 $\frac{3}{16}$ | 67 | 7.8 | \$ 2673 |
| | 29-1536WD <i>Two (2) Doors</i> | 36 | 15 | 17 $\frac{3}{16}$ | 58 | 6.7 | \$ 2386 |
| | 29-1530WD <i>Two (2) Doors</i> | 30 | 15 | 17 $\frac{3}{16}$ | 48 | 5.6 | \$ 2306 |

Must Specify (in this order):

Model #
Finish
Door Pull
Locking

Description

- Standard with: Soft-Close Hinged Wood Doors, Vertical Grain Direction,
- Top Profiled on Front only
- Optional Locking Doors, [See Option Details](#)
- Additional Options: Tackboards ([See Multiple Unit Details](#)); Tasklights ([See Multiple Units Details](#)); Magnetic Glass Marker Boards ([See Sizes and Details](#))

| | | | | | | | |
|-------------------------------|-----------|----|----|------------------|----|------|---------|
| SURFACE MOUNT BOOKCASE | 29-1534TU | 34 | 15 | 40 $\frac{7}{8}$ | 78 | 17.8 | \$ 1874 |
|-------------------------------|-----------|----|----|------------------|----|------|---------|

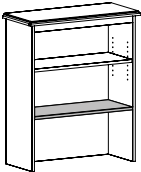

Description

- Top Profiled on Three (3) Sides for Flush Wall Application
- 1" Thick Shelves; One (1) Adjustable and One (1) Fixed (Shaded)
- Vertical Woodgrain
- 12" Clearance Below Fixed Shelf
- For Surface Mount Use on Two (2) Drawer Lateral File

Must Specify (in this order):

Model #
Finish

Pricing Codes:
P = HPL Top
W = Veneer Top

[See Arlington Intro Section for Ordering Options](#)

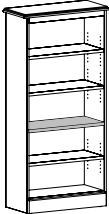
| Item | Model No. | Width | Depth | Height | Ship Wt | Cubic Ft | List Price |
|---|---|-------|-------|------------------|---------|----------|----------------------|
|  | 29-3470BC | 34 | 15 | 70 $\frac{1}{8}$ | 165 | 25.0 | W\$ 2593 |
| | <i>Three (3) Adjustable Shelves and One (1) Fixed Shelf</i> | | | | | | |
| | 29-3460BC | 34 | 15 | 60 | 155 | 21.9 | W\$ 2495 |
| | <i>Two (2) Adjustable Shelves and One (1) Fixed Shelf</i> | | | | | | |
| | 29-3448BC | 34 | 15 | 48 | 125 | 18.0 | P\$ 1835 W\$ 2276 |
| | <i>Two (2) Adjustable Shelves</i> | | | | | | |
| | 29-2870BC | 28 | 15 | 70 $\frac{1}{8}$ | 125 | 23.8 | W\$ 2303 |
| <i>Three (3) Adjustable Shelves and One (1) Fixed Shelf</i> | | | | | | | |
| <p><u>Must Specify (in this order):</u> Model # Surface Material (48"H Only) Finish/Color</p> | 29-2860BC | 28 | 15 | 60 | 115 | 18.3 | W\$ 2253 |
| | <i>Two (2) Adjustable Shelves and One (1) Fixed Shelf</i> | | | | | | |
| | 29-2848BC | 28 | 15 | 48 | 93 | 16.0 | P\$ 1823 W\$ 2204 |
| <i>Two (2) Adjustable Shelves</i> | | | | | | | |

Description

- Fixed Shelf (Shaded)
- Vertical Woodgrain
- 48"H Available with Veneer (W) or HPL (P) Top, Must Specify
- Top Profiled on only Three (3) Sides for Flush Wall Application

| | | | | | | | |
|---------------|-----------|----|----|------------------|----|------|---------|
| DOOR BOOKCASE | 29-2870DB | 28 | 15 | 70 $\frac{1}{8}$ | 78 | 17.8 | \$ 2592 |
|---------------|-----------|----|----|------------------|----|------|---------|

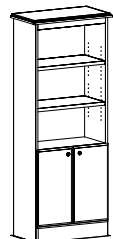

Shown with Arlington
(ARB) Door Pull

Description

- Open Bookcase with Two (2) 1" Thick Adjustable Shelves
- Vertical Woodgrain
- Storage Behind Doors; One (1) Adjustable Shelf
- Top Profiled on only Three (3) Sides for Flush Wall Application
- Optional Locking Doors, [See Option Details](#)

Must Specify (in this order):

Model #
Finish
Door Pull
Locking

[See Arlington Intro Section for Ordering Options](#)

| Item | Model No. | Width | Depth | Height | Ship Wt | Cubic Ft | List Price | |
|--------------------------|---------------------|-----------|-------|--------|------------------|----------|------------|---------|
| WARDROBE/STORAGE CABINET | Hinged Left | | | | | | | |
| | Hinged Right | | | | | | | |
| | 29-1870WL | 29-1870WR | 18 | 20 | 70 $\frac{1}{8}$ | 153 | 19.2 | \$ 3053 |

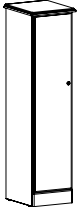

Shown as Left

Must Specify (in this order):

Model #
Finish
Locking
Door Pull

Description

- Coat Rod Under Top Fixed Shelf and Three (3) Adjustable Shelves
- Adjustable Shelves can be Removed for Wardrobe Application
- Vertical Woodgrain
- Top Profiled on only Three (3) Sides for Flush Wall Application
- Must Specify Door Pull: Arlington B (ARB), Jefferson (JEF), and Liberty (ALB)
- Optional Locking Doors, [See Option Details](#)

| | | | | | | | |
|-------------------------|-----------|----|----|------------------|-----|------|---------|
| DOUBLE WARDROBE/STORAGE | 29-3670WD | 36 | 20 | 70 $\frac{1}{8}$ | 310 | 34.2 | \$ 5391 |
|-------------------------|-----------|----|----|------------------|-----|------|---------|

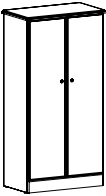

Must Specify (in this order):

Model #
Finish
Locking
Door Pull

Description

- Three (3) Adjustable Shelves on Both Sides; Coat Rod Under Top Fixed Shelf on Right
- Vertical Woodgrain
- Recommended Against Wall
- Top Profiled on only Three (3) Sides for Flush Wall Application
- Must Specify Door Pull: Arlington B (ARB), Jefferson (JEF), and Liberty (ALB)
- Optional Locking Doors, [See Option Details](#)

Pricing Codes:
P = HPL Top
W = Veneer Top

[See Arlington Intro Section for Ordering Options](#)

| Item | Model No. | Width | Depth | Height | Ship Wt | Cubic Ft | List Price |
|---|-----------------------------------|-------|-------|--------|---------|----------|----------------------|
|  | 29-3672WT <i>64" Kneespace</i> | 72 | 36 | 30 | 125 | 11.4 | P\$ 2235 W\$ 2636 |
| | 29-3060WT <i>52" Kneespace</i> | 60 | 30 | 30 | 89 | 8.0 | P\$ 1839 W\$ 2151 |

Description

- Available with Veneer (W) or HPL (P) Top, Must Specify
- Left to Right Grain Direction on Worksurface
- Some Assembly Required
- Optional Worksurface Grommet, [See Option Details](#); Must Specify: Black (BLK) or Silver (SLV)

Must Specify (in this order):

- Model #
- Surface Material
- Finish/Color
- Worksurface Grommet Location
- Grommet Color

COMPUTER DESK WITH HUTCH

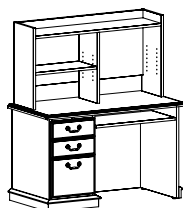

| | Left | Right | Width | Depth | Height | Ship Wt | Cubic Ft | List Price |
|--|-----------|-----------|-------|-------|--------|---------|----------|----------------------|
| | 29-2448LP | 29-2448RP | 48 | 24 | 30 | 148 | 23.1 | P\$ 2889 W\$ 3157 |
| | 29-1246HU | | 46 | 12 | 29½ | 54 | 10.3 | \$ 1142 |

Single Ped Desk Description (29-2448LP/29-2448RP)

- Standard With: Letter Width Box/Box/File Pedestal, Pull-Out Writing Shelf, Pull-Out Keyboard Shelf
- Available with Veneer (W) or HPL (P) Top, Must Specify
- Top Profiled on only Three (3) Sides for Flush Wall Application
- Grommet in Back Panel; Must Specify: Black (BLK) or Silver (SLV) or No Back Panel Grommet (NONE)
- Base Molding on Sides and User Side. Must Specify: Arlington or Wilmington (See Below)
- Additional Options: Dove Tail Drawer Construction ([See Construction Details](#)); Worksurface Grommet Options ([See Option Details](#))

Hutch Description (29-1246HU)

- One (1) Adjustable Shelf; Non-Handed
- Back Panel with Open Clearance for Wire Management

Must Specify for Desk (in this order):

- Model #
- Surface Material
- Finish/Color
- Base Molding
- Drawer Pull
- Drawer Construction
- Worksurface Grommet Location
- Back Panel Grommet
- Grommet Color

Must Specify for Hutch (in this order):

- Model #
- Finish Color

Desk Base Molding Options: Must Specify and Add

| | | |
|--------|-------------------------|-----|
| BM2900 | Arlington Base Molding | N/C |
| BM3600 | Wilmington Base Molding | N/C |

[See Arlington Intro Section for Ordering Options](#)

| Item | Model No. | Width | Depth | Height | Ship Wt | Cubic Ft | List Price |
|-----------|-----------|-------|-------|--------|---------|----------|----------------------|
| END TABLE | 29-2124ET | 21 | 24 | 21½ | 25 | 2.0 | P\$ 1027 W\$ 1197 |

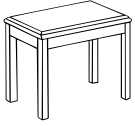

Description

- Available with Veneer (W) or HPL (P) Top, Must Specify
- Hardwood Legs
- Apron Rails and Legs Feature Multi-Step, Hand-Finished Catalyzed Finish
- Some Assembly Required

Must Specify (in this order):

Model #
Surface Material
Finish/Color

| | | | | | | | |
|------------|-----------|----|----|-----|----|-----|----------------------|
| LAMP TABLE | 29-2424LT | 24 | 24 | 21½ | 25 | 2.0 | P\$ 1149 W\$ 1233 |
|------------|-----------|----|----|-----|----|-----|----------------------|

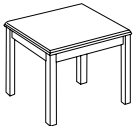

Description

- Available with Veneer (W) or HPL (P) Top, Must Specify
- Hardwood Legs
- Apron Rails and Legs Feature Multi-Step, Hand-Finished Catalyzed Finish
- Some Assembly Required

Must Specify (in this order):

Model #
Surface Material
Finish/Color

| | | | | | | | |
|----------------|-----------|----|----|----|----|-----|----------------------|
| MAGAZINE TABLE | 29-1847MT | 47 | 18 | 16 | 47 | 3.4 | P\$ 1233 W\$ 1438 |
|----------------|-----------|----|----|----|----|-----|----------------------|

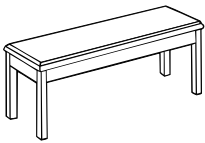

Description

- Available with Veneer (W) or HPL (P) Top, Must Specify
- Left to Right Grain Direction on Worksurface
- Hardwood Legs
- Apron Rails and Legs Feature Multi-Step, Hand-Finished Catalyzed Finish
- Some Assembly Required
- Optional 30" Legs; See Below

Must Specify (in this order):

Model #
Surface Material
Finish/Color
Leg

Desk Base Molding Options: Must Specify and Add

| | | |
|-------|---------------------|--------|
| SH-36 | Optional 30" H Legs | \$ 223 |
|-------|---------------------|--------|

Pricing Codes:
P = HPL Top
W = Veneer Top

[See Arlington Intro Section for Ordering Options](#)

| Item | Model No. | Width | Depth | Height | Ship Wt | Cubic Ft | List Price |
|-----------------------|-----------|-------|-------|--------|---------|----------|----------------------|
| SQUARE MAGAZINE TABLE | 29-3636MT | 36 | 36 | 16 | 60 | 5.5 | P\$ 1317 W\$ 1538 |

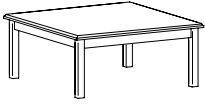

Description

- Available with Veneer (W) or HPL (P) Top, Must Specify
- Hardwood Legs
- Apron Rails and Legs Feature Multi-Step, Hand-Finished Catalyzed Finish
- Some Assembly Required

Must Specify (in this order):

Model #
Surface Material
Finish/Color

| Item | Model No. | Width | Depth | Height | Ship Wt | Cubic Ft | List Price |
|-----------------|--------------------------------------|-------|-------|--------|---------|----------|----------------------|
| ROUND TABLE TOP | 29-4848CT | 48 | 48 | 30 | 58 | 5.9 | P\$ 2625 W\$ 3083 |
| | <i>Accommodates Five (5) Chairs</i> | | | | | | |
| | 29-4242CT | 42 | 42 | 30 | 51 | 4.5 | P\$ 1829 W\$ 2247 |
| | <i>Accommodates Four (4) Chairs</i> | | | | | | |
| | 29-3636CT | 36 | 36 | 30 | 50 | 3.3 | P\$ 1590 W\$ 1959 |
| | <i>Accommodates Three (3) Chairs</i> | | | | | | |

Must Specify for Top (in this order):

Model #
Surface Material
Finish/Color
Base

Must Specify for Base (in this order):

Model #
Finish

Description

- Available with Veneer (W) or HPL (P) Top, Must Specify
- See Below for Queen Anne Base; One (1) Base Required
- Queen Anne Base Features Multi-Step, Hand-Finished Catalyzed Finish
- Power Options not Available

Base Options: Must Order & Add



Queen Anne Base

| | | | | |
|-----------|---------------------------------------|----|------|---------|
| 01-0606QB | Optional Queen Anne Base (1 Required) | 54 | 22.4 | \$ 1406 |
|-----------|---------------------------------------|----|------|---------|

Height Adjustable Pneumatic X-Bases



Maximum Round 42", Maximum Square 36"

| | | | | | | | |
|--------------|----------|----|----|--------|---|-----|---------|
| 01-3232HAXBB | Black | 32 | 32 | 26-45¾ | 1 | 0.2 | \$ 1721 |
| 01-3232HAXBA | Aluminum | | | | | | |

Maximum Round 36", Maximum Square 30"

| | | | | | | | |
|--------------|----------|----|----|--------|---|-----|---------|
| 01-2626HAXBB | Black | 22 | 22 | 26-45¾ | 1 | 0.2 | \$ 1687 |
| 01-2626HAXBA | Aluminum | | | | | | |

Description

- Pre-Drilled Boring Pattern May Not Match Underside of Table Top
- Steel Mounting Plate: 8"x 8"x ¼"
- Eight (8) Bolts Included for Assembly
- Some Assembly Required

[See Arlington Intro Section for Ordering Options](#)

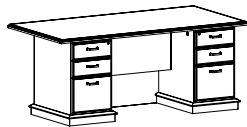
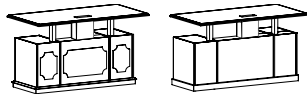
| Item | Model No. | Width | Depth | Height | K | Ship Wt | Cubic Ft | List Price | |
|--|--|-------|-------|--------|-----|---------|----------|----------------------|--|
| HEIGHT ADJUSTABLE DOUBLE PED DESK BOX/BOX/FILE  | 29-3672DPSTS | 72 | 36 | 30-45 | 31½ | 338 | 51.7 | P\$ 9226 W\$ 9629 | |
| | Chassis 64W x 24D, 10" Approach Overhang | | | | | | | | |
| | 29-3072DPSTS | 72 | 30 | 30-45 | 31½ | 327 | 43.9 | P\$ 9194 W\$ 9549 | |
| | Chassis 64W x 24D, 4" Approach Overhang | | | | | | | | |
|  | 29-3066DPSTS | 66 | 30 | 30-45 | 16 | 321 | 40.3 | P\$ 9160 W\$ 9490 | |
| | Chassis 64W x 24D, 4" Approach Overhang | | | | | | | | |
| | 29-3060DPSTS | 60 | 30 | 30-45 | 16 | 321 | 35.3 | P\$ 8987 W\$ 9297 | |
| Chassis 58W x 24D, 4" Approach Overhang | | | | | | | | | |

Approach Side Shown with Wire Management Box/Decorative Molding and Optional No Molding

Must Specify (in this order):

- Model #
- Surface Material
- Finish/Color
- Base Molding
- Decorative Molding
- Drawer Pull
- Drawer Construction
- Control Switch
- Top Grommet Location/Color

Description

- Standard with: Rectangle Top, Locking Letter Width Locking Box/Box/File Pedestals, Left to Right Grain Direction on Worksurface, 2-Channel Leg Configuration for Single Surface Height Adjustment, and Standard Up/Down Control Switch
- Available with Veneer (W) or HPL (P) Top, Must Specify
- Top Profiled on All 4 Sides
- Lock Core Color will Coordinate with Pull Selection, [See Option Details](#)
- Base Molding on Approach, Sides and User Side. Must Specify: Arlington or Wilmington (See Below)
- Standard with No Decorative Molding; Optional Wilmington Decorative Molding, [See Option Details](#) for Details; Must Specify (See Below)
- Wire Management Box Available; Attaches to Bottom Side of Worksurface and Moves Up/Down with Worksurface to Hide Cords/Wires from Top to Chassis ([See Option Details](#))
- Additional Options: Dove Tail Drawer Construction ([See Construction Details](#)); Grommet Options ([See Option Details](#)); Glass Marker Boards ([See Sizes and Details](#)); Advanced (Memory/Up/Down) Control Switch ([See Option Details](#)) Wire Management and Accessories (Order Separately; [See Multiple Unit Details](#))

Molding Options: Must Specify and Add

Arlington Molding Options

| | | |
|--------|---------------------------------------|-------|
| BM2900 | Arlington Base Molding | N/C |
| M2900 | Optional Arlington Decorative Molding | \$ 83 |

Wilmington Molding Options

| | | |
|--------|--|--------|
| BM3600 | Wilmington Base Molding | N/C |
| M3600 | Optional Wilmington Decorative Molding | \$ 139 |

Note: Arlington Decorative Molding may only be used with Arlington Base Molding and Wilmington Decorative Molding may only be used with Wilmington Base Molding

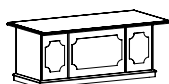

Approach View for all Double and Single Ped Desks with Arlington Molding

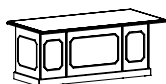

Approach View for all Double and Single Ped Desks with Wilmington Molding

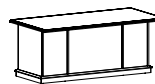

Approach View for all Double and Single Ped Desks with No Molding

Pricing Codes:
P = HPL Top
W = Veneer Top

[See Arlington Intro Section for Ordering Options](#)

| Item | Model No. | Width | Depth | Height | K | Ship Wt | Cubic Ft | List Price | |
|--|--|------------------|-------|--------|-------|---------|----------|------------|----------------------|
| HEIGHT ADJUSTABLE SINGLE PED DESK BOX/BOX/FILE | Left Ped | Right Ped | | | | | | | |
| | 29-3672LPSTS | 29-3672RPSTS | 72 | 36 | 30-45 | 30¾ | 338 | 51.7 | P\$ 9160 W\$ 9563 |
| | Chassis 70W x 24D, 10" Approach Overhang | | | | | | | | |
| | 29-3072LPSTS | 29-3072RPSTS | 72 | 30 | 30-45 | 30¾ | 283 | 43.9 | P\$ 8910 W\$ 9264 |
| | Chassis 70W x 24D, 4" Approach Overhang | | | | | | | | |
| | 29-3066LPSTS | 29-3066RPSTS | 66 | 30 | 30-45 | 24¾ | 283 | 43.9 | P\$ 8660 W\$ 8992 |
| | Chassis 64W x 24D, 4" Approach Overhang | | | | | | | | |
| | 29-3060LPSTS | 29-3060RPSTS | 66 | 30 | 30-45 | 18¾ | 258 | 35.3 | P\$ 8409 W\$ 8719 |
| | Chassis 58W x 24D, 4" Approach Overhang | | | | | | | | |

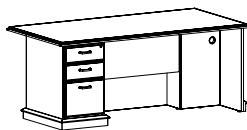

Shown as Left

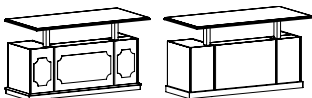

Approach Side Shown with Decorative Molding and Optional No Molding

Must Specify (in this order):

- Model #
- Premium or Standard Veneer
- Top Material
- Finish/Color
- Pull
- No Molding
- Drawer Track
- Leg Configuration
- Control Switch
- Top Grommet Location/Color

Description

- Standard with: Rectangle Top, Locking Letter Width Locking Box/Box/File Pedestal, Left to Right Grain Direction on Worksurface, 2-Channel Leg Configuration for Single Surface Height Adjustment, and Standard Up/Down Control Switch
- Available with Veneer (W) or HPL (P) Top, Must Specify
- Top Profiled on All 4 Sides
- Lock Core Color will Coordinate with Pull Selection, [See Option Details](#)
- Optional 3-Channel Leg Configuration (STS3) for Use with 3-Channel Returns; [See Option Details](#) and [3-Channel Returns](#)
- Stationary Returns Available for Use with Single Ped Desks, [See Stationary Return](#)
- Base Molding on Approach, Sides and User Side. Must Specify: Arlington or Wilmington (See Below)
- Standard with No Decorative Molding; Optional Wilmington Decorative Molding, [See Option Details](#) for Details; Must Specify (See Below)
- Wire Management Box Available; Attaches to Bottom Side of Worksurface and Moves Up/Down with Worksurface to Hide Cords/Wires from Top to Chassis ([See Option Details](#))
- Additional Options: Dove Tail Drawer Construction ([See Construction Details](#)); Grommet Options ([See Option Details](#)); Glass Marker Boards ([See Sizes and Details](#)); Advanced (Memory/Up/Down) Control Switch ([See Option Details](#)) Wire Management and Accessories (Order Separately; [See Multiple Unit Details](#))

Molding Options: Must Specify and Add

| Arlington Molding Options | | |
|----------------------------|--|--------|
| BM2900 | Arlington Base Molding | N/C |
| M2900 | Optional Arlington Decorative Molding | \$ 83 |
| Wilmington Molding Options | | |
| BM3600 | Wilmington Base Molding | N/C |
| M3600 | Optional Wilmington Decorative Molding | \$ 139 |

Note: Arlington Decorative Molding may only be used with Arlington Base Molding and Wilmington Decorative Molding may only be used with Wilmington Base Molding

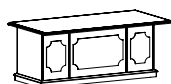

Approach View for all Double and Single Ped Desks with Arlington Molding

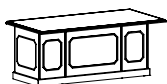

Approach View for all Double and Single Ped Desks with Wilmington Molding

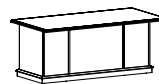

Approach View for all Double and Single Ped Desks with No Molding

[See Arlington Intro Section for Ordering Options](#)

| Item | Model No. | | Width | Depth | Height | K | Ship Wt | Cubic Ft | List Price | |
|---|-----------------|------------------|-------|-------|--------|-----|---------|----------|----------------------|--|
| HEIGHT ADJUSTABLE RETURN WITH FILE/FILE | Left Ped | Right Ped | | | | | | | | |
| | 29-2448LF2STS | 29-2448RF2STS | 48 | 24 | 30-45 | 30¼ | 197 | 23.1 | P\$ 8071 W\$ 8340 | |
| 2-CHANNEL, FOR ONE WORKSURFACE | 29-2442LF2STS | 29-2442RF2STS | 42 | 24 | 30-45 | 30¼ | 182 | 20.4 | P\$ 7690 W\$ 7951 | |

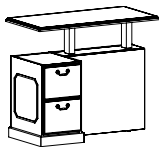

Shown as Left

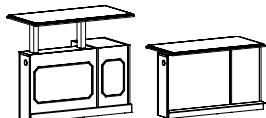

Approach Shown with and without Decorative Molding

Must Specify (in this order):

- Model #
- Surface Material
- Finish/Color
- Base Molding
- Decorative Molding
- Drawer Pull
- Locking
- Drawer Construction
- Control Switch
- Top Grommet Location/Color
- Modesty Grommet

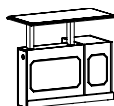

Description

- Standard with: Rectangle Top, Base Molding on All Sides, Decorative Molding on Approach and Side, Letter Width File/File Ped, Worksurface Grommet, Front-To-Back Grain Direction on Top, 2-Channel Leg Configuration for Single Surface Height Adjustment, Standard Up/Down Control Switch, and Wire Management from Pedestal to Kneespace
- Top Profiled on 4 Sides with Reverse Profile on Connecting Edge; Surface is ¼” Short on Connecting Side
- Available with Veneer (W) or HPL (P) Top, Must Specify
- Base Molding on Approach, Side, and User Side. Must Specify: Arlington or Wilmington (See Below)
- Standard with No Decorative Molding; Optional Wilmington Decorative Molding, [See Option Details](#) for Details; Must Specify (See Below)
- Control Switch Standard (Up/Down) or Upgrade to Advanced Switch (MSWCH-Up/Down/Memory); Switch is Field Installed; [See Switch Options](#)
- Optional Modesty Grommet for Wire Management to Wall; Must Specify: Black (GMBBL), Silver (GMBSV) or None (NONE)
- Wire Management Box Available; Attaches to Bottom Side of Worksurface and Moves Up/Down with Worksurface to Hide Cords/Wires from Top to Chassis ([See Option Details](#))
- Additional Options: Locking Pedestal ([See Locking Details](#)); Dove Tail Drawer Construction ([See Construction Details](#)); Grommet Options ([See Option Details](#)); Glass Marker Boards ([See Sizes and Details](#)); Advanced (Memory/Up/Down) Control Switch ([See Option Details](#)) Wire Management and Accessories (Order Separately; [See Multiple Unit Details](#))

Molding Options: Must Specify and Add

| Arlington Molding Options | | |
|----------------------------|--|--------|
| BM2900 | Arlington Base Molding | N/C |
| Wilmington Molding Options | | |
| BM3600 | Wilmington Base Molding | N/C |
| M3600 | Optional Wilmington Decorative Molding | \$ 139 |

Note: Wilmington Decorative Molding may only be used with Wilmington Base Molding

Pricing Codes:
P = HPL Top
W = Veneer Top

[See Arlington Intro Section for Ordering Options](#)

| Item | Model No. | Width | Depth | Height | K | Ship Wt | Cubic Ft | List Price | |
|--|------------------|--------------|-------|--------|-------|---------|----------|------------|----------------------|
| HEIGHT ADJUSTABLE RETURN WITH BOX/BOX/FILE | Left Ped | | | | | | | | |
| | Right Ped | | | | | | | | |
| | 29-2448LFSTS | 29-2448RFSTS | 48 | 24 | 30-45 | 30¼ | 197 | 23.1 | P\$ 8071 W\$ 8340 |
| 2-CHANNEL, FOR ONE WORKSURFACE | | | | | | | | | |
| | 29-2442LFSTS | 29-2442RFSTS | 42 | 24 | 30-45 | 30¼ | 182 | 20.4 | P\$ 7690 W\$ 7951 |

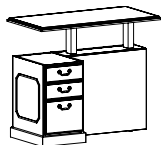

Shown as Left

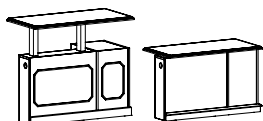

Approach Shown with and without Decorative Molding

Must Specify (in this order):

- Model #
- Surface Material
- Finish/Color
- Base Molding
- Decorative Molding
- Drawer Pull
- Locking
- Drawer Construction
- Control Switch
- Top Grommet Location/Color
- Modesty Grommet

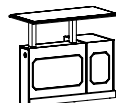

Description

- Standard with: Rectangle Top, Base Molding on All Sides, Decorative Molding on Approach and Side, Letter Width Box/Box/File Ped, Worksurface Grommet, Front-To-Back Grain Direction on Top, 2-Channel Leg Configuration for Single Surface Height Adjustment, Standard Up/Down Control Switch, and Wire Management from Pedestal to Kneespace
- Top Profiled on 4 Sides with Reverse Profile on Connecting Edge; Surface is 1/8" Short on Connecting Side
- Available with Veneer (W) or HPL (P) Top, Must Specify
- Base Molding on Approach, Side, and User Side. Must Specify: Arlington or Wilmington (See Below)
- Standard with No Decorative Molding; Optional Wilmington Decorative Molding, [See Option Details](#) for Details; Must Specify (See Below)
- Control Switch Standard (Up/Down) or Upgrade to Advanced Switch (MSWCH-Up/Down/Memory); Switch is Field Installed; [See Switch Options](#)
- Optional Modesty Grommet for Wire Management to Wall; Must Specify: Black (GMBBL), Silver (GMBSV) or None (NONE)
- Wire Management Box Available; Attaches to Bottom Side of Worksurface and Moves Up/Down with Worksurface to Hide Cords/Wires from Top to Chassis ([See Option Details](#))
- Additional Options: Locking Pedestal ([See Locking Details](#)); Dove Tail Drawer Construction ([See Construction Details](#)); Grommet Options ([See Option Details](#)); Glass Marker Boards ([See Sizes and Details](#)); Advanced (Memory/Up/Down) Control Switch ([See Option Details](#)) Wire Management and Accessories (Order Separately; [See Multiple Unit Details](#))

Molding Options: Must Specify and Add

| Arlington Molding Options | | |
|----------------------------|--|--------|
| BM2900 | Arlington Base Molding | N/C |
| Wilmington Molding Options | | |
| BM3600 | Wilmington Base Molding | N/C |
| M3600 | Optional Wilmington Decorative Molding | \$ 139 |

Note: Wilmington Decorative Molding may only be used with Wilmington Base Molding

[See Arlington Intro Section for Ordering Options](#)

| Item | Model No. | Width | Depth | Height | K | Ship Wt | Cubic Ft | List Price | |
|---|-----------------|------------------|-------|--------|-------|---------|----------|------------|----------------------|
| HEIGHT ADJUSTABLE RETURN WITH FILE/FILE FOR MULTIPLE SURFACES | Left Ped | Right Ped | | | | | | | |
| | 29-2448LF2STS3 | 29-2448RF2STS3 | 48 | 24 | 30-45 | 30¼ | 197 | 23.1 | P\$ 5651 W\$ 5920 |
| 3-CHANNEL, FOR TWO SIMULTANEOUS WORKSURFACES | 29-2442LF2STS3 | 29-2442RF2STS3 | 42 | 24 | 30-45 | 30¼ | 182 | 20.4 | P\$ 5271 W\$ 5532 |

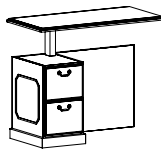

Shown as Left

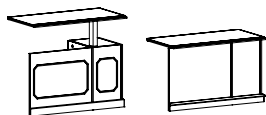

Approach Shown with and without Decorative Molding

Must Specify (in this order):

- Model #
- Surface Material Finish/Color
- Base Molding
- Decorative Molding
- Drawer Pull
- Locking
- Drawer Construction
- Top Grommet Location/Color
- Modesty Grommet

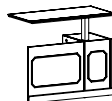

Description

- Standard with: Rectangle Top Profiled on Approach and User Sides with Reverse Profile on Connecting Side, Base Molding on All Sides, Decorative Molding on Approach and Side, File/File Ped, Front-To-Back Grain Direction on Top, 3-Channel Leg Configuration for Simultaneous Surface Height Adjustment Across Two Units, and Wire Management from Pedestal to Kneespace
- Available with Veneer (W) or HPL (P) Top, Must Specify
- **Must Be Used with Height Adjustable Single Pedestal Desk (Order Separately, See Single Ped Desk)**
- Control Switch Not Included, Will Be On Adjoining Unit
- Optional Worksurface Grommet with or without Mesh Wire Management Sleeve Available Over Ped Only; 6" from Ends and 20" from User; Must Specify Location and Color: GL or GL-MESH for Left or GR or GR-MESH for Right; Color Options: Black (BLK) or Silver (SLV)
- Optional Modesty Grommet for Wire Management to Wall; Must Specify: Black (GMBBL), Silver (GMBSV) or None (NONE)
- Monitor Arms not Available on this Unit
- Additional Options: Locking Pedestal (See Locking Details); Dove Tail Drawer Construction (See Construction Details); Grommet Options (See Option Details); Glass Marker Boards (See Sizes and Details); Wire Management and Accessories (Order Separately; See Multiple Unit Details)

Molding Options: Must Specify and Add

Arlington Molding Options

| | | |
|--------|------------------------|-----|
| BM2900 | Arlington Base Molding | N/C |
|--------|------------------------|-----|

Wilmington Molding Options

| | | |
|--------|--|--------|
| BM3600 | Wilmington Base Molding | N/C |
| M3600 | Optional Wilmington Decorative Molding | \$ 139 |

Note: Wilmington Decorative Molding may only be used with Wilmington Base Molding

Pricing Codes:
P = HPL Top
W = Veneer Top

[See Arlington Intro Section for Ordering Options](#)

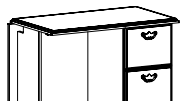
| Item | Model No. | | Width | Depth | Height | K | Ship Wt | Cubic Ft | List Price | |
|--|-----------------|------------------|-------|-------|--------|-----|---------|----------|------------|----------|
| STATIONARY RETURN WITH FILE/FILE  | Left Ped | Right Ped | | | | | | | | |
| | 29-2448LF2SR | 29-2448RF2SR | 48 | 24 | 30-45 | 30¼ | 125 | 23.1 | P\$ 3065 | W\$ 3333 |
| | 29-2442LF2SR | 29-2442RF2SR | 42 | 24 | 30-45 | 30¼ | 110 | 20.4 | P\$ 2684 | W\$ 2945 |
| | | | | | | | | | | |

Shown as Right

Must Specify (in this order):

- Model #
- Surface Material
- Finish/Color
- Base Molding
- Decorative Molding
- Drawer Pull
- Locking
- Drawer Construction
- Top Grommet Location/Color
- Modesty Grommet

Description

- Standard with: Rectangle Top, Decorative Molding on Approach and Side, File/File Ped, Front-To-Back Grain Direction on Top, 2-Channel Leg Configuration for Single Surface Height Adjustment, and Wire Management from Pedestal to Kneespace
- Top Profiled on 4 Sides; Surface is ¼" Short on Connecting Side
- Available with Veneer (W) or HPL (P) Top, Must Specify
- **Must Be Used with Height Adjustable Single Pedestal Desk (Order Separately, [See Single Ped Desk](#))**
- Control Switch Not Included, Will Be On Adjoining Unit
- Optional Modesty Grommet for Wire Management to Wall; Must Specify: Black (GMBBL), Silver (GMBSV) or None (NONE)
- Monitor Arms not Available on this Unit
- Additional Options: Locking Pedestal ([See Locking Details](#)); Dove Tail Drawer Construction ([See Construction Details](#)); Grommet Options ([See Option Details](#)); Glass Marker Boards ([See Sizes and Details](#)); Wire Management and Accessories (Order Separately; [See Multiple Unit Details](#))

Molding Options: Must Specify and Add

Arlington Molding Options

| | | |
|--------|------------------------|-----|
| BM2900 | Arlington Base Molding | N/C |
|--------|------------------------|-----|

Wilmington Molding Options

| | | |
|--------|--|--------|
| BM3600 | Wilmington Base Molding | N/C |
| M3600 | Optional Wilmington Decorative Molding | \$ 139 |

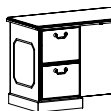

Note: Wilmington Decorative Molding may only be used with Wilmington Base Molding

[See Arlington Intro Section for Ordering Options](#)

| Item | Model No. | Width | Depth | Height | K | Ship Wt | Cubic Ft | List Price |
|--------------------------------|--------------|-------|-------|--------|----|---------|----------|----------------------|
| HEIGHT ADJUSTABLE BRIDGE | 29-2448UFSTS | 48 | 24 | 30-45 | 30 | 250 | 24.0 | P\$ 6744 W\$ 7011 |
| 2-CHANNEL, FOR ONE WORKSURFACE | 29-2442UFSTS | 42 | 24 | 30-45 | 30 | 230 | 21.8 | P\$ 6673 W\$ 6938 |

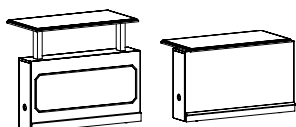
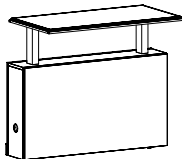

Approach Shown with and without Decorative Molding

Must Specify (in this order):

- Model #
- Surface Material
- Finish/Color
- Base Molding
- Decorative Molding
- Top Grommet Location/Color
- Back Panel Grommet
- Control Switch

Description

- Standard with: Rectangle Top Profiled on All Sides, Base Molding on Back Side, Decorative Molding on Approach, Front-To-Back Grain Direction on Top, 2-Channel Leg Configuration for Single Surface Height Adjustment, and Standard Up/Down Control Switch (Field Installed)
- Available with Veneer (W) or HPL (P) Top, Must Specify
- Optional Worksurface Grommet with or without Mesh Wire Management Sleeve or Wire Management Box Available On Center Only ([See Option Details](#))
- Optional Modesty Grommet for Wire Management to Wall; Must Specify: Black (GMBBL), Silver (GMBSV) or None (NONE)
- Control Switch Standard (Up/Down) or Upgrade to Advanced Switch (MSWCH-Up/Down/Memory); Switch is Field Installed; [See Switch Options](#)
- Base Molding on Approach, Must Specify: Arlington or Wilmington (See Below)
- Standard with No Decorative Molding; Optional Wilmington Decorative Molding, [See Option Details](#); Must Specify (See Below)
- Additional Options: Worksurface Grommet Options ([See Option Details](#)); Kneespace Options Available for Field Installation Only ([See 01-KB3](#)); Wire Management and Accessories (Order Separately; [See Multiple Unit Details](#))
- Note: Surface is 1/8" Short on Both Connecting Sides to Prevent Contact Between Tops

Molding Options: Must Specify and Add

Arlington Molding Options

| | | |
|--------|------------------------|-----|
| BM2900 | Arlington Base Molding | N/C |
|--------|------------------------|-----|

Wilmington Molding Options

| | | |
|--------|--|--------|
| BM3600 | Wilmington Base Molding | N/C |
| M3600 | Optional Wilmington Decorative Molding | \$ 139 |

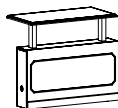

Note: Wilmington Decorative Molding may only be used with Wilmington Base Molding

Pricing Codes:
P = HPL Top
W = Veneer Top

[See Arlington Intro Section for Ordering Options](#)

| Item | Model No. | Width | Depth | Height | K | Ship Wt | Cubic Ft | List Price | |
|--|-----------------|------------------|-------|--------|-------|---------|----------|------------|----------------------|
| HEIGHT ADJUSTABLE BRIDGE FOR MULTIPLE SURFACES | Left Ped | Right Ped | | | | | | | |
| | 29-2448UFSTSL3 | 29-2448UFSTSR3 | 48 | 24 | 30-45 | 30 | 240 | 24.0 | P\$ 5554 W\$ 5821 |
| 3-CHANNEL, FOR TWO SIMULTANEOUS WORKSURFACES | 29-2442UFSTSL3 | 29-2442UFSTSR3 | 42 | 24 | 30-45 | 30 | 220 | 21.8 | P\$ 5482 W\$ 5747 |

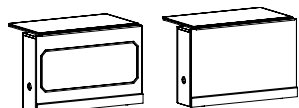

Approach Shown with and without Decorative Molding

Must Specify (in this order):

- Model #
- Surface Material
- Finish/Color
- Base Molding
- Decorative Molding
- Top Grommet Location/Color
- Back Panel Grommet
- Grommet Color

Description

- Standard with: Rectangle Top Profiled on All Sides, Base Molding on Back Side, Front-To-Back Grain Direction on Top, 3-Channel Leg Configuration for Multiple Surface Height Adjustment
- Available with Veneer (W) or HPL (P) Top, Must Specify
- Control Switch Not Included; Control Switch will be on Adjoining Worksurface
- Optional Worksurface Grommet with Mesh Wire Management Sleeve or Wire Management Box Available On Center Only ([See Option Details](#))
- Optional Modesty Grommet for Wire Management to Wall; Must Specify: Black (GMBBL), Silver (GMBSV) or None (NONE)
- Base Molding on Approach, Must Specify: Arlington or Wilmington (See Below)
- Standard with No Decorative Molding; Optional Wilmington Decorative Molding, [See Option Details](#); Must Specify (See Below)
- Additional Options: Wire Management and Accessories (Order Separately; [See Multiple Unit Details](#))
- Note: Surface is 1/8" Short on Both Connecting Sides to Prevent Contact Between Tops

Molding Options: Must Specify and Add

Arlington Molding Options

| | | |
|--------|------------------------|-----|
| BM2900 | Arlington Base Molding | N/C |
|--------|------------------------|-----|

Wilmington Molding Options

| | | |
|--------|--|--------|
| BM3600 | Wilmington Base Molding | N/C |
| M3600 | Optional Wilmington Decorative Molding | \$ 139 |

Note: Wilmington Decorative Molding may only be used with Wilmington Base Molding

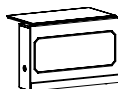

[See Arlington Intro Section for Ordering Options](#)

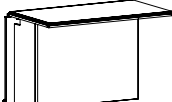
| Item | Model No. | | Width | Depth | Height | K | Ship Wt | Cubic Ft | List Price |
|--|------------------------|-------------------------|-------|-------|--------|----|---------|----------|----------------------|
| STATIONARY BRIDGE FULL MODESTY  | Left Attachment | Right Attachment | | | | | | | |
| | 29-2448SUFL | 29-2448SUFR | 48 | 24 | 30 | 22 | 89 | 5.5 | P\$ 1736 W\$ 2004 |
| | 29-2442SUFL | 29-2442SUFR | 42 | 24 | 30 | 22 | 89 | 5.5 | P\$ 1666 W\$ 1930 |

Shown as Right

Must Specify (in this order):

- Model #
- Top Material
- Finish/Color
- No Molding
- Top Grommet Location/Color
- Back Panel Grommet

Description

- Standard with: Rectangle Top Profiled on All Sides with Reverse Profile on Connecting Side (To Credenza), Base Molding on Back Side, Decorative Molding on Approach, and Front-To-Back Grain Direction on Top
- Available with Veneer (W) or HPL (P) Top, Must Specify
- **Must Be Used with Height Adjustable Single Pedestal Desk (Order Separately, [See Single Ped Desk](#))**
- Optional Modesty Grommet for Wire Management to Wall; Must Specify: Black (GMBBL), Silver (GMBSV) or None (NONE)
- Base Molding on Approach, Must Specify: Arlington or Wilmington (See Below)
- Standard with No Decorative Molding; Optional Wilmington Decorative Molding, [See Option Details](#) for Details; Must Specify (See Below)
- Additional Options: Worksurface Grommet Options ([See Option Details](#)); Kneespace Options Available for Field Installation Only ([See 01-KB3](#)); Wire Management and Accessories (Order Separately; [See Multiple Unit Details](#))
- Note: Surface is 1/8" Short on Connecting Side (To Height Adjustable Desk)

Molding Options: Must Specify and Add

Arlington Molding Options

| | | |
|--------|------------------------|-----|
| BM2900 | Arlington Base Molding | N/C |
|--------|------------------------|-----|

Wilmington Molding Options

| | | |
|--------|--|--------|
| BM3600 | Wilmington Base Molding | N/C |
| M3600 | Optional Wilmington Decorative Molding | \$ 139 |

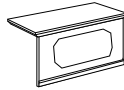

Note: Wilmington Decorative Molding may only be used with Wilmington Base Molding

Pricing Codes:
P = HPL Top
W = Veneer Top

[See Arlington Intro Section for Ordering Options](#)

| Item | Model No. | Width | Depth | Height | Ship Wt | Cubic Ft | List Price |
|---|--------------------------------------|-------|-------|--------|---------|----------|----------------------|
| CONFERENCE TABLE ONE PIECE TOP | 29-4296RT | 96 | 42 | 30 | 140 | 12.5 | P\$ 3724 W\$ 4387 |
| | <i>Accommodates Eight (8) Chairs</i> | | | | | | |
|  | 29-3672RT | 72 | 36 | 30 | 91 | 6.6 | P\$ 3085 W\$ 3596 |
| | <i>Accommodates Six (6) Chairs</i> | | | | | | |

Description

- One (1) Piece Top
- Available with Veneer (W) or HPL (P) Top, Must Specify
- Top and Bases Shipped Separately
- Bases Must e Specified. Top Price Includes Standard Two (2) Rectangle Bases with Two (2) Stretchers, Optional Queen Anne Bases Available (See Below)
- Queen Anne Base Features Multi-Step, Hand-Finished Catalyzed Finish
- Additional Options: Grommet Options ([See Options and Locations](#)), Power Options ([See Multiple Unit Details](#))

Must Specify for Top (in this order):

Model #
Surface Material
Finish/Color
PDC Style / Location
Base

Must Specify for Base (in this order):

Model #
Finish

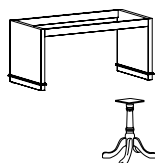

Options: Must Specify and Add

| | | | | |
|-----------|---|-----|------|----------|
| 29-2828TB | Rectangular Bases (Includes 2 Bases and 2 Stretchers) | 104 | 7.0 | Included |
| 01-0606QB | Upgrade Queen Anne Base (Includes 2 Bases) | 54 | 22.4 | \$ 943 |

Arlington Meeting and Conference Tables offer additional power and grommet options. See the Tables and Space Division Price List for more details.

| | | | | | | | |
|---|--|-----|----|----|-----|------|----------------------|
| CONFERENCE TABLE TWO PIECE TOP | 29-48144RT | 144 | 48 | 30 | 315 | 22.0 | P\$ 7711 W\$ 8820 |
| | <i>Accommodates Twelve (12) Chairs</i> | | | | | | |
|  | 29-48120RT | 120 | 48 | 30 | 198 | 22.0 | P\$ 4696 W\$ 5584 |
| | <i>Accommodates Ten (10) Chairs</i> | | | | | | |

Description

- Two (2) Piece Top
- Available with Veneer (W) or HPL (P) Top, Must Specify
- Top and Bases Shipped Separately
- Bases Must Be Specified. Top Price Includes Standard Three (3) Rectangle Bases with Four (4) Stretchers, Optional Queen Anne Bases Available (See Below)
- Queen Anne Base Features Multi-Step, Hand-Finished Catalyzed Finish
- Additional Options: Grommet Options ([See Options and Locations](#)), Power Options ([See Multiple Unit Details](#))

Must Specify for Top (in this order):

Model #
Finish Color
PDC Style / Location
Base

Must Specify for Base (in this order):

Model #
Finish Color

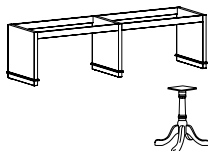

Options: Must Specify and Add

| | | | | |
|-----------|---|-----|------|----------|
| 29-2828TB | Rectangular Bases (Includes 3 Bases and 4 Stretchers) | 104 | 7.0 | Included |
| 01-0606QB | Upgrade Queen Anne Base (Includes 3 Bases) | 80 | 33.6 | \$ 1414 |

Arlington Meeting and Conference Tables offer additional power and grommet options. See the Tables and Space Division Price List for more details.

[See Arlington Intro Section for Ordering Options](#)

| Item | Model No. | | Width | Depth | Height | Ship Wt | Cubic Ft | List Price |
|---|-----------|--------|-----------------|-----------------|--------|---------|----------|------------|
| ROUND GROMMET COVER | 01-GRMTBK | Black | 2 $\frac{3}{8}$ | 2 $\frac{3}{8}$ | - | 1 | 0.1 | \$ 11 |
| | 01-GRMTSL | Silver | | | | | | |
|  <p>OPEN MARKET ONLY (SILVER)</p> <p>Description</p> <ul style="list-style-type: none"> • 2$\frac{3}{8}$" (60mm) Round Grommet Cover • Field Installed | | | | | | | | |

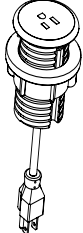
| | | | | | | | | |
|---|-------------|--------|---|---|---|---|-----|-------|
| SINGLE POWER SAND DOLLAR | 01-SAND60PW | White | 3 | 3 | 4 | 1 | 0.2 | \$ 98 |
| | 01-SAND60PB | Black | | | | | | |
| | 01-SAND60PS | Silver | | | | | | |
|  <p>Description</p> <ul style="list-style-type: none"> • Unit is 2" Diameter; Mounts in 60mm Round Grommet • 6' Cord • Single Power Outlet | | | | | | | | |

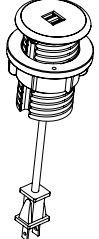
| | | | | | | | | |
|---|-------------|--------|---|---|---|---|-----|--------|
| DOUBLE USB SAND DOLLAR | 01-SAND60UW | White | 3 | 3 | 4 | 1 | 0.2 | \$ 277 |
| | 01-SAND60UB | Black | | | | | | |
| | 01-SAND60US | Silver | | | | | | |
|  <p>Description</p> <ul style="list-style-type: none"> • Unit is 2" Diameter; Mounts in 60mm Round Grommet • 6' Cord • Dual USB Outlets | | | | | | | | |

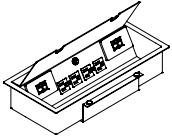
| | | | | | | | | |
|--|-------------|----------|------------------|-----------------|-----------------|----|-----|---------|
| WORKSURFACE POWER CENTER | 01-INTRFC1A | Aluminum | 14 $\frac{1}{4}$ | 6 $\frac{3}{8}$ | 3 $\frac{3}{8}$ | 11 | 0.3 | \$ 2064 |
| | 01-INTRFC1B | Black | | | | | | |
|  <p>Description</p> <ul style="list-style-type: none"> • For Use with Conference Tables • Includes: Four (4) Power Receptacles in Two (2) 15 Amp Duplexes, One (1) 15 Amp Circuit Breaker, One (1) Voice Port and Three (3) Data Ports, 6' Power Cord • One (1) Convenience Plug on Bottom • UL Listed/CSA Certified • Optional Telecom Plates, See Arlington Tables in the Table and Space Division Price List | | | | | | | | |

[See Arlington Intro Section for Ordering Options](#)

| Item | Model No. | | Width | Depth | Height | Ship Wt | Cubic Ft | List Price |
|-------------------------|------------|----------|-------|-------|--------|---------|----------|------------|
| OASIS MINI POWER & DATA | 01-OASISMA | Aluminum | 14¼ | 6⅔ | 2⅞ | 11 | 0.3 | \$ 3191 |
| | 01-OASISMB | Black | | | | | | |



Top View

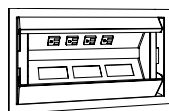

Description

- For Use with Conference Tables
- Plate Includes: Two (2) Data and Four (4) Power Outlets, 9' Power Cord
- Two (2) Telecom Plates Included with the Unit: One (1) 01-ABLAB Plate (Consists of One (1) RJ45 Cat 6, One (1) RJ11 Cat 3 Phone Jack); One (1) 01-ABLB Plate (Consists of One (1) RJ45 Cat 6)
- 9' Cord with Nema Plug; Fits 15A/120V AC Receptacles
- Soft Touch Hinged Lid
- UL Listed
- See Optional Telecom Plates in the Table and Space Division Price List

| | | | | | | | | |
|--------------------------|--------------|--------|----|---|---|---|-----|--------|
| DUO CLAMP WITH NEMA PLUG | 01-DUOCLAMPW | White | 5½ | 3 | 7 | 1 | 0.2 | \$ 572 |
| | 01-DUOCLAMPB | Black | | | | | | |
| | 01-DUOCLAMPS | Silver | | | | | | |

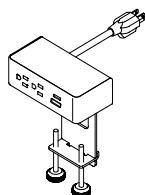

Description

- Standard with: Two (2) Power Outlet, **One (1) USB Charging Port and One (1) 60-Watt USB-C Power Delivery Port with GaN Technology** with 10' Cord
- Clamps to Top and Features Silver Metal Trim
- Independent USB Circuit Controllers Deliver up to 2.1 Amps to Each Post
- All Mounting Hardware Included
- FCC Part 15A and UL Approved for Horizontal and Vertical Applications

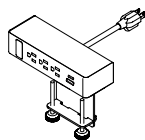

| | | | | | | | | |
|---------------------------|---------------|--------|---|---|---|---|-----|--------|
| TRIO CLAMP WITH NEMA PLUG | 01-TRIOCLAMPW | White | 8 | 3 | 7 | 1 | 0.2 | \$ 671 |
| | 01-TRIOCLAMPB | Black | | | | | | |
| | 01-TRIOCLAMPS | Silver | | | | | | |



Description

- Standard with: Three (3) Power Outlets, **One (1) USB Charging Port, One (1) 60-Watt USB-C Power Delivery Port with GaN Technology**, One (1) Open Data with 10' Cord
- Clamps to Top and Features Silver Metal Trim
- Independent USB Circuit Controllers Deliver up to 2.1 Amps to Each Post
- HDMI, VGA, or RJ45 Accessories Sold Separately
- All Mounting Hardware Included
- FCC Part 15A and UL Approved for Horizontal and Vertical Applications

[See Arlington Intro Section for Ordering Options](#)

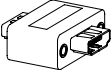
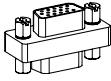
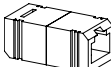
| Item | Model No. | | Width | Depth | Height | Ship Wt | Cubic Ft | List Price |
|--|--------------------|--------|-------|-------|--------|---------|----------|------------|
| DUO BEZEL WITH NEMA PLUG  | 01-DUOBEZELW | White | 6½ | 2¼ | 3¼ | 1 | 0.2 | \$ 675 |
| | 01-DUOBEZELB | Black | | | | | | |
| | 01-DUOBEZELS | Silver | | | | | | |
| | Description | | | | | | | |
| <ul style="list-style-type: none"> • For Use with Conference Tables • Sits on Worksurface and Includes: Two (2) Power Outlet, One (1) USB Charging Port and One (1) 60-Watt USB-C Power Delivery Port with GaN Technology with 10' Cord • All Mounting Hardware • Independent USB Circuit Controllers Deliver up to 2.1 Amps to Each Post • FCC Part 15A, UL Approved for Horizontal and Vertical Applications | | | | | | | | |
| TRIO BEZEL WITH NEMA PLUG  | 01-TRIOBEZELW | White | 9 | 2¼ | 3 | 1 | 0.2 | \$ 725 |
| | 01-TRIOBEZELB | Black | | | | | | |
| | 01-TRIOBEZELS | Silver | | | | | | |
| | Description | | | | | | | |
| <ul style="list-style-type: none"> • For Use with Conference Tables • Sits on Worksurface and Includes: Three (3) Power Outlets, One (1) USB Charging Port, One (1) 60-Watt USB-C Power Delivery Port with GaN Technology, and One (1) Open Data with 10' Cord • All Mounting Hardware • HDMI, VGA, or RJ45 Accessory for Open Data Port Specified Separately, See Below • Independent USB Circuit Controllers Deliver up to 2.1 Amps to Each Post • FCC Part 15A, UL Approved for Horizontal and Vertical Applications | | | | | | | | |
| HDMI DATA PORT ACCESSORY  | 01-LCOMHDMI | | - | - | - | 1 | 0.2 | \$ 166 |
| Description | | | | | | | | |
| <ul style="list-style-type: none"> • HDMI Port for Trio Bezel and Trio Clamp Units | | | | | | | | |
| OPEN MARKET ONLY | | | | | | | | |
| VGA DATA PORT ACCESSORY  | 01-LCOMVGA | | - | - | - | 1 | 0.2 | \$ 121 |
| Description | | | | | | | | |
| <ul style="list-style-type: none"> • VGA Port for Trio Bezel and Trio Clamp Units | | | | | | | | |
| RJ45 DATA PORT ACCESSORY  | 01-LCOMRJ45 | | - | - | - | 1 | 0.2 | \$ 79 |
| Description | | | | | | | | |
| <ul style="list-style-type: none"> • RJ45 Port for Trio Bezel and Trio Clamp Units | | | | | | | | |

[See Arlington Intro Section for Ordering Options](#)

| Item | Model No. | Width | Depth | Height | Ship Wt | Cubic Ft | List Price |
|-------------------------|-----------|-------|-------|--------|---------|----------|------------|
| WIRE MANAGEMENT CHANNEL | 01-WMGR4 | 16 | 1½ | 1 | 1 | - | \$ 116 |

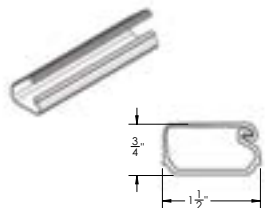

Description

- Set of Four (4) Black Plastic Wire Management Channels
- Snap Lock Channel
- Attaches with Adhesive Strips
- Ships via UPS Only

| | | | | | | | |
|--------------|----------|----|----|---|-----|-----|--------|
| WIRE CHANNEL | 01-32125 | 24 | 1% | 1 | .25 | 0.3 | \$ 106 |
|--------------|----------|----|----|---|-----|-----|--------|

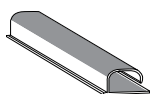

Description

- Available in Black
- Channels Attach with Two (2) Double-Sided Installation Tape
- Easily Attach to an Iconic Leg to Route Wires/Cords from the Top to the Floor
- Open J Channel for Easy Storage of Cables

| | | | | | | | |
|------------|-----------|----|----|---|---|---|-------|
| CABLE GRIP | 01-WMGRCB | 5¾ | 2¾ | - | - | - | \$ 17 |
|------------|-----------|----|----|---|---|---|-------|

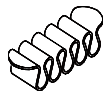

Description

- Under Surface Wire Management
- Black

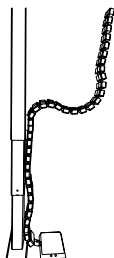

| | | | | | | | | |
|------------------------|----------------|--------|----|----|-------|---|-----|--------|
| LINK 360 CABLE MANAGER | 01-0251LINKSLV | Silver | 5¾ | 3¾ | 30-51 | 4 | 3.0 | \$ 390 |
| | 01-0251LINKBLK | Black | 5¾ | 3¾ | 30-51 | 4 | 3.0 | \$ 353 |



Description

- Kit Includes: 50 Link 360™ elements, One (1) Quad Connector, One (1) Dumbbell Connector, and One (1) Foot Assembly with Two (2) Magnetic Clips
- Can Be Used For Height-Adjustable Mechanisms Up To 51" or Free-Standing Use

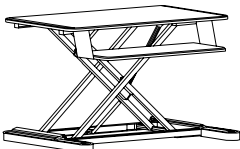
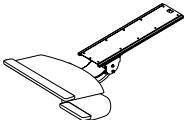
[See Arlington Intro Section for Ordering Options](#)

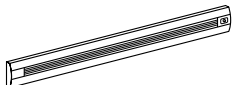
| Item | Model No. | | Width | Depth | Height | Ship Wt | Cubic Ft | List Price |
|---|---|--------------------|-------|-------|--------|---------|----------|------------|
| HEIGHT ADJUSTABLE WORKSTATION | 01-S2SBLK | Black | 35½ | 25 | 6-22 | 49 | 6.5 | \$ 1503 |
|  | Description <ul style="list-style-type: none"> • Height Adjustable • Weight Capacity: 35lbs • One-Handed Operation; Platforms Move Simultaneously • Keyboard Platform: 10½"D x 26½"W • Worksurface: 21"D x 35½"W • Can be Used on Worksurface 24"D x 35"W | | | | | | | |
| KEYBOARD MECHANISM WITH KEYBOARD CLAMP | 01-KB3 | | 26½ | 14 | 4.5 | 16 | 1.4 | \$ 914 |
|  | Description <ul style="list-style-type: none"> • Standard With: 18.75" Platform with Swivel-Below Mouse Platform, +/- 15° Tilt Adjustment, 360° Rotation, 7" Lift and Lock Height Adjustment, Independent Tilt Adjustment, Palm Rest for Mousing Surface • Left or Right Handed Mouse Platform • Cannot Be Used on 20" or 21" Deep Unit • Not Available with Optional Center Grommet • Track Measures 21" Options: Specify & Add | | | | | | | |
| | KB3 | Factory Installed | | | | | | \$ 208 |
| LED TASKLIGHTS | TL-0848 | 240-LED, 18 Watts | 47½ | 7/8 | 1½ | - | - | \$ 445 |
|  | TL-0824 | 84-LED, 7 Watts | 22½ | 7/8 | 1½ | - | - | \$ 368 |
| | Description <ul style="list-style-type: none"> • Includes the Power Supply and Three (3) Upper Wire Management Grommet • Rocker Style On/Off Switch with a 10' Power Cord • Grommet Color will Match Lower Grommet Color | | | | | | | |
| LED TASKLIGHTS | 01-188LED58 | 96-LED, 33.7 Watts | 57¾ | 2 | ¾ | - | - | \$ 1648 |
|  | 01-94LED31 | 48-LED, 17.6 Watts | 30¾ | 2 | ¾ | - | - | \$ 1195 |
| | 01-47LED17 | 24-LED, 9.1 Watts | 16¾ | 2 | ¾ | - | - | \$ 690 |
| | Description <ul style="list-style-type: none"> • Includes the Power Supply and Three (3) Upper Wire Management Grommet • 12' Power Cord • Grommet Color will Match Lower Grommet Color • Optional Occupancy Sensor Shuts Off After 30 Minutes of Inactivity and Turns On Immediately When Reentering the Detection Area Options: Specify & Add | | | | | | | |
| | 01-OSRP | Occupancy Sensor | | | | | | \$ 366 |

[See Arlington Intro Section for Ordering Options](#)

| Item | Model No. | Width | Depth | Height | Ship Wt | Cubic Ft | List Price |
|--|-----------|-------|-------|--------|---------|----------|------------|
| MAGNETIC GLASS MARKER BOARD | GMB-2372W | 72 | ½ | 23 | 56 | 10.2 | \$ 2595 |
| FOR USE WITH 30"H DESKS, CREDENZA AND WALL MOUNT HUTCHES | GMB-2366W | 66 | ½ | 23 | 52 | 9.5 | \$ 2458 |
| | GMB-2360W | 60 | ½ | 23 | 47 | 8.8 | \$ 2182 |
| | GMB-2354W | 54 | ½ | 23 | 42 | 8.0 | \$ 1976 |
| | GMB-2348W | 48 | ½ | 23 | 38 | 7.3 | \$ 1838 |
| | GMB-2342W | 42 | ½ | 23 | 33 | 6.6 | \$ 1563 |
| | GMB-2336W | 36 | ½ | 23 | 28 | 5.8 | \$ 1357 |
| | GMB-2330W | 30 | ½ | 23 | 23 | 5.1 | \$ 1151 |

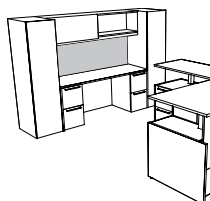
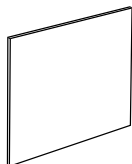

Must Specify (in this order):

Model #
Color

Description

- Available in Black (BLMKR) or White (WHMKR), Must Specify
- Tempered Glass Magnetic Marker Boards Are One (1) Piece with No Seams
- Mounting Brackets Included
- For Use over 30"H Desks and Credenzas with Wall Mount Hutches
- For Magnet, Marker and Eraser Sets Available; [See Set Details](#)



Magnet, Marker and Eraser Sets Available; [See Set Details](#)

| | | | | | | | |
|--|-----------|----|---|-----|----|------|---------|
| MAGNETIC GLASS MARKER BOARD | GMB-4048W | 48 | ½ | 40% | 67 | 11.0 | \$ 3128 |
| FOR USE WITH 30"H DESKS, CREDENZA AND WALL MOUNT HUTCHES | GMB-4042W | 42 | ½ | 40% | 58 | 9.9 | \$ 2644 |
| | GMB-4036W | 36 | ½ | 40% | 50 | 8.8 | \$ 2285 |
| | GMB-4030W | 30 | ½ | 40% | 42 | 7.7 | \$ 1924 |

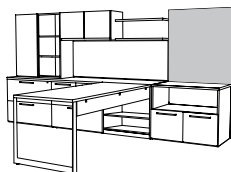

Must Specify (in this order):

Model #
Color

Description

- Available in Black (BLMKR) or White (WHMKR), Must Specify
- Tempered Glass Magnetic Marker Board Includes Mounting Brackets
- For Use over 30"H Desks and Credenzas with Wall Mount Hutches or Shelving
- For Magnet, Marker and Eraser Sets Available; [See Set Details](#)



Magnet, Marker and Eraser Sets Available; [See Set Details](#)

[See Arlington Intro Section for Ordering Options](#)

| Item | Model No. | Width | Depth | Height | Ship Wt | Cubic Ft | List Price |
|-----------------------------------|-----------|-------|-------|--------|---------|----------|------------|
| GLASS MARKER BOARD | GMB-7036W | 36 | ½ | 70% | 87 | 13.8 | \$ 3834 |
| FOR USE FROM FLOOR TO TOP OF UNIT | GMB-7030W | 30 | ½ | 70% | 72 | 12.1 | \$ 3215 |

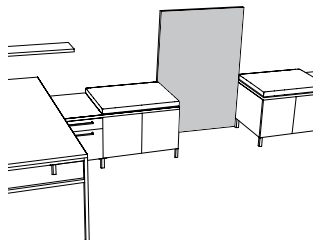

Description

- Available in Black (BLMKR) or White (WHMKR), Must Specify
- Tempered Glass Magnetic Marker Boards Marker Boards Are One (1) Piece with No Seams
- Mounting Brackets Included
- For Use From Floor to Top of Unit
- For Magnet, Marker and Eraser Sets Available; [See Set Details](#)

Must Specify (in this order):

Model #
Color

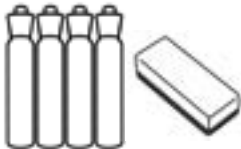

Magnet, Marker and Eraser Sets Available, [See Set Details](#)

| | | | |
|---|--------------|--|--------|
|  | 01-MRKRSETBL | For Use with Black Marker Boards and Black Glass Doors | \$ 123 |
| | 01-MRKRSETWH | For Use with White Marker Boards and White Glass Doors | |

Description

- 01-MRKRSETWH May Also be Used with Standard Dry Erase Doors and Boards
- Includes Four (4) Markers and an Eraser

| | | | |
|---|----------|----------------------------------|--------|
|  | 01-MAGBL | For Use with White Marker Boards | \$ 114 |
| | 01-MAGWH | For Use with Black Marker Boards | |

Description

- Includes Set of Five (5) Magnets

[See Arlington Intro Section for Ordering Options](#)

SURFACE MOUNT TACKBOARDS
23" H

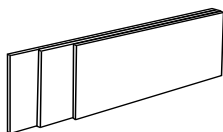

| Model # | Size | COM ydg | COM, 1, 2 or 3 | Grades | | | | | | | |
|----------|------|---------|-------------------|--------|------|------|------|------|------|------|--|
| | | | | 4 | 5 | 6 | 7 | 8 | 9 | 10 | |
| TB-2972H | 72" | 2.25 | \$ 566 | 879 | 1025 | 1174 | 1385 | 1606 | 1862 | 2159 | |
| TB-2966H | 66" | 2.00 | \$ 533 | 811 | 941 | 1073 | 1261 | 1457 | 1685 | 1949 | |
| TB-2960H | 60" | 2.00 | \$ 498 | 776 | 906 | 1038 | 1226 | 1422 | 1650 | 1914 | |

Description

- Coordinates with Surface Mount Hitches
- Factory Installed

WALL MOUNT TACKBOARDS
23" H

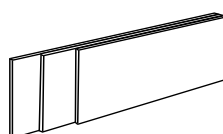

| Model # | Size | COM ydg | COM, 1, 2 or 3 | Grades | | | | | | | |
|----------|------|---------|-------------------|--------|------|------|------|------|------|------|--|
| | | | | 4 | 5 | 6 | 7 | 8 | 9 | 10 | |
| TB-6572W | 72" | 2.25 | \$ 642 | 955 | 1101 | 1250 | 1461 | 1682 | 1938 | 2235 | |
| TB-6566W | 66" | 2.00 | \$ 609 | 887 | 1017 | 1149 | 1337 | 1533 | 1761 | 2025 | |
| TB-6560W | 60" | 2.00 | \$ 566 | 844 | 974 | 1106 | 1294 | 1490 | 1718 | 1982 | |
| TB-6554W | 54" | 1.75 | \$ 539 | 782 | 896 | 1012 | 1176 | 1348 | 1547 | 1778 | |
| TB-6548W | 48" | 1.50 | \$ 492 | 701 | 798 | 897 | 1038 | 1185 | 1356 | 1554 | |
| TB-6542W | 42" | 1.25 | \$ 446 | 620 | 701 | 784 | 901 | 1024 | 1166 | 1331 | |
| TB-6536W | 36" | 1.25 | \$ 434 | 608 | 689 | 772 | 889 | 1012 | 1154 | 1319 | |
| TB-6530W | 30" | 1.00 | \$ 394 | 533 | 598 | 664 | 758 | 856 | 970 | 1102 | |

Description

- Coordinates with Wall Mount Hitches
- Field Installed

| Item | Model No. | Width | Depth | Height | Ship Wt | Cubic Ft | List Price |
|--------------------|-----------|-------|-------|--------|---------|----------|------------|
| VESTA POWER CENTER | 01-PDCTR | 10¾ | 12 | 28¾ | 14 | 2.5 | \$ 1776 |

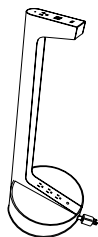

Description

- Top Includes One (1) Power Outlet, Two (2) USB Ports and One (1) USBC Port; Base Includes Three (3) Outlet
- Available in White
- 120" Power Cord
- Built with Weight Distribution for Optimal Stability
- Base is 5" Tall

[See Arlington Intro Section for Ordering Options](#)

Always stylish, comfortable, and effortlessly adaptable, Canvas enlivens environments with refined aesthetics born from an appealing mix of materials, finishes, and components. The redesign and expansion of integrated height adjustable units, white and black glass door options on hutch and storage units as well as a full line of white and black glass marker boards provide opportunities for more elegant and clean styling. Metal accents within the line include a broad scope of aluminum and black finishes with coordinating black, aluminum, chrome, and gold pull give you multiple choices to customize a look and feel for modern office environments.

CONSTRUCTION

Canvas Casegoods feature a TFL chassis with your choice of either a TFL or HPL top. Units ship assembled unless otherwise noted.

LAMINATES

- Exposed surfaces are woodgrain and solid color laminates fused to particle-board core
- Each laminate offers lasting beauty, superior resistance to normal wear, and easy maintenance

TOPS

- Worksurfaces are 1" thick Thermally-Fused Laminate (TFL) or High Pressure Laminate (HPL) with 3mm matching PVC rims on profiled edges and 1mm PVC rims on self edges HPL tops are 1 $\frac{3}{16}$ " thick with a 3mm PVC edge bands and TFL tops are 1" thick with a 3mm PVC edge bands; Designer White, Sugar Maple, Williamsburg Cherry feature ABS edge bands
- Optional 1 $\frac{1}{2}$ " thick HPL worksurfaces are available in select colors. Please contact Customer Service or your local Sales Rep for pricing and lead times.
- Grain direction runs left-to-right unless otherwise noted

CHASSIS

- Chassis is securely fastened using high-quality European fastening systems and heavy-duty, 16-gauge joining brackets to assure maximum strength
- All units ship with heavy-duty, adjustable leveling glides to ensure proper leveling and compensation for uneven floors
- All desks, non-lateral credenzas, and returns have wire management access from pedestal to kneespace

DRAWERS

- Drawers feature 5-sided construction allowing for easy removal of drawer fronts
- Drawer fronts are 3-ply construction, $\frac{3}{4}$ " thick with matched grain
- Drawer sides, back, and front are $\frac{1}{2}$ " thick, woodgrain vinyl wrapped construction with mitered corners
- Box and file drawers feature full extension, progressive action slides with precision steel ball bearings allowing side-to-side and front-to-back
- Optional soft close on box and file drawers allows front-to-back filing in file drawers**
- Optional wood dovetail construction with $\frac{7}{16}$ " thick hardwood sides and backs, and $\frac{5}{32}$ " thick hardboard bottoms
- Box and file drawers have $\frac{1}{8}$ " thick hardboard bottoms and tested for 100lb capacity
- Lateral files feature $\frac{1}{4}$ " thick bottoms. Drawers are tested for 200lb of equally distributed weight (ex: hanging file folders) and 65lbs of bottom load weight (ex: stacked catalogs)
- All suspensions have a limited lifetime warranty

FILING

- All file drawers are standard with filing systems designed to accommodate a variety of filing requirements
- Optional soft close on box and file drawers allows front-to-back filing in file drawer**
- Letter width file drawers provide letter filing front-to-back and legal filing side-to-side
- Lateral file drawers provide legal or letter filing front-to-back or side-to-side

STORAGE

- All hinged doors include soft close hinges, unless noted
- Soft close hinges reduce stress placed on the cabinet when the door is closed and offers a quiet closure

LOCKING

- All units with file drawers feature locking
- Removable lock cylinders allow for units to be re-keyed at a later date, if required
- Units are shipped randomly keyed as standard
- Keyed alike units available upon request at no additional charge
- Lock core is predetermined by pull color. Black lock cores are used with black and gold pulls while silver lock cores are used with chrome and aluminum pulls

CORD MANAGEMENT

- Grommets may be ordered in the tops of all assembled desks, returns, bridges, credenzas, and component worksurfaces
- All desks, returns, and credenzas (except lateral pedestals) have standard wire openings from inside the pedestal to the kneespace allowing quick access to technology below
- Additionally, returns, bridge units, kneespace credenzas, and hutch units have standard grommets in back panels
- Grommets are also standard in the tops of corner units and extended corner units
- Grommets are 2 $\frac{3}{8}$ " and are available in black or silver, must specify color
- [See all grommet options and locations](#)
- Undersurface Wire Manager (Q1-WMGR4) is available for additional cord management; See Accessories

HEIGHT ADJUSTABLE MECHANISMS

- Optional center drawer, Dock 950 and Dock 150, $\frac{3}{4}$ modesty panels, and kneespace options are not available with height adjustable units
- Height adjustment range 30"H-45"H
- 5-year warranty
- [See additional Height Adjust information](#)
- Height Adjustable units begin on [here](#)

STUDIO LEGS

- For each of the Studio models, standard or shared legs will need to be specified
- Choose to use four standard, a combination of standard or shared, or all shared legs on each unit
- The below images will provide a guide to the aesthetics of single, double, and shared legs
- Studio components begin on [here](#)



Single Standard Leg



Shared Leg (used between two models)



Double Standard Leg (standard legs used on each model)

INTERIOR DRAWER DIMENSIONS

Models

| | | |
|---------------|----------------|----------------|
| 66-2515SHDP1 | 68-3672DP | 68-3672BRPSTS |
| 66-2415PD1 | 68-3672DPSTS | 68-3672BDPS |
| 66-1519MP | 68-3672LPS | 68-3672BDPSSTS |
| 66-1519MP1 | 68-3672LPSSTS | 68-3666BDP |
| 68-4872CBLP | 68-3672RPS | 68-3666BDPSTS |
| 68-4872CBRP | 68-3672RPSSTS | 68-3072DP |
| 68-4272CLP | 68-3672DPS | 68-3072DPSTS |
| 68-4272CRP | 68-3672DPSSTS | 68-3066DP |
| 68-3672BDP | 68-3672BLPS | 68-3066DPSTS |
| 68-3672BDPSTS | 68-3672BLPSSTS | 68-3066RP |
| 68-3672LP | 68-3672BRPS | 68-3066RPSTS |
| 68-3672LPSTS | 68-3672BRPSSTS | 68-3060DP |
| 68-3672RP | 68-3672BLP | 68-3060DPSTS |
| 68-3672RPSTS | 68-3672BLPSTS | 68-3060LP |
| 68-3072LP | 68-3066LP | 68-3060LPSTS |
| 68-3072LPSTS | 68-3066LPSTS | 68-3060RP |
| 68-3072RP | 68-3072RPSTS | 68-3060RPSTS |

Drawers

| | | | |
|------|----------------------------------|-----------------------------------|----------------------------------|
| | W | L | D |
| Box | 12 ¹ / ₈ " | 16 ³ / ₁₆ " | 3 ¹ / ₂ " |
| File | 12 ¹ / ₈ " | 16 ³ / ₁₆ " | 9 ⁵ / ₁₆ " |

Models

| | | |
|----------------|---------------|----------------|
| 68-4824RF2 | 68-2466RC2 | 68-2448RF2 |
| 68-4824RF2STS | 68-2466RC2STS | 68-2448RF2STS |
| 68-4824LF2 | 68-2466LC2 | 68-2448RF2STS3 |
| 68-4824LF2STS | 68-2466LC2STS | 68-2448LF2 |
| 68-4224RF2 | 68-2472SC | 68-2448LF2STS |
| 68-4224RF2STS | 68-2472RC2 | 68-2448LF2STS3 |
| 68-4224RF2STS3 | 68-2472RC2STS | 68-2442RF2 |
| 68-4224LF2 | 68-2472LC2 | 68-2442RF2STS |
| 68-4224LF2STS | 68-2472LC2STS | 68-2442RF2STS3 |
| 66-1519MP2 | 68-2472KC | 68-2442LF2 |
| 68-2466KC | 68-2472KCSTS | 68-2442LF2STS |
| 68-2466KCSTS | 66-2415PD2 | 68-2442LF2STS3 |
| 66-2515SHPD2 | | |

Drawer

| | | | |
|------|----------------------------------|-----------------------------------|----------------------------------|
| | W | L | D |
| File | 12 ¹ / ₈ " | 16 ³ / ₁₆ " | 9 ⁵ / ₁₆ " |

Models

| | | |
|----------------|----------------|----------------|
| 68-4824RF1 | 68-2472RC1STS | 68-2448LF1 |
| 68-4824RF1STS | 68-2472LC1 | 68-2448LF1STS |
| 68-4824LF1 | 68-2472LC1STS | 68-2448LF1STS3 |
| 68-4824LF1STS | 68-2466RC1 | 68-2442RF1 |
| 68-4224RF1 | 68-2466RC1STS | 68-2442RF1STS |
| 68-4224RF1STS | 68-2466LC1 | 68-2442RF1STS3 |
| 68-4224RF1STS3 | 68-2466LC1STS | 68-2442LF1 |
| 68-4224LF1 | 68-2448RF1 | 68-2442LF1STS |
| 68-4224LF1STS | 68-2448RF1STS | 68-2442LF1STS3 |
| 68-2472RC1 | 68-2448RF1STS3 | |

Drawers

| | | | |
|------|----------------------------------|-----------------------------------|-----------------------------------|
| | W | L | D |
| Box | 12 ¹ / ₈ " | 16 ³ / ₁₆ " | 3 ¹ / ₂ " |
| File | 12 ¹ / ₈ " | 16 ³ / ₁₆ " | 9 ¹⁵ / ₁₆ " |

Models

| | | |
|--------------|--------------|------------|
| 66-3684WDS2L | 66-3672WDS2R | 66-2430LF3 |
| 66-3684WDS2R | 66-3084SU2 | 66-2430LF1 |
| 66-3672WDS2L | 66-3072SU2 | |

Drawer

| | | | |
|----------|-----------------------------------|-----------------------------------|----------------------------------|
| | W | L | D |
| Lat File | 26 ³ / ₃₂ " | 15 ¹ / ₁₆ " | 9 ⁷ / ₃₂ " |

Models

| | | |
|------------|-----------|------------|
| 66-3684SU2 | 66-2466RL | 66-2436LF3 |
| 66-3672SU2 | 66-2466LL | 66-2436LF1 |

Drawer

| | | | |
|----------|-----------------------------------|-----------------------------------|----------------------------------|
| | W | L | D |
| Lat File | 32 ⁹ / ₃₂ " | 15 ¹ / ₁₆ " | 9 ⁷ / ₃₂ " |

Models

| | | |
|----------------|----------------|--------------|
| 66-2472L21OBFL | 66-2072L21OBFL | 66-2436L21BF |
| 66-2472L21OBFR | 66-2072L21OBFR | 66-2036L21BF |
| 66-2472L21DBF | 66-2072L21DBF | |

Drawers

| | | | |
|------|-----------------------------------|-----------------------------------|----------------------------------|
| | W | L | D |
| Box | 32 ⁹ / ₃₂ " | 13 ⁵ / ₈ " | 3 ¹ / ₂ " |
| File | 32 ⁹ / ₃₂ " | 15 ¹ / ₁₆ " | 9 ⁷ / ₃₂ " |

Models

| | | |
|---------------|---------------|--------------|
| 66-2460L21OBL | 66-2060OBFL | 66-2430L21BF |
| 66-2460L21OBR | 66-2060OBFR | 66-2030L21BF |
| 66-2460L21DBF | 66-2060L21DBF | |

Drawers

| | | | |
|------|-----------------------------------|-----------------------------------|----------------------------------|
| | W | L | D |
| Box | 26 ⁹ / ₃₂ " | 13 ⁵ / ₈ " | 3 ¹ / ₂ " |
| File | 26 ⁹ / ₃₂ " | 15 ¹ / ₁₆ " | 9 ⁷ / ₃₂ " |

Models

| | |
|--------------|--------------|
| 66-2418L21BF | 66-2018L21BF |
|--------------|--------------|

Drawers

| | | | |
|------|-----------------------------------|-----------------------------------|----------------------------------|
| | W | L | D |
| Box | 14 ⁹ / ₃₂ " | 13 ⁵ / ₈ " | 3 ¹ / ₂ " |
| File | 14 ⁹ / ₃₂ " | 15 ¹ / ₁₆ " | 9 ⁷ / ₃₂ " |

Model

| |
|------------|
| 66-2436OMF |
|------------|

Drawers

| | | | |
|--------------|-----------------------------------|-----------------------------------|----------------------------------|
| | W | L | D |
| Box | 14 ⁹ / ₃₂ " | 15 ¹ / ₈ " | 3 ¹ / ₂ " |
| Lateral File | 32 ⁹ / ₃₂ " | 15 ¹ / ₁₆ " | 9 ⁷ / ₃₂ " |

Model

| |
|------------|
| 66-2430OMF |
|------------|

Drawers

| | | | |
|--------------|-----------------------------------|-----------------------------------|----------------------------------|
| | W | L | D |
| Box | 11 ³ / ₄ " | 16 ³ / ₁₆ " | 3 ¹ / ₂ " |
| Lateral File | 26 ⁹ / ₃₂ " | 15 ¹ / ₁₆ " | 9 ⁷ / ₃₂ " |

Model

| |
|-----------|
| 66-2472BF |
|-----------|

Drawer

| | | | |
|-----|----------------------------------|-----------------------------------|---------------------------------|
| | W | L | D |
| Box | 32 ¹ / ₈ " | 16 ³ / ₁₆ " | 3 ¹ / ₂ " |

Models

| | | |
|------------|------------|------------|
| 66-2472RMR | 66-2472LMF | 66-2436MF |
| 66-2472LMR | 66-2466RMF | 66-2436LF2 |
| 66-2472RMF | 66-2466LMF | |

Drawers

| | | | |
|----------|-----------------------------------|-----------------------------------|----------------------------------|
| | W | L | D |
| Box | 14 ⁹ / ₃₂ " | 15 ¹ / ₈ " | 3 ¹ / ₂ " |
| File | 14 ⁹ / ₃₂ " | 15 ¹ / ₈ " | 9 ⁵ / ₁₆ " |
| Lat File | 32 ⁹ / ₃₂ " | 15 ¹ / ₁₆ " | 9 ⁷ / ₃₂ " |

INTERIOR DRAWER DIMENSIONS (CONTINUED)

| Models | | | |
|----------------|-----------------------------------|-----------------------------------|----------------------------------|
| 66-2430LF2 | 66-2430MF | | |
| Drawers | | | |
| | W | L | D |
| Box | 11 ⁵ / ₁₆ " | 16 ³ / ₁₆ " | 3 ¹ / ₂ " |
| File | 12 ¹ / ₁₆ " | 16 ³ / ₁₆ " | 9 ⁵ / ₁₆ " |
| Lat File | 26 ⁵ / ₃₂ " | 15 ¹ / ₁₆ " | 9 ¹ / ₄ " |

| Models | | | |
|---------------|-------------|-------------|--|
| 66-2418PD2 | 66-2451WD2L | 66-1884WFO | |
| 66-3018PD2 | 66-2451WD2R | 66-1872DS2L | |
| 66-3618PD2 | 66-1884DS2L | 66-1872DS2R | |
| 66-2484WD2L | 66-1884DS2R | 66-1872WFL | |
| 66-2484WD2R | 66-1884WFL | 66-1872WFR | |
| 66-2472WD2L | 66-1884WFR | 66-1872WFO | |
| 66-2472WD2R | | | |

| Drawer | W | L | D |
|---------------|-----------------------------------|----------------------------------|----------------------------------|
| File | 14 ⁹ / ₃₂ " | 15 ¹ / ₈ " | 9 ⁵ / ₁₆ " |

| Models | | | |
|---------------|-------------|-------------|--|
| 66-3018PD1 | 66-2451WD1R | 66-1884WBO | |
| 66-2484WD1L | 66-2418PD1 | 66-1872DS1L | |
| 66-2484WD1R | 66-1884DS1L | 66-1872DS1R | |
| 66-2472WD1L | 66-1884DS1R | 66-1872WBL | |
| 66-2472WD1R | 66-1884WBL | 66-1872WBR | |
| 66-2451WD1L | 66-1884WBR | 66-1872WBO | |

| Drawers | W | L | D |
|----------------|-----------------------------------|----------------------------------|----------------------------------|
| Box | 14 ⁹ / ₃₂ " | 15 ¹ / ₈ " | 3 ¹ / ₂ " |
| File | 14 ⁹ / ₃₂ " | 15 ¹ / ₈ " | 9 ⁵ / ₁₆ " |

| Models | | | |
|---------------|--------------|------------|--|
| 66-2415PD2 | 66-2515SHPD2 | 66-1519MP2 | |

| Drawer | W | L | D |
|---------------|----------------------------------|-----------------------------------|-----------------------------------|
| File | 12 ¹ / ₈ " | 16 ³ / ₁₆ " | 9 ¹⁵ / ₁₆ " |

| Models | | | |
|---------------|-----------|-----------|--|
| 66-2430L4 | 66-2430L3 | 66-2430L2 | |

| Drawer | W | L | D |
|---------------|------------------------------------|-----------------------------------|----------------------------------|
| Lat File | 25 ¹⁷ / ₃₂ " | 15 ¹ / ₁₆ " | 9 ⁷ / ₃₂ " |

| Models | | | |
|---------------|-----------|-----------|--|
| 66-2472RL | 66-2472DL | 66-2436L3 | |
| 66-2472LL | 66-2436L4 | 66-2436L2 | |

| Drawer | W | L | D |
|---------------|----------------------------------|-----------------------------------|----------------------------------|
| Lat File | 31 ¹ / ₂ " | 15 ¹ / ₁₆ " | 9 ⁷ / ₃₂ " |

| Model | | | |
|--------------|--|--|--|
| 66-1622CD | | | |

| Drawer | W | L | D |
|---------------|------------------------------------|------------------------------------|---------------------------------|
| Center | 18 ¹⁵ / ₁₆ " | 14 ¹⁵ / ₁₆ " | 1 ³ / ₄ " |

FILING CAPABILITIES

Drawers with Dimensions: 11⁵/₁₆"W x 16³/₁₆"L

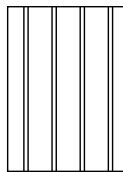

Letter or Legal Side to Side

Drawers with Dimensions: 12¹/₁₆"W x 16³/₁₆"L

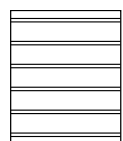

Letter Front to Back

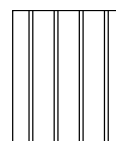

Legal Side to Side

Drawers with Dimensions: 14⁹/₃₂"W x 15¹/₈"L

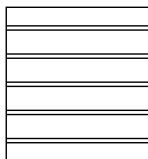

Letter Front to Back

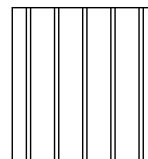

Legal Side to Side

Drawers with Dimensions: 25¹⁷/₃₂"W x 15¹/₁₆"L

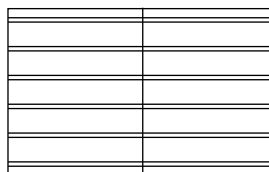

2 Rows Letter Front to Back

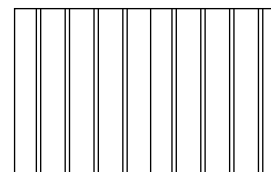

1 Row Letter or Legal Side to Side

Drawers with Dimensions: 26⁵/₃₂"W x 15¹/₁₆"L

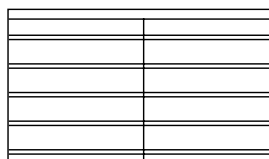

2 Rows Letter Front to Back

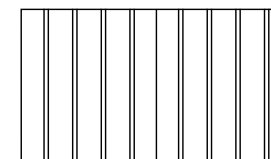

1 Row Legal Side to Side

Drawers with Dimensions: 31¹/₂"W x 15¹/₁₆"L

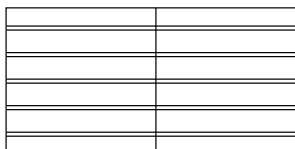

2 Rows Letter or Legal Front to Back

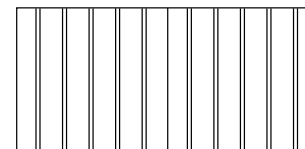

1 Row Letter or Legal Side to Side

Drawers with Dimensions: 32⁵/₃₂"W x 15¹/₁₆"L

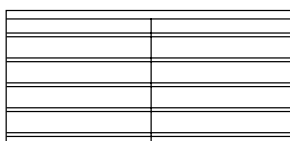

2 Rows Letter Front to Back

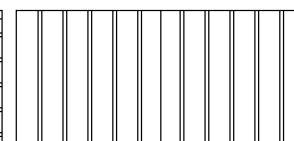

1 Row Legal Side to Side

HOW TO ORDER EXAMPLES

DESK WITH CREDENZA & HUTCH

| | QTY | MODEL NO. | DESCRIPTION | EXAMPLE |
|-----------------|-----|-------------|--------------------------------------|------------|
| DESK | 1 | 68-3672DPS | Top Material | P |
| | | | Top Color | WC |
| | | | Edge Profile | X |
| | | | Chassis Color | WC |
| | | | Drawer Construction | DOV |
| | | | Drawer Track | SFTCL |
| | | | Grain Direction | VERTICAL |
| | | | Drawer Color | WC |
| | | | Modesty Panel | 66-HGAF |
| | | | Modesty Color | GPA |
| | | | Grommet Location/ Wire Management | GL |
| | | | Grommet Color | BLK |
| | | | Power/Data | DOCK950B-R |
| Pull/Color | CFL | | | |
| Keyboard Option | N/A | | | |
| CREDENZA | 1 | 68-2472KC | Top Material | P |
| | | | Top Color | WC |
| | | | Edge Profile | X |
| | | | Chassis Color | WC |
| | | | Drawer Construction | DOV |
| | | | Drawer Track | SFTCL |
| | | | Drawer Color | WC |
| | | | Grain Direction | VERTICAL |
| | | | Pull/Color | CFL |
| | | | Back Panel Grommet | SVR |
| | | | Grommets | LR |
| | | | Power/Data | NONE |
| | | | Grommet Color | SVR |
| Keyboard Option | N/A | | | |
| HUTCH | 1 | 66-1572TWDS | Chassis Color | WC |
| | | | Door Style | HGA |
| | | | Door Color | GPA |
| | | | Locking | NO |
| | | | Paper Slot Color | WC |
| | | | Paper Slot Divider | CHROME |

STUDIO DESK

| | QTY | MODEL NO. | DESCRIPTION | EXAMPLE |
|-----------------|-----|-----------|---------------------|------------------|
| DESK TOP | 1 | 66-3672TP | Top Material | P |
| | | | Top Color | WTA |
| | | | Edge Profile | Y |
| | | | Grommet | GL |
| | | | PDC Type | 01-DUO BEZELW |
| | | | PDC Location | PDC-C |
| | | | Grommet Color | BLK |
| | | | PEDESTAL | 2 |
| | | | Drawer Color | WTA |
| | | | Grain Direction | VERTICAL |
| | | | Pull/Color | CST |
| | | | Drawer Construction | DOV |
| | | | Drawer Track | SFTCL |
| | | | Wire Management | NONE |

STUDIO DESK (CONTINUED)

| | QTY | MODEL NO. | DESCRIPTION | EXAMPLE |
|----------------|-----|--------------|---------------|---------|
| MODESTY | 1 | 66-3624MDHGA | HGA Color | WMA |
| | | | Grommet | GRMT |
| | | | Grommet Color | BLK |
| LEGS | 2 | 01-0404SL4 | Color | CHRM |

HEIGHT ADJUSTABLE

| | QTY | MODEL NO. | DESCRIPTION | EXAMPLE |
|---------------------------|-------|---------------|-----------------|----------|
| DESK | 1 | 68-3672LPSTS | Top Material | P |
| | | | Top Color | SBP |
| | | | Edge Profile | X |
| | | | Chassis Color | WTA |
| | | | Drawer Color | WTA |
| | | | Grain Direction | VERTICAL |
| | | | Pull/Color | CFL |
| | | | Drawer | DOV |
| | | | Construction | |
| | | | Drawer Track | SFTCL |
| | | | Moving Modesty | MOVMOD |
| | | | Height Adjust | MSWCH |
| | | | Switch | |
| | | | Wire Management | GL |
| | | | Grommet Color | BLK |
| | | | BRIDGE | 1 |
| Top Color | SBP | | | |
| Edge Profile | X | | | |
| Chassis Color | WTA | | | |
| Height Adjust | MSWCH | | | |
| Switch | | | | |
| Wire Management | GR | | | |
| Grommet Color | SLV | | | |
| CREDENZA RIGHT | 1 | 68-2472RC2STS | Modesty | GMBSV |
| | | | Grommet/Color | |
| | | | Top Material | P |
| | | | Top Color | SBP |
| | | | Edge Profile | X |
| | | | Chassis Color | WTA |
| | | | Drawer Color | WTA |
| | | | Grain Direction | VERTICAL |
| | | | Pull/Color | CFL |
| | | | Drawer | DOV |
| | | | Construction | |
| | | | Drawer Track | SFTCL |
| | | | Height Adjust | MSWCH |
| | | | Switch | |
| | | | Wire Management | GL |
| | | | Grommet Color | SLV |
| | | | Modesty | GMBSV |
| | | | Grommet/Color | |

TFL (T) AND HPL (P) LAMINATE OPTIONS

WOODGRAIN

| | |
|---------------------------|--------------------------|
| AS Asian Night | PNW Pinnacle Walnut |
| BW Beigewood | PTK Portico Teak |
| CO Columbian Walnut | RC River Cherry |
| EF Espresso | SCH Select Cherry |
| FLW Florence Walnut | SPW Sepia Walnut |
| GC Golden Cherry | SKC Shaker Cherry |
| HVM Harvest Maple | SBP Smoky Brown Pear |
| KHE Kirsche | TK Studio Teak |
| MW Mahogany Walnut | SM Sugar Maple |
| MNR Midnight Run | WTA Weathered Ash |
| NTM Natural Marrone | WNB White Nebbia |
| ORW Oak Riftwood | WC Williamsburg Cherry |

SOLID

| | |
|-------------------|-------------------|
| BL Black | FHG Fashion Grey* |
| WH Designer White | SG Slate Grey* |

* Not available on cylinder bases

1½" THICK WORKSURFACE HPL (P) LAMINATE OPTIONS

Tops 1½" thick are available in the following HPL colors. Top thickness will affect overall height of other units such as surface mounted hutches. Please contact Customer Service or your local Sales Representative for pricing and lead times.

WOODGRAIN

| | |
|---------------------------|--------------------------|
| AS Asian Night | PNW Pinnacle Walnut |
| BW Beigewood | PTK Portico Teak |
| CO Columbian Walnut | RC River Cherry |
| EF Espresso | SCH Select Cherry |
| FLW Florence Walnut | SPW Sepia Walnut |
| GC Golden Cherry | SKC Shaker Cherry |
| HVM Harvest Maple | SBP Smoky Brown Pear |
| KHE Kirsche | TK Studio Teak |
| MW Mahogany Walnut | SM Sugar Maple |
| MNR Midnight Run | WTA Weathered Ash |
| NTM Natural Marrone | WNB White Nebbia |
| ORW Oak Riftwood | WC Williamsburg Cherry |

SOLID

| | |
|-------------------|------------------|
| BL Black | FHG Fashion Grey |
| WH Designer White | SG Slate Grey |

EDGE PROFILES

| | |
|---------------|----------------|
| F Double Kerf | X Flute |
| G Duo | Y Square |



Double Kerf (F) Duo (G) **Flute (X)** Square (Y)

METAL FINISH OPTIONS

| | |
|---------------|-------------|
| ALUM Aluminum | CHRM Chrome |
| BLK Black | |

ACRYLIC OPTIONS

| | |
|--------------------------------------|---------------------------------|
| FSTA Frosted Acrylic | BLA Black High Gloss Acrylic |
| WHA White High Gloss Acrylic | GPA Graphite High Gloss Acrylic |
| WMA Wired Mercury High Gloss Acrylic | |

PULL OPTIONS

Lock core color is predetermined by pull color.

| | |
|----------------------|----------------------|
| AAV Alcove, Aluminum | BEL Elite, Black |
| CAV Alcove, Chrome | AFL Flair, Aluminum |
| AAC Arc, Aluminum | CFL Flair, Chrome |
| BAC Arc, Black | AFC Focus, Aluminum |
| ABM Beam, Aluminum | BFC Focus, Black |
| BBM Beam, Black | AQD Quadra, Aluminum |
| BBT Bow Tie, Black | BQD Quadra, Black |
| NBT Bow Tie, Nickel | AST Studio, Aluminum |
| ABU Buckle, Aluminum | BST Studio, Black |
| BBU Buckle, Black | CST Studio, Chrome |
| AEL Elite, Aluminum | GST Studio, Gold |

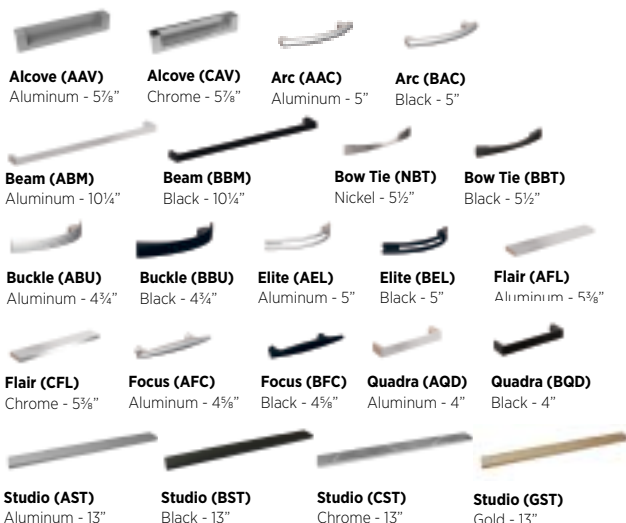

DRAWER CONSTRUCTION OPTIONS

Drawers come standard with woodgrain vinyl-wrapping and mitered corners. Optional wood dovetail construction for all box, file, and lateral file drawers is available. Must Specify when ordering.

Pricing is per Drawer, not per Model/Unit

| | |
|----------------------------------|-------|
| MITER Mitered Fold Construction | STD |
| DOVE Wood Dove Tail Construction | \$ 45 |

DRAWER TRACK OPTIONS

Soft close tracks are available on box and file drawers only. Soft close drawer tracks have many benefits including reduced stress on the unit, extends the life of the drawer, and ensures a gentle close so fingers don't accidentally get hurt. **File drawers with the soft close option feature front-to-back filing.** Must specify when ordering.

Pricing is per Drawer, not per Model/Unit

| | |
|---|-------|
| SFTCL Soft Close Drawer Track (Box & File Drawers Only) | \$ 34 |
|---|-------|

LOCK CORE COLOR OPTIONS

| |
|--|
| BLK Black (Used with Black and Gold Pulls) |
| SLV Silver (Used with Aluminum and Chrome Pulls) |



Grommet options on next page.

GROMMET OPTIONS & POWER UNIT LOCATIONS

Note: Wire Management Options for Integrated and Modular Height Adjustable Models may be found in their specific area within this section.

Grommets are standard in the back panels of returns, bridges, and credenzas, and may be ordered without grommets at no additional charge. Please specify NO GROMMET on order.

Grommets are available on hutches in standard locations for task light management at no additional charge. Please specify WMHUBL (Black) or WMHUSV (Silver).

Power units, Dock 950 and Dock 150 must be specified separately with surface mount location. Dock 950 and Dock 150 are available on Modular Benching Desk Tops, Modular Cabinet Tops, Work Tables, and Media Peninsula Tops, and where otherwise noted.

Grommets are available in standard locations. Please specify using info below. Multiple locations may be selected. Only one unit per location.

GROMMET LOCATIONS (Black = BLK and Silver = SLV)

| | | | |
|-----|--|----|----|
| GC | Grommet, Center | \$ | 52 |
| GL | Grommet, Left | \$ | 52 |
| GR | Grommet, Right | \$ | 52 |
| GAL | Grommet, Approach Left - D-Tops Only | \$ | 52 |
| GAR | Grommet, Approach Right - D-Tops Only | \$ | 52 |
| GSL | Grommet, Seat Side Left - D-Tops Only | \$ | 52 |
| GSR | Grommet, Seat Side Right - D-Tops Only | \$ | 52 |

DUO/TRIO BEZEL LOCATIONS

| | |
|-------|---------------|
| PDC-C | Bezel, Center |
| PDC-L | Bezel, Left |
| PDC-R | Bezel, Right |

DOCK 950 and DOCK 150 LOCATIONS (See Dock Units)

| | | | |
|-----------|---------------------------------------|----|-----|
| DOCK950-L | D950 Wireless Charger, Left | \$ | 265 |
| DOCK950-C | D950 Wireless Charger, Center | \$ | 265 |
| DOCK950-R | D950 Wireless Charger, Right | \$ | 265 |
| DOCK150-L | D150 Wireless and USB Charger, Left | \$ | 405 |
| DOCK150-C | D150 Wireless and USB Charger, Center | \$ | 405 |
| DOCK150-R | D150 Wireless and USB Charger, Right | \$ | 405 |

Verify Grommet Option is available on the model(s) you are specifying using the following location information. Grommets, Power Units, Dock 950 and Dock 150 may be ordered in non-standard locations. Call Customer Service to assist with specification and/or please attach a drawing to the PO showing the location of the grommet. Note additional charges and lead times may apply.

Models

| | | |
|-------------|-------------|------------|
| 68-4872CBLP | 68-3672BLPS | 68-3672BDP |
| 68-4872CBRP | 68-3672BRPS | 68-3666BDP |
| 68-3672BDPS | 68-3672BRP | 68-3672BLP |

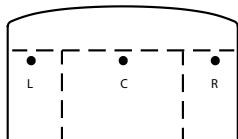

GL/GR: Located 6" from ends and 22½" from user side
GC: Located 22½" from user side

Models

| | | |
|------------|------------|------------|
| 68-4272CLP | 68-3672RPS | 66-3672SH* |
| 68-4272CRP | 68-3672LP | 66-3666SH* |
| 68-3672DPS | 68-3672RP | 66-3660SH* |
| 68-3672LPS | 68-3672DP | |

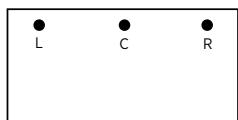

GL/GR: Located 6" from ends and 22½" from user side
GC: Located 22½" from user side

*PDC-L/PDC-R/DOCK950-L/DOCK950-R/DOCK150-L/DOCK150-R/PDC-C/DOCK950-C/DOCK150-C available only on Shell (SH) units in same locations

Models

| | | |
|-----------|-----------|------------|
| 68-3072DP | 68-3060RP | 66-3072SH* |
| 68-3066DP | 68-3066LP | 66-3066SH* |
| 68-3060DP | 68-3066RP | 66-3060SH* |
| 68-3060LP | 68-3072RP | 68-3072LP |

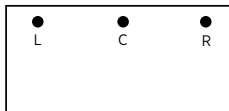

GL/GR: Located 6" from ends and 22½" from user side

GC: Located 22½" from user side

*PDC-L/PDC-R/DOCK950-L/DOCK950-R/DOCK150-L/DOCK150-R/PDC-C/DOCK950-C/DOCK150-C available only on Shell (SH) units in same locations

Models

| | | |
|------------|-------------|------------|
| 68-2448LF1 | 66-2448UF | 68-4824LF1 |
| 68-2448RF1 | 66-2448UFH | 68-4824RF1 |
| 68-2448LF2 | 66-2442UF | 68-4824LF2 |
| 68-2448RF2 | 66-2442UFH | 68-4824RF2 |
| 68-2442LF1 | 66-2448RSHL | 68-4224LF1 |
| 68-2442RF1 | 66-2448RSHR | 68-4224RF1 |
| 68-2442LF2 | 66-2442RSHL | 68-4224LF2 |
| 68-2442RF2 | 66-2442RSHR | 68-4224RF2 |
| 66-2436UF | 66-2436UFH | |

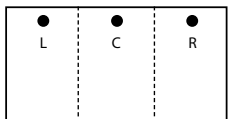

GL/GR: Located 6" from ends and 20" from user side

GC: Located 20" from user side

Models

| | | |
|------------|-----------|------------|
| 66-2472LMR | 66-2472LL | 66-2472RMF |
| 66-2472RMR | 66-2472RL | 66-2472LMF |
| 66-2466LL | 66-2466RL | 66-2466LMF |
| 66-2466RMF | | |

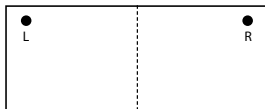

GL/GR: Located 6" from ends and 20" from user side

Grommets are only available on opposite side of pedestal

Models

| | | |
|------------|------------|------------|
| 68-2472KC | 68-2472RC2 | 68-2466RC1 |
| 68-2472LC1 | 68-2466KC | 68-2466LC2 |
| 68-2472RC1 | 68-2466LC1 | 68-2466RC2 |
| 68-2472LC2 | | |

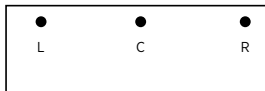

GL/GR: Located 6" from ends and 20" from user side

GC: Located 20" from user side

Models

| | | |
|-----------|-----------|-----------|
| 66-2472SH | 66-2466SH | 66-2460SH |
|-----------|-----------|-----------|

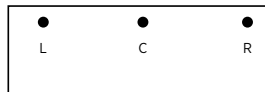

GL/GR/DOCK950-L/DOCK950-R/DOCK150-L/DOCK150-R: Located 6" from ends and 20" from user side

GC/DOCK950-C/DOCK150-C: Located 20" from user side

PDC-L/PDC-R: Located 6" from ends and 21" from user side

PDC-C: Located 21" from user side

GROMMET OPTIONS & POWER UNIT LOCATIONS (CONTINUED)

Models

66-2048UF 66-2042UF 66-2036UF
66-2048UFH 66-2042UFH 66-2036UFH

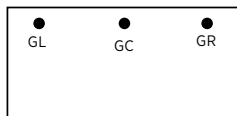

GL/GR: Located 6" from ends and 16" from user side
GC: Located 16" from user side

Models

66-2472L21DBF 66-2472L21OBFR 66-2472L21DO
66-2460L21DBF 66-2460L21OBFL 66-2460L21DO
66-2472L21OBFL 66-2460L21OBFR

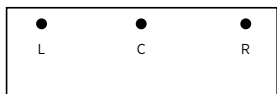

PDC-L/PDC-R: Located 11" from ends and 21½" from user side
PDC-C: Located 21½" from user side
GL/GR/DOCK950-L/DOCK950-R/DOCK150-L/DOCK150-R: Located 6" from ends and 20" from user side
GC/DOCK950-C/DOCK150-C: Located 20" from user side

Models

66-2072L21DBF 66-2072L21OBFR 66-2060L21OBFR
66-2060L21DBF 66-2060L21OBFL 66-2072L21DO
66-2072L21OBFL 66-2060L21DO

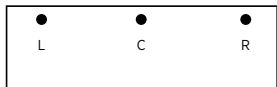

PDC-L/PDC-R: Located 11" from ends and 17½" from user side
PDC-C: Located 17½" from user side
GL/GR/DOCK950-L/DOCK950-R/DOCK150-L/DOCK150-R: Located 6" from ends and 16" from user side
GC/DOCK950-C/DOCK150-C: Located 16" from user side

Models

66-4284PR 66-4272PR
66-4284TR 66-4272TR

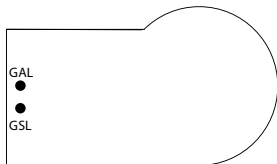

GAL/GSL: Located 12" from approach or seated side and 6" from end

Models

66-4284PL 66-4272PL
66-4284TL 66-4272TL

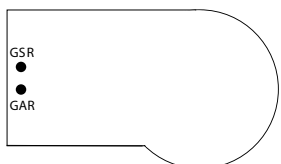

GAR/GSR: Located 12" from approach or seated side and 6" from end

Models

66-4272EDR



GAL: Located 12" from approach, 6" from end
GSL: Located 18" from approach, 6" from end

Model

66-4272EDL

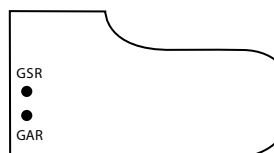

GAR: Located 12" from approach, 6" from end
GSR: Located 18" from approach, 6" from end

Models

66-3684DUR 66-3084DUR 66-3066DUR
66-3672DUR 66-3072DUR



GAL/GSL: Located 12" from approach or seated side and 6" from end

Models

66-3684DUL 66-3672DR 66-3066DUL
66-3672DUL 66-3084DUL 66-3066DR
66-3684DR 66-3072DUL



GAR/GSR: Located 12" from approach or seated side and 6" from end

MODULAR DESK TOPS

Models

66-3684TP 66-3648TP 66-3066TP
66-3678TP 66-3642TP 66-3060TP
66-3672TP 66-3084TP 66-3054TP
66-3666TP 66-3078TP 66-3048TP
66-3660TP 66-3072TP 66-3042TP
66-3654TP

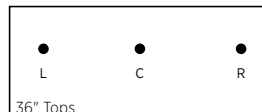
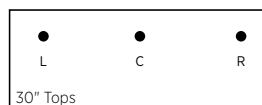
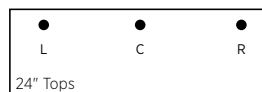

GL/GR/PDC-L/PDC-R/DOCK950-L/DOCK950-R/DOCK150-L/DOCK150-R: Located 11" from ends and 22½" from user side
GC/DOCK950-C/DOCK150-C: Located 22½" from user side

Additional grommet options on next page.

GROMMET OPTIONS & POWER UNIT LOCATIONS (CONTINUED)

MODULAR CABINET TOPS

Models

| | | |
|-----------|-----------|-----------|
| 66-2496TP | 66-2472TP | 66-2448TP |
| 66-2490TP | 66-2466TP | 66-2442TP |
| 66-2484TP | 66-2460TP | 66-2436TP |
| 66-2478TP | 66-2454TP | 66-2430TP |

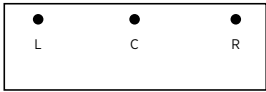

PDC-L/PDC-R: Located 11" from ends and 21½" from user side

PDC-C: Located 21½" from user side

GL/GR/DOCK950-L/DOCK950-R/DOCK150-L/DOCK150-R: Located 11" from ends and 20" from user side

GC/DOCK950-C/DOCK150-C: Located 20" from user side

Models

| | | |
|-----------|-----------|-----------|
| 66-2096TP | 66-2072TP | 66-2048TP |
| 66-2090TP | 66-2066TP | 66-2042TP |
| 66-2084TP | 66-2060TP | 66-2036TP |
| 66-2078TP | 66-2054TP | 66-2030TP |

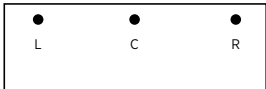

PDC-L/PDC-R: Located 11" from ends and 17½" from user side

PDC-C: Located 17½" from user side

GL/GR/DOCK950-L/DOCK950-R/DOCK150-L/DOCK150-R: Located 11" from ends and 16" from user side

GC/DOCK950-C/DOCK150-C: Located 16" from user side

Model

66-2418TP

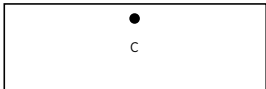

PDC-C: Located 21½" from user side

GC/DOCK950-C/DOCK150-C: Located 20" from user side

Model

66-2018TP

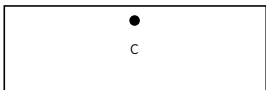

PDC-C: Located 17½" from user side

GC/DOCK950-C/DOCK150-C: Located 16" from user side

WORK TABLES

Models

| | | |
|------------|------------|------------|
| 66-4896WT | 66-4860CWT | 66-4260TWT |
| 66-4896TWT | 66-4296WT | 66-4260CWT |
| 66-4896CWT | 66-4296TWT | 66-3696TWT |
| 66-4884WT | 66-4296CWT | 66-3696CWT |
| 66-4884TWT | 66-4284WT | 66-3684TWT |
| 66-4884CWT | 66-4284TWT | 66-3684CWT |
| 66-4872WT | 66-4284CWT | 66-3672TWT |
| 66-4872TWT | 66-4272WT | 66-3672CWT |
| 66-4872CWT | 66-4272TWT | 66-3660TWT |
| 66-4860WT | 66-4272CWT | 66-3660CWT |
| 66-4860TWT | 66-4260WT | |

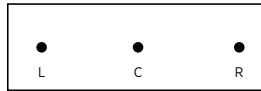

42" Work Tables

GL/GR/PDC-L/PDC-R/DOCK950-L/DOCK950-R/DOCK150-L/DOCK150-R: Located 6" from ends and 21" from user side

GC/PDC-C/DOCK950-C/DOCK150-C: Located 21" from user side

48" Work Tables

GL/GR/PDC-L/PDC-R/DOCK950-L/DOCK950-R/DOCK150-L/DOCK150-R: Located 6" from ends and 24" from user side

GC/PDC-C/DOCK950-C/DOCK150-C: Located 24" from user side

36" Work Tables

GL/GR/PDC-L/PDC-R/DOCK950-L/DOCK950-R/DOCK150-L/DOCK150-R: Located 6" from ends and 18" from user side

GC/PDC-C/DOCK950-C/DOCK150-C: Located 18" from user side

Models

| | | |
|------------|------------|------------|
| 66-2496WT | 66-2484TWT | 66-2472CWT |
| 66-2496TWT | 66-2484CWT | 66-2460WT |
| 66-2496CWT | 66-2472WT | 66-2460TWT |
| 66-2484WT | 66-2472TWT | 66-2460CWT |

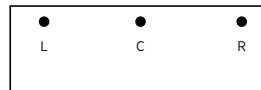

GL/GR/PDC-L/PDC-R/DOCK950-L/DOCK950-R/DOCK150-L/DOCK150-R: Located 6" from ends and 21½" from user side

GC/PDC-C/DOCK950-C/DOCK150-C: Located 21½" from user side

MODULAR BENCHING DESK TOPS

Models

| | | |
|-----------|-----------|-----------|
| 66-6072TP | 66-6066TP | 66-6060TP |
|-----------|-----------|-----------|

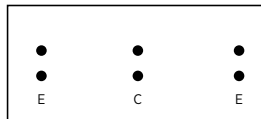

E = 11" from end
C = 25¼" from user

Only one style of unit per location.

Locations:

- 1C: 2 Center Cutouts
- 1E: 2 End Cutouts
- 2E: 4 End Cutouts
- C1E: 2 Center and 2 End Cutouts
- C2E: 2 Center and 4 End Cutouts

Models

| | | |
|-----------|-----------|-----------|
| 66-4872TP | 66-4866TP | 66-4860TP |
|-----------|-----------|-----------|

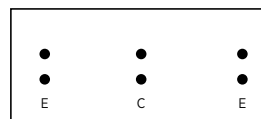

E = 11" from end
C = 19¾" from user

Only one style of unit per location.

Locations:

- 1C: 2 Center Cutouts
- 1E: 2 End Cutouts
- 2E: 4 End Cutouts
- C1E: 2 Center and 2 End Cutouts
- C2E: 2 Center and 4 End Cutouts

GROMMET OPTIONS & POWER UNIT LOCATIONS (CONTINUED)

Models

66-3672MPS
66-3672MP

66-3066MPS
66-3066MP

66-3060MPS
66-3060MP

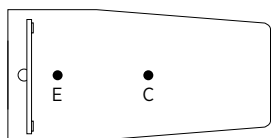

E = 12" from monitor end
C = Centered

DUO/TRIO BEZEL, Dock 950 and Dock 150. Only one style of unit per location.

Locations:

- C: Center Cutout
- E: End Cutout
- EC: End and Center Cutouts

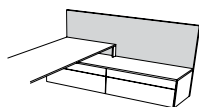

51" Gallery Screens Grommet Options

- DGL: Desk Height Left; 6" from ends and 25¼" from bottom
- DGR: Desk Height Right; 6" from ends and 25¼" from bottom
- DGC: Desk Height Center; 25¼" from bottom
- BGL: Bench Height Left; 6" from ends and 15" from bottom
- BGR: Bench Height Right; 6" from ends and 15" from bottom
- BGC: Bench Height Center; 15" from bottom

HEIGHT ADJUSTABLE MECHANISMS

Height Adjust method that increases user kneespace, offers more stability for overall unit and top construction, and two worksurfaces can move from sitting to standing simultaneously with or without moving modesty panel.

- Maximum height is 45"
- Recommended load capacity of 180lbs
- Gently adjust worksurface with a 1 second stop at each memory position
- Two leg configuration options include the standard 2-channel for Desks, Desk Shells, D-top and P-Top units for one height adjustable worksurface or 3-channel option for two height adjustable worksurfaces to raise simultaneously
- Two height adjustable switches available. Standard up/down switch (SWCH) and advanced switch features Bluetooth capabilities, three stand-up reminder intervals and four height memory positions (MSWCH)
- Moving Modesty (MOVMOD) option creates a clean aesthetic when seated or standing
- Height adjust control switch is factory installed on all units except Desk and Credenza Shells or 3-Channel units
- Bridges, returns, and credenzas will have an optional grommet on the back panel
- Black wire management mesh wrap included when worksurface grommet is selected
- Black wire management mesh wrap is made of polyester braided fabric, 10' long, expands up to 1¼"
- Grommets and one Latch Duct wire management channel provided within kneespace to manage wires from switch and control box. Two Latch Duct wire management channels will be shipped with Desk Shells

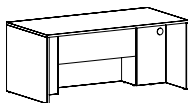

Height Adjustable User Side

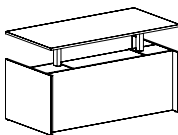

2-channel Configuration

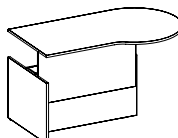

Moving Modesty



Black wire management mesh sleeve

HEIGHT ADJUST LEG CONFIGURATION

The 2-channel leg configuration is standard on height adjustable Desks, Desk Shells, D-top and P-Top units for one height adjustable worksurface. Select models offer an optional 3-channel leg configuration for use with 3-channel Returns to allow two worksurfaces to raise and lower simultaneously.

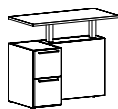

2-channel Configuration
Raise Single Surface

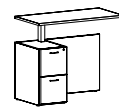

3-channel Configuration
Raise Multiple Surface

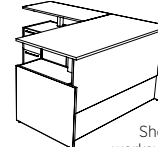

Shown with two worksurfaces raised and optional moving modesty.

| | | |
|------|---|--------|
| STS2 | 2-channel configuration (For one height adjustable worksurface) | STD |
| STS3 | 3-channel configuration (For two height adjustable worksurfaces) | \$ N/C |

HEIGHT ADJUST MOVING MODESTY PANEL

Height adjustable moving modesty panel available on double and single pedestal, D-top and P-Top desks. Moving modesty panels offer a clean aesthetic when seated or standing while giving more privacy to the user.

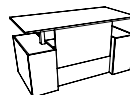

Stepped Front Desk with Moving Modesty

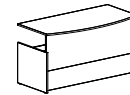

Recessed Front Desk with Moving Modesty

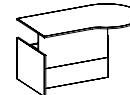

P-Top with Moving Modesty

| | | |
|--------|----------------------|--------|
| MOVMOD | Moving Modesty Panel | \$ 219 |
|--------|----------------------|--------|

HEIGHT ADJUST MODESTY/PEDESTAL PANEL GROMMET

Height adjustable credenza, bridge and return units feature a modesty panel grommet option for accessing power to a wall.

2-Channel units feature grommet centered on modesty only, 3" down from top. 3-Channel units feature grommets centered on pedestal only, 3" down from top.

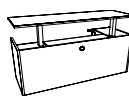

Credenza with Modesty Grommet

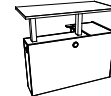

2-Channel Return with Modesty Grommet

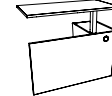

3-Channel Return with Pedestal Grommet

| | | |
|-------|------------------------|--------|
| GMBL | Black Modesty Grommet | \$ N/C |
| GMBSV | Silver Modesty Grommet | \$ N/C |

HEIGHT ADJUST SWITCH CONTROL OPTIONS

Height adjust units offer two switch options. The standard switch is a simple up and down paddle style switch to move your worksurface from seated to standing height. The advanced switch features Bluetooth capabilities to connect to smart devices, three stand-up reminder intervals and four height adjustment memory positions.

| | | |
|-------|------------------------------|--------|
| SWCH | Standard Up/Down Switch | STD |
| MSWCH | Advanced Up/Down with Memory | \$ 135 |



SWCH (standard)



MSWCH

Height adjustable grommet options on next page.

HEIGHT ADJUST GROMMET OPTIONS & POWER UNIT LOCATIONS

Ports, Locations and Wire Management:

- One data or wire management location per unit
- Order the port and then specify the location

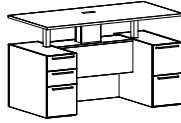

Shown with Wire Management Box with Grommet

Wire Management Box with Grommet **Add \$ 417**

Specify Location and Grommet Color (Black = BLK or Silver = SLV)

| Specify | Units | Locations |
|---------|-------------------------|-----------|
| GC-BOX | Desks/Credenzas/Bridges | Center |
| GC-BOX | Return (2-Channel Only) | Center |

Grommet with Mesh Sleeve **Add \$ 142**

Specify Location and Grommet Color (Black = BLK or Silver = SLV)

| Specify | Units | Locations |
|-----------|-------------------------|-----------------------|
| GL-MESH | Desks/Credenzas/Return | Left |
| GR-MESH | Desks/Credenzas/Return | Right |
| GC-MESH | Desks/Credenzas/Bridges | Center |
| GCKS-MESH | Return/Return Shell | Centered Between Legs |

Wire Management Box with DUOBEZEL **Add \$ 1128**

| Units | Locations |
|-------------------------|-----------------------|
| Desks/Credenzas/Bridges | Center |
| Return | Centered Between Legs |

Specify

| | |
|--------------|-----------------|
| 01-DUOBEZELB | DUOBEZEL Black |
| 01-DUOBEZELS | DUOBEZEL Silver |
| 01-DUOBEZELW | DUOBEZEL White |

Wire Management Box with TRIOBEZEL **Add \$ 1173**

| Units | Locations |
|-------------------------|-----------------------|
| Desks/Credenzas/Bridges | Center |
| Return | Centered Between Legs |

Specify Color

| | |
|---------------|------------------|
| 01-TRIOBEZELB | TRIOBEZEL Black |
| 01-TRIOBEZELS | TRIOBEZEL Silver |
| 01-TRIOBEZELW | TRIOBEZEL White |

Port Options for TRIOBEZEL - Must Specify

| Port Options for TRIOBEZEL - Must Specify | | Add |
|---|-----------------------------------|--------|
| 01-LCOMVGA | VGA Date Port | \$ 121 |
| 01-LCOMHDMI | HDMI Data Port (Open Market Only) | \$ 166 |
| 01-LCOMRJ45 | RJ45 Data Port | \$ 79 |

Wire Management Box with DPORT4 **Add \$ 1499**

| Units | Locations |
|-------------------------|-----------------------|
| Desks/Credenzas/Bridges | Center |
| Return | Centered Between Legs |

Specify Color

| | |
|------------|----------------|
| 01-DPORT4A | DPORT Aluminum |
| 01-DPORT4B | DPORT Black |

Port Options for DPORT - Must Specify

| Port Options for DPORT - Must Specify | | Add |
|---------------------------------------|---------------|--------|
| 01-USBPORT | USB Port | \$ 161 |
| 01-VOICE1 | Voice Coupler | \$ 73 |
| 01-RJ4DATA | Data Port | \$ 167 |

Models

| | | |
|----------------|----------------|----------------|
| 66-2048UFSTS | 66-2042UFSTS | 66-2036UFSTS |
| 66-2048UFSTSL3 | 66-2048UFSTSR3 | 66-2042UFSTSL3 |
| 66-2042UFSTSR3 | 66-2036UFSTSL3 | 66-2036UFSTSR3 |

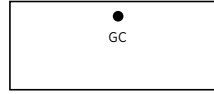

Center: Located 16" from user side

Models

| | | |
|----------------|----------------|----------------|
| 66-2448UFSTS | 66-2442UFSTS | 66-2436UFSTS |
| 66-2448UFSTSL3 | 66-2448UFSTSR3 | 66-2442UFSTSL3 |
| 66-2442UFSTSR3 | 66-2436UFSTSL3 | 66-2436UFSTSR3 |

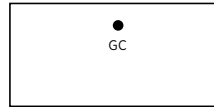

Center: Located 20" from user side

Models

| | | |
|--------------|---------------|--------------|
| 66-2472SHSTS | 68-3072LPSTS | 68-3072DPSTS |
| 66-2466SHSTS | 68-2472RC2STS | 68-3066RPSTS |
| 66-2460SHSTS | 68-2472LC2STS | 68-3066LPSTS |
| 66-3072SHSTS | 68-2466RC2STS | 68-3066DPSTS |
| 66-3066SHSTS | 68-2466LC2STS | 68-3060RPSTS |
| 68-2466KCSTS | 68-2472RC1STS | 68-3060LPSTS |
| 68-2472KCSTS | 68-2472LC1STS | 68-3060DPSTS |
| 66-3060SHSTS | 68-2466RC1STS | |
| 68-3072RPSTS | 68-2466LC1STS | |

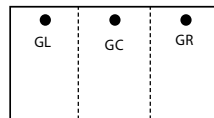

L/R: Located 6" from ends and 20" from user side

Center: Located 20" from user side

Models

| | | |
|---------------|-----------------|---------------|
| 68-4824RF2STS | 66-2448RSHRSTS* | 68-2448RF1STS |
| 68-4824LF2STS | 66-2448RSHLSTS* | 68-2448LF1STS |
| 68-4224RF2STS | 66-2442RSHRSTS* | 68-2442RF1STS |
| 68-4224LF2STS | 66-2442RSHLSTS* | 68-2442LF1STS |
| 68-2448RF2STS | 68-4824RF1STS | 68-4224LF1STS |
| 68-2448LF2STS | 68-4824LF1STS | 68-4224RF1STS |
| 68-2442RF2STS | 68-2442LF2STS | |

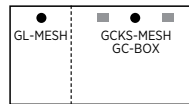

GL/GR-MESH: Located 6" from ends and 20" from user side

GCKS-MESH/GC-BOX: Centered between legs and 20" from user side

* = Only Available with Centered Grommet (GCKS-MESH)

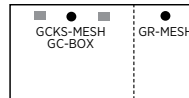

Models (Grommet only available in ped space)

| | | |
|----------------|----------------|----------------|
| 68-2448RF2STS3 | 68-2442LF2STS3 | 68-2442RF1STS3 |
| 68-2448LF2STS3 | 68-2448LF1STS3 | 68-2442LF1STS3 |
| 68-2442RF2STS3 | 68-2448RF1STS3 | |

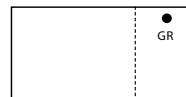
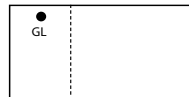

Grommet only available in ped space 6" from end

L/R: Located 6" from ends and 20" from user side

HEIGHT ADJUST GROMMET OPTIONS & POWER UNIT LOCATIONS (CONTINUED)

Models

| | | |
|---------------|---------------|-----------------|
| 68-3672BDPSTS | 68-3672BLPSTS | 68-3672BRPSSTS |
| 68-3666BDPSTS | 68-3672BRPSTS | 68-3672BLPSSTS |
| | | 68-3672BDPSSSTS |

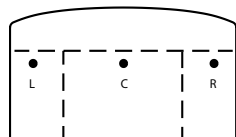

L/R: Located 6" from ends and 20" from user side
Center: Located 20" from user side

Models

| | | |
|---------------|---------------|--------------|
| 68-3672DPSTS | 68-3672RPSTS | 66-3672SHSTS |
| 68-3672DPSSTS | 68-3672RPSSTS | 66-3666SHSTS |
| 68-3672LPSTS | 68-3672LPSSTS | 66-3660SHSTS |

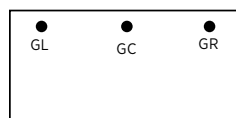

Left/Right: Located 6" from ends and 24" from user side
Center: Located 24" from user side

Models

| | | |
|---------------|---------------|--------------|
| 66-3684DURSTS | 66-3072DURSTS | 66-4284PLSTS |
| 66-3684DULSTS | 66-3072DULSTS | 66-4284PRSTS |
| 66-3672DURSTS | 66-3066DURSTS | 66-4272PLSTS |
| 66-3672DULSTS | 66-3066DULSTS | 66-4272PRSTS |
| 66-3084DURSTS | 66-3084DULSTS | |



Center: Located 18 7/8" from seated side and centered between legs

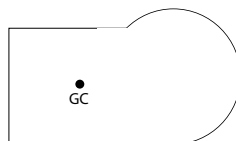

Left Unit / Center: Located 18 7/8" from seated side and centered between legs

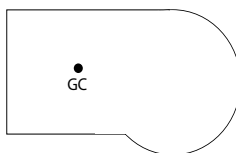

Right Unit / Center: Located 18 7/8" from seated side and centered between legs

MODULAR HEIGHT ADJUSTABLE GROMMET OPTIONS & POWER UNIT LOCATIONS

Grommets are standard in tops of cabinets and credenzas in Black (BLK) or Silver (SLV).

Grommets are available in locations shown below. Please specify and add upcharge for each grommet. Multiple locations may be selected. Only one unit per location.

GROMMET LOCATIONS (Black = BLK and Silver = SLV)

| | | | |
|----|--------------------------------------|----|----|
| GC | Grommet, Center - Specify BLK or SLV | \$ | 52 |
| GL | Grommet, Left - Specify BLK or SLV | \$ | 52 |
| GR | Grommet, Right - Specify BLK or SLV | \$ | 52 |

DUO/TRIO BEZEL LOCATIONS

| | |
|-------|---------------|
| PDC-C | Bezel, Center |
| PDC-L | Bezel, Left |
| PDC-R | Bezel, Right |

DOCK 950 and DOCK 150 LOCATIONS (See Dock Units)

| | | | |
|-----------|---------------------------------------|----|-----|
| DOCK950-L | D950 Wireless Charger, Left | \$ | 265 |
| DOCK950-C | D950 Wireless Charger, Center | \$ | 265 |
| DOCK950-R | D950 Wireless Charger, Right | \$ | 265 |
| DOCK150-L | D150 Wireless and USB Charger, Left | \$ | 405 |
| DOCK150-C | D150 Wireless and USB Charger, Center | \$ | 405 |
| DOCK150-R | D150 Wireless and USB Charger, Right | \$ | 405 |

Verify Grommet Option is available on the model(s) you are specifying using the following location information. Grommets, Power Units, Dock 950 and Dock 150 may be ordered in non-standard locations. Call Customer Service to assist with specification and/or please attach a drawing to the PO showing the location of the grommet. Note additional charges and lead times may apply.

Models

| | | |
|------------|------------|------------|
| 66-3470HTP | 66-3462HTP | 66-3456HTP |
| 66-3464HTP | 66-3458HTP | 66-2850HTP |
| 66-2870HTP | 66-2858HTP | 66-2846HTP |
| 66-2864HTP | 66-2856HTP | |
| 66-2862HTP | 66-2852HTP | |

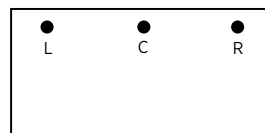

GL/GR/PDC-L/PDC-R/DOCK950-L/DOCK950-R/DOCK150-L/DOCK150-R: 18" from ends and 22 1/2" from user

GC/PDC-C/DOCK950-C/DOCK150-C: 22 1/2" from user

Models

| | | |
|------------|------------|------------|
| 66-2270HTP | 66-2258HTP | 66-2250HTP |
| 66-2264HTP | 66-2256HTP | 66-2246HTP |
| 66-2262HTP | 66-2252HTP | |

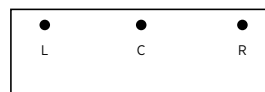

GL/GR/PDC-L/PDC-R/DOCK950-L/DOCK950-R/DOCK150-L/DOCK150-R: 18" from ends and user

GC/PDC-C/DOCK950-C/DOCK150-C: 18" from user

Models

| | | |
|-------------|-------------|-------------|
| 66-2472HDFL | 66-2472HMFR | 66-2466HMOL |
| 66-2472HDFR | 66-2472HMOL | 66-2466HMOR |
| 66-2472HMFL | 66-2472HMOR | 66-2466HMFL |
| 66-2472HDOL | 66-2466HDFL | 66-2466HMFR |
| 66-2472HDOR | 66-2466HDFR | 66-2460HDFR |
| 66-2460HDOL | 66-2466HDOL | 66-2460HDFL |
| 66-2460HDOR | 66-2466HDOR | 66-2460HMFR |
| 66-2460HMOL | 66-2460HMOR | 66-2460HMFL |

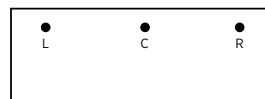

PDC-L/PDC-R: Located 11" from ends and 21 1/2" from user side

PDC-C: Located 21 1/2" from user side

GL/GR/DOCK950-L/DOCK950-R/DOCK150-L/DOCK150-R: Located 6" from ends and 20" from user side

GC/DOCK950-C/DOCK150-C: Located 20" from user side

GROMMET OPTIONS & POWER UNIT LOCATIONS

Models

| | | |
|-------------|-------------|-------------|
| 66-2072HDFL | 66-2072HMFR | 66-2066HMOL |
| 66-2072HDFR | 66-2072HMOL | 66-2066HMOR |
| 66-2072HMFL | 66-2072HMOR | 66-2066HMFL |
| 66-2072HDOL | 66-2066HDFL | 66-2066HMFR |
| 66-2072HDOR | 66-2066HDFR | 66-2060HDFR |
| 66-2060HDOL | 66-2066HDOL | 66-2060HDFL |
| 66-2060HDOR | 66-2066HDOR | 66-2060HMFR |
| 66-2060HMOL | 66-2060HMOR | 66-2060HMFL |

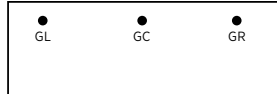

PDC-L/PDC-R: Located 11" from ends and 17½" from user side

PDC-C: Located 17½" from user side

GL/GR/DOCK950-L/DOCK950-R/DOCK150-L/DOCK150-R: Located 6" from ends and 16" from user side

GC/DOCK950-C/DOCK150-C: Located 16" from user side

Models

| | | |
|-----------|------------|------------|
| 66-2436HM | 66-2436HDL | 66-2430HDL |
| 66-2430HM | 66-2436HDR | 66-2430HDR |
| 66-2424HM | | |

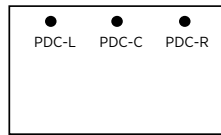

PDC-L/PDC-R: Located 11" from ends and 21½" from user side

PDC-C: Located 21½" from user side

Models

| | | |
|-----------|------------|------------|
| 66-2036HM | 66-2036HDL | 66-2030HDL |
| 66-2030HM | 66-2036HDR | 66-2030HDR |
| 66-2024HM | | |

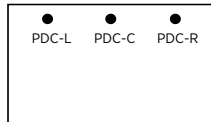

PDC-L/PDC-R: Located 11" from ends and 17½" from user side

PDC-C: Located 17½" from user side

HEIGHT ADJUSTABLE WORKSURFACE MONITOR ARM LOCATIONS

Monitor Arm Grommets are available in locations shown below. Please specify and add upcharge for each grommet. [Dual Monitor and Single Monitor Arms sold separately](#)

Monitor Arm Grommet available in one location per unit; grommet is 2¾".

MONITOR ARM GROMMET LOCATIONS

| | | | |
|---------|-------------------------|----|----|
| MGRMT-C | Monitor Grommet, Center | \$ | 52 |
| MGRMT-L | Monitor Grommet, Left | \$ | 52 |
| MGRMT-R | Monitor Grommet, Right | \$ | 52 |

Models

| | | |
|------------|------------|------------|
| 66-3470HTP | 66-3462HTP | 66-3456HTP |
| 66-3464HTP | 66-3458HTP | |

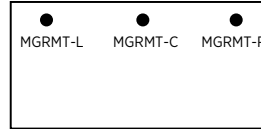

MGRMT-L/MGRMT-R: Located 18" from ends and 31" from user side

MGRMT-C: Located 31" from user side

Models

| | | |
|------------|------------|------------|
| 66-2870HTP | 66-2858HTP | 66-2850HTP |
| 66-2864HTP | 66-2856HTP | 66-2846HTP |
| 66-2862HTP | 66-2852HTP | |



MGRMT-L/MGRMT-R: Located 18" from ends and 25" from user side

MGRMT-C: Located 25" from user side

Models

| | | |
|------------|------------|------------|
| 66-2270HTP | 66-2258HTP | 66-2250HTP |
| 66-2264HTP | 66-2256HTP | 66-2246HTP |
| 66-2262HTP | 66-2252HTP | |



MGRMT-L/MGRMT-R: Located 18" from ends and 19" from user side

MGRMT-C: Located 19" from user side

CONFERENCE AND MEETING TABLE GROMMET OPTIONS

Meeting and Conference Tables offer power and grommet locations at multiple locations.

Must Specify Black (BLK) or Silver (SLV)

Grommet

| | | |
|-------------------------------|----|----|
| Factory Installed Grommet | \$ | 52 |
| Field Installed Grommet Cover | \$ | 11 |

Grommet + Power Locations

| | | | |
|----|---------------------|----|------------------------|
| OC | On Center | CL | 5½" Left of Center |
| EL | 24½" from Left End) | CR | 5½" Right of Center |
| ER | 24½" from Right End | BB | Centered Between Bases |

Location Availability by Top Size

| | |
|-----------------|--------------------------------|
| 72" + 96"W Tops | OC, EL+ER |
| 120"W Tops | BB, CL, CR, CL+EL+ER, CR+EL+ER |

LOCKING DOORS

Locking doors are available on select hinged doors. You must specify WITH LOCKING when ordering and add upcharge.

| | | | |
|--------|---------------------|----|-----|
| LKT_HU | 108"W to 84"W Units | \$ | 135 |
| LKT_HU | 78"W to 48"W Units | \$ | 115 |
| LKT_HU | 42"W to 24"W Units | \$ | 91 |
| LKT_HU | 18"W to 12"W Units | \$ | 69 |

WIRE MANAGEMENT

Wire Management openings available for modular pedestals.

| | | | |
|------|----------------------|----|-----|
| WML | Left Panel | \$ | 80 |
| WMR | Right Panel | \$ | 80 |
| WMLR | Left and Right Panel | \$ | 160 |

CERTIFICATIONS & COMPLIANCE

- Intertek Sustainability Certified
- BIFMA level® Certified
- BIFMA Compliant® Certified
- TSCA Title VI (formerly CARB) Compliance
- US Green Building's LEED® Contribution

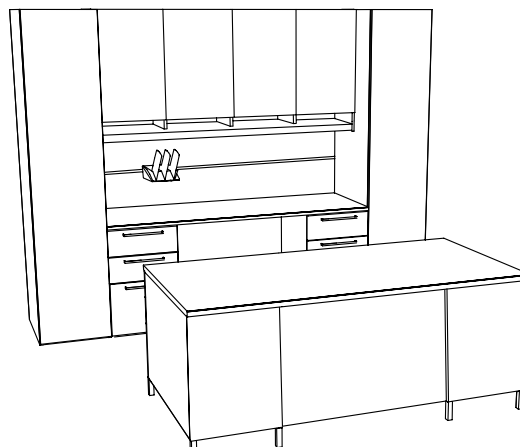
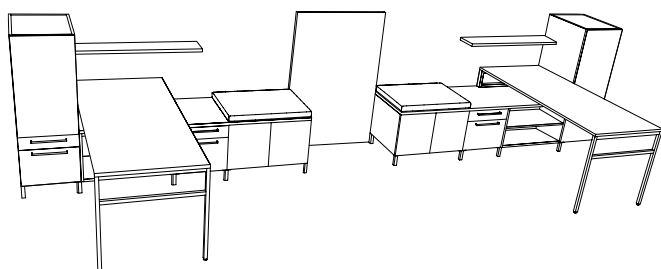
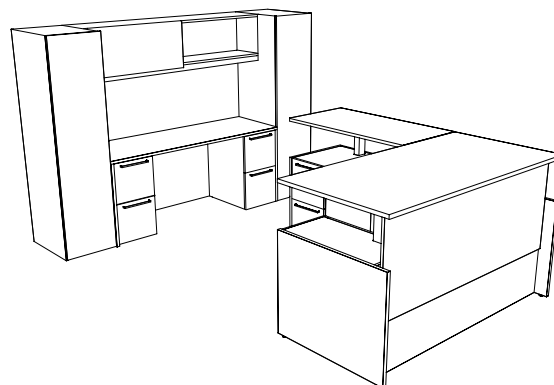
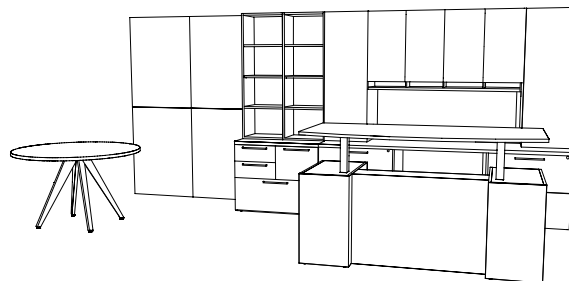

Standard Components



Double Ped Desks with or without Bow Tops
[\(See Multiple Unit Details\)](#)



Single Ped Desks with or without Bow Tops
[\(See Multiple Unit Details\)](#)



Curved Single Ped Desks with or without Bow Tops
[\(See Multiple Unit Details\)](#)

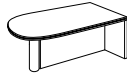

P-Top and D-Tops
[\(See Multiple Unit Details\)](#)

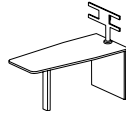

Media Peninsula
[\(See Multiple Unit Details\)](#)

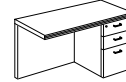

Returns
[\(See Multiple Unit Details\)](#)

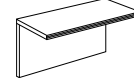

Bridges
[\(See Multiple Unit Details\)](#)

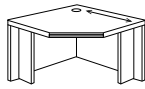

Corner Units
[\(See Multiple Unit Details\)](#)

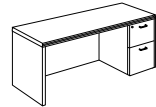

Kneespace, Storage, and Single Ped Credenzas
[\(See Multiple Unit Details\)](#)

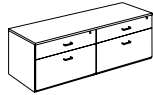

21" Low Storage and Open Credenzas
[\(See Multiple Unit Details\)](#)



Filing
[\(See Multiple Unit Details\)](#)

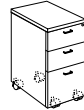

Mobile Pedestals
[\(See Multiple Unit Details\)](#)

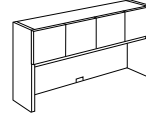

Surface Mount and Wall Mount Hutches
[\(See Multiple Unit Details\)](#)



Surface Mount Storage Towers
[\(See Multiple Unit Details\)](#)

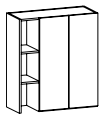

Surface Mount Bookcases
[\(See Multiple Unit Details\)](#)

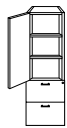

Storage Cabinets
[\(See Multiple Unit Details\)](#)

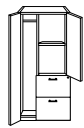

Tower Wardrobe
[\(See Multiple Unit Details\)](#)



Wardrobe/Storage Cabinet
[\(See Multiple Unit Details\)](#)

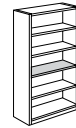

Bookcases
[\(See Multiple Unit Details\)](#)

Tables

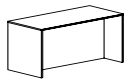

Work Tables
[\(See Multiple Unit Details\)](#)

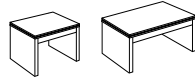

Occasional Tables
[\(See Multiple Unit Details\)](#)



Rectangular Tops
[\(See Details\)](#)
Round Tops
[\(See Details\)](#)



Strut Bases
[\(See Details\)](#)



Cylinder Bases
[\(See Details\)](#)



Metal Bases
[\(See Details\)](#)



Height Adjustable Bases and Lifts
[\(See Details\)](#)



Rectangular with Door
[\(See Details\)](#)

Modular Components

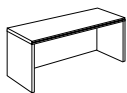

Desk, Credenza and Return Shells
[\(See Multiple Unit Details\)](#)



P-Tops, D-Tops And Media Peninsula
[\(See Multiple Unit Details\)](#)



Pedestals
[\(See Multiple Unit Details\)](#)

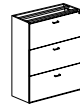

Filing
[\(See Multiple Unit Details\)](#)

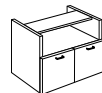

Door and Open Bookcase Pedestals
[\(See Multiple Unit Details\)](#)

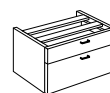

21" Low Storage Pedestals
[\(See Multiple Unit Details\)](#)



Seated and Low Height Metal Supports
[\(See Seated Height and Low Height Units\)](#)

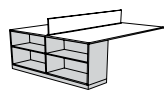

Desk End Bookcases
[\(See Multiple Unit Details\)](#)



Support Panels
[\(See Standard Height and Low Height\)](#)

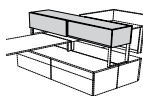

Dual and Single Access Hutches
[\(See Multiple Unit Details\)](#)

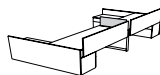

Privacy Panels
[\(See Multiple Unit Details\)](#)

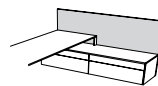

Floorstanding Gallery Screens
[\(See Multiple Unit Details\)](#)

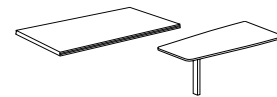

Modular Tops - Table, Desk, Benching Tops
[\(See Multiple Unit Details\)](#)

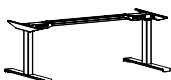

Height Adjustable Worksurface Lifts
[\(See Multiple Unit Details\)](#)

Studio Components

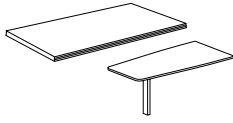

Modular Tops - Table, Desk, Benching Tops [\(See Multiple Unit Details\)](#)



Studio Pedestals [\(See Details\)](#)

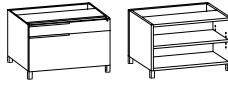

Studio Low Pedestals [\(See Multiple Unit Details\)](#)

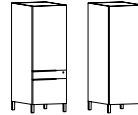

Studio Storage Cabinets [\(See Multiple Unit Details\)](#)



Kneespace Modesty Panels [\(See Multiple Unit Details\)](#)



Single and Shared Stanchions [\(See Details\)](#)



Studio Single and Shared Legs [\(See Details\)](#)

Height Adjustable Units and Components

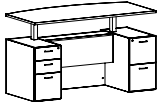

Double Ped Desks [\(See Details\)](#)

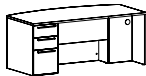

Single Ped Desks [\(See Multiple Unit Details\)](#)

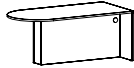

P and D-Top [\(See Multiple Unit Details\)](#)

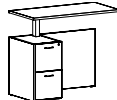

Returns [\(See Multiple Unit Details\)](#)

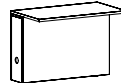

Bridge [\(See Multiple Unit Details\)](#)

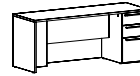

Credenzas [\(See Multiple Unit Details\)](#)

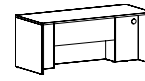

Desk Shell [\(See Details\)](#), Return Shell [\(See Details\)](#) and Credenza Shell [\(See Details\)](#)



Height Adjustable Worksurfaces [\(See Multiple Unit Details\)](#)



Height Adjustable Legs [\(See Multiple Unit Details\)](#)



Height Adjustable Cabinets [\(See Multiple Unit Details\)](#)

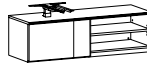

Height Adjustable Credenzas [\(See Multiple Unit Details\)](#)



Height Adjustable Modesty Panels [\(See Multiple Unit Details\)](#)



Height Adjustable Privacy Screens [\(See Multiple Unit Details\)](#)



Height Adjustable Worksurface Lifts [\(See Multiple Unit Details\)](#)

Tackboards, Work Walls, Marker Boards and Other Accessories

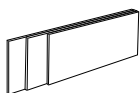

Tackboards [\(See Multiple Unit Details\)](#)



Work Walls and Accessories [\(See Multiple Unit Details\)](#)

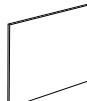

Marker Boards [\(See Multiple Unit Details\)](#)



Marker, Eraser and Magnet Sets [\(See Details\)](#)



Tasklights [\(See Multiple Unit Details\)](#)

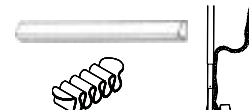

Wire Management [\(See Multiple Unit Details\)](#)



Power Options [\(See Multiple Unit Details\)](#)

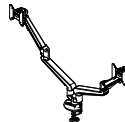
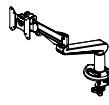

Monitor Arms [\(See Multiple Unit Details\)](#)

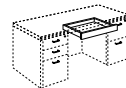

Kneespace Accessories [\(See Multiple Unit Details\)](#)



Cushion [\(See Details\)](#)

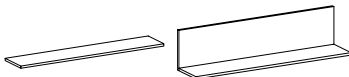

Floating and L Shelf [\(See Multiple Unit Details\)](#)

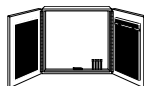

Visual Board [\(See Details\)](#)

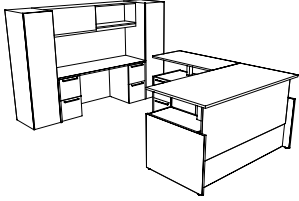
| Item | Model No. | Width | Depth | Height | Ship Wt | Cubic Ft | List Price |
|---|--------------------|-------|--|--------|----------------------|----------|------------------------|
|  | 66-21 | 108 | 105 | 70 7/8 | 1418 | 200.5 | T\$ 21184 P\$ 21899 |
| | CONSIST OF: | | QTY | | | | |
| | 68-3672RPSTS | 1 | Height Adjustable Single Ped Desk with Box/Box/File with Moving Modesty Option | | T\$ 5998 P\$ 6288 | | |
| | 68-2448LF2STS3 | 1 | Height Adjustable Return with File/File, 3-Channel | | T\$ 3436 P\$ 3623 | | |
| | GMB-2372W | 1 | 72"W Glass Marker Board for Wall Mount Hutch | | \$ 2595 | | |
| | 68-2472KC | 1 | Kneespace Credenza Full Pedestal | | T\$ 2697 P\$ 2935 | | |
| | 66-1572SWD | 1 | 72"W Wall Mount Hutch with Sliding Door | | T\$ 2352 | | |
| | 66-1872WR | 1 | Wardrobe Storage Cabinet, Right | | T\$ 2053 | | |
| | 66-1872WL | 1 | Wardrobe Storage Cabinet, Left | | T\$ 2053 | | |

Products are available as left or right, where applicable
Depth includes 42" between Double Ped Desk and Kneespace Credenza
List price does not include optional moving modesty

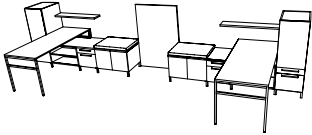
| | | | | | | | |
|---|--------------------|-----|--|--------|----------------------|-------|------------------------|
|  | 66-25 | 228 | 72 | 51 1/2 | 1121 | 121.8 | T\$ 20801 P\$ 21831 |
| | CONSIST OF: | | QTY | | | | |
| | 66-3072TP | 2 | Modular Desk Top | | T\$ 1354 P\$ 1894 | | |
| | 01-3028HL | 2 | H Modular Peninsula Support Seated Height | | \$ 2252 | | |
| | 01-3007OL | 2 | Layer Support for Desk Top | | T\$ 1114 | | |
| | 66-2430SBC | 2 | 30"W Studio Low Mod Open Bookcase | | T\$ 2102 | | |
| | 66-2418STF | 2 | 18"W Studio Low Mod Tray/File Ped | | T\$ 2030 | | |
| | 66-1851SWBL | 1 | Studio Storage Cabinet Door/Tray/File, Left | | T\$ 1588 | | |
| | 66-1851SWBR | 1 | Studio Storage Cabinet Door/Tray/File, Right | | T\$ 1588 | | |
| | 66-2430SDB | 2 | 30"W Studio Low Mod Door Bookcase | | T\$ 1836 | | |
| | 66-2478TP | 2 | 78" Modular Top for Storage | | T\$ 1222 P\$ 1712 | | |
| | 66-2430CUSHION | 2 | 30"W Component Cushion for Door Bookcase | | GR1\$ 770 | | |
| | 01-0404SSL4 | 3 | Studio Shared Leg, 4 Pack | | ALUM\$ 741 | | |
| | 01-0404SL4 | 2 | Studio Leg, 4 Pack | | ALUM\$ 494 | | |
| | GMB-5136W | 1 | 36"W Glass Marker Board From Floor | | \$ 2802 | | |
| | 66-0942FS | 2 | 42"W Floating Shelf | | T\$ 908 | | |

Products are available as left or right, where applicable

Pricing Codes:

T= TFL
P= HPL

[See Canvas Intro Section for Ordering Options](#)

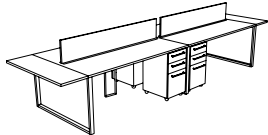
| Item | Model No. | Width | Depth | Height | Ship Wt | Cubic Ft | List Price |
|---|-----------|-------|-------|--------|---------|----------|------------------------|
|  | 66-12 | 174 | 60 | 41¾ | 986 | 86.8 | T\$ 13448 P\$ 14638 |

| CONSIST OF: | QTY | | | |
|-------------|-----|---|-----|------|
| 01-3028OLS | 2 | Seated Height Shared Metal Leg | A\$ | 1258 |
| 01-6028OL | 2 | Seated Height Modular Peninsula Support | A\$ | 1834 |
| 01-00060SB | 4 | Stiffener Bar | \$ | 516 |
| 01-1228OL | 2 | O Leg Support | A\$ | 884 |
| 66-1519MP1 | 4 | Mobile Pedestal Box/Box/File | T\$ | 5108 |
| 66-1560DTP | 2 | Desk Top Extensions | T\$ | 772 |
| | | | P\$ | 1078 |
| 66-6072TP | 2 | Modular Desk Top | T\$ | 2216 |
| | | | P\$ | 3100 |
| 66-6812PP | 2 | 12" TFL Privacy Panel | T\$ | 860 |

Products are available as left or right, where applicable

| | | | | | | | |
|---|-------|-----|-----|-----|------|-------|------------------------|
|  | 66-23 | 108 | 102 | 82¾ | 1127 | 152.3 | T\$ 17033 P\$ 17557 |
|---|-------|-----|-----|-----|------|-------|------------------------|

| CONSIST OF: | QTY | | | |
|--------------|-----|--|--------|------|
| 66-3672TP | 1 | Modular Desk Top | T\$ | 726 |
| | | | P\$ | 1015 |
| 66-2472TP | 1 | Modular Cabinet Top | T\$ | 595 |
| | | | P\$ | 830 |
| 01-0404SL4 | 2 | Single Studio Leg 4-Pack | ALUM\$ | 494 |
| 66-3618SPD1 | 2 | Studio Modular Desk Pedestal, Box/Box/File | T\$ | 2982 |
| 66-3624MDHGA | 1 | Studio Kneespace Modesty Panel, High Gloss Acrylic | \$ | 589 |
| | | | +GPA\$ | 676 |
| 66-1572TWDS | 1 | Tall Wall Mount Door Hutch with Paper Slots | T\$ | 3242 |
| 66-2418PD1 | 2 | Modular Desk Pedestal, Box/Box/File | T\$ | 2494 |
| 66-7228BP | 1 | Modular Modesty Panel | T\$ | 492 |
| 66-1884WL | 1 | Tall Wardrobe/Storage Cabinet, Left | T\$ | 2143 |
| 66-1884WR | 1 | Tall Wardrobe/Storage Cabinet, Right | T\$ | 2143 |
| WW-1972TRWPS | 1 | Tool Rail Work Wall | GRI\$ | 1004 |
| 01-FLDRSRTRC | 1 | Folder Sorter for Tool Rail Work Wall, Clear | \$ | 129 |

Products are available as left or right, where applicable

Depth includes 42" between Modular Double Ped Desk and Modular Credenza

Pricing Codes:

T= TFL

P= HPL

[See Canvas Intro Section for Ordering Options](#)

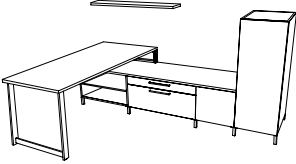
| Item | Model No. | Width | Depth | Height | Ship Wt | Cubic Ft | List Price |
|---|--------------------|-------|--|--------|--------------------|----------|----------------------|
|  | 66-22 | 102 | 72 | 47½ | 508 | 56.9 | T\$ 8153 P\$ 8675 |
| | CONSIST OF: | | QTY | | | | |
| | 66-3072TP | 1 | Modular Desk Top | | T\$ 677 P\$ 947 | | |
| | 66-2484TP | 1 | Modular Cabinet Top | | T\$ 624 P\$ 876 | | |
| | 01-3028BL | 1 | Bar Modular Peninsula Support | | ALUM\$ 644 | | |
| | 66-2430SBC | 1 | Studio Modular Low Storage, Open Bookcase | | T\$ 1051 | | |
| | 66-2436STF | 1 | Studio Modular Low Storage, Tray/File | | T\$ 1257 | | |
| | 66-2418SDBR | 1 | Studio Modular Low Door Bookcase, Right Hinged | | T\$ 825 | | |
| | 01-3007OL | 1 | Layer Support for 21" Low Credenzas | | \$ 557 | | |
| | 66-1851SWR | 1 | Studio Wardrobe, Right Hinged | | \$ 1387 | | |
| | 01-0404SL4 | 1 | Single Studio Leg 4-Pack | | ALUM\$ 247 | | |
| | 01-0404SSL2 | 1 | Shared Studio Leg 2-Pack | | ALUM\$ 143 | | |
| | 01-0404SSL4 | 1 | Shared Studio Leg 4-Pack | | ALUM\$ 247 | | |
| | 66-0948FS | 1 | 48" Canvas Floating Shelf Display | | T\$ 494 | | |

Products are available as left or right, where applicable

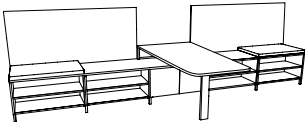
| | | | | | | | |
|---|--------------------|-----|---|-----|----------------------|-------|------------------------|
|  | 66-24 | 180 | 72 | 47¾ | 769 | 118.6 | T\$ 13997 P\$ 15367 |
| | CONSIST OF: | | QTY | | | | |
| | 66-2436SBC | 4 | Studio Modular Low Storage, Open Bookcase | | T\$ 4380 | | |
| | 66-2436SDB | 1 | Studio Modular Low Door Bookcase | | T\$ 1047 | | |
| | 01-0404SL4 | 1 | Single Studio Leg 4-Pack | | ALUM\$ 247 | | |
| | 01-0404SSL4 | 2 | Shared Studio Leg 4-Pack | | ALUM\$ 494 | | |
| | 66-2472TP | 2 | Modular Cabinet Top | | T\$ 1190 P\$ 1660 | | |
| | 66-2436TP | 1 | Modular Cabinet Top | | T\$ 371 P\$ 519 | | |
| | 66-2436CUSHION | 2 | Component Cushion | | GR1\$ 890 | | |
| | 01-3607OL | 1 | Layer Support For 21" Low Credenza | | \$ 576 | | |
| | 66-3672MP | 1 | Media Peninsula | | T\$ 2166 P\$ 2918 | | |
| | WW-3172TTRW | 2 | Tool Rail Work Wall | | GR1\$ 2636 | | |

Products are available as left or right, where applicable

Pricing Codes:

T= TFL
P= HPL

[See Canvas Intro Section for Ordering Options](#)

| Item | Model No. | Width | Depth | Height | K | R | Ship Wt | Cubic Ft | List Price |
|--|-------------|-------|-------|--------|-----|---|---------|----------|----------------------|
| DOUBLE PED DESK BOW TOP STEPPED FRONT | 68-3672BDPS | 72 | 36-30 | 30 | 40½ | - | 410 | 50.0 | T\$ 3311 P\$ 3609 |

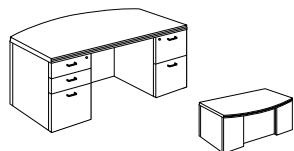

Stepped Front

Must Specify (in this order):

- Model #
- Top Material
- Top Color
- Edge Profile
- Chassis Color
- Drawer
 - Construction
 - Track
- Drawer Front
 - Color
 - Grain Direction (if applicable)
- Modesty/Color
- Grommet Location
- Wire Management
- Grommet Style/Color
- Power/Data Options
- Drawer Pull
- Kneespace Options

Description

- Standard With: Bow Top, Stepped Front, Full Modesty, Letter Width Locking Box/Box/File on Left Pedestal and File/File on Right, Left to Right Grain Direction on Worksurface, Wire Management from Pedestal to Kneespace, Black Utility Tray for Box Drawer
- Available with TFL (T) or HPL (P) Top; Must Specify
- Drawer Front Grain Direction Vertical Standard; Optional Horizontal Grain Direction
- Top, Chassis, Modesty and Drawer Fronts Available in Contrasting Colors; Must Specify Color of Each Component
- [Height Adjustable Units Available](#)
- Additional Options: Dove Tail Drawer Construction and Soft Close Drawers ([See Drawer Details](#)); Power and Grommet Options ([See Options and Locations](#)); Kneespace Options (Sold Separately, [See Unit Details](#))

Options: Specify & Add



| | | |
|---------|--|----------|
| 66-TMD | 18¼"H Laminat ¾ Modesty Panel - Must Specify Laminat Color | Included |
| 66-TSC | 18¼"H Aluminum Framed Satin Frosted Tempered Glass ¾ Modesty Panel | \$ 969 |
| 66-HGAF | High Gloss Acrylic Full Modesty Panel; Must Specify Color | |
| | (GPA) Graphite Acrylic | \$ 1914 |
| | (BLA) Black, (WMA) Wired Mercury, or (WHA) White Acrylic | \$ 1748 |

| | | | | | | | | | |
|--|------------|----|----|----|-----|---|-----|------|----------------------|
| DOUBLE PED DESK RECTANGLE TOP STEPPED FRONT | 68-3672DPS | 72 | 36 | 30 | 40½ | - | 425 | 50.0 | T\$ 3574 P\$ 3866 |
|--|------------|----|----|----|-----|---|-----|------|----------------------|

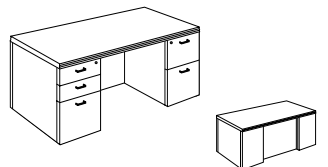

Stepped Front

Must Specify (in this order):

- Model #
- Top Material
- Top Color
- Edge Profile
- Chassis Color
- Drawer
 - Construction
 - Track
- Drawer Front
 - Color
 - Grain Direction (if applicable)
- Modesty/Color
- Grommet Location
- Wire Management
- Grommet Style/Color
- Power/Data Options
- Drawer Pull
- Kneespace Options

Description

- Standard With: Rectangle Top, Stepped Front, Full Modesty, Letter Width Locking Box/Box/File on Left Pedestal and File/File on Right, Left to Right Grain Direction on Worksurface, Wire Management from Pedestal to Kneespace, Black Utility Tray for Box Drawer
- Available with TFL (T) or HPL (P) Top; Must Specify
- Drawer Front Grain Direction Vertical Standard; Optional Horizontal Grain Direction
- Top, Chassis, Modesty and Drawer Fronts Available in Contrasting Colors; Must Specify Color of Each Component
- [Height Adjustable Units Available](#)
- Additional Options: Dove Tail Drawer Construction and Soft Close Drawers ([See Drawer Details](#)); Power and Grommet Options ([See Options and Locations](#)); Kneespace Options (Sold Separately, [See Unit Details](#))

Options: Specify & Add

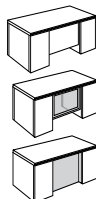

| | | |
|---------|--|----------|
| 66-TMD | 18¼"H Laminat ¾ Modesty Panel - Must Specify Laminat Color | Included |
| 66-TSC | 18¼"H Aluminum Framed Satin Frosted Tempered Glass ¾ Modesty Panel | \$ 969 |
| 66-HGAF | High Gloss Acrylic Full Modesty Panel; Must Specify Color | |
| | (GPA) Graphite Acrylic | \$ 1914 |
| | (BLA) Black, (WMA) Wired Mercury, or (WHA) White Acrylic | \$ 1748 |

Pricing Codes:

- T= TFL
- P= HPL

[See Canvas Intro Section for Ordering Options](#)

| Item | Model No. | Width | Depth | Height | K | R | Ship Wt | Cubic Ft | List Price |
|--|------------|-------|-------|--------|-----|----|---------|----------|----------------------|
| DOUBLE PED DESK BOW TOP RECESSED FRONT | 68-3672BDP | 72 | 36-30 | 30 | 40½ | 10 | 410 | 50.0 | T\$ 3180 P\$ 3474 |
| | 68-3666BDP | 66 | 30-36 | 30 | 34½ | 10 | 380 | 48.0 | T\$ 3064 P\$ 3401 |

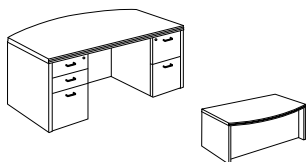

Recessed Front

Must Specify (in this order):

Model #
 Top Material
 Top Color
 Edge Profile
 Chassis Color
 Drawer
 Construction
 Track
 Drawer Front
 Color
 Grain Direction (if applicable)
 Modesty/Color
 Grommet Location
 Wire Management
 Grommet Style/Color
 Power/Data Options
 Drawer Pull
 Kneespace Options

Description

- Standard With: Bow Top, Recessed Front, Letter Width Locking Box/Box/File on Left Pedestal and File/File on Right, Left to Right Grain Direction on Worksurface, Wire Management from Pedestal to Kneespace, Black Utility Tray for Box Drawer
- Available with TFL (T) or HPL (P) Top; Must Specify
- Drawer Front Grain Direction Vertical Standard; Optional Horizontal Grain Direction
- Top, Chassis, and Drawer Fronts Available in Contrasting Colors; Must Specify Color of Each Component
- [Height Adjustable Units Available](#)
- Additional Options: Dove Tail Drawer Construction and Soft Close Drawers ([See Drawer Details](#)); Power and Grommet Options ([See Options and Locations](#)); Kneespace Options (Sold Separately, [See Unit Details](#))

| | | | | | | | | | |
|--|-----------|----|----|----|-----|----|-----|------|----------------------|
| DOUBLE PED DESK RECTANGLE TOP RECESSED FRONT | 68-3672DP | 72 | 36 | 30 | 40½ | 10 | 425 | 50.0 | T\$ 2774 P\$ 3060 |
| | 68-3072DP | 72 | 30 | 30 | 40½ | 4 | 410 | 43.9 | T\$ 2676 P\$ 2945 |
| | 68-3066DP | 66 | 30 | 30 | 34½ | 4 | 390 | 38.7 | T\$ 2579 P\$ 2839 |
| | 68-3060DP | 60 | 30 | 30 | 28½ | 4 | 358 | 35.3 | T\$ 2468 P\$ 2710 |

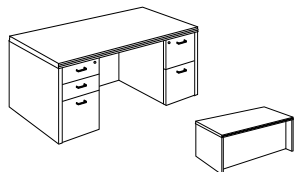

Recessed Front

Must Specify (in this order):

Model #
 Top Material
 Top Color
 Edge Profile
 Chassis Color
 Drawer
 Construction
 Track
 Drawer Front
 Color
 Grain Direction (if applicable)
 Modesty/Color
 Grommet Location
 Wire Management
 Grommet Style/Color
 Power/Data Options
 Drawer Pull
 Kneespace Options

Description

- Standard With: Rectangle Top, Recessed Front, Letter Width Locking Box/Box/File on Left Pedestal and File/File on Right, Left to Right Grain Direction on Worksurface, Wire Management from Pedestal to Kneespace, Black Utility Tray for Box Drawer
- Available with TFL (T) or HPL (P) Top; Must Specify
- Drawer Front Grain Direction Vertical Standard; Optional Horizontal Grain Direction
- Top, Chassis, and Drawer Fronts Available in Contrasting Colors; Must Specify Color of Each Component
- [Height Adjustable Units Available](#)
- Additional Options: Dove Tail Drawer Construction and Soft Close Drawers ([See Drawer Details](#)); Power and Grommet Options ([See Options and Locations](#)); Kneespace Options (Sold Separately, [See Unit Details](#))

Pricing Codes:

T= TFL
 P= HPL

[See Canvas Intro Section for Ordering Options](#)

| Item | Model No. | Width | Depth | Height | K | R | Ship Wt | Cubic Ft | List Price |
|--|-----------------|------------------|-------|--------|----|-----|---------|----------|----------------------|
| SINGLE PED DESK BOW TOP STEPPED FRONT | Left Ped | Right Ped | | | | | | | |
| | 68-3672BLPS | 68-3672BRPS | 72 | 30-36 | 30 | 32¼ | - | 320 | 50.0 |
| | | | | | | | | | T\$ 2971 P\$ 3267 |

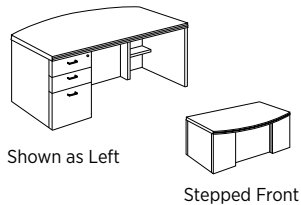

Must Specify (in this order):

- Model #
- Top Material
- Top Color
- Edge Profile
- Chassis Color
- Drawer
- Construction Track
- Drawer Front Color
- Grain Direction (if applicable)
- Modesty/Color
- Grommet Location
- Wire Management
- Grommet Style/Color
- Power/Data Options
- Drawer Pull
- Kneespace Options

Description

- Standard With: Bow Top, Stepped Front, Full Modesty, Letter Width Locking Box/Box/File in Pedestal, Left to Right Grain Direction on Worksurface, Wire Management from Pedestal to Kneespace, Black Utility Tray for Box Drawer
- Available with TFL (T) or HPL (P) Top; Must Specify
- Drawer Front Grain Direction Vertical Standard; Optional Horizontal Grain Direction
- Top, Chassis, Modesty and Drawer Fronts Available in Contrasting Colors; Must Specify Color of Each Component
- [Height Adjustable Units Available](#)
- Additional Options: Dove Tail Drawer Construction and Soft Close Drawers ([See Drawer Details](#)); Power and Grommet Options ([See Options and Locations](#)); Kneespace Options (Sold Separately, [See Unit Details](#))

Options: Specify & Add

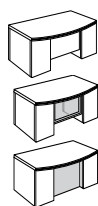

| | | |
|---------|--|----------|
| 66-TMD | 18¼"H Laminate ¾ Modesty Panel - Must Specify Laminate Color | Included |
| 66-TSC | 18¼"H Aluminum Framed Satin Frosted Tempered Glass ¾ Modesty Panel | \$ 969 |
| 66-HGAF | High Gloss Acrylic Full Modesty Panel; Must Specify Color | |
| | (GPA) Graphite Acrylic | \$ 1914 |
| | (BLA) Black, (WMA) Wired Mercury, or (WHA) White Acrylic | \$ 1748 |

| Item | Model No. | Width | Depth | Height | K | R | Ship Wt | Cubic Ft | List Price |
|--|-----------------|------------------|-------|--------|----|-----|---------|----------|----------------------|
| SINGLE PED DESK RECTANGLE TOP STEPPED FRONT | Left Ped | Right Ped | | | | | | | |
| | 68-3672LPS | 68-3672RPS | 72 | 36 | 30 | 32¼ | - | 330 | 50.0 |
| | | | | | | | | | T\$ 2575 P\$ 2865 |

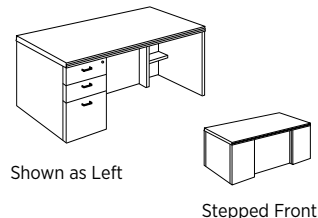

Must Specify (in this order):

- Model #
- Top Material
- Top Color
- Edge Profile
- Chassis Color
- Drawer
- Construction Track
- Drawer Front Color
- Grain Direction (if applicable)
- Modesty/Color
- Grommet Location
- Wire Management
- Grommet Style/Color
- Power/Data Options
- Drawer Pull
- Kneespace Options

Description

- Standard With: Rectangle Top, Stepped Front, Full Modesty, Letter Width Locking Box/Box/File in Pedestal, Left to Right Grain Direction on Worksurface, Wire Management from Pedestal to Kneespace, Black Utility Tray for Box Drawer
- Available with TFL (T) or HPL (P) Top; Must Specify
- Drawer Front Grain Direction Vertical Standard; Optional Horizontal Grain Direction
- Top, Chassis, Modesty and Drawer Fronts Available in Contrasting Colors; Must Specify Color of Each Component
- [Height Adjustable Units Available](#)
- Additional Options: Dove Tail Drawer Construction and Soft Close Drawers ([See Drawer Details](#)); Power and Grommet Options ([See Options and Locations](#)); Kneespace Options (Sold Separately, [See Unit Details](#))

Options: Specify & Add

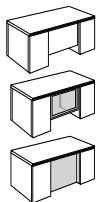

| | | |
|---------|--|----------|
| 66-TMD | 18¼"H Laminate ¾ Modesty Panel - Must Specify Laminate Color | Included |
| 66-TSC | 18¼"H Aluminum Framed Satin Frosted Tempered Glass ¾ Modesty Panel | \$ 969 |
| 66-HGAF | High Gloss Acrylic Full Modesty Panel; Must Specify Color | |
| | (GPA) Graphite Acrylic | \$ 1914 |
| | (BLA) Black, (WMA) Wired Mercury, or (WHA) White Acrylic | \$ 1748 |

Pricing Codes:

T= TFL
P= HPL

[See Canvas Intro Section for Ordering Options](#)

| Item | Model No. | Width | Depth | Height | K | R | Ship Wt | Cubic Ft | List Price |
|---|-----------------|------------------|-------|--------|----|-----|---------|----------|------------|
| SINGLE PED DESK BOW TOP RECESSED FRONT | Left Ped | Right Ped | | | | | | | |
| | 68-3672BLP | 68-3672BRP | 72 | 30-36 | 30 | 32¼ | 10 | 320 | 50.0 |

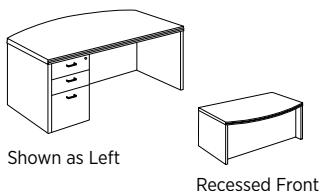

- Must Specify (in this order):
- Model #
 - Top Material
 - Top Color
 - Edge Profile
 - Chassis Color
 - Drawer
 - Construction
 - Track
 - Drawer Front
 - Color
 - Grain Direction (if applicable)
 - Grommet Location
 - Wire Management
 - Grommet Style/Color
 - Power/Data Options
 - Drawer Pull
 - Kneespace Options

Description

- Standard With: Bow Top, Recessed Front, Letter Width Locking Box/Box/File in Pedestal, Left to Right Grain Direction on Worksurface, Wire Management from Pedestal to Kneespace, Black Utility Tray for Box Drawer
- Available with TFL (T) or HPL (P) Top; Must Specify
- Drawer Front Grain Direction Vertical Standard; Optional Horizontal Grain Direction
- Top, Chassis, and Drawer Fronts Available in Contrasting Colors; Must Specify Color of Each Component
- [Height Adjustable Units Available](#)
- Additional Options: Dove Tail Drawer Construction and Soft Close Drawers ([See Drawer Details](#)); Power and Grommet Options ([See Options and Locations](#)); Kneespace Options (Sold Separately, [See Unit Details](#))

| | | | | | | | | | | |
|---|-----------------|------------------|----|----|----|-----|----|-----|------|----------------------|
| SINGLE PED DESK RECTANGLE TOP RECESSED FRONT | Left Ped | Right Ped | | | | | | | | |
| | 68-3672LP | 68-3672RP | 72 | 36 | 30 | 32¼ | 10 | 330 | 50.0 | T\$ 2357 P\$ 2645 |
| | 68-3072LP | 68-3072RP | 72 | 30 | 30 | 32¼ | 4 | 210 | 43.0 | T\$ 2322 P\$ 2595 |
| | 68-3066LP | 68-3066RP | 66 | 30 | 30 | 26¼ | 4 | 180 | 38.7 | T\$ 2229 P\$ 2486 |
| | 68-3060LP | 68-3060RP | 60 | 30 | 30 | 20¼ | 4 | 150 | 35.0 | T\$ 2140 P\$ 2395 |

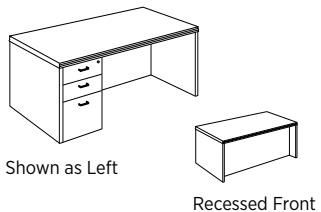

- Must Specify (in this order):
- Model #
 - Top Material
 - Top Color
 - Edge Profile
 - Chassis Color
 - Drawer
 - Construction
 - Track
 - Drawer Front
 - Color
 - Grain Direction (if applicable)
 - Grommet Location
 - Wire Management
 - Grommet Style/Color
 - Power/Data Options
 - Drawer Pull
 - Kneespace Options

Description

- Standard With: Rectangle Top, Recessed Front, Letter Width Locking Box/Box/File on Pedestal, Left to Right Grain Direction on Worksurface, Wire Management from Pedestal to Kneespace, Black Utility Tray for Box Drawer
- Available with TFL (T) or HPL (P) Top; Must Specify
- Drawer Front Grain Direction Vertical Standard; Optional Horizontal Grain Direction
- Top, Chassis, and Drawer Fronts Available in Contrasting Colors; Must Specify Color of Each Component
- [Height Adjustable Units Available](#)
- Additional Options: Dove Tail Drawer Construction and Soft Close Drawers ([See Drawer Details](#)); Power and Grommet Options ([See Options and Locations](#)); Kneespace Options (Sold Separately, [See Unit Details](#))

Pricing Codes:

T= TFL
P= HPL

[See Canvas Intro Section for Ordering Options](#)

| Item | Model No. | Width | Depth | Height | K | R | Ship Wt | Cubic Ft | List Price |
|--|-----------------|------------------|-------|--------|----|---|---------|----------|------------|
| CURVED SINGLE PED DESK BOW TOP RECESSED FRONT | Left Ped | Right Ped | | | | | | | |
| | 68-4872CBLP | 68-4872CBRP | 72 | 48-30 | 30 | - | - | 365 | 68.5 |

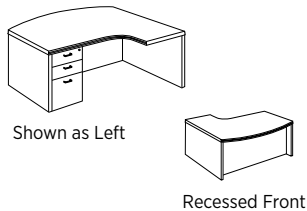

Shown as Left

Recessed Front

Must Specify (in this order):

- Model #
- Top Material
- Top Color
- Edge Profile
- Chassis Color
- Drawer
 - Construction
 - Track
- Drawer Front
 - Color
 - Grain Direction (if applicable)
- Grommet Location
- Wire Management
- Grommet Style/Color
- Power/Data Options
- Drawer Pull
- Kneespace Options

Description

- Standard With: Bow Top, Recessed Front, Full Modesty, Letter Width Locking Box/Box/File in Pedestal, Left to Right Grain Direction on Worksurface, Wire Management from Pedestal to Kneespace, Black Utility Tray for Box Drawer
- Available with TFL (T) or HPL (P) Top; Must Specify
- Drawer Front Grain Direction Vertical Standard; Optional Horizontal Grain Direction
- Top, Chassis, and Drawer Fronts Available in Contrasting Colors; Must Specify Color of Each Component
- Additional Options: Dove Tail Drawer Construction and Soft Close Drawers ([See Drawer Details](#)); Power and Grommet Options ([See Options and Locations](#)); Kneespace Options (Sold Separately, [See Unit Details](#))

| Item | Model No. | Width | Depth | Height | K | R | Ship Wt | Cubic Ft | List Price |
|--|-----------------|------------------|-------|--------|----|---|---------|----------|------------|
| CURVED SINGLE PED DESK RECTANGLE TOP RECESSED FRONT | Left Ped | Right Ped | | | | | | | |
| | 68-4272CLP | 68-4272CRP | 72 | 42-30 | 30 | - | - | 350 | 65.8 |

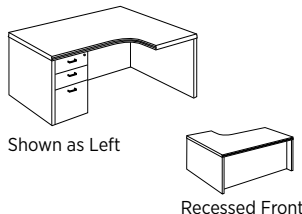

Shown as Left

Recessed Front

Must Specify (in this order):

- Model #
- Top Material
- Top Color
- Edge Profile
- Chassis Color
- Drawer
 - Construction
 - Track
- Drawer Front
 - Color
 - Grain Direction (if applicable)
- Grommet Location
- Wire Management
- Grommet Style/Color
- Power/Data Options
- Drawer Pull
- Kneespace Options

Description

- Standard With: Rectangle Top, Recessed Front, Full Modesty, Letter Width Locking Box/Box/File in Pedestal, Left to Right Grain Direction on Worksurface, Wire Management from Pedestal to Kneespace, Black Utility Tray for Box Drawer
- Available with TFL (T) or HPL (P) Top; Must Specify
- Drawer Front Grain Direction Vertical Standard; Optional Horizontal Grain Direction
- Top, Chassis, and Drawer Fronts Available in Contrasting Colors; Must Specify Color of Each Component
- Additional Options: Dove Tail Drawer Construction and Soft Close Drawers ([See Drawer Details](#)); Power and Grommet Options ([See Options and Locations](#)); Kneespace Options (Sold Separately, [See Unit Details](#))

Pricing Codes:

- T= TFL
- P= HPL

[See Canvas Intro Section for Ordering Options](#)

| Item | Model No. | Width | Depth | Height | Ship Wt | Cubic Ft | List Price |
|------------------------|-------------|--------------|-------|--------|---------|----------|----------------------|
| P-TOP CYLINDER BASE | Left | Right | | | | | |
| | 66-4284PL | 66-4284PR | 84 | 42-36 | 30 | 161 | T\$ 2662 P\$ 3335 |
| | 66-4272PL | 66-4272PR | 72 | 42-36 | 30 | 161 | T\$ 2442 P\$ 2966 |

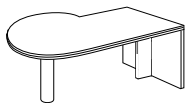

Shown as Left

Description

- Standard with: Left to Right Grain Direction on Worksurface, End Panel Support
- Available with TFL (T) or HPL (P) Top; Must Specify
- Metal Cylinder Base - 4½" Diameter. Must Specify: Black or Aluminum
- Not Recommended for Freestanding Applications
- [Height Adjustable Units Available](#)
- Additional Options: Power and Grommet Options ([See Options and Locations](#)); Kneespace Options (Sold Separately, Sold Separately, [See Unit Details](#))

Options: Specify & Add

| | | | |
|--|---------|--|---------------------------|
| | 66-HMD | 10"H Half Modesty Panel - Must Specify Laminate Color | 84" \$ 90 72" \$ 81 |
| | 66-FMD | Full Modesty Panel - Must Specify Laminate Color | 84" \$ 167 72" \$ 152 |
| | 66-HSC | 10"H Aluminum Framed Satin Frosted Tempered Glass Half Modesty Panel | 84" \$ 1091 72" \$ 983 |
| | 66-HGAH | 10"H High Gloss Acrylic Half Modesty Panel; Must Specify Color | |
| | | (GPA) Graphite Acrylic | 84" \$ 1366 |
| | | (BLA) Black, (WMA) Wired Mercury, or (WHA) White Acrylic | 84" \$ 1247 |
| | | (GPA) Graphite Acrylic | 72" \$ 1228 |
| | | (BLA) Black, (WMA) Wired Mercury, or (WHA) White Acrylic | 72" \$ 1117 |

Must Specify (in this order):

- Model #
- Top Material
- Top Color
- Edge Profile
- Chassis Color
- Modesty/Color
- Power/Data Options
- Kneespace Options
- Leg Color
- Worksurface Grommet
- Location
- Grommet Color

Pricing Codes:

- T= TFL
- P= HPL

[See Canvas Intro Section for Ordering Options](#)

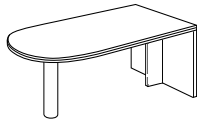
| Item | Model No. | Width | Depth | Height | Ship Wt | Cubic Ft | List Price |
|--|-------------|--------------|-------|--------|---------|----------|----------------------|
| D-TOP CYLINDER BASE  Shown as Left | Left | Right | | | | | |
| | 66-3684DUL | 66-3684DUR | 84 | 36 | 30 | 187 | T\$ 2392 P\$ 3046 |
| | 66-3672DUL | 66-3672DUR | 72 | 36 | 30 | 160 | T\$ 2036 P\$ 2565 |
| | 66-3084DUL | 66-3084DUR | 84 | 30 | 30 | 190 | T\$ 2316 P\$ 2905 |
| | 66-3072DUL | 66-3072DUR | 72 | 30 | 30 | 160 | T\$ 1971 P\$ 2492 |
| | 66-3066DUL | 66-3066DUR | 66 | 30 | 30 | 146 | T\$ 1885 P\$ 2389 |





Must Specify (in this order):

- Model #
- Top Material
- Top Color
- Edge Profile
- Chassis Color
- Modesty/Color
- Power/Data Options
- Kneespace Options
- Leg Color
- Worksurface Grommet Location
- Grommet Color

Description

- Standard with: Left to Right Grain Direction on Worksurface, End Panel Support
- Available with TFL (T) or HPL (P) Top; Must Specify
- Metal Cylinder Base - 4½" Diameter. Must Specify: Black or Aluminum
- Not Recommended for Freestanding Applications
- [Height Adjustable Units Available](#)
- Additional Options: Power and Grommet Options ([See Options and Locations](#)); Kneespace Options (Sold Separately, [See Unit Details](#))

Options: Specify & Add

| | | | | |
|---|--|---|--|--|
|  | 66-HMD | 10"H Half Modesty Panel - Must Specify Laminate Color | 84" \$ 90 72" \$ 81 66" \$ 71 | |
| |  | 66-FMD | Full Modesty Panel - Must Specify Laminate Color | 84" \$ 167 72" \$ 152 66" \$ 136 |
| | |  | 66-HSC | 10"H Aluminum Framed Satin Frosted Tempered Glass Half Modesty Panel |
|  | | | 66-HGAH | 10"H High Gloss Acrylic Half Modesty Panel; Must Specify Color |
| | | | (GPA) Graphite Acrylic | 84" \$ 1366 |
| | | (BLA) Black, (WMA) Wired Mercury, or (WHA) White Acrylic | 84" \$ 1247 | |
| | | (GPA) Graphite Acrylic | 72" \$ 1228 | |
| | | (BLA) Black, (WMA) Wired Mercury, or (WHA) White Acrylic | 72" \$ 1117 | |
| | | (GPA) Graphite Acrylic | 66" \$ 1093 | |
| | (BLA) Black, (WMA) Wired Mercury, or (WHA) White Acrylic | 66" \$ 996 | | |

Pricing Codes:

- T= TFL
- P= HPL

[See Canvas Intro Section for Ordering Options](#)

| Item | Model No. | Width | Depth | Height | Ship Wt | Cubic Ft | List Price |
|-------------------------------------|-------------|--------------|-------|--------|---------|----------|----------------------|
| EXTENDED D-TOP CYLINDER BASE | Left | Right | | | | | |
| | 66-4272EDL | 66-4272EDR | 72 | 42-36 | 30 | 163 | T\$ 2053 P\$ 2623 |

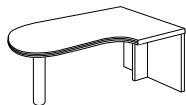

Shown as Left

Must Specify (in this order):

- Model #
- Top Material
- Top Color
- Edge Profile
- Chassis Color
- Modesty/Color
- Power/Data Options
- Kneespace Options
- Leg Color
- Worksurface Grommet Location
- Grommet Color

Description

- Standard with: Left to Right Grain Direction on Worksurface, End Panel Support
- Available with TFL (T) or HPL (P) Top; Must Specify
- Metal Cylinder Base - 4½" Diameter. Must Specify: Black or Aluminum
- Not Recommended for Freestanding Applications
- [Height Adjustable Units Available](#)
- Additional Options: Power and Grommet Options ([See Options and Locations](#)); Kneespace Options (Sold Separately, [See Unit Details](#))

Options: Specify & Add

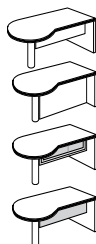

| | | |
|---------|--|---------|
| 66-HMD | 10"H Half Modesty Panel - Must Specify Laminate Color | \$ 81 |
| 66-FMD | Full Modesty Panel - Must Specify Laminate Color | \$ 152 |
| 66-HSC | 10"H Aluminum Framed Satin Frosted Tempered Glass Half Modesty Panel | \$ 983 |
| 66-HGAH | 10"H High Gloss Acrylic Half Modesty Panel; Must Specify Color (GPA) Graphite Acrylic | \$ 1228 |
| | (BLA) Black, (WMA) Wired Mercury, or (WHA) White Acrylic | \$ 1117 |

| | | | | | | | |
|------------------------|------------|----|----|----|-----|------|----------------------|
| MEDIA PENINSULA | 66-3672MPS | 72 | 36 | 30 | 164 | 52.1 | T\$ 3349 P\$ 4101 |
| | 66-3066MPS | 66 | 30 | 30 | 148 | 40.3 | T\$ 3180 P\$ 3866 |
| | 66-3060MPS | 60 | 30 | 30 | 143 | 36.7 | T\$ 3093 P\$ 3740 |

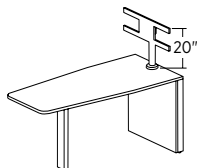

Must Specify (in this order):

- Model #
- Top Material
- Top Color
- Edge Profile
- Chassis Color
- Leg
- Power/Data Options
- Kneespace Options

Description

- Left to Right Grain Direction on Worksurface
- Available with TFL (T) or HPL (P) Top; Must Specify
- Not Recommended for Freestanding Applications Due to Open Back. May be Used with Component Gallery Screens
- Some Assembly Required
- Open Back for Wire Management
- Prevent Screen from Colliding with Walls or Furniture by Setting Rotation Limits at 15°, 30°, 45° or 90°
- Easily Route and Conceal Cables Through a Wide, In-column Channel for a Clean Finish
- Fits Most Screens 32" - 52"; Mounting Pattern Range: VESA® 100 x 100 mm - 600 x 400 mm
- Standard with Aluminum Rectangle Leg to be Installed 17¾" from Front to Allow for Kneespace Area
- Wire Management Trough Included; 4¼"W x 46⅜"L x 3½"H
- Additional Options: Leg Option (See Below); Power and Grommet Options ([See Options and Locations](#))

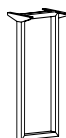

Leg Options: Specify & Add

| | | |
|-------|-----------------------|--------|
| OLEGA | 12" Aluminum Tube Leg | \$ 112 |
| OLEGB | 12" Black Tube Leg | \$ 112 |

Pricing Codes:

- T= TFL
- P= HPL

[See Canvas Intro Section for Ordering Options](#)

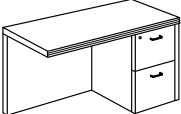
| Item | Model No. | Width | Depth | Height | K | R | Ship Wt | Cubic Ft | List Price | |
|--|--|------------------|-------|--------|----|-----|---------|----------|------------|----------------------|
|  RETURN WITH FILE/FILE Shown as Right | Left Ped | Right Ped | | | | | | | | |
| | 68-2448LF2 | 68-2448RF2 | 48 | 24 | 30 | 32¼ | - | 151 | 23.1 | T\$ 1531 P\$ 1714 |
| | Front to Back Grain Direction on Worksurface | | | | | | | | | |
| | 68-4824LF2 | 68-4824RF2 | 48 | 24 | 30 | 32¼ | - | 151 | 23.1 | T\$ 1531 P\$ 1714 |
| For Use with Extended Corner and Standard Corner Units; Left to Right Grain Direction | | | | | | | | | | |
| | 68-2442LF2 | 68-2442RF2 | 42 | 24 | 30 | 26¼ | - | 133 | 20.4 | T\$ 1469 P\$ 1635 |
| Front to Back Grain Direction on Worksurface | | | | | | | | | | |
| | 68-4224LF2 | 68-4224RF2 | 42 | 24 | 30 | 26¼ | - | 133 | 20.4 | T\$ 1469 P\$ 1635 |
| For Use with Extended Corner and Standard Corner Units; Left to Right Grain Direction | | | | | | | | | | |

Must Specify (in this order):

- Model #
- Top Material
- Top Color
- Edge Profile
- Chassis Color
- Drawer
 - Color
 - Grain Direction (if applicable)
 - Construction
 - Track
- Pull
- Back Panel Grommet Color
- Worksurface Grommet Location
- Grommet Color
- Power/Data Options
- Kneespace Options

Description

- Standard with: Letter Width Locking File/File Pedestal, Wire Management from Pedestal to Kneespace
- Available with TFL (T) or HPL (P) Top; Must Specify
- Back Panel Grommet Standard; Must Specify: Black (BLK), Silver (SLV) or No Back Panel Grommet (NONE)
- Drawer Front Grain Direction Vertical Standard; Optional Horizontal Grain Direction
- Top, Chassis, and Drawer Fronts Available in Contrasting Colors; Must Specify Color of Each Component
- [Height Adjustable Units Available](#)
- Additional Options: Dove Tail Drawer Construction and Soft Close Drawers ([See Drawer Details](#)); Power and Grommet Options ([See Options and Locations](#)); Kneespace Options (Sold Separately, [See Unit Details](#))

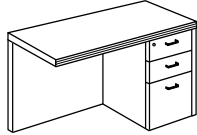
| Item | Model No. | Width | Depth | Height | K | R | Ship Wt | Cubic Ft | List Price | |
|---|--|------------------|-------|--------|----|-----|---------|----------|------------|----------------------|
|  RETURN WITH BOX/BOX/FILE Shown as Right | Left Ped | Right Ped | | | | | | | | |
| | 68-2448LF1 | 68-2448RF1 | 48 | 24 | 30 | 32¼ | - | 151 | 23.1 | T\$ 1531 P\$ 1714 |
| | Front to Back Grain Direction on Worksurface | | | | | | | | | |
| | 68-4824LF1 | 68-4824RF1 | 48 | 24 | 30 | 32¼ | - | 151 | 23.1 | T\$ 1531 P\$ 1714 |
| For Use with Extended Corner and Standard Corner Units; Left to Right Grain Direction | | | | | | | | | | |
| | 68-2442LF1 | 68-2442RF1 | 42 | 24 | 30 | 26¼ | - | 133 | 20.4 | T\$ 1469 P\$ 1635 |
| Front to Back Grain Direction on Worksurface | | | | | | | | | | |
| | 68-4224LF1 | 68-4224RF1 | 42 | 24 | 30 | 26¼ | - | 133 | 20.4 | T\$ 1469 P\$ 1635 |
| For Use with Extended Corner and Standard Corner Units; Left to Right Grain Direction | | | | | | | | | | |

Must Specify (in this order):

- Model #
- Top Material
- Top Color
- Edge Profile
- Chassis Color
- Drawer
 - Color
 - Grain Direction (if applicable)
 - Construction
 - Track
- Pull
- Back Panel Grommet Color
- Worksurface Grommet Location
- Grommet Color
- Power/Data Options
- Kneespace Options

Description

- Standard with: Letter Width Locking Box/Box/File Pedestal, Wire Management from Pedestal to Kneespace
- Available with TFL (T) or HPL (P) Top; Must Specify
- Back Panel Grommet Standard; Must Specify: Black (BLK), Silver (SLV) or No Back Panel Grommet (NONE)
- Drawer Front Grain Direction Vertical Standard; Optional Horizontal Grain Direction
- Top, Chassis, and Drawer Fronts Available in Contrasting Colors; Must Specify Color of Each Component
- [Height Adjustable Units Available](#)
- Additional Options: Dove Tail Drawer Construction and Soft Close Drawers ([See Drawer Details](#)); Power and Grommet Options ([See Options and Locations](#)); Kneespace Options (Sold Separately, [See Unit Details](#))

Pricing Codes:

- T= TFL
- P= HPL

[See Canvas Intro Section for Ordering Options](#)

| Item | Model No. | Width | Depth | Height | K | R | Ship Wt | Cubic Ft | List Price | |
|--|------------------|------------|-------|--------|----|----|---------|----------|------------|----------------------|
| MULTI-FILE RETURN WITH BOX/BOX/FILE/LATERAL | Left Ped | | | | | | | | | |
| | Right Ped | | | | | | | | | |
| | 66-2472LMR | 66-2472RMR | 72 | 24 | 30 | 36 | - | 280 | 33.6 | T\$ 2902 P\$ 3141 |

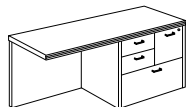

Shown as Right

Must Specify (in this order):

- Model #
- Top Material
- Top Color
- Edge Profile
- Chassis Color
- Drawer
 - Color
 - Grain Direction (if applicable)
 - Construction
 - Track
- Pull
- Back Panel Grommet Color
- Worksurface Grommet Location
- Grommet Color
- Power/Data Options
- Kneespace Options

Description

- Standard with: Box/Box/File/Lateral Pedestal, Locking File Drawer, Side-to-Side Grain Direction on Worksurface, Wire Management from Pedestal to Kneespace
- Available with TFL (T) or HPL (P) Top; Must Specify
- Back Panel Grommet Standard; Must Specify: Black (BLK), Silver (SLV) or No Back Panel Grommet (NONE)
- Drawer Front Grain Direction Vertical Standard; Optional Horizontal Grain Direction
- Top, Chassis, and Drawer Fronts Available in Contrasting Colors; Must Specify Color of Each Component
- [Height Adjustable Units Available](#)
- Additional Options: Dove Tail Drawer Construction and Soft Close Drawers ([See Drawer Details](#)); Power and Grommet Options ([See Options and Locations](#)); Kneespace Options (Sold Separately, [See Unit Details](#))

| | | | | | | | | | |
|---------------------------------|-----------|----|----|----|----|---|----|-----|--------------------|
| BRIDGE WITH FULL MODESTY | 66-2448UF | 48 | 24 | 30 | 48 | - | 82 | 5.3 | T\$ 698 P\$ 884 |
| | 66-2442UF | 42 | 24 | 30 | 42 | - | 68 | 4.7 | T\$ 673 P\$ 839 |
| | 66-2436UF | 36 | 24 | 30 | 36 | - | 46 | 4.1 | T\$ 637 P\$ 788 |
| | 66-2048UF | 48 | 20 | 30 | 48 | - | 77 | 5.3 | T\$ 650 P\$ 812 |
| | 66-2042UF | 42 | 20 | 30 | 42 | - | 64 | 4.7 | T\$ 628 P\$ 778 |
| | 66-2036UF | 36 | 20 | 30 | 36 | - | 43 | 4.1 | T\$ 597 P\$ 728 |

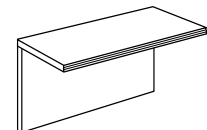

Must Specify (in this order):

- Model #
- Top Material
- Top Color
- Edge Profile
- Chassis Color
- Back Panel Grommet Color
- Worksurface Grommet Location
- Grommet Color
- Power/Data Options
- Kneespace Options

Description

- Standard with: Front to Back Grain Direction on Worksurface, Hinged Back Panel
- Available with TFL (T) or HPL (P) Top; Must Specify
- Back Panel Grommet Standard; Must Specify: Black (BLK), Silver (SLV) or No Back Panel Grommet (NONE)
- Top and Chassis Available in Contrasting Colors; Must Specify Color of Each Component
- [Height Adjustable Units Available](#)
- Keyboard Accessories Cannot be Factory Installed but are Available for Field Installation ([See Multiple Unit Details](#))
- Additional Options: Power and Grommet Options ([See Options and Locations](#))

Pricing Codes:

T= TFL
P= HPL

[See Canvas Intro Section for Ordering Options](#)

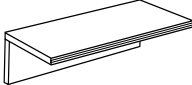
| Item | Model No. | Width | Depth | Height | K | R | Ship Wt | Cubic Ft | List Price |
|---|------------|-------|-------|--------|----|---|---------|----------|--------------------|
|  <p>BRIDGE WITH HALF MODESTY</p> | 66-2448UFH | 48 | 24 | 11 | 48 | - | 78 | 5.3 | T\$ 661 P\$ 843 |
| | 66-2442UFH | 42 | 24 | 11 | 42 | - | 74 | 4.6 | T\$ 632 P\$ 799 |
| | 66-2436UFH | 36 | 24 | 11 | 36 | - | 35 | 4.1 | T\$ 598 P\$ 750 |
| | 66-2048UFH | 48 | 20 | 11 | 48 | - | 73 | 5.3 | T\$ 610 P\$ 774 |
| | 66-2042UFH | 42 | 20 | 11 | 42 | - | 61 | 4.7 | T\$ 588 P\$ 735 |
| | 66-2036UFH | 36 | 20 | 11 | 36 | - | 32 | 4.1 | T\$ 561 P\$ 692 |

Must Specify (in this order):

- Model #
- Top Material
- Top Color
- Edge Profile
- Chassis Color
- Worksurface Grommet Location
- Grommet Color
- Power/Data Options
- Kneespace Options

Description

- Standard with: Front to Back Grain Direction on Worksurface, Hinged Back Panel
- Available with TFL (T) or HPL (P) Top; Must Specify
- Top and Chassis Available in Contrasting Colors; Must Specify Color of Each Component
- Keyboard Accessories Cannot be Factory Installed but are Available for Field Installation ([See Multiple Unit Details](#))
- Additional Options: Power and Grommet Options ([See Options and Locations](#))

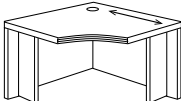
| Item | Model No. | Width | Depth | Height | K | R | Ship Wt | Cubic Ft | List Price |
|---|------------|-------|-------|--------|---------------------------------|---|---------|----------|----------------------|
|  <p>CORNER UNITS</p> | 66-4242CU | 42 | 42 | 30 | 25 ⁷ / ₁₆ | - | 145 | 34.5 | T\$ 1495 P\$ 1720 |
| | 66-4242CCU | 42 | 42 | 30 | 25 ⁷ / ₁₆ | - | 145 | 34.5 | T\$ 1846 P\$ 2120 |
| | 66-3636CU | 36 | 36 | 30 | 17 | - | 109 | 26.3 | T\$ 1241 P\$ 1422 |
| | 66-3636CCU | 36 | 36 | 30 | 17 | - | 109 | 26.3 | T\$ 1601 P\$ 1821 |

Shown as Curved

Must Specify (in this order):

- Model #
- Top Material
- Top Color
- Edge Profile
- Chassis Color
- Worksurface Grommet Color

Description

- Available with TFL (T) or HPL (P) Top; Must Specify
- Freestanding Support Unit
- Connects to 24" Deep Worksurfaces
- Surface Grommet Standard in Top; Must Specify: Black (BLK) or Silver (SLV)
- Top and Chassis Available in Contrasting Colors; Must Specify Color of Each Component
- Grain Direction Runs as Shown on Worksurface

Pricing Codes:

- T= TFL
- P= HPL

[See Canvas Intro Section for Ordering Options](#)

| Item | Model No. | Width | Depth | Height | K | R | Ship Wt | Cubic Ft | List Price |
|-----------------------------|-------------|--------------|-------|--------|----|---|---------|----------|------------|
| EXTENDED CORNER UNIT | Left | Right | | | | | | | |
| | 66-4854ECCL | 66-4854ECCR | 48 | 54 | 30 | - | - | 174 | 41.1 |

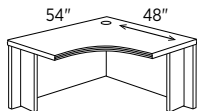

Shown as Right

Description

- Available with TFL (T) or HPL (P) Top; Must Specify
- Surface Grommet Standard in Top; Must Specify: Black (BLK), Silver (SLV)
- Top and Chassis Available in Contrasting Colors; Must Specify Color of Each Component
- Grain Direction Runs as Shown on Worksurface

Must Specify (in this order):

- Model #
- Top Material
- Top Color
- Edge Profile
- Chassis Color
- Worksurface Grommet Color

| SINGLE PED CREENZA FILE/FILE | Left Ped | Right Ped | | | | | | | | |
|---|-----------------|------------------|----|----|-----|-----|-----|------|----------------------|----------------------|
| | 68-2472LC2 | 68-2472RC2 | 72 | 24 | 30 | 32¼ | - | 199 | 35.6 | T\$ 1929 P\$ 2166 |
| 68-2466LC2 | 68-2466RC2 | 66 | 24 | 30 | 26¼ | - | 182 | 32.7 | T\$ 1909 P\$ 2135 | |

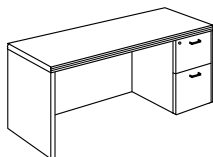

Shown as Right

Description

- Standard with: Letter Width Locking File/File Pedestal, Left to Right Grain Direction on Worksurface, Wire Management from Pedestal to Kneespace
- Available with TFL (T) or HPL (P) Top; Must Specify
- Back Panel Grommet Standard; Must Specify: Black (BLK), Silver (SLV) or No Back Panel Grommet (NONE)
- Drawer Front Grain Direction Vertical Standard; Optional Horizontal Grain Direction
- Top, Chassis, and Drawer Fronts Available in Contrasting Colors; Must Specify Color of Each Component
- [Height Adjustable Units Available](#)
- Additional Options: Dove Tail Drawer Construction and Soft Close Drawers ([See Drawer Details](#)); Power and Grommet Options ([See Options and Locations](#)); Kneespace Options (Sold Separately, [See Unit Details](#))

Must Specify (in this order):

- Model #
- Top Material
- Top Color
- Edge Profile
- Chassis Color
- Drawer
 - Color
 - Grain Direction (if applicable)
 - Construction
 - Track
- Pull
- Back Panel Grommet Color
- Worksurface Grommet Location
- Grommet Color
- Power/Data Options
- Kneespace Options

Pricing Codes:

- T= TFL
- P= HPL

[See Canvas Intro Section for Ordering Options](#)

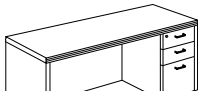
| Item | Model No. | Width | Depth | Height | K | R | Ship Wt | Cubic Ft | List Price | |
|--|-----------------|------------------|-------|--------|----|-----|---------|----------|------------|----------------------|
| SINGLE PED CREDENZA BOX/BOX/FILE  | Left Ped | Right Ped | | | | | | | | |
| | 68-2472LC1 | 68-2472RC1 | 72 | 24 | 30 | 32¼ | - | 199 | 35.6 | T\$ 1929 P\$ 2166 |
| | 68-2466LC1 | 68-2466RC1 | 66 | 24 | 30 | 26¼ | - | 182 | 32.7 | T\$ 1909 P\$ 2135 |

Shown as Right

Must Specify (in this order):

- Model #
- Top Material
- Top Color
- Edge Profile
- Chassis Color
- Drawer
 - Color
 - Grain Direction (if applicable)
 - Construction
 - Track
- Pull
- Back Panel Grommet Color
- Worksurface Grommet Location
- Grommet Color
- Power/Data Options
- Kneespace Options

Description

- Standard with: Letter Width Locking Box/Box/File Pedestal, Left to Right Grain Direction on Worksurface, Wire Management from Pedestal to Kneespace
- Available with TFL (T) or HPL (P) Top; Must Specify
- Back Panel Grommet Standard; Must Specify: Black (BLK), Silver (SLV) or No Back Panel Grommet (NONE)
- Drawer Front Grain Direction Vertical Standard; Optional Horizontal Grain Direction
- Top, Chassis, and Drawer Fronts Available in Contrasting Colors; Must Specify Color of Each Component
- [Height Adjustable Units Available](#)
- Additional Options: Dove Tail Drawer Construction and Soft Close Drawers ([See Drawer Details](#)); Power and Grommet Options ([See Options and Locations](#)); Kneespace Options (Sold Separately, [See Unit Details](#))

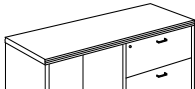
| | | | | | | | | | | |
|--|-----------------|------------------|----|----|----|----|---|-----|------|----------------------|
| SINGLE PED CREDENZA LATERAL FILE  | Left Ped | Right Ped | | | | | | | | |
| | 66-2472LL | 66-2472RL | 72 | 24 | 30 | 12 | - | 277 | 35.6 | T\$ 2533 P\$ 2773 |
| | 66-2466LL | 66-2466RL | 66 | 24 | 30 | 6 | - | 264 | 32.7 | T\$ 2500 P\$ 2726 |

Shown as Right

Must Specify (in this order):

- Model #
- Top Material
- Top Color
- Edge Profile
- Chassis Color
- Drawer
 - Color
 - Grain Direction (if applicable)
 - Construction
- Pull
- Back Panel Grommet Color
- Worksurface Grommet Location
- Grommet Color
- Power/Data Options

Description

- Standard with: Central Locking Lateral File, Left to Right Grain Direction on Worksurface
- Available with TFL (T) or HPL (P) Top; Must Specify
- Back Panel Grommet Standard; Must Specify: Black (BLK), Silver (SLV) or No Back Panel Grommet (NONE)
- Drawer Front Grain Direction Vertical Standard; Optional Horizontal Grain Direction
- Top, Chassis, and Drawer Fronts Available in Contrasting Colors; Must Specify Color of Each Component
- Additional Options: Dove Tail Drawer Construction ([See Drawer Details](#)); Power and Grommet Options ([See Options and Locations](#)); Kneespace Options (Sold Separately, [See Unit Details](#))

Pricing Codes:

T= TFL
P= HPL

[See Canvas Intro Section for Ordering Options](#)

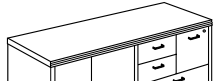
| Item | Model No. | Width | Depth | Height | K | R | Ship Wt | Cubic Ft | List Price | |
|---|-----------------|------------------|-------|--------|----|----|---------|----------|------------|----------------------|
| MULTI-FILE CREDENZA WITH BOX/BOX/FILE/LATERAL  | Left Ped | Right Ped | | | | | | | | |
| | 66-2472LMF | 66-2472RMF | 72 | 24 | 30 | 12 | - | 277 | 35.6 | T\$ 2658 P\$ 2895 |
| | 66-2466LMF | 66-2466RMF | 66 | 24 | 30 | 6 | - | 264 | 32.7 | T\$ 2623 P\$ 2851 |

Shown as Right

Must Specify (in this order):

Model #
 Top Material
 Top Color
 Edge Profile
 Chassis Color
 Drawer
 Color
 Grain Direction (if applicable)
 Construction
 Box and File Drawer Track
 Pull
 Back Panel Grommet Color
 Worksurface Grommet Location
 Grommet Color
 Power/Data Options

Description

- Standard with: Letter Width Locking Box/Box/File/Lateral Pedestal, Left to Right Grain Direction on Worksurface, Wire Management from Pedestal to Kneespace
- Available with TFL (T) or HPL (P) Top; Must Specify
- Back Panel Grommet Standard; Must Specify: Black (BLK), Silver (SLV) or No Back Panel Grommet (NONE)
- Drawer Front Grain Direction Vertical Standard; Optional Horizontal Grain Direction
- Top, Chassis, and Drawer Fronts Available in Contrasting Colors; Must Specify Color of Each Component
- Additional Options: Dove Tail Drawer Construction and Soft Close Box and File Drawers ([See Drawer Details](#)); Power and Grommet Options ([See Options and Locations](#)); Kneespace Options (Sold Separately, [See Unit Details](#))

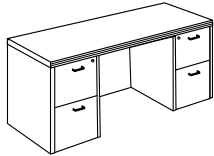
| | | | | | | | | | |
|--|-----------|----|----|----|----|---|-----|------|----------------------|
| KNEESPACE CREDENZA  | 68-2472KC | 72 | 24 | 30 | 39 | - | 240 | 35.6 | T\$ 2697 P\$ 2935 |
| | 68-2466KC | 66 | 24 | 30 | 33 | - | 220 | 32.7 | T\$ 2508 P\$ 2733 |

Must Specify (in this order):

Model #
 Top Material
 Top Color
 Edge Profile
 Chassis Color
 Drawer
 Color
 Grain Direction (if applicable)
 Construction
 Track
 Pull
 Back Panel Grommet Color
 Worksurface Grommet Location
 Grommet Color
 Power/Data Options
 Kneespace Options

Description

- Standard with: Letter Width Locking File/File Pedestals, Left to Right Grain Direction on Worksurface, Wire Management from Pedestal to Kneespace
- Available with TFL (T) or HPL (P) Top; Must Specify
- Modesty Panel Grommet Standard; Must Specify: Black (BLK), Silver (SLV) or No Back Panel Grommet (NONE)
- Drawer Front Grain Direction Vertical Standard; Optional Horizontal Grain Direction
- Top, Chassis, and Drawer Fronts Available in Contrasting Colors; Must Specify Color of Each Component
- [Height Adjustable Units Available](#)
- Additional Options: Dove Tail Drawer Construction and Soft Close Drawers ([See Drawer Details](#)); Power and Grommet Options ([See Options and Locations](#)); Kneespace Options (Sold Separately, [See Unit Details](#))

Pricing Codes:

T= TFL
 P= HPL

[See Canvas Intro Section for Ordering Options](#)

| Item | Model No. | Width | Depth | Height | K | R | Ship Wt | Cubic Ft | List Price |
|------------------|-----------|-------|-------|--------|---|---|---------|----------|----------------------|
| STORAGE CREDENZA | 68-2472SC | 72 | 24 | 30 | - | - | 285 | 35.6 | T\$ 2913 P\$ 3151 |
| | 68-2466SC | 66 | 24 | 30 | - | - | 261 | 32.7 | T\$ 2797 P\$ 3020 |

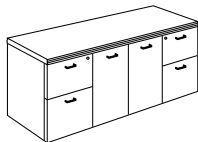

Must Specify (in this order):

Model #
Top Material
Top Color
Edge Profile
Chassis Color
Drawer
Color
Grain Direction (if applicable)
Construction
Track
Pull
Locking Doors

Description

- Standard with: Letter Width, File/File Locking Pedestals, One (1) Fixed Shelf Behind Doors, Top Profiles on Front Only Left to Right Grain Direction on Top Surface
- Available with TFL (T) or HPL (P) Top; Must Specify
- Drawer/Door Front Grain Direction Vertical Standard; Optional Horizontal Grain Direction
- Top, Chassis, and Drawer/Door Fronts Available in Contrasting Colors; Must Specify Color of Each Component
- Optional Locking Doors, Must Specify (LKT-DB) and Add \$108; [See Locking Options](#) For More Details
- Additional Options: Dove Tail Drawer Construction and Soft Close Drawers ([See Drawer Options](#))

| | | | | | | | | | |
|--------------------|-----------|----|----|----|---|---|-----|------|----------------------|
| FOUR DOOR CREDENZA | 66-2472CC | 72 | 24 | 30 | - | - | 290 | 34.2 | T\$ 2692 P\$ 2911 |
| | 66-2466CC | 66 | 24 | 30 | - | - | 246 | 33.0 | T\$ 2574 P\$ 2782 |

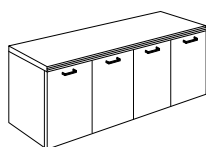

Must Specify (in this order):

Model #
Top Material
Top Color
Edge Profile
Chassis Color
Door
Color
Grain Direction (if applicable)
Pull
Locking Doors

Description

- Standard with: Four (4) Doors, One (1) Adjustable Shelf Behind Each Set of Doors, Top Profiles on Front Only, Left to Right Grain Direction on Top Surface
- Available with TFL (T) or HPL (P) Top; Must Specify
- Door Front Grain Direction Vertical Standard; Optional Horizontal Grain Direction
- Top, Chassis, and Door Fronts Available in Contrasting Colors; Must Specify Color of Each Component
- Optional Locking Doors Available; [See Locking Options](#)

| | | | | | | | | | |
|-----------------|-----------|----|----|----|---|---|-----|------|----------------------|
| BUFFET CREDENZA | 66-2472BF | 72 | 24 | 36 | - | - | 342 | 45.5 | T\$ 3388 P\$ 3625 |
|-----------------|-----------|----|----|----|---|---|-----|------|----------------------|

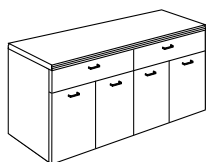

Must Specify (in this order):

Model #
Top Material
Top Color
Edge Profile
Chassis Color
Drawer
Color
Grain Direction (if applicable)
Construction
Track
Pull
Locking Doors

Description

- Standard with: Two (2) Drawers, Four (4) Doors, One (1) Adjustable Shelf Behind Doors Each Set of Doors, Left to Right Grain Direction on Top Surface
- Available with TFL (T) or HPL (P) Top; Must Specify
- Drawer/Door Front Grain Direction Vertical Standard; Optional Horizontal Grain Direction
- Top, Chassis, and Drawer/Door Fronts Available in Contrasting Colors; Must Specify Color of Each Component
- Optional Locking Doors Available; [See Locking Options](#) For More Details
- Additional Options: Dove Tail Drawer Construction and Soft Close Box Drawers ([See Drawer Options](#))

Pricing Codes:

T= TFL
P= HPL

[See Canvas Intro Section for Ordering Options](#)

| Item | Model No. | Width | Depth | Height | K | R | Ship Wt | Cubic Ft | List Price |
|-------------------------|-----------|-------|-------|--------|---|---|---------|----------|----------------------|
| DOUBLE LATERAL CREDENZA | 66-2472DL | 72 | 24 | 30 | - | - | 360 | 35.7 | T\$ 3507 P\$ 3747 |

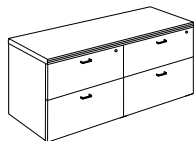

Must Specify (in this order):

- Model #
- Top Material
- Top Color
- Edge Profile
- Chassis Color
- Drawer Color
- Grain Direction (if applicable)
- Construction
- Pull

Description

- Standard with: Legal or Letter Filing, Dual Locking, Left to Right Grain Direction on Top Surface
- Available with TFL (T) or HPL (P) Top; Must Specify
- ¼" Thick Drawer Bottoms Allow for Storage Applications
- Drawer Front Grain Direction Vertical Standard; Optional Horizontal Grain Direction
- Top, Chassis, Drawer Fronts Available in Contrasting Colors; Must Specify Color of Each Component

| | | | | | | | | | |
|-------------------------------------|---------------|--|--|----|----|-----|-----|------|----------------------|
| 21" LOW CREDENZA DOUBLE BOX/FILE | 66-2472L2IDBF | | | 72 | 24 | 21¾ | 250 | 25.6 | T\$ 3332 P\$ 3568 |
| | 66-2460L2IDBF | | | 60 | 24 | 21¾ | 230 | 22.4 | T\$ 2968 P\$ 3187 |
| | 66-2072L2IDBF | | | 72 | 20 | 21¾ | 240 | 21.1 | T\$ 3223 P\$ 3435 |
| | 66-2060L2IDBF | | | 60 | 20 | 21¾ | 210 | 18.9 | T\$ 2935 P\$ 3125 |

Must Specify (in this order):

- Model #
- Top Material
- Top Color
- Edge Profile
- Chassis Color
- Drawer Color
- Grain Direction (if applicable)
- Construction
- Box Drawer Track
- Pull
- Power/Data Options
- Grommet Location/Color

Description

- Standard with: Legal or Letter Filing, Dual Locking Box/File Drawers, Left to Right Grain Direction on Top Surface
- Available with TFL (T) or HPL (P) Top; Must Specify
- ¼" Thick Drawer Bottoms Allow for Storage Applications
- Drawer Front Grain Direction Vertical Standard; Optional Horizontal Grain Direction
- Top, Chassis, Drawer Fronts Available in Contrasting Colors; Must Specify Color of Each Component
- Additional Options: Dove Tail Drawer Construction ([See Drawer Options](#)), Soft Close Box Drawers ([See Soft Close Option](#)), Power and Grommet Options ([See Options and Locations](#)); Dock 950 and Dock 150 Wireless Chargers ([See Multiple Unit Details](#))

| 21" LOW CREDENZA BOX/FILE/OPEN BOOKCASE | Left Box/File | Right Box/File | Width | Depth | Height | K | R | Ship Wt | Cubic Ft | List Price |
|--|----------------|----------------|-------|-------|--------|-----|------|----------------------|----------|------------|
| | | | | | | | | | | |
| Shown as Right | 66-2472L21OBFL | 66-2472L21OBFR | 72 | 24 | 21¾ | 230 | 25.6 | T\$ 2535 P\$ 2775 | | |
| | 66-2460L21OBFL | 66-2460L21OBFR | 60 | 24 | 21¾ | 210 | 22.4 | T\$ 2320 P\$ 2538 | | |
| | 66-2072L21OBFL | 66-2072L21OBFR | 72 | 20 | 21¾ | 220 | 21.1 | T\$ 2419 P\$ 2631 | | |
| | 66-2060L21OBFL | 66-2060L21OBFR | 60 | 20 | 21¾ | 200 | 18.9 | T\$ 2199 P\$ 2391 | | |

Must Specify (in this order):

- Model #
- Top Material
- Top Color
- Edge Profile
- Chassis Color
- Drawer Color
- Grain Direction (if applicable)
- Construction
- Box Drawer Track
- Pull
- Power/Data Options
- Grommet Location/Color

Description

- Standard with: Legal or Letter Filing, Locking Box/File with Open Bookcase, Adjustable Bookcase Shelf on Open Side, Left to Right Grain Direction on Top Surface
- Available with TFL (T) or HPL (P) Top; Must Specify
- ¼" Thick Drawer Bottoms Allow for Storage Applications
- Back Panel Grommet Standard; Must Specify Black or Silver
- Drawer Front Grain Direction Vertical Standard; Optional Horizontal Grain Direction
- Top, Chassis, Drawer Fronts Available in Contrasting Colors; Must Specify Color of Each Component
- Additional Options: Dove Tail Drawer Construction ([See Drawer Options](#)), Soft Close Box Drawers ([See Soft Close Option](#)), Power and Grommet Options ([See Options and Locations](#)); Dock 950 and Dock 150 Wireless Chargers ([See Multiple Unit Details](#))

Pricing Codes:

T= TFL
P= HPL

[See Canvas Intro Section for Ordering Options](#)

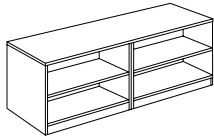
| Item | Model No. | Width | Depth | Height | Ship Wt | Cubic Ft | List Price |
|---|--------------|-------|-------|--------|---------|----------|----------------------|
| 21" LOW CREDENZA DOUBLE OPEN BOOKCASE  | 66-2472L21DO | 72 | 24 | 21¾ | 210 | 25.6 | T\$ 2072 P\$ 2310 |
| | 66-2460L21DO | 60 | 24 | 21¾ | 200 | 22.4 | T\$ 1873 P\$ 2065 |
| | 66-2072L21DO | 72 | 20 | 21¾ | 200 | 21.1 | T\$ 1931 P\$ 2142 |
| | 66-2060L21DO | 60 | 20 | 21¾ | 190 | 18.9 | T\$ 1762 P\$ 1951 |

Must Specify (in this order):

- Model #
- Top Material
- Top Color
- Edge Profile
- Chassis Color
- Power/Data Options
- Grommet Location/Color

Description

- Standard with: Open Bookcases, One Adjustable Shelf on Each Side, Left to Right Grain Direction on Top Surface
- Available with TFL (T) or HPL (P) Top; Must Specify
- Back Panel Grommet Standard; Must Specify Black or Silver
- Top and Chassis Available in Contrasting Colors; Must Specify Color of Each Component
- Additional Options: Power and Grommet Options ([See Options and Locations](#)); Dock 950 and Dock 150 Wireless Chargers ([See Multiple Unit Details](#))

LATERAL FILE

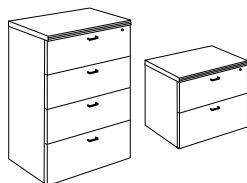

| | | | | | | |
|------------------------------------|----|----|-----|-----|------|----------------------|
| 66-2436L4 Four Lateral Drawers | 36 | 24 | 57½ | 312 | 32.6 | T\$ 3018 P\$ 3165 |
| 66-2430L4 Four Lateral Drawers | 30 | 24 | 57½ | 260 | 27.5 | T\$ 2877 P\$ 3018 |
| 66-2436L3 Three Lateral Drawers | 36 | 24 | 43¾ | 170 | 24.2 | T\$ 2419 P\$ 2567 |
| 66-2430L3 Three Lateral Drawers | 30 | 24 | 43¾ | 155 | 20.4 | T\$ 2294 P\$ 2437 |
| 66-2436L2 Two Lateral Drawers | 36 | 24 | 30 | 184 | 18.3 | T\$ 1598 P\$ 1744 |
| 66-2430L2 Two Lateral Drawers | 30 | 24 | 30 | 153 | 15.6 | T\$ 1517 P\$ 1659 |

Must Specify (in this order):

- Model #
- Top Material
- Top Color
- Edge Profile
- Chassis Color
- Drawer Color
- Grain Direction (if applicable)
- Construction
- Pull

Description

- Standard with: Central Locking, Anti-Tilt System, Legal or Letter Filing Front to Back or Side to Side
- Available with TFL (T) or HPL (P) Top; Must Specify
- ¼" Thick Drawer Bottoms Allow for Storage Applications
- Drawer Front Grain Direction Vertical Standard; Optional Horizontal Grain Direction
- Top, Chassis, Drawer Fronts Available in Contrasting Colors; Must Specify Color of Each Component
- Additional Options: Dove Tail Drawer Construction ([See Drawer Options](#))

MULTI-FILE

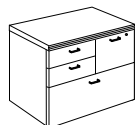

| | | | | | | |
|-----------|----|----|----|-----|------|----------------------|
| 66-2436MF | 36 | 24 | 30 | 184 | 18.3 | T\$ 1714 P\$ 1864 |
| 66-2430MF | 30 | 24 | 30 | 148 | 15.6 | T\$ 1626 P\$ 1770 |

Description

- Standard with: Box/Box/File/Lateral File, Locking File Drawer, Lateral File Provides Legal or Letter Filing
- Available with TFL (T) or HPL (P) Top; Must Specify
- Drawer Front Grain Direction Vertical Standard; Optional Horizontal Grain Direction
- Top, Chassis, Drawer Fronts Available in Contrasting Colors; Must Specify Color of Each Component
- Additional Options: Dove Tail Drawer Construction ([See Drawer Options](#)), Soft Close Box and File Drawers ([See Soft Close Option](#))

Must Specify (in this order):

- Model #
- Top Material
- Top Color
- Edge Profile
- Chassis Color
- Drawer Color
- Grain Direction (if applicable)
- Construction
- Box and File Drawer Track
- Pull

Pricing Codes:

- T= TFL
- P= HPL

[See Canvas Intro Section for Ordering Options](#)

| Item | Model No. | Width | Depth | Height | Ship Wt | Cubic Ft | List Price |
|-----------------------------|-----------|-------|-------|--------|---------|----------|------------|
| MOBILE PEDESTAL BOX/FILE | 66-1519MP | 15¾ | 19 | 23 | 85 | 9.0 | T\$ 1226 |

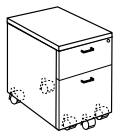

Must Specify (in this order):

Model #
Chassis and Top Color
Drawer
Color
Grain Direction (if applicable)
Construction
Track
Pull

Description

- Standard with: Locking Box/File Drawers, Black Plastic Pen Tray, Letter Width Pedestal, and Five Casters
- Fits Underneath 30"H Worksurface with Optional Cushion
- Optional Cushion Increases Height 2¼"; See [66-1519CUSHION](#)
- Drawer Front Grain Direction Vertical Standard; Optional Horizontal Grain Direction
- Drawer Fronts Available in Contrasting Colors; Must Specify
- Additional Options: Dove Tail Drawer Construction and Soft Close Drawers ([See Drawer Options](#))

| | | | | | | | |
|---------------------------------|------------|-----|----|-----|----|-----|----------|
| MOBILE PEDESTAL BOX/BOX/FILE | 66-1519MP1 | 15¾ | 19 | 27½ | 90 | 9.0 | T\$ 1277 |
|---------------------------------|------------|-----|----|-----|----|-----|----------|



Must Specify (in this order):

Model #
Chassis and Top Color
Drawer
Color
Grain Direction (if applicable)
Construction
Track
Pull

Description

- Standard with: Locking Box/Box/File Drawers, Black Plastic Pen Tray, Letter Width Pedestal, and Five Casters
- Optional Cushion Increases Height 2¼"; See [66-1519CUSHION](#)
- Fits Underneath 30"H Worksurface without Optional Cushion
- Drawer Front Grain Direction Vertical Standard; Optional Horizontal Grain Direction
- Drawer Fronts Available in Contrasting Colors; Must Specify
- Additional Options: Dove Tail Drawer Construction and Soft Close Drawers ([See Drawer Options](#))

| | | | | | | | |
|------------------------------|------------|-----|----|-----|----|-----|----------|
| MOBILE PEDESTAL FILE/FILE | 66-1519MP2 | 15¾ | 19 | 27½ | 90 | 9.0 | T\$ 1277 |
|------------------------------|------------|-----|----|-----|----|-----|----------|

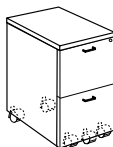

Must Specify (in this order):

Model #
Chassis and Top Color
Drawer
Color
Grain Direction (if applicable)
Construction
Track
Pull

Description

- Standard with: Locking File/File Drawers, Black Plastic Pen Tray, Letter Width Pedestal, and Five Casters
- Optional Cushion Increases Height 2¼"; See [66-1519CUSHION](#)
- Fits Underneath 30"H Worksurface without Optional Cushion
- Drawer Front Grain Direction Vertical Standard; Optional Horizontal Grain Direction
- Drawer Fronts Available in Contrasting Colors; Must Specify
- Additional Options: Dove Tail Drawer Construction and Soft Close Drawers ([See Drawer Options](#))

Pricing Codes:

T= TFL
P= HPL



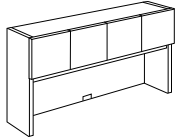
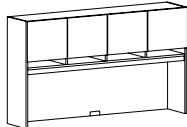

[See Canvas Intro Section for Ordering Options](#)

| Item | Model No. | Width | Depth | Height | Ship Wt | Cubic Ft | List Price |
|--|------------------------------|-------|-------|--------|---------|----------|------------|
| SURFACE MOUNT HUTCH HINGED DOOR  Must Specify (in this order): Model # Chassis and Top Color Door Style/Color Grain (if applicable) Locking Doors Paperslots Paperslot Divider Material/Color Tasklights Grommet Color Tackboard Fabric  Optional Paper Slots in laminate or chrome available; See Paper Slot Options Also available as 52 7/8" H Tall Surface Mount | 66-1596HU Six (6) Doors | 96 | 15 | 40 7/8 | 260 | 46.5 | T\$ 3019 |
| | 66-1590HU Five (5) Doors | 90 | 15 | 40 7/8 | 243 | 44.3 | T\$ 2822 |
| | 66-1584HU Five (5) Doors | 84 | 15 | 40 7/8 | 228 | 40.0 | T\$ 2433 |
| | 66-1578HU Four (4) Doors | 78 | 15 | 40 7/8 | 210 | 36.7 | T\$ 2371 |
| | 66-1572HU Four (4) Doors | 72 | 15 | 40 7/8 | 203 | 34.1 | T\$ 1998 |
| | 66-1566HU Four (4) Doors | 66 | 15 | 40 7/8 | 175 | 32.1 | T\$ 1930 |
| | 66-1560HU Four (4) Doors | 60 | 15 | 40 7/8 | 167 | 28.4 | T\$ 1895 |
| | 66-1554HU Three (3) Doors | 54 | 15 | 40 7/8 | 150 | 25.7 | T\$ 1763 |
| | 66-1548HU Three (3) Doors | 48 | 15 | 40 7/8 | 133 | 22.9 | T\$ 1627 |
| | 66-1542HU Two (2) Doors | 42 | 15 | 40 7/8 | 116 | 20.2 | T\$ 1222 |
| | 66-1536HU Two (2) Doors | 36 | 15 | 40 7/8 | 99 | 17.4 | T\$ 1064 |
| | 66-1530HU Two (2) Doors | 30 | 15 | 40 7/8 | 85 | 14.6 | T\$ 923 |

Description

- 23 3/4" Clearance Below Apron Rail
- Lower Center Grommet Standard; Must Specify: Black (BLK) or Silver (SLV)
- Safely Write on Dry Erase, White and Black Tempered Glass Doors with Our Dry Erase Marker Set; [See Sets](#)
- Door Fronts Available in Contrasting Colors; Must Specify Color
- Additional Support is Required when Surface Mounted Hutches Do Not Sit Directly Over an End Panel or Pedestal; [See 66-2812SP](#)
- Component Hutch Tops with Profiles are Available; [See Top Sizes](#)
- If Applicable, Door Front Grain Direction Vertical Standard; Optional Horizontal Grain Direction
- Additional Options: Paper Slots ([See Paper Slot Options](#)), Locking Doors ([See Locking Door Options](#)), Marker Boards, Work Wall, Tackboards, and Tasklights ([See Units](#)), Marker and Eraser Sets ([See Sets](#))

Options: Specify & Add

| | | Per Door |
|---|--|----------|
|  | 1-AD Aluminum Framed Satin Frosted Tempered Glass Doors (Non-Locking) | \$ 438 |
|  | 1-DEB Dry Erase Board Doors | \$ 28 |
|  | WHGLS Aluminum Framed Doors with White Tempered Glass (Non-locking) | \$ 652 |
|  | BLGLS Black Matte Framed Doors with Black Tempered Glass (Non-locking) | \$ 868 |
|  | 1-HGA High Gloss Acrylic Doors; Must Specify Color | |
| | (GPA) Graphite Acrylic | \$ 269 |
| | (BLA) Black, (WMA) Wired Mercury, or (WHA) White Acrylic | \$ 247 |

Pricing Codes:

T= TFL
P= HPL

[See Canvas Intro Section for Ordering Options](#)

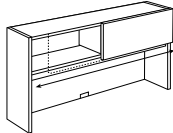
| Item | Model No. | Width | Depth | Height | Ship Wt | Cubic Ft | List Price |
|---|-----------------------------|-------|-------|--------|---------|----------|------------|
| SURFACE MOUNT HUTCH WITH SLIDING DOOR  | 66-1596SHU Two (2) Doors | 96 | 15 | 40 7/8 | 278 | 57.7 | T\$ 3288 |
| | 66-1590SHU Two (2) Doors | 90 | 15 | 40 7/8 | 260 | 53.7 | T\$ 3210 |
| | 66-1584SHU Two (2) Doors | 84 | 15 | 40 7/8 | 243 | 50.2 | T\$ 2757 |
| | 66-1578SHU One (1) Door | 78 | 15 | 40 7/8 | 226 | 46.7 | T\$ 2640 |
| | 66-1572SHU One (1) Door | 72 | 15 | 40 7/8 | 208 | 43.3 | T\$ 2311 |
| | 66-1566SHU One (1) Door | 66 | 15 | 40 7/8 | 190 | 39.7 | T\$ 2240 |
| | 66-1560SHU One (1) Door | 60 | 15 | 40 7/8 | 172 | 28.4 | T\$ 2223 |

Must Specify (in this order):
 Model #
 Chassis and Top Color
 Door
 Style/Color
 Grain (if applicable)
 Paperslots
 Paperslot Divider Material/Color
 Tasklights
 Grommet Color
 Tackboard Fabric

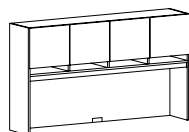

Optional Paper Slots in laminate or chrome available; [See Paper Slot Options](#)

Description

- Non-Locking Sliding Doors
- 23 3/4" Clearance Below Apron Rail
- Lower Center Grommet Standard; Must Specify: Black (BLK) or Silver (SLV)
- Safely Write on Dry Erase with Our Dry Erase Marker Set; [See Sets](#)
- Additional Support is Required when Surface Mounted Hutches Do Not Sit Directly Over an End Panel or Pedestal; [See 66-2812SP](#)
- Component Hutch Tops with Profiles are Available; [See Top Sizes](#)
- If Applicable, Door Front Grain Direction Vertical Standard; Optional Horizontal Grain Direction
- Door Fronts Available in Contrasting Colors; Must Specify Color
- Additional Options: Paper Slots ([See Paper Slot Options](#)), Marker Boards, Work Wall, Tackboards, and Tasklights ([See Units](#)), Marker and Eraser Sets ([See Sets](#))

Options: Specify & Add

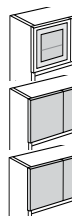

| | | Per Door |
|-------|--|----------|
| 1-AD | Aluminum Framed Satin Frosted Tempered Glass Doors (Non-Locking) | \$ 745 |
| 1-DEB | Dry Erase Board Door (Non-Locking) | \$ 77 |
| 1-HGA | High Gloss Acrylic Door (Non-Locking); Must Specify Color | |
| | (GPA) Graphite Acrylic | \$ 773 |
| | (BLA) Black, (WMA) Wired Mercury, or (WHA) White Acrylic | \$ 705 |

Pricing Codes:

T= TFL
 P= HPL

[See Canvas Intro Section for Ordering Options](#)

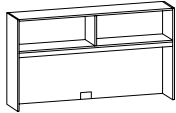
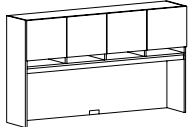
| Item | Model No. | Width | Depth | Height | Ship Wt | Cubic Ft | List Price |
|---|-------------------------------------|-------|-------|------------------|---------|----------|------------|
| SURFACE MOUNT HUTCH OPEN  Must Specify (in this order): Model # Chassis and Top Color Paperslots Paperslot Divider Material/Color Tasklights Grommet Color Tackboard Fabric  Optional Paper Slots in laminate or chrome available; See Paper Slot Options Also available as 52 $\frac{7}{8}$ " H Tall Surface Mount | 66-1596OH Three (3) Compartments | 96 | 15 | 40 $\frac{3}{8}$ | 158 | 41.5 | T\$ 2475 |
| | 66-1590OH Three (3) Compartments | 90 | 15 | 40 $\frac{3}{8}$ | 150 | 39.0 | T\$ 2316 |
| | 66-1584OH Three (3) Compartments | 84 | 15 | 40 $\frac{3}{8}$ | 142 | 36.7 | T\$ 1995 |
| | 66-1578OH Two (2) Compartments | 78 | 15 | 40 $\frac{3}{8}$ | 130 | 33.8 | T\$ 1944 |
| | 66-1572OH Two (2) Compartments | 72 | 15 | 40 $\frac{3}{8}$ | 121 | 30.7 | T\$ 1640 |
| | 66-1566OH Two (2) Compartments | 66 | 15 | 40 $\frac{3}{8}$ | 114 | 30.7 | T\$ 1581 |
| | 66-1560OH Two (2) Compartments | 60 | 15 | 40 $\frac{3}{8}$ | 106 | 28.4 | T\$ 1556 |
| | 66-1554OH Two (2) Compartments | 54 | 15 | 40 $\frac{3}{8}$ | 98 | 25.7 | T\$ 1443 |
| | 66-1548OH Two (2) Compartments | 48 | 15 | 40 $\frac{3}{8}$ | 89 | 21.2 | T\$ 1334 |
| | 66-1542OH One (1) Compartment | 42 | 15 | 40 $\frac{3}{8}$ | 77 | 18.6 | T\$ 1198 |
| | 66-1536OH One (1) Compartment | 36 | 15 | 40 $\frac{3}{8}$ | 69 | 16.0 | T\$ 1039 |
| | 66-1530OH One (1) Compartment | 30 | 15 | 40 $\frac{3}{8}$ | 61 | 13.5 | T\$ 904 |

Description

- 23 $\frac{3}{4}$ " Clearance Below Apron Rail
- Lower Center Grommet Standard; Must Specify: Black (BLK) or Silver (SLV)
- Additional Support is Required when Surface Mounted Hutches Do Not Sit Directly Over an End Panel or Pedestal; [See 66-2812SP](#)
- Component Hutch Tops with Profiles are Available; [See Top Sizes](#)
- Additional Options: Paper Slots ([See Paper Slot Options](#)), Marker Boards, Work Wall, Tackboards, and Tasklights ([See Units](#)), Marker and Eraser Sets ([See Set](#))

Pricing Codes:

T= TFL
P= HPL



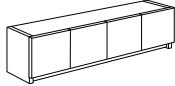

[See Canvas Intro Section for Ordering Options](#)

| Item | Model No. | Width | Depth | Height | Ship Wt | Cubic Ft | List Price |
|---|------------------------------|-------|-------|---------|---------|----------|------------|
| WALL MOUNT HUTCH HINGED DOORS  Must Specify (in this order): Model # Chassis and Top Color Door Style/Color Grain (if applicable) Locking Doors Also available as 29 3/16"H Tall Wall Mount | 66-1596WD Six (6) Doors | 96 | 15 | 17 3/16 | 158 | 17.3 | T\$ 2719 |
| | 66-1590WD Five (5) Doors | 90 | 15 | 17 3/16 | 148 | 16.2 | T\$ 2538 |
| | 66-1584WD Five (5) Doors | 84 | 15 | 17 3/16 | 138 | 15.2 | T\$ 2190 |
| | 66-1578WD Four (4) Doors | 78 | 15 | 17 3/16 | 128 | 14.1 | T\$ 2139 |
| | 66-1572WD Four (4) Doors | 72 | 15 | 17 3/16 | 118 | 13.1 | T\$ 1795 |
| | 66-1566WD Four (4) Doors | 66 | 15 | 17 3/16 | 105 | 12.0 | T\$ 1736 |
| | 66-1560WD Four (4) Doors | 60 | 15 | 17 3/16 | 96 | 11.0 | T\$ 1708 |
| | 66-1554WD Three (3) Doors | 54 | 15 | 17 3/16 | 87 | 9.9 | T\$ 1585 |
| | 66-1548WD Three (3) Doors | 48 | 15 | 17 3/16 | 77 | 8.9 | T\$ 1469 |
| | 66-1542WD Two (2) Doors | 42 | 15 | 17 3/16 | 67 | 7.8 | T\$ 1100 |
| | 66-1536WD Two (2) Doors | 36 | 15 | 17 3/16 | 58 | 6.7 | T\$ 958 |
| | 66-1530WD Two (2) Doors | 30 | 15 | 17 3/16 | 48 | 5.6 | T\$ 830 |

Description

- Component Hutch Tops with Profiles are Available; [See Top Sizes](#)
- If Applicable, Door Front Grain Direction Vertical Standard; Optional Horizontal Grain Direction
- Door Fronts Available in Contrasting Colors; Must Specify Color
- Safely Write on Dry Erase, White and Black Tempered Glass Doors with Our Dry Erase Marker Set; [See Sets](#)
- Indiana Furniture Will Not be Liable for Wall Mount Hutches that are not Properly Installed
- Additional Options: Locking Doors ([See Locking Door Options](#)), Marker Boards, Work Wall, Tackboards, and Tasklights ([See Units](#)), Marker and Eraser Sets ([See Sets](#))

Options: Specify & Add

| | | Per Door |
|---|--|----------|
|  | 1-AD Aluminum Framed Satin Frosted Tempered Glass Doors (Non-Locking) | \$ 438 |
|  | 1-DEB Dry Erase Board Doors | \$ 28 |
|  | WHGLS Aluminum Framed Doors with White Tempered Glass (Non-locking) | \$ 652 |
|  | BLGLS Black Matte Framed Doors with Black Tempered Glass (Non-locking) | \$ 868 |
|  | 1-HGA High Gloss Acrylic Doors; Must Specify Color | |
| | (GPA) Graphite Acrylic | \$ 269 |
| | (BLA) Black, (WMA) Wired Mercury, or (WHA) White Acrylic | \$ 247 |

Pricing Codes:





T= TFL
P= HPL

[See Canvas Intro Section for Ordering Options](#)

| Item | Model No. | Width | Depth | Height | Ship Wt | Cubic Ft | List Price |
|---|---|-------|-------|--------|---------|----------|------------|
| WALL MOUNT HUTCH DOORS WITH PAPER SLOTS  Must Specify (in this order): Model # Chassis and Top Color Door Style/Color Grain (if applicable) Paperslot Divider Material/Color Also available as 33%*H Tall Wall Mount | 66-1596WDS Six (6) Doors / Six (6) Paper Slots | 96 | 15 | 21½ | 186 | 24.6 | T\$ 3838 |
| | 66-1590WDS Five (5) Doors / Five (5) Paper Slots | 90 | 15 | 21½ | 172 | 23.1 | T\$ 3611 |
| | 66-1584WDS Five (5) Doors / Five (5) Paper Slots | 84 | 15 | 21½ | 162 | 21.6 | T\$ 3198 |
| | 66-1578WDS Four (4) Doors / Four (4) Paper Slots | 78 | 15 | 21½ | 149 | 20.0 | T\$ 3090 |
| | 66-1572WDS Four (4) Doors / Four (4) Paper Slots | 72 | 15 | 21½ | 140 | 18.5 | T\$ 2687 |
| | 66-1566WDS Four (4) Doors / Four (4) Paper Slots | 66 | 15 | 21½ | 131 | 16.9 | T\$ 2577 |
| | 66-1560WDS Four (4) Doors / Four (4) Paper Slots | 60 | 15 | 21½ | 121 | 15.4 | T\$ 2497 |
| | 66-1554WDS Three (3) Doors / Three (3) Paper Slots | 54 | 15 | 21½ | 108 | 13.9 | T\$ 2321 |
| | 66-1548WDS Three (3) Doors / Three (3) Paper Slots | 48 | 15 | 21½ | 99 | 12.3 | T\$ 2150 |
| | 66-1542WDS Two (2) Doors / Two (2) Paper Slots | 42 | 15 | 21½ | 86 | 10.8 | T\$ 1734 |
| | 66-1536WDS Two (2) Doors / Two (2) Paper Slots | 36 | 15 | 21½ | 76 | 9.2 | T\$ 1541 |
| | 66-1530WDS Two (2) Doors / Two (2) Paper Slots | 30 | 15 | 21½ | 67 | 7.7 | T\$ 1364 |

Description

- Paper Slot Divider Color Must Specify: Chrome (CHRM) or Laminate (T) and Color
- Component Hutch Tops with Profiles are Available; [See Top Sizes](#)
- If Applicable, Door Front Grain Direction Vertical Standard; Optional Horizontal Grain Direction
- Door Fronts Available in Contrasting Colors; Must Specify Color
- Safely Write on Dry Erase, White and Black Tempered Glass Doors with Our Dry Erase Marker Set; [See Sets](#)
- Indiana Furniture Will Not be Liable for Wall Mount Hutches that are not Properly Installed
- Additional Options: Locking Doors ([See Locking Door Options](#)), Work Wall, Tackboards, and Tasklights ([See Units](#)), Marker and Eraser Sets ([See Sets](#))

| Options: Specify & Add | | | Per Door |
|---|-------|--|----------|
|  | 1-AD | Aluminum Framed Satin Frosted Tempered Glass Doors (Non-Locking) | \$ 438 |
|  | 1-DEB | Dry Erase Board Doors | \$ 28 |
|  | WHGLS | Aluminum Framed Doors with White Tempered Glass (Non-locking) | \$ 652 |
|  | BLGLS | Black Matte Framed Doors with Black Tempered Glass (Non-locking) | \$ 868 |
|  | 1-HGA | High Gloss Acrylic Doors; Must Specify Color | |
| | (GPA) | Graphite Acrylic | \$ 269 |
| | (BLA) | Black, (WMA) Wired Mercury, or (WHA) White Acrylic | \$ 247 |

Pricing Codes:

T= TFL
P= HPL

[See Canvas Intro Section for Ordering Options](#)

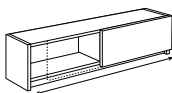
| Item | Model No. | Width | Depth | Height | Ship Wt | Cubic Ft | List Price |
|--|-----------------------------|-------|-------|-------------------|---------|----------|------------|
| WALL MOUNT HUTCH WITH SLIDING DOOR  | 66-1596SWD Two (2) Doors | 96 | 15 | 17 $\frac{3}{16}$ | 249 | 55.1 | T\$ 3130 |
| | 66-1590SWD Two (2) Doors | 90 | 15 | 17 $\frac{3}{16}$ | 233 | 53.7 | T\$ 2930 |
| | 66-1584SWD Two (2) Doors | 84 | 15 | 17 $\frac{3}{16}$ | 217 | 50.2 | T\$ 2662 |
| | 66-1578SWD One (1) Door | 78 | 15 | 17 $\frac{3}{16}$ | 201 | 46.7 | T\$ 2533 |
| | 66-1572SWD One (1) Door | 72 | 15 | 17 $\frac{3}{16}$ | 185 | 43.2 | T\$ 2352 |
| | 66-1566SWD One (1) Door | 66 | 15 | 17 $\frac{3}{16}$ | 170 | 39.7 | T\$ 2260 |
| | 66-1560SWD One (1) Door | 60 | 15 | 17 $\frac{3}{16}$ | 100 | 36.2 | T\$ 2203 |



Must Specify (in this order):

Model #
Chassis and Top Color
Door
Style/Color
Grain (if applicable)

Description

- Non-Locking Sliding Doors
- Component Hutch Tops with Profiles are Available; [See Top Sizes](#)
- If Applicable, Door Front Grain Direction Vertical Standard; Optional Horizontal Grain Direction
- Door Fronts Available in Contrasting Colors; Must Specify Color
- Safely Write on Dry Erase with Our Dry Erase Marker Set; [See Sets](#)
- Indiana Furniture Will Not be Liable for Wall Mount Hutches That are not Properly Installed
- Additional Options: Marker Boards, Work Wall, Tackboards, and Tasklights ([See Units](#)), Marker and Eraser Sets ([See Sets](#))

Options: Specify & Add

| | | Per Door |
|---|---|----------|
|  | 1-AD Aluminum Framed Satin Frosted Tempered Glass Doors (Non-Locking) | \$ 745 |
|  | 1-DEB Dry Erase Board Door (Non-Locking) | \$ 77 |
|  | 1-HGA High Gloss Acrylic Door (Non-Locking); Must Specify Color | |
| | (GPA) Graphite Acrylic | \$ 773 |
| | (BLA) Black, (WMA) Wired Mercury, or (WHA) White Acrylic | \$ 705 |

Pricing Codes:

T= TFL
P= HPL

[See Canvas Intro Section for Ordering Options](#)

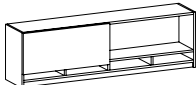
| Item | Model No. | Width | Depth | Height | Ship Wt | Cubic Ft | List Price |
|--|---|-------|-------|--------|---------|----------|------------|
| WALL MOUNT HUTCH SLIDING DOOR WITH PAPER SLOTS  | 66-1596SWDS Two (2) Doors / Six (6) Paper Slots | 96 | 15 | 21 | 186 | 24.6 | T\$ 4252 |
| | 66-1590SWDS Two (2) Doors / Five (5) Paper Slots | 90 | 15 | 21 | 172 | 23.1 | T\$ 4002 |
| | 66-1584SWDS Two (2) Doors / Five (5) Paper Slots | 84 | 15 | 21 | 162 | 21.6 | T\$ 3672 |
| | 66-1578SWDS One (1) Door / Five (5) Paper Slots | 78 | 15 | 21 | 149 | 20.0 | T\$ 3486 |
| | 66-1572SWDS One (1) Door / Four (4) Paper Slots | 72 | 15 | 21 | 140 | 18.5 | T\$ 3243 |
| | 66-1566SWDS One (1) Door / Four (4) Paper Slots | 66 | 15 | 21 | 131 | 16.9 | T\$ 3100 |
| | 66-1560SWDS One (1) Door / Four (4) Paper Slots | 60 | 15 | 21 | 121 | 15.4 | T\$ 2991 |

Must Specify (in this order):
 Model #
 Chassis and Top Color
 Door
 Style/Color
 Grain (if applicable)
 Paperslot Divider Material/Color

Description

- Non-Locking Sliding Doors
- Paper Slot Divider Color Must Specify: Chrome (CHRM) or Laminate (T) and Color
- Component Hutch Tops with Profiles are Available; [See Top Sizes](#)
- If Applicable, Door Front Grain Direction Vertical Standard; Optional Horizontal Grain Direction
- Door Fronts Available in Contrasting Colors; Must Specify Color
- Safely Write on Dry Erase, White and Black Glass Doors with Our Dry Erase Marker Set; [See Sets](#)
- Indiana Furniture Will Not be Liable for Wall Mount Hutches That are not Properly Installed
- Additional Options: Work Wall, Tackboards, and Tasklights ([See Units](#)), Marker and Eraser Sets ([See Sets](#))

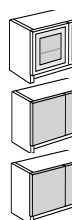

| Options: Specify & Add | | Per Door |
|------------------------|--|----------|
| 1-AD | Aluminum Framed Satin Frosted Tempered Glass Doors (Non-Locking) | \$ 745 |
| 1-DEB | Dry Erase Board Door (Non-Locking) | \$ 77 |
| 1-HGA | High Gloss Acrylic Door (Non-Locking); Must Specify Color | |
| | (GPA) Graphite Acrylic | \$ 773 |
| | (BLA) Black, (WMA) Wired Mercury, or (WHA) White Acrylic | \$ 705 |

Pricing Codes:
 T= TFL
 P= HPL

[See Canvas Intro Section for Ordering Options](#)

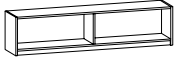
| Item | Model No. | Width | Depth | Height | Ship Wt | Cubic Ft | List Price |
|---|-------------------------------------|-------|--------|---------|---------|----------|------------|
| WALL MOUNT HUTCH OPEN  Must Specify (in this order): Model # Color Also available as 29 3/16" H Tall Wall Mount | 66-1596OW Three (3) Compartments | 96 | 14 1/4 | 17 3/16 | 150 | 19.2 | T\$ 2173 |
| | 66-1590OW Three (3) Compartments | 90 | 14 1/4 | 17 3/16 | 140 | 17.9 | T\$ 2031 |
| | 66-1584OW Three (3) Compartments | 84 | 14 1/4 | 17 3/16 | 130 | 16.8 | T\$ 1751 |
| | 66-1578OW Two (2) Compartments | 78 | 14 1/4 | 17 3/16 | 122 | 15.7 | T\$ 1711 |
| | 66-1572OW Two (2) Compartments | 72 | 14 1/4 | 17 3/16 | 112 | 14.5 | T\$ 1437 |
| | 66-1566OW Two (2) Compartments | 66 | 14 1/4 | 17 3/16 | 100 | 13.3 | T\$ 1391 |
| | 66-1560OW Two (2) Compartments | 60 | 14 1/4 | 17 3/16 | 92 | 12.1 | T\$ 1366 |
| | 66-1554OW Two (2) Compartments | 54 | 14 1/4 | 17 3/16 | 83 | 10.5 | T\$ 1269 |
| | 66-1548OW Two (2) Compartments | 48 | 14 1/4 | 17 3/16 | 73 | 9.7 | T\$ 1172 |
| | 66-1542OW One (1) Compartment | 42 | 14 1/4 | 17 3/16 | 63 | 8.6 | T\$ 1077 |
| | 66-1536OW One (1) Compartment | 36 | 14 1/4 | 17 3/16 | 54 | 7.5 | T\$ 935 |
| | 66-1530OW One (1) Compartment | 30 | 14 1/4 | 17 3/16 | 45 | 5.7 | T\$ 815 |

Description

- Component Hutch Tops with Profiles are Available; [See Top Sizes](#)
- Indiana Furniture Will Not be Liable for Wall Mount Hutches that are not Properly Installed
- Additional Options: Marker Boards, Work Wall, Tackboards, and Tasklights ([See Units](#)), Marker and Eraser Sets ([See Sets](#))

Pricing Codes:

T= TFL
P= HPL

[See Canvas Intro Section for Ordering Options](#)

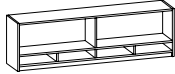
| Item | Model No. | Width | Depth | Height | Ship Wt | Cubic Ft | List Price |
|---|--------------------------------------|-------|--------|--------|---------|----------|------------|
| WALL MOUNT HUTCH OPEN WITH PAPER SLOTS  Must Specify (in this order): Model # Color Paperslot Divider Material/Color Also available as 33 3/4" H Tall Wall Mount | 66-1596OWS Three (3) Compartments | 96 | 14 1/4 | 21 | 150 | 22.2 | T\$ 3296 |
| | 66-1590OWS Three (3) Compartments | 90 | 14 1/4 | 21 | 145 | 20.8 | T\$ 3103 |
| | 66-1584OWS Three (3) Compartments | 84 | 14 1/4 | 21 | 135 | 19.5 | T\$ 2761 |
| | 66-1578OWS Two (2) Compartments | 78 | 14 1/4 | 21 | 124 | 18.1 | T\$ 2662 |
| | 66-1572OWS Two (2) Compartments | 72 | 14 1/4 | 21 | 114 | 16.7 | T\$ 2330 |
| | 66-1566OWS Two (2) Compartments | 66 | 14 1/4 | 21 | 105 | 15.4 | T\$ 2232 |
| | 66-1560OWS Two (2) Compartments | 60 | 14 1/4 | 21 | 95 | 14.1 | T\$ 2154 |
| | 66-1554OWS Two (2) Compartments | 54 | 14 1/4 | 21 | 88 | 12.7 | T\$ 2003 |
| | 66-1548OWS Two (2) Compartments | 48 | 14 1/4 | 21 | 80 | 11.3 | T\$ 1856 |
| | 66-1542OWS One (1) Compartment | 42 | 14 1/4 | 21 | 72 | 10.0 | T\$ 1710 |
| | 66-1536OWS One (1) Compartment | 36 | 14 1/4 | 21 | 64 | 8.6 | T\$ 1520 |
| | 66-1530OWS One (1) Compartment | 30 | 14 1/4 | 21 | 56 | 7.2 | T\$ 1349 |

Description

- Paper Slot Divider Color Must Specify: Chrome (CHRM) or Laminate (T) and Color
- Component Hutch Tops with Profiles are Available; [See Top Sizes](#)
- Indiana Furniture Will Not be Liable for Wall Mount Hutches that are not Properly Installed
- Also Available: Work Wall, Tackboards, and Tasklights ([See Units](#)), Marker and Eraser Sets ([See Sets](#))

Pricing Codes:

T= TFL
P= HPL

[See Canvas Intro Section for Ordering Options](#)

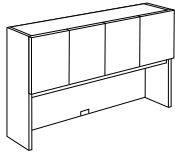
| Item | Model No. | Width | Depth | Height | Ship Wt | Cubic Ft | List Price |
|--|------------------------------|-------|-------|------------------|---------|----------|------------|
| TALL SURFACE MOUNT HUTCH HINGED DOOR  | 66-1596THU Six (6) Doors | 96 | 15 | 52 $\frac{7}{8}$ | 278 | 57.7 | T\$ 3483 |
| | 66-1590THU Five (5) Doors | 90 | 15 | 52 $\frac{7}{8}$ | 260 | 53.7 | T\$ 3305 |
| | 66-1584THU Five (5) Doors | 84 | 15 | 52 $\frac{7}{8}$ | 243 | 50.2 | T\$ 2959 |
| | 66-1578THU Four (4) Doors | 78 | 15 | 52 $\frac{7}{8}$ | 226 | 46.7 | T\$ 2901 |
| | 66-1572THU Four (4) Doors | 72 | 15 | 52 $\frac{7}{8}$ | 264 | 43.3 | T\$ 2551 |
| | 66-1566THU Four (4) Doors | 66 | 15 | 52 $\frac{7}{8}$ | 242 | 39.7 | T\$ 2468 |
| | 66-1560THU Four (4) Doors | 60 | 15 | 52 $\frac{7}{8}$ | 220 | 36.1 | T\$ 2427 |

Must Specify (in this order):

- Model #
- Chassis and Top Color
- Door
- Style/Color
- Grain (if applicable)
- Locking Doors
- Paperslots
- Paperslot Divider Material/Color
- Tasklights
- Grommet Color
- Tackboard Fabric

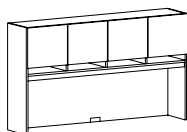

Optional Paper Slots in laminate or chrome available; See Paper Slot Options

Also available as 40 $\frac{7}{8}$ " H Standard Surface Mount

Description

- 23 $\frac{3}{4}$ " Clearance Below Apron Rail
- One (1) Fixed Shelf Behind Doors
- Lower Center Grommet Standard; Must Specify: Black (BLK) or Silver (SLV)
- Component Hutch Tops with Profiles are Available; [See Top Sizes](#)
- Safely Write on Dry Erase, White and Black Tempered Glass Doors with Our Dry Erase Marker Set; [See Sets](#)
- Additional Support is Required when Surface Mounted Hutches Do Not Sit Directly Over an End Panel or Pedestal; [See 66-2812SP](#)
- If Applicable, Door Front Grain Direction Vertical Standard; Optional Horizontal Grain Direction
- Door Fronts Available in Contrasting Colors; Must Specify
- Additional Options: Paper Slots ([See Paper Slot Options](#)), Locking Doors ([See Locking Door Options](#)), Marker Boards, Work Wall, Tackboards, and Tasklights ([See Units](#)), Marker and Eraser Sets ([See Sets](#))

Options: Specify & Add

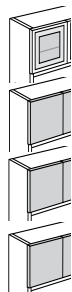

| | Per Door |
|--|----------|
| 1-AD Aluminum Framed Satin Frosted Tempered Glass Doors (Non-Locking) | \$ 621 |
| 1-DEB Dry Erase Board Doors | \$ 60 |
| WHGLS Aluminum Framed Doors with White Tempered Glass (Non-locking) | \$ 917 |
| BLGLS Black Matte Framed Doors with Black Tempered Glass (Non-locking) | \$ 1210 |
| 1-HGA High Gloss Acrylic Doors; Must Specify Color | |
| (GPA) Graphite Acrylic | \$ 602 |
| (BLA) Black, (WMA) Wired Mercury, or (WHA) White Acrylic | \$ 546 |

Pricing Codes:

- T= TFL
- P= HPL

[See Canvas Intro Section for Ordering Options](#)

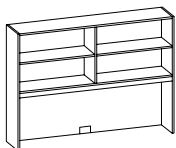
| Item | Model No. | Width | Depth | Height | Ship Wt | Cubic Ft | List Price |
|---|-------------------------------------|-------|-------|--------|---------|----------|------------|
| TALL SURFACE MOUNT HUTCH OPEN  | 66-1596TOH Six (6) Compartments | 96 | 14¼ | 52⅞ | 217 | 57.7 | T\$ 2849 |
| | 66-1590TOH Six (6) Compartments | 90 | 14¼ | 52⅞ | 206 | 50.2 | T\$ 2728 |
| | 66-1584TOH Six (6) Compartments | 84 | 14¼ | 52⅞ | 195 | 48.3 | T\$ 2415 |
| | 66-1578TOH Four (4) Compartments | 78 | 14¼ | 52⅞ | 177 | 46.7 | T\$ 2368 |
| | 66-1572TOH Four (4) Compartments | 72 | 14¼ | 52⅞ | 166 | 43.3 | T\$ 2080 |
| | 66-1566TOH Four (4) Compartments | 66 | 14¼ | 52⅞ | 149 | 39.7 | T\$ 2004 |
| | 66-1560TOH Four (4) Compartments | 60 | 14¼ | 52⅞ | 144 | 36.1 | T\$ 1995 |

Must Specify (in this order):

Model #
Color
Paperslots
Paperslot Divider Material/Color
Tasklights
Grommet Color
Tackboard Fabric

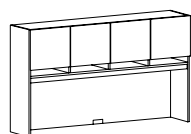

Optional Paper Slots in laminate or chrome available;
[See Paper Slot Options](#)

Also available as 40⅞" H
Standard Surface Mount

Description

- 23¾" Clearance Below Apron Rail
- Lower Center Grommet Standard; Must Specify: Black (BLK) or Silver (SLV)
- Additional Support is Required when Surface Mounted Hutches Do Not Sit Directly Over an End Panel or Pedestal; [See 66-2812SP](#)
- Component Hutch Tops with Profiles are Available; [See Top Sizes](#)
- Additional Options: Paper Slots ([See Paper Slot Options](#)), Marker Boards, Work Wall, Tackboards, and Tasklights ([See Units](#)), Marker and Eraser Sets ([See Sets](#))

Pricing Codes:

T= TFL
P= HPL



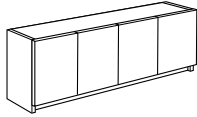

[See Canvas Intro Section for Ordering Options](#)

| Item | Model No. | Width | Depth | Height | Ship Wt | Cubic Ft | List Price |
|--|-------------------------------|-------|-------|---------|---------|----------|------------|
| TALL WALL MOUNT HUTCH HINGED DOOR  Must Specify (in this order): Model # Chassis and Top Color Door Style/Color Grain (if applicable) Locking Doors Also available as 17 3/16" H Standard Wall Mount | 66-1596TWD Six (6) Doors | 96 | 15 | 29 3/16 | 249 | 57.2 | T\$ 3182 |
| | 66-1590TWD Five (5) Doors | 90 | 15 | 29 3/16 | 233 | 53.7 | T\$ 2892 |
| | 66-1584TWD Five (5) Doors | 84 | 15 | 29 3/16 | 217 | 50.2 | T\$ 2722 |
| | 66-1578TWD Four (4) Doors | 78 | 15 | 29 3/16 | 201 | 46.7 | T\$ 2669 |
| | 66-1572TWD Four (4) Doors | 72 | 15 | 29 3/16 | 185 | 43.2 | T\$ 2351 |
| | 66-1566TWD Four (4) Doors | 66 | 15 | 29 3/16 | 170 | 22.0 | T\$ 2249 |
| | 66-1560TWD Four (4) Doors | 60 | 15 | 29 3/16 | 155 | 20.1 | T\$ 2139 |
| | 66-1554TWD Three (3) Doors | 54 | 15 | 29 3/16 | 140 | 18.1 | T\$ 1975 |
| | 66-1548TWD Three (3) Doors | 48 | 15 | 29 3/16 | 124 | 16.2 | T\$ 1844 |
| | 66-1542TWD Two (2) Doors | 42 | 15 | 29 3/16 | 109 | 12.3 | T\$ 1497 |
| | 66-1536TWD Two (2) Doors | 36 | 15 | 29 3/16 | 93 | 12.3 | T\$ 1410 |
| | 66-1530TWD Two (2) Doors | 30 | 15 | 29 3/16 | 77 | 9.1 | T\$ 1322 |

Description

- One (1) Fixed Shelf Behind Doors
- Component Hutch Tops with Profiles are Available; [See Top Sizes](#)
- If Applicable, Door Front Grain Direction Vertical Standard; Optional Horizontal Grain Direction
- Door Fronts Available in Contrasting Colors; Must Specify
- Safely Write on Dry Erase, White and Black Tempered Glass Doors with Our Dry Erase Marker Set; [See Sets](#)
- Indiana Furniture Will Not be Liable for Wall Mount Hutches that are not Properly Installed
- Additional Options: Locking Doors ([See Locking Door Options](#)), Marker Boards, Work Wall, Tackboards, and Tasklights ([See Units](#)), Marker and Eraser Sets ([See Sets](#))

Options: Specify & Add

| | | Per Door |
|---|--|----------|
|  | 1-AD Aluminum Framed Satin Frosted Tempered Glass Doors (Non-Locking) | \$ 621 |
|  | 1-DEB Dry Erase Board Doors | \$ 60 |
|  | WHGLS Aluminum Framed Doors with White Tempered Glass (Non-locking) | \$ 917 |
|  | BLGLS Black Matte Framed Doors with Black Tempered Glass (Non-locking) | \$ 1210 |
|  | 1-HGA High Gloss Acrylic Doors; Must Specify Color | |
| | (GPA) Graphite Acrylic | \$ 602 |
| | (BLA) Black, (WMA) Wired Mercury, or (WHA) White Acrylic | \$ 546 |

Pricing Codes:

T= TFL
P= HPL





[See Canvas Intro Section for Ordering Options](#)

| Item | Model No. | Width | Depth | Height | Ship Wt | Cubic Ft | List Price |
|--|--|-------|-------|----------------------------------|---------|----------|------------|
|  <p>TALL WALL MOUNT HUTCH HINGED DOOR WITH PAPER SLOTS</p> <p><i>Must Specify (in this order):</i> Model # Chassis and Top Color Door Style/Color Grain (if applicable) Paperslot Divider Material/Color</p> <p>Also available as 21¹/₄" H Standard Wall Mount</p> | 66-1596TWDS Six (6) Doors / Six (6) Paper Slots | 96 | 15 | 33 ¹ / ₂ " | 320 | 57.2 | T\$ 4301 |
| | 66-1590TWDS Five (5) Doors / Five (5) Paper Slots | 90 | 15 | 33 ¹ / ₂ " | 290 | 53.7 | T\$ 3967 |
| | 66-1584TWDS Five (5) Doors / Five (5) Paper Slots | 84 | 15 | 33 ¹ / ₂ " | 217 | 50.2 | T\$ 3732 |
| | 66-1578TWDS Four (4) Doors / Four (4) Paper Slots | 78 | 15 | 33 ¹ / ₂ " | 201 | 46.0 | T\$ 3621 |
| | 66-1572TWDS Four (4) Doors / Four (4) Paper Slots | 72 | 15 | 33 ¹ / ₂ " | 185 | 43.2 | T\$ 3242 |
| | 66-1566TWDS Four (4) Doors / Four (4) Paper Slots | 66 | 15 | 33 ¹ / ₂ " | 170 | 22.0 | T\$ 3092 |
| | 66-1560TWDS Four (4) Doors / Four (4) Paper Slots | 60 | 15 | 33 ¹ / ₂ " | 155 | 20.1 | T\$ 2928 |
| | 66-1554TWDS Three (3) Doors / Three (3) Paper Slots | 54 | 15 | 33 ¹ / ₂ " | 140 | 18.1 | T\$ 2706 |
| | 66-1548TWDS Three (3) Doors / Three (3) Paper Slots | 48 | 15 | 33 ¹ / ₂ " | 124 | 16.2 | T\$ 2526 |
| | 66-1542TWDS Two (2) Doors / Two (2) Paper Slots | 42 | 15 | 33 ¹ / ₂ " | 109 | 14.2 | T\$ 2131 |
| | 66-1536TWDS Two (2) Doors / Two (2) Paper Slots | 36 | 15 | 33 ¹ / ₂ " | 93 | 12.3 | T\$ 1992 |
| | 66-1530TWDS Two (2) Doors / Two (2) Paper Slots | 30 | 15 | 33 ¹ / ₂ " | 81 | 12.3 | T\$ 1852 |

Description

- One (1) Fixed Shelf Behind Doors
- Paper Slot Divider Color Must Specify: Chrome (CHRM) or Laminate (T) and Color
- Component Hutch Tops with Profiles are Available; [See Top Sizes](#)
- If Applicable, Door Front Grain Direction Vertical Standard; Optional Horizontal Grain Direction
- Door Fronts Available in Contrasting Colors; Must Specify
- Safely Write on Dry Erase, White and Black Tempered Glass Doors with Our Dry Erase Marker Set; [See Sets](#)
- Indiana Furniture Will Not be Liable for Wall Mount Hutches that are not Properly Installed
- Additional Options: Locking Doors ([See Locking Door Options](#)), Work Wall, Tackboards, and Tasklights ([See Units](#)), Marker and Eraser Sets ([See Sets](#))

Options: Specify & Add

| | | Per Door |
|---|--|----------|
|  | 1-AD Aluminum Framed Satin Frosted Tempered Glass Doors (Non-Locking) | \$ 621 |
|  | 1-DEB Dry Erase Board Doors | \$ 60 |
|  | WHGLS Aluminum Framed Doors with White Tempered Glass (Non-locking) | \$ 917 |
|  | BLGLS Black Matte Framed Doors with Black Tempered Glass (Non-locking) | \$ 1210 |
|  | 1-HGA High Gloss Acrylic Doors; Must Specify Color | |
| | (GPA) Graphite Acrylic | \$ 602 |
| | (BLA) Black, (WMA) Wired Mercury, or (WHA) White Acrylic | \$ 546 |

Pricing Codes:

T= TFL
P= HPL

[See Canvas Intro Section for Ordering Options](#)

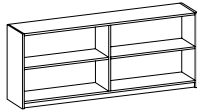
| Item | Model No. | Width | Depth | Height | Ship Wt | Cubic Ft | List Price |
|--|-------------------------------------|-------|-------|----------------------------------|---------|----------|------------|
| TALL WALL MOUNT HUTCH OPEN  | 66-1596TOW Six (6) Compartments | 96 | 14¼ | 29¾ ¹ / ₁₆ | 200 | 30.8 | T\$ 2541 |
| | 66-1590TOW Six (6) Compartments | 90 | 14¼ | 29¾ ¹ / ₁₆ | 186 | 29.0 | T\$ 2312 |
| | 66-1584TOW Six (6) Compartments | 84 | 14¼ | 29¾ ¹ / ₁₆ | 173 | 27.1 | T\$ 2179 |
| | 66-1578TOW Four (4) Compartments | 78 | 14¼ | 29¾ ¹ / ₁₆ | 161 | 25.2 | T\$ 2137 |
| | 66-1572TOW Four (4) Compartments | 72 | 14¼ | 29¾ ¹ / ₁₆ | 147 | 23.3 | T\$ 1879 |
| | 66-1566TOW Four (4) Compartments | 66 | 14¼ | 29¾ ¹ / ₁₆ | 135 | 21.4 | T\$ 1799 |
| | 66-1560TOW Four (4) Compartments | 60 | 14¼ | 29¾ ¹ / ₁₆ | 122 | 20.1 | T\$ 1710 |

Must Specify (in this order):

Model #
Color

Also available as 17¾" H
Standard Wall Mount

Description

- Component Hutch Tops with Profiles are Available; [See Top Sizes](#)
- Indiana Furniture Will Not be Liable for Wall Mount Hutches that are not Properly Installed
- Also Available: Marker Boards, Work Wall, Tackboards, and Tasklights ([See Units](#)), Marker and Eraser Sets ([See Set Options](#))

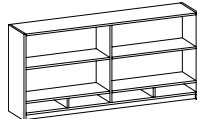
| | | | | | | | |
|---|---|----|-----|------|-----|------|----------|
| TALL WALL MOUNT HUTCH OPEN WITH PAPER SLOTS  | 66-1596TOWS Six (6) Compartments/Six (6) Paper Slots | 96 | 14¼ | 33 ⅝ | 220 | 30.8 | T\$ 3666 |
| | 66-1590TOWS Six (6) Compartments/Six (6) Paper Slots | 90 | 14¼ | 33 ⅝ | 206 | 29.0 | T\$ 3388 |
| | 66-1584TOWS Six (6) Compartments/Six (6) Paper Slots | 84 | 14¼ | 33 ⅝ | 193 | 27.1 | T\$ 3187 |
| | 66-1578TOWS Four (4) Compartments/Four (4) Paper Slots | 78 | 14¼ | 33 ⅝ | 181 | 25.2 | T\$ 3088 |
| | 66-1572TOWS Four (4) Compartments/Four (4) Paper Slots | 72 | 14¼ | 33 ⅝ | 167 | 23.2 | T\$ 2774 |
| | 66-1566TOWS Four (4) Compartments/Four (4) Paper Slots | 66 | 14¼ | 33 ⅝ | 155 | 21.4 | T\$ 2641 |
| | 66-1560TOWS Four (4) Compartments/Four (4) Paper Slots | 60 | 14¼ | 33 ⅝ | 142 | 20.1 | T\$ 2498 |

Must Specify (in this order):

Model #
Color
Paperslot Divider Material/Color

Also available as 21¼" H
Standard Wall Mount

Description

- Paper Slot Divider Color Must Specify: Chrome (CHRM) or Laminate (T) and Color
- Component Hutch Tops with Profiles are Available; [See Top Sizes](#)
- Indiana Furniture Will Not be Liable for Wall Mount Hutches that are not Properly Installed
- Also Available: Work Wall, Tackboards, and Tasklights ([See Units](#)), Marker and Eraser Sets ([See Set Options](#))

Pricing Codes:

T= TFL
P= HPL

[See Canvas Intro Section for Ordering Options](#)

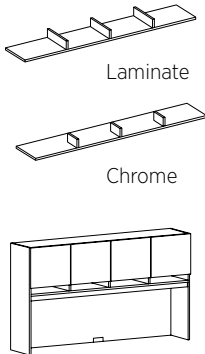
| Item | Model No. | For Use With | Width | Depth | Height | Ship Wt | Cubic Ft | List Price |
|---|-----------------|--|-------|-------|--------|---------|----------|------------|
| <p>OPTIONAL PAPER SLOTS FOR SURFACE MOUNT HUTCH</p>  <p>Must Specify (in this order): Model # Paperslot Divider Material Paperslot Divider Color</p> | 01-PAPERSLOT 96 | For Use with 96" Unit Six (6) Slots | 94½ | 11⅞ | 5¼ | - | - | \$ 1092 |
| | 01-PAPERSLOT 90 | For Use with 90" Unit Five (5) Slots | 88½ | 11⅞ | 5¼ | - | - | \$ 1043 |
| | 01-PAPERSLOT 84 | For Use with 84" Unit Five (5) Slots | 82½ | 11⅞ | ¼ | - | - | \$ 986 |
| | 01-PAPERSLOT 78 | For Use with 78" Unit Four (4) Slots | 76½ | 11⅞ | 5¼ | - | - | \$ 927 |
| | 01-PAPERSLOT 72 | For Use with 72" Unit Four (4) Slots | 70½ | 11⅞ | 5¼ | - | - | \$ 870 |
| | 01-PAPERSLOT 66 | For Use with 66" Unit Four (4) Slots | 64½ | 11⅞ | 5¼ | - | - | \$ 822 |
| | 01-PAPERSLOT 60 | For Use with 60" Unit Four (4) Slots | 58½ | 11⅞ | 5¼ | - | - | \$ 766 |
| | 01-PAPERSLOT 54 | For Use with 54" Unit Three (3) Slots | 52½ | 11⅞ | 5¼ | - | - | \$ 717 |
| | 01-PAPERSLOT 48 | For Use with 48" Unit Three (3) Slots | 46½ | 11⅞ | 5¼ | - | - | \$ 663 |
| | 01-PAPERSLOT 42 | For Use with 42" Unit Two (2) Slots | 40½ | 11⅞ | 5¼ | - | - | \$ 617 |
| | 01-PAPERSLOT 36 | For Use with 36" Unit Two (2) Slots | 34½ | 11⅞ | 5¼ | - | - | \$ 569 |
| | 01-PAPERSLOT 30 | For Use with 30" Unit Two (2) Slots | 28½ | 11⅞ | 5¼ | - | - | \$ 520 |

Description

- Ships Factory Installed
- Paper Slot Divider Material and Color Must Specify: Chrome (CHRM) or Laminate (T) and Color

Pricing Codes:

T= TFL
P= HPL

[See Canvas Intro Section for Ordering Options](#)

| Item | Model No. | Width | Depth | Height | Ship Wt | Cubic Ft | List Price |
|---|-----------|-------|-------|--------|---------|----------|------------|
| MODULAR TOP FOR 15" DEEP HUTCHES & BOOKCASES  Must Specify (in this order): Model # Color Edge Profile | 66-1596HT | 96 | 15 | 1 | 61 | 5.1 | T\$ 572 |
| | 66-1590HT | 90 | 15 | 1 | 57 | 4.8 | T\$ 552 |
| | 66-1584HT | 84 | 15 | 1 | 53 | 4.5 | T\$ 525 |
| | 66-1578HT | 78 | 15 | 1 | 50 | 4.2 | T\$ 513 |
| | 66-1572HT | 72 | 15 | 1 | 48 | 3.9 | T\$ 478 |
| | 66-1566HT | 66 | 15 | 1 | 42 | 3.5 | T\$ 456 |
| | 66-1560HT | 60 | 15 | 1 | 38 | 3.2 | T\$ 444 |
| | 66-1554HT | 54 | 15 | 1 | 34 | 2.9 | T\$ 437 |
| | 66-1548HT | 48 | 15 | 1 | 30 | 2.6 | T\$ 425 |
| | 66-1542HT | 42 | 15 | 1 | 27 | 2.3 | T\$ 410 |
| | 66-1536HT | 36 | 15 | 1 | 23 | 2.0 | T\$ 400 |
| | 66-1530HT | 30 | 15 | 1 | 11 | 1.0 | T\$ 384 |

Description

- Provides an Edge Profile on Overhead Units While Giving Multiple Overhead Units a Cohesive Appearance
- Profiled on Front Edge Only

SURFACE MOUNT PAPER SLOT TOWER

| | | | | | | |
|-----------|----|----|----|----|-----|---------|
| 66-1218HH | 18 | 12 | 21 | 45 | 4.4 | T\$ 828 |
|-----------|----|----|----|----|-----|---------|

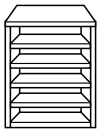

Description

- Four (4) Adjustable Shelves

Must Specify (in this order):

Model #
Color

Pricing Codes:

T= TFL
P= HPL

[See Canvas Intro Section for Ordering Options](#)

| Item | Model No. | Width | Depth | Height | Ship Wt | Cubic Ft | List Price |
|---|-------------|--------------|-------|--------|------------------|----------|------------|
| SURFACE MOUNT STORAGE TOWER WITH DOOR AND OPEN SHELVING | Hinged Left | Hinged Right | | | | | |
| | 66-1518HL1 | 66-1518HR1 | 18 | 15 | 40 $\frac{1}{2}$ | 78 | 8.6 |

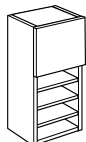

Shown as Left

Must Specify (in this order):

- Model #
- Color
- Door
- Style/Color
- Grain (if applicable)
- Locking Doors

Description

- Storage Behind Door in Upper Section
- Three (3) Adjustable Shelves
- If Applicable, Door Front Grain Direction Vertical Standard; Optional Horizontal Grain Direction
- Door Front Available in Contrasting Colors; Must Specify
- Safely Write on Dry Erase, White and Black Tempered Glass Doors with Our Dry Erase Marker Set; [See Sets](#)
- Additional Options: Locking Doors ([See Locking Options](#))

Options: Specify & Add

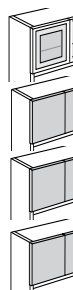

| | | Per Door |
|-------|--|----------|
| 1-AD | Aluminum Framed Satin Frosted Tempered Glass Doors (Non-Locking) | \$ 438 |
| 1-DEB | Dry Erase Board Doors | \$ 28 |
| WHGLS | Aluminum Framed Doors with White Tempered Glass (Non-locking) | \$ 652 |
| BLGLS | Black Matte Framed Doors with Black Tempered Glass (Non-locking) | \$ 868 |
| 1-HGA | High Gloss Acrylic Doors; Must Specify Color | |
| | (GPA) Graphite Acrylic | \$ 269 |
| | (BLA) Black, (WMA) Wired Mercury, or (WHA) White Acrylic | \$ 247 |

| Item | Model No. | Width | Depth | Height | Ship Wt | Cubic Ft | List Price |
|--|-------------|--------------|-------|--------|------------------|----------|------------|
| SURFACE MOUNT TALL STORAGE TOWER WITH DOOR AND OPEN SHELVING | Hinged Left | Hinged Right | | | | | |
| | 66-1518THL1 | 66-1518THR1 | 18 | 15 | 52 $\frac{1}{2}$ | 95 | 11.0 |

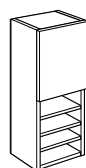

Shown as Left

Must Specify (in this order):

- Model #
- Color
- Door
- Style/Color
- Grain (if applicable)
- Locking Doors

Description

- Storage Behind Door in Upper Section with One (1) Adjustable Shelf
- Three (3) Adjustable Shelves
- If Applicable, Door Front Grain Direction Vertical Standard; Optional Horizontal Grain Direction
- Door Front Available in Contrasting Colors; Must Specify
- Safely Write on Dry Erase, White and Black Tempered Glass Doors with Our Dry Erase Marker Set; [See Set Options](#)
- Additional Options: Locking Doors ([See Locking Options](#))

Options: Specify & Add

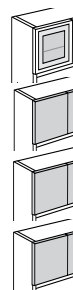

| | | Per Door |
|-------|--|----------|
| 1-AD | Aluminum Framed Satin Frosted Tempered Glass Doors (Non-Locking) | \$ 621 |
| 1-DEB | Dry Erase Board Doors | \$ 60 |
| WHGLS | Aluminum Framed Doors with White Tempered Glass (Non-locking) | \$ 917 |
| BLGLS | Black Matte Framed Doors with Black Tempered Glass (Non-locking) | \$ 1210 |
| 1-HGA | High Gloss Acrylic Doors; Must Specify Color | |
| | (GPA) Graphite Acrylic | \$ 602 |
| | (BLA) Black, (WMA) Wired Mercury, or (WHA) White Acrylic | \$ 546 |

Pricing Codes:

- T= TFL
- P= HPL

[See Canvas Intro Section for Ordering Options](#)

| Item | Model No. | Width | Depth | Height | Ship Wt | Cubic Ft | List Price |
|---|-----------|-------|-------|--------|---------|----------|------------|
| SURFACE MOUNT STORAGE TOWER OPEN BOOKCASE | 66-1518HB | 18 | 14¼ | 40⅞ | 62 | 8.6 | T\$ 810 |

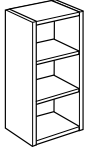

Description

- Two (2) Adjustable Shelves

Must Specify (in this order):

Model #
Color

| | | | | | | | |
|--|------------|----|-----|-----|----|------|---------|
| SURFACE MOUNT TALL STORAGE TOWER OPEN BOOKCASE | 66-1518THB | 18 | 14½ | 52⅞ | 68 | 11.0 | T\$ 961 |
|--|------------|----|-----|-----|----|------|---------|

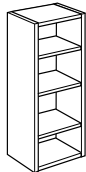

Description

- Three (3) Adjustable Shelves

Must Specify (in this order):

Model #
Color

Pricing Codes:

T= TFL
P= HPL

[See Canvas Intro Section for Ordering Options](#)

| Item | Model No. | Width | Depth | Height | Ship Wt | Cubic Ft | List Price |
|--|-------------|--------------|-------|--------|------------------|----------|------------|
| SURFACE MOUNT STORAGE TOWER WITH FULL DOOR | Hinged Left | Hinged Right | | | | | |
| | 66-1518HL3 | 66-1518HR3 | 18 | 15 | 40 $\frac{1}{2}$ | 78 | 8.6 |



Shown as Left

Must Specify (in this order):

- Model #
- Color
- Door
- Style/Color
- Grain (if applicable)
- Locking Doors

Description

- Touch Latch Door with One (1) Fixed Shelf/Two (2) Adjustable Shelves Behind Door
- If Applicable, Door Front Grain Direction Vertical Standard; Optional Horizontal Grain Direction
- Door Front Available in Contrasting Colors; Must Specify
- Safely Write on Dry Erase, White and Black Tempered Glass Doors with Our Dry Erase Marker Set; [See Sets](#)
- Additional Options: Locking Door ([See Locking Options](#))

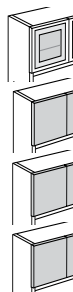

| Options: Specify & Add | | Per Unit |
|------------------------|---|----------|
| 1-AD | Aluminum Framed Satin Frosted Tempered Glass Door (Non-Locking) | \$ 710 |
| 1-DEB | Dry Erase Board Door | \$ 77 |
| WHGLS | Aluminum Framed Door with White Tempered Glass (Non-locking) | \$ 1113 |
| BLGLS | Black Matte Framed Door with Black Tempered Glass (Non-locking) | \$ 1486 |
| 1-HGA | High Gloss Acrylic Door; Must Specify Color | |
| | (GPA) Graphite Acrylic | \$ 733 |
| | (BLA) Black, (WMA) Wired Mercury, or (WHA) White Acrylic | \$ 668 |

| Item | Model No. | Width | Depth | Height | Ship Wt | Cubic Ft | List Price |
|---|-------------|--------------|-------|--------|------------------|----------|------------|
| SURFACE MOUNT TALL STORAGE TOWER WITH FULL DOOR | Hinged Left | Hinged Right | | | | | |
| | 66-1518THL3 | 66-1518THR3 | 18 | 15 | 52 $\frac{1}{2}$ | 95 | 11.0 |



Shown as Left

Must Specify (in this order):

- Model #
- Color
- Door
- Style/Color
- Grain (if applicable)
- Locking Doors

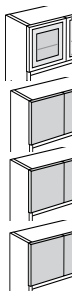

| Options: Specify & Add | | Per Unit |
|------------------------|---|----------|
| 1-AD | Aluminum Framed Satin Frosted Tempered Glass Door (Non-Locking) | \$ 849 |
| 1-DEB | Dry Erase Board Door | \$ 96 |
| WHGLS | Aluminum Framed Door with White Tempered Glass (Non-locking) | \$ 1347 |
| BLGLS | Black Matte Framed Door with Black Tempered Glass (Non-locking) | \$ 1796 |
| 1-HGA | High Gloss Acrylic; Must Specify Color | |
| | (GPA) Graphite Acrylic | \$ 960 |
| | (BLA) Black, (WMA) Wired Mercury, or (WHA) White Acrylic | \$ 876 |

Pricing Codes:

- T= TFL
- P= HPL

[See Canvas Intro Section for Ordering Options](#)

| Item | Model No. | Width | Depth | Height | Ship Wt | Cubic Ft | List Price |
|--------------------------------|-------------|-------|-------|------------------|---------|----------|------------|
| SURFACE MOUNT DOOR BOOKCASE | 66-1536TUDB | 36 | 15 | 40 $\frac{1}{8}$ | 168 | 16.1 | T\$ 1528 |
| | 66-1530TUDB | 30 | 15 | 40 $\frac{1}{8}$ | 140 | 13.4 | T\$ 1416 |

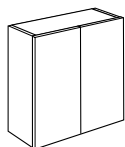

Must Specify (in this order):

- Model #
- Color
- Door
- Style/Color
- Grain (if applicable)
- Locking Doors

Description

- Touch Latch Door with One (1) Fixed Shelf/Two (2) Adjustable Shelves Behind Door
- If Applicable, Door Front Grain Direction Vertical Standard; Optional Horizontal Grain Direction
- Door Fronts Available in Contrasting Colors; Must Specify
- Safely Write on Dry Erase, White and Black Tempered Glass Doors with Our Dry Erase Marker Set; [See Sets](#)
- Additional Options: Locking Doors ([See Locking Options](#))

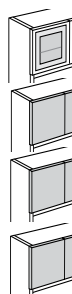

| Options: Specify & Add | | | Per Unit |
|------------------------|--|--|----------|
| 1-AD | Aluminum Framed Satin Frosted Tempered Glass Doors (Non-Locking) | | \$ 1420 |
| 1-DEB | Dry Erase Board Doors | | \$ 148 |
| WHGLS | Aluminum Framed Doors with White Tempered Glass (Non-locking) | | \$ 2228 |
| BLGLS | Black Matte Framed Doors with Black Tempered Glass (Non-locking) | | \$ 2975 |
| 1-HGA | High Gloss Acrylic; Must Specify Color | | |
| | (GPA) Graphite Acrylic | | \$ 1462 |
| | (BLA) Black, (WMA) Wired Mercury, or (WHA) White Acrylic | | \$ 1334 |

| | | | | | | | |
|-------------------------------------|--------------|----|----|------------------|-----|------|----------|
| SURFACE MOUNT TALL DOOR BOOKCASE | 66-1536TTUDB | 36 | 15 | 52 $\frac{1}{8}$ | 216 | 20.5 | T\$ 1792 |
| | 66-1530TTUDB | 30 | 15 | 52 $\frac{1}{8}$ | 180 | 17.3 | T\$ 1627 |

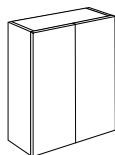

Must Specify (in this order):

- Model #
- Color
- Door
- Style/Color
- Grain (if applicable)
- Locking Doors

Description

- Touch Latch Door with One (1) Fixed Shelf/Three (3) Adjustable Shelves Behind Door
- If Applicable, Door Front Grain Direction Vertical Standard; Optional Horizontal Grain Direction
- Door Fronts Available in Contrasting Colors; Must Specify
- Safely Write on Dry Erase, White and Black Tempered Glass Doors with Our Dry Erase Marker Set; [See Sets](#)
- Additional Options: Locking Doors ([See Locking Options](#))

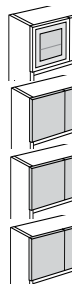

| Options: Specify & Add | | | Per Unit |
|------------------------|--|--|----------|
| 1-AD | Aluminum Framed Satin Frosted Tempered Glass Doors (Non-Locking) | | \$ 1697 |
| 1-DEB | Dry Erase Board Doors | | \$ 193 |
| WHGLS | Aluminum Framed Doors with White Tempered Glass (Non-locking) | | \$ 2692 |
| BLGLS | Black Matte Framed Doors with Black Tempered Glass (Non-locking) | | \$ 3589 |
| 1-HGA | High Gloss Acrylic; Must Specify Color | | |
| | (GPA) Graphite Acrylic | | \$ 1914 |
| | (BLA) Black, (WMA) Wired Mercury, or (WHA) White Acrylic | | \$ 1747 |

Pricing Codes:

- T= TFL
- P= HPL

[See Canvas Intro Section for Ordering Options](#)

| Item | Model No. | Width | Depth | Height | Ship Wt | Cubic Ft | List Price |
|--|---------------------|----------------------|-------|--------|------------------|----------|------------|
| SURFACE MOUNT DOOR BOOKCASE WITH SIDE SHELVING | Shelves Left | Shelves Right | | | | | |
| | 66-3615TUDBL | 66-3615TUDBR | 36 | 15 | 40 $\frac{1}{2}$ | 157 | T\$ 2080 |
| | 66-3015TUDBL | 66-3015TUDBR | 30 | 15 | 40 $\frac{1}{2}$ | 140 | T\$ 2007 |

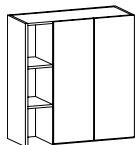

Shown as Left

Must Specify (in this order):

- Model #
- Color
- Door
 - Style/Color
 - Grain (if applicable)
 - Locking Doors

Description

- Touch Latch Door with Two (2) Adjustable Shelves Behind Doors
- Side Fixed Shelves; Top Shelf with 15" Clearance, Two (2) Remaining Shelves with 11 $\frac{1}{2}$ " Clearance
- If Applicable, Door Front Grain Direction Vertical Standard; Optional Horizontal Grain Direction
- Door Fronts Available in Contrasting Colors; Must Specify
- Safely Write on Dry Erase, White and Black Tempered Glass Doors with Our Dry Erase Marker Set; [See Sets](#)
- Additional Options: Locking Doors ([See Locking Options](#))

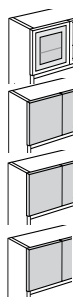

Options: Specify & Add

| | | Per Unit |
|-------|--|----------|
| 1-AD | Aluminum Framed Satin Frosted Tempered Glass Doors (Non-Locking) | \$ 1420 |
| 1-DEB | Dry Erase Board Doors | \$ 148 |
| WHGLS | Aluminum Framed Doors with White Tempered Glass (Non-locking) | \$ 2228 |
| BLGLS | Black Matte Framed Doors with Black Tempered Glass (Non-locking) | \$ 2975 |
| 1-HGA | High Gloss Acrylic; Must Specify Color | |
| | (GPA) Graphite Acrylic | \$ 1462 |
| | (BLA) Black, (WMA) Wired Mercury, or (WHA) White Acrylic | \$ 1334 |

| Item | Model No. | Width | Depth | Height | Ship Wt | Cubic Ft | List Price |
|--|---------------------|----------------------|-------|--------|---------|----------|------------|
| SURFACE MOUNT DOOR BOOKCASE WITH SIDE SHELVING | Shelves Left | Shelves Right | | | | | |
| | 66-3615TTUDBL | 66-3615TTUDBR | 36 | 15 | 52 | 157 | T\$ 2368 |
| | 66-3015TTUDBL | 66-3015TTUDBR | 30 | 15 | 52 | 140 | T\$ 2285 |

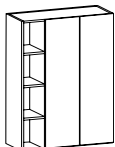

Shown as Left

Must Specify (in this order):

- Model #
- Color
- Door
 - Style/Color
 - Grain (if applicable)
 - Locking Doors

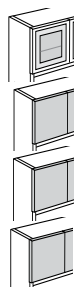

Options: Specify & Add

| | | Per Unit |
|-------|--|----------|
| 1-AD | Aluminum Framed Satin Frosted Tempered Glass Doors (Non-Locking) | \$ 1697 |
| 1-DEB | Dry Erase Board Doors | \$ 193 |
| WHGLS | Aluminum Framed Doors with White Tempered Glass (Non-locking) | \$ 2692 |
| BLGLS | Black Matte Framed Doors with Black Tempered Glass (Non-locking) | \$ 3589 |
| 1-HGA | High Gloss Acrylic; Must Specify Color | |
| | (GPA) Graphite Acrylic | \$ 1914 |
| | (BLA) Black, (WMA) Wired Mercury, or (WHA) White Acrylic | \$ 1747 |

Pricing Codes:

- T= TFL
- P= HPL

[See Canvas Intro Section for Ordering Options](#)

| Item | Model No. | Width | Depth | Height | Ship Wt | Cubic Ft | List Price |
|--|-------------|--------------|-------|--------|------------------|----------|------------|
| STORAGE CABINET WITH OPEN SHELVES AND BOX/BOX/FILE | Hinged Left | Hinged Right | | | | | |
| | 66-1872DSIL | 66-1872DS1R | 18 | 24 | 70 $\frac{1}{2}$ | 145 | 22.0 |

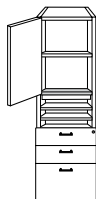

Shown as Left

Description

- One (1) Adjustable Shelf Behind Touch Latch Door; Two (2) Adjustable Shelves in Center
- Safely Write on Dry Erase Doors with Our Dry Erase Marker Set; [See Sets](#)
- Locking Drawers; File Drawer Provides Legal or Letter Filing
- If Applicable, Drawer/Door Fronts Grain Direction Vertical Standard; Optional Horizontal Grain Direction
- If Applicable, Drawer/Door Fronts Available in Contrasting Colors; Must Specify
- Additional Options: Dove Tail Drawer Construction and Soft Close Drawers ([See Drawer Options](#)), Locking Door ([See Locking Options](#))

Options: Specify & Add

Per Door

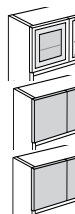

| | | |
|-------|--|--------|
| 1-AD | Aluminum Framed Satin Frosted Tempered Glass Doors (Non-Locking) | \$ 621 |
| 1-DEB | Dry Erase Board Doors | \$ 60 |
| 1-HGA | High Gloss Acrylic Doors; Must Specify Color | |
| | (GPA) Graphite Acrylic | \$ 602 |
| | (BLA) Black, (WMA) Wired Mercury, or (WHA) White Acrylic | \$ 546 |

Must Specify (in this order):

- Model #
- Color
- Door
 - Style/Color
 - Grain (if applicable)
- Locking Doors
- Drawer
 - Construction
 - Track
 - Color
 - Grain (if applicable)
- Pull

| Item | Model No. | Width | Depth | Height | Ship Wt | Cubic Ft | List Price |
|---|-------------|--------------|-------|--------|------------------|----------|------------|
| TALL STORAGE CABINET WITH OPEN SHELVES AND BOX/BOX/FILE | Hinged Left | Hinged Right | | | | | |
| | 66-1884DSIL | 66-1884DS1R | 18 | 24 | 82 $\frac{1}{2}$ | 196 | 25.8 |

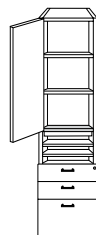

Shown as Left

Description

- Two (2) Adjustable Shelf Behind Touch Latch Door; Two (2) Adjustable Shelves in Center
- Safely Write on Dry Erase Doors with Our Dry Erase Marker Set; [See Sets](#)
- Locking Drawers; File Provide Legal or Letter Filing
- If Applicable, Drawer/Door Fronts Grain Direction Vertical Standard; Optional Horizontal Grain Direction
- If Applicable, Drawer/Door Fronts Available in Contrasting Colors; Must Specify
- Additional Options: Dove Tail Drawer Construction and Soft Close Drawers ([See Drawer Options](#)), Locking Door ([See Locking Options](#))

Options: Specify & Add

Per Unit

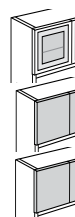

| | | |
|-------|---|--------|
| 1-AD | Aluminum Framed Satin Frosted Tempered Glass Door (Non-Locking) | \$ 710 |
| 1-DEB | Dry Erase Board Door | \$ 77 |
| 1-HGA | High Gloss Acrylic Door; Must Specify Color | |
| | (GPA) Graphite Acrylic | \$ 733 |
| | (BLA) Black, (WMA) Wired Mercury, or (WHA) White Acrylic | \$ 668 |

Must Specify (in this order):

- Model #
- Color
- Door
 - Style/Color
 - Grain (if applicable)
- Locking Doors
- Drawer
 - Construction
 - Track
 - Color
 - Grain (if applicable)
- Pull

Pricing Codes:

- T= TFL
- P= HPL

[See Canvas Intro Section for Ordering Options](#)

| Item | Model No. | Width | Depth | Height | Ship Wt | Cubic Ft | List Price |
|---|-------------|--------------|-------|--------|------------------|----------|------------|
| STORAGE CABINET WITH OPEN SHELVES AND FILE/FILE | Hinged Left | Hinged Right | | | | | |
| | 66-1872DS2L | 66-1872DS2R | 18 | 24 | 70 $\frac{1}{2}$ | 145 | 22.0 |

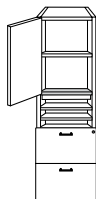

Shown as Left

Description

- One (1) Adjustable Shelf Behind Touch Latch Door; Two (2) Adjustable Shelves in Center
- Locking File Drawers Provide Legal or Letter Filing
- Safely Write on Dry Erase Doors with Our Dry Erase Marker Set; [See Sets](#)
- If Applicable, Drawer/Door Fronts Grain Direction Vertical Standard; Optional Horizontal Grain Direction
- If Applicable, Drawer/Door Fronts Available in Contrasting Colors; Must Specify
- Additional Options: Dove Tail Drawer Construction and Soft Close Drawers ([See Drawer Options](#)), Locking Door ([See Locking Options](#))

Must Specify (in this order):

- Model #
- Color
- Door Style/Color
- Door/Drawer Grain (if applicable)
- Locking Doors
- Drawer Construction
- Track
- Color
- Pull

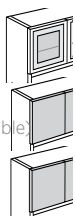

Options: Specify & Add

| | Per Door |
|---|----------|
| 1-AD Aluminum Framed Satin Frosted Tempered Glass Doors (Non-Locking) | \$ 621 |
| 1-DEB Dry Erase Board Doors | \$ 60 |
| 1-HGA High Gloss Acrylic Doors; Must Specify Color | |
| (GPA) Graphite Acrylic | \$ 602 |
| (BLA) Black, (WMA) Wired Mercury, or (WHA) White Acrylic | \$ 546 |

| Item | Model No. | Width | Depth | Height | Ship Wt | Cubic Ft | List Price |
|--|-------------|--------------|-------|--------|------------------|----------|------------|
| TALL STORAGE CABINET WITH OPEN SHELVES AND FILE/FILE | Hinged Left | Hinged Right | | | | | |
| | 66-1884DS2L | 66-1884DS2R | 18 | 24 | 82 $\frac{1}{2}$ | 196 | 25.8 |

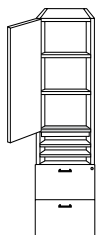

Shown as Left

Description

- Two (2) Adjustable Shelf Behind Touch Latch Door; Two (2) Adjustable Shelves in Center
- Safely Write on Dry Erase Doors with Our Dry Erase Marker Set; [See Sets](#)
- Locking File Drawers Provide Legal or Letter Filing
- If Applicable, Drawer/Door Fronts Grain Direction Vertical Standard; Optional Horizontal Grain Direction
- If Applicable, Drawer/Door Fronts Available in Contrasting Colors; Must Specify
- Additional Options: Dove Tail Drawer Construction and Soft Close Drawers ([See Drawer Options](#)), Locking Door ([See Locking Options](#))

Must Specify (in this order):

- Model #
- Color
- Door Style/Color
- Grain (if applicable)
- Locking Doors
- Drawer Construction
- Track
- Color
- Grain (if applicable)
- Pull

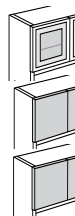

Options: Specify & Add

| | Per Unit |
|--|----------|
| 1-AD Aluminum Framed Satin Frosted Tempered Glass Door (Non-Locking) | \$ 710 |
| 1-DEB Dry Erase Board Door | \$ 77 |
| 1-HGA High Gloss Acrylic Door; Must Specify Color | |
| (GPA) Graphite Acrylic | \$ 733 |
| (BLA) Black, (WMA) Wired Mercury, or (WHA) White Acrylic | \$ 668 |

Pricing Codes:

- T= TFL
- P= HPL

[See Canvas Intro Section for Ordering Options](#)

| Item | Model No. | Width | Depth | Height | Ship Wt | Cubic Ft | List Price | |
|--|--|---------------------|-------|--------|------------------|----------|------------|--|
| STORAGE CABINET BOX/BOX/FILE | Hinged Left | Hinged Right | | | | | | |
| | 66-1884WBL | 66-1884WBR | 18 | 24 | 82 $\frac{1}{8}$ | 166 | T\$ 2370 | |
| | Three (3) Adjustable Shelves Behind Door | | | | | | | |
| | 66-1872WBL | 66-1872WBR | 18 | 24 | 70 $\frac{1}{8}$ | 145 | T\$ 2270 | |
| Two (2) Adjustable Shelves Behind Door | | | | | | | | |

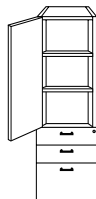

Shown as Left

Must Specify (in this order):

Model #
Color
Door/Drawer Grain (if applicable)
Door/Drawer Color
Locking Doors
Drawer
Construction
Track
Pull

Description

- Touch Latch Door
- Locking File Drawers Provide Legal or Letter Filing
- If Applicable, Drawer/Door Fronts Grain Direction Vertical Standard; Optional Horizontal Grain Direction
- If Applicable, Drawer/Door Fronts Available in Contrasting Colors; Must Specify
- Additional Options: Dove Tail Drawer Construction and Soft Close Drawers ([See Drawer Options](#)), Locking Door ([See Locking Options](#))

| | | | | | | | |
|--------------------------------------|------------------------------|----|----|------------------|-----|------|----------|
| OPEN STORAGE CABINET BOX/BOX/FILE | 66-1884WBO | 18 | 24 | 82 $\frac{1}{8}$ | 166 | 25.7 | T\$ 2181 |
| | Three (3) Adjustable Shelves | | | | | | |
| | 66-1872WBO | 18 | 24 | 70 $\frac{1}{8}$ | 145 | 22.0 | T\$ 2087 |
| Two (2) Adjustable Shelves | | | | | | | |



Description

- Locking File Drawers Provide Legal or Letter Filing
- If Applicable, Drawer Fronts Grain Direction Vertical Standard; Optional Horizontal Grain Direction
- If Applicable, Drawer Fronts Available in Contrasting Colors; Must Specify
- Additional Options: Dove Tail Drawer Construction and Soft Close Drawers ([See Drawer Options](#))

Must Specify (in this order):

Model #
Color
Drawer
Construction
Track
Color
Grain (if applicable)
Pull

Pricing Codes:

T= TFL
P= HPL

[See Canvas Intro Section for Ordering Options](#)

| Item | Model No. | Width | Depth | Height | Ship Wt | Cubic Ft | List Price | |
|------------------------------|--|---------------------|-------|--------|--------------------|----------|------------|----------|
| STORAGE CABINET FILE/FILE | Hinged Left | Hinged Right | | | | | | |
| | 66-1884WFL | 66-1884WFR | 18 | 24 | 82 $\frac{1}{2}$ " | 166 | 25.7 | T\$ 2370 |
| | Three (3) Adjustable Shelves Behind Door | | | | | | | |
| | 66-1872WFL | 66-1872WFR | 18 | 24 | 70 $\frac{1}{2}$ " | 145 | 22.0 | T\$ 2270 |
| | Two (2) Adjustable Shelves Behind Door | | | | | | | |

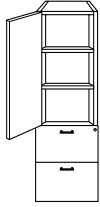

Shown as Left

Must Specify (in this order):

- Model #
- Color
- Door/Drawer Grain (if applicable)
- Door/Drawer Color
- Locking Doors
- Drawer
 - Construction
 - Track
 - Pull

Description

- Touch Latch Door
- Locking File Drawers Provide Legal or Letter Filing
- If Applicable, Drawer/Door Fronts Grain Direction Vertical Standard; Optional Horizontal Grain Direction
- If Applicable, Drawer/Door Fronts Available in Contrasting Colors; Must Specify
- Additional Options: Dove Tail Drawer Construction and Soft Close Drawers ([See Drawer Options](#)), Locking Door ([See Locking Options](#))

| | | | | | | | |
|-----------------------------------|------------------------------|----|----|--------------------|-----|------|----------|
| OPEN STORAGE CABINET FILE/FILE | 66-1884WFO | 18 | 24 | 82 $\frac{1}{2}$ " | 166 | 25.7 | T\$ 2181 |
| | Three (3) Adjustable Shelves | | | | | | |
| | 66-1872WFO | 18 | 24 | 70 $\frac{1}{2}$ " | 145 | 22.0 | T\$ 2087 |
| | Two (2) Adjustable Shelves | | | | | | |



Must Specify (in this order):

- Model #
- Color
- Drawer
 - Construction
 - Track
 - Color
 - Grain (if applicable)
 - Pull

Description

- Locking File Drawers Provide Legal or Letter Filing
- If Applicable, Drawer Fronts Grain Direction Vertical Standard; Optional Horizontal Grain Direction
- If Applicable, Drawer Fronts Available in Contrasting Colors; Must Specify
- Additional Options: Dove Tail Drawer Construction and Soft Close Drawers ([See Drawer Options](#))

Pricing Codes:

- T= TFL
- P= HPL

[See Canvas Intro Section for Ordering Options](#)

| Item | Model No. | Width | Depth | Height | Ship Wt | Cubic Ft | List Price |
|--------------|-------------|--------------|-------|--------|---------|----------|------------|
| NARROW TOWER | Hinged Left | Hinged Right | | | | | |
| | 66-1251WD1L | 66-1251WD1R | 12 | 24 | 51½ | 85 | 11.2 |

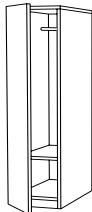

Shown as Left

Must Specify (in this order):

- Model #
- Color
- Door
- Style/Color
- Grain (if applicable)
- Locking Doors

Description

- 10" Coat Rod; One (1) Adjustable Shelf
- Touch Latch Door
- Safely Write on Dry Erase Doors with Our Dry Erase Marker Set; [See Set Options](#)
- If Applicable, Door Front Grain Direction Vertical Standard; Optional Horizontal Grain Direction
- If Applicable, Door Front Available in Contrasting Colors; Must Specify
- Additional Options: Locking Door ([See Locking Options](#))

Options: Specify & Add

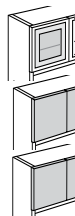

| | | |
|-------|---|--------|
| 1-AD | Aluminum Framed Satin Frosted Tempered Glass Door (Non-Locking) | \$ 678 |
| 1-DEB | Dry Erase Board Door | \$ 60 |
| 1-HGA | High Gloss Acrylic Door; Must Specify Color | |
| | (GPA) Graphite Acrylic | \$ 614 |
| | (BLA) Black, Wired Mercury (WMA), or White (WHA) Acrylic | \$ 560 |

| WARDROBE/STORAGE CABINET | Hinged Left | Hinged Right | Width | Depth | Height | Ship Wt | Cubic Ft | List Price |
|--------------------------|--|--------------|-------|-------|--------|---------|----------|------------|
| | 66-1884WL | 66-1884WR | 18 | 24 | 82¾ | 162 | 25.7 | T\$ 2143 |
| | Four (4) Adjustable Shelves Behind Door | | | | | | | |
| | 66-1872WL | 66-1872WR | 18 | 24 | 70¾ | 153 | 19.2 | T\$ 2053 |
| | Three (3) Adjustable Shelves Behind Door | | | | | | | |

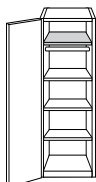

Shown as Left

Must Specify (in this order):

- Model #
- Color
- Door
- Style/Color
- Grain (if applicable)
- Locking Doors

Description

- Coat Rod Under Top Fixed Shelf
- Adjustable Shelves can be Removed for Wardrobe Application
- Touch Latch Door
- Safely Write on Dry Erase Doors with Our Dry Erase Marker Set; [See Set Options](#)
- If Applicable, Door Front Available in Contrasting Colors; Must Specify
- Additional Options: Locking Door ([See Locking Options](#))

Options: Specify & Add

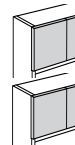

| | | |
|-------|--|---------|
| 1-DEB | Dry Erase Board Door | \$ 129 |
| 1-HGA | High Gloss Acrylic Door; Must Specify Color | |
| | (GPA) Graphite Acrylic | \$ 1275 |
| | (BLA) Black, Wired Mercury (WMA), or White (WHA) Acrylic | \$ 1162 |

Pricing Codes:

- T= TFL
- P= HPL

[See Canvas Intro Section for Ordering Options](#)

| Item | Model No. | Width | Depth | Height | Ship Wt | Cubic Ft | List Price | |
|--------------------------------|--|-----------------------|-------|--------|------------------|----------|------------|----------|
| TOWER WARDROBE BOX/BOX/FILE | Wardrobe Left | Wardrobe Right | | | | | | |
| | 66-2484WD1L | 66-2484WD1R | 24 | 24 | 82 $\frac{7}{8}$ | 252 | 22.7 | T\$ 3226 |
| | Three (3) Adjustable Shelves Behind Door | | | | | | | |
| | 66-2472WD1L | 66-2472WD1R | 24 | 24 | 70 $\frac{7}{8}$ | 242 | 20.7 | T\$ 2997 |
| | Two (2) Adjustable Shelves Behind Door | | | | | | | |
| | 66-2451WD1L | 66-2451WD1R | 24 | 24 | 51 $\frac{1}{2}$ | 172 | 20.7 | T\$ 2658 |
| | One (1) Adjustable Shelf Behind Door | | | | | | | |

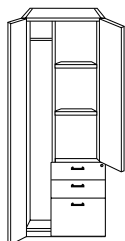

Shown as Left

Must Specify (in this order):

- Model #
- Chassis Color
- 51 $\frac{1}{2}$ "H Door/Drawer Color
- Locking Doors
- Drawer
- Construction
- Track
- Pull

Description

- Wardrobe Door Features Coat Rod and Knob Pull; Knob Color will Coordinate with Drawer Pull
- If Black or Gold Pull is Selected, Knob will be Black; If Chrome or Aluminum Pull is Selected, Knob will be Aluminum
- Cabinet Door Features Touch Latch Door
- Locking File Drawers Provides Legal or Letter Filing
- Door/Drawer Fronts Available in Contrasting Colors; Must Specify
- Additional Options: Dove Tail Drawer Construction and Soft Close Drawers ([See Drawer Options](#)), Locking Doors ([See Locking Options](#))

| Item | Model No. | Width | Depth | Height | Ship Wt | Cubic Ft | List Price | |
|-----------------------------|--|-----------------------|-------|--------|------------------|----------|------------|----------|
| TOWER WARDROBE FILE/FILE | Wardrobe Left | Wardrobe Right | | | | | | |
| | 66-2484WD2L | 66-2484WD2R | 24 | 24 | 82 $\frac{7}{8}$ | 252 | 22.7 | T\$ 3226 |
| | Three (3) Adjustable Shelves Behind Door | | | | | | | |
| | 66-2472WD2L | 66-2472WD2R | 24 | 24 | 70 $\frac{7}{8}$ | 242 | 20.7 | T\$ 2997 |
| | Two (2) Adjustable Shelves Behind Door | | | | | | | |
| | 66-2451WD2L | 66-2451WD2R | 24 | 24 | 51 $\frac{1}{2}$ | 172 | 20.7 | T\$ 2658 |
| | One (1) Adjustable Shelf Behind Door | | | | | | | |

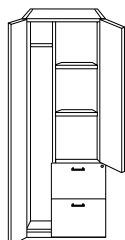

Shown as Left

Must Specify (in this order):

- Model #
- Chassis Color
- 51 $\frac{1}{2}$ "H Door/Drawer Color
- Locking Doors
- Drawer
- Construction
- Track
- Pull

Description

- Wardrobe Door Features Coat Rod and Knob Pull; Knob Color will Coordinate with Drawer Pull
- If Black or Gold Pull is Selected, Knob will be Black; If Chrome or Aluminum Pull is Selected, Knob will be Aluminum
- Cabinet Door Features Touch Latch Door
- Locking File Drawers Provides Legal or Letter Filing
- Door/Drawer Fronts Available in Contrasting Colors; Must Specify
- Additional Options: Dove Tail Drawer Construction and Soft Close Drawers ([See Drawer Options](#)), Locking Doors ([See Locking Options](#))

Pricing Codes:

- T= TFL
- P= HPL

[See Canvas Intro Section for Ordering Options](#)

| Item | Model No. | Width | Depth | Height | Ship Wt | Cubic Ft | List Price |
|-------------------------------|----------------------|-----------------------|-------|--------|---------|----------|------------|
| TALL WARDROBE/STORAGE CABINET | Wardrobe Left | Wardrobe Right | | | | | |
| | 66-3684WDS2L | 66-3684WDS2R | 36 | 24 | 82 7/8 | 368 | 49.2 |

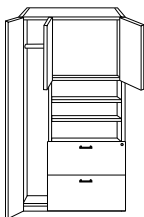

Shown as Left

Must Specify (in this order):

- Model #
- Chassis Color
- Door Style/Color
- Drawer Front Color
- Drawer Construction
- Locking Doors
- Pull

Description

- TFL Wardrobe Door Features Coat Rod and Knob Pull; Knob Color will Coordinate with Drawer Pull
- If Black or Gold Pull is Selected, Knob will be Black; If Chrome or Aluminum Pull is Selected, Knob will be Aluminum
- Hutch Doors Standard with Touch Latch; See Door Options Below
- Two (2) Adjustable Shelves
- Locking Lateral Drawers Provides Legal or Letter Filing
- Door/Drawer Fronts Available in Contrasting Colors; Must Specify
- Safely Write on Dry Erase Doors with Our Dry Erase Marker Set; [See Sets](#)
- Additional Options: Dove Tail Drawer Construction ([See Drawer Options](#)), Locking Doors ([See Locking Options](#))

Hutch Door Options: Specify & Add

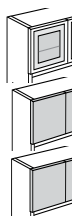

| | | |
|-------|--|---------|
| 1-AD | Aluminum Framed Satin Frosted Tempered Glass Doors (Non-Locking) | \$ 1243 |
| 1-DEB | Dry Erase Board Doors | \$ 121 |
| 1-HGA | High Gloss Acrylic Doors; Must Specify Color (Non-Locking) | |
| | (GPA) Graphite Acrylic | \$ 1200 |
| | (BLA) Black, (WMA), Wired Mercury or (WHA) White Acrylic | \$ 1095 |

| WARDROBE/STORAGE CABINET | Wardrobe Left | Wardrobe Right | Width | Depth | Height | Ship Wt | Cubic Ft | List Price |
|--------------------------|---------------|----------------|-------|-------|--------|---------|----------|------------|
| | 66-3672WDS2L | 66-3672WDS2R | 36 | 24 | 70 7/8 | 368 | 42.0 | T\$ 3370 |

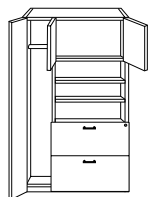

Shown as Left

Must Specify (in this order):

- Model #
- Chassis Color
- Door Style/Color
- Drawer Front Color
- Drawer Construction
- Locking Doors
- Pull

Description

- TFL Wardrobe Door Features Coat Rod and Knob Pull; Knob Color will Coordinate with Drawer Pull
- If Black or Gold Pull is Selected, Knob will be Black; If Chrome or Aluminum Pull is Selected, Knob will be Aluminum
- Hutch Doors Standard with Touch Latch; See Door Options Below
- Two (2) Adjustable Shelves
- Locking Lateral Drawers Provides Legal or Letter Filing
- Door/Drawer Fronts Available in Contrasting Colors; Must Specify
- Safely Write on Dry Erase Doors with Our Dry Erase Marker Set; [See Sets](#)
- Additional Options: Dove Tail Drawer Construction ([See Drawer Options](#)), Locking Doors ([See Locking Options](#))

Hutch Door Options: Specify & Add

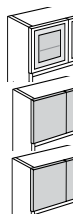

| | | |
|-------|--|--------|
| 1-AD | Aluminum Framed Satin Frosted Tempered Glass Doors (Non-Locking) | \$ 877 |
| 1-DEB | Dry Erase Board Doors | \$ 54 |
| 1-HGA | High Gloss Acrylic Doors; Must Specify Color (Non-Locking) | |
| | (GPA) Graphite Acrylic | \$ 535 |
| | (BLA) Black, (WMA), Wired Mercury or (WHA) White Acrylic | \$ 487 |

Pricing Codes:

- T= TFL
- P= HPL

[See Canvas Intro Section for Ordering Options](#)

| Item | Model No. | Width | Depth | Height | Ship Wt | Cubic Ft | List Price |
|--|--|-------|-------|------------------|---------|----------|------------|
| STORAGE CABINET WITH LATERAL FILES  | 66-3684SU2 Three Adjustable Shelves | 36 | 24 | 82 $\frac{7}{8}$ | 318 | 49.2 | T\$ 3656 |
| | 66-3084SU2 Three Adjustable Shelves | 30 | 24 | 82 $\frac{7}{8}$ | 271 | 42.9 | T\$ 3568 |
| | 66-3672SU2 Two Adjustable Shelves | 36 | 24 | 70 $\frac{7}{8}$ | 298 | 42.0 | T\$ 3457 |
| | 66-3072SU2 Two Adjustable Shelves | 30 | 24 | 70 $\frac{7}{8}$ | 251 | 35.7 | T\$ 3375 |

Description

- Top - Two (2) Doors with Adjustable Shelves
- Bottom - File/File Locking Drawers Provide Legal or Letter Filing
- Touch Latch Doors
- Door/Drawer Fronts Available in Contrasting Colors; Must Specify
- Additional Options: Locking Doors ([See Locking Options](#))

Must Specify (in this order):

- Model #
- Chassis Color
- Door/Drawer Front Color
- Drawer Construction
- Locking Doors

| | | | | | | | |
|--|-----------|----|----|------------------|-----|------|----------|
| WARDROBE/STORAGE CABINET  | 66-3672WC | 36 | 24 | 70 $\frac{7}{8}$ | 320 | 42.0 | T\$ 2850 |
| | 66-3072WC | 30 | 24 | 70 $\frac{7}{8}$ | 240 | 35.7 | T\$ 2774 |



Description

- Left Side: One (1) Fixed Shelf at Top and Three (3) Adjustable Shelves below
- Right Side: One (1) Fixed Shelf at Top and Coat Rod below
- Touch Latch Door
- Safely Write on Dry Erase Doors with Our Dry Erase Marker Set; [See Sets](#)
- If Applicable, Door Fronts Available in Contrasting Colors; Must Specify
- Additional Options: Locking Doors ([See Locking Options](#))

Must Specify (in this order):

- Model #
- Chassis Color
- Door Style/Color
- Locking Doors

Options: Specify & Add

| | | | |
|---|-------|--|---------|
|  | 1-DEB | Dry Erase Board Doors | \$ 257 |
|  | 1-HGA | High Gloss Acrylic Doors; Must Specify Color | |
| | | (GPA) Graphite Acrylic | \$ 2551 |
| | | (BLA) Black, (WMA), Wired Mercury or (WHA) White Acrylic | \$ 2329 |

Pricing Codes:

- T= TFL
- P= HPL

[See Canvas Intro Section for Ordering Options](#)

| Item | Model No. | Width | Depth | Height | Ship Wt | Cubic Ft | List Price |
|-------------------------------|-----------|-------|-------|------------------|---------|----------|------------|
| TALL WARDROBE/STORAGE CABINET | 66-3684WC | 36 | 24 | 82 $\frac{7}{8}$ | 340 | 49.2 | T\$ 2974 |
| | 66-3084WC | 30 | 24 | 82 $\frac{7}{8}$ | 320 | 41.4 | T\$ 2894 |

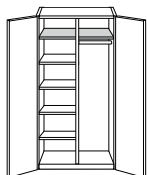



Must Specify (in this order):

- Model #
- Color
- Door Style/Color
- Locking Doors

Description

- Left Side: One (1) Fixed Shelf at Top and Four (4) Adjustable Shelves below
- Right Side: One (1) Fixed Shelf at Top and Coat Rod below
- Touch Latch Doors
- Safely Write on Dry Erase Doors with Our Dry Erase Marker Set; [See Sets](#)
- If Applicable, Door Fronts Available in Contrasting Colors; Must Specify
- Additional Options: Locking Doors ([See Locking Options](#))

Options: Specify & Add

| | | | |
|---|-------|--|---------|
|  | 1-DEB | Dry Erase Board Doors | \$ 257 |
|  | 1-HGA | High Gloss Acrylic Doors; Must Specify Color | |
| | | (GPA) Graphite Acrylic | \$ 2551 |
| | | (BLA) Black, (WMA), Wired Mercury or (WHA) White Acrylic | \$ 2329 |

END BOOKCASE

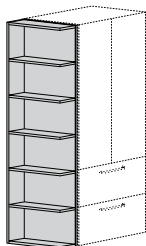

Shown as Left

Must Specify (in this order):

- Model #
- Color

| Mounts Left | Mounts Right | Width | Depth | Height | Ship Wt | Cubic Ft | List Price |
|---------------------------|--------------|-------|------------------|------------------|---------|----------|------------|
| 66-0984BEL | 66-0984BER | 9 | 23 $\frac{1}{2}$ | 82 $\frac{7}{8}$ | 90 | 13.6 | T\$ 1480 |
| Five (5) Fixed 8" Shelves | | | | | | | |
| 66-0972BEL | 66-0972BER | 9 | 23 $\frac{1}{2}$ | 70 $\frac{7}{8}$ | 75 | 11.7 | T\$ 1308 |
| Four (4) Fixed 8" Shelves | | | | | | | |

Description

- Top Shelf Clearance 15"
- Remaining Shelves 12 $\frac{1}{2}$ " Clearance Between Shelves
- Not for Freestanding, Must Mount to Other Storage Component

Pricing Codes:

- T= TFL
- P= HPL

[See Canvas Intro Section for Ordering Options](#)

| Item | Model No. | Width | Depth | Height | Ship Wt | Cubic Ft | List Price |
|---|---|-------|-------|--------|---------|----------|----------------------|
|  | 66-3684BC Four (4) Adjustable Shelves - One (1) Fixed Shelf | 36 | 14¼ | 82⅞ | 200 | 30.3 | T\$ 2114 |
| | 66-3672BC Three (3) Adjustable Shelves - One (1) Fixed Shelf | 36 | 14¼ | 70⅞ | 176 | 26.9 | T\$ 1822 |
| | 66-3660BC Three (3) Adjustable Shelves | 36 | 14¼ | 58⅞ | 147 | 23.2 | T\$ 1570 |
| | 66-3648BC Two (2) Adjustable Shelves | 36 | 14¼ | 46⅞ | 120 | 18.7 | T\$ 1451 |
| | 66-3630BC One (1) Adjustable Shelf - Top Front Edge Profiled | 36 | 14¼ | 30 | 75 | 11.9 | T\$ 1099 P\$ 1234 |
| | 66-3084BC Four (4) Adjustable Shelves - One (1) Fixed Shelf | 30 | 14¼ | 82⅞ | 175 | 25.5 | T\$ 1730 |
| | 66-3072BC Three (3) Adjustable Shelves - One (1) Fixed Shelf | 30 | 14¼ | 70⅞ | 146 | 23.3 | T\$ 1490 |
| | 66-3060BC Three (3) Adjustable Shelves | 30 | 14¼ | 58⅞ | 122 | 19.5 | T\$ 1308 |
| | 66-3048BC Two (2) Adjustable Shelves | 30 | 14¼ | 46⅞ | 100 | 15.7 | T\$ 1127 |
| | 66-3030BC One (1) Adjustable Shelf - Top Front Edge Profiled | 30 | 14¼ | 30 | 62 | 10.1 | T\$ 927 P\$ 1057 |

Must Specify (in this order):

Model #
Top Material
Color
Edge

Description

- 1" Thick Shelf

SURFACE MOUNT BOOKCASE

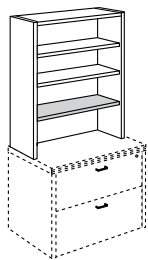

Must Specify (in this order):

Model #
Color

| | | | | | | |
|--|----|-----|-----|-----|------|----------|
| 66-1536TTU Two (2) Adjustable and One (1) Fixed Shelf | 36 | 14¼ | 52⅞ | 169 | 22.2 | T\$ 1269 |
| 66-1530TTU Two (2) Adjustable and One (1) Fixed Shelf | 30 | 14¼ | 52⅞ | 141 | 17.3 | T\$ 1157 |
| 66-1536TU One (1) Adjustable and One (1) Fixed Shelf | 36 | 14¼ | 40⅞ | 127 | 16.4 | T\$ 1004 |
| 66-1530TU One (1) Adjustable and One (1) Fixed Shelf | 30 | 14¼ | 40⅞ | 98 | 15.9 | T\$ 927 |

Description

- For Use on Two (2) Drawer Lateral Files
- 1" Thick Shelves

Pricing Codes:

T= TFL
P= HPL

[See Canvas Intro Section for Ordering Options](#)

| Item | Model No. | Width | Depth | Height | Ship Wt | Cubic Ft | List Price |
|--------------------------------|------------------------------------|-------|-------|--------|---------|----------|---------------------------------|
| WORK TABLES STANDING HEIGHT | 66-4896TWT | 96 | 48 | 42 | 402 | 14.2 | T\$ 2401 |
| | | | | | | | P\$ 2826 |
| | | | | | | | Wire Management Upcharge \$ 470 |
| | 66-4884TWT | 84 | 48 | 42 | 368 | 12.4 | T\$ 2240 |
| | | | | | | | P\$ 2626 |
| | | | | | | | Wire Management Upcharge \$ 426 |
| | 66-4872TWT | 72 | 48 | 42 | 332 | 10.7 | T\$ 2085 |
| | | | | | | | P\$ 2445 |
| | | | | | | | Wire Management Upcharge \$ 377 |
| | 66-4860TWT | 60 | 48 | 42 | 300 | 9.0 | T\$ 1926 |
| | | | | | | | P\$ 2256 |
| | | | | | | | Wire Management Upcharge \$ 335 |
| | 66-4296TWT | 96 | 42 | 42 | 374 | 12.5 | T\$ 2166 |
| | | | | | | | P\$ 2551 |
| | | | | | | | Wire Management Upcharge \$ 470 |
| | 66-4284TWT | 84 | 42 | 42 | 342 | 10.9 | T\$ 2031 |
| | | | | | | | P\$ 2375 |
| | | | | | | | Wire Management Upcharge \$ 426 |
| | 66-4272TWT | 72 | 42 | 42 | 308 | 9.4 | T\$ 1895 |
| | | | | | | | P\$ 2223 |
| | | | | | | | Wire Management Upcharge \$ 377 |
| | 66-4260TWT | 60 | 42 | 42 | 278 | 7.9 | T\$ 1763 |
| | | | | | | | P\$ 2060 |
| | | | | | | | Wire Management Upcharge \$ 335 |
| | 66-3696TWT | 96 | 36 | 42 | 346 | 10.8 | T\$ 2043 |
| | | | | | | | P\$ 2386 |
| | | | | | | | Wire Management Upcharge \$ 470 |
| | 66-3684TWT | 84 | 36 | 42 | 315 | 9.5 | T\$ 1920 |
| | | | | | | | P\$ 2224 |
| | | | | | | | Wire Management Upcharge \$ 426 |
| | 66-3672TWT | 72 | 36 | 42 | 283 | 8.1 | T\$ 1794 |
| | | | | | | | P\$ 2081 |
| | | | | | | | Wire Management Upcharge \$ 377 |
| | 66-3660TWT | 60 | 36 | 42 | 255 | 6.8 | T\$ 1669 |
| | | | | | | | P\$ 1933 |
| | | | | | | | Wire Management Upcharge \$ 335 |
| | 66-2496TWT Modesty Recessed 5¼" | 96 | 24 | 42 | 211 | 64.9 | T\$ 1828 |
| | | | | | | | P\$ 2111 |
| | 66-2484TWT Modesty Recessed 5¼" | 84 | 24 | 42 | 193 | 57.0 | T\$ 1722 |
| | | | | | | | P\$ 1976 |
| | 66-2472TWT Modesty Recessed 5¼" | 72 | 24 | 42 | 176 | 49.0 | T\$ 1614 |
| | | | | | | | P\$ 1851 |
| | 66-2460TWT Modesty Recessed 5¼" | 60 | 24 | 42 | 158 | 41.1 | T\$ 1505 |
| | | | | | | | P\$ 1727 |

Must Specify (in this order):

Model #
Top Material
Top Color
Edge Profile
Chassis Color
Modesty/Color
Grommet Location
Wire Management
Grommet Style/Color
Power/Data Options

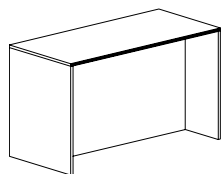

Description

- Available with TFL (T) or HPL (P) Top; Must Specify
- Centered Modesty Available in Contrasting Colors
- Double Modesty/Wire Management Upcharge Included when Grommet, Dock 950, Dock 150 or Power is Ordered
- Add a Purse Hook to Hold Personal Items; [See Hook Details](#)
- Duo/Trio and Power Data Port Units (01-DPORT4A/B); [See PDC Locations](#)
- 24"D Units Ship Assembled; Other Sizes Require Some Assembly
- 24"D Units Are Meant to be Used Against a Wall; Modesty Panel is Recessed 5¼"
- Additional Options: Power and Grommet Options ([See Options and Locations](#))

Pricing Codes:

T= TFL
P= HPL

[See Canvas Intro Section for Ordering Options](#)

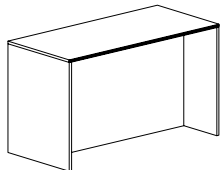
| Item | Model No. | Width | Depth | Height | Ship Wt | Cubic Ft | List Price |
|---|------------|-------|-------|--------|---------|----------|---------------------------------|
| WORK TABLES | 66-4896CWT | 96 | 48 | 36 | 326 | 14.2 | T\$ 2291 |
| | | | | | | | P\$ 2719 |
| COUNTER HEIGHT | 66-4884CWT | 84 | 48 | 36 | 298 | 12.4 | Wire Management Upcharge \$ 437 |
| | | | | | | | T\$ 2141 |
|  | 66-4872CWT | 72 | 48 | 36 | 268 | 10.7 | P\$ 2525 |
| | | | | | | | Wire Management Upcharge \$ 391 |
| | 66-4860CWT | 60 | 48 | 36 | 242 | 9.0 | T\$ 1989 |
| | | | | | | | P\$ 2352 |
| | 66-4296CWT | 96 | 42 | 36 | 338 | 12.5 | Wire Management Upcharge \$ 350 |
| | | | | | | | T\$ 1837 |
| <i>Must Specify (in this order):</i> | 66-4284CWT | 84 | 42 | 36 | 309 | 10.9 | P\$ 2169 |
| | | | | | | | Wire Management Upcharge \$ 306 |
| Model # | 66-4272CWT | 72 | 42 | 36 | 278 | 9.4 | T\$ 2067 |
| Top Material | | | | | | | P\$ 2448 |
| Top Color | 66-4260CWT | 60 | 42 | 36 | 251 | 7.9 | Wire Management Upcharge \$ 437 |
| Edge Profile | | | | | | | T\$ 1939 |
| Chassis Color | 66-3696CWT | 96 | 36 | 36 | 312 | 10.8 | P\$ 2283 |
| Modesty/Color | | | | | | | Wire Management Upcharge \$ 391 |
| Grommet Location | 66-3684CWT | 84 | 36 | 36 | 285 | 9.5 | T\$ 1934 |
| Wire Management | | | | | | | P\$ 2278 |
| Grommet Style/Color | 66-3672CWT | 72 | 36 | 36 | 256 | 8.1 | Wire Management Upcharge \$ 437 |
| Power/Data Options | | | | | | | T\$ 1819 |
| | 66-3660CWT | 60 | 36 | 36 | 231 | 6.8 | P\$ 2122 |
| | | | | | | | Wire Management Upcharge \$ 391 |
| | 66-2496CWT | 96 | 24 | 36 | 192 | 56.0 | T\$ 1698 |
| | | | | | | | P\$ 1988 |
| | 66-2484CWT | 84 | 24 | 36 | 176 | 49.2 | Wire Management Upcharge \$ 350 |
| | | | | | | | T\$ 1575 |
| | 66-2472CWT | 72 | 24 | 36 | 160 | 42.3 | P\$ 1829 |
| | | | | | | | T\$ 1476 |
| | 66-2460CWT | 60 | 24 | 36 | 143 | 35.5 | P\$ 1714 |
| | | | | | | | T\$ 1379 |
| | | | | | | | P\$ 1601 |

Description

- Available with TFL (T) or HPL (P) Top; Must Specify
- Centered Modesty Available in Contrasting Colors
- Double Modesty/Wire Management Upcharge will be Included when Grommet, Dock 950, Dock 150 or Power is Ordered
- Add a Purse Hook to Hold Personal Items; [See Hook Details](#)
- Duo/Trio and Power Data Port Units (01-DPORT4A/B); [See PDC Locations](#)
- 24"D Units Ship Assembled; Other Sizes Require Some Assembly
- 24"D Units Are Meant to be Used Against a Wall; Modesty Panel is Recessed 5/4"
- Additional Options: Power and Grommet Options ([See Options and Locations](#))

Pricing Codes:

T= TFL
P= HPL

[See Canvas Intro Section for Ordering Options](#)

| Item | Model No. | Width | Depth | Height | Ship Wt | Cubic Ft | List Price |
|------------------------------|----------------------|-------|-------|--------|---------|----------|---------------------------------|
| WORK TABLES SEATED HEIGHT | 66-4896WT | 96 | 48 | 30 | 326 | 14.2 | T\$ 2217 |
| | | | | | | | P\$ 2641 |
| | | | | | | | Wire Management Upcharge \$ 391 |
| | 66-4884WT | 84 | 48 | 30 | 298 | 12.4 | T\$ 2069 |
| | | | | | | | P\$ 2449 |
| | | | | | | | Wire Management Upcharge \$ 357 |
| | 66-4872WT | 72 | 48 | 30 | 268 | 10.7 | T\$ 1923 |
| | | | | | | | P\$ 2285 |
| | | | | | | | Wire Management Upcharge \$ 318 |
| | 66-4860WT | 60 | 48 | 30 | 242 | 9.0 | T\$ 1776 |
| | | | | | | | P\$ 2106 |
| | | | | | | | Wire Management Upcharge \$ 279 |
| | 66-4296WT | 96 | 42 | 30 | 374 | 12.5 | T\$ 1962 |
| | | | | | | | P\$ 2345 |
| | | | | | | | Wire Management Upcharge \$ 391 |
| | 66-4284WT | 84 | 42 | 30 | 342 | 10.9 | T\$ 1843 |
| | | | | | | | P\$ 2186 |
| | | | | | | | Wire Management Upcharge \$ 357 |
| | 66-4272WT | 72 | 42 | 30 | 308 | 9.4 | T\$ 1718 |
| | | | | | | | P\$ 2043 |
| | | | | | | | Wire Management Upcharge \$ 318 |
| | 66-4260WT | 60 | 42 | 30 | 278 | 7.9 | T\$ 1598 |
| | | | | | | | P\$ 1894 |
| | | | | | | | Wire Management Upcharge \$ 279 |
| | 66-2496WT | 96 | 24 | 30 | 173 | 47.2 | T\$ 1543 |
| | Modesty Recessed 5¼" | | | | | | P\$ 1827 |
| | 66-2484WT | 84 | 24 | 30 | 158 | 41.4 | T\$ 1457 |
| | Modesty Recessed 5¼" | | | | | | P\$ 1708 |
| | 66-2472WT | 72 | 24 | 30 | 143 | 35.6 | T\$ 1364 |
| | Modesty Recessed 5¼" | | | | | | P\$ 1603 |
| | 66-2460WT | 60 | 24 | 30 | 129 | 29.8 | T\$ 1275 |
| | Modesty Recessed 5¼" | | | | | | P\$ 1495 |

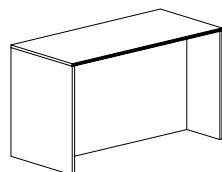

Must Specify (in this order):

Model #
Top Material
Top Color
Edge Profile
Chassis Color
Modesty/Color
Grommet Location
Wire Management
Grommet Style/Color
Power/Data Options

Description

- Available with TFL (T) or HPL (P) Top; Must Specify
- Centered Modesty Available in Contrasting Colors
- Double Modesty/Wire Management Upcharge will be Included when Grommet, Dock 950, Dock 150 or Power is Ordered
- Add a Purse Hook to Hold Personal Items; [See Hook Details](#)
- Duo/Trio and Power Data Port Units (01-DPORT4A/B); [See PDC Locations](#)
- 24"D Units Ship Assembled; Other Sizes Require Some Assembly
- 24"D Units Are Meant to be Used Against a Wall; Modesty Panel is Recessed 5¼"
- Additional Options: Power and Grommet Options ([See Options and Locations](#))

Pricing Codes:

T= TFL
P= HPL

[See Canvas Intro Section for Ordering Options](#)

| Item | Model No. | Width | Depth | Height | Ship Wt | Cubic Ft | List Price |
|---------------------|-----------|-------|-------|--------|---------|----------|----------------------|
| COMPUTER WORK TABLE | 66-2442CW | 42 | 24 | 27 | 115 | 19.2 | T\$ 1168 P\$ 1336 |
| | 66-2436CW | 36 | 24 | 27 | 99 | 16.6 | T\$ 1150 P\$ 1296 |

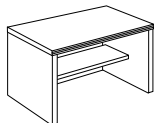

Must Specify (in this order):

- Model #
- Top Material
- Top Color
- Edge Profile
- Grommet Color
- Casters

Description

- Available with TFL (T) or HPL (P) Top; Must Specify
- Fixed Shelf
- Grommet Standard; Must Specify: Black (BLK), Silver (SLV)

Options: Specify & Add

| | | |
|---------|--|--------|
| CS-66BL | Optional Black Casters (Increases Height to 29") | \$ 239 |
|---------|--|--------|



Braking Casters on User Side/Non-Braking Casters on Approach

| | | | | | | | |
|----------------|-----------|----|----|----|----|------|---------------------|
| MAGAZINE TABLE | 66-2442MT | 42 | 24 | 16 | 70 | 11.9 | T\$ 970 P\$ 1136 |
|----------------|-----------|----|----|----|----|------|---------------------|

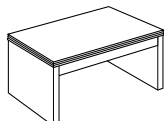

Must Specify (in this order):

- Model #
- Top Material
- Top Color
- Edge Profile

Description

- Available with TFL (T) or HPL (P) Top; Must Specify
- Slab Ends
- Apron Rail

| | | | | | | | |
|-----------|-----------|----|----|----|----|-----|---------------------|
| END TABLE | 66-2424ET | 24 | 24 | 22 | 65 | 9.4 | T\$ 921 P\$ 1057 |
|-----------|-----------|----|----|----|----|-----|---------------------|

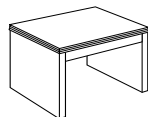

Must Specify (in this order):

- Model #
- Top Material
- Top Color
- Edge Profile

Description

- Available with TFL (T) or HPL (P) Top; Must Specify
- Slab Ends
- Apron Rail

Pricing Codes:

- T= TFL
- P= HPL

[See Canvas Intro Section for Ordering Options](#)

| Item | Model No. | Width | Depth | Height | Ship Wt | Cubic Ft | List Price |
|---|---|-------|-------|--------|---------|----------|---------------------|
|  | 66-4848CT <i>Accommodates Five (5) Chairs</i> | 48 | 48 | 1 | 95 | 4.3 | T\$ 732 P\$ 1026 |
| | 66-4242CT <i>Accommodates Four (4) Chairs</i> | 42 | 42 | 1 | 70 | 3.4 | T\$ 709 P\$ 989 |
| | 66-3636CT <i>Accommodates Three (3) Chairs</i> | 36 | 36 | 1 | 37 | 2.5 | T\$ 620 P\$ 869 |

Must Specify (in this order):

- Model #
- Top Material
- Color
- Edge Profile

Description

- Single Base or Four (4) Strut Legs (on 48" Top Only) Required; Ordered Separately, See Next Page
- Power Options not Available

METAL X-BASE

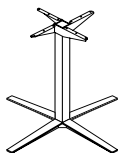

| For Use With | | Round Tops: 42" + 48" | | Top Surfaces: 42"x96" | | | | | |
|--------------|-----------------|-----------------------|-----|--------------------------------|----|----|------|----|------|
| 08-2642LXBB | For 42"H Tables | Black | 35% | 35% | 40 | 33 | 20.0 | \$ | 1322 |
| 08-2642LXBA | | Aluminum | | | | | | | |
| 08-2636LXBB | For 36"H Tables | Black | 35% | 35% | 34 | 30 | 17.2 | \$ | 1275 |
| 08-2636LXBA | | Aluminum | | | | | | | |
| 08-2630LXBB | For 30"H Tables | Black | 35% | 35% | 28 | 27 | 14.5 | \$ | 1219 |
| 08-2630LXBA | | Aluminum | | | | | | | |
| For Use With | | Round Tops: 30" + 36" | | Top Surfaces: 36"x84", 36"x72" | | | | | |
| 08-2042SXBB | For 42"H Tables | Black | 29 | 29 | 40 | 27 | 15.9 | \$ | 1235 |
| 08-2042SXBA | | Aluminum | | | | | | | |
| 08-2036SXBB | For 36"H Tables | Black | 29 | 29 | 34 | 24 | 13.7 | \$ | 1185 |
| 08-2036SXBA | | Aluminum | | | | | | | |
| 08-2030SXBB | For 30"H Tables | Black | 29 | 29 | 28 | 21 | 11.6 | \$ | 1139 |
| 08-2030SXBA | | Aluminum | | | | | | | |

Description

- See Number of Bases Required Per Top Width Below
- Power Units Available On Center When Using Two or More Metal X-Bases
- Not Available to be Sold Separately
- Some Assembly Required

| Table Widths | Round | 72" | 84" | 96" |
|--------------------------|-------|-----|-----|-----|
| Number of Bases Required | 1 | 2 | 2 | 2 |

**HEIGHT ADJUSTABLE
PNEUMATIC X-BASE**

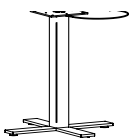

| Maximum Round 42", Maximum Square 36" | | | | | | | | | |
|---------------------------------------|----------|----|----|----|---|-----|----|------|--|
| 01-3232HAXBB | Black | 32 | 32 | 26 | 1 | 0.2 | \$ | 1721 | |
| 01-3232HAXBA | Aluminum | | | | | | | | |
| Maximum Round 36", Maximum Square 30" | | | | | | | | | |
| 01-2626HAXBB | Black | 22 | 22 | 26 | 1 | 0.2 | \$ | 1687 | |
| 01-2626HAXBA | Aluminum | | | | | | | | |

Description

- Pre-Drilled Boring Pattern May Not Match Underside of Table Top
- Steel Mounting Plate: 8"x 8"x 1/4"
- Eight (8) Bolts Included for Assembly
- Some Assembly Required; Hardware Included

Pricing Codes:

- T= TFL
- P= HPL

[See Canvas Intro Section for Ordering Options](#)

| Item | Model No. | Width | Depth | Height | Ship Wt | Cubic Ft | List Price |
|------|-----------|-------|-------|--------|---------|----------|------------|
|------|-----------|-------|-------|--------|---------|----------|------------|

TUBULAR X-BASE

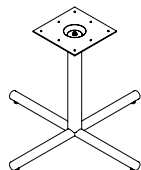

| | | | | | | | |
|---------------------|--|--|--|--|--|--|--|
| For Use With | | | | | | | |
| Round Tops: 48" | | | | | | | |
| Square Tops: 42" | | | | | | | |

| | | | | | | | |
|------------|----------|----|----|-----|----|-----|--------|
| 01-3830TXB | Black | 38 | 38 | 27¾ | 40 | 4.2 | \$ 699 |
| 01-3830TXA | Aluminum | | | | | | |

| | | | | | | | |
|--------------------------------|--|--|--|--|--|--|--|
| For Use With | | | | | | | |
| Round Tops: 30", 36", 42" | | | | | | | |
| Square Tops: 36" | | | | | | | |
| Top Surfaces: 36"x84", 36"x72" | | | | | | | |

| | | | | | | | |
|------------|----------|----|----|-----|----|-----|--------|
| 01-3230TXB | Black | 32 | 32 | 27¾ | 32 | 3.2 | \$ 633 |
| 01-3230TXA | Aluminum | | | | | | |

Description

- 3" Diameter Column
- See Number of Bases Required Per Top Width Below
- Power Units Available On Center When Using Two or More Tubular X-Bases
- Some Assembly Required

| Table Widths | Round | 72" | 84" | 96" |
|---------------------------------|-------|-----|-----|-----|
| Number of Bases Required | 1 | 2 | 2 | 2 |

DISC BASE



| | | | | | | | |
|---------------------------|--|--|--|--|--|--|--|
| For 48" Round Tops | | | | | | | |
|---------------------------|--|--|--|--|--|--|--|

| | | | | | | | |
|------------|----------|----|----|-----|----|-----|---------|
| 01-3230DBB | Black | 30 | 30 | 27¾ | 42 | 4.1 | \$ 1842 |
| 01-3230DBA | Aluminum | 30 | 30 | 27¾ | 42 | 4.1 | |

| | | | | | | | |
|-----------------------------------|--|--|--|--|--|--|--|
| For 36" and 42" Round Tops | | | | | | | |
|-----------------------------------|--|--|--|--|--|--|--|

| | | | | | | | |
|------------|----------|----|----|-----|----|-----|---------|
| 01-2430DBB | Black | 24 | 24 | 27¾ | 32 | 3.2 | \$ 1535 |
| 01-2430DBA | Aluminum | 24 | 24 | 27¾ | 32 | 3.2 | |

Description

- 4" Diameter 14 Gauge Steel Column with 12"x12" Mounting Plate at Top of Column
- ¼" Thick Disc Plate with 5 Levelers
- Stiffener Bar Not Included; Must Order Separately (See Stiffener Bars)
- Some Assembly Required

| Table Widths | Round | 72" | 84" | 96" |
|---------------------------------|-------|-----|-----|-----|
| Number of Bases Required | 1 | 2 | 2 | 2 |

STRUT TABLE LEGS

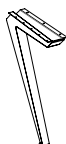

| | | | | | | | |
|-------------|-----------------|----|-----|-----|----|-----|---------|
| 01-2228STR2 | 1 Pair (2 Legs) | 1½ | 22½ | 28⅝ | 32 | 4.5 | \$ 1278 |
|-------------|-----------------|----|-----|-----|----|-----|---------|

| | | | | | | | |
|-------------|-----------------|----|-----|-----|----|-----|---------|
| 01-2228STR4 | 2 Pair (4 Legs) | 1½ | 22½ | 28⅝ | 64 | 9.0 | \$ 2556 |
|-------------|-----------------|----|-----|-----|----|-----|---------|

Description

- Available in Aluminum (ALUM) or Black (BLK); Must Specify Color
- Built-In Wire Management Cover on Inside of Legs
- Each Leg has Adjustable Glides
- Legs not Available To Be Sold Separately
- For Use with Indiana Furniture 48" Round Tops Only

Must Specify (in this order):

- Model # and Quantity
- Color
- Optional Stiffener Bar and Quantity

Options: Specify & Add

| | | | | | | | |
|------------|---------------|--|--|--|--|--|--------|
| 01-00048SB | Stiffener Bar | | | | | | \$ 121 |
|------------|---------------|--|--|--|--|--|--------|

See Individual Tops for Recommended Number of Stiffener Bars

| Table Widths | 48" CT | 72" | 84" | 120" |
|---------------------------------|--------|-----|-----|------|
| Number of Bases Required | 4 | 4 | 4 | 6 |

Pricing Codes:

- T= TFL
- P= HPL

[See Canvas Intro Section for Ordering Options](#)

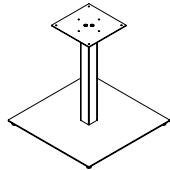
| Item | Model No. | | Width | Depth | Height | Ship Wt | Cubic Ft | List Price |
|---|---|----------|-------|-------|--------|---------|----------|------------|
| SQUARE BASE  | For Use With Round Tops: 48" Square Tops: 42" | | | | | | | |
| | 01-2630SBB | Black | 26 | 26 | 27¾ | 32 | 3.2 | \$ 1163 |
| | 01-2630SBA | Aluminum | | | | | | |
| | For Use With Round Tops: 42" Square Tops: 36" Top Surfaces: 36"x84", 36"x72" | | | | | | | |
| | 01-2030SBB | Black | 20 | 20 | 27¾ | 32 | 3.2 | \$ 956 |
| | 01-2030SBA | Aluminum | | | | | | |
| | For Use With Round Tops: 36" Square Tops: 30" | | | | | | | |
| | 01-1630SBB | Black | 16 | 16 | 27¾ | 32 | 3.2 | \$ 898 |
| | 01-1630SBA | Aluminum | | | | | | |

Description

- 2¾" Diameter Column
- 12"x12" Mounting Plate at Top of Column
- Stiffener Bar Not Included; Must Order Separately (See Stiffener Bars)
- See Number of Bases Required Per Top Width Below
- Power Units Available On Center When Using Two or More Square Bases
- Some Assembly Required

| Table Widths | Round | 72" | 84" | 96" |
|---------------------------------|-------|-----|-----|-----|
| Number of Bases Required | 1 | 2 | 2 | 2 |

CYLINDER BASE

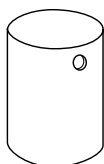

| | | | | | | | | |
|-------------------------|--|--|----|----|-----|-----|------|----------|
| For Tables 42"D to 48"D | | | | | | | | |
| 01-2020CB | | | 20 | 20 | 28½ | 136 | 10.9 | W\$ 1553 |
| For Tables 36"D | | | | | | | | |
| 01-1616CB | | | 16 | 16 | 28½ | 101 | 7.2 | W\$ 1419 |

Description

- Veneer Base Features Multi-Step, Hand-Finished Catalyzed Finish
- Weighted for Stability
- Two (2) Wire Management Black Grommets Standard at Top Edge; 8" Opening Standard at Bottom
- See Number of Bases Required Per Table Width Below

Additional Grommet Options: Specify & Add

| | | | |
|-------|----------------------------------|----|-----|
| GCB1S | Only One (1) Grommet At Top Edge | \$ | N/C |
| NOGC | No Grommets At Top Edge | \$ | N/C |

| Table Widths | Round | 72" | 96" | 120" |
|---------------------------------|-------|-----|-----|------|
| Number of Bases Required | 1 | 2 | 2 | 3 |

Must Specify (in this order):

Model # and Quantity
Finish
Grommet Options

Pricing Codes:

T= TFL
P= HPL

[See Canvas Intro Section for Ordering Options](#)

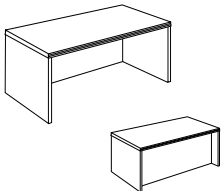
| Item | Model No. | Width | Depth | Height | Ship Wt | Cubic Ft | List Price |
|---|-----------|-------|-------|--------|---------|----------|----------------------|
|  Recessed Front | 66-3672SH | 72 | 36 | 30 | 154 | 50.0 | T\$ 1720 P\$ 2007 |
| | 66-3666SH | 66 | 36 | 30 | 148 | 48.0 | T\$ 1668 P\$ 1944 |
| | 66-3660SH | 60 | 36 | 30 | 139 | 43.7 | T\$ 1624 P\$ 1890 |
| | 66-3072SH | 72 | 30 | 30 | 145 | 43.8 | T\$ 1643 P\$ 1914 |
| | 66-3066SH | 66 | 30 | 30 | 141 | 39.0 | T\$ 1606 P\$ 1862 |
| | 66-3060SH | 60 | 30 | 30 | 136 | 35.3 | T\$ 1540 P\$ 1780 |

Must Specify (in this order):

- Model #
- Top Material
- Top Color
- Edge Profile
- Chassis Color
- Grommet Location
- Grommet Color

Description

- Available with TFL (T) or HPL (P) Top; Must Specify
- For Use With or Without Modular Pedestals
- Support Panel Required ([See 66-2812SP](#)), Stiffener Bar ([See Sizes](#)) Recommended in Kneespaces 60" or Greater When Surface is Not Supported by a Pedestal
- 10" Recessed Front on 36" Deep Units; 4" Recessed Front on 30" Deep Units
- If Using with Pedestal, Surface Grommet Only Available Opposite Pedestal
- Top and Chassis Available in Contrasting Colors; Must Specify Color of Each Component
- [Height Adjustable Units Available](#)
- Additional Options: Power and Grommet Options ([See Options and Locations](#))

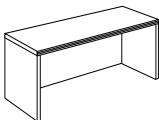
| | | | | | | | |
|--|---|----|----|----|-----|------|----------------------|
|  | 66-2472SH <i>Kneespace 70"</i> | 72 | 24 | 30 | 125 | 34.6 | T\$ 1489 P\$ 1725 |
| | 66-2466SH <i>Kneespace 64"</i> | 66 | 24 | 30 | 118 | 32.7 | T\$ 1446 P\$ 1671 |
| | 66-2460SH <i>Kneespace 58"; No Additional Support Needed</i> | 60 | 24 | 30 | 111 | 29.8 | T\$ 1411 P\$ 1632 |

Must Specify (in this order):

- Model #
- Top Material
- Top Color
- Edge Profile
- Chassis Color
- Grommet Location
- Grommet Color

Description

- Available with TFL (T) or HPL (P) Top; Must Specify
- For Use With or Without Modular Pedestals
- Support Panel Required ([See 66-2812SP](#)), Stiffener Bar ([See Sizes](#)) Recommended in Kneespaces 60" or Greater When Surface is Not Supported by a Pedestal
- [Height Adjustable Units Available](#)
- If Using with Pedestal, Surface Grommet Only Available Opposite Pedestal
- Top and Chassis Available in Contrasting Colors; Must Specify Color of Each Component
- Modesty Panel Grommet Standard; Must Specify: Black (BLK), Silver (SLV) or No Modesty Panel Grommet (NONE)
- Additional Options: Power and Grommet Options ([See Options and Locations](#))

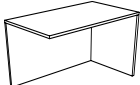
| RETURN SHELL | Left Shell | Right Shell | Width | Depth | Height | Ship Wt | Cubic Ft | List Price |
|--------------|---|-------------|-------|-------|--------|---------|----------|---------------------|
| |  | 66-2448RSHL | | | | | | |
| 66-2442RSHL | | 66-2442RSHR | 42 | 24 | 30 | 60 | 20.4 | T\$ 942 P\$ 1108 |

Shown as Right

Must Specify (in this order):

- Model #
- Top Material
- Top Color
- Edge Profile
- Chassis Color
- Grommet Location
- Grommet Color

Description

- Available with TFL (T) or HPL (P) Top; Must Specify
- For Use With or Without Modular Pedestals
- Optional Surface Grommet; Must Specify Black or Silver.
- Modesty Panel Grommet is Standard; Must Specify: Black (BLK), Silver (SLV) or No Modesty Panel Grommet (NONE)
- Top and Chassis Available in Contrasting Colors; Must Specify Color of Each Component
- Additional Options: Power and Grommet Options ([See Options and Locations](#))

Pricing Codes:

T= TFL
P= HPL

[See Canvas Intro Section for Ordering Options](#)

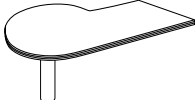
| Item | Model No. | Width | Depth | Height | Ship Wt | Cubic Ft | List Price |
|--|-----------------|------------------|-------|--------|---------|----------|----------------------|
| P-TOP PENINSULA WITH CYLINDER BASE  | Left Top | Right Top | | | | | |
| | 66-4284TL | 66-4284TR | 84 | 42-36 | 30 | 120 | T\$ 2044 P\$ 2718 |
| | 66-4272TL | 66-4272TR | 72 | 42-36 | 30 | 115 | T\$ 1678 P\$ 2200 |

Shown as Left

Must Specify (in this order):

- Model #
- Top Material
- Top Color
- Edge Profile
- Leg Color
- Grommet
- Grommet Color

Description

- Metal Cylinder Base Standard - 4" Diameter; Must Specify: Black or Aluminum
- 48" Stiffener Bar Required on 84" Units if Used as Runoff; [See Stiffener Bar Sizes](#)
- Some Assembly Required

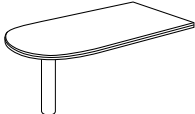
| | | | | | | | |
|--|-----------|----|----|----|-----|------|----------------------|
| D-TOP PENINSULA WITH CYLINDER BASE  | 66-3684DR | 84 | 36 | 30 | 134 | 13.2 | T\$ 2004 P\$ 2662 |
| | 66-3672DR | 72 | 36 | 30 | 115 | 9.8 | T\$ 1692 P\$ 2224 |
| | 66-3066DR | 66 | 30 | 30 | 120 | 7.5 | T\$ 1626 P\$ 2133 |

Must Specify (in this order):

- Model #
- Top Material
- Top Color
- Edge Profile
- Leg Color
- Grommet
- Grommet Color

Description

- Metal Cylinder Base Standard - 4" Diameter; Must Specify: Black or Aluminum
- 48" Stiffener Bar Required on 84" Units if Used as Runoff; [See Stiffener Bar Sizes](#)
- Some Assembly Required

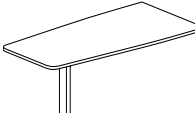
| | | | | | | | |
|--|-----------|----|----|----|----|------|----------------------|
| MEDIA PENINSULA WITH RECTANGLE LEG  | 66-3672MP | 36 | 72 | 30 | 90 | 52.1 | T\$ 2166 P\$ 2918 |
| | 66-3066MP | 30 | 66 | 30 | 77 | 40.3 | T\$ 1996 P\$ 2684 |
| | 66-3060MP | 30 | 60 | 30 | 70 | 36.7 | T\$ 1909 P\$ 2560 |

Must Specify (in this order):

- Model #
- Top Material
- Top Color
- Edge Profile
- Leg Option
- Power Option
- Grommet Color

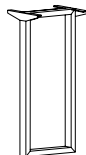

Description

- Aluminum Rectangular Post Standard
- Standard with Aluminum Rectangle Leg to be Installed 17¾" from Front to Allow for Kneespace Area
- Wire Management Trough Included; 4¼" W x 46⅜" L x 3½" H
- Some Assembly Required

Leg Options: Specify & Add

| | | |
|-------|-----------------------|--------|
| OLEGA | 12" Aluminum Tube Leg | \$ 112 |
| OLEGB | 12" Black Tube Leg | \$ 112 |

Pricing Codes:

- T= TFL
- P= HPL

[See Canvas Intro Section for Ordering Options](#)

| Item | Model No. | Width | Depth | Height | Ship Wt | Cubic Ft | List Price |
|---|---|-------|-------|--------|---------|----------|------------|
| MODULAR DESK TOPS | 66-6072TP | 72 | 60 | 1 | 120 | 10.6 | T\$ 1108 |
| | For Use as a Desk Top With Benching Units | | | | | | P\$ 1550 |
|  | 66-6066TP | 66 | 60 | 1 | 110 | 9.8 | T\$ 1056 |
| | For Use as a Desk Top With Benching Units | | | | | | P\$ 1476 |
| | 66-6060TP | 60 | 60 | 1 | 100 | 9.0 | T\$ 1008 |
| | For Use as a Desk Top With Benching Units | | | | | | P\$ 1411 |
| <u>Must Specify (in this order):</u> | 66-4872TP | 72 | 48 | 1 | 102 | 8.6 | T\$ 905 |
| | For Use as a Desk Top With Benching Units | | | | | | P\$ 1270 |
| Model # | 66-4866TP | 66 | 48 | 1 | 94 | 7.8 | T\$ 867 |
| Top Material | For Use as a Desk Top With Benching Units | | | | | | P\$ 1213 |
| Color | 66-4860TP | 60 | 48 | 1 | 86 | 7.0 | T\$ 825 |
| Edge Profile | For Use as a Desk Top With Benching Units | | | | | | P\$ 1159 |
| Grommet Location | 66-3684TP | 84 | 36 | 1 | 85 | 6.6 | T\$ 761 |
| Grommet Color | | | | | | | P\$ 1066 |
| | 66-3678TP | 78 | 36 | 1 | 80 | 6.2 | T\$ 745 |
| | | | | | | | P\$ 1040 |
| | 66-3672TP | 72 | 36 | 1 | 74 | 5.7 | T\$ 726 |
| | | | | | | | P\$ 1015 |
| | 66-3666TP | 66 | 36 | 1 | 68 | 5.2 | T\$ 692 |
| | | | | | | | P\$ 967 |
| | 66-3660TP | 60 | 36 | 1 | 63 | 4.8 | T\$ 661 |
| | | | | | | | P\$ 925 |
| | 66-3654TP | 54 | 36 | 1 | 57 | 4.3 | T\$ 606 |
| | | | | | | | P\$ 851 |
| | 66-3648TP | 48 | 36 | 1 | 51 | 3.8 | T\$ 565 |
| | | | | | | | P\$ 788 |
| | 66-3642TP | 42 | 36 | 1 | 45 | 3.4 | T\$ 512 |
| | | | | | | | P\$ 718 |
| | 66-3084TP | 84 | 30 | 1 | 72 | 5.6 | T\$ 713 |
| | | | | | | | P\$ 1000 |
| | 66-3078TP | 78 | 30 | 1 | 67 | 5.2 | T\$ 696 |
| | | | | | | | P\$ 975 |
| | 66-3072TP | 72 | 30 | 1 | 62 | 4.8 | T\$ 677 |
| | | | | | | | P\$ 947 |
| | 66-3066TP | 66 | 30 | 1 | 58 | 4.4 | T\$ 654 |
| | | | | | | | P\$ 911 |
| | 66-3060TP | 60 | 30 | 1 | 75 | 3.8 | T\$ 601 |
| | | | | | | | P\$ 842 |
| | 66-3054TP | 54 | 30 | 1 | 48 | 3.6 | T\$ 568 |
| | | | | | | | P\$ 794 |
| | 66-3048TP | 48 | 30 | 1 | 43 | 3.2 | T\$ 525 |
| | | | | | | | P\$ 734 |
| | 66-3042TP | 42 | 30 | 1 | 38 | 2.9 | T\$ 478 |
| | | | | | | | P\$ 670 |

Description

- Left to Right Grain Direction on Top; For Front to Back Grain Direction See Next Page
- Optional Surface Grommet; Must Specify: Black (BLK) or Silver (SLV)
- Profiled on Approach and User Side
- Support Panel Required ([See 66-2812SP](#)), Stiffener Bar ([See Sizes](#)) Recommended in Kneespaces 60" or Greater and With Peninsula Application When Surface is Not Supported by a Pedestal
- Additional Options: Power and Grommet Options ([See Options and Locations](#))

Pricing Codes:

T= TFL
P= HPL

[See Canvas Intro Section for Ordering Options](#)

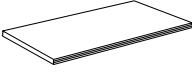
| Item | Model No. | Width | Depth | Height | Ship Wt | Cubic Ft | List Price |
|---|-----------|-------|-------|--------|---------|----------|--------------------|
|  <p>MODULAR DESK TOPS</p> <p><u>Must Specify (in this order):</u> Model # Top Material Color Edge Profile Grommet Location Grommet Color</p> | 66-6036TP | 60 | 36 | 1 | 63 | 4.8 | T\$ 661 P\$ 925 |
| | 66-5436TP | 54 | 36 | 1 | 57 | 4.3 | T\$ 606 P\$ 851 |
| | 66-4836TP | 48 | 36 | 1 | 51 | 3.8 | T\$ 565 P\$ 788 |
| | 66-4236TP | 42 | 36 | 1 | 45 | 3.4 | T\$ 512 P\$ 718 |
| | 66-6030TP | 60 | 30 | 1 | 75 | 3.8 | T\$ 601 P\$ 842 |
| | 66-5430TP | 54 | 30 | 1 | 48 | 3.6 | T\$ 568 P\$ 794 |
| | 66-4830TP | 48 | 30 | 1 | 43 | 3.2 | T\$ 525 P\$ 734 |
| | 66-4230TP | 42 | 30 | 1 | 38 | 2.9 | T\$ 478 P\$ 670 |

Description

- Front to Back Grain Direction on Top
- Optional Surface Grommet; Must Specify: Black (BLK) or Silver (SLV)
- Profiled on Approach and User Side
- Support Panel Required ([See 66-2812SP](#)), Stiffener Bar ([See Sizes](#)) Recommended in Kneespaces 60" or Greater and With Peninsula Application When Surface is Not Supported by a Pedestal
- Additional Options: Power and Grommet Options ([See Options and Locations](#))

Pricing Codes:

T= TFL
P= HPL

[See Canvas Intro Section for Ordering Options](#)

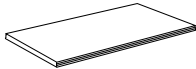
| Item | Model No. | Width | Depth | Height | Ship Wt | Cubic Ft | List Price |
|--|-----------|-------|-------|--------|---------|----------|--------------------|
| 24"D MODULAR BRIDGE, RETURN AND CREDENZA TOPS | 66-2496TP | 96 | 24 | 1 | 100 | 4.9 | T\$ 698 P\$ 979 |
| LEFT TO RIGHT GRAIN DIRECTION | 66-2490TP | 90 | 24 | 1 | 95 | 4.6 | T\$ 680 P\$ 955 |
|  | 66-2484TP | 84 | 24 | 1 | 90 | 4.3 | T\$ 624 P\$ 876 |
| | 66-2478TP | 78 | 24 | 1 | 85 | 4.0 | T\$ 611 P\$ 856 |
| Must Specify (in this order): Model # Top Material Color Edge Profile Grommet Location Grommet Color | 66-2472TP | 72 | 24 | 1 | 80 | 3.7 | T\$ 595 P\$ 830 |
| | 66-2466TP | 66 | 24 | 1 | 75 | 3.4 | T\$ 568 P\$ 792 |
| | 66-2460TP | 60 | 24 | 1 | 70 | 3.0 | T\$ 540 P\$ 760 |
| | 66-2454TP | 54 | 24 | 1 | 65 | 2.8 | T\$ 497 P\$ 695 |
| | 66-2448TP | 48 | 24 | 1 | 44 | 2.5 | T\$ 460 P\$ 645 |
| | 66-2442TP | 42 | 24 | 1 | 50 | 2.2 | T\$ 419 P\$ 587 |
| | 66-2436TP | 36 | 24 | 1 | 45 | 2.0 | T\$ 371 P\$ 519 |
| | 66-2430TP | 30 | 24 | 1 | 36 | 1.6 | T\$ 358 P\$ 501 |
| | 66-2418TP | 18 | 24 | 1 | 28 | 1.0 | T\$ 329 P\$ 461 |

Description

- Left to Right Grain Direction on Top; [See Tops with Front to Back Grain Direction](#)
- For 24"D Bridge, Return and Credenza Modular Tops
- Optional Surface Grommet; Must Specify: Black (BLK) or Silver (SLV)
- Profiled on User Side
- Support Panel Required ([See 66-2812SP](#)), Stiffener Bar ([See Sizes](#)) Recommended in Kneespaces 60" or Greater and With Peninsula Application When Surface is Not Supported by a Pedestal
- Additional Options: Power and Grommet Options ([See Options and Locations](#))

Pricing Codes:

T= TFL
P= HPL

[See Canvas Intro Section for Ordering Options](#)

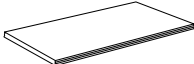
| Item | Model No. | Width | Depth | Height | Ship Wt | Cubic Ft | List Price |
|--|-----------|-------|-------|--------|---------|----------|--------------------|
| 20"D MODULAR BRIDGE, RETURN AND CREDENZA TOPS | 66-2096TP | 96 | 20 | 1 | 65 | 4.3 | T\$ 621 P\$ 870 |
| | 66-2090TP | 90 | 20 | 1 | 61 | 4.1 | T\$ 609 P\$ 854 |
| LEFT TO RIGHT GRAIN DIRECTION  | 66-2084TP | 84 | 20 | 1 | 57 | 3.8 | T\$ 556 P\$ 780 |
| | 66-2078TP | 78 | 20 | 1 | 53 | 3.6 | T\$ 543 P\$ 760 |
| | 66-2072TP | 72 | 20 | 1 | 49 | 3.3 | T\$ 528 P\$ 740 |
| | 66-2066TP | 66 | 20 | 1 | 45 | 2.7 | T\$ 505 P\$ 708 |
| | 66-2060TP | 60 | 20 | 1 | 41 | 2.7 | T\$ 482 P\$ 673 |
| | 66-2054TP | 54 | 20 | 1 | 37 | 2.5 | T\$ 441 P\$ 618 |
| | 66-2048TP | 48 | 20 | 1 | 33 | 2.3 | T\$ 410 P\$ 573 |
| | 66-2042TP | 42 | 20 | 1 | 29 | 1.9 | T\$ 373 P\$ 523 |
| | 66-2036TP | 36 | 20 | 1 | 25 | 1.7 | T\$ 328 P\$ 459 |
| | 66-2030TP | 30 | 20 | 1 | 21 | 1.4 | T\$ 318 P\$ 444 |
| | 66-2018TP | 18 | 20 | 1 | 15 | 0.9 | T\$ 295 P\$ 411 |

Must Specify (in this order):

Model #
Top Material
Color
Edge Profile
Grommet Location
Grommet Color

Description

- Left to Right Grain Direction on Top; [See Tops with Front to Back Grain Direction](#)
- For 20"D Bridge, Return and Credenza Modular Tops
- Optional Surface Grommet; Must Specify: Black (BLK) or Silver (SLV)
- Profiled on User Side
- Support Panel Required ([See 66-2812SP](#)), Stiffener Bar ([See Sizes](#)) Recommended in Kneespaces 60" or Greater and With Peninsula Application When Surface is Not Supported by a Pedestal
- Additional Options: Power and Grommet Options ([See Options and Locations](#))

Pricing Codes:

T= TFL
P= HPL

[See Canvas Intro Section for Ordering Options](#)

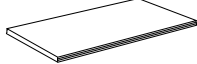
| Item | Model No. | Width | Depth | Height | Ship Wt | Cubic Ft | List Price |
|---|-----------|-------|-------|--------|---------|----------|--------------------|
| 24"D AND 20"D MODULAR BRIDGE, RETURN AND CREDENZA TOPS | 66-6024TP | 60 | 24 | 1 | 70 | 3.0 | T\$ 540 P\$ 760 |
| | 66-5424TP | 54 | 24 | 1 | 65 | 2.8 | T\$ 497 P\$ 695 |
| FRONT AND BACK GRAIN DIRECTION | 66-4824TP | 48 | 24 | 1 | 44 | 2.5 | T\$ 460 P\$ 645 |
| | 66-4224TP | 42 | 24 | 1 | 50 | 2.2 | T\$ 419 P\$ 587 |
|  <p>Must Specify (in this order): Model # Top Material Top Color Edge Profile Grommet Location Grommet Color</p> | 66-3624TP | 36 | 24 | 1 | 45 | 2.0 | T\$ 371 P\$ 519 |
| | 66-3024TP | 30 | 24 | 1 | 36 | 1.6 | T\$ 358 P\$ 501 |
| | 66-6020TP | 60 | 20 | 1 | 41 | 2.7 | T\$ 482 P\$ 673 |
| | 66-5420TP | 54 | 20 | 1 | 37 | 2.5 | T\$ 441 P\$ 618 |
| | 66-4820TP | 48 | 20 | 1 | 33 | 2.3 | T\$ 410 P\$ 573 |
| | 66-4220TP | 42 | 20 | 1 | 29 | 1.9 | T\$ 373 P\$ 523 |
| | 66-3620TP | 36 | 20 | 1 | 25 | 1.7 | T\$ 328 P\$ 459 |
| | 66-3020TP | 30 | 20 | 1 | 21 | 1.4 | T\$ 318 P\$ 444 |

Description

- Front to Back Grain Direction on Top
- For 24" Bridge, Return and Credenza Modular Tops
- Optional Surface Grommet; Must Specify: Black (BLK) or Silver (SLV)
- Profiled on User Side
- Support Panel Required ([See 66-2812SP](#)), Stiffener Bar (See Below) Recommended in Kneespaces 60" or Greater and With Peninsula Application When Surface is Not Supported by a Pedestal
- Additional Options: Power and Grommet Options ([See Options and Locations](#))

| Item | Model No. | Width | Depth | Height | Ship Wt | Cubic Ft | List Price |
|---|------------|-------|-------|--------|---------|----------|------------|
|  | 01-00060SB | 60 | 1¾ | ¾ | 8 | 0.3 | \$ 129 |
| | 01-00048SB | 48 | 1¾ | ¾ | 5 | 0.3 | \$ 121 |

Description

- Reinforces Worksurfaces with Large Kneespace Widths
- Includes End Caps to Cover Sharp Edges
- Recommended in Kneespaces 60" or Greater
- Field Installed

Pricing Codes:

T= TFL
P= HPL

[See Canvas Intro Section for Ordering Options](#)

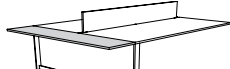
| Item | Model No. | Width | Depth | Height | Ship Wt | Cubic Ft | List Price |
|---|------------|-------|-------|--------|---------|----------|--------------------|
|  | 66-1560DTP | 60 | 15 | 1 | 21 | 1.7 | T\$ 386 P\$ 539 |
| | 66-1548DTP | 48 | 15 | 1 | 21 | 1.7 | T\$ 361 P\$ 505 |

Must Specify (in this order):

Model #
Top Material
Top Color
Edge Profile

Description

- Use as Extension of Top
- Profiled on Three Sides

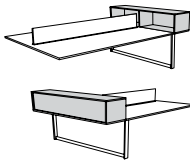
| Item | Model No. | Width | Depth | Height | Ship Wt | Cubic Ft | List Price |
|---|---------------------------------|-------|-------|--------|---------|----------|----------------------|
|  | 66-1560OBEA Two Compartments | 60 | 15 | 15 | 75 | 9.8 | T\$ 1171 P\$ 1326 |
| | 66-1548OBEA Two Compartments | 48 | 15 | 15 | 63 | 7.9 | T\$ 1043 P\$ 1189 |
| | 66-1530OBEA One Compartments | 30 | 15 | 15 | 40 | 4.8 | T\$ 854 P\$ 962 |
| | 66-1524OBEA One Compartments | 24 | 15 | 15 | 35 | 4.1 | T\$ 788 P\$ 895 |

Must Specify (in this order):

Model #
Top Material
Color
Edge Profile

Description

- Profiled on Two Short Sides Edges
- Attached with 11 Gauge Undermount Brackets
- Only Compatible with the O Modular Peninsula Support Seated Height; [See Supports](#)

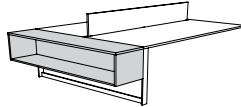
| Item | Model No. | Width | Depth | Height | Ship Wt | Cubic Ft | List Price |
|---|---------------------------------|-------|-------|--------|---------|----------|----------------------|
|  | 66-1560OBEB Two Compartments | 60 | 15 | 15 | 75 | 9.8 | T\$ 1171 P\$ 1326 |
| | 66-1548OBEB Two Compartments | 48 | 15 | 15 | 63 | 7.9 | T\$ 1043 P\$ 1189 |
| | 66-1530OBEB One Compartments | 30 | 15 | 15 | 40 | 4.8 | T\$ 854 P\$ 962 |
| | 66-1524OBEB One Compartments | 24 | 15 | 15 | 35 | 4.1 | T\$ 788 P\$ 895 |

Must Specify (in this order):

Model #
Top Material
Color
Edge Profile

Description

- Profiled on Three Edges
- Only Compatible with the O Modular Peninsula Support Seated Height; [See Supports](#)

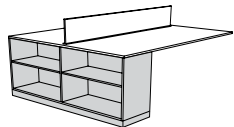
| Item | Model No. | Width | Depth | Height | Ship Wt | Cubic Ft | List Price |
|---|------------|-------|-------|--------|---------|----------|------------|
|  | 66-1560OBE | 60 | 15 | 28¼ | 115 | 19.5 | T\$ 1377 |
| | 66-1548OBE | 48 | 15 | 28¼ | 95 | 15.7 | T\$ 1234 |
| | 66-1530OBE | 30 | 15 | 28¼ | 60 | 10.1 | T\$ 1019 |
| | 66-1524OBE | 24 | 15 | 28¼ | 55 | 8.2 | T\$ 946 |

Must Specify (in this order):

Model #
Color

Description

- Adjustable Shelf
- To Be Used with Modular Benching Desk Top ([See Desk Tops](#)) or Can Be Used as Freestanding Unit with or without Hutch or Bookcase Modular Top ([See Bookcase Tops](#))

Pricing Codes:

T= TFL
P= HPL

[See Canvas Intro Section for Ordering Options](#)

| Item | Model No. | Width | Depth | Height | Ship Wt | Cubic Ft | List Price |
|---|---|-------|-------|--------|---------|----------|------------|
| MODULAR PEDESTAL BOX/BOX/FILE  | 66-3618PD1 Use with 36"D Modular Desk Tops | 18 | 35¼ | 28¼ | 125 | 13.6 | T\$ 1443 |
| | 66-3018PD1 Use with 30"D Modular Desk Tops | 18 | 29¼ | 28¼ | 105 | 11.6 | T\$ 1336 |
| | 66-2418PD1 Use with 24"D Modular Cabinet Tops and Shells | 18 | 23¼ | 28¼ | 98 | 8.9 | T\$ 1247 |
| | 66-2515SHPD1 Use with Desk Shells Only | 15¾ | 25 | 28¼ | 96 | 8.4 | T\$ 1139 |
| | 66-2415PD1 Use with 24"D Modular Cabinet Tops and Shells | 15¾ | 23¼ | 28¼ | 93 | 7.8 | T\$ 1181 |

Must Specify (in this order):

- Model #
- Chassis Color
- Drawer Color
- Grain (if applicable)
- Construction
- Track
- Pull
- Wire Management

Description

- Open Back; [See Back Panel Options](#)
- Top is Required; [See Top Sizes](#)
- Letter Width Locking Pedestal
- Drawer Front Grain Direction Vertical Standard; Optional Horizontal Grain Direction
- Chassis and Drawer Fronts Available in Contrasting Colors; Must Specify Color of Each Component
- Additional Options: Dove Tail Drawer Construction and Soft Close Drawers ([See Drawer Options](#)), Wire Management ([See Option Details](#))

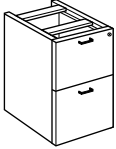
| | | | | | | | |
|---|---|-----|-----|-----|-----|------|----------|
| MODULAR PEDESTAL FILE/FILE  | 66-3618PD2 Use with 36"D Modular Desk Tops | 18 | 35¼ | 28¼ | 125 | 13.6 | T\$ 1443 |
| | 66-3018PD2 Use with 30"D Modular Desk Tops | 18 | 29¼ | 28¼ | 105 | 11.6 | T\$ 1336 |
| | 66-2418PD2 Use with 24"D Modular Cabinet Tops and Shells | 18 | 23¼ | 28¼ | 98 | 8.9 | T\$ 1247 |
| | 66-2515SHPD2 Use with Desk Shells Only | 15¾ | 25 | 28¼ | 96 | 8.4 | T\$ 1139 |
| | 66-2415PD2 Use with 24"D Modular Cabinet Tops and Shells | 15¾ | 23¼ | 28¼ | 93 | 7.8 | T\$ 1181 |

Must Specify (in this order):

- Model #
- Chassis Color
- Drawer Color
- Grain (if applicable)
- Construction
- Track
- Pull
- Wire Management

Description

- Open Back; [See Back Panel Options](#)
- Top is Required; [See Top Sizes](#)
- Letter Width Locking Pedestal
- Drawer Front Grain Direction Vertical Standard; Optional Horizontal Grain Direction
- Chassis and Drawer Fronts Available in Contrasting Colors; Must Specify Color of Each Component
- Additional Options: Dove Tail Drawer Construction and Soft Close Drawers ([See Drawer Options](#)), Wire Management ([See Option Details](#))

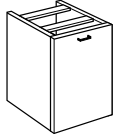
| MODULAR PEDESTAL DOOR BOOKCASE | Left Shell | Right Shell | Width | Depth | Height | Ship Wt | Cubic Ft | List Price |
|---|-------------|-------------|-------|-------|--------|---------|----------|------------|
|  | 66-2418PD4L | 66-2418PD4R | 18 | 23¼ | 28¼ | 90 | 8.9 | T\$ 1004 |

Must Specify (in this order):

- Model #
- Chassis Color
- Door Color
- Grain (if applicable)
- Pull
- Wire Management

Description

- Open Back; [See Back Panel Options](#)
- For Use with 24"D Tops; Top is Required; [See 24"/Left-to-Right Grain Tops](#) and [See 24"/Front-to-Back Grain Tops](#)
- Adjustable Shelf
- Door Front Grain Direction Vertical Standard; Optional Horizontal Grain Direction
- Chassis and Door Fronts Available in Contrasting Colors; Must Specify Color of Each Component
- Additional Options: Locking Door ([See Locking Options](#)) and Wire Management ([See Option Details](#))

Pricing Codes:

T= TFL
P= HPL

[See Canvas Intro Section for Ordering Options](#)

| Item | Model No. | Width | Depth | Height | Ship Wt | Cubic Ft | List Price |
|-----------------------------|------------|-------|-------|--------|---------|----------|------------|
| MODULAR PEDESTAL MULTI-FILE | 66-2436LF2 | 36 | 23¼ | 28¼ | 153 | 18.5 | T\$ 1710 |
| | 66-2430LF2 | 30 | 23¼ | 28¼ | 128 | 14.9 | T\$ 1643 |

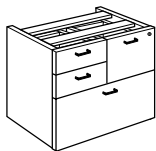

Must Specify (in this order):

Model #
 Chassis Color
 Drawer Front Color
 Grain (if applicable)
 Construction
 Box and File Drawer Track
 Pull
 Wire Management

Description

- Open Back; [See Back Panel Options](#)
- For Use with 24"D Tops; Top is Required; [See 24"/Left-to-Right Grain Tops](#) and [See 24"/Front-to-Back Grain Tops](#)
- Locking File Drawers; File and Lateral Drawer Provides Legal or Letter Filing Front to Back or Side to Side
- Drawer Front Grain Direction Vertical Standard; Optional Horizontal Grain Direction
- Chassis and Drawer Fronts Available in Contrasting Colors; Must Specify Color of Each Component
- Additional Options: Dove Tail Drawer Construction ([See Drawer Construction Options](#)), Soft Close Box and File Drawers ([See Soft Close Options](#)), Wire Management ([See Option Details](#))

| | | | | | | | |
|----------------------------------|------------|----|-----|-----|-----|------|----------|
| MODULAR PEDESTAL OPEN MULTI-FILE | 66-2436OMF | 36 | 23¼ | 28¼ | 118 | 14.9 | T\$ 1641 |
| | 66-2430OMF | 30 | 23¼ | 28¼ | 128 | 18.5 | T\$ 1575 |

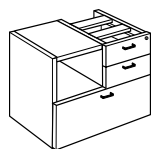

Must Specify (in this order):

Model #
 Chassis Color
 Drawer Front Color
 Grain (if applicable)
 Construction
 Box Drawer Track
 Pull
 Wire Management

Description

- Open Back; [See Back Panel Options](#)
- For Use with 24"D Tops; Top is Required; [See 24"/Left-to-Right Grain Tops](#) and [See 24"/Front-to-Back Grain Tops](#)
- Upper Section Provides Open Storage and Two Locking Box Drawers
- 13½" Open Storage Clearance for 66-2430OMF and 12¾" Open Storage Clearance for 66-2436OMF
- Locking Lateral Drawers Provide Legal or Letter Filing Front to Back or Side to Side
- Drawer Front Grain Direction Vertical Standard; Optional Horizontal Grain Direction
- Chassis and Drawer Fronts Available in Contrasting Colors; Must Specify Color of Each Component
- Additional Options: Dove Tail Drawer Construction ([See Drawer Construction Options](#)), Soft Close Box and File Drawers ([See Soft Close Options](#)), Wire Management ([See Option Details](#))

| | | | | | | | |
|--------------------------------|-----------|----|-----|-----|-----|------|----------|
| MODULAR PEDESTAL DOOR BOOKCASE | 66-2436DB | 36 | 23¼ | 28¼ | 105 | 18.5 | T\$ 1412 |
| | 66-2430DB | 30 | 23¼ | 28¼ | 87 | 14.9 | T\$ 1116 |

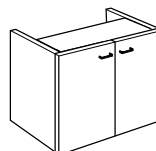

Must Specify (in this order):

Model #
 Chassis Color
 Door Color
 Grain (if applicable)
 Pull
 Locking Doors
 Wire Management

Description

- Open Back; [See Back Panel Options](#)
- For Use with 24"D Tops; Top is Required; [See 24"/Left-to-Right Grain Tops](#) and [See 24"/Front-to-Back Grain Tops](#)
- 12" Deep Adjustable Shelf Behind Doors
- Door Front Grain Direction Vertical Standard; Optional Horizontal Grain Direction
- Chassis and Door Fronts Available in Contrasting Colors; Must Specify Color of Each Component
- Additional Options: Locking Door ([See Locking Options](#)) and Wire Management ([See Option Details](#))

Pricing Codes:

T= TFL
 P= HPL

[See Canvas Intro Section for Ordering Options](#)

| Item | Model No. | Width | Depth | Height | Ship Wt | Cubic Ft | List Price |
|---|------------|-------|-------|--------|---------|----------|------------|
| MODULAR PEDESTAL DOOR BOOKCASE W/OPEN COMPARTMENT | 66-2436ODB | 36 | 23¼ | 28¼ | 118 | 18.5 | T\$ 1334 |
| | 66-2430ODB | 30 | 23¼ | 28¼ | 108 | 14.9 | T\$ 1032 |

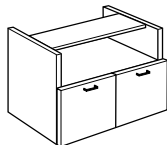

Must Specify (in this order):

Model #
Chassis Color
Door Color
Grain (if applicable)
Pull
Locking Doors
Wire Management

Description

- Open Back; [See Back Panel Options](#)
- For Use with 24"D Tops; Top is Required; [See 24"/Left-to-Right Grain Tops](#) and [See 24"/Front-to-Back Grain Tops](#)
- Upper Section Provides 12¾" Clearance for Open Storage
- Lower Section Provides Storage Behind Two Doors
- Chassis and Door Fronts Available in Contrasting Colors; Must Specify Color of Each Component
- Door Front Grain Direction Vertical Standard; Optional Horizontal Grain Direction
- Additional Options: Locking Door and Wire Management ([See Option Details](#))

| | | | | | | | |
|-------------------------------|------------|----|------|-----|-----|------|----------|
| MODULAR PEDESTAL OPEN STORAGE | 66-2436MBC | 36 | 22½½ | 28¼ | 118 | 18.5 | T\$ 1154 |
| | 66-2430MBC | 30 | 22½½ | 28¼ | 108 | 14.9 | T\$ 979 |

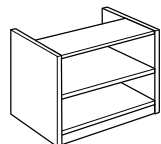

Must Specify (in this order):

Model #
Chassis Color
Wire Management

Description

- Open Back; [See Back Panel Options](#)
- For Use with 24"D Tops; Top is Required; [See 24"/Left-to-Right Grain Tops](#) and [See 24"/Front-to-Back Grain Tops](#)
- One Adjustable Shelf
- Optional Wire Management ([See Option Details](#))

| | | | | | | | |
|-------------------------------|------------|----|-----|-----|-----|------|----------|
| MODULAR PEDESTAL LATERAL FILE | 66-2436LF1 | 36 | 23¼ | 28¼ | 154 | 18.5 | T\$ 1489 |
| | 66-2430LF1 | 30 | 23¼ | 28¼ | 128 | 14.9 | T\$ 1384 |

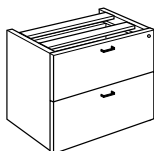

Must Specify (in this order):

Model #
Chassis Color
Drawer Front Color
Grain (if applicable)
Drawer Construction
Pull
Wire Management

Description

- Open Back; [See Back Panel Options](#)
- For Use with 24"D Tops; Top is Required; [See 24"/Left-to-Right Grain Tops](#) and [See 24"/Front-to-Back Grain Tops](#)
- Locking Lateral Drawers Provide Legal or Letter Filing Front to Back or Side to Side
- Drawer Front Grain Direction Vertical Standard; Optional Horizontal Grain Direction
- Chassis and Drawer Fronts Available in Contrasting Colors; Must Specify Color of Each Component
- Additional Options: Dove Tail Drawer Construction ([See Drawer Construction Options](#)), Wire Management ([See Option Details](#))

Pricing Codes:

T= TFL
P= HPL

[See Canvas Intro Section for Ordering Options](#)

| Item | Model No. | Width | Depth | Height | Ship Wt | Cubic Ft | List Price |
|-----------------------------------|------------|-------|-------|--------|---------|----------|------------|
| MODULAR THREE DRAWER LATERAL FILE | 66-2436LF3 | 36 | 24 | 42¾ | 130 | 24.2 | T\$ 2257 |
| | 66-2430LF3 | 30 | 24 | 42¾ | 120 | 20.4 | T\$ 2141 |

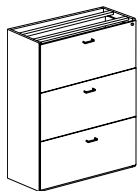

Must Specify (in this order):

Model #
 Chassis Color
 Drawer Front
 Color
 Grain (if applicable)
 Construction
 Pull
 Wire Management

Description

- Finished Back Panel Included
- For Use with 24"D Tops; Top is Required; [See 24"/Left-to-Right Grain Tops](#) and [See 24"/Front-to-Back Grain Tops](#)
- Locking Lateral Drawers Provide Legal or Letter Filing Front to Back or Side to Side
- Drawer Front Grain Direction Vertical Standard; Optional Horizontal Grain Direction
- Chassis and Drawer Fronts Available in Contrasting Colors; Must Specify Color of Each Component
- Additional Options: Dove Tail Drawer Construction ([See Drawer Construction Options](#))

| | | | | | | | |
|--------------------------|--------------|----|-----|-----|----|------|----------|
| 21" LOW MODULAR BOX/FILE | 66-2436L21BF | 36 | 23¼ | 20¾ | 84 | 13.2 | T\$ 1344 |
| | 66-2430L21BF | 30 | 23¼ | 20¾ | 76 | 11.1 | T\$ 1290 |
| | 66-2418L21BF | 18 | 23¼ | 20¾ | 42 | 6.6 | T\$ 1095 |
| | 66-2036L21BF | 36 | 19¼ | 20¾ | 80 | 11.2 | T\$ 1277 |
| | 66-2030L21BF | 30 | 19¼ | 20¾ | 72 | 9.4 | T\$ 1227 |
| | 66-2018L21BF | 18 | 19¼ | 20¾ | 40 | 5.6 | T\$ 1038 |

Must Specify (in this order):

Model #
 Chassis Color
 Drawer Front
 Color
 Grain (if applicable)
 Construction
 Box Drawer Track
 Pull
 Wire Management

Description

- Open Back; [See Low Height Back Panel Options](#)
- For Low Height Credenzas or Benching Applications
- Locking Tray/File Drawers; File Provides Legal or Letter Filing
- Drawer Front Grain Direction Vertical Standard; Optional Horizontal Grain Direction
- Chassis and Drawer Fronts Available in Contrasting Colors; Must Specify Color of Each Component
- Additional Options: Dove Tail Drawer Construction ([See Drawer Construction Options](#)), Soft Close Box and File Drawers ([See Soft Close Options](#)), Wire Management ([See Option Details](#))

Pricing Codes:

T= TFL
 P= HPL

[See Canvas Intro Section for Ordering Options](#)

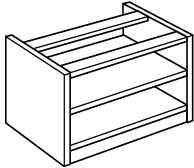
| Item | Model No. | Width | Depth | Height | Ship Wt | Cubic Ft | List Price |
|--|--------------|-------|-------|--------|---------|----------|------------|
| 21" LOW MODULAR OPEN STORAGE  | 66-2436L21BC | 36 | 22½ | 20¾ | 78 | 13.2 | T\$ 1105 |
| | 66-2430L21BC | 30 | 22½ | 20¾ | 74 | 11.1 | T\$ 1065 |
| | 66-2418L21BC | 18 | 22½ | 20¾ | 54 | 6.9 | T\$ 970 |
| | 66-2036L21BC | 36 | 18 ½ | 20¾ | 74 | 11.2 | T\$ 1051 |
| | 66-2030L21BC | 30 | 18 ½ | 20¾ | 70 | 9.4 | T\$ 1010 |
| | 66-2018L21BC | 18 | 18 ½ | 20¾ | 50 | 5.9 | T\$ 921 |

Must Specify (in this order):

Model #
Color
Wire Management

Description

- Open Back; [See Low Height Back Panel Options](#)
- For Low Height Credenzas or Benching Applications
- Removable Wire Management Panel
- One Adjustable Shelf
- Optional Wire Management ([See Option Details](#))

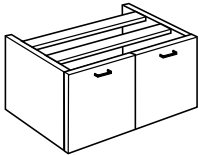
| | | | | | | | |
|--|--------------|----|-----|-----|----|------|----------|
| 21" LOW MODULAR DOOR BOOKCASE  | 66-2436L21DB | 36 | 23¼ | 20¾ | 93 | 13.2 | T\$ 1259 |
| | 66-2430L21DB | 30 | 23¼ | 20¾ | 86 | 11.1 | T\$ 1122 |
| | 66-2036L21DB | 36 | 19¼ | 20¾ | 89 | 11.2 | T\$ 1197 |
| | 66-2030L21DB | 30 | 19¼ | 20¾ | 82 | 9.4 | T\$ 1066 |

Must Specify (in this order):

Model #
Chassis Color
Door
Color
Grain (if applicable)
Pull
Locking Doors
Wire Management

Description

- Open Back; [See Low Height Back Panel Options](#)
- For Low Height Credenzas or Benching Applications
- Removable Wire Management Panel
- One Adjustable Shelf Behind Doors
- Door Front Grain Direction Vertical Standard; Optional Horizontal Grain Direction
- Chassis and Door Fronts Available in Contrasting Colors; Must Specify Color of Each Component
- Additional Options: Locking Doors ([See Locking Options](#)), Wire Management ([See Option Details](#))

Pricing Codes:

T= TFL
P= HPL

[See Canvas Intro Section for Ordering Options](#)

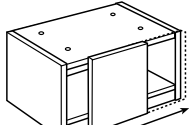
| Item | Model No. | Width | Depth | Height | Ship Wt | Cubic Ft | List Price |
|---|--------------|-------|-------|--------|---------|----------|------------|
| 21" LOW MODULAR SLIDING DOOR BOOKCASE  | 66-2436L21SD | 36 | 23¼ | 20¾ | 93 | 13.2 | T\$ 1439 |
| | 66-2430L21SD | 30 | 23¼ | 20¾ | 86 | 11.1 | T\$ 1264 |
| | 66-2036L21SD | 36 | 19¼ | 20¾ | 89 | 11.2 | T\$ 1367 |
| | 66-2030L21SD | 30 | 19¼ | 20¾ | 82 | 9.4 | T\$ 1200 |

Description

- One Non-Locking Sliding Door
- Open Back; [See Low Height Back Panel Options](#)
- For Low Height Credenzas or Benching Applications
- Removable Wire Management Panel
- Storage Behind Sliding Door
- Door Front Grain Direction Vertical Standard; Optional Horizontal Grain Direction
- Chassis and Door Front Available in Contrasting Colors; Must Specify Color of Each Component
- Optional Wire Management ([See Option Details](#))

Must Specify (in this order):

Model #
 Chassis Color
 Door Color
 Grain (if applicable)
 Wire Management

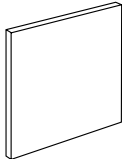
| | | | | | | | |
|--|-----------|----|---|-----|----|-----|---------|
| MODULAR PENINSULA SUPPORT SEATED HEIGHT  | 66-3630EP | 36 | 1 | 28¼ | 40 | 2.0 | T\$ 401 |
| | 66-3030EP | 30 | 1 | 28¼ | 34 | 1.6 | T\$ 375 |
| | 66-2812SP | 12 | 1 | 28¼ | 12 | 0.8 | T\$ 245 |

Description

- To Be Used with Modular Desk Tops at 30" High
- Required to Be Used with T Support or the Support Panel Perpendicular to 36" and 30" Unit

Must Specify (in this order):

Model #
 Color

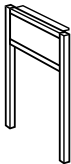
| | | | | | | | |
|---|-----------------------------------|----|---|-----|----|-----|---------|
| H MODULAR PENINSULA SUPPORT SEATED HEIGHT  | 01-3628HL Single Mounted Plate | 36 | 1 | 28¼ | 30 | 2.0 | \$ 1145 |
| | 01-3028HL Single Mounted Plate | 30 | 1 | 28¼ | 25 | 1.7 | \$ 1126 |
| | 01-2428HL Single Mounted Plate | 24 | 1 | 28¼ | 20 | 1.4 | \$ 847 |
| | 01-3628TL Double Mounted Plate | 36 | 1 | 28¼ | 30 | 2.0 | \$ 1182 |
| | 01-3028TL Double Mounted Plate | 30 | 1 | 28¼ | 25 | 1.7 | \$ 1163 |
| | 01-2428TL Double Mounted Plate | 24 | 1 | 28¼ | 20 | 1.4 | \$ 876 |

Must Specify (in this order):

Model #
 Laminate Insert
 Support Color

Description

- Available in Aluminum (ALUM) or Black (BLK), Must Specify
- Constructed of Tubular Steel
- Metal End Support to Be Used with Modular Desk Tops at 30" High - Not Available to be Sold Separately
- Double Mount Plate Required for Freestanding Table/Desk

Leg Options: Specify & Add

| | | |
|-----|------------|--------|
| HIM | TFL Insert | T\$ 62 |
|-----|------------|--------|

Pricing Codes:

T= TFL
 P= HPL

[See Canvas Intro Section for Ordering Options](#)

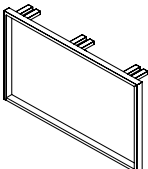
| Item | Model No. | Width | Depth | Height | Ship Wt | Cubic Ft | List Price |
|---|-----------|-------|-------|--------|---------|----------|------------|
| O MODULAR PENINSULA SUPPORT SEATED HEIGHT  | 01-6028OL | 60 | 2 | 28¼ | 60 | 6.0 | \$ 917 |
| | 01-4828OL | 48 | 2 | 28¼ | 55 | 4.7 | \$ 790 |
| | 01-3628OL | 36 | 2 | 28¼ | 30 | 2.7 | \$ 661 |
| | 01-3028OL | 30 | 2 | 28¼ | 25 | 2.3 | \$ 552 |
| | 01-2428OL | 24 | 2 | 28¼ | 20 | 1.8 | \$ 486 |

Must Specify (in this order):

Model #

Support Color

Description

- Available in Aluminum (ALUM) or Black (BLK), Must Specify
- Constructed of Tubular Steel
- Metal End Support to Be Used with Modular Desk Tops at 30" High - Not Available to be Sold Separately

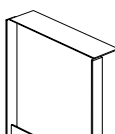
| | | | | | | | |
|---|-----------|----|-----|-----|----|-----|-------------------------------|
| BAR MODULAR PENINSULA SUPPORT SEATED HEIGHT  | 01-3628BL | 36 | 2 ½ | 28¼ | 30 | 2.7 | ALUM/BLK\$ 715 CHRM\$ 1239 |
| | 01-3028BL | 30 | 2 ½ | 28¼ | 25 | 2.3 | ALUM/BLK\$ 644 CHRM\$ 1039 |
| | 01-2428BL | 24 | 2 ½ | 28¼ | 20 | 1.8 | ALUM/BLK\$ 601 CHRM\$ 998 |

Must Specify (in this order):

Model #

Support Color

Description

- Available in Aluminum (ALUM), Black (BLK) or Chrome (CHRM)
- Constructed of Tubular Steel
- Metal End Support to Be Used with Modular Desk Tops at 30" High - Not Available to be Sold Separately

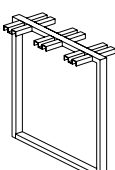
| | | | | | | | |
|--|------------|----|---|-----|----|-----|--------|
| O SHARED METAL LEG SEATED HEIGHT  | 01-3028OLS | 30 | 2 | 28¼ | 50 | 3.1 | \$ 629 |
| | 01-2428OLS | 24 | 2 | 28¼ | 45 | 2.5 | \$ 554 |

Must Specify (in this order):

Model #

Support Color

Description

- Available in Aluminum (ALUM) or Black (BLK), Must Specify
- Constructed of Tubular Steel
- Metal End Support to Be Used with Modular Desk Tops at 30" High - Not Available to be Sold Separately

Pricing Codes:

T= TFL

P= HPL

[See Canvas Intro Section for Ordering Options](#)

| Item | Model No. | | Width | Depth | Height | Ship Wt | Cubic Ft | List Price |
|---|------------|--------|-------|-------|--------|---------|----------|------------|
| 28"D ELECTRIC HEIGHT ADJUSTABLE TABLE LIFT | 01-2854ELB | Black | 54-78 | 28 | 22-48 | 30 | 2.4 | \$ 1832 |
| | 01-2854ELA | Silver | | | | | | |

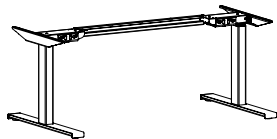
**Description**

- Standard with Up/Down Control Switch, 10' Power Cord, Integrated Anti-Collision Feature, Leveling Glides
- Standard Up/Down Control Switch can be Mounted for Left or Right Users; Upgrade to Advanced Memory Switch (01-MSWCH with Memory, Reminders, and Bluetooth), Must Specify and See Below for Details
- Adjusts to Accommodate Tops 54-78"W and 30"-36"D; Tops Sold Separately
- Lifting Capacity (Including Worksurface): 363 lbs
- Some Assembly Required; Installation Instructions Included

| | | | | | | | | |
|---|------------|--------|-------|----|-------|----|-----|---------|
| 22"D ELECTRIC HEIGHT ADJUSTABLE TABLE LIFT | 01-2254ELB | Black | 54-78 | 22 | 22-48 | 58 | 2.4 | \$ 1832 |
| | 01-2254ELA | Silver | | | | | | |

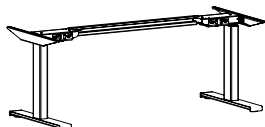
**Description**

- Standard with Up/Down Control Switch, 10' Power Cord, Anti-Collision Safety Feature, Leveling Glides
- Standard Up/Down Control Switch can be Mounted for Left or Right Users; Upgrade to Advanced Memory Switch (01-MSWCH with Memory, Reminders, and Bluetooth), Must Specify and See Below for Details
- Adjusts to Accommodate Tops 54-78"W and 24"D; Tops Sold Separately
- Lifting Capacity (Including Worksurface): 363 lbs
- Some Assembly Required; Installation Instructions Included

| | | | | | | | | |
|---|------------|--------|-------|----|-------|----|-----|---------|
| 22"D ELECTRIC HEIGHT ADJUSTABLE TABLE LIFT | 01-2242ELB | Black | 42-48 | 22 | 22-48 | 55 | 2.4 | \$ 1832 |
| | 01-2242ELA | Silver | | | | | | |

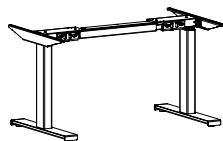
**Description**

- Standard with Up/Down Control Switch, 10' Power Cord, Anti-Collision Safety Feature, Leveling Glides
- Standard Up/Down Control Switch can be Mounted for Left or Right Users; Upgrade to Advanced Memory Switch (01-MSWCH with Memory, Reminders, and Bluetooth), Must Specify and See Below for Details
- Adjusts to Accommodate Tops 42-48"W and 24"-30"D; Tops Sold Separately
- Lifting Capacity (Including Worksurface): 363 lbs
- Some Assembly Required; Installation Instructions Included

| | | | | | | | | |
|---|----------|--|----|----|----|---|-----|--------|
| ELECTRIC HEIGHT ADJUSTABLE ADVANCED SWITCH WITH MEMORY | 01-MSWCH | | 3% | 4% | 1% | ½ | 0.8 | \$ 223 |
|---|----------|--|----|----|----|---|-----|--------|

**Description**

- Black Unit with Black Cord
- Bluetooth Capabilities
- Three Stand-Up Reminders
- Four Height Memory Positions

OPEN MARKET ONLY

Pricing Codes:T= TFL
P= HPL[See Canvas Intro Section for Ordering Options](#)

| Item | Model No. | Width | Depth | Height | Ship Wt | Cubic Ft | List Price |
|--|-----------|-------|-------|--------|---------|----------|------------|
| LAYER SUPPORT FOR 21" LOW CREDENZA  | 01-3607OL | 36 | 2 | 7 | 25 | 1.1 | \$ 576 |
| | 01-3007OL | 30 | 2 | 7 | 20 | 0.9 | \$ 557 |
| | 01-2407OL | 24 | 2 | 7 | 15 | 0.7 | \$ 523 |

Description

- Available in Aluminum (ALUM) or Black (BLK), Must Specify
- Supports 30" High Worksurfaces Over Low Height Components - Not Available to be Sold Separately

Must Specify (in this order):

Model #

Support Color

| | | | | | | | |
|--|--------------|----|----|---|----|-----|---------|
| LAYER SUPPORT OVER LOW HEIGHT CABINETS  | 66-1807USP21 | 18 | 5¾ | 7 | 20 | 1.2 | T\$ 260 |
|--|--------------|----|----|---|----|-----|---------|

Description

- Supports 30"H Worksurfaces Over Low Height Components - Not Available to be Sold Separately
- Open Throughout and On Back Side to Manage Cables
- Rectangle Grommet Cover Included; Must Specify: Black (BLK) or Silver (SLV)

Must Specify (in this order):

Model #

Color

Grommet Color

| | | | | | | | |
|---|---|---|---|-----|---|-----|---------|
| FILLER PANEL  | 66-2803FP | 3 | ¾ | 28¼ | 6 | 0.5 | T\$ 199 |
| | For Standard Height Modular Pedestals and Credenzas | | | | | | |
| | 66-2003FP | 3 | ¾ | 20¾ | 4 | 0.9 | T\$ 184 |
| | For Low Height Credenzas or Benching Applications | | | | | | |

Description

- Used to Fill Gap Behind Modular Pedestals with a Modular Top

Must Specify (in this order):

Model #

Color

Pricing Codes:

T= TFL

P= HPL

[See Canvas Intro Section for Ordering Options](#)

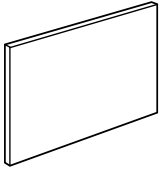
| Item | Model No. | Width | Depth | Height | Ship Wt | Cubic Ft | List Price |
|---|--------------------------------------|-------|-------|--------|---------|----------|------------|
|  | MODULAR MODESTY/BACK PANEL 66-9628BP | 96 | ¾ | 28¼ | 115 | 5.0 | T\$ 555 |
| | 66-9028BP | 90 | ¾ | 28¼ | 108 | 4.6 | T\$ 539 |
| | 66-8428BP | 84 | ¾ | 28¼ | 101 | 4.3 | T\$ 522 |
| | 66-7828BP | 78 | ¾ | 28¼ | 94 | 4.0 | T\$ 508 |
| | 66-7228BP | 72 | ¾ | 28¼ | 86 | 3.7 | T\$ 492 |
| | 66-6628BP | 66 | ¾ | 28¼ | 79 | 3.4 | T\$ 478 |
| | 66-6028BP | 60 | ¾ | 28¼ | 65 | 3.7 | T\$ 469 |
| | 66-5428BP | 54 | ¾ | 28¼ | 60 | 2.8 | T\$ 447 |
| | 66-4828BP | 48 | ¾ | 28¼ | 55 | 2.5 | T\$ 427 |
| | 66-4228BP | 42 | ¾ | 28¼ | 50 | 2.2 | T\$ 372 |
| | 66-3628BP | 36 | ¾ | 28¼ | 45 | 2.0 | T\$ 320 |
| | 66-3028BP | 30 | ¾ | 28¼ | 30 | 1.6 | T\$ 295 |
| | 66-1828BP | 18 | ¾ | 28¼ | 19 | 1.0 | T\$ 252 |
| 66-1528BP | 15¾ | ¾ | 28¼ | 18 | 1.0 | T\$ 232 | |

Must Specify (in this order):

Model #
Color
Grommet
Grommet Color

Description

- For Use as a Modesty Panel to Create Bridges, Returns, or Credenzas, or as a Back Panel on Modular Units
- Grain Runs Vertically Up to 60" - All Larger Sizes are Horizontal Grain Patterns

Leg Options: Specify & Add

| | | |
|--------|--|-------|
| 1-GRMT | Optional Top-Center Grommet, Must Specify: Black (BLK) or Silver (SLV) | \$ 52 |
|--------|--|-------|

| | | | | | | | |
|---|-----------------------------------|----|----|-----|----|-----|---------|
|  | FLIPDOWN MODESTY PANEL 66-2836FDM | 36 | 3½ | 28¼ | 35 | 3.3 | T\$ 904 |
| | 66-2830FDM | 30 | 3½ | 28¼ | 30 | 2.7 | T\$ 799 |

Description

- Modesty Panel with 3" Deep Case Allows Room for Plugs
- Does Not Feature Soft Close Hinges
- Upper Panel: Open at Top, Hinged and Opens Fully for Easy Access to Ports and Cord Management

Must Specify (in this order):

Model #
Color

Pricing Codes:

T= TFL
P= HPL

[See Canvas Intro Section for Ordering Options](#)

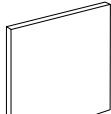
| Item | Model No. | Width | Depth | Height | Ship Wt | Cubic Ft | List Price |
|---|-----------|-------|-------|--------|---------|----------|------------|
|  | 66-3530EP | 35¼ | 1 | 28¼ | 41 | 2.6 | T\$ 396 |
| | 66-2930EP | 29¼ | 1 | 28¼ | 34 | 2.2 | T\$ 373 |
| | 66-2330EP | 23¼ | 1 | 28¼ | 27 | 1.6 | T\$ 355 |

Must Specify (in this order):
Model #
Color

Description

- Must Be Used with a Back Panel

| | | | | | | | |
|----------------------|-----------|----|---|-----|----|-----|---------|
| SUPPORT PANEL | 66-2812SP | 12 | 1 | 28¼ | 12 | 0.8 | T\$ 245 |
|----------------------|-----------|----|---|-----|----|-----|---------|

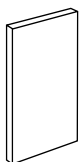

Must Specify (in this order):
Model #
Color

Description

- Required to be Used Perpendicular to Full Back Panels to Support Kneespace Areas of 60" or Longer

| | | | | | | | |
|------------------|--|----|----|-----|----|-----|---------|
| SUPPORT T | 66-1010SP | 10 | 10 | 28¼ | 20 | 0.8 | T\$ 358 |
| | 66-1010SPW Support T with Wire Management | 10 | 10 | 28¼ | 20 | 0.8 | T\$ 358 |



Must Specify (in this order):
Model #
Color

Description

- Supports Worksurfaces
- Required on Kneespace Areas of 60" or More Where Back Panels are Not Used

| | | | | | | | |
|----------------------|-----------|----|---|-----|----|-----|--------|
| O LEG SUPPORT | 01-1228OL | 12 | 2 | 28¼ | 20 | 1.2 | \$ 442 |
|----------------------|-----------|----|---|-----|----|-----|--------|

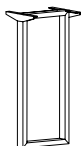

Must Specify (in this order):
Model #
Color
Wire Management Cover

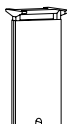

Description

- Available in Aluminum or Black; Must Specify Color
- Provides Additional Support Under Tops Greater Than 60" - Not Available to be Sold Separately

Leg Options: Specify & Add

| | | |
|-------------|--|--------|
| 01-1228OLWM | Wire Management Cover - Available in Aluminum or Black; Must Specify Color | \$ 291 |
|-------------|--|--------|

Pricing Codes:
T= TFL
P= HPL

[See Canvas Intro Section for Ordering Options](#)

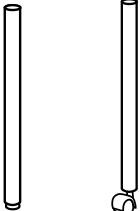
| Item | Model No. | Width | Depth | Height | Ship Wt | Cubic Ft | List Price |
|---|--------------------------------------|-------|-------|--------|---------|----------|------------|
|  | 01-0401MLA Aluminum Leg with Leveler | 2 | 2 | 28¾ | 10 | 0.5 | \$ 320 |
| | 01-0401MLB Black Leg with Leveler | | | | | | |
| | 01-0400MLA Aluminum Leg with Caster | 2 | 2 | 28¾ | 10 | 0.5 | \$ 272 |
| | 01-0400MLB Black Leg with Caster | | | | | | |
| Description | | | | | | | |
| <ul style="list-style-type: none"> Available in Adjustable Black Leveler or Locking Black Caster | | | | | | | |

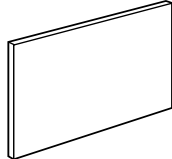
| Item | Model No. | Width | Depth | Height | Ship Wt | Cubic Ft | List Price |
|---|-----------|-------|-------|--------|---------|----------|------------|
|  | 66-9620BP | 96 | ¾ | 20¾ | 40 | 3.4 | T\$ 490 |
| | 66-9020BP | 90 | ¾ | 20¾ | 38 | 3.3 | T\$ 476 |
| | 66-8420BP | 84 | ¾ | 20¾ | 36 | 3.2 | T\$ 464 |
| | 66-7820BP | 78 | ¾ | 20¾ | 34 | 3.1 | T\$ 443 |
| | 66-7220BP | 72 | ¾ | 20¾ | 31 | 3.0 | T\$ 427 |
| | 66-6620BP | 66 | ¾ | 20¾ | 29 | 2.9 | T\$ 417 |
| | 66-6020BP | 60 | ¾ | 20¾ | 27 | 2.8 | T\$ 371 |
| | 66-5420BP | 54 | ¾ | 20¾ | 24 | 2.7 | T\$ 348 |
| | 66-4820BP | 48 | ¾ | 20¾ | 22 | 2.6 | T\$ 339 |
| | 66-4220BP | 42 | ¾ | 20¾ | 20 | 2.5 | T\$ 307 |
| | 66-3620BP | 36 | ¾ | 20¾ | 17 | 2.4 | T\$ 287 |
| | 66-3020BP | 30 | ¾ | 20¾ | 15 | 2.3 | T\$ 267 |
| | 66-2420BP | 24 | ¾ | 20¾ | 15 | 2.3 | T\$ 243 |
| | 66-1820BP | 18 | ¾ | 20¾ | 15 | 2.3 | T\$ 237 |

Must Specify (in this order):
 Model #
 Color
 Grommet
 Grommet Color

Description

- For Use as a Back Panels to Create Low Height Returns, Credenzas, or Benches
- Grain Runs Vertically Up to 60" - All Larger Sizes are Horizontal Grain Patterns

Leg Options: Specify & Add



| | | |
|--------|--|-------|
| 1-GRMT | Optional Top-Center Grommet, Must Specify: Black or Silver | \$ 52 |
|--------|--|-------|

| Item | Model No. | Width | Depth | Height | Ship Wt | Cubic Ft | List Price |
|----------------------|-----------|-------|-------|--------|---------|----------|------------|
| LOW HEIGHT END PANEL | 66-2420EP | 23¾ | 1 | 20¾ | 15 | 0.8 | T\$ 310 |
| | 66-2020EP | 19¾ | 1 | 20¾ | 15 | 0.8 | T\$ 254 |

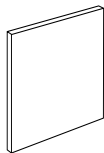

Description

- Must Be Used with a Back Panel

Must Specify (in this order):

Model #
Color

| | | | | | | | |
|--------------------------|-----------|----|---|-----|---|-----|---------|
| LOW HEIGHT SUPPORT PANEL | 66-2012SP | 12 | 1 | 20¾ | 7 | 0.4 | T\$ 222 |
|--------------------------|-----------|----|---|-----|---|-----|---------|



Description

- Required to be Used Perpendicular to Full Back Panels to Support Kneespace Areas of 60" or Longer

Must Specify (in this order):

Model #
Color

| | | | | | | | |
|----------------------|--|----|----|-----|----|-----|---------|
| LOW HEIGHT SUPPORT T | 66-2010SP | 10 | 10 | 20¾ | 11 | 2.3 | T\$ 317 |
| | 66-2010SPW Support T with Wire Management | 10 | 10 | 20¾ | 11 | 2.3 | T\$ 319 |

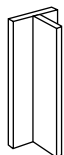

Description

- Supports Worksurfaces
- Required on Kneespace Areas of 60" or More Where Back Panels are Not Used

Must Specify (in this order):

Model #
Color

Pricing Codes:

T= TFL
P= HPL

[See Canvas Intro Section for Ordering Options](#)

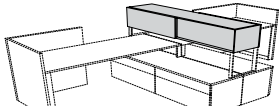
| Item | Model No. | Width | Depth | Height | Ship Wt | Cubic Ft | List Price |
|---|-------------|-------|-------|--------|---------|----------|------------|
|  DUAL ACCESS SLIDING DOOR HUTCH | 66-1572DAHS | 72 | 16½ | 15 | 117 | 14.5 | T\$ 2378 |
| | 66-1566DAHS | 66 | 16½ | 15 | 111 | 13.4 | T\$ 2285 |
| | 66-1560DAHS | 60 | 16½ | 15 | 104 | 12.2 | T\$ 2203 |



Must Specify (in this order):

Model #
Color
Door Style
Door Color
Dry Erase Back Panel

Description

- One Non-Locking Sliding Door
- Used with Shared Office Application
- Metal Stanchion Leg Sold Separately; [See Stanchion Sizes](#)
- Safely Write on Dry Erase Door and Dry Erase Back Panel with Our Dry Erase Marker Set; [See Set Options](#)
- If Applicable, Door Front Grain Direction Vertical Standard; Optional Horizontal Grain Direction
- If Applicable, Door Front Available in Contrasting Colors; Must Specify

Options: Specify & Add

| | | | |
|---|-------|--|---------|
|  | 1-AD | Aluminum Framed Satin Frosted Tempered Glass Doors (Non-Locking) | \$ 1490 |
| | 1-DEB | Dry Erase Board Door (Non-Locking) | \$ 154 |
|  | 1-HGA | High Gloss Acrylic Door (Non-Locking); Must Specify Color | |
| | | (GPA) Graphite Acrylic | \$ 1542 |
| | | (BLA) Black, (WMA) Wired Mercury, or (WHA) White Acrylic | \$ 1411 |
| | DEF | Dry Erase Fixed Back Panel | \$ 646 |

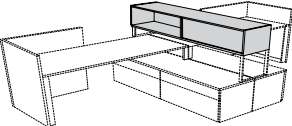
| | | | | | | | |
|---|-------------|----|----|----|----|------|----------|
|  DUAL ACCESS OPEN HUTCH | 66-1572DAOH | 72 | 15 | 15 | 95 | 14.5 | T\$ 1326 |
| | 66-1566DAOH | 66 | 15 | 15 | 90 | 13.4 | T\$ 1278 |
| | 66-1560DAOH | 60 | 15 | 15 | 85 | 12.2 | T\$ 1261 |

Must Specify (in this order):

Model #
Color
Dry Erase Back Panel
Tackboard
Tackboard Fabric

Description

- Right Side - Fixed/Left Side - Open
- Used with Shared Office Application
- Safely Write on Dry Erase Back Panel with Our Dry Erase Marker Set; [See Set Options](#)
- Metal Stanchion Leg Sold Separately; [See Stanchion Sizes](#)
- Optional Dry Erase Fixed Backs, See Below or Tackboard Fixed Backs; [See Tackboards](#)

Options: Specify & Add

| | | | |
|--|-----|----------------------------|--------|
| | DEF | Dry Erase Fixed Back Panel | \$ 646 |
|--|-----|----------------------------|--------|

Pricing Codes:

T= TFL
P= HPL

[See Canvas Intro Section for Ordering Options](#)

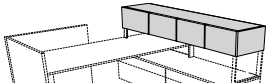
| Item | Model No. | Width | Depth | Height | Ship Wt | Cubic Ft | List Price |
|--|-------------|-------|-------|--------|---------|----------|------------|
| SINGLE SIDED FOUR DOOR HUTCH  | 66-1572SSHU | 72 | 15¾ | 15 | 98 | 12.4 | T\$ 1632 |
| | 66-1566SSHU | 66 | 15¾ | 15 | 93 | 11.4 | T\$ 1574 |
| | 66-1560SSHU | 60 | 15¾ | 15 | 88 | 10.4 | T\$ 1542 |

Description

- Storage Behind Doors
- Safely Write on Dry Erase, White and Black Tempered Glass Doors with Our Dry Erase Marker Set; [See Sets](#)
- Single or Shared Stanchions Must be Ordered Separately; See Next Page
- Optional Locking Doors Available; [See Locking Door Options](#) and Specify Lock Color

Must Specify (in this order):

- Model #
- Color
- Door Style
- Door Color
- Dry Erase Back Panel
- Locking Doors

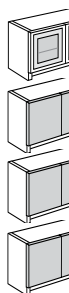

Options: Specify & Add

| | Per Door |
|--|----------|
| 1-AD Aluminum Framed Satin Frosted Tempered Glass Doors (Non-Locking) | \$ 438 |
| 1-DEB Dry Erase Board Doors | \$ 28 |
| WHGLS Aluminum Framed Doors with White Tempered Glass (Non-locking) | \$ 652 |
| BLGLS Black Matte Framed Doors with Black Tempered Glass (Non-locking) | \$ 868 |
| 1-HGA High Gloss Acrylic Doors; Must Specify Color | |
| (GPA) Graphite Acrylic | \$ 269 |
| (BLA) Black, (WMA) Wired Mercury, or (WHA) White Acrylic | \$ 247 |

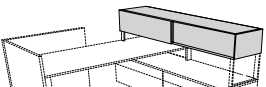
| | | | | | | | |
|---|-------------|----|-----|----|----|------|----------|
| SINGLE SIDED SLIDING DOOR HUTCH  | 66-1572SSHS | 72 | 15¾ | 15 | 89 | 12.4 | T\$ 1765 |
| | 66-1566SSHS | 66 | 15¾ | 15 | 84 | 11.4 | T\$ 1720 |
| | 66-1560SSHS | 60 | 15¾ | 15 | 79 | 10.4 | T\$ 1656 |

Description

- One Non-Locking Sliding Door
- Safely Write on Dry Erase Doors with Our Dry Erase Marker Set; [See Set Options](#)
- Storage Behind Sliding Door
- Single or Shared Stanchions Must be Ordered Separately; See Next Page

Must Specify (in this order):

- Model #
- Color
- Door Style
- Door Color

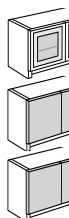

Options: Specify & Add

| | Per Door |
|---|----------|
| 1-AD Aluminum Framed Satin Frosted Tempered Glass Doors (Non-Locking) | \$ 745 |
| 1-DEB Dry Erase Board Door (Non-Locking) | \$ 77 |
| 1-HGA High Gloss Acrylic Door (Non-Locking); Must Specify Color | |
| (GPA) Graphite Acrylic | \$ 773 |
| (BLA) Black, (WMA) Wired Mercury, or (WHA) White Acrylic | \$ 705 |

Pricing Codes:

- T= TFL
- P= HPL

[See Canvas Intro Section for Ordering Options](#)

| Item | Model No. | Width | Depth | Height | Ship Wt | Cubic Ft | List Price |
|---|---|-------|-------|--------|---------|----------|------------|
| METAL STANCHION FOR USE WITH LOW STORAGE AND SINGLE OR DUAL HUTCHES | 01-1515OS For Use Over 21" Low Modular Ped | 15 | 2 | 15 | 25 | 0.5 | \$ 331 |
| | 01-1507OS For Use Over 30" Low Modular Ped | 15 | 2 | 7 | 15 | 0.3 | \$ 305 |

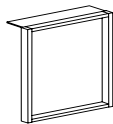

Must Specify (in this order):

Model #
Support Color

Description

- Available in Aluminum (ALUM) or Black (BLK), Must Specify
- For Use With Single Sided and Dual Access Hutches - Not Available to be Sold Separately

| | | | | | | | |
|--|--|----|---|----|----|-----|--------|
| SHARED METAL STANCHION FOR USE WITH LOW STORAGE AND SINGLE OR DUAL HUTCHES | 01-1515OSS For Use Over 21" Low Modular Ped | 15 | 2 | 15 | 25 | 0.5 | \$ 339 |
| | 01-1507OSS For Use Over 30" Low Modular Ped | 15 | 2 | 7 | 15 | 0.3 | \$ 327 |

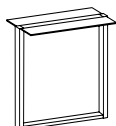

Must Specify (in this order):

Model #
Support Color

Description

- Available in Aluminum (ALUM) or Black (BLK), Must Specify
- For Use With Single Sided and Dual Access Hutches - Not Available to be Sold Separately
- Connects Two Dual Access Hutches

| | | | | | | | |
|-----------------------------------|-----------|----|---|----|----|-----|---------|
| 21" ABOVE AND BELOW SCREEN TFL | 66-6821AB | 68 | ¾ | 21 | 41 | 3.3 | T\$ 471 |
| | 66-6221AB | 62 | ¾ | 21 | 39 | 3.0 | T\$ 459 |
| | 66-5621AB | 56 | ¾ | 21 | 36 | 2.7 | T\$ 441 |
| | 66-5021AB | 50 | ¾ | 21 | 34 | 2.4 | T\$ 425 |
| | 66-4421AB | 44 | ¾ | 21 | 31 | 2.2 | T\$ 408 |

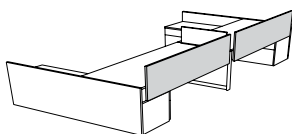

Must Specify (in this order):

Model #
Color

Description

- Mounts to Worksurface
- Provides Privacy 12" Above and 10¾" Modesty Below

Pricing Codes:

T= TFL
P= HPL

[See Canvas Intro Section for Ordering Options](#)

| Item | Model No. | Width | Depth | Height | Ship Wt | Cubic Ft | List Price |
|---|------------|-------|-------|--------|---------|----------|------------|
|  <p>21" ABOVE AND BELOW SCREEN FROSTED ACRYLIC</p> | 66-6821ABA | 68 | ¼ | 21 | 14 | 3.3 | \$ 1352 |
| | 66-6221ABA | 62 | ¼ | 21 | 12 | 2.8 | \$ 1265 |
| | 66-5621ABA | 56 | ¼ | 21 | 10 | 2.8 | \$ 1177 |
| | 66-5021ABA | 50 | ¼ | 21 | 9 | 2.2 | \$ 1088 |
| | 66-4421ABA | 44 | ¼ | 21 | 8 | 1.2 | \$ 998 |

Must Specify (in this order):
Model #
Decorative Hardware Color

Description

- Mounts to Worksurface
- Provides Privacy 12" Above and 10 ¾" Modesty Below
- Decorative Hardware; Must Specify: Aluminum (ALUM) or Chrome (CHRM)

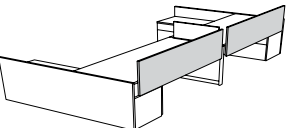
| | | | | | | | |
|---|-------------|----|---|----|----|-----|-----------------------|
|  <p>21" ABOVE AND BELOW SCREEN HIGH GLOSS ACRYLIC</p> | 66-6821ABGA | 68 | ¾ | 21 | 44 | 3.3 | \$ 1447 GPA\$ 1886 |
| | 66-6221ABGA | 62 | ¾ | 21 | 41 | 3.0 | \$ 1344 GPA\$ 1747 |
| | 66-5621ABGA | 56 | ¾ | 21 | 38 | 2.7 | \$ 1246 GPA\$ 1606 |
| | 66-5021ABGA | 50 | ¾ | 21 | 36 | 2.4 | \$ 1147 GPA\$ 1470 |
| | 66-4421ABGA | 44 | ¾ | 21 | 33 | 2.2 | \$ 1051 GPA\$ 1333 |

Must Specify (in this order):
Model #
Color

Description

- Mounts to Worksurface
- Provides Privacy 12" Above and 10 ¾" Modesty Below
- Available in Black (BLA), White (WHA) or Graphite Acrylic (GPA); Graphite Acrylic Pricing (GPA\$)

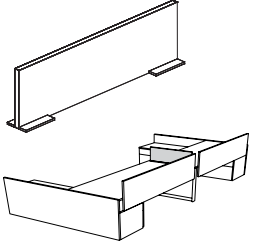
| | | | | | | | |
|--|-----------|----|---|----|----|-----|---------|
|  <p>12" PRIVACY PANEL TFL</p> | 66-2812PP | 28 | ¾ | 12 | 12 | 0.9 | T\$ 355 |
| | 66-2212PP | 22 | ¾ | 12 | 10 | 0.7 | T\$ 345 |

Must Specify (in this order):
Model #
Finish
Decorative Hardware Color

Description

- Mounts to Surface to Create Division Between Workstations
- Decorative Hardware; Must Specify: Aluminum (ALUM) or Chrome (CHRM)

Pricing Codes:

T= TFL
P= HPL

[See Canvas Intro Section for Ordering Options](#)

| Item | Model No. | Width | Depth | Height | Ship Wt | Cubic Ft | List Price |
|--------------------------------------|------------|-------|-------|--------|---------|----------|------------|
| 12" PRIVACY PANEL FROSTED ACRYLIC | 66-2812PPA | 28 | ¼ | 12 | 8 | 0.7 | \$ 580 |
| | 66-2212PPA | 22 | ¼ | 12 | 7 | 0.6 | \$ 523 |

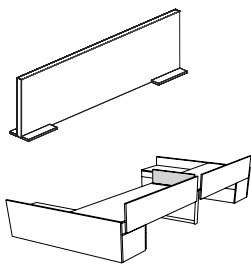
**Description**

- Mounts to Surface to Create Division Between Workstations
- Decorative Hardware; Must Specify: Aluminum (ALUM) or Chrome (CHRM)

Must Specify (in this order):

Model #
Decorative Hardware Color

| | | | | | | | |
|---|-------------|----|---|----|----|-----|---------------------|
| 12" PRIVACY PANEL HIGH GLOSS ACRYLIC | 66-2812PPGA | 68 | ¾ | 12 | 13 | 0.9 | \$ 609 GPA\$ 686 |
| | 66-2212PPGA | 62 | ¾ | 12 | 11 | 0.7 | \$ 546 GPA\$ 605 |

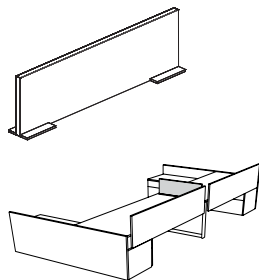
**Description**

- Mounts to Surface to Create Division Between Workstations
- Decorative Hardware; Must Specify: Aluminum (ALUM) or Chrome (CHRM)
- Available in Black (BLA), White (WHA) or Graphite Acrylic (GPA); Graphite Acrylic Pricing (GPA\$)

Must Specify (in this order):

Model #
Color
Decorative Hardware Color

| | | | | | | | |
|---------------------------------------|-----------|----|---|----|----|-----|---------|
| 12" FREESTANDING PRIVACY PANEL TFL | 66-6812PP | 68 | ¾ | 12 | 26 | 2.2 | T\$ 430 |
| | 66-6212PP | 62 | ¾ | 12 | 25 | 2.0 | T\$ 419 |
| | 66-5612PP | 56 | ¾ | 12 | 23 | 1.8 | T\$ 408 |

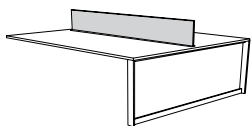
**Description**

- Freestanding on Surface to Create Division Between Workstations
- Decorative Hardware; Must Specify: Aluminum (ALUM) or Chrome (CHRM)

Must Specify (in this order):

Model #
Color
Decorative Hardware Color

Pricing Codes:

T= TFL
P= HPL

[See Canvas Intro Section for Ordering Options](#)

| Item | Model No. | Width | Depth | Height | Ship Wt | Cubic Ft | List Price |
|---|------------|-------|-------|--------|---------|----------|------------|
| 12" FREESTANDING PRIVACY PANEL FROSTED ACRYLIC | 66-6812PPA | 68 | ¼ | 12 | 8 | 2.2 | \$ 982 |
| | 66-6212PPA | 62 | ¼ | 12 | 7 | 2.0 | \$ 925 |
| | 66-5612PPA | 56 | ¼ | 12 | 6 | 1.8 | \$ 854 |

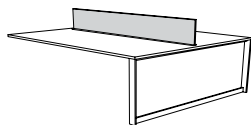

Must Specify (in this order):

Model #
Decorative Hardware Color

Description

- Freestanding on Surface to Create Division Between Workstations
- Decorative Hardware; Must Specify: Aluminum (ALUM) or Chrome (CHRM)

| | | | | | | | |
|--|-------------|----|---|----|----|-----|-----------------------|
| 12" FREESTANDING PRIVACY PANEL HIGH GLOSS ACRYLIC | 66-6812PPGA | 68 | ¾ | 12 | 25 | 3.3 | \$ 1051 GPA\$ 1233 |
| | 66-6212PPGA | 62 | ¾ | 12 | 23 | 3.0 | \$ 979 GPA\$ 1154 |
| | 66-5612PPGA | 56 | ¾ | 12 | 22 | 2.7 | \$ 886 GPA\$ 1073 |

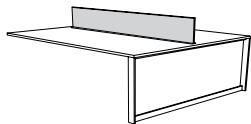

Must Specify (in this order):

Model #
Color
Decorative Hardware Color

Description

- Freestanding on Surface to Create Division Between Workstations
- Decorative Hardware; Must Specify: Aluminum (ALUM) or Chrome (CHRM)
- Available in Black (BLA), White (WHA) or Graphite Acrylic (GPA); Graphite Acrylic Pricing (GPA\$)

| | | | | | | | |
|---------------------------------------|------------|----|---|---|----|-----|---------|
| 7" MODESTY PANEL TFL | 66-6807MOD | 68 | ¾ | 7 | 17 | 1.3 | T\$ 406 |
| | 66-6207MOD | 62 | ¾ | 7 | 16 | 1.2 | T\$ 401 |
| | 66-5607MOD | 56 | ¾ | 7 | 16 | 1.1 | T\$ 390 |

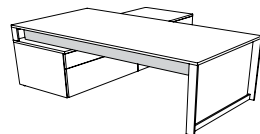

Must Specify (in this order):

Model #
Color

Description

- Works With Low Storage; [See Low Credenzas](#) and Modular Units; [See Modular Units](#)
- Attaches with Aluminum Mounting Brackets

Pricing Codes:

T= TFL
P= HPL

[See Canvas Intro Section for Ordering Options](#)

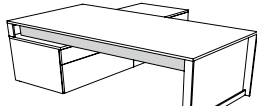
| Item | Model No. | Width | Depth | Height | Ship Wt | Cubic Ft | List Price |
|--|-------------|-------|-------|--------|---------|----------|------------|
| 7" MODESTY PANEL FROSTED ACRYLIC  | 66-6807MODA | 68 | ¼ | 7 | 12 | 1.3 | \$ 705 |
| | 66-6207MODA | 62 | ¼ | 7 | 11 | 1.2 | \$ 652 |
| | 66-5607MODA | 56 | ¼ | 7 | 10 | 1.1 | \$ 620 |

Must Specify (in this order):
Model #
Decorative Hardware Color

Description

- Works With Low Storage; [See Low Credenzas](#) and Modular Units; [See Modular Units](#)
- Exposed Decorative Hardware; Must Specify: Aluminum (ALUM) or Chrome (CHRM)

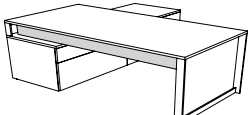
| | | | | | | | |
|---|--------------|----|---|---|----|-----|---------------------|
| 7" MODESTY PANEL HIGH GLOSS ACRYLIC  | 66-6807MODGA | 68 | ¾ | 7 | 17 | 1.3 | \$ 725 GPA\$ 826 |
| | 66-6207MODGA | 62 | ¾ | 7 | 16 | 1.2 | \$ 707 GPA\$ 780 |
| | 66-5607MODGA | 56 | ¾ | 7 | 16 | 1.1 | \$ 690 GPA\$ 738 |

Must Specify (in this order):
Model #
Color

Description

- Works With Low Storage; [See Low Credenzas](#) and Modular Units; [See Modular Units](#)
- Attaches with Aluminum Mounting Brackets
- Available in Black (BLA), Wired Mercury (WMA), White (WHA) or Graphite Acrylic (GPA); Graphite Acrylic Pricing (GPA\$)

Pricing Codes:

T= TFL
P= HPL

[See Canvas Intro Section for Ordering Options](#)

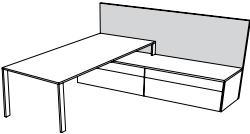
| Item | Model No. | Width | Depth | Height | Ship Wt | Cubic Ft | List Price |
|---|-----------|-------|-------|--------|---------|----------|------------|
| 51" GALLERY SCREEN STRAIGHT FLOORSTANDING  | 66-5173GS | 73 | 1 | 51¼ | 110 | 7.9 | T\$ 1147 |
| | 66-5172GS | 72 | 1 | 51¼ | 110 | 7.9 | T\$ 1139 |
| | 66-5167GS | 67 | 1 | 51¼ | 104 | 7.3 | T\$ 1103 |
| | 66-5166GS | 66 | 1 | 51¼ | 104 | 7.3 | T\$ 1096 |
| | 66-5161GS | 61 | 1 | 51¼ | 98 | 6.7 | T\$ 1057 |
| | 66-5160GS | 60 | 1 | 51¼ | 98 | 6.7 | T\$ 1051 |
| | 66-5155GS | 55 | 1 | 51¼ | 92 | 6.1 | T\$ 1010 |
| | 66-5154GS | 54 | 1 | 51¼ | 92 | 6.1 | T\$ 1003 |
| | 66-5149GS | 49 | 1 | 51¼ | 86 | 5.4 | T\$ 964 |
| | 66-5148GS | 48 | 1 | 51¼ | 86 | 5.4 | T\$ 957 |
| | 66-5143GS | 43 | 1 | 51¼ | 80 | 4.7 | T\$ 920 |
| | 66-5142GS | 42 | 1 | 51¼ | 80 | 4.7 | T\$ 913 |
| | 66-5137GS | 37 | 1 | 51¼ | 60 | 4.1 | T\$ 795 |
| | 66-5136GS | 36 | 1 | 51¼ | 60 | 4.1 | T\$ 772 |
| | 66-5131GS | 31 | 1 | 51¼ | 54 | 3.5 | T\$ 724 |
| | 66-5130GS | 30 | 1 | 51¼ | 54 | 3.5 | T\$ 713 |
| | 66-5125GS | 25 | 1 | 51¼ | 48 | 2.8 | T\$ 662 |
| | 66-5124GS | 24 | 1 | 51¼ | 48 | 2.8 | T\$ 652 |
| | 66-5119GS | 19 | 1 | 51¼ | 42 | 2.2 | T\$ 613 |
| | 66-5118GS | 18 | 1 | 51¼ | 42 | 2.2 | T\$ 603 |

Must Specify (in this order):

Model #
Color
Grommet
Grommet Color

Description

- Horizontal Woodgrain
- Mounts to Back of Modular Credenza for Space Division
- Extend up to 24" Beyond Workstation without Additional Support
- Six (6) Wire Management Grommet Location Options: [See Locations](#) and Specify Location Selections

Pricing Codes:

T= TFL
P= HPL

[See Canvas Intro Section for Ordering Options](#)

Studio Components

Boutique-inspired options to give all your working environments a fresh look with a subtle touch of home. Integrated into our ever-popular Canvas and Gesso Casegood lines, Studio models build upon simplicity and flexibility while allowing you to create eye-catching spaces. Whether you're looking to outfit an executive's office, team space, collaborative area, or anything in between, our Studio desk and storage components have the look and feel you desire.

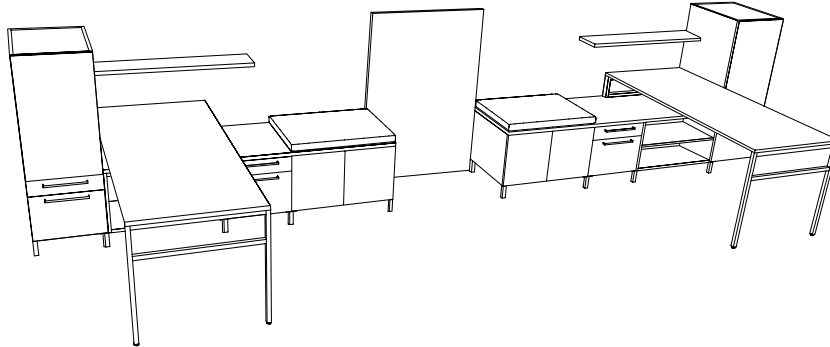

Studio components work with existing Canvas Tops, Peninsula Tops, and accessories such as Tackboards, Work Walls, Marker Boards, and Cushions to build the perfect workspace. The slim leg design provides an upscale feel for all of the Studio components. Storage units such as standard height pedestals offer the flexibility to build single or double pedestal desks or credenzas and low height pedestals allow you to create bench style credenzas.

The Studio pull features a clean application.



How to Use Studio

Start with a Modular Top to build a Desk, Peninsula Desk, Benching or Credenza
[\(See Modular Tops\)](#)



Next, choose from a number of Studio Pedestals options in Standard or Low Height. [\(See Studio Peds\)](#)

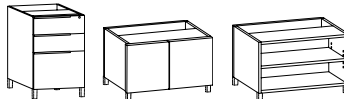

Kneespace Modesty Panels are available in standard height in TFL or High Gloss Acrylic or low height in TFL [\(See Modesty Panels\)](#)

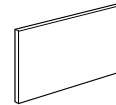

Add additional storage with Studio Storage Cabinets and the full door storage cabinet features high gloss acrylic and dry erase door options [\(See Storage Cabinets\)](#)

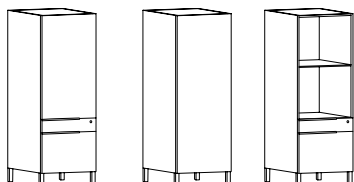

Single and Shared Stanchions offer a layer of support for workstations and single or dual sided hutches [\(See Stanchions\)](#)

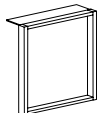

Studio Single and Shared Legs images below provide a simple and clean aesthetic. See below for a guide to the aesthetics of single, double, and shared legs [\(See Leg Options\)](#)



Single Standard Leg



Shared Leg (used between two models)



Double Standard Leg (standard legs used on each model)

| Item | Model No. | Width | Depth | Height | Ship Wt | Cubic Ft | List Price |
|---|-------------|-------|-------|--------|---------|----------|------------|
| STUDIO COMPONENT, MODULAR PEDESTAL BOX/BOX/FILE | 66-3618SPD1 | 18 | 36 | 24¼ | 68 | 11.4 | T\$ 1491 |
| | 66-3018SPD1 | 18 | 30 | 24¼ | 61 | 10.4 | T\$ 1368 |
| | 66-2418SPD1 | 18 | 24 | 24¼ | 54 | 8.4 | T\$ 1263 |



Must Specify (in this order):

Model #
Chassis Color
Drawer Front
Color
Grain (if applicable)
Pull
Drawer Construction
Drawer Track
Wire Management

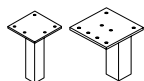

Legs Must be Ordered Separately; [See Leg Options](#)

Description

- For Use With Other Studio Components
- Standard Locking Pedestal; File Drawer Provides Legal or Letter Filing
- Studio Pulls Are Installed on Left Aligned Position; Drawers Feature a ¾ Extension
- Drawer Front Grain Direction Vertical Standard; Optional Horizontal Grain Direction
- Chassis and Drawer Fronts Available in Contrasting Colors; Must Specify Color of Each Component
- Finished Back Panel Included
- Height of Unit with Legs: 28¼; **Legs Must be Ordered Separately; [See Leg Options](#)**
- Worksurface Required; [See Worksurface Sizes](#)
- Additional Options: Dove Tail Drawer Construction and Soft Close Drawers ([See Drawer Options](#)), Wire Management ([See Option Details](#))

| | | | | | | | |
|--|------------|----|----|-----|----|------|----------|
| STUDIO COMPONENT, LOW MODULAR PEDESTAL TRAY/FILE | 66-2436STF | 36 | 24 | 16¾ | 59 | 10.6 | T\$ 1257 |
| | 66-2430STF | 30 | 24 | 16¾ | 51 | 8.9 | T\$ 1213 |
| | 66-2418STF | 18 | 24 | 16¾ | 37 | 5.6 | T\$ 1015 |



Must Specify (in this order):

Model #
Chassis Color
Drawer Front
Color
Grain (if applicable)
Pull
Drawer Construction
Drawer Track
Wire Management

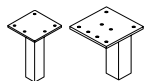

Legs Must be Ordered Separately; [See Leg Options](#)

Description

- For Use With Other Studio Components
- Standard Locking Pedestal; File Drawer Provides Legal or Letter Filing
- Studio Pulls Are Installed on Left Aligned Position; Drawers Feature a ¾ Extension
- Drawer Front Grain Direction Vertical Standard; Optional Horizontal Grain Direction
- Chassis and Drawer Fronts Available in Contrasting Colors; Must Specify Color of Each Component
- Finished Back Panel Included
- Height of Unit with Legs: 20¾; **Legs Must be Ordered Separately; [See Leg Options](#)**
- Worksurface Required; [See Worksurface Sizes](#)
- Additional Options: Dove Tail Drawer Construction and Soft Close Drawers ([See Drawer Options](#)), Wire Management ([See Option Details](#))

Pricing Codes:

T= TFL
P= HPL

[See Canvas Intro Section for Ordering Options](#)

| Item | Model No. | Width | Depth | Height | Ship Wt | Cubic Ft | List Price |
|--|------------|-------|-------|--------|---------|----------|------------|
| STUDIO COMPONENT, LOW MODULAR PEDESTAL OPEN BOOKCASE | 66-2436SBC | 36 | 24 | 16¾ | 67 | 10.6 | T\$ 1095 |
| | 66-2430SBC | 30 | 24 | 16¾ | 59 | 8.9 | T\$ 1051 |
| | 66-2418SBC | 18 | 24 | 16¾ | 45 | 5.6 | T\$ 960 |

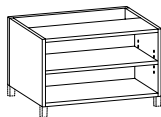

Must Specify (in this order):

Model #
Chassis Color
Wire Management

Description

- For Use With Other Studio Components
- One Adjustable Shelf
- Finished Back Panel Included
- Removable Wire Management Panel
- Height of Unit with Legs: 20¾; **Legs Must be Ordered Separately; [See Leg Options](#)**
- Worksurface Required; [See Worksurface Sizes](#)
- Optional Wire Management ([See Option Details](#))

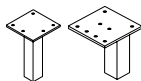

Legs Must be Ordered Separately; [See Leg Options](#)

| | | | | | | | |
|---|------------|----|----|-----|----|------|----------|
| STUDIO COMPONENT, LOW MODULAR PEDESTAL DOUBLE DOOR BOOKCASE | 66-2436SDB | 36 | 24 | 16¾ | 77 | 10.6 | T\$ 1047 |
| | 66-2430SDB | 30 | 24 | 16¾ | 67 | 8.9 | T\$ 918 |

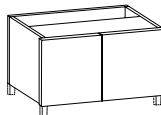

Must Specify (in this order):

Model #
Chassis Color
Door Color
Grain (if applicable)
Pull
Locking Doors
Wire Management

Description

- For Use With Other Studio Components
- 16" Deep Adjustable Shelf Behind Touch Latch Doors
- Finished Back Panel Included
- Removable Wire Management Panel
- Drawer Front Grain Direction Vertical Standard; Optional Horizontal Grain Direction
- Chassis and Door Fronts Available in Contrasting Colors; Must Specify Color of Each Component
- Height of Unit with Legs: 20¾; **Legs Must be Ordered Separately; [See Leg Options](#)**
- Worksurface Required; [See Worksurface Sizes](#)
- Optional Locking Door Available; [See Locking Options](#) and Specify Lock Color
- Optional Wire Management ([See Option Details](#))

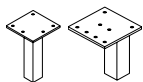

Legs Must be Ordered Separately; [See Leg Options](#)

Pricing Codes:

T= TFL
P= HPL

[See Canvas Intro Section for Ordering Options](#)

| Item | Model No. | | Width | Depth | Height | Ship Wt | Cubic Ft | List Price |
|---|-------------|-------------|-------|-------|--------|---------|----------|------------|
| STUDIO COMPONENT, LOW MODULAR PEDESTAL SINGLE DOOR BOOKCASE | Left | Right | | | | | | |
| | 66-2418SDBL | 66-2418SDBR | 18 | 24 | 16¾ | 51 | 5.6 | T\$ 825 |

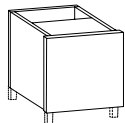

Must Specify (in this order):

- Model #
- Chassis Color
- Door Color
- Grain (if applicable)
- Pull
- Wire Management

Description

- For Use With Other Studio Components
- 16" Deep Adjustable Shelf Behind Touch Latch Door
- Finished Back Panel Included
- Removable Wire Management Panel
- Door Front Grain Direction Vertical Standard; Optional Horizontal Grain Direction
- Door Front Available in Contrasting Colors; Must Specify
- Height of Unit with Legs: 20¾; **Legs Must be Ordered Separately; See Leg Options**
- Worksurface Required; [See Worksurface Sizes](#)
- Optional Locking Door Available; [See Locking Options](#) and Specify Lock Color
- Optional Wire Management ([See Option Details](#))

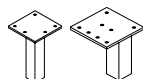

Legs Must be Ordered Separately; [See Leg Options](#)

| Item | Model No. | | Width | Depth | Height | Ship Wt | Cubic Ft | List Price |
|--|-------------|-------------|-------|-------|--------|---------|----------|------------|
| STUDIO COMPONENT, STORAGE CABINET DOOR/TRAY/FILE | Left | Right | | | | | | |
| | 66-1851SWBL | 66-1851SWBR | 18 | 24 | 47½ | 120 | 15.9 | T\$ 1588 |

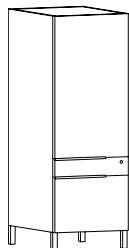

Must Specify (in this order):

- Model #
- Chassis Color
- Drawer Front/Door Color
- Grain (if applicable)
- Door Locking
- Pull

Description

- For Use With Other Studio Components
- One Adjustable Shelf Behind Touch Latch Door
- Locking File Drawer Provides Legal or Letter Filing
- Studio Pulls Are Installed on Left Aligned Position; Drawers Feature a ¾ Extension
- Drawer/Door Front Grain Direction Vertical Standard; Optional Horizontal Grain Direction
- Drawer/Door Fronts Available in Contrasting Colors; Must Specify
- Height of Unit with Legs: 51½; **Legs Must be Ordered Separately; See Leg Options**
- Optional Locking Door Available; [See Locking Options](#) and Specify Lock Color
- Additional Options: Dove Tail Drawer Construction and Soft Close Drawers ([See Drawer Options](#))

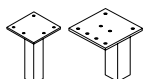

Legs Must be Ordered Separately; [See Leg Options](#)

Pricing Codes:

- T= TFL
- P= HPL

[See Canvas Intro Section for Ordering Options](#)

| Item | Model No. | Width | Depth | Height | Ship Wt | Cubic Ft | List Price |
|--|-------------|-------|-------|--------|---------|----------|------------|
| STUDIO COMPONENT, OPEN STORAGE CABINET TRAY/FILE | 66-1851SWBO | 18 | 24 | 47½ | 109 | 15.9 | T\$ 1517 |

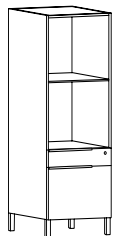

Description

- For Use With Other Studio Components
- One Adjustable Shelf
- Locking File Drawer Provides Legal or Letter Filing
- Studio Pulls Are Installed on Left Aligned Position; Drawers Feature a ¾ Extension
- Drawer Front Grain Direction Vertical Standard; Optional Horizontal Grain Direction
- Drawer Fronts Available in Contrasting Colors; Must Specify
- Height of Unit with Legs: 51½; **Legs Must be Ordered Separately**; [See Leg Options](#)
- Additional Options: Dove Tail Drawer Construction and Soft Close Drawers ([See Drawer Options](#))

Must Specify (in this order):

- Model #
- Chassis Color
- Drawer Front Color
- Grain (if applicable)
- Pull

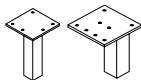

Legs Must be Ordered Separately; [See Leg Options](#)

| STUDIO COMPONENT, WARDROBE | Left | Right | Width | Depth | Height | Ship Wt | Cubic Ft | List Price |
|----------------------------|------------|------------|-------|-------|--------|---------|----------|------------|
| | 66-1851SWL | 66-1851SWR | 18 | 24 | 47½ | 108 | 15.9 | T\$ 1387 |

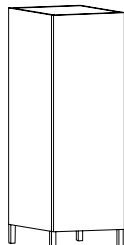

Description

- For Use With Other Studio Components
- Includes Coat Rod and (2) Adjustable Shelves Behind Touch Latch Door
- TFL Door Front Grain Direction Vertical Standard; Optional Horizontal Grain Direction
- Door Fronts Available in Contrasting Colors; Must Specify
- Safely Write on Dry Erase Doors with Our Dry Erase Marker Set; [See Set Options](#)
- Height of Unit with Legs: 51½; **Legs Must be Ordered Separately**; [See Leg Options](#)
- Optional Locking Door Available; [See Locking Options](#) and Specify Lock Color
- Optional Wire Management ([See Option Details](#))



Options: Specify & Add

| | | |
|-------|--|--------|
| 1-DEB | Dry Erase Board | \$ 96 |
| 1-HGA | High Gloss Acrylic; Must Specify Color | |
| | (GPA) Graphite Acrylic | \$ 960 |
| | (BLA) Black, (WMA) Wired Mercury, or (WHA) White Acrylic | \$ 876 |



Must Specify (in this order):

- Model #
- Chassis Color
- Door Color
- Grain (if applicable)
- Door Locking
- Pull

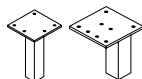

Legs Must be Ordered Separately; [See Leg Options](#)

Pricing Codes:

- T= TFL
- P= HPL

[See Canvas Intro Section for Ordering Options](#)

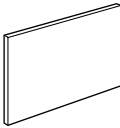
| Item | Model No. | Width | Depth | Height | Ship Wt | Cubic Ft | List Price |
|---|-----------|-------|-------|--------|---------|----------|------------|
| STUDIO COMPONENT, KNEESPACE MODESTY PANEL, TFL  | 66-6024MD | 60 | ¾ | 24½ | 37 | 2.9 | T\$ 419 |
| | 66-5424MD | 54 | ¾ | 24½ | 33 | 2.6 | T\$ 401 |
| | 66-4824MD | 48 | ¾ | 24½ | 30 | 2.3 | T\$ 385 |
| | 66-4224MD | 42 | ¾ | 24½ | 26 | 2.0 | T\$ 341 |
| | 66-3624MD | 36 | ¾ | 24½ | 22 | 1.7 | T\$ 304 |
| | 66-3024MD | 30 | ¾ | 24½ | 19 | 1.4 | T\$ 280 |

Must Specify (in this order):

Model #
Color
Grommet

Description

- For Use Between Two Studio Pedestals
- Attaches with L Bracket (Included)
- Optional Center Panel Grommet; Must Specify

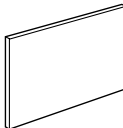
| | | | | | | | |
|---|--------------|----|---|-----|----|-----|---------------------|
| STUDIO COMPONENT, KNEESPACE MODESTY PANEL, HIGH GLOSS ACRYLIC  | 66-4824MDHGA | 48 | ¾ | 24½ | 30 | 2.3 | \$ 774 GPA\$ 893 |
| | 66-4224MDHGA | 42 | ¾ | 24½ | 30 | 2.1 | \$ 700 GPA\$ 805 |
| | 66-3624MDHGA | 36 | ¾ | 24½ | 26 | 2.0 | \$ 589 GPA\$ 676 |
| | 66-3024MDHGA | 30 | ¾ | 24½ | 19 | 1.4 | \$ 513 GPA\$ 589 |

Must Specify (in this order):

Model #
Color
Grommet

Description

- For Use Between Two Studio Pedestals
- Attaches with L Bracket (Included)
- Available in Black (BLA), Wired Mercury (WMA), White (WHA) or Graphite Acrylic (GPA); Graphite Acrylic Pricing (GPA\$)

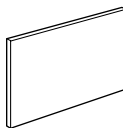
| | | | | | | | |
|--|-----------|----|---|-----|----|-----|---------|
| STUDIO COMPONENT, KNEESPACE MODESTY PANEL, FOR LOW STORAGE, TFL  | 66-6016MD | 60 | ¾ | 16¼ | 25 | 2.0 | T\$ 319 |
| | 66-5416MD | 54 | ¾ | 16¼ | 23 | 1.8 | T\$ 300 |
| | 66-4816MD | 48 | ¾ | 16¼ | 20 | 1.6 | T\$ 295 |
| | 66-4216MD | 42 | ¾ | 16¼ | 18 | 1.4 | T\$ 275 |
| | 66-3616MD | 36 | ¾ | 16¼ | 15 | 1.2 | T\$ 267 |
| | 66-3016MD | 30 | ¾ | 16¼ | 13 | 1.0 | T\$ 255 |

Must Specify (in this order):

Model #
Color
Grommet

Description

- For Use Between Two Studio Pedestals
- Attaches with L Bracket (Included)
- Optional Center Panel Grommet; Must Specify

Pricing Codes:

T= TFL
P= HPL

[See Canvas Intro Section for Ordering Options](#)

| Item | Model No. | Width | Depth | Height | Ship Wt | Cubic Ft | List Price |
|---------------------------|------------|-------|-------|--------|---------|----------|-------------|
| METAL STANCHION SINGLE | 01-1515SOS | 15 | 1 | 15 | 25 | 0.5 | ALUM \$ 219 |
| | | | | | | | BLK \$ 219 |
| | | | | | | | CHRM \$ 271 |

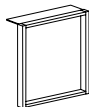

Must Specify (in this order):

Model #
Color

Description

- For Use With Single Sided Hutches ([See Hutches](#)) on Low Studio Components
- Available in Aluminum (ALUM), Black (BLK) or Chrome (CHRM); Must Specify

| | | | | | | | |
|---------------------------|-------------|-----|---|-----|----|-----|-------------|
| METAL STANCHION SHARED | 01-1515SOSS | 35¼ | 1 | 28¼ | 41 | 2.6 | ALUM \$ 273 |
| | | | | | | | BLK \$ 273 |
| | | | | | | | CHRM \$ 338 |

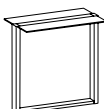

Must Specify (in this order):

Model #
Color

Description

- Connects Two Single Sided Hutches ([See Hutches](#)) on Low Studio Components
- Available in Aluminum (ALUM), Black (BLK) or Chrome (CHRM); Must Specify

| | | | | | | | | |
|---------------------------------|------------|--------|---|---|---|----|-----|-------------|
| STUDIO COMPONENT, SINGLE LEG | 01-0404SL4 | 4-pack | 1 | 1 | 4 | 10 | 1 | ALUM \$ 247 |
| | | | | | | | | BLK \$ 247 |
| | | | | | | | | CHRM \$ 303 |
| | 01-0404SL2 | 2-pack | 1 | 1 | 4 | 5 | 0.5 | ALUM \$ 143 |
| | | | | | | | | BLK \$ 143 |
| | | | | | | | | CHRM \$ 176 |

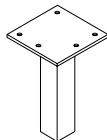

Must Specify (in this order):

Model #
Color

Description

- For Use With Studio Components
- Available in Aluminum (ALUM), Black (BLK) or Chrome (CHRM); Must Specify

| | | | | | | | | |
|---------------------------------|-------------|--------|---|---|---|----|-----|-------------|
| STUDIO COMPONENT, SHARED LEG | 01-0404SSL4 | 4-pack | 1 | 1 | 4 | 10 | 1 | ALUM \$ 247 |
| | | | | | | | | BLK \$ 247 |
| | | | | | | | | CHRM \$ 303 |
| | 01-0404SSL2 | 2-pack | 1 | 1 | 4 | 5 | 0.5 | ALUM \$ 143 |
| | | | | | | | | BLK \$ 143 |
| | | | | | | | | CHRM \$ 176 |

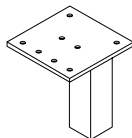

Must Specify (in this order):

Model #
Color

Description

- For Use With Studio Components
- Available in Aluminum (ALUM), Black (BLK) or Chrome (CHRM); Must Specify
- Connects Two Storage or Pedestal Units Together

Pricing Codes:

T= TFL
P= HPL

[See Canvas Intro Section for Ordering Options](#)

Height Adjustable Components

We've enhanced our height adjustable options to include a better integrated and easier to specify solution. These new models coupled with our existing modular height adjustable, and all of our standard models and storage options, provide you with the ultimate flexibility to meet the needs of your space and, more importantly, the needs of the user. And, we've made these new models more cost effective for you and more functional and spacious for the user.

Some Highlights of Our Integrated Solutions:

- Adjustable from 30"H to 45"H, with a load capacity up to 180lbs
- Gently adjust one worksurface or multiple worksurfaces with a 1 second stop at each memory position
- Two leg configuration options include the standard 2-channel for Desks, Desk Shells, D-top and P-Top units for one height adjustable worksurface or a 3-channel option for two height adjustable worksurfaces to raise simultaneously
- Two height adjustable control switches available. Standard up/down switch (SWCH) and advanced switch features Bluetooth capabilities, three stand-up reminder intervals and four height memory positions (MSWCH)
- Moving Modesty (MOVMOD) option creates a clean aesthetic when seated or standing
- Height adjust control switch is factory installed on all units except Desk Shells, Bridges or 3-Channel units
- Bridges, returns, and credenzas have an optional grommet on the back panel
- New black wire management mesh wrap included when worksurface grommet is selected
- Grommets and one Latch Duct wire management channel provided within kneespace to manage wires from switch and control box. Two Latch Duct wire management channels will be shipped with Desk Shells



Black wire management mesh sleeve included with worksurface grommet

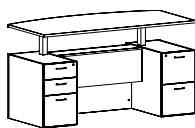

Standard 2-Channel Height Adjustable

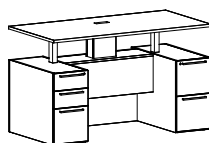

2-Channel Height Adjustable with Box



Standard (SWCH) and Advanced Switch (MSWCH)



Bring the Open Plan and Shared Spaces to Life!

Modular Height Adjustable components make it easy to create the perfect work environment for any space. Select from an array of sizes of worksurfaces, pedestals, filing units and more to connect teams together so collaborating can be easy and productive.

If you prefer our original solution or have specified it previously, and would like to do so again, simply contact our Customer Service team for assistance. We can make that happen for you!

| Item | Model No. | Width | Depth | Height | K | R | Ship Wt | Cubic Ft | List Price |
|--|---------------------------------|-------|-------|--------|-----|----|---------|----------|----------------------|
| HEIGHT ADJUSTABLE DOUBLE PED BOW TOP DESK | 68-3672BDPSSTS Stepped Front | 72 | 36-42 | 30-45 | 40½ | - | 510 | 50.0 | T\$ 6952 P\$ 7247 |
| | 68-3672BDPSTS Recessed Front | 72 | 36-42 | 30-45 | 40½ | 10 | 510 | 50.0 | T\$ 6823 P\$ 7115 |
| | 68-3666BDPSTS Recessed Front | 66 | 36-42 | 30-45 | 34½ | 4 | 480 | 48.0 | T\$ 6707 P\$ 7042 |

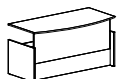
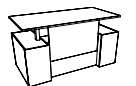
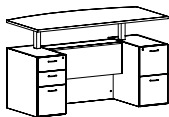

Shown with
Rectangle Top,
Stepped Front,
Moving Modesty
and Top Up

Shown with
Bow Top,
Recessed Front,
Moving Modesty
and Top Up

Must Specify (in this order):

- Model #
- Top Material
- Top Color
- Edge Profile
- Chassis Color
- Drawer Front Color
- Grain Direction (if applicable)
- Drawer Pull
- Drawer Construction
- Drawer Track
- Moving Modesty
- Height Adjust Switch
- Grommet Location
- Power/Data/Wire Management

Description

- Standard with: 2-Channel Leg Configuration for Single Surface Height Adjustment, Includes Controls, Letter Width Locking Box/Box/File on Left and File/File on Right, Bow Top Profiled on Approach and User Side, Left to Right Grain Direction on Worksurface, Wire Management from Pedestal to Kneespace
- Optional Moving Modesty; Must Specify; Some Assembly Required, [See Below and Options](#)
- Top, Chassis, and Drawer Fronts Available in Contrasting Colors; Must Specify Color of Each Component
- Stepped Front Units Available with Contrasting Modesty Panel; See High Gloss Acrylic Below or [TFL Color Options](#)
- Drawer Front Grain Direction Vertical Standard; Optional Horizontal Grain Direction
- Control Switch Standard (SWCH-Up/Down) or Upgrade to Advanced Switch (MSWCH-Up/Down/Memory); [See Switch Options](#)
- Optional Dove Tail Drawer Construction and Soft Close Drawers ([See Drawer Options](#))
- For Additional Information Including Worksurface Materials, Grommets and Wire Management Boxes, Power Locations, and More can be Found in the [Intro Section](#)

High Gloss Acrylic Modesty Options for Stepped Front Desks (68-3672BDPSSTS Only): Specify & Add

| | | |
|---------|--|---------|
| 66-HGAF | High Gloss Acrylic Full Modesty Panel; Must Specify Color (<i>Not Available as Moving Modesty</i>) | |
| | (GPA) Graphite Acrylic | \$ 1914 |
| | (BLA) Black, (WMA) Wired Mercury, or White (WHA) | \$ 1748 |

Moving Modesty Options: Specify & Add

| | | |
|--------|--|--------|
| MOVMOD | Moving Modesty (Available in Contrasting Colors; Must Specify) | \$ 219 |
|--------|--|--------|

Pricing Codes:

T= TFL
P= HPL

[See Canvas Intro Section for Ordering Options](#)

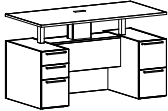
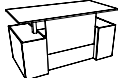
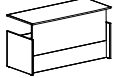
| Item | Model No. | Width | Depth | Height | K | R | Ship Wt | Cubic Ft | List Price |
|---|--------------------------------|-------|-------|--------|-----|----|---------|----------|----------------------|
| HEIGHT ADJUSTABLE DOUBLE PED DESK  <p>Shown with Wire Management Box and Top Up</p>  <p>Shown with Rectangle Top, Stepped Front, Moving Modesty and Top Up</p>  <p>Shown with Rectangle Top, Recessed Front, Moving Modesty and Top Up</p> | 68-3672DPSSTS Stepped Front | 72 | 36 | 30-45 | 40½ | - | 525 | 50.0 | T\$ 7218 P\$ 7506 |
| | 68-3672DPSTS Recessed Front | 72 | 36 | 30-45 | 40½ | 10 | 525 | 50.0 | T\$ 6418 P\$ 6705 |
| | 68-3072DPSTS Recessed Front | 72 | 30 | 30-45 | 40½ | 4 | 510 | 43.9 | T\$ 6320 P\$ 6590 |
| | 68-3066DPSTS Recessed Front | 66 | 30 | 30-45 | 34½ | 4 | 490 | 38.7 | T\$ 6223 P\$ 6480 |
| | 68-3060DPSTS Recessed Front | 60 | 30 | 30-45 | 28½ | 4 | 458 | 35.3 | T\$ 6109 P\$ 6350 |

Description

- Standard with: 2-Channel Leg Configuration for Single Surface Height Adjustment, Includes Controls, Letter Width Locking Box/Box/File on Left and File/File on Right, Rectangle Top Profiled on Approach and User Side, Left to Right Grain Direction on Worksurface, Wire Management from Pedestal to Kneespace
- Optional Moving Modesty; Must Specify; Some Assembly Required, [See Below and Option Details](#)
- Top, Chassis, and Drawer Fronts Available in Contrasting Colors; Must Specify Color of Each Component
- Drawer Front Grain Direction Vertical Standard; Optional Horizontal Grain Direction
- Stepped Front Units Available with Contrasting Modesty Panel; See High Gloss Acrylic Below or [TFL Color Options](#)
- Control Switch Standard (SWCH-Up/Down) or Upgrade to Advanced Switch (MSWCH-Up/Down/Memory); [See Switch Options](#)
- Optional Dove Tail Drawer Construction and Soft Close Drawers ([See Drawer Options](#))
- For Additional Information Including Worksurface Materials, Grommets and Wire Management Boxes, Power Locations, and More can be Found in the [Intro Section](#)

High Gloss Acrylic Modesty Options for Stepped Front Desks (68-3672DPSSTS Only): Specify & Add

| | | |
|---------|--|---------|
| 66-HGAF | High Gloss Acrylic Full Modesty Panel; Must Specify Color (<i>Not Available as Moving Modesty</i>) | |
| | (GPA) Graphite Acrylic | \$ 1914 |
| | (BLA) Black, (WMA) Wired Mercury, or White (WHA) | \$ 1748 |

Moving Modesty Options: Specify & Add

| | | |
|--------|--|--------|
| MOVMOD | Moving Modesty (Available in Contrasting Colors; Must Specify) | \$ 219 |
|--------|--|--------|

Must Specify (in this order):

- Model #
- Top Material
- Top Color
- Edge Profile
- Chassis Color
- Drawer Front Color
- Grain Direction (if applicable)
- Drawer Pull
- Drawer Construction
- Drawer Track
- Moving Modesty
- Height Adjust Switch
- Grommet Location
- Power/Data/Wire Management

Pricing Codes:

- T= TFL
- P= HPL

[See Canvas Intro Section for Ordering Options](#)

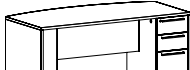
| Item | Model No. | Width | Depth | Height | K | R | Ship Wt | Cubic Ft | List Price | | |
|--|----------------|----------------|-------|--------|-------|-----|---------|----------|------------|----------------------|--|
| HEIGHT ADJUSTABLE SINGLE PED, BOW TOP DESK WITH BOX/BOX/FILE  | Left | Right | | | | | | | | | |
| | 68-3672BLPSSTS | 68-3672BRPSSTS | 72 | 30-36 | 30-45 | 32¼ | 10 | 420 | 50.0 | T\$ 6614 P\$ 6906 | |
| | Stepped Front | | | | | | | | | | |
| | 68-3672BLPSTS | 68-3672BRPSTS | 72 | 30-36 | 30-45 | 32¼ | 10 | 420 | 50.0 | T\$ 6446 P\$ 6738 | |
| Recessed Front | | | | | | | | | | | |

Description

- Standard with: 2-Channel Leg Configuration for Single Surface Height Adjustment, Includes Controls, Letter Width Locking Box/Box/File in Pedestal, Bow Top Profiled on Approach and User Side, Left to Right Grain Direction on Worksurface, Wire Management from Pedestal to Kneespace
- Support Panel ([66-2812RSP](#)) Needed When Connecting to Stationary Return or Bridge
- Control Switch Standard (SWCH-Up/Down) or Upgrade to Advanced Switch (MSWCH-Up/Down/Memory); [See Switch Options](#)
- Optional Moving Modesty; Must Specify; Some Assembly Required, [See Below and Option Details](#)
- Optional 3-Channel Leg Configuration (STS3) for Use with 3-Channel Returns and Bridges; [See Option Details and 3-Channel Units](#)
- Top, Chassis, and Drawer Fronts Available in Contrasting Colors; Must Specify Color of Each Component
- Stepped Front Units Available with Contrasting Modesty Panel; See High Gloss Acrylic Below or [TFL Color Options](#)
- Optional Dove Tail Drawer Construction and Soft Close Drawers ([See Drawer Options](#))
- For Additional Information Including Worksurface Materials, Grommets and Wire Management Boxes, Power Locations, and More can be Found in the [Intro Section](#)

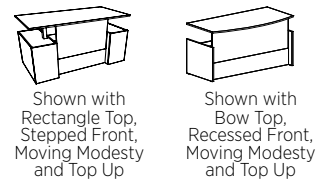

Must Specify (in this order):

- Model #
- Top Material
- Top Color
- Edge Profile
- Chassis Color
- Drawer Front Color
- Grain Direction (if applicable)
- Drawer Pull
- Drawer Construction
- Track
- Moving Modesty
- Modesty Color
- Height Adjust Switch
- Grommet Location
- Power/Data/Wire Management

High Gloss Acrylic Modesty Options for Stepped Front Desks (68-3672BDPSSTS Only): Specify & Add

| | | |
|---------|--|---------|
| 66-HGAF | High Gloss Acrylic Full Modesty Panel; Must Specify Color (<i>Not Available as Moving Modesty</i>) | |
| | (GPA) Graphite Acrylic | \$ 1914 |
| | (BLA) Black, (WMA) Wired Mercury, or White (WHA) | \$ 1748 |



Moving Modesty Options: Specify & Add

| | | |
|--------|--|--------|
| MOVMOD | Moving Modesty (Available in Contrasting Colors; Must Specify) | \$ 219 |
|--------|--|--------|

Pricing Codes:

- T= TFL
- P= HPL

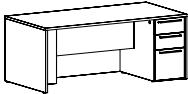
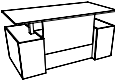
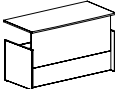
[See Canvas Intro Section for Ordering Options](#)

| Item | Model No. | Width | Depth | Height | K | R | Ship Wt | Cubic Ft | List Price | |
|--|--------------------------------|---------------|-------|--------|-------|-----|---------|----------|------------|----------------------|
| HEIGHT ADJUSTABLE SINGLE PED DESK WITH BOX/BOX/FILE    Shown with Rectangle Top, Stepped Front, Moving Modesty and Top Up Shown with Rectangle Top, Recessed Front, Moving Modesty and Top Up  Support Panel (66-2812RSP) Needed When Connecting to Standard Return or Bridge | Left | Right | | | | | | | | |
| | 68-3672LPSSTS Stepped Front | 68-3672RPSSTS | 72 | 36 | 30-45 | 32¼ | 10 | 420 | 50.0 | T\$ 6218 P\$ 6507 |
| | 68-3672LPSTS Recessed Front | 68-3672RPSTS | 72 | 36 | 30-45 | 32¼ | 10 | 430 | 50.0 | T\$ 5998 P\$ 6288 |
| | 68-3072LPSTS Recessed Front | 68-3072RPSTS | 72 | 30 | 30-45 | 32¼ | 4 | 310 | 43.0 | T\$ 5965 P\$ 6236 |
| | 68-3066LPSTS Recessed Front | 68-3066RPSTS | 66 | 30 | 30-45 | 26¼ | 4 | 280 | 38.7 | T\$ 5870 P\$ 6127 |
| | 68-3060LPSTS Recessed Front | 68-3060RPSTS | 60 | 30 | 30-45 | 20¼ | 4 | 250 | 35.0 | T\$ 5782 P\$ 6022 |

Description

- Standard with: 2-Channel Leg Configuration for Single Surface Height Adjustment, Includes Controls, Letter Width Locking Box/Box/File in Pedestal, Rectangle Top Profiled on Approach and User Side, Left to Right Grain Direction on Worksurface, Wire Management from Pedestal to Kneespace
- Control Switch Standard (SWCH-Up/Down) or Upgrade to Advanced Switch (MSWCH-Up/Down/Memory); [See Switch Options](#)
- Support Panel (66-2812RSP) Needed When Connecting to Stationary Return or Bridge
- Optional Moving Modesty; Must Specify; Some Assembly Required, [See Below and Option Details](#)
- Optional 3-Channel Leg Configuration (STS3) for Use with 3-Channel Returns and Bridges; [See Option Details and 3-Channel Units](#)
- Top, Chassis, and Drawer Fronts Available in Contrasting Colors; Must Specify Color of Each Component
- Stepped Front Units Available with Contrasting Modesty Panel; See High Gloss Acrylic Below and TFL Colors ([See Color Options](#))
- Optional Dove Tail Drawer Construction and Soft Close Drawers ([See Drawer Options](#))
- For Additional Information Including Worksurface Materials, Grommets and Wire Management Boxes, Power Locations, and More can be Found in the [Intro Section](#)

High Gloss Acrylic Modesty Options for Stepped Front Desks: Specify & Add

| | | |
|---------|--|---------|
| 66-HGAF | High Gloss Acrylic Full Modesty Panel; Must Specify Color (<i>Not Available as Moving Modesty</i>) | |
| | (GPA) Graphite Acrylic | \$ 1914 |
| | (BLA) Black, (WMA) Wired Mercury, or White (WHA) | \$ 1748 |

Moving Modesty Options: Specify & Add

| | | |
|--------|--|--------|
| MOVMOD | Moving Modesty (Available in Contrasting Colors; Must Specify) | \$ 219 |
|--------|--|--------|

Must Specify (in this order):

- Model #
- Top Material
- Top Color
- Edge Profile
- Chassis Color
- Drawer Front Color
- Grain Direction (if applicable)
- Drawer Pull
- Drawer Construction
- Track
- Moving Modesty
- Modesty Color
- Height Adjust Switch
- Grommet Location
- Power/Data/Wire Management

Pricing Codes:

T= TFL
P= HPL

[See Canvas Intro Section for Ordering Options](#)

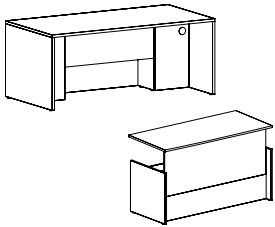
| Item | Model No. | Width | Depth | Height | Ship Wt | Cubic Ft | List Price |
|---|--------------|-------|-------|--------|---------|----------|----------------------|
| HEIGHT ADJUSTABLE DESK SHELL  Shown with Rectangle Top, Recessed Front, Moving Modesty and Top Up | 66-3672SHSTS | 72 | 36 | 30-45 | 274 | 50.0 | T\$ 5361 P\$ 5652 |
| | 66-3666SHSTS | 66 | 36 | 30-45 | 268 | 48.0 | T\$ 5311 P\$ 5586 |
| | 66-3660SHSTS | 60 | 36 | 30-45 | 259 | 43.7 | T\$ 5266 P\$ 5530 |
| | 66-3072SHSTS | 72 | 30 | 30-45 | 265 | 43.0 | T\$ 5286 P\$ 5557 |
| | 66-3066SHSTS | 66 | 30 | 30-45 | 261 | 39.0 | T\$ 5250 P\$ 5506 |
| | 66-3060SHSTS | 60 | 30 | 30-45 | 256 | 35.3 | T\$ 5182 P\$ 5421 |

Must Specify (in this order):

- Model #
- Top Material
- Top Color
- Edge Profile
- Chassis Color
- Moving Modesty
- Leg Configuration
- Height Adjust Switch
- Grommet Color
- Power/Data/Wire Management



Support Panel (66-2812RSP) Needed When Connecting to Standard Return or Bridge

Description

- Standard with: 2-Channel Leg Configuration for Single Surface Height Adjustment, Includes Controls, Recessed Front, Left to Right Grain Direction on Worksurface, Profiled on Approach and User Side
- Top and Chassis Available in Contrasting Colors; Must Specify Color of Each Component
- Modular Pedestals not Applicable
- Support Panel (66-2812RSP) Needed When Connecting to Stationary Return or Bridge
- Optional 3-Channel Leg Configuration (STS3) for Use with 3-Channel Returns and Bridges; [See Option Details](#) and [3-Channel Units](#)
- Optional Moving Modesty; Must Specify; Some Assembly Required, [See Below and Option Details](#)
- Control Switch Standard (Up/Down) or Upgrade to Advanced Switch (MSWCH-Up/Down/Memory); Switch is Field Installed; [See Switch Options](#)
- For Additional Information Including Worksurface Materials, Grommets and Wire Management Boxes, Power Locations, and More can be Found in the [Intro Section](#)

Moving Modesty Options: Specify & Add

| | | |
|--------|----------------|--------|
| MOVMOD | Moving Modesty | \$ 219 |
|--------|----------------|--------|

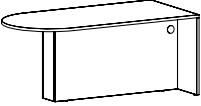
| HEIGHT ADJUSTABLE D-TOP | | | Left | Right | Width | Depth | Height | Ship Wt | Cubic Ft | List Price |
|--|---------------|---------------|------|-------|-------|-------|--------|----------------------|----------|------------|
| | Left | Right | | | | | | | | |
|  Shown as Left | 66-3684DULSTS | 66-3684DURSTS | 84 | 36 | 30-45 | 287 | 60.5 | T\$ 6033 P\$ 6692 | | |
| | 66-3672DULSTS | 66-3672DURSTS | 72 | 36 | 30-45 | 260 | 50.0 | T\$ 5677 P\$ 6209 | | |
| | 66-3084DULSTS | 66-3084DURSTS | 84 | 30 | 30-45 | 290 | 51.0 | T\$ 5959 P\$ 6548 | | |
| | 66-3072DULSTS | 66-3072DURSTS | 72 | 30 | 30-45 | 260 | 50.0 | T\$ 5614 P\$ 6132 | | |
| | 66-3066DULSTS | 66-3066DURSTS | 66 | 30 | 30-45 | 246 | 40.0 | T\$ 5526 P\$ 6032 | | |

Must Specify (in this order):

- Model #
- Top Material
- Top Color
- Edge Profile
- Chassis Color
- Moving Modesty
- Leg Configuration
- Height Adjust Switch
- Grommet Location
- Power/Data/Wire Management

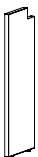

Support Panel (66-2812RSP) Needed When Connecting to Standard Return or Bridge

Description

- Standard with: 2-Channel Leg Configuration for Single Surface Height Adjustment, Includes Controls, Left to Right Grain Direction on Worksurface
- Must be Used with Stationary or Height Adjustable Return or Bridge with Credenza
- Support Panel (66-2812RSP) Needed When Connecting to Stationary Return or Bridge
- Control Switch Standard (Up/Down) or Upgrade to Advanced Switch (MSWCH-Up/Down/Memory); Switch is Field Installed; [See Switch Options](#)
- Optional Moving Modesty; Must Specify; Some Assembly Required, [See Below and Option Details](#)
- Optional 3-Channel Leg Configuration (STS3) for Use with 3-Channel Returns and Bridges; [See Option Details](#) and [3-Channel Units](#)
- Top and Chassis Available in Contrasting Colors; Must Specify Color of Each Component
- For Additional Information Including Worksurface Materials, Grommets and Wire Management Boxes, Power Locations, and More can be Found in the [Intro Section](#)

Moving Modesty Options: Specify & Add

| | | |
|--------|----------------|--------|
| MOVMOD | Moving Modesty | \$ 219 |
|--------|----------------|--------|

Pricing Codes:

- T= TFL
- P= HPL

[See Canvas Intro Section for Ordering Options](#)

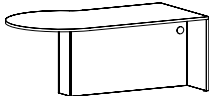
| Item | Model No. | Width | Depth | Height | Ship Wt | Cubic Ft | List Price |
|---|--------------|--------------|-------|--------|---------|----------|----------------------|
| HEIGHT ADJUSTABLE P-TOP  | Left | Right | | | | | |
| | 66-4284PLSTS | 66-4284PRSTS | 84 | 42-36 | 30-45 | 270 | T\$ 6304 P\$ 6974 |
| | 66-4272PLSTS | 66-4272PRSTS | 72 | 42-36 | 30-45 | 261 | T\$ 6086 P\$ 6608 |

Shown as Left

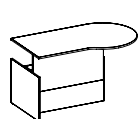

Shown as Left with Moving Modesty

Support Panel (66-2812RSP) Needed When Connecting to Standard Return or Bridge

Description

- Standard with: 2-Channel Leg Configuration for Single Surface Height Adjustment, Includes Controls, Left to Right Grain Direction on Worksurface
- Must be Used with Stationary or Height Adjustable Return, Bridge or Credenza
- Support Panel (66-2812RSP) Needed When Connecting to Stationary Return or Bridge
- Optional Worksurface Center Grommet Only; Must Specify: Black (BLK), Silver (SLV) or None (NONE)
- Control Switch Standard (Up/Down) or Upgrade to Advanced Switch (MSWCH-Up/Down/Memory); Switch is Field Installed; [See Switch Options](#)
- Optional Moving Modesty; Must Specify; Some Assembly Required, [See Below and Option Details](#)
- Optional 3-Channel Leg Configuration (STS3) for Use with 3-Channel Returns and Bridges; [See Option Details and 3-Channel Units](#)
- Top and Chassis Available in Contrasting Colors; Must Specify Color of Each Component
- For Additional Information Including Worksurface Materials, Worksurface Center Grommet and Wire Management Boxes, Power Locations, and More can be Found in the [Intro Section](#)

Must Specify (in this order):

- Model #
- Top Material
- Top Color
- Edge Profile
- Chassis Color
- Moving Modesty
- Leg Configuration
- Height Adjust Switch
- Grommet Location
- Power/Data/Wire Management

Moving Modesty Options: Specify & Add

| | | | |
|--------|----------------|----|-----|
| MOVMOD | Moving Modesty | \$ | 219 |
|--------|----------------|----|-----|

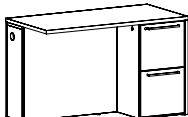
| Item | Model No. | Width | Depth | Height | Ship Wt | Cubic Ft | List Price | |
|--|--|---------------|-------|--------|---------|----------------------|----------------------|--|
| HEIGHT ADJUSTABLE RETURN WITH FILE/FILE 2-CHANNEL, FOR ONE WORKSURFACE  | Left | Right | | | | | | |
| | 68-2448LF2STS | 68-2448RF2STS | 48 | 24 | 30-45 | 251 | T\$ 5173 P\$ 5359 | |
| | Front to Back Grain Direction on Worksurface | | | | | | | |
| | 68-2442LF2STS | 68-2442RF2STS | 42 | 24 | 30-45 | 233 | T\$ 5110 P\$ 5278 | |
| | Front to Back Grain Direction on Worksurface | | | | | | | |
| | 68-4824LF2STS | 68-4824RF2STS | 48 | 24 | 30-45 | 251 | T\$ 5173 P\$ 5359 | |
| Left to Right Grain Direction on Worksurface | | | | | | | | |
| 68-4224LF2STS | 68-4224RF2STS | 42 | 24 | 30-45 | 233 | T\$ 5110 P\$ 5278 | | |
| Left to Right Grain Direction on Worksurface | | | | | | | | |

Shown as Right

Must Specify (in this order):

- Model #
- Top Material
- Top Color
- Edge Profile
- Chassis Color
- Drawer Front Color
- Grain Direction (if applicable)
- Drawer Pull Construction
- Track
- Moving Modesty
- Height Adjust Switch
- Grommet Location
- Power/Data/Wire Management
- Modesty Grommet
- Grommet Color

Description

- Standard with: 2-Channel Leg Configuration for Single Surface Height Adjustment, Includes Controls, Letter Width Locking File/File in Pedestal, Top Profiled on User Side, Wire Management from Pedestal to Kneespace
- Control Switch Standard (SWCH-Up/Down) or Upgrade to Advanced Switch (MSWCH-Up/Down/Memory); [See Switch Options](#)
- Top, Chassis, and Drawer Fronts Available in Contrasting Colors; Must Specify Color of Each Component
- Optional Modesty Grommet for Wire Management to Wall; Must Specify: Black (GMBBL), Silver (GMBSV) or None (NONE); [See Wire Management Options](#)
- Optional Worksurface Grommet with Mesh Wire Management Sleeve or Wire Management Boxes Available Centered Between Height Adjustable Legs (CKS) and Over Peds and 6" from End (GL or GR); Must Specify Location and Color: GL or GL-MESH for Left or GR or GR-MESH for Right; Color Options: Black (BLK) or Silver (SLV); [See Grommet Options](#)
- Optional Dove Tail Drawer Construction and Soft Close Drawers ([See Drawer Options](#))
- For Additional Information Including Worksurface Materials, Grommets and Wire Management Boxes, Power Locations, and More can be Found in the [Intro Section](#)

Pricing Codes:

T= TFL
P= HPL

[See Canvas Intro Section for Ordering Options](#)

| Item | Model No. | Width | Depth | Height | Ship Wt | Cubic Ft | List Price |
|---|--|---------------|-------|--------|---------|----------|----------------------|
| HEIGHT ADJUSTABLE RETURN WITH BOX/BOX/FILE | Left | | | | | | |
| | Right | | | | | | |
| 2-CHANNEL, FOR ONE WORKSURFACE | 68-2448LF1STS | 68-2448RF1STS | 48 | 24 | 30-45 | 251 | T\$ 5173 P\$ 5359 |
| | Front to Back Grain Direction on Worksurface | | | | | | |
| | 68-2442LF1STS | 68-2442RF1STS | 42 | 24 | 30-45 | 233 | T\$ 5110 P\$ 5278 |
| | Front to Back Grain Direction on Worksurface | | | | | | |
| | 68-4824LF1STS | 68-4824RF1STS | 48 | 24 | 30-45 | 251 | T\$ 5173 P\$ 5359 |
| | Left to Right Grain Direction on Worksurface | | | | | | |
| | 68-4224LF1STS | 68-4224RF1STS | 42 | 24 | 30-45 | 233 | T\$ 5110 P\$ 5278 |
| | Left to Right Grain Direction on Worksurface | | | | | | |

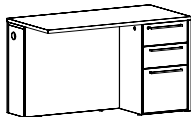

Shown as Right

Must Specify (in this order):

- Model #
- Top Material
- Top Color
- Edge Profile
- Chassis Color
- Drawer Front
- Color
- Grain Direction (if applicable)
- Drawer Pull
- Drawer
- Construction
- Track
- Height Adjust Switch
- Grommet Location
- Power/Data/Wire Management
- Modesty Grommet
- Grommet Color

Description

- Standard with: 2-Channel Leg Configuration for Single Surface Height Adjustment, Includes Controls, Letter Width Locking Box/Box/File in Pedestal, Top Profiled on User Side, Wire Management from Pedestal to Kneespace
- Control Switch Standard (SWCH-Up/Down) or Upgrade to Advanced Switch (MSWCH-Up/Down/Memory); [See Switch Options](#)
- Top, Chassis, and Drawer Fronts Available in Contrasting Colors; Must Specify Color of Each Component
- Optional Modesty Grommet for Wire Management to Wall; Must Specify: Black (GMBBL), Silver (GMBSV) or None (NONE); [See Wire Management Options](#)
- Optional Worksurface Grommet with Mesh Wire Management Sleeve or Wire Management Boxes Available Centered Between Height Adjustable Legs (CKS) and Over Peds and 6" from End (GL or GR); Must Specify Location and Color: GL or GL-MESH for Left or GR or GR-MESH for Right; Color Options: Black (BLK) or Silver (SLV); [See Grommet Options](#)
- Optional Dove Tail Drawer Construction and Soft Close Drawers ([See Drawer Options](#))
- For Additional Information Including Worksurface Materials, Grommets and Wire Management Boxes, Power Locations, and More can be Found in the [Intro Section](#)

| Item | Model No. | Width | Depth | Height | Ship Wt | Cubic Ft | List Price |
|---|--|----------------|-------|--------|---------|----------|----------------------|
| HEIGHT ADJUSTABLE RETURN WITH FILE/FILE | Left | | | | | | |
| | Right | | | | | | |
| 3-CHANNEL, FOR TWO SIMULTANEOUS WORKSURFACES | 68-2448LF2STS3 | 68-2448RF2STS3 | 48 | 24 | 30-45 | 201 | T\$ 3436 P\$ 3623 |
| | Front to Back Grain Direction on Worksurface | | | | | | |
| | 68-2442LF2STS3 | 68-2442RF2STS3 | 42 | 24 | 30-45 | 183 | T\$ 3373 P\$ 3540 |
| | Front to Back Grain Direction on Worksurface | | | | | | |

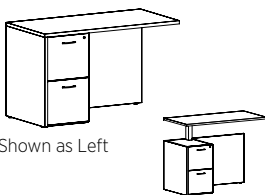

Shown as Left

Shown as Left
Top Up

Must Specify (in this order):

- Model #
- Top Material
- Top Color
- Edge Profile
- Chassis Color
- Drawer Front
- Color
- Grain Direction (if applicable)
- Drawer Pull
- Drawer
- Construction
- Track
- Height Adjust Switch
- Grommet
- Power/Data/Wire Management
- Modesty Grommet
- Grommet Color

Description

- Standard with: 3-Channel Leg Configuration for Multiple Worksurface Height Adjustment, Letter Width Locking File/File in Pedestal, Top Profiled on User Side, Wire Management from Pedestal to Kneespace
- Must be Used with Height Adjustable Single Ped Desk, Height Adjustable D-Top or P-Top
- Control Switch Not Included; Control Switch will be on Adjoining Worksurface
- Top, Chassis, and Drawer Fronts Available in Contrasting Colors; Must Specify Color of Each Component
- Optional Worksurface Grommet with Mesh Wire Management Sleeve Available Over Ped Only; 6" from Ends and 20" from User; Must Specify Location and Color: GL or GL-MESH for Left or GR or GR-MESH for Right; Color Options: Black (BLK) or Silver (SLV); [See Grommet Options](#)
- Monitor Arms not Available on this Unit
- Optional Modesty/Pedestal Grommet for Wire Management to Wall **Centered on Pedestal Only**; Must Specify: Black (GMBBL), Silver (GMBSV) or None (NONE); [See Wire Management Options](#)
- Optional Dove Tail Drawer Construction and Soft Close Drawers ([See Drawer Options](#))
- For Additional Information Including Worksurface Materials, Grommets and Wire Management Boxes, Power Locations, and More can be Found in the [Intro Section](#)

Pricing Codes:

- T= TFL
- P= HPL

[See Canvas Intro Section for Ordering Options](#)

| Item | Model No. | Width | Depth | Height | Ship Wt | Cubic Ft | List Price | |
|---|--|----------------|-------|--------|---------|----------|------------|----------|
| HEIGHT ADJUSTABLE RETURN WITH BOX/BOX/FILE | Left | | | | | | | |
| | Right | | | | | | | |
| | 68-2448LF1STS3 | 68-2448RF1STS3 | 48 | 24 | 30-45 | 201 | T\$ 3436 | |
| | Front to Back Grain Direction on Worksurface | | | | | | | P\$ 3623 |
| 3-CHANNEL, FOR TWO SIMULTANEOUS WORKSURFACES | 68-2442LF1STS3 | 68-2442RF1STS3 | 42 | 24 | 30-45 | 183 | T\$ 3373 | |
| | Front to Back Grain Direction on Worksurface | | | | | | | P\$ 3540 |

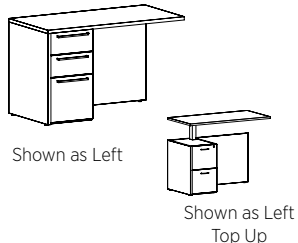

Must Specify (in this order):

- Model #
- Top Material
- Top Color
- Edge Profile
- Chassis Color
- Drawer Front Color
- Grain Direction (if applicable)
- Drawer Pull
- Drawer Construction
- Track
- Height Adjust Switch
- Grommet
- Power/Data/Wire Management
- Modesty Grommet
- Grommet Colors.

Description

- Standard with: 3-Channel Leg Configuration for Multiple Worksurface Height Adjustment, Letter Width Locking Box/Box/File in Pedestal, Top Profiled on User Side
- Must be Used with Height Adjustable Single Ped Desk, Height Adjustable D-Top or P-Top
- Control Switch Not Included; Control Switch will be on Adjoining Worksurface
- Top, Chassis, and Drawer Fronts Available in Contrasting Colors; Must Specify Color of Each Component
- Optional Modesty/Pedestal Grommet for Wire Management to Wall **Centered on Pedestal Only**; Must Specify: Black (GMBBL), Silver (GMBSV) or None (NONE); [See Wire Management Options](#)
- Optional Worksurface Grommet with Mesh Wire Management Sleeve Available Over Ped Only; 6” from Ends and 20” from User; Must Specify Location and Color: GL or GL-MESH for Left or GR or GR-MESH for Right; Color Options: Black (BLK) or Silver (SLV); [See Grommet Options](#)
- Monitor Arms not Available on this Unit
- Optional Dove Tail Drawer Construction and Soft Close Drawers ([See Drawer Options](#))
- For Additional Information Including Worksurface Materials, Pulls, Grommets, Power Locations, and More can be Found in the [Intro Section](#)

| HEIGHT ADJUSTABLE RETURN SHELL | End Panel Left | End Panel Right | Width | Depth | Height | Ship Wt | Cubic Ft | List Price |
|--------------------------------|----------------|-----------------|-------|-------|--------|---------|----------|------------|
| | 66-2448RSHLSTS | 66-2448RSHRSTS | 48 | 24 | 30-45 | 280 | 24.0 | T\$ 4649 |
| | | | | | | | | P\$ 4833 |
| | 66-2442RSHLSTS | 66-2442RSHRSTS | 42 | 24 | 30-45 | 250 | 24.0 | T\$ 4585 |
| | | | | | | | | P\$ 4753 |

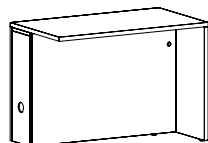

Must Specify (in this order):

- Model #
- Top Material
- Top Color
- Edge Profile
- Chassis Color
- Height Adjust Switch
- Grommet
- Power/Data/Wire Management
- Modesty Grommet
- Grommet Color

Description

- Standard with: 2-Channel Leg Configuration for Single Surface Height Adjustment, Includes Controls, Top Profiled on User Side
- Optional Worksurface Center Grommet Only; Must Specify: Black (BLK), Silver (SLV) or None (NONE); [See Grommet Options](#)
- Control Switch Standard (SWCH-Up/Down) or Upgrade to Advanced Switch (MSWCH-Up/Down/Memory); [See Switch Options](#)
- Top and Chassis Available in Contrasting Colors; Must Specify Color of Each Component
- Optional Modesty Grommet for Wire Management to Wall; Must Specify: Black (GMBBL), Silver (GMBSV) or None (NONE); [See Wire Management Options](#)
- For Additional Information Including Worksurface Materials, Grommets and Wire Management Boxes, Power Locations, and More can be Found in the [Intro Section](#)

Pricing Codes:

T= TFL
P= HPL

[See Canvas Intro Section for Ordering Options](#)

| Item | Model No. | Width | Depth | Height | Ship Wt | Cubic Ft | List Price |
|--|--------------|-------|-------|--------|---------|----------|----------------------|
| HEIGHT ADJUSTABLE BRIDGE 2-CHANNEL, FOR ONE WORKSURFACE | 66-2448UFSTS | 48 | 24 | 30-45 | 182 | 24.0 | T\$ 4340 P\$ 4526 |
| | 66-2442UFSTS | 42 | 24 | 30-45 | 168 | 21.0 | T\$ 4317 P\$ 4484 |
| | 66-2436UFSTS | 36 | 24 | 30-45 | 146 | 18.0 | T\$ 4281 P\$ 4430 |
| | 66-2048UFSTS | 48 | 20 | 30-45 | 177 | 20.0 | T\$ 4292 P\$ 4456 |
| | 66-2042UFSTS | 42 | 20 | 30-45 | 167 | 18.0 | T\$ 4271 P\$ 4420 |
| | 66-2036UFSTS | 36 | 20 | 30-45 | 143 | 15.0 | T\$ 4240 P\$ 4371 |

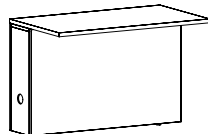

Must Specify (in this order):

Model #
 Top Material
 Top Color
 Edge Profile
 Chassis Color
 Height Adjust Switch
 Grommet
 Power/Data/Wire Management
 Modesty Grommet
 Grommet Color

Description

- Standard with: 2-Channel Leg Configuration for Single Surface Height Adjustment, Includes Controls, Top Profiled on User Side, Front to Back Grain Direction on Worksurface
- Optional Worksurface Grommet and Power Units Available on Center Only; [See Options](#)
- Control Switch Standard (Up/Down) or Upgrade to Advanced Switch (MSWCH-Up/Down/Memory); Switch is Field Installed; [See Switch Options](#)
- Top and Chassis Available in Contrasting Colors; Must Specify Color of Each Component
- Optional Modesty Grommet for Wire Management to Wall; Must Specify: Black (GMBBL), Silver (GMBSV) or None (NONE); [See Wire Management Options](#)
- For Additional Information Including Worksurface Materials, Grommet and Power/Data Options, and More can be Found in the [Intro Section](#)

| HEIGHT ADJUSTABLE BRIDGE FOR MULTIPLE SURFACES | | | | | | | | | |
|---|----------------|----------------|-------|-------|--------|---------|----------|----------------------|--|
| | Left | Right | Width | Depth | Height | Ship Wt | Cubic Ft | List Price | |
| 3-CHANNEL, FOR TWO SIMULTANEOUS WORKSURFACES | 66-2448UFSTSL3 | 66-2448UFSTSR3 | 48 | 24 | 30-45 | 172 | 24.0 | T\$ 3190 P\$ 3376 | |
| | 66-2442UFSTSL3 | 66-2442UFSTSR3 | 42 | 24 | 30-45 | 158 | 21.0 | T\$ 3167 P\$ 3334 | |
| | 66-2436UFSTSL3 | 66-2436UFSTSR3 | 36 | 24 | 30-45 | 136 | 18.0 | T\$ 3131 P\$ 3280 | |
| | 66-2048UFSTSL3 | 66-2048UFSTSR3 | 48 | 20 | 30-45 | 167 | 20.0 | T\$ 3142 P\$ 3306 | |
| | 66-2042UFSTSL3 | 66-2042UFSTSR3 | 42 | 20 | 30-45 | 154 | 18.0 | T\$ 3121 P\$ 3270 | |
| | 66-2036UFSTSL3 | 66-2036UFSTSR3 | 36 | 20 | 30-45 | 133 | 15.0 | T\$ 3090 P\$ 3221 | |

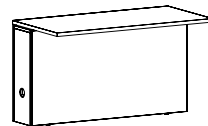

SIN PENDING

Must Specify (in this order):

Model #
 Top Material
 Top Color
 Edge Profile
 Chassis Color
 Grommet
 Power/Data/Wire Management
 Modesty Grommet
 Grommet Color

Description

- Standard with: 3-Channel Leg Configuration for Multiple Surface Height Adjustment, Top Profiled on User Side, Front to Back Grain Direction on Worksurface
- Optional Worksurface Grommet and Power Units Available on Center Only; [See Options](#)
- Control Switch Not Included; Control Switch will be on Adjoining Worksurface
- Top and Chassis Available in Contrasting Colors; Must Specify Color of Each Component
- Optional Modesty Grommet for Wire Management to Wall; Must Specify: Black (GMBBL), Silver (GMBSV) or None (NONE); [See Wire Management Options](#)
- For Additional Information Including Worksurface Materials, Grommet and Power/Data Options, and More can be Found in the [Intro Section](#)

Pricing Codes:

T= TFL
 P= HPL

[See Canvas Intro Section for Ordering Options](#)

| Item | Model No. | Width | Depth | Height | Ship Wt | Cubic Ft | List Price |
|--|-----------------------|------------------------|-------|--------|---------|----------|----------------------|
| HEIGHT ADJUSTABLE SINGLE PED CREDENZA WITH BOX/BOX/FILE | End Panel Left | End Panel Right | | | | | |
| | 68-2472LC1STS | 68-2472RC1STS | 72 | 24 | 30-45 | 300 | T\$ 5571 P\$ 5806 |
| | 68-2466LC1STS | 68-2466RC1STS | 66 | 24 | 30-45 | 282 | T\$ 5553 P\$ 5775 |

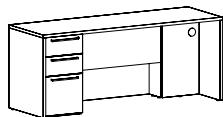

Shown as Left



Support Panel (66-2812RSP) Needed When Connecting to Standard Return or Bridge

Must Specify (in this order):

- Model #
- Top Material
- Top Color
- Edge Profile
- Chassis Color
- Drawer Front Color
- Grain Direction (if applicable)
- Drawer Pull
- Drawer Construction
- Track
- Height Adjust Switch
- Grommet Color
- Power/Data/Wire Management

Description

- Standard with: 2-Channel Leg Configuration for Single Surface Height Adjustment, Includes Controls, Letter Width Locking Box/Box/File in Pedestal, Top Profiled on Approach and User Side, Left to Right Grain Direction on Worksurface
- Support Panel (66-2812RSP) Needed When Connecting to Standard Return or Bridge
- Control Switch Standard (SWCH-Up/Down) or Upgrade to Advanced Switch (MSWCH-Up/Down/Memory); [See Switch Options](#)
- Optional 3-Channel Leg Configuration (STS3) for Use with 3-Channel Returns; [See Option Details](#) and [3-Channel Units](#)
- Top, Chassis, and Drawer Fronts Available in Contrasting Colors; Must Specify Color of Each Component
- Optional Modesty Grommet on Approach for Wire Management to Wall; Must Specify: Black (GMBBL), Silver (GMBSV); [See Wire Management Options](#)
- Optional Dove Tail Drawer Construction and Soft Close Drawers ([See Drawer Options](#))
- For Additional Information Including Worksurface Grommet and Wire Management Box Locations, Pulls, Power Availability, and More can be Found in the [Intro Section](#)

| | | | | | | | |
|---|-----------------------|------------------------|----|----|-------|-----|----------------------|
| HEIGHT ADJUSTABLE SINGLE PED CREDENZA WITH FILE/FILE | End Panel Left | End Panel Right | | | | | |
| | 68-2472LC2STS | 68-2472RC2STS | 72 | 24 | 30-45 | 300 | T\$ 5571 P\$ 5806 |
| | 68-2466LC2STS | 68-2466RC2STS | 66 | 24 | 30-45 | 282 | T\$ 5553 P\$ 5775 |

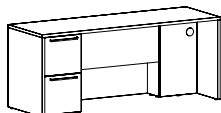

Shown as Left

Must Specify (in this order):

- Model #
- Top Material
- Top Color
- Edge Profile
- Chassis Color
- Drawer Front Color
- Grain Direction (if applicable)
- Drawer Pull
- Drawer Construction
- Track
- Height Adjust Switch
- Grommet Color
- Power/Data/Wire Management



Support Panel (66-2812RSP) Needed When Connecting to Standard Return or Bridge

Description

- Standard with: 2-Channel Leg Configuration for Single Surface Height Adjustment, Letter Width Locking File/File in Pedestal, Top Profiled on Approach and User Side, Left to Right Grain Direction on Worksurface
- Support Panel (66-2812RSP) Needed When Connecting to Standard Return or Bridge
- Control Switch Standard (SWCH-Up/Down) or Upgrade to Advanced Switch (MSWCH-Up/Down/Memory); [See Switch Options](#)
- Top, Chassis, and Drawer Fronts Available in Contrasting Colors; Must Specify Color of Each Component
- Optional 3-Channel Leg Configuration (STS3) for Use with 3-Channel Returns; [See Option Details](#) and [3-Channel Units](#)
- Optional Modesty Grommet for Wire Management to Wall; Must Specify: Black (GMBBL), Silver (GMBSV) or None (NONE); [See Wire Management Options](#)
- Optional Dove Tail Drawer Construction and Soft Close Drawers ([See Drawer Options](#))
- For Additional Information Including Worksurface Materials, Grommets, Power Locations, and More can be Found in the [Intro Section](#)

Pricing Codes:

T= TFL
P= HPL

[See Canvas Intro Section for Ordering Options](#)

| Item | Model No. | Width | Depth | Height | Ship Wt | Cubic Ft | List Price |
|--|--------------|-------|-------|--------|---------|----------|----------------------|
| HEIGHT ADJUSTABLE KNEESPACE CREDENZA WITH FILE/FILE PEDS | 68-2472KCSTS | 72 | 24 | 30-45 | 340 | 35.6 | T\$ 6338 P\$ 6576 |
| | 68-2466KCSTS | 66 | 24 | 30-45 | 320 | 32.7 | T\$ 6152 P\$ 6375 |

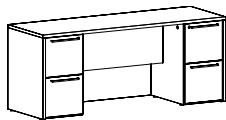

Must Specify (in this order):

Model #
Top Material
Top Color
Edge Profile
Chassis Color
Drawer Front
Color
Grain Direction (if applicable)
Drawer Pull
Drawer
Construction
Track
Height Adjust Switch
Grommet Color
Power/Data/Wire Management

Description

- Standard with: 2-Channel Leg Configuration for Single Surface Height Adjustment, Includes Controls, Letter Width Locking File/File in Pedestals, Top Profiled on Approach and User Side, Left to Right Grain Direction on Worksurface
- Control Switch Standard (SWCH-Up/Down) or Upgrade to Advanced Switch (MSWCH-Up/Down/Memory); [See Switch Options](#)
- Top, Chassis, and Drawer Fronts Available in Contrasting Colors; Must Specify Color of Each Component
- Optional Modesty Grommet for Wire Management to Wall; Must Specify: Black (GMBBL), Silver (GMBSV) or None (NONE); [See Wire Management Options](#)
- Optional Dove Tail Drawer Construction and Soft Close Drawers ([See Drawer Options](#))
- For Additional Information Including Worksurface Grommet and Wire Management Box Locations, Pulls, Power Availability, and More can be Found in the [Intro Section](#)

| | | | | | | | |
|-------------------------------------|--------------|----|----|-------|-----|------|----------------------|
| HEIGHT ADJUSTABLE CREDENZA SHELL | 66-2472SHSTS | 72 | 24 | 30-45 | 294 | 36.0 | T\$ 5132 P\$ 5367 |
| | 66-2466SHSTS | 66 | 24 | 30-45 | 287 | 33.0 | T\$ 5090 P\$ 5316 |
| | 66-2460SHSTS | 60 | 24 | 30-45 | 280 | 30.0 | T\$ 5055 P\$ 5273 |

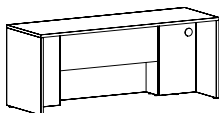

Support Panel
([66-2812RSP](#))
Needed When
Connecting to
Standard Return
or Bridge

Description

- Standard with: 2-Channel Leg Configuration for Single Surface Height Adjustment, Includes Controls, Profiled on User Side, and Modesty Grommet
- Modular Pedestals not Applicable
- Top and Chassis Available in Contrasting Colors; Must Specify Color of Each Component
- Support Panel ([66-2812RSP](#)) Needed When Connecting to Standard Return or Bridge
- Optional Worksurface Grommet; Must Specify: Black (BLK), Silver (SLV) or None (NONE); [See Grommet Options](#)
- Optional 3-Channel Leg Configuration (STS3) for Use with 3-Channel Returns; [See Option Details](#) and [3-Channel Units](#)
- Control Switch Standard (Up/Down) or Upgrade to Advanced Switch (MSWCH-Up/Down/Memory); Switch is Field Installed
- For Additional Information Including Worksurface Grommet and Wire Management Box Locations, Power Availability, and More can be Found in the [Intro Section](#)

Must Specify (in this order):

Model #
Top Material
Top Color
Edge Profile
Chassis Color
Leg Configuration
Height Adjust Switch
Grommet Color
Power/Data/Wire Management

| | | | | | | | |
|---------------|------------|----|---|-----|----|-----|---------|
| SUPPORT PANEL | 66-2812RSP | 12 | 1 | 28½ | 12 | 0.8 | T\$ 245 |
|---------------|------------|----|---|-----|----|-----|---------|



Description

- To be Used to Support Stationary Returns and Bridges Worksurfaces with Height Adjustable Units
- Required to be Used Perpendicular to Full Back Panels for Support of Kneespace Areas 60" or Longer

Must Specify (in this order):

Model #
Color

Pricing Codes:

T= TFL
P= HPL

[See Canvas Intro Section for Ordering Options](#)

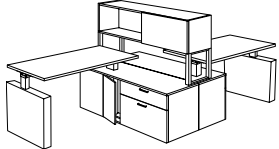
| Item | Model No. | Width | Depth | Height | Ship Wt | Cubic Ft | List Price |
|--|---------------------------------|-------|-------|--------|---------|----------|--------------------|
| HEIGHT ADJUSTABLE WORK SURFACE FOR OVERHEAD STORAGE   | 66-3462HTP For 72" Footprint | 62 | 34 | 1 | 84 | 5.3 | T\$ 650 P\$ 906 |
| | 66-3456HTP For 66" Footprint | 56 | 34 | 1 | 78 | 4.8 | T\$ 620 P\$ 867 |
| | 66-2862HTP For 72" Footprint | 62 | 28 | 1 | 79 | 4.2 | T\$ 613 P\$ 858 |
| | 66-2856HTP For 66" Footprint | 56 | 28 | 1 | 75 | 3.8 | T\$ 565 P\$ 791 |
| | 66-2850HTP For 60" Footprint | 50 | 28 | 1 | 71 | 3.4 | T\$ 534 P\$ 746 |
| | 66-2262HTP For 72" Footprint | 62 | 22 | 1 | 42 | 3.3 | T\$ 531 P\$ 745 |
| | 66-2256HTP For 66" Footprint | 56 | 22 | 1 | 36 | 3.0 | T\$ 506 P\$ 709 |
| | 66-2250HTP For 60" Footprint | 50 | 22 | 1 | 33 | 2.7 | T\$ 465 P\$ 651 |

Must Specify (in this order):

Model #
Top Material
Color
Edge Profile
Grommet Location
Grommet Color
Power/Data/Wire Management

Description

- Profiled on Approach and User Side
- 10" Width Offset to Provide Clearance for Overhead Storage and Access to Optional Power in Credenza
- Depth Allows for Use With Gallery Screens
- Not Available for Use with Height Adjustable Open Bookcase with Controls
- [See Height Adjustable Legs and Cabinets](#)
- Additional Options: Power, Monitor Arm and Grommet Options ([See Options](#))

| | | | | | | | |
|--|--------------------------------------|----|----|---|-----|-----|---------------------|
| HEIGHT ADJUSTABLE WORK SURFACE FOR INDIVIDUAL WORKSTATIONS  | 66-3470HTP Stiffener Bar Included | 70 | 34 | 1 | 115 | 6.2 | T\$ 902 P\$ 1263 |
| | 66-3464HTP | 64 | 34 | 1 | 68 | 5.2 | T\$ 692 P\$ 967 |
| | 66-3458HTP | 58 | 34 | 1 | 62 | 4.8 | T\$ 659 P\$ 922 |
| | 66-2870HTP Stiffener Bar Included | 70 | 28 | 1 | 85 | 4.6 | T\$ 779 P\$ 1089 |
| | 66-2864HTP | 64 | 28 | 1 | 81 | 4.3 | T\$ 597 P\$ 835 |
| | 66-2858HTP | 58 | 28 | 1 | 77 | 3.9 | T\$ 569 P\$ 795 |
| | 66-2852HTP | 52 | 28 | 1 | 73 | 3.5 | T\$ 522 P\$ 730 |
| | 66-2846HTP | 46 | 28 | 1 | 69 | 3.1 | T\$ 486 P\$ 678 |

Must Specify (in this order):

Model #
Top Material
Color
Edge Profile
Grommet Location
Grommet Color
Power/Data/Wire Management

Description

- Profiled on Approach and User Side
- [See Height Adjustable Legs and Cabinets](#)
- Additional Options: Power, Monitor Arm and Grommet Options ([See Options](#))

Pricing Codes:

T= TFL
P= HPL

[See Canvas Intro Section for Ordering Options](#)

| Item | Model No. | Width | Depth | Height | Ship Wt | Cubic Ft | List Price |
|---|--------------------------------------|-------|-------|--------|---------|----------|--------------------|
| HEIGHT ADJUSTABLE WORK SURFACE FOR MULTIPLE AND INDIVIDUAL WORKSTATIONS  | 66-2270HTP Stiffener Bar Included | 70 | 22 | 1 | 50 | 3.8 | T\$ 702 P\$ 985 |
| | 66-2264HTP | 64 | 22 | 1 | 44 | 3.4 | T\$ 538 P\$ 752 |
| | 66-2258HTP | 58 | 22 | 1 | 38 | 3.1 | T\$ 512 P\$ 718 |
| | 66-2252HTP | 52 | 22 | 1 | 35 | 2.8 | T\$ 469 P\$ 658 |
| | 66-2246HTP | 46 | 22 | 1 | 31 | 2.5 | T\$ 438 P\$ 613 |

Must Specify (in this order):

Model #
Top Material
Color
Edge Profile
Grommet Location
Grommet Color
Power/Data/Wire Management

Description

- Profiled on Approach and User Side
- Can Also be Used in Individual Workstations Applications
- [See Height Adjustable Legs and Cabinets](#)
- Additional Options: Power, Monitor Arm and Grommet Options ([See Options](#))

| Item | Model No. | Width | Depth | Height | Ship Wt | Cubic Ft | List Price |
|--|---|-------|-------|--------|---------|----------|------------|
| HEIGHT ADJUSTABLE T-LEG  | 01-2245HTLC Includes Control, Motor Cable and Keypad | 22 | 2 | 28¼ | 40 | 0.5 | \$ 2077 |
| | 01-2245HTL Does Not Include Control, Requires a Unit with Control | 22 | 2 | 28¼ | 40 | 0.5 | \$ 1442 |

Must Specify (in this order):

Model #
Color

Description

- Available in Black or Silver; Must Specify
- 16" Adjustable Range

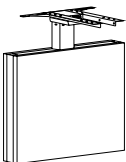
| Item | Model No. | Width | Depth | Height | Ship Wt | Cubic Ft | List Price |
|---|---|-------|-------|--------|---------|----------|------------|
| HEIGHT ADJUSTABLE PANEL LEG  | 66-0536HPC For Use With 34"D Top Includes Control, Motor Cable and Keypad | 36 | 5% | 28¼ | 50 | 4.5 | T\$ 2394 |
| | 66-0530HPC For Use With 28"D Top Includes Control, Motor Cable and Keypad | 30 | 5% | 28¼ | 49 | 4.5 | T\$ 2356 |
| | 66-0524HPC For Use With 22"D Top Includes Control, Motor Cable and Keypad | 24 | 5% | 28¼ | 48 | 4.5 | T\$ 2252 |
| | 66-0536HP For Use With 34"D Top Does Not Include Control, Requires a Unit with Control | 36 | 5% | 28¼ | 50 | 4.5 | T\$ 1834 |
| | 66-0530HP For Use With 28"D Top Does Not Include Control, Requires a Unit with Control | 30 | 5% | 28¼ | 49 | 4.5 | T\$ 1799 |
| | 66-0524HP For Use With 22"D Top Does Not Include Control, Requires a Unit with Control | 24 | 5% | 28¼ | 48 | 4.5 | T\$ 1696 |

Must Specify (in this order):

Model #
Color

Description

- Available in Black or Silver; Must Specify
- 16" Adjustable Range

Pricing Codes:

T= TFL
P= HPL

[See Canvas Intro Section for Ordering Options](#)

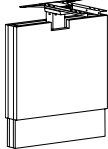
| Item | Model No. | Width | Depth | Height | Ship Wt | Cubic Ft | List Price |
|---|--|-------|-------|--------|---------|----------|------------|
| HEIGHT ADJUSTABLE PANEL LEG WITH SLEEVE  | 66-0536HPSC For Use With 34"D Top Includes Control, Motor Cable and Keypad | 34 | 5 5/8 | 28 1/4 | 50 | 4.5 | T\$ 2928 |
| | 66-0530HPSC For Use With 28"D Top Includes Control, Motor Cable and Keypad | 28 | 5 5/8 | 28 1/4 | 49 | 4.5 | T\$ 2857 |
| | 66-0524HPSC For Use With 22"D Top Includes Control, Motor Cable and Keypad | 22 | 5 5/8 | 28 1/4 | 48 | 4.5 | T\$ 2717 |
| | 66-0536HPS For Use With 34"D Top Does Not Include Control, Requires a Unit with Control | 34 | 5 5/8 | 28 1/4 | 50 | 4.5 | T\$ 2371 |
| | 66-0530HPS For Use With 28"D Top Does Not Include Control, Requires a Unit with Control | 28 | 5 5/8 | 28 1/4 | 49 | 4.5 | T\$ 2302 |
| | 66-0524HPS For Use With 22"D Top Does Not Include Control, Requires a Unit with Control | 22 | 5 5/8 | 28 1/4 | 48 | 4.5 | T\$ 2158 |

Must Specify (in this order):

Model #
Color

Description

- For Use in Place of Cabinet
- 16" Adjustable Range
- Not Compatible with 4" Modesty Panels

| | | | | | | | |
|--|-----------|----|--------|--------|----|-----|----------|
| HEIGHT ADJUSTABLE PANEL LEG FOR SHARED WORKSTATION  | 66-1124HP | 24 | 10 1/4 | 28 1/4 | 50 | 4.5 | T\$ 2686 |
|--|-----------|----|--------|--------|----|-----|----------|

Description

- Available in Black or Silver; Must Specify
- 16" Adjustable Range
- Shared Cabinet with Dual Legs For Multi-Workstation Footprints
- Required to be Used with a Unit Including Controls
- For Use with 24"D Worksurfaces

Must Specify (in this order):

Model #
Color

Pricing Codes:

T= TFL
P= HPL

[See Canvas Intro Section for Ordering Options](#)

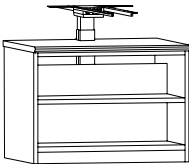
| Item | Model No. | Width | Depth | Height | Ship Wt | Cubic Ft | List Price |
|---|------------|-------|-------|--------|---------|----------|----------------------|
|  <p>HEIGHT ADJUSTABLE OPEN BOOKCASE WITH CONTROL</p> | 66-2436HBM | 36 | 24 | 21¾ | 99 | 18.3 | T\$ 3223 P\$ 3373 |
| | 66-2430HBM | 30 | 24 | 21¾ | 89 | 15.4 | T\$ 3176 P\$ 3318 |
| | 66-2424HBM | 24 | 24 | 21¾ | 79 | 12.5 | T\$ 3119 P\$ 3259 |
| | 66-2036HBM | 36 | 20 | 21¾ | 89 | 15.5 | T\$ 3164 P\$ 3296 |
| | 66-2030HBM | 30 | 20 | 21¾ | 79 | 13.1 | T\$ 3122 P\$ 3251 |
| | 66-2024HBM | 24 | 20 | 21¾ | 69 | 10.6 | T\$ 3065 P\$ 3190 |

Must Specify (in this order):

- Model #
- Top Material
- Top Color
- Edge Profile
- Chassis Color
- Leg Color
- Wire Management Sleeve
- Wire Management Kneespace Access

Description

- Open Back; [See Back Panel Options](#)
- Open Book Case with Controls; Profiled on User Side
- One Adjustable Shelf; 13" Deep Shelf on 24" Units/9" Deep Shelf on 20" Units
- Not Available for Use with Overhead Storage
- When Used as Peninsula Desk, Additional Height Adjustable Panel Leg (Without Control) Must be Used on Opposite Side for Support; [See Panel Legs](#) 01-2245HTL, 66-0536HP, 66-0530HP, 66-0524HP, 66-0536HPS, 66-0530HPS, or 66-0524HPS
- Leg Available in Black or Silver; Must Specify
- Top and Chassis Available in Contrasting Colors; Must Specify Color of Each Component
- Worksurface Grommet Standard; Must Specify: Black (BLK), Silver (SLV)
- Optional Wire Management Sleeve Available (See Below); Wire Management Sleeve Replaces Standard Work Surface Grommet
- Wire Management Access from Pedestal to Kneespace; Specify Left (WML), Right (WMR) or Left and Right (WMLR)



Options: Specify & Add

| | | |
|-----------|------------------------|---------|
| WM Sleeve | Wire Management Sleeve | T\$ 405 |
|-----------|------------------------|---------|

Pricing Codes:

- T= TFL
- P= HPL

[See Canvas Intro Section for Ordering Options](#)

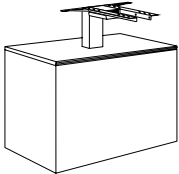
| Item | Model No. | Width | Depth | Height | Ship Wt | Cubic Ft | List Price |
|--|-----------|-------|-------|--------|---------|----------|----------------------|
| HEIGHT ADJUSTABLE CABINET WITH CONTROL  | 66-2436HM | 36 | 24 | 21¾ | 99 | 18.3 | T\$ 2922 P\$ 3072 |
| | 66-2430HM | 30 | 24 | 21¾ | 89 | 15.4 | T\$ 2879 P\$ 3020 |
| | 66-2424HM | 24 | 24 | 21¾ | 79 | 12.5 | T\$ 2830 P\$ 2968 |
| | 66-2036HM | 36 | 20 | 21¾ | 89 | 15.5 | T\$ 2867 P\$ 3000 |
| | 66-2030HM | 30 | 20 | 21¾ | 79 | 13.1 | T\$ 2831 P\$ 2959 |
| | 66-2024HM | 24 | 20 | 21¾ | 69 | 10.6 | T\$ 2779 P\$ 2902 |

Must Specify (in this order):

- Model #
- Top Material
- Top Color
- Edge Profile
- Chassis Color
- Leg Color
- Wire Management Sleeve
- Wire Management Kneespace Access

Description

- Open Back; [See Back Panel Options](#)
- Cabinet with Controls; Profiled on User Side
- Open Bottom Allows for Wire Management
- Removable Access Front Panel Available in Contrasting Color; Must Specify
- Top and Chassis Available in Contrasting Colors; Must Specify Color of Each Component
- When Used as Peninsula Desk, Additional Height Adjustable Panel Leg (Without Control) Must be Used on Opposite Side for Support; [See Panel Legs](#) for Panel Legs 01-2245HTL, 66-0536HP, 66-0530HP, 66-0524HP, 66-0536HPS, 66-0530HPS, or 66-0524HPS
- Leg Available in Black or Silver; Must Specify
- Work Surface Grommet Standard; Must Specify: Black (BLK), Silver (SLV)
- Optional Wire Management Sleeve Available (See Below); Wire Management Sleeve Replaces Standard Work Surface Grommet
- Wire Management Access from Pedestal to Kneespace; Specify Left (WML), Right (WMR) or Left and Right (WMLR)

Options: Specify & Add

| | | |
|-----------|------------------------|---------|
| WM Sleeve | Wire Management Sleeve | T\$ 405 |
|-----------|------------------------|---------|

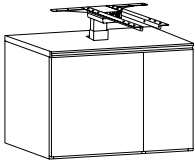

| Item | Leg Left of Door | | Leg Right of Door | | Width | Depth | Height | Ship Wt | Cubic Ft | List Price |
|---|------------------|------------|-------------------|------------|-------|-------|--------|---------|----------|----------------------|
| | Model No. | Model No. | Model No. | Model No. | | | | | | |
| HEIGHT ADJUSTABLE CABINET WITH DOOR AND CONTROL  | 66-2436HDL | 66-2436HDL | 66-2436HDR | 66-2436HDR | 30 | 24 | 21¾ | 95 | 18.3 | T\$ 3254 P\$ 3402 |
| | 66-2430HDL | 66-2430HDL | 66-2430HDR | 66-2430HDR | 24 | 24 | 21¾ | 75 | 15.4 | T\$ 3200 P\$ 3345 |
| | 66-2036HDL | 66-2036HDL | 66-2036HDR | 66-2036HDR | 36 | 20 | 21¾ | 85 | 15.5 | T\$ 3193 P\$ 3324 |
| | 66-2030HDL | 66-2030HDL | 66-2030HDR | 66-2030HDR | 30 | 20 | 21¾ | 65 | 13.1 | T\$ 3149 P\$ 3273 |

Shown as Left
(Leg is Left of Door)

Must Specify (in this order):

- Model #
- Top Material
- Top Color
- Edge Profile
- Chassis Color
- Leg Color
- Wire Management Sleeve
- Wire Management Kneespace Access

Description

- Open Back; [See Back Panel Options](#)
- Handed Based on Facing the Unit
- Cabinet with Controls; Profiled on User Side
- Open Bottom Allows for Wire Management
- 9" Door Opening With Touch Latch and Includes Bottom Panel, Storage Behind Door
- When Used as Peninsula Desk, Additional Height Adjustable Panel Leg (Without Control) Must be Used on Opposite Side for Support; [See Panel Legs](#) for Panel Legs 01-2245HTL, 66-0536HP, 66-0530HP, 66-0524HP, 66-0536HPS, 66-0530HPS, or 66-0524HPS
- Door and Removable Access Front Panel Available in Contrasting Color; Must Specify
- Top and Chassis Available in Contrasting Colors; Must Specify Color of Each Component
- Leg Available in Black or Silver; Must Specify
- Worksurface Grommet Standard; Must Specify: Black (BLK), Silver (SLV)
- Wire Management Access from Pedestal to Kneespace; Specify Left (WML), Right (WMR) or Left and Right (WMLR)

Pricing Codes:

T= TFL
P= HPL

[See Canvas Intro Section for Ordering Options](#)

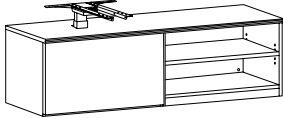
| Item | Model No. | | Width | Depth | Height | Ship Wt | Cubic Ft | List Price |
|--|--|-----------------------------|-------|-------|--------|---------|----------|----------------------|
| HEIGHT ADJUSTABLE CREDENZA WITH OPEN BOOKCASE AND CONTROL  Shown as Left | Leg in Left Cabinet | Leg in Right Cabinet | | | | | | |
| | 66-2472HMOL | 66-2472HMOR | 72 | 24 | 21¾ | 240 | 35.6 | T\$ 3875 P\$ 4114 |
| | 66-2466HMOL | 66-2466HMOR | 66 | 24 | 21¾ | 220 | 32.7 | T\$ 3806 P\$ 4029 |
| | 66-2460HMOL | 66-2460HMOR | 60 | 24 | 21¾ | 220 | 29.9 | T\$ 3734 P\$ 3956 |
| | 66-2072HMOL | 66-2072HMOR | 72 | 20 | 21¾ | 220 | 30.2 | T\$ 3757 P\$ 3968 |
| | 66-2066HMOL | 66-2066HMOR | 66 | 20 | 21¾ | 210 | 27.7 | T\$ 3691 P\$ 3891 |
| | 66-2060HMOL | 66-2060HMOR | 60 | 20 | 21¾ | 210 | 25.3 | T\$ 3618 P\$ 3809 |
| | Description <ul style="list-style-type: none"> • Standard with: Controls, Back Panel, One Adjustable Shelf in Bookcase End, Profiled on User Side • Bottom Panel Not Included Behind Removable Access Front Panel for Wire Management • Designed for 28" Deep Worksurfaces Only (See Worksurfaces) • Handed Based on Height Adjust Cabinet and Facing the Unit • Removable Access Front Panel Available in Contrasting Color; Must Specify • Top and Chassis Available in Contrasting Colors; Must Specify Color of Each Component • When Used as Peninsula Desk, Additional Height Adjustable Panel Leg (Without Control) Must be Used on Opposite Side for Support; See Panel Legs for Panel Legs 01-2245HTL, 66-0536HPS, 66-0530HPS, or 66-0524HPS • Leg Available in Black or Silver; Must Specify • Worksurface Grommet Standard; Must Specify: Black (BLK), Silver (SLV) • Optional Back Panel Grommet, Must Specify: Black (GMBBL), Silver (GMBSV); Color Must Match Worksurface Grommet • Optional Wire Management Sleeve Available (See Below); Wire Management Sleeve Replaces Standard Work Surface Grommet • Optional Power Locations (See Power Options) | | | | | | | |
| Options: Specify & Add | | | | | | | | |
| WM Sleeve | Wire Management Sleeve | | | | | | | T\$ 405 |

Must Specify (in this order):

- Model #
- Top Material
- Top Color
- Edge Profile
- Wire Management Sleeve
- Chassis Color
- Front Panel Color
- Grain Direction (if applicable)
- Leg Color
- Worksurface Grommet
- Grommet Color
- Power/Data/Wire Management
- Back Panel Grommet



Pricing Codes:

- T= TFL
- P= HPL

[See Canvas Intro Section for Ordering Options](#)

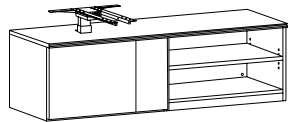
| Item | Model No. | Width | Depth | Height | Ship Wt | Cubic Ft | List Price |
|--|----------------------------|-----------------------------|-------|--------|---------|----------|----------------------|
| HEIGHT ADJUSTABLE CREDENZA WITH DOOR, OPEN BOOKCASE AND CONTROL  Shown as Left | Leg in Left Cabinet | Leg in Right Cabinet | | | | | |
| | 66-2472HDOL | 66-2472HDOR | 72 | 24 | 21¾ | 240 | T\$ 4251 P\$ 4488 |
| | 66-2466HDOL | 66-2466HDOR | 66 | 24 | 21¾ | 230 | T\$ 4171 P\$ 4394 |
| | 66-2460HDOL | 66-2460HDOR | 60 | 24 | 21¾ | 220 | T\$ 4095 P\$ 4317 |
| | 66-2072HDOL | 66-2072HDOR | 72 | 20 | 21¾ | 240 | T\$ 4118 P\$ 4330 |
| | 66-2066HDOL | 66-2066HDOR | 66 | 20 | 21¾ | 230 | T\$ 4045 P\$ 4247 |
| | 66-2060HDOL | 66-2060HDOR | 60 | 20 | 21¾ | 220 | T\$ 3968 P\$ 4159 |

Must Specify (in this order):

Model #
 Top Material
 Top Color
 Edge Profile
 Wire Management Sleeve
 Chassis Color
 Front Panel
 Color
 Grain Direction (if applicable)
 Leg Color
 Worksurface Grommet
 Grommet Color
 Power/Data/Wire Management
 Back Panel Grommet

Description

- Credenza with Controls; Profiled on User Side; Back Panel Included, One Adjustable Shelf in Bookcase End
- Bottom Panel Not Included Behind Removable Access Front Panel for Wire Management
- 9" Door Opening With Touch Latch and Includes Bottom Panel, Storage Behind Door
- Designed for 28" Deep Worksurfaces Only ([See Worksurfaces](#))
- Handed Based on Height Adjust Cabinet and Facing the Unit
- Door and Removable Access Front Panel Available in Contrasting Color; Must Specify
- Top and Chassis Available in Contrasting Colors; Must Specify Color of Each Component
- When Used as Peninsula Desk, Additional Height Adjustable Panel Leg (Without Control) Must be Used on Opposite Side for Support; [See Panel Legs](#) 01-2245HTL, 66-0536HPS, or 66-0530HPS
- Leg Available in Black or Silver; Must Specify
- Worksurface Grommet Standard; Must Specify: Black (BLK), Silver (SLV)
- Optional Back Panel Grommet, Must Specify: Black (GMBBL), Silver (GMBSV); Color Must Match Worksurface Grommet
- Optional Power Locations ([See Power Options](#))

Pricing Codes:

T= TFL
 P= HPL

[See Canvas Intro Section for Ordering Options](#)

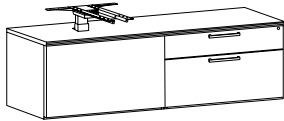
| Item | Model No. | Width | Depth | Height | Ship Wt | Cubic Ft | List Price | |
|---|---|---|-------|--------|---------|----------------------|------------|----------------------|
| HEIGHT ADJUSTABLE CREDENZA WITH BOX/FILE AND CONTROL  Shown as Left Must Specify (in this order): Model # Top Material Top Color Edge Profile Wire Management Sleeve Chassis Color Drawer Front/Front Panel Color Grain Direction (if applicable) Leg Color Worksurface Grommet Grommet Color Power/Data/Wire Management Back Panel Grommet | Leg in Left Cabinet 66-2472HMFL 66-2466HMFL 66-2460HMFL 66-2072HMFL 66-2066HMFL 66-2060HMFL | Leg in Right Cabinet 66-2472HMFR 66-2466HMFR 66-2460HMFR 66-2072HMFR 66-2066HMFR 66-2060HMFR | 72 | 24 | 21¾ | 260 | 35.6 | T\$ 4228 P\$ 4468 |
| | 66 | 24 | 21¾ | 240 | 32.7 | T\$ 4153 P\$ 4377 | | |
| | 60 | 24 | 21¾ | 240 | 29.9 | T\$ 4078 P\$ 4295 | | |
| | 72 | 20 | 21¾ | 220 | 30.2 | T\$ 4098 P\$ 4309 | | |
| | 66 | 20 | 21¾ | 210 | 27.7 | T\$ 4024 P\$ 4226 | | |
| | 60 | 20 | 21¾ | 210 | 25.3 | T\$ 3949 P\$ 4139 | | |
| | Description <ul style="list-style-type: none"> • Cabinet with Controls; Profiled on User Side; Back Panel Included • Bottom Panel Not Included Behind Removable Access Front Panel for Wire Management • Locking Box/File; File Drawers Provide Legal or Letter Filing • Designed for 28" Deep Worksurfaces Only (See Worksurfaces) • Handed Based on Height Adjust Cabinet and Facing the Unit • When Used as Peninsula Desk, Additional Height Adjustable Panel Leg (Without Control) Must be Used on Opposite Side for Support; See Panel Legs 01-2245HTL, 66-0536HPS, or 66-0530HPS • Drawer Fronts and Removable Access Front Panel Available in Contrasting Color; Must Specify • Top and Chassis Available in Contrasting Colors; Must Specify Color of Each Component • If Black or Gold Pull is Selected, Leg and Lock Core will be Black; If Chrome or Aluminum Pull is Selected, Leg and Lock Core will be Silver • Worksurface Grommet Standard; Must Specify: Black (BLK), Silver (SLV) • Optional Back Panel Grommet, Must Specify: Black (GMBBL), Silver (GMBSV); Color Must Match Worksurface Grommet • Optional Wire Management Sleeve Available (See Below); Wire Management Sleeve Replaces Standard Work Surface Grommet • Additional Options: Dove Tail Drawer Construction and Soft Close Drawers (See Drawer Options), Power Locations (See Power Options) | | | | | | | |
| | Options: Specify & Add | | | | | | | |
| | WM Sleeve Wire Management Sleeve | | | | | | | T\$ 405 |

Pricing Codes:

 T= TFL
 P= HPL

[See Canvas Intro Section for Ordering Options](#)

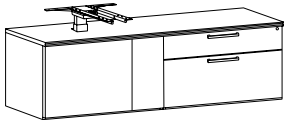
| Item | Model No. | Width | Depth | Height | Ship Wt | Cubic Ft | List Price |
|--|----------------------------|-----------------------------|-------|--------|---------|----------|----------------------|
| HEIGHT ADJUSTABLE CREDENZA WITH DOOR, WITH BOX/FILE AND CONTROL  Shown as Left | Leg in Left Cabinet | Leg in Right Cabinet | | | | | |
| | 66-2472HDFL | 66-2472HDFR | 72 | 24 | 21¾ | 260 | T\$ 4515 P\$ 4752 |
| | 66-2466HDFL | 66-2466HDFR | 66 | 24 | 21¾ | 250 | T\$ 4429 P\$ 4655 |
| | 66-2460HDFL | 66-2460HDFR | 60 | 24 | 21¾ | 240 | T\$ 4350 P\$ 4570 |
| | 66-2072HDFL | 66-2072HDFR | 72 | 20 | 21¾ | 240 | T\$ 4375 P\$ 4585 |
| | 66-2066HDFL | 66-2066HDFR | 66 | 20 | 21¾ | 230 | T\$ 4293 P\$ 4496 |
| | 66-2060HDFL | 66-2060HDFR | 60 | 20 | 21¾ | 220 | T\$ 4215 P\$ 4406 |

Must Specify (in this order):

Model #
 Top Material
 Top Color
 Edge Profile
 Wire Management Sleeve
 Chassis Color
 Drawer Front/Front Panel
 Color
 Grain Direction (if applicable)
 Leg Color
 Worksurface Grommet
 Grommet Color
 Power/Data/Wire Management
 Back Panel Grommet

Description

- Credenza with Controls; Profiled on User Side; Back Panel Included
- Bottom Panel Not Included Behind Removable Access Front Panel for Wire Management
- 9" Door Opening With Touch Latch and Includes Bottom Panel, Storage Behind Door
- Locking Box/File; File Drawers Provide Legal or Letter Filing
- Designed for 28" Deep Worksurfaces Only ([See Worksurfaces](#))
- Handed Based on Height Adjust Cabinet and Facing the Unit
- When Used as Peninsula Desk, Additional Height Adjustable Panel Leg (Without Control) Must be Used on Opposite Side for Support; [See Panel Legs](#) 01-2245HTL, 66-0536HPS, or 66-0530HPS
- Door, Drawers and Removable Access Front Panel Available in Contrasting Color; Must Specify
- Top and Chassis Available in Contrasting Colors; Must Specify Color of Each Component
- If Black or Gold Pull is Selected, Leg and Lock Core will be Black; If Chrome or Aluminum Pull is Selected, Leg and Lock Core will be Silver
- Worksurface Grommet Standard; Must Specify: Black (BLK), Silver (SLV)
- Optional Back Panel Grommet, Must Specify: Black (GMBBL), Silver (GMBSV); Color Must Match Worksurface Grommet
- Additional Options: Dove Tail Drawer Construction and Soft Close Drawers ([See Drawer Options](#)), Power Locations ([See Power Options](#))

Pricing Codes:

T= TFL
P= HPL

[See Canvas Intro Section for Ordering Options](#)

CANVAS™

HEIGHT ADJUSTABLE COMPONENTS (6600/6800 SERIES)

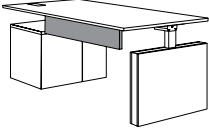
| Item | Model No. | Width | Depth | Height | Ship Wt | Cubic Ft | List Price |
|--|--|-------|-------|--------|---------|----------|------------|
|  <p>7" MODESTY PANEL, TFL</p> <p><u>Must Specify (in this order):</u> Model # Modesty Color</p> | 66-5707MOD For Use with 70" Surface with Panel Leg | 57 | ¾ | 7 | 16 | 1.1 | T\$ 396 |
| | 66-5107MOD For Use with 64" Surface with Panel Leg | 51 | ¾ | 7 | 16 | 1.1 | T\$ 388 |
| | 66-4507MOD For Use with 70" Surface with 20" Credenza | 45 | ¾ | 7 | 15 | 1 | T\$ 378 |
| | 66-4107MOD For Use with 70" Surface with 24" Credenza | 41 | ¾ | 7 | 15 | 1 | T\$ 376 |
| | 66-3907MOD For Use with 64" Surface with 20" Credenza | 39 | ¾ | 7 | 15 | 0.9 | T\$ 373 |
| | 66-3507MOD For Use with 64" Surface with 24" Credenza | 35 | ¾ | 7 | 15 | 0.9 | T\$ 370 |
| | 66-3307MOD For Use with 58" Surface with 20" Credenza | 33 | ¾ | 7 | 15 | 0.8 | T\$ 363 |
| | 66-2907MOD For Use with 58" Surface with 24" Credenza | 29 | ¾ | 7 | 15 | 0.8 | T\$ 358 |

Description

- Works With Low Storage; [See Low Storage](#) and Modular Units; [See Modular Units](#)
- Attaches with Aluminum Mounting Brackets

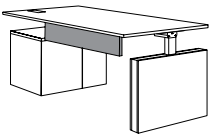
| | | | | | | | |
|--|---|----|---|---|----|-----|--------|
|  <p>7" MODESTY PANEL, FROSTED ACRYLIC</p> <p><u>Must Specify (in this order):</u> Model # Decorative Hardware Color</p> | MD-5707FA For Use with 70" Surface with Panel Leg | 57 | ¾ | 7 | 10 | 1.1 | \$ 623 |
| | MD-5107FA For Use with 64" Surface with Panel Leg | 51 | ¾ | 7 | 9 | 1 | \$ 612 |
| | MD-4507FA For Use with 70" Surface with 20" Credenza | 45 | ¾ | 7 | 9 | 1 | \$ 602 |
| | MD-4107FA For Use with 70" Surface with 24" Credenza | 41 | ¾ | 7 | 8 | 0.9 | \$ 597 |
| | MD-3907FA For Use with 64" Surface with 20" Credenza | 39 | ¾ | 7 | 8 | 0.8 | \$ 590 |
| | MD-3507FA For Use with 64" Surface with 24" Credenza | 35 | ¾ | 7 | 7 | 0.7 | \$ 581 |
| | MD-3307FA For Use with 58" Surface with 20" Credenza | 33 | ¾ | 7 | 7 | 0.6 | \$ 574 |
| | MD-2907FA For Use with 58" Surface with 24" Credenza | 29 | ¾ | 7 | 6 | 0.5 | \$ 564 |

Description

- Works With Low Storage; [See Low Storage](#) and Modular Units; [See Modular Units](#)
- Exposed Decorative Hardware; Must Specify: Aluminum (ALUM) or Chrome (CHRM)

Pricing Codes:

T= TFL
P= HPL

[See Canvas Intro Section for Ordering Options](#)

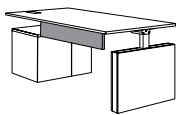
| Item | Model No. | Width | Depth | Height | Ship Wt | Cubic Ft | List Price | |
|--|------------|--|-------|--------|---------|----------|------------|---------------------|
| 7" MODESTY PANEL, HIGH GLOSS ACRYLIC  | MD-5707HGA | For Use with 70" Surface with Panel Leg | 57 | ¾ | 7 | 16 | 1.1 | \$ 693 GPA\$ 741 |
| | MD-5107HGA | For Use with 64" Surface with Panel Leg | 51 | ¾ | 7 | 15 | 1 | \$ 680 GPA\$ 730 |
| | MD-4507HGA | For Use with 70" Surface with 20" Credenza | 45 | ¾ | 7 | 15 | 1 | \$ 668 GPA\$ 714 |
| | MD-4107HGA | For Use with 70" Surface with 24" Credenza | 41 | ¾ | 7 | 14 | 0.9 | \$ 661 GPA\$ 707 |
| | MD-3907HGA | For Use with 64" Surface with 20" Credenza | 39 | ¾ | 7 | 14 | 0.8 | \$ 655 GPA\$ 702 |
| | MD-3507HGA | For Use with 64" Surface with 24" Credenza | 35 | ¾ | 7 | 13 | 0.7 | \$ 644 GPA\$ 690 |
| | MD-3307HGA | For Use with 58" Surface with 20" Credenza | 33 | ¾ | 7 | 13 | 0.6 | \$ 637 GPA\$ 680 |
| | MD-2907HGA | For Use with 58" Surface with 24" Credenza | 29 | ¾ | 7 | 12 | 0.5 | \$ 627 GPA\$ 670 |

Must Specify (in this order):
 Model #
 Modesty Color
 Decorative Hardware Color

Description

- Works With Low Storage; [See Low Storage](#) and Modular Units; [See Modular Units](#)
- Attaches with Aluminum Mounting Brackets
- Available in Black (BLA), Wired Mercury (WMA), White (WHA) or Graphite (GPA); Graphite Acrylic Pricing (GPA\$)

| | | | | | | | |
|--|------------|----|---|---|----|-----|---------|
| 4" MODESTY PANEL, TFL  | 66-6804MOD | 68 | ¾ | 4 | 17 | 1.3 | T\$ 388 |
| | 66-6204MOD | 62 | ¾ | 4 | 16 | 1.2 | T\$ 377 |
| | 66-5604MOD | 56 | ¾ | 4 | 16 | 1.1 | T\$ 373 |

Must Specify (in this order):
 Model #
 Modesty Color

Description

- Attaches with Aluminum Mounting Brackets
- Not Compatible with Height Adjustable Panel Leg with Sleeve

| | | | | | | | |
|---|-----------|----|---|---|----|-----|--------|
| 4" MODESTY PANEL, FROSTED ACRYLIC  | MD-6804FA | 68 | ¾ | 4 | 12 | 1.3 | \$ 669 |
| | MD-6204FA | 62 | ¾ | 4 | 11 | 1.2 | \$ 619 |
| | MD-5604FA | 56 | ¾ | 4 | 10 | 1.1 | \$ 589 |

Must Specify (in this order):
 Model #
 Modesty Color
 Decorative Hardware Color

Description

- Attaches with Aluminum Mounting Brackets
- Exposed Decorative Hardware; Must Specify (ALUM) Aluminum or (CHRM) Chrome
- Not Compatible with Height Adjustable Panel Leg with Sleeve

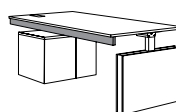
| | | | | | | | |
|--|------------|----|---|---|----|-----|---------------------|
| 4" MODESTY PANEL, HIGH GLOSS ACRYLIC  | MD-6804HGA | 68 | ¾ | 4 | 17 | 1.3 | \$ 730 GPA\$ 781 |
| | MD-6204HGA | 62 | ¾ | 4 | 16 | 1.2 | \$ 693 GPA\$ 742 |
| | MD-5604HGA | 56 | ¾ | 4 | 16 | 1.1 | \$ 654 GPA\$ 699 |

Must Specify (in this order):
 Model #
 Modesty Color

Description

- Attaches with Aluminum Mounting Brackets
- Available in Black (BLA), Wired Mercury (WMA), White (WHA) or Graphite (GPA); Graphite Acrylic Pricing (GPA\$)
- Not Compatible with Height Adjustable Panel Leg with Sleeve

Pricing Codes:

T= TFL
 P= HPL

[See Canvas Intro Section for Ordering Options](#)

| Item | Model No. | Width | Depth | Height | Ship Wt | Cubic Ft | List Price |
|---|---|-------|-------|--------|---------|----------|------------|
|  <p>20”H ABOVE/BELOW PRIVACY SCREEN, TFL</p> | 66-5720PS For Use with 70” Surface with Panel Leg | 57 | ¾ | 20 | 36 | 2.7 | \$ 438 |
| | 66-5120PS For Use with 64” Surface with Panel Leg | 51 | ¾ | 20 | 34 | 2.5 | \$ 420 |
| | 66-4520PS For Use with 70” Surface with 20” Credenza | 45 | ¾ | 20 | 32 | 2.3 | \$ 405 |
| | 66-4120PS For Use with 70” Surface with 24” Credenza | 41 | ¾ | 20 | 30 | 2.2 | \$ 389 |
| | 66-3920PS For Use with 64” Surface with 20” Credenza | 39 | ¾ | 20 | 29 | 2.2 | \$ 375 |
| | 66-3520PS For Use with 64” Surface with 24” Credenza | 35 | ¾ | 20 | 28 | 2.1 | \$ 362 |
| | 66-3320PS For Use with 58” Surface with 20” Credenza | 33 | ¾ | 20 | 27 | 2.1 | \$ 348 |
| | 66-2920PS For Use with 58” Surface with 24” Credenza | 29 | ¾ | 20 | 26 | 1.9 | \$ 335 |

Must Specify (in this order):
Model #
Modesty Color

Description

- Mounts to Worksurface
- Provides Privacy 12” Above and 7” Modesty Below

| Item | Model No. | Width | Depth | Height | Ship Wt | Cubic Ft | List Price |
|--|---|-------|-------|--------|---------|----------|--------------|
|  <p>20”H ABOVE/BELOW PRIVACY SCREEN, TACKBOARD</p> | PS-5720TB For Use with 70” Surface with Panel Leg | 57 | ⅝ | 20 | 14 | 2.2 | \$ See Below |
| | PS-5120TB For Use with 64” Surface with Panel Leg | 51 | ⅝ | 20 | 13 | 2.2 | \$ See Below |
| | PS-4520TB For Use with 70” Surface with 20” Credenza | 45 | ⅝ | 20 | 12 | 2 | \$ See Below |
| | PS-4120TB For Use with 70” Surface with 24” Credenza | 41 | ⅝ | 20 | 12 | 1.8 | \$ See Below |
| | PS-3920TB For Use with 64” Surface with 20” Credenza | 39 | ⅝ | 20 | 11 | 1.8 | \$ See Below |
| | PS-3520TB For Use with 64” Surface with 24” Credenza | 35 | ⅝ | 20 | 11 | 1.5 | \$ See Below |
| | PS-3320TB For Use with 58” Surface with 20” Credenza | 33 | ⅝ | 20 | 10 | 1.5 | \$ See Below |
| | PS-2920TB For Use with 58” Surface with 24” Credenza | 29 | ⅝ | 20 | 10 | 1.5 | \$ See Below |

Must Specify (in this order):
Model #
Fabric Vendor, Pattern, and Color

Description

- Mounts to Worksurface
- Provides Privacy 12” Above and 7” Modesty Below

| Model | Ydg | Grades 1,2,3 | Grade 4 | Grade 5 | Grade 6 | Grade 7 | Grade 8 | Grade 9 | Grade 10 |
|-----------|---------|--------------|---------|---------|---------|---------|---------|---------|----------|
| PS-5720TB | 2.00 \$ | 623 | 901 | 1031 | 1163 | 1351 | 1547 | 1775 | 2039 |
| PS-5120TB | 2.00 \$ | 578 | 856 | 986 | 1118 | 1306 | 1502 | 1730 | 1994 |
| PS-4520TB | 1.75 \$ | 513 | 756 | 870 | 986 | 1150 | 1322 | 1521 | 1752 |
| PS-4120TB | 1.50 \$ | 473 | 682 | 779 | 878 | 1019 | 1166 | 1337 | 1535 |
| PS-3920TB | 1.50 \$ | 459 | 668 | 765 | 864 | 1005 | 1152 | 1323 | 1521 |
| PS-3520TB | 1.50 \$ | 443 | 652 | 749 | 848 | 989 | 1136 | 1307 | 1505 |
| PS-3320TB | 1.25 \$ | 404 | 578 | 659 | 742 | 859 | 982 | 1124 | 1289 |
| PS-2920TB | 1.25 \$ | 383 | 557 | 638 | 721 | 838 | 961 | 1103 | 1268 |

Pricing Codes:
T= TFL
P= HPL

[See Canvas Intro Section for Ordering Options](#)

| Item | Model No. | Width | Depth | Height | Ship Wt | Cubic Ft | List Price |
|--|---|-------|-------|--------|---------|----------|------------|
|  <p>20"H ABOVE/BELOW PRIVACY SCREEN, FROSTED ACRYLIC</p> <p>Must Specify (in this order): Model #</p> | PS-5720FA For Use with 70" Surface with Panel Leg | 57 | ¼ | 20 | 20 | 2.2 | \$ 1163 |
| | PS-5120FA For Use with 64" Surface with Panel Leg | 51 | ¼ | 20 | 19 | 2.1 | \$ 1075 |
| | PS-5120FA For Use with 64" Surface with Panel Leg | 51 | ¼ | 20 | 19 | 2.1 | \$ 1075 |
| | PS-4520FA For Use with 70" Surface with 20" Credenza | 45 | ¼ | 20 | 19 | 2 | \$ 988 |
| | PS-4120FA For Use with 70" Surface with 24" Credenza | 41 | ¼ | 20 | 18 | 1.9 | \$ 951 |
| | PS-3920FA For Use with 64" Surface with 20" Credenza | 39 | ¼ | 20 | 18 | 1.8 | \$ 918 |
| | PS-3520FA For Use with 64" Surface with 24" Credenza | 35 | ¼ | 20 | 17 | 1.7 | \$ 881 |
| | PS-3320FA For Use with 58" Surface with 20" Credenza | 33 | ¼ | 20 | 17 | 1.6 | \$ 849 |
| | PS-2920FA For Use with 58" Surface with 24" Credenza | 29 | ¼ | 20 | 16 | 1.5 | \$ 814 |

Description

- Mounts to Worksurface
- Provides Privacy 12" Above and 7" Modesty Below

| | | | | | | | |
|---|--|----|---|----|----|-----|-----------------------|
|  <p>20"H ABOVE/BELOW PRIVACY SCREEN, HIGH GLOSS ACRYLIC</p> <p>Must Specify (in this order): Model # Modesty Color</p> | PS-5720HGA For Use with 70" Surface with Panel Leg | 57 | ⅝ | 20 | 36 | 2.7 | \$ 1230 GPA\$ 1586 |
| | PS-5120HGA For Use with 64" Surface with Panel Leg | 51 | ⅝ | 20 | 34 | 2.5 | \$ 1131 GPA\$ 1451 |
| | PS-4520HGA For Use with 70" Surface with 20" Credenza | 45 | ⅝ | 20 | 32 | 2.3 | \$ 1032 GPA\$ 1313 |
| | PS-4120HGA For Use with 70" Surface with 24" Credenza | 41 | ⅝ | 20 | 30 | 2.2 | \$ 990 GPA\$ 1261 |
| | PS-3920HGA For Use with 64" Surface with 20" Credenza | 39 | ⅝ | 20 | 29 | 2.2 | \$ 960 GPA\$ 1219 |
| | PS-3520HGA For Use with 64" Surface with 24" Credenza | 35 | ⅝ | 20 | 29 | 2.2 | \$ 922 GPA\$ 1174 |
| | PS-3320HGA For Use with 58" Surface with 20" Credenza | 33 | ⅝ | 20 | 27 | 2.1 | \$ 889 GPA\$ 1133 |
| | PS-2920HGA For Use with 58" Surface with 24" Credenza | 29 | ⅝ | 20 | 26 | 1.9 | \$ 851 GPA\$ 1087 |

Description

- Mounts to Worksurface
- Provides Privacy 12" Above and 7" Modesty Below
- Available in Available in Black (BLA), White (WHA) or Graphite (GPA); Graphite Acrylic Pricing (GPA\$)

Pricing Codes:

T= TFL
P= HPL

[See Canvas Intro Section for Ordering Options](#)

| Item | Model No. | Width | Depth | Height | Ship Wt | Cubic Ft | List Price |
|--|-----------|-------|-------|--------|---------|----------|------------|
| 17"H ABOVE/BELOW PRIVACY SCREEN, TFL  | 66-6817PS | 68 | ¾ | 17 | 24 | 3.3 | \$ 450 |
| | 66-6217PS | 62 | ¾ | 17 | 22 | 3.1 | \$ 437 |
| | 66-5617PS | 56 | ¾ | 17 | 20 | 2.7 | \$ 419 |
| | 66-5017PS | 50 | ¾ | 17 | 18 | 2.5 | \$ 405 |
| | 66-4417PS | 44 | ¾ | 17 | 16 | 2.3 | \$ 390 |

Must Specify (in this order):
Model #
Modesty Color

Description

- Aluminum Hardware Used to Mount Screen to Worksurface
- Provides Privacy 12" Above and 4" Modesty Below

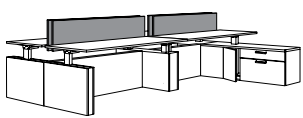
| | | | | | | | |
|--|-----------|----|---|----|----|-----|--------------|
| 17"H ABOVE/BELOW PRIVACY SCREEN, TACKBOARD  | PS-6817TB | 68 | ⅝ | 17 | 15 | 2.5 | \$ See Below |
| | PS-6217TB | 62 | ⅝ | 17 | 14 | 2.5 | \$ See Below |
| | PS-5617TB | 56 | ⅝ | 17 | 13 | 2.2 | \$ See Below |
| | PS-5017TB | 50 | ⅝ | 17 | 12 | 2 | \$ See Below |
| | PS-4417TB | 44 | ⅝ | 17 | 11 | 1.8 | \$ See Below |

Must Specify (in this order):
Model #
Fabric Vendor, Pattern, and Color

Description

- Mounts to Worksurface
- Provides Privacy 12" Above and 4" Modesty Below
- Decorative Hardware; Must Specify: Aluminum (ALUM) or Chrome (CHRM)

| Model | Ydg | Grades 1,2,3 | Grade 4 | Grade 5 | Grade 6 | Grade 7 | Grade 8 | Grade 9 | Grade 10 |
|-----------|---------|--------------|---------|---------|---------|---------|---------|---------|----------|
| PS-6817TB | 2.00 \$ | 642 | 920 | 1050 | 1182 | 1370 | 1566 | 1794 | 2058 |
| PS-6217TB | 2.00 \$ | 602 | 880 | 1010 | 1142 | 1330 | 1526 | 1754 | 2018 |
| PS-5617TB | 2.00 \$ | 549 | 827 | 957 | 1089 | 1277 | 1473 | 1701 | 1965 |
| PS-5017TB | 2.00 \$ | 520 | 798 | 928 | 1060 | 1248 | 1444 | 1672 | 1936 |
| PS-4417TB | 1.75 \$ | 468 | 711 | 825 | 941 | 1105 | 1277 | 1476 | 1707 |

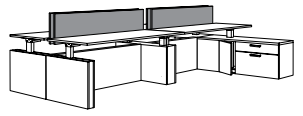
| | | | | | | | |
|--|-----------|----|---|----|----|-----|---------|
| 17"H ABOVE/BELOW PRIVACY SCREEN, FROSTED ACRYLIC  | PS-6817FA | 68 | ¼ | 17 | 14 | 3.3 | \$ 1196 |
| | PS-6217FA | 62 | ¼ | 17 | 14 | 3.1 | \$ 1160 |
| | PS-5617FA | 56 | ¼ | 17 | 13 | 2.9 | \$ 1121 |
| | PS-5017FA | 50 | ¼ | 17 | 13 | 2.7 | \$ 1036 |
| | PS-4417FA | 44 | ¼ | 17 | 12 | 2.5 | \$ 954 |

Must Specify (in this order):
Model #

Description

- Mounts to Worksurface
- Provides Privacy 12" Above and 4" Modesty Below
- Decorative Hardware; Must Specify: Aluminum (ALUM) or Chrome (CHRM)

Pricing Codes:

T= TFL
P= HPL

[See Canvas Intro Section for Ordering Options](#)

| Item | Model No. | Width | Depth | Height | Ship Wt | Cubic Ft | List Price |
|---|------------|-------|-------|--------|---------|----------|------------|
| 17”H ABOVE/BELOW PRIVACY SCREEN, HIGH GLOSS ACRYLIC  | PS-6817HGA | 68 | ¾ | 17 | 24 | 3.3 | \$ 1260 |
| | | | | | | | GPA\$ 1627 |
| | PS-6217HGA | 62 | ¾ | 17 | 22 | 3.1 | \$ 1223 |
| | | | | | | | GPA\$ 1579 |
| | PS-5617HGA | 56 | ¾ | 17 | 20 | 2.7 | \$ 1180 |
| | | | | | | | GPA\$ 1521 |
| | PS-5017HGA | 50 | ¾ | 17 | 18 | 2.5 | \$ 1088 |
| | | | | | | | GPA\$ 1395 |
| | PS-4417HGA | 44 | ¾ | 17 | 16 | 2.3 | \$ 995 |
| | | | | | | | GPA\$ 1267 |

Must Specify (in this order):
Model #
Modesty Color

Description

- Mounts to Worksurface
- Provides Privacy 12” Above and 4” Modesty Below
- Available in Available in Black (BLA), White (WHA) or Graphite Acrylic (GPA); Graphite Acrylic Pricing (GPA\$)

| GALLERY SCREEN, TFL | Model No. | Width | Depth | Height | Ship Wt | Cubic Ft | List Price |
|---------------------|-----------|-------|-------|--------|---------|----------|------------|
| | 66-2272GS | 72 | 1 | 22 | 31 | 3 | T\$ 489 |
| | 66-2266GS | 66 | 1 | 22 | 29 | 2.9 | T\$ 469 |
| | 66-2260GS | 60 | 1 | 22 | 27 | 2.8 | T\$ 450 |
| | 66-2254GS | 54 | 1 | 22 | 24 | 2.7 | T\$ 430 |

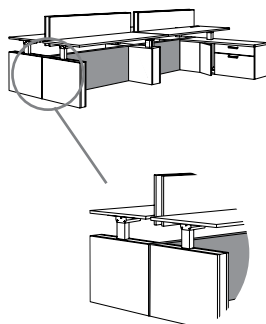

Gallery Screen is Positioned Between Height Adjustable Legs

Must Specify (in this order):
Model #
Modesty Color

Description

- Not Compatible with Optional Wire Management Sleeve
- Gallery Screens are Visible and Can Provide an Accent Between Users in Multi-Station Settings by Selecting a Contrasting Color
- When Used with Height Adjustable Legs, Gallery Screen is Positioned Between Height Adjustable Legs

Pricing Codes:
T= TFL
P= HPL

[See Canvas Intro Section for Ordering Options](#)

| Item | Model No. | Width | Depth | Height | Ship Wt | Cubic Ft | List Price |
|-----------------|-------------------------|-------|-------|--------|---------|----------|------------|
| RECTANGULAR TOP | 72" or 6' - 1 Piece Top | | | | | | |
| | 94-3672RT | 72 | 36 | 1¾" | 100 | 6.2 | P\$ 1570 |

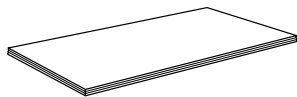

Must Specify (in this order):
 Model #
 Color
 Edge Profile
 Grommet/Power/Data Location

Description

- Grain Runs the Width of the Table
- Heavy-Duty Ganging Mechanisms Connect Two (2) Piece Tops
- See Rectangle Box Base and Number Required For Each Top Size Below; Must Order Bases/Legs Separately
- When Using with Strut Legs, We Recommend Using Two (2) Stiffener Bars on Tops 96"W; Must Order Separately, [See Strut Details](#)
- Tops 120"W Do Not Need Stretcher Rails When Used with Strut Legs, the Location and Number of Strut Legs Required Offer Sufficient Support
- Optional Grommets and Power/Data Units; [See Location Options](#), [See Power Units Available](#)

| | | | | | | | |
|----------|----------------------------|-----|----|-----|-----|------|----------|
| BOAT TOP | 120" or 10' - 2 Piece Tops | | | | | | |
| | 94-48120BT | 120 | 48 | 1¾" | 225 | 10.3 | P\$ 3823 |
| | 96" or 8' - 1 Piece Top | | | | | | |
| | 94-4296BT | 96 | 42 | 1¾" | 180 | 9.4 | P\$ 2476 |

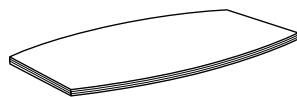

Must Specify (in this order):
 Model #
 Color
 Edge Profile
 Grommet/Power/Data Location

Description

- Grain Runs the Width of the Table
- Heavy-Duty Ganging Mechanisms Connect Two (2) Piece Tops
- See Rectangle Box Base and Number Required For Each Top Size Below; Must Order Bases/Legs Separately
- When Using with Strut Legs, We Recommend Using Two (2) Stiffener Bars on Tops 96"W; Must Order Separately, [See Strut Details](#)
- Tops 120"W Do Not Need Stretcher Rails When Used with Strut Legs, the Location and Number of Strut Legs Required Offer Sufficient Support
- Optional Grommets and Power/Data Units; [See Location Options](#), [See Power Units Available](#)

| | | | | | | | |
|--------------------------------|------------|----|----|------|----|-----|---------|
| RECTANGULAR BOX BASE WITH DOOR | 01-1220RBD | 20 | 12 | 28½" | 50 | 5.4 | T\$ 617 |
|--------------------------------|------------|----|----|------|----|-----|---------|

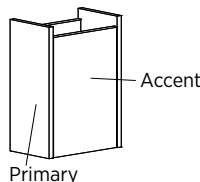

Must Specify (in this order):
 Model # and Quantity
 Primary Color
 Accent Color

Description

- Rectangular Base with Lift-Off Removable Panel
- Available in Single or Contrasting Colors; Must Indicate Accent Selection and Primary Selection on Order ([See Color Options](#))
- 2" Wire Management Access Across Both Sides
- Fully Open for Wire Management at the Bottom

| Table Widths | 72" | 96" | 120" |
|---------------------------------|-----|-----|------|
| Number of Bases Required | 2 | 2 | 3 |

Pricing Codes:
 T= TFL
 P= HPL

[See Canvas Intro Section for Ordering Options](#)

| Item | Model No. | | Width | Depth | Height | Ship Wt | Cubic Ft | List Price |
|--|-----------|--------|-------|-------|--------|---------|----------|------------|
| ROUND GROMMET COVER FIELD INSTALLED | 01-GRMTBK | Black | - | - | - | - | - | \$ 11 |
| | 01-GRMTSL | Silver | | | | | | |



OPEN MARKET ONLY
(SILVER)

Description

- 60mm Round Grommet Cover
- Field Installed

| | | | | | | | | |
|---------------------|-------------|--------|---|---|---|---|----|-------|
| RECTANGULAR GROMMET | 01-HUGRMTSL | Silver | - | - | - | 1 | .1 | \$ 11 |
|---------------------|-------------|--------|---|---|---|---|----|-------|

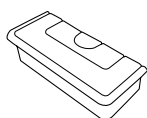

OPEN MARKET ONLY

Description

- For Use with Surface Mount Hatches Only
- 70mm x 30mm Silver Rectangular Grommet with Cover
- Field Installed

| | | | | | | | | |
|--------------------------|-------------|--------|---|---|---|---|-----|-------|
| SINGLE POWER SAND DOLLAR | 01-SAND60PW | White | 3 | 3 | 4 | 1 | 0.2 | \$ 98 |
| | 01-SAND60PB | Black | | | | | | |
| | 01-SAND60PS | Silver | | | | | | |

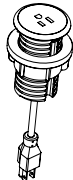

Description

- Unit is 2" Diameter; Mounts in 60mm Round Grommet
- 6' Cord
- Single Power Outlet



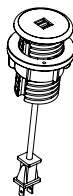

| | | | | | | | | |
|------------------------|-------------|--------|---|---|---|---|-----|--------|
| DOUBLE USB SAND DOLLAR | 01-SAND60UW | White | 3 | 3 | 4 | 1 | 0.2 | \$ 277 |
| | 01-SAND60UB | Black | | | | | | |
| | 01-SAND60US | Silver | | | | | | |



Description

- Unit is 2" Diameter; Mounts in 60mm Round Grommet
- 6' Cord
- Dual USB Outlets

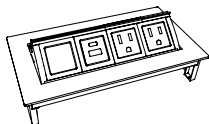
[See Canvas Intro Section for Ordering Options](#)

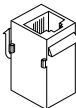
| Item | Model No. | | Width | Depth | Height | Ship Wt | Cubic Ft | List Price | |
|--------------------------------------|-------------|---|--------------------|--------------------|-----------------|---------|----------|------------|--|
| DOCK 950 WIRELESS CHARGER | 01-DOCK950W | White | 3 $\frac{3}{16}$ " | 3 $\frac{3}{16}$ " | - | 1 | 0.2 | \$ 265 | |
| | 01-DOCK950B | Black | | | | | | | |
| | |  | | | | | | | |
| | | OPEN MARKET ONLY | | | | | | | |
| | | Description | | | | | | | |
| | | <ul style="list-style-type: none"> • For Use with Wireless Charging Enabled Devices • 5 Watts Maximum Output with a Direct Current of 5V 2A and 10 Watts Maximum with Quick Charge 2.0 • Mounts in 76mm Round Cut-Out • LED will Confirm Pairing with Device and Begin Wireless Charging | | | | | | | |
| DOCK 150 WIRELESS AND USB CHARGER | 01-DOCK150W | White | 3 | 3 | $\frac{3}{4}$ " | 1 | 0.2 | \$ 405 | |
| | 01-DOCK150B | Black | | | | | | | |
| | |  | | | | | | | |
| | | OPEN MARKET ONLY | | | | | | | |
| | | Description | | | | | | | |
| | | <ul style="list-style-type: none"> • For Use with Wireless Charging Enabled Devices and USB Charging Devices • 5 Watt Maximum Output with a Direct Current Input of 5V 6A (Wireless Fast Charge) • Mounts in 76mm Round Cut-Out • Pop-Up is $\frac{3}{4}$"H and Includes Three (3) USB Ports; One (1) 12 Watt Maximum with 2.4A (USB Fast Charge) and Two (2) 5 Watt with 1A (USB Standard Charge) • LED Light will Confirm Pairing with Device and Begin Wireless Charging • UL and cUL Certified | | | | | | | |
| POWER DATA PORT | 01-DPORT4A | Aluminum | 8 | 4 | - | 7 | 0.2 | \$ 1093 | |
| | 01-DPORT4B | Black | 8 | 4 | - | 7 | 0.2 | \$ 1093 | |
| | |  | | | | | | | |
| | | Description | | | | | | | |
| | | <ul style="list-style-type: none"> • Retracts into Worksurface to Regain Productive Space • One-Touch Access to Power and Data • Two Power Outlets and Two Open Ports for Data • Water-Proof Simplex (Outlets) • Includes a Voice/Data Adapter Kit to Accept Couplers and Jacks When Required 6' Power Cord • Only Available on 66-4872TP, 66-4866TP, 66-4860TP, 66-3672TP, 66-3072TP, 66-3066TP and 66-3060TP Modular Desktops (See Modular Tops) Centered, One End | | | | | | | |
| USB PORT | 01-USBPORT | | - | - | - | - | - | \$ 161 | |
| | |  | | | | | | | |
| | | Description | | | | | | | |
| | | <ul style="list-style-type: none"> • For Use with 01-DPORT4A and 01-DPORT4B • Passive USB-A Port with Increased Transfer Speed Up to 5 gbs/sec • Simultaneous Read/Write Capability • Idle Device Power Saving State • 6' Cord • See Voice Coupler and Data Port on Next Page | | | | | | | |
| VOICE COUPLER | 01-VOICE1 | | - | - | - | - | - | \$ 73 | |
| | |  | | | | | | | |
| | | Description | | | | | | | |
| | | <ul style="list-style-type: none"> • For Use with 01-DPORT4A and 01-DPORT4B • 6-Pin Modular Plug • Molded Black • Cord Not included | | | | | | | |

[See Canvas Intro Section for Ordering Options](#)

| Item | Model No. | Width | Depth | Height | Ship Wt | Cubic Ft | List Price |
|-----------|------------|-------|-------|--------|---------|----------|------------|
| DATA PORT | 01-RJ4DATA | - | - | - | - | - | \$ 167 |



OPEN MARKET ONLY

Description

- For Use with 01-DPORT4A and 01-DPORT4B
- 8-Pin Modular Plug; Cat6 Ethernet Cable; Pre-terminated Cable
- 10' Cord

| | | | | | | | |
|-------------------------|-----------|---|---|---|---|-----|--------|
| VGA CONNECTOR ACCESSORY | 01-VGACON | - | - | - | 1 | 0.2 | \$ 149 |
|-------------------------|-----------|---|---|---|---|-----|--------|

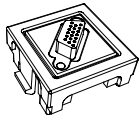

Description

- VGA Port for 01-DPORT4A and 01-DPORT4B
- Enables Devices to Remote Display on Monitors
- 10' Cord
- Male/Female Connector

| | | | | | | | |
|--------------------------|------------|---|---|---|---|-----|--------|
| HDMI CONNECTOR ACCESSORY | 01-HDMICON | - | - | - | 1 | 0.2 | \$ 124 |
|--------------------------|------------|---|---|---|---|-----|--------|

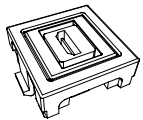

Description

- HDMI Port for 01-DPORT4A and 01-DPORT4B
- Connects to High Definition Displays
- Female/Female Connector
- 18" Cord

| | | | | | | | | |
|-----------------------|----------------|----------|---|----|----|---|-----|--------|
| INTERACT POWER & DATA | 01-INTERACTG2A | Aluminum | 9 | 5% | 2¾ | 5 | 0.2 | \$ 891 |
| | 01-INTERACTG2B | Black | | | | | | |



Description

- Includes: Two (2) Power Outlets, Two (2) USB-A Charging Ports, One (1) Telecom Plate Opening; Two (2) Keystone Openings for Voice/Data Jacks, 6' Power Cord on Bottom
- One (1) Telecom Plates Included with the Unit: One (1) 01-ABLAB Plate (Consists of One (1) RJ45 Cat 6, One (1) RJ11 Cat 3 Phone Jack)
- UL and CSA Recognized
- See Optional Telecom Plates in the Table and Space Division Price List
- For Use with Rectangle and Boat Table Tops

[See Canvas Intro Section for Ordering Options](#)

| Item | Model No. | | Width | Depth | Height | Ship Wt | Cubic Ft | List Price |
|-------------------------|------------|----------|-------|-------|--------|---------|----------|------------|
| OASIS MINI POWER & DATA | 01-OASISMA | Aluminum | 14¼ | 6⅝ | 2⅞ | 11 | 0.3 | \$ 3191 |
| | 01-OASISMB | Black | | | | | | |



Top View

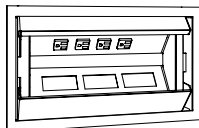

Description

- For Use with Conference Tables
- Plate Includes: Two (2) Data, One (1) Voice Telecom Plates, Four (4) Power Outlets, 9' Power Cord
- Opening for One (1) Additional Plate Sold Separately
- Soft Touch Hinged Lid
- 9' Cord with Nema Plug; Fits 15A/120V AC Receptacles
- UL Listed
- See Optional Telecom Plates in the Table and Space Division Price List

| | | | | | | | | |
|--------------------------|---------------|--------|----|---|---|---|-----|--------|
| DUO CLAMP WITH NEMA PLUG | 01-DUOCLAMPW | White | 6½ | 3 | 7 | 1 | 0.2 | \$ 572 |
| | 01-DUOCLAMPB | Black | | | | | | |
| | 01-DUOCLAMP S | Silver | | | | | | |

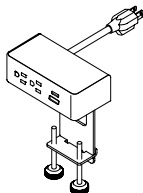

Description

- Standard with: Two (2) Power Outlet, **One (1) USB Charging Port and One (1) 60-Watt USB-C Power Delivery Port with GaN Technology with 10' Cord**
- Clamps to Top and Features Silver Metal Trim
- Independent USB Circuit Controllers Deliver up to 2.1 Amps to Each Post
- All Mounting Hardware Included
- FCC Part 15A and UL Approved for Horizontal and Vertical Applications

| | | | | | | | | |
|---------------------------|----------------|--------|---|---|---|---|-----|--------|
| TRIO CLAMP WITH NEMA PLUG | 01-TRIOCLAMPW | White | 9 | 3 | 7 | 1 | 0.2 | \$ 671 |
| | 01-TRIOCLAMPB | Black | | | | | | |
| | 01-TRIOCLAMP S | Silver | | | | | | |

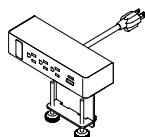

Description

- Standard with: Three (3) Power Outlets, **One (1) USB Charging Port, One (1) 60-Watt USB-C Power Delivery Port with GaN Technology, One (1) Open Data with 10' Cord**
- Clamps to Top and Features Silver Metal Trim
- Independent USB Circuit Controllers Deliver up to 2.1 Amps to Each Post
- HDMI, VGA, or RJ45 Sold Separately; [See Accessories](#)
- All Mounting Hardware Included
- FCC Part 15A and UL Approved for Horizontal and Vertical Applications

| | | | | | | | | |
|--------------------------|--------------|--------|----|----|---|---|-----|--------|
| DUO BEZEL WITH NEMA PLUG | 01-DUOBEZELW | White | 6½ | 2⅝ | 3 | 1 | 0.2 | \$ 675 |
| | 01-DUOBEZELB | Black | | | | | | |
| | 01-DUOBEZELS | Silver | | | | | | |



Description

- Sits On Top of the Worksurface and Includes: Two (2) Power, **One (1) USB Charging Port and One (1) 60-Watt USB-C Power Delivery Port with GaN Technology with 10' Cord**
- Independent USB Circuit Controllers Deliver up to 2.1 Amps to Each Post
- All Mounting Hardware Included
- FCC Part 15A and UL Approved for Horizontal and Vertical Applications

[See Canvas Intro Section for Ordering Options](#)

| Item | Model No. | | Width | Depth | Height | Ship Wt | Cubic Ft | List Price |
|------------------------------|---------------|--------|-------|-------|--------|---------|----------|------------|
| TRIO BEZEL WITH NEMA PLUG | 01-TRIOBEZELW | White | 9 | 2½ | 3 | 1 | 0.2 | \$ 725 |
| | 01-TRIOBEZELB | Black | | | | | | |
| | 01-TRIOBEZELS | Silver | | | | | | |



Description

- Sits On Top of the Worksurface and Includes: Three (3) Power, **One (1) USB Charging Port and One (1) 60-Watt USB-C Power Delivery Port with GaN Technology**, One (1) Open Data, and 10' Cord
- Independent USB Circuit Controllers Deliver up to 2.1 Amps to Each Post
- HDMI, VGA, or RJ45 Sold Separately; [See Accessories](#)
- All Mounting Hardware Included
- FCC Part 15A and UL Approved for Horizontal and Vertical Applications

DUO BEZEL WITH HARD WIRE CONNECTION



Circuit 1

| | | | | | | | |
|-----------------|--------|----|----|---|---|-----|--------|
| 01-HWDUOBEZELW1 | White | 6½ | 2½ | 3 | 1 | 0.2 | \$ 730 |
| 01-HWDUOBEZELB1 | Black | | | | | | |
| 01-HWDUOBEZELS1 | Silver | | | | | | |

Circuit 2

| | | | | | | | |
|-----------------|--------|----|----|---|---|-----|--------|
| 01-HWDUOBEZELW2 | White | 6½ | 2½ | 3 | 1 | 0.2 | \$ 730 |
| 01-HWDUOBEZELB2 | Black | | | | | | |
| 01-HWDUOBEZELS2 | Silver | | | | | | |

Circuit 3

| | | | | | | | |
|-----------------|--------|----|----|---|---|-----|--------|
| 01-HWDUOBEZELW3 | White | 6½ | 2½ | 3 | 1 | 0.2 | \$ 730 |
| 01-HWDUOBEZELB3 | Black | | | | | | |
| 01-HWDUOBEZELS3 | Silver | | | | | | |

Circuit 4

| | | | | | | | |
|-----------------|--------|----|----|---|---|-----|--------|
| 01-HWDUOBEZELW4 | White | 6½ | 2½ | 3 | 1 | 0.2 | \$ 730 |
| 01-HWDUOBEZELB4 | Black | | | | | | |
| 01-HWDUOBEZELS4 | Silver | | | | | | |

Description

- Must Specify Color and Circuit
- Sits on worksurface and Includes: Two (2) Power, **One (1) USB Charging Port and One (1) 60-Watt USB-C Power Delivery Port with GaN Technology**, and All Mounting Hardware
- Independent USB Circuit Controllers Deliver up to 2.1 Amps to Each Post
- FCC Part 15A and UL Approved for Horizontal and Vertical Applications
- Maximum 10 Duo Units per Circuit
- Eight (8) Wire/Four (4) Circuit Hard Wire Power Unit
- See Power Entry, Jumper Cable, and Quad Block on Next Page

[See Canvas Intro Section for Ordering Options](#)

| Item | Model No. | | Width | Depth | Height | Ship Wt | Cubic Ft | List Price | |
|--|------------------|--------|-------|-------|--------|---------|----------|------------|--|
| TRIO BEZEL WITH HARD WIRE CONNECTION  | Circuit 1 | | | | | | | | |
| | 01-HWTRIOBEZELW1 | White | 9 | 2½ | 3 | 1 | 0.2 | \$ 749 | |
| | 01-HWTRIOBEZELB1 | Black | | | | | | | |
| | 01-HWTRIOBEZELS1 | Silver | | | | | | | |
| | Circuit 2 | | | | | | | | |
| | 01-HWTRIOBEZELW2 | White | 9 | 2½ | 3 | 1 | 0.2 | \$ 749 | |
| | 01-HWTRIOBEZELB2 | Black | | | | | | | |
| | 01-HWTRIOBEZELS2 | Silver | | | | | | | |
| | Circuit 3 | | | | | | | | |
| | 01-HWTRIOBEZELW3 | White | 9 | 2½ | 3 | 1 | 0.2 | \$ 749 | |
| | 01-HWTRIOBEZELB3 | Black | | | | | | | |
| | 01-HWTRIOBEZELS3 | Silver | | | | | | | |
| | Circuit 4 | | | | | | | | |
| | 01-HWTRIOBEZELW4 | White | 9 | 2½ | 3 | 1 | 0.2 | \$ 749 | |
| | 01-HWTRIOBEZELB4 | Black | | | | | | | |
| | 01-HWTRIOBEZELS4 | Silver | | | | | | | |

Description

- Must Specify Color and Circuit
- Sits on Worksurface and Includes: Three (3) Power, **One (1) USB Charging Port and One (1) 60-Watt USB-C Power Delivery Port with GaN Technology**, and All Mounting Hardware
- Independent USB Circuit Controllers Deliver up to 2.1 Amps to Each Post
- FCC Part 15A and UL Approved for Horizontal and Vertical Applications
- Maximum 6 Trio Units per Circuit
- Eight (8) Wire/Four (4) Circuit Hard Wire Power Unit
- HDMI, VGA, or RJ45 Sold Separately; [See Accessories](#)
- See Power Entry, Jumper Cable, and Quad Block Below and on Next Page

| | | | | | | | | |
|------------------------------|----------------|--|---|---|---|---|-----|-------|
| QUAD BLOCK HARD WIRED | 01-HWQUADBLOCK | | - | - | - | 1 | 0.2 | \$ 62 |
|------------------------------|----------------|--|---|---|---|---|-----|-------|

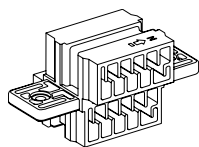

Description

- Eight (8) Wire/Four (4) Circuit Hard Wire Connector
- UL183 Compliant
- For Connecting Jumpers and Power Units
- Quantity of Four (4) Female Inputs

| | | | | | | | | |
|-------------------------------|-----------------|--|----|---|---|---|-----|--------|
| POWER ENTRY HARD WIRED | 01-HWPOWERENTRY | | 72 | - | - | 1 | 0.2 | \$ 322 |
|-------------------------------|-----------------|--|----|---|---|---|-----|--------|

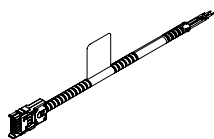

Description

- Eight (8) Wire/Four (4) Circuit Hard Wire Infeed
- UL183 Compliant

[See Canvas Intro Section for Ordering Options](#)

| Item | Model No. | Width | Depth | Height | Ship Wt | Cubic Ft | List Price |
|---|------------|-------|-------|--------|---------|----------|------------|
|  <p>JUMPER HARD WIRE CABLE</p> | 01-HW2JUMP | 24 | - | - | 1 | 0.2 | \$ 193 |
| | 01-HW3JUMP | 36 | - | - | 1 | 0.2 | \$ 206 |
| | 01-HW4JUMP | 48 | - | - | 1 | 0.2 | \$ 212 |
| | 01-HW5JUMP | 60 | - | - | 1 | 0.2 | \$ 255 |
| | 01-HW6JUMP | 72 | - | - | 1 | 0.2 | \$ 270 |

Description

- Eight (8) Wire/Four (4) Circuit Hard Wire Jumper
- UL183 Compliant

| Item | Model No. | Color | Width | Depth | Height | Ship Wt | Cubic Ft | List Price |
|--|---------------|--------|-------|-------|--------|---------|----------|------------|
|  <p>DUO BEZEL WITH DAISY CHAIN PLUG</p> | 01-PDUOBEZELW | White | 6½ | 2½ | 3 | 1 | 0.2 | \$ 668 |
| | 01-PDUOBEZELB | Black | | | | | | |
| | 01-PDUOBEZELS | Silver | | | | | | |

Description

- Sits On Top of the Worksurface and Includes: Two (2) Power, **One (1) USB Charging Port and One (1) 60-Watt USB-C Power Delivery Port with GaN Technology** with 12" Cord
- Independent USB Circuit Controllers Deliver up to 2.1 Amps to Each Post
- All Mounting Hardware Included
- FCC Part 15A, RU Listed and UL Recognized for Horizontal and Vertical Applications
- Non Sequential System Allows Up to Eight (8) Modules To Be Connected With Jumper Cord
- Requires Power Box, See Below; See Jumper Cable on Next Page

| Item | Model No. | Color | Width | Depth | Height | Ship Wt | Cubic Ft | List Price |
|---|----------------|--------|-------|-------|--------|---------|----------|------------|
|  <p>TRIO BEZEL WITH DAISY CHAIN PLUG</p> | 01-PTRIOBEZELW | White | 9 | 2½ | 3 | 1 | 0.2 | \$ 715 |
| | 01-PTRIOBEZELB | Black | | | | | | |
| | 01-PTRIOBEZELS | Silver | | | | | | |

Description

- Sits On Top of the Worksurface and Includes: Three (3) Power, **One (1) USB Charging Port, One (1) 60-Watt USB-C Power Delivery Port with GaN Technology**, and One (1) Open Data with 12" Cord
- HDMI, VGA, or RJ45 Sold Separately; [See Accessories](#)
- All Mounting Hardware Included
- FCC Part 15A, RU Listed and UL Recognized for Horizontal and Vertical Applications
- Non Sequential System Allows Up to Eight (8) Modules To Be Connected With Jumper Cord
- Requires Power Box, See Below; See Jumper Cable on Next Page

[See Canvas Intro Section for Ordering Options](#)

| Item | Model No. | Width | Depth | Height | Ship Wt | Cubic Ft | List Price |
|---|--|-------|-------|--------|---------|----------|------------|
|  DAISY CHAIN POWER BOX | 01-PPOWER 76" Perimeter, 36" Power Cord | - | - | - | 1 | 0.2 | \$ 775 |
| | 01-PPOWER2 24" Perimeter, 144" Power Cord | - | - | - | 1 | 0.2 | \$ 796 |

Description

- Powers up to Eight (8) Duo and Trio Daisy Chain Units
- One (1) Nema Plug and One (1) Daisy Chain Plug
- 12 Amp System Rating
- 15 Amp Over-Current Protection

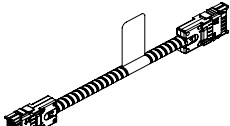
| | | | | | | | |
|---|----------------------|---|---|---|---|-----|--------|
|  DAISY CHAIN JUMPER CORD | 01-6JUMP 72" Long | - | - | - | 1 | 0.2 | \$ 299 |
| | 01-5JUMP 60" Long | - | - | - | 1 | 0.2 | \$ 284 |
| | 01-4JUMP 48" Long | - | - | - | 1 | 0.2 | \$ 240 |
| | 01-2JUMP 24" Long | - | - | - | 1 | 0.2 | \$ 220 |

Description

- Connects Duo and Trio Daisy Chain Units
- Non Sequential System Allows up to Eight (8) Modules to be Connected

| | | | | | | | |
|--|-------------|---|---|---|---|-----|--------|
|  HDMI DATA PORT ACCESSORY | 01-LCOMHDMI | - | - | - | 1 | 0.2 | \$ 166 |
|--|-------------|---|---|---|---|-----|--------|

Description

- HDMI Port for Trio Bezel and Trio Clamp Units

OPEN MARKET ONLY

| | | | | | | | |
|---|------------|---|---|---|---|-----|--------|
|  VGA DATA PORT ACCESSORY | 01-LCOMVGA | - | - | - | 1 | 0.2 | \$ 121 |
|---|------------|---|---|---|---|-----|--------|

Description

- VGA Port for Trio Bezel and Trio Clamp Units

| | | | | | | | |
|--|-------------|---|---|---|---|-----|-------|
|  RJ45 DATA PORT ACCESSORY | 01-LCOMRJ45 | - | - | - | 1 | 0.2 | \$ 79 |
|--|-------------|---|---|---|---|-----|-------|

Description

- RJ45 Port for Trio Bezel and Trio Clamp Units

[See Canvas Intro Section for Ordering Options](#)

| Item | Model No. | Width | Depth | Height | Ship Wt | Cubic Ft | List Price |
|-------------------------|-----------|-------|-------|--------|---------|----------|------------|
| WIRE MANAGEMENT CHANNEL | 01-WMGR4 | 16 | 1½ | ¾ | 1 | - | \$ 116 |

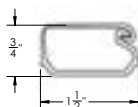

Description

- Set of Four (4) Black Plastic Wire Management Channels
- Snap Lock Channel
- Attaches with Adhesive Strips
- Ships via UPS Only

| | | | | | | | |
|--------------|----------|----|----|---|-----|-----|--------|
| WIRE CHANNEL | 01-32125 | 24 | 1½ | 1 | .25 | 0.3 | \$ 106 |
|--------------|----------|----|----|---|-----|-----|--------|

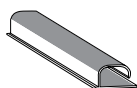

Description

- Available in Black
- Channels Attach with Two (2) Double-Sided Installation Tape
- Open J Channel for Easy Storage of Cables

| | | | | | | | |
|------------|-----------|-----|-----|---|---|---|-------|
| CABLE GRIP | 01-WMGRCB | 5 ¾ | 2 ¾ | - | - | - | \$ 17 |
|------------|-----------|-----|-----|---|---|---|-------|

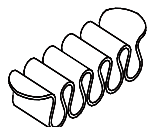

Description

- Under Surface Wire Management
- Black

| | | | | | | | | |
|------------------------|----------------|--------|-----|-----|-------|---|-----|--------|
| LINK 360 CABLE MANAGER | 01-0251LINKSLV | Silver | 5 ¾ | 3 ¾ | 30-51 | 4 | 3.0 | \$ 390 |
| | 01-0251LINKBLK | Black | 5 ¾ | 3 ¾ | 30-51 | 4 | 3.0 | \$ 353 |

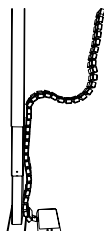

Description

- Kit Includes: 50 Link 360™ elements, One (1) Quad Connector, One (1) Dumbbell Connector, One (1) Foot Assembly with Two (2) Magnetic Clips
- Can Be Used For Height-Adjustable Mechanisms Up To 51" or Free-Standing Use

[See Canvas Intro Section for Ordering Options](#)

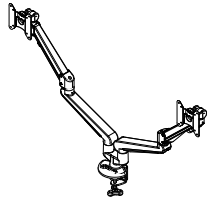
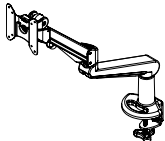
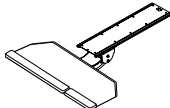
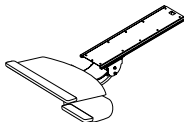
| Item | Model No. | | Width | Depth | Height | Ship Wt | Cubic Ft | List Price |
|---|--|-------------------|-------|-------|--------|---------|----------|------------|
| DUAL ARTICULATING MONITOR ARM | 01-MLEDGE2A | Aluminum | - | - | 6½-19½ | 15 | 1.4 | \$ 1313 |
| | 01-MLEDGE2B | Black | | | | | | |
|  | Description <ul style="list-style-type: none"> • Dual Mount with Independent Adjustment Includes Desk Clamp, Grommet Mount, and Enclosed Cable Management • 180° Lockout Feature • 21" Monitor Extension; 3.5" Monitor Retraction • +30/-25° Monitor Tilt; 360° Swivel at Two Points with 17.6lb Weight Capacity per Arm • VESA 75mm and VESA 100mm Compatible with Quick Monitor Release | | | | | | | |
| | | | | | | | | |
| SINGLE MONITOR ARM | 01-MLEDGE1A | Aluminum | - | - | 6½-19½ | 13 | 2.2 | \$ 773 |
| | 01-MLEDGE1B | Black | | | | | | |
|  | Description <ul style="list-style-type: none"> • Includes Desk Clamp, Grommet Mount, and Enclosed Cable Management • 180° Lockout Feature • 21" Monitor Extension; 3.5" Monitor Retraction • +30/-25° Monitor Tilt; 17.6lb Weight Capacity • VESA 75mm and VESA 100mm Compatible with Quick Monitor Release | | | | | | | |
| | | | | | | | | |
| ARTICULATING KEYBOARD CORNER PLATFORM | 01-KB2CC | | 25 | 10½ | 4½ | 16 | 1.4 | \$ 832 |
|  | Description <ul style="list-style-type: none"> • Standard With: +/- 15° Tilt Adjustment , 360° Rotation, Independent Tilt Adjustment, 7" Lift and Lock Height Adjustment, 25" Cut Corner Platform • Keyboard and Mouse on same level; Single Palm Rest for both Left & Right Hands • Works with 17"+ Diagonal Work Surface • Cannot Be Used on 20" or 21" Deep Unit • Not Available with Optional Center Grommet • Track Measures 21" | | | | | | | |
| | Options: Specify & Add | | | | | | | |
| | KB2CC | Factory Installed | | | | | | \$ 208 |
| KEYBOARD MECHANISM WITH KEYBOARD CLAMP | 01-KB3 | | 26½ | 14 | 4.5 | 16 | 1.4 | \$ 914 |
|  | Description <ul style="list-style-type: none"> • Standard With: 18.75" Platform with Swivel-Below Mouse Platform,+/- 15° Tilt Adjustment, 360° Rotation, 7" Lift and Lock Height Adjustment, Independent Tilt Adjustment, Palm Rest for Mousing Surface • Left or Right Handed Mouse Platform • Cannot Be Used on 20" or 21" Deep Unit • Not Available with Optional Center Grommet • Track Measures 21" | | | | | | | |
| | Options: Specify & Add | | | | | | | |
| | KB3 | Factory Installed | | | | | | \$ 208 |

[See Canvas Intro Section for Ordering Options](#)

| Item | Model No. | Width | Depth | Height | Ship Wt | Cubic Ft | List Price |
|---------------|-----------|-------|-------|--------|---------|----------|------------|
| CENTER DRAWER | 66-1622CD | 22 | 16 | 2 | 7 | 1.4 | T\$ 401 |

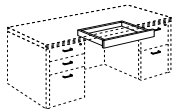
**Description**

- Fits Desks, P-Top Units, and D-Top Units
- Will Not Work in Conjunction with Height Adjustable Mechanisms or Modesty Panels on 30" D-Top Units

Must Specify (in this order):

Model #
Color
Drawer Front Grain
Factory Installed

Options: Specify & Add

| | | |
|------|-------------------|--------|
| CD16 | Factory Installed | \$ 208 |
|------|-------------------|--------|

| Item | Model No. | Width | Depth | Height | Ship Wt | Cubic Ft | List Price |
|---------------|--------------------------|-------|-------|--------|---------|----------|------------|
| LED TASKLIGHT | TL-0848 | 47½ | 7⅞ | 1⅝ | - | - | \$ 445 |
| | <i>240-LED, 18 Watts</i> | | | | | | |
| LED TASKLIGHT | TL-0824 | 22½ | 7⅞ | 1⅝ | - | - | \$ 368 |
| | <i>84-LED, 7 Watts</i> | | | | | | |

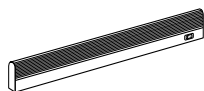
**Description**

- Includes the Power Supply and Three Upper Wire Management Grommets
- Rocker Style On/Off Switch with a 10' Power Cord
- Grommet Color will Match Lower Grommet Color

| Item | Model No. | Width | Depth | Height | Ship Wt | Cubic Ft | List Price |
|---------------------------|---------------------------|-------|-------|--------|---------|----------|------------|
| LED TASKLIGHT | 01-188LED58 | 57¾ | 2 | ¾ | - | - | \$ 1648 |
| | <i>96-LED, 33.7 Watts</i> | | | | | | |
| | 01-94LED31 | 30¾ | 2 | ¾ | - | - | \$ 1195 |
| <i>48-LED, 17.6 Watts</i> | | | | | | | |
| LED TASKLIGHT | 01-47LED17 | 16¾ | 2 | ¾ | - | - | \$ 690 |
| | <i>24-LED, 9.1 Watts</i> | | | | | | |

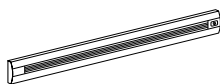
**Description**

- Includes the Power Supply and Three Upper Wire Management Grommets
- 12' Power Cord
- Grommet Color will Match Lower Grommet Color
- Optional Occupancy Sensor Shuts Off After 30 Minutes of Inactivity and Turns On Immediately When Reentering the Detection Area

Options: Specify & Add

| | | |
|---------|------------------|--------|
| 01-OSRP | Occupancy Sensor | \$ 366 |
|---------|------------------|--------|

[See Canvas Intro Section for Ordering Options](#)

| Item | Model No. | | Width | Depth | Height | Ship Wt | Cubic Ft | List Price | |
|--|-----------|----------------------|----------------------|-------|--------|---------|----------|------------|----------|
|  <p>Must Specify (in this order): Model # Color</p> | L SHELF | 66-1596LS | 192 lbs Weight Limit | 96 | 15 | 17 | 85 | 18.3 | T\$ 1147 |
| | 66-1590LS | 192 lbs Weight Limit | 90 | 15 | 17 | 80 | 17.2 | T\$ 1090 | |
| | 66-1584LS | 154 lbs Weight Limit | 84 | 15 | 17 | 75 | 16.0 | T\$ 1034 | |
| | 66-1578LS | 154 lbs Weight Limit | 78 | 15 | 17 | 70 | 14.9 | T\$ 979 | |
| | 66-1572LS | 154 lbs Weight Limit | 72 | 15 | 17 | 65 | 13.8 | T\$ 922 | |
| | 66-1566LS | 128lbs Weight Limit | 66 | 15 | 17 | 60 | 12.7 | T\$ 869 | |
| | 66-1560LS | 128 lbs Weight Limit | 60 | 15 | 17 | 55 | 11.6 | T\$ 815 | |
| | 66-1554LS | 90 lbs Weight Limit | 54 | 15 | 17 | 50 | 10.5 | T\$ 761 | |
| | 66-1548LS | 90 lbs Weight Limit | 48 | 15 | 17 | 45 | 9.3 | T\$ 709 | |
| | 66-1542LS | 90 lbs Weight Limit | 42 | 15 | 17 | 40 | 8.2 | T\$ 656 | |
| | 66-1536LS | 64 lbs Weight Limit | 36 | 15 | 17 | 35 | 7.1 | T\$ 601 | |
| | 66-1530LS | 64 lbs Weight Limit | 30 | 15 | 17 | 30 | 6.0 | T\$ 546 | |

Description

- Weight Capacity is a Distributed Load
- Not Liable for Wall Mount Units that are not Properly Installed

| Item | Model No. | | Width | Depth | Height | Ship Wt | Cubic Ft | List Price | |
|--|----------------|----------------------|----------------------|-------|--------|---------|----------|------------|---------|
|  <p>Must Specify (in this order): Model # Color</p> | FLOATING SHELF | 66-0996FS | 123 lbs Weight Limit | 96 | 9 | 1 | 20 | 2.2 | T\$ 785 |
| | 66-0990FS | 123 lbs Weight Limit | 90 | 9 | 1 | 19 | 2.1 | T\$ 753 | |
| | 66-0984FS | 99 lbs Weight Limit | 84 | 9 | 1 | 18 | 1.9 | T\$ 719 | |
| | 66-0978FS | 99 lbs Weight Limit | 78 | 9 | 1 | 16 | 1.8 | T\$ 687 | |
| | 66-0972FS | 99 lbs Weight Limit | 72 | 9 | 1 | 16 | 1.6 | T\$ 655 | |
| | 66-0966FS | 82 lbs Weight Limit | 66 | 9 | 1 | 14 | 1.5 | T\$ 614 | |
| | 66-0960FS | 82 lbs Weight Limit | 60 | 9 | 1 | 13 | 1.4 | T\$ 572 | |
| | 66-0954FS | 57 lbs Weight Limit | 54 | 9 | 1 | 12 | 1.3 | T\$ 534 | |
| | 66-0948FS | 57 lbs Weight Limit | 48 | 9 | 1 | 10 | 1.1 | T\$ 494 | |
| | 66-0942FS | 57 lbs Weight Limit | 42 | 9 | 1 | 9 | 0.9 | T\$ 454 | |
| | 66-0936FS | 40 lbs Weight Limit | 36 | 9 | 1 | 8 | 0.8 | T\$ 411 | |
| | 66-0930FS | 40 lbs Weight Limit | 30 | 9 | 1 | 6 | 0.7 | T\$ 372 | |

Description

- Weight Capacity is a Distributed Load
- Not Liable for Wall Mount Units that are not Properly Installed

[See Canvas Intro Section for Ordering Options](#)

| Item | Model No. | Width | Depth | Height | Ship Wt | Cubic Ft | List Price |
|--------------|-----------|-------|-------|--------|---------|----------|------------|
| VISUAL BOARD | 66-4848VB | 48 | 5 | 48 | 150 | 11.0 | T\$ 2770 |

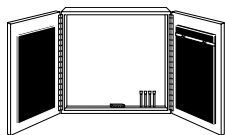

Description

- Standard with: Flipchart, Set of Four Dry Erase Markers, Eraser, Mounting Hardware, Tackboard on Each Door in Black Fabric, Display Rail with Adjustable Hooks for Flipchart
- Price Valid for Fabric Grades 1, 2, and 3
- Does Not Feature Soft Close Hinges
- Magnetic Porcelain Non-Glare Writing Surface

Must Specify (in this order):

- Model #
- Color
- Door Grain Direction
- Tackboard Fabric Vendor, Pattern, and Color
- Pull
- Projection Screen Installation

Options: Specify & Add

| | GRADE | 4 | 5 | 6 | 7 | 8 | 9 | 10 |
|---|-------|--------|-----|-----|-----|-----|------|---------|
| TB-4214 Tackboard | | \$ 278 | 408 | 540 | 728 | 924 | 1152 | 1416 |
| 1-PS Optional Factory Installed Projection Screen | | | | | | | | \$ 1062 |

CUSHIONS

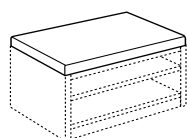

Must Specify (in this order):

- Model #
- Fabric Vendor, Pattern, and Color

| Model # | Size | COM Ydg | COM, 1, 2 or 3 | Grades | | | | | | | | | |
|-----------------|------|---------|----------------|--------|------|------|------|------|------|------|------|------|--|
| | | | | 4 | 5 | 6 | 7 | 8 | 9 | 10 | L1 | L2 | |
| 66-24108CUSHION | 108" | 3.25 | \$ 790 | 1242 | 1453 | 1668 | 1973 | 2292 | 2662 | 3091 | 1863 | 2321 | |
| 66-2490CUSHION | 90" | 2.75 | \$ 715 | 1097 | 1276 | 1458 | 1716 | 1986 | 2299 | 2662 | 1623 | 2010 | |
| 66-2472CUSHION | 72" | 2.25 | \$ 604 | 917 | 1063 | 1212 | 1423 | 1644 | 1900 | 2197 | 1347 | 1664 | |
| 66-2460CUSHION | 60" | 2.00 | \$ 523 | 801 | 931 | 1063 | 1251 | 1447 | 1675 | 1939 | 1183 | 1465 | |
| 66-2436CUSHION | 36" | 1.25 | \$ 445 | 619 | 700 | 783 | 900 | 1023 | 1165 | 1330 | 858 | 1034 | |
| 66-2430CUSHION | 30" | 1.25 | \$ 385 | 559 | 640 | 723 | 840 | 963 | 1105 | 1270 | 798 | 974 | |
| 66-20108CUSHION | 108" | 3.25 | \$ 746 | 1198 | 1409 | 1624 | 1929 | 2248 | 2618 | 3047 | 1819 | 2277 | |
| 66-2090CUSHION | 90" | 2.75 | \$ 675 | 1057 | 1236 | 1418 | 1676 | 1946 | 2259 | 2622 | 1583 | 1970 | |
| 66-2072CUSHION | 72" | 2.25 | \$ 569 | 882 | 1028 | 1177 | 1388 | 1609 | 1865 | 2162 | 1312 | 1629 | |
| 66-2060CUSHION | 60" | 2.00 | \$ 495 | 773 | 903 | 1035 | 1223 | 1419 | 1647 | 1911 | 1155 | 1437 | |
| 66-2036CUSHION | 36" | 1.25 | \$ 416 | 590 | 671 | 754 | 871 | 994 | 1136 | 1301 | 829 | 1005 | |
| 66-2030CUSHION | 30" | 1.25 | \$ 361 | 535 | 616 | 699 | 816 | 939 | 1081 | 1246 | 774 | 950 | |
| 66-1519CUSHION | 15" | 0.75 | \$ 331 | 435 | 484 | 534 | 604 | 678 | 763 | 862 | 579 | 684 | |

Description

- For Use with Mobile Pedestals; [See Mobile Peds](#)
- Increases Height of Mobile Pedestal 2¼"

[See Canvas Intro Section for Ordering Options](#)

| Item | Model No. | Width | Depth | Height | Ship Wt | Cubic Ft | List Price |
|--|------------|-------|-------|--------|---------|----------|------------|
| MAGNETIC GLASS MARKER BOARD | GMB-23108H | 106½ | ½ | 23 | 83 | 14.3 | \$ 3834 |
| FOR USE WITH 30"H DESKS AND CREENZA AND SURFACE MOUNT HUTCHES WITHOUT PAPERSLOTS | GMB-23102H | 100½ | ½ | 23 | 78 | 13.6 | \$ 3558 |
| | GMB-2396H | 94½ | ½ | 23 | 74 | 12.9 | \$ 3351 |
| | GMB-2390H | 88½ | ½ | 23 | 69 | 12.2 | \$ 3145 |
| | GMB-2384H | 82½ | ½ | 23 | 64 | 11.4 | \$ 3009 |
| | GMB-2378H | 76½ | ½ | 23 | 59 | 10.7 | \$ 2802 |
| | GMB-2372H | 70½ | ½ | 23 | 55 | 10.0 | \$ 2526 |
| | GMB-2366H | 64½ | ½ | 23 | 50 | 9.2 | \$ 2318 |
| | GMB-2360H | 58½ | ½ | 23 | 45 | 8.5 | \$ 2182 |
| | GMB-2354H | 52½ | ½ | 23 | 41 | 7.8 | \$ 1908 |
| | GMB-2348H | 46½ | ½ | 23 | 36 | 7.0 | \$ 1770 |
| | GMB-2342H | 40½ | ½ | 23 | 31 | 6.3 | \$ 1494 |
| | GMB-2336H | 34½ | ½ | 23 | 27 | 5.6 | \$ 1287 |
| GMB-2330H | 28½ | ½ | 23 | 22 | 4.9 | \$ 1151 | |

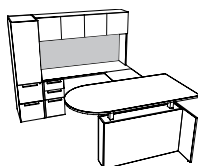
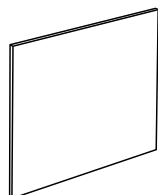

Must Specify (in this order):

Model #
Color



Rare Earth Magnets, Marker and Eraser set available; [See Set Options](#)

Description

- Available in Black (BLMKR) or White (WHMKR), Must Specify
- Tempered Glass Magnetic Marker Boards Are One (1) Piece with No Seams
- Mounting Brackets Included
- For Use with 30"H Desks and Credenzas with Surface Mount Hutches Without Paperslots
- For Rare Earth Magnets, Marker and Eraser Sets; [See Set Options](#)

| Item | Model No. | Width | Depth | Height | Ship Wt | Cubic Ft | List Price |
|---|------------|-------|-------|--------|---------|----------|------------|
| MAGNETIC GLASS MARKER BOARD | GMB-23108W | 108 | ½ | 23 | 85 | 14.6 | \$ 3834 |
| FOR USE WITH 30"H DESKS AND CREENZA AND WALL MOUNT HUTCHES WITHOUT PAPERSLOTS | GMB-23102W | 102 | ½ | 23 | 80 | 13.9 | \$ 3696 |
| | GMB-2396W | 96 | ½ | 23 | 75 | 13.1 | \$ 3489 |
| | GMB-2390W | 90 | ½ | 23 | 70 | 12.4 | \$ 3215 |
| | GMB-2384W | 84 | ½ | 23 | 66 | 11.7 | \$ 3009 |
| | GMB-2378W | 78 | ½ | 23 | 61 | 10.9 | \$ 2802 |
| | GMB-2372W | 72 | ½ | 23 | 56 | 10.2 | \$ 2595 |
| | GMB-2366W | 66 | ½ | 23 | 52 | 9.5 | \$ 2458 |
| | GMB-2360W | 60 | ½ | 23 | 47 | 8.8 | \$ 2182 |
| | GMB-2354W | 54 | ½ | 23 | 42 | 8.0 | \$ 1976 |
| | GMB-2348W | 48 | ½ | 23 | 38 | 7.3 | \$ 1838 |
| | GMB-2342W | 42 | ½ | 23 | 33 | 6.6 | \$ 1563 |
| | GMB-2336W | 36 | ½ | 23 | 28 | 5.8 | \$ 1357 |
| GMB-2330W | 30 | ½ | 23 | 23 | 5.1 | \$ 1151 | |

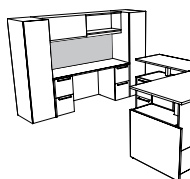
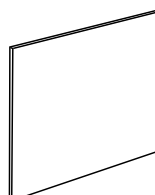

Must Specify (in this order):

Model #
Color



Rare Earth Magnets, Marker and Eraser set available; [See Set Options](#)

Description

- Available in Black (BLMKR) or White (WHMKR), Must Specify
- Tempered Glass Magnetic Marker Boards Are One (1) Piece with No Seams
- Mounting Brackets Included
- For Use over 30"H Desks and Credenzas with Wall Mount Hutches Without Paperslots
- For Rare Earth Magnets, Marker and Eraser Sets; [See Set Options](#)

[See Canvas Intro Section for Ordering Options](#)

| Item | Model No. | Width | Depth | Height | Ship Wt | Cubic Ft | List Price |
|--|------------|-------|-------|--------|---------|----------|------------|
| MAGNETIC GLASS MARKER BOARD | GMB-31108W | 108 | ½ | 31 | 114 | 17.9 | \$ 5073 |
| FOR USE WITH 21" LOW CREDENZA AND WALL MOUNT HUTCHES | GMB-31102W | 102 | ½ | 31 | 108 | 17.0 | \$ 4889 |
| | GMB-3196W | 96 | ½ | 31 | 101 | 16.1 | \$ 4613 |
| | GMB-3190W | 90 | ½ | 31 | 95 | 15.2 | \$ 4246 |
| | GMB-3184W | 84 | ½ | 31 | 89 | 14.3 | \$ 3972 |
| | GMB-3178W | 78 | ½ | 31 | 82 | 13.4 | \$ 3696 |
| | GMB-3172W | 72 | ½ | 31 | 76 | 12.5 | \$ 3421 |
| | GMB-3166W | 66 | ½ | 31 | 70 | 11.6 | \$ 3235 |
| | GMB-3160W | 60 | ½ | 31 | 63 | 10.8 | \$ 2870 |
| | GMB-3154W | 54 | ½ | 31 | 57 | 9.9 | \$ 2595 |
| | GMB-3148W | 48 | ½ | 31 | 51 | 9.0 | \$ 2414 |
| | GMB-3142W | 42 | ½ | 31 | 44 | 8.1 | \$ 2045 |
| | GMB-3136W | 36 | ½ | 31 | 38 | 7.2 | \$ 1770 |
| | GMB-3130W | 30 | ½ | 31 | 32 | 6.3 | \$ 1494 |

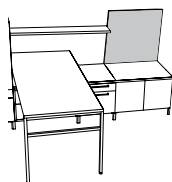
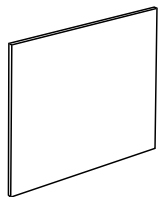

Must Specify (in this order):

Model #
Color



Rare Earth Magnets, Marker and Eraser set available; [See Set Options](#)

Description

- Available in Black (BLMKR) or White (WHMKR), Must Specify
- Tempered Glass Magnetic Marker Boards Are One (1) Piece with No Seams
- Mounting Brackets Included
- For Use over 21"H Desks and Credenzas with Wall Mount Hutches
- For Rare Earth Magnets, Marker and Eraser Sets; [See Set Options](#)

| | | | | | | | |
|---|-----------|----|---|-----|----|------|---------|
| MAGNETIC GLASS MARKER BOARD | GMB-4048W | 48 | ½ | 40% | 67 | 11.0 | \$ 3128 |
| FOR USE WITH 30"H DESKS AND CREDENZA AND WALL MOUNT HUTCHES OR SHELVING | GMB-4042W | 42 | ½ | 40% | 58 | 9.9 | \$ 2644 |
| | GMB-4036W | 36 | ½ | 40% | 50 | 8.8 | \$ 2285 |
| | GMB-4030W | 30 | ½ | 40% | 42 | 7.7 | \$ 1924 |

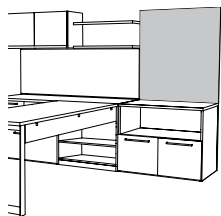

Must Specify (in this order):

Model #
Color



Rare Earth Magnets, Marker and Eraser set available; [See Set Options](#)

Description

- Available in Black (BLMKR) or White (WHMKR), Must Specify
- Tempered Glass Magnetic Marker Boards Include Mounting Brackets
- For Use over 30"H Desks and Credenzas with Wall Mount Hutches or Shelving
- For Rare Earth Magnets, Marker and Eraser Sets; [See Set Options](#)

[See Canvas Intro Section for Ordering Options](#)

| Item | Model No. | Width | Depth | Height | Ship Wt | Cubic Ft | List Price |
|--|-----------|-------|-------|--------|---------|----------|------------|
| MAGNETIC GLASS MARKER BOARD | GMB-5248W | 48 | ½ | 52⅞ | 86 | 13.5 | \$ 3988 |
| FOR USE WITH 30"H DESKS AND CREDENZA AND TALL WALL MOUNT HUTCHES OR SHELVING | GMB-5242W | 42 | ½ | 52⅞ | 76 | 12.2 | \$ 3369 |
| | GMB-5236W | 36 | ½ | 52⅞ | 65 | 10.8 | \$ 2904 |
| | GMB-5230W | 30 | ½ | 52⅞ | 54 | 9.5 | \$ 2441 |

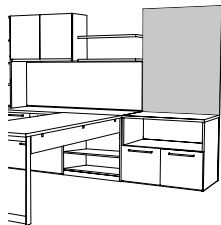

Must Specify (in this order):

Model #
Color

Description

- Available in Black (BLMKR) or White (WHMKR), Must Specify
- Tempered Glass Magnetic Marker Boards Include Mounting Brackets
- For Use Next to Tall Surface or Wall Mount Hutches
- For Rare Earth Magnets, Marker and Eraser Sets; [See Set Options](#)



Rare Earth Magnets, Marker and Eraser set available; [See Set Options](#)

| | | | | | | | |
|-----------------------------------|-----------|----|---|-----|-----|------|---------|
| MAGNETIC GLASS MARKER BOARD | GMB-8236W | 36 | ½ | 82⅞ | 102 | 15.8 | \$ 4453 |
| FOR USE FROM FLOOR TO TOP OF UNIT | GMB-7036W | 36 | ½ | 70⅞ | 87 | 13.8 | \$ 3834 |
| | GMB-5136W | 36 | ½ | 51⅞ | 63 | 10.6 | \$ 2802 |
| | GMB-8230W | 30 | ½ | 82⅞ | 85 | 13.8 | \$ 3730 |
| | GMB-7030W | 30 | ½ | 70⅞ | 72 | 12.1 | \$ 3215 |
| | GMB-5130W | 30 | ½ | 51⅞ | 53 | 9.3 | \$ 2354 |

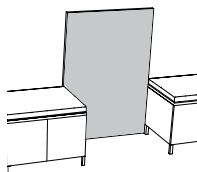

Must Specify (in this order):

Model #
Color



Rare Earth Magnets, Marker and Eraser set available; [See Set Options](#)

Description

- Available in Black (BLMKR) or White (WHMKR), Must Specify
- Tempered Glass Magnetic Marker Boards Are One (1) Piece with No Seams
- Mounting Brackets Included
- For Use From Floor to Top of Unit
- For Rare Earth Magnets, Marker and Eraser Sets; [See Set Options](#)

| | | | |
|-----------------------|--------------|--|--------|
| MARKER AND ERASER SET | 01-MRKRSETBL | For Use with Black Marker Boards and Black Glass Doors | \$ 123 |
| | 01-MRKRSETWH | For Use with White Marker Boards and White Glass Doors | |

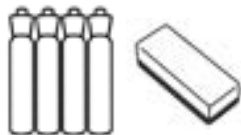

Description

- 01-MRKRSETWH May Also be Used with Dry Erase Doors and Boards
- Includes 4 Markers and an Eraser

| | | | |
|-----------------------|----------|-------|--------|
| RARE EARTH MAGNET SET | 01-MAGBL | Black | \$ 114 |
| | 01-MAGWH | White | |



Description

- Includes Set of Five (5) Rare Earth Magnets
- To be Used with Tempered Glass Magnetic Marker Boards
- Comfort Grip with Stylish Protective Plastic Coating

[See Canvas Intro Section for Ordering Options](#)

**TALL TOOL RAIL WORK WALL
FOR SURFACE MOUNT HUTCHES**

**USE OVER 30"H CREDENZA
23" TALL**

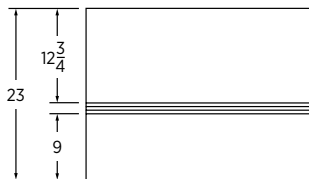

Must Specify (in this order):

- Model #
- Tackboard on Top or Bottom
- Dry Erase on Top or Bottom
- Tackboard Fabric Vendor, Pattern, and Color

Tackboard/Dry Erase Locations

- TB-TB: Tackboard Over Tackboard (Use Grade Prices)
- DEB-TB: Dry Erase Over Tackboard (Use Grade Prices)
- DEB-DEB: Dry Erase Over Dry Erase (Use Grade 1 Prices)

| Model # | Size | COM ydg | COM, 1, 2 or 3 | Grades | | | | | | |
|-------------|------|---------|-------------------|--------|------|------|------|------|------|------|
| | | | | 4 | 5 | 6 | 7 | 8 | 9 | 10 |
| WW-23108TRH | 108" | 3.50 | \$ 1715 | 2202 | 2429 | 2660 | 2989 | 3332 | 3731 | 4193 |
| WW-23102TRH | 102" | 3.25 | \$ 1635 | 2087 | 2298 | 2513 | 2818 | 3137 | 3507 | 3936 |
| WW-2396TRH | 96" | 3.00 | \$ 1565 | 1982 | 2177 | 2375 | 2657 | 2951 | 3293 | 3689 |
| WW-2390TRH | 90" | 2.75 | \$ 1471 | 1853 | 2032 | 2214 | 2472 | 2742 | 3055 | 3418 |
| WW-2384TRH | 84" | 2.50 | \$ 1334 | 1682 | 1844 | 2009 | 2244 | 2489 | 2774 | 3104 |
| WW-2378TRH | 78" | 2.50 | \$ 1285 | 1633 | 1795 | 1960 | 2195 | 2440 | 2725 | 3055 |
| WW-2372TRH | 72" | 2.25 | \$ 1023 | 1336 | 1482 | 1631 | 1842 | 2063 | 2319 | 2616 |
| WW-2366TRH | 66" | 2.00 | \$ 967 | 1245 | 1375 | 1507 | 1695 | 1891 | 2119 | 2383 |
| WW-2360TRH | 60" | 2.00 | \$ 910 | 1188 | 1318 | 1450 | 1638 | 1834 | 2062 | 2326 |
| WW-2354TRH | 54" | 1.75 | \$ 887 | 1130 | 1244 | 1360 | 1524 | 1696 | 1895 | 2126 |
| WW-2348TRH | 48" | 1.50 | \$ 806 | 1015 | 1112 | 1211 | 1352 | 1499 | 1670 | 1868 |
| WW-2342TRH | 42" | 1.25 | \$ 745 | 919 | 1000 | 1083 | 1200 | 1323 | 1465 | 1630 |
| WW-2336TRH | 36" | 1.25 | \$ 727 | 901 | 982 | 1065 | 1182 | 1305 | 1447 | 1612 |
| WW-2330TRH | 30" | 1.00 | \$ 671 | 810 | 875 | 941 | 1035 | 1133 | 1247 | 1379 |

Description

- Aluminum Tool Rail
- Work Walls 78" and Larger will Ship in 4 Pieces
- [See Work Wall Accessories](#)

**TALL TOOL RAIL WORK WALL
FOR SURFACE MOUNT HUTCHES
WITH PAPER SLOTS**

**USE OVER 30"H CREDENZA
19" TALL**

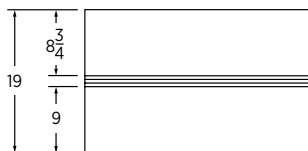

Must Specify (in this order):

- Model #
- Tackboard on Top or Bottom
- Dry Erase on Top or Bottom
- Tackboard Fabric Vendor, Pattern, and Color

Tackboard/Dry Erase Locations

- TB-TB: Tackboard Over Tackboard (Use Grade Prices)
- DEB-TB: Dry Erase Over Tackboard (Use Grade Prices)
- DEB-DEB: Dry Erase Over Dry Erase (Use Grade 1 Prices)

| Model # | Size | COM ydg | COM, 1, 2 or 3 | Grades | | | | | | |
|---------------|------|---------|-------------------|--------|------|------|------|------|------|------|
| | | | | 4 | 5 | 6 | 7 | 8 | 9 | 10 |
| WW-19108TRHPS | 108" | 3.50 | \$ 1579 | 2066 | 2293 | 2524 | 2853 | 3196 | 3595 | 4057 |
| WW-19102TRHPS | 102" | 3.25 | \$ 1505 | 1957 | 2168 | 2383 | 2688 | 3007 | 3377 | 3806 |
| WW-1996TRHPS | 96" | 3.00 | \$ 1440 | 1857 | 2052 | 2250 | 2532 | 2826 | 3168 | 3564 |
| WW-1990TRHPS | 90" | 2.75 | \$ 1349 | 1731 | 1910 | 2092 | 2350 | 2620 | 2933 | 3296 |
| WW-1984TRHPS | 84" | 2.50 | \$ 1215 | 1563 | 1725 | 1890 | 2125 | 2370 | 2655 | 2985 |
| WW-1978TRHPS | 78" | 2.50 | \$ 1173 | 1521 | 1683 | 1848 | 2083 | 2328 | 2613 | 2943 |
| WW-1972TRHPS | 72" | 2.25 | \$ 935 | 1248 | 1394 | 1543 | 1754 | 1975 | 2231 | 2528 |
| WW-1966TRHPS | 66" | 2.00 | \$ 887 | 1165 | 1295 | 1427 | 1615 | 1811 | 2039 | 2303 |
| WW-1960TRHPS | 60" | 2.00 | \$ 845 | 1123 | 1253 | 1385 | 1573 | 1769 | 1997 | 2261 |
| WW-1954TRHPS | 54" | 1.75 | \$ 830 | 1073 | 1187 | 1303 | 1467 | 1639 | 1838 | 2069 |
| WW-1948TRHPS | 48" | 1.50 | \$ 771 | 980 | 1077 | 1176 | 1317 | 1464 | 1635 | 1833 |
| WW-1942TRHPS | 42" | 1.25 | \$ 709 | 883 | 964 | 1047 | 1164 | 1287 | 1429 | 1594 |
| WW-1936TRHPS | 36" | 1.25 | \$ 698 | 872 | 953 | 1036 | 1153 | 1276 | 1418 | 1583 |
| WW-1930TRHPS | 30" | 1.00 | \$ 643 | 782 | 847 | 913 | 1007 | 1105 | 1219 | 1351 |

Description

- Aluminum Tool Rail
- Work Walls 78" and Larger will Ship in 4 Pieces
- [See Work Wall Accessories](#)

[See Canvas Intro Section for Ordering Options](#)

**TALL TOOL RAIL WORK WALL
FOR WALL MOUNT HUTCHES**

**USE OVER 21" H CREDENZA
31" TALL**

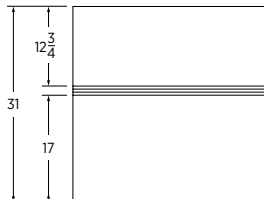

Must Specify (in this order):

- Model #
- Tackboard on Top or Bottom
- Dry Erase on Top or Bottom
- Tackboard Fabric Vendor, Pattern, and Color

Tackboard/Dry Erase Locations

- TB-TB: Tackboard Over Tackboard (Use Grade Prices)
- DEB-TB: Dry Erase Over Tackboard (Use Grade Prices)
- DEB-DEB: Dry Erase Over Dry Erase (Use Grade 1 Prices)

| Model # | Size | COM ydg | COM, 1, 2 or 3 | Grades | | | | | | |
|--------------|------|---------|-------------------|--------|------|------|------|------|------|------|
| | | | | 4 | 5 | 6 | 7 | 8 | 9 | 10 |
| WW-31108TTRW | 108" | 3.50 | \$ 2159 | 2646 | 2873 | 3104 | 3433 | 3776 | 4175 | 4637 |
| WW-31102TTRW | 102" | 3.25 | \$ 2044 | 2496 | 2707 | 2922 | 3227 | 3546 | 3916 | 4345 |
| WW-3196TTRW | 96" | 3.00 | \$ 1969 | 2386 | 2581 | 2779 | 3061 | 3355 | 3697 | 4093 |
| WW-3190TTRW | 90" | 2.75 | \$ 1854 | 2236 | 2415 | 2597 | 2855 | 3125 | 3438 | 3801 |
| WW-3184TTRW | 84" | 2.50 | \$ 1658 | 2006 | 2168 | 2333 | 2568 | 2813 | 3098 | 3428 |
| WW-3178TTRW | 78" | 2.50 | \$ 1585 | 1933 | 2095 | 2260 | 2495 | 2740 | 3025 | 3355 |
| WW-3172TTRW | 72" | 2.25 | \$ 1318 | 1631 | 1777 | 1926 | 2137 | 2358 | 2614 | 2911 |
| WW-3166TTRW | 66" | 2.00 | \$ 1265 | 1543 | 1673 | 1805 | 1993 | 2189 | 2417 | 2681 |
| WW-3160TTRW | 60" | 2.00 | \$ 1191 | 1469 | 1599 | 1731 | 1919 | 2115 | 2343 | 2607 |
| WW-3154TTRW | 54" | 1.75 | \$ 1137 | 1380 | 1494 | 1610 | 1774 | 1946 | 2145 | 2376 |
| WW-3148TTRW | 48" | 1.50 | \$ 1044 | 1253 | 1350 | 1449 | 1590 | 1737 | 1908 | 2106 |
| WW-3142TTRW | 42" | 1.25 | \$ 960 | 1134 | 1215 | 1298 | 1415 | 1538 | 1680 | 1845 |
| WW-3136TTRW | 36" | 1.25 | \$ 940 | 1114 | 1195 | 1278 | 1395 | 1518 | 1660 | 1825 |
| WW-3130TTRW | 30" | 1.00 | \$ 865 | 1004 | 1069 | 1135 | 1229 | 1327 | 1441 | 1573 |

Description

- Aluminum Tool Rail
- Work Walls 78" and Larger will Ship in 4 Pieces
- [See Work Wall Accessories](#)

**TALL TOOL RAIL WORK WALL
FOR WALL MOUNT HUTCHES
WITH PAPER SLOTS**

**USE OVER 21" H CREDENZA
27" TALL**

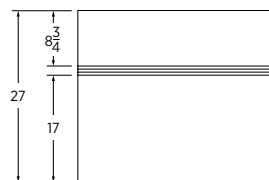

Must Specify (in this order):

- Model #
- Tackboard on Top or Bottom
- Dry Erase on Top or Bottom
- Tackboard Fabric Vendor, Pattern, and Color

Tackboard/Dry Erase Locations

- TB-TB: Tackboard Over Tackboard (Use Grade Prices)
- DEB-TB: Dry Erase Over Tackboard (Use Grade Prices)
- DEB-DEB: Dry Erase Over Dry Erase (Use Grade 1 Prices)

| Model # | Size | COM ydg | COM, 1, 2 or 3 | Grades | | | | | | |
|----------------|------|---------|-------------------|--------|------|------|------|------|------|------|
| | | | | 4 | 5 | 6 | 7 | 8 | 9 | 10 |
| WW-27108TTRWPS | 108" | 3.50 | \$ 1978 | 2465 | 2692 | 2923 | 3252 | 3595 | 3994 | 4456 |
| WW-27102TTRWPS | 102" | 3.25 | \$ 1867 | 2319 | 2530 | 2745 | 3050 | 3369 | 3739 | 4168 |
| WW-2796TTRWPS | 96" | 3.00 | \$ 1805 | 2222 | 2417 | 2615 | 2897 | 3191 | 3533 | 3929 |
| WW-2790TTRWPS | 90" | 2.75 | \$ 1699 | 2081 | 2260 | 2442 | 2700 | 2970 | 3283 | 3646 |
| WW-2784TTRWPS | 84" | 2.50 | \$ 1518 | 1866 | 2028 | 2193 | 2428 | 2673 | 2958 | 3288 |
| WW-2778TTRWPS | 78" | 2.50 | \$ 1454 | 1802 | 1964 | 2129 | 2364 | 2609 | 2894 | 3224 |
| WW-2772TTRWPS | 72" | 2.25 | \$ 1204 | 1517 | 1663 | 1812 | 2023 | 2244 | 2500 | 2797 |
| WW-2766TTRWPS | 66" | 2.00 | \$ 1153 | 1431 | 1561 | 1693 | 1881 | 2077 | 2305 | 2569 |
| WW-2760TTRWPS | 60" | 2.00 | \$ 1085 | 1363 | 1493 | 1625 | 1813 | 2009 | 2237 | 2501 |
| WW-2754TTRWPS | 54" | 1.75 | \$ 1035 | 1278 | 1392 | 1508 | 1672 | 1844 | 2043 | 2274 |
| WW-2748TTRWPS | 48" | 1.50 | \$ 954 | 1163 | 1260 | 1359 | 1500 | 1647 | 1818 | 2016 |
| WW-2742TTRWPS | 42" | 1.25 | \$ 879 | 1053 | 1134 | 1217 | 1334 | 1457 | 1599 | 1764 |
| WW-2736TTRWPS | 36" | 1.25 | \$ 859 | 1033 | 1114 | 1197 | 1314 | 1437 | 1579 | 1744 |
| WW-2730TTRWPS | 30" | 1.00 | \$ 791 | 930 | 995 | 1061 | 1155 | 1253 | 1367 | 1499 |

Description

- Aluminum Tool Rail
- Work Walls 78" and Larger will Ship in 4 Pieces
- [See Work Wall Accessories](#)

[See Canvas Intro Section for Ordering Options](#)

TOOL RAIL WORK WALL FOR WALL MOUNT HUTCHES

USE OVER 30"H CREDENZA 23" TALL

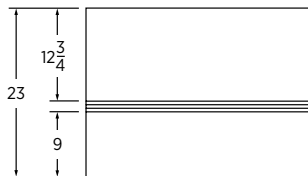

Must Specify (in this order):
 Model #
 Tackboard on Top or Bottom
 Dry Erase on Top or Bottom
 Tackboard Fabric Vendor, Pattern,
 and Color

- Tackboard/Dry Erase Locations
- TB-TB: Tackboard Over Tackboard (Use Grade Prices)
 - DEB-TB: Dry Erase Over Tackboard (Use Grade Prices)
 - DEB-DEB: Dry Erase Over Dry Erase (Use Grade 1 Prices)

| Model # | Size | COM ydg | COM, 1, 2 or 3 | Grades | | | | | | |
|-------------|------|---------|-------------------|--------|------|------|------|------|------|------|
| | | | | 4 | 5 | 6 | 7 | 8 | 9 | 10 |
| WW-23108TRW | 108" | 3.50 | \$ 1797 | 2284 | 2511 | 2742 | 3071 | 3414 | 3813 | 4275 |
| WW-23102TRW | 102" | 3.25 | \$ 1693 | 2145 | 2356 | 2571 | 2876 | 3195 | 3565 | 3994 |
| WW-2396TRW | 96" | 3.00 | \$ 1643 | 2060 | 2255 | 2453 | 2735 | 3029 | 3371 | 3767 |
| WW-2390TRW | 90" | 2.75 | \$ 1548 | 1930 | 2109 | 2291 | 2549 | 2819 | 3132 | 3495 |
| WW-2384TRW | 84" | 2.50 | \$ 1379 | 1727 | 1889 | 2054 | 2289 | 2534 | 2819 | 3149 |
| WW-2378TRW | 78" | 2.50 | \$ 1319 | 1667 | 1829 | 1994 | 2229 | 2474 | 2759 | 3089 |
| WW-2372TRW | 72" | 2.25 | \$ 1099 | 1412 | 1558 | 1707 | 1918 | 2139 | 2395 | 2692 |
| WW-2366TRW | 66" | 2.00 | \$ 1040 | 1318 | 1448 | 1580 | 1768 | 1964 | 2192 | 2456 |
| WW-2360TRW | 60" | 2.00 | \$ 976 | 1254 | 1384 | 1516 | 1704 | 1900 | 2128 | 2392 |
| WW-2354TRW | 54" | 1.75 | \$ 934 | 1177 | 1291 | 1407 | 1571 | 1743 | 1942 | 2173 |
| WW-2348TRW | 48" | 1.50 | \$ 863 | 1072 | 1169 | 1268 | 1409 | 1556 | 1727 | 1925 |
| WW-2342TRW | 42" | 1.25 | \$ 795 | 969 | 1050 | 1133 | 1250 | 1373 | 1515 | 1680 |
| WW-2336TRW | 36" | 1.25 | \$ 780 | 954 | 1035 | 1118 | 1235 | 1358 | 1500 | 1665 |
| WW-2330TRW | 30" | 1.00 | \$ 716 | 855 | 920 | 986 | 1080 | 1178 | 1292 | 1424 |

- Description**
- Aluminum Tool Rail
 - Work Walls 78" and Larger will Ship in 4 Pieces
 - See Accessories on Next Page

TALL TOOL RAIL WORK WALL FOR WALL MOUNT HUTCHES WITH PAPER SLOTS

USE OVER 30"H CREDENZA 19" TALL



Must Specify (in this order):
 Model #
 Tackboard on Top or Bottom
 Dry Erase on Top or Bottom
 Tackboard Fabric Vendor, Pattern,
 and Color

- Tackboard/Dry Erase Locations
- TB-TB: Tackboard Over Tackboard (Use Grade Prices)
 - DEB-TB: Dry Erase Over Tackboard (Use Grade Prices)
 - DEB-DEB: Dry Erase Over Dry Erase (Use Grade 1 Prices)

| Model # | Size | COM ydg | COM, 1, 2 or 3 | Grades | | | | | | |
|---------------|------|---------|-------------------|--------|------|------|------|------|------|------|
| | | | | 4 | 5 | 6 | 7 | 8 | 9 | 10 |
| WW-19108TRWPS | 108" | 3.50 | \$ 1654 | 2141 | 2368 | 2599 | 2928 | 3271 | 3670 | 4132 |
| WW-19102TRWPS | 102" | 3.25 | \$ 1555 | 2007 | 2218 | 2433 | 2738 | 3057 | 3427 | 3856 |
| WW-1996TRWPS | 96" | 3.00 | \$ 1507 | 1924 | 2119 | 2317 | 2599 | 2893 | 3235 | 3631 |
| WW-1990TRWPS | 90" | 2.75 | \$ 1419 | 1801 | 1980 | 2162 | 2420 | 2690 | 3003 | 3366 |
| WW-1984TRWPS | 84" | 2.50 | \$ 1258 | 1606 | 1768 | 1933 | 2168 | 2413 | 2698 | 3028 |
| WW-1978TRWPS | 78" | 2.50 | \$ 1203 | 1551 | 1713 | 1878 | 2113 | 2358 | 2643 | 2973 |
| WW-1972TRWPS | 72" | 2.25 | \$ 1004 | 1317 | 1463 | 1612 | 1823 | 2044 | 2300 | 2597 |
| WW-1966TRWPS | 66" | 2.00 | \$ 953 | 1231 | 1361 | 1493 | 1681 | 1877 | 2105 | 2369 |
| WW-1960TRWPS | 60" | 2.00 | \$ 901 | 1179 | 1309 | 1441 | 1629 | 1825 | 2053 | 2317 |
| WW-1954TRWPS | 54" | 1.75 | \$ 871 | 1114 | 1228 | 1344 | 1508 | 1680 | 1879 | 2110 |
| WW-1948TRWPS | 48" | 1.50 | \$ 818 | 1027 | 1124 | 1223 | 1364 | 1511 | 1682 | 1880 |
| WW-1942TRWPS | 42" | 1.25 | \$ 756 | 930 | 1011 | 1094 | 1211 | 1334 | 1476 | 1641 |
| WW-1936TRWPS | 36" | 1.25 | \$ 741 | 915 | 996 | 1079 | 1196 | 1319 | 1461 | 1626 |
| WW-1930TRWPS | 30" | 1.00 | \$ 684 | 823 | 888 | 954 | 1048 | 1146 | 1260 | 1392 |

- Description**
- Aluminum Tool Rail
 - Work Walls 78" and Larger will Ship in 4 Pieces
 - See Accessories on Next Page

[See Canvas Intro Section for Ordering Options](#)

| Item | Model No. | | Width | Depth | Height | Ship Wt | Cubic Ft | List Price |
|------------|-------------|-------|------------------|------------------|-----------------|---------|----------|------------|
| LEGAL TRAY | 01-LGLTRAYC | Clear | 14 $\frac{7}{8}$ | 10 $\frac{1}{2}$ | 1 $\frac{1}{8}$ | | | \$ 115 |

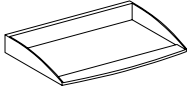

| | | | | | | | | |
|---------------|--------------|-------|-----------------|------------------|-----------------|--|--|--------|
| FOLDER SORTER | 01-FLDRSRTRC | Clear | 7 $\frac{1}{4}$ | 12 $\frac{3}{8}$ | 7 $\frac{1}{8}$ | | | \$ 129 |
|---------------|--------------|-------|-----------------|------------------|-----------------|--|--|--------|

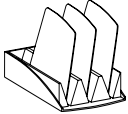

| | | | | | | | | |
|------------------|-------------|-------|-----------------|------------------|-----------------|--|--|--------|
| ACCESSORIES TRAY | 01-ACCTRAYC | Clear | 9 $\frac{1}{4}$ | 10 $\frac{1}{8}$ | 1 $\frac{1}{8}$ | | | \$ 125 |
|------------------|-------------|-------|-----------------|------------------|-----------------|--|--|--------|

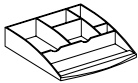

[See Canvas Intro Section for Ordering Options](#)

**TACKBOARDS
FOR SURFACE MOUNT HUTCHES**

23" TALL

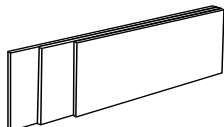

Must Specify (in this order):
Model #
Fabric Vendor, Pattern, and Color

| Model # | Size | COM ydg | COM, 1, 2 or 3 | Grades | | | | | | |
|----------|------|---------|-------------------|--------|------|------|------|------|------|------|
| | | | | 4 | 5 | 6 | 7 | 8 | 9 | 10 |
| TB-6696H | 96" | 3.00 | \$ 707 | 1124 | 1319 | 1517 | 1799 | 2093 | 2435 | 2831 |
| TB-6690H | 90" | 2.75 | \$ 673 | 1055 | 1234 | 1416 | 1674 | 1944 | 2257 | 2620 |
| TB-6684H | 84" | 2.50 | \$ 639 | 987 | 1149 | 1314 | 1549 | 1794 | 2079 | 2409 |
| TB-6678H | 78" | 2.50 | \$ 628 | 976 | 1138 | 1303 | 1538 | 1783 | 2068 | 2398 |
| TB-6672H | 72" | 2.25 | \$ 566 | 879 | 1025 | 1174 | 1385 | 1606 | 1862 | 2159 |
| TB-6666H | 66" | 2.00 | \$ 533 | 811 | 941 | 1073 | 1261 | 1457 | 1685 | 1949 |
| TB-6660H | 60" | 2.00 | \$ 498 | 776 | 906 | 1038 | 1226 | 1422 | 1650 | 1914 |
| TB-6654H | 54" | 1.75 | \$ 485 | 728 | 842 | 958 | 1122 | 1294 | 1493 | 1724 |
| TB-6648H | 48" | 1.50 | \$ 436 | 645 | 742 | 841 | 982 | 1129 | 1300 | 1498 |
| TB-6642H | 42" | 1.25 | \$ 396 | 570 | 651 | 734 | 851 | 974 | 1116 | 1281 |
| TB-6636H | 36" | 1.25 | \$ 385 | 559 | 640 | 723 | 840 | 963 | 1105 | 1270 |
| TB-6630H | 30" | 1.00 | \$ 346 | 485 | 550 | 616 | 710 | 808 | 922 | 1054 |

Description
• All Tackboards 78" and Longer will Ship in 2 Pieces

**TACKBOARDS
FOR SURFACE MOUNT HUTCHES
WITH PAPER SLOTS**

19" TALL

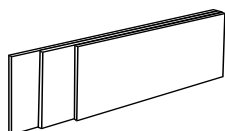

Must Specify (in this order):
Model #
Fabric Vendor, Pattern, and Color

| Model # | Size | COM ydg | COM, 1, 2 or 3 | Grades | | | | | | |
|------------|------|---------|-------------------|--------|------|------|------|------|------|------|
| | | | | 4 | 5 | 6 | 7 | 8 | 9 | 10 |
| TB-1996HPS | 96" | 3.00 | \$ 635 | 1052 | 1247 | 1445 | 1727 | 2021 | 2363 | 2759 |
| TB-1990HPS | 90" | 2.75 | \$ 609 | 991 | 1170 | 1352 | 1610 | 1880 | 2193 | 2556 |
| TB-1984HPS | 84" | 2.50 | \$ 575 | 923 | 1085 | 1250 | 1485 | 1730 | 2015 | 2345 |
| TB-1978HPS | 78" | 2.50 | \$ 566 | 914 | 1076 | 1241 | 1476 | 1721 | 2006 | 2336 |
| TB-1972HPS | 72" | 2.25 | \$ 510 | 823 | 969 | 1118 | 1329 | 1550 | 1806 | 2103 |
| TB-1966HPS | 66" | 2.00 | \$ 476 | 754 | 884 | 1016 | 1204 | 1400 | 1628 | 1892 |
| TB-1960HPS | 60" | 2.00 | \$ 445 | 723 | 853 | 985 | 1173 | 1369 | 1597 | 1861 |
| TB-1954HPS | 54" | 1.75 | \$ 433 | 676 | 790 | 906 | 1070 | 1242 | 1441 | 1672 |
| TB-1948HPS | 48" | 1.50 | \$ 390 | 599 | 696 | 795 | 936 | 1083 | 1254 | 1452 |
| TB-1942HPS | 42" | 1.25 | \$ 352 | 526 | 607 | 690 | 807 | 930 | 1072 | 1237 |
| TB-1936HPS | 36" | 1.25 | \$ 343 | 517 | 598 | 681 | 798 | 921 | 1063 | 1228 |
| TB-1930HPS | 30" | 1.00 | \$ 311 | 450 | 515 | 581 | 675 | 773 | 887 | 1019 |

Description
• All Tackboards 78" and Longer will Ship in 2 Pieces

[See Canvas Intro Section for Ordering Options](#)

TACKBOARDS FOR WALL MOUNT HUTCHES

USE OVER 21" H CREDENZA
31" TALL

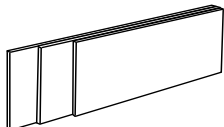

Must Specify (in this order):
Model #
Fabric Vendor, Pattern, and Color

| Model # | Size | COM ydg | COM, 1, 2 or 3 | Grades | | | | | | |
|-----------|------|---------|-------------------|--------|------|------|------|------|------|------|
| | | | | 4 | 5 | 6 | 7 | 8 | 9 | 10 |
| TB-31108W | 108" | 3.50 | \$ 1014 | 1501 | 1728 | 1959 | 2288 | 2631 | 3030 | 3492 |
| TB-31102W | 102" | 3.25 | \$ 969 | 1421 | 1632 | 1847 | 2152 | 2471 | 2841 | 3270 |
| TB-3196W | 96" | 3.00 | \$ 943 | 1360 | 1555 | 1753 | 2035 | 2329 | 2671 | 3067 |
| TB-3190W | 90" | 2.75 | \$ 899 | 1281 | 1460 | 1642 | 1900 | 2170 | 2483 | 2846 |
| TB-3184W | 84" | 2.50 | \$ 851 | 1199 | 1361 | 1526 | 1761 | 2006 | 2291 | 2621 |
| TB-3178W | 78" | 2.50 | \$ 836 | 1184 | 1346 | 1511 | 1746 | 1991 | 2276 | 2606 |
| TB-3172W | 72" | 2.25 | \$ 772 | 1085 | 1231 | 1380 | 1591 | 1812 | 2068 | 2365 |
| TB-3166W | 66" | 2.00 | \$ 738 | 1016 | 1146 | 1278 | 1466 | 1662 | 1890 | 2154 |
| TB-3160W | 60" | 2.00 | \$ 691 | 969 | 1099 | 1231 | 1419 | 1615 | 1843 | 2107 |
| TB-3154W | 54" | 1.75 | \$ 656 | 899 | 1013 | 1129 | 1293 | 1465 | 1664 | 1895 |
| TB-3148W | 48" | 1.50 | \$ 598 | 807 | 904 | 1003 | 1144 | 1291 | 1462 | 1660 |
| TB-3142W | 42" | 1.25 | \$ 539 | 713 | 794 | 877 | 994 | 1117 | 1259 | 1424 |
| TB-3136W | 36" | 1.25 | \$ 525 | 699 | 780 | 863 | 980 | 1103 | 1245 | 1410 |
| TB-3130W | 30" | 1.00 | \$ 473 | 612 | 677 | 743 | 837 | 935 | 1049 | 1181 |

Description

- All Tackboards 78" and Longer will Ship in 2 Pieces

TACKBOARDS FOR WALL MOUNT HUTCHES WITH PAPER SLOTS

USE OVER 21" H CREDENZA
27" TALL

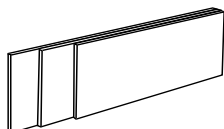

Must Specify (in this order):
Model #
Fabric Vendor, Pattern, and Color

| Model # | Size | COM ydg | COM, 1, 2 or 3 | Grades | | | | | | |
|-------------|------|---------|-------------------|--------|------|------|------|------|------|------|
| | | | | 4 | 5 | 6 | 7 | 8 | 9 | 10 |
| TB-27108WPS | 108" | 3.50 | \$ 929 | 1416 | 1643 | 1874 | 2203 | 2546 | 2945 | 3407 |
| TB-27102WPS | 102" | 3.25 | \$ 887 | 1339 | 1550 | 1765 | 2070 | 2389 | 2759 | 3188 |
| TB-2796WPS | 96" | 3.00 | \$ 864 | 1281 | 1476 | 1674 | 1956 | 2250 | 2592 | 2988 |
| TB-2790WPS | 90" | 2.75 | \$ 829 | 1211 | 1390 | 1572 | 1830 | 2100 | 2413 | 2776 |
| TB-2784WPS | 84" | 2.50 | \$ 783 | 1131 | 1293 | 1458 | 1693 | 1938 | 2223 | 2553 |
| TB-2778WPS | 78" | 2.50 | \$ 767 | 1115 | 1277 | 1442 | 1677 | 1922 | 2207 | 2537 |
| TB-2772WPS | 72" | 2.25 | \$ 707 | 1020 | 1166 | 1315 | 1526 | 1747 | 2003 | 2300 |
| TB-2766WPS | 66" | 2.00 | \$ 671 | 949 | 1079 | 1211 | 1399 | 1595 | 1823 | 2087 |
| TB-2760WPS | 60" | 2.00 | \$ 627 | 905 | 1035 | 1167 | 1355 | 1551 | 1779 | 2043 |
| TB-2754WPS | 54" | 1.75 | \$ 598 | 841 | 955 | 1071 | 1235 | 1407 | 1606 | 1837 |
| TB-2748WPS | 48" | 1.50 | \$ 545 | 754 | 851 | 950 | 1091 | 1238 | 1409 | 1607 |
| TB-2742WPS | 42" | 1.25 | \$ 492 | 666 | 747 | 830 | 947 | 1070 | 1212 | 1377 |
| TB-2736WPS | 36" | 1.25 | \$ 481 | 655 | 736 | 819 | 936 | 1059 | 1201 | 1366 |
| TB-2730WPS | 30" | 1.00 | \$ 433 | 572 | 637 | 703 | 797 | 895 | 1009 | 1141 |

Description

- All Tackboards 78" and Longer will Ship in 2 Pieces

[See Canvas Intro Section for Ordering Options](#)

TACKBOARDS FOR WALL MOUNT HUTCHES

23" TALL

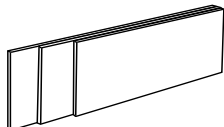

Must Specify (in this order):

Model #
Fabric Vendor, Pattern, and Color

| Model # | Size | COM ydg | COM, 1, 2 or 3 | Grades | | | | | | | | | | | | |
|-----------|------|---------|-------------------|--------|------|------|------|------|------|------|--|--|--|--|--|--|
| | | | | 4 | 5 | 6 | 7 | 8 | 9 | 10 | | | | | | |
| TB-66108W | 108" | 3.50 | \$ 845 | 1332 | 1559 | 1790 | 2119 | 2462 | 2861 | 3323 | | | | | | |
| TB-66102W | 102" | 3.25 | \$ 805 | 1257 | 1468 | 1683 | 1988 | 2307 | 2677 | 3106 | | | | | | |
| TB-6696W | 96" | 3.00 | \$ 788 | 1205 | 1400 | 1598 | 1880 | 2174 | 2516 | 2912 | | | | | | |
| TB-6690W | 90" | 2.75 | \$ 751 | 1133 | 1312 | 1494 | 1752 | 2022 | 2335 | 2698 | | | | | | |
| TB-6684W | 84" | 2.50 | \$ 711 | 1059 | 1221 | 1386 | 1621 | 1866 | 2151 | 2481 | | | | | | |
| TB-6678W | 78" | 2.50 | \$ 698 | 1046 | 1208 | 1373 | 1608 | 1853 | 2138 | 2468 | | | | | | |
| TB-6672W | 72" | 2.25 | \$ 642 | 955 | 1101 | 1250 | 1461 | 1682 | 1938 | 2235 | | | | | | |
| TB-6666W | 66" | 2.00 | \$ 609 | 887 | 1017 | 1149 | 1337 | 1533 | 1761 | 2025 | | | | | | |
| TB-6660W | 60" | 2.00 | \$ 566 | 844 | 974 | 1106 | 1294 | 1490 | 1718 | 1982 | | | | | | |
| TB-6654W | 54" | 1.75 | \$ 539 | 782 | 896 | 1012 | 1176 | 1348 | 1547 | 1778 | | | | | | |
| TB-6648W | 48" | 1.50 | \$ 492 | 701 | 798 | 897 | 1038 | 1185 | 1356 | 1554 | | | | | | |
| TB-6642W | 42" | 1.25 | \$ 446 | 620 | 701 | 784 | 901 | 1024 | 1166 | 1331 | | | | | | |
| TB-6636W | 36" | 1.25 | \$ 434 | 608 | 689 | 772 | 889 | 1012 | 1154 | 1319 | | | | | | |
| TB-6630W | 30" | 1.00 | \$ 394 | 533 | 598 | 664 | 758 | 856 | 970 | 1102 | | | | | | |

Description

- All Tackboards 78" and Longer will Ship in 2 Pieces
- Not Compatible with Gallery Screens; Consider Work Wall Applications

TACKBOARDS FOR WALL MOUNT HUTCHES WITH PAPER SLOTS

19" TALL

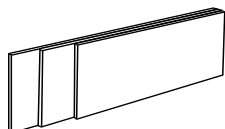

Must Specify (in this order):

Model #
Fabric Vendor, Pattern, and Color

| Model # | Size | COM ydg | COM, 1, 2 or 3 | Grades | | | | | | | | | | | | |
|-------------|------|---------|-------------------|--------|------|------|------|------|------|------|--|--|--|--|--|--|
| | | | | 4 | 5 | 6 | 7 | 8 | 9 | 10 | | | | | | |
| TB-19108WPS | 108" | 3.50 | \$ 758 | 1245 | 1472 | 1703 | 2032 | 2375 | 2774 | 3236 | | | | | | |
| TB-19102WPS | 102" | 3.25 | \$ 723 | 1175 | 1386 | 1601 | 1906 | 2225 | 2595 | 3024 | | | | | | |
| TB-1996WPS | 96" | 3.00 | \$ 708 | 1125 | 1320 | 1518 | 1800 | 2094 | 2436 | 2832 | | | | | | |
| TB-1990WPS | 90" | 2.75 | \$ 676 | 1058 | 1237 | 1419 | 1677 | 1947 | 2260 | 2623 | | | | | | |
| TB-1984WPS | 84" | 2.50 | \$ 638 | 986 | 1148 | 1313 | 1548 | 1793 | 2078 | 2408 | | | | | | |
| TB-1978WPS | 78" | 2.50 | \$ 626 | 974 | 1136 | 1301 | 1536 | 1781 | 2066 | 2396 | | | | | | |
| TB-1972WPS | 72" | 2.25 | \$ 578 | 891 | 1037 | 1186 | 1397 | 1618 | 1874 | 2171 | | | | | | |
| TB-1966WPS | 66" | 2.00 | \$ 542 | 820 | 950 | 1082 | 1270 | 1466 | 1694 | 1958 | | | | | | |
| TB-1960WPS | 60" | 2.00 | \$ 502 | 780 | 910 | 1042 | 1230 | 1426 | 1654 | 1918 | | | | | | |
| TB-1954WPS | 54" | 1.75 | \$ 481 | 724 | 838 | 954 | 1118 | 1290 | 1489 | 1720 | | | | | | |
| TB-1948WPS | 48" | 1.50 | \$ 442 | 651 | 748 | 847 | 988 | 1135 | 1306 | 1504 | | | | | | |
| TB-1942WPS | 42" | 1.25 | \$ 398 | 572 | 653 | 736 | 853 | 976 | 1118 | 1283 | | | | | | |
| TB-1936WPS | 36" | 1.25 | \$ 388 | 562 | 643 | 726 | 843 | 966 | 1108 | 1273 | | | | | | |
| TB-1930WPS | 30" | 1.00 | \$ 351 | 490 | 555 | 621 | 715 | 813 | 927 | 1059 | | | | | | |

Description

- All Tackboards 78" and Longer will Ship in 2 Pieces
- Not Compatible with Gallery Screens; Consider Work Wall Applications

[See Canvas Intro Section for Ordering Options](#)

**TACKBOARDS
FOR DUAL ACCESS OPEN HUTCHES**

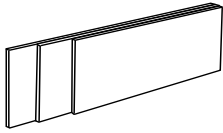

| Model # | Coordinating Unit | COM ydg | COM, 1, 2 or 3 | Grades | | | | | | |
|---------|-------------------|---------|----------------|--------|-----|-----|-----|------|------|------|
| | | | | 4 | 5 | 6 | 7 | 8 | 9 | 10 |
| TB-1334 | 66-1572DAOH | 1.25 | \$ 446 | 620 | 701 | 784 | 901 | 1024 | 1166 | 1331 |
| TB-1331 | 66-1566DAOH | 1.00 | \$ 377 | 516 | 581 | 647 | 741 | 839 | 953 | 1085 |
| TB-1328 | 66-1560DAOH | 1.00 | \$ 351 | 490 | 555 | 621 | 715 | 813 | 927 | 1059 |

Description

- Includes 2 Tackboards

Must Specify (in this order):

- Model #
- Fabric Vendor, Pattern, and Color

| Item | Model No. | Width | Depth | Height | Ship Wt | Cubic Ft | List Price |
|---------------------------|-----------|-------|-------|------------------|---------|----------|------------|
| PURSE HOOK FOR WORK TABLE | 01-HOOK | 2 | 1¾ | 2½ ₂₅ | | | \$ 79 |



Description

- Black Hook Includes Mounting Hardware
- For Use with Work Tables, [See Work Tables](#)
- Field Installed

| | | | | | | | |
|--------------------|----------|-----|----|-----|----|-----|---------|
| VESTA POWER CENTER | 01-PDCTR | 10¾ | 12 | 28¼ | 14 | 2.5 | \$ 1776 |
|--------------------|----------|-----|----|-----|----|-----|---------|



Description

- Top Includes One (1) Power Outlet, Two (2) USB Ports and One (1) USBC Port; Base Includes Three (3) Outlet
- Available in White
- 120" Power Cord
- Built with Weight Distribution for Optimal Stability
- Base is 5" Tall

See next page for Accessories, Power, Data, Communication

[See Canvas Intro Section for Ordering Options](#)

A foundational suite of casegoods primed to evolve with your needs. Gesso allows you to combine luxurious veneers, top grade laminates, metal accents, and other materials to create stylish, reconfigurable work spaces and storage options. With integrated height adjustable units, white and black glass door options on hutch and storage units as well as a full line of white and black glass marker boards provide opportunities for more elegant and clean aesthetic.

CONSTRUCTION

Gesso Casegoods feature a Veneer chassis with your choice of either a Veneer or HPL top. Units ship assembled unless otherwise noted.

VENEERS

- Exposed surfaces feature select grade plain sliced hardwood Cherry, Maple, American Black Walnut, White Oak, or composite veneers
- Veneers are carefully selected and matched to assure proper balance and consistency

TOPS

- Veneer and standard High Pressure Laminate (HPL) tops are 3-ply balanced construction and 1 $\frac{3}{16}$ " thick, with 3mm wood edge-banded rims contoured to the selected profile
- Optional 1 $\frac{1}{2}$ " thick HPL worksurfaces are available in select colors. Please contact Customer Service or your local Sales Rep for pricing and lead times. Sugar Maple and Williamsburg Cherry feature ABS edge bands
- Tops are shaped on user and approach sides
- Grain direction runs left to right unless otherwise noted

CHASSIS

- Chassis is securely fastened using high quality European fastening systems and heavy-duty, 16-gauge joining brackets to assure maximum strength
- All units ship with heavy-duty, adjustable leveling glides to ensure proper leveling and compensation for uneven floors
- All desks, non-lateral credenzas, and returns have wire management access from pedestal to kneespace

DRAWERS

- Drawers feature 5-sided construction allowing for easy removal of drawer fronts
- Drawer fronts are 3-ply construction, $\frac{3}{4}$ " thick with matched grain
- Drawer sides, back, and front are $\frac{1}{2}$ " thick, woodgrain vinyl wrapped construction with mitered corners
- Box and file drawers feature full extension, progressive action slides with precision steel ball bearings allowing side-to-side and front-to-back
- Optional soft close on box and file drawers allows front-to-back filing in file drawers
- Optional wood dovetail construction with $\frac{7}{16}$ " thick hardwood sides and backs, and $\frac{5}{16}$ " thick hardboard bottoms
- Box and file drawers have $\frac{1}{8}$ " thick hardboard bottoms and tested for 100lb capacity
- Lateral files feature $\frac{1}{4}$ " thick bottoms. Drawers are tested for 200lb of equally distributed weight (ex: hanging file folders) and 65lbs of bottom load weight (ex: stacked catalogs)
- All suspensions have a limited lifetime warranty

FILING

- All file drawers are standard with filing systems designed to accommodate a variety of filing requirements
- Optional soft close on box and file drawers allows front-to-back filing in file drawer
- Letter width file drawers provide letter filing front-to-back and legal filing side-to-side
- Lateral file drawers provide legal or letter filing front-to-back or side-to-side

STORAGE

- All hinged doors include soft close hinges, unless noted
- Soft close hinges reduce stress placed on the cabinet when the door is closed and offers a quiet closure

LOCKING

- All units with file drawers feature locking
- Removable lock cylinders allow for units to be re-keyed at a later date, if required
- Units are shipped randomly keyed as standard
- Keyed alike units available upon request at no additional charge
- Lock core is predetermined by pull color. Black lock cores are used with black and gold pulls while silver lock cores are used with chrome and aluminum pulls

CORD MANAGEMENT

- Grommets may be ordered in the tops of all assembled desks, returns, bridges, credenzas, and component worksurfaces
- All desks, returns, and credenzas (except lateral pedestals) have standard wire openings from inside the pedestal to the kneespace allowing quick access to technology below
- Additionally, returns, bridge units, kneespace credenzas, and hutch units have standard grommets in back panels
- Grommets are also standard in the tops of corner units and extended corner units
- Grommets are 2 $\frac{3}{8}$ " and are available in black or silver, must specify color
- [See all grommet options](#)
- Undersurface Wire Manager (01-WMGR4) is available for additional cord management; See Accessories

HEIGHT ADJUSTABLE MECHANISMS

- Optional center drawer, Dock 950 and Dock 150, $\frac{3}{4}$ modesty panels, and kneespace options are not available with height adjustable units
- Height adjustment range 30"H-45"H
- 5-year warranty
- [See Height Adjust Information and Options](#)
- Height Adjustable units begin [here](#)

STUDIO LEGS

- For each of the Studio models, standard or shared legs will need to be specified
- Choose to use four standard, a combination of standard or shared, or all shared legs on each unit
- The below images will provide a guide to the aesthetics of single, double, and shared legs
- Studio components begin [here](#)



Single Standard Leg



Shared Leg (used between two models)



Double Standard Leg (standard legs used on each model)

INTERIOR DRAWER DIMENSIONS

Models

| | | |
|--------------|-------------|-------------|
| 65-2515SHPD1 | 67-3672DP | 67-3672BRP |
| 65-2415PD1 | 67-3672LPS | 67-3672BDPS |
| 65-1519MP | 67-3672RPS | 67-3072LP |
| 65-1519MPI | 67-3672LP | 67-3072RP |
| 67-4872CBLP | 67-3672RP | 67-3072DP |
| 67-4872CBRP | 67-3672DPS | 67-3066DP |
| 67-4272CLP | 67-3672BLPS | 67-3066LP |
| 67-4272CRP | 67-3672BRPS | 67-3066RP |
| 67-3672BDP | 67-3672BLP | 67-3066DP |

Drawers

| | W | L | D |
|------|--------------------|---------------------|--------------------|
| Box | 12 $\frac{1}{8}$ " | 16 $\frac{3}{16}$ " | 3 $\frac{1}{2}$ " |
| File | 12 $\frac{1}{8}$ " | 16 $\frac{3}{16}$ " | 9 $\frac{5}{16}$ " |

Models

| | | |
|--------------|------------|------------|
| 65-2415PD2 | 67-2472SC | 67-2466LC2 |
| 65-2515SHPD2 | 67-2472RC2 | 67-2466KC |
| 65-1519MP2 | 67-2472LC2 | 67-2448RF2 |
| 67-4824RF2 | 67-2472KC | 67-2448LF2 |
| 67-4824LF2 | 67-2466SC | 67-2442RF2 |
| 67-4224RF2 | 67-2466RC2 | 67-2442LF2 |

Drawer

| | W | L | D |
|------|--------------------|---------------------|--------------------|
| File | 12 $\frac{1}{8}$ " | 16 $\frac{3}{16}$ " | 9 $\frac{5}{16}$ " |

Models

| | | |
|------------|------------|------------|
| 67-4824RF1 | 67-2472RC1 | 67-2448RF1 |
| 67-4824LF1 | 67-2472LC1 | 67-2448LF1 |
| 67-4224RF1 | 67-2466RC1 | 67-2442RF1 |
| 67-4224LF1 | 67-2466LC1 | 67-2442LF1 |

Drawers

| | W | L | D |
|------|--------------------|---------------------|---------------------|
| Box | 12 $\frac{1}{8}$ " | 16 $\frac{3}{16}$ " | 3 $\frac{1}{2}$ " |
| File | 12 $\frac{1}{8}$ " | 16 $\frac{3}{16}$ " | 9 $\frac{15}{16}$ " |

Models

| | | |
|--------------|--------------|------------|
| 65-3684WDS2L | 65-3672WDS2R | 65-2430LF3 |
| 65-3684WDS2R | 65-3084SU2 | 65-2430LF1 |
| 65-3672WDS2L | 65-3072SU2 | |

Drawer

| | W | L | D |
|----------|---------------------|---------------------|--------------------|
| Lat File | 26 $\frac{3}{32}$ " | 15 $\frac{1}{16}$ " | 9 $\frac{7}{32}$ " |

Models

| | | |
|------------|-----------|------------|
| 65-3684SU2 | 65-2466RL | 65-2436LF3 |
| 65-3672SU2 | 65-2466LL | 65-2436LF1 |

Drawer

| | W | L | D |
|----------|---------------------|---------------------|--------------------|
| Lat File | 32 $\frac{3}{32}$ " | 15 $\frac{1}{16}$ " | 9 $\frac{7}{32}$ " |

Models

| | | |
|----------------|----------------|--------------|
| 65-2472L21OBFL | 65-2072L21OBFL | 65-2436L21BF |
| 65-2472L21OBFR | 65-2072L21OBFR | 65-2036L21BF |
| 65-2472L21DBF | 65-2072L21DBF | |

Drawers

| | W | L | D |
|------|---------------------|---------------------|--------------------|
| Box | 32 $\frac{3}{32}$ " | 13 $\frac{3}{8}$ " | 3 $\frac{1}{2}$ " |
| File | 32 $\frac{3}{32}$ " | 15 $\frac{1}{16}$ " | 9 $\frac{7}{32}$ " |

Models

| | | |
|---------------|---------------|--------------|
| 65-2460L21OBL | 65-2060OBFL | 65-2430L21BF |
| 65-2460L21OBR | 65-2060OBFR | 65-2030L21BF |
| 65-2460L21DBF | 65-2060L21DBF | |

Drawers

| | W | L | D |
|------|---------------------|---------------------|--------------------|
| Box | 26 $\frac{3}{32}$ " | 13 $\frac{3}{8}$ " | 3 $\frac{1}{2}$ " |
| File | 26 $\frac{3}{32}$ " | 15 $\frac{1}{16}$ " | 9 $\frac{7}{32}$ " |

Models

| | |
|--------------|--------------|
| 65-2418L21BF | 65-2018L21BF |
|--------------|--------------|

Drawers

| | W | L | D |
|------|---------------------|--------------------|--------------------|
| Box | 14 $\frac{9}{32}$ " | 13 $\frac{3}{8}$ " | 3 $\frac{1}{2}$ " |
| File | 14 $\frac{9}{32}$ " | 15 $\frac{1}{8}$ " | 9 $\frac{7}{32}$ " |

Model

65-2436OMF

Drawers

| | W | L | D |
|--------------|---------------------|---------------------|--------------------|
| Box | 14 $\frac{9}{32}$ " | 15 $\frac{1}{8}$ " | 3 $\frac{1}{2}$ " |
| Lateral File | 32 $\frac{3}{32}$ " | 15 $\frac{1}{16}$ " | 9 $\frac{7}{32}$ " |

Model

65-2430OMF

Drawers

| | W | L | D |
|--------------|---------------------|---------------------|--------------------|
| Box | 11 $\frac{3}{4}$ " | 16 $\frac{3}{16}$ " | 3 $\frac{1}{2}$ " |
| Lateral File | 26 $\frac{3}{32}$ " | 15 $\frac{1}{16}$ " | 9 $\frac{7}{32}$ " |

Model

65-2472BF

Drawer

| | W | L | D |
|-----|--------------------|---------------------|-------------------|
| Box | 32 $\frac{1}{8}$ " | 16 $\frac{3}{16}$ " | 3 $\frac{1}{2}$ " |

Models

| | | |
|------------|------------|------------|
| 65-2472RMR | 65-2472LMF | 65-2436MF |
| 65-2472LMR | 65-2466RMF | 65-2466LMF |
| 65-2472RMF | | |

Drawers

| | W | L | D |
|----------|---------------------|---------------------|--------------------|
| Box | 14 $\frac{9}{32}$ " | 15 $\frac{1}{8}$ " | 3 $\frac{1}{2}$ " |
| File | 14 $\frac{9}{32}$ " | 15 $\frac{1}{8}$ " | 9 $\frac{5}{16}$ " |
| Lat File | 32 $\frac{3}{32}$ " | 15 $\frac{1}{16}$ " | 9 $\frac{7}{32}$ " |

Model

65-2436LF2

Drawers

| | W | L | D |
|----------|---------------------|---------------------|-------------------|
| Box | 14 $\frac{9}{32}$ " | 15 $\frac{1}{8}$ " | 3 $\frac{1}{2}$ " |
| File | 14 $\frac{9}{32}$ " | 15 $\frac{1}{8}$ " | 9 $\frac{1}{4}$ " |
| Lat File | 32 $\frac{3}{32}$ " | 15 $\frac{1}{16}$ " | 9 $\frac{1}{4}$ " |

Model

65-2430LF2 65-2430MF

Drawers

| | W | L | D |
|----------|---------------------|---------------------|--------------------|
| Box | 11 $\frac{5}{16}$ " | 16 $\frac{3}{16}$ " | 3 $\frac{1}{2}$ " |
| File | 12 $\frac{1}{8}$ " | 16 $\frac{3}{16}$ " | 9 $\frac{5}{16}$ " |
| Lat File | 26 $\frac{3}{32}$ " | 15 $\frac{1}{16}$ " | 9 $\frac{1}{4}$ " |

INTERIOR DRAWER DIMENSIONS (CONTINUED)

Models

| | | |
|-------------|-------------|-------------|
| 65-2418PD2 | 65-2451WD2L | 65-1884WFO |
| 65-3018PD2 | 65-2451WD2R | 65-1872DS2L |
| 65-3618PD2 | 65-1884DS2L | 65-1872DS2R |
| 65-2484WD2L | 65-1884DS2R | 65-1872WFL |
| 65-2484WD2R | 65-1884WFL | 65-1872WFR |
| 65-2472WD2L | 65-1884WFR | 65-1872WFO |
| 65-2472WD2R | | |

| Drawer | W | L | D |
|--------|-----------------------------------|----------------------------------|----------------------------------|
| File | 14 ⁹ / ₃₂ " | 15 ¹ / ₈ " | 9 ⁵ / ₁₆ " |

Models

| | | |
|-------------|-------------|-------------|
| 65-3018PD1 | 65-2451WD1R | 65-1884WBO |
| 65-2484WD1L | 65-2418PD1 | 65-1872DS1L |
| 65-2484WD1R | 65-1884DS1L | 65-1872DS1R |
| 65-2472WD1L | 65-1884DS1R | 65-1872WBL |
| 65-2472WD1R | 65-1884WBL | 65-1872WBR |
| 65-2451WD1L | 65-1884WBR | 65-1872WBO |

| Drawers | W | L | D |
|---------|-----------------------------------|----------------------------------|----------------------------------|
| Box | 14 ⁹ / ₃₂ " | 15 ¹ / ₈ " | 3 ¹ / ₂ " |
| File | 14 ⁹ / ₃₂ " | 15 ¹ / ₈ " | 9 ⁵ / ₁₆ " |

Models

| | | |
|------------|--------------|------------|
| 65-2415PD2 | 65-2515SHPD2 | 65-1519MP2 |
|------------|--------------|------------|

| Drawer | W | L | D |
|--------|----------------------------------|-----------------------------------|-----------------------------------|
| File | 12 ¹ / ₈ " | 16 ³ / ₁₆ " | 9 ¹⁵ / ₁₆ " |

Models

| | | |
|-----------|-----------|-----------|
| 65-2430L4 | 65-2430L3 | 65-2430L2 |
|-----------|-----------|-----------|

| Drawer | W | L | D |
|----------|------------------------------------|----------------------------------|----------------------------------|
| Lat File | 25 ¹⁷ / ₃₂ " | 15 ¹ / ₈ " | 9 ⁷ / ₃₂ " |

Models

| | | |
|-----------|-----------|-----------|
| 65-2472RL | 65-2472DL | 65-2436L3 |
| 65-2472LL | 65-2436L4 | 65-2436L2 |

| Drawer | W | L | D |
|----------|----------------------------------|----------------------------------|----------------------------------|
| Lat File | 31 ¹ / ₂ " | 15 ¹ / ₈ " | 9 ⁷ / ₃₂ " |

Model

65-1622CD

| Drawer | W | L | D |
|--------|------------------------------------|------------------------------------|---------------------------------|
| Center | 18 ¹⁵ / ₁₆ " | 14 ¹⁵ / ₁₆ " | 1 ³ / ₄ " |

FILING CAPABILITIES

Drawers with Dimensions: 11¹/₁₆"W x 16³/₁₆"L

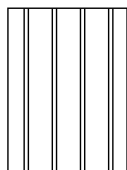

Letter or Legal Side to Side

Drawers with Dimensions: 12¹/₈"W x 16³/₁₆"L

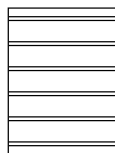

Letter Front to Back

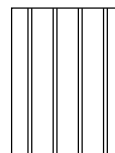

Legal Side to Side

Drawers with Dimensions: 14⁹/₃₂"W x 15¹/₈"L

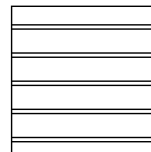

Letter Front to Back

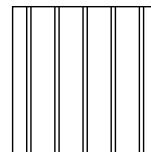

Legal Side to Side

Drawers with Dimensions: 25¹⁷/₃₂"W x 15¹/₈"L

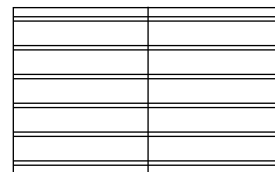

2 Rows Letter Front to Back

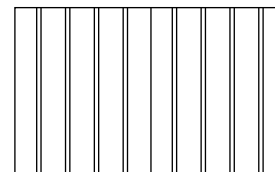

1 Row Letter or Legal Side to Side

Drawers with Dimensions: 26³/₃₂"W x 15¹/₈"L

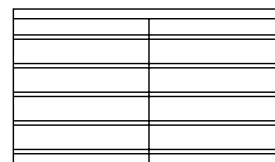

2 Rows Letter Front to Back

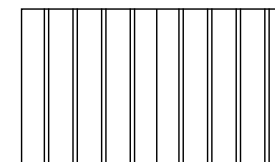

1 Row Legal Side to Side

Drawers with Dimensions: 31¹/₂"W x 15¹/₈"L

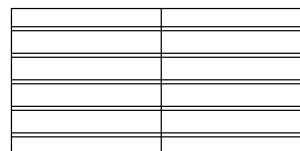

2 Rows Letter or Legal Front to Back

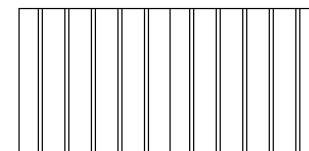

1 Row Letter or Legal Side to Side

Drawers with Dimensions: 32³/₃₂"W x 15¹/₈"L

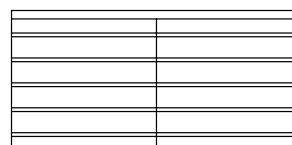

2 Rows Letter Front to Back

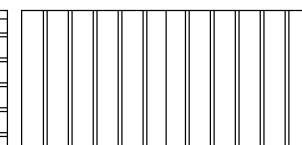

1 Row Legal Side to Side

HOW TO ORDER EXAMPLES
DESK WITH CREDENZA & HUTCH

| | QTY | MODEL NO. | DESCRIPTION | EXAMPLE |
|-----------------|-----|-------------|--------------------------------------|------------|
| DESK | 1 | 67-3672DPS | Top Material | P |
| | | | Finish | WC |
| | | | Edge Profile | X |
| | | | Drawer Construction | DOV |
| | | | Drawer Track | SFTCL |
| | | | Grain Direction | VERTICAL |
| | | | Modesty Panel | 65-HGAF |
| | | | Modesty Color | GPA |
| | | | Grommet Location/ Wire Management | GL |
| | | | Grommet Color | BLK |
| | | | Power/Data | DOCK950B-R |
| | | | Pull/Color | CFL |
| | | | Keyboard Option | N/A |
| CREDENZA | 1 | 67-2472KC | Top Material | P |
| | | | Finish | WC |
| | | | Edge Profile | X |
| | | | Drawer Construction | DOV |
| | | | Drawer Track | SFTCL |
| | | | Drawer Color | WC |
| | | | Grain Direction | VERTICAL |
| | | | Pull/Color | CFL |
| | | | Back Panel Grommet | SVR |
| | | | Grommets | LR |
| | | | Power/Data | NONE |
| | | | Grommet Color | SVR |
| | | | Keyboard Option | N/A |
| HUTCH | 1 | 65-1572TWDS | Finish | WC |
| | | | Door Style | HGA |
| | | | Door Color | GPA |
| | | | Locking | NO |
| | | | Paper Slot Color | WC |
| | | | Paper Slot Divider | CHROME |

STUDIO DESK

| | QTY | MODEL NO. | DESCRIPTION | EXAMPLE |
|-----------------|-----|-----------|---------------------|------------------|
| DESK TOP | 1 | 65-3672TP | Top Material | P |
| | | | Finish | WTA |
| | | | Edge Profile | Y |
| | | | Grommet | GL |
| | | | PDC Type | 01-DUO BEZELW |
| | | | PDC Location | PDC-C |
| | | | Grommet Color | BLK |
| | | | PEDESTAL | 2 |
| | | | Grain Direction | VERTICAL |
| | | | Pull/Color | CST |
| | | | Drawer Construction | DOV |
| | | | Drawer Track | SFTCL |
| | | | Wire Management | NONE |

STUDIO DESK (CONTINUED)

| | QTY | MODEL NO. | DESCRIPTION | EXAMPLE |
|----------------|-----|--------------|---------------|---------|
| MODESTY | 1 | 65-3624MDHGA | HGA Color | WMA |
| | | | Grommet | GRMT |
| | | | Grommet Color | BLK |
| LEGS | 2 | 01-0404SL4 | Color | CHRM |

HEIGHT ADJUSTABLE

| | QTY | MODEL NO. | DESCRIPTION | EXAMPLE |
|-------------|-----|--------------|-------------------------|----------|
| DESK | 1 | 67-3672LPSTS | Top Material | P |
| | | | Top Color | SBP |
| | | | Edge Profile | X |
| | | | Chassis Color | WTA |
| | | | Drawer Color | WTA |
| | | | Grain Direction | VERTICAL |
| | | | Pull/Color | CFL |
| | | | Drawer | DOV |
| | | | Construction | |
| | | | Drawer Track | SFTCL |
| | | | Moving Modesty | MOVMOD |
| | | | Height Adjust Switch | MSWCH |
| | | | Wire Management | GL |
| | | | Grommet Color | BLK |

| | | | | |
|---------------|---|---------------|-------------------------|-------|
| BRIDGE | 1 | 67-2448LF2STS | Top Material | P |
| | | | Top Color | SBP |
| | | | Edge Profile | X |
| | | | Chassis Color | WTA |
| | | | Height Adjust Switch | MSWCH |
| | | | Wire Management | GR |
| | | | Grommet Color | SLV |
| | | | Modesty | GMBSV |
| | | | Grommet/Color | |

| | | | | |
|---------------------------|-------|---------------|-------------------------|----------|
| CREDENZA RIGHT | 1 | 67-2472RC2STS | Top Material | P |
| | | | Top Color | SBP |
| | | | Edge Profile | X |
| | | | Chassis Color | WTA |
| | | | Drawer Color | WTA |
| | | | Grain Direction | VERTICAL |
| | | | Pull/Color | CFL |
| | | | Drawer | DOV |
| | | | Construction | |
| | | | Drawer Track | SFTCL |
| | | | Height Adjust Switch | MSWCH |
| | | | Wire Management | GL |
| | | | Grommet Color | SLV |
| Modesty | GMBSV | | | |
| Grommet/Color | | | | |

VENEER (W) OPTIONS

Veneer features UVAdvantage, an ultra-violet finish, on all exposed surfaces by utilizing roll-coat UV technology.

| | | | |
|-----|--------------------|-----|---------------------|
| AW | Artisan Walnut | MW | Mahogany Walnut |
| AS | Asian Night | MAS | Mesa Sunset* |
| CO | Columbian Walnut | MTS | Metropolis Sky |
| DC | Dark Cherry | ORW | Oak Riftwood* |
| DFW | Dark Forest Walnut | PNW | Pinnacle Walnut |
| EW | Espresso | SCH | Select Cherry |
| FO | Fawn Oak* | SKC | Shaker Cherry |
| GC | Golden Cherry | SM | Sugar Maple |
| HW | Harvest Walnut | WTA | Weathered Ash* |
| HNW | Henna Walnut | WC | Williamsburg Cherry |
| LW | Legacy Walnut | | |

* Finish is Low Sheen

HPL (P) LAMINATE OPTIONS

WOODGRAIN

| | | | |
|-----|------------------|-----|---------------------|
| AS | Asian Night | PNW | Pinnacle Walnut |
| CO | Columbian Walnut | SCH | Select Cherry |
| EF | Espresso | SKC | Shaker Cherry |
| GC | Golden Cherry | SM | Sugar Maple |
| MW | Mahogany Walnut | WTA | Weathered Ash |
| ORW | Oak Riftwood | WC | Williamsburg Cherry |

1½" thick tops also available in above HPL colors only. Top thickness will affect overall height of other units such as surface mounted hutches. Please contact Customer Service or your local Sales Representative for pricing and extended lead times.

EDGE PROFILES

| | | | |
|---|-------------|---|--------|
| F | Double Kerf | X | Flute |
| G | Duo | Y | Square |



Double Kerf (F) Duo (G) Flute (X) Square (Y)

METAL FINISH OPTIONS

| | |
|------|--|
| ALUM | Aluminum |
| BLK | Black (Height Adjustable, Studio Components) |
| CHRM | Chrome |

ACRYLIC OPTIONS

| | | | |
|------|----------------------------------|-----|-----------------------------|
| FSTA | Frosted Acrylic | BLA | Black High Gloss Acrylic |
| WHA | White High Gloss Acrylic | GPA | Graphite High Gloss Acrylic |
| WMA | Wired Mercury High Gloss Acrylic | | |

PULL OPTIONS

Lock core color is predetermined by pull color.

| | | | |
|-----|------------------|-----|------------------|
| AAV | Alcove, Aluminum | BEL | Elite, Black |
| CAV | Alcove, Chrome | AFL | Flair, Aluminum |
| AAC | Arc, Aluminum | CFL | Flair, Chrome |
| BAC | Arc, Black | AFC | Focus, Aluminum |
| ABM | Beam, Aluminum | BFC | Focus, Black |
| BBM | Beam, Black | AQD | Quadra, Aluminum |
| BBT | Bow Tie, Black | BQD | Quadra, Black |
| NBT | Bow Tie, Nickel | AST | Studio, Aluminum |
| ABU | Buckle, Aluminum | BST | Studio, Black |
| BBU | Buckle, Black | CST | Studio, Chrome |
| AEL | Elite, Aluminum | GST | Studio, Gold |



DRAWER CONSTRUCTION OPTIONS

Drawers come standard with woodgrain vinyl-wrapping and mitered corners. Optional wood dovetail construction for all box, file, and lateral file drawers is available. Must Specify when ordering.

Pricing is per Drawer, not per Model/Unit

| | | |
|-------|-----------------------------|-------|
| MITER | Mitered Fold Construction | STD |
| DOVE | Wood Dove Tail Construction | \$ 45 |

DRAWER TRACK OPTIONS

Soft close tracks are available on box and file drawers only. Soft close drawer tracks have many benefits including reduced stress on the unit, extends the life of the drawer, and ensures a gentle close so fingers don't accidentally get hurt. **File drawers with the soft close option feature front-to-back filing.** Must specify when ordering.

Pricing is per Drawer, not per Model/Unit

| | | |
|-------|---|-------|
| SFTCL | Soft Close Drawer Track (Box & File Drawers Only) | \$ 34 |
|-------|---|-------|

LOCK CORE COLOR OPTIONS

| | |
|-----|--|
| BLK | Black (Used with Black and Gold Pulls) |
| SLV | Silver (Used with Aluminum and Chrome Pulls) |



Black (BLK) Silver (SLV)

Grommet options on next page.

GROMMET OPTIONS & POWER UNIT LOCATIONS

Note: Wire Management Options for Integrated and Modular Height Adjustable Models may be found in their specific area within this section.

Grommets are standard in the back panels of returns, bridges, and credenzas, and may be ordered without grommets at no additional charge. Please specify NO GROMMET on order.

Grommets are available on hutches in standard locations for task light management at no additional charge. Please specify WMHUBL (Black) or WMHUSV (Silver).

Power units, Dock 950 and Dock 150 must be specified separately with surface mount location. Dock 950 and Dock 150 are available on Modular Benching Desk Tops, Modular Cabinet Tops, Work Tables, and Media Peninsula Tops, and where otherwise noted.

Grommets are available in standard locations. Please specify using info below. Multiple locations may be selected. Only one unit per location.

GROMMET LOCATIONS (Black = BLK and Silver = SLV)

| | | | |
|-----|--|----|----|
| GC | Grommet, Center | \$ | 52 |
| GL | Grommet, Left | \$ | 52 |
| GR | Grommet, Right | \$ | 52 |
| GAL | Grommet, Approach Left - D-Tops Only | \$ | 52 |
| GAR | Grommet, Approach Right - D-Tops Only | \$ | 52 |
| GSL | Grommet, Seat Side Left - D-Tops Only | \$ | 52 |
| GSR | Grommet, Seat Side Right - D-Tops Only | \$ | 52 |

DUO/TRIO BEZEL LOCATIONS

| | |
|-------|---------------|
| PDC-C | Bezel, Center |
| PDC-L | Bezel, Left |
| PDC-R | Bezel, Right |

DOCK 950 and DOCK 150 LOCATIONS (See Dock Units)

| | | | |
|-----------|---------------------------------------|----|-----|
| DOCK950-L | D950 Wireless Charger, Left | \$ | 265 |
| DOCK950-C | D950 Wireless Charger, Center | \$ | 265 |
| DOCK950-R | D950 Wireless Charger, Right | \$ | 265 |
| DOCK150-L | D150 Wireless and USB Charger, Left | \$ | 405 |
| DOCK150-C | D150 Wireless and USB Charger, Center | \$ | 405 |
| DOCK150-R | D150 Wireless and USB Charger, Right | \$ | 405 |

Verify Grommet Option is available on the model(s) you are specifying using the following location information. Grommets, Power Units, Dock 950 and Dock 150 may be ordered in non-standard locations. Call Customer Service to assist with specification and/or please attach a drawing to the PO showing the location of the grommet. Note additional charges and lead times may apply.

Models

| | | |
|-------------|-------------|------------|
| 67-4872CBLP | 67-3672BLPS | 67-3672BDP |
| 67-4872CBRP | 67-3672BRPS | 67-3666BDP |
| 67-3672BDPS | 67-3672BRP | 67-3672BLP |

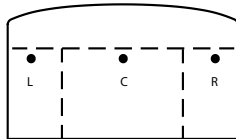

GL/GR: Located 6" from ends and 22½" from user side
GC: Located 22½" from user side

Models

| | | |
|------------|------------|------------|
| 67-4272CLP | 67-3672RPS | 65-3672SH* |
| 67-4272CRP | 67-3672LP | 65-3666SH* |
| 67-3672DPS | 67-3672RP | 65-3660SH* |
| 67-3672LPS | 67-3672DP | |

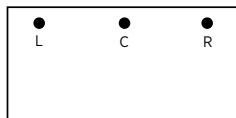

GL/GR: Located 6" from ends and 22½" from user side
GC: Located 22½" from user side

*PDC-L/PDC-R/DOCK950-L/DOCK950-R/DOCK150-L/DOCK150-R/PDC-C/DOCK950-C/DOCK150-C available only on Shell (SH) units in same locations

Models

| | | |
|-----------|-----------|------------|
| 67-3072DP | 67-3060RP | 65-3072SH* |
| 67-3066DP | 67-3066LP | 65-3066SH* |
| 67-3060DP | 67-3066RP | 65-3060SH* |
| 67-3060LP | 67-3072RP | 67-3072LP |

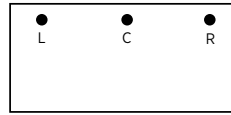

GL/GR: Located 6" from ends and 22½" from user side

GC: Located 22½" from user side

*PDC-L/PDC-R/DOCK950-L/DOCK950-R/DOCK150-L/DOCK150-R/PDC-C/DOCK950-C/DOCK150-C available only on Shell (SH) units in same locations

Models

| | | |
|------------|-------------|------------|
| 67-2448LF1 | 65-2448UF | 67-4824LF1 |
| 67-2448RF1 | 65-2448UFH | 67-4824RF1 |
| 67-2448LF2 | 65-2442UF | 67-4824LF2 |
| 67-2448RF2 | 65-2442UFH | 67-4824RF2 |
| 67-2442LF1 | 65-2448RSHL | 67-4224LF1 |
| 67-2442RF1 | 65-2448RSHR | 67-4224RF1 |
| 67-2442LF2 | 65-2442RSHL | 67-4224LF2 |
| 67-2442RF2 | 65-2442RSHR | 67-4224RF2 |
| 65-2436UF | 65-2436UFH | |

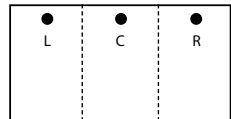

GL/GR: Located 6" from ends and 20" from user side

GC: Located 20" from user side

Models

| | | |
|------------|-----------|------------|
| 65-2472LMR | 65-2472LL | 65-2472RMF |
| 65-2472RMR | 65-2472RL | 65-2472LMF |
| 65-2466LL | 65-2466RL | 65-2466LMF |
| 65-2466RMF | | |

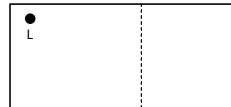

GL/GR: Located 6" from ends and 20" from user side

Grommets are only available on opposite side of pedestal

Models

| | | |
|------------|------------|------------|
| 67-2472KC | 67-2472RC2 | 67-2466RC1 |
| 67-2472LC1 | 67-2466KC | 67-2466LC2 |
| 67-2472RC1 | 67-2466LC1 | 67-2466RC2 |
| 67-2472LC2 | | |

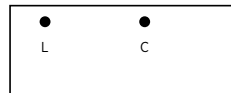

GL/GR: Located 6" from ends and 20" from user side

GC: Located 20" from user side

Models

| | | |
|-----------|-----------|-----------|
| 65-2472SH | 65-2466SH | 65-2460SH |
|-----------|-----------|-----------|

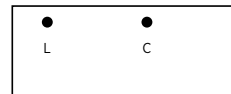

GL/GR/DOCK950-L/DOCK950-R/DOCK150-L/DOCK150-R: Located 6" from ends and 20" from user side

GC/DOCK950-C/DOCK150-C: Located 20" from user side

PDC-L/PDC-R: Located 6" from ends and 21" from user side

PDC-C: Located 21" from user side

GROMMET OPTIONS & POWER UNIT LOCATIONS (CONTINUED)

Models

65-2048UF 65-2042UF 65-2036UF
65-2048UFH 65-2042UFH 65-2036UFH

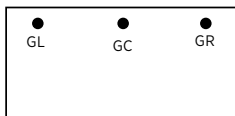

GL/GR: Located 6" from ends and 16" from user side
GC: Located 16" from user side

Models

65-2472L21DBF 65-2472L21OBFR 65-2472L21DO
65-2460L21DBF 65-2460L21OBFL 65-2460L21DO
65-2472L21OBFL 65-2460L21OBFR

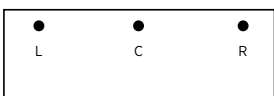

PDC-L/PDC-R: Located 11" from ends and 21½" from user side
PDC-C: Located 21½" from user side
GL/GR/DOCK950-L/DOCK950-R/DOCK150-L/DOCK150-R: Located 6" from ends and 20" from user side
GC/DOCK950-C/DOCK150-C: Located 20" from user side

Models

65-2072L21DBF 65-2072L21OBFR 65-2060L21OBFR
65-2060L21DBF 65-2060L21OBFL 65-2072L21DO
65-2072L21OBFL 65-2060L21DO

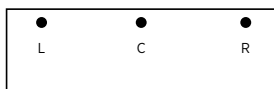

PDC-L/PDC-R: Located 11" from ends and 17½" from user side
PDC-C: Located 17½" from user side
GL/GR/DOCK950-L/DOCK950-R/DOCK150-L/DOCK150-R: Located 6" from ends and 16" from user side
GC/DOCK950-C/DOCK150-C: Located 16" from user side

Models

65-4284PR 65-4272PR
65-4284TR 65-4272TR

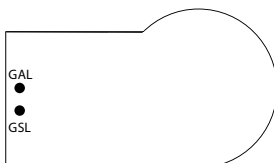

GAL/GSL: Located 12" from approach or seated side and 6" from end

Models

65-4284PL 65-4272PL
65-4284TL 65-4272TL

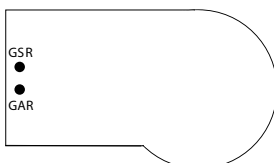

GAR/GSR: Located 12" from approach or seated side and 6" from end

Models

65-4272EDR

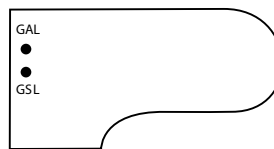

GAL: Located 12" from approach, 6" from end
GSL: Located 18" from approach, 6" from end

Model

65-4272EDL

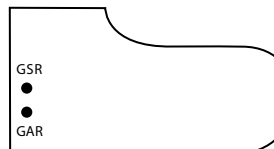

GAR: Located 12" from approach, 6" from end
GSR: Located 18" from approach, 6" from end

Models

65-3684DUR 65-3084DUR 65-3066DUR
65-3672DUR 65-3072DUR

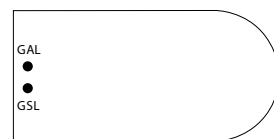

GAL/GSL: Located 12" from approach or seated side and 6" from end

Models

65-3684DUL 65-3672DR 65-3066DUL
65-3672DUL 65-3084DUL 65-3066DR
65-3684DR 65-3072DUL

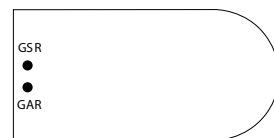

GAR/GSR: Located 12" from approach or seated side and 6" from end

MODULAR DESK TOPS

Models

65-3684TP 65-3648TP 65-3066TP
65-3678TP 65-3642TP 65-3060TP
65-3672TP 65-3084TP 65-3054TP
65-3666TP 65-3078TP 65-3048TP
65-3660TP 65-3072TP 65-3042TP
65-3654TP

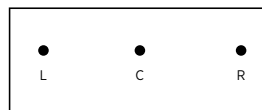
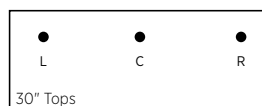
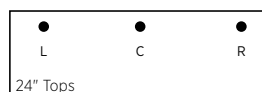

GL/GR/PDC-L/PDC-R/DOCK950-L/DOCK950-R/DOCK150-L/DOCK150-R: Located 11" from ends and 22½" from user side
GC/DOCK950-C/DOCK150-C: Located 22½" from user side

Additional grommet options on next page.

GROMMET OPTIONS & POWER UNIT LOCATIONS (CONTINUED)

MODULAR CABINET TOPS

Models

| | | |
|------------|-----------|-----------|
| 65-24108TP | 65-2478TP | 65-2448TP |
| 65-24102TP | 65-2472TP | 65-2442TP |
| 65-2496TP | 65-2466TP | 65-2436TP |
| 65-2490TP | 65-2460TP | 65-2430TP |
| 65-2484TP | 65-2454TP | |

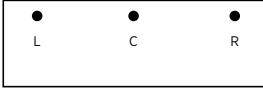

PDC-L/PDC-R: Located 11" from ends and 21½" from user side

PDC-C: Located 21½" from user side

GL/GR/DOCK950-L/DOCK950-R/DOCK150-L/DOCK150-R: Located 11" from ends and 20" from user side

GC/DOCK950-C/DOCK150-C: Located 20" from user side

Models

| | | |
|------------|-----------|-----------|
| 65-20108TP | 65-2078TP | 65-2048TP |
| 65-20102TP | 65-2072TP | 65-2042TP |
| 65-2096TP | 65-2066TP | 65-2036TP |
| 65-2090TP | 65-2060TP | 65-2030TP |
| 65-2084TP | 65-2054TP | |

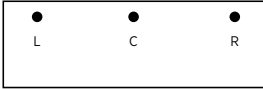

PDC-L/PDC-R: Located 11" from ends and 17½" from user side

PDC-C: Located 17½" from user side

GL/GR/DOCK950-L/DOCK950-R/DOCK150-L/DOCK150-R: Located 11" from ends and 16" from user side

GC/DOCK950-C/DOCK150-C: Located 16" from user side

Model

65-2418TP

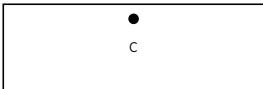

PDC-C: Located 21½" from user side

GC/DOCK950-C/DOCK150-C: Located 20" from user side

Model

65-2018TP

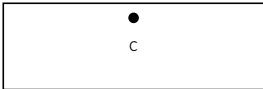

PDC-C: Located 17½" from user side

GC/DOCK950-C/DOCK150-C: Located 16" from user side

WORK TABLES

Models

| | | |
|------------|------------|------------|
| 65-4896WT | 65-4860CWT | 65-4260TWT |
| 65-4896TWT | 65-4296WT | 65-4260CWT |
| 65-4896CWT | 65-4296TWT | 65-3696TWT |
| 65-4884WT | 65-4296CWT | 65-3696CWT |
| 65-4884TWT | 65-4284WT | 65-3684TWT |
| 65-4884CWT | 65-4284TWT | 65-3684CWT |
| 65-4872WT | 65-4284CWT | 65-3672TWT |
| 65-4872TWT | 65-4272WT | 65-3672CWT |
| 65-4872CWT | 65-4272TWT | 65-3660TWT |
| 65-4860WT | 65-4272CWT | 65-3660CWT |
| 65-4860TWT | 65-4260WT | |

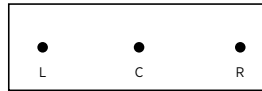

42" Work Tables

GL/GR/PDC-L/PDC-R/DOCK950-L/DOCK950-R/DOCK150-L/DOCK150-R: Located 6" from ends and 21" from user side

GC/PDC-C/DOCK950-C/DOCK150-C: Located 21" from user side

48" Work Tables

GL/GR/PDC-L/PDC-R/DOCK950-L/DOCK950-R/DOCK150-L/DOCK150-R: Located 6" from ends and 24" from user side

GC/PDC-C/DOCK950-C/DOCK150-C: Located 24" from user side

36" Work Tables

GL/GR/PDC-L/PDC-R/DOCK950-L/DOCK950-R/DOCK150-L/DOCK150-R: Located 6" from ends and 18" from user side

GC/PDC-C/DOCK950-C/DOCK150-C: Located 18" from user side

Models

| | | |
|------------|------------|------------|
| 65-2496WT | 65-2484TWT | 65-2472CWT |
| 65-2496TWT | 65-2484CWT | 65-2460WT |
| 65-2496CWT | 65-2472WT | 65-2460TWT |
| 65-2484WT | 65-2472TWT | 65-2460CWT |

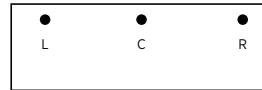

GL/GR/PDC-L/PDC-R/DOCK950-L/DOCK950-R/DOCK150-L/DOCK150-R: Located 6" from ends and 21½" from user side

GC/PDC-C/DOCK950-C/DOCK150-C: Located 21½" from user side

MODULAR BENCHING DESK TOPS

Models

| | | |
|-----------|-----------|-----------|
| 65-6072TP | 65-6066TP | 65-6060TP |
|-----------|-----------|-----------|

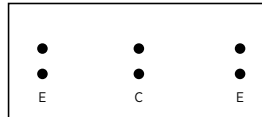

E = 11" from end
C = 25¼" from user

Only one style of unit per location.

Locations:

- 1C: 2 Center Cutouts
- 1E: 2 End Cutouts
- 2E: 4 End Cutouts
- C1E: 2 Center and 2 End Cutouts
- C2E: 2 Center and 4 End Cutouts

Models

| | | |
|-----------|-----------|-----------|
| 65-4872TP | 65-4866TP | 65-4860TP |
|-----------|-----------|-----------|

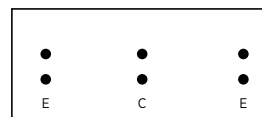

E = 11" from end
C = 19¾" from user

Only one style of unit per location.

Locations:

- 1C: 2 Center Cutouts
- 1E: 2 End Cutouts
- 2E: 4 End Cutouts
- C1E: 2 Center and 2 End Cutouts
- C2E: 2 Center and 4 End Cutouts

GROMMET OPTIONS & POWER UNIT LOCATIONS (CONTINUED)

Models

65-3672MPS
65-3672MP

65-3066MPS
65-3066MP

65-3060MPS
65-3060MP

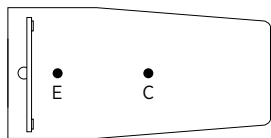

E = 12" from monitor end
C = Centered

DUO/TRIO BEZEL, Dock 950 and Dock 150. Only one style of unit per location.

Locations:

- C: Center Cutout
- E: End Cutout
- EC: End and Center Cutouts

GALLERY SCREENS

51" and 42" Gallery Screens

- DGL: Desk Height Left; 6" from ends and 25/4" from bottom
- DGR: Desk Height Right; 6" from ends and 25/4" from bottom
- DGC: Desk Height Center; 25/4" from bottom
- BGL: Bench Height Left; 6" from ends and 15" from bottom
- BGR: Bench Height Right; 6" from ends and 15" from bottom
- BGC: Bench Height Center; 15" from bottom

30" Gallery Screens

- BGL: Bench Height Left; 6" from ends and 15" from bottom
- BGR: Bench Height Right; 6" from ends and 15" from bottom
- BGC: Bench Height Center; 15" from bottom

HEIGHT ADJUSTABLE MECHANISMS

Height Adjust method that increases user kneespace, offers more stability for overall unit and top construction, and two worksurfaces can move from sitting to standing simultaneously with or without moving modesty panel.

- Maximum height is 45"
- Recommended load capacity of 180lbs
- Gently adjust worksurface with a 1 second stop at each memory position
- Two leg configuration options include the standard 2-channel for Desks, Desk Shells, D-top and P-Top units for one height adjustable worksurface or 3-channel option for two height adjustable worksurfaces to raise simultaneously
- Two height adjustable switches available. Standard up/down switch (SWCH) and advanced switch features Bluetooth capabilities, three stand-up reminder intervals and four height memory positions (MSWCH)
- Moving Modesty (MOVMOD) option creates a clean aesthetic when seated or standing
- Height adjust control switch is factory installed on all units except Desk Shells, Bridges or 3-Channel units
- Bridges, returns, and credenzas will have an optional grommet on the back panel
- Black wire management mesh wrap included when worksurface grommet is selected
- Black wire management mesh wrap is made of polyester braided fabric, 10' long, expands up to 1 3/4"
- Grommets and one Latch Duct wire management channel provided within kneespace to manage wires from switch and control box. Two Latch Duct wire management channels will be shipped with Desk Shells

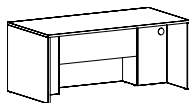

Height Adjustable User Side

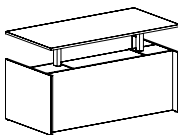

2-channel Configuration

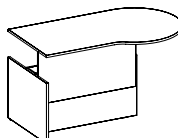

Moving Modesty



Black wire management mesh sleeve

HEIGHT ADJUST LEG CONFIGURATION

The 2-channel leg configuration is standard on height adjustable Desks, Desk Shells, D-top and P-Top units for one height adjustable worksurface. Select models offer an optional 3-channel leg configuration for use with 3-channel Returns to allow two worksurfaces to raise and lower simultaneously.

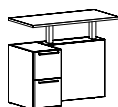

2-channel Configuration
Raise Single Surface

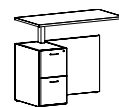

3-channel Configuration
Raise Multiple Surface

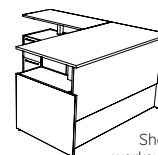

Shown with two worksurfaces raised and optional moving modesty.

| | | |
|------|--|--------|
| STS2 | 2-channel configuration (for one height adjustable worksurface) | STD |
| STS3 | 3-channel configuration (for two height adjustable worksurfaces) | \$ N/C |

HEIGHT ADJUST MOVING MODESTY PANEL

Height adjustable moving modesty panel available on double and single pedestal, D-top and P-Top desks. Moving modesty panels offer a clean aesthetic when seated or standing while giving more privacy to the user.

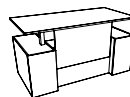

Stepped Front Desk with Moving Modesty

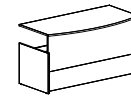

Recessed Front Desk with Moving Modesty

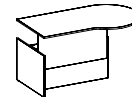

P-Top with Moving Modesty

| | | |
|--------|----------------------|--------|
| MOVMOD | Moving Modesty Panel | \$ 219 |
|--------|----------------------|--------|

HEIGHT ADJUST MODESTY PANEL GROMMET

Height adjustable credenza, bridge and return units feature a modesty panel grommet option for accessing power to a wall.

2-Channel units feature grommet centered on modesty only, 3" down from top. 3-Channel units feature grommets centered on pedestal only, 3" down from top.

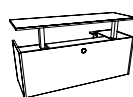

Credenza with Modesty Grommet

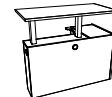

2-Channel Return with Modesty Grommet

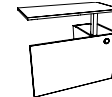

3-Channel Return with Modesty Grommet

| | | |
|-------|------------------------|--------|
| GMBBL | Black Modesty Grommet | \$ N/C |
| GMBSV | Silver Modesty Grommet | \$ N/C |

HEIGHT ADJUST SWITCH CONTROL OPTIONS

Height adjust units offer two switch options. The standard switch is a simple up and down paddle style switch to move your worksurface from seated to standing height. The advanced switch features Bluetooth capabilities to connect to smart devices, three stand-up reminder intervals and four height adjustment memory positions.

| | | |
|-------|------------------------------|--------|
| SWCH | Standard Up/Down Switch | STD |
| MSWCH | Advanced Up/Down with Memory | \$ 135 |



SWCH (standard)



MSWCH

Height adjustable grommet options on next page.

HEIGHT ADJUST GROMMET OPTIONS & POWER UNIT LOCATIONS

Ports, Locations and Wire Management:

- One data or wire management location per unit
- Order the port and then specify the location

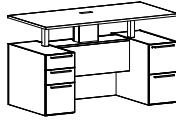

Shown with Wire Management Box with Grommet

Wire Management Box with Center Grommet Add \$ 485

Specify Location and Grommet Color (Black = BLK or Silver = SLV)

| Specify | Units | Locations |
|---------|-------------------------|-----------|
| GC-BOX | Desks/Credenzas/Bridges | Center |
| GC-BOX | Return (2-Channel Only) | Center |

Grommet with Mesh Sleeve Add \$ 142

Specify Location and Grommet Color (Black = BLK or Silver = SLV)

| Specify | Units | Locations |
|-----------|-------------------------|-----------------------|
| GL-MESH | Desks/Credenzas/Return | Left |
| GR-MESH | Desks/Credenzas/Return | Right |
| GC-MESH | Desks/Credenzas/Bridges | Center |
| GCKS-MESH | Return/Return Shell | Centered Between Legs |

Wire Management Box with DUOBEZEL Add \$ 1398

| Units | Locations |
|-------------------------|-----------------------|
| Desks/Credenzas/Bridges | Center |
| Return | Centered Between Legs |

Specify

| | |
|--------------|-----------------|
| 01-DUOBEZELB | DUOBEZEL Black |
| 01-DUOBEZELS | DUOBEZEL Silver |
| 01-DUOBEZELW | DUOBEZEL White |

Wire Management Box with TRIOBEZEL Add \$ 1452

| Units | Locations |
|-------------------------|-----------------------|
| Desks/Credenzas/Bridges | Center |
| Return | Centered Between Legs |

Specify Color

| | |
|---------------|------------------|
| 01-TRIOBEZELB | TRIOBEZEL Black |
| 01-TRIOBEZELS | TRIOBEZEL Silver |
| 01-TRIOBEZELW | TRIOBEZEL White |

Port Options for TRIOBEZEL - Must Specify Add

| | | |
|-------------|-----------------------------------|--------|
| 01-LCOMVGA | VGA Date Port | \$ 121 |
| 01-LCOMHDMI | HDMI Data Port (Open Market Only) | \$ 166 |
| 01-LCOMRJ45 | RJ45 Data Port | \$ 79 |

Wire Management Box with DPORT4 Add \$ 1755

| Units | Locations |
|-------------------------|-----------------------|
| Desks/Credenzas/Bridges | Center |
| Return | Centered Between Legs |

Specify Color

| | |
|------------|----------------|
| 01-DPORT4A | DPORT Aluminum |
| 01-DPORT4B | DPORT Black |

Port Options for DPORT - Must Specify Add

| | | |
|------------|---------------|--------|
| 01-USBPORT | USB Port | \$ 161 |
| 01-VOICE1 | Voice Coupler | \$ 73 |
| 01-RJ4DATA | Data Port | \$ 167 |

Models

| | | |
|----------------|----------------|----------------|
| 65-2048UFSTS | 65-2042UFSTS | 65-2036UFSTS |
| 65-2048UFSTSL3 | 65-2048UFSTSR3 | 65-2042UFSTSL3 |
| 65-2042UFSTSR3 | 65-2036UFSTSL3 | 65-2036UFSTSR3 |



Center Located 16" from user side

Models

| | | |
|----------------|----------------|----------------|
| 65-2448UFSTS | 65-2442UFSTS | 65-2436UFSTS |
| 65-2448UFSTSL3 | 65-2448UFSTSR3 | 65-2442UFSTSL3 |
| 65-2442UFSTSR3 | 65-2436UFSTSL3 | 65-2436UFSTSR3 |

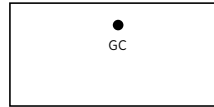

Center Located 20" from user side

Models

| | | |
|--------------|---------------|---------------|
| 65-2472SHSTS | 67-3072DPSTS | 67-2466LCISTS |
| 65-2466SHSTS | 67-2472RC2STS | 67-3066RPSTS |
| 65-2460SHSTS | 67-2472LC2STS | 67-3066LPSTS |
| 65-3072SHSTS | 67-2466RC2STS | 67-3066DPSTS |
| 65-3066SHSTS | 67-2466LC2STS | 67-3066RPSTS |
| 65-3060SHSTS | 67-2472RC1STS | 67-3066LPSTS |
| 67-3072RPSTS | 67-2472LC1STS | 67-3066DPSTS |
| 67-3072LPSTS | 67-2466RC1STS | |

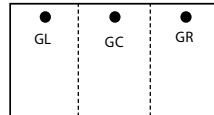

L/R: Located 6" from ends and 20" from user side
Center: Located 20" from user side

Models

| | | |
|---------------|-----------------|---------------|
| 67-4824RF2STS | 65-2448RSHRSTS* | 67-2448RF1STS |
| 67-4824LF2STS | 65-2448RSHLSTS* | 67-2448LF1STS |
| 67-4224RF2STS | 65-2442RSHRSTS* | 67-2442RF1STS |
| 67-4224LF2STS | 65-2442RSHLSTS* | 67-2442LF1STS |
| 67-2448RF2STS | 67-4824RF1STS | 67-2466KCSTS |
| 67-2448LF2STS | 67-4824LF1STS | 67-2472KCSTS |
| 67-2442RF2STS | 67-4224RF1STS | 67-4224LF1STS |
| 67-2442LF2STS | | |

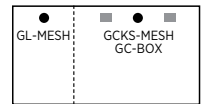

L/R: Located 6" from ends and 20" from user side
CKS: Centered between legs and 20" from user side

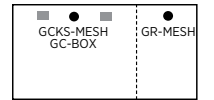

* = Only Available with Centered Grommet CKS

Models (Grommet only available in ped space)

| | | |
|----------------|----------------|----------------|
| 67-2448RF2STS3 | 67-2442LF2STS3 | 67-2442RF1STS3 |
| 67-2448LF2STS3 | 67-2448LF1STS3 | 67-2442LF1STS3 |
| 67-2442RF2STS3 | 67-2448RF1STS3 | |

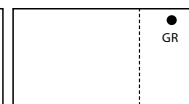
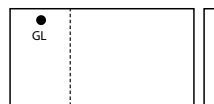

Grommet with Mesh Wire Management Sleeve only available in ped space

L/R: Located 6" from ends and 20" from user side

HEIGHT ADJUST GROMMET OPTIONS & POWER UNIT LOCATIONS (CONTINUED)

Models

| | | |
|---------------|---------------|----------------|
| 67-3672BDPSTS | 67-3672BLPSTS | 67-3672BDPSSTS |
| 67-3666BDPSTS | 67-3672BRPSTS | 67-3672BLPSSTS |
| | | 67-3672BRPSSTS |

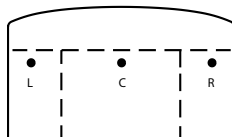

L/R: Located 6" from ends and 20" from user side
Center: Located 20" from user side

Models

| | | |
|---------------|---------------|---------------|
| 67-3672DPSTS | 67-3672RPSTS | 67-3672LPSTS |
| 67-3672DPSSTS | 67-3672RPSSTS | 67-3672LPSSTS |
| 65-3672SHSTS | 65-3666SHSTS | 65-3660SHSTS |

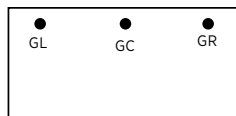

Left/Right: Located 6" from ends and 24" from user side
Center: Located 24" from user side

Models

| | | |
|---------------|---------------|--------------|
| 65-3684DURSTS | 65-3072DURSTS | 65-4284PLSTS |
| 65-3684DULSTS | 65-3072DULSTS | 65-4284PRSTS |
| 65-3672DURSTS | 65-3066DURSTS | 65-4272PLSTS |
| 65-3672DULSTS | 65-3066DULSTS | 65-4272PRSTS |
| 65-3084DURSTS | 65-3084DULSTS | |



Center: Located 18 7/8" from seated side and centered between legs

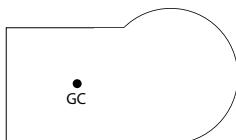

Left Unit / Center: Located 18 7/8" from seated side and centered between legs

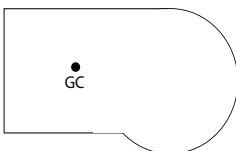

Right Unit / Center: Located 18 7/8" from seated side and centered between legs

MODULAR HEIGHT ADJUSTABLE GROMMET OPTIONS & POWER UNIT LOCATIONS

Grommets are standard in tops of cabinets and credenzas in Black (BLK) or Silver (SLV).

Grommets are available in locations shown below. Please specify and add upcharge for each grommet. Multiple locations may be selected. Only one unit per location.

GROMMET LOCATIONS (Black = BLK and Silver = SLV)

| | | | |
|----|--------------------------------------|----|----|
| GC | Grommet, Center - Specify BLK or SLV | \$ | 52 |
| GL | Grommet, Left - Specify BLK or SLV | \$ | 52 |
| GR | Grommet, Right - Specify BLK or SLV | \$ | 52 |

DUO/TRIO BEZEL LOCATIONS

| | |
|-------|---------------|
| PDC-C | Bezel, Center |
| PDC-L | Bezel, Left |
| PDC-R | Bezel, Right |

DOCK 950 and DOCK 150 LOCATIONS (See Dock Units)

| | | | |
|-----------|---------------------------------------|----|-----|
| DOCK950-L | D950 Wireless Charger, Left | \$ | 265 |
| DOCK950-C | D950 Wireless Charger, Center | \$ | 265 |
| DOCK950-R | D950 Wireless Charger, Right | \$ | 265 |
| DOCK150-L | D150 Wireless and USB Charger, Left | \$ | 405 |
| DOCK150-C | D150 Wireless and USB Charger, Center | \$ | 405 |
| DOCK150-R | D150 Wireless and USB Charger, Right | \$ | 405 |

Verify Grommet Option is available on the model(s) you are specifying using the following location information. Grommets, Power Units, Dock 950 and Dock 150 may be ordered in non-standard locations. Call Customer Service to assist with specification and/or please attach a drawing to the PO showing the location of the grommet. Note additional charges and lead times may apply.

Models

| | | |
|------------|------------|------------|
| 65-3470HTP | 65-3462HTP | 65-3456HTP |
| 65-3464HTP | 65-3458HTP | 65-2850HTP |
| 65-2870HTP | 65-2858HTP | 65-2846HTP |
| 65-2864HTP | 65-2856HTP | |
| 65-2862HTP | 65-2852HTP | |

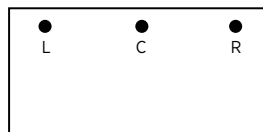

GL/GR/PDC-L/PDC-R/DOCK950-L/DOCK950-R/DOCK150-L/DOCK150-R: 18" from ends and 22 1/2" from user

GC/PDC-C/DOCK950-C/DOCK150-C: 22 1/2" from user

Models

| | | |
|------------|------------|------------|
| 65-2270HTP | 65-2258HTP | 65-2250HTP |
| 65-2264HTP | 65-2256HTP | 65-2246HTP |
| 65-2262HTP | 65-2252HTP | |

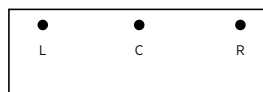

GL/GR/PDC-L/PDC-R/DOCK950-L/DOCK950-R/DOCK150-L/DOCK150-R: 18" from ends and user

GC/PDC-C/DOCK950-C/DOCK150-C: 18" from user

Models

| | | |
|-------------|-------------|-------------|
| 65-2472HDFL | 65-2472HMFR | 65-2466HMOL |
| 65-2472HDFR | 65-2472HMOL | 65-2466HMOR |
| 65-2472HMFL | 65-2472HMOR | 65-2466HMFL |
| 65-2472HDOL | 65-2466HDFL | 65-2466HMFR |
| 65-2472HDOR | 65-2466HDFR | 65-2460HDFR |
| 65-2460HDOL | 65-2466HDOL | 65-2460HDFL |
| 65-2460HDOR | 65-2466HDOR | 65-2460HMFR |
| 65-2460HMOL | 65-2460HMOR | 65-2460HMFL |

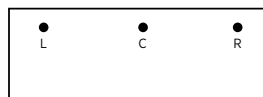

PDC-L/PDC-R: Located 11" from ends and 21 1/8" from user side

PDC-C: Located 21 1/8" from user side

GL/GR/DOCK950-L/DOCK950-R/DOCK150-L/DOCK150-R: Located 6" from ends and 20" from user side

GC/DOCK950-C/DOCK150-C: Located 20" from user side

GROMMET OPTIONS & POWER UNIT LOCATIONS

Models

| | | |
|-------------|-------------|-------------|
| 65-2072HDFL | 65-2072HMFR | 65-2066HMOL |
| 65-2072HDFR | 65-2072HMOL | 65-2066HMOR |
| 65-2072HMFL | 65-2072HMOR | 65-2066HMFL |
| 65-2072HDOL | 65-2066HDFL | 65-2066HMFR |
| 65-2072HDOR | 65-2066HDFR | 65-2060HDFR |
| 65-2060HDOL | 65-2066HDOL | 65-2060HDFL |
| 65-2060HDOR | 65-2066HDOR | 65-2060HMFR |
| 65-2060HMOL | 65-2060HMOR | 65-2060HMFL |

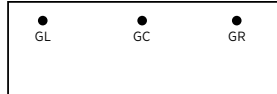

PDC-L/PDC-R: Located 11" from ends and 17½" from user side

PDC-C: Located 17½" from user side

GL/GR/DOCK950-L/DOCK950-R/DOCK150-L/DOCK150-R: Located 6" from ends and 16" from user side

GC/DOCK950-C/DOCK150-C: Located 16" from user side

Models

| | | |
|-----------|------------|------------|
| 65-2436HM | 65-2436HDL | 65-2430HDL |
| 65-2430HM | 65-2436HDR | 65-2430HDR |
| 65-2424HM | | |

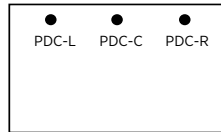

PDC-L/PDC-R: Located 11" from ends and 21½" from user side

PDC-C: Located 21½" from user side

Models

| | | |
|-----------|------------|------------|
| 65-2036HM | 65-2036HDL | 65-2030HDL |
| 65-2030HM | 65-2036HDR | 65-2030HDR |
| 65-2024HM | | |

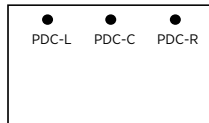

PDC-L/PDC-R: Located 11" from ends and 17½" from user side

PDC-C: Located 17½" from user side

HEIGHT ADJUSTABLE WORKSURFACE MONITOR ARM LOCATIONS

Monitor Arm Grommets are available in locations shown below. Please specify and add upcharge for each grommet. [Dual Monitor and Single Monitor Arms sold separately.](#)

Monitor Arm Grommet available in one location per unit; grommet is 2½".

MONITOR ARM GROMMET LOCATIONS

| | | | |
|---------|-------------------------|----|----|
| MGRMT-C | Monitor Grommet, Center | \$ | 52 |
| MGRMT-L | Monitor Grommet, Left | \$ | 52 |
| MGRMT-R | Monitor Grommet, Right | \$ | 52 |

Models

| | | |
|------------|------------|------------|
| 65-3470HTP | 65-3462HTP | 65-3456HTP |
| 65-3464HTP | 65-3458HTP | |

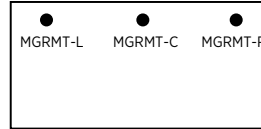

MGRMT-L/MGRMT-R: Located 18" from ends and 31" from user side

MGRMT-C: Located 31" from user side

Models

| | | |
|------------|------------|------------|
| 65-2870HTP | 65-2858HTP | 65-2850HTP |
| 65-2864HTP | 65-2856HTP | 65-2846HTP |
| 65-2862HTP | 65-2852HTP | |



MGRMT-L/MGRMT-R: Located 18" from ends and 25" from user side

MGRMT-C: Located 25" from user side

Models

| | | |
|------------|------------|------------|
| 65-2270HTP | 65-2258HTP | 65-2250HTP |
| 65-2264HTP | 65-2256HTP | 65-2246HTP |
| 65-2262HTP | 65-2252HTP | |



MGRMT-L/MGRMT-R: Located 18" from ends and 19" from user side

MGRMT-C: Located 19" from user side

LOCKING DOORS

Locking doors are available on select hinged doors. You must specify WITH LOCKING when ordering and add upcharge.

| | | | |
|--------|---------------------|----|-----|
| LKT_HU | 108"W to 84"W Units | \$ | 135 |
| LKT_HU | 78"W to 48"W Units | \$ | 115 |
| LKT_HU | 42"W to 24"W Units | \$ | 91 |
| LKT_HU | 18"W to 12"W Units | \$ | 69 |

WIRE MANAGEMENT

Wire Management openings available for modular pedestals.

| | | | |
|------|----------------------|----|-----|
| WML | Left Panel | \$ | 80 |
| WMR | Right Panel | \$ | 80 |
| WMLR | Left and Right Panel | \$ | 160 |

CERTIFICATIONS & COMPLIANCE

- Intertek Sustainability Certified
- BIFMA level® Certified
- BIFMA Compliant Certified
- TSCA Title VI (formerly CARB) Compliance
- US Green Building's LEED Contribution

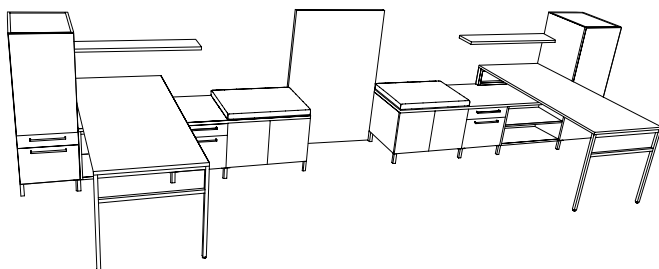
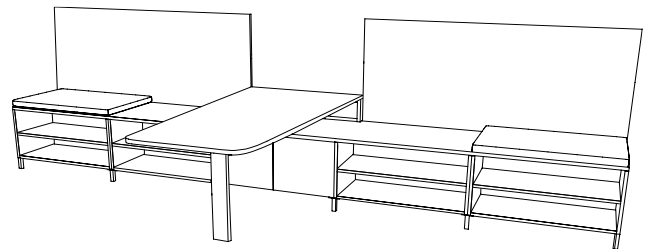
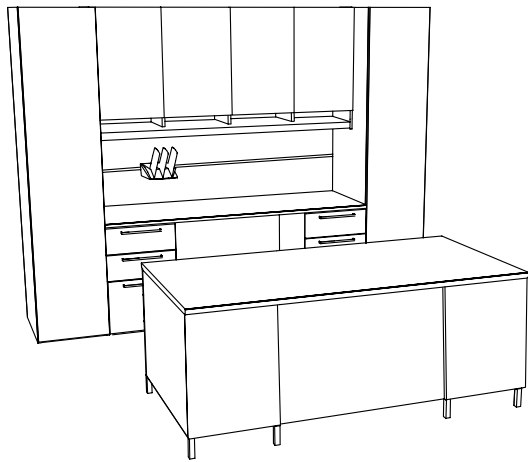
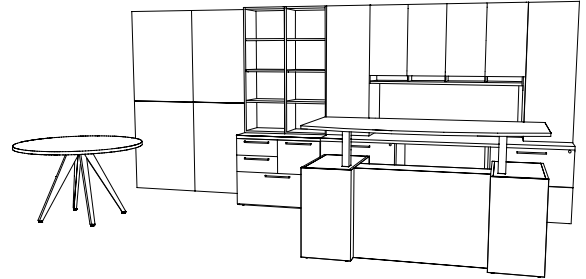
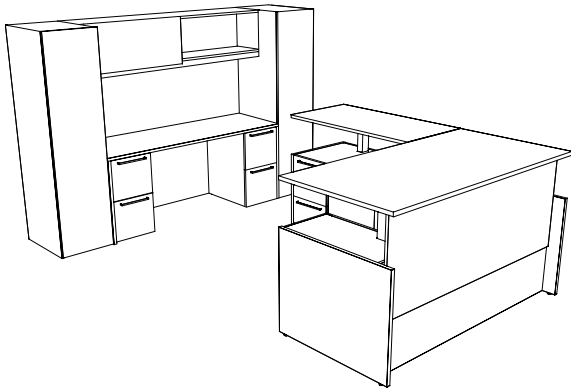

Standard Components



Double Ped Desks with or without Bow Tops
[\(See Multiple Unit Details\)](#)



Single Ped Desks with or without Bow Tops
[\(See Multiple Unit Details\)](#)



Curved Single Ped Desks with or without Bow Tops
[\(See Multiple Unit Details\)](#)



P-Top and D-Tops
[\(See Multiple Unit Details\)](#)

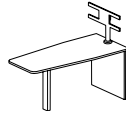

Media Peninsula
[\(See Multiple Unit Details\)](#)

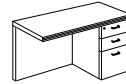

Returns
[\(See Multiple Unit Details\)](#)

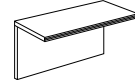

Bridges
[\(See Multiple Unit Details\)](#)

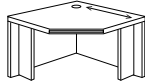

Corner Units
[\(See Multiple Unit Details\)](#)

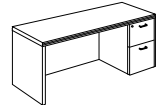

Kneespace, Storage, and Single Ped Credenzas
[\(See Multiple Unit Details\)](#)

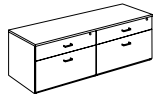

21" Low Storage and Open Credenzas
[\(See Multiple Unit Details\)](#)



Filing
[\(See Multiple Unit Details\)](#)

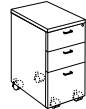

Mobile Pedestals
[\(See Multiple Unit Details\)](#)

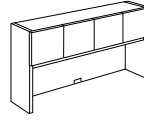

Surface Mount and Wall Mount Hutches
[\(See Multiple Unit Details\)](#)



Surface Mount Storage Towers
[\(See Multiple Unit Details\)](#)



Surface Mount Bookcases
[\(See Multiple Unit Details\)](#)



Storage Cabinets
[\(See Multiple Unit Details\)](#)

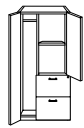

Tower Wardrobe
[\(See Multiple Unit Details\)](#)

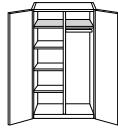

Wardrobe/Storage Cabinet
[\(See Multiple Unit Details\)](#)

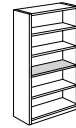

Bookcases
[\(See Multiple Unit Details\)](#)

Tables

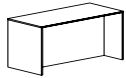

Work Tables
[\(See Multiple Unit Details\)](#)

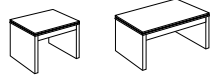

Occasional Tables
[\(See Multiple Unit Details\)](#)



Round Tops
[\(See Details\)](#)



Strut Bases
[\(See Details\)](#)



Cylinder Bases
[\(See Details\)](#)



Metal Bases
[\(See Details\)](#)



Height Adjustable Bases and Lifts
[\(See Details\)](#)

Modular Components

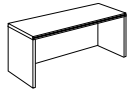

Desk, Credenza and Return Shells
[\(See Multiple Unit Details\)](#)

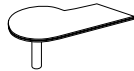

P-Tops, D-Tops And Media Peninsula
[\(See Multiple Unit Details\)](#)



Pedestals
[\(See Details\)](#)



Filing
[\(See Multiple Unit Details\)](#)

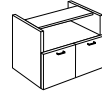

Door and Open Bookcase Pedestals
[\(See Multiple Unit Details\)](#)

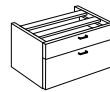

21" Low Storage
[\(See Multiple Unit Details\)](#)



Seated and Low Height Metal Supports
[\(See Seated Height and Low Height\)](#)

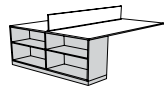

Desk End Bookcases
[\(See Details\)](#)



Support Panels
[\(See Standard Height and Low Height\)](#)

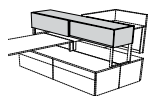

Dual and Single Access Hutches
[\(See Multiple Unit Details\)](#)

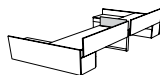

Privacy Panels
[\(See Multiple Unit Details\)](#)

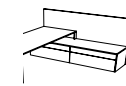

Floorstanding Gallery Screens
[\(See Multiple Unit Details\)](#)

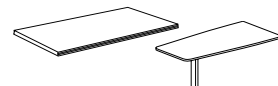

Modular Tops - Table, Desk, Benching Tops
[\(See Multiple Unit Details\)](#)



Height Adjustable Worksurface Lifts
[\(See Multiple Unit Details\)](#)

Studio Components

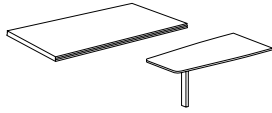

Modular Tops - Table, Desk, Benching Tops [\(See Multiple Unit Details\)](#)



Studio Pedestals [\(See Details\)](#)

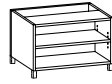

Studio Low Pedestals [\(See Multiple Unit Details\)](#)

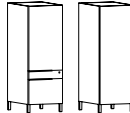

Studio Storage Cabinets [\(See Multiple Unit Details\)](#)



Kneespace Modesty Panels [\(See Multiple Unit Details\)](#)



Single and Shared Stanchions [\(See Details\)](#)



Studio Single and Shared Legs [\(See Details\)](#)

Height Adjustable Units and Components

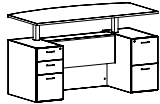

Double Ped Desks [\(See Details\)](#)

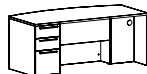

Single Ped Desks [\(See Details\)](#)

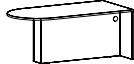

P and D-Top [\(See Details\)](#)

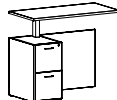

Returns [\(See Multiple Unit Details\)](#)

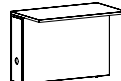

Bridge [\(See Details\)](#)

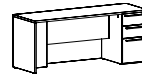

Credenzas [\(See Multiple Unit Details\)](#)

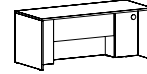

Desk Shell [\(See Details\)](#)
Return Shell [\(See Details\)](#)
Credenza Shell [\(See Details\)](#)



Height Adjustable Worksurfaces [\(See Multiple Unit Details\)](#)



Height Adjustable Legs [\(See Multiple Unit Details\)](#)



Height Adjustable Cabinets [\(See Multiple Unit Details\)](#)



Height Adjustable Credenzas [\(See Multiple Unit Details\)](#)

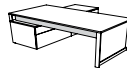

Height Adjustable Modesty Panels [\(See Multiple Unit Details\)](#)



Height Adjustable Privacy Screens [\(See Multiple Unit Details\)](#)



Height Adjustable Worksurface Lifts [\(See Multiple Unit Details\)](#)

Tackboards, Work Walls, Marker Boards and Other Accessories

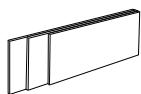

Tackboards [\(See Multiple Unit Details\)](#)



Work Walls [\(See Multiple Unit Details\)](#)

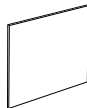

Marker Boards [\(See Multiple Unit Details\)](#)



Marker, Eraser and Magnet Sets [\(See Details\)](#)



Tasklights [\(See Multiple Unit Details\)](#)

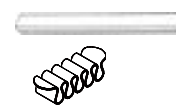

Wire Management [\(See Multiple Unit Details\)](#)



Power Options [\(See Multiple Unit Details\)](#)

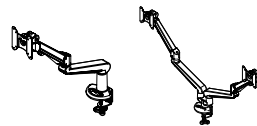
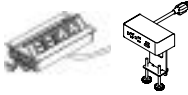

Monitor Arms [\(See Multiple Unit Details\)](#)

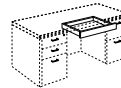

Kneespace Accessories [\(See Multiple Unit Details\)](#)



Cushion [\(See Details\)](#)

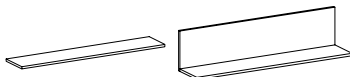

Floating and L Shelf [\(See Multiple Unit Details\)](#)

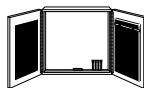

Visual Board [\(See Details\)](#)

| Item | Model No. | Width | Depth | Height | Ship Wt | Cubic Ft | List Price |
|---|----------------|------------|--|--------|---------|----------|------------|
|  | 65-21 | 108 | 105 | 70 7/8 | 1418 | 200.5 | W/P 33806 |
| CONSIST OF: | | QTY | | | | | |
| | 67-3672RPSTS | 1 | Height Adjustable Single Ped Desk with Box/Box/File with Moving Modesty Option | | | W/P\$ | 9398 |
| | 67-2448LF2STS3 | 1 | Height Adjustable Return with File/File, 3-Channel | | | W/P\$ | 5570 |
| | GMB-2372W | 1 | 72"W Glass Marker Board for Wall Mount Hutch | | | \$ | 2595 |
| | 67-2472KC | 1 | Kneespace Credenza Full Pedestal | | | W/P\$ | 4785 |
| | 65-1572SWD | 1 | 72"W Wall Mount Hutch with Sliding Door | | | W\$ | 4168 |
| | 65-1872WR | 1 | Wardrobe Storage Cabinet, Right | | | W\$ | 3645 |
| | 65-1872WL | 1 | Wardrobe Storage Cabinet, Left | | | W\$ | 3645 |

Products are available as left or right, where applicable
 Depth includes 42" between Double Ped Desk and Kneespace Credenza
 List price does not include optional moving modesty

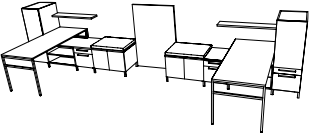
| | | | | | | | |
|---|----------------|------------|--|--------|------|--------|-------------|
|  | 65-25 | 198 | 72 | 51 1/2 | 1121 | 121.8 | W/P\$ 30545 |
| CONSIST OF: | | QTY | | | | | |
| | 65-3072TP | 2 | Modular Desk Top | | | W/P\$ | 2394 |
| | 01-3028HLV | 2 | H Modular Peninsula Support Seated Height | | | \$ | 2252 |
| | 01-3007OL | 2 | Layer Support for Desk Top | | | \$ | 1114 |
| | 65-2430SBC | 2 | 30"W Studio Low Mod Open Bookcase | | | W\$ | 3714 |
| | 65-2418STF | 2 | 18"W Studio Low Mod Tray/File Ped | | | W\$ | 3596 |
| | 65-1851SWBL | 1 | Studio Storage Cabinet Door/Tray/File, Left | | | W\$ | 2818 |
| | 65-1851SWBR | 1 | Studio Storage Cabinet Door/Tray/File, Right | | | W\$ | 2818 |
| | 65-2430SDB | 2 | 30"W Studio Low Mod Door Bookcase | | | W\$ | 3252 |
| | 65-2478TP | 2 | 78" Modular Top for Storage | | | W/P\$ | 2170 |
| | 65-2430CUSHION | 2 | 30"W Component Cushion for Door Bookcase | | | GR1\$ | 770 |
| | 01-0404SSL4 | 3 | Studio Shared Leg, 4 Pack | | | ALUM\$ | 741 |
| | 01-0404SL4 | 2 | Studio Leg, 4 Pack | | | ALUM\$ | 494 |
| | GMB-5136W | 1 | 36"W Glass Marker Board From Floor | | | \$ | 2802 |
| | 65-0942FS | 2 | 42"W Floating Shelf | | | W\$ | 1610 |

Products are available as left or right, where applicable

Pricing Codes:

W= Wood Top

P= HPL Top

[See Gesso Intro Section for Ordering Options](#)

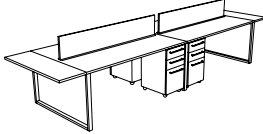
| Item | Model No. | Width | Depth | Height | Ship Wt | Cubic Ft | List Price |
|---|--------------------|-------|---|--------|---------|----------|-------------|
|  | 65-12 | 174 | 60 | 41¾ | 954 | 85.6 | W/P\$ 20392 |
| | CONSIST OF: | | QTY | | | | |
| | 01-3028OLS | 2 | Seated Height Shared Metal Leg | | A\$ | 1258 | |
| | 01-6028OL | 2 | Seated Height Modular Peninsula Support | | A\$ | 1834 | |
| | 01-00060SB | 4 | Stiffener Bar | | \$ | 516 | |
| | 01-1228OL | 2 | O Leg Support | | A\$ | 884 | |
| | 65-1519MP1 | 4 | Mobile Pedestal Box/Box/File | | W\$ | 9072 | |
| | 65-1560DTP | 2 | Desk Top Extensions | | W/P\$ | 1372 | |
| | 65-6072TP | 2 | Modular Desk Top | | W/P\$ | 3934 | |
| | 65-6812PP | 2 | 12" Privacy Panel | | W\$ | 1522 | |

Products are available as left or right, where applicable

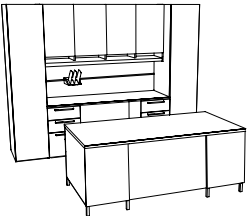
| | | | | | | | |
|---|--------------------|-----|---|-----|--------|-------|-------------|
|  | 65-23 | 108 | 102 | 82¾ | 1127 | 152.3 | W/P\$ 28499 |
| | CONSIST OF: | | QTY | | | | |
| | 65-3672TP | 1 | Modular Desk Top | | W/P\$ | 1281 | |
| | 65-2472TP | 1 | Modular Cabinet Top | | W/P\$ | 1054 | |
| | 01-0404SL4 | 2 | Single Studio Leg 4-Pack | | ALUM\$ | 494 | |
| | 65-3618SPD1 | 2 | Studio Modular Desk Pedestal, Box/Box/File | | W\$ | 5292 | |
| | 65-3624MDHGA | 1 | Studio Kneespace Modesty Panel, High Gloss Acrylic, Wired Mercury | | \$ | 589 | |
| | | | | | GPA\$ | 676 | |
| | 65-1572TWDS | 1 | Tall Wall Mount Door Hutch with Paper Slots | | W\$ | 5750 | |
| | 65-2418PD1 | 2 | Modular Desk Pedestal, Box/Box/File | | W\$ | 4420 | |
| | 65-7228BP | 1 | Modular Modesty Panel | | W\$ | 878 | |
| | 65-1884WL | 1 | Tall Wardrobe/Storage Cabinet, Left | | W\$ | 3804 | |
| | 65-1884WR | 1 | Tall Wardrobe/Storage Cabinet, Right | | W\$ | 3804 | |
| | WW-1972TRWPS | 1 | Tool Rail Work Wall | | GR1\$ | 1004 | |
| | 01-FLDRSRTRC | 1 | Folder Sorter for Tool Rail Work Wall, Clear | | \$ | 129 | |

Products are available as left or right, where applicable

Depth includes 42" between Modular Double Ped Desk and Modular Credenza

Modesty Panel High Gloss Acrylic Color Pricing, \$ = Black, White, Wired Mercury and GPA\$ = Graphite

Pricing Codes:
W= Wood Top
P= HPL Top

[See Gesso Intro Section for Ordering Options](#)

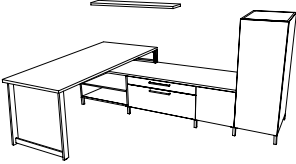
| Item | Model No. | Width | Depth | Height | Ship Wt | Cubic Ft | List Price |
|---|-------------|------------|--|--------|---------|----------|-------------|
|  | 65-22 | 102 | 72 | 47½ | 508 | 56.9 | W/P\$ 13031 |
| CONSIST OF: | | QTY | | | | | |
| | 65-3072TP | 1 | Modular Desk Top | | | | W/P\$ 1197 |
| | 65-2484TP | 1 | Modular Cabinet Top | | | | W/P\$ 1107 |
| | 01-3028BL | 1 | Bar Modular Peninsula Support | | | | ALUM\$ 644 |
| | 65-2430SBC | 1 | Studio Modular Low Storage, Open Bookcase | | | | W\$ 1857 |
| | 65-2436STF | 1 | Studio Modular Low Storage, Tray/File | | | | W\$ 2228 |
| | 65-2418SDBR | 1 | Studio Modular Low Door Bookcase, Right Hinged | | | | W\$ 1468 |
| | 01-3007OL | 1 | Layer Support for 21" Low Credenzas | | | | \$ 557 |
| | 65-1851SWR | 1 | Studio Wardrobe, Right Hinged | | | | W\$ 2460 |
| | 01-0404SL4 | 1 | Single Studio Leg 4-Pack | | | | ALUM\$ 247 |
| | 01-0404SSL2 | 1 | Shared Studio Leg 2-Pack | | | | ALUM\$ 143 |
| | 01-0404SSL4 | 1 | Shared Studio Leg 4-Pack | | | | ALUM\$ 247 |
| | 65-0948FS | 1 | 48" Floating Shelf Display | | | | W\$ 876 |

Products are available as left or right, where applicable

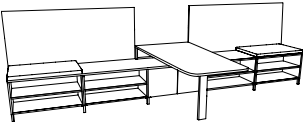
| | | | | | | | |
|---|----------------|------------|---|-----|-----|-------|-------------|
|  | 65-24 | 180 | 72 | 47¾ | 769 | 118.6 | W/P\$ 21067 |
| CONSIST OF: | | QTY | | | | | |
| | 65-2436SBC | 4 | Studio Modular Low Storage, Open Bookcase | | | | W\$ 7764 |
| | 65-2436SDB | 1 | Studio Modular Low Door Bookcase | | | | W\$ 1856 |
| | 01-0404SL4 | 1 | Single Studio Leg 4-Pack | | | | ALUM\$ 247 |
| | 01-0404SSL4 | 2 | Shared Studio Leg 4-Pack | | | | ALUM\$ 494 |
| | 65-2472TP | 2 | Modular Cabinet Top | | | | W/P\$ 2108 |
| | 65-2436TP | 1 | Modular Cabinet Top | | | | W/P\$ 655 |
| | 65-2436CUSHION | 2 | Component Cushion | | | | GR1\$ 890 |
| | 01-3607OL | 1 | Layer Support For 21" Low Credenza | | | | \$ 576 |
| | 65-3672MP | 1 | Media Peninsula | | | | W/P\$ 3841 |
| | WW-3172TTRW | 2 | Tool Rail Work Wall | | | | GR1\$ 2636 |

Products are available as left or right, where applicable

Pricing Codes:

W= Wood Top

P= HPL Top

[See Gesso Intro Section for Ordering Options](#)

| Item | Model No. | Width | Depth | Height | K | R | Ship Wt | Cubic Ft | List Price |
|--|-------------|-------|-------|--------|-----|---|---------|----------|------------|
| DOUBLE PED DESK BOW TOP STEPPED FRONT | 67-3672BDPS | 72 | 36-30 | 30 | 40½ | - | 410 | 50.0 | W/P\$ 5873 |

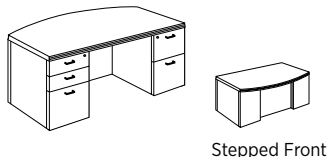

Stepped Front

Must Specify (in this order):

- Model #
- Top Material
- Finish
- Edge Profile
- Drawer Construction
- Drawer Track
- Drawer Front
- Grain Direction
- Modesty Finish/Color
- Grommet Location
- Wire Management
- Grommet Style/Color
- Power/Data Options
- Drawer Pull
- Kneespace Options

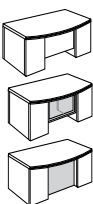

Description

- Standard With: Bow Top, Stepped Front, Full Modesty, Letter Width Locking Box/Box/File on Left Pedestal and File/File on Right, Left to Right Grain Direction on Worksurface, Wire Management from Pedestal to Kneespace, Black Utility Tray for Box Drawer
- Available with Veneer (W) or HPL (P) Top; Must Specify
- Drawer Front Grain Direction Vertical Standard; Optional Horizontal Grain Direction
- [Height Adjustable Units Available](#)
- Additional Options: Dove Tail Drawer Construction and Soft Close Drawers ([See Drawer Details](#)), Power and Grommet Options ([See Options and Locations](#)), Kneespace Options (Sold Separately, [See Unit Details](#))

Options: Specify & Add

| | | |
|---------|--|----------|
| 65-TMD | 18¼"H Veneer ¾ Modesty Panel - Must Specify Finish Color | Included |
| 65-TSC | 18¼"H Aluminum Framed Satin Frosted Tempered Glass ¾ Modesty Panel | \$ 969 |
| 65-HGAF | High Gloss Acrylic Full Modesty Panel; Must Specify Color | |
| | (GPA) Graphite Acrylic | \$ 1846 |
| | (BLA) Black, (WMA) Wired Mercury, or (WHA) White Acrylic | \$ 1687 |

| | | | | | | | | | |
|--|------------|----|----|----|-----|---|-----|------|------------|
| DOUBLE PED DESK RECTANGLE TOP STEPPED FRONT | 67-3672DPS | 72 | 36 | 30 | 40½ | - | 425 | 50.0 | W/P\$ 5783 |
|--|------------|----|----|----|-----|---|-----|------|------------|

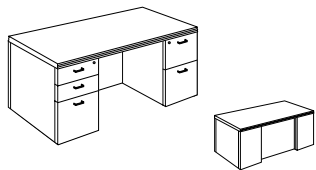

Stepped Front

Must Specify (in this order):

- Model #
- Top Material
- Finish
- Edge Profile
- Drawer Construction
- Drawer Track
- Drawer Front
- Grain Direction
- Modesty Finish/Color
- Grommet Location
- Wire Management
- Grommet Style/Color
- Power/Data Options
- Drawer Pull
- Kneespace Options

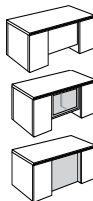

Description

- Standard With: Rectangle Top, Stepped Front, Full Modesty, Letter Width Locking Box/Box/File on Left Pedestal and File/File on Right, Left to Right Grain Direction on Worksurface, Wire Management from Pedestal to Kneespace, Black Utility Tray for Box Drawer
- Available with Veneer (W) or HPL (P) Top; Must Specify
- Drawer Front Grain Direction Vertical Standard; Optional Horizontal Grain Direction
- [Height Adjustable Units Available](#)
- Additional Options: Dove Tail Drawer Construction and Soft Close Drawers ([See Drawer Details](#)), Power and Grommet Options ([See Options and Locations](#)), Kneespace Options (Sold Separately, [See Unit Details](#))

Options: Specify & Add

| | | |
|---------|--|----------|
| 65-TMD | 18¼"H Veneer ¾ Modesty Panel - Must Specify Finish Color | Included |
| 65-TSC | 18¼"H Aluminum Framed Satin Frosted Tempered Glass ¾ Modesty Panel | \$ 969 |
| 65-HGAF | High Gloss Acrylic Full Modesty Panel; Must Specify Color | |
| | (GPA) Graphite Acrylic | \$ 1846 |
| | (BLA) Black, (WMA) Wired Mercury, or (WHA) White Acrylic | \$ 1687 |

Pricing Codes:

- W= Wood Top
- P= HPL Top

[See Gesso Intro Section for Ordering Options](#)

| Item | Model No. | Width | Depth | Height | K | R | Ship Wt | Cubic Ft | List Price |
|--|------------|-------|-------|--------|-----|----|---------|----------|------------|
| DOUBLE PED DESK BOW TOP RECESSED FRONT | 67-3672BDP | 72 | 36-30 | 30 | 40½ | 10 | 410 | 50.0 | W/P\$ 5637 |
| | 67-3666BDP | 66 | 30-36 | 30 | 34½ | 10 | 380 | 48.0 | W/P\$ 5432 |

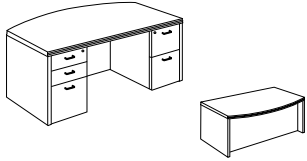

Recessed Front

Must Specify (in this order):

- Model #
- Top Material
- Finish
- Edge Profile
- Drawer Construction
- Drawer Track
- Drawer Front Grain Direction
- Grommet Location
- Wire Management
- Grommet Style/Color
- Power/Data Options
- Drawer Pull
- Kneespace Options

Description

- Standard With: Bow Top, Recessed Front, Letter Width Locking Box/Box/File on Left Pedestal and File/File on Right, Left to Right Grain Direction on Worksurface, Wire Management from Pedestal to Kneespace, Black Utility Tray for Box Drawer
- Available with Veneer (W) or HPL (P) Top; Must Specify
- Drawer Front Grain Direction Vertical Standard; Optional Horizontal Grain Direction
- [Height Adjustable Units Available](#)
- Additional Options: Dove Tail Drawer Construction and Soft Close Drawers ([See Drawer Details](#)), Power and Grommet Options ([See Options and Locations](#)), Kneespace Options (Sold Separately, [See Unit Details](#))

| | | | | | | | | | |
|--|-----------|----|----|----|-----|----|-----|------|------------|
| DOUBLE PED DESK RECTANGLE TOP RECESSED FRONT | 67-3672DP | 72 | 36 | 30 | 40½ | 10 | 425 | 50.0 | W/P\$ 4916 |
| | 67-3072DP | 72 | 30 | 30 | 40½ | 4 | 410 | 43.9 | W/P\$ 4753 |
| | 67-3066DP | 66 | 30 | 30 | 34½ | 4 | 390 | 38.7 | W/P\$ 4578 |
| | 67-3060DP | 60 | 30 | 30 | 28½ | 4 | 358 | 35.3 | W/P\$ 4375 |

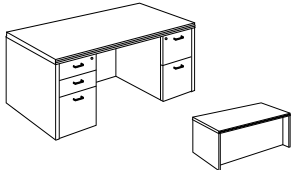

Recessed Front

Must Specify (in this order):

- Model #
- Top Material
- Finish
- Edge Profile
- Drawer Construction
- Drawer Track
- Drawer Front Grain Direction
- Grommet Location
- Wire Management
- Grommet Style/Color
- Power/Data Options
- Drawer Pull
- Kneespace Options

Description

- Standard With: Rectangle Top, Recessed Front, Letter Width Locking Box/Box/File on Left Pedestal and File/File on Right, Left to Right Grain Direction on Worksurface, Wire Management from Pedestal to Kneespace, Black Utility Tray for Box Drawer
- Available with Veneer (W) or HPL (P) Top; Must Specify
- Drawer Front Grain Direction Vertical Standard; Optional Horizontal Grain Direction
- [Height Adjustable Units Available](#)
- Additional Options: Dove Tail Drawer Construction and Soft Close Drawers ([See Drawer Details](#)), Power and Grommet Options ([See Options and Locations](#)), Kneespace Options (Sold Separately, [See Unit Details](#))

Pricing Codes:

W= Wood Top
P= HPL Top

[See Gesso Intro Section for Ordering Options](#)

| Item | Model No. | Width | Depth | Height | K | R | Ship Wt | Cubic Ft | List Price |
|---|-----------------|------------------|-------|--------|----|-----|---------|----------|------------|
| SINGLE PED DESK BOW TOP STEPPED FRONT | Left Ped | Right Ped | | | | | | | |
| | 67-3672BLPS | 67-3672BRPS | 72 | 30-36 | 30 | 32¼ | - | 320 | 50.0 |

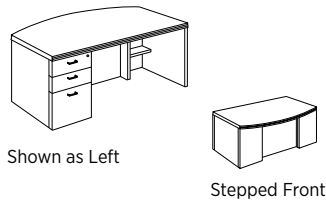

Description

- Standard With: Bow Top, Stepped Front, Full Modesty, Letter Width Locking Box/Box/File in Pedestal, Left to Right Grain Direction on Worksurface, Wire Management from Pedestal to Kneespace, Black Utility Tray for Box Drawer
- Available with Veneer (W) or HPL (P) Top; Must Specify
- Drawer Front Grain Direction Vertical Standard; Optional Horizontal Grain Direction
- [Height Adjustable Units Available](#)
- Additional Options: Dove Tail Drawer Construction and Soft Close Drawers ([See Drawer Details](#)), Power and Grommet Options ([See Options and Locations](#)), Kneespace Options (Sold Separately, [See Unit Details](#))

Must Specify (in this order):

- Model #
- Top Material
- Finish
- Edge Profile
- Drawer Construction
- Drawer Track
- Drawer Front
- Grain Direction
- Modesty Finish/Color
- Grommet Location
- Wire Management
- Grommet Style/Color
- Power/Data Options
- Drawer Pull
- Kneespace Options

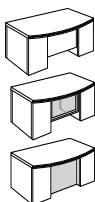

Options: Specify & Add

| | | |
|---------|--|----------|
| 65-TMD | 18¼"H Veneer ¾ Modesty Panel - Must Specify Finish Color | Included |
| 65-TSC | 18¼"H Aluminum Framed Satin Frosted Tempered Glass ¾ Modesty Panel | \$ 969 |
| 65-HGAF | High Gloss Acrylic Full Modesty Panel; Must Specify Color | |
| | (GPA) Graphite Acrylic | \$ 1846 |
| | (BLA) Black, (WMA) Wired Mercury, or (WHA) White Acrylic | \$ 1687 |

| Item | Model No. | Width | Depth | Height | K | R | Ship Wt | Cubic Ft | List Price |
|---|-----------------|------------------|-------|--------|----|-----|---------|----------|------------|
| SINGLE PED DESK RECTANGLE TOP STEPPED FRONT | Left Ped | Right Ped | | | | | | | |
| | 67-3672LPS | 67-3672RPS | 72 | 36 | 30 | 32¼ | - | 330 | 50.0 |

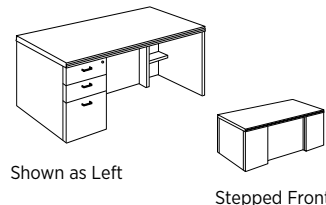

Description

- Standard With: Rectangle Top, Stepped Front, Full Modesty, Letter Width Locking Box/Box/File in Pedestal, Left to Right Grain Direction on Worksurface, Wire Management from Pedestal to Kneespace, Black Utility Tray for Box Drawer
- Available with Veneer (W) or HPL (P) Top; Must Specify
- Drawer Front Grain Direction Vertical Standard; Optional Horizontal Grain Direction
- [Height Adjustable Units Available](#)
- Additional Options: Dove Tail Drawer Construction and Soft Close Drawers ([See Drawer Details](#)), Power and Grommet Options ([See Options and Locations](#)), Kneespace Options (Sold Separately, [See Unit Details](#))

Must Specify (in this order):

- Model #
- Top Material
- Finish
- Edge Profile
- Drawer Construction
- Drawer Track
- Drawer Front
- Grain Direction
- Modesty Finish/Color
- Grommet Location
- Wire Management
- Grommet Style/Color
- Power/Data Options
- Drawer Pull
- Kneespace Options

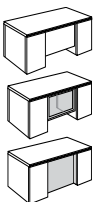

Options: Specify & Add

| | | |
|---------|--|----------|
| 65-TMD | 18¼"H Veneer ¾ Modesty Panel - Must Specify Finish Color | Included |
| 65-TSC | 18¼"H Aluminum Framed Satin Frosted Tempered Glass ¾ Modesty Panel | \$ 969 |
| 65-HGAF | High Gloss Acrylic Full Modesty Panel; Must Specify Color | |
| | (GPA) Graphite Acrylic | \$ 1846 |
| | (BLA) Black, (WMA) Wired Mercury, or (WHA) White Acrylic | \$ 1687 |

Pricing Codes:
W= Wood Top
P= HPL Top

[See Gesso Intro Section for Ordering Options](#)

| Item | Model No. | Width | Depth | Height | K | R | Ship Wt | Cubic Ft | List Price | |
|---|------------------|------------|-------|--------|----|-----|---------|----------|------------|------------|
| SINGLE PED DESK BOW TOP RECESSED FRONT | Left Ped | | | | | | | | | |
| | Right Ped | | | | | | | | | |
| | 67-3672BLP | 67-3672BRP | 72 | 30-36 | 30 | 32¼ | 10 | 320 | 50.0 | W/P\$ 4967 |

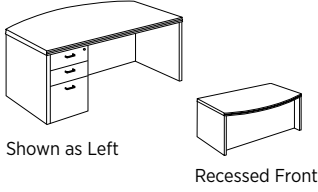

Description

- Standard With: Bow Top, Recessed Front, Letter Width Locking Box/Box/File in Pedestal, Left to Right Grain Direction on Worksurface, Wire Management from Pedestal to Kneespace, Black Utility Tray for Box Drawer
- Available with Veneer (W) or HPL (P) Top; Must Specify
- Drawer Front Grain Direction Vertical Standard; Optional Horizontal Grain Direction
- [Height Adjustable Units Available](#)
- Additional Options: Dove Tail Drawer Construction and Soft Close Drawers ([See Drawer Details](#)), Power and Grommet Options ([See Options and Locations](#)), Kneespace Options (Sold Separately, [See Unit Details](#))

Must Specify (in this order):

- Model #
- Top Material
- Finish
- Edge Profile
- Drawer Construction
- Drawer Track
- Drawer Front Grain Direction
- Grommet Location
- Wire Management
- Grommet Style/Color
- Power/Data Options
- Drawer Pull
- Kneespace Options

| | | | | | | | | | | |
|---|-----------------|------------------|----|----|----|-----|----|-----|------|------------|
| SINGLE PED DESK RECTANGLE TOP RECESSED FRONT | Left Ped | Right Ped | | | | | | | | |
| | 67-3672LP | 67-3672RP | 72 | 36 | 30 | 32¼ | 10 | 330 | 50.0 | W/P\$ 4180 |
| | 67-3072LP | 67-3072RP | 72 | 30 | 30 | 32¼ | 4 | 210 | 43.0 | W/P\$ 4116 |
| | 67-3066LP | 67-3066RP | 66 | 30 | 30 | 26¼ | 4 | 180 | 38.7 | W/P\$ 3945 |
| | 67-3060LP | 67-3060RP | 60 | 30 | 30 | 20¼ | 4 | 150 | 35.0 | W/P\$ 3796 |

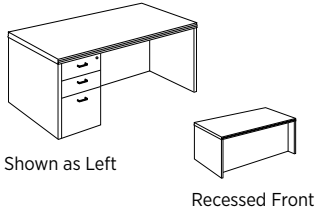

Description

- Standard With: Rectangle Top, Recessed Front, Letter Width Locking Box/Box/File in Pedestal, Left to Right Grain Direction on Worksurface, Wire Management from Pedestal to Kneespace, Black Utility Tray for Box Drawer
- Available with Veneer (W) or HPL (P) Top; Must Specify
- Drawer Front Grain Direction Vertical Standard; Optional Horizontal Grain Direction
- [Height Adjustable Units Available](#)
- Additional Options: Dove Tail Drawer Construction and Soft Close Drawers ([See Drawer Details](#)), Power and Grommet Options ([See Options and Locations](#)), Kneespace Options (Sold Separately, [See Unit Details](#))

Must Specify (in this order):

- Model #
- Top Material
- Finish
- Edge Profile
- Drawer Construction
- Drawer Track
- Drawer Front Grain Direction
- Grommet Location
- Wire Management
- Grommet Style/Color
- Power/Data Options
- Drawer Pull
- Kneespace Options

Pricing Codes:

W= Wood Top
P= HPL Top

[See Gesso Intro Section for Ordering Options](#)

| Item | Model No. | Width | Depth | Height | K | R | Ship Wt | Cubic Ft | List Price |
|---|-----------------|------------------|-------|--------|----|---|---------|----------|------------|
| CURVED SINGLE PED DESK BOW TOP RECESSED FRONT | Left Ped | Right Ped | | | | | | | |
| | 67-4872CBLP | 67-4872CBRP | 72 | 48-30 | 30 | - | - | 365 | 68.5 |

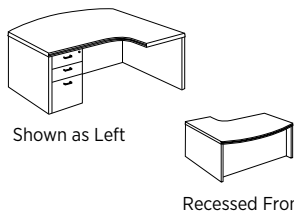

Description

- Standard With: Bow Top, Recessed Front, Full Modesty, Letter Width Locking Box/Box/File in Pedestal, Left to Right Grain Direction on Worksurface, Wire Management from Pedestal to Kneespace, Black Utility Tray for Box Drawer
- Available with Veneer (W) or HPL (P) Top; Must Specify
- Drawer Front Grain Direction Vertical Standard; Optional Horizontal Grain Direction
- Additional Options: Dove Tail Drawer Construction and Soft Close Drawers ([See Drawer Details](#)), Power and Grommet Options ([See Options and Locations](#)), Kneespace Options (Sold Separately, [See Unit Details](#))

Must Specify (in this order):

- Model #
- Top Material
- Finish
- Edge Profile
- Drawer Construction
- Drawer Track
- Drawer Front Grain Direction
- Grommet Location
- Wire Management
- Grommet Style/Color
- Power/Data Options
- Drawer Pull
- Kneespace Options

| Item | Model No. | Width | Depth | Height | K | R | Ship Wt | Cubic Ft | List Price |
|---|-----------------|------------------|-------|--------|----|---|---------|----------|------------|
| CURVED SINGLE PED DESK RECTANGLE TOP RECESSED FRONT | Left Ped | Right Ped | | | | | | | |
| | 67-4272CLP | 67-4272CRP | 72 | 42-30 | 30 | - | - | 350 | 65.8 |

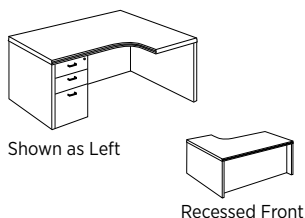

Description

- Standard With: Rectangle Top, Recessed Front, Full Modesty, Letter Width Locking Box/Box/File in Pedestal, Left to Right Grain Direction on Worksurface, Wire Management from Pedestal to Kneespace, Black Utility Tray for Box Drawer
- Available with Veneer (W) or HPL (P) Top; Must Specify
- Drawer Front Grain Direction Vertical Standard; Optional Horizontal Grain Direction
- Additional Options: Dove Tail Drawer Construction and Soft Close Drawers ([See Drawer Details](#)), Power and Grommet Options ([See Options and Locations](#)), Kneespace Options (Sold Separately, [See Unit Details](#))

Must Specify (in this order):

- Model #
- Top Material
- Finish
- Edge Profile
- Drawer Construction
- Drawer Track
- Drawer Front Grain Direction
- Grommet Location
- Wire Management
- Grommet Style/Color
- Power/Data Options
- Drawer Pull
- Kneespace Options

Pricing Codes:
W= Wood Top
P= HPL Top

[See Gesso Intro Section for Ordering Options](#)

| Item | Model No. | Width | Depth | Height | Ship Wt | Cubic Ft | List Price |
|------------------------|-----------------|------------------|-------|--------|---------|----------|-----------------|
| P-TOP CYLINDER BASE | Left Ped | Right Ped | | | | | |
| | 65-4284PL | 65-4284PR | 84 | 42-36 | 30 | 161 | 59.8 W/P\$ 4721 |
| | 65-4272PL | 65-4272PR | 72 | 42-36 | 30 | 161 | 59.8 W/P\$ 4326 |

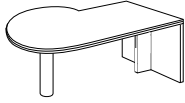

Shown as Left

Description

- Standard with: Left to Right Grain Direction on Worksurface, End Panel Support
- Available with Veneer (W) or HPL (P) Top; Must Specify
- Metal Cylinder Base - 4½" Diameter. Must Specify: Black or Aluminum
- Not Recommended for Freestanding Applications
- [Height Adjustable Units Available](#)
- Additional Options: Power and Grommet Options ([See Options and Locations](#)), Kneespace Options (Sold Separately, [See Unit Details](#))

Must Specify (in this order):

- Model #
- Top Material
- Finish
- Edge Profile
- Modesty Finish/Color
- Power/Data Options
- Kneespace Options
- Leg Color
- Worksurface Grommet Location
- Grommet Color

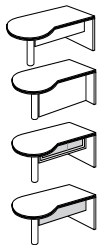

Options: Specify & Add

| | | |
|---------|--|-------------|
| 65-HMD | 10"H Half Modesty Panel - Must Specify Laminate Color | 84" \$ 320 |
| | | 72" \$ 285 |
| 65-FMD | Full Modesty Panel - Must Specify Laminate Color | 84" \$ 380 |
| | | 72" \$ 341 |
| 65-HSC | 10"H Aluminum Framed Satin Frosted Tempered Glass Half Modesty Panel | 84" \$ 1091 |
| | | 72" \$ 983 |
| 65-HGAH | 10"H High Gloss Acrylic Half Modesty Panel; Must Specify Color | |
| | (GPA) Graphite Acrylic | 84" \$ 1319 |
| | (BLA) Black, (WMA) Wired Mercury, or (WHA) White Acrylic | 84" \$ 1203 |
| | (GPA) Graphite Acrylic | 72" \$ 1182 |
| | (BLA) Black, (WMA) Wired Mercury, or (WHA) White Acrylic | 72" \$ 1076 |

Pricing Codes:

W= Wood Top
P= HPL Top

[See Gesso Intro Section for Ordering Options](#)

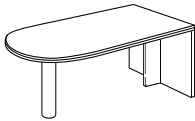
| Item | Model No. | Width | Depth | Height | Ship Wt | Cubic Ft | List Price |
|--|-----------------|------------------|-------|--------|---------|----------|------------|
| D-TOP CYLINDER BASE  Shown as Left | Left Ped | Right Ped | | | | | |
| | 65-3684DUL | 65-3684DUR | 84 | 36 | 30 | 187 | W/P\$ 4237 |
| | 65-3672DUL | 65-3672DUR | 72 | 36 | 30 | 160 | W/P\$ 3606 |
| | 65-3084DUL | 65-3084DUR | 84 | 30 | 30 | 190 | W/P\$ 4109 |
| | 65-3072DUL | 65-3072DUR | 72 | 30 | 30 | 160 | W/P\$ 3493 |
| | 65-3066DUL | 65-3066DUR | 66 | 30 | 30 | 146 | W/P\$ 3340 |





Must Specify (in this order):

- Model #
- Top Material
- Finish
- Edge Profile
- Modesty Finish/Color
- Power/Data Options
- Kneespace Options
- Leg Color
- Worksurface Grommet Location
- Grommet Color

Description

- Standard with: Left to Right Grain Direction on Worksurface, End Panel Support
- Available with Veneer (W) or HPL (P) Top; Must Specify
- Metal Cylinder Base - 4½" Diameter. Must Specify: Black or Aluminum
- Not Recommended for Freestanding Applications
- [Height Adjustable Units Available](#)
- Additional Options: Power and Grommet Options ([See Options and Locations](#)), Kneespace Options (Sold Separately, [See Unit Details](#))

Options: Specify & Add

| | | | |
|---|--|--|-------------|
|  | 65-HMD | 10"H Half Modesty Panel - Must Specify Laminate Color | 84" \$ 320 |
| | | | 72" \$ 285 |
| | | | 66" \$ 258 |
|  | 65-FMD | Full Modesty Panel - Must Specify Laminate Color | 84" \$ 380 |
| | | | 72" \$ 341 |
| | | | 66" \$ 306 |
|  | 65-HSC | 10"H Aluminum Framed Satin Frosted Tempered Glass Half Modesty Panel | 84" \$ 1091 |
| | | | 72" \$ 983 |
| | | | 66" \$ 901 |
|  | 65-HGAH | 10"H High Gloss Acrylic Half Modesty Panel; Must Specify Color | |
| | | (GPA) Graphite Acrylic | 84" \$ 1319 |
| | | (BLA) Black, (WMA) Wired Mercury, or (WHA) White Acrylic | 84" \$ 1203 |
| | | (GPA) Graphite Acrylic | 72" \$ 1182 |
| | | (BLA) Black, (WMA) Wired Mercury, or (WHA) White Acrylic | 72" \$ 1076 |
| | | (GPA) Graphite Acrylic | 66" \$ 1054 |
| | (BLA) Black, (WMA) Wired Mercury, or (WHA) White Acrylic | 66" \$ 962 | |

Pricing Codes:

- W= Wood Top
- P= HPL Top

[See Gesso Intro Section for Ordering Options](#)

| Item | Model No. | Width | Depth | Height | Ship Wt | Cubic Ft | List Price |
|---------------------------------|-----------------|------------------|-------|--------|---------|----------|-----------------|
| EXTENDED D-TOP CYLINDER BASE | Left Ped | Right Ped | | | | | |
| | 65-4272EDL | 65-4272EDR | 72 | 42-36 | 30 | 163 | 58.0 W/P\$ 3645 |

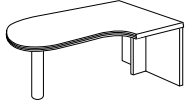

Shown as Left

Must Specify (in this order):

- Model #
- Top Material
- Finish
- Edge Profile
- Modesty Finish/Color
- Power/Data Options
- Kneespace Options
- Leg Color
- Worksurface Grommet Location
- Grommet Color

Description

- Standard with: Left to Right Grain Direction on Worksurface, End Panel Support
- Available with Veneer (W) or HPL (P) Top; Must Specify
- Metal Cylinder Base - 41/2" Diameter. Must Specify: Black or Aluminum
- Not Recommended for Freestanding Applications
- [Height Adjustable Units Available](#)
- Additional Options: Power and Grommet Options ([See Options and Locations](#)), Kneespace Options (Sold Separately, [See Unit Details](#))

Options: Specify & Add

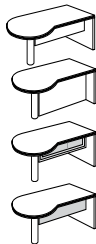

| | | |
|---------|--|---------|
| 65-HMD | 10"H Half Modesty Panel - Must Specify Laminate Color | \$ 285 |
| 65-FMD | Full Modesty Panel - Must Specify Laminate Color | \$ 341 |
| 65-HSC | 10"H Aluminum Framed Satin Frosted Tempered Glass Half Modesty Panel | \$ 983 |
| 65-HGAH | 10"H High Gloss Acrylic Half Modesty Panel; Must Specify Color | |
| | (GPA) Graphite Acrylic | \$ 1182 |
| | (BLA) Black, (WMA) Wired Mercury, or (WHA) White Acrylic | \$ 1076 |

| | | | | | | | |
|-----------------|------------|----|----|----|-----|------|------------|
| MEDIA PENINSULA | 65-3672MPS | 72 | 36 | 30 | 164 | 52.1 | W/P\$ 5938 |
| | 65-3066MPS | 66 | 30 | 30 | 148 | 40.3 | W/P\$ 5640 |
| | 65-3060MPS | 60 | 30 | 30 | 143 | 36.7 | W/P\$ 5482 |

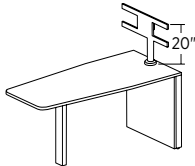

Must Specify (in this order):

- Model #
- Top Material
- Finish
- Edge Profile
- Leg
- Power/Data Options
- Kneespace Options

Description

- Left to Right Grain Direction on Worksurface
- Available with Veneer (W) or HPL (P) Top; Must Specify
- Not Recommended for Freestanding Applications Due to Open Back. May be Used with Component Gallery Screens
- Some Assembly Required
- Open Back for Wire Management
- Prevent Screen from Colliding with Walls or Furniture by Setting Rotation Limits at 15°, 30°, 45° or 90°
- Easily Route and Conceal Cables Through a Wide, In-column Channel for a Clean Finish
- Fits Most Screens 32"- 52"; Mounting Pattern Range: VESA® 100 x 100 mm - 600 x 400 mm
- Standard with Aluminum Rectangle Leg to be Installed 17¾" from Front to Allow for Kneespace Area
- Wire Management Trough Included; 4¼" W x 46⅜" L x 3½" H
- Additional Options: Leg Option (See Below), Power and Grommet Options ([See Options and Locations](#))



Leg Options: Specify & Add

| | | |
|-------|-----------------------|--------|
| OLEGA | 12" Aluminum Tube Leg | \$ 112 |
| OLEGB | 12" Black Tube Leg | \$ 112 |

Pricing Codes:

W= Wood Top
P= HPL Top

[See Gesso Intro Section for Ordering Options](#)

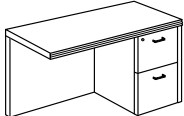
| Item | Model No. | Width | Depth | Height | K | R | Ship Wt | Cubic Ft | List Price | |
|--|--|------------------|-------|--------|----|-----|---------|----------|------------|------------|
|  RETURN WITH FILE/FILE Shown as Right | Left Ped | Right Ped | | | | | | | | |
| | 67-2448LF2 | 67-2448RF2 | 48 | 24 | 30 | 32¼ | - | 151 | 23.1 | W/P\$ 2717 |
| | Front to Back Grain Direction on Worksurface | | | | | | | | | |
| | 67-4824LF2 | 67-4824RF2 | 48 | 24 | 30 | 32¼ | - | 151 | 23.1 | W/P\$ 2717 |
| For Use with Extended Corner and Standard Corner Units; Left to Right Grain Direction on Worksurface | | | | | | | | | | |
| | 67-2442LF2 | 67-2442RF2 | 42 | 24 | 30 | 26¼ | - | 133 | 20.4 | W/P\$ 2600 |
| Front to Back Grain Direction on Worksurface | | | | | | | | | | |
| | 67-4224LF2 | 67-4224RF2 | 42 | 24 | 30 | 26¼ | - | 133 | 20.4 | W/P\$ 2600 |
| For Use with Extended Corner and Standard Corner Units; Left to Right Grain Direction | | | | | | | | | | |

Must Specify (in this order):

- Model #
- Top Material
- Finish
- Edge Profile
- Drawer Front Grain Direction
- Pull
- Drawer Construction
- Drawer Track
- Back Panel Grommet Color
- Worksurface Grommet Location
- Grommet Color
- Power/Data Options
- Kneespace Options

Description

- Standard with: Letter Width Locking File/File Pedestal, Wire Management from Pedestal to Kneespace
- Available with Veneer (W) or HPL (P) Top; Must Specify
- Back Panel Grommet Standard; Must Specify: Black (BLK), Silver (SLV) or No Back Panel Grommet (NONE)
- Drawer Front Grain Direction Vertical Standard; Optional Horizontal Grain Direction
- [Height Adjustable Units Available](#)
- Additional Options: Dove Tail Drawer Construction and Soft Close Drawers ([See Drawer Details](#)), Power and Grommet Options ([See Options and Locations](#)), Kneespace Options (Sold Separately, [See Unit Details](#))

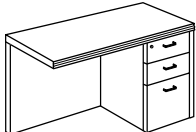
| Item | Model No. | Width | Depth | Height | K | R | Ship Wt | Cubic Ft | List Price | |
|---|--|------------------|-------|--------|----|-----|---------|----------|------------|------------|
|  RETURN WITH BOX/BOX/FILE Shown as Right | Left Ped | Right Ped | | | | | | | | |
| | 67-2448LF1 | 67-2448RF1 | 48 | 24 | 30 | 32¼ | - | 151 | 23.1 | W/P\$ 2717 |
| | Front to Back Grain Direction on Worksurface | | | | | | | | | |
| | 67-4824LF1 | 67-4824RF1 | 48 | 24 | 30 | 32¼ | - | 151 | 23.1 | W/P\$ 2717 |
| For Use with Extended Corner and Standard Corner Units; Left to Right Grain Direction | | | | | | | | | | |
| | 67-2442LF1 | 67-2442RF1 | 42 | 24 | 30 | 26¼ | - | 133 | 20.4 | W/P\$ 2600 |
| Front to Back Grain Direction on Worksurface | | | | | | | | | | |
| | 67-4224LF1 | 67-4224RF1 | 42 | 24 | 30 | 26¼ | - | 133 | 20.4 | W/P\$ 2600 |
| For Use with Extended Corner and Standard Corner Units; Left to Right Grain Direction | | | | | | | | | | |

Must Specify (in this order):

- Model #
- Top Material
- Finish
- Edge Profile
- Drawer Front Grain Direction
- Pull
- Drawer Construction
- Drawer Track
- Back Panel Grommet Color
- Worksurface Grommet Location
- Grommet Color
- Power/Data Options
- Kneespace Options

Description

- Standard with: Letter Width Locking Box/Box/File Pedestal, Wire Management from Pedestal to Kneespace
- Available with Veneer (W) or HPL (P) Top; Must Specify
- Back Panel Grommet Standard; Must Specify: Black (BLK), Silver (SLV) or No Back Panel Grommet (NONE)
- Drawer Front Grain Direction Vertical Standard; Optional Horizontal Grain Direction
- [Height Adjustable Units Available](#)
- Additional Options: Dove Tail Drawer Construction and Soft Close Drawers ([See Drawer Details](#)), Power and Grommet Options ([See Options and Locations](#)), Kneespace Options (Sold Separately, [See Unit Details](#))

Pricing Codes:

- W= Wood Top
- P= HPL Top

[See Gesso Intro Section for Ordering Options](#)

| Item | Model No. | Width | Depth | Height | K | R | Ship Wt | Cubic Ft | List Price | |
|---|------------------|------------|-------|--------|----|----|---------|----------|------------|------------|
| MULTI-FILE RETURN WITH BOX/BOX/FILE/LATERAL | Left Ped | | | | | | | | | |
| | Right Ped | | | | | | | | | |
| | 65-2472LMR | 65-2472RMR | 72 | 24 | 30 | 36 | - | 280 | 33.6 | W/P\$ 5149 |

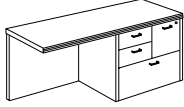

Shown as Right

Must Specify (in this order):

Model #
 Top Material
 Finish
 Edge Profile
 Drawer Construction
 Drawer Track
 Drawer Front Grain Direction
 Pull
 Back Panel Grommet Color
 Worksurface Grommet Location
 Grommet Color
 Power/Data Options
 Kneespace Options

Description

- Standard with: Box/Box/File/Lateral Pedestal, Locking File Drawer, Side to Side Grain Direction on Worksurface, Wire Management from Pedestal to Kneespace
- Available with Veneer (W) or HPL (P) Top; Must Specify
- Back Panel Grommet Standard; Must Specify: Black (BLK), Silver (SLV) or No Back Panel Grommet (NONE)
- Drawer Front Grain Direction Vertical Standard; Optional Horizontal Grain Direction
- [Height Adjustable Units Available](#)
- Additional Options: Dove Tail Drawer Construction and Soft Close Drawers ([See Drawer Details](#)), Power and Grommet Options ([See Options and Locations](#)), Kneespace Options (Sold Separately, [See Unit Details](#))

| | | | | | | | | | |
|--------------------------|-----------|----|----|----|----|---|----|-----|------------|
| BRIDGE WITH FULL MODESTY | 65-2448UF | 48 | 24 | 30 | 48 | - | 82 | 5.3 | W/P\$ 1242 |
| | 65-2442UF | 42 | 24 | 30 | 42 | - | 68 | 4.7 | W/P\$ 1192 |
| | 65-2436UF | 36 | 24 | 30 | 36 | - | 46 | 4.1 | W/P\$ 1133 |
| | 65-2048UF | 48 | 20 | 30 | 48 | - | 77 | 5.3 | W/P\$ 1149 |
| | 65-2042UF | 42 | 20 | 30 | 42 | - | 64 | 4.7 | W/P\$ 1113 |
| | 65-2036UF | 36 | 20 | 30 | 36 | - | 43 | 4.1 | W/P\$ 1057 |

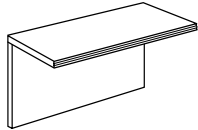

Must Specify (in this order):

Model #
 Top Material
 Finish
 Edge Profile
 Back Panel Grommet Color
 Worksurface Grommet Location
 Grommet Color
 Power/Data Options
 Kneespace Options

Description

- Standard with: Front to Back Grain Direction on Worksurface, Hinged Back Panel
- Available with Veneer (W) or HPL (P) Top; Must Specify
- Back Panel Grommet Standard; Must Specify: Black (BLK), Silver (SLV) or No Back Panel Grommet (NONE)
- [Height Adjustable Units Available](#)
- Keyboard Accessories Cannot be Factory Installed but are Available for Field Installation ([See Unit Details](#))
- Additional Options: Power and Grommet Options ([See Options and Locations](#))

Pricing Codes:

W= Wood Top
 P= HPL Top

[See Gesso Intro Section for Ordering Options](#)

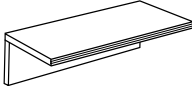
| Item | Model No. | Width | Depth | Height | K | R | Ship Wt | Cubic Ft | List Price |
|---|------------|-------|-------|--------|----|---|---------|----------|------------|
|  <p>BRIDGE WITH HALF MODESTY</p> | 65-2448UFH | 48 | 24 | 11 | 48 | - | 78 | 5.3 | W/P\$ 1170 |
| | 65-2442UFH | 42 | 24 | 11 | 42 | - | 74 | 4.6 | W/P\$ 1122 |
| | 65-2436UFH | 36 | 24 | 11 | 36 | - | 35 | 4.1 | W/P\$ 1066 |
| | 65-2048UFH | 48 | 20 | 11 | 48 | - | 73 | 5.3 | W/P\$ 1083 |
| | 65-2042UFH | 42 | 20 | 11 | 42 | - | 61 | 4.7 | W/P\$ 1040 |
| | 65-2036UFH | 36 | 20 | 11 | 36 | - | 32 | 4.1 | W/P\$ 993 |

Must Specify (in this order):

Model #
 Top Material
 Finish
 Edge Profile
 Worksurface Grommet Location
 Grommet Color
 Power/Data Options
 Kneespace Options

Description

- Standard with: Front to Back Grain Direction on Worksurface, Hinged Back Panel
- Available with Veneer (W) or HPL (P) Top; Must Specify
- Keyboard Accessories Cannot be Factory Installed but are Available for Field Installation ([See Unit Details](#))
- Additional Options: Power and Grommet Options ([See Options and Locations](#))

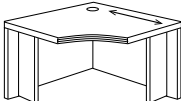
| Item | Model No. | Width | Depth | Height | K | R | Ship Wt | Cubic Ft | List Price |
|---|----------------------------------|-------|-------|--------|-------------------|---|---------|----------|------------|
|  <p>CORNER UNITS</p> | 65-4242CU | 42 | 42 | 30 | 25 $\frac{1}{16}$ | - | 145 | 34.5 | W/P\$ 2643 |
| | 65-4242CCU Curved Corner Unit | 42 | 42 | 30 | 25 $\frac{1}{16}$ | - | 145 | 34.5 | W/P\$ 3273 |
| | 65-3636CU | 36 | 36 | 30 | 17 | - | 109 | 26.3 | W/P\$ 2204 |
| | 65-3636CCU Curved Corner Unit | 36 | 36 | 30 | 17 | - | 109 | 26.3 | W/P\$ 2833 |

Shown as Curved

Must Specify (in this order):

Model #
 Top Material
 Finish
 Edge Profile
 Worksurface Grommet Color

Description

- Available with Veneer (W) or HPL (P) Top; Must Specify
- Freestanding Support Unit
- Connects to 24" Deep Worksurfaces
- Surface Grommet Standard in Top; Must Specify: Black (BLK) or Silver (SLV)
- Grain Direction Runs as Shown on Worksurface

Pricing Codes:

W= Wood Top
 P= HPL Top

[See Gesso Intro Section for Ordering Options](#)

| Item | Model No. | Width | Depth | Height | K | R | Ship Wt | Cubic Ft | List Price |
|----------------------|-----------------|------------------|-------|--------|----|---|---------|----------|------------|
| EXTENDED CORNER UNIT | Left Ped | Right Ped | | | | | | | |
| | 65-4854ECCL | 65-4854ECCR | 48 | 54 | 30 | - | - | 174 | 41.1 |

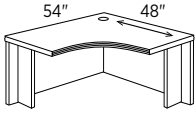

Shown as Right

Description

- Available with Veneer (W) or HPL (P) Top; Must Specify
- Surface Grommet Standard in Top; Must Specify: Black (BLK), Silver (SLV)
- Grain Direction Runs as Shown on Worksurface

Must Specify (in this order):

Model #
 Top Material
 Finish
 Edge Profile
 Worksurface Grommet Color

| SINGLE PED CREDENZA FILE/FILE | Left Ped | Right Ped | Width | Depth | Height | K | R | Ship Wt | Cubic Ft | List Price |
|----------------------------------|------------|------------|-------|-------|--------|-----|---|---------|----------|------------|
| | 67-2472LC2 | 67-2472RC2 | | | | | | | | |
| | 67-2472LC2 | 67-2472RC2 | 72 | 24 | 30 | 32¼ | - | 199 | 35.6 | W/P\$ 3420 |
| | 67-2466LC2 | 67-2466RC2 | 66 | 24 | 30 | 26¼ | - | 182 | 32.7 | W/P\$ 3383 |

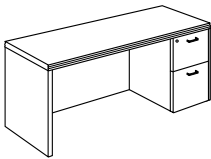

Shown as Right

Description

- Standard with: Letter Width Locking File/File Pedestal, Left to Right Grain Direction on Worksurface, Wire Management from Pedestal to Kneespace
- Available with Veneer (W) or HPL (P) Top; Must Specify
- Back Panel Grommet Standard; Must Specify: Black (BLK), Silver (SLV) or No Back Panel Grommet (NONE)
- Drawer Front Grain Direction Vertical Standard; Optional Horizontal Grain Direction
- [Height Adjustable Units Available](#)
- Additional Options: Dove Tail Drawer Construction and Soft Close Drawers ([See Drawer Details](#)), Power and Grommet Options ([See Options and Locations](#)), Kneespace Options (Sold Separately, [See Unit Details](#))

Must Specify (in this order):

Model #
 Top Material
 Finish
 Edge Profile
 Drawer Construction
 Drawer Track
 Drawer Front Grain Direction
 Pull
 Back Panel Grommet Color
 Worksurface Grommet Location
 Grommet Color
 Power/Data Options
 Kneespace Options

Pricing Codes:

W= Wood Top
 P= HPL Top

[See Gesso Intro Section for Ordering Options](#)

| Item | Model No. | Width | Depth | Height | K | R | Ship Wt | Cubic Ft | List Price | |
|-------------------------------------|-----------------|------------------|-------|--------|----|-----|---------|----------|------------|------------|
| SINGLE PED CREDENZA BOX/BOX/FILE | Left Ped | Right Ped | | | | | | | | |
| | 67-2472LC1 | 67-2472RC1 | 72 | 24 | 30 | 32¼ | - | 199 | 35.6 | W/P\$ 3420 |
| | 67-2466LC1 | 67-2466RC1 | 66 | 24 | 30 | 26¼ | - | 182 | 32.7 | W/P\$ 3383 |

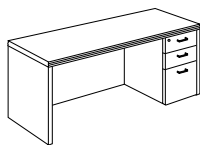

Shown as Right

Must Specify (in this order):

Model #
Top Material
Finish
Edge Profile
Drawer Construction
Drawer Track
Drawer Front Grain Direction
Pull
Back Panel Grommet Color
Worksurface Grommet Location
Grommet Color
Power/Data Options
Kneespace Options

Description

- Standard with: Letter Width Locking Box/Box/File Pedestal, Left to Right Grain Direction on Worksurface, Wire Management from Pedestal to Kneespace
- Available with Veneer (W) or HPL (P) Top; Must Specify
- Back Panel Grommet Standard; Must Specify: Black (BLK), Silver (SLV) or No Back Panel Grommet (NONE)
- Drawer Front Grain Direction Vertical Standard; Optional Horizontal Grain Direction
- [Height Adjustable Units Available](#)
- Additional Options: Dove Tail Drawer Construction and Soft Close Drawers ([See Drawer Details](#)), Power and Grommet Options ([See Options and Locations](#)), Kneespace Options (Sold Separately, [See Unit Details](#))

| | | | | | | | | | | |
|-------------------------------------|-----------------|------------------|----|----|----|----|---|-----|------|------------|
| SINGLE PED CREDENZA LATERAL FILE | Left Ped | Right Ped | | | | | | | | |
| | 65-2472LL | 65-2472RL | 72 | 24 | 30 | 12 | - | 277 | 35.6 | W/P\$ 4496 |
| | 65-2466LL | 65-2466RL | 66 | 24 | 30 | 6 | - | 264 | 32.7 | W/P\$ 4433 |

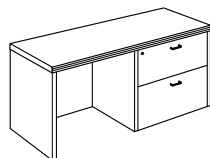

Shown as Right

Must Specify (in this order):

Model #
Top Material
Finish
Edge Profile
Drawer Construction
Drawer Front Grain Direction
Pull
Back Panel Grommet Color
Worksurface Grommet Location
Grommet Color
Power/Data Options

Description

- Standard with: Central Locking Lateral File, Left to Right Grain Direction on Worksurface
- Available with Veneer (W) or HPL (P) Top; Must Specify
- Back Panel Grommet Standard; Must Specify: Black (BLK), Silver (SLV) or No Back Panel Grommet (NONE)
- Drawer Front Grain Direction Vertical Standard; Optional Horizontal Grain Direction
- Additional Options: Dove Tail Drawer Construction ([See Drawer Details](#)), Power and Grommet Options ([See Options and Locations](#)), Kneespace Options (Sold Separately, [See Unit Details](#))

Pricing Codes:

W= Wood Top
P= HPL Top

[See Gesso Intro Section for Ordering Options](#)

| Item | Model No. | Width | Depth | Height | K | R | Ship Wt | Cubic Ft | List Price | |
|--|-----------------|------------------|-------|--------|----|----|---------|----------|------------|------------|
| MULTI-FILE CREDENZA WITH BOX/BOX/FILE/LATERAL | Left Ped | Right Ped | | | | | | | | |
| | 65-2472LMF | 65-2472RMF | 72 | 24 | 30 | 12 | - | 277 | 35.6 | W/P\$ 4713 |
| | 65-2466LMF | 65-2466RMF | 66 | 24 | 30 | 6 | - | 264 | 32.7 | W/P\$ 4654 |

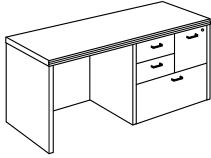

Shown as Right

Must Specify (in this order):

- Model #
- Top Material
- Finish
- Edge Profile
- Drawer Construction
- Drawer Track
- Drawer Front Grain Direction
- Pull
- Back Panel Grommet Color
- Worksurface Grommet Location
- Grommet Color
- Power/Data Options

Description

- Standard with: Letter Width Locking Box/Box/File/Lateral Pedestal, Left to Right Grain Direction on Worksurface, Wire Management from Pedestal to Kneespace
- Available with Veneer (W) or HPL (P) Top; Must Specify
- Back Panel Grommet Standard; Must Specify: Black (BLK), Silver (SLV) or No Back Panel Grommet (NONE)
- Drawer Front Grain Direction Vertical Standard; Optional Horizontal Grain Direction
- Additional Options: Dove Tail Drawer Construction ([See Drawer Details](#)), Soft Close Box and File Drawers ([See Soft Close Options](#)), Power and Grommet Options ([See Options and Locations](#)), Kneespace Options (Sold Separately, [See Unit Details](#))

| | | | | | | | | | |
|---------------------------|-----------|----|----|----|----|---|-----|------|------------|
| KNEESPACE CREDENZA | 67-2472KC | 72 | 24 | 30 | 39 | - | 240 | 35.6 | W/P\$ 4785 |
| | 67-2466KC | 66 | 24 | 30 | 33 | - | 220 | 32.7 | W/P\$ 4444 |

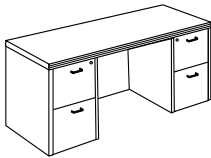

Must Specify (in this order):

- Model #
- Top Material
- Finish
- Edge Profile
- Drawer Construction
- Drawer Track
- Drawer Front Grain Direction
- Pull
- Back Panel Grommet Color
- Worksurface Grommet Location
- Grommet Color
- Power/Data Options
- Kneespace Options

Description

- Standard with: Letter Width Locking File/File Pedestals, Left to Right Grain Direction on Worksurface, Wire Management from Pedestal to Kneespace
- Available with Veneer (W) or HPL (P) Top; Must Specify
- Modesty Panel Grommet Standard; Must Specify: Black (BLK), Silver (SLV) or No Back Panel Grommet (NONE)
- Drawer Front Grain Direction Vertical Standard; Optional Horizontal Grain Direction
- [Height Adjustable Units Available](#)
- Additional Options: Dove Tail Drawer Construction and Soft Close Drawers ([See Drawer Details](#)), Power and Grommet Options ([See Options and Locations](#)), Kneespace Options (Sold Separately, [See Unit Details](#))

Pricing Codes:

W= Wood Top
P= HPL Top

[See Gesso Intro Section for Ordering Options](#)

| Item | Model No. | Width | Depth | Height | K | R | Ship Wt | Cubic Ft | List Price |
|------------------|-----------|-------|-------|--------|---|---|---------|----------|------------|
| STORAGE CREDENZA | 67-2472SC | 72 | 24 | 30 | - | - | 285 | 35.6 | W/P\$ 5165 |
| | 67-2466SC | 66 | 24 | 30 | - | - | 261 | 32.7 | W/P\$ 4951 |

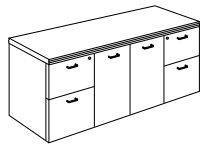

Must Specify (in this order):

Model #
 Top Material
 Finish
 Edge Profile
 Drawer Construction
 Drawer Track
 Drawer/Door Grain Direction
 Pull
 Locking Doors

Description

- Standard with: Letter Width, File/File Locking Pedestals, One (1) Fixed Shelf Behind Doors, Top Profiles on Front Only Left to Right Grain Direction on Top Surface
- Available with Veneer (W) or HPL (P) Top; Must Specify
- Drawer/Door Front Grain Direction Vertical Standard; Optional Horizontal Grain Direction
- Optional Locking Doors, Must Specify (LKT-DB) and Add \$108; [See Locking Option](#) For More Details
- Additional Options: Dove Tail Drawer Construction and Soft Close Drawers ([See Drawer Details](#))

| | | | | | | | | | |
|--------------------|-----------|----|----|----|---|---|-----|------|------------|
| FOUR DOOR CREDENZA | 65-2472CC | 72 | 24 | 30 | - | - | 290 | 34.2 | W/P\$ 4773 |
| | 65-2466CC | 66 | 24 | 30 | - | - | 246 | 33.0 | W/P\$ 4563 |

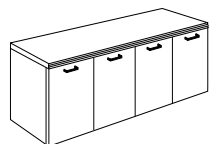

Must Specify (in this order):

Model #
 Top Material
 Finish
 Edge Profile
 Door Front Grain Direction
 Pull
 Locking Doors

Description

- Standard with: Four (4) Doors, One (1) Adjustable Shelf Behind Each Set of Doors, Top Profiles on Front Only, Left to Right Grain Direction on Top Surface
- Available with Veneer (W) or HPL (P) Top; Must Specify
- Door Front Grain Direction Vertical Standard; Optional Horizontal Grain Direction
- Optional Locking Doors Available; [See Locking Option](#) For More Details

| | | | | | | | | | |
|-----------------|-----------|----|----|----|---|---|-----|------|------------|
| BUFFET CREDENZA | 65-2472BF | 72 | 24 | 36 | - | - | 342 | 45.5 | W/P\$ 6004 |
|-----------------|-----------|----|----|----|---|---|-----|------|------------|

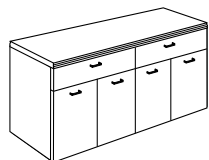

Must Specify (in this order):

Model #
 Top Material
 Finish
 Edge Profile
 Drawer Construction
 Drawer Track
 Drawer/Door Grain Direction
 Pull
 Locking Doors

Description

- Standard with: Two (2) Drawers, Four (4) Doors, One (1) Adjustable Shelf Behind Doors Each Set of Doors, Left to Right Grain Direction on Top Surface
- Available with Veneer (W) or HPL (P) Top; Must Specify
- Drawer/Door Front Grain Direction Vertical Standard; Optional Horizontal Grain Direction
- Optional Locking Doors Available; [See Locking Option](#) For More Details
- Additional Options: Dove Tail Drawer Construction and Soft Close Box Drawers ([See Drawer Options](#))

Pricing Codes:

W= Wood Top
 P= HPL Top

[See Gesso Intro Section for Ordering Options](#)

| Item | Model No. | Width | Depth | Height | K | R | Ship Wt | Cubic Ft | List Price |
|-------------------------|-----------|-------|-------|--------|---|---|---------|----------|------------|
| DOUBLE LATERAL CREDENZA | 65-2472DL | 72 | 24 | 30 | - | - | 360 | 35.7 | W/P\$ 6221 |



Must Specify (in this order):
 Model #
 Top Material
 Finish
 Edge Profile
 Drawer Construction
 Drawer Front Grain Direction
 Pull

Description

- Standard with: Legal or Letter Filing, Dual Locking, Left to Right Grain Direction on Top Surface
- Available with Veneer (W) or HPL (P) Top; Must Specify
- ¼" Thick Drawer Bottoms Allow for Storage Applications
- Drawer Front Grain Direction Vertical Standard; Optional Horizontal Grain Direction

| | | | | | | | | | |
|-------------------------------------|---------------|--|--|----|----|-----|-----|------|------------|
| 21" LOW CREDENZA DOUBLE BOX/FILE | 65-2472L2IDBF | | | 72 | 24 | 21¾ | 250 | 25.6 | W/P\$ 5906 |
| | 65-2460L2IDBF | | | 60 | 24 | 21¾ | 230 | 22.4 | W/P\$ 5263 |
| | 65-2072L2IDBF | | | 72 | 20 | 21¾ | 240 | 21.1 | W/P\$ 5717 |
| | 65-2060L2IDBF | | | 60 | 20 | 21¾ | 210 | 18.9 | W/P\$ 5202 |

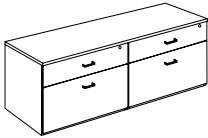

Must Specify (in this order):
 Model #
 Top Material
 Finish
 Edge Profile
 Drawer Construction
 Drawer Track
 Drawer Front Grain Direction
 Pull
 Power/Data Options
 Grommet Location/Color

Description

- Standard with: Legal or Letter Filing, Dual Locking Box/File Drawers, Left to Right Grain Direction on Top Surface
- Available with Veneer (W) or HPL (P) Top; Must Specify
- ¼" Thick Drawer Bottoms Allow for Storage Applications
- Drawer Front Grain Direction Vertical Standard; Optional Horizontal Grain Direction
- Additional Options: Dove Tail Drawer Construction ([See Drawer Options](#)), Soft Close Box Drawers ([See Soft Close Options](#)), Power and Grommet Options ([See Options and Locations](#)), Dock 950 and Dock 150 Wireless Chargers ([See Multiple Unit Details](#))

| 21" LOW CREDENZA BOX/FILE/OPEN BOOKCASE | Left Box/File | Right Box/File | Width | Depth | Height | K | R | Ship Wt | Cubic Ft | List Price |
|--|----------------|----------------|-------|-------|--------|-----|------|------------|----------|------------|
| | | | | | | | | | | |
| | 65-2472L21OBFL | 65-2472L21OBFR | 72 | 24 | 21¾ | 230 | 25.6 | W/P\$ 4500 | | |
| | 65-2460L21OBFL | 65-2460L21OBFR | 60 | 24 | 21¾ | 210 | 22.4 | W/P\$ 4114 | | |
| | 65-2072L21OBFL | 65-2072L21OBFR | 72 | 20 | 21¾ | 220 | 21.1 | W/P\$ 4289 | | |
| | 65-2060L21OBFL | 65-2060L21OBFR | 60 | 20 | 21¾ | 200 | 18.9 | W/P\$ 3901 | | |

Shown as Right

Must Specify (in this order):
 Model #
 Top Material
 Finish
 Edge Profile
 Drawer Construction
 Drawer Track
 Drawer Front Grain Direction
 Pull
 Power/Data Options
 Grommet Location/Color

Description

- Standard with: Legal or Letter Filing, Locking Box/File with Open Bookcase, Adjustable Bookcase Shelf on Open Side, Left to Right Grain Direction on Top Surface
- Available with Veneer (W) or HPL (P) Top; Must Specify
- ¼" Thick Drawer Bottoms Allow for Storage Applications
- Back Panel Grommet Standard; Must Specify Black or Silver
- Drawer Front Grain Direction Vertical Standard; Optional Horizontal Grain Direction
- Additional Options: Dove Tail Drawer Construction ([See Drawer Options](#)), Soft Close Box Drawers ([See Soft Close Options](#)), Power and Grommet Options ([See Options and Locations](#)), Dock 950 and Dock 150 Wireless Chargers ([See Multiple Unit Details](#))

Pricing Codes:

W= Wood Top
 P= HPL Top

[See Gesso Intro Section for Ordering Options](#)

| Item | Model No. | Width | Depth | Height | Ship Wt | Cubic Ft | List Price |
|--|--------------|-------|-------|--------|---------|----------|------------|
| 21" LOW CREDENZA DOUBLE OPEN BOOKCASE | 65-2472L21DO | 72 | 24 | 21¾ | 210 | 25.6 | W/P\$ 3676 |
| | 65-2460L21DO | 60 | 24 | 21¾ | 200 | 22.4 | W/P\$ 3318 |
| | 65-2072L21DO | 72 | 20 | 21¾ | 200 | 21.1 | W/P\$ 3425 |
| | 65-2060L21DO | 60 | 20 | 21¾ | 190 | 18.9 | W/P\$ 3124 |

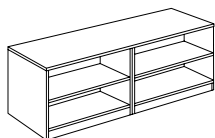

Must Specify (in this order):

Model #
Top Material
Finish
Edge Profile
Power/Data Options
Grommet Location/Color

Description

- Standard with: Open Bookcases, One Adjustable Shelf on Each Side, Left to Right Grain Direction on Top Surface
- Available with Veneer (W) or HPL (P) Top; Must Specify
- Back Panel Grommet Standard; Must Specify Black or Silver
- Additional Options: Power and Grommet Options ([See Options and Locations](#)), Dock 950 and Dock 150 Wireless Chargers ([See Multiple Unit Details](#))

| Item | Model No. | Width | Depth | Height | Ship Wt | Cubic Ft | List Price |
|---------------------|------------------------------------|-------|-------|--------|---------|----------|------------|
| LATERAL FILE | 65-2436L4 Four Lateral Drawers | 36 | 24 | 57½ | 312 | 32.6 | W/P\$ 5349 |
| | 65-2430L4 Four Lateral Drawers | 30 | 24 | 57½ | 260 | 27.5 | W/P\$ 5100 |
| | 65-2436L3 Three Lateral Drawers | 36 | 24 | 43¾ | 170 | 24.2 | W/P\$ 4289 |
| | 65-2430L3 Three Lateral Drawers | 30 | 24 | 43¾ | 155 | 20.4 | W/P\$ 4067 |
| | 65-2436L2 Two Lateral Drawers | 36 | 24 | 30 | 184 | 18.3 | W/P\$ 2829 |
| | 65-2430L2 Two Lateral Drawers | 30 | 24 | 30 | 153 | 15.6 | W/P\$ 2687 |

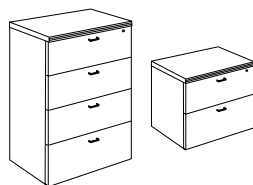

Must Specify (in this order):

Model #
Top Material
Finish
Edge Profile
Drawer Construction
Drawer Front Grain Direction
Pull

Description

- Standard with: Central Locking, Anti-Tilt System, Legal or Letter Filing Front to Back or Side to Side
- Available with Veneer (W) or HPL (P) Top; Must Specify
- ¼" Thick Drawer Bottoms Allow for Storage Applications
- Drawer Front Grain Direction Vertical Standard; Optional Horizontal Grain Direction
- Additional Options: Dove Tail Drawer Construction ([See Drawer Options](#))

| Item | Model No. | Width | Depth | Height | Ship Wt | Cubic Ft | List Price |
|-------------------|-----------|-------|-------|--------|---------|----------|------------|
| MULTI-FILE | 65-2436MF | 36 | 24 | 30 | 184 | 18.3 | W/P\$ 3248 |
| | 65-2430MF | 30 | 24 | 30 | 148 | 15.6 | W/P\$ 2886 |

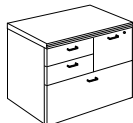

Must Specify (in this order):

Model #
Top Material
Finish
Edge Profile
Drawer Construction
Box and File Drawer Track
Drawer Front Grain Direction
Pull

Description

- Standard with: Box/Box/File/Lateral File, Locking File Drawer, Lateral File Provides Legal or Letter Filing
- Available with Veneer (W) or HPL (P) Top; Must Specify
- Drawer Front Grain Direction Vertical Standard; Optional Horizontal Grain Direction
- Additional Options: Dove Tail Drawer Construction ([See Drawer Options](#)), Soft Close Box and File Drawers ([See Soft Close Options](#))

Pricing Codes:

W= Wood Top
P= HPL Top

[See Gesso Intro Section for Ordering Options](#)

| Item | Model No. | Width | Depth | Height | Ship Wt | Cubic Ft | List Price |
|---------------------------------|-----------|-------|-------|--------|---------|----------|------------|
| MOBILE PEDESTAL BOX/FILE | 65-1519MP | 15¾ | 19 | 23 | 85 | 9.0 | W\$ 2172 |

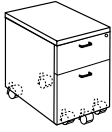

Must Specify (in this order):

- Model #
- Finish
- Drawer Construction
- Drawer Track
- Drawer Front Grain Direction
- Pull

Description

- Standard with: Locking Box/File Drawers, Black Plastic Pen Tray, Letter Width Pedestal, and Five Casters
- Fits Underneath 30"H Worksurface with Optional Cushion
- Optional Cushion Increases Height 2¼"; See [65-1519CUSHION](#)
- Drawer Front Grain Direction Vertical Standard; Optional Horizontal Grain Direction
- Additional Options: Dove Tail Drawer Construction and Soft Close Drawers ([See Drawer Details](#))

| | | | | | | | |
|-------------------------------------|------------|-----|----|-----|----|-----|----------|
| MOBILE PEDESTAL BOX/BOX/FILE | 65-1519MP1 | 15¾ | 19 | 27½ | 90 | 9.0 | W\$ 2268 |
|-------------------------------------|------------|-----|----|-----|----|-----|----------|

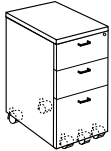

Must Specify (in this order):

- Model #
- Finish
- Drawer Construction
- Drawer Track
- Drawer Front Grain Direction
- Pull

Description

- Standard with: Locking Box/Box/File Drawers, Black Plastic Pen Tray, Letter Width Pedestal, and Five Casters
- Optional Cushion Increases Height 2¼"; See [65-1519CUSHION](#)
- Fits Underneath 30"H Worksurface without Optional Cushion
- Drawer Front Grain Direction Vertical Standard; Optional Horizontal Grain Direction
- Additional Options: Dove Tail Drawer Construction and Soft Close Drawers ([See Drawer Details](#))

| | | | | | | | |
|----------------------------------|------------|-----|----|-----|----|-----|----------|
| MOBILE PEDESTAL FILE/FILE | 65-1519MP2 | 15¾ | 19 | 27½ | 90 | 9.0 | W\$ 2268 |
|----------------------------------|------------|-----|----|-----|----|-----|----------|

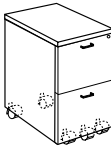

Must Specify (in this order):

- Model #
- Finish
- Drawer Construction
- Drawer Track
- Drawer Front Grain Direction
- Pull

Description

- Standard with: Locking File/File Drawers, Black Plastic Pen Tray, Letter Width Pedestal, and Five Casters
- Optional Cushion Increases Height 2¼"; See [65-1519CUSHION](#)
- Fits Underneath 30"H Worksurface without Optional Cushion
- Drawer Front Grain Direction Vertical Standard; Optional Horizontal Grain Direction
- Additional Options: Dove Tail Drawer Construction and Soft Close Drawers ([See Drawer Details](#))

Pricing Codes:

- W= Wood Top
- P= HPL Top

[See Gesso Intro Section for Ordering Options](#)

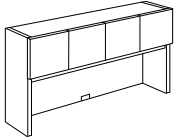
| Item | Model No. | Width | Depth | Height | Ship Wt | Cubic Ft | List Price |
|---|------------------------------|-------|-------|------------------|---------|----------|------------|
| SURFACE MOUNT HUTCH HINGED DOOR  | 65-15108HU Six (6) Doors | 108 | 15 | 40 $\frac{3}{8}$ | 301 | 51.7 | W\$ 5681 |
| | 65-15102HU Six (6) Doors | 102 | 15 | 40 $\frac{3}{8}$ | 283 | 48.3 | W\$ 5441 |
| | 65-1596HU Six (6) Doors | 96 | 15 | 40 $\frac{3}{8}$ | 260 | 46.5 | W\$ 5354 |
| | 65-1590HU Five (5) Doors | 90 | 15 | 40 $\frac{3}{8}$ | 243 | 44.3 | W\$ 5005 |
| | 65-1584HU Five (5) Doors | 84 | 15 | 40 $\frac{3}{8}$ | 228 | 40.0 | W\$ 4311 |
| | 65-1578HU Four (4) Doors | 78 | 15 | 40 $\frac{3}{8}$ | 210 | 36.7 | W\$ 4212 |
| | 65-1572HU Four (4) Doors | 72 | 15 | 40 $\frac{3}{8}$ | 203 | 34.1 | W\$ 3549 |
| | 65-1566HU Four (4) Doors | 66 | 15 | 40 $\frac{3}{8}$ | 175 | 32.1 | W\$ 3424 |
| | 65-1560HU Four (4) Doors | 60 | 15 | 40 $\frac{3}{8}$ | 167 | 28.4 | W\$ 3363 |
| | 65-1554HU Three (3) Doors | 54 | 15 | 40 $\frac{3}{8}$ | 150 | 25.7 | W\$ 3125 |
| | 65-1548HU Three (3) Doors | 48 | 15 | 40 $\frac{3}{8}$ | 133 | 22.9 | W\$ 2887 |
| | 65-1542HU Two (2) Doors | 42 | 15 | 40 $\frac{3}{8}$ | 116 | 20.2 | W\$ 2165 |
| | 65-1536HU Two (2) Doors | 36 | 15 | 40 $\frac{3}{8}$ | 99 | 17.4 | W\$ 1887 |
| | 65-1530HU Two (2) Doors | 30 | 15 | 40 $\frac{3}{8}$ | 85 | 14.6 | W\$ 1636 |

Must Specify (in this order):

- Model #
- Finish
- Door
 - Style/Finish
 - Grain Direction (if applicable)
- Locking Doors
- Paperslots
- Paperslot Divider Material/Color
- Tasklights
- Grommet Color
- Tackboard Fabric

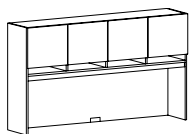

Optional Paper Slots in veneer or chrome available; [See Paper Slot Options](#)

Also available as 52 $\frac{3}{8}$ " H Tall Surface Mount

Description

- 23 $\frac{3}{4}$ " Clearance Below Apron Rail
- Lower Center Grommet Standard; Must Specify: Black (BLK) or Silver (SLV)
- Safely Write on Dry Erase, White and Black Tempered Glass Doors with Our Dry Erase Marker Set; [See Sets](#)
- Additional Support is Required when Surface Mounted Hutches Do Not Sit Directly Over an End Panel or Pedestal; [See 65-2812SP](#)
- Component Hutch Tops with Profiles are Available; [See Top Sizes](#)
- If Applicable, Door Front Grain Direction Vertical Standard; Optional Horizontal Grain Direction
- Additional Options: Paper Slots ([See Paper Slot Options](#)), Locking Doors ([See Locking Door Options](#)), Marker Boards, Work Wall, Tackboards, and Tasklights ([See Units](#)), Marker and Eraser Sets ([See Sets](#))

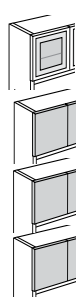

| Options: Specify & Add | | Per Door |
|------------------------|--|----------|
| 1-AD | Aluminum Framed Satin Frosted Tempered Glass Doors (Non-Locking) | \$ 438 |
| 1-DEB | Dry Erase Board Doors | \$ 28 |
| WHGLS | Aluminum Framed Doors with White Tempered Glass (Non-locking) | \$ 652 |
| BLGLS | Black Matte Framed Doors with Black Tempered Glass (Non-locking) | \$ 868 |
| 1-HGA | High Gloss Acrylic Doors; Must Specify Color | |
| | (GPA) Graphite Acrylic | \$ 269 |
| | (BLA) Black, (WMA) Wired Mercury, or (WHA) White Acrylic | \$ 247 |

Pricing Codes:
W= Wood Top
P= HPL Top

[See Gesso Intro Section for Ordering Options](#)

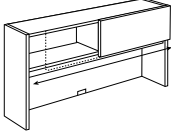
| Item | Model No. | Width | Depth | Height | Ship Wt | Cubic Ft | List Price |
|--|------------------------------|-------|-------|------------------|---------|----------|------------|
|  Must Specify (in this order): Model # Finish Door Style/Color Grain Direction (if applicable) Paperslots Paperslot Divider Material/Color Tasklights Grommet Color Tackboard Fabric | 65-15108SHU Two (2) Doors | 108 | 15 | 40 $\frac{7}{8}$ | 313 | 64.2 | W\$ 6586 |
| | 65-15102SHU Two (2) Doors | 102 | 15 | 40 $\frac{7}{8}$ | 296 | 60.7 | W\$ 6122 |
| | 65-1596SHU Two (2) Doors | 96 | 15 | 40 $\frac{7}{8}$ | 278 | 57.7 | W\$ 5827 |
| | 65-1590SHU Two (2) Doors | 90 | 15 | 40 $\frac{7}{8}$ | 260 | 53.7 | W\$ 5689 |
| | 65-1584SHU Two (2) Doors | 84 | 15 | 40 $\frac{7}{8}$ | 243 | 50.2 | W\$ 4889 |
| | 65-1578SHU One (1) Door | 78 | 15 | 40 $\frac{7}{8}$ | 226 | 46.7 | W\$ 4679 |
| | 65-1572SHU One (1) Door | 72 | 15 | 40 $\frac{7}{8}$ | 208 | 43.3 | W\$ 4102 |
| | 65-1566SHU One (1) Door | 66 | 15 | 40 $\frac{7}{8}$ | 190 | 39.7 | W\$ 3978 |
| | 65-1560SHU One (1) Door | 60 | 15 | 40 $\frac{7}{8}$ | 172 | 28.4 | W\$ 3941 |

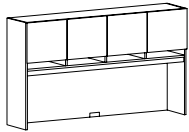

Optional Paper Slots in veneer or chrome available; [See Paper Slot Options](#)

Description

- Non-Locking Sliding Doors
- 23 $\frac{3}{4}$ " Clearance Below Apron Rail
- Lower Center Grommet Standard; Must Specify: Black (BLK) or Silver (SLV)
- Safely Write on Dry Erase Doors with Our Dry Erase Marker Set; [See Sets](#)
- Additional Support is Required when Surface Mounted Hutches Do Not Sit Directly Over an End Panel or Pedestal; [See 65-2812SP](#)
- Component Hutch Tops with Profiles are Available; [See Top Sizes](#)
- If Applicable, Door Front Grain Direction Vertical Standard; Optional Horizontal Grain Direction
- Additional Options: Paper Slots ([See Paper Slot Options](#)), Marker Boards, Work Wall, Tackboards, and Tasklights ([See Units](#)), Marker and Eraser Sets ([See Sets](#))

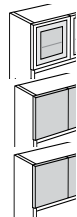

| Options: Specify & Add | | Per Door |
|------------------------|--|----------|
| 1-AD | Aluminum Framed Satin Frosted Tempered Glass Doors (Non-Locking) | \$ 745 |
| 1-DEB | Dry Erase Board Door (Non-Locking) | \$ 77 |
| 1-HGA | High Gloss Acrylic Door (Non-Locking); Must Specify Color | |
| | (GPA) Graphite Acrylic | \$ 773 |
| | (BLA) Black, (WMA) Wired Mercury, or (WHA) White Acrylic | \$ 705 |

Pricing Codes:

W= Wood Top
P= HPL Top

[See Gesso Intro Section for Ordering Options](#)

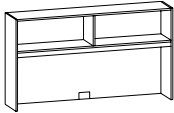
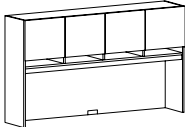
| Item | Model No. | Width | Depth | Height | Ship Wt | Cubic Ft | List Price |
|---|----------------------------------|-------|-------|------------------|---------|----------|------------|
| SURFACE MOUNT HUTCH OPEN  <p>Must Specify (in this order): Model # Finish Paperslots Paperslot Divider Material/Color Tasklights Grommet Color Tackboard Fabric</p>  <p>Optional Paper Slots in veneer or chrome available; See Paper Slot Options</p> <p>Also available as 52$\frac{1}{8}$" H Tall Surface Mount</p> | 65-15108OH Three Compartments | 108 | 15 | 40 $\frac{7}{8}$ | 192 | 46.5 | W\$ 4656 |
| | 65-15102OH Three Compartments | 102 | 15 | 40 $\frac{7}{8}$ | 173 | 44.0 | W\$ 4462 |
| | 65-1596OH Three Compartments | 96 | 15 | 40 $\frac{7}{8}$ | 158 | 41.5 | W\$ 4387 |
| | 65-1590OH Three Compartments | 90 | 15 | 40 $\frac{7}{8}$ | 150 | 39.0 | W\$ 4105 |
| | 65-1584OH Three Compartments | 84 | 15 | 40 $\frac{7}{8}$ | 142 | 36.7 | W\$ 3541 |
| | 65-1578OH Two Compartments | 78 | 15 | 40 $\frac{7}{8}$ | 130 | 33.8 | W\$ 3448 |
| | 65-1572OH Two Compartments | 72 | 15 | 40 $\frac{7}{8}$ | 121 | 30.7 | W\$ 2911 |
| | 65-1566OH Two Compartments | 66 | 15 | 40 $\frac{7}{8}$ | 114 | 30.7 | W\$ 2807 |
| | 65-1560OH Two Compartments | 60 | 15 | 40 $\frac{7}{8}$ | 106 | 28.4 | W\$ 2759 |
| | 65-1554OH Two Compartments | 54 | 15 | 40 $\frac{7}{8}$ | 98 | 25.7 | W\$ 2561 |
| | 65-1548OH Two Compartments | 48 | 15 | 40 $\frac{7}{8}$ | 89 | 21.2 | W\$ 2369 |
| | 65-1542OH One Compartment | 42 | 15 | 40 $\frac{7}{8}$ | 77 | 18.6 | W\$ 2124 |
| | 65-1536OH One Compartment | 36 | 15 | 40 $\frac{7}{8}$ | 69 | 16.0 | W\$ 1846 |
| | 65-1530OH One Compartment | 30 | 15 | 40 $\frac{7}{8}$ | 61 | 13.5 | W\$ 1604 |

Description

- 23 $\frac{3}{4}$ " Clearance Below Apron Rail
- Lower Center Grommet Standard; Must Specify: Black (BLK) or Silver (SLV)
- Additional Support is Required when Surface Mounted Hutch Do Not Sit Directly Over an End Panel or Pedestal; [See 65-2812SP](#)
- Component Hutch Tops with Profiles are Available; [See Top Sizes](#)
- Additional Options: Paper Slots ([See Paper Slot Options](#)), Locking Doors ([See Locking Door Options](#)), Marker Boards, Work Wall, Tackboards, and Tasklights ([See Units](#)), Marker and Eraser Sets ([See Sets](#))

Pricing Codes:

W= Wood Top
P= HPL Top



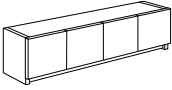

[See Gesso Intro Section for Ordering Options](#)

| Item | Model No. | Width | Depth | Height | Ship Wt | Cubic Ft | List Price |
|--|------------------------------|-------|-------|-------------------|---------|----------|------------|
| WALL MOUNT HUTCH HINGED DOORS  Must Specify (in this order): Model # Finish Door Style/Color Grain Direction (if applicable) Locking Doors Also available as 33% H Tall Wall Mount | 65-15108WD Six (6) Doors | 108 | 15 | 17 $\frac{3}{16}$ | 178 | 19.4 | W\$ 5112 |
| | 65-15102WD Six (6) Doors | 102 | 15 | 17 $\frac{3}{16}$ | 168 | 18.3 | W\$ 4893 |
| | 65-1596WD Six (6) Doors | 96 | 15 | 17 $\frac{3}{16}$ | 158 | 17.3 | W\$ 4820 |
| | 65-1590WD Five (5) Doors | 90 | 15 | 17 $\frac{3}{16}$ | 148 | 16.2 | W\$ 4502 |
| | 65-1584WD Five (5) Doors | 84 | 15 | 17 $\frac{3}{16}$ | 138 | 15.2 | W\$ 3883 |
| | 65-1578WD Four (4) Doors | 78 | 15 | 17 $\frac{3}{16}$ | 128 | 14.1 | W\$ 3790 |
| | 65-1572WD Four (4) Doors | 72 | 15 | 17 $\frac{3}{16}$ | 118 | 13.1 | W\$ 3186 |
| | 65-1566WD Four (4) Doors | 66 | 15 | 17 $\frac{3}{16}$ | 105 | 12.0 | W\$ 3078 |
| | 65-1560WD Four (4) Doors | 60 | 15 | 17 $\frac{3}{16}$ | 96 | 11.0 | W\$ 3027 |
| | 65-1554WD Three (3) Doors | 54 | 15 | 17 $\frac{3}{16}$ | 87 | 9.9 | W\$ 2815 |
| | 65-1548WD Three (3) Doors | 48 | 15 | 17 $\frac{3}{16}$ | 77 | 8.9 | W\$ 2600 |
| | 65-1542WD Two (2) Doors | 42 | 15 | 17 $\frac{3}{16}$ | 67 | 7.8 | W\$ 1951 |
| | 65-1536WD Two (2) Doors | 36 | 15 | 17 $\frac{3}{16}$ | 58 | 6.7 | W\$ 1701 |
| | 65-1530WD Two (2) Doors | 30 | 15 | 17 $\frac{3}{16}$ | 48 | 5.6 | W\$ 1471 |

Description

- Component Hutch Tops with Profiles are Available; [See Top Sizes](#)
- If Applicable, Door Front Grain Direction Vertical Standard; Optional Horizontal Grain Direction
- Safely Write on Dry Erase, White and Black Tempered Glass Doors with Our Dry Erase Marker Set; [See Sets](#)
- Indiana Furniture Will Not be Liable for Wall Mount Hutches that are not Properly Installed
- Additional Options: Locking Doors ([See Locking Door Options](#)), Marker Boards, Work Wall, Tackboards, and Tasklights ([See Units](#)), Marker and Eraser Sets ([See Sets](#))

Options: Specify & Add

| | | Per Door |
|---|--|----------|
|  | 1-AD Aluminum Framed Satin Frosted Tempered Glass Doors (Non-Locking) | \$ 438 |
|  | 1-DEB Dry Erase Board Doors | \$ 28 |
|  | WHGLS Aluminum Framed Doors with White Tempered Glass (Non-locking) | \$ 652 |
|  | BLGLS Black Matte Framed Doors with Black Tempered Glass (Non-locking) | \$ 868 |
|  | 1-HGA High Gloss Acrylic Doors; Must Specify Color | |
| | (GPA) Graphite Acrylic | \$ 269 |
| | (BLA) Black, (WMA) Wired Mercury, or (WHA) White Acrylic | \$ 247 |

Pricing Codes:

W= Wood Top



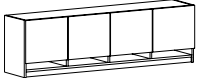

P= HPL Top

[See Gesso Intro Section for Ordering Options](#)

| Item | Model No. | Width | Depth | Height | Ship Wt | Cubic Ft | List Price |
|--|---|-------|-------|---------|---------|----------|------------|
| WALL MOUNT HUTCH DOORS WITH PAPER SLOTS  Must Specify (in this order): Model # Finish Door Style/Color Grain Direction (if applicable) Locking Doors Paperslot Divider Material/Color Also available as 29 3/16" H Tall Wall Mount | 65-15108WDS Six (6) Doors / Six (6) Paper Slots | 108 | 15 | 21 1/16 | 204 | 27.7 | W\$ 7273 |
| | 65-15102WDS Six (6) Doors / Six (6) Paper Slots | 102 | 15 | 21 1/16 | 194 | 26.2 | W\$ 6967 |
| | 65-1596WDS Six (6) Doors / Six (6) Paper Slots | 96 | 15 | 21 1/16 | 186 | 24.6 | W\$ 6807 |
| | 65-1590WDS Five (5) Doors / Five (5) Paper Slots | 90 | 15 | 21 1/16 | 172 | 23.1 | W\$ 6405 |
| | 65-1584WDS Five (5) Doors / Five (5) Paper Slots | 84 | 15 | 21 1/16 | 162 | 21.6 | W\$ 5675 |
| | 65-1578WDS Four (4) Doors / Four (4) Paper Slots | 78 | 15 | 21 1/16 | 149 | 20.0 | W\$ 5479 |
| | 65-1572WDS Four (4) Doors / Four (4) Paper Slots | 72 | 15 | 21 1/16 | 140 | 18.5 | W\$ 4766 |
| | 65-1566WDS Four (4) Doors / Four (4) Paper Slots | 66 | 15 | 21 1/16 | 131 | 16.9 | W\$ 4568 |
| | 65-1560WDS Four (4) Doors / Four (4) Paper Slots | 60 | 15 | 21 1/16 | 121 | 15.4 | W\$ 4429 |
| | 65-1554WDS Three (3) Doors / Three (3) Paper Slots | 54 | 15 | 21 1/16 | 108 | 13.9 | W\$ 4116 |
| | 65-1548WDS Three (3) Doors / Three (3) Paper Slots | 48 | 15 | 21 1/16 | 99 | 12.3 | W\$ 3810 |
| | 65-1542WDS Two (2) Doors / Two (2) Paper Slots | 42 | 15 | 21 1/16 | 86 | 10.8 | W\$ 3077 |
| | 65-1536WDS Two (2) Doors / Two (2) Paper Slots | 36 | 15 | 21 1/16 | 76 | 9.2 | W\$ 2733 |
| | 65-1530WDS Two (2) Doors / Two (2) Paper Slots | 30 | 15 | 21 1/16 | 67 | 7.7 | W\$ 2419 |

Description

- Paper Slot Divider Material and Color Must Specify: Chrome (CHRM) or Veneer (W) and Finish Color
- Component Hutch Tops with Profiles are Available; [See Top Sizes](#)
- Safely Write on Dry Erase, White and Black Tempered Glass Doors with Our Dry Erase Marker Set; [See Sets](#)
- If Applicable, Door Front Grain Direction Vertical Standard; Optional Horizontal Grain Direction
- Indiana Furniture Will Not be Liable for Wall Mount Hutches that are not Properly Installed
- Additional Options: Locking Doors ([See Locking Door Options](#)), Work Wall, Tackboards, and Tasklights ([See Units](#)), Marker and Eraser Sets ([See Sets](#))

| Options: Specify & Add | | | Per Door |
|---|-------|--|----------|
|  | 1-AD | Aluminum Framed Satin Frosted Tempered Glass Doors (Non-Locking) | \$ 438 |
|  | 1-DEB | Dry Erase Board Doors | \$ 28 |
|  | WHGLS | Aluminum Framed Doors with White Tempered Glass (Non-locking) | \$ 652 |
|  | BLGLS | Black Matte Framed Doors with Black Tempered Glass (Non-locking) | \$ 868 |
|  | 1-HGA | High Gloss Acrylic Doors; Must Specify Color | |
| | | (GPA) Graphite Acrylic | \$ 269 |
| | | (BLA) Black, (WMA) Wired Mercury, or (WHA) White Acrylic | \$ 247 |

Pricing Codes:
W= Wood Top
P= HPL Top

[See Gesso Intro Section for Ordering Options](#)

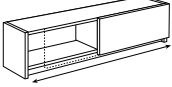
| Item | Model No. | Width | Depth | Height | Ship Wt | Cubic Ft | List Price |
|--|------------------------------|-------|-------|-------------------|---------|----------|------------|
| WALL MOUNT HUTCH WITH SLIDING DOOR  | 65-15108SWD Two (2) Doors | 108 | 15 | 17 $\frac{3}{16}$ | 281 | 60.7 | W\$ 6090 |
| | 65-15102SWD Two (2) Doors | 102 | 15 | 17 $\frac{3}{16}$ | 265 | 57.2 | W\$ 5800 |
| | 65-1596SWD Two (2) Doors | 96 | 15 | 17 $\frac{3}{16}$ | 249 | 55.1 | W\$ 5550 |
| | 65-1590SWD Two (2) Doors | 90 | 15 | 17 $\frac{3}{16}$ | 233 | 53.7 | W\$ 5199 |
| | 65-1584SWD Two (2) Doors | 84 | 15 | 17 $\frac{3}{16}$ | 217 | 50.2 | W\$ 4721 |
| | 65-1578SWD One (1) Door | 78 | 15 | 17 $\frac{3}{16}$ | 201 | 46.7 | W\$ 4496 |
| | 65-1572SWD One (1) Door | 72 | 15 | 17 $\frac{3}{16}$ | 185 | 43.2 | W\$ 4168 |
| | 65-1566SWD One (1) Door | 66 | 15 | 17 $\frac{3}{16}$ | 170 | 39.7 | W\$ 4006 |
| | 65-1560SWD One (1) Door | 60 | 15 | 17 $\frac{3}{16}$ | 155 | 36.2 | W\$ 3909 |



Must Specify (in this order):

Model #
Finish
Door
Style/Color
Grain Direction (if applicable)

Description

- Non-Locking Sliding Doors
- Component Hutch Tops with Profiles are Available; [See Top Sizes](#)
- If Applicable, Door Front Grain Direction Vertical Standard; Optional Horizontal Grain Direction
- Safely Write on Dry Erase Doors with Our Dry Erase Marker Set; [See Sets](#)
- Indiana Furniture Will Not be Liable for Wall Mount Hutches that are not Properly Installed
- Additional Options: Marker Boards, Work Wall, Tackboards, and Tasklights ([See Units](#)), Marker and Eraser Sets ([See Sets](#))

Options: Specify & Add

| | | Per Door |
|---|---|----------|
|  | 1-AD Aluminum Framed Satin Frosted Tempered Glass Doors (Non-Locking) | \$ 745 |
|  | 1-DEB Dry Erase Board Door (Non-Locking) | \$ 77 |
|  | 1-HGA High Gloss Acrylic Door (Non-Locking); Must Specify Color | |
| | (GPA) Graphite Acrylic | \$ 773 |
| | (BLA) Black, (WMA) Wired Mercury, or (WHA) White Acrylic | \$ 705 |

Pricing Codes:

W= Wood Top
P= HPL Top

[See Gesso Intro Section for Ordering Options](#)

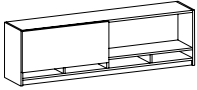
| Item | Model No. | Width | Depth | Height | Ship Wt | Cubic Ft | List Price |
|--|---|-------|-------|--------|---------|----------|------------|
| WALL MOUNT HUTCH SLIDING DOOR WITH PAPER SLOTS  | 65-15108SWDS Two (2) Doors / Six (6) Paper Slots | 108 | 15 | 21 | 204 | 27.7 | W\$ 8255 |
| | 65-15102SWDS Two (2) Doors / Six (6) Paper Slots | 102 | 15 | 21 | 194 | 26.2 | W\$ 7874 |
| | 65-1596SWDS Two (2) Doors / Six (6) Paper Slots | 96 | 15 | 21 | 186 | 24.6 | W\$ 7540 |
| | 65-1590SWDS Two (2) Doors / Five (5) Paper Slots | 90 | 15 | 21 | 172 | 23.1 | W\$ 7096 |
| | 65-1584SWDS Two (2) Doors / Five (5) Paper Slots | 84 | 15 | 21 | 162 | 21.6 | W\$ 6512 |
| | 65-1578SWDS One (1) Door / Five (5) Paper Slots | 78 | 15 | 21 | 149 | 20.0 | W\$ 6183 |
| | 65-1572SWDS One (1) Door / Four (4) Paper Slots | 72 | 15 | 21 | 140 | 18.5 | W\$ 5753 |
| | 65-1566SWDS One (1) Door / Four (4) Paper Slots | 66 | 15 | 21 | 131 | 16.9 | W\$ 5498 |
| | 65-1560SWDS One (1) Door / Four (4) Paper Slots | 60 | 15 | 21 | 121 | 15.4 | W\$ 5305 |



Must Specify (in this order):

- Model #
- Finish
- Door
 - Style/Color
 - Grain Direction (if applicable)
 - Paperslot Divider Material/Color

Description

- Non-Locking Sliding Doors
- Paper Slot Divider Material and Color Must Specify: Chrome (CHRM) or Veneer (W) and Finish Color
- Component Hutch Tops with Profiles are Available; [See Top Sizes](#)
- Safely Write on Dry Erase Doors with Our Dry Erase Marker Set; [See Sets](#)
- If Applicable, Door Front Grain Direction Vertical Standard; Optional Horizontal Grain Direction
- Indiana Furniture Will Not be Liable for Wall Mount Hutches that are not Properly Installed
- Additional Options: Work Wall, Tackboards, and Tasklights ([See Units](#)), Marker and Eraser Sets ([See Sets](#))

Options: Specify & Add

| | | Per Door |
|---|---|----------|
|  | 1-AD Aluminum Framed Satin Frosted Tempered Glass Doors (Non-Locking) | \$ 745 |
|  | 1-DEB Dry Erase Board Door (Non-Locking) | \$ 77 |
|  | 1-HGA High Gloss Acrylic Door (Non-Locking); Must Specify Color | |
| | (GPA) Graphite Acrylic | \$ 773 |
| | (BLA) Black, (WMA) Wired Mercury, or (WHA) White Acrylic | \$ 705 |

Pricing Codes:
W= Wood Top
P= HPL Top

[See Gesso Intro Section for Ordering Options](#)

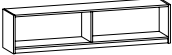
| Item | Model No. | Width | Depth | Height | Ship Wt | Cubic Ft | List Price |
|--|----------------------------------|--------|---------|---------|---------|----------|------------|
| WALL MOUNT HUTCH OPEN  Must Specify (in this order): Model # Finish Also available as 29 3/16" H Tall Wall Mount | 65-15108OW Three Compartments | 108 | 14 1/4 | 17 3/16 | 168 | 21.5 | W\$ 4092 |
| | 65-15102OW Three Compartments | 102 | 14 1/4 | 17 3/16 | 158 | 20.3 | W\$ 3915 |
| | 65-1596OW Three Compartments | 96 | 14 1/4 | 17 3/16 | 150 | 19.2 | W\$ 3854 |
| | 65-1590OW Three Compartments | 90 | 14 1/4 | 17 3/16 | 140 | 17.9 | W\$ 3602 |
| | 65-1584OW Three Compartments | 84 | 14 1/4 | 17 3/16 | 130 | 16.8 | W\$ 3106 |
| | 65-1578OW Two Compartments | 78 | 14 1/4 | 17 3/16 | 122 | 15.7 | W\$ 3037 |
| | 65-1572OW Two Compartments | 72 | 14 1/4 | 17 3/16 | 112 | 14.5 | W\$ 2548 |
| | 65-1566OW Two Compartments | 66 | 14 1/4 | 17 3/16 | 100 | 13.3 | W\$ 2462 |
| | 65-1560OW Two Compartments | 60 | 14 1/4 | 17 3/16 | 92 | 12.1 | W\$ 2421 |
| | 65-1554OW Two Compartments | 54 | 14 1/4 | 17 3/16 | 83 | 10.5 | W\$ 2248 |
| | 65-1548OW Two Compartments | 48 | 14 1/4 | 17 3/16 | 73 | 9.7 | W\$ 2081 |
| | 65-1542OW One Compartments | 42 | 14 1/4 | 17 3/16 | 63 | 8.6 | W\$ 1909 |
| | 65-1536OW One Compartments | 36 | 14 1/4 | 17 3/16 | 54 | 7.5 | W\$ 1661 |
| 65-1530OW One Compartments | 30 | 14 1/4 | 17 3/16 | 45 | 5.7 | W\$ 1448 | |

Description

- Component Hutch Tops with Profiles are Available; [See Top Sizes](#)
- Indiana Furniture Will Not be Liable for Wall Mount Hutches that are not Properly Installed
- Additional Options: Marker Boards, Work Wall, Tackboards, and Tasklights ([See Units](#)), Marker and Eraser Sets ([See Sets](#))

Pricing Codes:

W= Wood Top

P= HPL Top

[See Gesso Intro Section for Ordering Options](#)

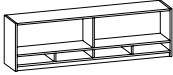
| Item | Model No. | Width | Depth | Height | Ship Wt | Cubic Ft | List Price |
|---|-----------------------------------|-------|--------|--------|---------|----------|------------|
| WALL MOUNT HUTCH OPEN WITH PAPER SLOTS  Must Specify (in this order): Model # Finish Paperslot Divider Material/Color Also available as 29 3/16" H Tall Wall Mount | 65-15108OWS Three Compartments | 108 | 14 1/4 | 21 | 160 | 24.9 | W\$ 6251 |
| | 65-15102OWS Three Compartments | 102 | 14 1/4 | 21 | 155 | 23.5 | W\$ 5990 |
| | 65-1596OWS Three Compartments | 96 | 14 1/4 | 21 | 150 | 22.2 | W\$ 5844 |
| | 65-1590OWS Three Compartments | 90 | 14 1/4 | 21 | 145 | 20.8 | W\$ 5504 |
| | 65-1584OWS Three Compartments | 84 | 14 1/4 | 21 | 135 | 19.5 | W\$ 4899 |
| | 65-1578OWS Two Compartments | 78 | 14 1/4 | 21 | 124 | 18.1 | W\$ 4723 |
| | 65-1572OWS Two Compartments | 72 | 14 1/4 | 21 | 114 | 16.7 | W\$ 4130 |
| | 65-1566OWS Two Compartments | 66 | 14 1/4 | 21 | 105 | 15.4 | W\$ 3956 |
| | 65-1560OWS Two Compartments | 60 | 14 1/4 | 21 | 95 | 14.1 | W\$ 3821 |
| | 65-1554OWS Two Compartments | 54 | 14 1/4 | 21 | 88 | 12.7 | W\$ 3552 |
| | 65-1548OWS Two Compartments | 48 | 14 1/4 | 21 | 80 | 11.3 | W\$ 3292 |
| | 65-1542OWS One Compartment | 42 | 14 1/4 | 21 | 72 | 10.0 | W\$ 3030 |
| | 65-1536OWS One Compartment | 36 | 14 1/4 | 21 | 64 | 8.6 | W\$ 2696 |
| | 65-1530OWS One Compartment | 30 | 14 1/4 | 21 | 56 | 7.2 | W\$ 2389 |

Description



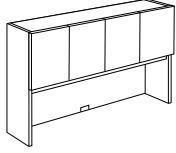
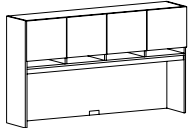

- Paper Slot Divider Material and Color Must Specify: Chrome (CHRM) or Veneer (W) and Finish Color
- Component Hutch Tops with Profiles are Available; [See Top Sizes](#)
- Indiana Furniture Will Not be Liable for Wall Mount Hutches that are not Properly Installed
- Additional Options: Work Wall, Tackboards, and Tasklights ([See Units](#)), Marker and Eraser Sets ([See Sets](#))

| Item | Model No. | Width | Depth | Height | Ship Wt | Cubic Ft | List Price |
|--|------------------------------|-------|-------|--------|---------|----------|------------|
|  <p>TALL SURFACE MOUNT HUTCH HINGED DOOR</p> <p>Must Specify (in this order): Model # Finish Door Style/Color Grain Direction (if applicable) Locking Doors Paperslots Paperslot Divider Material/Color Tasklights Grommet Color Tackboard Fabric</p>  <p>Optional Paper Slots in veneer or chrome available; See Paper Slot Options</p> <p>Also available as 40 7/8" H Standard Surface Mount</p> | 65-15108THU Six (6) Doors | 108 | 15 | 52 7/8 | 313 | 64.2 | W\$ 6496 |
| | 65-15102THU Six (6) Doors | 102 | 15 | 52 7/8 | 296 | 60.7 | W\$ 6292 |
| | 65-1596THU Six (6) Doors | 96 | 15 | 52 7/8 | 278 | 57.7 | W\$ 6179 |
| | 65-1590THU Five (5) Doors | 90 | 15 | 52 7/8 | 260 | 53.7 | W\$ 5863 |
| | 65-1584THU Five (5) Doors | 84 | 15 | 52 7/8 | 243 | 50.2 | W\$ 5246 |
| | 65-1578THU Four (4) Doors | 78 | 15 | 52 7/8 | 226 | 46.7 | W\$ 5145 |
| | 65-1572THU Four (4) Doors | 72 | 15 | 52 7/8 | 264 | 43.3 | W\$ 4518 |
| | 65-1566THU Four (4) Doors | 66 | 15 | 52 7/8 | 242 | 39.7 | W\$ 4375 |
| | 65-1560THU Four (4) Doors | 60 | 15 | 52 7/8 | 220 | 36.1 | W\$ 4299 |

Description

- 23 3/4" Clearance Below Apron Rail
- One Fixed Shelf Behind Doors
- Lower Center Grommet Standard; Must Specify: Black (BLK) or Silver (SLV)
- Additional Support is Required when Surface Mounted Hutches Do Not Sit Directly Over an End Panel or Pedestal; [See 65-2812SP](#)
- Component Hutch Tops with Profiles are Available; [See Top Sizes](#)
- Safely Write on Dry Erase, White and Black Tempered Glass Doors with Our Dry Erase Marker Set; [See Sets](#)
- If Applicable, Door Front Grain Direction Vertical Standard; Optional Horizontal Grain Direction
- Additional Options: Paper Slots ([See Paper Slot Options](#)), Locking Doors ([See Locking Door Options](#)), Marker Boards, Work Wall, Tackboards, and Tasklights ([See Units](#)), Marker and Eraser Sets ([See Sets](#))

Options: Specify & Add

| | | Per Door |
|---|--|----------|
|  | 1-AD Aluminum Framed Satin Frosted Tempered Glass Doors (Non-Locking) | \$ 621 |
|  | 1-DEB Dry Erase Board Doors | \$ 60 |
|  | WHGLS Aluminum Framed Doors with White Tempered Glass (Non-locking) | \$ 917 |
|  | BLGLS Black Matte Framed Doors with Black Tempered Glass (Non-locking) | \$ 1210 |
| | 1-HGA High Gloss Acrylic Doors; Must Specify Color | |
| | (GPA) Graphite Acrylic | \$ 602 |
| | (BLA) Black, (WMA) Wired Mercury, or (WHA) White Acrylic | \$ 546 |

Pricing Codes:

W= Wood Top
P= HPL Top

[See Gesso Intro Section for Ordering Options](#)

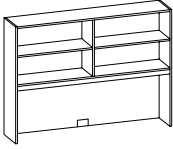
| Item | Model No. | Width | Depth | Height | Ship Wt | Cubic Ft | List Price |
|---|---------------------------------|-------|-------|--------|---------|----------|------------|
| TALL SURFACE MOUNT HUTCH OPEN  | 65-15108TOH Six Compartments | 108 | 14¼ | 52⅞ | 239 | 64.2 | W\$ 5295 |
| | 65-15102TOH Six Compartments | 102 | 14¼ | 52⅞ | 228 | 60.7 | W\$ 5117 |
| | 65-1596TOH Six Compartments | 96 | 14¼ | 52⅞ | 217 | 57.7 | W\$ 5049 |
| | 65-1590TOH Five Compartments | 90 | 14¼ | 52⅞ | 206 | 50.2 | W\$ 4837 |
| | 65-1584TOH Five Compartments | 84 | 14¼ | 52⅞ | 195 | 48.3 | W\$ 4286 |
| | 65-1578TOH Four Compartments | 78 | 14¼ | 52⅞ | 177 | 46.7 | W\$ 4199 |
| | 65-1572TOH Four Compartments | 72 | 14¼ | 52⅞ | 166 | 43.3 | W\$ 3689 |
| | 65-1566TOH Four Compartments | 66 | 14¼ | 52⅞ | 149 | 39.7 | W\$ 3583 |
| 65-1560TOH Four Compartments | 60 | 14¼ | 52⅞ | 144 | 36.1 | W\$ 3541 | |

Must Specify (in this order):

Model #
Finish
Paperslots
Paperslot Divider Material/Color
Tasklights
Grommet Color
Tackboard Fabric

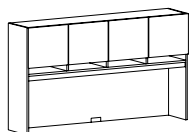

Optional Paper Slots in veneer or chrome available; [See Paper Slot Options](#)

Also available as 40⅞" H Standard Surface Mount

Description

- 23¾" Clearance Below Apron Rail
- Lower Center Grommet Standard; Must Specify: Black (BLK) or Silver (SLV)
- Additional Support is Required when Surface Mounted Hutches Do Not Sit Directly Over an End Panel or Pedestal; [See 65-2812SP](#)
- Component Hutch Tops with Profiles are Available; [See Top Sizes](#)
- Additional Options: Paper Slots ([See Paper Slot Options](#)), Locking Doors ([See Locking Door Options](#)), Marker Boards, Work Wall, Tackboards, and Tasklights ([See Units](#)), Marker and Eraser Sets ([See Sets](#))

Pricing Codes:



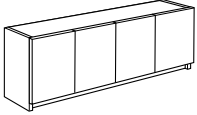

W= Wood Top
P= HPL Top

[See Gesso Intro Section for Ordering Options](#)

| Item | Model No. | Width | Depth | Height | Ship Wt | Cubic Ft | List Price |
|---|-------------------------------|-------|-------|-------------------|---------|----------|------------|
|  <p>TALL WALL MOUNT HUTCH HINGED DOOR</p> <p><i>Must Specify (in this order):</i> Model # Finish Door Style/Color Grain Direction (if applicable) Locking Doors</p> <p>Also available as 17$\frac{3}{16}$" H Standard Wall Mount</p> | 65-15108TWD Six (6) Doors | 108 | 15 | 29 $\frac{3}{16}$ | 281 | 55.1 | W\$ 6009 |
| | 65-15102TWD Six (6) Doors | 102 | 15 | 29 $\frac{3}{16}$ | 265 | 60.7 | W\$ 5868 |
| | 65-1596TWD Six (6) Doors | 96 | 15 | 29 $\frac{3}{16}$ | 249 | 57.2 | W\$ 5638 |
| | 65-1590TWD Five (5) Doors | 90 | 15 | 29 $\frac{3}{16}$ | 233 | 53.7 | W\$ 5129 |
| | 65-1584TWD Five (5) Doors | 84 | 15 | 29 $\frac{3}{16}$ | 217 | 50.2 | W\$ 4826 |
| | 65-1578TWD Four (4) Doors | 78 | 15 | 29 $\frac{3}{16}$ | 201 | 46.7 | W\$ 4732 |
| | 65-1572TWD Four (4) Doors | 72 | 15 | 29 $\frac{3}{16}$ | 185 | 43.2 | W\$ 4166 |
| | 65-1566TWD Four (4) Doors | 66 | 15 | 29 $\frac{3}{16}$ | 170 | 22.0 | W\$ 3987 |
| | 65-1560TWD Four (4) Doors | 60 | 15 | 29 $\frac{3}{16}$ | 155 | 20.1 | W\$ 3790 |
| | 65-1554TWD Three (3) Doors | 54 | 15 | 29 $\frac{3}{16}$ | 140 | 18.1 | W\$ 3496 |
| | 65-1548TWD Three (3) Doors | 48 | 15 | 29 $\frac{3}{16}$ | 124 | 16.2 | W\$ 3270 |
| | 65-1542TWD Two (2) Doors | 42 | 15 | 29 $\frac{3}{16}$ | 109 | 12.3 | W\$ 2653 |
| | 65-1536TWD Two (2) Doors | 36 | 15 | 29 $\frac{3}{16}$ | 93 | 12.3 | W\$ 2502 |
| | 65-1530TWD Two (2) Doors | 30 | 15 | 29 $\frac{3}{16}$ | 77 | 9.1 | W\$ 2343 |

Description

- One Fixed Shelf Behind Doors
- Component Hutch Tops with Profiles are Available; [See Top Sizes](#)
- If Applicable, Door Front Grain Direction Vertical Standard; Optional Horizontal Grain Direction
- Safely Write on Dry Erase, White and Black Tempered Glass Doors with Our Dry Erase Marker Set; [See Sets](#)
- Indiana Furniture Will Not be Liable for Wall Mount Hutches that are not Properly Installed
- Additional Options: Locking Doors ([See Locking Door Options](#)), Marker Boards, Work Wall, Tackboards, and Tasklights ([See Units](#)), Marker and Eraser Sets ([See Sets](#))

| Options: Specify & Add | | | Per Door |
|---|-------|--|----------|
|  | 1-AD | Aluminum Framed Satin Frosted Tempered Glass Doors (Non-Locking) | \$ 621 |
|  | 1-DEB | Dry Erase Board Doors | \$ 60 |
|  | WHGLS | Aluminum Framed Doors with White Tempered Glass (Non-locking) | \$ 917 |
|  | BLGLS | Black Matte Framed Doors with Black Tempered Glass (Non-locking) | \$ 1210 |
|  | 1-HGA | High Gloss Acrylic Doors; Must Specify Color | |
| | | (GPA) Graphite Acrylic | \$ 602 |
| | | (BLA) Black, (WMA) Wired Mercury, or (WHA) White Acrylic | \$ 546 |

Pricing Codes:

W= Wood Top

P= HPL Top



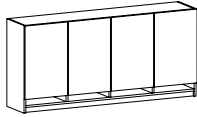

[See Gesso Intro Section for Ordering Options](#)

| Item | Model No. | Width | Depth | Height | Ship Wt | Cubic Ft | List Price |
|---|--|-------|-------|--------|---------|----------|------------|
|  <p>TALL WALL MOUNT HUTCH HINGED DOOR WITH PAPER SLOTS</p> <p><i>Must Specify (in this order):</i> Model # Finish Door Style/Color Grain Direction (if applicable) Locking Doors Paperslot Divider Material/Color</p> <p>Also available as 21 1/4" H Standard Wall Mount</p> | 65-15108TWDS Six (6) Doors / Six (6) Paper Slots | 108 | 15 | 33 3/8 | 350 | 62.7 | W\$ 8171 |
| | 65-15102TWDS Six (6) Doors / Six (6) Paper Slots | 102 | 15 | 33 3/8 | 335 | 60.7 | W\$ 7941 |
| | 65-1596TWDS Six (6) Doors / Six (6) Paper Slots | 96 | 15 | 33 3/8 | 320 | 57.2 | W\$ 7628 |
| | 65-1590TWDS Five (5) Doors / Five (5) Paper Slots | 90 | 15 | 33 3/8 | 290 | 53.7 | W\$ 7033 |
| | 65-1584TWDS Five (5) Doors / Five (5) Paper Slots | 84 | 15 | 33 3/8 | 217 | 50.2 | W\$ 6618 |
| | 65-1578TWDS Four (4) Doors / Four (4) Paper Slots | 78 | 15 | 33 3/8 | 201 | 46.0 | W\$ 6419 |
| | 65-1572TWDS Four (4) Doors / Four (4) Paper Slots | 72 | 15 | 33 3/8 | 185 | 43.2 | W\$ 5750 |
| | 65-1566TWDS Four (4) Doors / Four (4) Paper Slots | 66 | 15 | 33 3/8 | 170 | 22.0 | W\$ 5481 |
| | 65-1560TWDS Four (4) Doors / Four (4) Paper Slots | 60 | 15 | 33 3/8 | 155 | 20.1 | W\$ 5191 |
| | 65-1554TWDS Three (3) Doors / Three (3) Paper Slots | 54 | 15 | 33 3/8 | 140 | 18.1 | W\$ 4801 |
| | 65-1548TWDS Three (3) Doors / Three (3) Paper Slots | 48 | 15 | 33 3/8 | 124 | 16.2 | W\$ 4477 |
| | 65-1542TWDS Two (2) Doors / Two Paper Slots | 42 | 15 | 33 3/8 | 109 | 14.2 | W\$ 3780 |
| | 65-1536TWDS Two (2) Doors / Two Paper Slots | 36 | 15 | 33 3/8 | 93 | 12.3 | W\$ 3535 |
| | 65-1530TWDS Two (2) Doors / Two Paper Slots | 30 | 15 | 33 3/8 | 81 | 12.3 | W\$ 3286 |

Description

- One Fixed Shelf Behind Doors
- Paper Slot Divider Material and Color Must Specify: Chrome (CHRM) or Veneer (W) and Finish Color
- Component Hutch Tops with Profiles are Available; [See Top Sizes](#)
- If Applicable, Door Front Grain Direction Vertical Standard; Optional Horizontal Grain Direction
- Safely Write on Dry Erase, White and Black Tempered Glass Doors with Our Dry Erase Marker Set; [See Sets](#)
- Indiana Furniture Will Not be Liable for Wall Mount Hutches that are not Properly Installed
- Additional Options: Locking Doors ([See Locking Door Options](#)), Work Wall, Tackboards, and Tasklights ([See Units](#)), Marker and Eraser Sets ([See Sets](#))

Options: Specify & Add

| | | Per Door |
|---|--|----------|
|  | 1-AD Aluminum Framed Satin Frosted Tempered Glass Doors (Non-Locking) | \$ 621 |
|  | 1-DEB Dry Erase Board Doors | \$ 60 |
|  | WHGLS Aluminum Framed Doors with White Tempered Glass (Non-locking) | \$ 917 |
|  | BLGLS Black Matte Framed Doors with Black Tempered Glass (Non-locking) | \$ 1210 |
|  | 1-HGA High Gloss Acrylic Doors; Must Specify Color | |
| | (GPA) Graphite Acrylic | \$ 602 |
| | (BLA) Black, (WMA) Wired Mercury, or (WHA) White Acrylic | \$ 546 |

Pricing Codes:
 W= Wood Top
 P= HPL Top

[See Gesso Intro Section for Ordering Options](#)

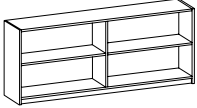
| Item | Model No. | Width | Depth | Height | Ship Wt | Cubic Ft | List Price |
|--|---------------------------------|-------|--------|---------|---------|----------|------------|
| TALL WALL MOUNT HUTCH OPEN  Must Specify (in this order): Model # Finish Also available as 17 3/16" H Standard Wall Mount | 65-15108TOW Six Compartments | 108 | 14 1/4 | 29 3/16 | 225 | 34.6 | W\$ 4809 |
| | 65-15102TOW Six Compartments | 102 | 14 1/4 | 29 3/16 | 212 | 32.7 | W\$ 4697 |
| | 65-1596TOW Six Compartments | 96 | 14 1/4 | 29 3/16 | 200 | 30.8 | W\$ 4511 |
| | 65-1590TOW Six Compartments | 90 | 14 1/4 | 29 3/16 | 186 | 29.0 | W\$ 4103 |
| | 65-1584TOW Six Compartments | 84 | 14 1/4 | 29 3/16 | 173 | 27.1 | W\$ 3864 |
| | 65-1578TOW Four Compartments | 78 | 14 1/4 | 29 3/16 | 161 | 25.2 | W\$ 3790 |
| | 65-1572TOW Four Compartments | 72 | 14 1/4 | 29 3/16 | 147 | 23.3 | W\$ 3336 |
| | 65-1566TOW Four Compartments | 66 | 14 1/4 | 29 3/16 | 135 | 21.4 | W\$ 3191 |
| | 65-1560TOW Four Compartments | 60 | 14 1/4 | 29 3/16 | 122 | 20.1 | W\$ 3030 |

Description

- Component Hutch Tops with Profiles are Available; [See Top Sizes](#)
- Indiana Furniture Will Not be Liable for Wall Mount Hutches that are not Properly Installed
- Additional Options: Marker Boards, Work Wall, Tackboards, and Tasklights ([See Units](#)), Marker and Eraser Sets ([See Sets](#))

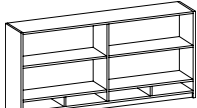
| | | | | | | | |
|---|---|-----|--------|--------|-----|------|----------|
| TALL WALL MOUNT HUTCH OPEN WITH PAPER SLOTS  Must Specify (in this order): Model # Finish Paperslot Divider Material/Color Also available as 17 3/16" H Standard Wall Mount | 65-15108TOWS Six Compartments / Six (6) Paper Slots | 108 | 14 1/4 | 33 3/8 | 245 | 34.6 | W\$ 6969 |
| | 65-15102TOWS Six Compartments / Six (6) Paper Slots | 102 | 14 1/4 | 33 3/8 | 232 | 32.7 | W\$ 6772 |
| | 65-1596TOWS Six Compartments / Six (6) Paper Slots | 96 | 14 1/4 | 33 3/8 | 220 | 30.8 | W\$ 6500 |
| | 65-1590TOWS Six Compartments / Six (6) Paper Slots | 90 | 14 1/4 | 33 3/8 | 206 | 29.0 | W\$ 6006 |
| | 65-1584TOWS Six Compartments / Six (6) Paper Slots | 84 | 14 1/4 | 33 3/8 | 193 | 27.1 | W\$ 5652 |
| | 65-1578TOWS Four Compartments / Four (4) Paper Slots | 78 | 14 1/4 | 33 3/8 | 181 | 25.2 | W\$ 5476 |
| | 65-1572TOWS Four Compartments / Four (4) Paper Slots | 72 | 14 1/4 | 33 3/8 | 167 | 23.2 | W\$ 4916 |
| | 65-1566TOWS Four Compartments / Four (4) Paper Slots | 66 | 14 1/4 | 33 3/8 | 155 | 21.4 | W\$ 4684 |
| | 65-1560TOWS Four Compartments / Four (4) Paper Slots | 60 | 14 1/4 | 33 3/8 | 142 | 20.1 | W\$ 4432 |

Description

- Paper Slot Divider Material and Color Must Specify: Chrome (CHRM) or Veneer (W) and Finish Color
- Component Hutch Tops with Profiles are Available; [See Top Sizes](#)
- Indiana Furniture Will Not be Liable for Wall Mount Hutches that are not Properly Installed
- Additional Options: Work Wall, Tackboards, and Tasklights ([See Units](#)), Marker and Eraser Sets ([See Sets](#))

Pricing Codes:

W= Wood Top
P= HPL Top

[See Gesso Intro Section for Ordering Options](#)

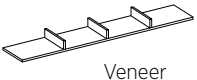
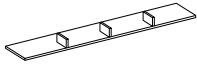
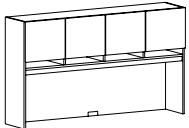
| Item | Model No. | For Use With | Width | Depth | Height | Ship Wt | Cubic Ft | List Price |
|--|------------------|--|-------|-------|--------|---------|----------|------------|
| OPTIONAL PAPER SLOTS FOR SURFACE MOUNT HUTCH  Veneer  Chrome  | 01-PAPERSLOT 108 | For Use with 108" Unit Six (6) Slots | 106½ | 11⅞ | 5¼ | - | - | \$ 2107 |
| | 01-PAPERSLOT 102 | For Use with 102" Unit Six (6) Slots | 100½ | 11⅞ | 5¼ | - | - | \$ 2022 |
| | 01-PAPERSLOT 96 | For Use with 96" Unit Six (6) Slots | 94½ | 11⅞ | 5¼ | - | - | \$ 1940 |
| | 01-PAPERSLOT 90 | For Use with 90" Unit Five (5) Slots | 88½ | 11⅞ | 5¼ | - | - | \$ 1854 |
| | 01-PAPERSLOT 84 | For Use with 84" Unit Five (5) Slots | 82½ | 11⅞ | 5¼ | - | - | \$ 1746 |
| | 01-PAPERSLOT 78 | For Use with 78" Unit Four (4) Slots | 76½ | 11⅞ | 5¼ | - | - | \$ 1644 |
| | 01-PAPERSLOT 72 | For Use with 72" Unit Four (4) Slots | 70½ | 11⅞ | 5¼ | - | - | \$ 1540 |
| | 01-PAPERSLOT 66 | For Use with 66" Unit Four (4) Slots | 64½ | 11⅞ | 5¼ | - | - | \$ 1454 |
| | 01-PAPERSLOT 60 | For Use with 60" Unit Four (4) Slots | 58½ | 11⅞ | 5¼ | - | - | \$ 1361 |
| | 01-PAPERSLOT 54 | For Use with 54" Unit Three (3) Slots | 52½ | 11⅞ | 5¼ | - | - | \$ 1274 |
| | 01-PAPERSLOT 48 | For Use with 48" Unit Three (3) Slots | 46½ | 11⅞ | 5¼ | - | - | \$ 1181 |
| | 01-PAPERSLOT 42 | For Use with 42" Unit Two (2) Slots | 40½ | 11⅞ | 5¼ | - | - | \$ 1095 |
| | 01-PAPERSLOT 36 | For Use with 36" Unit Two (2) Slots | 34½ | 11⅞ | 5¼ | - | - | \$ 1008 |
| | 01-PAPERSLOT 30 | For Use with 30" Unit Two (2) Slots | 28½ | 11⅞ | 5¼ | - | - | \$ 923 |

Must Specify (in this order):
 Model #
 Paperslot Divider Material/Color

Description

- Ships Factory Installed
- Paper Slot Divider Material and Color Must Specify: Chrome (CHRM) or Veneer (W) and Finish

| Item | Model No. | Width | Depth | Height | Ship Wt | Cubic Ft | List Price |
|--|------------|-------|-------|--------|---------|----------|------------|
| MODULAR TOP FOR 15" DEEP HUTCHES & BOOKCASES  | 65-15108HT | 108 | 15 | 1 | 67 | 5.7 | W\$ 1075 |
| | 65-15102HT | 102 | 15 | 1 | 63 | 5.4 | W\$ 1056 |
| | 65-1596HT | 96 | 15 | 1 | 61 | 5.1 | W\$ 1018 |
| | 65-1590HT | 90 | 15 | 1 | 57 | 4.8 | W\$ 974 |
| | 65-1584HT | 84 | 15 | 1 | 53 | 4.5 | W\$ 932 |
| | 65-1578HT | 78 | 15 | 1 | 50 | 4.2 | W\$ 910 |
| | 65-1572HT | 72 | 15 | 1 | 48 | 3.9 | W\$ 846 |
| | 65-1566HT | 66 | 15 | 1 | 42 | 3.5 | W\$ 810 |
| | 65-1560HT | 60 | 15 | 1 | 38 | 3.2 | W\$ 790 |
| | 65-1554HT | 54 | 15 | 1 | 34 | 2.9 | W\$ 774 |
| | 65-1548HT | 48 | 15 | 1 | 30 | 2.6 | W\$ 755 |
| | 65-1542HT | 42 | 15 | 1 | 27 | 2.3 | W\$ 731 |
| | 65-1536HT | 36 | 15 | 1 | 23 | 2.0 | W\$ 702 |
| | 65-1530HT | 30 | 15 | 1 | 11 | 1.0 | W\$ 679 |

Must Specify (in this order):

Model #
Finish
Edge Profile

Description

- Provides an Edge Profile on Overhead Units While Giving Multiple Overhead Units a Cohesive Appearance
- Profiled on Front Edge Only

| | | | | | | | |
|---------------------------------------|-----------|----|----|----|----|-----|----------|
| SURFACE MOUNT PAPER SLOT TOWER | 65-1218HH | 18 | 12 | 21 | 45 | 4.4 | W\$ 1470 |
|---------------------------------------|-----------|----|----|----|----|-----|----------|

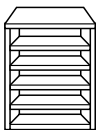

Description

- Four Adjustable Shelves

Must Specify (in this order):

Model #
Finish

Pricing Codes:

W= Wood Top
P= HPL Top

[See Gesso Intro Section for Ordering Options](#)

| Item | Model No. | Width | Depth | Height | Ship Wt | Cubic Ft | List Price |
|---|--------------------|---------------------|-------|--------|------------------|----------|------------|
| SURFACE MOUNT STORAGE TOWER WITH DOOR AND OPEN SHELVING | Hinged Left | Hinged Right | | | | | |
| | 65-1518HL1 | 65-1518HR1 | 18 | 15 | 40 $\frac{1}{8}$ | 78 | 8.6 |

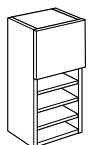

Shown as Right

Must Specify (in this order):

- Model #
- Finish
- Door
 - Style/Color
 - Grain Direction (if applicable)
 - Locking Doors

Description

- Storage Behind Door in Upper Section
- Three Adjustable Shelves
- If Applicable, Door Front Grain Direction Vertical Standard; Optional Horizontal Grain Direction
- Safely Write on Dry Erase, White and Black Tempered Glass Doors with Our Dry Erase Marker Set; [See Sets](#)
- Additional Options: Locking Door ([See Locking Options](#))

Options: Specify & Add

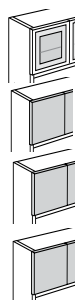

| | | Per Door |
|-------|--|----------|
| 1-AD | Aluminum Framed Satin Frosted Tempered Glass Doors (Non-Locking) | \$ 438 |
| 1-DEB | Dry Erase Board Doors | \$ 28 |
| WHGLS | Aluminum Framed Doors with White Tempered Glass (Non-locking) | \$ 652 |
| BLGLS | Black Matte Framed Doors with Black Tempered Glass (Non-locking) | \$ 868 |
| 1-HGA | High Gloss Acrylic Doors; Must Specify Color | |
| | (GPA) Graphite Acrylic | \$ 269 |
| | (BLA) Black, (WMA) Wired Mercury, or (WHA) White Acrylic | \$ 247 |

| SURFACE MOUNT TALL STORAGE TOWER WITH DOOR AND OPEN SHELVING | Hinged Left | Hinged Right | Width | Depth | Height | Ship Wt | Cubic Ft | List Price |
|--|-------------|--------------|-------|-------|--------|---------|----------|------------|
| | 65-1518THL1 | 65-1518THR1 | | | | | | |

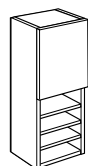

Shown as Right

Must Specify (in this order):

- Model #
- Finish
- Door
 - Style/Color
 - Grain Direction (if applicable)
 - Locking Doors

Description

- Storage Behind Door in Upper Section with One Adjustable Shelf
- Three Adjustable Shelves
- If Applicable, Door Front Grain Direction Vertical Standard; Optional Horizontal Grain Direction
- Safely Write on Dry Erase, White and Black Tempered Glass Doors with Our Dry Erase Marker Set; [See Sets](#)
- Additional Options: Locking Door ([See Locking Options](#))

Options: Specify & Add

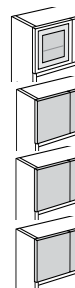

| | | Per Door |
|-------|--|----------|
| 1-AD | Aluminum Framed Satin Frosted Tempered Glass Doors (Non-Locking) | \$ 621 |
| 1-DEB | Dry Erase Board Doors | \$ 60 |
| WHGLS | Aluminum Framed Doors with White Tempered Glass (Non-locking) | \$ 917 |
| BLGLS | Black Matte Framed Doors with Black Tempered Glass (Non-locking) | \$ 1210 |
| 1-HGA | High Gloss Acrylic Doors; Must Specify Color | |
| | (GPA) Graphite Acrylic | \$ 602 |
| | (BLA) Black, (WMA) Wired Mercury, or (WHA) White Acrylic | \$ 546 |

Pricing Codes:
W= Wood Top
P= HPL Top

[See Gesso Intro Section for Ordering Options](#)

| Item | Model No. | Width | Depth | Height | Ship Wt | Cubic Ft | List Price |
|---|-----------|-------|-------|--------|---------|----------|------------|
| SURFACE MOUNT STORAGE TOWER OPEN BOOKCASE | 65-1518HB | 18 | 14¼ | 40⅞ | 62 | 8.6 | W\$ 1436 |

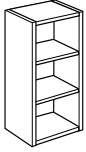

Description

- Two Adjustable Shelves

Must Specify (in this order):

Model #
Finish

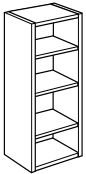
| | | | | | | | |
|--|------------|----|-----|-----|----|------|----------|
| SURFACE MOUNT TALL STORAGE TOWER OPEN BOOKCASE | 65-1518THB | 18 | 14½ | 52⅞ | 68 | 11.0 | W\$ 1709 |
|--|------------|----|-----|-----|----|------|----------|

Description

- Three Adjustable Shelves

Must Specify (in this order):

Model #
Finish

Pricing Codes:

W= Wood Top
P= HPL Top

[See Gesso Intro Section for Ordering Options](#)

| Item | Model No. | Width | Depth | Height | Ship Wt | Cubic Ft | List Price |
|--|-------------|--------------|-------|--------|------------------|----------|--------------|
| SURFACE MOUNT STORAGE TOWER WITH FULL DOOR | Hinged Left | Hinged Right | | | | | |
| | 65-1518HL3 | 65-1518HR3 | 18 | 15 | 40 $\frac{7}{8}$ | 78 | 8.6 W\$ 1891 |

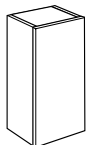

Shown as Right

Must Specify (in this order):

- Model #
- Finish
- Door
- Style/Color
- Grain Direction (if applicable)
- Locking Doors

Description

- Touch Latch Door with One Fixed Shelf/Two Adjustable Shelves Behind Door
- If Applicable, Door Front Grain Direction Vertical Standard; Optional Horizontal Grain Direction
- Safely Write on Dry Erase, White and Black Tempered Glass Doors with Our Dry Erase Marker Set; [See Sets](#)
- Additional Options: Locking Door ([See Locking Options](#))

Options: Specify & Add

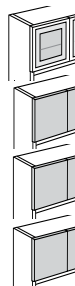

| | | Per Unit |
|-------|---|----------|
| 1-AD | Aluminum Framed Satin Frosted Tempered Glass Door (Non-Locking) | \$ 710 |
| 1-DEB | Dry Erase Board Door | \$ 77 |
| WHGLS | Aluminum Framed Door with White Tempered Glass (Non-locking) | \$ 1113 |
| BLGLS | Black Matte Framed Door with Black Tempered Glass (Non-locking) | \$ 1486 |
| 1-HGA | High Gloss Acrylic Door; Must Specify Color | |
| | (GPA) Graphite Acrylic | \$ 733 |
| | (BLA) Black, (WMA) Wired Mercury, or (WHA) White Acrylic | \$ 668 |

| Item | Model No. | Width | Depth | Height | Ship Wt | Cubic Ft | List Price |
|---|-------------|--------------|-------|--------|------------------|----------|---------------|
| SURFACE MOUNT TALL STORAGE TOWER WITH FULL DOOR | Hinged Left | Hinged Right | | | | | |
| | 65-1518THL3 | 65-1518THR3 | 18 | 15 | 52 $\frac{7}{8}$ | 95 | 11.0 W\$ 2241 |

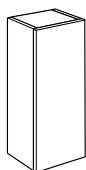

Shown as Right

Must Specify (in this order):

- Model #
- Finish
- Door
- Style/Color
- Grain Direction (if applicable)
- Locking Doors

Description

- Touch Latch Door with One Fixed Shelf/Three Adjustable Shelves Behind Door
- If Applicable, Door Front Grain Direction Vertical Standard; Optional Horizontal Grain Direction
- Safely Write on Dry Erase, White and Black Tempered Glass Doors with Our Dry Erase Marker Set; [See Sets](#)
- Additional Options: Locking Door ([See Locking Options](#))

Options: Specify & Add

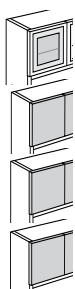

| | | Per Unit |
|-------|---|----------|
| 1-AD | Aluminum Framed Satin Frosted Tempered Glass Door (Non-Locking) | \$ 849 |
| 1-DEB | Dry Erase Board Door | \$ 96 |
| WHGLS | Aluminum Framed Door with White Tempered Glass (Non-locking) | \$ 1347 |
| BLGLS | Black Matte Framed Door with Black Tempered Glass (Non-locking) | \$ 1796 |
| 1-HGA | High Gloss Acrylic; Must Specify Color | |
| | (GPA) Graphite Acrylic | \$ 960 |
| | (BLA) Black, (WMA) Wired Mercury, or (WHA) White Acrylic | \$ 876 |

Pricing Codes:
W= Wood Top
P= HPL Top

[See Gesso Intro Section for Ordering Options](#)

| Item | Model No. | Width | Depth | Height | Ship Wt | Cubic Ft | List Price |
|--------------------------------|-------------|-------|-------|--------------------------------|---------|----------|------------|
| SURFACE MOUNT DOOR BOOKCASE | 65-1536TUDB | 36 | 15 | 40 ⁷ / ₈ | 168 | 16.1 | W\$ 2708 |
| | 65-1530TUDB | 30 | 15 | 40 ⁷ / ₈ | 140 | 13.4 | W\$ 2514 |

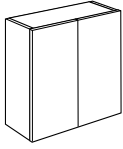

Description

- Touch Latch Door with One Fixed Shelf/Two Adjustable Shelves Behind Door
- If Applicable, Door Front Grain Direction Vertical Standard; Optional Horizontal Grain Direction
- Safely Write on Dry Erase, White and Black Tempered Glass Doors with Our Dry Erase Marker Set; [See Sets](#)
- Additional Options: Locking Doors ([See Locking Options](#))

Must Specify (in this order):

- Model #
- Finish
- Door
- Style/Color
- Grain Direction (if applicable)
- Locking Doors

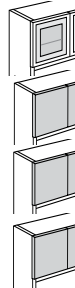

| Options: Specify & Add | | | Per Unit |
|------------------------|--|--|----------|
| 1-AD | Aluminum Framed Satin Frosted Tempered Glass Doors (Non-Locking) | | \$ 1420 |
| 1-DEB | Dry Erase Board Doors | | \$ 148 |
| WHGLS | Aluminum Framed Doors with White Tempered Glass (Non-locking) | | \$ 2228 |
| BLGLS | Black Matte Framed Doors with Black Tempered Glass (Non-locking) | | \$ 2975 |
| 1-HGA | High Gloss Acrylic; Must Specify Color | | |
| | (GPA) Graphite Acrylic | | \$ 1462 |
| | (BLA) Black, (WMA) Wired Mercury, or (WHA) White Acrylic | | \$ 1334 |

| | | | | | | | |
|-------------------------------------|--------------|----|----|--------------------------------|-----|------|----------|
| SURFACE MOUNT TALL DOOR BOOKCASE | 65-1536TTUDB | 36 | 15 | 52 ⁷ / ₈ | 216 | 20.5 | W\$ 3183 |
| | 65-1530TTUDB | 30 | 15 | 52 ⁷ / ₈ | 180 | 17.3 | W\$ 2888 |

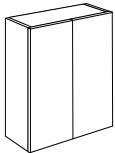

Description

- Touch Latch Door with One Fixed Shelf/Three Adjustable Shelves Behind Door
- If Applicable, Door Front Grain Direction Vertical Standard; Optional Horizontal Grain Direction
- Safely Write on Dry Erase, White and Black Tempered Glass Doors with Our Dry Erase Marker Set; [See Sets](#)
- Additional Options: Locking Doors ([See Locking Options](#))

Must Specify (in this order):

- Model #
- Finish
- Door
- Style/Color
- Grain Direction (if applicable)
- Locking Doors

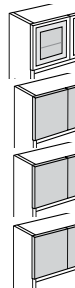

| Options: Specify & Add | | | Per Unit |
|------------------------|--|--|----------|
| 1-AD | Aluminum Framed Satin Frosted Tempered Glass Doors (Non-Locking) | | \$ 1697 |
| 1-DEB | Dry Erase Board Doors | | \$ 193 |
| WHGLS | Aluminum Framed Doors with White Tempered Glass (Non-locking) | | \$ 2692 |
| BLGLS | Black Matte Framed Doors with Black Tempered Glass (Non-locking) | | \$ 3589 |
| 1-HGA | High Gloss Acrylic; Must Specify Color | | |
| | (GPA) Graphite Acrylic | | \$ 1914 |
| | (BLA) Black, (WMA) Wired Mercury, or (WHA) White Acrylic | | \$ 1747 |

Pricing Codes:

W= Wood Top
P= HPL Top

[See Gesso Intro Section for Ordering Options](#)

| Item | Model No. | Width | Depth | Height | Ship Wt | Cubic Ft | List Price |
|--|---------------------|----------------------|-------|--------|------------------|----------|---------------|
| SURFACE MOUNT DOOR BOOKCASE WITH SIDE SHELVING | Shelves Left | Shelves Right | | | | | |
| | 65-3615TUDBL | 65-3615TUDBR | 36 | 15 | 40 $\frac{1}{2}$ | 157 | 13.8 W\$ 3689 |
| | 65-3015TUDBL | 65-3015TUDBR | 30 | 15 | 40 $\frac{1}{2}$ | 140 | 13.4 W\$ 3559 |

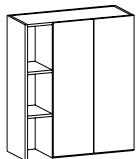

Shown as Left





Must Specify (in this order):

- Model #
- Finish
- Door
 - Style/Color
 - Grain Direction (if applicable)
- Locking Doors

Description

- Touch Latch Door with Two Adjustable Shelves Behind Doors
- Side Fixed Shelves; Top Shelf with 15" Clearance, Two Remaining Shelves with 11 $\frac{1}{2}$ " Clearance
- If Applicable, Door Front Grain Direction Vertical Standard; Optional Horizontal Grain Direction
- Safely Write on Dry Erase, White and Black Tempered Glass Doors with Our Dry Erase Marker Set; [See Sets](#)
- Additional Options: Locking Doors ([See Locking Options](#))

Options: Specify & Add

| | | Per Unit |
|---|--|----------|
|  | 1-AD Aluminum Framed Satin Frosted Tempered Glass Doors (Non-Locking) | \$ 1420 |
|  | 1-DEB Dry Erase Board Doors | \$ 148 |
|  | WHGLS Aluminum Framed Doors with White Tempered Glass (Non-locking) | \$ 2228 |
|  | BLGLS Black Matte Framed Doors with Black Tempered Glass (Non-locking) | \$ 2975 |
|  | 1-HGA High Gloss Acrylic; Must Specify Color | |
| | (GPA) Graphite Acrylic | \$ 1462 |
| | (BLA) Black, (WMA) Wired Mercury, or (WHA) White Acrylic | \$ 1334 |

| Item | Model No. | Width | Depth | Height | Ship Wt | Cubic Ft | List Price |
|--|---------------------|----------------------|-------|--------|---------|----------|---------------|
| SURFACE MOUNT DOOR BOOKCASE WITH SIDE SHELVING | Shelves Left | Shelves Right | | | | | |
| | 65-3615TTUDBL | 65-3615TTUDBR | 36 | 15 | 52 | 157 | 13.8 W\$ 4199 |
| | 65-3015TTUDBL | 65-3015TTUDBR | 30 | 15 | 52 | 140 | 13.4 W\$ 4053 |

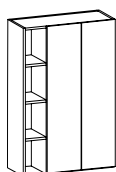

Shown as Left





Must Specify (in this order):

- Model #
- Finish
- Door
 - Style/Color
 - Grain Direction (if applicable)
- Locking Doors

Description

- Touch Latch Door with Three Adjustable Shelves Behind Doors
- Side Fixed Shelves; Top Shelf with 15" Clearance, Two Remaining Shelves with 12" Clearance
- If Applicable, Door Front Grain Direction Vertical Standard; Optional Horizontal Grain Direction
- Safely Write on Dry Erase, White and Black Tempered Glass Doors with Our Dry Erase Marker Set; [See Sets](#)
- Additional Options: Locking Doors ([See Locking Options](#))

Options: Specify & Add

| | | Per Unit |
|---|--|----------|
|  | 1-AD Aluminum Framed Satin Frosted Tempered Glass Doors (Non-Locking) | \$ 1697 |
|  | 1-DEB Dry Erase Board Doors | \$ 193 |
|  | WHGLS Aluminum Framed Doors with White Tempered Glass (Non-locking) | \$ 2692 |
|  | BLGLS Black Matte Framed Doors with Black Tempered Glass (Non-locking) | \$ 3589 |
|  | 1-HGA High Gloss Acrylic; Must Specify Color | |
| | (GPA) Graphite Acrylic | \$ 1914 |
| | (BLA) Black, (WMA) Wired Mercury, or (WHA) White Acrylic | \$ 1747 |

Pricing Codes:
 W= Wood Top
 P= HPL Top

[See Gesso Intro Section for Ordering Options](#)

| Item | Model No. | Width | Depth | Height | Ship Wt | Cubic Ft | List Price |
|---|-------------|--------------|-------|--------|------------------|----------|------------|
| STORAGE CABINET WITH OPEN SHELVES AND FILE/FILE | Hinged Left | Hinged Right | | | | | |
| | 65-1872DS2L | 65-1872DS2R | 18 | 24 | 70 $\frac{1}{8}$ | 145 | 22.0 |

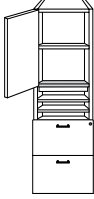

Shown as Left

Must Specify (in this order):

Model #
Finish
Door Style/Color
Door/Drawer Grain Direction
(if applicable)
Locking Doors
Drawer
Construction
Track
Pull

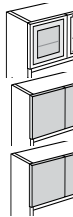

Description

- One Adjustable Shelf Behind Touch Latch Door; Two Adjustable Shelves in Center
- Locking File Drawers Provide Legal or Letter Filing
- If Applicable, Drawer/Door Front Grain Direction Vertical Standard; Optional Horizontal Grain Direction
- Safely Write on Dry Erase Doors with Our Dry Erase Marker Set; [See Sets](#)
- Additional Options: Dove Tail Drawer Construction and Soft Close Drawers ([See Drawer Options](#)), Locking Door ([See Locking Options](#))

Options: Specify & Add

| Options: Specify & Add | Per Door |
|---|----------|
| 1-AD Aluminum Framed Satin Frosted Tempered Glass Doors (Non-Locking) | \$ 621 |
| 1-DEB Dry Erase Board Doors | \$ 60 |
| 1-HGA High Gloss Acrylic Doors; Must Specify Color | |
| (GPA) Graphite Acrylic | \$ 602 |
| (BLA) Black, (WMA) Wired Mercury, or (WHA) White Acrylic | \$ 546 |

| Item | Model No. | Width | Depth | Height | Ship Wt | Cubic Ft | List Price |
|--|-------------|--------------|-------|--------|------------------|----------|------------|
| TALL STORAGE CABINET WITH OPEN SHELVES AND FILE/FILE | Hinged Left | Hinged Right | | | | | |
| | 65-1884DS2L | 65-1884DS2R | 18 | 24 | 82 $\frac{1}{8}$ | 196 | 25.8 |

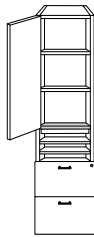

Shown as Left

Must Specify (in this order):

Model #
Finish
Door Style/Color
Door/Drawer Grain Direction
(if applicable)
Locking Doors
Drawer
Construction
Track
Pull

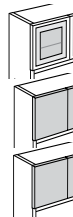

Description

- Two Adjustable Shelf Behind Touch Latch Door; Two Adjustable Shelves in Center
- Locking File Drawers Provide Legal or Letter Filing
- If Applicable, Drawer/Door Front Grain Direction Vertical Standard; Optional Horizontal Grain Direction
- Safely Write on Dry Erase Doors with Our Dry Erase Marker Set; [See Sets](#)
- Additional Options: Dove Tail Drawer Construction and Soft Close Drawers ([See Drawer Options](#)), Locking Door ([See Locking Options](#))

Options: Specify & Add

| Options: Specify & Add | Per Unit |
|--|----------|
| 1-AD Aluminum Framed Satin Frosted Tempered Glass Door (Non-Locking) | \$ 710 |
| 1-DEB Dry Erase Board Door | \$ 77 |
| 1-HGA High Gloss Acrylic Door; Must Specify Color | |
| (GPA) Graphite Acrylic | \$ 733 |
| (BLA) Black, (WMA) Wired Mercury, or (WHA) White Acrylic | \$ 668 |

Pricing Codes:

W= Wood Top

P= HPL Top

[See Gesso Intro Section for Ordering Options](#)

| Item | Model No. | Width | Depth | Height | Ship Wt | Cubic Ft | List Price |
|--|-------------|--------------|-------|--------|--------------------------------|----------|------------|
| STORAGE CABINET WITH OPEN SHELVES AND BOX/BOX/FILE | Hinged Left | Hinged Right | | | | | |
| | 65-1872DSIL | 65-1872DSIR | 18 | 24 | 70 ⁷ / ₈ | 145 | 22.0 |

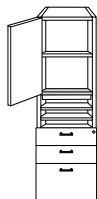

Shown as Left

Description

- One Adjustable Shelf Behind Touch Latch Door; Two Adjustable Shelves in Center
- Locking Drawers; File Drawer Provides Legal or Letter Filing
- If Applicable, Drawer/Door Front Grain Direction Vertical Standard; Optional Horizontal Grain Direction
- Safely Write on Dry Erase Doors with Our Dry Erase Marker Set; [See Sets](#)
- Additional Options: Dove Tail Drawer Construction and Soft Close Drawers ([See Drawer Options](#)), Locking Door ([See Locking Options](#))

Must Specify (in this order):

- Model #
- Finish
- Door Style/Color
- Door/Drawer Grain Direction (if applicable)
- Locking Doors
- Drawer Construction
- Track
- Pull

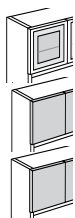

Options: Specify & Add

| | Per Door |
|---|----------|
| 1-AD Aluminum Framed Satin Frosted Tempered Glass Doors (Non-Locking) | \$ 621 |
| 1-DEB Dry Erase Board Doors | \$ 60 |
| 1-HGA High Gloss Acrylic Doors; Must Specify Color | |
| (GPA) Graphite Acrylic | \$ 602 |
| (BLA) Black, (WMA) Wired Mercury, or (WHA) White Acrylic | \$ 546 |

| | | | | | | | | |
|---|-------------|--------------|----|----|--------------------------------|-----|------|----------|
| TALL STORAGE CABINET WITH OPEN SHELVES AND BOX/BOX/FILE | Hinged Left | Hinged Right | | | | | | |
| | 65-1884DSIL | 65-1884DSIR | 18 | 24 | 82 ⁷ / ₈ | 196 | 25.8 | W\$ 4519 |

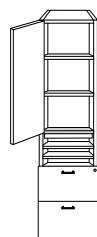

Shown as Left

Description

- Two Adjustable Shelf Behind Touch Latch Door; Two Adjustable Shelves in Center
- Locking Drawers; File Provide Legal or Letter Filing
- If Applicable, Drawer/Door Front Grain Direction Vertical Standard; Optional Horizontal Grain Direction
- Safely Write on Dry Erase Doors with Our Dry Erase Marker Set; [See Sets](#)
- Additional Options: Dove Tail Drawer Construction and Soft Close Drawers ([See Drawer Options](#)), Locking Door ([See Locking Options](#))

Must Specify (in this order):

- Model #
- Finish
- Door Style/Color
- Door/Drawer Grain Direction (if applicable)
- Locking Doors
- Drawer Construction
- Track
- Pull

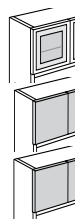

Options: Specify & Add

| | Per Unit |
|--|----------|
| 1-AD Aluminum Framed Satin Frosted Tempered Glass Door (Non-Locking) | \$ 710 |
| 1-DEB Dry Erase Board Door | \$ 77 |
| 1-HGA High Gloss Acrylic Door; Must Specify Color | |
| (GPA) Graphite Acrylic | \$ 733 |
| (BLA) Black, (WMA) Wired Mercury, or (WHA) White Acrylic | \$ 668 |

Pricing Codes:
W= Wood Top
P= HPL Top

[See Gesso Intro Section for Ordering Options](#)

| Item | Model No. | Width | Depth | Height | Ship Wt | Cubic Ft | List Price | |
|------------------------------|--------------------------------------|---------------------|-------|--------|--------------------|----------|------------|----------|
| STORAGE CABINET FILE/FILE | Hinged Left | Hinged Right | | | | | | |
| | 65-1884WFL | 65-1884WFR | 18 | 24 | 82 $\frac{1}{2}$ " | 166 | 25.7 | W\$ 4201 |
| | Three Adjustable Shelves Behind Door | | | | | | | |
| | 65-1872WFL | 65-1872WFR | 18 | 24 | 70 $\frac{1}{2}$ " | 145 | 22.0 | W\$ 4025 |
| | Two Adjustable Shelves Behind Door | | | | | | | |

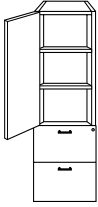

Shown as Left

Description

- Touch Latch Door
- Locking File Drawers Provide Legal or Letter Filing
- If Applicable, Drawer/Door Front Grain Direction Vertical Standard; Optional Horizontal Grain Direction
- Additional Options: Dove Tail Drawer Construction and Soft Close Drawers ([See Drawer Options](#)), Locking Door ([See Locking Options](#))

Must Specify (in this order):

Model #
 Finish
 Drawer Front/Door Grain Direction
 (if applicable)
 Locking Doors
 Drawer
 Construction
 Track
 Pull

| | | | | | | | |
|-----------------------------------|--------------------------|----|----|--------------------|-----|------|----------|
| OPEN STORAGE CABINET FILE/FILE | 65-1884WFO | 18 | 24 | 82 $\frac{1}{2}$ " | 166 | 25.7 | W\$ 3866 |
| | Three Adjustable Shelves | | | | | | |
| | 65-1872WFO | 18 | 24 | 70 $\frac{1}{2}$ " | 145 | 22.0 | W\$ 3701 |
| | Two Adjustable Shelves | | | | | | |

**Description**

- Locking File Drawers Provide Legal or Letter Filing
- If Applicable, Drawer/Door Front Grain Direction Vertical Standard; Optional Horizontal Grain Direction
- Additional Options: Dove Tail Drawer Construction and Soft Close Drawers ([See Drawer Options](#))

Must Specify (in this order):

Model #
 Finish
 Drawer Front Grain Direction
 Drawer
 Construction
 Track
 Pull

Pricing Codes:

W= Wood Top
 P= HPL Top

[See Gesso Intro Section for Ordering Options](#)

| Item | Model No. | Width | Depth | Height | Ship Wt | Cubic Ft | List Price | |
|---------------------------------|--------------------------------------|---------------------|-------|--------|------------------|----------|------------|----------|
| STORAGE CABINET BOX/BOX/FILE | Hinged Left | Hinged Right | | | | | | |
| | 65-1884WBL | 65-1884WBR | 18 | 24 | 82 $\frac{7}{8}$ | 166 | 25.7 | W\$ 4201 |
| | Three Adjustable Shelves Behind Door | | | | | | | |
| | 65-1872WBL | 65-1872WBR | 18 | 24 | 70 $\frac{7}{8}$ | 145 | 22.0 | W\$ 4025 |
| | Two Adjustable Shelves Behind Door | | | | | | | |

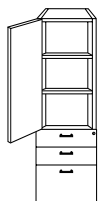

Shown as Left

Description

- Touch Latch Door
- Locking File Drawers Provide Legal or Letter Filing
- If Applicable, Drawer/Door Front Grain Direction Vertical Standard; Optional Horizontal Grain Direction
- Additional Options: Dove Tail Drawer Construction and Soft Close Drawers ([See Drawer Options](#)), Locking Door ([See Locking Options](#))

Must Specify (in this order):

- Model #
- Finish
- Door/Drawer Grain Direction (if applicable)
- Locking Door
- Drawer
- Construction
- Track
- Pull

| | | | | | | | |
|--------------------------------------|--------------------------|----|----|------------------|-----|------|----------|
| OPEN STORAGE CABINET BOX/BOX/FILE | 65-1884WBO | 18 | 24 | 82 $\frac{7}{8}$ | 166 | 25.7 | W\$ 3866 |
| | Three Adjustable Shelves | | | | | | |
| | 65-1872WBO | 18 | 24 | 70 $\frac{7}{8}$ | 145 | 22.0 | W\$ 3701 |
| | Two Adjustable Shelves | | | | | | |

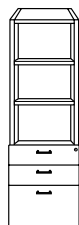

Description

- Locking File Drawers Provide Legal or Letter Filing
- If Applicable, Drawer/Door Front Grain Direction Vertical Standard; Optional Horizontal Grain Direction
- Additional Options: Dove Tail Drawer Construction and Soft Close Drawers ([See Drawer Options](#))

Must Specify (in this order):

- Model #
- Finish
- Drawer Front Grain Direction
- Drawer
- Construction
- Track
- Pull

Pricing Codes:
W= Wood Top
P= HPL Top

[See Gesso Intro Section for Ordering Options](#)

| Item | Model No. | Width | Depth | Height | Ship Wt | Cubic Ft | List Price |
|--------------|-------------|--------------|-------|--------|---------|----------|------------|
| NARROW TOWER | Hinged Left | Hinged Right | | | | | |
| | 65-1251WD1L | 65-1251WD1R | 12 | 24 | 51½ | 85 | 11.2 |

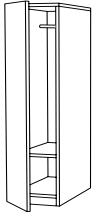

Shown as Left

Description

- 10" Coat Rod; One Adjustable Shelf
- Touch Latch Door
- Safely Write on Dry Erase Doors with Our Dry Erase Marker Set; [See Sets](#)
- If Applicable, Door Front Grain Direction Vertical Standard; Optional Horizontal Grain Direction
- Additional Options: Locking Door ([See Locking Options](#))

Must Specify (in this order):

Model #
Finish
Door Style/Color
Door Grain Direction
(if applicable)
Locking Doors

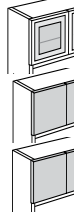
Options: Specify & Add

| | | |
|-------|---|--------|
| 1-AD | Aluminum Framed Satin Frosted Tempered Glass Door (Non-Locking) | \$ 678 |
| 1-DEB | Dry Erase Board Door | \$ 60 |
| 1-HGA | High Gloss Acrylic Door; Must Specify Color | |
| | (GPA) Graphite Acrylic | \$ 614 |
| | (BLA) Black, Wired Mercury (WMA), or White (WHA) Acrylic | \$ 560 |

| WARDROBE/STORAGE CABINET | Hinged Left | Hinged Right | Width | Depth | Height | Ship Wt | Cubic Ft | List Price |
|--------------------------|--------------------------------------|--------------|-------|-------|--------|---------|----------|------------|
| | 65-1884WL | 65-1884WR | 18 | 24 | 82⅞ | 162 | 25.7 | W\$ 3804 |
| | Four Adjustable Shelves Behind Door | | | | | | | |
| | 65-1872WL | 65-1872WR | 18 | 24 | 70⅞ | 153 | 19.2 | W\$ 3645 |
| | Three Adjustable Shelves Behind Door | | | | | | | |

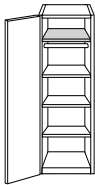
Must Specify (in this order):

Model #
Finish
Door Style/Color
Locking Doors

Description

- Coat Rod Under Top Fixed Shelf
- Adjustable Shelves can be Removed for Wardrobe Application
- Touch Latch Door
- Safely Write on Dry Erase Doors with Our Dry Erase Marker Set; [See Sets](#)
- Additional Options: Locking Door ([See Locking Options](#))

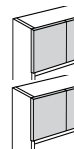
Options: Specify & Add

| | | |
|-------|--|---------|
| 1-DEB | Dry Erase Board Door | \$ 129 |
| 1-HGA | High Gloss Acrylic Door; Must Specify Color | |
| | (GPA) Graphite Acrylic | \$ 1275 |
| | (BLA) Black, Wired Mercury (WMA), or White (WHA) Acrylic | \$ 1162 |

Pricing Codes:

W= Wood Top
P= HPL Top

[See Gesso Intro Section for Ordering Options](#)

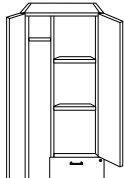
| Item | Model No. | Width | Depth | Height | Ship Wt | Cubic Ft | List Price | |
|--|--------------------------------------|-----------------------|-------|--------|------------------|----------|------------|----------|
| TOWER WARDROBE FILE/FILE  | Wardrobe Left | Wardrobe Right | | | | | | |
| | 65-2484WD2L | 65-2484WD2R | 24 | 24 | 82 $\frac{7}{8}$ | 252 | 22.7 | W\$ 5720 |
| | Three Adjustable Shelves Behind Door | | | | | | | |
| | 65-2472WD2L | 65-2472WD2R | 24 | 24 | 70 $\frac{7}{8}$ | 242 | 20.7 | W\$ 5316 |
| Two Adjustable Shelves Behind Door | | | | | | | | |
| | 65-2451WD2L | 65-2451WD2R | 24 | 24 | 51 $\frac{1}{2}$ | 172 | 20.7 | W\$ 4716 |
| One Adjustable Shelf Behind Door | | | | | | | | |

Shown as Left

Must Specify (in this order):

- Model #
- Finish
- Drawer
 - Construction
 - Track
- Locking Doors
- Pull

Description

- Wardrobe Door Features Coat Rod and Knob Pull; Knob Color will Coordinate with Drawer Pull
- If Black or Gold Pull is Selected, Knob will be Black; If Chrome or Aluminum Pull is Selected, Knob will be Aluminum
- Cabinet Door Features Touch Latch Door
- Locking File Drawers Provides Legal or Letter Filing
- Additional Options: Dove Tail Drawer Construction and Soft Close Drawers ([See Drawer Options](#)), Locking Doors ([See Locking Options](#))

| Item | Model No. | Width | Depth | Height | Ship Wt | Cubic Ft | List Price | |
|---|--------------------------------------|-----------------------|-------|--------|------------------|----------|------------|----------|
| TOWER WARDROBE BOX/BOX/FILE  | Wardrobe Left | Wardrobe Right | | | | | | |
| | 65-2484WD1L | 65-2484WD1R | 24 | 24 | 82 $\frac{7}{8}$ | 252 | 22.7 | W\$ 5720 |
| | Three Adjustable Shelves Behind Door | | | | | | | |
| | 65-2472WD1L | 65-2472WD1R | 24 | 24 | 70 $\frac{7}{8}$ | 242 | 20.7 | W\$ 5316 |
| Two Adjustable Shelves Behind Door | | | | | | | | |
| | 65-2451WD1L | 65-2451WD1R | 24 | 24 | 51 $\frac{1}{2}$ | 172 | 20.7 | W\$ 4716 |
| One Adjustable Shelf Behind Door | | | | | | | | |

Shown as Left

Must Specify (in this order):

- Model #
- Finish
- Drawer
 - Construction
 - Track
- Locking Doors
- Pull

Description

- Wardrobe Door Features Coat Rod and Knob Pull; Knob Color will Coordinate with Drawer Pull
- If Black or Gold Pull is Selected, Knob will be Black; If Chrome or Aluminum Pull is Selected, Knob will be Aluminum
- Cabinet Door Features Touch Latch Door
- Locking File Drawer Provides Legal or Letter Filing
- Additional Options: Dove Tail Drawer Construction and Soft Close Drawers ([See Drawer Options](#)), Locking Doors ([See Locking Options](#))

Pricing Codes:
W= Wood Top
P= HPL Top

[See Gesso Intro Section for Ordering Options](#)

| Item | Model No. | Width | Depth | Height | Ship Wt | Cubic Ft | List Price |
|-------------------------------|---------------|----------------|-------|--------|------------------|----------|------------|
| TALL WARDROBE/STORAGE CABINET | Wardrobe Left | Wardrobe Right | | | | | |
| | 65-3684WDS2L | 65-3684WDS2R | 36 | 24 | 82 $\frac{1}{2}$ | 368 | 49.2 |

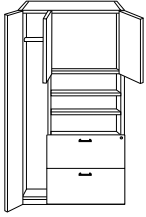

Shown as Left

Must Specify (in this order):

- Model #
- Finish
- Drawer Construction
- Locking Doors
- Pull

Description

- Veneer Wardrobe Door Features Coat Rod and Knob Pull; Knob Color will Coordinate with Drawer Pull
- If Black or Gold Pull is Selected, Knob will be Black; If Chrome or Aluminum Pull is Selected, Knob will be Aluminum
- Hutch Doors Standard with Touch Latch; See Door Options Below
- Safely Write on Dry Erase Doors with Our Dry Erase Marker Set; [See Sets](#)
- Two Adjustable Shelves
- Locking Lateral Drawers Provides Legal or Letter Filing
- Additional Options: Dove Tail Drawer Construction ([See Drawer Options](#)), Locking Doors ([See Locking Options](#))

Hutch Door Options: Specify & Add

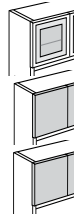

| | | |
|-------|--|---------|
| 1-AD | Aluminum Framed Satin Frosted Tempered Glass Doors (Non-Locking) | \$ 1243 |
| 1-DEB | Dry Erase Board Doors | \$ 121 |
| 1-HGA | High Gloss Acrylic Doors; Must Specify Color (Non-Locking) | |
| | (GPA) Graphite Acrylic | \$ 1200 |
| | (BLA) Black, (WMA), Wired Mercury or (WHA) White Acrylic | \$ 1095 |

| WARDROBE/STORAGE CABINET | Wardrobe Left | Wardrobe Right | Width | Depth | Height | Ship Wt | Cubic Ft | List Price |
|--------------------------|---------------|----------------|-------|-------|------------------|---------|----------|------------|
| | 65-3672WDS2L | 65-3672WDS2R | 36 | 24 | 70 $\frac{1}{8}$ | 368 | 42.0 | W\$ 5974 |

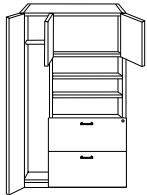

Shown as Left

Must Specify (in this order):

- Model #
- Finish
- Drawer Construction
- Locking Doors
- Pull

Description

- Veneer Wardrobe Door Features Coat Rod and Knob Pull; Knob Color will Coordinate with Drawer Pull
- If Black or Gold Pull is Selected, Knob will be Black; If Chrome or Aluminum Pull is Selected, Knob will be Aluminum
- Hutch Doors Standard with Touch Latch; See Door Options Below
- Safely Write on Dry Erase Doors with Our Dry Erase Marker Set; [See Sets](#)
- Two Adjustable Shelves
- Locking Lateral Drawers Provides Legal or Letter Filing
- Additional Options: Dove Tail Drawer Construction ([See Drawer Options](#)), Locking Doors ([See Locking Options](#))

Hutch Door Options: Specify & Add

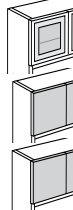

| | | |
|-------|--|--------|
| 1-AD | Aluminum Framed Satin Frosted Tempered Glass Doors (Non-Locking) | \$ 877 |
| 1-DEB | Dry Erase Board Doors | \$ 54 |
| 1-HGA | High Gloss Acrylic Doors; Must Specify Color (Non-Locking) | |
| | (GPA) Graphite Acrylic | \$ 535 |
| | (BLA) Black, (WMA), Wired Mercury or (WHA) White Acrylic | \$ 487 |

Pricing Codes:

- W= Wood Top
- P= HPL Top

[See Gesso Intro Section for Ordering Options](#)

| Item | Model No. | Width | Depth | Height | Ship Wt | Cubic Ft | List Price |
|--|--|-------|-------|------------------|---------|----------|------------|
| STORAGE CABINET WITH LATERAL FILES  | 65-3684SU2 Three Adjustable Shelves | 36 | 24 | 82 $\frac{7}{8}$ | 318 | 49.2 | W\$ 6480 |
| | 65-3084SU2 Three Adjustable Shelves | 30 | 24 | 82 $\frac{7}{8}$ | 271 | 42.9 | W\$ 6329 |
| | 65-3672SU2 Two Adjustable Shelves | 36 | 24 | 70 $\frac{7}{8}$ | 298 | 42.0 | W\$ 6132 |
| | 65-3072SU2 Two Adjustable Shelves | 30 | 24 | 70 $\frac{7}{8}$ | 251 | 35.7 | W\$ 5990 |

Description

- Top - Two (2) Doors with Adjustable Shelves
- Bottom - File/File Locking Drawers Provide Legal or Letter Filing
- Touch Latch Doors
- Additional Options: Dove Tail Drawer Construction ([See Drawer Options](#)), Locking Doors ([See Locking Options](#))

Must Specify (in this order):

- Model #
- Finish
- Drawer Construction
- Locking Doors

| | | | | | | | |
|--|-----------|----|----|------------------|-----|------|----------|
| WARDROBE/STORAGE CABINET  | 65-3672WC | 36 | 24 | 70 $\frac{7}{8}$ | 320 | 42.0 | W\$ 5050 |
| | 65-3072WC | 30 | 24 | 70 $\frac{7}{8}$ | 240 | 35.7 | W\$ 4916 |

Description

- Left Side: One (1) Fixed Shelf at Top and Three (3) Adjustable Shelves below
- Right Side: One (1) Fixed Shelf at Top and Coat Rod below
- Touch Latch Door
- Safely Write on Dry Erase Doors with Our Dry Erase Marker Set; [See Sets](#)
- Additional Options: Locking Doors ([See Locking Options](#))

Must Specify (in this order):

- Model #
- Finish
- Door Style/Color
- Locking Doors

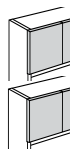

Options: Specify & Add

| | | |
|-------|--|---------|
| 1-DEB | Dry Erase Board Doors | \$ 257 |
| 1-HGA | High Gloss Acrylic Doors; Must Specify Color | |
| | (GPA) Graphite Acrylic | \$ 2551 |
| | (BLA) Black, (WMA), Wired Mercury or (WHA) White Acrylic | \$ 2329 |

Pricing Codes:

- W= Wood Top
- P= HPL Top

[See Gesso Intro Section for Ordering Options](#)

| Item | Model No. | Width | Depth | Height | Ship Wt | Cubic Ft | List Price |
|-------------------------------|-----------|-------|-------|------------------|---------|----------|------------|
| TALL WARDROBE/STORAGE CABINET | 65-3684WC | 36 | 24 | 82 $\frac{7}{8}$ | 340 | 49.2 | W\$ 5277 |
| | 65-3084WC | 30 | 24 | 82 $\frac{7}{8}$ | 320 | 41.4 | W\$ 5134 |

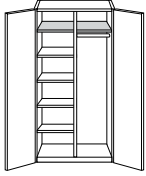



Must Specify (in this order):

- Model #
- Finish
- Door Style/Color
- Locking Doors

Description

- Left Side: One (1) Fixed Shelf at Top and Four (4) Adjustable Shelves below
- Right Side: One (1) Fixed Shelf at Top and Coat Rod below
- Touch Latch Doors
- Safely Write on Dry Erase Doors with Our Dry Erase Marker Set; [See Sets](#)
- Additional Options: Locking Doors ([See Locking Options](#))

Options: Specify & Add

| | | | |
|---|-------|--|---------|
|  | 1-DEB | Dry Erase Board Doors | \$ 257 |
|  | 1-HGA | High Gloss Acrylic Doors; Must Specify Color | |
| | | (GPA) Graphite Acrylic | \$ 2551 |
| | | (BLA) Black, (WMA), Wired Mercury or (WHA) White Acrylic | \$ 2329 |

END BOOKCASE

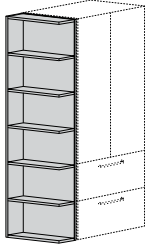

Shown as Left

| Mounts Left | Mounts Right | Width | Depth | Height | Ship Wt | Cubic Ft | List Price |
|-----------------------|--------------|-------|------------------|------------------|---------|----------|------------|
| 65-0984BEL | 65-0984BER | 9 | 23 $\frac{1}{2}$ | 82 $\frac{7}{8}$ | 90 | 13.6 | W\$ 2626 |
| Five Fixed 8" Shelves | | | | | | | |
| 65-0972BEL | 65-0972BER | 9 | 23 $\frac{1}{2}$ | 70 $\frac{7}{8}$ | 75 | 11.7 | W\$ 2318 |
| Four Fixed 8" Shelves | | | | | | | |

Description

- Top Shelf Clearance 15"
- Remaining Shelves 12 $\frac{1}{2}$ " Clearance Between Shelves
- Not for Freestanding, Must Mount to Other Storage Component

Must Specify (in this order):

- Model #
- Finish

Pricing Codes:

- W= Wood Top
- P= HPL Top

[See Gesso Intro Section for Ordering Options](#)

| Item | Model No. | Width | Depth | Height | Ship Wt | Cubic Ft | List Price |
|---|---|-------|-------|--------|---------|----------|------------|
|  | 65-3684BC Four Adjustable Shelves - One Fixed Shelf | 36 | 14¼ | 82⅞ | 200 | 30.3 | W\$ 3747 |
| | 65-3672BC Three Adjustable Shelves - One Fixed Shelf | 36 | 14¼ | 70⅞ | 176 | 26.9 | W\$ 3227 |
| | 65-3660BC Three Adjustable Shelves | 36 | 14¼ | 58⅞ | 147 | 23.2 | W\$ 2783 |
| | 65-3648BC Two Adjustable Shelves | 36 | 14¼ | 46⅞ | 120 | 18.7 | W\$ 2568 |
| | 65-3630BC One Adjustable Shelf - Top Front Edge Profiled | 36 | 14¼ | 30 | 75 | 11.9 | W/P\$ 1950 |
| | 65-3084BC Four Adjustable Shelves - One Fixed Shelf | 30 | 14¼ | 82⅞ | 175 | 25.5 | W\$ 3070 |
| | 65-3072BC Three Adjustable Shelves - One Fixed Shelf | 30 | 14¼ | 70⅞ | 146 | 23.3 | W\$ 2642 |
| | 65-3060BC Three Adjustable Shelves | 30 | 14¼ | 58⅞ | 122 | 19.5 | W\$ 2320 |
| | 65-3048BC Two Adjustable Shelves | 30 | 14¼ | 46⅞ | 100 | 15.7 | W\$ 1999 |
| | 65-3030BC One Adjustable Shelf - Top Front Edge Profiled | 30 | 14¼ | 30 | 62 | 10.1 | W/P\$ 1639 |

Must Specify (in this order):

Model #
Material
Finish/Color
Edge

Description

- 1" Thick Shelf

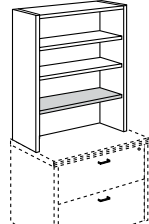
| Item | Model No. | Width | Depth | Height | Ship Wt | Cubic Ft | List Price |
|---|--|-------|-------|--------|---------|----------|------------|
|  | 65-1536TTU Two Adjustable and One Fixed Shelf | 36 | 14¼ | 52⅞ | 169 | 22.2 | W\$ 2248 |
| | 65-1530TTU Two Adjustable and One Fixed Shelf | 30 | 14¼ | 52⅞ | 141 | 17.3 | W\$ 2048 |
| | 65-1536TU One Adjustable and One Fixed Shelf | 36 | 14¼ | 40⅞ | 127 | 16.4 | W\$ 1780 |
| | 65-1530TU One Adjustable and One Fixed Shelf | 30 | 14¼ | 40⅞ | 98 | 15.9 | W\$ 1639 |

Description

- For Use on Two Drawer Lateral Files
- 1" Thick Shelves

Must Specify (in this order):

Model #
Finish

Pricing Codes:
W= Wood Top
P= HPL Top

[See Gesso Intro Section for Ordering Options](#)

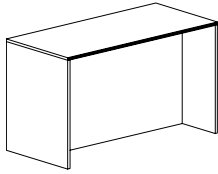
| Item | Model No. | Width | Depth | Height | Ship Wt | Cubic Ft | List Price |
|---|----------------------|-------|-------|--------|---------|----------|---------------------------------|
| WORK TABLES STANDING HEIGHT | 65-4896TWT | 96 | 48 | 42 | 402 | 14.2 | W/P\$ 4256 |
| | | | | | | | Wire Management Upcharge \$ 836 |
|  | 65-4884TWT | 84 | 48 | 42 | 368 | 12.4 | W/P\$ 3976 |
| | | | | | | | Wire Management Upcharge \$ 757 |
| | 65-4872TWT | 72 | 48 | 42 | 332 | 10.7 | W/P\$ 3695 |
| | | | | | | | Wire Management Upcharge \$ 672 |
| | 65-4860TWT | 60 | 48 | 42 | 300 | 9.0 | W/P\$ 3414 |
| | | | | | | | Wire Management Upcharge \$ 591 |
| | 65-4296TWT | 96 | 42 | 42 | 374 | 12.5 | W/P\$ 3841 |
| | | | | | | | Wire Management Upcharge \$ 836 |
| | 65-4284TWT | 84 | 42 | 42 | 342 | 10.9 | W/P\$ 3602 |
| | | | | | | | Wire Management Upcharge \$ 757 |
| | 65-4272TWT | 72 | 42 | 42 | 308 | 9.4 | W/P\$ 3363 |
| | | | | | | | Wire Management Upcharge \$ 672 |
| | 65-4260TWT | 60 | 42 | 42 | 278 | 7.9 | W/P\$ 3125 |
| | | | | | | | Wire Management Upcharge \$ 591 |
| | 65-3696TWT | 96 | 36 | 42 | 346 | 10.8 | W/P\$ 3624 |
| | | | | | | | Wire Management Upcharge \$ 836 |
| | 65-3684TWT | 84 | 36 | 42 | 315 | 9.5 | W/P\$ 3405 |
| | | | | | | | Wire Management Upcharge \$ 757 |
| | 65-3672TWT | 72 | 36 | 42 | 283 | 8.1 | W/P\$ 3184 |
| | | | | | | | Wire Management Upcharge \$ 672 |
| | 65-3660TWT | 60 | 36 | 42 | 255 | 6.8 | W/P\$ 2962 |
| | | | | | | | Wire Management Upcharge \$ 591 |
| | 65-2496TWT | 96 | 24 | 42 | 211 | 64.9 | W/P\$ 3244 |
| | Modesty Recessed 5¼" | | | | | | |
| | 65-2484TWT | 84 | 24 | 42 | 193 | 57.0 | W/P\$ 3053 |
| | Modesty Recessed 5¼" | | | | | | |
| | 65-2472TWT | 72 | 24 | 42 | 176 | 49.0 | W/P\$ 2864 |
| | Modesty Recessed 5¼" | | | | | | |
| | 65-2460TWT | 60 | 24 | 42 | 158 | 41.1 | W/P\$ 2673 |
| | Modesty Recessed 5¼" | | | | | | |

Must Specify (in this order):

- Model #
- Top Material
- Finish/Color
- Edge Profile
- Chassis Finish
- Modesty Finish/Color
- Grommet Location
- Wire Management
- Grommet Style/Color
- Power/Data Options

Description

- Available with Veneer (W) or HPL (P) Top; Must Specify
- Centered Modesty Available in Contrasting Colors
- Double Modesty/Wire Management Upcharge Included when Grommet, Dock 950, Dock 150 or other Power Units are Ordered
- Add a Purse Hook to Hold Personal Items; [See Hook Details](#)
- Duo/Trio and Power Data Port Units ([01-DPORT4A/B](#)); [See PDC Locations](#)
- 24"D Units Ship Assembled; Other Sizes Require Some Assembly
- 24"D Units Are Meant to be Used Against a Wall; Modesty Panel is Recessed 5¼"
- Additional Options: Power and Grommet Options ([See Options and Locations](#))

Pricing Codes:

W= Wood Top
P= HPL Top

[See Gesso Intro Section for Ordering Options](#)

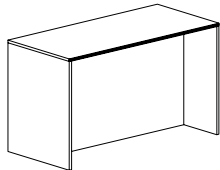
| Item | Model No. | Width | Depth | Height | Ship Wt | Cubic Ft | List Price |
|---|----------------------|-------|-------|--------|---------|--------------------------|------------|
| WORK TABLES COUNTER HEIGHT | 65-4896CWT | 96 | 48 | 36 | 326 | 14.2 | W/P\$ 4063 |
| | | | | | | Wire Management Upcharge | \$ 773 |
|  | 65-4884CWT | 84 | 48 | 36 | 298 | 12.4 | W/P\$ 3797 |
| | | | | | | Wire Management Upcharge | \$ 698 |
| | 65-4872CWT | 72 | 48 | 36 | 268 | 10.7 | W/P\$ 3526 |
| | | | | | | Wire Management Upcharge | \$ 620 |
| | 65-4860CWT | 60 | 48 | 36 | 242 | 9.0 | W/P\$ 3259 |
| | | | | | | Wire Management Upcharge | \$ 545 |
| | 65-4296CWT | 96 | 42 | 36 | 338 | 12.5 | W/P\$ 3664 |
| | | | | | | Wire Management Upcharge | \$ 773 |
| | 65-4284CWT | 84 | 42 | 36 | 309 | 10.9 | W/P\$ 3438 |
| | | | | | | Wire Management Upcharge | \$ 698 |
| | 65-4272CWT | 72 | 42 | 36 | 278 | 9.4 | W/P\$ 3207 |
| | | | | | | Wire Management Upcharge | \$ 620 |
| | 65-4260CWT | 60 | 42 | 36 | 251 | 7.9 | W/P\$ 2980 |
| | | | | | | Wire Management Upcharge | \$ 545 |
| | 65-3696CWT | 96 | 36 | 36 | 312 | 10.8 | W/P\$ 3431 |
| | | | | | | Wire Management Upcharge | \$ 773 |
| | 65-3684CWT | 84 | 36 | 36 | 285 | 9.5 | W/P\$ 3222 |
| | | | | | | Wire Management Upcharge | \$ 698 |
| | 65-3672CWT | 72 | 36 | 36 | 256 | 8.1 | W/P\$ 3014 |
| | | | | | | Wire Management Upcharge | \$ 620 |
| | 65-3660CWT | 60 | 36 | 36 | 231 | 6.8 | W/P\$ 2805 |
| | | | | | | Wire Management Upcharge | \$ 545 |
| | 65-2496CWT | 96 | 24 | 36 | 192 | 56.0 | W/P\$ 2970 |
| | Modesty Recessed 5¼" | | | | | | |
| | 65-2484CWT | 84 | 24 | 36 | 176 | 49.2 | W/P\$ 2797 |
| | Modesty Recessed 5¼" | | | | | | |
| | 65-2472CWT | 72 | 24 | 36 | 160 | 42.3 | W/P\$ 2622 |
| | Modesty Recessed 5¼" | | | | | | |
| | 65-2460CWT | 60 | 24 | 36 | 143 | 35.5 | W/P\$ 2448 |
| | Modesty Recessed 5¼" | | | | | | |

Must Specify (in this order):

Model #
Top Material
Finish/Color
Edge Profile
Chassis Finish
Modesty Finish/Color
Grommet Location
Wire Management
Grommet Style/Color
Power/Data Options

Description

- Available with Veneer (W) or HPL (P) Top; Must Specify
- Centered Modesty Available in Contrasting Colors
- Double Modesty/Wire Management Upcharge Included when Grommet, Dock 950, Dock 150 or other Power Units are Ordered
- Add a Purse Hook to Hold Personal Items; [See Hook Details](#)
- Duo/Trio and Power Data Port Units ([01-DPORT4A/B](#)); [See PDC Locations](#)
- 24"D Units Ship Assembled; Other Sizes Require Some Assembly
- 24"D Units Are Meant to be Used Against a Wall; Modesty Panel is Recessed 5¼"
- Additional Options: Power and Grommet Options ([See Options and Locations](#))

Pricing Codes:

W= Wood Top
P= HPL Top

[See Gesso Intro Section for Ordering Options](#)

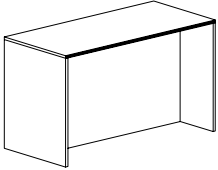
| Item | Model No. | Width | Depth | Height | Ship Wt | Cubic Ft | List Price |
|---|-----------------------------------|-------|-------|--------|---------|----------|---|
| WORK TABLES SEATED HEIGHT  | 65-4896WT | 96 | 48 | 30 | 326 | 14.2 | W/P\$ 3926 Wire Management Upcharge \$ 698 |
| | 65-4884WT | 84 | 48 | 30 | 298 | 12.4 | W/P\$ 3667 Wire Management Upcharge \$ 633 |
| | 65-4872WT | 72 | 48 | 30 | 268 | 10.7 | W/P\$ 3409 Wire Management Upcharge \$ 563 |
| | 65-4860WT | 60 | 48 | 30 | 242 | 9.0 | W/P\$ 3150 Wire Management Upcharge \$ 496 |
| | 65-4296WT | 96 | 42 | 30 | 374 | 12.5 | W/P\$ 3480 Wire Management Upcharge \$ 698 |
| | 65-4284WT | 84 | 42 | 30 | 342 | 10.9 | W/P\$ 3265 Wire Management Upcharge \$ 633 |
| | 65-4272WT | 72 | 42 | 30 | 308 | 9.4 | W/P\$ 3045 Wire Management Upcharge \$ 563 |
| | 65-4260WT | 60 | 42 | 30 | 278 | 7.9 | W/P\$ 2831 Wire Management Upcharge \$ 496 |
| | 65-2496WT Modesty Recessed 5¼" | 96 | 24 | 30 | 173 | 47.2 | W/P\$ 2738 |
| | 65-2484WT Modesty Recessed 5¼" | 84 | 24 | 30 | 158 | 41.4 | W/P\$ 2583 |
| | 65-2472WT Modesty Recessed 5¼" | 72 | 24 | 30 | 143 | 35.6 | W/P\$ 2419 |
| | 65-2460WT Modesty Recessed 5¼" | 60 | 24 | 30 | 129 | 29.8 | W/P\$ 2260 |

Must Specify (in this order):

- Model #
- Top Material
- Finish/Color
- Edge Profile
- Chassis Finish
- Modesty Finish/Color
- Grommet Location
- Wire Management
- Grommet Style/Color
- Power/Data Options

Description

- Available with Veneer (W) or HPL (P) Top; Must Specify
- Centered Modesty Available in Contrasting Colors
- Double Modesty/Wire Management Upcharge Included when Grommet, Dock 950, Dock 150 or other Power Units are Ordered
- Add a Purse Hook to Hold Personal Items; [See Hook Details](#)
- Duo/Trio and Power Data Port Units ([01-DPORT4A/B](#)); [See PDC Locations](#)
- 24"D Units Ship Assembled; Other Sizes Require Some Assembly
- 24"D Units Are Meant to be Used Against a Wall; Modesty Panel is Recessed 5¼"
- Additional Options: Power and Grommet Options ([See Options and Locations](#))

| | | | | | | | |
|---|-----------|----|----|----|-----|------|------------|
| COMPUTER WORK TABLE  | 65-2442CW | 42 | 24 | 27 | 115 | 19.2 | W/P\$ 2071 |
| | 65-2436CW | 36 | 24 | 27 | 99 | 16.6 | W/P\$ 2030 |

Description

- Available with Veneer (W) or HPL (P) Top; Must Specify
- Fixed Shelf
- Grommet Standard; Must Specify: Black (BLK), Silver (SLV)

Options: Specify & Add

| | | |
|---------|--|--------|
| CS-66BL | Optional Black Casters (Increases Height to 29") | \$ 239 |
|---------|--|--------|



Braking Casters on User Side/Non-Braking Casters on Approach

Pricing Codes:

W= Wood Top
P= HPL Top

[See Gesso Intro Section for Ordering Options](#)

| Item | Model No. | Width | Depth | Height | Ship Wt | Cubic Ft | List Price |
|----------------|-----------|-------|-------|--------|---------|----------|------------|
| MAGAZINE TABLE | 65-2442MT | 42 | 24 | 16 | 70 | 11.9 | W/P\$ 1718 |

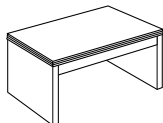

Description

- Available with Veneer (W) or HPL (P) Top; Must Specify
- Apron Rails and Panel Legs Feature Multi-Step, Hand-Finished Catalyzed Finish

Must Specify (in this order):

- Model #
- Top Material
- Finish/Color
- Edge Profile

| | | | | | | | |
|-----------|-----------|----|----|----|----|-----|------------|
| END TABLE | 65-2424ET | 24 | 24 | 22 | 65 | 9.4 | W/P\$ 1632 |
|-----------|-----------|----|----|----|----|-----|------------|

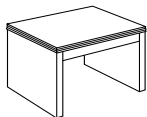

Description

- Available with Veneer (W) or HPL (P) Top; Must Specify
- Apron Rails and Panel Legs Feature Multi-Step, Hand-Finished Catalyzed Finish

Must Specify (in this order):

- Model #
- Top Material
- Finish/Color
- Edge Profile

| | | | | | | | |
|-----------|-----------|----|----|---|----|-----|------------|
| ROUND TOP | 65-4848CT | 48 | 48 | 1 | 95 | 4.3 | W/P\$ 1295 |
|-----------|-----------|----|----|---|----|-----|------------|



Accommodates Five (5) Chairs

| | | | | | | | |
|--|-----------|----|----|---|----|-----|------------|
| | 65-4242CT | 42 | 42 | 1 | 70 | 3.4 | W/P\$ 1251 |
|--|-----------|----|----|---|----|-----|------------|

Accommodates Four (4) Chairs

| | | | | | | | |
|--|-----------|----|----|---|----|-----|------------|
| | 65-3636CT | 36 | 36 | 1 | 37 | 2.5 | W/P\$ 1100 |
|--|-----------|----|----|---|----|-----|------------|

Accommodates Three (3) Chairs

Must Specify (in this order):

- Model #
- Top Material
- Finish
- Edge Profile

Description

- Single Base or Four (4) Strut Legs (on 48" Top Only) Required; Ordered Separately, See Next Page
- Power Options not Available

Pricing Codes:
W= Wood Top
P= HPL Top

[See Gesso Intro Section for Ordering Options](#)

| Item | Model No. | | Width | Depth | Height | Ship Wt | Cubic Ft | List Price | |
|---|-----------------------------------|----------|-------|-------|--------|---------|----------|------------|--|
| DISC BASE  | For 48" Round Tops | | | | | | | | |
| | 01-3230DBB | Black | 30 | 30 | 27¾ | 42 | 4.1 | \$ 1842 | |
| | 01-3230DBA | Aluminum | | | | | | | |
| | For 36" and 42" Round Tops | | | | | | | | |
| | 01-2430DBB | Black | 24 | 24 | 27¾ | 32 | 3.2 | \$ 1535 | |
| | 01-2430DBA | Aluminum | | | | | | | |

Description

- 4" Diameter 14 Gauge Steel Column with 12"x12" Mounting Plate at Top of Column
- ¼" Thick Disc Plate with 5 Levelers
- Stiffener Bar Not Included; Must Order Separately (See Stiffener Bars)
- Some Assembly Required

| Table Widths | Round | 72" | 84" | 96" |
|---------------------------------|-------|-----|-----|-----|
| Number of Bases Required | 1 | 2 | 2 | 2 |

METAL X-BASE

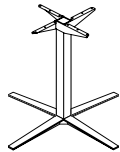

| | | | | | | | | | |
|---------------------------------------|-----------------|----------|-----|-----|----|----|------|---------|--|
| For Use With | | | | | | | | | |
| Round Tops: 42" + 48" | | | | | | | | | |
| Top Surfaces: 42"x96" | | | | | | | | | |
| 08-2642LXBB | For 42"H Tables | Black | 35½ | 35½ | 40 | 33 | 20.0 | \$ 1322 | |
| 08-2642LXBA | | Aluminum | | | | | | | |
| 08-2636LXBB | For 36"H Tables | Black | 35½ | 35½ | 34 | 30 | 17.2 | \$ 1275 | |
| 08-2636LXBA | | Aluminum | | | | | | | |
| 08-2630LXBB | For 30"H Tables | Black | 35½ | 35½ | 28 | 27 | 14.5 | \$ 1219 | |
| 08-2630LXBA | | Aluminum | | | | | | | |
| For Use With | | | | | | | | | |
| Round Tops: 30" + 36" | | | | | | | | | |
| Top Surfaces: 36"x84", 36"x72" | | | | | | | | | |
| 08-2042SXBB | For 42"H Tables | Black | 29 | 29 | 40 | 27 | 15.9 | \$ 1235 | |
| 08-2042SXBA | | Aluminum | | | | | | | |
| 08-2036SXBB | For 36"H Tables | Black | 29 | 29 | 34 | 24 | 13.7 | \$ 1185 | |
| 08-2036SXBA | | Aluminum | | | | | | | |
| 08-2030SXBB | For 30"H Tables | Black | 29 | 29 | 28 | 21 | 11.6 | \$ 1139 | |
| 08-2030SXBA | | Aluminum | | | | | | | |

Description

- See Number of Bases Required Per Top Width Below
- Power Units Available On Center When Using Two or More Metal X-Bases
- Not Available to be Sold Separately
- Ships Assembled

| Table Widths | Round | 72" | 84" | 96" |
|---------------------------------|-------|-----|-----|-----|
| Number of Bases Required | 1 | 2 | 2 | 2 |

Pricing Codes:

W= Wood Top
P= HPL Top

[See Gesso Intro Section for Ordering Options](#)

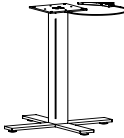
| Item | Model No. | | Width | Depth | Height | Ship Wt | Cubic Ft | List Price | |
|--|--|----------|-------|-------|--------|---------|----------|------------|--|
| HEIGHT ADJUSTABLE PNEUMATIC X-BASE  | Maximum Round 42", Maximum Square 36" | | | | | | | | |
| | 01-3232HAXBB | Black | 32 | 32 | 26 | 1 | 0.2 | \$ 1721 | |
| | 01-3232HAXBA | Aluminum | | | | | | | |
| | Maximum Round 36", Maximum Square 30" | | | | | | | | |
| | 01-2626HAXBB | Black | 22 | 22 | 26 | 1 | 0.2 | \$ 1687 | |
| | 01-2626HAXBA | Aluminum | | | | | | | |

Description

- Pre-Drilled Boring Pattern May Not Match Underside of Table Top
- Steel Mounting Plate: 8"x 8"x ¼"
- Eight (8) Bolts Included for Assembly
- Some Assembly Required; Hardware Included

TUBULAR X-BASE

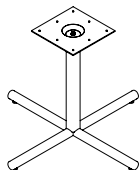

| | | | | | | | | |
|--------------------------------|----------|----|----|-----|----|-----|--------|--|
| For Use With | | | | | | | | |
| Round Tops: 48" | | | | | | | | |
| Square Tops: 42" | | | | | | | | |
| 01-3830TXB | Black | 38 | 38 | 27¾ | 40 | 4.2 | \$ 699 | |
| 01-3830TXA | Aluminum | | | | | | | |
| For Use With | | | | | | | | |
| Round Tops: 36", 42" | | | | | | | | |
| Square Tops: 36" | | | | | | | | |
| Top Surfaces: 36"x84", 36"x72" | | | | | | | | |
| 01-3230TXB | Black | 32 | 32 | 27¾ | 32 | 3.2 | \$ 633 | |
| 01-3230TXA | Aluminum | | | | | | | |

Description

- 3" Diameter Column
- See Number of Bases Required Per Top Width Below
- Power Units Available On Center When Using Two or More Tubular X-Bases
- Some Assembly Required

| Table Widths | Round | 72" | 84" | 96" |
|---------------------------------|-------|-----|-----|-----|
| Number of Bases Required | 1 | 2 | 2 | 2 |

STRUT TABLE LEGS

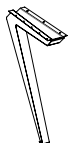

| | | | | | | | |
|-------------|-----------------|----|-----|-----|----|-----|---------|
| 01-2228STR2 | 1 Pair (2 Legs) | 1½ | 22½ | 28¾ | 32 | 4.5 | \$ 1278 |
| 01-2228STR4 | 2 Pair (4 Legs) | 1½ | 22½ | 28¾ | 64 | 9.0 | \$ 2556 |

Description

- Available in Aluminum (ALUM) or Black (BLK); Must Specify Color
- Built-In Wire Management Cover on Inside of Legs
- Each Leg has Adjustable Glides
- Legs not Available To Be Sold Separately
- For Use with Indiana Furniture 48" Round Tops Only

Options: Specify & Add

| | | | | | | | |
|------------|---------------|--|--|--|--|--|--------|
| 01-00048SB | Stiffener Bar | | | | | | \$ 121 |
|------------|---------------|--|--|--|--|--|--------|

See Individual Tops for Recommended Number of Stiffener Bars

| Table Widths | 48" CT | 72" | 96" |
|---------------------------------|--------|-----|-----|
| Number of Bases Required | 4 | 4 | 4 |

Must Specify (in this order):

Model # and Quantity

Color

Optional Stiffener Bar and Quantity

Pricing Codes:

W= Wood Top

P= HPL Top

[See Gesso Intro Section for Ordering Options](#)

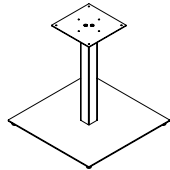
| Item | Model No. | | Width | Depth | Height | Ship Wt | Cubic Ft | List Price |
|---|---|----------|-------|-------|--------|---------|----------|------------|
| SQUARE BASE  | For Use With Round Tops: 48" Square Tops: 42" | | | | | | | |
| | 01-2630SBB | Black | 26 | 26 | 27¾ | 32 | 3.2 | \$ 1163 |
| | 01-2630SBA | Aluminum | | | | | | |
| | For Use With Round Tops: 42" Square Tops: 36" Top Surfaces: 36"x84", 36"x72" | | | | | | | |
| | 01-2030SBB | Black | 20 | 20 | 27¾ | 32 | 3.2 | \$ 956 |
| | 01-2030SBA | Aluminum | | | | | | |
| | For Use With Round Tops: 36" Square Tops: 30" | | | | | | | |
| | 01-1630SBB | Black | 16 | 16 | 27¾ | 32 | 3.2 | \$ 898 |
| | 01-1630SBA | Aluminum | | | | | | |

Description

- 2¾" Diameter Column
- 12"x12" Mounting Plate at Top of Column
- Stiffener Bar Not Included; Must Order Separately (See Stiffener Bars)
- See Number of Bases Required Per Top Width Below
- Power Units Available On Center When Using Two or More Square Bases
- Some Assembly Required

| Table Widths | Round | 72" | 84" | 96" |
|---------------------------------|-------|-----|-----|-----|
| Number of Bases Required | 1 | 2 | 2 | 2 |

CYLINDER BASE

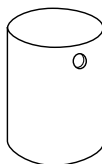

| | | | | | | | | |
|-------------------------|--|--|----|----|-----|-----|------|----------|
| For Tables 42"D to 48"D | | | | | | | | |
| 01-2020CB | | | 20 | 20 | 28½ | 136 | 10.9 | W\$ 1553 |
| For Tables 36"D | | | | | | | | |
| 01-1616CB | | | 16 | 16 | 28½ | 101 | 7.2 | W\$ 1419 |

Description

- Veneer Cylinder Base Features Multi-Step, Hand-Finished Catalyzed Finish
- Weighted for Stability
- Two (2) Wire Management Black Grommets Standard at Top Edge; 8" Opening Standard at Bottom
- See Number of Bases Required Per Table Width Below

Additional Grommet Options: Specify & Add

| | | | |
|-------|----------------------------------|----|-----|
| GCBIS | Only One (1) Grommet At Top Edge | \$ | N/C |
| NOGC | No Grommets At Top Edge | \$ | N/C |

| Table Widths | Round | 72" | 96" |
|---------------------------------|-------|-----|-----|
| Number of Bases Required | 1 | 2 | 2 |

Must Specify (in this order):

- Model # and Quantity
- Finish
- Grommet Options

Pricing Codes:

- W= Wood Top
- P= HPL Top

[See Gesso Intro Section for Ordering Options](#)

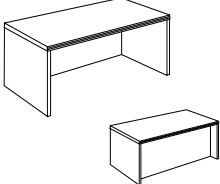
| Item | Model No. | Width | Depth | Height | Ship Wt | Cubic Ft | List Price |
|---|-----------|-------|-------|--------|---------|----------|------------|
|  Recessed Front | 65-3672SH | 72 | 36 | 30 | 154 | 50.0 | W/P\$ 3047 |
| | 65-3666SH | 66 | 36 | 30 | 148 | 48.0 | W/P\$ 2960 |
| | 65-3660SH | 60 | 36 | 30 | 139 | 43.7 | W/P\$ 2878 |
| | 65-3072SH | 72 | 30 | 30 | 145 | 43.8 | W/P\$ 2918 |
| | 65-3066SH | 66 | 30 | 30 | 141 | 39.0 | W/P\$ 2847 |
| | 65-3060SH | 60 | 30 | 30 | 136 | 35.3 | W/P\$ 2731 |

Must Specify (in this order):

- Model #
- Top Material
- Finish/Color
- Edge Profile
- Grommet Location
- Grommet Color

Kneespace 58"; No Additional Support Needed

Description

- Available with Veneer (W) or HPL (P) Top; Must Specify
- For Use With or Without Modular Pedestals
- Support Panel Required (See [65-2812SP](#)), Stiffener Bar ([See Sizes](#)) Recommended in Kneespaces 60" or Greater When Unsupported by a Pedestal
- 10" Recessed Front on 36" Deep Units; 4" Recessed Front on 30" Deep Units
- If Using with Pedestal, Surface Grommet Only Available Opposite Pedestal
- [Height Adjustable Units Available](#)
- Additional Options: Power and Grommet Options ([See Options and Locations](#))

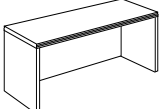
| | | | | | | | |
|---|---|----|----|----|-----|------|------------|
|  | 65-2472SH <i>Kneespace 70"</i> | 72 | 24 | 30 | 125 | 34.6 | W/P\$ 2640 |
| | 65-2466SH <i>Kneespace 64"</i> | 66 | 24 | 30 | 118 | 32.7 | W/P\$ 2568 |
| | 65-2460SH <i>Kneespace 58"; No Additional Support Needed</i> | 60 | 24 | 30 | 111 | 29.8 | W/P\$ 2503 |

Must Specify (in this order):

- Model #
- Top Material
- Finish/Color
- Edge Profile
- Grommet Location
- Grommet Color

Description

- Available with Veneer (W) or HPL (P) Top; Must Specify
- For Use With or Without Modular Pedestals
- Support Panel Required (See [65-2812SP](#)), Stiffener Bar ([See Sizes](#)) Recommended in Kneespaces 60" or Greater When Unsupported by a Pedestal
- [Height Adjustable Units Available](#)
- If Using with Pedestal, Surface Grommet Only Available Opposite Pedestal
- Modesty Panel Grommet Standard; Must Specify: Black (BLK), Silver (SLV) or No Modesty Panel Grommet (NONE)
- Additional Options: Power and Grommet Options ([See Options and Locations](#))

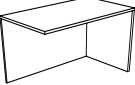
| RETURN SHELL | Left Shell | Right Shell | Width | Depth | Height | Ship Wt | Cubic Ft | List Price |
|---|-------------|-------------|-------|-------|--------|---------|----------|------------|
|  | 65-2448RSHL | 65-2448RSHR | 48 | 24 | 30 | 70 | 24.2 | W/P\$ 1780 |
| | 65-2442RSHL | 65-2442RSHR | 42 | 24 | 30 | 60 | 20.4 | W/P\$ 1667 |

Must Specify (in this order):

- Model #
- Top Material
- Finish/Color
- Edge Profile
- Grommet Location
- Grommet Color

Description

- Available with Veneer (W) or HPL (P) Top; Must Specify
- Optional Surface Grommet; Must Specify Black or Silver
- For Use With or Without Modular Pedestals Modesty Panel Grommet is Standard; Must Specify: Black (BLK), Silver (SLV) or No Modesty Panel Grommet (NONE)
- Additional Options: Power and Grommet Options ([See Options and Locations](#))

Pricing Codes:
W= Wood Top
P= HPL Top

[See Gesso Intro Section for Ordering Options](#)

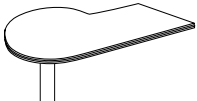
| Item | Model No. | Width | Depth | Height | Ship Wt | Cubic Ft | List Price |
|--|-----------------|------------------|-------|--------|---------|----------|-----------------|
| P-TOP PENINSULA WITH CYLINDER BASE  | Left Top | Right Top | | | | | |
| | 65-4284TL | 65-4284TR | 84 | 42-36 | 30 | 120 | 13.2 W/P\$ 3628 |
| | 65-4272TL | 65-4272TR | 72 | 42-36 | 30 | 115 | 11.3 W/P\$ 2975 |

Description

- Metal Cylinder Base Standard - 4" Diameter; Must Specify: Black or Aluminum
- 48" Stiffener Bar Required on 84" Units if Used as Runoff; [See Stiffener Bars](#)
- Some Assembly Required

Must Specify (in this order):

- Model #
- Top Material
- Top Finish/Color
- Edge Profile
- Leg Color
- Grommet
- Grommet Color

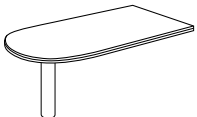
| | | | | | | | |
|--|-----------|----|----|----|-----|------|------------|
| D-TOP PENINSULA WITH CYLINDER BASE  | 65-3684DR | 84 | 36 | 30 | 134 | 13.2 | W/P\$ 3559 |
| | 65-3672DR | 72 | 36 | 30 | 115 | 9.8 | W/P\$ 2997 |
| | 65-3066DR | 66 | 30 | 30 | 120 | 7.5 | W/P\$ 2886 |

Description

- Metal Cylinder Base Standard - 4" Diameter; Must Specify: Black or Aluminum
- 48" Stiffener Bar Required on 84" Units if Used as Runoff; [See Stiffener Bars](#)
- Some Assembly Required

Must Specify (in this order):

- Model #
- Material
- Top Finish/Color
- Edge Profile
- Leg Color
- Grommet
- Grommet Color

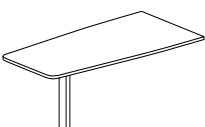
| | | | | | | | |
|--|-----------|----|----|----|----|------|------------|
| MEDIA PENINSULA WITH RECTANGLE LEG  | 65-3672MP | 36 | 72 | 30 | 90 | 52.1 | W/P\$ 3841 |
| | 65-3066MP | 30 | 66 | 30 | 77 | 40.3 | W/P\$ 3543 |
| | 65-3060MP | 30 | 60 | 30 | 70 | 36.7 | W/P\$ 3387 |

Description

- Aluminum Rectangular Post Standard
- Standard with Aluminum Rectangle Leg to be Installed 17¾" from Front to Allow for Kneespace Area
- Wire Management Trough Included; 4¼" W x 46¾" L x 3½" H
- Some Assembly Required

Must Specify (in this order):

- Model #
- Material
- Top Finish/Color
- Edge Profile
- Leg Option
- Power Option
- Grommet Color

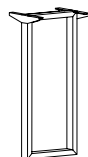

Leg Options: Specify & Add

| | | |
|-------|-----------------------|--------|
| OLEGA | 12" Aluminum Tube Leg | \$ 112 |
| OLEGB | 12" Black Tube Leg | \$ 112 |

Pricing Codes:

W= Wood Top
P= HPL Top

[See Gesso Intro Section for Ordering Options](#)

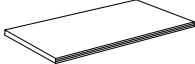
| Item | Model No. | Width | Depth | Height | Ship Wt | Cubic Ft | List Price |
|--|--|-------|------------------|------------------|---------|-----------|------------|
|  <p>MODULAR DESK TOPS</p> <p><u>Must Specify (in this order):</u> Model # Material Finish/Color Edge Profile Grommet Location Grommet Color</p> | 65-6072TP For Use as a Desk Top With Benching Units | 72 | 60 | 1 $\frac{3}{16}$ | 120 | 10.6 | W/P\$ 1967 |
| | 65-6066TP For Use as a Desk Top With Benching Units | 66 | 60 | 1 $\frac{3}{16}$ | 110 | 9.8 | W/P\$ 1873 |
| | 65-6060TP For Use as a Desk Top With Benching Units | 60 | 60 | 1 $\frac{3}{16}$ | 100 | 9.0 | W/P\$ 1791 |
| | 65-4872TP For Use as a Desk Top With Benching Units | 72 | 48 | 1 $\frac{3}{16}$ | 102 | 8.6 | W/P\$ 1606 |
| | 65-4866TP For Use as a Desk Top With Benching Units | 66 | 48 | 1 $\frac{3}{16}$ | 94 | 7.8 | W/P\$ 1537 |
| | 65-4860TP For Use as a Desk Top With Benching Units | 60 | 48 | 1 $\frac{3}{16}$ | 86 | 7.0 | W/P\$ 1466 |
| | 65-3684TP | 84 | 36 | 1 $\frac{3}{16}$ | 85 | 6.6 | W/P\$ 1351 |
| | 65-3678TP | 78 | 36 | 1 $\frac{3}{16}$ | 80 | 6.2 | W/P\$ 1319 |
| | 65-3672TP | 72 | 36 | 1 $\frac{3}{16}$ | 74 | 5.7 | W/P\$ 1281 |
| | 65-3666TP | 66 | 36 | 1 $\frac{3}{16}$ | 68 | 5.2 | W/P\$ 1228 |
| | 65-3660TP | 60 | 36 | 1 $\frac{3}{16}$ | 63 | 4.8 | W/P\$ 1170 |
| | 65-3654TP | 54 | 36 | 1 $\frac{3}{16}$ | 57 | 4.3 | W/P\$ 1075 |
| | 65-3648TP | 48 | 36 | 1 $\frac{3}{16}$ | 51 | 3.8 | W/P\$ 997 |
| | 65-3642TP | 42 | 36 | 1 $\frac{3}{16}$ | 45 | 3.4 | W/P\$ 910 |
| | 65-3084TP | 84 | 30 | 1 $\frac{3}{16}$ | 72 | 5.6 | W/P\$ 1266 |
| | 65-3078TP | 78 | 30 | 1 $\frac{3}{16}$ | 67 | 5.2 | W/P\$ 1239 |
| | 65-3072TP | 72 | 30 | 1 $\frac{3}{16}$ | 62 | 4.8 | W/P\$ 1197 |
| | 65-3066TP | 66 | 30 | 1 $\frac{3}{16}$ | 58 | 4.4 | W/P\$ 1156 |
| | 65-3060TP | 60 | 30 | 1 $\frac{3}{16}$ | 75 | 3.8 | W/P\$ 1066 |
| | 65-3054TP | 54 | 30 | 1 $\frac{3}{16}$ | 48 | 3.6 | W/P\$ 1007 |
| 65-3048TP | 48 | 30 | 1 $\frac{3}{16}$ | 43 | 3.2 | W/P\$ 932 | |
| 65-3042TP | 42 | 30 | 1 $\frac{3}{16}$ | 38 | 2.9 | W/P\$ 848 | |

Description

- Left to Right Grain Direction on Top; For Front to Back Grain Direction See Next Page
- Optional Surface Grommet; Must Specify: Black (BLK) or Silver (SLV)
- Profiled on Approach and User Side
- Support Panel Required ([See 65-2812SP](#)), Stiffener Bar ([See Sizes](#)) Recommended in Kneespaces 60" or Greater and With Peninsula Application When Surface is Not Supported by a Pedestal
- For Power and Grommet Options ([See Options and Locations](#))

Pricing Codes:
 W= Wood Top
 P= HPL Top

[See Gesso Intro Section for Ordering Options](#)

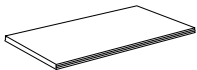
| Item | Model No. | Width | Depth | Height | Ship Wt | Cubic Ft | List Price |
|--|-----------|-------|-------|------------------|---------|----------|------------|
|  <p>MODULAR DESK TOPS</p> | 65-6036TP | 60 | 36 | 1 $\frac{1}{16}$ | 63 | 4.8 | W/P\$ 1170 |
| | 65-5436TP | 54 | 36 | 1 $\frac{1}{16}$ | 57 | 4.3 | W/P\$ 1075 |
| | 65-4836TP | 48 | 36 | 1 $\frac{1}{16}$ | 51 | 3.8 | W/P\$ 997 |
| | 65-4236TP | 42 | 36 | 1 $\frac{1}{16}$ | 45 | 3.4 | W/P\$ 910 |
| | 65-6030TP | 60 | 30 | 1 $\frac{1}{16}$ | 75 | 3.8 | W/P\$ 1066 |
| | 65-5430TP | 54 | 30 | 1 $\frac{1}{16}$ | 48 | 3.6 | W/P\$ 1007 |
| | 65-4830TP | 48 | 30 | 1 $\frac{1}{16}$ | 43 | 3.2 | W/P\$ 932 |
| | 65-4230TP | 42 | 30 | 1 $\frac{1}{16}$ | 38 | 2.9 | W/P\$ 848 |

Must Specify (in this order):

Model #
Material
Finish/ Color
Edge Profile
Grommet Location
Grommet Color

Description

- Front to Back Grain Direction on Top
- Optional Surface Grommet; Must Specify: Black (BLK) or Silver (SLV)
- Profiled on Approach and User Side
- Support Panel Required ([See 65-2812SP](#)), Stiffener Bar ([See Sizes](#)) Recommended in Kneespaces 60" or Greater and With Peninsula Application When Surface is Not Supported by a Pedestal
- For Power and Grommet Options ([See Options and Locations](#))

Pricing Codes:

W= Wood Top
P= HPL Top

[See Gesso Intro Section for Ordering Options](#)

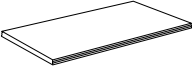
| Item | Model No. | Width | Depth | Height | Ship Wt | Cubic Ft | List Price |
|---|------------|-------|-------|------------------|---------|----------|------------|
| 24"D MODULAR BRIDGE, RETURN AND CREENZA TOPS | 65-24108TP | 108 | 24 | 1 $\frac{3}{16}$ | 110 | 5.5 | W/P\$ 1295 |
| LEFT TO RIGHT GRAIN DIRECTION | 65-24102TP | 102 | 24 | 1 $\frac{3}{16}$ | 105 | 5.2 | W/P\$ 1269 |
|  | 65-2496TP | 96 | 24 | 1 $\frac{3}{16}$ | 100 | 4.9 | W/P\$ 1242 |
| | 65-2490TP | 90 | 24 | 1 $\frac{3}{16}$ | 95 | 4.6 | W/P\$ 1210 |
| | 65-2484TP | 84 | 24 | 1 $\frac{3}{16}$ | 90 | 4.3 | W/P\$ 1107 |
| | 65-2478TP | 78 | 24 | 1 $\frac{3}{16}$ | 85 | 4.0 | W/P\$ 1085 |
| | 65-2472TP | 72 | 24 | 1 $\frac{3}{16}$ | 80 | 3.7 | W/P\$ 1054 |
| | 65-2466TP | 66 | 24 | 1 $\frac{3}{16}$ | 75 | 3.4 | W/P\$ 1007 |
| | 65-2460TP | 60 | 24 | 1 $\frac{3}{16}$ | 70 | 3.0 | W/P\$ 963 |
| | 65-2454TP | 54 | 24 | 1 $\frac{3}{16}$ | 65 | 2.8 | W/P\$ 881 |
| | 65-2448TP | 48 | 24 | 1 $\frac{3}{16}$ | 44 | 2.5 | W/P\$ 817 |
| | 65-2442TP | 42 | 24 | 1 $\frac{3}{16}$ | 50 | 2.2 | W/P\$ 743 |
| | 65-2436TP | 36 | 24 | 1 $\frac{3}{16}$ | 45 | 2.0 | W/P\$ 655 |
| | 65-2430TP | 30 | 24 | 1 $\frac{3}{16}$ | 36 | 1.6 | W/P\$ 634 |
| | 65-2418TP | 18 | 24 | 1 $\frac{3}{16}$ | 28 | 1.0 | W/P\$ 583 |

Must Specify (in this order):

Model #
Material
Finish/Color
Edge Profile
Grommet Location
Grommet Color

Description

- Left to Right Grain Direction on Top; [See Tops with Front-to-Back Grain Direction](#)
- For Use as 24" Bridge, Return and Credenza Modular Tops
- Optional Surface Grommet; Must Specify: Black (BLK) or Silver (SLV)
- Profiled on User Side
- Support Panel Required ([See 65-2812SP](#)), Stiffener Bar ([See Sizes](#)) Recommended in Kneespaces 60" or Greater and With Peninsula Application When Surface is Not Supported by a Pedestal
- For Power and Grommet Options ([See Options and Locations](#))

Pricing Codes:

W= Wood Top
P= HPL Top

[See Gesso Intro Section for Ordering Options](#)

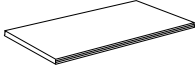
| Item | Model No. | Width | Depth | Height | Ship Wt | Cubic Ft | List Price |
|---|------------|-------|-------|------------------|---------|----------|------------|
| 20"D MODULAR BRIDGE, RETURN AND CREDENZA TOPS | 65-20108TP | 108 | 20 | 1 $\frac{3}{16}$ | 74 | 4.9 | W/P\$ 1154 |
| LEFT TO RIGHT GRAIN DIRECTION | 65-20102TP | 102 | 20 | 1 $\frac{3}{16}$ | 70 | 4.6 | W/P\$ 1130 |
|  | 65-2096TP | 96 | 20 | 1 $\frac{3}{16}$ | 65 | 4.3 | W/P\$ 1101 |
| | 65-2090TP | 90 | 20 | 1 $\frac{3}{16}$ | 61 | 4.1 | W/P\$ 1076 |
| | 65-2084TP | 84 | 20 | 1 $\frac{3}{16}$ | 57 | 3.8 | W/P\$ 988 |
| | 65-2078TP | 78 | 20 | 1 $\frac{3}{16}$ | 53 | 3.6 | W/P\$ 964 |
| | 65-2072TP | 72 | 20 | 1 $\frac{3}{16}$ | 49 | 3.3 | W/P\$ 936 |
| | 65-2066TP | 66 | 20 | 1 $\frac{3}{16}$ | 45 | 2.7 | W/P\$ 895 |
| | 65-2060TP | 60 | 20 | 1 $\frac{3}{16}$ | 41 | 2.7 | W/P\$ 851 |
| | 65-2054TP | 54 | 20 | 1 $\frac{3}{16}$ | 37 | 2.5 | W/P\$ 782 |
| | 65-2048TP | 48 | 20 | 1 $\frac{3}{16}$ | 33 | 2.3 | W/P\$ 730 |
| | 65-2042TP | 42 | 20 | 1 $\frac{3}{16}$ | 29 | 1.9 | W/P\$ 661 |
| | 65-2036TP | 36 | 20 | 1 $\frac{3}{16}$ | 25 | 1.7 | W/P\$ 581 |
| | 65-2030TP | 30 | 20 | 1 $\frac{3}{16}$ | 21 | 1.4 | W/P\$ 563 |
| | 65-2018TP | 18 | 20 | 1 $\frac{3}{16}$ | 15 | 0.9 | W/P\$ 522 |

Must Specify (in this order):

Model #
Material
Finish/Color
Edge Profile
Grommet Location
Grommet Color

Description

- Left to Right Grain Direction on Top; [See Tops with Front-to-Back Grain Direction](#)
- For use as 20" Bridge, Return and Credenza Modular Tops
- Optional Surface Grommet; Must Specify: Black (BLK) or Silver (SLV)
- Profiled on User Side
- Support Panel Required ([See 65-2812SP](#)), Stiffener Bar ([See Sizes](#)) Recommended in Kneespaces 60" or Greater and With Peninsula Application When Surface is Not Supported by a Pedestal
- For Power and Grommet Options ([See Options and Locations](#))

Pricing Codes:

W= Wood Top
P= HPL Top

[See Gesso Intro Section for Ordering Options](#)

| Item | Model No. | Width | Depth | Height | Ship Wt | Cubic Ft | List Price |
|--|-----------|-------|-------|------------------|---------|----------|------------|
| 24"D AND 20"D MODULAR BRIDGE, RETURN AND CREDENZA TOPS | 65-6024TP | 60 | 24 | 1 $\frac{3}{16}$ | 70 | 3.0 | W/P\$ 963 |
| FRONT AND BACK GRAIN DIRECTION | 65-5424TP | 54 | 24 | 1 $\frac{3}{16}$ | 65 | 2.8 | W/P\$ 881 |
| | 65-4824TP | 48 | 24 | 1 $\frac{3}{16}$ | 44 | 2.5 | W/P\$ 817 |
| | 65-4224TP | 42 | 24 | 1 $\frac{3}{16}$ | 50 | 2.2 | W/P\$ 743 |
| | 65-3624TP | 36 | 24 | 1 $\frac{3}{16}$ | 45 | 2.0 | W/P\$ 655 |
| | 65-3024TP | 30 | 24 | 1 $\frac{3}{16}$ | 36 | 1.6 | W/P\$ 634 |
| | 65-6020TP | 60 | 20 | 1 $\frac{3}{16}$ | 41 | 2.7 | W/P\$ 851 |
| | 65-5420TP | 54 | 20 | 1 $\frac{3}{16}$ | 37 | 2.5 | W/P\$ 782 |
| | 65-4820TP | 48 | 20 | 1 $\frac{3}{16}$ | 33 | 2.3 | W/P\$ 730 |
| | 65-4220TP | 42 | 20 | 1 $\frac{3}{16}$ | 29 | 1.9 | W/P\$ 661 |
| | 65-3620TP | 36 | 20 | 1 $\frac{3}{16}$ | 25 | 1.7 | W/P\$ 581 |
| | 65-3020TP | 30 | 20 | 1 $\frac{3}{16}$ | 21 | 1.4 | W/P\$ 563 |

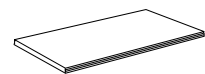

Must Specify (in this order):

Model #
Material
Finish/Color
Edge Profile
Grommet Location
Grommet Color

Description

- Front to Back Grain Direction on Top
- For use as 24" and 20" Bridge, Return and Credenza Modular Tops
- Optional Surface Grommet; Must Specify: Black (BLK) or Silver (SLV)
- Profiled on User Side
- Support Panel Required ([See 65-2812SP](#)), Stiffener Bar ([See Sizes](#)) Recommended in Kneespaces 60" or Greater and With Peninsula Application When Surface is is Not Supported by a Pedestal
- For Power and Grommet Options ([See Options and Locations](#))

| Item | Model No. | Width | Depth | Height | Ship Wt | Cubic Ft | List Price |
|---------------|------------|-------|-----------------|---------------|---------|----------|------------|
| STIFFENER BAR | 01-00060SB | 60 | 1 $\frac{3}{4}$ | $\frac{3}{4}$ | 8 | 0.3 | \$ 129 |
| | 01-00048SB | 48 | 1 $\frac{3}{4}$ | $\frac{3}{4}$ | 5 | 0.3 | \$ 121 |

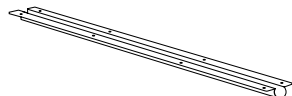

Description

- Reinforces Worksurfaces with Large Kneespace Widths
- Includes End Caps to Cover Sharp Edges
- Recommended in Kneespaces 60" or Greater
- Field Installed

Pricing Codes:

W= Wood Top
P= HPL Top

[See Gesso Intro Section for Ordering Options](#)

| Item | Model No. | Width | Depth | Height | Ship Wt | Cubic Ft | List Price |
|------|-----------|-------|-------|--------|---------|----------|------------|
|------|-----------|-------|-------|--------|---------|----------|------------|

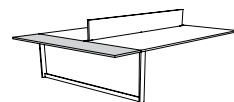

Must Specify (in this order):

Model #
Material
Finish/Color
Edge Profile

| | | | | | | | |
|--------------------|------------|----|----|---|----|-----|---------|
| EXTENDED DESK TOPS | 65-1560DTP | 60 | 15 | 1 | 21 | 1.7 | W\$ 686 |
| | 65-1548DTP | 48 | 15 | 1 | 21 | 1.7 | W\$ 639 |

Description

- Use as Extension of Top
- Profiled on Three Sides

ABOVE WORKSURFACE OPEN BOOKCASE END

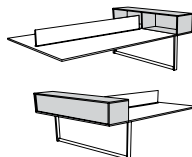

Must Specify (in this order):

Model #
Material
Finish/Color
Edge Profile

| | | | | | | |
|---------------------------------|----|----|----|----|-----|------------|
| 65-1560OBEA Two Compartments | 60 | 15 | 15 | 75 | 9.8 | W/P\$ 2079 |
| 65-1548OBEA Two Compartments | 48 | 15 | 15 | 63 | 7.9 | W/P\$ 1852 |
| 65-1530OBEA One Compartments | 30 | 15 | 15 | 40 | 4.8 | W/P\$ 1509 |
| 65-1524OBEA One Compartments | 24 | 15 | 15 | 35 | 4.1 | W/P\$ 1396 |

Description

- Profiled on Two Short Sides Edges
- Attached with 11 Gauge Undermount Brackets
- Only Compatible with the O Modular Peninsula Support Seated Height; [See Supports](#)

BELOW WORKSURFACE OPEN BOOKCASE END

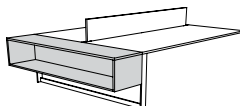

Must Specify (in this order):

Model #
Material
Finish/Color
Edge Profile

| | | | | | | |
|---------------------------------|----|----|----|----|-----|------------|
| 65-1560OBEB Two Compartments | 60 | 15 | 15 | 75 | 9.8 | W/P\$ 2079 |
| 65-1548OBEB Two Compartments | 48 | 15 | 15 | 63 | 7.9 | W/P\$ 1852 |
| 65-1530OBEB One Compartments | 30 | 15 | 15 | 40 | 4.8 | W/P\$ 1509 |
| 65-1524OBEB One Compartments | 24 | 15 | 15 | 35 | 4.1 | W/P\$ 1396 |

Description

- Profiled on Three Edges
- Only Compatible with the O Modular Peninsula Support Seated Height; [See Supports](#)

DESK END BOOKCASE

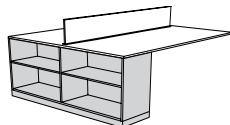

Must Specify (in this order):

Model #
Finish/Color

| | | | | | | |
|------------|----|----|-----|-----|------|----------|
| 65-1560OBE | 60 | 15 | 28¼ | 115 | 19.5 | W\$ 2444 |
| 65-1548OBE | 48 | 15 | 28¼ | 95 | 15.7 | W\$ 2191 |
| 65-1530OBE | 30 | 15 | 28¼ | 60 | 10.1 | W\$ 1805 |
| 65-1524OBE | 24 | 15 | 28¼ | 55 | 8.2 | W\$ 1677 |

Description

- Adjustable Shelf
- To Be Used with Modular Benching Desk Top ([See Desk Tops](#)) or Can Be Used as Freestanding Unit with or without Hutch or Bookcase Modular Top ([See Bookcase Tops](#))

Pricing Codes:

W= Wood Top
P= HPL Top

[See Gesso Intro Section for Ordering Options](#)

| Item | Model No. | Width | Depth | Height | Ship Wt | Cubic Ft | List Price |
|---|---|-------|-------|--------|---------|----------|------------|
| MODULAR PEDESTAL BOX/BOX/FILE  | 65-3618PD1 Use with 36"D Modular Desk Tops | 18 | 35¼ | 28¼ | 125 | 13.6 | W\$ 2561 |
| | 65-3018PD1 Use with 30"D Modular Desk Tops | 18 | 29¼ | 28¼ | 105 | 11.6 | W\$ 2373 |
| | 65-2418PD1 Use with 24"D Modular Cabinet Tops and Shells | 18 | 23¼ | 28¼ | 98 | 8.9 | W\$ 2210 |
| | 65-2515SHPD1 Use with Desk Shells Only | 15¾ | 25 | 28¼ | 96 | 8.4 | W\$ 2022 |
| | 65-2415PD1 Use with 24"D Modular Cabinet Tops and Shells | 15¾ | 23¼ | 28¼ | 93 | 7.8 | W\$ 2094 |

Must Specify (in this order):

- Model #
- Finish
- Drawer
- Grain Direction
- Construction
- Track
- Pull
- Wire Management

Description

- Open Back; [See Back Panel Options](#)
- Top is Required; [See Top Sizes](#)
- Letter Width Locking Pedestal
- Drawer Front Grain Direction Vertical Standard; Optional Horizontal Grain Direction
- Additional Options: Dove Tail Drawer Construction and Soft Close Drawers ([See Drawer Options](#)), Power and Grommet Options ([See Option Details](#))

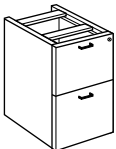
| | | | | | | | |
|---|---|-----|-----|-----|-----|------|----------|
| MODULAR PEDESTAL FILE/FILE  | 65-3618PD2 Use with 36"D Modular Desk Tops | 18 | 35¼ | 28¼ | 125 | 13.6 | W\$ 2561 |
| | 65-3018PD2 Use with 30"D Modular Desk Tops | 18 | 29¼ | 28¼ | 105 | 11.6 | W\$ 2373 |
| | 65-2418PD2 Use with 24"D Modular Cabinet Tops and Shells | 18 | 23¼ | 28¼ | 98 | 8.9 | W\$ 2210 |
| | 65-2515SHPD2 Use with Desk Shells Only | 15¾ | 25 | 28¼ | 96 | 8.4 | W\$ 2022 |
| | 65-2415PD2 Use with 24"D Modular Cabinet Tops and Shells | 15¾ | 23¼ | 28¼ | 93 | 7.8 | W\$ 2094 |

Must Specify (in this order):

- Model #
- Finish
- Drawer
- Grain Direction
- Construction
- Track
- Pull
- Wire Management

Description

- Open Back; [See Back Panel Options](#)
- Top is Required; [See Top Sizes](#)
- Letter Width Locking Pedestal
- Drawer Front Grain Direction Vertical Standard; Optional Horizontal Grain Direction
- Additional Options: Dove Tail Drawer Construction and Soft Close Drawers ([See Drawer Options](#)), Power and Grommet Options ([See Option Details](#))

| MODULAR PEDESTAL DOOR BOOKCASE | Left Shell | Right Shell | Width | Depth | Height | Ship Wt | Cubic Ft | List Price |
|--------------------------------|-------------|-------------|-------|-------|--------|---------|----------|------------|
| | 65-2418PD4L | 65-2418PD4R | | | | | | |

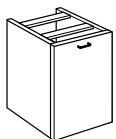

Must Specify (in this order):

- Model #
- Finish
- Door Grain Direction
- Pull
- Wire Management
- Locking Door

Description

- Open Back; [See Back Panel Options](#)
- Top is Required; [See Top Sizes](#)
- Adjustable Shelf
- Door Front Grain Direction Vertical Standard; Optional Horizontal Grain Direction
- Additional Options: Locking Door ([See Locking Options](#)) and Wire Management ([See Option Details](#))

Pricing Codes:
W= Wood Top
P= HPL Top

[See Gesso Intro Section for Ordering Options](#)

| Item | Model No. | Width | Depth | Height | Ship Wt | Cubic Ft | List Price |
|--------------------------------|------------|-------|-------|--------|---------|----------|------------|
| MODULAR PEDESTAL MULTI-FILE | 65-2436LF2 | 36 | 23¼ | 28¼ | 153 | 18.5 | W\$ 3030 |
| | 65-2430LF2 | 30 | 23¼ | 28¼ | 128 | 14.9 | W\$ 2918 |

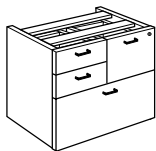

Must Specify (in this order):

Model #
Finish
Drawer
Grain Direction
Construction
Box and File Drawer Track
Pull
Wire Management

Description

- Open Back; [See Back Panel Options](#)
- For Use with 24" Deep Tops; Top is Required; [See 24"/Left-to-Right Grain Direction Tops](#) and [See 24"/Front-to-Back Grain Direction Tops](#)
- Locking File Drawers; File and Lateral Drawer Provides Legal or Letter Filing Front to Back or Side to Side
- Drawer Front Grain Direction Vertical Standard; Optional Horizontal Grain Direction
- Additional Options: Dove Tail Drawer Construction ([See Drawer Construction Options](#)), Soft Close Box and File Drawers ([See Soft Close Options](#)), Power and Grommet Options ([See Option Details](#))

| | | | | | | | |
|-------------------------------------|------------|----|-----|-----|-----|------|----------|
| MODULAR PEDESTAL OPEN MULTI-FILE | 65-2436OMF | 36 | 23¼ | 28¼ | 118 | 14.9 | W\$ 2916 |
| | 65-2430OMF | 30 | 23¼ | 28¼ | 128 | 18.5 | W\$ 2799 |

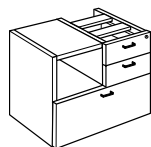

Must Specify (in this order):

Model #
Finish
Drawer
Grain Direction
Construction
Box Drawer Track
Pull
Wire Management

Description

- Open Back; [See Back Panel Options](#)
- For Use with 24" Deep Tops; Top is Required; [See 24"/Left-to-Right Grain Direction Tops](#) and [See 24"/Front-to-Back Grain Direction Tops](#)
- Upper Section Provides Open Storage and Two Locking Box Drawers
- 13½" Open Storage Clearance for 65-2430OMF and 12¾" Open Storage Clearance for 65-2436OMF
- Locking Lateral Drawers Provide Legal or Letter Filing Front to Back or Side to Side
- Drawer Front Grain Direction Vertical Standard; Optional Horizontal Grain Direction
- Additional Options: Dove Tail Drawer Construction ([See Drawer Construction Options](#)), Soft Close Box and File Drawers ([See Soft Close Options](#)), Power and Grommet Options ([See Option Details](#))

| | | | | | | | |
|-----------------------------------|-----------|----|-----|-----|-----|------|----------|
| MODULAR PEDESTAL DOOR BOOKCASE | 65-2436DB | 36 | 23¼ | 28¼ | 105 | 18.5 | W\$ 2509 |
| | 65-2430DB | 30 | 23¼ | 28¼ | 87 | 14.9 | W\$ 1983 |

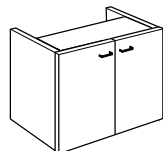

Must Specify (in this order):

Model #
Finish
Drawer Front Grain Direction
Pull
Locking Doors
Wire Management

Description

- Open Back; [See Back Panel Options](#)
- For Use with 24" Deep Tops; Top is Required; [See 24"/Left-to-Right Grain Direction Tops](#) and [See 24"/Front-to-Back Grain Direction Tops](#)
- 12" Deep Adjustable Shelf Behind Doors
- Door Front Grain Direction Vertical Standard; Optional Horizontal Grain Direction
- Additional Options: Locking Door ([See Locking Options](#)) and Wire Management ([See Option Details](#))

Pricing Codes:

W= Wood Top
P= HPL Top

[See Gesso Intro Section for Ordering Options](#)

| Item | Model No. | Width | Depth | Height | Ship Wt | Cubic Ft | List Price |
|---|------------|-------|-------|--------|---------|----------|------------|
| MODULAR PEDESTAL DOOR BOOKCASE W/OPEN COMPARTMENT | 65-2436ODB | 36 | 23¼ | 28¼ | 118 | 18.5 | W\$ 2367 |
| | 65-2430ODB | 30 | 23¼ | 28¼ | 108 | 14.9 | W\$ 1829 |

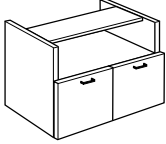

Must Specify (in this order):
 Model #
 Finish
 Door Front Grain Direction
 Pull
 Locking Doors
 Wire Management

Description

- Open Back; [See Back Panel Options](#)
- For Use with 24" Deep Tops; Top is Required; [See 24"/Left-to-Right Grain Direction Tops](#) and [See 24"/Front-to-Back Grain Direction Tops](#)
- Upper Section Provides 12¾" Clearance for Open Storage
- Lower Section Provides Storage Behind Two (2) Doors
- Door Front Grain Direction Vertical Standard; Optional Horizontal Grain Direction
- Additional Options: Locking Door ([See Locking Options](#)) and Wire Management ([See Option Details](#))

| | | | | | | | |
|-------------------------------|------------|----|-------------------|-----|-----|------|----------|
| MODULAR PEDESTAL OPEN STORAGE | 65-2436MBC | 36 | 22½ ₃₂ | 28¼ | 118 | 18.5 | W\$ 2045 |
| | 65-2430MBC | 30 | 22½ ₃₂ | 28¼ | 108 | 14.9 | W\$ 1735 |

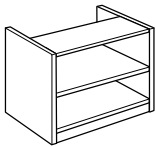

Must Specify (in this order):
 Model #
 Finish
 Wire Management

Description

- Open Back; [See Back Panel Options](#)
- For Use with 24" Deep Tops; Top is Required; [See 24"/Left-to-Right Grain Direction Tops](#) and [See 24"/Front-to-Back Grain Direction Tops](#)
- One Adjustable Shelf
- Optional Wire Management ([See Option Details](#))

| | | | | | | | |
|-------------------------------|------------|----|-----|-----|-----|------|----------|
| MODULAR PEDESTAL LATERAL FILE | 65-2436LF1 | 36 | 23¼ | 28¼ | 154 | 18.5 | W\$ 2640 |
| | 65-2430LF1 | 30 | 23¼ | 28¼ | 128 | 14.9 | W\$ 2456 |

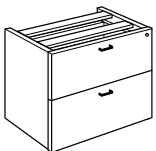

Must Specify (in this order):
 Model #
 Finish
 Drawer
 Grain Direction
 Construction
 Pull
 Wire Management

Description

- Open Back; [See Back Panel Options](#)
- For Use with 24" Deep Tops; Top is Required; [See 24"/Left-to-Right Grain Direction Tops](#) and [See 24"/Front-to-Back Grain Direction Tops](#)
- Locking Lateral Drawers Provide Legal or Letter Filing Front to Back or Side to Side
- Drawer Front Grain Direction Vertical Standard; Optional Horizontal Grain Direction
- Additional Options: Dove Tail Drawer Construction ([See Drawer Construction Options](#)), Wire Management ([See Option Details](#))

Pricing Codes:
 W= Wood Top
 P= HPL Top

[See Gesso Intro Section for Ordering Options](#)

| Item | Model No. | Width | Depth | Height | Ship Wt | Cubic Ft | List Price |
|-----------------------------------|------------|-------|-------|--------|---------|----------|------------|
| MODULAR THREE DRAWER LATERAL FILE | 65-2436LF3 | 36 | 24 | 42¾ | 130 | 24.2 | W\$ 4004 |
| | 65-2430LF3 | 30 | 24 | 42¾ | 120 | 20.4 | W\$ 3797 |

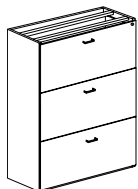

Must Specify (in this order):

Model #
Finish
Drawer
Grain Direction
Construction
Pull
Wire Management

Description

- Finished Back Panel Included
- For Use with 24" Deep Tops; Top is Required; [See 24"/Left-to-Right Grain Direction Tops](#) and [See 24"/Front-to-Back Grain Direction Tops](#)
- Locking Lateral Drawers Provide Legal or Letter Filing Front to Back or Side to Side
- Drawer Front Grain Direction Vertical Standard; Optional Horizontal Grain Direction
- Additional Options: Dove Tail Drawer Construction ([See Drawer Construction Options](#))

| | | | | | | | |
|--------------------------|--------------|----|-----|-----|----|------|----------|
| 21" LOW MODULAR BOX/FILE | 65-2436L21BF | 36 | 23¼ | 20¾ | 84 | 13.2 | W\$ 2386 |
| | 65-2430L21BF | 30 | 23¼ | 20¾ | 76 | 11.1 | W\$ 2288 |
| | 65-2418L21BF | 18 | 23¼ | 20¾ | 42 | 6.6 | W\$ 1942 |
| | 65-2036L21BF | 36 | 19¼ | 20¾ | 80 | 11.2 | W\$ 2267 |
| | 65-2030L21BF | 30 | 19¼ | 20¾ | 72 | 9.4 | W\$ 2174 |
| | 65-2018L21BF | 18 | 19¼ | 20¾ | 40 | 5.6 | W\$ 1842 |

Must Specify (in this order):

Model #
Finish
Drawer
Grain Direction
Construction
Box Drawer Track
Pull
Wire Management

Description

- Open Back; [See Back Panel Options](#)
- For Low Height Credenzas or Benching Applications
- Locking Tray/File Drawers; File Provides Legal or Letter Filing
- Drawer Front Grain Direction Vertical Standard; Optional Horizontal Grain Direction
- Additional Options: Dove Tail Drawer Construction ([See Drawer Construction Options](#)), Soft Close Box Drawer ([See Soft Close Options](#)), Power and Grommet Options ([See Option Details](#))

Pricing Codes:

W= Wood Top
P= HPL Top

[See Gesso Intro Section for Ordering Options](#)

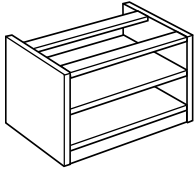
| Item | Model No. | Width | Depth | Height | Ship Wt | Cubic Ft | List Price |
|--|--------------|-------|-------|--------|---------|----------|------------|
| 21" LOW MODULAR OPEN STORAGE  | 65-2436L21BC | 36 | 22½ | 20¾ | 78 | 13.2 | W\$ 1955 |
| | 65-2430L21BC | 30 | 22½ | 20¾ | 74 | 11.1 | W\$ 1889 |
| | 65-2418L21BC | 18 | 22½ | 20¾ | 54 | 6.9 | W\$ 1721 |
| | 65-2036L21BC | 36 | 18½ | 20¾ | 74 | 11.2 | W\$ 1857 |
| | 65-2030L21BC | 30 | 18½ | 20¾ | 70 | 9.4 | W\$ 1794 |
| | 65-2018L21BC | 18 | 18½ | 20¾ | 50 | 5.9 | W\$ 1633 |

Must Specify (in this order):

Model #
Finish
Wire Management

Description

- Open Back; [See Back Panel Options](#)
- For Low Height Credenzas or Benching Applications
- Removable Wire Management Panel
- One Adjustable Shelf
- Optional Wire Management ([See Option Details](#))

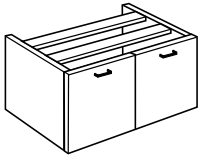
| | | | | | | | |
|--|--------------|----|-----|-----|----|------|----------|
| 21" LOW MODULAR DOOR BOOKCASE  | 65-2436L21DB | 36 | 23¼ | 20¾ | 93 | 13.2 | W\$ 2230 |
| | 65-2430L21DB | 30 | 23¼ | 20¾ | 86 | 11.1 | W\$ 1989 |
| | 65-2036L21DB | 36 | 19¼ | 20¾ | 89 | 11.2 | W\$ 2123 |
| | 65-2030L21DB | 30 | 19¼ | 20¾ | 82 | 9.4 | W\$ 1891 |

Must Specify (in this order):

Model #
Finish
Door Front Grain Direction
Pull
Locking Doors
Wire Management

Description

- Open Back; [See Back Panel Options](#)
- For Low Height Credenzas or Benching Applications
- Removable Wire Management Panel
- One Adjustable Shelf Behind Doors
- Door Front Grain Direction Vertical Standard; Optional Horizontal Grain Direction
- Additional Options: Locking Door ([See Locking Options](#)) and Wire Management ([See Option Details](#))

Pricing Codes:

W= Wood Top
P= HPL Top

[See Gesso Intro Section for Ordering Options](#)

| Item | Model No. | Width | Depth | Height | Ship Wt | Cubic Ft | List Price |
|--|--------------|-------|-------|--------|---------|----------|------------|
| 21" LOW MODULAR SLIDING DOOR BOOKCASE | 65-2436L21SD | 36 | 23¼ | 20¾ | 93 | 13.2 | W\$ 2551 |
| | 65-2430L21SD | 30 | 23¼ | 20¾ | 86 | 11.1 | W\$ 2241 |
| | 65-2036L21SD | 36 | 19¼ | 20¾ | 89 | 11.2 | W\$ 2426 |
| | 65-2030L21SD | 30 | 19¼ | 20¾ | 82 | 9.4 | W\$ 2129 |

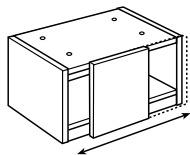

Must Specify (in this order):

Model #
Finish
Door Front Grain Direction
Wire Management

Description

- One Non-Locking Sliding Door
- Open Back; [See Back Panel Options](#)
- For Low Height Credenzas or Benching Applications
- Removable Wire Management Panel
- Storage Behind Sliding Door
- Door Front Grain Direction Vertical Standard; Optional Horizontal Grain Direction
- Optional Wire Management ([See Option Details](#))

| | | | | | | | |
|--|-----------|----|---|-----|----|-----|---------|
| MODULAR PENINSULA SUPPORT SEATED HEIGHT | 65-3630EP | 36 | 1 | 28¾ | 40 | 2.0 | W\$ 706 |
| | 65-3030EP | 30 | 1 | 28¾ | 34 | 1.6 | W\$ 669 |
| | 65-2812SP | 12 | 1 | 28¾ | 12 | 0.8 | W\$ 436 |

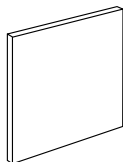

Must Specify (in this order):

Model #
Finish

Description

- To Be Used with Modular Desk Tops at 30" High
- Required to Be Used with T Support or the Support Panel Perpendicular to 36" and 30" Unit

| | | | | | | | |
|--|----------------------|----|-----|-----|-----|---------|---------|
| H MODULAR PENINSULA SUPPORT SEATED HEIGHT | 01-3628HLV | 36 | 1 | 28¾ | 30 | 2.0 | \$ 1145 |
| | Single Mounted Plate | | | | | | |
| | 01-3028HLV | 30 | 1 | 28¾ | 25 | 1.7 | \$ 1126 |
| | Single Mounted Plate | | | | | | |
| | 01-2428HLV | 24 | 1 | 28¾ | 20 | 1.4 | \$ 847 |
| | Single Mounted Plate | | | | | | |
| | 01-3628TLV | 36 | 1 | 28¾ | 30 | 2.0 | \$ 1182 |
| Double Mounted Plate | | | | | | | |
| 01-3028TLV | 30 | 1 | 28¾ | 25 | 1.7 | \$ 1163 | |
| Double Mounted Plate | | | | | | | |
| 01-2428TLV | 24 | 1 | 28¾ | 20 | 1.4 | \$ 876 | |
| Double Mounted Plate | | | | | | | |

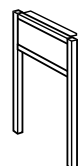

Must Specify (in this order):

Model #
Veneer Insert
Support Finish

Description

- Available in Aluminum (ALUM) or Black (BLK), Must Specify
- Constructed of Tubular Steel
- Metal End Support to Be Used with Modular Desk Tops at 30" High - Not Available to be Sold Separately
- Double Mount Plate Required for Freestanding Table/Desk

Leg Options: Specify & Add

| | | |
|-----|---------------|--------|
| HIW | Veneer Insert | \$ 117 |
|-----|---------------|--------|

Pricing Codes:

W= Wood Top
P= HPL Top

[See Gesso Intro Section for Ordering Options](#)

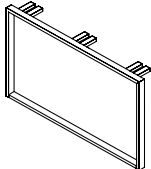
| Item | Model No. | Width | Depth | Height | Ship Wt | Cubic Ft | List Price |
|--|-----------|-------|-------|--------|---------|----------|------------|
| O MODULAR PENINSULA SUPPORT SEATED HEIGHT  | 01-6028OL | 60 | 2 | 28¼ | 60 | 6.0 | \$ 917 |
| | 01-4828OL | 48 | 2 | 28¼ | 55 | 4.7 | \$ 790 |
| | 01-3628OL | 36 | 2 | 28¼ | 30 | 2.7 | \$ 661 |
| | 01-3028OL | 30 | 2 | 28¼ | 25 | 2.3 | \$ 552 |
| | 01-2428OL | 24 | 2 | 28¼ | 20 | 1.8 | \$ 486 |

Must Specify (in this order):

Model #
Support Color

Description

- Available in Aluminum (ALUM) or Black (BLK), Must Specify
- Constructed of Tubular Steel
- Metal End Support to Be Used with Modular Desk Tops at 30" High - Not Available to be Sold Separately

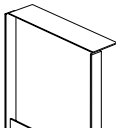
| | | | | | | | |
|---|-----------|----|-----|-----|----|-----|-------------------------------|
| BAR MODULAR PENINSULA SUPPORT SEATED HEIGHT  | 01-3628BL | 36 | 2 ½ | 28¼ | 30 | 2.7 | ALUM/BLK\$ 715 CHRM\$ 1239 |
| | 01-3028BL | 30 | 2 ½ | 28¼ | 25 | 2.3 | ALUM/BLK\$ 644 CHRM\$ 1039 |
| | 01-2428BL | 24 | 2 ½ | 28¼ | 20 | 1.8 | ALUM/BLK\$ 601 CHRM\$ 998 |

Must Specify (in this order):

Model #
Support Color

Description

- Available in Aluminum (ALUM), Black (BLK) or Chrome (CHRM)
- Constructed of Tubular Steel
- Metal End Support to Be Used with Modular Desk Tops at 30" High - Not Available to be Sold Separately

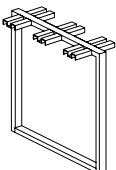
| | | | | | | | |
|---|------------|----|---|-----|----|-----|--------|
| O SHARED METAL LEG SEATED HEIGHT  | 01-3028OLS | 30 | 2 | 28¼ | 50 | 3.1 | \$ 629 |
| | 01-2428OLS | 24 | 2 | 28¼ | 45 | 2.5 | \$ 554 |

Must Specify (in this order):

Model #
Support Color

Description

- Available in Aluminum (ALUM) or Black (BLK), Must Specify
- Constructed of Tubular Steel
- Metal End Support to Be Used with Modular Desk Tops at 30" High - Not Available to be Sold Separately

Pricing Codes:

W= Wood Top
P= HPL Top

[See Gesso Intro Section for Ordering Options](#)

| Item | Model No. | | Width | Depth | Height | Ship Wt | Cubic Ft | List Price |
|---|------------|--------|-------|-------|--------|---------|----------|------------|
| 28"D ELECTRIC HEIGHT ADJUSTABLE TABLE LIFT | 01-2854ELB | Black | 54-78 | 28 | 22-48 | 30 | 2.4 | \$ 1832 |
| | 01-2854ELA | Silver | | | | | | |
| 22"D ELECTRIC HEIGHT ADJUSTABLE TABLE LIFT | 01-2254ELB | Black | 54-78 | 22 | 22-48 | 58 | 2.4 | \$ 1832 |
| | 01-2254ELA | Silver | | | | | | |
| 22"D ELECTRIC HEIGHT ADJUSTABLE TABLE LIFT | 01-2242ELB | Black | 42-48 | 22 | 22-48 | 55 | 2.4 | \$ 1832 |
| | 01-2242ELA | Silver | | | | | | |
| ELECTRIC HEIGHT ADJUSTABLE ADVANCED SWITCH WITH MEMORY | 01-MSWCH | | 3% | 4% | 1% | ½ | 0.8 | \$ 223 |

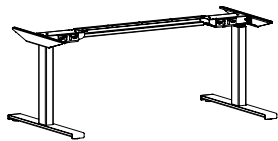

Description

- Standard with Up/Down Control Switch, 10' Power Cord, Integrated Anti-Collision Feature, Leveling Glides
- Standard Up/Down Control Switch can be Mounted for Left or Right Users; Upgrade to Advanced Memory Switch (01-MSWCH with Memory, Reminders, and Bluetooth), Must Specify and See Below for Details
- Adjusts to Accommodate Tops 54-78"W and 30"-36"D; Tops Sold Separately
- Lifting Capacity (Including Worksurface): 363 lbs
- Some Assembly Required; Installation Instructions Included

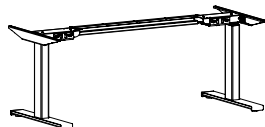

Description

- Standard with Up/Down Control Switch, 10' Power Cord, Anti-Collision Safety Feature, Leveling Glides
- Standard Up/Down Control Switch can be Mounted for Left or Right Users; Upgrade to Advanced Memory Switch (01-MSWCH with Memory, Reminders, and Bluetooth), Must Specify and See Below for Details
- Adjusts to Accommodate Tops 54-78"W and 24"D; Tops Sold Separately
- Lifting Capacity (Including Worksurface): 363 lbs
- Some Assembly Required; Installation Instructions Included

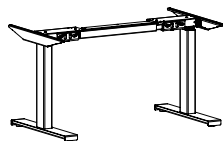

Description

- Standard with Up/Down Control Switch, 10' Power Cord, Anti-Collision Safety Feature, Leveling Glides
- Standard Up/Down Control Switch can be Mounted for Left or Right Users; Upgrade to Advanced Memory Switch (01-MSWCH with Memory, Reminders, and Bluetooth), Must Specify and See Below for Details
- Adjusts to Accommodate Tops 42-48"W and 24"-30"D; Tops Sold Separately
- Lifting Capacity (Including Worksurface): 363 lbs
- Some Assembly Required; Installation Instructions Included



Description

- Black Unit with Black Cord
- Bluetooth Capabilities
- Three Stand-Up Reminders
- Four Height Memory Positions

OPEN MARKET ONLY

Pricing Codes:

W= Wood Top

P= HPL Top

[See Gesso Intro Section for Ordering Options](#)

| Item | Model No. | Width | Depth | Height | Ship Wt | Cubic Ft | List Price |
|---------------------------------------|-----------|-------|-------|--------|---------|----------|------------|
| LAYER SUPPORT FOR 21" LOW CREDENZA | 01-3607OL | 36 | 2 | 7 | 25 | 1.1 | \$ 576 |
| | 01-3007OL | 30 | 2 | 7 | 20 | 0.9 | \$ 557 |
| | 01-2407OL | 24 | 2 | 7 | 15 | 0.7 | \$ 523 |

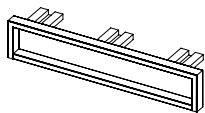

Must Specify (in this order):

Model #
Support Color

Description

- Available in Aluminum (ALUM) or Black (BLK), Must Specify
- Supports 30" High Worksurfaces Over Low Height Components - Not Available to be Sold Separately

| | | | | | | | |
|---|--------------|----|----|---|----|-----|---------|
| LAYER SUPPORT OVER LOW HEIGHT CABINETS | 65-1807USP21 | 18 | 5¾ | 7 | 20 | 1.2 | W\$ 455 |
|---|--------------|----|----|---|----|-----|---------|

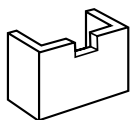

Must Specify (in this order):

Model #
Color
Grommet Color

Description

- Supports 30" High Worksurfaces Over Low Height Components - Not Available to be Sold Separately
- Open Throughout and On Back Side to Manage Cables
- Rectangle Grommet Cover Included; Must Specify: Black (BLK) or Silver (SLV)

| | | | | | | | |
|--------------|---|---|---|-----|---|-----|---------|
| FILLER PANEL | 65-2803FP | 3 | ¾ | 28¾ | 6 | 0.5 | W\$ 350 |
| | For Standard Height Modular Pedestals and Credenzas | | | | | | |
| | 65-2003FP | 3 | ¾ | 20¾ | 4 | 0.9 | W\$ 326 |
| | For Low Height Credenzas or Benching Applications | | | | | | |



Must Specify (in this order):

Model #
Finish

Description

- Used to Fill Gap Behind Modular Pedestals with a Modular Top

Pricing Codes:

W= Wood Top
P= HPL Top

[See Gesso Intro Section for Ordering Options](#)

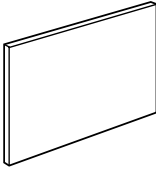
| Item | Model No. | Width | Depth | Height | Ship Wt | Cubic Ft | List Price |
|---|------------|-------|-------|--------|---------|----------|------------|
|  <p>MODULAR MODESTY/BACK PANEL</p> | 65-10828BP | 108 | ¾ | 28¼ | 130 | 5.7 | W\$ 1073 |
| | 65-10228BP | 102 | ¾ | 28¼ | 122 | 5.4 | W\$ 1024 |
| | 65-9628BP | 96 | ¾ | 28¼ | 115 | 5.0 | W\$ 979 |
| | 65-9028BP | 90 | ¾ | 28¼ | 108 | 4.6 | W\$ 960 |
| | 65-8428BP | 84 | ¾ | 28¼ | 101 | 4.3 | W\$ 923 |
| | 65-7828BP | 78 | ¾ | 28¼ | 94 | 4.0 | W\$ 899 |
| | 65-7228BP | 72 | ¾ | 28¼ | 86 | 3.7 | W\$ 878 |
| | 65-6628BP | 66 | ¾ | 28¼ | 79 | 3.4 | W\$ 846 |
| | 65-6028BP | 60 | ¾ | 28¼ | 65 | 3.7 | W\$ 832 |
| | 65-5428BP | 54 | ¾ | 28¼ | 60 | 2.8 | W\$ 794 |
| | 65-4828BP | 48 | ¾ | 28¼ | 55 | 2.5 | W\$ 756 |
| | 65-4228BP | 42 | ¾ | 28¼ | 50 | 2.2 | W\$ 658 |
| | 65-3628BP | 36 | ¾ | 28¼ | 45 | 2.0 | W\$ 566 |
| | 65-3028BP | 30 | ¾ | 28¼ | 30 | 1.6 | W\$ 520 |
| | 65-1828BP | 18 | ¾ | 28¼ | 19 | 1.0 | W\$ 446 |
| | 65-1528BP | 15¾ | ¾ | 28¼ | 18 | 1.0 | W\$ 413 |

Must Specify (in this order):

Model #
Finish
Grommet
Grommet Color

Description

- For Use as a Modesty Panel to Create Bridges, Returns, or Credenzas, or as a Back Panel on Modular Units

Leg Options: Specify & Add

| | | |
|--------|--|-------|
| 1-GRMT | Optional Top-Center Grommet, Must Specify: Black (BLK) or Silver (SLV) | \$ 52 |
|--------|--|-------|

| | | | | | | | |
|---|------------|----|----|-----|----|-----|----------|
|  <p>FLIPDOWN MODESTY PANEL</p> | 65-2836FDM | 36 | 3½ | 28¼ | 35 | 3.3 | W\$ 1605 |
| | 65-2830FDM | 30 | 3½ | 28¼ | 30 | 2.7 | W\$ 1421 |

Description

- Modesty Panel with 3" Deep Case Allows Room for Plugs
- Does Not Feature Soft Close Hinges
- Upper Panel: Open at Top, Hinged and Opens Fully for Easy Access to Ports and Cord Management

Must Specify (in this order):

Model #
Finish

Pricing Codes:

W= Wood Top
P= HPL Top

[See Gesso Intro Section for Ordering Options](#)

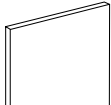
| Item | Model No. | Width | Depth | Height | Ship Wt | Cubic Ft | List Price |
|---|-----------|-------|-------|--------|---------|----------|------------|
|  | 65-3530EP | 35¼ | 1 | 28¼ | 41 | 2.6 | W\$ 700 |
| | 65-2930EP | 29¼ | 1 | 28¼ | 34 | 2.2 | W\$ 662 |
| | 65-2330EP | 23¼ | 1 | 28¼ | 27 | 1.6 | W\$ 623 |

Description

- Must Be Used with a Back Panel

Must Specify (in this order):

Model #
Finish

| | | | | | | | |
|----------------------|-----------|----|---|-----|----|-----|---------|
| SUPPORT PANEL | 65-2812SP | 12 | 1 | 28¼ | 12 | 0.8 | W\$ 436 |
|----------------------|-----------|----|---|-----|----|-----|---------|



Description

- Required to be Used Perpendicular to Full Back Panels to Support Kneespace Areas of 60" or Longer

Must Specify (in this order):

Model #
Finish

| | | | | | | | |
|------------------|------------|----|----|-----|----|-----|---------|
| SUPPORT T | 65-1010SP | 10 | 10 | 28¼ | 20 | 0.8 | W\$ 634 |
| | 65-1010SPW | 10 | 10 | 28¼ | 20 | 0.8 | W\$ 634 |



Support T with Wire Management

Description

- Supports Worksurfaces
- Required on Kneespace Areas of 60" or More Where Back Panels are Not Used

Must Specify (in this order):

Model #
Finish

| | | | | | | | |
|----------------------|-----------|----|---|-----|----|-----|--------|
| O LEG SUPPORT | 01-1228OL | 12 | 2 | 28¼ | 20 | 1.2 | \$ 442 |
|----------------------|-----------|----|---|-----|----|-----|--------|

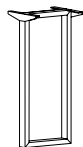

Description

- Available in Aluminum or Black; Must Specify Color
- Provides Additional Support Under Tops Greater Than 60"- Not Available to be Sold Separately

Must Specify (in this order):

Model #
Color
Wire Management Cover

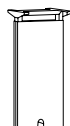

Leg Options: Specify & Add

| | | |
|-------------|--|--------|
| 01-1228OLWM | Wire Management Cover - Available in Aluminum or Black; Must Specify Color | \$ 291 |
|-------------|--|--------|

Pricing Codes:

W= Wood Top
P= HPL Top

[See Gesso Intro Section for Ordering Options](#)

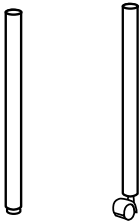
| Item | Model No. | Width | Depth | Height | Ship Wt | Cubic Ft | List Price |
|---|---|-------|-------|--------|---------|----------|------------|
|  | MODULAR TABLE DESK LEG | | | | | | |
| | 01-0401MLA Aluminum Leg with Leveler | 2 | 2 | 28¾ | 10 | 0.5 | \$ 320 |
| | 01-0401MLB Black Leg with Leveler | 2 | 2 | 28¾ | 10 | 0.5 | \$ 320 |
| | 01-0400MLA Aluminum Leg with Caster | 2 | 2 | 28¾ | 10 | 0.5 | \$ 272 |
| | 01-0400MLB Black Leg with Caster | 2 | 2 | 28¾ | 10 | 0.5 | \$ 272 |

Description

- Available in Adjustable Black Leveler or Locking Black Caster

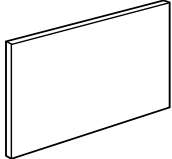
| Item | Model No. | Width | Depth | Height | Ship Wt | Cubic Ft | List Price |
|---|-----------------------|-------|-------|--------|---------|----------|------------|
|  | LOW HEIGHT BACK PANEL | | | | | | |
| | 65-10820BP | 108 | ¾ | 20¾ | 45 | 3.6 | W\$ 957 |
| | 65-10220BP | 102 | ¾ | 20¾ | 43 | 3.5 | W\$ 914 |
| | 65-9620BP | 96 | ¾ | 20¾ | 40 | 3.4 | W\$ 866 |
| | 65-9020BP | 90 | ¾ | 20¾ | 38 | 3.3 | W\$ 846 |
| | 65-8420BP | 84 | ¾ | 20¾ | 36 | 3.2 | W\$ 821 |
| | 65-7820BP | 78 | ¾ | 20¾ | 34 | 3.1 | W\$ 783 |
| | 65-7220BP | 72 | ¾ | 20¾ | 31 | 3.0 | W\$ 759 |
| | 65-6620BP | 66 | ¾ | 20¾ | 29 | 2.9 | W\$ 739 |
| | 65-6020BP | 60 | ¾ | 20¾ | 27 | 2.8 | W\$ 655 |
| | 65-5420BP | 54 | ¾ | 20¾ | 24 | 2.7 | W\$ 618 |
| | 65-4820BP | 48 | ¾ | 20¾ | 22 | 2.6 | W\$ 601 |
| | 65-4220BP | 42 | ¾ | 20¾ | 20 | 2.5 | W\$ 548 |
| | 65-3620BP | 36 | ¾ | 20¾ | 17 | 2.4 | W\$ 503 |
| | 65-3020BP | 30 | ¾ | 20¾ | 15 | 2.3 | W\$ 473 |
| 65-2420BP | 24 | ¾ | 20¾ | 15 | 2.3 | W\$ 431 | |
| 65-1820BP | 18 | ¾ | 20¾ | 15 | 2.3 | W\$ 416 | |

Must Specify (in this order):

Model #
Finish
Grommet
Grommet Color

Description

- For Use as a Back Panels to Create Low Height Returns, Credenzas, or Benches

Leg Options: Specify & Add

1-GRMT Optional Top-Center Grommet, Must Specify: Black (BLK) or Silver (SLV) \$ 52

Pricing Codes:

W= Wood Top
P= HPL Top

[See Gesso Intro Section for Ordering Options](#)

| Item | Model No. | Width | Depth | Height | Ship Wt | Cubic Ft | List Price |
|----------------------|-----------|-------|-------|--------|---------|----------|------------|
| LOW HEIGHT END PANEL | 65-2420EP | 23¾ | 1 | 20¾ | 15 | 0.8 | W\$ 554 |
| | 65-2020EP | 19¾ | 1 | 20¾ | 15 | 0.8 | W\$ 451 |

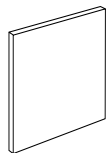

Must Specify (in this order):

Model #
Finish

Description

- Must Be Used with a Back Panel

| | | | | | | | |
|--------------------------|-----------|----|---|-----|---|-----|---------|
| LOW HEIGHT SUPPORT PANEL | 65-2012SP | 12 | 1 | 20¾ | 7 | 0.4 | W\$ 396 |
|--------------------------|-----------|----|---|-----|---|-----|---------|

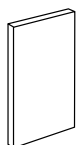

Must Specify (in this order):

Model #
Finish

Description

- Required to be Used Perpendicular to Full Back Panels to Support Kneespace Areas of 60" or Longer

| | | | | | | | |
|----------------------|--|----|----|-----|----|-----|---------|
| LOW HEIGHT SUPPORT T | 65-2010SP | 10 | 10 | 20¾ | 11 | 2.3 | W\$ 560 |
| | 65-2010SPW Support T with Wire Management | 10 | 10 | 20¾ | 11 | 2.3 | W\$ 564 |



Must Specify (in this order):

Model #
Finish

Description

- Supports Worksurfaces
- Required on Kneespace Areas of 60" or More Where Back Panels are Not Used

Pricing Codes:
W= Wood Top
P= HPL Top

[See Gesso Intro Section for Ordering Options](#)

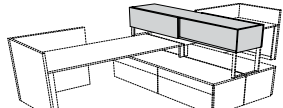
| Item | Model No. | Width | Depth | Height | Ship Wt | Cubic Ft | List Price |
|---|-------------|-------|-------|--------|---------|----------|------------|
|  DUAL ACCESS SLIDING DOOR HUTCH | 65-1572DAHS | 72 | 16½ | 15 | 117 | 14.5 | W\$ 4221 |
| | 65-1566DAHS | 66 | 16½ | 15 | 111 | 13.4 | W\$ 4053 |
| | 65-1560DAHS | 60 | 16½ | 15 | 104 | 12.2 | W\$ 3909 |

Description

- One Non-Locking Sliding Door
- Used with Shared Office Application
- Safely Write on Dry Erase Door and Dry Erase Back Panel with Our Dry Erase Marker Set; [See Sets](#)
- Metal Stanchion Leg Sold Separately; [See Stanchion Sizes](#)
- If Applicable, Door Front Grain Direction Vertical Standard; Optional Horizontal Grain Direction

Must Specify (in this order):

Model #
 Finish
 Door Style
 Door Finish (if applicable)
 Door Grain Direction (if applicable)
 Dry Erase Back Panel

Options: Specify & Add

| | | |
|-------|--|---------|
| 1-AD | Aluminum Framed Satin Frosted Tempered Glass Doors (Non-Locking) | \$ 1490 |
| 1-DEB | Dry Erase Board Door (Non-Locking) | \$ 154 |
| 1-HGA | High Gloss Acrylic Door (Non-Locking); Must Specify Color | |
| | (GPA) Graphite Acrylic | \$ 1542 |
| | (BLA) Black, (WMA) Wired Mercury, or (WHA) White Acrylic | \$ 1411 |
| DEF | Dry Erase Fixed Back Panel | \$ 646 |

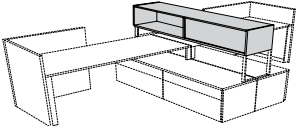
| | | | | | | | |
|---|-------------|----|----|----|----|------|----------|
|  DUAL ACCESS OPEN HUTCH | 65-1572DAOH | 72 | 15 | 15 | 95 | 14.5 | W\$ 2350 |
| | 65-1566DAOH | 66 | 15 | 15 | 90 | 13.4 | W\$ 2270 |
| | 65-1560DAOH | 60 | 15 | 15 | 85 | 12.2 | W\$ 2237 |

Description

- Right Side - Fixed/Left Side - Open
- Used with Shared Office Application
- Safely Write on Dry Erase Back Panel with Our Dry Erase Marker Set; [See Sets](#)
- Metal Stanchion Leg Sold Separately; [See Stanchion Sizes](#)
- Optional Dry Erase Fixed Backs, See Below or Tackboard Fixed Backs; [See Tackboards](#)

Must Specify (in this order):

Model #
 Finish
 Dry Erase Back Panel
 Tackboard
 Tackboard Fabric

Options: Specify & Add

| | | |
|-----|----------------------------|--------|
| DEF | Dry Erase Fixed Back Panel | \$ 646 |
|-----|----------------------------|--------|

Pricing Codes:

W= Wood Top
 P= HPL Top

[See Gesso Intro Section for Ordering Options](#)

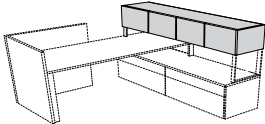
| Item | Model No. | Width | Depth | Height | Ship Wt | Cubic Ft | List Price |
|---|-------------|-------|-------|--------|---------|----------|------------|
|  SINGLE SIDED FOUR DOOR HUTCH | 65-1572SSHU | 72 | 15¾ | 15 | 98 | 12.4 | W\$ 2892 |
| | 65-1566SSHU | 66 | 15¾ | 15 | 93 | 11.4 | W\$ 2792 |
| | 65-1560SSHU | 60 | 15¾ | 15 | 88 | 10.4 | W\$ 2737 |





Must Specify (in this order):

- Model #
- Finish
- Door Style
- Door Finish (if applicable)
- Locking Doors

Description

- Storage Behind Doors
- Safely Write on Dry Erase, White and Black Tempered Glass Doors with Our Dry Erase Marker Set; [See Sets](#)
- Single or Shared Stanchions Must be Ordered Separately; See Next Page
- Optional Locking Door Available; [See Locking Door Options](#) and Specify Lock Color

Options: Specify & Add

| | | Per Door |
|--|--|----------|
|  | 1-AD Aluminum Framed Satin Frosted Tempered Glass Doors (Non-Locking) | \$ 438 |
|  | 1-DEB Dry Erase Board Doors | \$ 28 |
|  | WHGLS Aluminum Framed Doors with White Tempered Glass (Non-locking) | \$ 652 |
|  | BLGLS Black Matte Framed Doors with Black Tempered Glass (Non-locking) | \$ 868 |
|  | 1-HGA High Gloss Acrylic Doors; Must Specify Color | |
| | (GPA) Graphite Acrylic | \$ 269 |
| | (BLA) Black, (WMA) Wired Mercury, or (WHA) White Acrylic | \$ 247 |

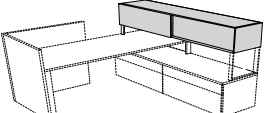
| Item | Model No. | Width | Depth | Height | Ship Wt | Cubic Ft | List Price |
|--|-------------|-------|-------|--------|---------|----------|------------|
|  SINGLE SIDED SLIDING DOOR HUTCH | 65-1572SSHS | 72 | 15¾ | 15 | 89 | 12.4 | W\$ 3132 |
| | 65-1566SSHS | 66 | 15¾ | 15 | 84 | 11.4 | W\$ 3048 |
| | 65-1560SSHS | 60 | 15¾ | 15 | 79 | 10.4 | W\$ 2936 |



Must Specify (in this order):

- Model #
- Finish
- Door Style
- Door Finish (if applicable)

Description

- One Non-Locking Sliding Door
- Safely Write on Dry Erase Doors =with Our Dry Erase Marker Set; [See Sets](#)
- Storage Behind Sliding Door
- Single or Shared Stanchions Must be Ordered Separately; See Next Page

Options: Specify & Add

| | | Per Door |
|---|---|----------|
|  | 1-AD Aluminum Framed Satin Frosted Tempered Glass Doors (Non-Locking) | \$ 745 |
|  | 1-DEB Dry Erase Board Door (Non-Locking) | \$ 77 |
|  | 1-HGA High Gloss Acrylic Door (Non-Locking); Must Specify Color | |
| | (GPA) Graphite Acrylic | \$ 773 |
| | (BLA) Black, (WMA) Wired Mercury, or (WHA) White Acrylic | \$ 705 |

Pricing Codes:

- W= Wood Top
- P= HPL Top

[See Gesso Intro Section for Ordering Options](#)

| Item | Model No. | Width | Depth | Height | Ship Wt | Cubic Ft | List Price |
|---|---|-------|-------|--------|---------|----------|------------|
| METAL STANCHION FOR USE WITH LOW STORAGE AND SINGLE OR DUAL HUTCHES | 01-1515OS For Use Over 21" Low Modular Ped | 15 | 2 | 15 | 25 | 0.5 | \$ 331 |
| | 01-1507OS For Use Over 30" Low Modular Ped | 15 | 2 | 7 | 15 | 0.3 | \$ 305 |

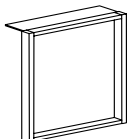

Must Specify (in this order):

Model #

Support Color

Description

- Available in Aluminum (ALUM) or Black (BLK), Must Specify
- For Use With Single Sided and Dual Access Hutches - Not Available to be Sold Separately

| | | | | | | | |
|--|--|----|---|----|----|-----|--------|
| SHARED METAL STANCHION FOR USE WITH LOW STORAGE AND SINGLE OR DUAL HUTCHES | 01-1515OSS For Use Over 21" Low Modular Ped | 15 | 2 | 15 | 25 | 0.5 | \$ 339 |
| | 01-1507OSS For Use Over 30" Low Modular Ped | 15 | 2 | 7 | 15 | 0.3 | \$ 327 |

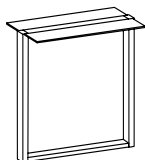

Must Specify (in this order):

Model #

Support Color

Description

- Available in Aluminum (ALUM) or Black (BLK), Must Specify
- For Use With Single Sided and Dual Access Hutches - Not Available to be Sold Separately
- Connects Two Dual Access Hutches

| | | | | | | | |
|--------------------------------------|-----------|----|---|----|----|-----|---------|
| 21" ABOVE AND BELOW SCREEN VENEER | 65-6821AB | 68 | ¾ | 21 | 41 | 3.3 | W\$ 840 |
| | 65-6221AB | 62 | ¾ | 21 | 39 | 3.0 | W\$ 814 |
| | 65-5621AB | 56 | ¾ | 21 | 36 | 2.7 | W\$ 782 |
| | 65-5021AB | 50 | ¾ | 21 | 34 | 2.4 | W\$ 755 |
| | 65-4421AB | 44 | ¾ | 21 | 31 | 2.2 | W\$ 723 |

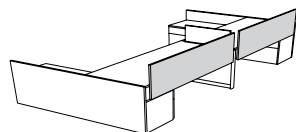

Must Specify (in this order):

Model #

Finish

Description

- Mounts to Worksurface
- Provides Privacy 12" Above and 10¾" Modesty Below

Pricing Codes:

W= Wood Top

P= HPL Top

[See Gesso Intro Section for Ordering Options](#)

| Item | Model No. | Width | Depth | Height | Ship Wt | Cubic Ft | List Price |
|---|------------|-------|-------|--------|---------|----------|------------|
| 21" ABOVE AND BELOW SCREEN FROSTED ACRYLIC  | 65-6821ABA | 68 | ¼ | 21 | 14 | 3.3 | \$ 1352 |
| | 65-6221ABA | 62 | ¼ | 21 | 12 | 2.8 | \$ 1265 |
| | 65-5621ABA | 56 | ¼ | 21 | 10 | 2.8 | \$ 1177 |
| | 65-5021ABA | 50 | ¼ | 21 | 9 | 2.2 | \$ 1088 |
| | 65-4421ABA | 44 | ¼ | 21 | 8 | 1.2 | \$ 998 |

Must Specify (in this order):
Model #
Decorative Hardware Color

Description

- Mounts to Worksurface
- Provides Privacy 12" Above and 10¾" Modesty Below
- Decorative Hardware; Must Specify: Aluminum (ALUM) or Chrome (CHRM)

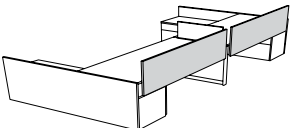
| | | | | | | | |
|---|-------------|----|---|----|----|-----|-----------------------|
| 21" ABOVE AND BELOW SCREEN HIGH GLOSS ACRYLIC  | 66-6821ABGA | 68 | ¾ | 21 | 44 | 3.3 | \$ 1447 GPA\$ 1886 |
| | 66-6221ABGA | 62 | ¾ | 21 | 41 | 3.0 | \$ 1344 GPA\$ 1747 |
| | 66-5621ABGA | 56 | ¾ | 21 | 38 | 2.7 | \$ 1246 GPA\$ 1606 |
| | 66-5021ABGA | 50 | ¾ | 21 | 36 | 2.4 | \$ 1147 GPA\$ 1470 |
| | 66-4421ABGA | 44 | ¾ | 21 | 33 | 2.2 | \$ 1051 GPA\$ 1333 |

Must Specify (in this order):
Model #
Color

Description

- Mounts to Worksurface
- Provides Privacy 12" Above and 10¾" Modesty Below
- Available in Black (BLA), White (WHA) or Graphite Acrylic (GPA); Graphite Acrylic Pricing (GPA\$)

| | | | | | | | |
|---|-----------|----|---|----|----|-----|---------|
| 12" PRIVACY PANEL VENEER   | 65-2812PP | 28 | ¾ | 12 | 12 | 0.9 | W\$ 626 |
| | 65-2212PP | 22 | ¾ | 12 | 10 | 0.7 | W\$ 612 |

Must Specify (in this order):
Model #
Finish
Decorative Hardware Color

Description

- Mounts to Surface to Create Division Between Workstations
- Decorative Hardware; Must Specify: Aluminum (ALUM) or Chrome (CHRM)

Pricing Codes:
W= Wood Top
P= HPL Top

[See Gesso Intro Section for Ordering Options](#)

| Item | Model No. | Width | Depth | Height | Ship Wt | Cubic Ft | List Price |
|--------------------------------------|------------|-------|-------|--------|---------|----------|------------|
| 12" PRIVACY PANEL FROSTED ACRYLIC | 65-2812PPA | 28 | ¼ | 12 | 8 | 0.7 | \$ 580 |
| | 65-2212PPA | 22 | ¼ | 12 | 7 | 0.6 | \$ 523 |

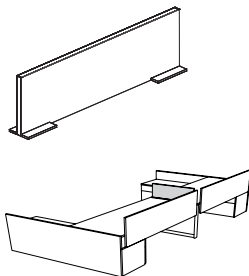

Must Specify (in this order):

Model #

Decorative Hardware Color

Description

- Mounts to Surface to Create Division Between Workstations
- Decorative Hardware; Must Specify: Aluminum (ALUM) or Chrome (CHRM)

| | | | | | | | |
|---|-------------|----|---|----|----|-----|---------------------|
| 12" PRIVACY PANEL HIGH GLOSS ACRYLIC | 66-2812PPGA | 68 | ¾ | 12 | 13 | 0.9 | \$ 609 GPA\$ 686 |
| | 66-2212PPGA | 62 | ¾ | 12 | 11 | 0.7 | \$ 546 GPA\$ 605 |

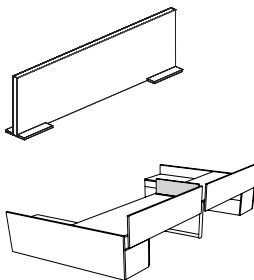

Must Specify (in this order):

Model #

Color

Decorative Hardware Color

Description

- Mounts to Surface to Create Division Between Workstations
- Decorative Hardware; Must Specify: Aluminum (ALUM) or Chrome (CHRM)
- Available in Black (BLA), White (WHA) or Graphite Acrylic (GPA); Graphite Acrylic Pricing (GPA\$)

| | | | | | | | |
|--|-----------|----|---|----|----|-----|---------|
| 12" FREESTANDING PRIVACY PANEL VENEER | 65-6812PP | 68 | ¾ | 12 | 26 | 2.2 | W\$ 761 |
| | 65-6212PP | 62 | ¾ | 12 | 25 | 2.0 | W\$ 745 |
| | 65-5612PP | 56 | ¾ | 12 | 23 | 1.8 | W\$ 723 |

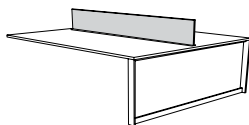

Must Specify (in this order):

Model #

Finish

Decorative Hardware Color

Description

- Freestanding on Surface to Create Division Between Workstations
- Decorative Hardware; Must Specify: Aluminum (ALUM) or Chrome (CHRM)

Pricing Codes:

W= Wood Top

P= HPL Top

[See Gesso Intro Section for Ordering Options](#)

| Item | Model No. | Width | Depth | Height | Ship Wt | Cubic Ft | List Price |
|---|------------|-------|-------|--------|---------|----------|------------|
| 12" FREESTANDING PRIVACY PANEL FROSTED ACRYLIC | 65-6812PPA | 68 | ¼ | 12 | 8 | 2.2 | \$ 982 |
| | 65-6212PPA | 62 | ¼ | 12 | 7 | 2.0 | \$ 925 |
| | 65-5612PPA | 56 | ¼ | 12 | 6 | 1.8 | \$ 854 |

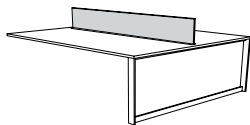

Must Specify (in this order):
Model #
Decorative Hardware Color

Description

- Freestanding on Surface to Create Division Between Workstations
- Decorative Hardware; Must Specify: Aluminum (ALUM) or Chrome (CHRM)

| | | | | | | | |
|--|-------------|----|---|----|----|-----|-----------------------|
| 12" FREESTANDING PRIVACY PANEL HIGH GLOSS ACRYLIC | 66-6812PPGA | 68 | ¾ | 12 | 25 | 3.3 | \$ 1051 GPA\$ 1233 |
| | 66-6212PPGA | 62 | ¾ | 12 | 23 | 3.0 | \$ 979 GPA\$ 1154 |
| | 66-5612PPGA | 56 | ¾ | 12 | 22 | 2.7 | \$ 886 GPA\$ 1073 |

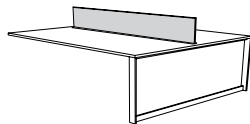

Must Specify (in this order):
Model #
Color
Decorative Hardware Color

Description

- Freestanding on Surface to Create Division Between Workstations
- Decorative Hardware; Must Specify: Aluminum (ALUM) or Chrome (CHRM)
- Available in Black (BLA), White (WHA) or Graphite Acrylic (GPA); Graphite Acrylic Pricing (GPA\$)

| | | | | | | | |
|--|------------|----|---|---|----|-----|---------|
| 7" MODESTY PANEL VENEER | 65-6807MOD | 68 | ¾ | 7 | 17 | 1.3 | W\$ 720 |
| | 65-6207MOD | 62 | ¾ | 7 | 16 | 1.2 | W\$ 707 |
| | 65-5607MOD | 56 | ¾ | 7 | 16 | 1.1 | W\$ 694 |

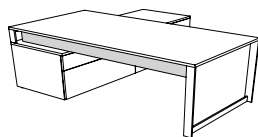

Must Specify (in this order):
Model #
Finish

Description

- Works With Low Storage; [See Low Credenzas](#) and Modular Units; [See Modular Units](#)
- Attaches with Aluminum Mounting Brackets

Pricing Codes:
W= Wood Top
P= HPL Top

[See Gesso Intro Section for Ordering Options](#)

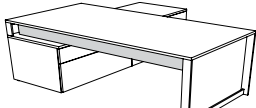
| Item | Model No. | Width | Depth | Height | Ship Wt | Cubic Ft | List Price |
|--|-------------|-------|-------|--------|---------|----------|------------|
| 7" MODESTY PANEL FROSTED ACRYLIC  | 65-6807MODA | 68 | ¼ | 7 | 12 | 1.3 | \$ 705 |
| | 65-6207MODA | 62 | ¼ | 7 | 11 | 1.2 | \$ 652 |
| | 65-5607MODA | 56 | ¼ | 7 | 10 | 1.1 | \$ 620 |

Description

- Works With Low Storage; [See Low Credenzas](#) and Modular Units; [See Modular Units](#)
- Exposed Decorative Hardware; Must Specify: Aluminum (ALUM) or Chrome (CHRM)

Must Specify (in this order):

Model #

Decorative Hardware Color

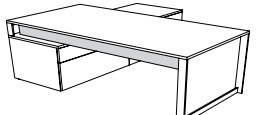
| | | | | | | | |
|---|--------------|----|---|---|----|-----|-----------|
| 7" MODESTY PANEL HIGH GLOSS ACRYLIC  | 65-6807MODGA | 68 | ¾ | 7 | 17 | 1.3 | \$ 725 |
| | | | | | | | GPA\$ 826 |
| | 65-6207MODGA | 62 | ¾ | 7 | 16 | 1.2 | \$ 707 |
| | | | | | | | GPA\$ 780 |
| | 65-5607MODGA | 56 | ¾ | 7 | 16 | 1.1 | \$ 690 |
| | | | | | | | GPA\$ 738 |

Description

- Works With Low Storage; [See Low Credenzas](#) and Modular Units; [See Modular Units](#)
- Attaches with Aluminum Mounting Brackets
- Available in Black (BLA), Wired Mercury (WMA), White (WHA) or Graphite Acrylic (GPA); Graphite Acrylic Pricing (GPA\$)

Must Specify (in this order):

Model #

Color

Pricing Codes:

W= Wood Top

P= HPL Top

[See Gesso Intro Section for Ordering Options](#)

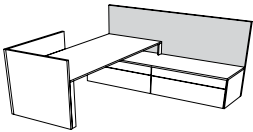
| Item | Model No. | Width | Depth | Height | Ship Wt | Cubic Ft | List Price |
|---|-----------|-------|-------|--------|---------|----------|------------|
| 51" GALLERY SCREEN STRAIGHT FLOORSTANDING  Must Specify (in this order): Model # Finish Grommet Grommet Color | 65-5173GS | 73 | 1 | 51¼ | 110 | 7.9 | W\$ 2036 |
| | 65-5172GS | 72 | 1 | 51¼ | 110 | 7.9 | W\$ 2021 |
| | 65-5167GS | 67 | 1 | 51¼ | 104 | 7.3 | W\$ 1955 |
| | 65-5166GS | 66 | 1 | 51¼ | 104 | 7.3 | W\$ 1943 |
| | 65-5161GS | 61 | 1 | 51¼ | 98 | 6.7 | W\$ 1874 |
| | 65-5160GS | 60 | 1 | 51¼ | 98 | 6.7 | W\$ 1861 |
| | 65-5155GS | 55 | 1 | 51¼ | 92 | 6.1 | W\$ 1792 |
| | 65-5154GS | 54 | 1 | 51¼ | 92 | 6.1 | W\$ 1778 |
| | 65-5149GS | 49 | 1 | 51¼ | 86 | 5.4 | W\$ 1711 |
| | 65-5148GS | 48 | 1 | 51¼ | 86 | 5.4 | W\$ 1695 |
| | 65-5143GS | 43 | 1 | 51¼ | 80 | 4.7 | W\$ 1632 |
| | 65-5142GS | 42 | 1 | 51¼ | 80 | 4.7 | W\$ 1620 |
| | 65-5137GS | 37 | 1 | 51¼ | 60 | 4.1 | W\$ 1413 |
| | 65-5136GS | 36 | 1 | 51¼ | 60 | 4.1 | W\$ 1369 |
| | 65-5131GS | 31 | 1 | 51¼ | 54 | 3.5 | W\$ 1283 |
| | 65-5130GS | 30 | 1 | 51¼ | 54 | 3.5 | W\$ 1266 |
| | 65-5125GS | 25 | 1 | 51¼ | 48 | 2.8 | W\$ 1173 |
| | 65-5124GS | 24 | 1 | 51¼ | 48 | 2.8 | W\$ 1154 |
| | 65-5119GS | 19 | 1 | 51¼ | 42 | 2.2 | W\$ 1085 |
| | 65-5118GS | 18 | 1 | 51¼ | 42 | 2.2 | W\$ 1070 |

Description

- Vertical Woodgrain
- Mounts to Back of Modular Credenza for Space Division
- Extend up to 24" Beyond Workstation without Additional Support
- Gallery Screens 49" and Wider Feature Multi-Step, Hand-Finished Catalyzed Finish
- Six (6) Wire Management Grommet Location Options: [See Locations](#) and Specify Location Selections

Pricing Codes:

W= Wood Top
P= HPL Top

[See Gesso Intro Section for Ordering Options](#)

Studio Components

Boutique-inspired options to give all your working environments a fresh look with a subtle touch of home. Integrated into our ever-popular Canvas and Gesso Casegood lines, Studio models build upon simplicity and flexibility while allowing you to create eye-catching spaces. Whether you're looking to outfit an executive's office, team space, collaborative area, or anything in between, our Studio desk and storage components have the look and feel you desire.

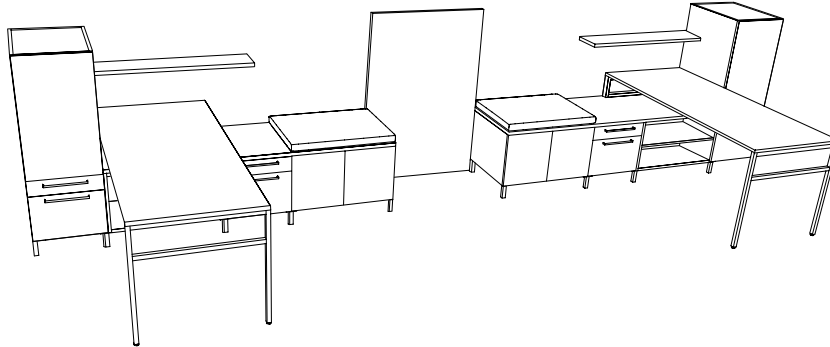

Studio components work with existing Canvas Tops, Peninsula Tops, and accessories such as Tackboards, Work Walls, Marker Boards, and Cushions to build the perfect workspace. The slim leg design provides an upscale feel for all of the Studio components. Storage units such as standard height pedestals offer the flexibility to build single or double pedestal desks or credenzas and low height pedestals allow you to create bench style credenzas.

The Studio pull features a clean application.



How to Use Studio

Start with a Modular Top to build a Desk, Peninsula Desk, Benching or Credenza ([See Modular Tops](#))

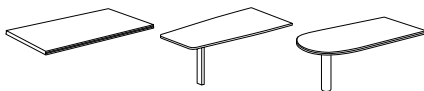

Next, choose from a number of Studio Pedestals options in Standard or Low Height. ([See Studio Peds](#))

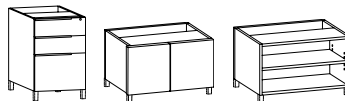

Kneespace Modesty Panels are available in standard height in TFL or High Gloss Acrylic or low height in TFL ([See Modesty Panels](#))

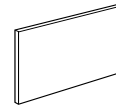

Add additional storage with Studio Storage Cabinets and the full door storage cabinet features high gloss acrylic and dry erase door options ([See Storage Cabinets](#))

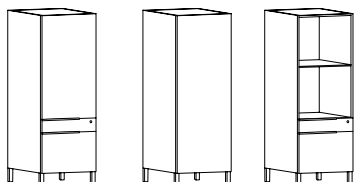

Single and Shared Stanchions offer a layer of support for workstations and single or dual sided hutches ([See Stanchions](#))

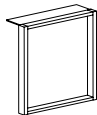

Studio Single and Shared Legs images below provide a simple and clean aesthetic. See below for a guide to the aesthetics of single, double, and shared legs ([See Leg Options](#))



Single Standard Leg



Shared Leg (used between two models)



Double Standard Leg (standard legs used on each model)

| Item | Model No. | Width | Depth | Height | Ship Wt | Cubic Ft | List Price |
|--|-------------|-------|-------|--------|---------|----------|------------|
| STUDIO COMPONENT, MODULAR PEDESTAL BOX/BOX/FILE  | 65-3618SPD1 | 18 | 36 | 24¼ | 68 | 11.4 | W\$ 2646 |
| | 65-3018SPD1 | 18 | 30 | 24¼ | 61 | 10.4 | W\$ 2430 |
| | 65-2418SPD1 | 18 | 24 | 24¼ | 54 | 8.4 | W\$ 2240 |

Description

- For Use With Other Studio Components
- Standard Locking Pedestal; File Drawer Provides Legal or Letter Filing
- Studio Pulls Are Installed on Left Aligned Position; Drawers Feature a ¾ Extension
- Drawer Front Grain Direction Vertical Standard; Optional Horizontal Grain Direction
- Finished Back Panel Included
- Height of Unit with Legs: 28¾; **Legs Must be Ordered Separately;** [See Leg Options](#)
- Worksurface Required; [See Worksurface Sizes](#)
- Additional Options: Dove Tail Drawer Construction and Soft Close Drawers ([See Drawer Options](#)), Wire Management ([See Option Details](#))

Must Specify (in this order):

Model #
Finish
Drawer Front Grain Direction
Pull
Drawer Construction
Drawer Track
Wire Management

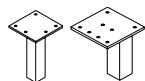

Legs Must be Ordered Separately; [See Leg Options](#)

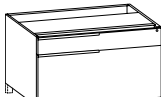
| | | | | | | | |
|---|------------|----|----|-----|----|------|----------|
| STUDIO COMPONENT, MODULAR PEDESTAL TRAY/FILE  | 65-2436STF | 36 | 24 | 16¾ | 59 | 10.6 | W\$ 2228 |
| | 65-2430STF | 30 | 24 | 16¾ | 51 | 8.9 | W\$ 2155 |
| | 65-2418STF | 18 | 24 | 16¾ | 37 | 5.6 | W\$ 1798 |

Description

- For Use With Other Studio Components
- Standard Locking Pedestal; File Drawer Provides Legal or Letter Filing
- Studio Pulls Are Installed on Left Aligned Position; Drawers Feature a ¾ Extension
- Drawer Front Grain Direction Vertical Standard; Optional Horizontal Grain Direction
- Finished Back Panel Included
- Height of Unit with Legs: 20¾; **Legs Must be Ordered Separately;** [See Leg Options](#)
- Worksurface Required; [See Worksurface Sizes](#)
- Additional Options: Dove Tail Drawer Construction and Soft Close Drawers ([See Drawer Options](#)), Wire Management ([See Option Details](#))

Must Specify (in this order):

Model #
Finish
Drawer Front Grain Direction
Pull
Drawer Construction
Drawer Track
Wire Management

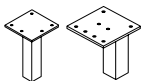

Legs Must be Ordered Separately; [See Leg Options](#)

Pricing Codes:

W= Wood Top
P= HPL Top

[See Gesso Intro Section for Ordering Options](#)

| Item | Model No. | Width | Depth | Height | Ship Wt | Cubic Ft | List Price |
|--|------------|-------|-------|--------|---------|----------|------------|
| STUDIO COMPONENT, LOW MODULAR PEDESTAL OPEN BOOKCASE | 65-2436SBC | 36 | 24 | 16¾ | 67 | 10.6 | W\$ 1941 |
| | 65-2430SBC | 30 | 24 | 16¾ | 59 | 8.9 | W\$ 1857 |
| | 65-2418SBC | 18 | 24 | 16¾ | 45 | 5.6 | W\$ 1705 |

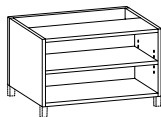

Must Specify (in this order):

Model #
Finish
Wire Management

Description

- For Use With Other Studio Components
- One Adjustable Shelf
- Finished Back Panel Included
- Removable Wire Management Panel
- Height of Unit with Legs: 20¾; **Legs Must be Ordered Separately;** [See Leg Options](#)
- Worksurface Required; [See Worksurface Sizes](#)
- Additional Options: Wire Management ([See Option Details](#))

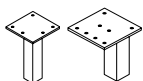

Legs Must be Ordered Separately; [See Leg Options](#)

| | | | | | | | |
|---|------------|----|----|-----|----|------|----------|
| STUDIO COMPONENT, LOW MODULAR PEDESTAL DOUBLE DOOR BOOKCASE | 65-2436SDB | 36 | 24 | 16¾ | 77 | 10.6 | W\$ 1856 |
| | 65-2430SDB | 30 | 24 | 16¾ | 67 | 8.9 | W\$ 1626 |

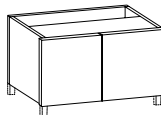

Must Specify (in this order):

Model #
Finish
Door Front Grain Direction
Pull
Locking Doors
Wire Management

Description

- For Use With Other Studio Components
- 16" Deep Adjustable Shelf Behind Doors
- Finished Back Panel Included
- Removable Wire Management Panel
- Drawer Front Grain Direction Vertical Standard; Optional Horizontal Grain Direction
- Height of Unit with Legs: 20¾; **Legs Must be Ordered Separately;** [See Leg Options](#)
- Worksurface Required; [See Worksurface Sizes](#)
- Optional Locking Doors ([See Locking Door Options](#)) and Specify Lock Color
- Optional Wire Management ([See Optional Details](#))

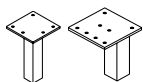

Legs Must be Ordered Separately; [See Leg Options](#)

Pricing Codes:

W= Wood Top
P= HPL Top

[See Gesso Intro Section for Ordering Options](#)

| Item | Model No. | Width | Depth | Height | Ship Wt | Cubic Ft | List Price |
|---|-------------|--------------|-------|--------|---------|----------|------------|
| STUDIO COMPONENT, LOW MODULAR PEDESTAL SINGLE DOOR BOOKCASE | Left | Right | | | | | |
| | 65-2418SDBL | 65-2418SDBR | 18 | 24 | 16¾ | 51 | 5.6 |

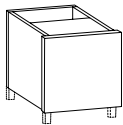

Must Specify (in this order):

Model #
Finish
Door Front Grain Direction
Pull
Wire Management

Description

- For Use With Other Studio Components
- 16" Deep Adjustable Shelf Behind Doors
- Finished Back Panel Included
- Removable Wire Management Panel
- Door Front Grain Direction Vertical Standard; Optional Horizontal Grain Direction
- Height of Unit with Legs: 20¾; **Legs Must be Ordered Separately; See Leg Options**
- Worksurface Required; [See Worksurface Sizes](#)
- Optional Locking Door ([See Locking Door Options](#)) and Specify Lock Color
- Optional Wire Management ([See Optional Details](#))

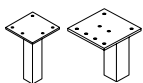

Legs Must be Ordered Separately; [See Leg Options](#)

| Item | Model No. | Width | Depth | Height | Ship Wt | Cubic Ft | List Price |
|--|-------------|--------------|-------|--------|---------|----------|------------|
| STUDIO COMPONENT, STORAGE CABINET DOOR/TRAY/FILE | Left | Right | | | | | |
| | 65-1851SWBL | 65-1851SWBR | 18 | 24 | 47½ | 120 | 15.9 |

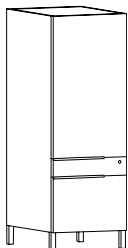

Must Specify (in this order):

Model #
Finish
Door/Drawer Front Grain Direction
Door Locking
Pull

Description

- For Use With Other Studio Components
- One Adjustable Shelf Behind Door
- Locking File Drawer Provides Legal or Letter Filing
- Studio Pulls Are Installed on Left Aligned Position; Drawers Feature a ¾ Extension
- Door/Drawer Front Grain Direction Vertical Standard; Optional Horizontal Grain Direction
- Height of Unit with Legs: 51½; **Legs Must be Ordered Separately; See Leg Options**
- Additional Options: Dove Tail Drawer Construction and Soft Close Drawers ([See Drawer Options](#)), Locking Doors ([See Locking Door Options](#))

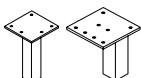

Legs Must be Ordered Separately; [See Leg Options](#)

Pricing Codes:

W= Wood Top
P= HPL Top

[See Gesso Intro Section for Ordering Options](#)

| Item | Model No. | Width | Depth | Height | Ship Wt | Cubic Ft | List Price |
|--|-------------|-------|-------|--------|---------|----------|------------|
| STUDIO COMPONENT, OPEN STORAGE CABINET TRAY/FILE | 65-1851SWBO | 18 | 24 | 47½ | 109 | 15.9 | W\$ 2692 |

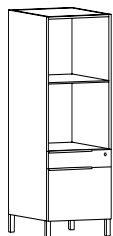

Description

- For Use With Other Studio Components
- One Adjustable Shelf
- Locking File Drawer Provides Legal or Letter Filing
- Studio Pulls Are Installed on Left Aligned Position; Drawers Feature a ¾ Extension
- Drawer Front Grain Direction Vertical Standard; Optional Horizontal Grain Direction
- Height of Unit with Legs: 51½; **Legs Must be Ordered Separately**; [See Leg Options](#)
- Additional Options: Dove Tail Drawer Construction and Soft Close Drawers ([See Drawer Options](#))

Must Specify (in this order):

- Model #
- Finish
- Drawer Front Grain Direction
- Pull

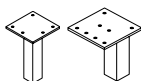

Legs Must be Ordered Separately; [See Leg Options](#)

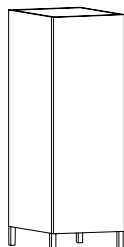

| STUDIO COMPONENT, WARDROBE | Left | Right | Width | Depth | Height | Ship Wt | Cubic Ft | List Price |
|----------------------------|------------|------------|-------|-------|--------|---------|----------|------------|
| | Model No. | Model No. | | | | | | |
| | 65-1851SWL | 65-1851SWR | 18 | 24 | 47½ | 108 | 15.9 | W\$ 2460 |



Description

- For Use With Other Studio Components
- Includes Coat Rod and (2) Adjustable Shelves
- Door Front Grain Direction Vertical Standard; Optional Horizontal Grain Direction
- Height of Unit with Legs: 51½; **Legs Must be Ordered Separately**; [See Leg Options](#)
- Additional Options: Locking Door ([See Locking Door Options](#))

Options: Specify & Add

| | | | |
|---|-------|--|--------|
|  | 1-DEB | Dry Erase Board | \$ 96 |
|  | 1-HGA | High Gloss Acrylic; Must Specify Color | |
| | | (GPA) Graphite Acrylic | \$ 960 |
| | | (BLA) Black, (WMA) Wired Mercury, or (WHA) White Acrylic | \$ 876 |

Must Specify (in this order):

- Model #
- Finish
- Door Front Grain Direction
- Door Locking
- Pull

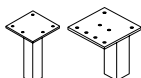

Legs Must be Ordered Separately; [See Leg Options](#)

Pricing Codes:

- W= Wood Top
- P= HPL Top

[See Gesso Intro Section for Ordering Options](#)

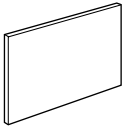
| Item | Model No. | Width | Depth | Height | Ship Wt | Cubic Ft | List Price |
|--|-----------|-------|-------|--------|---------|----------|------------|
| STUDIO COMPONENT, KNEESPACE MODESTY PANEL, VENEER  | 65-6024MD | 60 | ¾ | 24½ | 37 | 2.9 | W\$ 745 |
| | 65-5424MD | 54 | ¾ | 24½ | 33 | 2.6 | W\$ 706 |
| | 65-4824MD | 48 | ¾ | 24½ | 30 | 2.3 | W\$ 676 |
| | 65-4224MD | 42 | ¾ | 24½ | 26 | 2.0 | W\$ 604 |
| | 65-3624MD | 36 | ¾ | 24½ | 22 | 1.7 | W\$ 535 |
| | 65-3024MD | 30 | ¾ | 24½ | 19 | 1.4 | W\$ 498 |

Must Specify (in this order):

Model #
Finish
Grommet

Description

- For Use Between Two Studio Pedestals
- Attaches with L Bracket (Included)
- Optional Center Panel Grommet; Must Specify

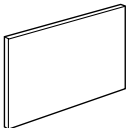
| | | | | | | | |
|---|--------------|----|---|-----|----|-----|---------------------|
| STUDIO COMPONENT, KNEESPACE MODESTY PANEL, HIGH GLOSS ACRYLIC  | 65-4824MDHGA | 48 | ¾ | 24½ | 30 | 2.3 | \$ 774 GPA\$ 893 |
| | 65-4224MDHGA | 42 | ¾ | 24½ | 30 | 2.1 | \$ 700 GPA\$ 805 |
| | 65-3624MDHGA | 36 | ¾ | 24½ | 26 | 2.0 | \$ 589 GPA\$ 676 |
| | 65-3024MDHGA | 30 | ¾ | 24½ | 19 | 1.4 | \$ 513 GPA\$ 589 |

Must Specify (in this order):

Model #
Color
Grommet

Description

- For Use Between Two Studio Pedestals
- Attaches with L Bracket (Included)
- Available in Black (BLA), Wired Mercury (WMA), White (WHA) or Graphite Acrylic (GPA); Graphite Acrylic Pricing (GPA\$)

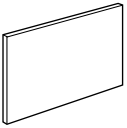
| | | | | | | | |
|---|-----------|----|---|-----|----|-----|---------|
| STUDIO COMPONENT, KNEESPACE MODESTY PANEL, FOR LOW STORAGE, VENEER  | 65-6016MD | 60 | ¾ | 16¼ | 25 | 2.0 | W\$ 563 |
| | 65-5416MD | 54 | ¾ | 16¼ | 23 | 1.8 | W\$ 532 |
| | 65-4816MD | 48 | ¾ | 16¼ | 20 | 1.6 | W\$ 520 |
| | 65-4216MD | 42 | ¾ | 16¼ | 18 | 1.4 | W\$ 490 |
| | 65-3616MD | 36 | ¾ | 16¼ | 15 | 1.2 | W\$ 471 |
| | 65-3016MD | 30 | ¾ | 16¼ | 13 | 1.0 | W\$ 450 |

Must Specify (in this order):

Model #
Finish
Grommet

Description

- For Use Between Two Studio Pedestals
- Attaches with L Bracket (Included)
- Optional Center Panel Grommet; Must Specify

Pricing Codes:
W= Wood Top
P= HPL Top

[See Gesso Intro Section for Ordering Options](#)

| Item | Model No. | Width | Depth | Height | Ship Wt | Cubic Ft | List Price |
|---------------------------|------------|-------|-------|--------|---------|----------|-------------|
| METAL STANCHION SINGLE | 01-1515SOS | 15 | 1 | 15 | 25 | 0.5 | ALUM \$ 219 |
| | | | | | | | BLK \$ 219 |
| | | | | | | | CHRM \$ 271 |

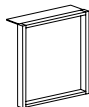

Must Specify (in this order):

Model #
Color

Description

- For Use With Single Sided Hutches ([See Hutches](#)) on Low Studio Components
- Available in Aluminum (ALUM), Black (BLK) or Chrome (CHRM); Must Specify

| | | | | | | | |
|---------------------------|-------------|-----|---|-----|----|-----|-------------|
| METAL STANCHION SHARED | 01-1515SOSS | 35¼ | 1 | 28¼ | 41 | 2.6 | ALUM \$ 273 |
| | | | | | | | BLK \$ 273 |
| | | | | | | | CHRM \$ 338 |

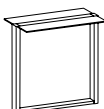

Must Specify (in this order):

Model #
Color

Description

- Connects Two Single Sided Hutches ([See Hutches](#)) on Low Studio Components
- Available in Aluminum (ALUM), Black (BLK) or Chrome (CHRM); Must Specify

| | | | | | | | | |
|---------------------------------|------------|--------|---|---|---|----|-----|-------------|
| STUDIO COMPONENT, SINGLE LEG | 01-0404SL4 | 4-pack | 1 | 1 | 4 | 10 | 1 | ALUM \$ 247 |
| | | | | | | | | BLK \$ 247 |
| | | | | | | | | CHRM \$ 303 |
| | 01-0404SL2 | 2-pack | 1 | 1 | 4 | 5 | 0.5 | ALUM \$ 143 |
| | | | | | | | | BLK \$ 143 |
| | | | | | | | | CHRM \$ 176 |

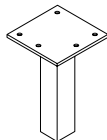

Must Specify (in this order):

Model #
Color

Description

- For Use With Studio Components
- Available in Aluminum (ALUM), Black (BLK) or Chrome (CHRM); Must Specify

| | | | | | | | | |
|---------------------------------|-------------|--------|---|---|---|----|-----|-------------|
| STUDIO COMPONENT, SHARED LEG | 01-0404SSL4 | 4-pack | 1 | 1 | 4 | 10 | 1 | ALUM \$ 247 |
| | | | | | | | | BLK \$ 247 |
| | | | | | | | | CHRM \$ 303 |
| | 01-0404SSL2 | 2-pack | 1 | 1 | 4 | 5 | 0.5 | ALUM \$ 143 |
| | | | | | | | | BLK \$ 143 |
| | | | | | | | | CHRM \$ 176 |

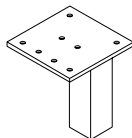

Must Specify (in this order):

Model #
Color

Description

- For Use With Studio Components
- Available in Aluminum (ALUM), Black (BLK) or Chrome (CHRM); Must Specify
- Connects Two Storage or Pedestal Units Together

Pricing Codes:

W= Wood Top
P= HPL Top

[See Gesso Intro Section for Ordering Options](#)

Height Adjustable Components

We've enhanced our height adjustable options to include a better integrated and easier to specify solution. These new models coupled with our existing modular height adjustable, and all of our standard models and storage options, provide you with the ultimate flexibility to meet the needs of your space and, more importantly, the needs of the user. And, we've made these new models more cost effective for you and more functional and spacious for the user.

Some Highlights of Our Integrated Solutions:

- Adjustable from 30"H to 45"H, with a load capacity up to 180lbs
- Gently adjust one worksurface or multiple worksurfaces with a 1 second stop at each memory position
- Two leg configuration options include the standard 2-channel for Desks, Desk Shells, D-top and P-Top units for one height adjustable worksurface or a 3-channel option for two height adjustable worksurfaces to raise simultaneously
- Two height adjustable control switches available. Standard up/down switch (SWCH) and advanced switch features Bluetooth capabilities, three stand-up reminder intervals and four height memory positions (MSWCH)
- Moving Modesty (MOVMOD) option creates a clean aesthetic when seated or standing
- Height adjust control switch is factory installed on all units except Desk Shells, Bridges or 3-Channel units
- Bridges, returns, and credenzas have an optional grommet on the back panel
- New black wire management mesh wrap included when worksurface grommet is selected
- Grommets and one Latch Duct wire management channel provided within kneespace to manage wires from switch and control box. Two Latch Duct wire management channels will be shipped with Desk Shells



Black wire management mesh sleeve included with worksurface grommet

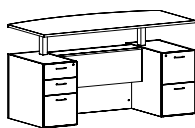

Standard 2-Channel Height Adjustable

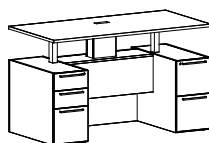

2-Channel Height Adjustable with Box



Bring the Open Plan and Shared Spaces to Life!

Modular Height Adjustable components make it easy to create the perfect work environment for any space. Select from an array of sizes of worksurfaces, pedestals, filing units and more to connect teams together so collaborating can be easy and productive.

If you prefer our original solution or have specified it previously, and would like to do so again, simply contact our Customer Service team for assistance. We can make that happen for you!

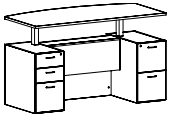
| Item | Model No. | Width | Depth | Height | K | R | Ship Wt | Cubic Ft | List Price |
|---|---------------------------------|-------|-------|--------|-----|----|---------|------------|------------|
| HEIGHT ADJUSTABLE DOUBLE PED BOW TOP DESK  | 67-3672BDPSSTS Stepped Front | 72 | 36-42 | 30-45 | 40½ | - | 510 | 50.0 W/P\$ | 11086 |
| | 67-3672BDPSTS Recessed Front | 72 | 36-42 | 30-45 | 40½ | 10 | 510 | 50.0 W/P\$ | 10855 |
| | 67-3666BDPSTS Recessed Front | 66 | 36-42 | 30-45 | 34½ | 4 | 480 | 48.0 W/P\$ | 10650 |

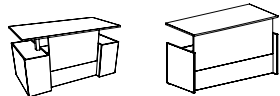

Shown with Rectangle Top, Stepped Front, Moving Modesty and Top Up

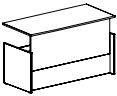

Shown with Rectangle Top, Recessed Front, Moving Modesty and Top Up

Must Specify (in this order):

- Model #
- Top Material
- Finish/Color
- Edge Profile
- Drawer Front Grain Direction
- Drawer Pull
- Drawer Construction
- Drawer Track
- Moving Modesty
- Height Adjust Switch
- Grommet Location
- Power/Data/Wire Management

Description

- Standard with: 2-Channel Leg Configuration for Single Surface Height Adjustment, Includes Controls, Top Profiled on Approach and User Side, Left to Right Grain Direction on Worksurface, Wire Management from Pedestal to Kneespace
- Optional Moving Modesty; Must Specify; Some Assembly Required; [See Below and Options](#)
- Control Switch Standard (SWCH-Up/Down) or Upgrade to Advanced Switch (MSWCH-Up/Down/Memory); [See Switch Options](#)
- Optional Dove Tail Drawer Construction and Soft Close Drawers ([See Drawer Options](#))
- For Additional Information Including Worksurface Grommets and Wire Management Boxes, Power Locations, and More can be Found in the [Intro Section](#)

High Gloss Acrylic Modesty Options for Stepped Front Desks: Specify & Add

| | | |
|---------|--|---------|
| 65-HGAF | High Gloss Acrylic Full Modesty Panel; Must Specify Color (<i>Not Available as Moving Modesty</i>) | |
| | (GPA) Graphite Acrylic | \$ 1846 |
| | (BLA) Black, (WMA) Wired Mercury, or (WHA) White Acrylic | \$ 1687 |

Moving Modesty Options: Specify & Add

| | | |
|--------|----------------|--------|
| MOVMOD | Moving Modesty | \$ 219 |
|--------|----------------|--------|

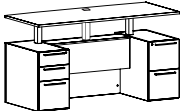
| | | | | | | | | | |
|---|--------------------------------|----|----|-------|-----|----|-----|------------|-------|
| HEIGHT ADJUSTABLE DOUBLE PED DESK  | 67-3672DPSSTS Stepped Front | 72 | 36 | 30-45 | 40½ | - | 525 | 50.0 W/P\$ | 11557 |
| | 67-3672DPSTS Recessed Front | 72 | 36 | 30-45 | 40½ | 10 | 525 | 50.0 W/P\$ | 10136 |
| | 67-3072DPSTS Recessed Front | 72 | 30 | 30-45 | 40½ | 4 | 510 | 43.9 W/P\$ | 9963 |
| | 67-3066DPSTS Recessed Front | 66 | 30 | 30-45 | 34½ | 4 | 490 | 38.7 W/P\$ | 9793 |
| | 67-3060DPSTS Recessed Front | 60 | 30 | 30-45 | 28½ | 4 | 458 | 35.3 W/P\$ | 9593 |

Must Specify (in this order):

- Model #
- Top Material
- Finish/Color
- Edge Profile
- Drawer Front Grain Direction
- Drawer Pull
- Drawer Construction
- Drawer Track
- Moving Modesty
- Height Adjust Switch
- Grommet Location
- Power/Data/Wire Management

Description

- Standard with: 2-Channel Leg Configuration for Single Surface Height Adjustment, Includes Controls, Top Profiled on Approach and User Side, Wire Management from Pedestal to Kneespace
- Optional Moving Modesty; Must Specify; Some Assembly Required; [See Below and Options](#)
- Control Switch Standard (SWCH-Up/Down) or Upgrade to Advanced Switch (MSWCH-Up/Down/Memory); [See Switch Options](#)
- Optional Dove Tail Drawer Construction and Soft Close Drawers ([See Drawer Options](#))
- For Additional Information Including Worksurface Grommets and Wire Management Boxes, Power Locations, and More can be Found in the [Intro Section](#)

High Gloss Acrylic Modesty Options for Stepped Front Desks: Specify & Add

| | | |
|---------|--|---------|
| 65-HGAF | High Gloss Acrylic Full Modesty Panel; Must Specify Color (<i>Not Available as Moving Modesty</i>) | |
| | (GPA) Graphite Acrylic | \$ 1846 |
| | (BLA) Black, (WMA) Wired Mercury, or (WHA) White Acrylic | \$ 1687 |



Moving Modesty Options: Specify & Add

| | | |
|--------|----------------|--------|
| MOVMOD | Moving Modesty | \$ 219 |
|--------|----------------|--------|

Pricing Codes:

W= Wood Top
P= HPL Top

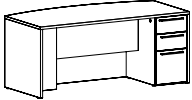
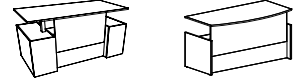
[See Gesso Intro Section for Ordering Options](#)

| Item | Model No. | Width | Depth | Height | K | R | Ship Wt | Cubic Ft | List Price |
|--|--|----------------|-------|--------|-------|-----|---------|----------|------------------|
| HEIGHT ADJUSTABLE SINGLE PED, BOW TOP DESK WITH BOX/BOX/FILE | Left | Right | | | | | | | |
| | 67-3672BLPSSTS | 67-3672BRPSSTS | 72 | 36-42 | 30-45 | 32¼ | 10 | 420 | 50.0 W/P\$ 10485 |
|  | | | | | | | | | |
| | 67-3672BLPSTS | 67-3672BRPSTS | 72 | 36-42 | 30-45 | 32¼ | 10 | 420 | 50.0 W/P\$ 10184 |
|  | | | | | | | | | |
| Shown with Rectangle Top, Stepped Front, Moving Modesty and Top Up | Shown with Bow Top, Recessed Front, Moving Modesty and Top Up | | | | | | | | |
|  | Support Panel (65-2812RSP) Needed When Connecting to Standard Return or Bridge | | | | | | | | |
| Must Specify (in this order): | | | | | | | | | |
| Model # | | | | | | | | | |
| Top Material | | | | | | | | | |
| Finish/Color | | | | | | | | | |
| Edge Profile | | | | | | | | | |
| Drawer Front Grain Direction | | | | | | | | | |
| Drawer Pull | | | | | | | | | |
| Drawer Construction | | | | | | | | | |
| Drawer Track | | | | | | | | | |
| Moving Modesty | | | | | | | | | |
| Height Adjust Switch | | | | | | | | | |
| Grommet Location | | | | | | | | | |
| Power/Data/Wire Management | | | | | | | | | |
| Description | | | | | | | | | |
| <ul style="list-style-type: none"> Standard with: 2-Channel Leg Configuration for Single Surface Height Adjustment, Includes Controls, Top Profiled on Approach and User Side, Left to Right Grain Direction on Worksurface, Wire Management from Pedestal to Kneespace Support Panel (65-2812RSP) Needed When Connecting to Stationary Return or Bridge Control Switch Standard (SWCH-Up/Down) or Upgrade to Advanced Switch (MSWCH-Up/Down/Memory); See Switch Options Optional Moving Modesty (MOVMOD); Must Specify; Some Assembly Required; See Below and Options Optional 3-Channel Leg Configuration (STS3) for Use with 3-Channel Returns and Bridges; See Option Details and See 3-Channel Units Optional Dove Tail Drawer Construction and Soft Close Drawers (See Drawer Options) For Additional Information Including Worksurface Grommets and Wire Management Boxes, Power Locations, and More can be Found in the Intro Section | | | | | | | | | |
| High Gloss Acrylic Modesty Options for Stepped Front Desks: Specify & Add | | | | | | | | | |
| 65-HGAF | High Gloss Acrylic Full Modesty Panel; Must Specify Color (<i>Not Available as Moving Modesty</i>) | | | | | | | | |
| | (GPA) Graphite Acrylic | | | | | | | | \$ 1846 |
| | (BLA) Black, (WMA) Wired Mercury, or (WHA) White Acrylic | | | | | | | | \$ 1687 |
| Moving Modesty Options: Specify & Add | | | | | | | | | |
| MOVMOD | Moving Modesty | | | | | | | | \$ 219 |

Pricing Codes:
W= Wood Top
P= HPL Top

[See Gesso Intro Section for Ordering Options](#)

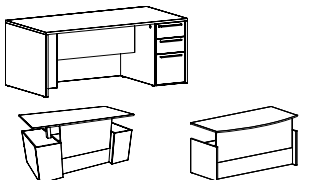
| Item | Model No. | Width | Depth | Height | K | R | Ship Wt | Cubic Ft | List Price | | |
|--|----------------|---------------|-------|--------|-------|-----|---------|----------|------------|------------|--|
| HEIGHT ADJUSTABLE SINGLE PED DESK WITH BOX/BOX/FILE  Shown with Rectangle Top, Stepped Front, Moving Modesty and Top Up Shown with Bow Top, Recessed Front, Moving Modesty and Top Up | Left | Right | | | | | | | | | |
| | 67-3672LPSSTS | 67-3672RPSSTS | 72 | 36 | 30-45 | 32¼ | 10 | 420 | 50.0 | W/P\$ 9784 | |
| | Stepped Front | | | | | | | | | | |
| | 67-3672LPSTS | 67-3672RPSTS | 72 | 36 | 30-45 | 32¼ | 10 | 430 | 50.0 | W/P\$ 9398 | |
| | Recessed Front | | | | | | | | | | |
| | 67-3072LPSTS | 67-3072RPSTS | 72 | 30 | 30-45 | 32¼ | 4 | 310 | 43.0 | W/P\$ 9336 | |
| Recessed Front | | | | | | | | | | | |
| 67-3066LPSTS | 67-3066RPSTS | 66 | 30 | 30-45 | 26¼ | 4 | 280 | 38.7 | W/P\$ 9170 | | |
| Recessed Front | | | | | | | | | | | |
| 67-3060LPSTS | 67-3060RPSTS | 60 | 30 | 30-45 | 20¼ | 4 | 250 | 35.0 | W/P\$ 9013 | | |
| Recessed Front | | | | | | | | | | | |

Support Panel (65-2812RSP) Needed When Connecting to Standard Return or Bridge

Must Specify (in this order):

- Model #
- Top Material
- Finish/Color
- Edge Profile
- Drawer Front Grain Direction
- Drawer Pull
- Drawer Construction
- Drawer Track
- Moving Modesty
- Height Adjust Switch
- Grommet Location
- Power/Data/Wire Management

Description

- Standard with: 2-Channel Leg Configuration for Single Surface Height Adjustment, Includes Controls, Left to Right Grain Direction on Worksurface, Wire Management from Pedestal to Kneespace
- Control Switch Standard (SWCH-Up/Down) or Upgrade to Advanced Switch (MSWCH-Up/Down/Memory); [See Switch Options](#)
- Support Panel (65-2812RSP) Needed When Connecting to Stationary Return or Bridge
- Optional Moving Modesty (MOVMOD); Some Assembly Required; [See Below and Options](#)
- Optional 3-Channel Leg Configuration (STS3) for Use with 3-Channel Returns and Bridges; [See Option Details](#) and [See 3-Channel Units](#)
- Optional Dove Tail Drawer Construction and Soft Close Drawers ([See Drawer Options](#))
- For Additional Information Including Worksurface Grommets and Wire Management Boxes, Power Locations, and More can be Found in the [Intro Section](#)

High Gloss Acrylic Modesty Options for Stepped Front Desks: Specify & Add

| | | |
|---------|--|---------|
| 65-HGAF | High Gloss Acrylic Full Modesty Panel; Must Specify Color (<i>Not Available as Moving Modesty</i>) | |
| | (GPA) Graphite Acrylic | \$ 1846 |
| | (BLA) Black, (WMA) Wired Mercury, or (WHA) White Acrylic | \$ 1687 |

Moving Modesty Options: Specify & Add

| | | |
|--------|----------------|--------|
| MOVMOD | Moving Modesty | \$ 219 |
|--------|----------------|--------|

Pricing Codes:

W= Wood Top
P= HPL Top

[See Gesso Intro Section for Ordering Options](#)

| Item | Model No. | Width | Depth | Height | Ship Wt | Cubic Ft | List Price |
|--|--------------|-------|-------|--------|---------|----------|------------|
| HEIGHT ADJUSTABLE DESK SHELL  <p>Shown with Recessed Front, Moving Modesty and Top Up</p> | 65-3672SHSTS | 72 | 36 | 30-45 | 274 | 50.0 | W/P\$ 8269 |
| | 65-3666SHSTS | 66 | 36 | 30-45 | 268 | 48.0 | W/P\$ 8179 |
| | 65-3660SHSTS | 60 | 36 | 30-45 | 259 | 43.7 | W/P\$ 8098 |
| | 65-3072SHSTS | 72 | 30 | 30-45 | 265 | 43.0 | W/P\$ 8134 |
| | 65-3066SHSTS | 66 | 30 | 30-45 | 261 | 39.0 | W/P\$ 8068 |
| | 65-3060SHSTS | 60 | 30 | 30-45 | 256 | 35.3 | W/P\$ 7951 |

Must Specify (in this order):

- Model #
- Top Material
- Finish/Color
- Edge Profile
- Drawer Front Grain Direction
- Moving Modesty
- Leg Configuration
- Height Adjust Switch
- Grommet Color
- Power/Data/Wire Management

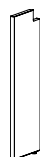

Support Panel (65-2812RSP) Needed When Connecting to Standard Return or Bridge

Description

- Standard with: 2-Channel Leg Configuration for Single Surface Height Adjustment, Includes Controls, Left to Right Grain Direction on Worksurface, Profiled on Approach and User Side
- Modular Pedestals not Applicable
- Optional 3-Channel Leg Configuration (STS3) for Use with 3-Channel Returns; [See Option Details](#) and [See 3-Channel Units](#)
- Optional Moving Modesty (MOVMOD); Must Specify; Some Assembly Required; [See Below and Options](#)
- Control Switch Standard (Up/Down) or Upgrade to Advanced Switch (MSWCH-Up/Down/Memory); Switch is Field Installed; [See Switch Options](#)
- For Additional Information Including Worksurface Grommets and Wire Management Boxes, Power Locations, and More can be Found in the [Intro Section](#)

Moving Modesty Options: Specify & Add

| | | |
|--------|----------------|--------|
| MOVMOD | Moving Modesty | \$ 219 |
|--------|----------------|--------|

HEIGHT ADJUSTABLE D-TOP

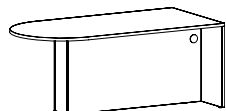

Shown as Left

| | Left | Right | Width | Depth | Height | Ship Wt | Cubic Ft | List Price |
|--|---------------|---------------|-------|-------|--------|---------|----------|------------|
| | 65-3684DULSTS | 65-3684DURSTS | 84 | 36 | 30-45 | 287 | 60.5 | W/P\$ 9459 |
| | 65-3672DULSTS | 65-3672DURSTS | 72 | 36 | 30-45 | 260 | 50.0 | W/P\$ 8828 |
| | 65-3084DULSTS | 65-3084DURSTS | 84 | 30 | 30-45 | 290 | 51.0 | W/P\$ 9323 |
| | 65-3072DULSTS | 65-3072DURSTS | 72 | 30 | 30-45 | 260 | 50.0 | W/P\$ 8715 |
| | 65-3066DULSTS | 65-3066DURSTS | 66 | 30 | 30-45 | 246 | 40.0 | W/P\$ 8559 |

Must Specify (in this order):

- Model #
- Top Material
- Finish/Color
- Edge Profile
- Moving Modesty
- Leg Configuration
- Height Adjust Switch
- Grommet Location
- Power/Data/Wire Management



Support Panel (65-2812RSP) Needed When Connecting to Standard Return or Bridge

Description

- Standard with: 2-Channel Leg Configuration for Single Surface Height Adjustment, Includes Controls, Left to Right Grain Direction on Worksurface
- Must be Used with Stationary or Height Adjustable Return or Bridge with Credenza
- Support Panel (65-2812RSP) Needed When Connecting to Stationary Return or Bridge
- Optional Worksurface Center Grommet Only; Must Specify: Black (BLK), Silver (SLV) or None (NONE)
- Control Switch Standard (Up/Down) or Upgrade to Advanced Switch (MSWCH-Up/Down/Memory); Switch is Field Installed; [See Switch Options](#)
- Optional Moving Modesty (MOVMOD); Some Assembly Required; [See Below and Options](#)
- Optional 3-Channel Leg Configuration (STS3) for Use with 3-Channel Returns and Bridges; [See Option Details](#) and [See 3-Channel Units](#)
- For Additional Information Including Worksurface Materials and Wire Management Boxes, and More can be Found in the [Intro Section](#)

Moving Modesty Options for Recessed Front Desks: Specify & Add

| | | |
|--------|----------------|--------|
| MOVMOD | Moving Modesty | \$ 219 |
|--------|----------------|--------|

Pricing Codes:

W= Wood Top
P= HPL Top

[See Gesso Intro Section for Ordering Options](#)

| Item | Model No. | Width | Depth | Height | Ship Wt | Cubic Ft | List Price |
|-------------------------|--------------|--------------|-------|--------|---------|----------|-----------------|
| HEIGHT ADJUSTABLE P-TOP | Left | Right | | | | | |
| | 65-4284PLSTS | 65-4284PRSTS | 84 | 36-42 | 30-45 | 270 | 70.0 W/P\$ 9936 |
| | 65-4272PLSTS | 65-4272PRSTS | 72 | 36-42 | 30-45 | 261 | 60.3 W/P\$ 9548 |

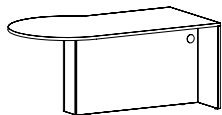

Shown as Left

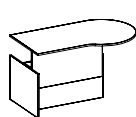

Shown as Left with Moving Modesty



Support Panel (65-2812RSP) Needed When Connecting to Standard Return or Bridge

Must Specify (in this order):

- Model #
- Top Material
- Finish/Color
- Edge Profile
- Moving Modesty
- Leg Configuration
- Height Adjust Switch
- Grommet Location
- Power/Data/Wire Management

Description

- Standard with: 2-Channel Leg Configuration for Single Surface Height Adjustment, Includes Controls, Left to Right Grain Direction on Worksurface
- Must be Used with Stationary or Height Adjustable Return or Bridge with Credenza
- Support Panel (65-2812RSP) Needed When Connecting to Stationary Return or Bridge
- Optional Worksurface Center Grommet Only; Must Specify: Black (BLK), Silver (SLV) or None (NONE)
- Control Switch Standard (Up/Down) or Upgrade to Advanced Switch (MSWCH-Up/Down/Memory); Switch is Field Installed; [See Switch Options](#)
- Optional Moving Modesty (MOVMOD); Some Assembly Required; [See Below and Options](#)
- Optional 3-Channel Leg Configuration (STS3) for Use with 3-Channel Returns and Bridges; [See Option Details](#) and [See 3-Channel Units](#)
- For Additional Information Including Worksurface Materials and Wire Management Boxes, and More can be Found in the [Intro Section](#)

Moving Modesty Options: Specify & Add

| | | |
|--------|----------------|--------|
| MOVMOD | Moving Modesty | \$ 219 |
|--------|----------------|--------|

| Item | Model No. | Width | Depth | Height | Ship Wt | Cubic Ft | List Price |
|---|--|---------------|-------|--------|---------|----------|-----------------|
| HEIGHT ADJUSTABLE RETURN WITH FILE/FILE 2-CHANNEL, FOR ONE WORKSURFACE | Left | Right | | | | | |
| | 67-2448LF2STS | 67-2448RF2STS | 48 | 24 | 30-45 | 251 | 23.1 W/P\$ 7935 |
| | Front to Back Grain Direction on Worksurface | | | | | | |
| | 67-2442LF2STS | 67-2442RF2STS | 42 | 24 | 30-45 | 233 | 20.4 W/P\$ 7823 |
| Front to Back Grain Direction on Worksurface | | | | | | | |
| | 67-4824LF2STS | 67-4824RF2STS | 48 | 24 | 30-45 | 251 | 23.1 W/P\$ 7935 |
| Left to Right Grain Direction on Worksurface | | | | | | | |
| | 67-4224LF2STS | 67-4224RF2STS | 42 | 24 | 30-45 | 233 | 20.4 W/P\$ 7823 |
| Left to Right Grain Direction on Worksurface | | | | | | | |

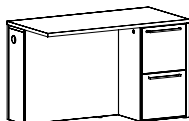

Shown as Right

Must Specify (in this order):

- Model #
- Top Material
- Finish/Color
- Edge Profile
- Drawer Front Grain Direction
- Drawer Pull
- Drawer Construction
- Drawer Track
- Moving Modesty
- Height Adjust Switch
- Grommet Location
- Power/Data/Wire Management
- Modesty Grommet
- Grommet Color

Description

- Standard with: 2-Channel Leg Configuration for Single Surface Height Adjustment, Includes Controls, Top Profiled on User Side, Wire Management from Pedestal to Kneespace
- Control Switch Standard (SWCH-Up/Down) or Upgrade to Advanced Switch (MSWCH-Up/Down/Memory); [See Switch Options](#)
- Optional Modesty Grommet for Wire Management to Wall; Must Specify: Black (GMBBL), Silver (GMSBV) or None (NONE); [See Wire Management Option](#)
- Optional Worksurface Grommet with Mesh Wire Management Sleeve or Wire Management Boxes Available Centered Between Height Adjustable Legs (CKS) and Over Peds and 6" from End (GL or GR); Must Specify Location and Color: GL or GL-MESH for Left or GR or GR-MESH for Right; Color Options: Black (BLK) or Silver (SLV); [See Wire Management Options](#)
- Optional Dove Tail Drawer Construction and Soft Close Drawers ([See Drawer Options](#))
- For Additional Information Including Worksurface Materials, Pulls, Power Availability, and More can be Found in the [Intro Section](#)

Pricing Codes:

- W= Wood Top
- P= HPL Top

[See Gesso Intro Section for Ordering Options](#)

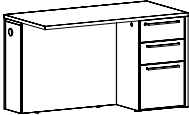
| Item | Model No. | Width | Depth | Height | Ship Wt | Cubic Ft | List Price | |
|---|--|---------------|-------|--------|---------|----------|------------|------------|
| HEIGHT ADJUSTABLE RETURN WITH BOX/BOX/FILE | Left | | | | | | | |
| | Right | | | | | | | |
| 2-CHANNEL, FOR ONE WORKSURFACE | 67-2448LF1STS | 67-2448RF1STS | 48 | 24 | 30-45 | 251 | 23.1 | W/P\$ 7935 |
| | Front to Back Grain Direction on Worksurface | | | | | | | |
| | 67-2442LF1STS | 67-2442RF1STS | 42 | 24 | 30-45 | 233 | 20.4 | W/P\$ 7823 |
| | Front to Back Grain Direction on Worksurface | | | | | | | |
|  | 67-4824LF1STS | 67-4824RF1STS | 48 | 24 | 30-45 | 251 | 23.1 | W/P\$ 7935 |
| | Left to Right Grain Direction on Worksurface | | | | | | | |
| Shown as Right | 67-4224LF1STS | 67-4224RF1STS | 42 | 24 | 30-45 | 233 | 20.4 | W/P\$ 7823 |
| | Left to Right Grain Direction on Worksurface | | | | | | | |

Must Specify (in this order):

- Model #
- Top Material
- Finish/Color
- Edge Profile
- Drawer Front Grain Direction
- Drawer Pull
- Drawer Construction
- Drawer Track
- Height Adjust Switch
- Grommet Location
- Power/Data/Wire Management
- Modesty Grommet
- Grommet Color

Description

- Standard with: 2-Channel Leg Configuration for Single Surface Height Adjustment, Includes Controls, Top Profiled on User Side, Wire Management from Pedestal to Kneespace
- Control Switch Standard (SWCH-Up/Down) or Upgrade to Advanced Switch (MSWCH-Up/Down/Memory); [See Switch Options](#)
- Optional Modesty Grommet for Wire Management to Wall; Must Specify: Black (GMBBL), Silver (GMBSV) or None (NONE); [See Wire Management Option](#)
- Optional Worksurface Grommet with Mesh Wire Management Sleeve or Wire Management Boxes Available Centered Between Height Adjustable Legs (CKS) and Over Peds and 6" from End (GL or GR); Must Specify Location and Color: GL or GL-MESH for Left or GR or GR-MESH for Right; Color Options: Black (BLK) or Silver (SLV); [See Wire Management Options](#)
- Optional Dove Tail Drawer Construction and Soft Close Drawers ([See Drawer Options](#))
- For Additional Information Including Worksurface Materials, Pulls, Power Availability, and More can be Found in the [Intro Section](#)

| Item | Model No. | Width | Depth | Height | Ship Wt | Cubic Ft | List Price | |
|---|--|----------------|-------|--------|---------|----------|------------|------------|
| HEIGHT ADJUSTABLE RETURN WITH FILE/FILE | Left | | | | | | | |
| | Right | | | | | | | |
| 3-CHANNEL, FOR TWO SIMULTANEOUS WORKSURFACES | 67-2448LF2STS3 | 67-2448RF2STS3 | 48 | 24 | 30-45 | 201 | 23.1 | W/P\$ 5570 |
| | Front to Back Grain Direction on Worksurface | | | | | | | |
| | 67-2442LF2STS3 | 67-2442RF2STS3 | 42 | 24 | 30-45 | 183 | 20.4 | W/P\$ 5458 |
| | Front to Back Grain Direction on Worksurface | | | | | | | |

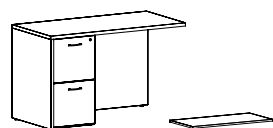

Shown as Left

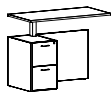

Shown as Left
Top Up

Must Specify (in this order):

- Model #
- Top Material
- Finish/Color
- Edge Profile
- Drawer Front Grain Direction
- Drawer Pull
- Drawer Construction
- Drawer Track
- Height Adjust Switch
- Grommet
- Power/Data/Wire Management
- Modesty Grommet
- Grommet Color

Description

- Standard with: 3-Channel Leg Configuration for Multiple Worksurface Height Adjustment, Top Profiled on User Side, Wire Management from Pedestal to Kneespace
- Must be Used with Height Adjustable Single Ped Desk, Height Adjustable D-Top or P-Top
- Control Switch Not Included; Control Switch will be on Adjoining Worksurface
- Optional Modesty/Pedestal Grommet for Wire Management to Wall **Centered on Pedestal Only**; Must Specify: Black (GMBBL), Silver (GMBSV) or None (NONE); [See Wire Management Option](#)
- Optional Worksurface Grommet with or without Mesh Wire Management Sleeve Available Over Ped Only; 6" from Ends and 20" from User; Must Specify Location and Color: GL or GL-MESH for Left or GR or GR-MESH for Right; Color Options: Black (BLK) or Silver (SLV); [See Wire Management Options](#)
- Monitor Arms not Available on this Unit
- Optional Dove Tail Drawer Construction and Soft Close Drawers ([See Drawer Options](#))
- For Additional Information Including Worksurface Materials, Pulls, Power Availability, and More can be Found in the [Intro Section](#)

Pricing Codes:

- W= Wood Top
- P= HPL Top

[See Gesso Intro Section for Ordering Options](#)

| Item | Model No. | Width | Depth | Height | Ship Wt | Cubic Ft | List Price |
|---|--|----------------|-------|--------|---------|----------|------------|
| HEIGHT ADJUSTABLE RETURN WITH BOX/BOX/FILE | Left | | | | | | |
| | Right | | | | | | |
| 3-CHANNEL, FOR TWO SIMULTANEOUS WORKSURFACES | 67-2448LF1STS3 | 67-2448RF1STS3 | 48 | 24 | 30-45 | 201 | W/P\$ 5570 |
| | Front to Back Grain Direction on Worksurface | | | | | | |
| | 67-2442LF1STS3 | 67-2442RF1STS3 | 42 | 24 | 30-45 | 183 | W/P\$ 5458 |
| | Front to Back Grain Direction on Worksurface | | | | | | |

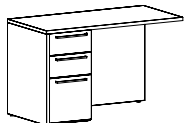

Shown as Left

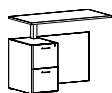

Shown as Left
Top Up

Must Specify (in this order):

- Model #
- Top Material
- Finish/Color
- Edge Profile
- Drawer Front Grain Direction
- Drawer Pull
- Drawer Construction
- Drawer Track
- Height Adjust Switch
- Grommet
- Power/Data/Wire Management
- Modesty Grommet
- Grommet Colors.

Description

- Standard with: 3-Channel Leg Configuration for Multiple Worksurface Height Adjustment, Top Profiled on User Side, Wire Management from Pedestal to Kneespace
- Must be Used with Height Adjustable Single Ped Desk, Height Adjustable D-Top or P-Top
- Control Switch Not Included; Control Switch will be on Adjoining Worksurface
- Optional Modesty/Pedestal Grommet for Wire Management to Wall **Centered on Pedestal Only**; Must Specify: Black (GMBBL), Silver (GMBSV) or None (NONE); [See Wire Management Option](#)
- Optional Worksurface Grommet with or without Mesh Wire Management Sleeve Available Over Ped Only; 6" from Ends and 20" from User; Must Specify Location and Color: GL or GL-MESH for Left or GR or GR-MESH for Right; Color Options: Black (BLK) or Silver (SLV); [See Wire Management Options](#)
- Monitor Arms not Available on this Unit
- Optional Dove Tail Drawer Construction and Soft Close Drawers ([See Drawer Options](#))
- For Additional Information Including Worksurface Materials, Pulls, Power Availability, and More can be Found in the [Intro Section](#)

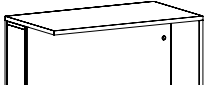
| HEIGHT ADJUSTABLE RETURN SHELL | End Panel Left | End Panel Right | Width | Depth | Height | Ship Wt | Cubic Ft | List Price |
|---|----------------|-----------------|-------|-------|--------|---------|----------|------------|
|  | 65-2448RSHLSTS | 65-2448RSHRSTS | 48 | 24 | 30-45 | 280 | 24.0 | W/P\$ 7001 |
| | 65-2442RSHLSTS | 65-2442RSHRSTS | 42 | 24 | 30-45 | 250 | 24.0 | W/P\$ 6891 |

Must Specify (in this order):

- Model #
- Top Material
- Finish/Color
- Edge Profile
- Height Adjust Switch
- Grommet
- Power/Data/Wire Management
- Modesty Grommet
- Grommet Color

Description

- Standard with: 2-Channel Leg Configuration for Single Surface Height Adjustment, Includes Controls, Top Profiled on User Side, Front to Back Grain Direction on Worksurface
- Optional Worksurface Grommet with Mesh Wire Management Sleeve or Wire Management Box on Center Only; Must Specify: Black (BLK), Silver (SLV) or None (NONE); [See Grommet Option](#)
- Control Switch Standard (SWCH-Up/Down) or Upgrade to Advanced Switch (MSWCH-Up/Down/Memory); [See Switch Options](#)
- Optional Modesty Grommet on Approach for Wire Management to Wall; Must Specify: Black (GMBBL), Silver (GMBSV) or None (NONE); [See Wire Management Option](#)
- For Additional Information Including Worksurface Materials, Pulls, Power Availability, and More can be Found in the [Intro Section](#)

Pricing Codes:

W= Wood Top
P= HPL Top

[See Gesso Intro Section for Ordering Options](#)

| Item | Model No. | Width | Depth | Height | Ship Wt | Cubic Ft | List Price |
|--|--------------|-------|-------|--------|---------|----------|------------|
| HEIGHT ADJUSTABLE BRIDGE 2-CHANNEL, FOR ONE WORKSURFACE | 65-2448UFSTS | 48 | 24 | 30-45 | 182 | 24.0 | W/P\$ 6462 |
| | 65-2442UFSTS | 42 | 24 | 30-45 | 168 | 21.0 | W/P\$ 6415 |
| | 65-2436UFSTS | 36 | 24 | 30-45 | 146 | 18.0 | W/P\$ 6356 |
| | 65-2048UFSTS | 48 | 20 | 30-45 | 177 | 20.0 | W/P\$ 6372 |
| | 65-2042UFSTS | 42 | 20 | 30-45 | 167 | 18.0 | W/P\$ 6333 |
| | 65-2036UFSTS | 36 | 20 | 30-45 | 143 | 15.0 | W/P\$ 6279 |

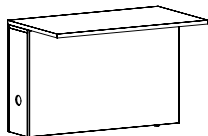

SIN PENDING

Must Specify (in this order):

- Model #
- Top Material
- Finish/Color
- Edge Profile
- Height Adjust Switch
- Grommet
- Power/Data/Wire Management
- Modesty Grommet
- Grommet Color

Description

- Standard with: 2-Channel Leg Configuration for Single Surface Height Adjustment, Includes Controls, Top Profiled on User Side, Front to Back Grain Direction on Worksurface
- Optional Worksurface Grommet with or without Mesh Wire Management Sleeve or Wire Management Box Available On Center Only [See Grommet Option](#)
- Control Switch Standard (Up/Down) or Upgrade to Advanced Switch (MSWCH-Up/Down/Memory); Switch is Field Installed; [See Switch Options](#)
- Optional Modesty Grommet on Approach for Wire Management to Wall; Must Specify: Black (GMBBL), Silver (GMBSV) or None (NONE); [See Wire Management Option](#)
- For Additional Information Including Worksurface Materials, Grommet and Power/Data Options, and More can be Found in the [Intro Section](#)

| HEIGHT ADJUSTABLE BRIDGE FOR MULTIPLE SURFACES | | | | | | | | | |
|---|----------------|----------------|-------|-------|--------|---------|----------|------------|--|
| | Left | Right | Width | Depth | Height | Ship Wt | Cubic Ft | List Price | |
| 3-CHANNEL, FOR TWO SIMULTANEOUS WORKSURFACES | 65-2448UFSTSL3 | 65-2448UFSTSR3 | 48 | 24 | 30-45 | 172 | 24.0 | W/P\$ 5271 | |
| | 65-2442UFSTSL3 | 65-2442UFSTSR3 | 42 | 24 | 30-45 | 158 | 21.0 | W/P\$ 5225 | |
| | 65-2436UFSTSL3 | 65-2436UFSTSR3 | 36 | 24 | 30-45 | 136 | 18.0 | W/P\$ 5166 | |
| | 65-2048UFSTSL3 | 65-2048UFSTSR3 | 48 | 20 | 30-45 | 167 | 20.0 | W/P\$ 5182 | |
| | 65-2042UFSTSL3 | 65-2042UFSTSR3 | 42 | 20 | 30-45 | 154 | 18.0 | W/P\$ 5143 | |
| | 65-2036UFSTSL3 | 65-2036UFSTSR3 | 36 | 20 | 30-45 | 133 | 15.0 | W/P\$ 5089 | |

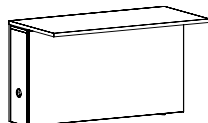

SIN PENDING

Must Specify (in this order):

- Model #
- Top Material
- Top Color
- Edge Profile
- Chassis Color
- Grommet
- Power/Data/Wire Management
- Modesty Grommet
- Grommet Color

Description

- Standard with: 3-Channel Leg Configuration for Multiple Surface Height Adjustment, Top Profiled on User Side, Front to Back Grain Direction on Worksurface
- Optional Worksurface Grommet with Mesh Wire Management Sleeve or Wire Management Box Available On Center Only [See Grommet Option](#)
- Control Switch Not Included; Control Switch will be on Adjoining Worksurface
- Optional Modesty Grommet on Approach for Wire Management to Wall; Must Specify: Black (GMBBL), Silver (GMBSV) or None (NONE); [See Wire Management Option](#)
- For Additional Information Including Worksurface Materials, Grommet and Power/Data Options, and More can be Found in the [Intro Section](#)

Pricing Codes:

- W= Wood Top
- P= HPL Top

[See Gesso Intro Section for Ordering Options](#)

| Item | Model No. | Width | Depth | Height | Ship Wt | Cubic Ft | List Price |
|--|-----------------------|------------------------|-------|--------|---------|----------|------------|
| HEIGHT ADJUSTABLE SINGLE PED CREDENZA WITH FILE/FILE | End Panel Left | End Panel Right | | | | | |
| | 67-2472LC2STS | 67-2472RC2STS | 72 | 24 | 30-45 | 300 | W/P\$ 8639 |
| | 67-2466LC2STS | 67-2466RC2STS | 66 | 24 | 30-45 | 282 | W/P\$ 8606 |

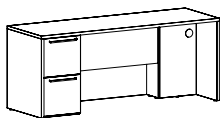

Shown as Left

Must Specify (in this order):

- Model #
- Top Material
- Finish/Color
- Edge Profile
- Drawer Front Grain Direction
- Drawer Pull
- Drawer Construction
- Drawer Track
- Height Adjust Switch
- Grommet Color
- Power/Data/Wire Management

Description

- Standard with: 2-Channel Leg Configuration for Single Surface Height Adjustment, Includes Controls; Top Profiled on Approach and User Side, Left to Right Grain Direction on Worksurface
- Support Panel ([65-2812RSP](#)) Needed When Connecting to Standard Return or Bridge
- Control Switch Standard (SWCH-Up/Down) or Upgrade to Advanced Switch (MSWCH-Up/Down/Memory); [See Switch Options](#)
- Optional 3-Channel Leg Configuration (STS3) for Use with 3-Channel Returns; [See Option Details](#) and [See 3-Channel Units](#)
- Optional Modesty Grommet on Approach for Wire Management to Wall; Must Specify: Black (GMBBL), Silver (GMBSV); [See Wire Management Option](#)
- Optional Dove Tail Drawer Construction and Soft Close Drawers ([See Drawer Options](#))
- For Additional Information Including Worksurface Grommet and Wire Management Box Locations, Pulls, Power Availability, and More can be Found in the [Intro Section](#)



Support Panel ([65-2812RSP](#)) Needed When Connecting to Standard Return or Bridge

| | | | | | | | |
|---|-----------------------|------------------------|----|----|-------|-----|------------|
| HEIGHT ADJUSTABLE SINGLE PED CREDENZA WITH BOX/BOX/FILE | End Panel Left | End Panel Right | | | | | |
| | 67-2472LC1STS | 67-2472RC1STS | 72 | 24 | 30-45 | 300 | W/P\$ 8639 |
| | 67-2466LC1STS | 67-2466RC1STS | 66 | 24 | 30-45 | 282 | W/P\$ 8606 |

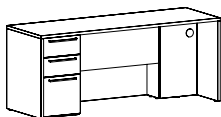

Shown as Left

Must Specify (in this order):

- Model #
- Top Material
- Finish/Color
- Edge Profile
- Drawer Front Grain Direction
- Drawer Pull
- Drawer Construction
- Drawer Track
- Height Adjust Switch
- Grommet Color
- Power/Data/Wire Management

Description

- Standard with: 2-Channel Leg Configuration for Single Surface Height Adjustment, Includes Controls; Top Profiled on Approach and User Side, Left to Right Grain Direction on Worksurface
- Support Panel ([65-2812RSP](#)) Needed When Connecting to Standard Return or Bridge
- Control Switch Standard (SWCH-Up/Down) or Upgrade to Advanced Switch (MSWCH-Up/Down/Memory); [See Switch Options](#)
- Optional 3-Channel Leg Configuration (STS3) for Use with 3-Channel Returns; [See Option Details](#) and [See 3-Channel Units](#)
- Optional Modesty Grommet on Approach for Wire Management to Wall; Must Specify: Black (GMBBL), Silver (GMBSV); [See Wire Management Option](#)
- Optional Dove Tail Drawer Construction and Soft Close Drawers ([See Drawer Options](#))
- For Additional Information Including Worksurface Grommet and Wire Management Box Locations, Pulls, Power Availability, and More can be Found in the [Intro Section](#)



Support Panel ([65-2812RSP](#)) Needed When Connecting to Standard Return or Bridge

Pricing Codes:

W= Wood Top
P= HPL Top

[See Gesso Intro Section for Ordering Options](#)

| Item | Model No. | Width | Depth | Height | Ship Wt | Cubic Ft | List Price |
|--|--------------|-------|-------|--------|---------|----------|------------|
| HEIGHT ADJUSTABLE KNEESPACE CREDENZA WITH FILE/FILE PEDS | 67-2472KCSTS | 72 | 24 | 30-45 | 340 | 35.6 | W/P\$ 9999 |
| | 67-2466KCSTS | 66 | 24 | 30-45 | 320 | 32.7 | W/P\$ 9666 |

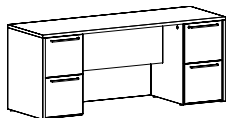

Must Specify (in this order):

- Model #
- Top Material
- Finish/Color
- Edge Profile
- Drawer Front Grain Direction
- Drawer Pull
- Drawer Construction
- Drawer Track
- Height Adjust Switch
- Grommet Color
- Power/Data/Wire Management

Description

- Standard with: 2-Channel Leg Configuration for Single Surface Height Adjustment, Includes Controls; Top Profiled on Approach and User Side, Left to Right Grain Direction on Worksurface
- Control Switch Standard (SWCH-Up/Down) or Upgrade to Advanced Switch (MSWCH-Up/Down/Memory); [See Switch Options](#)
- Optional Modesty Grommet on Approach for Wire Management to Wall; Must Specify: Black (GMBBL), Silver (GMBSV); [See Wire Management Option](#)
- Optional Dove Tail Drawer Construction and Soft Close Drawers ([See Drawer Options](#))
- For Additional Information Including Worksurface Grommet and Wire Management Box Locations, Pulls, Power Availability, and More can be Found in the [Intro Section](#)

| | | | | | | | |
|----------------------------------|--------------|----|----|-------|-----|------|------------|
| HEIGHT ADJUSTABLE CREDENZA SHELL | 65-2472SHSTS | 72 | 24 | 30-45 | 294 | 36.0 | W/P\$ 7861 |
| | 65-2466SHSTS | 66 | 24 | 30-45 | 287 | 33.0 | W/P\$ 7786 |
| | 65-2460SHSTS | 60 | 24 | 30-45 | 280 | 30.0 | W/P\$ 7722 |

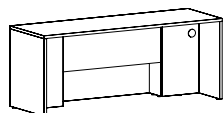

Must Specify (in this order):

- Model #
- Top Material
- Finish/Color
- Edge Profile
- Leg Configuration
- Height Adjust Switch
- Grommet Color
- Power/Data/Wire Management

Description

- Standard with: 2-Channel Leg Configuration for Single Surface Height Adjustment, Includes Controls; Profiled on User Side, Modesty Grommet, and Left to Right Grain Direction on Worksurface
- Optional 3-Channel Leg Configuration (STS3) for Use with 3-Channel Returns; [See Option Details](#) and [See 3-Channel Units](#)
- Modular Pedestals not Applicable
- Support Panel ([65-2812RSP](#)) Needed When Connecting to Standard Return or Bridge
- Control Switch Standard (Up/Down) or Upgrade to Advanced Switch (MSWCH-Up/Down/Memory); Switch is Field Installed; [See Switch Options](#)
- For Additional Information Including Worksurface Grommet and Wire Management Box Locations, Power Availability, and More can be Found in the [Intro Section](#)



Support Panel
[\(65-2812RSP\)](#)
Needed When
Connecting to
Standard Return
or Bridge

| | | | | | | | |
|---------------|------------|----|---|-----|----|-----|---------|
| SUPPORT PANEL | 65-2812RSP | 12 | 1 | 28¼ | 12 | 0.8 | W\$ 436 |
|---------------|------------|----|---|-----|----|-----|---------|



Description

- To be Used to Support Stationary Returns and Bridges Worksurfaces with Height Adjustable Units
- Required to be Used Perpendicular to Full Back Panels for Support of Kneespace Areas 60" or Longer

Must Specify (in this order):

- Model #
- Finish

Pricing Codes:
W= Wood Top
P= HPL Top

[See Gesso Intro Section for Ordering Options](#)

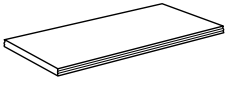
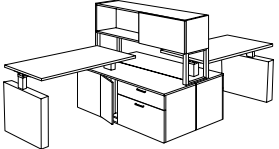
| Item | Model No. | Width | Depth | Height | Ship Wt | Cubic Ft | List Price |
|--|---------------------------------|-------|-------|--------------------|---------|----------|------------|
|   | 65-3462HTP For 72" Footprint | 62 | 34 | 1 $\frac{1}{16}$ " | 84 | 5.3 | W/P\$ 1141 |
| | 65-3456HTP For 66" Footprint | 56 | 34 | 1 $\frac{1}{16}$ " | 78 | 4.8 | W/P\$ 1092 |
| | 65-2862HTP For 72" Footprint | 62 | 28 | 1 $\frac{1}{16}$ " | 79 | 4.2 | W/P\$ 1076 |
| | 65-2856HTP For 66" Footprint | 56 | 28 | 1 $\frac{1}{16}$ " | 75 | 3.8 | W/P\$ 990 |
| | 65-2850HTP For 60" Footprint | 50 | 28 | 1 $\frac{1}{16}$ " | 71 | 3.4 | W/P\$ 936 |
| | 65-2262HTP For 72" Footprint | 62 | 22 | 1 $\frac{1}{16}$ " | 42 | 3.3 | W/P\$ 935 |
| | 65-2256HTP For 66" Footprint | 56 | 22 | 1 $\frac{1}{16}$ " | 36 | 3.0 | W/P\$ 892 |
| | 65-2250HTP For 60" Footprint | 50 | 22 | 1 $\frac{1}{16}$ " | 33 | 2.7 | W/P\$ 818 |

Must Specify (in this order):

Model #
Top Material
Finish/Color
Edge Profile
Grommet Location
Grommet Color
Power/Data/Wire Management

Description

- Profiled on Approach and User Side
- 10" Width Offset to Provide Clearance for Overhead Storage and Access to Optional Power in Credenza
- Depth Allows for Use With Gallery Screens
- Not Available for Use with Height Adjustable Open Bookcase with Controls
- Optional Height Adjustable Legs and Cabinets; Starting on Next Page
- Additional Options: Power, Monitor Arm and Grommet Options ([See Options](#))

| | | | | | | | |
|---|--------------------------------------|----|----|--------------------|-----|-----|------------|
|  | 65-3470HTP Stiffener Bar Included | 70 | 34 | 1 $\frac{1}{16}$ " | 115 | 6.2 | W/P\$ 1588 |
| | 65-3464HTP | 64 | 34 | 1 $\frac{1}{16}$ " | 68 | 5.2 | W/P\$ 1215 |
| | 65-3458HTP | 58 | 34 | 1 $\frac{1}{16}$ " | 62 | 4.8 | W/P\$ 1159 |
| | 65-2870HTP Stiffener Bar Included | 70 | 28 | 1 $\frac{1}{16}$ " | 85 | 4.6 | W/P\$ 1370 |
| | 65-2864HTP | 64 | 28 | 1 $\frac{1}{16}$ " | 81 | 4.3 | W/P\$ 1052 |
| | 65-2858HTP | 58 | 28 | 1 $\frac{1}{16}$ " | 77 | 3.9 | W/P\$ 999 |
| | 65-2852HTP | 52 | 28 | 1 $\frac{1}{16}$ " | 73 | 3.5 | W/P\$ 918 |
| | 65-2846HTP | 46 | 28 | 1 $\frac{1}{16}$ " | 69 | 3.1 | W/P\$ 853 |

Must Specify (in this order):

Model #
Top Material
Finish/Color
Edge Profile
Grommet Location
Grommet Color
Power/Data/Wire Management

Description

- Profiled on Approach and User Side
- Optional Height Adjustable Legs and Cabinets; Starting on Next Page
- Additional Options: Power, Monitor Arm and Grommet Options ([See Options](#))

Pricing Codes:

W= Wood Top
P= HPL Top

[See Gesso Intro Section for Ordering Options](#)

| Item | Model No. | Width | Depth | Height | Ship Wt | Cubic Ft | List Price |
|---|--------------------------------------|-------|-------|--------|---------|----------|------------|
| HEIGHT ADJUSTABLE WORK SURFACE FOR MULTIPLE AND INDIVIDUAL WORKSTATIONS  | 65-2270HTP Stiffener Bar Included | 70 | 22 | 1 | 50 | 3.8 | W/P\$ 1237 |
| | 65-2264HTP | 64 | 22 | 1 | 44 | 3.4 | W/P\$ 946 |
| | 65-2258HTP | 58 | 22 | 1 | 38 | 3.1 | W/P\$ 901 |
| | 65-2252HTP | 52 | 22 | 1 | 35 | 2.8 | W/P\$ 827 |
| | 65-2246HTP | 46 | 22 | 1 | 31 | 2.5 | W/P\$ 768 |

Must Specify (in this order):

- Model #
- Top Material
- Finish/Color
- Edge Profile
- Grommet Location
- Grommet Color
- Power/Data/Wire Management

Description

- Profiled on Approach and User Side
- Can Also be Used in Individual Workstations Applications
- Optional Height Adjustable Legs and Cabinets; Starting below
- Additional Options: Power, Monitor Arm and Grommet Options ([See Options](#))

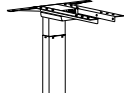
| | | | | | | | |
|---|---|----|---|-----|----|-----|---------|
| HEIGHT ADJUSTABLE T-LEG  | 01-2245HTLC Includes Control, Motor Cable and Keypad | 22 | 2 | 28¼ | 40 | 0.5 | \$ 2077 |
| | 01-2245HTL Does Not Include Control, Requires a Unit with Control | 22 | 2 | 28¼ | 40 | 0.5 | \$ 1442 |

Must Specify (in this order):

- Model #
- Color

Description

- Available in Black or Silver; Must Specify
- 16" Adjustable Range

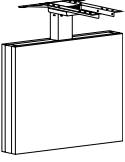
| | | | | | | | |
|---|---|----|----|-----|----|-----|------------|
| HEIGHT ADJUSTABLE PANEL LEG  | 65-0536HPC For Use With 34"D Top Includes Control, Motor Cable and Keypad | 36 | 5½ | 28¼ | 50 | 4.5 | W/P\$ 3257 |
| | 65-0530HPC For Use With 28"D Top Includes Control, Motor Cable and Keypad | 30 | 5½ | 28¼ | 49 | 4.5 | W/P\$ 3191 |
| | 65-0524HPC For Use With 22"D Top Includes Control, Motor Cable and Keypad | 24 | 5½ | 28¼ | 48 | 4.5 | W/P\$ 3010 |
| | 65-0536HP For Use With 34"D Top Does Not Include Control, Requires a Unit with Control | 36 | 5½ | 28¼ | 50 | 4.5 | W/P\$ 2664 |
| | 65-0530HP For Use With 28"D Top Does Not Include Control, Requires a Unit with Control | 30 | 5½ | 28¼ | 49 | 4.5 | W/P\$ 2597 |
| | 65-0524HP For Use With 22"D Top Does Not Include Control, Requires a Unit with Control | 24 | 5½ | 28¼ | 48 | 4.5 | W/P\$ 2418 |

Must Specify (in this order):

- Model #
- Finish/Color

Description

- Available in Black or Silver; Must Specify
- 16" Adjustable Range

Pricing Codes:
W= Wood Top
P= HPL Top

[See Gesso Intro Section for Ordering Options](#)

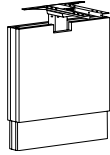
| Item | Model No. | Width | Depth | Height | Ship Wt | Cubic Ft | List Price |
|---|--|-------|-----------------|------------------|---------|----------|------------|
| HEIGHT ADJUSTABLE PANEL LEG WITH SLEEVE  | 65-0536HPSC For Use With 34"D Top Includes Control, Motor Cable and Keypad | 34 | 5 $\frac{5}{8}$ | 28 $\frac{1}{4}$ | 50 | 4.5 | W/P\$ 4198 |
| | 65-0530HPSC For Use With 28"D Top Includes Control, Motor Cable and Keypad | 28 | 5 $\frac{5}{8}$ | 28 $\frac{1}{4}$ | 49 | 4.5 | W/P\$ 4076 |
| | 65-0524HPSC For Use With 22"D Top Includes Control, Motor Cable and Keypad | 22 | 5 $\frac{5}{8}$ | 28 $\frac{1}{4}$ | 48 | 4.5 | W/P\$ 3827 |
| | 65-0536HPS For Use With 34"D Top Does Not Include Control, Requires a Unit with Control | 34 | 5 $\frac{5}{8}$ | 28 $\frac{1}{4}$ | 50 | 4.5 | W/P\$ 3603 |
| | 65-0530HPS For Use With 28"D Top Does Not Include Control, Requires a Unit with Control | 28 | 5 $\frac{5}{8}$ | 28 $\frac{1}{4}$ | 49 | 4.5 | W/P\$ 3483 |
| | 65-0524HPS For Use With 22"D Top Does Not Include Control, Requires a Unit with Control | 22 | 5 $\frac{5}{8}$ | 28 $\frac{1}{4}$ | 48 | 4.5 | W/P\$ 3232 |

Must Specify (in this order):

Model #
Finish/Color

Description

- For Use in Place of Cabinet
- 16" Adjustable Range
- Not Compatible with 4" Modesty Panels

| | | | | | | | |
|---|-----------|----|------------------|------------------|----|-----|------------|
| HEIGHT ADJUSTABLE PANEL LEG FOR SHARED WORKSTATION | 65-1124HP | 24 | 10 $\frac{1}{4}$ | 28 $\frac{1}{4}$ | 50 | 4.5 | W/P\$ 3547 |
|---|-----------|----|------------------|------------------|----|-----|------------|

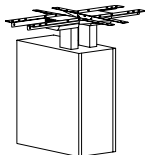

Description

- Available in Black or Silver; Must Specify
- 16" Adjustable Range
- Shared Cabinet with Dual Legs For Multi-Workstation Footprints
- Required to be Used with a Unit Including Controls
- For Use with 24" Deep Worksurfaces

Must Specify (in this order):

Model #
Finish/Color

Pricing Codes:

W= Wood Top
P= HPL Top

[See Gesso Intro Section for Ordering Options](#)

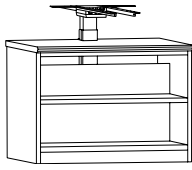
| Item | Model No. | Width | Depth | Height | Ship Wt | Cubic Ft | List Price |
|---|------------|-------|-------|--------|---------|----------|------------|
|  <p>HEIGHT ADJUSTABLE OPEN BOOKCASE WITH CONTROL</p> | 65-2436HBM | 36 | 24 | 21¾ | 99 | 18.3 | W/P\$ 4721 |
| | 65-2430HBM | 30 | 24 | 21¾ | 89 | 15.4 | W/P\$ 4634 |
| | 65-2424HBM | 24 | 24 | 21¾ | 79 | 12.5 | W/P\$ 4537 |
| | 65-2036HBM | 36 | 20 | 21¾ | 89 | 15.5 | W/P\$ 4616 |
| | 65-2030HBM | 30 | 20 | 21¾ | 79 | 13.1 | W/P\$ 4543 |
| | 65-2024HBM | 24 | 20 | 21¾ | 69 | 10.6 | W/P\$ 4444 |

Must Specify (in this order):

- Model #
- Top Material
- Finish/Color
- Edge Profile
- Leg Color
- Wire Management Sleeve
- Wire Management Kneespace Access

Description

- Open Back; [See Back Panel Options](#)
- Open Book Case with Controls; Profiled on User Side
- One Adjustable Shelf; 13" Deep Shelf on 24" Units/9" Deep Shelf on 20" Units
- Not Available for Use with Overhead Storage
- When Used as Peninsula Desk, Additional Panel Leg Must be Used on Opposite Side for Support ([See Panel Legs](#) 01-2245HTL, 65-0536HPS, 65-0530HPS, 65-0524HPS, 65-0536HP, 65-0530HPS, or 65-0524HPS)
- Leg Available in Black or Silver; Must Specify
- Worksurface Grommet Standard; Must Specify: Black (BLK), Silver (SLV)
- Optional Wire Management Sleeve Available (See Below); Wire Management Sleeve Replaces Standard Work Surface Grommet
- Wire Management Access from Pedestal to Kneespace; Specify Left (WML), Right (WMR) or Left and Right (WMLR)



Options: Specify & Add

| | | |
|-----------|------------------------|---------|
| WM Sleeve | Wire Management Sleeve | W\$ 715 |
|-----------|------------------------|---------|

Pricing Codes:
W= Wood Top
P= HPL Top

[See Gesso Intro Section for Ordering Options](#)

| Item | Model No. | Width | Depth | Height | Ship Wt | Cubic Ft | List Price |
|--|-----------|-------|-------|--------|---------|----------|------------|
| HEIGHT ADJUSTABLE CABINET WITH CONTROL  | 65-2436HM | 36 | 24 | 21¾ | 99 | 18.3 | W/P\$ 4190 |
| | 65-2430HM | 30 | 24 | 21¾ | 89 | 15.4 | W/P\$ 4112 |
| | 65-2424HM | 24 | 24 | 21¾ | 79 | 12.5 | W/P\$ 4025 |
| | 65-2036HM | 36 | 20 | 21¾ | 89 | 15.5 | W/P\$ 4095 |
| | 65-2030HM | 30 | 20 | 21¾ | 79 | 13.1 | W/P\$ 4028 |
| | 65-2024HM | 24 | 20 | 21¾ | 69 | 10.6 | W/P\$ 3940 |

Must Specify (in this order):

- Model #
- Top Material
- Finish/Color
- Edge Profile
- Access Front Panel Grain Direction
- Leg Color
- Wire Management Sleeve
- Wire Management Kneespace Access

Description

- Open Back; [See Back Panel Options](#)
- Cabinet with Controls; Profiled on User Side
- Open Bottom Allows for Wire Management
- Removable Access Front Panel Available in Vertical Grain Direction Standard; Optional Horizontal Grain Direction; Must Specify
- When Used as Peninsula Desk, Additional Panel Leg Must be Used on Opposite Side for Support ([See Panel Legs](#) 01-2245HTL, 65-0536HPS, 65-0530HPS, 65-0524HPS, 65-0536HP, 65-0530HP, or 65-0524HP)
- Leg Available in Black or Silver; Must Specify
- Worksurface Grommet Standard; Must Specify: Black (BLK), Silver (SLV)
- Optional Wire Management Sleeve Available (See Below); Wire Management Sleeve Replaces Standard Work Surface Grommet
- Wire Management Access from Pedestal to Kneespace; Specify Left (WML), Right (WMR) or Left and Right (WMLR)

Options: Specify & Add

| | | |
|-----------|------------------------|---------|
| WM Sleeve | Wire Management Sleeve | W\$ 715 |
|-----------|------------------------|---------|

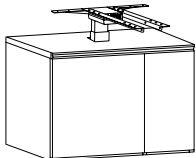

| HEIGHT ADJUSTABLE CABINET WITH DOOR AND CONTROL  | Leg Left of Door | Leg Right of Door | Width | Depth | Height | Ship Wt | Cubic Ft | List Price |
|---|------------------|-------------------|-------|-------|--------|---------|----------|------------|
| | 65-2436HDL | 65-2436HDR | 30 | 24 | 21¾ | 95 | 18.3 | W/P\$ 4770 |
| | 65-2430HDL | 65-2430HDR | 24 | 24 | 21¾ | 75 | 15.4 | W/P\$ 4680 |
| | 65-2036HDL | 65-2036HDR | 36 | 20 | 21¾ | 85 | 15.5 | W/P\$ 4669 |
| | 65-2030HDL | 65-2030HDR | 30 | 20 | 21¾ | 65 | 13.1 | W/P\$ 4585 |

Shown as Left
(Leg is Left of Door)

Must Specify (in this order):

- Model #
- Top Material
- Finish/Color
- Edge Profile
- Door/Front Panel Grain Direction
- Leg Color
- Wire Management Sleeve
- Wire Management Kneespace Access

Description

- Open Back; [See Back Panel Options](#)
- Handed Based on Facing the Unit
- Cabinet with Controls; Profiled on User Side
- Open Bottom Allows for Wire Management
- 9" Door Opening With Touch Latch and Includes Bottom Panel, Storage Behind Door
- When Used as Peninsula Desk, Additional Panel Leg Must be Used on Opposite Side for Support ([See Panel Legs](#) 01-2245HTL, 65-0536HPS, 65-0530HPS, 65-0524HPS, 65-0536HP, 65-0530HP, or 65-0524HP)
- Door and Removable Access Front Panel Available in Vertical Grain Direction Standard; Optional Horizontal Grain Direction; Must Specify
- Leg Available in Black or Silver; Must Specify
- Worksurface Grommet Standard; Must Specify: Black (BLK), Silver (SLV)
- Wire Management Access from Pedestal to Kneespace; Specify Left (WML), Right (WMR) or Left and Right (WMLR)

Pricing Codes:

W= Wood Top
P= HPL Top

[See Gesso Intro Section for Ordering Options](#)

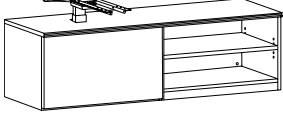
| Item | Model No. | | Width | Depth | Height | Ship Wt | Cubic Ft | List Price | |
|--|--|-----------------------------|-------|-------|--------|---------|----------|------------|------|
| HEIGHT ADJUSTABLE CREDENZA WITH OPEN BOOKCASE AND CONTROL  Shown as Left | Leg in Left Cabinet | Leg in Right Cabinet | | | | | | | |
| | 65-2472HMOL | 65-2472HMOR | 72 | 24 | 21¾ | 240 | 35.6 | W/P\$ | 5871 |
| | 65-2466HMOL | 65-2466HMOR | 66 | 24 | 21¾ | 220 | 32.7 | W/P\$ | 5746 |
| | 65-2460HMOL | 65-2460HMOR | 60 | 24 | 21¾ | 220 | 29.9 | W/P\$ | 5621 |
| | 65-2072HMOL | 65-2072HMOR | 72 | 20 | 21¾ | 220 | 30.2 | W/P\$ | 5658 |
| | 65-2066HMOL | 65-2066HMOR | 66 | 20 | 21¾ | 210 | 27.7 | W/P\$ | 5539 |
| | 65-2060HMOL | 65-2060HMOR | 60 | 20 | 21¾ | 210 | 25.3 | W/P\$ | 5416 |
| | Description <ul style="list-style-type: none"> • Standard with: Controls, Back Panel, One Adjustable Shelf in Bookcase End, Profiled on User Side • Bottom Panel Not Included Behind Removable Access Front Panel for Wire Management • Designed for 28" Deep Worksurfaces Only (See Worksurfaces) • Handed Based on Height Adjust Cabinet and Facing the Unit • Removable Access Front Panel Available in Vertical Grain Direction Standard; Optional Horizontal Grain Direction; Must Specify • When Used as Peninsula Desk, Additional Panel Leg Must be Used on Opposite Side for Support (See Panel Legs 01-2245HTL, 65-0536HPS, or 65-0530HPS) • Leg Available in Black or Silver; Must Specify • Worksurface Grommet Standard; Must Specify: Black (BLK), Silver (SLV) • Optional Back Panel Grommet, Must Specify • Optional Wire Management Sleeve Available (See Below); Wire Management Sleeve Replaces Standard Work Surface Grommet • Optional Power Locations; See Power Options | | | | | | | | |
| Options: Specify & Add | | | | | | | | | |
| | WM Sleeve | Wire Management Sleeve | | | | | | W\$ | 715 |

Must Specify (in this order):
 Model #
 Top Material
 Finish/Color
 Edge Profile
 Wire Management Sleeve
 Front Panel Grain Direction
 Leg Color
 Worksurface Grommet
 Grommet Color
 Power/Data/Wire Management
 Back Panel Grommet



Pricing Codes:
 W= Wood Top
 P= HPL Top

[See Gesso Intro Section for Ordering Options](#)

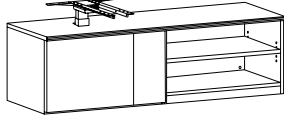
| Item | Model No. | | Width | Depth | Height | Ship Wt | Cubic Ft | List Price | |
|--|----------------------------|-----------------------------|-------|-------|--------|---------|----------|------------|------|
| HEIGHT ADJUSTABLE CREDENZA WITH DOOR, OPEN BOOKCASE AND CONTROL  Shown as Left | Leg in Left Cabinet | Leg in Right Cabinet | | | | | | | |
| | 65-2472HDOL | 65-2472HDOR | 72 | 24 | 21¾ | 240 | 35.6 | W/P\$ | 6528 |
| | 65-2466HDOL | 65-2466HDOR | 66 | 24 | 21¾ | 230 | 32.6 | W/P\$ | 6391 |
| | 65-2460HDOL | 65-2460HDOR | 60 | 24 | 21¾ | 220 | 29.8 | W/P\$ | 6256 |
| | 65-2072HDOL | 65-2072HDOR | 72 | 20 | 21¾ | 240 | 30.2 | W/P\$ | 6296 |
| | 65-2066HDOL | 65-2066HDOR | 66 | 20 | 21¾ | 230 | 27.7 | W/P\$ | 6162 |
| | 65-2060HDOL | 65-2060HDOR | 60 | 20 | 21¾ | 220 | 25.2 | W/P\$ | 6033 |

Must Specify (in this order):

Model #
 Top Material
 Finish/Color
 Edge Profile
 Wire Management Sleeve
 Door/Front Panel Grain Direction
 Leg Color
 Worksurface Grommet
 Grommet Color
 Power/Data/Wire Management
 Back Panel Grommet

Description

- Credenza with Controls; Profiled on User Side; Back Panel Included, One Adjustable Shelf in Bookcase End
- Bottom Panel Not Included Behind Removable Access Front Panel for Wire Management
- 9" Door Opening With Touch Latch and Includes Bottom Panel, Storage Behind Door
- Designed for 28" Deep Worksurfaces Only ([See Worksurfaces](#))
- Handed Based on Height Adjust Cabinet and Facing the Unit
- Door and Removable Access Front Panel Available in Vertical Grain Direction Standard; Optional Horizontal Grain Direction; Must Specify
- When Used as Peninsula Desk, Additional Panel Leg Must be Used on Opposite Side for Support ([See Panel Legs](#) 01-2245HTL, 65-0536HPS, or 65-0530HPS)
- Leg Available in Black or Silver; Must Specify
- Worksurface Grommet Standard; Must Specify: Black (BLK), Silver (SLV)
- Optional Back Panel Grommet, Must Specify
- Optional Power Locations; [See Power Options](#)

Pricing Codes:

W= Wood Top
 P= HPL Top

[See Gesso Intro Section for Ordering Options](#)

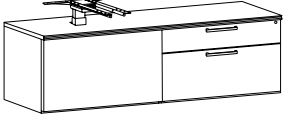
| Item | Model No. | Width | Depth | Height | Ship Wt | Cubic Ft | List Price | |
|---|---|-----------------------------|-------|--------|---------|----------|------------|--|
| HEIGHT ADJUSTABLE CREDENZA WITH BOX/FILE AND CONTROL  Shown as Left | Leg in Left Cabinet | Leg in Right Cabinet | | | | | | |
| | 65-2472HMFL | 65-2472HMFR | 72 | 24 | 21¾ | 260 | W/P\$ 6494 | |
| | 65-2466HMFL | 65-2466HMFR | 66 | 24 | 21¾ | 240 | W/P\$ 6356 | |
| | 65-2460HMFL | 65-2460HMFR | 60 | 24 | 21¾ | 240 | W/P\$ 6222 | |
| | 65-2072HMFL | 65-2072HMFR | 72 | 20 | 21¾ | 220 | W/P\$ 6260 | |
| | 65-2066HMFL | 65-2066HMFR | 66 | 20 | 21¾ | 210 | W/P\$ 6132 | |
| | 65-2060HMFL | 65-2060HMFR | 60 | 20 | 21¾ | 210 | W/P\$ 6000 | |
| | Description | | | | | | | |
| | <ul style="list-style-type: none"> • Cabinet with Controls; Profiled on User Side; Back Panel Included • Bottom Panel Not Included Behind Removable Access Front Panel for Wire Management • Locking Box/File; File Drawers Provide Legal or Letter Filing • Designed for 28" Deep Worksurfaces Only (See Worksurfaces) • Handed Based on Height Adjust Cabinet and Facing the Unit • When Used as Peninsula Desk, Additional Panel Leg Must be Used on Opposite Side for Support (See Panel Legs 01-2245HTL, 65-0536HPS, or 65-0530HPS) • Drawer Fronts and Removable Access Front Panel Available in Vertical Grain Direction Standard; Optional Horizontal Grain Direction; Must Specify • If Black or Gold Pull is Selected, Leg and Lock Core will be Black; If Chrome or Aluminum Pull is Selected, Leg and Lock Core will be Silver • Worksurface Grommet Standard; Must Specify: Black (BLK), Silver (SLV) • Optional Back Panel Grommet, Must Specify • Optional Wire Management Sleeve Available (See Below); Wire Management Sleeve Replaces Standard Work Surface Grommet • Additional Options: Dove Tail Drawer Construction and Soft Close Box Drawer (See Drawer Options), Power Locations (See Power Options) | | | | | | | |
| | Options: Specify & Add | | | | | | | |
| WM Sleeve | Wire Management Sleeve | | | | | | W\$ 715 | |

Must Specify (in this order):

- Model #
- Top Material
- Finish/Color
- Edge Profile
- Wire Management Sleeve
- Front Panel Grain Direction
- Leg Color
- Worksurface Grommet
- Grommet Color
- Power/Data/Wire Management
- Back Panel Grommet



Pricing Codes:
W= Wood Top
P= HPL Top

[See Gesso Intro Section for Ordering Options](#)

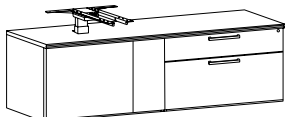
| Item | Model No. | Width | Depth | Height | Ship Wt | Cubic Ft | List Price |
|--|----------------------------|-----------------------------|-------|--------|---------|----------|------------|
| HEIGHT ADJUSTABLE CREDENZA WITH DOOR, WITH BOX/FILE AND CONTROL  Shown as Left | Leg in Left Cabinet | Leg in Right Cabinet | | | | | |
| | 65-2472HDFL | 65-2472HDFR | 72 | 24 | 21¾ | 260 | W/P\$ 6992 |
| | 65-2466HDFL | 65-2466HDFR | 66 | 24 | 21¾ | 250 | W/P\$ 6845 |
| | 65-2460HDFL | 65-2460HDFR | 60 | 24 | 21¾ | 240 | W/P\$ 6705 |
| | 65-2072HDFL | 65-2072HDFR | 72 | 20 | 21¾ | 240 | W/P\$ 6744 |
| | 65-2066HDFL | 65-2066HDFR | 66 | 20 | 21¾ | 230 | W/P\$ 6605 |
| | 65-2060HDFL | 65-2060HDFR | 60 | 20 | 21¾ | 220 | W/P\$ 6465 |

Must Specify (in this order):

Model #
 Top Material
 Finish/Color
 Edge Profile
 Wire Management Sleeve
 Door/Front Panel Grain Direction
 Leg Color
 Worksurface Grommet
 Grommet Color
 Power/Data/Wire Management
 Back Panel Grommet

Description

- Credenza with Controls; Profiled on User Side; Back Panel Included
- Bottom Panel Not Included Behind Removable Access Front Panel for Wire Management
- 9" Door Opening With Touch Latch and Includes Bottom Panel, Storage Behind Door
- Locking Box/File; File Drawers Provide Legal or Letter Filing
- Designed for 28" Deep Worksurfaces Only ([See Worksurfaces](#))
- Handed Based on Height Adjust Cabinet and Facing the Unit
- When Used as Peninsula Desk, Additional Panel Leg Must be Used on Opposite Side for Support ([See Panel Legs](#) 01-2245HTL, 65-0536HPS, or 65-0530HPS)
- Door, Drawers and Removable Access Front Panel Available in Vertical Grain Direction Standard; Optional Horizontal Grain Direction; Must Specify
- If Black or Gold Pull is Selected, Leg and Lock Core will be Black; If Chrome or Aluminum Pull is Selected, Leg and Lock Core will be Silver
- Worksurface Grommet Standard; Must Specify: Black (BLK), Silver (SLV)
- Optional Back Panel Grommet, Must Specify
- Additional Options: Dove Tail Drawer Construction and Soft Close Box Drawer ([See Drawer Options](#)), Power Locations ([See Power Options](#))

Pricing Codes:

W= Wood Top
 P= HPL Top

[See Gesso Intro Section for Ordering Options](#)

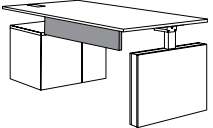
| Item | Model No. | Width | Depth | Height | Ship Wt | Cubic Ft | List Price |
|--|--|-------|-------|--------|---------|----------|------------|
| 7" MODESTY PANEL, VENEER  | 65-5707MOD For Use with 70" Surface with Panel Leg | 57 | ¾ | 7 | 16 | 1.1 | W/P\$ 696 |
| | 65-5107MOD For Use with 64" Surface with Panel Leg | 51 | ¾ | 7 | 16 | 1.1 | W/P\$ 684 |
| | 65-4507MOD For Use with 70" Surface with 20" Credenza | 45 | ¾ | 7 | 15 | 1 | W/P\$ 670 |
| | 65-4107MOD For Use with 70" Surface with 24" Credenza | 41 | ¾ | 7 | 15 | 1 | W/P\$ 666 |
| | 65-3907MOD For Use with 64" Surface with 20" Credenza | 39 | ¾ | 7 | 15 | 0.9 | W/P\$ 658 |
| | 65-3507MOD For Use with 64" Surface with 24" Credenza | 35 | ¾ | 7 | 15 | 0.9 | W/P\$ 647 |
| | 65-3307MOD For Use with 58" Surface with 20" Credenza | 33 | ¾ | 7 | 15 | 0.8 | W/P\$ 639 |
| | 65-2907MOD For Use with 58" Surface with 24" Credenza | 29 | ¾ | 7 | 15 | 0.8 | W/P\$ 629 |

Must Specify (in this order):
Model #
Modesty Finish/Color

Description

- Works With Low Storage; [See Low Credenzas](#) and Modular Units; [See Modular Units](#)
- Attaches with Aluminum Mounting Brackets

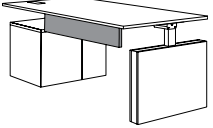
| | | | | | | | |
|---|---|----|---|---|----|-----|--------|
| 7" MODESTY PANEL, FROSTED ACRYLIC  | MD-5707FA For Use with 70" Surface with Panel Leg | 57 | ¾ | 7 | 10 | 1.1 | \$ 623 |
| | MD-5107FA For Use with 64" Surface with Panel Leg | 51 | ¾ | 7 | 9 | 1 | \$ 612 |
| | MD-4507FA For Use with 70" Surface with 20" Credenza | 45 | ¾ | 7 | 9 | 1 | \$ 602 |
| | MD-4107FA For Use with 70" Surface with 24" Credenza | 41 | ¾ | 7 | 8 | 0.9 | \$ 597 |
| | MD-3907FA For Use with 64" Surface with 20" Credenza | 39 | ¾ | 7 | 8 | 0.8 | \$ 590 |
| | MD-3507FA For Use with 64" Surface with 24" Credenza | 35 | ¾ | 7 | 7 | 0.7 | \$ 581 |
| | MD-3307FA For Use with 58" Surface with 20" Credenza | 33 | ¾ | 7 | 7 | 0.6 | \$ 574 |
| | MD-2907FA For Use with 58" Surface with 24" Credenza | 29 | ¾ | 7 | 6 | 0.5 | \$ 564 |

Must Specify (in this order):
Model #
Decorative Hardware Color

Description

- Works With Low Storage; [See Low Credenzas](#) and Modular Units; [See Modular Units](#)
- Exposed Decorative Hardware; Must Specify: Aluminum (ALUM) or Chrome (CHRM)

Pricing Codes:
W= Wood Top
P= HPL Top

[See Gesso Intro Section for Ordering Options](#)

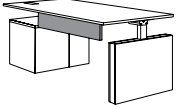
| Item | Model No. | Width | Depth | Height | Ship Wt | Cubic Ft | List Price | |
|--|--|--|-------|--------|---------|----------|------------|-----------|
| 7" MODESTY PANEL, HIGH GLOSS ACRYLIC  | MD-5707HGA | For Use with 70" Surface with Panel Leg | 57 | ¾ | 7 | 16 | 1.1 | \$ 693 |
| | | | | | | | | GPA\$ 741 |
| | MD-5107HGA | For Use with 64" Surface with Panel Leg | 51 | ¾ | 7 | 15 | 1 | \$ 680 |
| | | | | | | | | GPA\$ 730 |
| | MD-4507HGA | For Use with 70" Surface with 20" Credenza | 45 | ¾ | 7 | 15 | 1 | \$ 668 |
| | | | | | | | | GPA\$ 714 |
| | MD-4107HGA | For Use with 70" Surface with 24" Credenza | 41 | ¾ | 7 | 14 | 0.9 | \$ 661 |
| | | | | | | | | GPA\$ 707 |
| | MD-3907HGA | For Use with 64" Surface with 20" Credenza | 39 | ¾ | 7 | 14 | 0.8 | \$ 655 |
| | | | | | | | GPA\$ 702 | |
| MD-3507HGA | For Use with 64" Surface with 24" Credenza | 35 | ¾ | 7 | 13 | 0.7 | \$ 644 | |
| | | | | | | | GPA\$ 690 | |
| MD-3307HGA | For Use with 58" Surface with 20" Credenza | 33 | ¾ | 7 | 13 | 0.6 | \$ 637 | |
| | | | | | | | GPA\$ 680 | |
| MD-2907HGA | For Use with 58" Surface with 24" Credenza | 29 | ¾ | 7 | 12 | 0.5 | \$ 627 | |
| | | | | | | | GPA\$ 670 | |

Must Specify (in this order):

Model #
Modesty Color
Decorative Hardware Color

Description

- Works With Low Storage; [See Low Storage](#) and Modular Units; [See Modular Units](#)
- Attaches with Aluminum Mounting Brackets
- Available in Black (BLA), Wired Mercury (WMA), White (WHA) or Graphite (GPA); Graphite Acrylic Pricing (GPA\$)

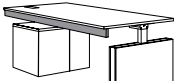
| | | | | | | | | |
|---|------------|--|----|---|---|----|-----|-----------|
| 4" MODESTY PANEL, VENEER  | 65-6804MOD | | 68 | ¾ | 4 | 17 | 1.3 | W/P\$ 684 |
| | 65-6204MOD | | 62 | ¾ | 4 | 16 | 1.2 | W/P\$ 668 |
| | 65-5604MOD | | 56 | ¾ | 4 | 16 | 1.1 | W/P\$ 658 |

Must Specify (in this order):

Model #
Modesty Finish/Color

Description

- Attaches with Aluminum Mounting Brackets
- Not Compatible with Height Adjustable Panel Leg with Sleeve

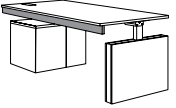
| | | | | | | | | |
|---|-----------|--|----|---|---|----|-----|--------|
| 4" MODESTY PANEL, FROSTED ACRYLIC  | MD-6804FA | | 68 | ¾ | 4 | 12 | 1.3 | \$ 669 |
| | MD-6204FA | | 62 | ¾ | 4 | 11 | 1.2 | \$ 619 |
| | MD-5604FA | | 56 | ¾ | 4 | 10 | 1.1 | \$ 589 |

Must Specify (in this order):

Model #
Modesty Color
Decorative Hardware Color

Description

- Attaches with Aluminum Mounting Brackets
- Exposed Decorative Hardware; Must Specify (ALUM) Aluminum or (CHRM) Chrome
- Not Compatible with Height Adjustable Panel Leg with Sleeve

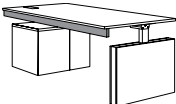
| | | | | | | | | |
|--|------------|----|----|---|----|-----|--------|-----------|
| 4" MODESTY PANEL, HIGH GLOSS ACRYLIC  | MD-6804HGA | | 68 | ¾ | 4 | 17 | 1.3 | \$ 730 |
| | | | | | | | | GPA\$ 781 |
| | MD-6204HGA | | 62 | ¾ | 4 | 16 | 1.2 | \$ 693 |
| | | | | | | | | GPA\$ 742 |
| MD-5604HGA | | 56 | ¾ | 4 | 16 | 1.1 | \$ 654 | |
| | | | | | | | | GPA\$ 699 |

Description

- Attaches with Aluminum Mounting Brackets
- Available in Black (BLA), Wired Mercury (WMA), White (WHA) or Graphite (GPA); Graphite Acrylic Pricing (GPA\$)
- Not Compatible with Height Adjustable Panel Leg with Sleeve

Pricing Codes:

W= Wood Top
P= HPL Top

[See Gesso Intro Section for Ordering Options](#)

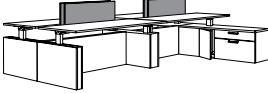
| Item | Model No. | Width | Depth | Height | Ship Wt | Cubic Ft | List Price |
|---|---|-------|-------|--------|---------|----------|------------|
| 20"H ABOVE/BELOW PRIVACY SCREEN, VENEER  | 65-5720PS For Use with 70" Surface with Panel Leg | 57 | ¾ | 20 | 36 | 2.7 | W/P\$ 768 |
| | 65-5120PS For Use with 64" Surface with Panel Leg | 51 | ¾ | 20 | 34 | 2.5 | W/P\$ 742 |
| | 65-4520PS For Use with 70" Surface with 20" Credenza | 45 | ¾ | 20 | 32 | 2.3 | W/P\$ 714 |
| | 65-4120PS For Use with 70" Surface with 24" Credenza | 41 | ¾ | 20 | 30 | 2.2 | W/P\$ 687 |
| | 65-3920PS For Use with 64" Surface with 20" Credenza | 39 | ¾ | 20 | 29 | 2.2 | W/P\$ 662 |
| | 65-3520PS For Use with 64" Surface with 24" Credenza | 35 | ¾ | 20 | 28 | 2.1 | W/P\$ 638 |
| | 65-3320PS For Use with 58" Surface with 20" Credenza | 33 | ¾ | 20 | 27 | 2.1 | W/P\$ 614 |
| | 65-2920PS For Use with 58" Surface with 24" Credenza | 29 | ¾ | 20 | 26 | 1.9 | W/P\$ 589 |

Must Specify (in this order):
Model #
Modesty Finish/Color

Description

- Mounts to Worksurface
- Provides Privacy 12" Above and 7" Modesty Below

| Item | Model No. | Width | Depth | Height | Ship Wt | Cubic Ft | List Price |
|---|---|-------|-------|--------|---------|----------|--------------|
| 20"H ABOVE/BELOW PRIVACY SCREEN, TACKBOARD  | PS-5720TB For Use with 70" Surface with Panel Leg | 57 | ¾ | 20 | 14 | 2.2 | \$ See Below |
| | PS-5120TB For Use with 64" Surface with Panel Leg | 51 | ¾ | 20 | 13 | 2.2 | \$ See Below |
| | PS-4520TB For Use with 70" Surface with 20" Credenza | 45 | ¾ | 20 | 12 | 2 | \$ See Below |
| | PS-4120TB For Use with 70" Surface with 24" Credenza | 41 | ¾ | 20 | 12 | 1.8 | \$ See Below |
| | PS-3920TB For Use with 64" Surface with 20" Credenza | 39 | ¾ | 20 | 11 | 1.8 | \$ See Below |
| | PS-3520TB For Use with 64" Surface with 24" Credenza | 35 | ¾ | 20 | 11 | 1.5 | \$ See Below |
| | PS-3320TB For Use with 58" Surface with 20" Credenza | 33 | ¾ | 20 | 10 | 1.5 | \$ See Below |
| | PS-2920TB For Use with 58" Surface with 24" Credenza | 29 | ¾ | 20 | 10 | 1.5 | \$ See Below |

Must Specify (in this order):
Model #
Fabric Vendor
Fabric Pattern
Fabric Color

Description

- Mounts to Worksurface
- Provides Privacy 12" Above and 7" Modesty Below

| Model | Ydg | Grades 1,2,3 | Grade 4 | Grade 5 | Grade 6 | Grade 7 | Grade 8 | Grade 9 | Grade 10 |
|-----------|------|--------------|---------|---------|---------|---------|---------|---------|----------|
| PS-5720TB | 2.00 | \$ 623 | 901 | 1031 | 1163 | 1351 | 1547 | 1775 | 2039 |
| PS-5120TB | 2.00 | \$ 578 | 856 | 986 | 1118 | 1306 | 1502 | 1730 | 1994 |
| PS-4520TB | 1.75 | \$ 513 | 756 | 870 | 986 | 1150 | 1322 | 1521 | 1752 |
| PS-4120TB | 1.50 | \$ 473 | 682 | 779 | 878 | 1019 | 1166 | 1337 | 1535 |
| PS-3920TB | 1.50 | \$ 459 | 668 | 765 | 864 | 1005 | 1152 | 1323 | 1521 |
| PS-3520TB | 1.50 | \$ 443 | 652 | 749 | 848 | 989 | 1136 | 1307 | 1505 |
| PS-3320TB | 1.25 | \$ 404 | 578 | 659 | 742 | 859 | 982 | 1124 | 1289 |
| PS-2920TB | 1.25 | \$ 383 | 557 | 638 | 721 | 838 | 961 | 1103 | 1268 |

Pricing Codes:
W= Wood Top
P= HPL Top

[See Gesso Intro Section for Ordering Options](#)

| Item | Model No. | Width | Depth | Height | Ship Wt | Cubic Ft | List Price |
|--|---|-------|-------|--------|---------|----------|------------|
|  <p>20"H ABOVE/BELOW PRIVACY SCREEN, FROSTED ACRYLIC</p> <p>Must Specify (in this order): Model #</p> | PS-5720FA For Use with 70" Surface with Panel Leg | 57 | ¼ | 20 | 20 | 2.2 | \$ 1163 |
| | PS-5120FA For Use with 64" Surface with Panel Leg | 51 | ¼ | 20 | 19 | 2.1 | \$ 1075 |
| | PS-4520FA For Use with 70" Surface with 20" Credenza | 45 | ¼ | 20 | 19 | 2 | \$ 988 |
| | PS-4120FA For Use with 70" Surface with 24" Credenza | 41 | ¼ | 20 | 18 | 1.9 | \$ 951 |
| | PS-3920FA For Use with 64" Surface with 20" Credenza | 39 | ¼ | 20 | 18 | 1.8 | \$ 918 |
| | PS-3520FA For Use with 64" Surface with 24" Credenza | 35 | ¼ | 20 | 17 | 1.7 | \$ 881 |
| | PS-3320FA For Use with 58" Surface with 20" Credenza | 33 | ¼ | 20 | 17 | 1.6 | \$ 849 |
| | PS-2920FA For Use with 58" Surface with 24" Credenza | 29 | ¼ | 20 | 16 | 1.5 | \$ 814 |

Description

- Mounts to Worksurface
- Provides Privacy 12" Above and 7" Modesty Below

| | | | | | | | |
|---|--|----|---|----|----|-----|-----------------------|
|  <p>20"H ABOVE/BELOW PRIVACY SCREEN, HIGH GLOSS ACRYLIC</p> <p>Must Specify (in this order): Model # Modesty Color</p> | PS-5720HGA For Use with 70" Surface with Panel Leg | 57 | ⅝ | 20 | 36 | 2.7 | \$ 1230 GPA\$ 1586 |
| | PS-5120HGA For Use with 64" Surface with Panel Leg | 51 | ⅝ | 20 | 34 | 2.5 | \$ 1131 GPA\$ 1451 |
| | PS-4520HGA For Use with 70" Surface with 20" Credenza | 45 | ⅝ | 20 | 32 | 2.3 | \$ 1032 GPA\$ 1313 |
| | PS-4120HGA For Use with 70" Surface with 24" Credenza | 41 | ⅝ | 20 | 30 | 2.2 | \$ 990 GPA\$ 1261 |
| | PS-3920HGA For Use with 64" Surface with 20" Credenza | 39 | ⅝ | 20 | 29 | 2.2 | \$ 960 GPA\$ 1219 |
| | PS-3520HGA For Use with 64" Surface with 24" Credenza | 35 | ⅝ | 20 | 29 | 2.2 | \$ 922 GPA\$ 1174 |
| | PS-3320HGA For Use with 58" Surface with 20" Credenza | 33 | ⅝ | 20 | 27 | 2.1 | \$ 889 GPA\$ 1133 |
| | PS-2920HGA For Use with 58" Surface with 24" Credenza | 29 | ⅝ | 20 | 26 | 1.9 | \$ 851 GPA\$ 1087 |

Description

- Mounts to Worksurface
- Provides Privacy 12" Above and 7" Modesty Below
- Available in Available in Black (BLA), White (WHA) or Graphite (GPA); Graphite Acrylic Pricing (GPA\$)

Pricing Codes:

W= Wood Top

P= HPL Top

[See Gesso Intro Section for Ordering Options](#)

| Item | Model No. | Width | Depth | Height | Ship Wt | Cubic Ft | List Price |
|---|-----------|-------|-------|--------|---------|----------|------------|
| 17"H ABOVE/BELOW PRIVACY SCREEN, VENEER  | 65-6817PS | 68 | ¾ | 17 | 24 | 3.3 | W/P\$ 791 |
| | 65-6217PS | 62 | ¾ | 17 | 22 | 3.1 | W/P\$ 767 |
| | 65-5617PS | 56 | ¾ | 17 | 20 | 2.7 | W/P\$ 741 |
| | 65-5017PS | 50 | ¾ | 17 | 18 | 2.5 | W/P\$ 714 |
| | 65-4417PS | 44 | ¾ | 17 | 16 | 2.3 | W/P\$ 690 |

Must Specify (in this order):
Model #
Modesty Finish/Color

Description

- Aluminum Hardware Used to Mount Screen to Worksurface
- Provides Privacy 12" Above and 4" Modesty Below

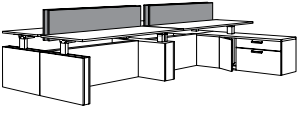
| | | | | | | | |
|--|-----------|----|---|----|----|-----|--------------|
| 17"H ABOVE/BELOW PRIVACY SCREEN, TACKBOARD  | PS-6817TB | 68 | ⅝ | 17 | 15 | 2.5 | \$ See Below |
| | PS-6217TB | 62 | ⅝ | 17 | 14 | 2.5 | \$ See Below |
| | PS-5617TB | 56 | ⅝ | 17 | 13 | 2.2 | \$ See Below |
| | PS-5017TB | 50 | ⅝ | 17 | 12 | 2 | \$ See Below |
| | PS-4417TB | 44 | ⅝ | 17 | 11 | 1.8 | \$ See Below |

Must Specify (in this order):
Model #
Fabric Vendor
Fabric Pattern
Fabric Color

Description

- Mounts to Worksurface
- Provides Privacy 12" Above and 4" Modesty Below
- Decorative Hardware; Must Specify: Aluminum (ALUM) or Chrome (CHRM)

| Model | Ydg | Grades 1,2,3 | Grade 4 | Grade 5 | Grade 6 | Grade 7 | Grade 8 | Grade 9 | Grade 10 |
|-----------|---------|--------------|---------|---------|---------|---------|---------|---------|----------|
| PS-6817TB | 2.00 \$ | 642 | 920 | 1050 | 1182 | 1370 | 1566 | 1794 | 2058 |
| PS-6217TB | 2.00 \$ | 602 | 880 | 1010 | 1142 | 1330 | 1526 | 1754 | 2018 |
| PS-5617TB | 2.00 \$ | 549 | 827 | 957 | 1089 | 1277 | 1473 | 1701 | 1965 |
| PS-5017TB | 2.00 \$ | 520 | 798 | 928 | 1060 | 1248 | 1444 | 1672 | 1936 |
| PS-4417TB | 1.75 \$ | 468 | 711 | 825 | 941 | 1105 | 1277 | 1476 | 1707 |

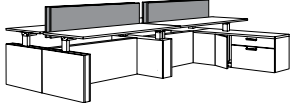
| | | | | | | | |
|--|-----------|----|---|----|----|-----|---------|
| 17"H ABOVE/BELOW PRIVACY SCREEN, FROSTED ACRYLIC  | PS-6817FA | 68 | ¼ | 17 | 14 | 3.3 | \$ 1196 |
| | PS-6217FA | 62 | ¼ | 17 | 14 | 3.1 | \$ 1160 |
| | PS-5617FA | 56 | ¼ | 17 | 13 | 2.9 | \$ 1121 |
| | PS-5017FA | 50 | ¼ | 17 | 13 | 2.7 | \$ 1036 |
| | PS-4417FA | 44 | ¼ | 17 | 12 | 2.5 | \$ 954 |

Must Specify (in this order):
Model #

Description

- Mounts to Worksurface
- Provides Privacy 12" Above and 4" Modesty Below
- Decorative Hardware; Must Specify: Aluminum (ALUM) or Chrome (CHRM)

Pricing Codes:
W= Wood Top
P= HPL Top

[See Gesso Intro Section for Ordering Options](#)

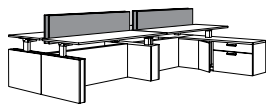
| Item | Model No. | Width | Depth | Height | Ship Wt | Cubic Ft | List Price |
|---|------------|-------|-------|--------|---------|----------|-----------------------|
|  <p>17"H ABOVE/BELOW PRIVACY SCREEN, HIGH GLOSS ACRYLIC</p> <p>Must Specify (in this order): Model # Modesty Color</p> | PS-6817HGA | 68 | ¾ | 17 | 24 | 3.3 | \$ 1260 GPA\$ 1627 |
| | PS-6217HGA | 62 | ¾ | 17 | 22 | 3.1 | \$ 1223 GPA\$ 1579 |
| | PS-5617HGA | 56 | ¾ | 17 | 20 | 2.7 | \$ 1180 GPA\$ 1521 |
| | PS-5017HGA | 50 | ¾ | 17 | 18 | 2.5 | \$ 1088 GPA\$ 1395 |
| | PS-4417HGA | 44 | ¾ | 17 | 16 | 2.3 | \$ 995 GPA\$ 1267 |

Description

- Mounts to Worksurface
- Provides Privacy 12" Above and 4" Modesty Below
- Available in Available in Black (BLA), White (WHA) or Graphite Acrylic (GPA); Graphite Acrylic Pricing (GPA\$)

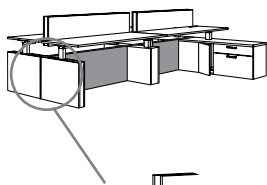
| Item | Model No. | Width | Depth | Height | Ship Wt | Cubic Ft | List Price |
|---|-----------|-------|-------|--------|---------|----------|------------|
|  <p>GALLERY SCREEN, VENEER</p> <p>Gallery Screen is Positioned Between Height Adjustable Legs</p> | 65-2272GS | 72 | 1 | 22 | 31 | 3 | W/P\$ 859 |
| | 65-2266GS | 66 | 1 | 22 | 29 | 2.9 | W/P\$ 827 |
| | 65-2260GS | 60 | 1 | 22 | 27 | 2.8 | W/P\$ 791 |
| | 65-2254GS | 54 | 1 | 22 | 24 | 2.7 | W/P\$ 757 |

Description

- Not Compatible with Optional Wire Management Sleeve
- Gallery Screens are Visible and Can Provide an Accent Between Users in Multi-Station Settings by Selecting a Contrasting Color
- Gallery Screen Positioned Between Height Adjustable Legs

Must Specify (in this order):
Model #
Modesty Finish/Color

Pricing Codes:

W= Wood Top
P= HPL Top

[See Gesso Intro Section for Ordering Options](#)

| Item | Model No. | | Width | Depth | Height | Ship Wt | Cubic Ft | List Price |
|--|-----------|--------|-------|-------|--------|---------|----------|------------|
| ROUND GROMMET COVER FIELD INSTALLED | 01-GRMTBK | Black | - | - | - | - | - | \$ 11 |
| | 01-GRMTSL | Silver | | | | | | |

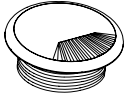

OPEN MARKET ONLY
(SILVER)

Description

- 60mm Round Grommet Cover
- Field Installed

| | | | | | | | | |
|---------------------|-------------|--------|---|---|---|---|----|-------|
| RECTANGULAR GROMMET | 01-HUGRMTSL | Silver | - | - | - | 1 | .1 | \$ 11 |
|---------------------|-------------|--------|---|---|---|---|----|-------|

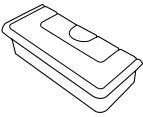

OPEN MARKET ONLY

Description

- For Use with Surface Mount Hatches Only
- 70mm x 30mm Silver Rectangular Grommet with Cover
- Field Installed

| | | | | | | | | |
|--------------------------|-------------|--------|---|---|---|---|-----|-------|
| SINGLE POWER SAND DOLLAR | 01-SAND60PW | White | 3 | 3 | 4 | 1 | 0.2 | \$ 98 |
| | 01-SAND60PB | Black | | | | | | |
| | 01-SAND60PS | Silver | | | | | | |

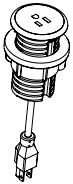

Description

- Unit is 2" Diameter; Mounts in 60mm Round Grommet
- 6' Cord
- Single Power Outlet

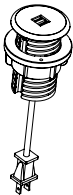

| | | | | | | | | |
|------------------------|-------------|--------|---|---|---|---|-----|--------|
| DOUBLE USB SAND DOLLAR | 01-SAND60UW | White | 3 | 3 | 4 | 1 | 0.2 | \$ 277 |
| | 01-SAND60UB | Black | | | | | | |
| | 01-SAND60US | Silver | | | | | | |



Description

- Unit is 2" Diameter; Mounts in 60mm Round Grommet
- 6' Cord
- Dual USB Outlets

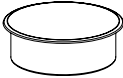
[See Gesso Intro Section for Ordering Options](#)

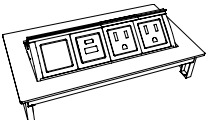
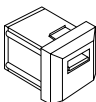
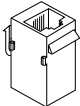
| Item | Model No. | | Width | Depth | Height | Ship Wt | Cubic Ft | List Price |
|---|-------------|----------|------------------|------------------|---------------|---------|----------|------------|
| DOCK 950 WIRELESS CHARGER | 01-DOCK950W | White | 3 $\frac{3}{16}$ | 3 $\frac{3}{16}$ | - | 1 | 0.2 | \$ 265 |
| | 01-DOCK950B | Black | | | | | | |
|  <p>OPEN MARKET ONLY</p> <p>Description</p> <ul style="list-style-type: none"> • For Use with Wireless Charging Enabled Devices • 5 Watts Maximum Output with a Direct Current of 5V 2A and 10 Watts Maximum with Quick Charge 2.0 • Mounts in 76mm Round Cut-Out • LED will Confirm Pairing with Device and Begin Wireless Charging | | | | | | | | |
| DOCK 150 WIRELESS AND USB CHARGER | 01-DOCK150W | White | 3 | 3 | $\frac{3}{4}$ | 1 | 0.2 | \$ 405 |
| | 01-DOCK150B | Black | | | | | | |
|  <p>OPEN MARKET ONLY</p> <p>Description</p> <ul style="list-style-type: none"> • For Use with Wireless Charging Enabled Devices and USB Charging Devices • 5 Watt Maximum Output with a Direct Current Input of 5V 6A (Wireless Fast Charge) • Mounts in 76mm Round Cut-Out • Pop-Up is $\frac{3}{4}$"H and Includes Three (3) USB Ports; One (1) 12 Watt Maximum with 2.4A (USB Fast Charge) and Two (2) 5 Watt with 1A (USB Standard Charge) • LED Light will Confirm Pairing with Device and Begin Wireless Charging • UL and cUL Certified | | | | | | | | |
| POWER DATA PORT | 01-DPORT4A | Aluminum | 8 | 4 | - | 7 | 0.2 | \$ 1093 |
| | 01-DPORT4B | Black | 8 | 4 | - | 7 | 0.2 | \$ 1093 |
|  <p>Description</p> <ul style="list-style-type: none"> • Retracts into Worksurface to Regain Productive Space • One-Touch Access to Power and Data • Two Power Outlets and Two Open Ports for Data • Water-Proof Simplex (Outlets) • Includes a Voice/Data Adapter Kit to Accept Couplers and Jacks When Required 6' Power Cord • Only Available on 66-4872TP, 66-4866TP, 66-4860TP, 66-3672TP, 66-3072TP, 66-3066TP and 66-3060TP Modular Desktops (See Modular Tops) Centered, One End | | | | | | | | |
| USB PORT | 01-USBPORT | | - | - | - | - | - | \$ 161 |
|  <p>Description</p> <ul style="list-style-type: none"> • For Use with 01-DPORT4A and 01-DPORT4B • Passive USB-A Port with Increased Transfer Speed Up to 5 gbs/sec • Simultaneous Read/Write Capability • Idle Device Power Saving State • 6' Cord • See Voice Coupler and Data Port on Next Page | | | | | | | | |
| VOICE COUPLER | 01-VOICE1 | | - | - | - | - | - | \$ 73 |
|  <p>Description</p> <ul style="list-style-type: none"> • For Use with 01-DPORT4A and 01-DPORT4B • 6-Pin Modular Plug • Molded Black • Cord Not included | | | | | | | | |

[See Gesso Intro Section for Ordering Options](#)

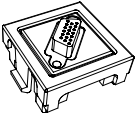
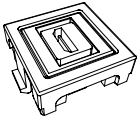
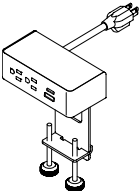
| Item | Model No. | Width | Depth | Height | Ship Wt | Cubic Ft | List Price | |
|---|--|--------|-------|--------|---------|----------|------------|--------|
| DATA PORT | 01-RJ4DATA | - | - | - | - | - | \$ 167 | |
|  | Description | | | | | | | |
| OPEN MARKET ONLY | <ul style="list-style-type: none"> • For Use with 01-DPORT4A and 01-DPORT4B • 8-Pin Modular Plug; Cat6 Ethernet Cable; Pre-terminated Cable • 10' Cord | | | | | | | |
| VGA CONNECTOR ACCESSORY | 01-VGACON | - | - | - | 1 | 0.2 | \$ 149 | |
|  | Description | | | | | | | |
| | <ul style="list-style-type: none"> • VGA Port for 01-DPORT4A and 01-DPORT4B • Enables Devices to Remote Display on Monitors • 10' Cord • Male/Female Connector | | | | | | | |
| HDMI CONNECTOR ACCESSORY | 01-HDMICON | - | - | - | 1 | 0.2 | \$ 124 | |
|  | Description | | | | | | | |
| | <ul style="list-style-type: none"> • HDMI Port for 01-DPORT4A and 01-DPORT4B • Connects to High Definition Displays • Female/Female Connector • 18" Cord | | | | | | | |
| DUO CLAMP WITH NEMA PLUG | 01-DUOCLAMPW | White | 6½ | 3 | 7 | 1 | 0.2 | \$ 572 |
| | 01-DUOCLAMPB | Black | | | | | | |
| | 01-DUOCLAMPS | Silver | | | | | | |
|  | Description | | | | | | | |
| | <ul style="list-style-type: none"> • Standard with: Two (2) Power Outlet, One (1) USB Charging Port and One (1) 60-Watt USB-C Power Delivery Port with GaN Technology with 10' Cord • Clamps to Top and Features Silver Metal Trim • Independent USB Circuit Controllers Deliver up to 2.1 Amps to Each Post • All Mounting Hardware Included • FCC Part 15A and UL Approved for Horizontal and Vertical Applications | | | | | | | |

[See Gesso Intro Section for Ordering Options](#)

| Item | Model No. | | Width | Depth | Height | Ship Wt | Cubic Ft | List Price |
|------------------------------|----------------|--------|-------|-------|--------|---------|----------|------------|
| TRIO CLAMP WITH NEMA PLUG | 01-TRIOCLAMPW | White | 9 | 3 | 7 | 1 | 0.2 | \$ 671 |
| | 01-TRIOCLAMPB | Black | | | | | | |
| | 01-TRIOCLAMP S | Silver | | | | | | |

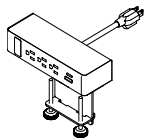

Description

- Standard with: Three (3) Power Outlets, **One (1) USB Charging Port, One (1) 60-Watt USB-C Power Delivery Port with GaN Technology, One (1) Open Data** with 10' Cord
- Clamps to Top and Features Silver Metal Trim
- Independent USB Circuit Controllers Deliver up to 2.1 Amps to Each Post
- HDMI, VGA, or RJ45 Sold Separately; [See Accessories](#)
- All Mounting Hardware Included
- FCC Part 15A and UL Approved for Horizontal and Vertical Applications

| | | | | | | | | |
|-----------------------------|--------------|--------|----|----|---|---|-----|--------|
| DUO BEZEL WITH NEMA PLUG | 01-DUOBEZELW | White | 6½ | 2½ | 3 | 1 | 0.2 | \$ 675 |
| | 01-DUOBEZELB | Black | | | | | | |
| | 01-DUOBEZELS | Silver | | | | | | |



Description

- Sits On Top of the Worksurface and Includes: Two (2) Power, **One (1) USB Charging Port and One (1) 60-Watt USB-C Power Delivery Port with GaN Technology** with 10' Cord
- Independent USB Circuit Controllers Deliver up to 2.1 Amps to Each Post
- All Mounting Hardware Included
- FCC Part 15A and UL Approved for Horizontal and Vertical Applications

| | | | | | | | | |
|------------------------------|---------------|--------|---|----|---|---|-----|--------|
| TRIO BEZEL WITH NEMA PLUG | 01-TRIOBEZELW | White | 9 | 2½ | 3 | 1 | 0.2 | \$ 725 |
| | 01-TRIOBEZELB | Black | | | | | | |
| | 01-TRIOBEZELS | Silver | | | | | | |



Description

- Sits On Top of the Worksurface and Includes: Three (3) Power, **One (1) USB Charging Port and One (1) 60-Watt USB-C Power Delivery Port with GaN Technology**, One (1) Open Data with 10' Cord
- Independent USB Circuit Controllers Deliver up to 2.1 Amps to Each Post
- HDMI, VGA, or RJ45 Sold Separately; [See Accessories](#)
- All Mounting Hardware Included
- FCC Part 15A and UL Approved for Horizontal and Vertical Applications

[See Gesso Intro Section for Ordering Options](#)

| Item | Model No. | | Width | Depth | Height | Ship Wt | Cubic Ft | List Price |
|---|------------------|--------|-------|-------|--------|---------|----------|------------|
| DUO BEZEL WITH HARD WIRE CONNECTION  | Circuit 1 | | | | | | | |
| | 01-HWDUOBEZELW1 | White | 6½ | 2½ | 3 | 1 | 0.2 | \$ 730 |
| | 01-HWDUOBEZELB1 | Black | | | | | | |
| | 01-HWDUOBEZELS1 | Silver | | | | | | |
| | Circuit 2 | | | | | | | |
| | 01-HWDUOBEZELW2 | White | 6½ | 2½ | 3 | 1 | 0.2 | \$ 730 |
| | 01-HWDUOBEZELB2 | Black | | | | | | |
| | 01-HWDUOBEZELS2 | Silver | | | | | | |
| | Circuit 3 | | | | | | | |
| | 01-HWDUOBEZELW3 | White | 6½ | 2½ | 3 | 1 | 0.2 | \$ 730 |
| | 01-HWDUOBEZELB3 | Black | | | | | | |
| | 01-HWDUOBEZELS3 | Silver | | | | | | |
| Circuit 4 | | | | | | | | |
| 01-HWDUOBEZELW4 | White | 6½ | 2½ | 3 | 1 | 0.2 | \$ 730 | |
| 01-HWDUOBEZELB4 | Black | | | | | | | |
| 01-HWDUOBEZELS4 | Silver | | | | | | | |

Description

- Must Specify Color and Circuit
- Sits on worksurface and Includes: Two (2) Power, **One (1) USB Charging Port and One (1) 60-Watt USB-C Power Delivery Port with GaN Technology**, and All Mounting Hardware
- Independent USB Circuit Controllers Deliver up to 2.1 Amps to Each Post
- FCC Part 15A and UL Approved for Horizontal and Vertical Applications
- Maximum 10 Duo Units per Circuit
- Eight (8) Wire/Four (4) Circuit Hard Wire Power Unit
- See Power Entry, Jumper Cable, and Quad Block on Next Page

[See Gesso Intro Section for Ordering Options](#)

| Item | Model No. | | Width | Depth | Height | Ship Wt | Cubic Ft | List Price | |
|--|------------------|--------|-------|-------|--------|---------|----------|------------|--|
| TRIO BEZEL WITH HARD WIRE CONNECTION  | Circuit 1 | | | | | | | | |
| | 01-HWTRIOBEZELW1 | White | 9 | 2½ | 3 | 1 | 0.2 | \$ 749 | |
| | 01-HWTRIOBEZELB1 | Black | | | | | | | |
| | 01-HWTRIOBEZELS1 | Silver | | | | | | | |
| | Circuit 2 | | | | | | | | |
| | 01-HWTRIOBEZELW2 | White | 9 | 2½ | 3 | 1 | 0.2 | \$ 749 | |
| | 01-HWTRIOBEZELB2 | Black | | | | | | | |
| | 01-HWTRIOBEZELS2 | Silver | | | | | | | |
| | Circuit 3 | | | | | | | | |
| | 01-HWTRIOBEZELW3 | White | 9 | 2½ | 3 | 1 | 0.2 | \$ 749 | |
| | 01-HWTRIOBEZELB3 | Black | | | | | | | |
| | 01-HWTRIOBEZELS3 | Silver | | | | | | | |
| | Circuit 4 | | | | | | | | |
| | 01-HWTRIOBEZELW4 | White | 9 | 2½ | 3 | 1 | 0.2 | \$ 749 | |
| | 01-HWTRIOBEZELB4 | Black | | | | | | | |
| | 01-HWTRIOBEZELS4 | Silver | | | | | | | |

Description

- Must Specify Color and Circuit
- Sits on Worksurface and Includes: Three (3) Power, **One (1) USB Charging Port and One (1) 60-Watt USB-C Power Delivery Port with GaN Technology**, and All Mounting Hardware
- Independent USB Circuit Controllers Deliver up to 2.1 Amps to Each Post
- FCC Part 15A and UL Approved for Horizontal and Vertical Applications
- Maximum 6 Trio Units per Circuit
- Eight (8) Wire/Four (4) Circuit Hard Wire Power Unit
- HDMI, VGA, or RJ45 Sold Separately; [See Accessories](#)
- See Power Entry, Jumper Cable, and Quad Block Below and on Next Page

| | | | | | | | | |
|------------------------------|----------------|--|---|---|---|---|-----|-------|
| QUAD BLOCK HARD WIRED | 01-HWQUADBLOCK | | - | - | - | 1 | 0.2 | \$ 62 |
|------------------------------|----------------|--|---|---|---|---|-----|-------|

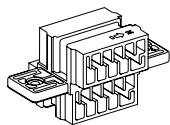

Description

- Eight (8) Wire/Four (4) Circuit Hard Wire Connector
- UL183 Compliant
- For Connecting Jumpers and Power Units
- Quantity of Four (4) Female Inputs

| | | | | | | | | |
|-------------------------------|-----------------|--|----|---|---|---|-----|--------|
| POWER ENTRY HARD WIRED | 01-HWPOWERENTRY | | 72 | - | - | 1 | 0.2 | \$ 322 |
|-------------------------------|-----------------|--|----|---|---|---|-----|--------|

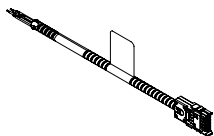

Description

- Eight (8) Wire/Four (4) Circuit Hard Wire Infeed
- UL183 Compliant

[See Gesso Intro Section for Ordering Options](#)

| Item | Model No. | Width | Depth | Height | Ship Wt | Cubic Ft | List Price |
|---|------------|-------|-------|--------|---------|----------|------------|
|  <p>JUMPER HARD WIRE CABLE</p> | 01-HW2JUMP | 24 | - | - | 1 | 0.2 | \$ 193 |
| | 01-HW3JUMP | 36 | - | - | 1 | 0.2 | \$ 206 |
| | 01-HW4JUMP | 48 | - | - | 1 | 0.2 | \$ 212 |
| | 01-HW5JUMP | 60 | - | - | 1 | 0.2 | \$ 255 |
| | 01-HW6JUMP | 72 | - | - | 1 | 0.2 | \$ 270 |

Description

- Eight (8) Wire/Four (4) Circuit Hard Wire Jumper
- UL183 Compliant

| | | | | | | | | |
|--|---------------|--------|----|----|---|---|-----|--------|
|  <p>DUO BEZEL WITH DAISY CHAIN PLUG</p> | 01-PDUOBEZELW | White | 6½ | 2½ | 3 | 1 | 0.2 | \$ 668 |
| | 01-PDUOBEZELB | Black | | | | | | |
| | 01-PDUOBEZELS | Silver | | | | | | |

Description

- Sits On Top of the Worksurface and Includes: Two (2) Power, **One (1) USB Charging Port and One (1) 60-Watt USB-C Power Delivery Port with GaN Technology** with 12" Cord
- Independent USB Circuit Controllers Deliver up to 2.1 Amps to Each Post
- All Mounting Hardware Included
- FCC Part 15A, RU Listed and UL Recognized for Horizontal and Vertical Applications
- Non Sequential System Allows Up to Eight (8) Modules To Be Connected With Jumper Cord
- Requires Power Box, See Below; See Jumper Cable on Next Page

| | | | | | | | | |
|---|----------------|--------|---|----|---|---|-----|--------|
|  <p>TRIO BEZEL WITH DAISY CHAIN PLUG</p> | 01-PTRIOBEZELW | White | 9 | 2½ | 3 | 1 | 0.2 | \$ 715 |
| | 01-PTRIOBEZELB | Black | | | | | | |
| | 01-PTRIOBEZELS | Silver | | | | | | |

Description

- Sits On Top of the Worksurface and Includes: Three (3) Power, **One (1) USB Charging Port, One (1) 60-Watt USB-C Power Delivery Port with GaN Technology**, and One (1) Open Data with 12" Cord
- HDMI, VGA, or RJ45 Sold Separately; [See Accessories](#)
- All Mounting Hardware Included
- FCC Part 15A, RU Listed and UL Recognized for Horizontal and Vertical Applications
- Non Sequential System Allows Up to Eight (8) Modules To Be Connected With Jumper Cord
- Requires Power Box, See Below; See Jumper Cable on Next Page

[See Gesso Intro Section for Ordering Options](#)

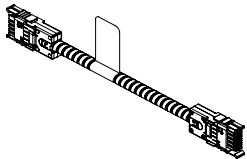
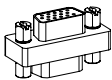
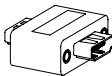
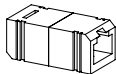
| Item | Model No. | | Width | Depth | Height | Ship Wt | Cubic Ft | List Price |
|---|---|--------------------------------|-------|-------|--------|---------|----------|------------|
| DAISY CHAIN POWER BOX  | 01-PPOWER | 76" Perimeter, 36" Power Cord | - | - | - | 1 | 0.2 | \$ 775 |
| | 01-PPOWER2 | 24" Perimeter, 144" Power Cord | - | - | - | 1 | 0.2 | \$ 796 |
| Description | | | | | | | | |
| <ul style="list-style-type: none"> • Powers up to Eight (8) Duo and Trio Daisy Chain Units • One (1) Nema Plug and One (1) Daisy Chain Plug • 12 Amp System Rating • 15 Amp Over-Current Protection | | | | | | | | |
| DAISY CHAIN JUMPER CORD  | 01-6JUMP | 72" Long | - | - | - | 1 | 0.2 | \$ 299 |
| | 01-5JUMP | 60" Long | - | - | - | 1 | 0.2 | \$ 284 |
| | 01-4JUMP | 48" Long | - | - | - | 1 | 0.2 | \$ 240 |
| | 01-2JUMP | 24" Long | - | - | - | 1 | 0.2 | \$ 220 |
| Description | | | | | | | | |
| <ul style="list-style-type: none"> • Connects Duo and Trio Daisy Chain Units • Non Sequential System Allows up to Eight (8) Modules to be Connected | | | | | | | | |
| VGA DATA PORT ACCESSORY | 01-LCOMVGA | | - | - | - | 1 | 0.2 | \$ 121 |
|  | Description | | | | | | | |
| | <ul style="list-style-type: none"> • VGA Port for Trio Bezel and Trio Clamp Units | | | | | | | |
| HDMI DATA PORT ACCESSORY | 01-LCOMHDMI | | - | - | - | 1 | 0.2 | \$ 166 |
|  | Description | | | | | | | |
| | <ul style="list-style-type: none"> • HDMI Port for Trio Bezel and Trio Clamp Units | | | | | | | |
| OPEN MARKET ONLY | | | | | | | | |
| RJ45 DATA PORT ACCESSORY | 01-LCOMRJ45 | | - | - | - | 1 | 0.2 | \$ 79 |
|  | Description | | | | | | | |
| | <ul style="list-style-type: none"> • RJ45 Port for Trio Bezel and Trio Clamp Units | | | | | | | |

[See Gesso Intro Section for Ordering Options](#)

| Item | Model No. | Width | Depth | Height | Ship Wt | Cubic Ft | List Price |
|-------------------------|-----------|-------|-------|--------|---------|----------|------------|
| WIRE MANAGEMENT CHANNEL | 01-WMGR4 | 16 | 1½ | ¾ | 1 | - | \$ 116 |

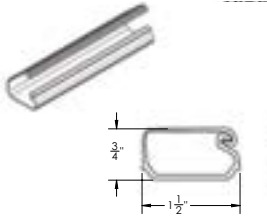

Description

- Set of Four (4) Black Plastic Wire Management Channels
- Snap Lock Channel
- Attaches with Adhesive Strips
- Ships via UPS Only

| | | | | | | | |
|--------------|----------|----|----|---|-----|-----|--------|
| WIRE CHANNEL | 01-32125 | 24 | 1¾ | 1 | .25 | 0.3 | \$ 106 |
|--------------|----------|----|----|---|-----|-----|--------|

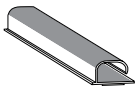

Description

- Available in Black
- Channels Attach with 2 Double-Sided Installation Tape
- Open J Channel for Easy Storage of Cables

| | | | | | | | |
|------------|-----------|-----|-------|---|---|---|--------|
| CABLE GRIP | 01-WMGRCB | 5 ¾ | 2 5/8 | - | - | - | \$ 117 |
|------------|-----------|-----|-------|---|---|---|--------|

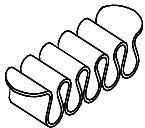

Description

- Under Surface Wire Management
- Black

| | | | | | | | | |
|------------------------|----------------|--------|--------|--------|-------|---|-----|--------|
| LINK 360 CABLE MANAGER | 01-0251LINKSLV | Silver | 5 3/16 | 3 3/16 | 30-51 | 4 | 3.0 | \$ 390 |
| | 01-0251LINKBLK | Black | 5 3/16 | 3 3/16 | 30-51 | 4 | 3.0 | \$ 353 |

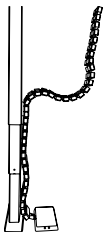

Description

- Kit Includes: 50 Link 360™ elements, One (1) Quad Connector, One (1) Dumbbell Connector, One (1) Foot Assembly with Two (2) Magnetic Clips
- Can Be Used For Height-Adjustable Mechanisms Up To 51" or Free-Standing Use

[See Gesso Intro Section for Ordering Options](#)

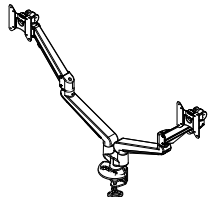
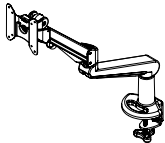
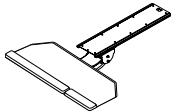
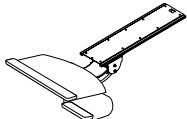
| Item | Model No. | | Width | Depth | Height | Ship Wt | Cubic Ft | List Price |
|---|---|-------------------|-------|-------|--------|---------|----------|------------|
| DUAL ARTICULATING MONITOR ARM | 01-MLEDGE2A | Aluminum | - | - | 6½-19½ | 15 | 1.4 | \$ 1313 |
| | 01-MLEDGE2B | Black | | | | | | |
|  | Description | | | | | | | |
| | <ul style="list-style-type: none"> • Dual Mount with Independent Adjustment Includes Desk Clamp, Grommet Mount, and Enclosed Cable Management • 180° Lockout Feature • 21" Monitor Extension; 3.5" Monitor Retraction • +30/-25° Monitor Tilt; 360° Swivel at Two Points • 17.6lb Weight Capacity per Arm • VESA 75mm and VESA 100mm Compatible with Quick Monitor Release | | | | | | | |
| SINGLE MONITOR ARM | 01-MLEDGE1A | Aluminum | - | - | 6½-19½ | 13 | 2.2 | \$ 773 |
| | 01-MLEDGE1B | Black | | | | | | |
|  | Description | | | | | | | |
| | <ul style="list-style-type: none"> • Includes Desk Clamp, Grommet Mount, and Enclosed Cable Management • 180° Lockout Feature • 21" Monitor Extension; 3.5" Monitor Retraction • +30/-25° Monitor Tilt; 17.6lb Weight Capacity • VESA 75mm and VESA 100mm Compatible with Quick Monitor Release | | | | | | | |
| ARTICULATING KEYBOARD CORNER PLATFORM | 01-KB2CC | | 25 | 10½ | 4½ | 16 | 1.4 | \$ 832 |
| | Description | | | | | | | |
|  | <ul style="list-style-type: none"> • Standard With: +/- 15° Tilt Adjustment , 360° Rotation, Independent Tilt Adjustment, 7" Lift and Lock Height Adjustment, 25" Cut Corner Platform • Keyboard and Mouse on same level; Single Palm Rest for both Left & Right Hands • Works with 17"+ Diagonal Work Surface • Cannot Be Used on 20" or 21" Deep Unit • Not Available with Optional Center Grommet • Track Measures 21" | | | | | | | |
| | Options: Specify & Add | | | | | | | |
| | KB2CC | Factory Installed | | | | | | \$ 208 |
| KEYBOARD MECHANISM WITH KEYBOARD CLAMP | 01-KB3 | | 26½ | 14 | 4.5 | 16 | 1.4 | \$ 914 |
| | Description | | | | | | | |
|  | <ul style="list-style-type: none"> • Standard With: 18.75" Platform with Swivel-Below Mouse Platform,+/- 15° Tilt Adjustment, 360° Rotation, 7" Lift and Lock Height Adjustment, Independent Tilt Adjustment, Palm Rest for Mousing Surface • Left or Right Handed Mouse Platform • Cannot Be Used on 20" or 21" Deep Unit • Not Available with Optional Center Grommet • Track Measures 21" | | | | | | | |
| | Options: Specify & Add | | | | | | | |
| | KB3 | Factory Installed | | | | | | \$ 208 |

[See Gesso Intro Section for Ordering Options](#)

| Item | Model No. | Width | Depth | Height | Ship Wt | Cubic Ft | List Price |
|---------------|-----------|-------|-------|--------|---------|----------|------------|
| CENTER DRAWER | 65-1622CD | 22 | 16 | 2 | 7 | 1.4 | W\$ 495 |

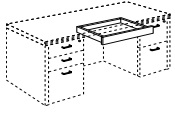
Description

- Fits Desks, P-Top Units, and D-Top Units
- Center Drawer Features Multi-Step, Hand-Finished Catalyzed Finish
- Will Not Work in Conjunction with Height Adjustable Mechanisms or Modesty Panels on 30" D-Top Units

Must Specify (in this order):

Model #
Color
Drawer Front Grain
Factory Installed

Options: Specify & Add

| | | |
|------|-------------------|--------|
| CD16 | Factory Installed | \$ 208 |
|------|-------------------|--------|

| Item | Model No. | Width | Depth | Height | Ship Wt | Cubic Ft | List Price |
|----------------|-----------|-------|-------|--------|---------|----------|------------|
| LED TASKLIGHTS | TL-0848 | 47½ | 7/8 | 1½ | - | - | \$ 445 |

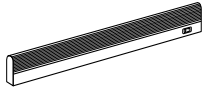

240-LED, 18 Watts

| | | | | | | | |
|---------|--|-----|-----|----|---|---|--------|
| TL-0824 | | 22½ | 7/8 | 1½ | - | - | \$ 368 |
|---------|--|-----|-----|----|---|---|--------|

84-LED, 7 Watts

Description

- Includes the Power Supply and Three Upper Wire Management Grommets
- Rocker Style On/Off Switch with a 10' Power Cord
- Grommet Color will Match Lower Grommet Color

| Item | Model No. | Width | Depth | Height | Ship Wt | Cubic Ft | List Price |
|----------------|-------------|-------|-------|--------|---------|----------|------------|
| LED TASKLIGHTS | 01-188LED58 | 57¾ | 2 | ¾ | - | - | \$ 1648 |

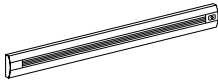

96-LED, 33.7 Watts

| | | | | | | | |
|------------|--|-----|---|---|---|---|---------|
| 01-94LED31 | | 30¾ | 2 | ¾ | - | - | \$ 1195 |
|------------|--|-----|---|---|---|---|---------|

48-LED, 17.6 Watts

| | | | | | | | |
|------------|--|-----|---|---|---|---|--------|
| 01-47LED17 | | 16¾ | 2 | ¾ | - | - | \$ 690 |
|------------|--|-----|---|---|---|---|--------|

24-LED, 9.1 Watts

Description

- Includes the Power Supply and Three Upper Wire Management Grommets
- 12' Power Cord
- Grommet Color will Match Lower Grommet Color
- Optional Occupancy Sensor Shuts Off After 30 Minutes of Inactivity and Turns On Immediately When Reentering the Detection Area

Options: Specify & Add

| | | |
|---------|------------------|--------|
| 01-OSRP | Occupancy Sensor | \$ 366 |
|---------|------------------|--------|

[See Gesso Intro Section for Ordering Options](#)

| Item | Model No. | | Width | Depth | Height | Ship Wt | Cubic Ft | List Price |
|--|------------|----------------------|-------|-------|--------|---------|----------|------------|
|  <p>Must Specify (in this order): Model # Color</p> | 65-15108LS | 192 lbs Weight Limit | 108 | 15 | 17 | 95 | 20.6 | W\$ 2235 |
| | 65-15102LS | 192 lbs Weight Limit | 102 | 15 | 17 | 90 | 19.4 | W\$ 2135 |
| | 65-1596LS | 192 lbs Weight Limit | 96 | 15 | 17 | 85 | 18.3 | W\$ 2033 |
| | 65-1590LS | 192 lbs Weight Limit | 90 | 15 | 17 | 80 | 17.2 | W\$ 1938 |
| | 65-1584LS | 154 lbs Weight Limit | 84 | 15 | 17 | 75 | 16.0 | W\$ 1836 |
| | 65-1578LS | 154 lbs Weight Limit | 78 | 15 | 17 | 70 | 14.9 | W\$ 1736 |
| | 65-1572LS | 154 lbs Weight Limit | 72 | 15 | 17 | 65 | 13.8 | W\$ 1635 |
| | 65-1566LS | 128 lbs Weight Limit | 66 | 15 | 17 | 60 | 12.7 | W\$ 1539 |
| | 65-1560LS | 128 lbs Weight Limit | 60 | 15 | 17 | 55 | 11.6 | W\$ 1448 |
| | 65-1554LS | 90 lbs Weight Limit | 54 | 15 | 17 | 50 | 10.5 | W\$ 1351 |
| | 65-1548LS | 90 lbs Weight Limit | 48 | 15 | 17 | 45 | 9.3 | W\$ 1255 |
| | 65-1542LS | 90 lbs Weight Limit | 42 | 15 | 17 | 40 | 8.2 | W\$ 1162 |
| | 65-1536LS | 64 lbs Weight Limit | 36 | 15 | 17 | 35 | 7.1 | W\$ 1067 |
| | 65-1530LS | 64 lbs Weight Limit | 30 | 15 | 17 | 30 | 6.0 | W\$ 969 |

Description

- Weight Capacity is a Distributed Load
- Not Liable for Wall Mount Units that are not Properly Installed

| Item | Model No. | | Width | Depth | Height | Ship Wt | Cubic Ft | List Price |
|--|------------|----------------------|-------|-------|--------|---------|----------|------------|
|  <p>Must Specify (in this order): Model # Color</p> | 65-09108FS | 123 lbs Weight Limit | 108 | 9 | 1 | 23 | 2.5 | W\$ 1508 |
| | 65-09102FS | 123 lbs Weight Limit | 102 | 9 | 1 | 22 | 2.3 | W\$ 1452 |
| | 65-0996FS | 123 lbs Weight Limit | 96 | 9 | 1 | 20 | 2.2 | W\$ 1394 |
| | 65-0990FS | 123 lbs Weight Limit | 90 | 9 | 1 | 19 | 2.1 | W\$ 1335 |
| | 65-0984FS | 99 lbs Weight Limit | 84 | 9 | 1 | 18 | 1.9 | W\$ 1275 |
| | 65-0978FS | 99 lbs Weight Limit | 78 | 9 | 1 | 16 | 1.8 | W\$ 1216 |
| | 65-0972FS | 99 lbs Weight Limit | 72 | 9 | 1 | 16 | 1.6 | W\$ 1159 |
| | 65-0966FS | 82 lbs Weight Limit | 66 | 9 | 1 | 14 | 1.5 | W\$ 1091 |
| | 65-0960FS | 82 lbs Weight Limit | 60 | 9 | 1 | 13 | 1.4 | W\$ 1018 |
| | 65-0954FS | 57 lbs Weight Limit | 54 | 9 | 1 | 12 | 1.3 | W\$ 946 |
| | 65-0948FS | 57 lbs Weight Limit | 48 | 9 | 1 | 10 | 1.1 | W\$ 876 |
| | 65-0942FS | 57 lbs Weight Limit | 42 | 9 | 1 | 9 | 0.9 | W\$ 805 |
| | 65-0936FS | 40 lbs Weight Limit | 36 | 9 | 1 | 8 | 0.8 | W\$ 731 |
| | 65-0930FS | 40 lbs Weight Limit | 30 | 9 | 1 | 6 | 0.7 | W\$ 659 |

Description

- Weight Capacity is a Distributed Load
- Not Liable for Wall Mount Units that are not Properly Installed

[See Gesso Intro Section for Ordering Options](#)

| Item | Model No. | Width | Depth | Height | Ship Wt | Cubic Ft | List Price |
|---|------------|-------|-------|--------|---------|----------|------------|
| MAGNETIC GLASS MARKER BOARD | GMB-23108H | 106½ | ½ | 23 | 83 | 14.3 | \$ 3834 |
| FOR USE WITH 30"H DESKS AND CREDENZA AND SURFACE MOUNT HUTCHES WITHOUT PAPERSLOTS | GMB-23102H | 100½ | ½ | 23 | 78 | 13.6 | \$ 3558 |
| | GMB-2396H | 94½ | ½ | 23 | 74 | 12.9 | \$ 3351 |
| | GMB-2390H | 88½ | ½ | 23 | 69 | 12.2 | \$ 3145 |
| | GMB-2384H | 82½ | ½ | 23 | 64 | 11.4 | \$ 3009 |
| | GMB-2378H | 76½ | ½ | 23 | 59 | 10.7 | \$ 2802 |
| | GMB-2372H | 70½ | ½ | 23 | 55 | 10.0 | \$ 2526 |
| | GMB-2366H | 64½ | ½ | 23 | 50 | 9.2 | \$ 2318 |
| | GMB-2360H | 58½ | ½ | 23 | 45 | 8.5 | \$ 2182 |
| | GMB-2354H | 52½ | ½ | 23 | 41 | 7.8 | \$ 1908 |
| | GMB-2348H | 46½ | ½ | 23 | 36 | 7.0 | \$ 1770 |
| | GMB-2342H | 40½ | ½ | 23 | 31 | 6.3 | \$ 1494 |
| | GMB-2336H | 34½ | ½ | 23 | 27 | 5.6 | \$ 1287 |
| GMB-2330H | 28½ | ½ | 23 | 22 | 4.9 | \$ 1151 | |

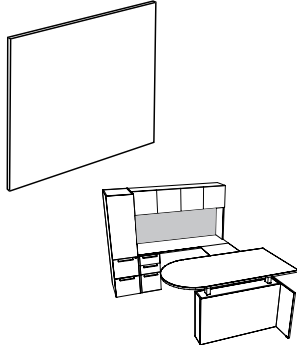

Must Specify (in this order):

Model #
Color



Rare Earth Magnets, Marker and Eraser set available; [See Set Options](#)

Description

- Available in Black (BLMKR) or White (WHMKR), Must Specify
- Tempered Glass Magnetic Marker Boards Are One (1) Piece with No Seams
- Mounting Brackets Included
- For Use with 30"H Desks and Credenzas with Surface Mount Hutches Without Paperslots
- For Rare Earth Magnets, Marker and Eraser Sets; [See Set Options](#)

| | | | | | | | |
|--|------------|-----|----|----|-----|---------|---------|
| MAGNETIC GLASS MARKER BOARD | GMB-23108W | 108 | ½ | 23 | 85 | 14.6 | \$ 3834 |
| FOR USE WITH 30"H DESKS AND CREDENZA AND WALL MOUNT HUTCHES WITHOUT PAPERSLOTS | GMB-23102W | 102 | ½ | 23 | 80 | 13.9 | \$ 3696 |
| | GMB-2396W | 96 | ½ | 23 | 75 | 13.1 | \$ 3489 |
| | GMB-2390W | 90 | ½ | 23 | 70 | 12.4 | \$ 3215 |
| | GMB-2384W | 84 | ½ | 23 | 66 | 11.7 | \$ 3009 |
| | GMB-2378W | 78 | ½ | 23 | 61 | 10.9 | \$ 2802 |
| | GMB-2372W | 72 | ½ | 23 | 56 | 10.2 | \$ 2595 |
| | GMB-2366W | 66 | ½ | 23 | 52 | 9.5 | \$ 2458 |
| | GMB-2360W | 60 | ½ | 23 | 47 | 8.8 | \$ 2182 |
| | GMB-2354W | 54 | ½ | 23 | 42 | 8.0 | \$ 1976 |
| | GMB-2348W | 48 | ½ | 23 | 38 | 7.3 | \$ 1838 |
| | GMB-2342W | 42 | ½ | 23 | 33 | 6.6 | \$ 1563 |
| | GMB-2336W | 36 | ½ | 23 | 28 | 5.8 | \$ 1357 |
| GMB-2330W | 30 | ½ | 23 | 23 | 5.1 | \$ 1151 | |

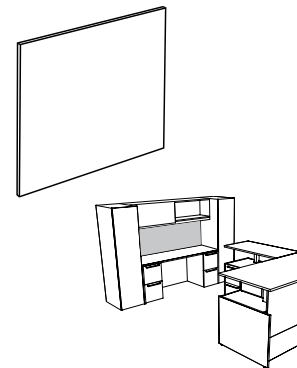

Must Specify (in this order):

Model #
Color



Rare Earth Magnets, Marker and Eraser set available; [See Set Options](#)

Description

- Available in Black (BLMKR) or White (WHMKR), Must Specify
- Tempered Glass Magnetic Marker Boards Are One (1) Piece with No Seams
- Mounting Brackets Included
- For Use over 30"H Desks and Credenzas with Wall Mount Hutches Without Paperslots
- For Rare Earth Magnets, Marker and Eraser Sets; [See Set Options](#)

[See Gesso Intro Section for Ordering Options](#)

| Item | Model No. | Width | Depth | Height | Ship Wt | Cubic Ft | List Price |
|--|------------|-------|-------|--------|---------|----------|------------|
| MAGNETIC GLASS MARKER BOARD | GMB-31108W | 108 | ½ | 31 | 114 | 17.9 | \$ 5073 |
| FOR USE WITH 21" LOW CREDENZA AND WALL MOUNT HUTCHES | GMB-31102W | 102 | ½ | 31 | 108 | 17.0 | \$ 4889 |
| | GMB-3196W | 96 | ½ | 31 | 101 | 16.1 | \$ 4613 |
| | GMB-3190W | 90 | ½ | 31 | 95 | 15.2 | \$ 4246 |
| | GMB-3184W | 84 | ½ | 31 | 89 | 14.3 | \$ 3972 |
| | GMB-3178W | 78 | ½ | 31 | 82 | 13.4 | \$ 3696 |
| | GMB-3172W | 72 | ½ | 31 | 76 | 12.5 | \$ 3421 |
| | GMB-3166W | 66 | ½ | 31 | 70 | 11.6 | \$ 3235 |
| | GMB-3160W | 60 | ½ | 31 | 63 | 10.8 | \$ 2870 |
| | GMB-3154W | 54 | ½ | 31 | 57 | 9.9 | \$ 2595 |
| | GMB-3148W | 48 | ½ | 31 | 51 | 9.0 | \$ 2414 |
| | GMB-3142W | 42 | ½ | 31 | 44 | 8.1 | \$ 2045 |
| | GMB-3136W | 36 | ½ | 31 | 38 | 7.2 | \$ 1770 |
| | GMB-3130W | 30 | ½ | 31 | 32 | 6.3 | \$ 1494 |

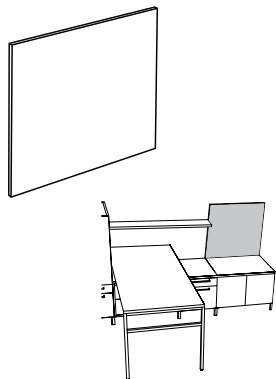

Must Specify (in this order):

Model #
Color



Rare Earth Magnets, Marker and Eraser set available; [See Set Options](#)

Description

- Available in Black (BLMKR) or White (WHMKR), Must Specify
- Tempered Glass Magnetic Marker Boards Are One (1) Piece with No Seams
- Mounting Brackets Included
- For Use over 21"H Desks and Credenzas with Wall Mount Hutches
- For Rare Earth Magnets, Marker and Eraser Sets; [See Set Options](#)

| | | | | | | | |
|---|-----------|----|---|-----|----|------|---------|
| MAGNETIC GLASS MARKER BOARD | GMB-4048W | 48 | ½ | 40⅞ | 67 | 11.0 | \$ 3128 |
| FOR USE WITH 30"H DESKS AND CREDENZA AND WALL MOUNT HUTCHES OR SHELVING | GMB-4042W | 42 | ½ | 40⅞ | 58 | 9.9 | \$ 2644 |
| | GMB-4036W | 36 | ½ | 40⅞ | 50 | 8.8 | \$ 2285 |
| | GMB-4030W | 30 | ½ | 40⅞ | 42 | 7.7 | \$ 1924 |

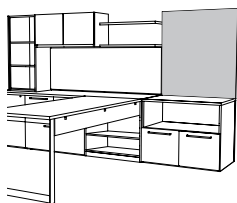

Must Specify (in this order):

Model #
Color



Rare Earth Magnets, Marker and Eraser set available; [See Set Options](#)

Description

- Available in Black (BLMKR) or White (WHMKR), Must Specify
- Tempered Glass Magnetic Marker Boards Include Mounting Brackets
- For Use over 30"H Desks and Credenzas with Wall Mount Hutches or Shelving
- For Rare Earth Magnets, Marker and Eraser Sets; [See Set Options](#)

[See Gesso Intro Section for Ordering Options](#)

| Item | Model No. | Width | Depth | Height | Ship Wt | Cubic Ft | List Price |
|--|-----------|-------|-------|--------|---------|----------|------------|
| MAGNETIC GLASS MARKER BOARD | GMB-5248W | 48 | ½ | 52⅞ | 86 | 13.5 | \$ 3988 |
| FOR USE WITH 30"H DESKS AND CREDENZA AND TALL WALL MOUNT HUTCHES OR SHELVING | GMB-5242W | 42 | ½ | 52⅞ | 76 | 12.2 | \$ 3369 |
| | GMB-5236W | 36 | ½ | 52⅞ | 65 | 10.8 | \$ 2904 |
| | GMB-5230W | 30 | ½ | 52⅞ | 54 | 9.5 | \$ 2441 |

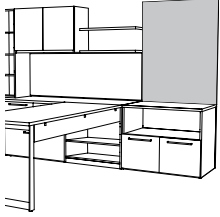

Must Specify (in this order):

Model #
Color



Rare Earth Magnets, Marker and Eraser set available; See Below

Description

- Available in Black (BLMKR) or White (WHMKR), Must Specify
- Tempered Glass Magnetic Marker Boards Include Mounting Brackets
- For Use Next to Tall Surface or Wall Mount Hutches
- For Rare Earth Magnets, Marker and Eraser Sets; See Below

| | | | | | | | |
|-----------------------------------|-----------|----|---|-----|-----|------|---------|
| MAGNETIC GLASS MARKER BOARD | GMB-8236W | 36 | ½ | 82⅞ | 102 | 15.8 | \$ 4453 |
| FOR USE FROM FLOOR TO TOP OF UNIT | GMB-7036W | 36 | ½ | 70⅞ | 87 | 13.8 | \$ 3834 |
| | GMB-5136W | 36 | ½ | 51⅞ | 63 | 10.6 | \$ 2802 |
| | GMB-8230W | 30 | ½ | 82⅞ | 85 | 13.8 | \$ 3730 |
| | GMB-7030W | 30 | ½ | 70⅞ | 72 | 12.1 | \$ 3215 |
| | GMB-5130W | 30 | ½ | 51⅞ | 53 | 9.3 | \$ 2354 |

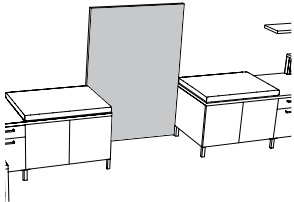

Must Specify (in this order):

Model #
Color



Rare Earth Magnets, Marker and Eraser set available; See Below

Description

- Available in Black (BLMKR) or White (WHMKR), Must Specify
- Tempered Glass Magnetic Marker Boards Are One (1) Piece with No Seams
- Mounting Brackets Included
- For Use From Floor to Top of Unit
- For Rare Earth Magnets, Marker and Eraser Sets; See Below

| | | | |
|-----------------------|--------------|--|--------|
| MARKER AND ERASER SET | 01-MRKRSETBL | For Use with Black Marker Boards and Black Glass Doors | \$ 123 |
| | 01-MRKRSETWH | For Use with White Marker Boards and White Glass Doors | |



Description

- 01-MRKRSETWH May Also be Used with Standard Dry Erase Doors and Boards
- Includes Four (4) Markers and an Eraser

| | | | |
|------------|----------|-------|--------|
| MAGNET SET | 01-MAGBL | Black | \$ 114 |
| | 01-MAGWH | White | |



Description

- Includes Set of Five (5) Rare Earth Magnets
- To be Used with Tempered Glass Magnetic Marker Boards
- Comfort Grip with Stylish Protective Plastic Coating

[See Gesso Intro Section for Ordering Options](#)

TALL TOOL RAIL WORK WALL FOR SURFACE MOUNT HUTCHES

USE OVER 30" H CREDENZA
23" TALL

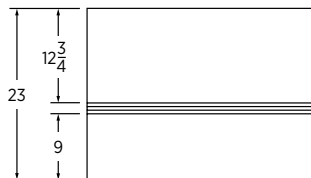

Must Specify (in this order):

- Model #
- Tackboard on Top or Bottom
- Dry Erase on Top or Bottom
- Tackboard Fabric Vendor, Pattern, and Color

Tackboard/Dry Erase Locations

- TB-TB: Tackboard Over Tackboard (Use Grade Prices)
- DEB-TB: Dry Erase Over Tackboard (Use Grade Prices)
- DEB-DEB: Dry Erase Over Dry Erase (Use Grade 1 Prices)

| Model # | Size | COM ydg | COM, 1, 2 or 3 | Grades | | | | | | |
|-------------|------|---------|-------------------|--------|------|------|------|------|------|------|
| | | | | 4 | 5 | 6 | 7 | 8 | 9 | 10 |
| WW-23108TRH | 108" | 3.50 | \$ 1715 | 2202 | 2429 | 2660 | 2989 | 3332 | 3731 | 4193 |
| WW-23102TRH | 102" | 3.25 | \$ 1635 | 2087 | 2298 | 2513 | 2818 | 3137 | 3507 | 3936 |
| WW-2396TRH | 96" | 3.00 | \$ 1565 | 1982 | 2177 | 2375 | 2657 | 2951 | 3293 | 3689 |
| WW-2390TRH | 90" | 2.75 | \$ 1471 | 1853 | 2032 | 2214 | 2472 | 2742 | 3055 | 3418 |
| WW-2384TRH | 84" | 2.50 | \$ 1334 | 1682 | 1844 | 2009 | 2244 | 2489 | 2774 | 3104 |
| WW-2378TRH | 78" | 2.50 | \$ 1285 | 1633 | 1795 | 1960 | 2195 | 2440 | 2725 | 3055 |
| WW-2372TRH | 72" | 2.25 | \$ 1023 | 1336 | 1482 | 1631 | 1842 | 2063 | 2319 | 2616 |
| WW-2366TRH | 66" | 2.00 | \$ 967 | 1245 | 1375 | 1507 | 1695 | 1891 | 2119 | 2383 |
| WW-2360TRH | 60" | 2.00 | \$ 910 | 1188 | 1318 | 1450 | 1638 | 1834 | 2062 | 2326 |
| WW-2354TRH | 54" | 1.75 | \$ 887 | 1130 | 1244 | 1360 | 1524 | 1696 | 1895 | 2126 |
| WW-2348TRH | 48" | 1.50 | \$ 806 | 1015 | 1112 | 1211 | 1352 | 1499 | 1670 | 1868 |
| WW-2342TRH | 42" | 1.25 | \$ 745 | 919 | 1000 | 1083 | 1200 | 1323 | 1465 | 1630 |
| WW-2336TRH | 36" | 1.25 | \$ 727 | 901 | 982 | 1065 | 1182 | 1305 | 1447 | 1612 |
| WW-2330TRH | 30" | 1.00 | \$ 671 | 810 | 875 | 941 | 1035 | 1133 | 1247 | 1379 |

Description

- Aluminum Tool Rail
- Work Walls 78" and Larger will Ship in 4 Pieces
- [See Work Wall Accessories](#)

TALL TOOL RAIL WORK WALL FOR SURFACE MOUNT HUTCHES WITH PAPER SLOTS

USE OVER 30" H CREDENZA
19" TALL



Must Specify (in this order):

- Model #
- Tackboard on Top or Bottom
- Dry Erase on Top or Bottom
- Tackboard Fabric Vendor, Pattern, and Color

Tackboard/Dry Erase Locations

- TB-TB: Tackboard Over Tackboard (Use Grade Prices)
- DEB-TB: Dry Erase Over Tackboard (Use Grade Prices)
- DEB-DEB: Dry Erase Over Dry Erase (Use Grade 1 Prices)

| Model # | Size | COM ydg | COM, 1, 2 or 3 | Grades | | | | | | |
|---------------|------|---------|-------------------|--------|------|------|------|------|------|------|
| | | | | 4 | 5 | 6 | 7 | 8 | 9 | 10 |
| WW-19108TRHPS | 108" | 3.50 | \$ 1579 | 2066 | 2293 | 2524 | 2853 | 3196 | 3595 | 4057 |
| WW-19102TRHPS | 102" | 3.25 | \$ 1505 | 1957 | 2168 | 2383 | 2688 | 3007 | 3377 | 3806 |
| WW-1996TRHPS | 96" | 3.00 | \$ 1440 | 1857 | 2052 | 2250 | 2532 | 2826 | 3168 | 3564 |
| WW-1990TRHPS | 90" | 2.75 | \$ 1349 | 1731 | 1910 | 2092 | 2350 | 2620 | 2933 | 3296 |
| WW-1984TRHPS | 84" | 2.50 | \$ 1215 | 1563 | 1725 | 1890 | 2125 | 2370 | 2655 | 2985 |
| WW-1978TRHPS | 78" | 2.50 | \$ 1173 | 1521 | 1683 | 1848 | 2083 | 2328 | 2613 | 2943 |
| WW-1972TRHPS | 72" | 2.25 | \$ 935 | 1248 | 1394 | 1543 | 1754 | 1975 | 2231 | 2528 |
| WW-1966TRHPS | 66" | 2.00 | \$ 887 | 1165 | 1295 | 1427 | 1615 | 1811 | 2039 | 2303 |
| WW-1960TRHPS | 60" | 2.00 | \$ 845 | 1123 | 1253 | 1385 | 1573 | 1769 | 1997 | 2261 |
| WW-1954TRHPS | 54" | 1.75 | \$ 830 | 1073 | 1187 | 1303 | 1467 | 1639 | 1838 | 2069 |
| WW-1948TRHPS | 48" | 1.50 | \$ 771 | 980 | 1077 | 1176 | 1317 | 1464 | 1635 | 1833 |
| WW-1942TRHPS | 42" | 1.25 | \$ 709 | 883 | 964 | 1047 | 1164 | 1287 | 1429 | 1594 |
| WW-1936TRHPS | 36" | 1.25 | \$ 698 | 872 | 953 | 1036 | 1153 | 1276 | 1418 | 1583 |
| WW-1930TRHPS | 30" | 1.00 | \$ 643 | 782 | 847 | 913 | 1007 | 1105 | 1219 | 1351 |

Description

- Aluminum Tool Rail
- Work Walls 78" and Larger will Ship in 4 Pieces
- [See Work Wall Accessories](#)

[See Gesso Intro Section for Ordering Options](#)

**TALL TOOL RAIL WORK WALL
FOR WALL MOUNT HUTCHES**

**USE OVER 21" H CREDENZA
31" TALL**

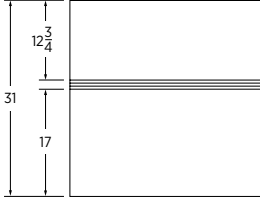

Must Specify (in this order):
 Model #
 Tackboard on Top or Bottom
 Dry Erase on Top or Bottom
 Tackboard Fabric Vendor, Pattern,
 and Color

- Tackboard/Dry Erase Locations**
- TB-TB: Tackboard Over Tackboard (Use Grade Prices)
 - DEB-TB: Dry Erase Over Tackboard (Use Grade Prices)
 - DEB-DEB: Dry Erase Over Dry Erase (Use Grade 1 Prices)

| Model # | Size | COM ydg | COM, 1, 2 or 3 | Grades | | | | | | |
|--------------|------|---------|-------------------|--------|------|------|------|------|------|------|
| | | | | 4 | 5 | 6 | 7 | 8 | 9 | 10 |
| WW-31108TTRW | 108" | 3.50 | \$ 2159 | 2646 | 2873 | 3104 | 3433 | 3776 | 4175 | 4637 |
| WW-31102TTRW | 102" | 3.25 | \$ 2044 | 2496 | 2707 | 2922 | 3227 | 3546 | 3916 | 4345 |
| WW-3196TTRW | 96" | 3.00 | \$ 1969 | 2386 | 2581 | 2779 | 3061 | 3355 | 3697 | 4093 |
| WW-3190TTRW | 90" | 2.75 | \$ 1854 | 2236 | 2415 | 2597 | 2855 | 3125 | 3438 | 3801 |
| WW-3184TTRW | 84" | 2.50 | \$ 1658 | 2006 | 2168 | 2333 | 2568 | 2813 | 3098 | 3428 |
| WW-3178TTRW | 78" | 2.50 | \$ 1585 | 1933 | 2095 | 2260 | 2495 | 2740 | 3025 | 3355 |
| WW-3172TTRW | 72" | 2.25 | \$ 1318 | 1631 | 1777 | 1926 | 2137 | 2358 | 2614 | 2911 |
| WW-3166TTRW | 66" | 2.00 | \$ 1265 | 1543 | 1673 | 1805 | 1993 | 2189 | 2417 | 2681 |
| WW-3160TTRW | 60" | 2.00 | \$ 1191 | 1469 | 1599 | 1731 | 1919 | 2115 | 2343 | 2607 |
| WW-3154TTRW | 54" | 1.75 | \$ 1137 | 1380 | 1494 | 1610 | 1774 | 1946 | 2145 | 2376 |
| WW-3148TTRW | 48" | 1.50 | \$ 1044 | 1253 | 1350 | 1449 | 1590 | 1737 | 1908 | 2106 |
| WW-3142TTRW | 42" | 1.25 | \$ 960 | 1134 | 1215 | 1298 | 1415 | 1538 | 1680 | 1845 |
| WW-3136TTRW | 36" | 1.25 | \$ 940 | 1114 | 1195 | 1278 | 1395 | 1518 | 1660 | 1825 |
| WW-3130TTRW | 30" | 1.00 | \$ 865 | 1004 | 1069 | 1135 | 1229 | 1327 | 1441 | 1573 |

- Description**
- Aluminum Tool Rail
 - Work Walls 78" and Larger will Ship in 4 Pieces
 - [See Work Wall Accessories](#)

**TALL TOOL RAIL WORK WALL
FOR WALL MOUNT HUTCHES
WITH PAPER SLOTS**

**USE OVER 21" H CREDENZA
27" TALL**

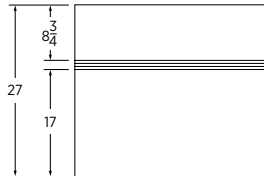

Must Specify (in this order):
 Model #
 Tackboard on Top or Bottom
 Dry Erase on Top or Bottom
 Tackboard Fabric Vendor, Pattern,
 and Color

- Tackboard/Dry Erase Locations**
- TB-TB: Tackboard Over Tackboard (Use Grade Prices)
 - DEB-TB: Dry Erase Over Tackboard (Use Grade Prices)
 - DEB-DEB: Dry Erase Over Dry Erase (Use Grade 1 Prices)

| Model # | Size | COM ydg | COM, 1, 2 or 3 | Grades | | | | | | |
|----------------|------|---------|-------------------|--------|------|------|------|------|------|------|
| | | | | 4 | 5 | 6 | 7 | 8 | 9 | 10 |
| WW-27108TTRWPS | 108" | 3.50 | \$ 1978 | 2465 | 2692 | 2923 | 3252 | 3595 | 3994 | 4456 |
| WW-27102TTRWPS | 102" | 3.25 | \$ 1867 | 2319 | 2530 | 2745 | 3050 | 3369 | 3739 | 4168 |
| WW-2796TTRWPS | 96" | 3.00 | \$ 1805 | 2222 | 2417 | 2615 | 2897 | 3191 | 3533 | 3929 |
| WW-2790TTRWPS | 90" | 2.75 | \$ 1699 | 2081 | 2260 | 2442 | 2700 | 2970 | 3283 | 3646 |
| WW-2784TTRWPS | 84" | 2.50 | \$ 1518 | 1866 | 2028 | 2193 | 2428 | 2673 | 2958 | 3288 |
| WW-2778TTRWPS | 78" | 2.50 | \$ 1454 | 1802 | 1964 | 2129 | 2364 | 2609 | 2894 | 3224 |
| WW-2772TTRWPS | 72" | 2.25 | \$ 1204 | 1517 | 1663 | 1812 | 2023 | 2244 | 2500 | 2797 |
| WW-2766TTRWPS | 66" | 2.00 | \$ 1153 | 1431 | 1561 | 1693 | 1881 | 2077 | 2305 | 2569 |
| WW-2760TTRWPS | 60" | 2.00 | \$ 1085 | 1363 | 1493 | 1625 | 1813 | 2009 | 2237 | 2501 |
| WW-2754TTRWPS | 54" | 1.75 | \$ 1035 | 1278 | 1392 | 1508 | 1672 | 1844 | 2043 | 2274 |
| WW-2748TTRWPS | 48" | 1.50 | \$ 954 | 1163 | 1260 | 1359 | 1500 | 1647 | 1818 | 2016 |
| WW-2742TTRWPS | 42" | 1.25 | \$ 879 | 1053 | 1134 | 1217 | 1334 | 1457 | 1599 | 1764 |
| WW-2736TTRWPS | 36" | 1.25 | \$ 859 | 1033 | 1114 | 1197 | 1314 | 1437 | 1579 | 1744 |
| WW-2730TTRWPS | 30" | 1.00 | \$ 791 | 930 | 995 | 1061 | 1155 | 1253 | 1367 | 1499 |

- Description**
- Aluminum Tool Rail
 - Work Walls 78" and Larger will Ship in 4 Pieces
 - [See Work Wall Accessories](#)

[See Gesso Intro Section for Ordering Options](#)

**TOOL RAIL WORK WALL
FOR WALL MOUNT HUTCHES**

**USE OVER 30”H CREDENZA
23” TALL**

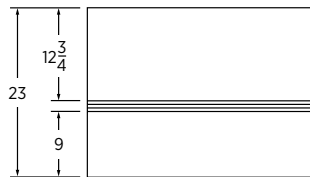

Must Specify (in this order):
 Model #
 Tackboard on Top or Bottom
 Dry Erase on Top or Bottom
 Tackboard Fabric Vendor, Pattern,
 and Color

Tackboard/Dry Erase Locations

- TB-TB: Tackboard Over Tackboard (Use Grade Prices)
- DEB-TB: Dry Erase Over Tackboard (Use Grade Prices)
- DEB-DEB: Dry Erase Over Dry Erase (Use Grade 1 Prices)

| Model # | Size | COM ydgs | COM, 1, 2 or 3 | Grades | | | | | | |
|-------------|------|----------|-------------------|--------|------|------|------|------|------|------|
| | | | | 4 | 5 | 6 | 7 | 8 | 9 | 10 |
| WW-23108TRW | 108" | 3.50 | \$ 1797 | 2284 | 2511 | 2742 | 3071 | 3414 | 3813 | 4275 |
| WW-23102TRW | 102" | 3.25 | \$ 1693 | 2145 | 2356 | 2571 | 2876 | 3195 | 3565 | 3994 |
| WW-2396TRW | 96" | 3.00 | \$ 1643 | 2060 | 2255 | 2453 | 2735 | 3029 | 3371 | 3767 |
| WW-2390TRW | 90" | 2.75 | \$ 1548 | 1930 | 2109 | 2291 | 2549 | 2819 | 3132 | 3495 |
| WW-2384TRW | 84" | 2.50 | \$ 1379 | 1727 | 1889 | 2054 | 2289 | 2534 | 2819 | 3149 |
| WW-2378TRW | 78" | 2.50 | \$ 1319 | 1667 | 1829 | 1994 | 2229 | 2474 | 2759 | 3089 |
| WW-2372TRW | 72" | 2.25 | \$ 1099 | 1412 | 1558 | 1707 | 1918 | 2139 | 2395 | 2692 |
| WW-2366TRW | 66" | 2.00 | \$ 1040 | 1318 | 1448 | 1580 | 1768 | 1964 | 2192 | 2456 |
| WW-2360TRW | 60" | 2.00 | \$ 976 | 1254 | 1384 | 1516 | 1704 | 1900 | 2128 | 2392 |
| WW-2354TRW | 54" | 1.75 | \$ 934 | 1177 | 1291 | 1407 | 1571 | 1743 | 1942 | 2173 |
| WW-2348TRW | 48" | 1.50 | \$ 863 | 1072 | 1169 | 1268 | 1409 | 1556 | 1727 | 1925 |
| WW-2342TRW | 42" | 1.25 | \$ 795 | 969 | 1050 | 1133 | 1250 | 1373 | 1515 | 1680 |
| WW-2336TRW | 36" | 1.25 | \$ 780 | 954 | 1035 | 1118 | 1235 | 1358 | 1500 | 1665 |
| WW-2330TRW | 30" | 1.00 | \$ 716 | 855 | 920 | 986 | 1080 | 1178 | 1292 | 1424 |

Description

- Aluminum Tool Rail
- Work Walls 78" and Larger will Ship in 4 Pieces
- [See Work Wall Accessories](#)

**TALL TOOL RAIL WORK WALL
FOR WALL MOUNT HUTCHES
WITH PAPER SLOTS**

**USE OVER 30”H CREDENZA
19” TALL**



Must Specify (in this order):
 Model #
 Tackboard on Top or Bottom
 Dry Erase on Top or Bottom
 Tackboard Fabric Vendor, Pattern,
 and Color

Tackboard/Dry Erase Locations

- TB-TB: Tackboard Over Tackboard (Use Grade Prices)
- DEB-TB: Dry Erase Over Tackboard (Use Grade Prices)
- DEB-DEB: Dry Erase Over Dry Erase (Use Grade 1 Prices)

| Model # | Size | COM ydgs | COM, 1, 2 or 3 | Grades | | | | | | |
|---------------|------|----------|-------------------|--------|------|------|------|------|------|------|
| | | | | 4 | 5 | 6 | 7 | 8 | 9 | 10 |
| WW-19108TRWPS | 108" | 3.50 | \$ 1654 | 2141 | 2368 | 2599 | 2928 | 3271 | 3670 | 4132 |
| WW-19102TRWPS | 102" | 3.25 | \$ 1555 | 2007 | 2218 | 2433 | 2738 | 3057 | 3427 | 3856 |
| WW-1996TRWPS | 96" | 3.00 | \$ 1507 | 1924 | 2119 | 2317 | 2599 | 2893 | 3235 | 3631 |
| WW-1990TRWPS | 90" | 2.75 | \$ 1419 | 1801 | 1980 | 2162 | 2420 | 2690 | 3003 | 3366 |
| WW-1984TRWPS | 84" | 2.50 | \$ 1258 | 1606 | 1768 | 1933 | 2168 | 2413 | 2698 | 3028 |
| WW-1978TRWPS | 78" | 2.50 | \$ 1203 | 1551 | 1713 | 1878 | 2113 | 2358 | 2643 | 2973 |
| WW-1972TRWPS | 72" | 2.25 | \$ 1004 | 1317 | 1463 | 1612 | 1823 | 2044 | 2300 | 2597 |
| WW-1966TRWPS | 66" | 2.00 | \$ 953 | 1231 | 1361 | 1493 | 1681 | 1877 | 2105 | 2369 |
| WW-1960TRWPS | 60" | 2.00 | \$ 901 | 1179 | 1309 | 1441 | 1629 | 1825 | 2053 | 2317 |
| WW-1954TRWPS | 54" | 1.75 | \$ 871 | 1114 | 1228 | 1344 | 1508 | 1680 | 1879 | 2110 |
| WW-1948TRWPS | 48" | 1.50 | \$ 818 | 1027 | 1124 | 1223 | 1364 | 1511 | 1682 | 1880 |
| WW-1942TRWPS | 42" | 1.25 | \$ 756 | 930 | 1011 | 1094 | 1211 | 1334 | 1476 | 1641 |
| WW-1936TRWPS | 36" | 1.25 | \$ 741 | 915 | 996 | 1079 | 1196 | 1319 | 1461 | 1626 |
| WW-1930TRWPS | 30" | 1.00 | \$ 684 | 823 | 888 | 954 | 1048 | 1146 | 1260 | 1392 |

Description

- Aluminum Tool Rail
- Work Walls 78" and Larger will Ship in 4 Pieces
- [See Work Wall Accessories](#)

[See Gesso Intro Section for Ordering Options](#)

| Item | Model No. | | Width | Depth | Height | Ship Wt | Cubic Ft | List Price |
|------------|-------------|-------|--------------------------------|--------------------------------|-------------------------------|---------|----------|------------|
| LEGAL TRAY | 01-LGLTRAYC | Clear | 14 ⁷ / ₈ | 10 ¹ / ₂ | 1 ¹ / ₈ | | | \$ 115 |

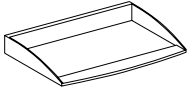

| | | | | | | | | |
|---------------|--------------|-------|-------------------------------|--------------------------------|-------------------------------|--|--|--------|
| FOLDER SORTER | 01-FLDRSRTRC | Clear | 7 ¹ / ₄ | 12 ³ / ₈ | 7 ¹ / ₈ | | | \$ 129 |
|---------------|--------------|-------|-------------------------------|--------------------------------|-------------------------------|--|--|--------|

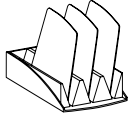

| | | | | | | | | |
|------------------|-------------|-------|-------------------------------|--------------------------------|-------------------------------|--|--|--------|
| ACCESSORIES TRAY | 01-ACCTRAYC | Clear | 9 ³ / ₄ | 10 ¹ / ₈ | 1 ¹ / ₈ | | | \$ 125 |
|------------------|-------------|-------|-------------------------------|--------------------------------|-------------------------------|--|--|--------|

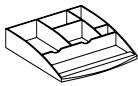

**TACKBOARDS
FOR SURFACE MOUNT HUTCHES**

23" TALL

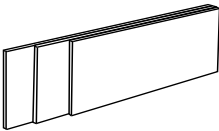

Must Specify (in this order):
Model #
Fabric Vendor, Pattern, and Color

| Model # | Size | COM ydg | COM, 1, 2 or 3 | Grades | | | | | | | |
|-----------|------|---------|-------------------|--------|------|------|------|------|------|------|--|
| | | | | 4 | 5 | 6 | 7 | 8 | 9 | 10 | |
| TB-66108H | 108" | 3.50 | \$ 758 | 1245 | 1472 | 1703 | 2032 | 2375 | 2774 | 3236 | |
| TB-66102H | 102" | 3.25 | \$ 731 | 1183 | 1394 | 1609 | 1914 | 2233 | 2603 | 3032 | |
| TB-6696H | 96" | 3.00 | \$ 707 | 1124 | 1319 | 1517 | 1799 | 2093 | 2435 | 2831 | |
| TB-6690H | 90" | 2.75 | \$ 673 | 1055 | 1234 | 1416 | 1674 | 1944 | 2257 | 2620 | |
| TB-6684H | 84" | 2.50 | \$ 639 | 987 | 1149 | 1314 | 1549 | 1794 | 2079 | 2409 | |
| TB-6678H | 78" | 2.50 | \$ 628 | 976 | 1138 | 1303 | 1538 | 1783 | 2068 | 2398 | |
| TB-6672H | 72" | 2.25 | \$ 566 | 879 | 1025 | 1174 | 1385 | 1606 | 1862 | 2159 | |
| TB-6666H | 66" | 2.00 | \$ 533 | 811 | 941 | 1073 | 1261 | 1457 | 1685 | 1949 | |
| TB-6660H | 60" | 2.00 | \$ 498 | 776 | 906 | 1038 | 1226 | 1422 | 1650 | 1914 | |
| TB-6654H | 54" | 1.75 | \$ 485 | 728 | 842 | 958 | 1122 | 1294 | 1493 | 1724 | |
| TB-6648H | 48" | 1.50 | \$ 436 | 645 | 742 | 841 | 982 | 1129 | 1300 | 1498 | |
| TB-6642H | 42" | 1.25 | \$ 396 | 570 | 651 | 734 | 851 | 974 | 1116 | 1281 | |
| TB-6636H | 36" | 1.25 | \$ 385 | 559 | 640 | 723 | 840 | 963 | 1105 | 1270 | |
| TB-6630H | 30" | 1.00 | \$ 346 | 485 | 550 | 616 | 710 | 808 | 922 | 1054 | |

Description

- All Tackboards 78" and Longer will Ship in 2 Pieces

[See Gesso Intro Section for Ordering Options](#)

**TACKBOARDS
FOR SURFACE MOUNT HUTCHES
WITH PAPER SLOTS**

19" TALL

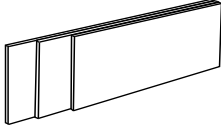

Must Specify (in this order):

Model #
Fabric Vendor, Pattern, and Color

| Model # | Size | COM ydg | COM, 1, 2 or 3 | Grades | | | | | | |
|-------------|------|---------|-------------------|--------|------|------|------|------|------|------|
| | | | | 4 | 5 | 6 | 7 | 8 | 9 | 10 |
| TB-19108HPS | 108" | 3.50 | \$ 680 | 1167 | 1394 | 1625 | 1954 | 2297 | 2696 | 3158 |
| TB-19102HPS | 102" | 3.25 | \$ 658 | 1110 | 1321 | 1536 | 1841 | 2160 | 2530 | 2959 |
| TB-1996HPS | 96" | 3.00 | \$ 635 | 1052 | 1247 | 1445 | 1727 | 2021 | 2363 | 2759 |
| TB-1990HPS | 90" | 2.75 | \$ 609 | 991 | 1170 | 1352 | 1610 | 1880 | 2193 | 2556 |
| TB-1984HPS | 84" | 2.50 | \$ 575 | 923 | 1085 | 1250 | 1485 | 1730 | 2015 | 2345 |
| TB-1978HPS | 78" | 2.50 | \$ 566 | 914 | 1076 | 1241 | 1476 | 1721 | 2006 | 2336 |
| TB-1972HPS | 72" | 2.25 | \$ 510 | 823 | 969 | 1118 | 1329 | 1550 | 1806 | 2103 |
| TB-1966HPS | 66" | 2.00 | \$ 476 | 754 | 884 | 1016 | 1204 | 1400 | 1628 | 1892 |
| TB-1960HPS | 60" | 2.00 | \$ 445 | 723 | 853 | 985 | 1173 | 1369 | 1597 | 1861 |
| TB-1954HPS | 54" | 1.75 | \$ 433 | 676 | 790 | 906 | 1070 | 1242 | 1441 | 1672 |
| TB-1948HPS | 48" | 1.50 | \$ 390 | 599 | 696 | 795 | 936 | 1083 | 1254 | 1452 |
| TB-1942HPS | 42" | 1.25 | \$ 352 | 526 | 607 | 690 | 807 | 930 | 1072 | 1237 |
| TB-1936HPS | 36" | 1.25 | \$ 343 | 517 | 598 | 681 | 798 | 921 | 1063 | 1228 |
| TB-1930HPS | 30" | 1.00 | \$ 311 | 450 | 515 | 581 | 675 | 773 | 887 | 1019 |

Description

- All Tackboards 78" and Longer will Ship in 2 Pieces

**TACKBOARDS
FOR WALL MOUNT HUTCHES**

USE OVER 21"H CREDENZA
31" TALL

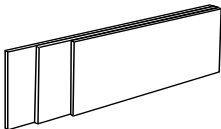

Must Specify (in this order):

Model #
Fabric Vendor, Pattern, and Color

| Model # | Size | COM ydg | COM, 1, 2 or 3 | Grades | | | | | | |
|-----------|------|---------|-------------------|--------|------|------|------|------|------|------|
| | | | | 4 | 5 | 6 | 7 | 8 | 9 | 10 |
| TB-31108W | 108" | 3.50 | \$ 1014 | 1501 | 1728 | 1959 | 2288 | 2631 | 3030 | 3492 |
| TB-31102W | 102" | 3.25 | \$ 969 | 1421 | 1632 | 1847 | 2152 | 2471 | 2841 | 3270 |
| TB-3196W | 96" | 3.00 | \$ 943 | 1360 | 1555 | 1753 | 2035 | 2329 | 2671 | 3067 |
| TB-3190W | 90" | 2.75 | \$ 899 | 1281 | 1460 | 1642 | 1900 | 2170 | 2483 | 2846 |
| TB-3184W | 84" | 2.50 | \$ 851 | 1199 | 1361 | 1526 | 1761 | 2006 | 2291 | 2621 |
| TB-3178W | 78" | 2.50 | \$ 836 | 1184 | 1346 | 1511 | 1746 | 1991 | 2276 | 2606 |
| TB-3172W | 72" | 2.25 | \$ 772 | 1085 | 1231 | 1380 | 1591 | 1812 | 2068 | 2365 |
| TB-3166W | 66" | 2.00 | \$ 738 | 1016 | 1146 | 1278 | 1466 | 1662 | 1890 | 2154 |
| TB-3160W | 60" | 2.00 | \$ 691 | 969 | 1099 | 1231 | 1419 | 1615 | 1843 | 2107 |
| TB-3154W | 54" | 1.75 | \$ 656 | 899 | 1013 | 1129 | 1293 | 1465 | 1664 | 1895 |
| TB-3148W | 48" | 1.50 | \$ 598 | 807 | 904 | 1003 | 1144 | 1291 | 1462 | 1660 |
| TB-3142W | 42" | 1.25 | \$ 539 | 713 | 794 | 877 | 994 | 1117 | 1259 | 1424 |
| TB-3136W | 36" | 1.25 | \$ 525 | 699 | 780 | 863 | 980 | 1103 | 1245 | 1410 |
| TB-3130W | 30" | 1.00 | \$ 473 | 612 | 677 | 743 | 837 | 935 | 1049 | 1181 |

Description

- All Tackboards 78" and Longer will Ship in 2 Pieces

[See Gesso Intro Section for Ordering Options](#)

**TACKBOARDS
FOR WALL MOUNT HUTCHES
WITH PAPER SLOTS**

**USE OVER 21" H CREDENZA
27" TALL**

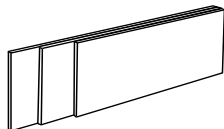

Must Specify (in this order):
Model #
Fabric Vendor, Pattern, and Color

| Model # | Size | COM ydg | COM, 1, 2 or 3 | Grades | | | | | | |
|-------------|------|---------|-------------------|--------|------|------|------|------|------|------|
| | | | | 4 | 5 | 6 | 7 | 8 | 9 | 10 |
| TB-27108WPS | 108" | 3.50 | \$ 929 | 1416 | 1643 | 1874 | 2203 | 2546 | 2945 | 3407 |
| TB-27102WPS | 102" | 3.25 | \$ 887 | 1339 | 1550 | 1765 | 2070 | 2389 | 2759 | 3188 |
| TB-2796WPS | 96" | 3.00 | \$ 864 | 1281 | 1476 | 1674 | 1956 | 2250 | 2592 | 2988 |
| TB-2790WPS | 90" | 2.75 | \$ 829 | 1211 | 1390 | 1572 | 1830 | 2100 | 2413 | 2776 |
| TB-2784WPS | 84" | 2.50 | \$ 783 | 1131 | 1293 | 1458 | 1693 | 1938 | 2223 | 2553 |
| TB-2778WPS | 78" | 2.50 | \$ 767 | 1115 | 1277 | 1442 | 1677 | 1922 | 2207 | 2537 |
| TB-2772WPS | 72" | 2.25 | \$ 707 | 1020 | 1166 | 1315 | 1526 | 1747 | 2003 | 2300 |
| TB-2766WPS | 66" | 2.00 | \$ 671 | 949 | 1079 | 1211 | 1399 | 1595 | 1823 | 2087 |
| TB-2760WPS | 60" | 2.00 | \$ 627 | 905 | 1035 | 1167 | 1355 | 1551 | 1779 | 2043 |
| TB-2754WPS | 54" | 1.75 | \$ 598 | 841 | 955 | 1071 | 1235 | 1407 | 1606 | 1837 |
| TB-2748WPS | 48" | 1.50 | \$ 545 | 754 | 851 | 950 | 1091 | 1238 | 1409 | 1607 |
| TB-2742WPS | 42" | 1.25 | \$ 492 | 666 | 747 | 830 | 947 | 1070 | 1212 | 1377 |
| TB-2736WPS | 36" | 1.25 | \$ 481 | 655 | 736 | 819 | 936 | 1059 | 1201 | 1366 |
| TB-2730WPS | 30" | 1.00 | \$ 433 | 572 | 637 | 703 | 797 | 895 | 1009 | 1141 |

Description

- All Tackboards 78" and Longer will Ship in 2 Pieces

**TACKBOARDS
FOR WALL MOUNT HUTCHES**

23" TALL

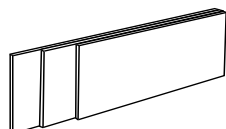

Must Specify (in this order):
Model #
Fabric Vendor, Pattern, and Color

| Model # | Size | COM ydg | COM, 1, 2 or 3 | Grades | | | | | | |
|-----------|------|---------|-------------------|--------|------|------|------|------|------|------|
| | | | | 4 | 5 | 6 | 7 | 8 | 9 | 10 |
| TB-66108W | 108" | 3.50 | \$ 845 | 1332 | 1559 | 1790 | 2119 | 2462 | 2861 | 3323 |
| TB-66102W | 102" | 3.25 | \$ 805 | 1257 | 1468 | 1683 | 1988 | 2307 | 2677 | 3106 |
| TB-6696W | 96" | 3.00 | \$ 788 | 1205 | 1400 | 1598 | 1880 | 2174 | 2516 | 2912 |
| TB-6690W | 90" | 2.75 | \$ 751 | 1133 | 1312 | 1494 | 1752 | 2022 | 2335 | 2698 |
| TB-6684W | 84" | 2.50 | \$ 711 | 1059 | 1221 | 1386 | 1621 | 1866 | 2151 | 2481 |
| TB-6678W | 78" | 2.50 | \$ 698 | 1046 | 1208 | 1373 | 1608 | 1853 | 2138 | 2468 |
| TB-6672W | 72" | 2.25 | \$ 642 | 955 | 1101 | 1250 | 1461 | 1682 | 1938 | 2235 |
| TB-6666W | 66" | 2.00 | \$ 609 | 887 | 1017 | 1149 | 1337 | 1533 | 1761 | 2025 |
| TB-6660W | 60" | 2.00 | \$ 566 | 844 | 974 | 1106 | 1294 | 1490 | 1718 | 1982 |
| TB-6654W | 54" | 1.75 | \$ 539 | 782 | 896 | 1012 | 1176 | 1348 | 1547 | 1778 |
| TB-6648W | 48" | 1.50 | \$ 492 | 701 | 798 | 897 | 1038 | 1185 | 1356 | 1554 |
| TB-6642W | 42" | 1.25 | \$ 446 | 620 | 701 | 784 | 901 | 1024 | 1166 | 1331 |
| TB-6636W | 36" | 1.25 | \$ 434 | 608 | 689 | 772 | 889 | 1012 | 1154 | 1319 |
| TB-6630W | 30" | 1.00 | \$ 394 | 533 | 598 | 664 | 758 | 856 | 970 | 1102 |

Description

- All Tackboards 78" and Longer will Ship in 2 Pieces
- Not Compatible with Gallery Screens; Consider Work Wall Applications

[See Gesso Intro Section for Ordering Options](#)

**TACKBOARDS
FOR WALL MOUNT HUTCHES
WITH PAPER SLOTS**

19" TALL

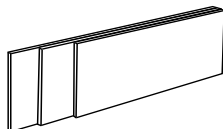

Must Specify (in this order):

Model #
Fabric Vendor, Pattern, and Color

| Model # | Size | COM ydg | COM, 1, 2 or 3 | Grades | | | | | | | |
|-------------|------|---------|-------------------|--------|------|------|------|------|------|------|--|
| | | | | 4 | 5 | 6 | 7 | 8 | 9 | 10 | |
| TB-19108WPS | 108" | 3.50 | \$ 758 | 1245 | 1472 | 1703 | 2032 | 2375 | 2774 | 3236 | |
| TB-19102WPS | 102" | 3.25 | \$ 723 | 1175 | 1386 | 1601 | 1906 | 2225 | 2595 | 3024 | |
| TB-1996WPS | 96" | 3.00 | \$ 708 | 1125 | 1320 | 1518 | 1800 | 2094 | 2436 | 2832 | |
| TB-1990WPS | 90" | 2.75 | \$ 676 | 1058 | 1237 | 1419 | 1677 | 1947 | 2260 | 2623 | |
| TB-1984WPS | 84" | 2.50 | \$ 638 | 986 | 1148 | 1313 | 1548 | 1793 | 2078 | 2408 | |
| TB-1978WPS | 78" | 2.50 | \$ 626 | 974 | 1136 | 1301 | 1536 | 1781 | 2066 | 2396 | |
| TB-1972WPS | 72" | 2.25 | \$ 578 | 891 | 1037 | 1186 | 1397 | 1618 | 1874 | 2171 | |
| TB-1966WPS | 66" | 2.00 | \$ 542 | 820 | 950 | 1082 | 1270 | 1466 | 1694 | 1958 | |
| TB-1960WPS | 60" | 2.00 | \$ 502 | 780 | 910 | 1042 | 1230 | 1426 | 1654 | 1918 | |
| TB-1954WPS | 54" | 1.75 | \$ 481 | 724 | 838 | 954 | 1118 | 1290 | 1489 | 1720 | |
| TB-1948WPS | 48" | 1.50 | \$ 442 | 651 | 748 | 847 | 988 | 1135 | 1306 | 1504 | |
| TB-1942WPS | 42" | 1.25 | \$ 398 | 572 | 653 | 736 | 853 | 976 | 1118 | 1283 | |
| TB-1936WPS | 36" | 1.25 | \$ 388 | 562 | 643 | 726 | 843 | 966 | 1108 | 1273 | |
| TB-1930WPS | 30" | 1.00 | \$ 351 | 490 | 555 | 621 | 715 | 813 | 927 | 1059 | |

Description

- All Tackboards 78" and Longer will Ship in 2 Pieces
- Not Compatible with Gallery Screens; Consider Work Wall Applications

**TACKBOARDS
FOR DUAL ACCESS OPEN HUTCHES**

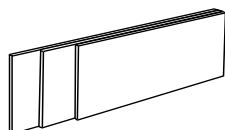

Must Specify (in this order):

Model #
Fabric Vendor, Pattern, and Color

| Model # | Coordinating Unit | COM ydg | COM, 1, 2 or 3 | Grades | | | | | | | |
|---------|-------------------|---------|-------------------|--------|-----|-----|-----|------|------|------|--|
| | | | | 4 | 5 | 6 | 7 | 8 | 9 | 10 | |
| TB-1334 | 65-1572DAOH | 1.25 | \$ 446 | 620 | 446 | 784 | 901 | 1024 | 1166 | 1331 | |
| TB-1331 | 65-1566DAOH | 1.00 | \$ 377 | 516 | 377 | 647 | 741 | 839 | 953 | 1085 | |
| TB-1328 | 65-1560DAOH | 1.00 | \$ 351 | 490 | 351 | 621 | 715 | 813 | 927 | 1059 | |

Description

- Includes 2 Tackboards

| Item | Model No. | Width | Depth | Height | Ship Wt | Cubic Ft | List Price |
|---------------------------|-----------|-------|-------|--------|---------|----------|------------|
| PURSE HOOK FOR WORK TABLE | 01-HOOK | 2 | 1¼ | 2½ | | | \$ 79 |



Description

- Black Hook Includes Mounting Hardware
- For Use with Work Tables, [See Work Tables](#)
- Field Installed

[See Gesso Intro Section for Ordering Options](#)

| Item | Model No. | Width | Depth | Height | Ship Wt | Cubic Ft | List Price |
|--------------------|-----------|-------|-------|--------|---------|----------|------------|
| VESTA POWER CENTER | 01-PDCTR | 10¾ | 12 | 28¼ | 14 | 2.5 | \$ 1776 |

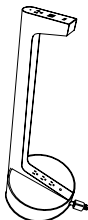

Description

- Top Includes One (1) Power Outlet, Two (2) USB Ports and One (1) USBC Port; Base Includes Three (3) Outlet
- Available in White
- 120" Power Cord
- Built with Weight Distribution for Optimal Stability
- Base is 5" Tall

| | | | | | | | |
|--------------|-----------|----|---|----|-----|------|----------|
| VISUAL BOARD | 65-4848VB | 48 | 5 | 48 | 150 | 11.0 | W\$ 4908 |
|--------------|-----------|----|---|----|-----|------|----------|

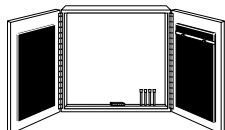

Description

- Standard with: Flipchart, Set of Four Dry Erase Markers, Eraser, Mounting Hardware, Tackboard on Each Door in Black Fabric, Display Rail with Adjustable Hooks for Flipchart
- Price Valid for Fabric Grades 1, 2, and 3
- Does Not Feature Soft Close Hinges
- Magnetic Porcelain Non-Glare Writing Surface

Must Specify (in this order):

- Model #
- Color
- Door Grain Direction
- Tackboard Fabric Vendor, Pattern, and Color
- Pull
- Projection Screen Installation

Options: Specify & Add

| | GRADE | 4 | 5 | 6 | 7 | 8 | 9 | 10 |
|---|-------|--------|-----|-----|-----|-----|------|---------|
| TB-4214 Tackboard | | \$ 278 | 408 | 540 | 728 | 924 | 1152 | 1416 |
| 1-PS Optional Factory Installed Projection Screen | | | | | | | | \$ 1062 |

CUSHIONS

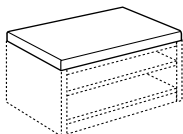

| Model # | Size | COM Ydg | COM, 1, 2 or 3 | Grades | | | | | | | | | |
|-----------------|------|---------|----------------|--------|------|------|------|------|------|------|------|------|--|
| | | | | 4 | 5 | 6 | 7 | 8 | 9 | 10 | L1 | L2 | |
| 65-24108CUSHION | 108" | 3.25 | \$ 790 | 1242 | 1453 | 1668 | 1973 | 2292 | 2662 | 3091 | 1863 | 2321 | |
| 65-2490CUSHION | 90" | 2.75 | \$ 715 | 1097 | 1276 | 1458 | 1716 | 1986 | 2299 | 2662 | 1623 | 2010 | |
| 65-2472CUSHION | 72" | 2.25 | \$ 604 | 917 | 1063 | 1212 | 1423 | 1644 | 1900 | 2197 | 1347 | 1664 | |
| 65-2460CUSHION | 60" | 2.00 | \$ 523 | 801 | 931 | 1063 | 1251 | 1447 | 1675 | 1939 | 1183 | 1465 | |
| 65-2436CUSHION | 36" | 1.25 | \$ 445 | 619 | 700 | 783 | 900 | 1023 | 1165 | 1330 | 858 | 1034 | |
| 65-2430CUSHION | 30" | 1.25 | \$ 385 | 559 | 640 | 723 | 840 | 963 | 1105 | 1270 | 798 | 974 | |
| 65-20108CUSHION | 108" | 3.25 | \$ 746 | 1198 | 1409 | 1624 | 1929 | 2248 | 2618 | 3047 | 1819 | 2277 | |
| 65-2090CUSHION | 90" | 2.75 | \$ 675 | 1057 | 1236 | 1418 | 1676 | 1946 | 2259 | 2622 | 1583 | 1970 | |
| 65-2072CUSHION | 72" | 2.25 | \$ 569 | 882 | 1028 | 1177 | 1388 | 1609 | 1865 | 2162 | 1312 | 1629 | |
| 65-2060CUSHION | 60" | 2.00 | \$ 495 | 773 | 903 | 1035 | 1223 | 1419 | 1647 | 1911 | 1155 | 1437 | |
| 65-2036CUSHION | 36" | 1.25 | \$ 416 | 590 | 671 | 754 | 871 | 994 | 1136 | 1301 | 829 | 1005 | |
| 65-2030CUSHION | 30" | 1.25 | \$ 361 | 535 | 616 | 699 | 816 | 939 | 1081 | 1246 | 774 | 950 | |
| 65-1519CUSHION | 15" | 0.75 | \$ 331 | 435 | 484 | 534 | 604 | 678 | 763 | 862 | 579 | 684 | |

Description

- For Use with Mobile Pedestals; [See Mobile Peds](#)
- Increases Height of Mobile Pedestal 2¼"

[See Gesso Intro Section for Ordering Options](#)

With a nod to the '50s and '60s, Iconic's clean lines, tapered legs, and unexpected details present a timeless, approachable quality while being suited to outfit a multitude of areas, including private office, open plan/benching, small meeting areas, and ancillary spaces.

CONSTRUCTION

Iconic features a Veneer chassis with your choice of a Veneer, HPL or 3D Laminate top. Units ship assembled unless otherwise noted.

VENEER

- Exposed surfaces feature select-grade, plain-sliced hardwood Cherry, Maple, American Black Walnut, White Oak, and composite veneers; Veneers are carefully selected and matched to assure proper balance and consistency
- Veneer features UVAdvantage, an ultra-violet finish, on all exposed surfaces by utilizing roll-coat UV technology

LAMINATE

- TFL and HPL are made of woodgrain and solid color laminates fused to particleboard core; Each laminate offers lasting beauty, superior resistance to normal wear, and easy maintenance
- 3D laminate surfaces eliminate the need for edge banding, visible seams, and special edge treatments; elimination of seams helps mitigate the accumulation of potential contaminants and simplifies cleaning

TOPS

- Tops are 1 3/16" thick
- Square (Y) Edge Profile is 3-ply balanced construction with 3mm wood edge-banded rims
- Square edge tops are shaped on all four sides
- Knife (KB) and Illusion (I) Edge Profile are 5-ply balanced construction with hardwood rims. Knife (KB) and Illusion (I) Edge Profile are profiled on three sides of Double Ped and Single Ped Desks with user side featuring Square Edge (Y)
- Grain direction runs left-to-right unless noted

CHASSIS

- Chassis are fastened by using high quality European fastening systems and heavy-duty, 16-gauge joining brackets to assure maximum strength
- All units ship with heavy-duty, adjustable glides to ensure proper leveling and compensate for uneven floors
- Horizontal grain direction unless otherwise noted

DRAWERS

- Box and file drawers are tested for 100lb capacity
- 5-sided drawer construction for easy removal of drawer fronts
- Fronts are 3-ply construction, 3/4" thick with matched grain
- Sides, back, and front are 1/2" thick woodgrain vinyl-wrapped miter fold construction; box and file drawers have 1/8" thick hardboard bottoms, lateral file drawers feature 1/4" thick bottoms
- Optional Dovetail construction with 7/16" thick hardwood sides and backs and 5/32" thick hardboard bottoms
- Box and file drawers feature full extension, progressive action slides with precision steel ball bearings allowing side-to-side and front-to-back
- Optional soft close on box and file drawers allows front-to-back filing in file drawers
- Lateral files 3/4 extension, progressive action slides with precision steel ball bearings
- All suspensions have a limited lifetime warranty

FILING

- All file drawers are standard with filing systems designed to accommodate a variety of filing requirements
- Optional soft close on box and file drawers allows front-to-back filing in file drawer
- Legal width file drawers provide legal filing front to back, and letter or legal filing side to side

STORAGE

- All hinged doors include soft close hinges
- Soft close hinges reduce stress placed on the cabinet when the door is closed and offers a quiet closure

LOCKING

- All units with drawers feature standard locking; optional locking available on models with doors where noted ([see locking option](#))
- Lock core available in black or silver, please specify color
- Removable lock cylinders allow for units to be re-keyed at a later date if required
- Units are shipped randomly keyed as standard
- Keyed alike units available upon request at no additional charge

CORD MANAGEMENT

- Grommets are available in the tops of desks, returns, bridge tops, kneespace credenzas, and credenzas
- An exit grommet is standard on the bottom of pedestals for wires to escape
- Hutch units have standard grommets in back panels
- On units, where noted, a removable back panel for wire access/wire management, as well as an exit grommet, come standard
- Grommets are 2 3/8" in diameter and available in black or silver
- [See all optional grommet locations](#)
- Wire channel ([01-WMGRCB](#)) available for additional undersurface cord management

INTERIOR DRAWER DIMENSIONS

Models

| | | | |
|-------------|-------------|-------------|-------------|
| 50-3672DP | 50-3072DP | 50-2472LKC | 50-2472RKC |
| 50-3666DP | 50-3066DP | 50-2466LKC | 50-2466RKC |
| 50-3660DP | 50-3060DP | 50-2460LKC | 50-2460RKC |
| 50-3672LP | 50-3672RP | 50-3072LP | 50-3072RP |
| 50-3666LP | 50-3666RP | 50-3066LP | 50-3066RP |
| 50-3660LP | 50-3660RP | 50-3060LP | 50-3060RP |
| 50-4824LPDR | 50-4824RPDR | 50-4224LPDR | 50-4224RPDR |
| 50-1872SWBL | 50-1872SWBR | | |

Drawers

| | W | L | D |
|------|---------|----------|---------|
| Box | 15 3/8" | 16 3/16" | 3 1/2" |
| File | 15 3/8" | 16 3/16" | 9 5/16" |

Models

| | | | |
|-------------|-------------|------------|------------|
| 50-2472LOBL | 50-2472LOBR | 50-2472DBF | 50-2472LDF |
| 50-2472OBFL | 50-2472OBFR | | |

Drawers

| | W | L | D |
|----------|----------|----------|--------|
| Lat File | 32 5/32" | 15 1/16" | 9 1/4" |

Models

| | | | |
|-------------|-------------|-------------|-------------|
| 50-2460LOBL | 50-2466LOBL | 50-2460OBFL | 50-2466OBFL |
| 50-2460LOBR | 50-2466LOBR | 50-2460OBFR | 50-2466OBFR |
| 50-2460DBF | 50-2460LDF | 50-6024LLR | 50-6024RLR |

Drawers

| | W | L | D |
|----------|----------|----------|--------|
| Box | 15 3/8" | 12 1/8" | 3 1/2" |
| Lat File | 26 5/32" | 15 1/16" | 9 1/4" |

FILING CAPABILITIES

Drawers with Dimensions: 15⁵/₁₆"W x 16¹/₁₆"L

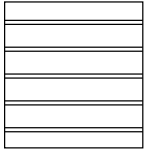

Letter Font to Back

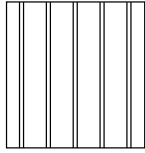

Legal Side to Side

Drawers with Dimensions: 26⁵/₃₂"W x 15¹/₁₆"L

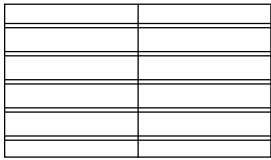

2 Rows Letter Font to Back

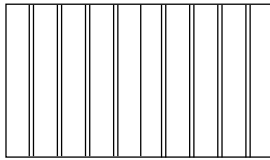

1 Row Legal Side to Side

Drawers with Dimensions: 32⁵/₃₂"W x 15¹/₁₆"L

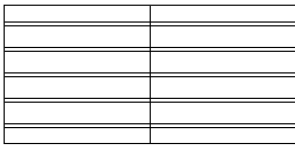

2 Rows Letter Font to Back

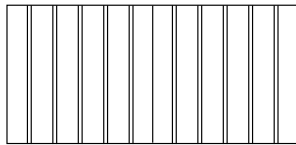

1 Row Legal Side to Side

HOW TO ORDER EXAMPLES

| Model No. | Description | Example |
|-------------|-----------------------------------|-----------|
| 50-3672DP | Top Material | 3D |
| | Edge Profile | KB |
| | Top Finish/Color | CR3 |
| | Chassis Finish | PNW |
| | Finger Pull Accent Material/Color | FPPFHG |
| | Leg Finish | PNW |
| | Modesty Accent Material | 50-APFMD |
| | Modesty Accent Color | MAPFHG |
| | Drawer Construction | DOVE |
| | Drawer Track | SFTCL |
| | Lock Color | BLK |
| | Power/Data | GC, SLV |
| | Kneespace Options | 01-1622CD |
| 50-2472OBFL | Top Material | P |
| | Top Finish/Color | SKC |
| | Chassis Finish | SKC |
| | Cabinet Accent Color | CABSH |
| | Finger Pull Accent Material/Color | FPPBSH |
| | Leg Finish | SKC |
| | Drawer Construction | - |
| | Drawer Track | SFTCL |
| | Lock Color | BLK |
| | Power/Data | GC, BLK |

| Model No. | Description | Example |
|--------------|-------------------------------|---------|
| 50-24600SD72 | Chassis Finish | WTA |
| | Cabinet Accent Color | CAENL |
| | Round Pull/Metal Accent Color | CRD |
| | Leg Finish | BL |

VENEER (W) OPTIONS

Veneer features UV Advantage, an ultra-violet finish, on all exposed surfaces by utilizing roll-coat UV technology

| | | | |
|-----|--------------------|-----|---------------------|
| AW | Artisan Walnut | MW | Mahogany Walnut |
| AS | Asian Night | MAS | Mesa Sunset* |
| CO | Columbian Walnut | MTS | Metropolis Sky |
| DC | Dark Cherry | ORW | Oak Riftwood* |
| DFW | Dark Forest Walnut | PNW | Pinnacle Walnut |
| EW | Espresso | SCH | Select Cherry |
| FO | Fawn Oak* | SKC | Shaker Cherry |
| GC | Golden Cherry | SM | Sugar Maple |
| HW | Harvest Walnut | WTA | Weathered Ash* |
| HNW | Henna Walnut | WC | Williamsburg Cherry |
| LW | Legacy Walnut | | |

* Finish is Low Sheen

HPL (P) OPTIONS

| | | | |
|-----|------------------|-----|---------------------|
| AS | Asian Night | PNW | Pinnacle Walnut |
| CO | Columbian Walnut | SCH | Select Cherry |
| EW | Espresso | SKC | Shaker Cherry |
| GC | Golden Cherry | SM | Sugar Maple |
| MW | Mahogany Walnut | WTA | Weathered Ash |
| ORW | Oak Riftwood | WC | Williamsburg Cherry |

3D LAMINATE (3D) OPTIONS

3D laminate surfaces eliminate the need for edge banding, visible seams, and special edge treatments. The elimination of seams helps to mitigate the accumulation of potential contaminants and simplifies cleaning. See cleaning instructions on our website under Resources.

Our Matte White and Matte Black options are not only durable, they leave no fingerprints. The matte, soft touch finish will add a sense of luxury, beauty, and style to any interior space.

Our Concrete option features a city-inspired, grey concrete surface with an embossed texture that is real to the touch and feel.

See individual select products for availability.

| | | | |
|-----|-------------|-----|-------------|
| CR3 | Concrete | WH3 | Matte White |
| BL3 | Matte Black | | |

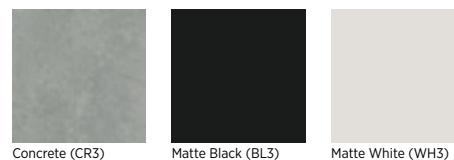

WOOD FINISH LEG OPTIONS

| | | | |
|-----|--------------------|-----|---------------------|
| AW | Artisan Walnut | LW | Legacy Walnut |
| AS | Asian Night | MW | Mahogany Walnut |
| CO | Columbian Walnut | MAS | Mesa Sunset* |
| DC | Dark Cherry | MTS | Metropolis Sky |
| DFW | Dark Forest Walnut | ORW | Oak Riftwood* |
| EW | Espresso | PNW | Pinnacle Walnut |
| FO | Fawn Oak* | SCH | Select Cherry |
| GC | Golden Cherry | SKC | Shaker Cherry |
| HW | Harvest Walnut | SM | Sugar Maple |
| HNW | Henna Walnut | WTA | Weathered Ash* |
| | | WC | Williamsburg Cherry |

* Finish is Low Sheen

SOLID COLORS

| | | | |
|----|-------|----|----------------|
| BL | Black | WH | Designer White |
|----|-------|----|----------------|

EDGE PROFILE

Select units feature multiple profile options. See specific units for details. Double Ped and Single Ped Desks are profiled on three sides with user side featuring Square Edge (Y).

| | | | |
|----|----------|---|--------|
| I | Illusion | Y | Square |
| KB | Knife | | |



PULL OPTIONS

| | | | |
|-----|----------------------|-----|-------------------------|
| STD | Finger Pull, Veneer* | BRD | Round Door Pull, Black |
| FPF | Finger Pull, Fabric | CRD | Round Door Pull, Chrome |
| FPP | Finger Pull, HPL | | |



Finger Pull



Round Door Pull

*Veneer Finger Pull Finish will match Chassis Finish

FINGER PULL HPL ACCENT (FPP) OPTIONS

| | | | |
|--------|----------------|--------|-----------------|
| FPPBL | Black | FPPFK | First Kiss |
| FPPBSH | Blush | FPPSG | Slate Grey |
| FPPWH | Designer White | FPPSV | Summer Vacation |
| FPPFHG | Fashion Grey | FPPSUS | Surfin USA |



MODESTY ACCENT HPL (P) OPTIONS

| | | | |
|--------|----------------|--------|-----------------|
| MAPBL | Black | MAPFK | First Kiss |
| MAPBSH | Blush | MAPSG | Slate Grey |
| MAPWH | Designer White | MAPSV | Summer Vacation |
| MAPFHG | Fashion Grey | MAPSUS | Surfin USA |



Modesty Panel is available in veneer only, while the Modesty Accent is available in veneer, HPL, or fabric.

UPHOLSTERY OPTIONS

For units available with a Fabric Finger Pull or Modesty Accent, as well as tackboards, we offer a wide variety of graded-in or contract options. Due to the minimal, 1/2 yard requirement for Accent Features, all leather options for these units will be COL.

All graded-in fabrics, contract partners, and our COM/COL Form may be found online at: www.indianafurniture.com/resources/textiles

INTERIOR CABINET ACCENT HPL (P) OPTIONS

Select units feature an optional interior HPL accent color. See specific units for details.

| | | | |
|-------|----------------|-------|-----------------|
| CABL | Black | CAFK | First Kiss |
| CABSH | Blush | CASG | Slate Grey |
| CAWH | Designer White | CASV | Summer Vacation |
| CAFHG | Fashion Grey | CASUS | Surfin USA |

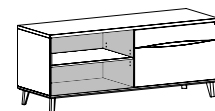

For example, Shaded Area Denotes Cabinet Accent Location

DRAWER OPTIONS

Units with drawers come standard with woodgrain vinyl-wrapped drawers. Optional dove tail construction for all box, file, and lateral file drawers is available. Soft close is also available for all box and file drawers. **File drawers with the soft close option feature front-to-back filing.** Must specify when ordering.

Pricing is per Drawer, not per Model/Unit.

| | | | |
|-------|---|----|----|
| DOVE | Wood Dove Tail Construction | \$ | 45 |
| SFTCL | Soft Close Drawer Track (Box & File Drawers Only) | \$ | 34 |

LOCK CORE COLOR OPTIONS

| | | | |
|-----|-------|-----|--------|
| BLK | Black | SLV | Silver |
|-----|-------|-----|--------|



LOCKING DOORS

Locking doors are available on specific units, where noted. Must specify WITH LOCKING when ordering, denote color, and add upcharge. Color Options: Black (BLK) or Silver (SLV)

| | | | |
|--------|--------------------|----|-----|
| LKT_HU | 78"W to 48"W Units | \$ | 115 |
| LKT_HU | 42"W to 30"W Units | \$ | 91 |
| LKT_HU | 18"W Units | \$ | 69 |

GROMMET OPTIONS & POWER UNIT LOCATIONS

Grommets are available in tops of returns, bridges, and credenzas, and may be ordered without grommets at no additional charge. Please specify NO GROMMET on order.

Grommets are available on hutches in standard locations for task light management at no additional charge. Please specify WMHUBL (Black) or WMHUSV (Silver).

Power/Data, Dock 950 and Dock 150 units must be specified separately with surface mount location. Dock 950 and Dock 150 units are available on Table Desks and Credenza Tops, and where otherwise noted.

Grommets are available in standard locations. Please specify using info below. Multiple locations may be selected. Only one unit per location.

GROMMET LOCATIONS (Black = BLK and Silver = SLV)

| | | | |
|----|--------------------------------------|----|----|
| GC | Grommet, Center - Specify BLK or SLV | \$ | 52 |
| GL | Grommet, Left - Specify BLK or SLV | \$ | 52 |
| GR | Grommet, Right - Specify BLK or SLV | \$ | 52 |

DUO/TRIO BEZEL LOCATIONS

| | |
|-------|---------------|
| PDC-C | Bezel, Center |
| PDC-L | Bezel, Left |
| PDC-R | Bezel, Right |

DOCK 950 and DOCK 150 LOCATIONS (See Dock Units)

| | | | |
|-----------|---------------------------------------|----|-----|
| DOCK950-L | D950 Wireless Charger, Left | \$ | 265 |
| DOCK950-C | D950 Wireless Charger, Center | \$ | 265 |
| DOCK950-R | D950 Wireless Charger, Right | \$ | 265 |
| DOCK150-L | D150 Wireless and USB Charger, Left | \$ | 405 |
| DOCK150-C | D150 Wireless and USB Charger, Center | \$ | 405 |
| DOCK150-R | D150 Wireless and USB Charger, Right | \$ | 405 |

Verify Grommet Option is available on the model(s) you are specifying using the following location information. Grommets, Power Units, Dock 950 and Dock 150 may be ordered in non-standard locations. Call Customer Service to assist with specification and/or please attach a drawing to the PO showing the location of the grommet. Note additional charges and lead times may apply.

Models

| | | | |
|-------------|-------------|-------------|-------------|
| 50-3672DP | 50-3072DP | 50-3072LP | 50-3072RP |
| 50-3666DP | 50-3066DP | 50-3066LP | 50-3066RP |
| 50-3660DP | 50-3060DP | 50-3060LP | 50-3060RP |
| 50-3672LP | 50-3672RP | 50-3672TD | 50-3072TD |
| 50-3666LP | 50-3666RP | 50-3666TD | 50-3066TD |
| 50-3660LP | 50-3660RP | 50-3660TD | 50-3060TD |
| 50-3672ROTD | 50-3072ROTD | 50-3666ROTD | 50-3066ROTD |
| 50-3660ROTD | 50-3060ROTD | | |

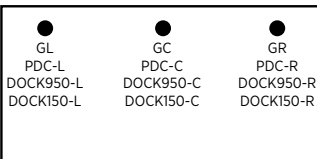

GL/GR/PDC-L/PDC-R/DOCK950-L/DOCK950-R/DOCK150-L/DOCK150-R: 6" from ends; 21" from user side

GC/PDC-C/DOCK950-C/DOCK150-C: 21" from user side

Models

| | | | |
|-------------|-------------|-------------|-------------|
| 50-2472LOB | 50-4224RPDR | 50-6024RLR* | 50-2472OBFL |
| 50-2466LOB | 50-2472DBF | 50-4824TP | 50-2472OBFR |
| 50-2460LOB | 50-2460DBF | 50-4224TP | 50-2466OBFL |
| 50-4824LPDR | 50-2472LDF | 50-3624TP | 50-2466OBFR |
| 50-4224LPDR | 50-2460LDF | 50-2472SDB | 50-2460OBFL |
| 50-4824RPDR | 50-6024LLR* | 50-2466SDB | 50-2460OBFR |
| 50-2472LOBR | 50-2460LOBR | 50-2460SDB | 50-2466LOBL |
| 50-2466LOBR | 50-2460LOBL | 50-2472LOBL | |

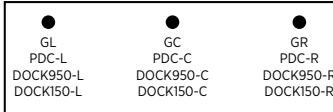

* Center grommet not available

PDC-L/PDC-R: 11" from ends; 21 1/2" from user side
PDC-C: 21 1/2" from user side

GL/GR/DOCK950-L/DOCK950-R/DOCK150-L/DOCK150-R: 6" from ends; 20" from user side

GC/DOCK950-C/DOCK150-C: 20" from user side

Models

| | | | |
|------------|------------|------------|------------|
| 50-2472LKC | 50-2472RKC | 50-2466LKC | 50-2466RKC |
| 50-2460LKC | 50-2460RKC | | |

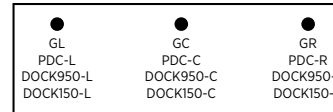

PDC-L/PDC-R: 6" from ends; 20" from user side
PDC-C: 20" from user side

GL/GR/DOCK950-L/DOCK950-R/DOCK150-L/DOCK150-R: 4" from ends; 20" from user side

GC/DOCK950-C/DOCK150-C: 20" from user side

Models

| | | | |
|------------|-------------|-------------|-------------|
| 50-4824TDR | 50-2472ROTD | 50-2466ROTD | 50-2460ROTD |
| 50-4224TDR | | | |

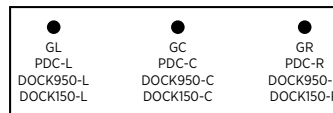

PDC-L/PDC-R: 11" from ends; 15" from user side
PDC-C: 15" from user side

GL/GR/DOCK950-L/DOCK950-R/DOCK150-L/DOCK150-R: 6" from ends; 15" from user side

GC/DOCK950-C/DOCK150-C: 15" from user side

Models

| | | | |
|-----------|-----------|-----------|-----------|
| 50-2436BF | 50-2436LL | 50-2430BF | 50-2430LL |
|-----------|-----------|-----------|-----------|

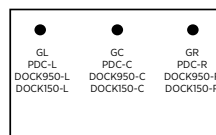

GL/GR/PDC-L/PDC-R/DOCK950-L/DOCK950-R/DOCK150-L/DOCK150-R: 6" from ends; 20" from user side

GC/PDC-C/DOCK950-C/DOCK150-C: 20" from user side

CERTIFICATIONS & COMPLIANCE

- Intertek Sustainability Certified
- BIFMA level® Certified
- BIFMA Compliant® Certified
- TSCA Title VI (formerly CARB) Compliance
- US Green Building's LEED® Contribution

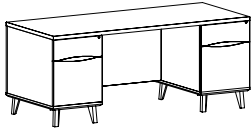

Double Ped Desks
[\(See Details\)](#)

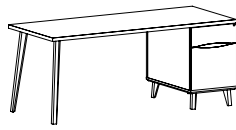

Single Ped Desks
[\(See Details\)](#)

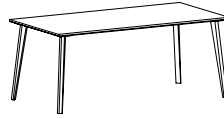
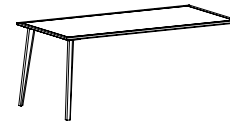
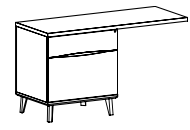

Table Desks
[\(See Details\)](#)



Run Off Table Desks
[\(See Multiple Unit Details\)](#)



Returns
[\(See Details\)](#)



Bridge Surfaces
[\(See Details\)](#)

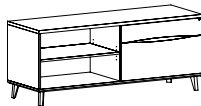

Standard & Low Height Credenzas
[\(See Multiple Unit Details\)](#)

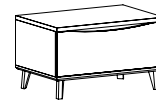
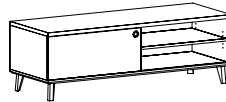

Low Height Lateral
[\(See Details\)](#)



Box/Lateral File
[\(See Details\)](#)

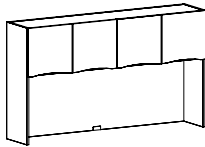

Wall Mount and Surface
Mount Hutches
[\(See Multiple Unit Details\)](#)

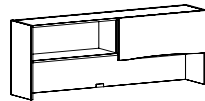

Low Surface Mount Hutches
[\(See Multiple Unit Details\)](#)

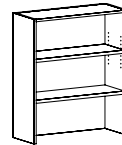

Surface Mount Bookcase
[\(See Details\)](#)

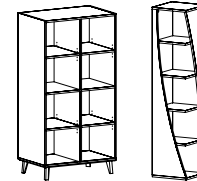

Bookcases and Twisted Bookcases
[\(See Multiple Unit Details\)](#)



Freestanding [\(See Details\)](#), Surface Mount
Open Storage/Dividers [\(See Multiple Unit Details\)](#)

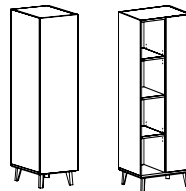
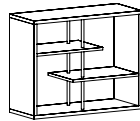

Storage/Wardrobes
[\(See Multiple Unit Details\)](#)



L-Shelves
[\(See Details\)](#)

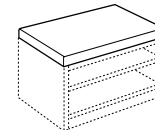

Component Cushions
[\(See Details\)](#)

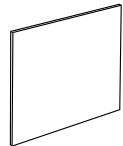

Marker Boards
[\(See Multiple Unit Details\)](#)

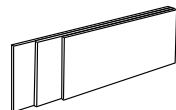

Tackboards
[\(See Multiple Unit Details\)](#)

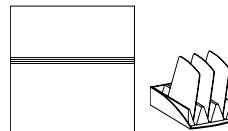

WorkWalls & Accessories
[\(See Multiple Unit Details\)](#)

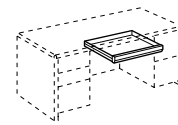

Kneespace Options
[\(See Multiple Unit Details\)](#)



Task Lighting
[\(See Multiple Unit Details\)](#)

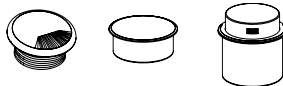

Power/Data and Accessories
[\(See Multiple Unit Details\)](#)

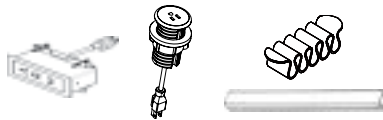

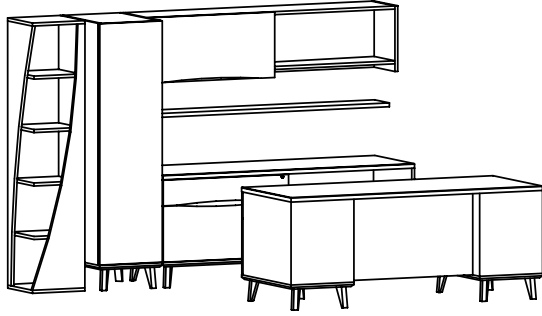

The floating shelf shown is part of the Gesso Casegoods line and can be used with Iconic.

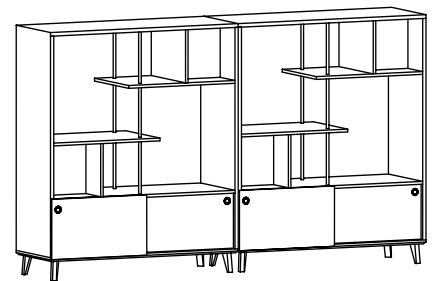
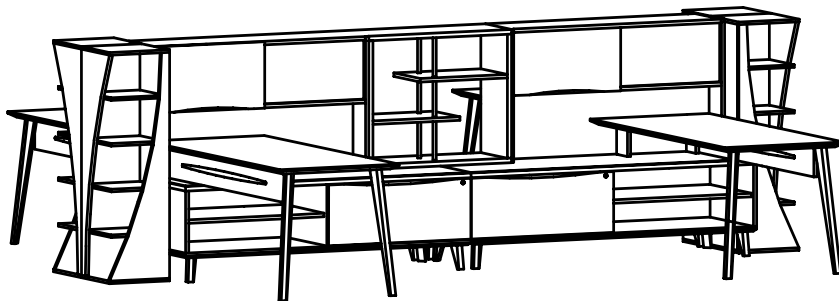
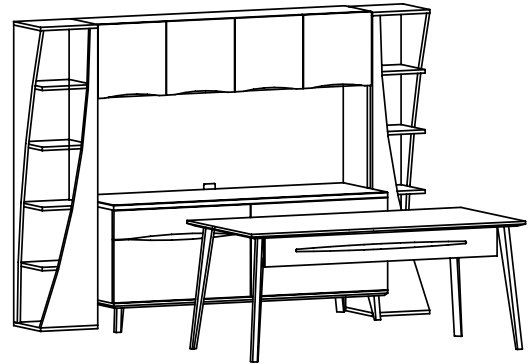
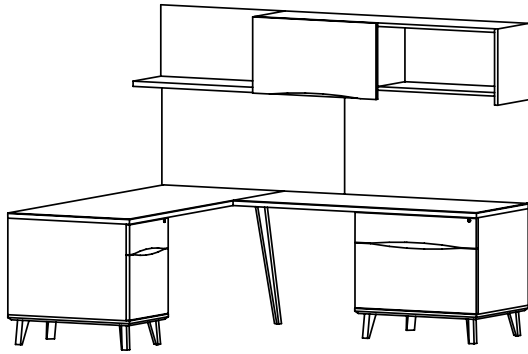
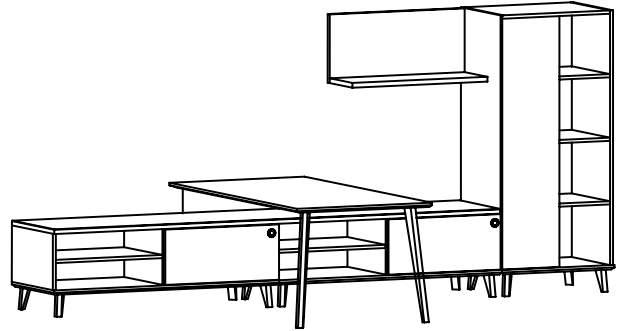

| Item | Model No. | Width | Depth | Height | Ship Wt | Cubic Ft | List Price |
|---------------|-----------|-------|-------|--------|---------|----------|---------------------------|
| L-UNIT OFFICE | 50-1 | 96 | 72 | 78 | 527 | 100.8 | P/W\$ 11583 3D\$ 14026 |

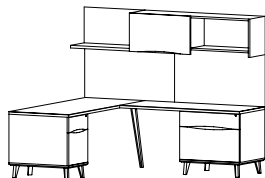
CONSISTS OF: QTY

| | | | |
|------------|---|---|-------------------------|
| 50-3672LP | 1 | Single Ped Desk, Left with Square Edge and Finger Pull Accent in Veneer | P/W\$ 3990 3D\$ 6433 |
| 50-6024RLR | 1 | Box/Lateral Return, Right with Finger Pull Accent in Veneer | \$ 3647 |
| 50-1560SWD | 1 | Wall Mount Hutch with Sliding Door with Finger Pull Accent in Veneer | \$ 2314 |
| 50-1536LS | 1 | Open Wall Mounted L-Shelf | \$ 844 |
| TB-6696W | 1 | 96" Tackboard | GR1\$ 788 |

Products are available as left or right and with other features, where applicable
List does not include seating or accessories

| | | | | | | | |
|------------------|------|-----|-----|-----|------|-------|---------------------------|
| EXECUTIVE OFFICE | 50-2 | 105 | 102 | 70% | 1089 | 125.7 | P/W\$ 22102 3D\$ 24546 |
|------------------|------|-----|-----|-----|------|-------|---------------------------|

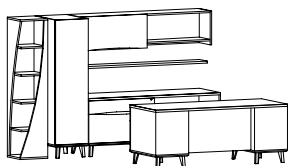
CONSISTS OF: QTY

| | | | |
|-------------|---|---|-------------------------|
| 50-3672DP | 1 | Double Ped Desk with Square Edge and Finger Pull Accent in Veneer | P/W\$ 5798 3D\$ 8242 |
| 50-2472OBFL | 1 | Credenza, Open Bookcase and Box/Lateral File, Left and Finger Pull Accent in Veneer | \$ 5423 |
| 50-1572SWD | 1 | Wall Mount Hutch with Sliding Door and Finger Pull Accent in Veneer | \$ 2419 |
| 50-2472WL | 1 | Storage Wardrobe, Left | \$ 4281 |
| 50-1572TBL | 1 | Twisted Bookcase, Left | \$ 3022 |
| 65-0972FS | 1 | Gesso Floating Display Shelf | \$ 1159 |

Products are available as left or right and with other features, where applicable
Depth includes 42" between Double Ped Desk and Credenza
List does not include seating or accessories

The floating shelf shown is part of the Gesso Casegoods line and can be used with Iconic.

| Item | Model No. | Width | Depth | Height | Ship Wt | Cubic Ft | List Price |
|---------------------------|-----------|-------|-------|------------------|---------|----------|---------------------------|
| RUN-OFF TABLE DESK OFFICE | 50-3 | 180 | 72 | 70 $\frac{1}{8}$ | 971 | 111.3 | P/W\$ 17957 3D\$ 20398 |



| CONSISTS OF: | | QTY | | | | |
|---------------|---|--|-------|------|--|--|
| 50-3672ROTD | 1 | Run Off Table Desk with Square Edge + Optional 7" Veneer Modesty | P/W\$ | 1468 | | |
| | | | 3D\$ | 3909 | | |
| 50-1807US | 1 | Layer Support for Low Storage | \$ | 561 | | |
| 50-2472SDB | 2 | Low Credenza with Open Bookcase and Sliding Door | \$ | 4517 | | |
| 50-1542LS | 1 | Open Wall Mounted L-Shelf | \$ | 958 | | |
| 50-2436OBD72L | 1 | Open Bookcase with Side Door, Left | \$ | 5713 | | |

Products are available as left or right and with other features, where applicable
List price does not include optional 7" veneer modesty, seating, or accessories

| | | | | | | | |
|-------------------|------|-----|-----|------------------|-----|-------|---------------------------|
| TABLE DESK OFFICE | 50-4 | 102 | 102 | 70 $\frac{1}{8}$ | 916 | 100.9 | P/W\$ 19848 3D\$ 22291 |
|-------------------|------|-----|-----|------------------|-----|-------|---------------------------|

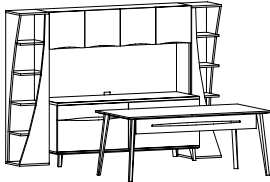

| CONSISTS OF: | | QTY | | | | |
|--------------|---|--|-------|------|--|--|
| 50-3672TD | 1 | Table Desk with Square Edge + Optional 7" Veneer Modesty with Modesty Accent in Veneer | P/W\$ | 1991 | | |
| | | | 3D\$ | 4434 | | |
| 50-2472DBF | 1 | Credenza, Double Box/Lateral File with Finger Pull Accent in Veneer | \$ | 6274 | | |
| 50-1572HU | 1 | Surface Mount Hutch with Finger Pull Accent in Veneer | \$ | 5316 | | |
| 50-1572TBL | 1 | Twisted Bookcase, Left | \$ | 3022 | | |
| 50-1572TBR | 1 | Twisted Bookcase, Right | \$ | 3022 | | |

Products are available as left or right and with other features, where applicable
Depth includes 42" between Table Desk and Credenza
List price does not include optional 7" veneer modesty, modesty accent, seating, or accessories

[See Iconic Intro For Ordering Options and Grommet Locations](#)

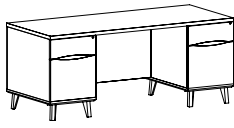
| Item | Model No. | | Width | Depth | Height | K | Ship Wt | Cubic Ft | List Price | | |
|---|--|---------------------------|-------|-------|--------|-----|---------|---------------|---------------|--------------|--|
|  <p>Shown with Square Edge</p> <p><u>Must Specify (in this order):</u> Model # Top Material Edge Profile Top Finish/Color Chassis Finish Finger Pull Accent Material/Color Leg Finish Modesty Accent Material Modesty Accent Color Drawer Construction Drawer Track Lock Color Power/Data Kneespace Options</p> | SQUARE (Y) EDGE PROFILE | | | | | | | | | | |
| | 50-3672DP | HPL/Veneer 3D Laminate | 72 | 36 | 30 | 36 | 320 | 52.1 | P/W\$ 3D\$ | 5798 8242 | |
| | 50-3666DP | HPL/Veneer 3D Laminate | 66 | 36 | 30 | 30 | 310 | 47.9 | P/W\$ 3D\$ | 5742 7619 | |
| | 50-3660DP | HPL/Veneer 3D Laminate | 60 | 36 | 30 | 24 | 300 | 43.6 | P/W\$ 3D\$ | 5683 7274 | |
| | 50-3072DP | HPL/Veneer 3D Laminate | 72 | 30 | 30 | 36 | 285 | 43.9 | P/W\$ 3D\$ | 5648 7610 | |
| | 50-3066DP | HPL/Veneer 3D Laminate | 66 | 30 | 30 | 30 | 275 | 40.3 | P/W\$ 3D\$ | 5569 7147 | |
| | 50-3060DP | HPL/Veneer 3D Laminate | 60 | 30 | 30 | 24 | 265 | 36.7 | P/W\$ 3D\$ | 5500 6958 | |
| | KNIFE (KB) OR ILLUSION (I) EDGE PROFILE | | | | | | | | | | |
| | 50-3672DP | HPL/Veneer 3D Laminate | 72 | 36 | 30 | 36 | 320 | 52.1 | P/W\$ 3D\$ | 6157 8400 | |
| | 50-3666DP | HPL/Veneer 3D Laminate | 66 | 36 | 30 | 30 | 310 | 47.9 | P/W\$ 3D\$ | 6069 7689 | |
| | 50-3660DP | HPL/Veneer 3D Laminate | 60 | 36 | 30 | 24 | 300 | 43.6 | P/W\$ 3D\$ | 5982 7328 | |
| | 50-3072DP | HPL/Veneer 3D Laminate | 72 | 30 | 30 | 36 | 285 | 43.9 | P/W\$ 3D\$ | 5948 7901 | |
| 50-3066DP | HPL/Veneer 3D Laminate | 66 | 30 | 30 | 30 | 275 | 40.3 | P/W\$ 3D\$ | 5843 7206 | | |
| 50-3060DP | HPL/Veneer 3D Laminate | 60 | 30 | 30 | 24 | 265 | 36.7 | P/W\$ 3D\$ | 5750 7058 | | |

Description

- Standard With: Box/File Legal Width Locking Pedestals, Left to Right Grain Direction on Worksurface, Horizontal Grain on Chassis
- Available with Contrasting Top, Chassis, and Leg Color
- Top Available in Veneer (W), HPL (P), or 3D Laminate (3D)
- Three (3) Edge Profiles Available; Square (Y) Edge Profiled on All Four (4) Sides; Knife (KB) and Illusion Edge (I) Profiled on Approach and Sides with Square (Y) Edge Profile on User Side
- Finger Pull Accents Available in Veneer (FPV), HPL (FPP), or Fabric (FPF); See Below
- Locking Pedestals; Available with Black (BLK) or Silver (SLV) Lock Cores
- Exit Grommet on the Bottom of Both Pedestals for Wires to Escape
- Additional Options: Modesty Accent (See Below), Dove Tail Drawer Construction and Soft Close Drawers (See [Drawer Options](#)), Power and Grommet Options (See [Option Details](#)), Kneespace Options (See [Multiple Unit Detail](#)), Glass Marker Boards, Work Wall, Tackboards and Other Accessories (See [Multiple Unit Details](#))

Finger Pull Options: Must Specify & Add

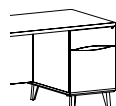

| | | | |
|-----|--|----|-----------|
| FPV | Finger Pull, Veneer Accent (Finish Will Match Chassis Selection) | \$ | NC |
| FPP | Finger Pull, HPL Accent; Must Specify Color, See Color Options | \$ | 108 |
| FPF | Finger Pull, Fabric Accent; Must Specify Fabric | \$ | See Below |

| List Price/Grade | Yards | GR 1/ COM/COL | 2 | 3 | 4 | 5 | 6 | 7 | 8 | 9 | 10 | |
|------------------|---------------------|---------------|-----|-----|-----|-----|-----|-----|-----|-----|-----|-----|
| FPF | Finger Pull, Fabric | 0.5 \$ | 153 | 179 | 201 | 223 | 255 | 288 | 335 | 384 | 441 | 507 |

Optional Modesty Accent: Specify & Add

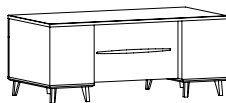

| | | | |
|----------|--|----|-----------|
| 50-AVFMD | Modesty Accent, Veneer (Finish Will Match Chassis Selection) | \$ | NC |
| 50-APFMD | Modesty Accent, HPL; Must Specify Color, See Color Options | \$ | 54 |
| 50-AFFMD | Modesty Accent, Fabric; Must Specify Fabric | \$ | See Below |

| List Price/Grade | Yards | GR 1/ COM/COL | 2 | 3 | 4 | 5 | 6 | 7 | 8 | 9 | 10 | |
|------------------|------------------------|---------------|----|-----|-----|-----|-----|-----|-----|-----|-----|-----|
| 50-AFFMD | Modesty Accent, Fabric | 0.5 \$ | 77 | 103 | 125 | 147 | 179 | 212 | 259 | 308 | 365 | 431 |

[See Iconic Intro For Ordering Options and Grommet Locations](#)

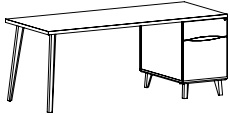
| Item | Model No. | | Width | Depth | Height | Ship Wt | Cubic Ft | List Price | |
|--|--|-----------------|---------------------------|-------|--------|---------|----------|------------|-------------------------|
|  <p>Shown as Right with Square Edge</p> <p><u>Must Specify (in this order):</u> Model # Top Material Edge Profile Top Finish/Color Chassis Finish Finger Pull Accent Material/Color Leg Finish Modesty Panel Finish Drawer Construction Drawer Track Lock Color Power/Data Kneespace Options</p> | SQUARE (Y) EDGE PROFILE | | | | | | | | |
| | | Left Ped | Right Ped | | | | | | |
| | 50-3672LP | 50-3672RP | HPL/Veneer 3D Laminate | 72 | 36 | 30 | 230 | 52.1 | P/W\$ 3990 3D\$ 6433 |
| | 50-3666LP | 50-3666RP | HPL/Veneer 3D Laminate | 66 | 36 | 30 | 220 | 47.9 | P/W\$ 3944 3D\$ 5823 |
| | 50-3660LP | 50-3660RP | HPL/Veneer 3D Laminate | 60 | 36 | 30 | 210 | 43.6 | P/W\$ 3866 3D\$ 5457 |
| | 50-3072LP | 50-3072RP | HPL/Veneer 3D Laminate | 72 | 30 | 30 | 206 | 43.9 | P/W\$ 3842 3D\$ 5807 |
| | 50-3066LP | 50-3066RP | HPL/Veneer 3D Laminate | 66 | 30 | 30 | 196 | 40.3 | P/W\$ 3774 3D\$ 5353 |
| | 50-3060LP | 50-3060RP | HPL/Veneer 3D Laminate | 60 | 30 | 30 | 186 | 36.7 | P/W\$ 3720 3D\$ 5176 |
| | KNIFE (KB) OR ILLUSION (I) EDGE PROFILE | | | | | | | | |
| | | Left Ped | Right Ped | | | | | | |
| | 50-3672LP | 50-3672RP | HPL/Veneer 3D Laminate | 72 | 36 | 30 | 230 | 52.1 | P/W\$ 4351 3D\$ 6591 |
| | 50-3666LP | 50-3666RP | HPL/Veneer 3D Laminate | 66 | 36 | 30 | 220 | 47.9 | P/W\$ 4272 3D\$ 5893 |
| | 50-3660LP | 50-3660RP | HPL/Veneer 3D Laminate | 60 | 36 | 30 | 210 | 43.6 | P/W\$ 4164 3D\$ 5511 |
| | 50-3072LP | 50-3072RP | HPL/Veneer 3D Laminate | 72 | 30 | 30 | 206 | 43.9 | P/W\$ 4144 3D\$ 6097 |
| | 50-3066LP | 50-3066RP | HPL/Veneer 3D Laminate | 66 | 30 | 30 | 196 | 40.3 | P/W\$ 4048 3D\$ 5410 |
| | 50-3060LP | 50-3060RP | HPL/Veneer 3D Laminate | 60 | 30 | 30 | 186 | 36.7 | P/W\$ 3970 3D\$ 5277 |

Description

- Standard With: Box/File Legal-Width Locking Pedestal, Left to Right Grain Direction on Worksurface, Horizontal Grain on Chassis
- Available with Contrasting Top, Modesty, Chassis, and Leg Color
- Top Available in Veneer (W), HPL (P), or 3D Laminate (3D)
- Three (3) Edge Profiles Available; Square (Y) Edge Profiled on All Four (4) Sides; Knife (KB) and Illusion Edge (I) Profiled on Approach and Sides with Square (Y) Edge Profile on User Side
- Square (Y) Edge Profile Required on Top if Attaching to Another Unit
- Finger Pull Accents Available in Veneer (FPV), HPL (FPP), or Fabric (FPF)
- Locking Pedestal; Available with Black (BLK) or Silver (SLV) Lock Cores
- Exit Grommet on the Bottom of Pedestal for Wires to Escape
- Additional Options: Modesty Accent (See Below), Dove Tail Drawer Construction and Soft Close Drawers ([See Drawer Options](#)), Power and Grommet Options ([See Option Details](#)), Kneespace Options ([See Multiple Unit Detail](#)), Glass Marker Boards, Work Wall, Tackboards and Other Accessories ([See Multiple Unit Details](#))

Finger Pull Options: Must Specify & Add



| | | | |
|------------------------|--|----|-----------|
| FPV | Finger Pull, Veneer Accent (Finish Will Match Chassis Selection) | \$ | NC |
| FPP _{,3672LP} | Finger Pull, HPL Accent; Must Specify Color, See Color Options | \$ | 54 |
| FPF | Finger Pull, Fabric Accent; Must Specify Fabric | \$ | See Below |

| List Price/Grade | Yards | GR 1/ COM/COL | 2 | 3 | 4 | 5 | 6 | 7 | 8 | 9 | 10 | |
|------------------|---------------------|---------------|----|-----|-----|-----|-----|-----|-----|-----|-----|-----|
| FPF | Finger Pull, Fabric | 0.5 \$ | 77 | 103 | 125 | 147 | 179 | 212 | 259 | 308 | 365 | 431 |

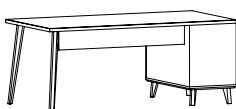

Optional Modesty: Specify & Add

| | | | |
|---------------------------|--|----|-----|
| 50-HMD _{,3672LP} | 7" Veneer Modesty; Must Specify Color, See Color Options | \$ | 195 |
|---------------------------|--|----|-----|

Modesty Accent Not Available On This Unit.

[See Iconic Intro For Ordering Options and Grommet Locations](#)

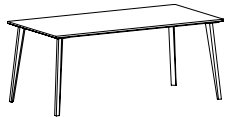
| Item | Model No. | | Width | Depth | Height | Ship Wt | Cubic Ft | List Price | | |
|--|--|----------------|-------|-------|--------|---------|----------|------------|------|--|
|  <p>Shown with Knife Edge</p> <p><u>Must Specify (in this order):</u> Model # Top Material Edge Profile Top Finish/Color Leg Finish Modesty Panel Finish Modesty Accent Material Modesty Accent Color Power/Data</p> | SQUARE (Y) EDGE PROFILE | | | | | | | | | |
| | 50-3672TD | HPL/Veneer | 72 | 36 | 30 | 137 | 9.8 | P/W\$ | 1991 | |
| | | Square | | | | | | 3D\$ | 4434 | |
| | 50-3666TD | HPL/Veneer | 66 | 36 | 30 | 129 | 9.0 | P/W\$ | 1944 | |
| | | Square | | | | | | 3D\$ | 3823 | |
| | 50-3660TD | HPL/Veneer | 60 | 36 | 30 | 121 | 8.2 | P/W\$ | 1895 | |
| | | Square | | | | | | 3D\$ | 3486 | |
| | 50-3072TD | HPL/Veneer | 72 | 30 | 30 | 103 | 10.2 | P/W\$ | 1894 | |
| | | Square | | | | | | 3D\$ | 3857 | |
| | 50-3066TD | HPL/Veneer | 66 | 30 | 30 | 95 | 9.6 | P/W\$ | 1837 | |
| | | Square | | | | | | 3D\$ | 3419 | |
| | 50-3060TD | HPL/Veneer | 60 | 30 | 30 | 87 | 8.9 | P/W\$ | 1787 | |
| | | Square | | | | | | 3D\$ | 3246 | |
| | KNIFE (KB) OR ILLUSION (I) EDGE PROFILE | | | | | | | | | |
| | 50-3672TD | HPL/Veneer | 72 | 36 | 30 | 137 | 9.8 | P/W\$ | 2352 | |
| | | Knife/Illusion | | | | | | 3D\$ | 4592 | |
| 50-3666TD | HPL/Veneer | 66 | 36 | 30 | 129 | 9.0 | P/W\$ | 2272 | | |
| | Knife/Illusion | | | | | | 3D\$ | 3893 | | |
| 50-3660TD | HPL/Veneer | 60 | 36 | 30 | 121 | 8.2 | P/W\$ | 2195 | | |
| | Knife/Illusion | | | | | | 3D\$ | 3542 | | |
| 50-3072TD | HPL/Veneer | 72 | 30 | 30 | 103 | 10.2 | P/W\$ | 2194 | | |
| | Knife/Illusion | | | | | | 3D\$ | 4147 | | |
| 50-3066TD | HPL/Veneer | 66 | 30 | 30 | 95 | 9.6 | P/W\$ | 2111 | | |
| | Knife/Illusion | | | | | | 3D\$ | 3474 | | |
| 50-3060TD | HPL/Veneer | 60 | 30 | 30 | 87 | 8.9 | P/W\$ | 2036 | | |
| | Knife/Illusion | | | | | | 3D\$ | 3343 | | |

Description

- Standard With: Left to Right Grain Direction on Worksurface and Stiffener Bar
- Available with Contrasting Top, Modesty (optional), and Leg Color
- Top Available in Veneer (W), HPL (P), or 3D Laminate (3D)
- Three (3) Edge Profiles Available; Square (Y), Knife (KB), and Illusion (I)
- Some Assembly Required
- Additional Options: Modesty Panel and Accent Feature (See Below), Power and Grommet Options ([See Option Details](#)), Kneespace Options ([See Multiple Unit Detail](#)), Glass Marker Boards, Work Wall, Tackboards and Other Accessories ([See Multiple Unit Details](#))

Optional Modesty: Specify & Add

| | | | |
|--------|-------------------|----|-----|
| 50-HMD | 7" Veneer Modesty | \$ | 223 |
|--------|-------------------|----|-----|

Optional Modesty Accent: Specify & Add

| | | | |
|----------|--|----|-----------|
| 50-AVHMD | Modesty Accent, Veneer (Finish Will Match Modesty Selection) | \$ | NC |
| 50-APHMD | Modesty Accent, HPL; Must Specify Color, See Color Options | \$ | 54 |
| 50-AFHMD | Modesty Accent, Fabric; Must Specify Fabric | \$ | See Below |



| List Price/Grade | Yards | GR 1/ COM/COL | 2 | 3 | 4 | 5 | 6 | 7 | 8 | 9 | 10 | |
|------------------|------------------------|---------------|----|-----|-----|-----|-----|-----|-----|-----|-----|-----|
| 50-AFFMD | Modesty Accent, Fabric | 0.5 \$ | 77 | 103 | 125 | 147 | 179 | 212 | 259 | 308 | 365 | 431 |

[See Iconic Intro For Ordering Options and Grommet Locations](#)

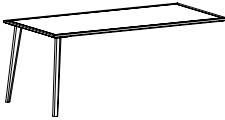
| Item | Model No. | | Width | Depth | Height | Ship Wt | Cubic Ft | List Price | | |
|---|--------------------------------|-------------|-------|-------|--------|---------|----------|------------|------|--|
|  <p>Shown with Knife Edge</p> <p>Must Specify (in this order): Model # Top Material Edge Profile Top Finish/Color Leg Finish Modesty Panel Finish Modesty Accent Material Modesty Accent Color Power/Data</p> | SQUARE (Y) EDGE PROFILE | | | | | | | | | |
| | 50-3672ROTD | HPL/Veneer | 72 | 36 | 30 | 117 | 9.8 | P/W\$ | 1468 | |
| | <i>Square</i> | 3D Laminate | | | | | | 3D\$ | 3909 | |
| | 50-3666ROTD | HPL/Veneer | 66 | 36 | 30 | 109 | 9.0 | P/W\$ | 1417 | |
| | <i>Square</i> | 3D Laminate | | | | | | 3D\$ | 3293 | |
| | 50-3660ROTD | HPL/Veneer | 60 | 36 | 30 | 101 | 8.2 | P/W\$ | 1379 | |
| | <i>Square</i> | 3D Laminate | | | | | | 3D\$ | 2968 | |
| | 50-3072ROTD | HPL/Veneer | 72 | 30 | 30 | 101 | 8.2 | P/W\$ | 1378 | |
| | <i>Square</i> | 3D Laminate | | | | | | 3D\$ | 3340 | |
| | 50-3066ROTD | HPL/Veneer | 66 | 30 | 30 | 94 | 7.6 | P/W\$ | 1325 | |
| | <i>Square</i> | 3D Laminate | | | | | | 3D\$ | 2904 | |
| | 50-3060ROTD | HPL/Veneer | 60 | 30 | 30 | 87 | 6.9 | P/W\$ | 1275 | |
| | <i>Square</i> | 3D Laminate | | | | | | 3D\$ | 2732 | |
| | 50-2472ROTD | HPL/Veneer | 72 | 24 | 30 | 85 | 6.7 | P/W\$ | 1269 | |
| | <i>Square</i> | 3D Laminate | | | | | | 3D\$ | 3223 | |
| | 50-2466ROTD | HPL/Veneer | 66 | 24 | 30 | 79 | 6.1 | P/W\$ | 1232 | |
| | <i>Square</i> | 3D Laminate | | | | | | 3D\$ | 2806 | |
| | 50-2460ROTD | HPL/Veneer | 60 | 24 | 30 | 74 | 5.6 | P/W\$ | 1186 | |
| <i>Square</i> | 3D Laminate | | | | | | 3D\$ | 2639 | | |
| KNIFE (KB) OR ILLUSION (I) EDGE PROFILE | | | | | | | | | | |
| 50-3672ROTD | HPL/Veneer | 72 | 36 | 30 | 117 | 9.8 | P/W\$ | 1826 | | |
| <i>Knife/Illusion</i> | 3D Laminate | | | | | | 3D\$ | 4065 | | |
| 50-3666ROTD | HPL/Veneer | 66 | 36 | 30 | 109 | 9.0 | P/W\$ | 1745 | | |
| <i>Knife/Illusion</i> | 3D Laminate | | | | | | 3D\$ | 3365 | | |
| 50-3660ROTD | HPL/Veneer | 60 | 36 | 30 | 101 | 8.2 | P/W\$ | 1678 | | |
| <i>Knife/Illusion</i> | 3D Laminate | | | | | | 3D\$ | 3024 | | |
| 50-3072ROTD | HPL/Veneer | 72 | 30 | 30 | 101 | 8.2 | P/W\$ | 1677 | | |
| <i>Knife/Illusion</i> | 3D Laminate | | | | | | 3D\$ | 3630 | | |
| 50-3066ROTD | HPL/Veneer | 66 | 30 | 30 | 94 | 7.6 | P/W\$ | 1599 | | |
| <i>Knife/Illusion</i> | 3D Laminate | | | | | | 3D\$ | 2961 | | |
| 50-3060ROTD | HPL/Veneer | 60 | 30 | 30 | 87 | 6.9 | P/W\$ | 1524 | | |
| <i>Knife/Illusion</i> | 3D Laminate | | | | | | 3D\$ | 2831 | | |
| 50-2472ROTD | HPL/Veneer | 72 | 24 | 30 | 85 | 6.7 | P/W\$ | 1507 | | |
| <i>Knife/Illusion</i> | 3D Laminate | | | | | | 3D\$ | 3515 | | |
| 50-2466ROTD | HPL/Veneer | 66 | 24 | 30 | 79 | 6.1 | P/W\$ | 1452 | | |
| <i>Knife/Illusion</i> | 3D Laminate | | | | | | 3D\$ | 2864 | | |
| 50-2460ROTD | HPL/Veneer | 60 | 24 | 30 | 74 | 5.6 | P/W\$ | 1387 | | |
| <i>Knife/Illusion</i> | 3D Laminate | | | | | | 3D\$ | 2738 | | |

Description

- Standard With: Left to Right Grain Direction on Worksurface and Stiffener Bar
- To Be Used With 50-1807US Layer Support for Low Storage
- Available with Contrasting Top, Modesty (optional), and Leg Color
- Top Available in Veneer (W), HPL (P), or 3D Laminate (3D)
- Three (3) Edge Profiles Available; Square (Y), Knife (KB), and Illusion (I)
- Non-Handed; Some Assembly Required
- Additional Options: Modesty Panel and Accent Feature (See Next Page), Power and Grommet Options ([See Option Details](#)), Kneespace Options ([See Multiple Unit Detail](#)), Glass Marker Boards, Work Wall, Tackboards and Other Accessories ([See Multiple Unit Details](#))

CONTINUED ONTO NEXT PAGE

[See Iconic Intro For Ordering Options and Grommet Locations](#)

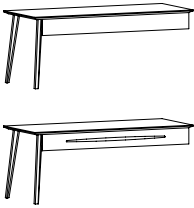
| Item | Model No. | Width | Depth | Height | Ship Wt | Cubic Ft | List Price | | | | | | |
|--|---|--|--------------|----------------------|----------|----------|------------|-----------|----------|----------|----------|----------|-----------|
| RUN OFF TABLE DESK (CONTINUED)  | Optional Modesty: Specify & Add | | | | | | | | | | | | |
| | 50-HMD | 7" Veneer Modesty | | | | | \$ | 223 | | | | | |
| | Optional Modesty Accent: Specify & Add | | | | | | | | | | | | |
| | 50-AVHMD | Modesty Accent, Veneer (Finish Will Match Modesty Selection) | | | | | \$ | NC | | | | | |
| | 50-APHMD | Modesty Accent, HPL; Must Specify Color, See Color Options | | | | | \$ | 54 | | | | | |
| | 50-AFHMD | Modesty Accent, Fabric; Must Specify Fabric | | | | | \$ | See Below | | | | | |
| | List Price/Grade | | Yards | GR 1/ COM/COL | 2 | 3 | 4 | 5 | 6 | 7 | 8 | 9 | 10 |
| | 50-AFFMD | Modesty Accent, Fabric | 0.5 | \$ 77 | 103 | 125 | 147 | 179 | 212 | 259 | 308 | 365 | 431 |

| | | | | | | | | |
|--------------------------------------|-----------|----|----|---|---|-----|----|-----|
| LAYER SUPPORT FOR LOW STORAGE | 50-1807US | 18 | 5¾ | 7 | 4 | 0.6 | \$ | 561 |
|--------------------------------------|-----------|----|----|---|---|-----|----|-----|

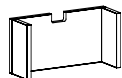

Must Specify (in this order):

- Model #
- Finish
- Grommet Color

Description

- Supports Run-Off Table Desks Over Low Height Components
- Available in Veneer (W)
- Grommet Included; Available in Black (BLK) or Silver (SLV)
- Open Throughout and On Back Side to Manage Cables

| | | | | | | | | |
|--------------------------|------------|----|----|----|----|-----|----|-----|
| RETURN TABLE DESK | 50-4824TDR | 48 | 24 | 30 | 63 | 4.5 | \$ | 974 |
|--------------------------|------------|----|----|----|----|-----|----|-----|

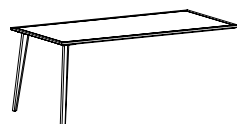

Shown with Knife Edge

Must Specify (in this order):

- Model #
- Top Material
- Top Finish/Color
- Leg Finish
- Power/Data

Description

- Standard With: Front to Back Grain Direction on Worksurface and Square (Y) Edge Profile
- Available with Contrasting Top and Leg Color
- Top Available in Veneer (W) or HPL (P)
- Non-Handed; Some Assembly Required
- Optional Power and Grommet Options ([See Option Details](#))

[See Iconic Intro For Ordering Options and Grommet Locations](#)

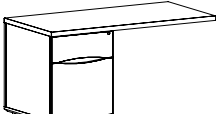
| Item | Model No. | Width | Depth | Height | Ship Wt | Cubic Ft | List Price |
|---|-----------------|------------------|-------|--------|---------|----------|------------|
|  | Left Ped | Right Ped | | | | | |
| | 50-4824LPDR | 50-4824RPDR | 48 | 24 | 30 | 129 | \$ 3256 |
| | 50-4224LPDR | 50-4224RPDR | 42 | 24 | 30 | 119 | \$ 3175 |

Shown as Left with Square Edge

Must Specify (in this order):

- Model #
- Top Material
- Top Finish/Color
- Chassis Finish
- Finger Pull Accent Material/Color
- Leg Finish
- Drawer Construction
- Drawer Track
- Lock Color
- Power/Data

Description

- Standard With: Box/File Legal Width Locking Ped, Front to Back Grain Direction on Worksurface, Horizontal Grain on Chassis, and Square (Y) Edge Profile
- Available with Contrasting Top, Chassis, and Leg Color
- Top Available in Veneer (W) or HPL (P)
- Finger Pull Accents Available in Veneer (FPV), HPL (FPP), or Fabric (FPF)
- Locking Pedestal; Available with Black (BLK) or Silver (SLV) Lock Cores
- Exit Grommet on the Bottom of Pedestal for Wires to Escape
- Additional Options: Dove Tail Drawer Construction and Soft Close Drawers ([See Drawer Options](#)), Power and Grommet Options ([See Option Details](#)), Kneespace Options ([See Multiple Unit Detail](#)), Glass Marker Boards, Work Wall, Tackboards and Other Accessories ([See Multiple Unit Details](#))

Finger Pull Options: Must Specify & Add

| | | | |
|-----|--|----|-----------|
| FPV | Finger Pull, Veneer Accent (Finish Will Match Chassis Selection) | \$ | NC |
| FPP | Finger Pull, HPL Accent; Must Specify Color, See Color Options | \$ | 54 |
| FPF | Finger Pull, Fabric Accent; Must Specify Fabric | \$ | See Below |

| List Price/Grade | Yards | GR 1/COM/COL | 2 | 3 | 4 | 5 | 6 | 7 | 8 | 9 | 10 |
|-------------------------|-------|--------------|-----|-----|-----|-----|-----|-----|-----|-----|-----|
| FPF Finger Pull, Fabric | 0.5 | \$ 77 | 103 | 125 | 147 | 179 | 212 | 259 | 308 | 365 | 431 |

| Item | Model No. | Width | Depth | Height | Ship Wt | Cubic Ft | List Price |
|---|-----------------|------------------|-------|--------|---------|----------|------------|
|  | Left Ped | Right Ped | | | | | |
| | 50-6024LLR | 50-6024RLR | 60 | 24 | 30 | 170 | \$ 3647 |

Shown as Left with Square Edge

Must Specify (in this order):

- Model #
- Top Material
- Top Finish/Color
- Chassis Finish
- Finger Pull Accent Material/Color
- Leg Finish
- Drawer Construction
- Box Drawer Track
- Lock Color
- Power/Data

Description

- Standard With: 30" Wide Box/Lateral File Legal Width Locking Ped, Front to Back Grain Direction on Worksurface, Horizontal Grain on Chassis, and Square (Y) Edge Profile
- Available with Contrasting Top, Chassis, and Leg Color
- Top Available in Veneer (W) or HPL (P)
- Finger Pull Accents Available in Veneer (FPV), HPL (FPP), or Fabric (FPF)
- Locking Pedestal; Available with Black (BLK) or Silver (SLV) Lock Cores
- Exit Grommet on the Bottom of Pedestal for Wires to Escape
- Additional Options: Dove Tail Drawer Construction and Soft Close Box Drawer ([See Drawer Options](#)), Power and Grommet Options ([See Option Details](#)), Kneespace Options ([See Multiple Unit Detail](#)), Glass Marker Boards, Work Wall, Tackboards and Other Accessories ([See Multiple Unit Details](#))

Finger Pull Options: Must Specify & Add

| | | | |
|-----|--|----|-----------|
| FPV | Finger Pull, Veneer Accent (Finish Will Match Chassis Selection) | \$ | NC |
| FPP | Finger Pull, HPL Accent; Must Specify Color, See Color Options | \$ | 54 |
| FPF | Finger Pull, Fabric Accent; Must Specify Fabric | \$ | See Below |

| List Price/Grade | Yards | GR 1/COM/COL | 2 | 3 | 4 | 5 | 6 | 7 | 8 | 9 | 10 |
|-------------------------|-------|--------------|-----|-----|-----|-----|-----|-----|-----|-----|-----|
| FPF Finger Pull, Fabric | 0.5 | \$ 77 | 103 | 125 | 147 | 179 | 212 | 259 | 308 | 365 | 431 |

[See Iconic Intro For Ordering Options and Grommet Locations](#)

| Item | Model No. | Width | Depth | Height | K | Ship Wt | Cubic Ft | List Price |
|---|-----------|-------|-------|------------------|---|---------|----------|------------|
|  | 50-4824TP | 48 | 24 | 1 $\frac{3}{16}$ | - | 48 | 4.5 | \$ 570 |
| | 50-4224TP | 42 | 24 | 1 $\frac{3}{16}$ | - | 42 | 4.0 | \$ 538 |
| | 50-3624TP | 36 | 24 | 1 $\frac{3}{16}$ | - | 36 | 3.5 | \$ 505 |

Must Specify (in this order):

- Model #
- Top Material
- Top Finish/Color
- Power/Data

Description

- Standard With: Front to Back Grain Direction and Square (Y) Edge Profile
- Available in Veneer (W) or HPL (P)
- For Bridge Application Only
- Optional Power and Grommet Options ([See Option Details](#))

KNEESPACE CREDENZA WITH
OPEN BOOKCASE AND BOX/FILE

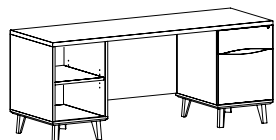

Shown as Right with Square Edge

Must Specify (in this order):

- Model #
- Top Material
- Top Finish/Color
- Chassis Finish
- Cabinet Accent Color
- Finger Pull Accent Material/Color
- Leg Finish
- Drawer Construction
- Drawer Track
- Lock Color
- Power/Data
- Kneespace Options

| Left Ped | Right Ped | Width | Depth | Height | K | Ship Wt | Cubic Ft | List Price |
|------------|------------|-------|-------|--------|----|---------|----------|------------|
| 50-2472LKC | 50-2472RKC | 72 | 24 | 30 | 36 | 265 | 35.4 | \$ 5114 |
| 50-2466LKC | 50-2466RKC | 66 | 24 | 30 | 30 | 255 | 32.7 | \$ 4928 |
| 50-2460LKC | 50-2460RKC | 60 | 24 | 30 | 24 | 245 | 30.0 | \$ 4724 |

Description

- Standard With: Legal Width Locking Box/File Ped with Open Bookcase Ped, One (1) Adjustable Shelf in Open Bookcase, Left to Right Grain Direction on Worksurface, Horizontal Grain on Chassis, and Square (Y) Edge Profile
- For Use in U-Shaped Workstation or Freestanding Applications
- 16" Opening in Open Bookcase Pedestal
- Open Bookcase Features Removable Back Panel for Wire Management; Exit Grommet on the Bottom of Both Pedestals for Wires to Escape
- Available with Contrasting Top, Chassis, and Leg Color
- Tops Available in Veneer (W) or HPL (P)
- Finger Pull Accents Available in Veneer (FPV), HPL (FPP), or Fabric (FPF)
- Locking Pedestal; Available with Black (BLK) or Silver (SLV) Lock Cores
- Additional Options: HPL Cabinet Accent on Bookcase Interior ([See Below](#) and [See Color Options](#)), Dove Tail Drawer Construction and Soft Close Drawers ([See Drawer Options](#)), Power and Grommet Options ([See Option Details](#)), Kneespace Options ([See Multiple Unit Detail](#)), Glass Marker Boards, Work Wall, Tackboards and Other Accessories ([See Multiple Unit Details](#))

Finger Pull Options: Must Specify & Add

| | | | |
|-----|--|----|-----------|
| FPV | Finger Pull, Veneer Accent (Finish Will Match Chassis Selection) | \$ | NC |
| FPP | Finger Pull, HPL Accent; Must Specify Color, See Color Options | \$ | 54 |
| FPF | Finger Pull, Fabric Accent; Must Specify Fabric | \$ | See Below |

| List Price/Grade | Yards | GR 1/COM/COL | 2 | 3 | 4 | 5 | 6 | 7 | 8 | 9 | 10 | |
|------------------|---------------------|--------------|----|-----|-----|-----|-----|-----|-----|-----|-----|-----|
| FPF | Finger Pull, Fabric | 0.5 \$ | 77 | 103 | 125 | 147 | 179 | 212 | 259 | 308 | 365 | 431 |

Cabinet Accent Option: Specify & Add

| | | | |
|-----|--|----|-----|
| HPL | Cabinet Accent on Bookcase Interior; Must Specify Color, See Color Options | \$ | 102 |
|-----|--|----|-----|

[See Iconic Intro For Ordering Options and Grommet Locations](#)

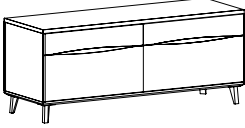
| Item | Model No. | Width | Depth | Height | Ship Wt | Cubic Ft | List Price |
|---|--|-------|-------|--------|---------|----------|------------|
| CREDENZA WITH DOUBLE BOX/LATERAL FILE  | 50-2472DBF <i>Includes (2) 36" Wide Box/Lateral Files</i> | 72 | 24 | 30 | 316 | 35.4 | \$ 6274 |
| | 50-2460DBF <i>Includes (2) 30" Wide Box/Lateral Files</i> | 60 | 24 | 30 | 276 | 30.0 | \$ 5847 |

Shown with Square Edge

Must Specify (in this order):

- Model #
- Top Material
- Top Finish/Color
- Chassis Finish
- Finger Pull Accent Material/Color
- Leg Finish
- Drawer Construction
- Drawer Track
- Lock Color
- Power/Data

Description

- Standard With: Dual Locking Box/Lateral Pedestals, Legal or Letter Filing, Left to Right Grain Direction on Top, Horizontal Grain on Chassis, Square (Y) Edge Profile, and Two (2) Stiffener Bars for Added Support
- Available with Contrasting Top, Chassis, and Leg Color
- Top Available in Veneer (W) or HPL (P)
- Finger Pull Accents Available in Veneer (FPV), HPL (FPP), or Fabric (FPF)
- Locking Pedestals; Available with Black (BLK) or Silver (SLV) Lock Cores
- Additional Options: Dove Tail Drawer Construction and Soft Close Box Drawers ([See Drawer Options](#)), Power and Grommet Options ([See Option Details](#)), Glass Marker Boards, Work Wall, Tackboards and Other Accessories ([See Multiple Unit Details](#))

Finger Pull Options: Must Specify & Add

| | | | |
|-----|--|----|-----------|
| FPV | Finger Pull, Veneer Accent (Finish Will Match Chassis Selection) | \$ | NC |
| FPP | Finger Pull, HPL Accent; Must Specify Color, See Color Options | \$ | 108 |
| FPF | Finger Pull, Fabric Accent; Must Specify Fabric | \$ | See Below |

| List Price/Grade | Yards | 1/COM/COL | 2 | 3 | 4 | 5 | 6 | 7 | 8 | 9 | 10 |
|-------------------------|-------|-----------|-----|-----|-----|-----|-----|-----|-----|-----|-----|
| FPF Finger Pull, Fabric | 0.5 | \$ 153 | 179 | 201 | 223 | 255 | 288 | 335 | 384 | 441 | 507 |

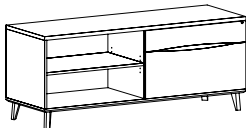
| CREDENZA WITH OPEN BOOKCASE AND BOX/LATERAL  | Left Ped | Right Ped | Width | Depth | Height | Ship Wt | Cubic Ft | List Price |
|--|---|---|-------------|-------|--------|---------|----------|------------|
| | | 50-2472OBFL <i>36" Wide Box/Lateral File</i> | 50-2472OBFR | 72 | 24 | 30 | 296 | 35.4 |
| | 50-2466OBFL <i>30" Wide Box/Lateral File</i> | 50-2466OBFR | 66 | 24 | 30 | 276 | 32.7 | \$ 5208 |
| | 50-2460OBFL <i>30" Wide Box/Lateral File</i> | 50-2460OBFR | 60 | 24 | 30 | 256 | 30.0 | \$ 4911 |

Shown as Right with Square Edge

Must Specify (in this order):

- Model #
- Top Material
- Top Finish/Color
- Chassis Finish
- Cabinet Accent Color
- Finger Pull Accent Material/Color
- Leg Finish
- Drawer Construction
- Drawer Track
- Lock Color
- Power/Data

Description

- Standard With: Box/Lateral File Locking Ped and Open Bookcase, One (1) Adjustable Shelf in Bookcase Ped, Legal or Letter Filing in Lateral File, Left to Right Grain Direction on Top, Horizontal Grain on Chassis, Square (Y) Edge Profile, and Two (2) Stiffener Bars for Added Support
- Open Bookcase Features Removable Back Panel for Wire Management; Exit Grommet on the Bottom of Both Sides for Wires to Escape
- Available with Contrasting Top, Chassis, and Leg Color
- Top Available in Veneer (W) or HPL (P)
- Finger Pull Accents Available in Veneer (FPV), HPL (FPP), or Fabric (FPF)
- Locking Pedestal; Available with Black (BLK) or Silver (SLV) Lock Cores
- Additional Options: HPL Cabinet Accent on Bookcase Interior ([See Below](#) and [See Color Options](#)), Dove Tail Drawer Construction and Soft Close Box Drawer ([See Drawer Options](#)), Power and Grommet Options ([See Option Details](#)), Glass Marker Boards, Work Wall, Tackboards and Other Accessories ([See Multiple Unit Details](#))

Finger Pull Options: Must Specify & Add

| | | | |
|-----|--|----|-----------|
| FPV | Finger Pull, Veneer Accent (Finish Will Match Chassis Selection) | \$ | NC |
| FPP | Finger Pull, HPL Accent; Must Specify Color, See Color Options | \$ | 54 |
| FPF | Finger Pull, Fabric Accent; Must Specify Fabric | \$ | See Below |

| List Price/Grade | Yards | 1/COM/COL | 2 | 3 | 4 | 5 | 6 | 7 | 8 | 9 | 10 |
|-------------------------|-------|-----------|-----|-----|-----|-----|-----|-----|-----|-----|-----|
| FPF Finger Pull, Fabric | 0.5 | \$ 77 | 103 | 125 | 147 | 179 | 212 | 259 | 308 | 365 | 431 |

Cabinet Accent Option: Specify & Add

| | | | |
|-----|--|----|-----|
| HPL | Cabinet Accent on Bookcase Interior; Must Specify Color, See Color Options | \$ | 162 |
|-----|--|----|-----|

[See Iconic Intro For Ordering Options and Grommet Locations](#)

| Item | Model No. | Width | Depth | Height | Ship Wt | Cubic Ft | List Price |
|--|------------|-------|-------|------------------|---------|----------|------------|
| LOW CREDENZA WITH OPEN BOOKCASE AND SLIDING DOOR | 50-2472SDB | 72 | 24 | 21 $\frac{1}{8}$ | 250 | 25.5 | \$ 4517 |
| | 50-2466SDB | 66 | 24 | 21 $\frac{1}{8}$ | 230 | 23.5 | \$ 4254 |
| | 50-2460SDB | 60 | 24 | 21 $\frac{1}{8}$ | 210 | 21.5 | \$ 4082 |

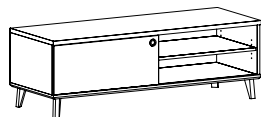

Must Specify (in this order):

- Model #
- Top Material
- Top Finish/Color
- Chassis Finish
- Cabinet Accent Color
- Round Pull Color
- Leg Finish
- Power/Data

Description

- Standard With: Open Bookcase with One (1) Non-Locking Sliding Door, One (1) Adjustable Shelf on Each Side, Left to Right Grain Direction on Top, Horizontal Grain on Chassis, and Square (Y) Edge Profile
- Open Bookcase Features Removable Back Panel for Wire Management; Exit Grommet on the Bottom of Both Sides for Wires to Escape
- Available with Contrasting Top, Chassis, and Leg Color
- Top Available in Veneer (W) or HPL (P)
- Optional Cushion Provides Additional Seating, [See Cushion Details](#)
- Sliding Door; Available with Round Door Pull in Black (BRD) or Chrome (CRD)
- Additional Options: HPL Cabinet Accent on Bookcase Interior (See Below and [See Color Options](#)), Power and Grommet Options ([See Option Details](#)), Glass Marker Boards, Work Wall, Tackboards and Other Accessories ([See Multiple Unit Details](#))

Cabinet Accent Option: Specify & Add

| | | |
|-----|--|--------|
| HPL | Cabinet Accent on Bookcase Interior; Must Specify Color, See Color Options | \$ 271 |
|-----|--|--------|

LOW CREDENZA WITH OPEN BOOKCASE AND LATERAL FILE

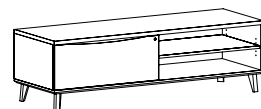

Shown as Left with Square Edge

| Left Ped | Right Ped | Width | Depth | Height | Ship Wt | Cubic Ft | List Price |
|-------------|-------------|------------------------------|-------|------------------|---------|----------|------------|
| 50-2472LOBL | 50-2472LOBR | 72 | 24 | 21 $\frac{1}{8}$ | 255 | 25.5 | \$ 4903 |
| | | <i>36" Wide Lateral File</i> | | | | | |
| 50-2466LOBL | 50-2466LOBR | 66 | 24 | 21 $\frac{1}{8}$ | 235 | 23.5 | \$ 4711 |
| | | <i>30" Wide Lateral File</i> | | | | | |
| 50-2460LOBL | 50-2460LOBR | 60 | 24 | 21 $\frac{1}{8}$ | 215 | 21.5 | \$ 4532 |
| | | <i>30" Wide Lateral File</i> | | | | | |

Description

- Standard With: Locking Lateral File Ped with Open Bookcase, Legal or Letter Filing in Lateral File Drawer, One (1) Adjustable Shelf in Bookcase, Left to Right Grain Direction on Top, Horizontal Grain on Chassis, and Square (Y) Edge Profile
- Open Bookcase Features Removable Back Panel for Wire Management; Exit Grommet on the Bottom of Both Sides for Wires to Escape
- Available with Contrasting Top, Chassis, and Leg Color
- Top Available in Veneer (W) or HPL (P)
- Finger Pull Accents Available in Veneer (FPV), HPL (FPP), or Fabric (FPF)
- Optional Cushion Provides Additional Seating, [See Cushion Details](#)
- Locking Pedestal; Available with Black (BLK) or Silver (SLV) Lock Cores
- Additional Options: HPL Cabinet Accent on Bookcase Interior (See Below and [See Color Options](#)), Dove Tail Drawer Construction ([See Drawer Options](#)), Power and Grommet Options ([See Option Details](#)); Glass Marker Boards, Work Wall, Tackboards and Other Accessories ([See Multiple Unit Details](#))

Finger Pull Options: Must Specify & Add

| | | |
|-----|--|--------------|
| FPV | Finger Pull, Veneer Accent (Finish Will Match Chassis Selection) | \$ NC |
| FPP | Finger Pull, HPL Accent; Must Specify Color, See Color Options | \$ 54 |
| FPF | Finger Pull, Fabric Accent; Must Specify Fabric | \$ See Below |

| List Price/Grade | Yards | GR 1/ COM/COL | 2 | 3 | 4 | 5 | 6 | 7 | 8 | 9 | 10 |
|-------------------------|--------|---------------|-----|-----|-----|-----|-----|-----|-----|-----|-----|
| FPF Finger Pull, Fabric | 0.5 \$ | 77 | 103 | 125 | 147 | 179 | 212 | 259 | 308 | 365 | 431 |

Cabinet Accent Option: Specify & Add

| | | |
|-----|--|--------|
| HPL | Cabinet Accent on Bookcase Interior; Must Specify Color, See Color Options | \$ 146 |
|-----|--|--------|

[See Iconic Intro For Ordering Options and Grommet Locations](#)

| Item | Model No. | Width | Depth | Height | Ship Wt | Cubic Ft | List Price |
|---|---|-------|-------|------------------|---------|----------|------------|
| LOW CREDENZA WITH DOUBLE LATERAL FILE  | 50-2472LDF <i>Includes (2) 36" Wide Lateral File</i> | 72 | 24 | 21 $\frac{7}{8}$ | 265 | 25.5 | \$ 5631 |
| | 50-2460LDF <i>Includes (2) 30" Wide Lateral File</i> | 60 | 24 | 21 $\frac{7}{8}$ | 225 | 21.5 | \$ 5114 |

Shown with Square Edge

Must Specify (in this order):

- Model #
- Top Material
- Top Finish/Color
- Chassis Finish
- Finger Pull Accent Material/Color
- Leg Finish
- Drawer Construction
- Lock Color
- Power/Data

Description

- Standard With: Legal or Letter Filing in Lateral File Drawers, Left to Right Grain Direction on Top, Horizontal Grain Direction on Chassis, Square (Y) Edge Profile, and Two (2) Stiffener Bars for Added Support
- Available with Contrasting Top, Chassis, and Leg Color
- Top Available in Veneer (W) or HPL (P)
- Finger Pull Accents Available in Veneer (FPV), HPL (FPP), or Fabric (FPF)
- Optional Cushion Provides Additional Seating, [See Cushion Details](#)
- Locking Pedestals; Available with Black (BLK) or Silver (SLV) Lock Cores
- Additional Options: Dove Tail Drawer Construction ([See Drawer Options](#)), Power and Grommet Options ([See Option Details](#)), Glass Marker Boards, Work Wall, Tackboards and Other Accessories ([See Multiple Unit Details](#))

Finger Pull Options: Must Specify & Add

| | | | |
|-----|--|----|-----------|
| FPV | Finger Pull, Veneer Accent (Finish Will Match Chassis Selection) | \$ | NC |
| FPP | Finger Pull, HPL Accent; Must Specify Color, See Color Options | \$ | 108 |
| FPF | Finger Pull, Fabric Accent; Must Specify Fabric | \$ | See Below |

| List Price/Grade | Yards | 1/COM/COL | 2 | 3 | 4 | 5 | 6 | 7 | 8 | 9 | 10 |
|-------------------------|-------|-----------|-----|-----|-----|-----|-----|-----|-----|-----|-----|
| FPF Finger Pull, Fabric | 0.5 | \$ 153 | 179 | 201 | 223 | 255 | 288 | 335 | 384 | 441 | 507 |

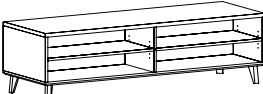
| | | | | | | | |
|--|------------|----|----|------------------|-----|------|---------|
| LOW CREDENZA WITH DOUBLE OPEN BOOKCASE  | 50-2472LOB | 72 | 24 | 21 $\frac{7}{8}$ | 245 | 25.5 | \$ 4369 |
| | 50-2466LOB | 66 | 24 | 21 $\frac{7}{8}$ | 225 | 23.5 | \$ 4151 |
| | 50-2460LOB | 60 | 24 | 21 $\frac{7}{8}$ | 205 | 21.5 | \$ 4001 |

Shown with Square Edge

Must Specify (in this order):

- Model #
- Top Material
- Top Finish/Color
- Chassis Finish
- Cabinet Accent Color
- Leg Finish
- Power/Data

Description

- Standard With: One (1) Adjustable Shelf on Each Side, Left to Right Grain Direction on Top, Horizontal Grain Direction on Chassis, and Square (Y) Edge Profile
- Both Sides Feature Removable Back Panel for Wire Management and Exit Grommet on the Bottom for Wires to Escape
- Available with Contrasting Top, Chassis, and Leg Color
- Tops Available in Veneer (W) or HPL (P)
- Optional Cushion Provides Additional Seating, [See Cushion Details](#)
- Additional Options: HPL Cabinet Accent on Bookcase Interior (See Below and [See Color Options](#)), Power and Grommet Options ([See Option Details](#)), Glass Marker Boards, Work Wall, Tackboards and Other Accessories ([See Multiple Unit Details](#))

Cabinet Accent Option: Specify & Add

| | | | |
|-----|--|----|-----|
| HPL | Cabinet Accent on Bookcase Interior; Must Specify Color, See Color Options | \$ | 261 |
|-----|--|----|-----|

[See Iconic Intro For Ordering Options and Grommet Locations](#)

| Item | Model No. | Width | Depth | Height | Ship Wt | Cubic Ft | List Price |
|------------------|-----------|-------|-------|--------|---------|----------|------------|
| BOX/LATERAL FILE | 50-2436BF | 36 | 24 | 30 | 158 | 18.3 | \$ 3240 |
| | 50-2430BF | 30 | 24 | 30 | 138 | 15.4 | \$ 3069 |

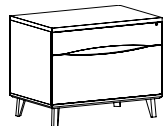

Shown with Square Edge

Must Specify (in this order):

- Model #
- Top Material
- Top Finish/Color
- Chassis Finish
- Finger Pull Accent Material/Color
- Leg Finish
- Drawer Construction
- Box Drawer Track
- Lock Color
- Power/Data

Description

- Standard With: Locking Box/Lateral Pedestal and Legal or Letter Filing in Lateral File Drawer, Left to Right Grain Direction on Top, Horizontal Grain on Chassis, Square (Y) Edge Profile
- Available with Contrasting Top, Chassis, and Leg Color
- Top Available in Veneer (W) or HPL (P)
- Finger Pull Accents Available in Veneer (FPV), HPL (FPP), or Fabric (FPF)
- Locking Pedestal; Available with Black (BLK) or Silver (SLV) Lock Cores
- Additional Options: Dove Tail Drawer Construction ([See Drawer Construction Details](#)), Soft Close Box Drawers ([See Soft Close Options](#)), Power and Grommet Options ([See Option Details](#)), Glass Marker Boards, Work Wall, Tackboards and Other Accessories ([See Multiple Unit Details](#))

Finger Pull Options: Must Specify & Add

| | | | |
|-----|--|----|-----------|
| FPV | Finger Pull, Veneer Accent (Finish Will Match Chassis Selection) | \$ | NC |
| FPP | Finger Pull, HPL Accent; Must Specify Color, See Color Options | \$ | 54 |
| FPF | Finger Pull, Fabric Accent; Must Specify Fabric | \$ | See Below |

| List Price/Grade | Yards | GR 1/ COM/COL | 2 | 3 | 4 | 5 | 6 | 7 | 8 | 9 | 10 |
|-------------------------|--------|------------------|-----|-----|-----|-----|-----|-----|-----|-----|-----|
| FPF Finger Pull, Fabric | 0.5 \$ | 77 | 103 | 125 | 147 | 179 | 212 | 259 | 308 | 365 | 431 |

| Item | Model No. | Width | Depth | Height | Ship Wt | Cubic Ft | List Price |
|------------------|-----------|-------|-------|--------------------------------|---------|----------|------------|
| LOW LATERAL FILE | 50-2436LL | 36 | 24 | 21 ⁷ / ₈ | 132 | 13.2 | \$ 2740 |
| | 50-2430LL | 30 | 24 | 21 ⁷ / ₈ | 113 | 11.1 | \$ 2592 |

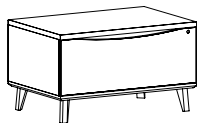

Shown with Square Edge

Must Specify (in this order):

- Model #
- Top Material
- Top Finish/Color
- Chassis Finish
- Finger Pull Accent Material/Color
- Leg Finish
- Drawer Construction
- Lock Color
- Power/Data

Description

- Standard With: One (1) Lateral File, Legal or Letter Filing, Left to Right Grain Direction on Top, Horizontal Grain Direction on Chassis, and Square (Y) Edge Profile
- Available with Contrasting Top, Chassis, and Leg Color
- Tops Available in Veneer (W) or HPL (P)
- Finger Pull Accents Available in Veneer (FPV), HPL (FPP), or Fabric (FPF)
- Optional Cushion Provides Additional Seating, [See Cushion Details](#)
- Locking Drawer; Available with Black (BLK) or Silver (SLV) Lock Cores
- Additional Options: Dove Tail Drawer Construction ([See Drawer Options](#)), Power and Grommet Options ([See Option Details](#)), Glass Marker Boards, Work Wall, Tackboards and Other Accessories ([See Multiple Unit Details](#))

Finger Pull Options: Must Specify & Add

| | | | |
|-----|--|----|-----------|
| FPV | Finger Pull, Veneer Accent (Finish Will Match Chassis Selection) | \$ | NC |
| FPP | Finger Pull, HPL Accent; Must Specify Color, See Color Options | \$ | 54 |
| FPF | Finger Pull, Fabric Accent; Must Specify Fabric | \$ | See Below |

| List Price/Grade | Yards | GR 1/ COM/COL | 2 | 3 | 4 | 5 | 6 | 7 | 8 | 9 | 10 |
|-------------------------|--------|------------------|-----|-----|-----|-----|-----|-----|-----|-----|-----|
| FPF Finger Pull, Fabric | 0.5 \$ | 77 | 103 | 125 | 147 | 179 | 212 | 259 | 308 | 365 | 431 |

[See Iconic Intro For Ordering Options and Grommet Locations](#)

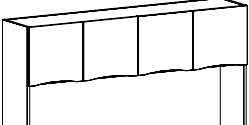
| Item | Model No. | Width | Depth | Height | Ship Wt | Cubic Ft | List Price |
|---|-------------------------------|-------|-------|--------|---------|----------|------------|
|  | SURFACE MOUNT HUTCH 50-1572HU | 72 | 15 | 40 7/8 | 203 | 34.1 | \$ 5316 |
| | 50-1566HU | 66 | 15 | 40 7/8 | 166 | 32.1 | \$ 5132 |
| | 50-1560HU | 60 | 15 | 40 7/8 | 129 | 28.4 | \$ 5011 |

Description

- Standard With: Veneer Finish, Four (4) Soft-Close Hinged Doors, Horizontal Grain Direction, and Grommet
- 23 3/4" Clearance Below Doors
- Finger Pull Accents Available in Veneer (FPV), HPL (FPP), or Fabric (FPF); Fabric Patterns May Not Align From Door-to-Door, Use Caution with Patterned/Striped Fabrics
- Grommet Included; Available in Black (BLK) or Silver (SLV)
- Additional Options: HPL Cabinet Accent on Hutch Interior (See Below and [See Color Options](#)), Locking Doors ([See Locking Options](#)), Glass Marker Boards, Work Wall, Tackboards ([See Multiple Unit Details](#)), and Tasklights ([See Multiple Unit Details](#))

Must Specify (in this order):
 Model #
 Chassis Finish
 Cabinet Accent Color
 Finger Pull Accent Material/Color
 Lock Color
 Tackboard Fabric
 Tasklight
 Grommet Color

Finger Pull Options: Must Specify & Add

| | | | |
|-----|--|----|-----------|
| FPV | Finger Pull, Veneer Accent (Finish Will Match Chassis Selection) | \$ | NC |
| FPP | Finger Pull, HPL Accent; Must Specify Color, See Color Options | \$ | 156 |
| FPF | Finger Pull, Fabric Accent; Must Specify Fabric | \$ | See Below |

| List Price/Grade | Yards | GR 1/ COM/COL | 2 | 3 | 4 | 5 | 6 | 7 | 8 | 9 | 10 |
|-------------------------|--------|---------------|-----|-----|-----|-----|-----|-----|-----|-----|-----|
| FPF Finger Pull, Fabric | 0.5 \$ | 191 | 217 | 239 | 261 | 293 | 326 | 373 | 422 | 479 | 545 |

Cabinet Accent Option: Specify & Add

| | | | |
|-----|---|----|-----|
| HPL | Cabinet Accent on Hutch Interior; Must Specify Color, See Color Options | \$ | 346 |
|-----|---|----|-----|

SURFACE MOUNT HUTCH WITH SLIDING DOOR

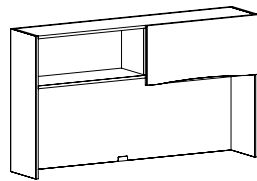

| | | | | | | |
|--|----|----|--------|-----|------|---------|
| SURFACE MOUNT HUTCH WITH SLIDING DOOR 50-1572SHU | 72 | 15 | 40 7/8 | 203 | 34.1 | \$ 3690 |
| 50-1566SHU | 66 | 15 | 40 7/8 | 166 | 32.1 | \$ 3577 |
| 50-1560SHU | 60 | 15 | 40 7/8 | 129 | 28.4 | \$ 3455 |

Description

- Standard With: Veneer Finish, One (1) Non-Locking Sliding Door, Horizontal Grain Direction, Grommet
- 23 3/4" Clearance Below Door
- Sliding Door; Available with Round Door Pull in Black (BRD) or Chrome (CRD) or Finger Pull with Accents Available in Veneer (FPV), HPL (FPP), or Fabric (FPF)
- Grommet Included; Available in Black (BLK) or Silver (SLV)
- Additional Options: HPL Cabinet Accent on Hutch Interior (See Below and [See Color Options](#)), Glass Marker Boards, Work Wall, Tackboards ([See Multiple Unit Details](#)), and Tasklights ([See Multiple Unit Details](#))

Must Specify (in this order):
 Model #
 Chassis Finish
 Cabinet Accent Color
 Select Round Pull or Finger Pull:
 Round Pull Color
 Finger Pull Accent Material/Color
 Tackboard Fabric
 Tasklight
 Grommet Color

Finger Pull Options: Must Specify & Add

| | | | |
|-----|--|----|-----------|
| FPV | Finger Pull, Veneer Accent (Finish Will Match Chassis Selection) | \$ | NC |
| FPP | Finger Pull, HPL Accent; Must Specify Color, See Color Options | \$ | 38 |
| FPF | Finger Pull, Fabric Accent; Must Specify Fabric | \$ | See Below |

| List Price/Grade | Yards | GR 1/ COM/COL | 2 | 3 | 4 | 5 | 6 | 7 | 8 | 9 | 10 |
|-------------------------|--------|---------------|----|----|-----|-----|-----|-----|-----|-----|-----|
| FPF Finger Pull, Fabric | 0.5 \$ | 48 | 74 | 96 | 118 | 150 | 183 | 230 | 279 | 336 | 402 |

Cabinet Accent Option: Specify & Add

| | | | |
|-----|---|----|-----|
| HPL | Cabinet Accent on Hutch Interior; Must Specify Color, See Color Options | \$ | 331 |
|-----|---|----|-----|

[See Iconic Intro For Ordering Options and Grommet Locations](#)

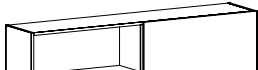
| Item | Model No. | Width | Depth | Height | Ship Wt | Cubic Ft | List Price |
|--|------------|-------|-------|--------|---------|----------|------------|
| WALL MOUNT HUTCH WITH SLIDING DOOR  | 50-1572SWD | 72 | 15 | 17 | 114 | 13.8 | \$ 2419 |
| | 50-1566SWD | 66 | 15 | 17 | 101 | 12.7 | \$ 2384 |
| | 50-1560SWD | 60 | 15 | 17 | 92 | 11.6 | \$ 2314 |

Description

- Standard With: Veneer Finish, One (1) Non-Locking Sliding Door, Installation Hardware, and Horizontal Grain Direction
- Sliding Door; Available with Round Door Pull in Black (BRD) or Chrome (CRD) or Finger Pull with Accents Available in Veneer (FPV), HPL (FPP), or Fabric (FPF)
- Indiana Furniture Will Not Be Liable for Wall Mount Hutches That are Not Properly Installed
- Additional Option: HPL Cabinet Accent on Hutch Interior (See Below and [See Color Options](#)), Glass Marker Boards, Work Wall, Tackboards ([See Multiple Unit Details](#)), and Tasklights ([See Multiple Unit Details](#))

Must Specify (in this order):

- Model #
- Chassis Finish
- Cabinet Accent Color
- Select Round Pull or Finger Pull:
 - Round Pull Color
 - Finger Pull Accent Material/Color

Finger Pull Options: Must Specify & Add

| | | | |
|-----|--|----|-----------|
| FPV | Finger Pull, Veneer Accent (Finish Will Match Chassis Selection) | \$ | NC |
| FPP | Finger Pull, HPL Accent; Must Specify Color, See Color Options | \$ | 38 |
| FPF | Finger Pull, Fabric Accent; Must Specify Fabric | \$ | See Below |

| List Price/Grade | Yards | GR 1/COM/COL | 2 | 3 | 4 | 5 | 6 | 7 | 8 | 9 | 10 | |
|------------------|---------------------|--------------|----|----|----|-----|-----|-----|-----|-----|-----|-----|
| FPF | Finger Pull, Fabric | 0.5 \$ | 48 | 74 | 96 | 118 | 150 | 183 | 230 | 279 | 336 | 402 |

Cabinet Accent Option: Specify & Add

| | | | |
|-----|---|----|-----|
| HPL | Cabinet Accent on Hutch Interior; Must Specify Color, See Color Options | \$ | 219 |
|-----|---|----|-----|

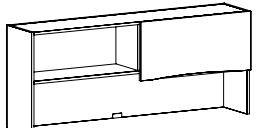
| | | | | | | | |
|---|-------------|----|----|----|-----|------|---------|
| LOW SURFACE MOUNT HUTCH WITH SLIDING DOOR  | 50-1572SSHS | 72 | 15 | 30 | 124 | 23.3 | \$ 3576 |
| | 50-1566SSHS | 66 | 15 | 30 | 116 | 21.4 | \$ 3466 |
| | 50-1560SSHS | 60 | 15 | 30 | 109 | 21.4 | \$ 3373 |
| | 50-1554SSHS | 54 | 15 | 30 | 101 | 17.6 | \$ 3262 |
| | 50-1548SSHS | 48 | 15 | 30 | 101 | 15.7 | \$ 3024 |

Description

- Standard With: Veneer Finish, One (1) Non-Locking Sliding Door, Horizontal Grain Direction, and Grommet
- For Use with Low Storage Units; 12⁷/₈" Clearance Below Door
- Sliding Door; Available with Round Door Pull in Black (BRD) or Chrome (CRD) or Finger Pull with Accents Available in Veneer (FPV), HPL (FPP), or Fabric (FPF)
- Grommet Included; Available in Black (BLK) or Silver (SLV)
- Additional Option: HPL Cabinet Accent on Hutch Interior (See Below and [See Color Options](#)), Glass Marker Boards, Work Wall, Tackboards ([See Multiple Unit Details](#)), and Tasklights ([See Multiple Unit Details](#))

Must Specify (in this order):

- Model #
- Chassis Finish
- Cabinet Accent Color
- Select Round Pull or Finger Pull:
 - Round Pull Color
 - Finger Pull Accent Material/Color
- Grommet Color

Finger Pull Options: Must Specify & Add

| | | | |
|-----|--|----|-----------|
| FPV | Finger Pull, Veneer Accent (Finish Will Match Chassis Selection) | \$ | NC |
| FPP | Finger Pull, HPL Accent; Must Specify Color, See Color Options | \$ | 38 |
| FPF | Finger Pull, Fabric Accent; Must Specify Fabric | \$ | See Below |

| List Price/Grade | Yards | GR 1/COM/COL | 2 | 3 | 4 | 5 | 6 | 7 | 8 | 9 | 10 | |
|------------------|---------------------|--------------|----|----|----|-----|-----|-----|-----|-----|-----|-----|
| FPF | Finger Pull, Fabric | 0.5 \$ | 48 | 74 | 96 | 118 | 150 | 183 | 230 | 279 | 336 | 402 |

Cabinet Accent Option: Specify & Add

| | | | |
|-----|---|----|-----|
| HPL | Cabinet Accent on Hutch Interior; Must Specify Color, See Color Options | \$ | 323 |
|-----|---|----|-----|

[See Iconic Intro For Ordering Options and Grommet Locations](#)

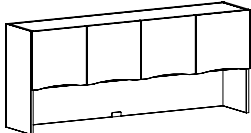
| Item | Model No. | Width | Depth | Height | Ship Wt | Cubic Ft | List Price |
|---|------------------------------------|-------|-------|--------|---------|----------|------------|
|  | 50-1572SSHU <i>Four (4) Doors</i> | 72 | 15 | 30 | 141 | 23.3 | \$ 4968 |
| | 50-1566SSHU <i>Four (4) Doors</i> | 66 | 15 | 30 | 132 | 21.4 | \$ 4755 |
| | 50-1560SSHU <i>Four (4) Doors</i> | 60 | 15 | 30 | 123 | 19.5 | \$ 4620 |
| | 50-1554SSHU <i>Three (3) Doors</i> | 54 | 15 | 30 | 111 | 17.6 | \$ 4171 |
| | 50-1548SSHU <i>Three (3) Doors</i> | 48 | 15 | 30 | 102 | 15.7 | \$ 3959 |

Description

- Standard With: Veneer Finish, Soft-Close Hinged Doors, Horizontal Grain Direction, and Grommet
- For Use with Low Storage Units; 12 7/8" Clearance Below Doors
- Finger Pull Accents Available in Veneer (FPV), HPL (FPP), or Fabric (FPF); Fabric Patterns May Not Align From Door-to-Door, Use Caution with Patterned/Striped Fabrics
- Grommet Included; Available in Black (BLK) or Silver (SLV)
- Additional Options: HPL Cabinet Accent on Hutch Interior (See Below and [See Color Options](#)), Locking Doors ([See Locking Options](#)), Glass Marker Boards, Work Wall, Tackboards ([See Multiple Unit Details](#)), and Tasklights ([See Multiple Unit Details](#))

Must Specify (in this order):

- Model #
- Chassis Finish
- Cabinet Accent Color
- Finger Pull Accent Material/Color
- Lock Color
- Grommet Color

Finger Pull Options: Must Specify & Add

| | | | |
|-----|--|----|-----------|
| FPV | Finger Pull, Veneer Accent (Finish Will Match Chassis Selection) | \$ | NC |
| FPP | Finger Pull, HPL Accent; Must Specify Color, See Color Options | \$ | See Below |
| FPF | Finger Pull, Fabric Accent; Must Specify Fabric | \$ | See Below |

HPL Accent: Specify & Add

| | | | | |
|-----|---|----------------|----|-----|
| FPP | Finger Pull, HPL, See Color Options | 3 Doors | \$ | 117 |
| | | 4 Doors | \$ | 156 |

Fabric Accent:

| List Price/Grade | Yards | GR 1/ COM/COL | 2 | 3 | 4 | 5 | 6 | 7 | 8 | 9 | 10 |
|--------------------------|--------|------------------|-----|-----|-----|-----|-----|-----|-----|-----|-----|
| FPF Pull, Fabric 3 Doors | 0.5 \$ | 144 | 170 | 192 | 214 | 246 | 279 | 326 | 375 | 432 | 498 |
| FPF Pull, Fabric 4 Doors | 0.5 \$ | 191 | 217 | 239 | 261 | 293 | 326 | 373 | 422 | 479 | 545 |

Cabinet Accent Option: Specify & Add

| | | | | |
|-----|---|----------------|----|-----|
| HPL | Cabinet Accent on Hutch Interior; Must Specify Color, See Color Options | 3 Doors | \$ | 271 |
| | | 4 Doors | \$ | 323 |

| Item | Model No. | Width | Depth | Height | Ship Wt | Cubic Ft | List Price |
|--|-------------|-------|-------|--------|---------|----------|------------|
| LOW DUAL SIDED SURFACE MOUNT HUTCH WITH SLIDING DOOR  | 50-1572DSHS | 72 | 15 | 30 | 135 | 23.3 | \$ 4230 |
| | 50-1566DSHS | 66 | 15 | 30 | 127 | 21.4 | \$ 4114 |
| | 50-1560DSHS | 60 | 15 | 30 | 119 | 19.5 | \$ 4021 |
| | 50-1554DSHS | 54 | 15 | 30 | 108 | 17.6 | \$ 3922 |
| | 50-1548DSHS | 48 | 15 | 30 | 100 | 15.7 | \$ 3614 |

Must Specify (in this order):

- Model #
- Chassis Finish
- Cabinet Accent Color
- Select Round Pull or Finger Pull:
 - Round Pull Color
 - Finger Pull Accent Material/Color
- Dry Erase Fixed Back

Description

- Standard With: Veneer Finish, One (1) Non-Locking Sliding Door on Each Side, Horizontal Grain Direction
- For Use with Low Storage Units in Shared Office Applications; 12 7/8" Clearance Below Door
- Sliding Door; Available with Round Door Pull in Black (BRD) or Chrome (CRD) or Finger Pull with Accents Available in Veneer (FPV), HPL (FPP), or Fabric (FPF)
- Additional Options: HPL Cabinet Accent on Hutch Interior (See Below and [See Color Options](#)), Glass Marker Boards, Work Wall, Tackboards ([See Multiple Unit Details](#)), and Tasklights ([See Multiple Unit Details](#))

Finger Pull Options: Must Specify & Add

| | | | |
|-----|--|----|-----------|
| FPV | Finger Pull, Veneer Accent (Finish Will Match Chassis Selection) | \$ | NC |
| FPP | Finger Pull, HPL Accent; Must Specify Color, See Color Options | \$ | 79 |
| FPF | Finger Pull, Fabric Accent; Must Specify Fabric | \$ | See Below |

| List Price/Grade | Yards | GR 1/COM/COL | 2 | 3 | 4 | 5 | 6 | 7 | 8 | 9 | 10 |
|-------------------------|-------|--------------|-----|-----|-----|-----|-----|-----|-----|-----|-----|
| FPF Finger Pull, Fabric | 0.5 | \$ 96 | 122 | 144 | 166 | 198 | 231 | 278 | 327 | 384 | 450 |

Cabinet Accent Option: Specify & Add

| | | | |
|-----|---|----|-----|
| HPL | Cabinet Accent on Bookcase Interior; Must Specify Color, See Color Option | \$ | 381 |
|-----|---|----|-----|

Dry Erase Fixed Back Option: Specify & Add

| | | | |
|-----|----------------------------|----|-----|
| DEF | Dry Erase Fixed Back Panel | \$ | 646 |
|-----|----------------------------|----|-----|

Dry Erase Panel always located on right, when facing the unit.

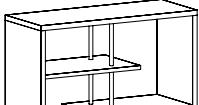
| | | | | | | | |
|--|-------------|----|----|----|----|------|---------|
| LOW SURFACE MOUNT OPEN STORAGE/DIVIDER  | 50-1536SOSD | 36 | 15 | 30 | 99 | 11.9 | \$ 1822 |
| | 50-1530SOSD | 30 | 15 | 30 | 71 | 10.1 | \$ 1782 |
| | 50-1524SOSD | 24 | 15 | 30 | 49 | 8.2 | \$ 1744 |

Description

- Standard With: Veneer Finish, Horizontal Grain Direction, Two (2) Shelves, and Metal Rods
- Open Fixed Shelving; 9" Clearance Between Shelves
- Recommended For Use with Low Storage Units
- Set On Application Only
- Accent Metal Rod; Available in Black (BLK) or Chrome (CHRM)
- Additional Option: HPL Cabinet Accent on Interior (See Below and [See Color Options](#))

Cabinet Accent Option: Specify & Add

| | | | |
|-----|---|----|-----|
| HPL | Cabinet Accent on Bookcase Interior; Must Specify Color, See Color Option | \$ | 109 |
|-----|---|----|-----|

[See Iconic Intro For Ordering Options and Grommet Locations](#)

| Item | Model No. | Width | Depth | Height | Ship Wt | Cubic Ft | List Price |
|------------------------------------|---------------|-------|-------|------------------|---------|----------|------------|
| SURFACE MOUNT OPEN STORAGE/DIVIDER | 50-153640SOSD | 36 | 15 | 40 $\frac{3}{8}$ | 96 | 14.5 | \$ 1894 |
| | 50-153040SOSD | 30 | 15 | 40 $\frac{3}{8}$ | 81 | 13.5 | \$ 1856 |

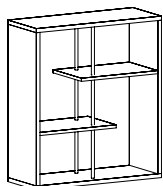

Must Specify (in this order):

Model #
Chassis Finish
Cabinet Accent Color
Metal Accent

Description

- Standard With: Veneer Finish, Horizontal Grain Direction, Two (2) Fixed Shelves, and Metal Rods
- Open Fixed Shelving; 12" Clearance Between Shelves
- Set On Application Only
- Accent Metal Rod; Available in Black (BLK) or Chrome (CHRM)
- Additional Option: HPL Cabinet Accent on Interior (See Below and [See Color Options](#))

Cabinet Accent Option: Specify & Add

| | | |
|-----|---|--------|
| HPL | Cabinet Accent on Bookcase Interior; Must Specify Color, See Color Option | \$ 109 |
|-----|---|--------|

| | | | | | | | |
|------------------------|-----------|----|----|------------------|-----|------|---------|
| SURFACE MOUNT BOOKCASE | 50-1536TU | 36 | 15 | 40 $\frac{3}{8}$ | 127 | 16.1 | \$ 1930 |
| | 50-1530TU | 30 | 15 | 40 $\frac{3}{8}$ | 98 | 15.9 | \$ 1844 |

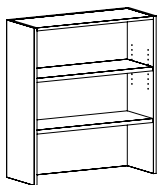

Must Specify (in this order):

Model #
HPL Cabinet Finish
Cabinet Accent Color

Description

- Standard With: Veneer Finish, One (1) Adjustable Shelf, One (1) Fixed Shelf, and Horizontal Grain
- Set On Application Only
- Additional Option: HPL Cabinet Accent on Bookcase Interior (See Below and [See Color Options](#))

Cabinet Accent Option: Specify & Add

| | | |
|-----|---|--------|
| HPL | Cabinet Accent on Bookcase Interior; Must Specify Color, See Color Option | \$ 193 |
|-----|---|--------|

| | | | | | | | |
|-----------------------------------|-------------|----|----|------------------|-----|------|---------|
| SURFACE MOUNT BOOKCASE WITH DOORS | 50-1536TUDB | 36 | 15 | 40 $\frac{3}{8}$ | 168 | 16.1 | \$ 3343 |
| | 50-1530TUDB | 30 | 15 | 40 $\frac{3}{8}$ | 140 | 13.4 | \$ 3231 |

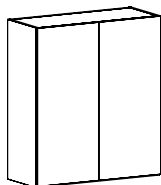

Must Specify (in this order):

Model #
Chassis Finish
Lock Color

Description

- Standard With: Veneer Finish, Soft-Close Touch Latch Doors, Two (2) Adjustable Shelves Inside, and Horizontal Grain Direction
- Set On Application Only
- Additional Option: Locking Doors ([See Locking Options](#))

[See Iconic Intro For Ordering Options and Grommet Locations](#)

| Item | Model No. | | Width | Depth | Height | Ship Wt | Cubic Ft | List Price |
|-------------------------------|------------------|-------------------|-------|-------|------------------|---------|----------|------------|
| STORAGE CABINET WITH BOX/FILE | Door Hinged Left | Door Hinged Right | | | | | | |
| | 50-1872SWBL | 50-1872SWBR | 18 | 24 | 70 $\frac{7}{8}$ | 230 | 22.0 | \$ 4774 |

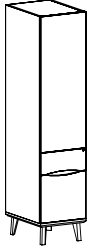

Description

- Standard With: Veneer Finish, Locking Box/File Drawers (Legal or Letter Filling), Soft-Close Touch Latch Door, Two (2) Adjustable Shelves Inside, and Horizontal Grain Direction
- Available with Contrasting Chassis and Leg Color
- Finger Pull Accents Available in Veneer (FPV), HPL (FPP), or Fabric (FPF)
- Locking Box/File Drawers; Available with Black (BLK) or Silver (SLV) Lock Cores
- Additional Options: Dove Tail Drawer Construction and Soft Close Drawers ([See Drawer Options](#)); Locking Door ([See Locking Options](#))

Must Specify (in this order):

- Model #
- Chassis Finish
- Finger Pull Accent Material/Color
- Leg Finish
- Drawer Construction
- Drawer Track
- Lock Color

Finger Pull Options: Must Specify & Add

| | | | |
|-----|--|----|-----------|
| FPV | Finger Pull, Veneer Accent (Finish Will Match Chassis Selection) | \$ | NC |
| FPP | Finger Pull, HPL Accent; Must Specify Color, See Color Options | \$ | 108 |
| FPF | Finger Pull, Fabric Accent; Must Specify Fabric | \$ | See Below |

FPF_SWBL

| List Price/Grade | Yards | GR 1/COM/COL | 2 | 3 | 4 | 5 | 6 | 7 | 8 | 9 | 10 | |
|------------------|---------------------|--------------|-----|-----|-----|-----|-----|-----|-----|-----|-----|-----|
| FPF | Finger Pull, Fabric | 0.5 \$ | 153 | 179 | 201 | 223 | 255 | 288 | 335 | 384 | 441 | 507 |

STORAGE WARDROBE

| Door Hinged Left | | Door Hinged Right | | Width | Depth | Height | Ship Wt | Cubic Ft | List Price |
|------------------|-----------|-------------------|----|------------------|-------|--------|---------|----------|------------|
| 50-2472WL | 50-2472WR | 18 | 24 | 70 $\frac{7}{8}$ | 213 | 22.0 | \$ | 4281 | |
| 50-2451WL | 50-2451WR | 18 | 24 | 51 $\frac{1}{2}$ | 154 | 15.9 | \$ | 3712 | |

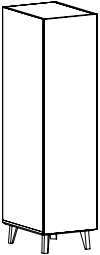

Description

- Standard With: Veneer Finish, Soft-Close Touch Latch Door, One (1) Fixed Shelf, Coat Rod Under Fixed Shelf, Three (3) Adjustable Shelves, and Horizontal Grain Direction
- Available with Contrasting Chassis and Leg Color
- Additional Option: Locking Door ([See Locking Options](#))

Must Specify (in this order):

- Model #
- Chassis Finish
- Leg Finish
- Lock Color

[See Iconic Intro For Ordering Options and Grommet Locations](#)

| Item | Model No. | Width | Depth | Height | Ship Wt | Cubic Ft | List Price |
|-----------------|-----------|-------|-------|------------------|---------|----------|------------|
| DOUBLE WARDROBE | 50-3672WC | 36 | 24 | 70 $\frac{3}{8}$ | 321 | 41.7 | \$ 6711 |
| | 50-3072WC | 30 | 24 | 70 $\frac{3}{8}$ | 283 | 35.1 | \$ 6538 |

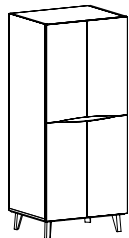

Description

- Standard With: Veneer Finish, Four (4) Soft-Close Touch Latch Doors, Both Sides Feature One (1) Fixed Shelf at Center and Two (2) Adjustable Shelves Inside, and Horizontal Grain Direction
- Available with Contrasting Chassis and Leg Color
- Finger Pull Accents Available in Veneer (FPV), HPL (FPP), or Fabric (FPF)
- Additional Option: Locking Door ([See Locking Options](#))

Finger Pull Options: Must Specify & Add

| | | | |
|-----|--|----|-----------|
| FPV | Finger Pull, Veneer Accent (Finish Will Match Chassis Selection) | \$ | NC |
| FPP | Finger Pull, HPL Accent; Must Specify Color, See Color Options | \$ | 108 |
| FPF | Finger Pull, Fabric Accent; Must Specify Fabric | \$ | See Below |

| List Price/Grade | Yards | GR 1/COM/COL | 2 | 3 | 4 | 5 | 6 | 7 | 8 | 9 | 10 |
|-------------------------|-------|--------------|-----|-----|-----|-----|-----|-----|-----|-----|-----|
| FPF Finger Pull, Fabric | 0.5 | \$ 153 | 179 | 201 | 223 | 255 | 288 | 335 | 384 | 441 | 507 |

Must Specify (in this order):

- Model #
- Chassis Finish
- Finger Pull Accent Material/Color
- Leg Finish
- Lock Color

OPEN STORAGE/DIVIDER WITH SLIDING DOORS

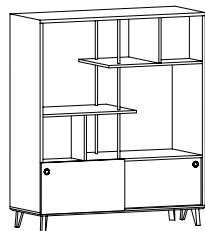

| | | | | | | | |
|--------------|---|----|----|------------------|-----|------|---------|
| 50-2460OSD72 | | 60 | 24 | 70 $\frac{3}{8}$ | 328 | 68.1 | \$ 7223 |
| | <i>15" Clearance Between Shelves</i> | | | | | | |
| 50-2460OSD51 | | 60 | 24 | 51 $\frac{1}{2}$ | 308 | 49.4 | \$ 6853 |
| | <i>8$\frac{3}{8}$" Clearance Between Shelves</i> | | | | | | |

Description

- Standard With: Veneer Finish, Dual Access Open Bookcase with Fixed Shelves, Two (2) Adjustable Shelves Behind Two (2) Non-Locking Sliding Doors, Metal Rods, and Horizontal Grain Direction
- Dual Access Cubbies are 10" Deep on each side
- Available with Contrasting Chassis and Leg Color
- Round Door Pull Available in Black (BRD) or Chrome (CRD)
- Accent Metal Rod Color Will Match Round Door Pull
- Additional Option: HPL Cabinet Accent on Interior ([See Below](#) and [See Color Options](#))

Cabinet Accent Option: Specify & Add

| | | | |
|-----|--|----|-----|
| HPL | 72"H Unit, HPL Cabinet Accent on Interior; Must Specify Color, See Color Options | \$ | 290 |
| HPL | 51"H Unit, HPL Cabinet Accent on Interior; Must Specify Color, See Color Options | \$ | 273 |

Must Specify (in this order):

- Model #
- Chassis Finish
- Cabinet Accent Color
- Round Pull/Metal Accent Color
- Leg Finish

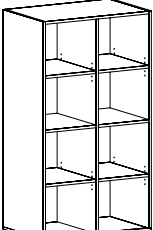
| Item | Model No. | Width | Depth | Height | Ship Wt | Cubic Ft | List Price |
|---|---|-------|-------|------------------|---------|----------|------------|
|  | 50-2436OB72 <i>Two (2) Adjustable Shelves and Fixed Middle Shelf</i> | 36 | 24 | 70 $\frac{7}{8}$ | 291 | 42.0 | \$ 5124 |
| | 50-2436OB51 <i>Two (2) Adjustable Shelves</i> | 36 | 24 | 51 $\frac{1}{2}$ | 216 | 30.3 | \$ 4161 |
| | 50-2430OB72 <i>Two (2) Adjustable Shelves and Fixed Middle Shelf</i> | 30 | 24 | 70 $\frac{7}{8}$ | 267 | 35.6 | \$ 5024 |
| | 50-2430OB51 <i>Two (2) Adjustable Shelves</i> | 30 | 24 | 51 $\frac{1}{2}$ | 202 | 25.5 | \$ 4065 |

Must Specify (in this order):
Model #
Chassis Finish
Cabinet Accent Color
Leg Finish

Description

- Standard With: Veneer Finish, Fixed Vertical Divider, and Horizontal Grain Direction
- Available with Contrasting Chassis and Leg Color
- Additional Option: HPL Cabinet Accent on Bookcase Interior (See Below and [See Color Options](#))

Cabinet Accent Option: Specify & Add

| | |
|--|--------|
| HPL 72"H Units, HPL Cabinet Accent on Bookcase Interior; Must Specify Color, See Color Options | \$ 513 |
| HPL 51"H Units, HPL Cabinet Accent on Bookcase Interior; Must Specify Color, See Color Options | \$ 415 |

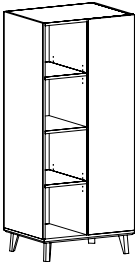
| WARDROBE WITH OPEN BOOKCASE | Left Door | Right Door | Width | Depth | Height | Ship Wt | Cubic Ft | List Price |
|---|--|---------------|-------|-------|------------------|---------|----------|------------|
|  | 50-2436OBD72L | 50-2436OBD72R | 36 | 24 | 70 $\frac{7}{8}$ | 310 | 41.7 | \$ 5713 |
| | <i>Bookcase Features Two (2) Adjustable Shelves and Fixed Middle Shelf</i> | | | | | | | |
| | 50-2436OBD51L | 50-2436OBD51R | 36 | 24 | 51 $\frac{1}{2}$ | 236 | 30.3 | \$ 4749 |
| | <i>Bookcase Features Two (2) Adjustable Shelves</i> | | | | | | | |
| | 50-2430OBD72L | 50-2430OBD72R | 30 | 24 | 70 $\frac{7}{8}$ | 287 | 35.6 | \$ 5598 |
| | <i>Bookcase Features Two (2) Adjustable Shelves and Fixed Middle Shelf</i> | | | | | | | |
| | 50-2430OBD51L | 50-2430OBD51R | 30 | 24 | 51 $\frac{1}{2}$ | 220 | 25.5 | \$ 4645 |
| | <i>Bookcase Features Two (2) Adjustable Shelves</i> | | | | | | | |

Shown as Right

Must Specify (in this order):
Model #
Chassis Finish
Cabinet Accent Color
Leg Finish
Lock Color

Description

- Standard With: Veneer Finish, Soft-Close Touch Latch Hinged Door, Hanging Storage and Coat Rod Behind Door, and Horizontal Grain Direction
- Available with Contrasting Chassis and Leg Color
- Additional Options: HPL Cabinet Accent on Bookcase Interior (See Below and [See Color Options](#)), Locking Door ([See Locking Options](#))

Cabinet Accent Option: Specify & Add

| | |
|--|--------|
| HPL 72"H Units, HPL Cabinet Accent on Bookcase Interior; Must Specify Color, See Color Options | \$ 287 |
| HPL 51"H Units, HPL Cabinet Accent on Bookcase Interior; Must Specify Color, See Color Options | \$ 237 |

[See Iconic Intro For Ordering Options and Grommet Locations](#)

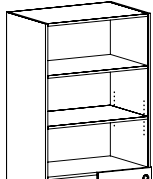
| Item | Model No. | Width | Depth | Height | Ship Wt | Cubic Ft | List Price |
|--|---|-------|-------|--------------------------------|---------|----------|------------|
| OPEN BOOKCASE WITH LOWER SLIDING DOORS  | 50-2436OBS72 <i>One (1) Adjustable Shelf and One (1) Fixed Shelf</i> | 36 | 24 | 70 ⁷ / ₈ | 310 | 41.7 | \$ 4927 |
| | 50-2436OBS51 <i>One (1) Adjustable Shelf</i> | 36 | 24 | 51 ¹ / ₂ | 236 | 30.3 | \$ 4309 |
| | 50-2430OBS72 <i>One (1) Adjustable Shelf and One (1) Fixed Shelf</i> | 30 | 24 | 70 ⁷ / ₈ | 287 | 35.6 | \$ 4682 |
| | 50-2430OBS51 <i>One (1) Adjustable Shelf</i> | 30 | 24 | 51 ¹ / ₂ | 220 | 25.5 | \$ 4023 |

Description

- Standard With: Veneer Finish, Two (2) Non-Locking Sliding Doors, and Horizontal Grain Direction
- Available with Contrasting Chassis and Leg Color
- Round Door Pull Available in Black (BRD) or Chrome (CRD)
- Additional Option: HPL Cabinet Accent on Bookcase Interior (See Below and [See Color Options](#))

Cabinet Accent Option: Specify & Add

| | | |
|-----|--|--------|
| HPL | 72"H Units, HPL Cabinet Accent on Bookcase Interior; Must Specify Color, See Color Options | \$ 247 |
| HPL | 51"H Units, HPL Cabinet Accent on Bookcase Interior; Must Specify Color, See Color Options | \$ 213 |

Must Specify (in this order):

- Model #
- Chassis Finish
- Cabinet Accent Color
- Round Pull Color
- Leg Finish

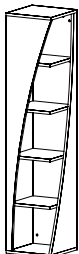
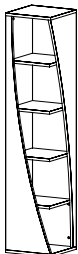
| TWISTED BOOKCASE | | Left Twist | Right Twist | Width | Depth | Height | Ship Wt | Cubic Ft | List Price |
|---|---|---|-------------|-------|-------|--------------------------------|---------|----------|------------|
|  |  | 50-1572TBL <i>Four (4) 3/4" Fixed Shelves</i> | 50-1572TBR | 15 | 15 | 70 ⁷ / ₈ | 130 | 10.8 | \$ 3022 |
| | | 50-1551TBL <i>Three (3) 3/4" Fixed Shelves</i> | 50-1551TBR | 15 | 15 | 51 ¹ / ₂ | 100 | 8.9 | \$ 2835 |

Description

- Standard With: Veneer Finish, Adjustable Glides, and Horizontal Grain Direction
- Must Attach to Wall or Another Unit; Not Freestanding; Attachment Hardware Included
- Additional Option: HPL Cabinet Accent on Bookcase Interior (See Below and [See Color Options](#))

Cabinet Accent Option: Specify & Add

| | | |
|-----|--|--------|
| HPL | 72"H Units, HPL Cabinet Accent on Bookcase Interior; Must Specify Color, See Color Options | \$ 150 |
| HPL | 51"H Units, HPL Cabinet Accent on Bookcase Interior; Must Specify Color, See Color Options | \$ 143 |

Must Specify (in this order):

- Model #
- Chassis Finish
- Cabinet Accent Color

Left

Right

| Item | Model No. | | Width | Depth | Height | Ship Wt | Cubic Ft | List Price |
|--|-----------|--------|-------|-------|--------|---------|----------|------------|
| ROUND GROMMET COVER FIELD INSTALLED | 01-GRMTBK | Black | - | - | - | - | - | \$ 11 |
| | 01-GRMTSL | Silver | | | | | | |

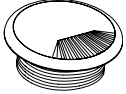

OPEN MARKET ONLY
(SILVER)

Description

- 60mm Round Grommet Cover
- Field Installed

| | | | | | | | | |
|--------------------------|-------------|--------|---|---|---|---|-----|-------|
| SINGLE POWER SAND DOLLAR | 01-SAND60PW | White | 3 | 3 | 4 | 1 | 0.2 | \$ 98 |
| | 01-SAND60PB | Black | | | | | | |
| | 01-SAND60PS | Silver | | | | | | |

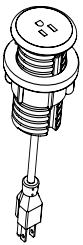

Description

- Unit is 2" Diameter; Mounts in 60mm Round Grommet
- 6' Cord
- Single Power Outlet

| | | | | | | | | |
|------------------------|-------------|--------|---|---|---|---|-----|--------|
| DOUBLE USB SAND DOLLAR | 01-SAND60UW | White | 3 | 3 | 4 | 1 | 0.2 | \$ 277 |
| | 01-SAND60UB | Black | | | | | | |
| | 01-SAND60US | Silver | | | | | | |

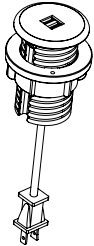

Description

- Unit is 2" Diameter; Mounts in 60mm Round Grommet
- 6' Cord
- Dual USB Outlets

| | | | | | | | | |
|------------------------------|-------------|-------|------------------|------------------|---|---|-----|--------|
| DOCK 950 WIRELESS CHARGER | 01-DOCK950W | White | 3 $\frac{3}{16}$ | 3 $\frac{3}{16}$ | - | 1 | 0.2 | \$ 265 |
| | 01-DOCK950B | Black | | | | | | |

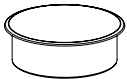

OPEN MARKET ONLY

Description

- For Use with Wireless Charging Enabled Devices
- Mounts in 76mm Round Cut-Out
- 5 Watts Maximum Output with a Direct Current of 5V 2A and 10 Watts Maximum with Quick Charge 2.0
- LED will Confirm Pairing with Device and Begin Wireless Charging

[See Iconic Intro For Ordering Options and Grommet Locations](#)

| Item | Model No. | Width | Depth | Height | Ship Wt | Cubic Ft | List Price | |
|--------------------------------------|-------------|-------|-------|--------|---------|----------|------------|--------|
| DOCK 150 WIRELESS AND USB CHARGER | 01-DOCK150W | White | 3 | 3 | ¾ | 1 | 0.2 | \$ 405 |
| | 01-DOCK150B | Black | | | | | | |



OPEN MARKET ONLY

Description

- For Use with Wireless Charging Enabled Devices and USB Charging Devices
- 5 Watt Maximum Output with a Direct Current Input of 5V 6A (Wireless Fast Charge)
- Mounts in 76mm Round Cut-Out
- Pop-Up is ¾"H and Includes Three (3) USB Ports; One (1) 12 Watt Maximum with 2.4A (USB Fast Charge) and Two (2) 5 Watt with 1A (USB Standard Charge)
- LED Light will Confirm Pairing with Device and Begin Wireless Charging
- UL and cUL Certified

DUO CLAMP WITH NEMA PLUG

| | | | | | | | |
|--------------|--------|----|---|---|---|-----|--------|
| 01-DUOCLAMPW | White | 6½ | 3 | 7 | 1 | 0.2 | \$ 572 |
| 01-DUOCLAMPB | Black | | | | | | |
| 01-DUOCLAMPS | Silver | | | | | | |

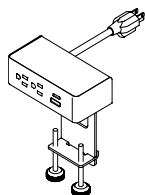
**Description**

- Standard with: Two (2) Power Outlet, **One (1) USB Charging Port and One (1) 60-Watt USB-C Power Delivery Port with GaN Technology with 10' Cord**
- Clamps to Top and Features Silver Metal Trim
- Independent USB Circuit Controllers Deliver up to 2.1 Amps to Each Post
- All Mounting Hardware Included
- FCC Part 15A and UL Approved for Horizontal and Vertical Applications

TRIO CLAMP WITH NEMA PLUG

| | | | | | | | |
|---------------|--------|---|---|---|---|-----|--------|
| 01-TRIOCLAMPW | White | 9 | 3 | 7 | 1 | 0.2 | \$ 671 |
| 01-TRIOCLAMPB | Black | | | | | | |
| 01-TRIOCLAMPS | Silver | | | | | | |

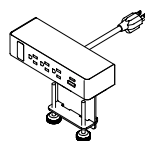
**Description**

- Standard with: Three (3) Power Outlets, **One (1) USB Charging Port, One (1) 60-Watt USB-C Power Delivery Port with GaN Technology, One (1) Open Data with 10' Cord**
- Clamps to Top and Features Silver Metal Trim
- Independent USB Circuit Controllers Deliver up to 2.1 Amps to Each Post
- HDMI, VGA, or RJ45 Sold Separately; [See Accessories](#)
- All Mounting Hardware Included
- FCC Part 15A and UL Approved for Horizontal and Vertical Applications

UNDERMOUNT DUO WITH NEMA PLUG

| | | | | | | | |
|---------------|--------|----|----|---|---|-----|--------|
| 01-DUOUNDERW | White | 6½ | 2½ | 3 | 1 | 0.2 | \$ 546 |
| 01-DUOUNDERB | Black | | | | | | |
| 01-DUOUNDEERS | Silver | | | | | | |

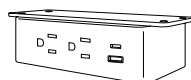
**Description**

- Sits Under Worksurface and Includes: Two (2) Power, **One (1) USB Charging Port and One (1) 60-Watt USB-C Power Delivery Port with GaN Technology with 10' Cord**
- All Mounting Hardware
- Independent USB Circuit Controllers Deliver up to 2.1 Amps to Each Post
- FCC Part 15A, UL Approved for Horizontal and Vertical Applications

[See Iconic Intro For Ordering Options and Grommet Locations](#)

| Item | Model No. | | Width | Depth | Height | Ship Wt | Cubic Ft | List Price |
|--|---------------|--------|-------|-------|--------|---------|----------|------------|
| UNDERMOUNT TRIO WITH NEMA PLUG  | 01-TRIOUNDERW | White | 9 | 2½ | 3 | 1 | 0.2 | \$ 655 |
| | 01-TRIOUNDERB | Black | | | | | | |
| | 01-TRIOUNDERS | Silver | | | | | | |

Description

- Sits Under Worksurfaces and Includes: Three (3) Power, **One (1) USB Charging Port, One (1) 60-Watt USB-C Power Delivery Port with GaN Technology**, One (1) Open Port and 10' Cord,
- All Mounting Hardware
- HDMI, VGA, or RJ45 Accessory for Open Port Specified Separately, [See Accessories](#)
- Independent USB Circuit Controllers Deliver up to 2.1 Amps to Each Post
- FCC Part 15A, UL Approved for Horizontal and Vertical Applications

| | | | | | | | | |
|--|--------------|--------|----|----|---|---|-----|--------|
| DUO BEZEL WITH NEMA PLUG  | 01-DUOBEZELW | White | 6½ | 2½ | 3 | 1 | 0.2 | \$ 675 |
| | 01-DUOBEZELB | Black | | | | | | |
| | 01-DUOBEZELS | Silver | | | | | | |

Description

- Sits On Top of the Worksurface and Includes: Two (2) Power, **One (1) USB Charging Port and One (1) 60-Watt USB-C Power Delivery Port with GaN Technology with 10' Cord**
- Independent USB Circuit Controllers Deliver up to 2.1 Amps to Each Post
- All Mounting Hardware Included
- FCC Part 15A and UL Approved for Horizontal and Vertical Applications

| | | | | | | | | |
|---|---------------|--------|---|----|---|---|-----|--------|
| TRIO BEZEL WITH NEMA PLUG  | 01-TRIOBEZELW | White | 9 | 2½ | 3 | 1 | 0.2 | \$ 725 |
| | 01-TRIOBEZELB | Black | | | | | | |
| | 01-TRIOBEZELS | Silver | | | | | | |

Description

- Sits On Top of the Worksurface and Includes: Three (3) Power, **One (1) USB Charging Port and One (1) 60-Watt USB-C Power Delivery Port with GaN Technology**, One (1) Open Data, and 10' Cord
- Independent USB Circuit Controllers Deliver up to 2.1 Amps to Each Post
- HDMI, VGA, or RJ45 Sold Separately; [See Accessories](#)
- All Mounting Hardware Included
- FCC Part 15A and UL Approved for Horizontal and Vertical Applications

[See Iconic Intro For Ordering Options and Grommet Locations](#)

| Item | Model No. | | Width | Depth | Height | Ship Wt | Cubic Ft | List Price |
|---|------------------|--------|-------|-------|--------|---------|----------|------------|
| DUO BEZEL WITH HARD WIRE CONNECTION  | Circuit 1 | | | | | | | |
| | 01-HWDUOBEZELW1 | White | 6½ | 2⅝ | 3 | 1 | 0.2 | \$ 730 |
| | 01-HWDUOBEZELB1 | Black | | | | | | |
| | 01-HWDUOBEZELS1 | Silver | | | | | | |
| | Circuit 2 | | | | | | | |
| | 01-HWDUOBEZELW2 | White | 6½ | 2⅝ | 3 | 1 | 0.2 | \$ 730 |
| | 01-HWDUOBEZELB2 | Black | | | | | | |
| | 01-HWDUOBEZELS2 | Silver | | | | | | |
| | Circuit 3 | | | | | | | |
| | 01-HWDUOBEZELW3 | White | 6½ | 2⅝ | 3 | 1 | 0.2 | \$ 730 |
| | 01-HWDUOBEZELB3 | Black | | | | | | |
| | 01-HWDUOBEZELS3 | Silver | | | | | | |
| Circuit 4 | | | | | | | | |
| 01-HWDUOBEZELW4 | White | 6½ | 2⅝ | 3 | 1 | 0.2 | \$ 730 | |
| 01-HWDUOBEZELB4 | Black | | | | | | | |
| 01-HWDUOBEZELS4 | Silver | | | | | | | |

Description

- Must Specify Color and Circuit
- Sits on worksurface and Includes: Two (2) Power, **One (1) USB Charging Port and One (1) 60-Watt USB-C Power Delivery Port with GaN Technology**, and All Mounting Hardware
- Independent USB Circuit Controllers Deliver up to 2.1 Amps to Each Post
- FCC Part 15A and UL Approved for Horizontal and Vertical Applications
- Maximum 10 Duo Units per Circuit
- Eight (8) Wire/Four (4) Circuit Hard Wire Power Unit
- See Power Entry, Jumper Cable, and Quad Block on Next Page

[See Iconic Intro For Ordering Options and Grommet Locations](#)

| Item | Model No. | | Width | Depth | Height | Ship Wt | Cubic Ft | List Price | |
|--|------------------|--------|-------|-------|--------|---------|----------|------------|--|
| TRIO BEZEL WITH HARD WIRE CONNECTION  | Circuit 1 | | | | | | | | |
| | 01-HWTRIOBEZELW1 | White | 9 | 2½ | 3 | 1 | 0.2 | \$ 749 | |
| | 01-HWTRIOBEZELB1 | Black | | | | | | | |
| | 01-HWTRIOBEZELS1 | Silver | | | | | | | |
| | Circuit 2 | | | | | | | | |
| | 01-HWTRIOBEZELW2 | White | 9 | 2½ | 3 | 1 | 0.2 | \$ 749 | |
| | 01-HWTRIOBEZELB2 | Black | | | | | | | |
| | 01-HWTRIOBEZELS2 | Silver | | | | | | | |
| | Circuit 3 | | | | | | | | |
| | 01-HWTRIOBEZELW3 | White | 9 | 2½ | 3 | 1 | 0.2 | \$ 749 | |
| | 01-HWTRIOBEZELB3 | Black | | | | | | | |
| | 01-HWTRIOBEZELS3 | Silver | | | | | | | |
| | Circuit 4 | | | | | | | | |
| 01-HWTRIOBEZELW4 | White | 9 | 2½ | 3 | 1 | 0.2 | \$ 749 | | |
| 01-HWTRIOBEZELB4 | Black | | | | | | | | |
| 01-HWTRIOBEZELS4 | Silver | | | | | | | | |

Description

- Must Specify Color and Circuit
- Sits on Worksurface and Includes: Three (3) Power, **One (1) USB Charging Port and One (1) 60-Watt USB-C Power Delivery Port with GaN Technology**, and All Mounting Hardware
- Independent USB Circuit Controllers Deliver up to 2.1 Amps to Each Post
- FCC Part 15A and UL Approved for Horizontal and Vertical Applications
- Maximum 6 Trio Units per Circuit
- Eight (8) Wire/Four (4) Circuit Hard Wire Power Unit
- HDMI, VGA, or RJ45 Sold Separately; [See Accessories](#)
- See Power Entry, Jumper Cable, and Quad Block Below and on Next Page

| | | | | | | | | |
|-------------------------------|-----------------|--|----|---|---|---|-----|--------|
| POWER ENTRY HARD WIRED | 01-HWPOWERENTRY | | 72 | - | - | 1 | 0.2 | \$ 322 |
|-------------------------------|-----------------|--|----|---|---|---|-----|--------|

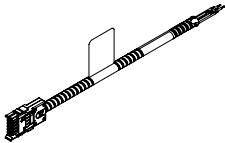
**Description**



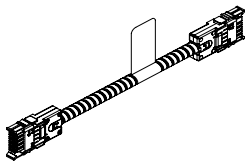

- Eight (8) Wire/Four (4) Circuit Hard Wire Infeed
- UL183 Compliant

| | | | | | | | | |
|-------------------------------|------------|--|----|---|---|---|-----|--------|
| JUMPER HARD WIRE CABLE | 01-HW2JUMP | | 24 | - | - | 1 | 0.2 | \$ 193 |
| | 01-HW3JUMP | | 36 | - | - | 1 | 0.2 | \$ 206 |
| | 01-HW4JUMP | | 48 | - | - | 1 | 0.2 | \$ 212 |
| | 01-HW5JUMP | | 60 | - | - | 1 | 0.2 | \$ 255 |
| | 01-HW6JUMP | | 72 | - | - | 1 | 0.2 | \$ 270 |

**Description**

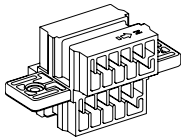
- Eight (8) Wire/Four (4) Circuit Hard Wire Jumper
- UL183 Compliant

[See Iconic Intro For Ordering Options and Grommet Locations](#)

| Item | Model No. | Width | Depth | Height | Ship Wt | Cubic Ft | List Price | |
|---|---|--------|-------|--------|---------|----------|------------|--------|
| QUAD BLOCK HARD WIRED | 01-HWQUADBLOCK | - | - | - | 1 | 0.2 | \$ 62 | |
|  | Description <ul style="list-style-type: none"> • Eight (8) Wire/Four (4) Circuit Hard Wire Connector • UL183 Compliant • For Connecting Jumpers and Power Units • Quantity of Four (4) Female Inputs | | | | | | | |
| DUO BEZEL WITH DAISY CHAIN PLUG | 01-PDUOBEZELW | White | 6½ | 2½ | 3 | 1 | 0.2 | \$ 668 |
|  | 01-PDUOBEZELB | Black | | | | | | |
| | 01-PDUOBEZELS | Silver | | | | | | |
| | Description <ul style="list-style-type: none"> • Sits On Top of the Worksurface and Includes: Two (2) Power, One (1) USB Charging Port and One (1) 60-Watt USB-C Power Delivery Port with GaN Technology with 12" Cord • Independent USB Circuit Controllers Deliver up to 2.1 Amps to Each Post • All Mounting Hardware Included • FCC Part 15A, RU Listed and UL Recognized for Horizontal and Vertical Applications • Non Sequential System Allows Up to Eight (8) Modules To Be Connected With Jumper Cord • Requires Power Box, See Below; See Jumper Cable on Next Page | | | | | | | |
| TRIO BEZEL WITH DAISY CHAIN PLUG | 01-PTRIOBEZELW | White | 9 | 2½ | 3 | 1 | 0.2 | \$ 715 |
|  | 01-PTRIOBEZELB | Black | | | | | | |
| | 01-PTRIOBEZELS | Silver | | | | | | |
| | Description <ul style="list-style-type: none"> • Sits On Top of the Worksurface and Includes: Three (3) Power, One (1) USB Charging Port, One (1) 60-Watt USB-C Power Delivery Port with GaN Technology, and One (1) Open Data with 12" Cord • HDMI, VGA, or RJ45 Sold Separately; See Accessories • All Mounting Hardware Included • FCC Part 15A, RU Listed and UL Recognized for Horizontal and Vertical Applications • Non Sequential System Allows Up to Eight (8) Modules To Be Connected With Jumper Cord • Requires Power Box, See Below; See Jumper Cable on Next Page | | | | | | | |
| DAISY CHAIN POWER BOX | 01-PPOWER | | - | - | - | 1 | 0.2 | \$ 775 |
|  | 76" Perimeter, 36" Power Cord | | | | | | | |
| | 01-PPOWER2 | | - | - | - | 1 | 0.2 | \$ 796 |
| | 24" Perimeter, 144" Power Cord | | | | | | | |
| | Description <ul style="list-style-type: none"> • Powers up to Eight (8) Duo and Trio Daisy Chain Units • One (1) Nema Plug and One (1) Daisy Chain Plug • 12 Amp System Rating • 15 Amp Over-Current Protection | | | | | | | |

[See Iconic Intro For Ordering Options and Grommet Locations](#)

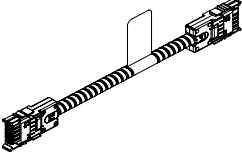
| Item | Model No. | Width | Depth | Height | Ship Wt | Cubic Ft | List Price |
|---|-----------------------------|-------|-------|--------|---------|----------|------------|
|  DAISY CHAIN JUMPER CORD | 01-6JUMP <i>72" Long</i> | - | - | - | 1 | 0.2 | \$ 299 |
| | 01-5JUMP <i>60" Long</i> | - | - | - | 1 | 0.2 | \$ 284 |
| | 01-4JUMP <i>48" Long</i> | - | - | - | 1 | 0.2 | \$ 240 |
| | 01-2JUMP <i>24" Long</i> | - | - | - | 1 | 0.2 | \$ 220 |

Description

- Connects Duo and Trio Daisy Chain Units
- Non Sequential System Allows up to Eight (8) Modules to be Connected

| | | | | | | | |
|--------------------------|-------------|---|---|---|---|-----|--------|
| HDMI DATA PORT ACCESSORY | 01-LCOMHDMI | - | - | - | 1 | 0.2 | \$ 166 |
|--------------------------|-------------|---|---|---|---|-----|--------|

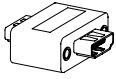

OPEN MARKET ONLY

Description

- HDMI Port for Trio Clamp, Undermount Trio, and Trio Bezel Units

| | | | | | | | |
|-------------------------|------------|---|---|---|---|-----|--------|
| VGA DATA PORT ACCESSORY | 01-LCOMVGA | - | - | - | 1 | 0.2 | \$ 121 |
|-------------------------|------------|---|---|---|---|-----|--------|

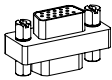
**Description**

- VGA Port for Trio Clamp, Undermount Trio, and Trio Bezel Units

| | | | | | | | |
|--------------------------|-------------|---|---|---|---|-----|-------|
| RJ45 DATA PORT ACCESSORY | 01-LCOMRJ45 | - | - | - | 1 | 0.2 | \$ 79 |
|--------------------------|-------------|---|---|---|---|-----|-------|

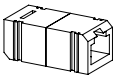
**Description**

- RJ45 Port for Trio Clamp, Undermount Trio, and Trio Bezel Units

| | | | | | | | |
|-------------------------|----------|----|----|---|---|---|--------|
| WIRE MANAGEMENT CHANNEL | 01-WMGR4 | 16 | 1½ | 1 | 1 | - | \$ 116 |
|-------------------------|----------|----|----|---|---|---|--------|

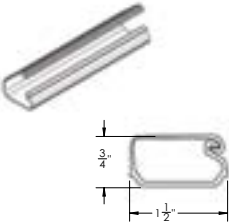
**Description**

- Set of Four (4) Black Plastic Wire Management Channels
- Snap Lock Channel
- Attaches with Adhesive Strips
- Ships via UPS Only
- Additional Wire Management Units on Next Page

[See Iconic Intro For Ordering Options and Grommet Locations](#)

| Item | Model No. | Width | Depth | Height | Ship Wt | Cubic Ft | List Price |
|--------------|-----------|-------|-----------------|--------|---------|----------|------------|
| WIRE CHANNEL | 01-32125 | 24 | 1 $\frac{5}{8}$ | 1 | .25 | 0.3 | \$ 106 |

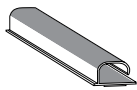

Description

- Available in Black
- Channels Attach with Two (2) Double-Sided Installation Tape
- Open J Channel for Easy Storage of Cables

| | | | | | | | |
|------------|-----------|-----------------|-----------------|---|---|---|-------|
| CABLE GRIP | 01-WMGRCB | 5 $\frac{3}{8}$ | 2 $\frac{5}{8}$ | - | - | - | \$ 17 |
|------------|-----------|-----------------|-----------------|---|---|---|-------|

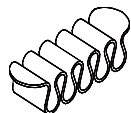

Description

- Under Surface Wire Management
- Black

| | | | | | | | | |
|------------------------|----------------|--------|------------------|------------------|-------|---|-----|--------|
| LINK 360 CABLE MANAGER | 01-0251LINKSLV | Silver | 5 $\frac{3}{16}$ | 3 $\frac{3}{16}$ | 30-51 | 4 | 3.0 | \$ 390 |
| | 01-0251LINKBLK | Black | 5 $\frac{3}{16}$ | 3 $\frac{3}{16}$ | 30-51 | 4 | 3.0 | \$ 353 |

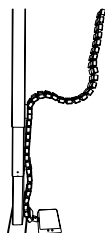

Description

- Kit Includes: 50 Link 360™ elements, One (1) Quad Connector, One (1) Dumbbell Connector, One (1) Foot Assembly with Two (2) Magnetic Clips
- Can Be Used For Height-Adjustable Mechanisms Up To 51" or Free-Standing Use

| | | | | | | | |
|-------------|---------|---|---|---|---|---|--------|
| POWER STRIP | 01-PRSP | 9 | 2 | 2 | 1 | - | \$ 205 |
|-------------|---------|---|---|---|---|---|--------|



Description

- Includes Four (4) Outlets and Two (2) Phone Jacks
- Black Plastic with Rocker On/Off Switch
- 13 Amp Circuit Breaker
- 10' Power Cord and Two (2) 14' Phone Hook Up Cords
- UL Listed and CSA Certified
- Suitable for Surface or Recessed Mounting
- Ships via UPS Only

| Item | Model No. | Width | Depth | Height | Ship Wt | Cubic Ft | List Price |
|---------------|-----------|-------|------------------|-----------------|---------|----------|------------|
| CENTER DRAWER | 01-1622CD | 22 | 16 $\frac{5}{8}$ | 2 $\frac{3}{4}$ | 7 | 1.4 | \$ 495 |

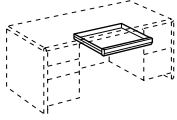

Description

- Standard With: Beveled Drawer Front, $\frac{3}{4}$ Extension, and Wood Drawer Interiors with Built-in Pen Tray

Options: Specify & Add

| | | |
|------|-------------------|--------|
| CD16 | Factory Installed | \$ 208 |
|------|-------------------|--------|

| | | | | | | | |
|--|----------|----|------------------|-----------------|----|-----|--------|
| ARTICULATING KEYBOARD CORNER PLATFORM | 01-KB2CC | 25 | 10 $\frac{1}{2}$ | 4 $\frac{1}{2}$ | 16 | 1.4 | \$ 832 |
|--|----------|----|------------------|-----------------|----|-----|--------|

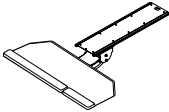

Description

- Standard With: +/- 15° Tilt Adjustment , 360° Rotation, Independent Tilt Adjustment, 7" Lift and Lock Height Adjustment, 25" Cut Corner Platform
- Keyboard and Mouse on same level; Single Palm Rest for both Left & Right Hands
- Works with 17"+ Diagonal Work Surface
- Cannot Be Used on 20" or 21" Deep Unit
- Not Available with Optional Center Grommet
- Track Measures 21"

Options: Specify & Add

| | | |
|-------|-------------------|--------|
| KB2CC | Factory Installed | \$ 208 |
|-------|-------------------|--------|

| | | | | | | | |
|--|--------|------------------|----|-----|----|-----|--------|
| KEYBOARD MECHANISM WITH KEYBOARD PLATFORM, MOUSE TRAY, AND PALM REST | 01-KB3 | 26 $\frac{1}{2}$ | 14 | 4.5 | 16 | 1.4 | \$ 914 |
|--|--------|------------------|----|-----|----|-----|--------|

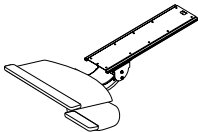

Description

- Standard With: 18 $\frac{3}{4}$ " Platform & Swivel-Below Mouse Platform, Palm Rest for Mousing Surface, Life & Lock 7" Height Adjustment, +/- 15° Tilt Adjustment, 360° Rotation, and Independent Tilt Adjustment
- Cannot be Used on 20"D or 21"D Unit
- Track Measures 21"
- Not Available with Optional Center Grommet

Options: Specify & Add

| | | |
|-----|-------------------|--------|
| KB3 | Factory Installed | \$ 208 |
|-----|-------------------|--------|

[See Iconic Intro For Ordering Options and Grommet Locations](#)

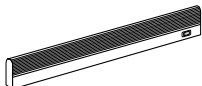
| Item | Model No. | Width | Depth | Height | Ship Wt | Cubic Ft | List Price |
|---|--------------------------|-------|-------|--------|---------|----------|------------|
| LED TASKLIGHTS  | TL-0848 | 47½ | 7/8 | 1½ | - | - | \$ 445 |
| | <i>240-LED, 18 Watts</i> | | | | | | |
| | TL-0824 | 22½ | 7/8 | 1½ | - | - | \$ 368 |
| | <i>84-LED, 7 Watts</i> | | | | | | |

Description

- Includes the Power Supply and Three (3) Upper Wire Management Grommets
- Rocker Style On/Off Switch with a 10' Power Cord
- Three (3) Upper Wire Management Grommets; Must Specify Color: Black (BLK), Silver (SLV)

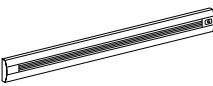
| | | | | | | | |
|---|---------------------------|-----|---|---|---|---|---------|
| LED TASKLIGHTS  | 01-188LED58 | 57¾ | 2 | ¾ | - | - | \$ 1648 |
| | <i>96-LED, 33.7 Watts</i> | | | | | | |
| | 01-94LED31 | 30½ | 2 | ¾ | - | - | \$ 1195 |
| | <i>48-LED, 17.6 Watts</i> | | | | | | |
| | 01-47LED17 | 16¾ | 2 | ¾ | - | - | \$ 690 |
| | <i>24-LED, 9.1 Watts</i> | | | | | | |

Description

- Includes the Power Supply and Three (3) Upper Wire Management Grommets
- 12' Power Cord
- Three (3) Upper Wire Management Grommets; Must Specify Color: Black (BLK), Silver (SLV)
- Optional Occupancy Sensor Shuts Off After 30 Minutes of Inactivity and Turns On Immediately When Reentering the Detection Area

Options: Specify & Add

| | | | | | | | |
|---------|------------------|--|--|--|--|--|--------|
| 01-OSRP | Occupancy Sensor | | | | | | \$ 366 |
|---------|------------------|--|--|--|--|--|--------|

| L SHELF | Model No. | Weight Limit | Width | Depth | Height | Ship Wt | Cubic Ft | List Price |
|---|-----------|--------------------|-------|-------|--------|---------|----------|------------|
|  | 50-1572LS | 154lb Weight Limit | 72 | 15 | 17 | 65 | 13.8 | \$ 1341 |
| | 50-1566LS | 128lb Weight Limit | 66 | 15 | 17 | 60 | 12.7 | \$ 1317 |
| | 50-1560LS | 128lb Weight Limit | 60 | 15 | 17 | 55 | 11.6 | \$ 1232 |
| | 50-1554LS | 90lb Weight Limit | 54 | 15 | 17 | 50 | 10.5 | \$ 1180 |
| | 50-1548LS | 90lb Weight Limit | 48 | 15 | 17 | 45 | 9.3 | \$ 1068 |
| | 50-1542LS | 90lb Weight Limit | 42 | 15 | 17 | 40 | 8.2 | \$ 958 |
| | 50-1536LS | 64lb Weight Limit | 36 | 15 | 17 | 35 | 7.1 | \$ 844 |
| | 50-1530LS | 64lb Weight Limit | 30 | 15 | 17 | 30 | 6.0 | \$ 788 |

Must Specify (in this order):

Model #

Finish

Description

- Standard With: Veneer Finish, Installation Hardware, and Horizontal Grain Direction
- Wall Mounted Application
- Weight Capacity is a Distributed Load

[See Iconic Intro For Ordering Options and Grommet Locations](#)

| Item | Model No. | Width | Depth | Height | Ship Wt | Cubic Ft | List Price |
|--|------------|-------|-------|--------|---------|----------|------------|
| MAGNETIC GLASS MARKER BOARD FOR USE WITH 30"H DESKS, CREDENZA AND SURFACE MOUNT HUTCHES | GMB-23108H | 106½ | ½ | 23 | 83 | 14.3 | \$ 3834 |
| | GMB-23102H | 100½ | ½ | 23 | 78 | 13.6 | \$ 3558 |
| | GMB-2396H | 94½ | ½ | 23 | 74 | 12.9 | \$ 3351 |
| | GMB-2390H | 88½ | ½ | 23 | 69 | 12.2 | \$ 3145 |
| | GMB-2384H | 82½ | ½ | 23 | 64 | 11.4 | \$ 3009 |
| | GMB-2378H | 76½ | ½ | 23 | 59 | 10.7 | \$ 2802 |
| | GMB-2372H | 70½ | ½ | 23 | 55 | 10.0 | \$ 2526 |
| | GMB-2366H | 64½ | ½ | 23 | 50 | 9.2 | \$ 2318 |
| | GMB-2360H | 58½ | ½ | 23 | 45 | 8.5 | \$ 2182 |
| | GMB-2354H | 52½ | ½ | 23 | 41 | 7.8 | \$ 1908 |
| | GMB-2348H | 46½ | ½ | 23 | 36 | 7.0 | \$ 1770 |
| | GMB-2342H | 40½ | ½ | 23 | 31 | 6.3 | \$ 1494 |
| | GMB-2336H | 34½ | ½ | 23 | 27 | 5.6 | \$ 1287 |
| | GMB-2330H | 28½ | ½ | 23 | 22 | 4.9 | \$ 1151 |

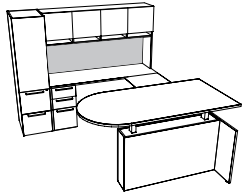
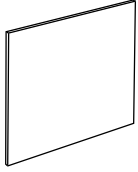

Must Specify (in this order):

Model #

Color



Rare Earth Magnet, Marker and Eraser Sets Available, [See Set Options](#)

Description

- Available in Black (BLMKR) or White (WHMKR), Must Specify
- Marker Boards Are One (1) Piece with No Seams
- Mounting Brackets Included
- For Use with 30"H Desks and Credenzas with Surface Mount Hutches
- For Rare Earth Magnets, Marker and Eraser Sets; [See Set Options](#)

| | | | | | | | |
|---|------------|-----|---|----|----|------|---------|
| MAGNETIC GLASS MARKER BOARD FOR USE WITH 30"H DESKS, CREDENZA AND WALL MOUNT HUTCHES | GMB-23108W | 108 | ½ | 23 | 85 | 14.6 | \$ 3834 |
| | GMB-23102W | 102 | ½ | 23 | 80 | 13.9 | \$ 3696 |
| | GMB-2396W | 96 | ½ | 23 | 75 | 13.1 | \$ 3489 |
| | GMB-2390W | 90 | ½ | 23 | 70 | 12.4 | \$ 3215 |
| | GMB-2384W | 84 | ½ | 23 | 66 | 11.7 | \$ 3009 |
| | GMB-2378W | 78 | ½ | 23 | 61 | 10.9 | \$ 2802 |
| | GMB-2372W | 72 | ½ | 23 | 56 | 10.2 | \$ 2595 |
| | GMB-2366W | 66 | ½ | 23 | 52 | 9.5 | \$ 2458 |
| | GMB-2360W | 60 | ½ | 23 | 47 | 8.8 | \$ 2182 |
| | GMB-2354W | 54 | ½ | 23 | 42 | 8.0 | \$ 1976 |
| | GMB-2348W | 48 | ½ | 23 | 38 | 7.3 | \$ 1838 |
| | GMB-2342W | 42 | ½ | 23 | 33 | 6.6 | \$ 1563 |
| | GMB-2336W | 36 | ½ | 23 | 28 | 5.8 | \$ 1357 |
| | GMB-2330W | 30 | ½ | 23 | 23 | 5.1 | \$ 1151 |

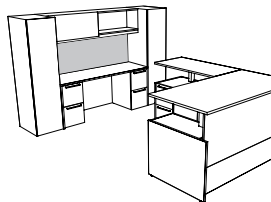
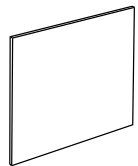

Must Specify (in this order):

Model #

Color



Rare Earth Magnet, Marker and Eraser Sets Available, [See Set Options](#)

Description

- Available in Black (BLMKR) or White (WHMKR), Must Specify
- Marker Boards Are One (1) Piece with No Seams
- Mounting Brackets Included
- For Use over 30"H Desks and Credenzas with Wall Mount Hutches
- For Rare Earth Magnets, Marker and Eraser Sets; [See Set Options](#)

| Item | Model No. | Width | Depth | Height | Ship Wt | Cubic Ft | List Price |
|--|------------|-------|-------|--------|---------|----------|------------|
| MAGNETIC GLASS MARKER BOARD | GMB-31108W | 108 | ½ | 31 | 114 | 17.9 | \$ 5073 |
| FOR USE WITH 21" LOW CREDENZA AND WALL MOUNT HUTCHES | GMB-31102W | 102 | ½ | 31 | 108 | 17.0 | \$ 4889 |
| | GMB-3196W | 96 | ½ | 31 | 101 | 16.1 | \$ 4613 |
| | GMB-3190W | 90 | ½ | 31 | 95 | 15.2 | \$ 4246 |
| | GMB-3184W | 84 | ½ | 31 | 89 | 14.3 | \$ 3972 |
| | GMB-3178W | 78 | ½ | 31 | 82 | 13.4 | \$ 3696 |
| | GMB-3172W | 72 | ½ | 31 | 76 | 12.5 | \$ 3421 |
| | GMB-3166W | 66 | ½ | 31 | 70 | 11.6 | \$ 3235 |
| | GMB-3160W | 60 | ½ | 31 | 63 | 10.8 | \$ 2870 |
| | GMB-3154W | 54 | ½ | 31 | 57 | 9.9 | \$ 2595 |
| | GMB-3148W | 48 | ½ | 31 | 51 | 9.0 | \$ 2414 |
| | GMB-3142W | 42 | ½ | 31 | 44 | 8.1 | \$ 2045 |
| | GMB-3136W | 36 | ½ | 31 | 38 | 7.2 | \$ 1770 |
| | GMB-3130W | 30 | ½ | 31 | 32 | 6.3 | \$ 1494 |

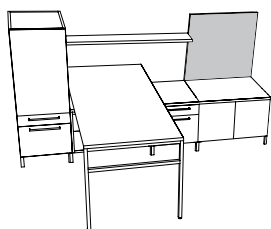
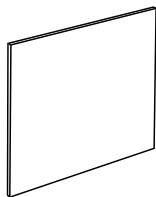

Must Specify (in this order):

Model #
Color



Rare Earth Magnet, Marker and Eraser Sets Available, [See Set Options](#)

Description

- Available in Black (BLMKR) or White (WHMKR), Must Specify
- Marker Boards Are One (1) Piece with No Seams
- Mounting Brackets Included
- For Use over 21"H Desks and Credenzas with Wall Mount Hutches
- For Rare Earth Magnets, Marker and Eraser Sets; [See Set Options](#)

| | | | | | | | |
|--|-----------|----|---|-----|----|------|---------|
| MAGNETIC GLASS MARKER BOARD | GMB-4048W | 48 | ½ | 40% | 67 | 11.0 | \$ 3128 |
| FOR USE WITH 30"H DESKS, CREDENZA AND WALL MOUNT HUTCHES OR SHELVING | GMB-4042W | 42 | ½ | 40% | 58 | 9.9 | \$ 2644 |
| | GMB-4036W | 36 | ½ | 40% | 50 | 8.8 | \$ 2285 |
| | GMB-4030W | 30 | ½ | 40% | 42 | 7.7 | \$ 1924 |

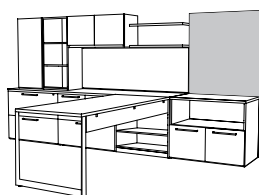

Must Specify (in this order):

Model #
Color



Rare Earth Magnet, Marker and Eraser Sets Available, [See Set Options](#)

Description

- Available in Black (BLMKR) or White (WHMKR), Must Specify
- Mounting Brackets Included
- For Use over 30"H Desks and Credenzas with Wall Mount Hutches or Shelving
- For Rare Earth Magnets, Marker and Eraser Sets; [See Set Options](#)

| Item | Model No. | Width | Depth | Height | Ship Wt | Cubic Ft | List Price |
|-----------------------------------|-----------|-------|-------|--------|---------|----------|------------|
| MAGNETIC GLASS MARKER BOARD | GMB-7036W | 36 | ½ | 70⅝ | 87 | 13.8 | \$ 3834 |
| FOR USE FROM FLOOR TO TOP OF UNIT | GMB-5136W | 36 | ½ | 51⅝ | 63 | 10.6 | \$ 2802 |
| | GMB-7030W | 30 | ½ | 70⅝ | 72 | 12.1 | \$ 3215 |
| | GMB-5130W | 30 | ½ | 51⅝ | 53 | 9.3 | \$ 2354 |

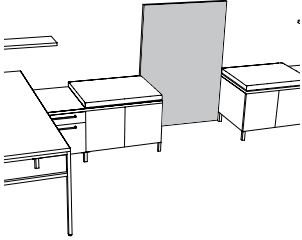

Description

- Available in Black (BLMKR) or White (WHMKR), Must Specify
- Marker Boards Are One (1) Piece with No Seams
- Mounting Brackets Included
- For Use From Floor to Top of Unit
- For Rare Earth Magnets, Marker and Eraser Sets; See Below

Must Specify (in this order):

Model #
Color



Rare Earth Magnet, Marker and Eraser Sets Available, See Below

| | | | |
|-----------------------|--------------|--|--------|
| MARKER AND ERASER SET | 01-MRKRSETBL | For Use with Black Marker Boards and Black Glass Doors | \$ 123 |
| | 01-MRKRSETWH | For Use with White Marker Boards and White Glass Doors | |

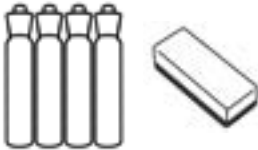

Description

- 01-MRKRSETWH May Also be Used with Standard Dry Erase Doors and Boards
- Includes Four (4) Markers and an Eraser

| | | | |
|------------|----------|----------------------------------|--------|
| MAGNET SET | 01-MAGBL | For Use with White Marker Boards | \$ 114 |
| | 01-MAGWH | For Use with Black Marker Boards | |



Description

- Includes Set of Five (5) Magnets

TALL TOOL RAIL WORK WALL FOR WALL MOUNT HUTCHES

USE OVER 21" H CREDENZA
31" TALL

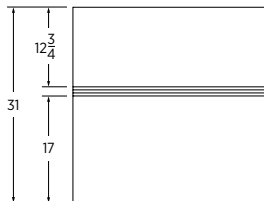

Must Specify (in this order):
Model #
Tackboard on Top or Bottom
Dry Erase on Top or Bottom
Tackboard Fabric Vendor, Pattern,
and Color

- Must Specify:**
- TB-TB: Tackboard Over Tackboard (Use Grade Prices)
 - DEB-TB: Dry Erase Over Tackboard (Use Grade Prices)
 - DEB-DEB: Dry Erase Over Dry Erase (Use Grade 1 Prices)

| Model # | Size | COM ydg | COM, 1, 2 or 3 | Grades | | | | | | |
|--------------|------|---------|-------------------|--------|------|------|------|------|------|------|
| | | | | 4 | 5 | 6 | 7 | 8 | 9 | 10 |
| WW-31108TTRW | 108" | 3.50 | \$ 2159 | 2646 | 2873 | 3104 | 3433 | 3776 | 4175 | 4637 |
| WW-31102TTRW | 102" | 3.25 | \$ 2044 | 2496 | 2707 | 2922 | 3227 | 3546 | 3916 | 4345 |
| WW-3196TTRW | 96" | 3.00 | \$ 1969 | 2386 | 2581 | 2779 | 3061 | 3355 | 3697 | 4093 |
| WW-3190TTRW | 90" | 2.75 | \$ 1854 | 2236 | 2415 | 2597 | 2855 | 3125 | 3438 | 3801 |
| WW-3184TTRW | 84" | 2.50 | \$ 1658 | 2006 | 2168 | 2333 | 2568 | 2813 | 3098 | 3428 |
| WW-3178TTRW | 78" | 2.50 | \$ 1585 | 1933 | 2095 | 2260 | 2495 | 2740 | 3025 | 3355 |
| WW-3172TTRW | 72" | 2.25 | \$ 1318 | 1631 | 1777 | 1926 | 2137 | 2358 | 2614 | 2911 |
| WW-3166TTRW | 66" | 2.00 | \$ 1265 | 1543 | 1673 | 1805 | 1993 | 2189 | 2417 | 2681 |
| WW-3160TTRW | 60" | 2.00 | \$ 1191 | 1469 | 1599 | 1731 | 1919 | 2115 | 2343 | 2607 |
| WW-3154TTRW | 54" | 1.75 | \$ 1137 | 1380 | 1494 | 1610 | 1774 | 1946 | 2145 | 2376 |
| WW-3148TTRW | 48" | 1.50 | \$ 1044 | 1253 | 1350 | 1449 | 1590 | 1737 | 1908 | 2106 |
| WW-3142TTRW | 42" | 1.25 | \$ 960 | 1134 | 1215 | 1298 | 1415 | 1538 | 1680 | 1845 |
| WW-3136TTRW | 36" | 1.25 | \$ 940 | 1114 | 1195 | 1278 | 1395 | 1518 | 1660 | 1825 |
| WW-3130TTRW | 30" | 1.00 | \$ 865 | 1004 | 1069 | 1135 | 1229 | 1327 | 1441 | 1573 |

- Description**
- Aluminum Tool Rail
 - Work Walls 78" and Larger will Ship in 4 Pieces
 - [See Work Wall Accessories](#)

TOOL RAIL WORK WALL FOR WALL MOUNT HUTCHES

USE OVER 30" H CREDENZA
23" TALL



Must Specify (in this order):
Model #
Tackboard on Top or Bottom
Dry Erase on Top or Bottom
Tackboard Fabric Vendor, Pattern,
and Color

- Must Specify:**
- TB-TB: Tackboard Over Tackboard (Use Grade Prices)
 - DEB-TB: Dry Erase Over Tackboard (Use Grade Prices)
 - DEB-DEB: Dry Erase Over Dry Erase (Use Grade 1 Prices)

| Model # | Size | COM ydg | COM, 1, 2 or 3 | Grades | | | | | | |
|-------------|------|---------|-------------------|--------|------|------|------|------|------|------|
| | | | | 4 | 5 | 6 | 7 | 8 | 9 | 10 |
| WW-23108TRW | 108" | 3.50 | \$ 1797 | 2284 | 2511 | 2742 | 3071 | 3414 | 3813 | 4275 |
| WW-23102TRW | 102" | 3.25 | \$ 1693 | 2145 | 2356 | 2571 | 2876 | 3195 | 3565 | 3994 |
| WW-2396TRW | 96" | 3.00 | \$ 1643 | 2060 | 2255 | 2453 | 2735 | 3029 | 3371 | 3767 |
| WW-2390TRW | 90" | 2.75 | \$ 1548 | 1930 | 2109 | 2291 | 2549 | 2819 | 3132 | 3495 |
| WW-2384TRW | 84" | 2.50 | \$ 1379 | 1727 | 1889 | 2054 | 2289 | 2534 | 2819 | 3149 |
| WW-2378TRW | 78" | 2.50 | \$ 1319 | 1667 | 1829 | 1994 | 2229 | 2474 | 2759 | 3089 |
| WW-2372TRW | 72" | 2.25 | \$ 1099 | 1412 | 1558 | 1707 | 1918 | 2139 | 2395 | 2692 |
| WW-2366TRW | 66" | 2.00 | \$ 1040 | 1318 | 1448 | 1580 | 1768 | 1964 | 2192 | 2456 |
| WW-2360TRW | 60" | 2.00 | \$ 976 | 1254 | 1384 | 1516 | 1704 | 1900 | 2128 | 2392 |
| WW-2354TRW | 54" | 1.75 | \$ 934 | 1177 | 1291 | 1407 | 1571 | 1743 | 1942 | 2173 |
| WW-2348TRW | 48" | 1.50 | \$ 863 | 1072 | 1169 | 1268 | 1409 | 1556 | 1727 | 1925 |
| WW-2342TRW | 42" | 1.25 | \$ 795 | 969 | 1050 | 1133 | 1250 | 1373 | 1515 | 1680 |
| WW-2336TRW | 36" | 1.25 | \$ 780 | 954 | 1035 | 1118 | 1235 | 1358 | 1500 | 1665 |
| WW-2330TRW | 30" | 1.00 | \$ 716 | 855 | 920 | 986 | 1080 | 1178 | 1292 | 1424 |

- Description**
- Aluminum Tool Rail
 - Work Walls 78" and Larger will Ship in 4 Pieces
 - [See Work Wall Accessories](#)

[See Iconic Intro For Ordering Options and Grommet Locations](#)

**TALL TOOL RAIL WORK WALL
FOR SURFACE MOUNT HUTCHES**

**USE OVER 30" H CREDENZA
23" TALL**

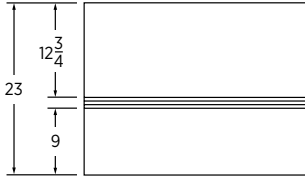

| Model # | Size | COM ydg | COM, 1, 2 or 3 | Grades | | | | | | | |
|------------|------|---------|-------------------|--------|------|------|------|------|------|------|--|
| | | | | 4 | 5 | 6 | 7 | 8 | 9 | 10 | |
| WW-2372TRH | 72" | 2.25 | \$ 1023 | 1336 | 1482 | 1631 | 1842 | 2063 | 2319 | 2616 | |
| WW-2366TRH | 66" | 2.00 | \$ 967 | 1245 | 1375 | 1507 | 1695 | 1891 | 2119 | 2383 | |
| WW-2360TRH | 60" | 2.00 | \$ 910 | 1188 | 1318 | 1450 | 1638 | 1834 | 2062 | 2326 | |

Description

- Aluminum Tool Rail
- Work Walls 78" and Larger will Ship in 4 Pieces
- [See Work Wall Accessories](#)

Must Specify (in this order):

- Model #
- Tackboard on Top or Bottom
- Dry Erase on Top or Bottom
- Tackboard Fabric Vendor, Pattern, and Color

Must Specify:

- TB-TB: Tackboard Over Tackboard (Use Grade Prices)
- DEB-TB: Dry Erase Over Tackboard (Use Grade Prices)
- DEB-DEB: Dry Erase Over Dry Erase (Use Grade 1 Prices)

LEGAL TRAY

| | | | | | | | |
|-------------|-------|-----|-----|----|---|-----|---------|
| 01-LGLTRAYC | Clear | 14% | 10½ | 1⅞ | 1 | 0.2 | \$ 1115 |
|-------------|-------|-----|-----|----|---|-----|---------|

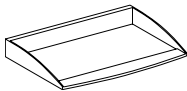

FOLDER SORTER

| | | | | | | | |
|--------------|-------|----|-----|----|---|-----|---------|
| 01-FLDRSRTRC | Clear | 7¼ | 12¾ | 7⅞ | 1 | 0.2 | \$ 1129 |
|--------------|-------|----|-----|----|---|-----|---------|

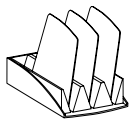

ACCESSORIES TRAY

| | | | | | | | |
|-------------|-------|----|-----|----|---|-----|---------|
| 01-ACCTRAYC | Clear | 9¼ | 10¾ | 1⅞ | 1 | 0.2 | \$ 1125 |
|-------------|-------|----|-----|----|---|-----|---------|

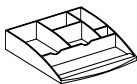

[See Iconic Intro For Ordering Options and Grommet Locations](#)

**TACKBOARDS
FOR WALL MOUNT HUTCHES**

USE OVER 21" H CREDENZA
31" TALL

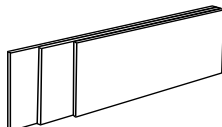

Must Specify (in this order):
Model #
Fabric Vendor, Pattern, and Color

| Model # | Size | COM ydg | COM, 1, 2 or 3 | Grades | | | | | | | |
|-----------|------|---------|-------------------|--------|------|------|------|------|------|------|--|
| | | | | 4 | 5 | 6 | 7 | 8 | 9 | 10 | |
| TB-31108W | 108" | 3.50 | \$ 1014 | 1501 | 1728 | 1959 | 2288 | 2631 | 3030 | 3492 | |
| TB-31102W | 102" | 3.25 | \$ 969 | 1421 | 1632 | 1847 | 2152 | 2471 | 2841 | 3270 | |
| TB-3196W | 96" | 3.00 | \$ 943 | 1360 | 1555 | 1753 | 2035 | 2329 | 2671 | 3067 | |
| TB-3190W | 90" | 2.75 | \$ 899 | 1281 | 1460 | 1642 | 1900 | 2170 | 2483 | 2846 | |
| TB-3184W | 84" | 2.50 | \$ 851 | 1199 | 1361 | 1526 | 1761 | 2006 | 2291 | 2621 | |
| TB-3178W | 78" | 2.50 | \$ 836 | 1184 | 1346 | 1511 | 1746 | 1991 | 2276 | 2606 | |
| TB-3172W | 72" | 2.25 | \$ 772 | 1085 | 1231 | 1380 | 1591 | 1812 | 2068 | 2365 | |
| TB-3166W | 66" | 2.00 | \$ 738 | 1016 | 1146 | 1278 | 1466 | 1662 | 1890 | 2154 | |
| TB-3160W | 60" | 2.00 | \$ 691 | 969 | 1099 | 1231 | 1419 | 1615 | 1843 | 2107 | |
| TB-3154W | 54" | 1.75 | \$ 656 | 899 | 1013 | 1129 | 1293 | 1465 | 1664 | 1895 | |
| TB-3148W | 48" | 1.50 | \$ 598 | 807 | 904 | 1003 | 1144 | 1291 | 1462 | 1660 | |
| TB-3142W | 42" | 1.25 | \$ 539 | 713 | 794 | 877 | 994 | 1117 | 1259 | 1424 | |
| TB-3136W | 36" | 1.25 | \$ 525 | 699 | 780 | 863 | 980 | 1103 | 1245 | 1410 | |
| TB-3130W | 30" | 1.00 | \$ 473 | 612 | 677 | 743 | 837 | 935 | 1049 | 1181 | |

Description
• All Tackboards 78" and Longer will Ship in 2 Pieces

**TACKBOARDS
FOR SURFACE MOUNT HUTCHES**

23" TALL

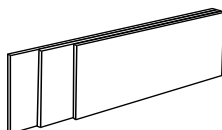

Must Specify (in this order):
Model #
Fabric Vendor, Pattern, and Color

| Model # | Size | COM ydg | COM, 1, 2 or 3 | Grades | | | | | | | |
|-----------|------|---------|-------------------|--------|------|------|------|------|------|------|--|
| | | | | 4 | 5 | 6 | 7 | 8 | 9 | 10 | |
| TB-65108H | 108" | 3.50 | \$ 758 | 1245 | 1472 | 1703 | 2032 | 2375 | 2774 | 3236 | |
| TB-65102H | 102" | 3.25 | \$ 731 | 1183 | 1394 | 1609 | 1914 | 2233 | 2603 | 3032 | |
| TB-6596H | 96" | 3.00 | \$ 707 | 1124 | 1319 | 1517 | 1799 | 2093 | 2435 | 2831 | |
| TB-6590H | 90" | 2.75 | \$ 673 | 1055 | 1234 | 1416 | 1674 | 1944 | 2257 | 2620 | |
| TB-6584H | 84" | 2.50 | \$ 639 | 987 | 1149 | 1314 | 1549 | 1794 | 2079 | 2409 | |
| TB-6578H | 78" | 2.50 | \$ 628 | 976 | 1138 | 1303 | 1538 | 1783 | 2068 | 2398 | |
| TB-6572H | 72" | 2.25 | \$ 566 | 879 | 1025 | 1174 | 1385 | 1606 | 1862 | 2159 | |
| TB-6566H | 66" | 2.00 | \$ 533 | 811 | 941 | 1073 | 1261 | 1457 | 1685 | 1949 | |
| TB-6560H | 60" | 2.00 | \$ 498 | 776 | 906 | 1038 | 1226 | 1422 | 1650 | 1914 | |
| TB-6554H | 54" | 1.75 | \$ 485 | 728 | 842 | 958 | 1122 | 1294 | 1493 | 1724 | |
| TB-6548H | 48" | 1.50 | \$ 436 | 645 | 742 | 841 | 982 | 1129 | 1300 | 1498 | |
| TB-6542H | 42" | 1.25 | \$ 396 | 570 | 651 | 734 | 851 | 974 | 1116 | 1281 | |
| TB-6536H | 36" | 1.25 | \$ 385 | 559 | 640 | 723 | 840 | 963 | 1105 | 1270 | |
| TB-6530H | 30" | 1.00 | \$ 346 | 485 | 550 | 616 | 710 | 808 | 922 | 1054 | |

Description
• All Tackboards 78" and Longer will Ship in 2 Pieces

[See Iconic Intro For Ordering Options and Grommet Locations](#)

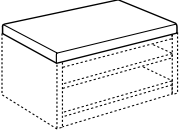
| Item | Model No. | Width | Depth | Height | Ship Wt | Cubic Ft | List Price | | | | | | |
|---|-----------------|---------------|---------|----------------|---------|----------|------------|------|------|------|------|------|------|
| CUSHIONS | | Grades | | | | | | | | | | | |
|  | Model # | Size | COM Ydg | COM, 1, 2 or 3 | 4 | 5 | 6 | 7 | 8 | 9 | 10 | L1 | L2 |
| | 65-24108CUSHION | 108" | 3.25 | \$ 790 | 1242 | 1453 | 1668 | 1973 | 2292 | 2662 | 3091 | 1863 | 2321 |
| | 65-2490CUSHION | 90" | 2.75 | \$ 715 | 1097 | 1276 | 1458 | 1716 | 1986 | 2299 | 2662 | 1623 | 2010 |
| | 65-2472CUSHION | 72" | 2.25 | \$ 604 | 917 | 1063 | 1212 | 1423 | 1644 | 1900 | 2197 | 1347 | 1664 |
| | 65-2460CUSHION | 60" | 2.00 | \$ 523 | 801 | 931 | 1063 | 1251 | 1447 | 1675 | 1939 | 1183 | 1465 |
| | 65-2436CUSHION | 36" | 1.25 | \$ 445 | 619 | 700 | 783 | 900 | 1023 | 1165 | 1330 | 858 | 1034 |
| 65-2430CUSHION | 30" | 1.25 | \$ 385 | 559 | 640 | 723 | 840 | 963 | 1105 | 1270 | 798 | 974 | |

Must Specify (in this order):
Model #
Fabric Vendor, Pattern and Color

Description

- Create Bench-Style Seating Over Low Height Storage Units
- Cushions are Shipped with Installation Hardware for Both Fixed and Movable Applications
- Increases Height of Pedestal 2¼"

PLANTER BOX

| | | | | | | |
|-----------|------|-----|---|----|-----|--------|
| 01-1909PL | 19 ¼ | 9 ½ | 6 | 16 | 2.0 | \$ 572 |
|-----------|------|-----|---|----|-----|--------|

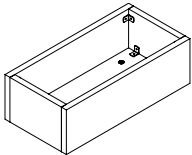

SIN NEW

Description

- Standard With: TFL, Installation Hardware (2-Black and 2-Nickel Bolts), and Horizontal Grain Direction
- Must Specify TFL (T) Color; Available in all Indiana Furniture TFL options
- Can Be Freestanding or Secured with Included Hardware
- Not Intended to Hold Water; Optional Planter Box Insert Sold Separately (See Below)

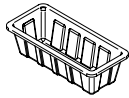

Options: Specify & Add

| | | |
|-----|-----------------------------------|-------|
| PBI | Planter Box Insert, Black Plastic | \$ 52 |
|-----|-----------------------------------|-------|

Must Specify (in this order):
Model #
TFL Color
Planter Insert

VESTA POWER CENTER

| | | | | | | |
|----------|-----|----|-----|----|-----|---------|
| 01-PDCTR | 10¾ | 12 | 28¾ | 14 | 2.5 | \$ 1776 |
|----------|-----|----|-----|----|-----|---------|



Description

- Available in White
- 120" Power Cord
- Four (4) Power Outlets, Three (3) on the Base and One (1) on the Top
- Two (2) USB Ports and One (1) USBC Port, All on Top
- Built with Weight Distribution for Optimal Stability
- Base is 5" Tall

[See Iconic Intro For Ordering Options and Grommet Locations](#)

Jefferson echoes history and creates a timeless foundation for today's sophisticated work place. Finely crafted in select solids with Walnut and Cherry veneers, the tailored details of this collection accentuate our expert craftsmanship and perfect attention to detail.

Jefferson forges traditional styling with modern sensibility with new Height Adjustable options and coordinating reception models, allowing the premium feel and flexibility of Jefferson to easily function throughout entire facilities.

CONSTRUCTION

Jefferson features a Veneer chassis with your choice of a Veneer or HPL top. Units ship assembled unless otherwise noted.

VENEER

- Choose from premium or select veneer on exposed surfaces in American Black Walnut or Cherry species in bookmatched veneer faces
- Veneers are carefully selected and matched to assure proper balance and consistency

TOPS

- Veneer tops offer a 5-ply balanced construction, 1 3/16" thick with solid hardwood mitered rims
- High Pressure Laminate (HPL) tops offer a 3-ply balanced construction, 1 3/16" thick with solid hardwood mitered rims
- Grain direction runs left-to-right unless otherwise noted
- All Jefferson tops are standard with the Jefferson edge profile (C2), unless otherwise noted.



CHASSIS

- Chassis is securely fastened using high quality European fastening systems, heavy-duty, 16-gauge joining brackets and wood dowels to assure maximum strength
- Bases are solid hardwood with mitered corners
- All units have finished veneer backs
- Construction offers tight tolerances and long term durability
- All units equipped with heavy-duty, adjustable glides to ensure proper leveling and compensate for uneven floors
- Vertical grain direction on chassis

DRAWERS

- Drawer fronts standard with bookmatched veneer faces
- Fronts are 3-ply construction and 3/4" thick
- Drawer interiors are dovetail, wood constructed with 7/16" hardwood sides and backs and 5/32" thick hardboard bottoms
- All drawers feature full extension, progressive action slides with precision steel ball bearings
- Box and file drawers are tested for 100lb capacity
- Lateral files feature 1/4" thick bottoms. Drawers are tested for 200lb of equally distributed weight (ex: hanging file folders) and 65lbs of bottom load weight (ex: stacked catalogs)
- All suspensions have a limited lifetime warranty
- Optional soft close ([see soft close options](#)) is available on center, tray, box, and file drawers, unless otherwise noted; **File drawers with the soft close option feature front-to-back filing.**

FILING

- All file drawers are standard with filing systems designed to accommodate a variety of filing requirements
- **Optional soft close on box and file drawers allows front-to-back filing in file drawer**

FILING (CONT.)

- Legal width file drawers provide legal filing front to back, and letter or legal filing side to side
- Letter width file drawers provide letter filing front to back, and letter or legal filing side to side

STORAGE

- All hinged doors include soft close hinges, unless noted
- Soft close hinges reduce stress placed on the cabinet when the door is closed and offers a quiet closure

LOCKING

- Central locking is standard on all desks and optional for credenzas and returns; one key in the lock cylinder locks all drawers in the desk
- Lock core color will coordinate with pull selection (brass pulls will have black cores, while aluminum pulls will have silver cores)
- Removable lock cylinders allow for units to be re-keyed at a later date if required
- Units are shipped randomly keyed as standard. Keyed alike units available upon request at no additional charge.

CORD MANAGEMENT

- Grommets are standard in back panels of returns, bridges, kneespace credenzas, and hutch units (does not apply to height adjustable or reception units)
- Grommets may be ordered in the tops of desks, returns, bridges, credenzas, and component worksurfaces
- [See all optional grommet locations](#)
- Undersurface Wire Managers are available for additional cord management; [See Multiple Units](#)

HEIGHT ADJUSTABILITY

- Electric-powered height adjustable mechanisms are offered in 2-channel for single surface height adjustment and 3-channel for simultaneous, two surface height adjustment
- Height adjustable legs available in black finish only
- Height adjustment range 30"H to 45"H
- 5-year warranty
- Recommended load capacity of 180lbs
- Two control switches are available, including an up/down switch (standard with product, unless noted) and an advanced switch with Bluetooth capabilities, position memory, three stand up reminder intervals, and more; gently adjust worksurface with a one second stop at each memory position
- The standard control switch is factory installed on all units except bridges and 3-channel units
- Bridges, returns, and credenzas will not have a standard grommet on the back panel
- New wire management mesh wrap included when worksurface grommet is selected
- Grommets and one wire management channel provided within kneespace to manage wires from switch and control box; two wire management channels will be shipped with desk shells

INTERIOR DRAWER DIMENSIONS

Models

46-4284DPS 46-4278DPS 46-3672CHS

| Drawers | W | L | D |
|---------|----------------------------------|------------------------------------|-----------------------------------|
| Tray | 15 ³ / ₈ " | 19 ³ / ₈ " | 1 ²⁷ / ₃₂ " |
| Box | 15 ³ / ₈ " | 19 ³ / ₈ " | 3 ²¹ / ₃₂ " |
| File | 15 ³ / ₈ " | 25 ³ / ₄ " | 8 ²⁹ / ₃₂ " |
| Center | 30 ⁵ / ₈ " | 19 ¹¹ / ₃₂ " | 1 ²⁷ / ₃₂ " |

Models

46-3672LPS 46-3672RPS

| Drawers | W | L | D |
|---------|----------------------------------|------------------------------------|-----------------------------------|
| Tray | 15 ³ / ₈ " | 19 ³ / ₈ " | 1 ²⁷ / ₃₂ " |
| Box | 15 ³ / ₈ " | 19 ³ / ₈ " | 3 ²¹ / ₃₂ " |
| File | 15 ³ / ₈ " | 25 ³ / ₄ " | 8 ²⁹ / ₃₂ " |
| Center | 25 ³ / ₄ " | 19 ¹¹ / ₃₂ " | 1 ²⁷ / ₃₂ " |

Models

46-3672DPS 46-3066DPS

| Drawers | W | L | D |
|---------|----------------------------------|------------------------------------|-----------------------------------|
| Tray | 12 ³ / ₈ " | 19 ³ / ₈ " | 1 ²⁷ / ₃₂ " |
| Box | 12 ³ / ₈ " | 19 ³ / ₈ " | 3 ²¹ / ₃₂ " |
| File | 12 ³ / ₈ " | 25 ³ / ₄ " | 8 ²⁹ / ₃₂ " |
| Center | 30 ⁵ / ₈ " | 19 ¹¹ / ₃₂ " | 1 ²⁷ / ₃₂ " |

Models

46-3066LPS 46-3066RPS

| Drawers | W | L | D |
|---------|----------------------------------|------------------------------------|-----------------------------------|
| Tray | 12 ³ / ₈ " | 19 ³ / ₈ " | 1 ²⁷ / ₃₂ " |
| Box | 12 ³ / ₈ " | 19 ³ / ₈ " | 3 ²¹ / ₃₂ " |
| File | 12 ³ / ₈ " | 25 ³ / ₄ " | 8 ²⁹ / ₃₂ " |
| Center | 22 ⁷ / ₈ " | 19 ¹¹ / ₃₂ " | 1 ²⁷ / ₃₂ " |

Models

46-4284DP 46-4278DP 46-3672CH

| Drawers | W | L | D |
|---------|----------------------------------|------------------------------------|------------------------------------|
| Box | 15 ³ / ₈ " | 19 ³ / ₈ " | 3 ²¹ / ₃₂ " |
| File | 15 ³ / ₈ " | 25 ³ / ₄ " | 11 ¹³ / ₃₂ " |
| Center | 30 ⁵ / ₈ " | 19 ¹¹ / ₃₂ " | 1 ²⁷ / ₃₂ " |

Models

46-3672LP 46-3672RP

| Drawers | W | L | D |
|---------|----------------------------------|----------------------------------|------------------------------------|
| Box | 15 ³ / ₈ " | 19 ³ / ₈ " | 3 ²¹ / ₃₂ " |
| File | 15 ³ / ₈ " | 25 ³ / ₄ " | 11 ¹³ / ₃₂ " |
| Center | 25 ³ / ₄ " | 19 ³ / ₈ " | 1 ²⁷ / ₃₂ " |

Models

46-3672DP 46-3066DP

| Drawers | W | L | D |
|---------|----------------------------------|----------------------------------|------------------------------------|
| Box | 12 ³ / ₈ " | 19 ³ / ₈ " | 3 ²¹ / ₃₂ " |
| File | 12 ³ / ₈ " | 25 ³ / ₄ " | 11 ¹³ / ₃₂ " |
| Center | 30 ⁵ / ₈ " | 19 ³ / ₈ " | 1 ²⁷ / ₃₂ " |

Models

46-3066LP 46-3066RP

| Drawers | W | L | D |
|---------|----------------------------------|----------------------------------|------------------------------------|
| Box | 12 ³ / ₈ " | 19 ³ / ₈ " | 3 ²¹ / ₃₂ " |
| File | 12 ³ / ₈ " | 25 ³ / ₄ " | 11 ¹³ / ₃₂ " |
| Center | 22 ⁷ / ₈ " | 19 ³ / ₈ " | 1 ²⁷ / ₃₂ " |

Models

46-2448LF 46-2448RF 46-2442LF 46-2442RF
46-2066KC 46-2066LC 46-2066RC

| Drawers | W | L | D |
|---------|----------------------------------|-----------------------------------|------------------------------------|
| Box | 12 ³ / ₈ " | 16 ⁷ / ₃₂ " | 3 ²¹ / ₃₂ " |
| File | 12 ³ / ₈ " | 16 ⁷ / ₃₂ " | 11 ¹³ / ₃₂ " |

Models

46-2072SC1 46-2072KC 46-2072LC 46-2072RC

| Drawers | W | L | D |
|---------|----------------------------------|-----------------------------------|------------------------------------|
| Box | 15 ³ / ₈ " | 16 ⁷ / ₃₂ " | 3 ²¹ / ₃₂ " |
| File | 15 ³ / ₈ " | 16 ⁷ / ₃₂ " | 11 ¹³ / ₃₂ " |

Models

46-2072KC1

| Drawers | W | L | D |
|---------|----------------------------------|-----------------------------------|------------------------------------|
| Box | 15 ³ / ₈ " | 16 ⁷ / ₃₂ " | 3 ²¹ / ₃₂ " |
| File | 15 ³ / ₈ " | 16 ⁷ / ₃₂ " | 11 ¹³ / ₃₂ " |
| Center | 30 ⁵ / ₈ " | 14 ³ / ₁₆ " | 1 ²⁷ / ₃₂ " |

Models

46-2066KC1

| Drawers | W | L | D |
|---------|----------------------------------|-----------------------------------|------------------------------------|
| Box | 12 ³ / ₈ " | 16 ⁷ / ₃₂ " | 3 ²¹ / ₃₂ " |
| File | 12 ³ / ₈ " | 16 ⁷ / ₃₂ " | 11 ¹³ / ₃₂ " |
| Center | 30 ⁵ / ₈ " | 14 ³ / ₁₆ " | 1 ²⁷ / ₃₂ " |

Models

46-2036L2 46-2036L4 46-2034L2FE 46-2034L4FE
46-2072LL 46-2072RL 46-2072DL 46-2066LL
46-2066RL

| Drawers | W | L | D |
|---------|----------------------------------|----------------------------------|-----------------------------------|
| File | 12 ³ / ₈ " | 25 ³ / ₄ " | 8 ¹³ / ₃₂ " |

Models

46-1829MU

| Drawers | W | L | D |
|---------|----------------------------------|-----------------------------------|-----------------------------------|
| Box | 25 ¹ / ₂ " | 16 ⁷ / ₃₂ " | 3 ²¹ / ₃₂ " |
| File | 25 ¹ / ₂ " | 16 ⁷ / ₃₂ " | 8 ¹³ / ₃₂ " |

Models

46-1829MF

| Drawers | W | L | D |
|---------|----------------------------------|-----------------------------------|-----------------------------------|
| File | 25 ¹ / ₂ " | 16 ⁷ / ₃₂ " | 8 ¹³ / ₃₂ " |

INTERIOR DRAWER DIMENSIONS

| Models | | | |
|-----------|----------------------------------|----------------------------------|-----------------------------------|
| 46-3672TD | 43-3066TD | 46-3672TDQ | 43-3066TDQ |
| Drawers | W | L | D |
| Center | 30 ⁵ / ₈ " | 19 ³ / ₈ " | 12 ⁷ / ₃₂ " |

| Models | | | |
|-----------|----------------------------------|-----------------------------------|-----------------------------------|
| 46-1818MU | | | |
| Drawers | W | L | D |
| Box | 15 ³ / ₈ " | 19 ³ / ₈ " | 3 ²¹ / ₃₂ " |
| File | 15 ³ / ₈ " | 16 ⁷ / ₃₂ " | 8 ²⁹ / ₃₂ " |

| Models | | | |
|-----------|----------------------------------|-----------------------------------|-----------------------------------|
| 46-1818MF | 46-2072KC2 | 46-2072LC2 | 46-2072RC2 |
| Drawers | W | L | D |
| File | 15 ³ / ₈ " | 16 ⁷ / ₃₂ " | 8 ²⁹ / ₃₂ " |

| Models | | | |
|---------------|----------------------------------|-----------------------------------|-----------------------------------|
| 46-2448LF2 | 46-2448RF2 | 46-2442LF2 | 46-2442RF2 |
| 46-2066KC2 | 46-2066LC2 | 46-2066RC2 | 46-2448LF2STS |
| 46-2448RF2STS | 46-2442LF2STS | 46-2442RF2STS | 46-2448LF2SR |
| 46-2448RF2SR | 46-2442LF2SR | 46-2442RF2SR | 46-2472RCL |
| 46-2472RCR | 46-2466RCL | 46-2466RCR | 46-2448RPD2L |
| 46-2448RPD2R | | | |
| Drawers | W | L | D |
| File | 12 ³ / ₈ " | 16 ⁷ / ₃₂ " | 8 ²⁹ / ₃₂ " |

| Models | | | |
|--------------|----------------------------------|-----------------------------------|-----------------------------------|
| 46-3672DPSTS | 46-3066DPSTS | 46-3066LPSTS | 46-3066RPSTS |
| 46-2066SC1 | | | |
| Drawers | W | L | D |
| Box | 12 ³ / ₈ " | 16 ⁷ / ₃₂ " | 3 ²¹ / ₃₂ " |
| File | 12 ³ / ₈ " | 16 ⁷ / ₃₂ " | 8 ²⁹ / ₃₂ " |

| Models | | | |
|--------------|----------------------------------|-----------------------------------|-----------------------------------|
| 46-3672LPSTS | 46-3672RPSTS | | |
| Drawers | W | L | D |
| Box | 15 ³ / ₈ " | 16 ⁷ / ₃₂ " | 3 ²¹ / ₃₂ " |
| File | 15 ³ / ₈ " | 16 ⁷ / ₃₂ " | 8 ²⁹ / ₃₂ " |

| Models | | | |
|---------------|----------------------------------|-----------------------------------|-----------------------------------|
| 46-3672DPSSTS | 46-3066DPSSTS | 46-3066LPSSTS | 46-3066RPSSTS |
| Drawers | W | L | D |
| Tray | 12 ³ / ₈ " | 16 ⁷ / ₃₂ " | 12 ⁷ / ₃₂ " |
| Box | 12 ³ / ₈ " | 16 ⁷ / ₃₂ " | 3 ²¹ / ₃₂ " |
| File | 12 ³ / ₈ " | 16 ⁷ / ₃₂ " | 8 ²⁹ / ₃₂ " |

| Models | | | |
|---------------|----------------------------------|-----------------------------------|-----------------------------------|
| 46-3672LPSSTS | 46-3672RPSSTS | | |
| Drawers | W | L | D |
| Tray | 15 ³ / ₈ " | 16 ⁷ / ₃₂ " | 12 ⁷ / ₃₂ " |
| Box | 15 ³ / ₈ " | 16 ⁷ / ₃₂ " | 3 ²¹ / ₃₂ " |
| File | 15 ³ / ₈ " | 16 ⁷ / ₃₂ " | 8 ²⁹ / ₃₂ " |

| Models | | | |
|----------------|----------------------------------|----------------------------------|-----------------------------------|
| 46-2448LF2STS3 | 46-2448RF2STS3 | | |
| 46-2442LF2STS3 | 46-2442RF2STS3 | | |
| Drawers | W | L | D |
| File | 12 ³ / ₈ " | 12 ⁷ / ₈ " | 8 ²⁹ / ₃₂ " |

| Models | | | |
|--------------|----------------------------------|----------------------------------|-----------------------------------|
| 46-3672RPD1L | 46-3672RPD1R | | |
| Drawers | W | L | D |
| Box | 15 ³ / ₈ " | 19 ³ / ₈ " | 3 ²¹ / ₃₂ " |
| File | 15 ³ / ₈ " | 25 ³ / ₄ " | 8 ²⁹ / ₃₂ " |
| Center | 25 ³ / ₄ " | 19 ³ / ₈ " | 12 ⁷ / ₃₂ " |

| Models | | | |
|--------------|----------------------------------|----------------------------------|-----------------------------------|
| 46-3066RPD1L | 46-3066RPD1R | | |
| Drawers | W | L | D |
| Box | 12 ³ / ₈ " | 19 ³ / ₈ " | 3 ²¹ / ₃₂ " |
| File | 12 ³ / ₈ " | 25 ³ / ₄ " | 8 ²⁹ / ₃₂ " |
| Center | 22 ⁷ / ₈ " | 19 ³ / ₈ " | 12 ⁷ / ₃₂ " |

FILING CAPABILITIES

Drawers with Dimensions:

15³/₈"W x 25³/₄"L

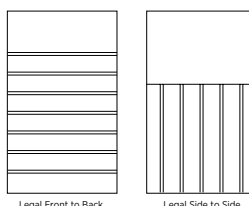

12³/₈"W x 25³/₄"L

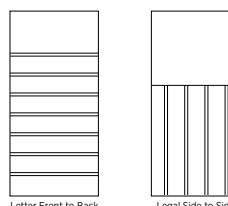

12³/₈"W x 12⁷/₈"L

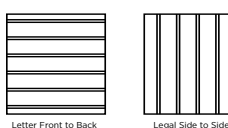

15³/₈"W x 16⁷/₃₂"L

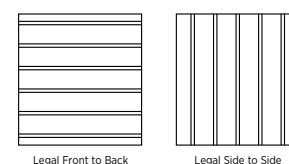

12³/₈"W x 16⁷/₃₂"L

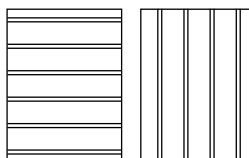

25¹/₂"W x 16⁷/₃₂"L

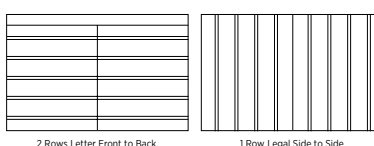

HOW TO ORDER EXAMPLES

DESKS, RETURNS, AND CREDENZAS

| MODEL # | QTY | DESCRIPTION | EXAMPLE |
|------------|-----|----------------------------|---------|
| 46-4284DPS | 1 | Premium or Standard Veneer | PV |
| | | Top Material | P |
| | | Finish/Color | MW |
| | | Pull | JEF |
| | | No Molding | - |
| | | Dictation Slide | DSL |
| | | Drawer Track | SOFT |
| | | Top Grommet Loc./Color | GC/BLK |
| | | Flip Down Center Drawer | LFD |

HEIGHT ADJUSTABLE 3-COLUMN L-UNIT

| | | | |
|--------------|---|----------------------------|------------|
| 46-3672LPSTS | 1 | Premium or Standard Veneer | W |
| | | Top Material | W |
| | | Finish/Color | SKC |
| | | Pull | ALB |
| | | No Molding | NO MOLDING |
| | | Drawer Track | STD |
| | | Leg Configuration | STS3 |
| | | Top Grommet Loc./Color | GC-BOX/SLV |
| | | Control Switch | MSWCH |

| | | | |
|----------------|---|----------------------------|------------|
| 46-2448RF2STS3 | 1 | Premium or Standard Veneer | W |
| | | Top Material | W |
| | | Finish/Color | SKC |
| | | Pull | ALB |
| | | No Molding | NO MOLDING |
| | | Locking Pedestal | LKI-46L |
| | | Drawer Track | STD |
| | | Top Grommet Loc./Color | GC-BOX/SLV |

RECEPTION L-UNIT

| | | | |
|--------------|---|----------------------------|---------------------------|
| 46-3672RPD1L | 1 | Premium or Standard Veneer | W |
| | | Top Material | P |
| | | Finish/Color | GC |
| | | Pull | ARA |
| | | No Molding | - |
| | | Drawer Track | SOFT |
| | | Top Grommet Loc./Color | GC/BLK |
| | | Flip Down Center Drawer | LFD |
| | | Tackboard/Fabric | CF Stinson Nikko Beach |

| | | | |
|--------------|---|----------------------------|--------|
| 46-2448RPD2R | 1 | Premium or Standard Veneer | W |
| | | Top Material | P |
| | | Finish/Color | GC |
| | | Pull | ARA |
| | | No Molding | - |
| | | Drawer Track | SOFT |
| | | Top Grommet Loc./Color | GC/BLK |

PREMIUM AND STANDARD VENEER (W) OPTIONS

Veneer features UVAdvantage, an ultra-violet finish, on all exposed surfaces by utilizing roll-coat UV technology.

| | | | |
|-----|--------------------|-----|---------------------|
| AW | Artisan Walnut | LW | Legacy Walnut |
| CO | Columbian Walnut | MW | Mahogany Walnut |
| DC | Dark Cherry | MTS | Metropolis Sky** |
| DFW | Dark Forest Walnut | PNW | Pinnacle Walnut** |
| EW | Espresso | SCH | Select Cherry |
| GC | Golden Cherry | SKC | Shaker Cherry |
| HW | Harvest Walnut | WC | Williamsburg Cherry |
| HNW | Henna Walnut** | | |

** Available in Standard Veneer Only

HPL (P) TOP OPTIONS

WOODGRAIN

| | | | |
|----|------------------|-----|---------------------|
| CO | Columbian Walnut | PNW | Pinnacle Walnut |
| EF | Espresso | SCH | Select Cherry |
| GC | Golden Cherry | SKC | Shaker Cherry |
| MW | Mahogany Walnut | WC | Williamsburg Cherry |

DRAWER AND DOOR PULL OPTIONS

Units with doors and drawers will feature coordinating pulls however door and drawer pulls cannot be intermixed.

| | | | |
|-----|----------------------------|-----|--------------------------|
| ARA | Arlington A, Antique Brass | JEF | Jefferson, Antique Brass |
| ARB | Arlington B, Antique Brass | ALB | Liberty, Aluminum |
| WLM | Wilmington, Antique Brass | | |



Arlington A (ARA)
Antique Brass - 5/4"



Arlington B (ARB)
Antique Brass - 5/4"



Jefferson (JEF)
Antique Brass - 5/4"



Wilmington (WLM)
Antique Brass - 5/4"



Liberty (ALB)
Aluminum - 4/4"

DRAWER TRACK OPTIONS

Soft close tracks are available on center, tray, box, and file drawers in Jefferson. Soft close drawer tracks have many benefits including reduced stress on the unit, extends the life of the drawer, and ensures a gentle close so fingers don't accidentally get hurt. **File drawers with the soft close option feature front-to-back filing.** Must specify when ordering.

Pricing is per Drawer, not per Model/Unit

| | | | |
|-------|-------------------------|----|----|
| SFTCL | Soft Close Drawer Track | \$ | 34 |
|-------|-------------------------|----|----|

LOCKING FLIP DOWN CENTER DRAWER

Single and double pedestal desks and kneespace credenzas standard with a center drawer have an optional central locking, keyboard flip down drawer. Drawer front is wood veneer with laminate drawer interior.

| | | | |
|-----|---------------------------------------|----|----|
| LFD | Locking Flip Down Front Center Drawer | \$ | 82 |
|-----|---------------------------------------|----|----|

APPROACH SIDE DICTATION SLIDES

Some desk models offer an approach side pull-out dictation slide. Specify DSLD when placing your order and add upcharge. If adding the dictation slide, the center grommet will not be available.

| | | | |
|------|-------------------------------|----|-----|
| NONE | No Approach Dictation Slide | \$ | STD |
| DSL | Approach Side Dictation Slide | \$ | 611 |

MOLDING OPTIONS

All standard, height adjustable, and reception units ship with decorative pencil molding. If you do not want molding, please specify "NO MOLDING" when ordering each model.

Modular components come standard with no molding. To accommodate for flush ends, molding is offered as an option. Specify one of the following codes when ordering.

| | | | |
|-------|--------------------------------------|----|-----|
| STD | No Molding | \$ | STD |
| M46R1 | Molding on Right Side Only | \$ | 85 |
| M46L1 | Molding on Left Side Only | \$ | 85 |
| M46LR | Molding on Both Right and Left Sides | \$ | 170 |

Note: Left or right is determined when facing the front of the unit. Molding features multi-step, hand-finished catalyzed finish

GLASS SHELVES OPTION

Units with beveled glass and mesh grille inserts offer the option of glass shelving.

| | | | |
|-------|-----------------------|----|-----|
| GLSSH | Units with Two Doors | \$ | 104 |
| GLSSH | Units with Four Doors | \$ | 208 |

DOWN LIGHTING OPTION

Select units with beveled glass and mesh grille inserts offer the option of down lighting. See individual models for availability.

| | | | |
|-------|-----------------------|----|-----|
| DNLGT | Units with Two Doors | \$ | 410 |
| DNLGT | Units with Four Doors | \$ | 820 |

LOCKING PEDESTALS ON RETURNS/CREDENZAS

Locking drawers are available on returns and credenzas. Please specify LKI-46L on order and add upcharge. Lock core will coordinate with pull selection.

Returns and single pedestal credenzas will have the lock positioned in the upper right corner of the top pedestal drawer.

| | | | |
|---------|--|----|-----|
| LKI-46L | Return or Single Pedestal Credenza Locking | \$ | 205 |
|---------|--|----|-----|

Double pedestal credenzas will have locks positioned in the upper right corner of both of the top drawers.

| | | | |
|---------|----------------------------------|----|-----|
| LKI-46L | Double Pedestal Credenza Locking | \$ | 410 |
|---------|----------------------------------|----|-----|

LOCKING DOORS

Locking doors are available on specific units, where noted. Specify WITH LOCKING when ordering and add upcharge. Lock core will coordinate with pull selection.

| | | | |
|--------|----------------------------------|----|-----|
| LKT_HU | Two & Four Door Vertical Hutches | \$ | 135 |
| LKT_HU | 72"W to 48"W Units | \$ | 115 |
| LKT_HU | 42"W to 30"W Units | \$ | 91 |
| LKT_HU | 18"W Units | \$ | 69 |

HEIGHT ADJUST LEG CONFIGURATION

The 2-channel leg configuration is standard on height adjustable Desks, Returns, Bridges, and Credenza for one height adjustable worksurface. Desk models offer an optional 3-channel leg configuration for use with 3-channel Returns to allow two worksurfaces to raise and lower simultaneously.

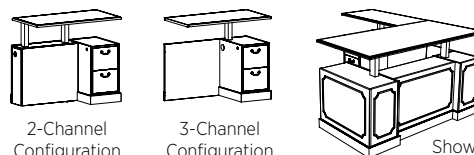

| | | |
|------|---|--------|
| STS2 | 2-Channel Configuration (For one height adjustable worksurface) | STD |
| STS3 | 3-Channel Configuration (For two height adjustable worksurfaces) | \$ N/C |

HEIGHT ADJUST CONTROL OPTIONS

Height adjustable units offer two switch options. The standard switch is a simple up and down switch to move your worksurface from seated to standing height. This comes standard with height adjustable units, unless otherwise noted. The advanced switch features Bluetooth capabilities to connect to smart devices, three stand-up reminder intervals, and height adjustment memory positions, and more.

Please specify desired Control Switch when ordering applicable Height Adjustable units.

| | | | |
|-------|-------------------------------------|----|-----|
| SWCH | Standard Up/Down Switch | \$ | STD |
| MSWCH | Advanced Up/Down with Memory Switch | \$ | 135 |



SWCH (standard) MSWCH

WORKSURFACE GROMMETS FOR STANDARD UNITS & RECEPTION

| | | | |
|----|---|----|----|
| GC | Grommet, Center; Must Specify Black (BLK) or Silver (SLV) | \$ | 52 |
| GL | Grommet, Left; Must Specify Black (BLK) or Silver (SLV) | \$ | 52 |
| GR | Grommet, Right; Must Specify Black (BLK) or Silver (SLV) | \$ | 52 |

Verify Grommet Option is available on the model(s) you are specifying using the location information on Pages 430-431.

Grommets may be ordered in non-standard locations. Call Customer Service to assist with specification. Note additional charges and lead times may apply.

Multiple locations may be selected.

See Grommet Locations on Next Page.

WORKSURFACE GROMMETS FOR STANDARD UNITS & RECEPTION (CONT.)

Models

46-4284DPS 46-4284DP

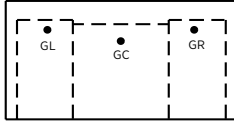

GL/GR: Located 17" from ends and 32" from user side

GC: Located 28" from user side

Models

46-4278DPS 46-4278DP

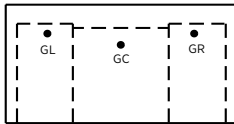

GL/GR: Located 14" from ends and 32" from user side

GC: Located 28" from user side

Models

46-3672CHS 46-3672CH 46-3672LP 46-3672RP
46-3672LPS 46-3672RPS

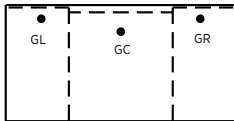

GL/GR: Located 11" from ends and 32" from user side

GC: Located 28" from user side

Models

46-3672DPS 46-3672DP

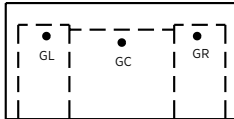

GL/GR: Located 13" from ends and 26" from user side

GC: Located 24" from user side

Models

46-3066DPS 46-3066DP 46-3066LP 46-3066RP
46-3066LPS 46-3066RPS

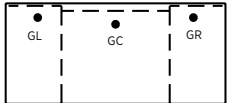

GL/GR: Located 10" from ends and 26" from user side

GC: Located 24" from user side

Models

46-2448UF 46-2448UFH 46-2442UF 46-2442UFH
46-2448LF 46-2448RF 46-2442LF 46-2442RF
46-2448LF2 46-2448RF2 46-2442LF2 46-2442RF2
46-2436CW



GL/GR: Located 4" from ends and 20" from user side

GC: Located 20" from user side

Models

46-2072KC 46-2072LC 46-2072RC 46-2072LL*
46-2072RL*

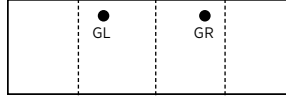

GL/GR: Located 22½" from ends and 17" from user side

* Grommets are only available opposite the pedestal

Models

46-2066KC 46-2066LC 46-2066RC 46-2066LL*
46-2066RL*

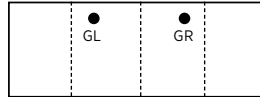

GL/GR: Located 19½" from ends and 17" from user side

* Grommets are only available opposite the pedestal

Models

46-2072KC1 46-2072KC2 46-2066KC2 46-2072LC2
46-2072RC2

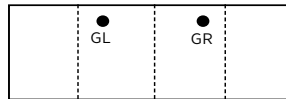

GL/GR: Located 22½" from ends and 17" from user side

Models

46-2066KC1 46-2066LC2 46-2066RC2

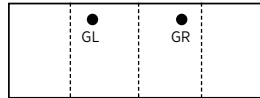

GL/GR: Located 19½" from ends and 17" from user side

Models

46-3672RPD1L 46-3672RPD1R

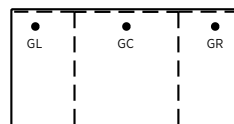

GL/GR: Located 6" from sides and 31¼" from user side

GC: 31¼" from user side

Models

46-3066RPD1L 46-3066RPD1R

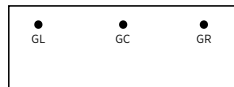

GL/GR: Located 6" from sides and 26%" from user side

GC: 26%" from user side

Models

46-2448RPD2L 46-2448RPD2R 46-2448RUF 46-2442RUF

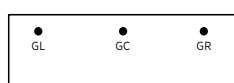

GL/GR: Located 6" from ends and 20" from user side

GC: Located 19" from user side

Models

46-2472RCL 46-2472RCR 46-2466RCL 46-2466RCR

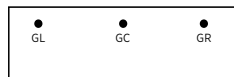

GL/GR: Located 6" from sides and 19" from user

GC: 19" from user side

WORKSURFACE GROMMETS FOR HEIGHT ADJUSTABILITY UNITS

When you select a grommet for use with Height Adjustable worksurfaces, it will automatically come with a wire management sleeve. One grommet per worksurface. Must specify Left, Right, or Center. See below for specific location availability by model. You may also choose to add the Wire Management Box, which will automatically come with a center grommet.

Grommet with Mesh Sleeve \$ 142
Must Specify Grommet Color: Black (BLK) or Silver (SLV)

HA Desks/Returns/Credenzas Choose Left, Right, or Center (See Below)
 HA Bridges Center Only

- GC-MESH Grommet, Center
- GL-MESH Grommet, Left
- GR-MESH Grommet, Right
- GCKS-MESH Grommet, Centered Between Legs



Wire Management Box with Center Grommet \$ 485
Must Specify Black (BLK) or Silver (SLV)

Available on All HA Desks, Returns and Bridges

GC-BOX Grommet, Center

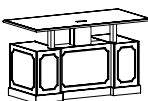

Verify Grommet Option is available on the model(s) you are specifying using the following location information.

Grommets may be ordered in non-standard locations. Call Customer Service to assist with specification. Note additional charges and lead times may apply.

Models

46-3672DPSTS 46-3672DPSSTS

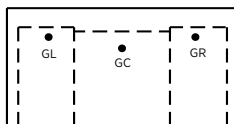

GL or GR: Located 9" from ends and 22½" from user side
 GC: Located 20" from user side

Models

46-3066DPSTS 46-3066DPSSTS 46-3672LPSTS 46-3672RPSTS
 46-3672LPSSTS 46-3672RPSSTS 46-3066LPSTS 46-3672RPSTS
 46-3066LPSSTS 46-3066RPSSTS

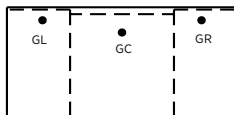

GL or GR: Located 6" from ends and 22½" from user side
 GC: Located 20" from user side

Models

46-2448LF2STS 46-2448RF2STS 46-2442LF2STS 46-2442RF2STS



GL or GR: Located 6" from ends and 20" from user side
 GCKS-MESH GC-BOX
 GKS: Located 20" from user side

Models

46-2448LF2STS3 46-2448RF2STS3 46-2442LF2STS3 46-2442RF2STS3

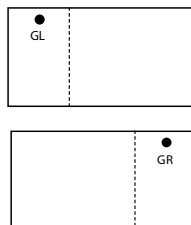

Grommet with Mesh Wire Management Sleeve only available in ped space

GL-MESH or GR-MESH: Located 6" from ends and 20" from user side

Models

46-2448UFSTS 46-2442UFSTS 46-2448UFSTSL3
 46-2442UFSTSL3 46-2448UFSTSR3 46-2442UFSTSR3

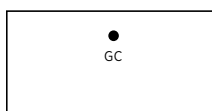

GC: Located 18" from user side

Models

46-2448LF2SR 46-2448RF2SR 46-2442LF2SR 46-2442RF2SR
 46-2448SUFL 46-2448SUFR 46-2442SUFL 46-2442SUFR

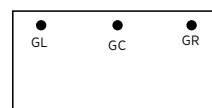

GL/GR: Located 4" from ends and 20" from user side
 GC: Located 20" from user side

HUTCH GROMMET OPTIONS

Select Surface Mount and Vertical Hutches come standard with a lower, center grommet in the back panel. Please specify color: Black (BLK) or Silver (SLV).

Three upper wire management grommets are also available, and are great for use with tasklights. Must specify color option.

WMHUBL Black Lower + 3 Upper Grommets \$ N/C
 WMHUSV Silver Lower + 3 Upper Grommets \$ N/C

CERTIFICATIONS & COMPLIANCE

- Intertek Sustainability Certified
- BIFMA level® Certified
- BIFMA Compliant® Certified
- TSCA Title VI (formerly CARB) Compliance
- US Green Building's LEED® Contribution

Standard Units + Tables



Double Ped Desks
(See Details)

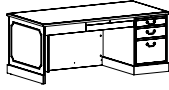

Single Ped Desks
(See Details)

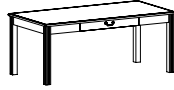
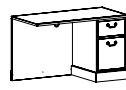
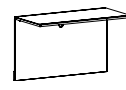

Table Desks
(See Details)



Returns
(See Multiple Unit Details)



Bridges
(See Multiple Unit Details)

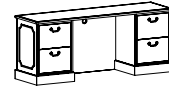

Single Ped, Storage, Kneespace, and Double Lateral Credenzas
(See Multiple Unit Details)

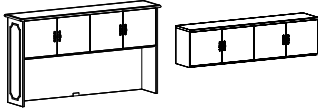

Standard and Tall Surface Mount Hutches and Wall Mount Hutches
(See Multiple Unit Details)

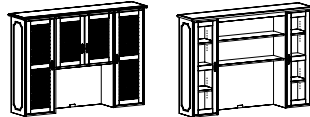

Two and Four Door Vertical Mount Hutches
(See Multiple Unit Details)



Lateral Filing
(See Multiple Unit Details)



Surface Mount Bookcases with Molding or Flush Ends
(See Multiple Unit Details)



Bookcases with or without Doors
(See Multiple Unit Details)

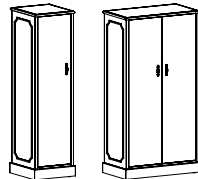

Single and Double Wardrobe/Storage Cabinets
(See Multiple Unit Details)

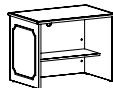

Computer Work Table
(See Details)



Round Tables and Bases
(See Details)

Modular Units

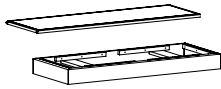

Modular Tops and Bases
(See Multiple Unit Details)
Modular Bookcase Tops and Bases
(See Multiple Unit Details)

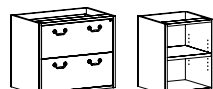

Modular Pedestals
(See Multiple Unit Details)

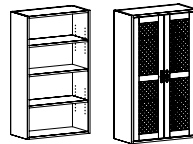

Modular Bookcases
(See Multiple Unit Details)

Occasional Tables



End Tables
(See Details) Lamp Tables
(See Details) Magazine Tables
(See Details)

Height Adjustable (HA) Units

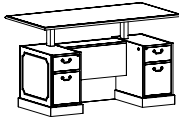

HA Double Ped Desks
(See Multiple Unit Details)

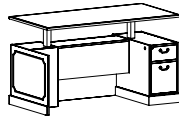

HA Single Ped Desks
(See Multiple Unit Details)



HA Returns
(See Multiple Unit Details)

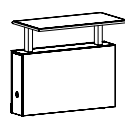

HA Bridges
(See Multiple Unit Details)

Tackboards + Tasklights

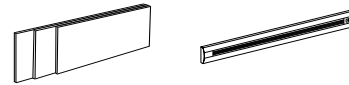

Tackboards
(See Multiple Unit Details) Tasklights
(See Multiple Unit Details)

Reception Units



Reception Desks
(See Multiple Unit Details)



Reception Returns
(See Details)

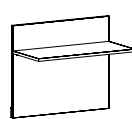

Reception Bridges
(See Multiple Unit Details)

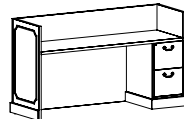

Reception Credenzas
(See Multiple Unit Details)

Kneespace Options + Accessories

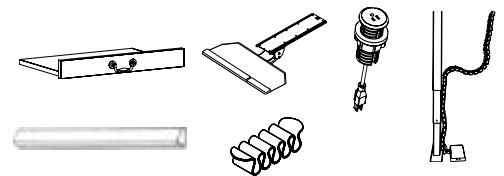

| Item | Model No. | Width | Depth | Height | K | R | Ship Wt | Cubic Ft | List Price |
|--------|-----------|-------|-------|--------|-----|---|---------|----------|---------------------------|
| L UNIT | 46-20 | 72 | 84 | 30 | 27¾ | - | 480 | 71.8 | W/P\$ 10661 PV\$ 11940 |

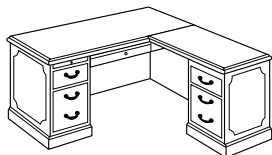

| CONSISTS OF: | | QTY | | | |
|--------------|---|--------------------|------------|-----------|--|
| 46-3672LP | 1 | Left Pedestal Desk | W/P\$ 6338 | PV\$ 7099 | |
| 46-2448RF | 1 | Right Return | W/P\$ 4323 | PV\$ 4841 | |

Products are available as left or right, where applicable

| | | | | | | | | | |
|--------|-------|----|-----|----|---|---|-----|------|---------------------------|
| U UNIT | 46-21 | 72 | 104 | 30 | - | - | 658 | 84.5 | W/P\$ 13408 PV\$ 15019 |
|--------|-------|----|-----|----|---|---|-----|------|---------------------------|

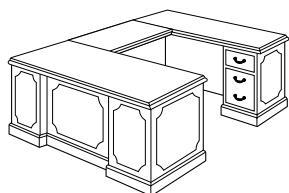

| CONSISTS OF: | | QTY | | | |
|--------------|---|--------------------------|------------|-----------|--|
| 46-3672LP | 1 | Left Pedestal Desk | W/P\$ 6338 | PV\$ 7099 | |
| 46-2448UF | 1 | Bridge with Full Modesty | W/P\$ 2213 | PV\$ 2480 | |
| 46-2072RC | 1 | Credenza, Right Pedestal | W/P\$ 4857 | PV\$ 5440 | |

Products are available as left or right, where applicable

| | | | | | | | | | |
|----------------------|------|-----|----|----|---|---|-----|------|---------------------------|
| MODULAR STORAGE UNIT | 46-4 | 88½ | 20 | 83 | - | - | 721 | 88.6 | W/P\$ 18760 PV\$ 20739 |
|----------------------|------|-----|----|----|---|---|-----|------|---------------------------|



| CONSISTS OF: | | QTY | | | |
|--------------|---|----------------------------------|------------|-----------|--|
| 46-1589FC | 1 | Modular Cornice Frame | W\$ 1111 | | |
| 46-2952BC | 2 | Modular Bookcases | W\$ 3600 | PV\$ 4034 | |
| 46-2952MB | 1 | Modular Bookcase with Mesh Doors | W\$ 3141 | PV\$ 3519 | |
| 46-2089TP | 1 | Modular Top | W/P\$ 1740 | PV\$ 1948 | |
| 46-1829MU | 2 | Modular Box/Box/File Cabinets | W\$ 5848 | PV\$ 6550 | |
| 46-1829MS | 1 | Modular Storage Cabinet | W\$ 2148 | PV\$ 2405 | |
| 46-2089BS | 1 | Modular Base | W\$ 1172 | | |

Products are available as left or right, where applicable

| Item | Model No. | Width | Depth | Height | K | R | Ship Wt | Cubic Ft | List Price |
|----------------------|-----------|-------|-------|--------|---|---|---------|----------|---------------------------|
| MODULAR STORAGE UNIT | 46-17 | 88½ | 20 | 83 | - | - | 547 | 62.8 | W/P\$ 16007 PV\$ 17673 |



| CONSIST OF: | QTY | | | |
|-------------|-----|----------------------------------|---------------|--------------|
| 46-1589FC | 1 | Modular Cornice Frame | W\$ | 1111 |
| 46-2952MB | 2 | Modular Bookcase with Mesh Doors | W\$ PV\$ | 6282 7038 |
| 46-2089TP | 1 | Modular Top | W/P\$ PV\$ | 1740 1948 |
| 46-1829MF | 2 | Modular File/File Cabinets | W\$ PV\$ | 5848 6550 |
| 46-2031BS | 2 | Modular Bases | W\$ | 1026 |

Products are available as left or right, where applicable

| | | | | | | | | | |
|---|-------|----|-----|----|---|---|------|-------|---------------------------|
| HEIGHT ADJUSTABLE L UNIT WITH CRENDENZA/HUTCH | 46-22 | 72 | 140 | 83 | - | - | 1207 | 139.9 | W/P\$ 31492 PV\$ 35270 |
|---|-------|----|-----|----|---|---|------|-------|---------------------------|

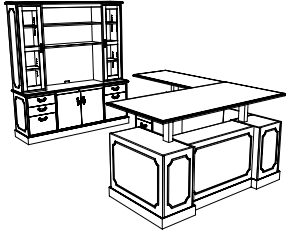

| CONSISTS OF: | QTY | | | |
|----------------|-----|--|---------------|----------------|
| 46-3672RPSTS | 1 | Height Adjustable Right Pedestal Desk | W/P\$ PV\$ | 11552 12936 |
| 46-2448LF2STS3 | 1 | Height Adjustable Left Return for Multiple Surfaces, 3-Channel | W/P\$ PV\$ | 7474 8372 |
| 46-2072SC1 | 1 | Storage Credenza | W/P\$ PV\$ | 6915 7745 |
| 46-1572VHG | 1 | Vertical Open Hutch with Glass Doors | W/P\$ PV\$ | 5551 6217 |

Products are available as left or right, where applicable; Depth is figured with 36" between return and credenza

| | | | | | | | | | |
|------------------|-------|----|-----|----|---|---|-----|-------|---------------------------|
| RECEPTION U-UNIT | 46-23 | 72 | 108 | 42 | - | - | 677 | 104.5 | W/P\$ 17386 PV\$ 19471 |
|------------------|-------|----|-----|----|---|---|-----|-------|---------------------------|

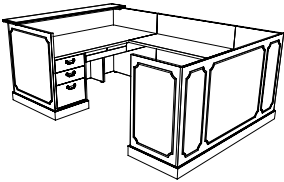

| CONSISTS OF: | QTY | | | |
|--------------|-----|----------------------|---------------|--------------|
| 46-3672RPD1L | 1 | Reception Desk, Left | W/P\$ PV\$ | 8254 9245 |
| 46-2448RUF | 1 | Reception Bridge | W/P\$ PV\$ | 2520 2821 |
| 46-2472RCR | 1 | Reception Credenza | W/P\$ PV\$ | 6612 7405 |

Products are available as left or right, where applicable

[See Jefferson Intro Section for Ordering Options](#)

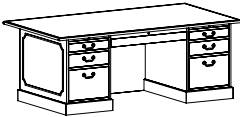
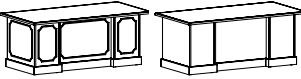
| Item | Model No. | Width | Depth | Height | K | R | Ship Wt | Cubic Ft | List Price | |
|---|--|-------|-------|--------|-----|-----|---------|--------------------------|---------------------------|--|
| DOUBLE PED DESK TRAY/BOX/FILE   Approach Side Shown with Decorative Molding and Optional No Molding | TOP OVERHANG FEATURE | | | | | | | | | |
| | 46-4284DPS | 84 | 42 | 30 | 32½ | 3 | 458 | 67.4 | W/P\$ 11864 PV\$ 13288 | |
| | <i>Chassis 72W x 36D - Legal Ped; Approach Overhang 6", Side Overhang 7"</i> | | | | | | | | | |
| | 46-4278DPS | 78 | 42 | 30 | 32½ | 3 | 408 | 62.6 | W/P\$ 10520 PV\$ 11785 | |
| | <i>Chassis 72W x 36D - Legal Ped; Approach Overhang 6", Side Overhang 4"</i> | | | | | | | | | |
| | 46-3672DPS | 72 | 36 | 30 | 32½ | 3 | 358 | 50.0 | W/P\$ 7118 PV\$ 7973 | |
| <i>Chassis 66W x 30D - Letter Ped; Approach Overhang 6", Side Overhang 4"</i> | | | | | | | | | | |
| STANDARD TOP | | | | | | | | | | |
| 46-3672CHS | 72 | 36 | 30 | 32½ | 3 | 358 | 50.0 | W/P\$ 9942 PV\$ 11132 | | |
| <i>Legal Ped</i> | | | | | | | | | | |
| 46-3066DPS | 66 | 30 | 30 | 32½ | 3 | 300 | 38.7 | W/P\$ 6873 PV\$ 7697 | | |
| <i>Letter Ped</i> | | | | | | | | | | |

Must Specify (in this order):

Model #
 Premium or Standard Veneer
 Top Material
 Finish/Color
 Pull
 No Molding
 Dictation Slide
 Drawer Track
 Top Grommet Location/Color
 Flip Down Center Drawer

Description

- Standard with: Stepped Front, Rectangle Top Profiled on All Sides, Base Molding on All Sides, Decorative Molding on Approach and Both Sides, Central Locking in Center Drawer, Tray/Box/File Peds, Left-to-Right Grain Direction on Top, Pull Out Writing Shelf on Both Sides (Above Tray Drawer), and Dovetail Wood Drawer Construction
- Chassis Available with Premium Veneer (PV) or Standard Veneer (W); Must Specify
- Top Available with Premium/Standard Veneer (PV/W) or HPL (P); Must Specify
- [Height Adjustable Units Available](#)
- Lock Core Color will Coordinate with Pull Selection (Brass Pull with Black Lock, Silver Pull with Silver Lock)
- Additional Options: No Decorative Molding (Specify NO MOLDING); Keyboard Flip Down Center Drawer (Order Separately, [See Center Drawer](#)); Dictation Slide on Approach Side for 36"D and 30"D Units Only ([See Dictation Slide Options](#)); Soft Close Drawer Closure ([See Soft Close Drawer Option](#)); Top Grommet Options ([See Grommet Options](#)); Wire Management + Accessories (Order Separately; [See Multiple Unit Details](#))

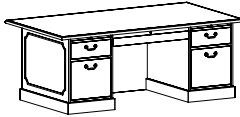
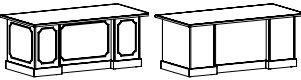
| Item | Model No. | Width | Depth | Height | K | R | Ship Wt | Cubic Ft | List Price | |
|--|--|-------|-------|--------|-----|-----|---------|--------------------------|---------------------------|--|
| DOUBLE PED DESK BOX/FILE   Approach Side Shown with Decorative Molding and Optional No Molding | TOP OVERHANG FEATURE | | | | | | | | | |
| | 46-4284DP | 84 | 42 | 30 | 32½ | 3 | 458 | 67.4 | W/P\$ 10728 PV\$ 12016 | |
| | <i>Chassis 72W x 36D - Legal Ped; Approach Overhang 6", Side Overhang 7"</i> | | | | | | | | | |
| | 46-4278DP | 78 | 42 | 30 | 32½ | 3 | 408 | 62.6 | W/P\$ 9514 PV\$ 10655 | |
| | <i>Chassis 72W x 36D - Legal Ped; Approach Overhang 6", Side Overhang 4"</i> | | | | | | | | | |
| | 46-3672DP | 72 | 36 | 30 | 32½ | 3 | 358 | 50.0 | W/P\$ 6743 PV\$ 7553 | |
| <i>Chassis 66W x 30D - Letter Ped; Approach Overhang 6", Side Overhang 4"</i> | | | | | | | | | | |
| STANDARD TOP | | | | | | | | | | |
| 46-3672CH | 72 | 36 | 30 | 32½ | 3 | 358 | 50.0 | W/P\$ 9167 PV\$ 10268 | | |
| <i>Legal Ped</i> | | | | | | | | | | |
| 46-3066DP | 66 | 30 | 30 | 32½ | 3 | 300 | 38.7 | W/P\$ 6468 PV\$ 7244 | | |
| <i>Letter Ped</i> | | | | | | | | | | |

Must Specify (in this order):

Model #
 Premium or Standard Veneer
 Top Material
 Finish/Color
 Pull
 No Molding
 Dictation Slide
 Drawer Track
 Top Grommet Location/Color
 Flip Down Center Drawer

Description

- Standard with: Stepped Front, Rectangle Top Profiled on All Sides, Base Molding on All Sides, Decorative Molding on Approach and Both Sides, Central Locking in Center Drawer, Box/File Peds, Left-to-Right Grain Direction on Top, Pull Out Writing Shelf on Both Sides (Above Box Drawer), and Dovetail Wood Drawer Construction
- Chassis Available with Premium Veneer (PV) or Standard Veneer (W); Must Specify
- Top Available with Premium/Standard Veneer (PV/W) or HPL (P); Must Specify
- [Height Adjustable Units Available](#)
- Lock Core Color will Coordinate with Pull Selection (Brass Pull with Black Lock, Silver Pull with Silver Lock)
- Additional Options: No Decorative Molding (Specify NO MOLDING); Keyboard Flip Down Center Drawer (Order Separately, [See Center Drawer](#)); Dictation Slide on Approach Side for 36"D and 30"D Units Only ([See Dictation Slide Options](#)); Soft Close Drawer Closure ([See Soft Close Drawer Option](#)); Top Grommet Options ([See Grommet Options](#)); Wire Management + Accessories (Order Separately; [See Multiple Unit Details](#))

P = HPL W = Veneer PV = Premium Veneer

[See Jefferson Intro Section for Ordering Options](#)

| Item | Model No. | Width | Depth | Height | K | R | Ship Wt | Cubic Ft | List Price | |
|----------------------------------|---------------------------------|------------------|-------|--------|----|-----|---------|----------|------------|-------------------------|
| SINGLE PED DESK TRAY/BOX/FILE | Left Ped | Right Ped | | | | | | | | |
| | 46-3672LPS <i>Legal Ped</i> | 46-3672RPS | 72 | 36 | 30 | 28¼ | 3 | 315 | 50.4 | W/P\$ 6705 PV\$ 7509 |
| | 46-3066LPS <i>Letter Ped</i> | 46-3066RPS | 66 | 30 | 30 | 25¼ | 3 | 262 | 38.7 | W/P\$ 6126 PV\$ 6864 |

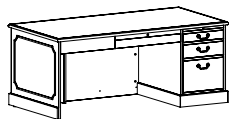

Shown as Right

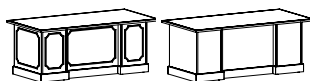

Approach Side Shown with Decorative Molding and Optional No Molding

Must Specify (in this order):

- Model #
- Premium or Standard Veneer
- Top Material
- Finish/Color
- Pull
- No Molding
- Dictation Slide
- Drawer Track
- Top Grommet Location/Color
- Flip Down Center Drawer

Description

- Standard with: Stepped Front, Rectangle Top Profiled on All Sides, Base Molding on All Sides, Decorative Molding on Approach and Both Sides, Central Locking in Center Drawer, Tray/Box/File Ped, Left-to-Right Grain Direction on Top, Pull Out Writing Shelf Above Tray Drawer, and Dovetail Wood Drawer Construction
- Chassis Available with Premium Veneer (PV) or Standard Veneer (W); Must Specify
- Top Available with Premium/Standard Veneer (PV/W) or HPL (P); Must Specify
- [Height Adjustable Units Available](#)
- Lock Core Color will Coordinate with Pull Selection (Brass Pull with Black Lock, Silver Pull with Silver Lock)
- Additional Options: No Decorative Molding (Specify NO MOLDING); Keyboard Flip Down Center Drawer (Order Separately, [See Center Drawer](#)); Dictation Slide on Approach Side for 36"D and 30"D Units Only ([See Dictation Slide Options](#)); Soft Close Drawer Closure ([See Soft Close Drawer Option](#)); Top Grommet Options ([See Grommet Options](#)); Wire Management + Accessories (Order Separately; [See Multiple Unit Details](#))

| Item | Model No. | Width | Depth | Height | K | R | Ship Wt | Cubic Ft | List Price | |
|-----------------------------|--------------------------------|------------------|-------|--------|----|-----|---------|----------|------------|-------------------------|
| SINGLE PED DESK BOX/FILE | Left Ped | Right Ped | | | | | | | | |
| | 46-3672LP <i>Legal Ped</i> | 46-3672RP | 72 | 36 | 30 | 28¼ | 3 | 315 | 50.4 | W/P\$ 6338 PV\$ 7099 |
| | 46-3066LP <i>Letter Ped</i> | 46-3066RP | 66 | 30 | 30 | 25¼ | 3 | 262 | 38.7 | W/P\$ 5760 PV\$ 6451 |

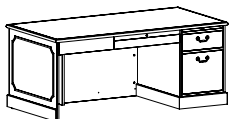

Shown as Right

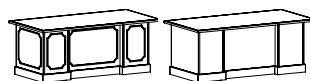

Approach Side Shown with Decorative Molding and Optional No Molding

Must Specify (in this order):

- Model #
- Premium or Standard Veneer
- Top Material
- Finish/Color
- Pull
- No Molding
- Dictation Slide
- Drawer Track
- Top Grommet Location/Color
- Flip Down Center Drawer

Description

- Standard with: Stepped Front, Rectangle Top Profiled on All Sides, Base Molding on All Sides, Decorative Molding on Approach and Both Sides, Central Locking in Center Drawer, Box/File Ped, Left-to-Right Grain Direction on Top, Pull Out Writing Shelf Above Box Drawer, and Dovetail Wood Drawer Construction
- Chassis Available with Premium Veneer (PV) or Standard Veneer (W); Must Specify
- Top Available with Premium/Standard Veneer (PV/W) or HPL (P); Must Specify
- [Height Adjustable Units Available](#)
- Lock Core Color will Coordinate with Pull Selection (Brass Pull with Black Lock, Silver Pull with Silver Lock)
- Additional Options: No Decorative Molding (Specify NO MOLDING); Keyboard Flip Down Center Drawer (Order Separately, [See Center Drawer](#)); Dictation Slide on Approach Side for 36"D and 30"D Units Only ([See Dictation Slide Options](#)); Soft Close Drawer Closure ([See Soft Close Drawer Option](#)); Top Grommet Options ([See Grommet Options](#)); Wire Management + Accessories (Order Separately; [See Multiple Unit Details](#))

P = HPL W = Veneer PV = Premium Veneer

[See Jefferson Intro Section for Ordering Options](#)

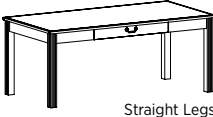
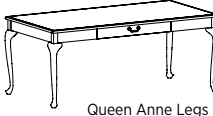
| Item | Model No. | Width | Depth | Height | K | R | Ship Wt | Cubic Ft | List Price |
|--|------------|-------|-------|--------|---|---|---------|----------|-------------------------|
| TABLE DESK | | | | | | | | | |
| WITH STRAIGHT LEGS | | | | | | | | | |
|  Straight Legs | 46-3672TD | 72 | 36 | 30 | - | - | 120 | 12.2 | W/P\$ 3975 PV\$ 4453 |
| | 46-3066TD | 66 | 30 | 30 | - | - | 110 | 9.7 | W/P\$ 3326 PV\$ 3727 |
| WITH QUEEN ANNE LEGS | | | | | | | | | |
|  Queen Anne Legs | 46-3672TDQ | 72 | 36 | 30 | - | - | 120 | 12.2 | W/P\$ 6327 PV\$ 6804 |
| | 46-3066TDQ | 66 | 30 | 30 | - | - | 110 | 9.7 | W/P\$ 5678 PV\$ 6079 |

Must Specify (in this order):

- Model #
- Top Material
- Finish/Color
- Pull
- Drawer Track

Description

- Standard with: Rectangle Top Profiled on All Sides, Center Drawer with Dovetail Wood Drawer Construction, and Left-to-Right Grain Direction on Top
- Top Available with Premium Veneer (PV), Veneer (W), or HPL (P); Must Specify
- Top and Legs Ship Separately; Some Assembly Required
- Additional Option: Soft Close Drawer Closure ([See Soft Close Drawer Option](#))

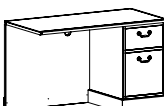
| RETURN WITH BOX/FILE | Left Ped | Right Ped | Width | Depth | Height | K | R | Ship Wt | Cubic Ft | List Price |
|--|-----------|-----------|-------|-------|--------|-----|---|---------|----------|-------------------------|
|  Shown as Right | 46-2448LF | 46-2448RF | 48 | 24 | 30 | 30¾ | - | 165 | 21.8 | W/P\$ 4323 PV\$ 4841 |
| | 46-2442LF | 46-2442RF | 42 | 24 | 30 | 27¾ | - | 165 | 21.8 | W/P\$ 4271 PV\$ 4786 |

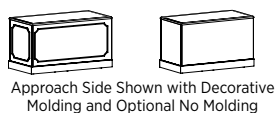

Must Specify (in this order):

- Model #
- Premium or Standard Veneer
- Top Material
- Finish/Color
- Pull
- No Molding
- Drawer Track
- Locking Pedestal
- Back Panel Grommet Color
- Top Grommet Location/Color
- Kneespace Options

Description

- Standard with: Rectangle Top Profiled on Three Sides with Reverse Profile on Connecting Side, Base Molding on All Sides, Decorative Molding on Approach and Side, Box/File Ped, Grommet in Back Panel, Front-to-Back Grain Direction on Top, and Dovetail Wood Drawer Construction
- Chassis Available with Premium Veneer (PV) or Standard Veneer (W); Must Specify
- Top Available with Premium/Standard Veneer (PV/W) or HPL (P); Must Specify
- [Height Adjustable Units Available](#)
- Grommet in Back Panel; Must Specify: Black (BLK), Silver (SLV), or None (NONE)
- Additional Options: No Decorative Molding (Specify NO MOLDING); Locking Pedestal ([See Locking Options](#)); Kneespace Options (Order Separately, [See Multiple Units](#)); Soft Close Drawer Closure ([See Soft Close Drawer Option](#)); Top Grommet Options ([See Grommet Options](#)); Wire Management + Accessories (Order Separately; [See Multiple Unit Details](#))

P = HPL W = Veneer PV = Premium Veneer

[See Jefferson Intro Section for Ordering Options](#)

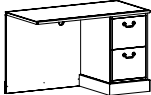
| Item | Model No. | Width | Depth | Height | K | R | Ship Wt | Cubic Ft | List Price | |
|---|-----------------|------------------|-------|--------|----|-----|---------|----------|------------|-------------------------|
|  Shown as Right | Left Ped | Right Ped | | | | | | | | |
| | 46-2448LF2 | 46-2448RF2 | 48 | 24 | 30 | 30¾ | - | 165 | 21.8 | W/P\$ 4680 PV\$ 5240 |
| | 46-2442LF2 | 46-2442RF2 | 42 | 24 | 30 | 27¾ | - | 165 | 21.8 | W/P\$ 4627 PV\$ 5185 |

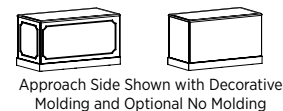

Must Specify (in this order):
 Model #
 Premium or Standard Veneer
 Top Material
 Finish/Color
 Pull
 No Molding
 Drawer Track
 Locking Pedestal
 Back Panel Grommet Color
 Top Grommet Location/Color
 Kneespace Options

Description

- Standard with: Rectangle Top Profiled on Three Sides with Reverse Profile on Connecting Side, Base Molding on All Sides, Decorative Molding on Approach and Side, File/File Ped, Grommet in Back Panel, Front-to-Back Grain Direction on Top, and Dovetail Wood Drawer Construction
- Chassis Available with Premium Veneer (PV) or Standard Veneer (W); Must Specify
- Top Available with Premium/Standard Veneer (PV/W) or HPL (P); Must Specify
- [Height Adjustable Units Available](#)
- Grommet in Back Panel; Must Specify: Black (BLK), Silver (SLV), or None (NONE)
- Additional Options: No Decorative Molding (Specify NO MOLDING); Locking Pedestal ([See Locking Options](#)); Kneespace Options (Order Separately, [See Multiple Units](#)); Soft Close Drawer Closure ([See Soft Close Drawer Option](#)); Top Grommet Options ([See Grommet Options](#)); Wire Management + Accessories (Order Separately; [See Multiple Unit Details](#))

| | | | | | | | | | | |
|---|---------------------------------|-----------|----|----|----|----|---|----|-----|-------------------------|
|  Approach Side Shown with Decorative Molding and Optional No Molding | BRIDGE WITH FULL MODESTY | 46-2448UF | 48 | 24 | 30 | 50 | - | 89 | 5.4 | W/P\$ 2213 PV\$ 2480 |
| | | 46-2442UF | 42 | 24 | 30 | 42 | - | 85 | 4.6 | W/P\$ 2088 PV\$ 2338 |

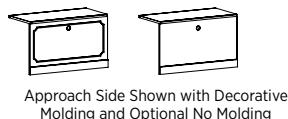

Must Specify (in this order):
 Model #
 Premium or Standard Veneer
 Top Material
 Finish/Color
 No Molding
 Top Grommet Location/Color

Description

- Standard With: Rectangle Top Profiled on Approach and User Side with Reverse Profile on Connecting Sides, Base and Decorative Molding on Approach Side, Grommet in Back Panel, Front-to-Back Grain Direction on Top, and Hinged Back Panel
- Chassis Available with Premium Veneer (PV) or Standard Veneer (W); Must Specify
- Top Available with Premium/Standard Veneer (PV/W) or HPL (P); Must Specify
- [Height Adjustable Units Available](#)
- Grommet in Back Panel; Must Specify: Black (BLK) or Silver (SLV) or None (NONE)
- Additional Options: No Decorative Molding (Specify No Molding); Kneespace Options (Order Separately, Available for Field Installation Only [See Multiple Units](#)); Soft Close Drawer Closure ([See Soft Close Drawer Option](#)); Top Grommet Options ([See Grommet Options](#)); Wire Management + Accessories (Order Separately; [See Multiple Unit Details](#))

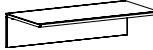
| | | | | | | | | | | |
|---|---------------------------------|------------|----|----|-----|----|---|----|-----|-------------------------|
|  | BRIDGE WITH HALF MODESTY | 46-2448UFH | 48 | 24 | 11½ | 50 | - | 89 | 5.4 | W/P\$ 1939 PV\$ 2170 |
| | | 46-2442UFH | 42 | 24 | 11½ | 42 | - | 85 | 4.6 | W/P\$ 1822 PV\$ 2040 |

Must Specify (in this order):
 Model #
 Premium or Standard Veneer
 Top Material
 Finish/Color
 Top Grommet Location/Color

Description

- Standard With: Rectangle Top Profiled on Approach and User Side with Reverse Profile on Connecting Sides, Front-to-Back Grain Direction on Top, and Hinged Back Panel
- Chassis Available with Premium Veneer (PV) or Standard Veneer (W); Must Specify
- Top Available with Premium/Standard Veneer (PV/W) or HPL (P); Must Specify
- No Base or Decorative Molding
- Additional Options: Top Grommet Options (Starting on Page 429); Kneespace Options (Order Separately, Available for Field Installation Only [See Multiple Units](#)); Soft Close Drawer Closure ([See Soft Close Drawer Option](#)); Top Grommet Options ([See Grommet Options](#)); Wire Management + Accessories (Order Separately; [See Multiple Unit Details](#))

P = HPL W = Veneer PV = Premium Veneer

[See Jefferson Intro Section for Ordering Options](#)

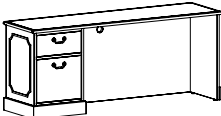
| Item | Model No. | Width | Depth | Height | K | R | Ship Wt | Cubic Ft | List Price | |
|--|--------------------------------|------------------|-------|--------|----|-----|---------|----------|------------|-------------------------|
|  Shown as Left | Left Ped | Right Ped | | | | | | | | |
| | 46-2072LC <i>Legal Ped</i> | 46-2072RC | 72 | 20 | 30 | 28¼ | - | 254 | 29.0 | W/P\$ 4857 PV\$ 5440 |
| | 46-2066LC <i>Letter Ped</i> | 46-2066RC | 66 | 20 | 30 | 25¼ | - | 195 | 26.6 | W/P\$ 4787 PV\$ 5360 |

Description

- Standard With: Rectangle Top Profiled on All Sides, Base Molding on All Sides, Decorative Molding on Back and Both Sides, Box/File Ped, Grommet in Back Panel, Left-to-Right Grain Direction on Top, and Dovetail Wood Drawer Construction
- Chassis Available with Premium Veneer (PV) or Standard Veneer (W); Must Specify
- Top Available with Premium/Standard Veneer (PV/W) or HPL (P); Must Specify
- Grommet in Back Panel; Must Specify: Black (BLK), Silver (SLV), or None (NONE)
- Additional Options: No Decorative Molding (Specify NO MOLDING); Locking Pedestal ([See Locking Options](#)); Soft Close Drawer Closure ([See Soft Close Drawer Option](#)); Top Grommet Options ([See Grommet Options](#)); Wire Management + Accessories (Order Separately; [See Multiple Unit Details](#))

Must Specify (in this order):

- Model #
- Premium or Standard Veneer
- Top Material
- Finish/Color
- Pull
- No Molding
- Drawer Track
- Locking Pedestal
- Back Panel Grommet Color
- Top Grommet Location/Color

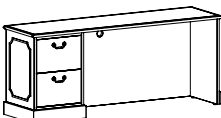
| Item | Model No. | Width | Depth | Height | K | R | Ship Wt | Cubic Ft | List Price | |
|--|---------------------------------|------------------|-------|--------|----|-----|---------|----------|------------|-------------------------|
|  Shown as Left | Left Ped | Right Ped | | | | | | | | |
| | 46-2072LC2 <i>Legal Ped</i> | 46-2072RC2 | 72 | 20 | 30 | 28¼ | - | 254 | 29.0 | W/P\$ 4955 PV\$ 5550 |
| | 46-2066LC2 <i>Letter Ped</i> | 46-2066RC2 | 66 | 20 | 30 | 25¼ | - | 195 | 26.6 | W/P\$ 4866 PV\$ 5449 |

Description

- Standard With: Rectangle Top Profiled on All Sides, Base Molding on All Sides, Decorative Molding on Back and Both Sides, File/File Ped, Grommet in Back Panel, Left-to-Right Grain Direction on Top, and Dovetail Wood Drawer Construction
- Chassis Available with Premium Veneer (PV) or Standard Veneer (W); Must Specify
- Top Available with Premium/Standard Veneer (PV/W) or HPL (P); Must Specify
- Grommet in Back Panel; Must Specify: Black (BLK), Silver (SLV), or None (NONE)
- Additional Options: No Decorative Molding (Specify NO MOLDING); Locking Pedestal ([See Locking Options](#)); Soft Close Drawer Closure ([See Soft Close Drawer Option](#)); Top Grommet Options ([See Grommet Options](#)); Wire Management + Accessories (Order Separately; [See Multiple Unit Details](#))

Must Specify (in this order):

- Model #
- Premium or Standard Veneer
- Top Material
- Finish/Color
- Pull
- No Molding
- Drawer Track
- Locking Pedestal
- Back Panel Grommet Color
- Top Grommet Location/Color

P = HPL W = Veneer PV = Premium Veneer

[See Jefferson Intro Section for Ordering Options](#)

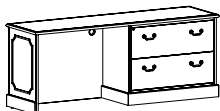
| Item | Model No. | Width | Depth | Height | K | R | Ship Wt | Cubic Ft | List Price | |
|--|-----------------|------------------|-------|--------|----|-----|---------|----------|------------|-------------------------|
| CREDENZA WITH LATERAL/LATERAL FILE  | Left Ped | Right Ped | | | | | | | | |
| | 46-2072LL | 46-2072RL | 72 | 20 | 30 | 28¼ | - | 315 | 50.4 | W/P\$ 5053 PV\$ 5658 |
| | 46-2066LL | 46-2066RL | 66 | 20 | 30 | 25¼ | - | 262 | 38.7 | W/P\$ 4946 PV\$ 5539 |

Shown as Right

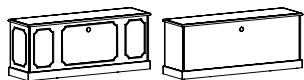

Back Side Shown with Decorative Molding and Optional No Molding

Must Specify (in this order):

- Model #
- Premium or Standard Veneer
- Top Material
- Finish/Color
- Pull
- No Molding
- Back Panel Grommet Color
- Top Grommet Location/Color

Description

- Standard With: Rectangle Top Profiled on All Sides, Base Molding on All Sides, Decorative Molding on Back and Both Sides, Locking Lateral/Lateral File Ped with Legal or Letter Filing, Grommet in Back Panel, Left-to-Right Grain Direction on Top, and Dovetail Wood Drawer Construction
- Chassis Available with Premium Veneer (PV) or Standard Veneer (W); Must Specify
- Top Available with Premium/Standard Veneer (PV/W) or HPL (P); Must Specify
- Grommet in Back Panel; Must Specify: Black (BLK), Silver (SLV), or None (NONE)
- Additional Options: No Decorative Molding (Specify NO MOLDING); Top Grommet Options ([See Grommet Options](#)); Wire Management + Accessories (Order Separately; [See Multiple Unit Details](#))

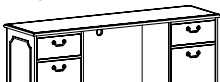
| | | | | | | | | | |
|--|------------------|----|----|----|-----|---|-----|------|-------------------------|
| KNEESPACE CREDENZA WITH BOX/FILE  | 46-2072KC | 72 | 20 | 30 | 32½ | - | 275 | 29.0 | W/P\$ 5794 PV\$ 6489 |
| | <i>Legal Ped</i> | | | | | | | | |
| | 46-2066KC | 66 | 20 | 30 | 32½ | - | 216 | 26.6 | W/P\$ 5262 PV\$ 5893 |

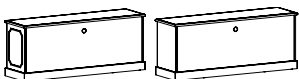

Side Shown with Decorative Molding and Optional No Molding

Must Specify (in this order):

- Model #
- Premium or Standard Veneer
- Top Material
- Finish/Color
- Pull
- No Molding
- Drawer Track
- Locking Pedestal
- Back Panel Grommet Color
- Top Grommet Location/Color

Description

- Standard With: Rectangle Top Profiled on All Sides, Base Molding on All Sides, Decorative Molding on Both Sides, Box/File Peds, Grommet in Back Panel, Left-to-Right Grain Direction on Top, and Dovetail Wood Drawer Construction
- Chassis Available with Premium Veneer (PV) or Standard Veneer (W); Must Specify
- Top Available with Premium/Standard Veneer (PV/W) or HPL (P); Must Specify
- Grommet in Back Panel; Must Specify: Black (BLK), Silver (SLV), or None (NONE)
- Additional Options: No Decorative Molding (Specify NO MOLDING); Locking Pedestal ([See Locking Options](#)); Soft Close Drawer Closure ([See Soft Close Drawer Option](#)); Top Grommet Options ([See Grommet Options](#)); Wire Management + Accessories (Order Separately; [See Multiple Unit Details](#))

P = HPL W = Veneer PV = Premium Veneer

[See Jefferson Intro Section for Ordering Options](#)

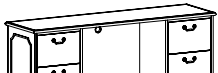
| Item | Model No. | Width | Depth | Height | K | R | Ship Wt | Cubic Ft | List Price |
|---|---------------------------------|-------|-------|--------|-----|---|---------|----------|-------------------------|
| KNEESPACE CREDENZA WITH FILE/FILE  | 46-2072KC2 <i>Legal Ped</i> | 72 | 20 | 30 | 32½ | - | 275 | 29.0 | W/P\$ 6177 PV\$ 6918 |
| | 46-2066KC2 <i>Letter Ped</i> | 66 | 20 | 30 | 32½ | - | 216 | 26.6 | W/P\$ 5645 PV\$ 6324 |

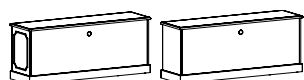

Side Shown with Decorative Molding and
Optional No Molding

Must Specify (in this order):

Model #
Premium or Standard Veneer
Top Material
Finish/Color
Pull
No Molding
Drawer Track
Locking Pedestal
Back Panel Grommet Color
Top Grommet Location/Color

Description

- Standard With: Rectangle Top Profiled on All Sides, Base Molding on All Sides, Decorative Molding on Both Sides, File/File Peds, Grommet in Back Panel, Left-to-Right Grain Direction on Top, and Dovetail Wood Drawer Construction
- Chassis Available with Premium Veneer (PV) or Standard Veneer (W); Must Specify
- Top Available with Premium/Standard Veneer (PV/W) or HPL (P); Must Specify
- Grommet in Back Panel; Must Specify: Black (BLK), Silver (SLV), or None (NONE)
- Additional Options: No Decorative Molding (Specify NO MOLDING); Locking Pedestal ([See Locking Options](#)); Soft Close Drawer Closure ([See Soft Close Drawer Option](#)); Top Grommet Options ([See Grommet Options](#)); Wire Management + Accessories (Order Separately; [See Multiple Unit Details](#))

| | | | | | | | | | |
|--|---------------------------------|----|----|----|-----|---|-----|------|-------------------------|
| KNEESPACE CREDENZA WITH BOX/BOX/FILE  | 46-2072KC1 <i>Legal Ped</i> | 72 | 20 | 30 | 32½ | - | 275 | 29.0 | W/P\$ 6558 PV\$ 7346 |
| | 46-2066KC1 <i>Letter Ped</i> | 66 | 20 | 30 | 32½ | - | 216 | 26.6 | W/P\$ 6028 PV\$ 6749 |

With Decorative Molding

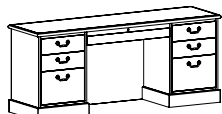

Without Decorative Molding

Must Specify (in this order):

Model #
Premium or Standard Veneer
Top Material
Finish/Color
Pull
No Molding
Drawer Track
Back Panel Grommet Color
Top Grommet Location/Color
Flip Down Center Drawer

Description

- Standard With: Rectangle Top Profiled on All Sides, Central Locking in Center Drawer, Base Molding on All Sides, Decorative Molding on Both Sides, Box/Box/File Peds, Grommet in Back Panel, Left-to-Right Grain Direction on Top, and Dovetail Wood Drawer Construction
- Chassis Available with Premium Veneer (PV) or Standard Veneer (W); Must Specify
- Top Available with Premium/Standard Veneer (PV/W) or HPL (P); Must Specify
- Grommet in Back Panel; Must Specify: Black (BLK), Silver (SLV), or None (NONE)
- Additional Options: No Decorative Molding (Specify NO MOLDING); Soft Close Drawer Closure ([See Soft Close Drawer Option](#)); Top Grommet Options ([See Grommet Options](#)); Wire Management + Accessories (Order Separately; [See Multiple Unit Details](#))

P = HPL W = Veneer PV = Premium Veneer

[See Jefferson Intro Section for Ordering Options](#)

| Item | Model No. | Width | Depth | Height | Ship Wt | Cubic Ft | List Price |
|-------------------------|-----------|-------|-------|--------|---------|----------|-------------------------|
| DOUBLE LATERAL CREDENZA | 46-2072DL | 72 | 20 | 30 | 304 | 29.0 | W/P\$ 7531 PV\$ 8433 |

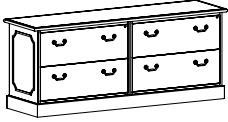

With Decorative Molding

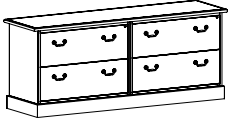

Without Decorative Molding

Description

- Standard With: Rectangle Top Profiled on All Sides, Base Molding on All Sides, Decorative Molding on Both Sides, Dual Locking Double Lateral/Lateral Peds with Legal or Letter Filing, Side-to-Side Grain Direction on Top, Dovetail Wood Drawer Construction, and Anti-Tilt System
- Chassis Available with Premium Veneer (PV) or Standard Veneer (W); Must Specify
- Top Available with Premium/Standard Veneer (PV/W) or HPL (P); Must Specify
- Lock Core Color will Coordinate with Pull Selection (Brass Pull with Black Lock, Silver Pull with Silver Lock)
- Additional Options: No Decorative Molding (Specify NO MOLDING)

Must Specify (in this order):

- Model #
- Premium or Standard Veneer
- Top Material
- Finish/Color
- Pull
- No Molding

| | | | | | | | |
|------------------------------------|-------------------|----|----|----|-----|------|-------------------------|
| STORAGE CREDENZA WITH BOX/BOX/FILE | 46-2072SC1 | 72 | 20 | 30 | 296 | 29.0 | W/P\$ 6915 PV\$ 7745 |
| | <i>Legal Ped</i> | | | | | | |
| | 46-2066SC1 | 66 | 20 | 30 | 296 | 29.0 | W/P\$ 6222 PV\$ 6968 |
| | <i>Letter Ped</i> | | | | | | |

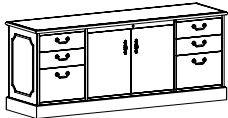

With Decorative Molding

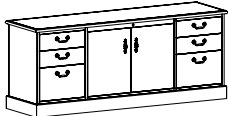

Without Decorative Molding

Description

- Standard With: Rectangle Top Profiled on All Sides, Central Locking, Base Molding on All Sides, Decorative Molding on Both Sides, Box/Box/File Peds with Legal or Letter Filing, One Fixed Shelf Behind Doors, Side-to-Side Grain Direction on Top, and Dovetail Wood Drawer Construction
- Chassis Available with Premium Veneer (PV) or Standard Veneer (W); Must Specify
- Top Available with Premium/Standard Veneer (PV/W) or HPL (P); Must Specify
- Lock Core Color will Coordinate with Pull Selection (Brass Pull with Black Lock, Silver Pull with Silver Lock)
- Additional Options: No Decorative Molding (Specify NO MOLDING); Soft Close Drawer Closure ([See Soft Close Drawer Option](#))

Must Specify (in this order):

- Model #
- Premium or Standard Veneer
- Top Material
- Finish/Color
- Pull
- No Molding
- Drawer Track

P = HPL W = Veneer PV = Premium Veneer

[See Jefferson Intro Section for Ordering Options](#)

| Item | Model No. | Width | Depth | Height | Ship Wt | Cubic Ft | List Price |
|---------------------------------------|------------------------------------|-------|-------|--------|---------|----------|-----------------------|
| SURFACE MOUNTED HUTCH WITH WOOD DOORS | 46-1572HU <i>Four (4) Doors</i> | 72 | 15 | 39¾ | 200 | 30.2 | W\$ 6824 PV\$ 7643 |
| | 46-1566HU <i>Four (4) Doors</i> | 66 | 15 | 39¾ | 192 | 26.9 | W\$ 6443 PV\$ 7216 |

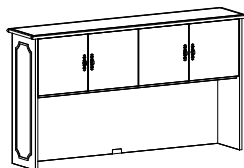

Must Specify (in this order):

Model #
Premium or Standard Veneer
Finish
Pull
No Molding
Tasklights
Upper Grommets
Grommet Color
Locking Door
Tackboard/Fabric

Description

- Standard With: Top Profiled on All Sides, Decorative Molding on Both Sides, Four (4) Soft-Close Doors, and Grommet in Back Panel
- Available in Premium Veneer (PV) or Standard Veneer (W); Must Specify
- Lower, Center Grommet in Back Panel; Must Specify: Black (BLK) or Silver (SLV)
- 20⅞" Clearance Below Doors
- Additional Options: No Decorative Molding (Specify NO MOLDING); Locking Doors ([See Locking Door Options](#)); Factory-Installed Tackboard ([See Sizes](#)); Tasklights ([See Sizes](#)); Upper Wire Management Grommets ([See Grommet Options](#))

| | | | | | | | |
|----------------------------------|-------------------------------------|----|----|----|-----|------|-----------------------|
| WALL MOUNT HUTCH WITH WOOD DOORS | 46-1584WD <i>Five (5) Doors</i> | 84 | 15 | 18 | 138 | 15.2 | W\$ 5380 PV\$ 6028 |
| | 46-1578WD <i>Four (4) Doors</i> | 78 | 15 | 18 | 128 | 14.1 | W\$ 4672 PV\$ 5233 |
| | 46-1572WD <i>Four (4) Doors</i> | 72 | 15 | 18 | 118 | 13.1 | W\$ 4600 PV\$ 5153 |
| | 46-1566WD <i>Four (4) Doors</i> | 66 | 15 | 18 | 105 | 12.0 | W\$ 4498 PV\$ 5038 |
| | 46-1560WD <i>Four (4) Doors</i> | 60 | 15 | 18 | 96 | 11.0 | W\$ 4304 PV\$ 4820 |
| | 46-1554WD <i>Three (3) Doors</i> | 54 | 15 | 18 | 87 | 9.9 | W\$ 4029 PV\$ 4513 |
| | 46-1548WD <i>Three (3) Doors</i> | 48 | 15 | 18 | 77 | 8.9 | W\$ 3751 PV\$ 4200 |
| | 46-1542WD <i>Two (2) Doors</i> | 42 | 15 | 18 | 67 | 7.8 | W\$ 3454 PV\$ 3870 |
| | 46-1536WD <i>Two (2) Doors</i> | 36 | 15 | 18 | 55 | 5.9 | W\$ 3081 PV\$ 3452 |

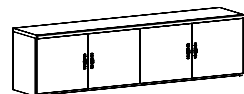

Must Specify (in this order):

Model #
Premium or Standard Veneer
Finish
Pull
Locking Door

Description

- Standard With: Top Profiled on Front Only for Multiple Unit Application, No Molding, Onset Doors with Soft-Close Hinges, and Wall Mounting Brackets
- Available in Premium Veneer (PV) or Standard Veneer (W); Must Specify
- Additional Options: Locking Doors ([See Locking Door Options](#)); Tackboards ([See Sizes](#)); Tasklights ([See Sizes](#))
- Indiana Furniture will not be held liable for wall mount hutches that are not properly installed

W = Veneer PV = Premium Veneer

[See Jefferson Intro Section for Ordering Options](#)

| Item | Model No. | Width | Depth | Height | Ship Wt | Cubic Ft | List Price |
|--|------------------------------|-------|-------|--------|---------|----------|-----------------------|
| TALL SURFACE MOUNTED HUTCH WITH FOUR WOOD DOORS | 46-1572THU <i>4 Doors</i> | 72 | 15 | 51 | 231 | 38.7 | W\$ 8699 PV\$ 9743 |
| | 46-1566THU <i>4 Doors</i> | 66 | 15 | 51 | 226 | 36.0 | W\$ 8218 PV\$ 9204 |

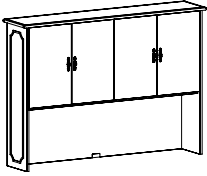

Must Specify (in this order):

Model #
Premium or Standard Veneer
Finish
Pull
No Molding
Tasklights
Upper Grommets
Grommet Color
Locking Door
Tackboard/Fabric

Description

- Standard With: Top Profiled on All Sides, Decorative Molding on Both Sides, Four (4) Soft-Close Doors, One (1) Adjustable Shelf Behind Doors, and Grommet in Back Panel
- Available in Premium Veneer (PV) or Standard Veneer (W); Must Specify
- Lower, Center Grommet in Back Panel; Must Specify: Black (BLK) or Silver (SLV)
- 21½" Clearance Below Doors
- Additional Options: No Decorative Molding (Specify NO MOLDING); Locking Doors ([See Locking Door Options](#)); Factory-Installed Tackboard ([See Sizes](#)); Tasklights ([See Sizes](#)); Upper Wire Management Grommets ([See Grommet Options](#))

| | | | | | | | |
|-------------------------------------|-------------|----|----|----|-----|------|-----------------------|
| VERTICAL HUTCH WITH OPEN STORAGE | 46-1572VH4O | 72 | 15 | 51 | 231 | 38.7 | W\$ 4621 PV\$ 5175 |
| | 46-1566VH4O | 66 | 15 | 51 | 185 | 36.0 | W\$ 4394 PV\$ 4920 |

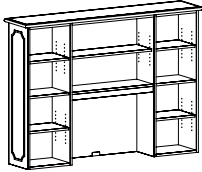

Must Specify (in this order):

Model #
Premium or Standard Veneer
Finish
No Molding
Tasklights
Upper Grommets
Grommet Color
Tackboard/Fabric

Description

- Standard With: Top Profiled on All Sides, Decorative Molding on Both Sides, One (1) Adjustable Shelf and One (1) Fixed Shelf In Center Cabinet, Two (2) Adjustable Shelves and One (1) Fixed Middle Shelf in Each End Cabinet, and Grommet in Back Panel
- Available in Premium Veneer (PV) or Standard Veneer (W); Must Specify
- Lower, Center Grommet in Back Panel; Must Specify: Black (BLK) or Silver (SLV)
- 24½" Clearance Below Center Shelves
- Additional Options: No Decorative Molding (Specify NO MOLDING); Factory-Installed Tackboard ([See Sizes](#)); Tasklights ([See Sizes](#)); Upper Wire Management Grommets ([See Grommet Options](#))

W = Veneer PV = Premium Veneer

[See Jefferson Intro Section for Ordering Options](#)

| Item | Model No. | Width | Depth | Height | Ship Wt | Cubic Ft | List Price |
|--|-------------------------------|-------|-------|--------|---------|----------|-----------------------|
| VERTICAL HUTCH WITH FOUR DOORS AND WOOD DOOR INSERTS | 46-1572VH4W <i>4 Doors</i> | 72 | 15 | 51 | 231 | 38.7 | W\$ 6674 PV\$ 7474 |
| | 46-1566VH4W <i>4 Doors</i> | 66 | 15 | 51 | 226 | 36.0 | W\$ 6445 PV\$ 7217 |

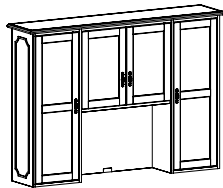

Must Specify (in this order):

Model #
Premium or Standard Veneer
Finish
Pull
No Molding
Locking Doors
Tasklights
Upper Grommets
Grommet Color
Tackboard/Fabric

Description

- Standard With: Top Profiled on All Sides, Decorative Molding on Both Sides, Four (4) Wood-Framed Soft-Close Doors with Wood Inserts, One (1) Adjustable Shelf and One (1) Fixed Shelf Behind Center Doors, Two (2) Adjustable Shelves and One (1) Fixed Middle Shelf Behind Each End Door, and Grommet in Back Panel
- Available in Premium Veneer (PV) or Standard Veneer (W); Must Specify
- Lower, Center Grommet in Back Panel; Must Specify: Black (BLK) or Silver (SLV)
- 24 $\frac{1}{2}$ " Clearance Below Center Doors
- Additional Options: No Decorative Molding (Specify NO MOLDING); Locking Doors ([See Locking Door Options](#)); Factory-Installed Tackboard ([See Sizes](#)); Tasklights ([See Sizes](#)); Upper Wire Management Grommets ([See Grommet Options](#))

| | | | | | | | |
|---|-------------------------------|----|----|----|-----|------|-----------------------|
| VERTICAL HUTCH WITH FOUR DOORS AND GLASS DOOR INSERTS | 46-1572VH4G <i>4 Doors</i> | 72 | 15 | 51 | 244 | 38.7 | W\$ 7382 PV\$ 8267 |
| | 46-1566VH4G <i>4 Doors</i> | 66 | 15 | 51 | 231 | 36.0 | W\$ 7145 PV\$ 8004 |

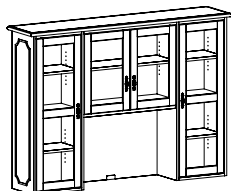

Must Specify (in this order):

Model #
Premium or Standard Veneer
Finish
Pull
Beveled Glass Design
No Molding
Locking Doors
Glass Shelves
Down Lighting
Tasklights
Upper Grommets
Grommet Color
Tackboard/Fabric

Description

- Standard With: Top Profiled on All Sides, Decorative Molding on Both Sides, Four (4) Wood-Framed Soft-Close Doors with Glass Inserts, One (1) Adjustable Shelf and One (1) Fixed Shelf Behind Center Doors, Two (2) Adjustable Shelves and One (1) Fixed Middle Shelf Behind Each End Door, and Grommet in Back Panel
- Available in Premium Veneer (PV) or Standard Veneer (W); Must Specify
- Beveled Glass Inserts Available in Clear and Cracked Ice; Must Specify (See Below)
- Lower, Center Grommet in Back Panel; Must Specify: Black (BLK) or Silver (SLV)
- 24 $\frac{1}{2}$ " Clearance Below Center Doors
- Additional Options: No Decorative Molding (Specify NO MOLDING); Locking Doors ([See Locking Door Options](#)); Factory-Installed Tackboard ([See Sizes](#)); Tasklights ([See Sizes](#)); Upper Wire Management Grommets ([See Grommet Options](#))

Beveled Glass Options: Specify & Add

| | | |
|------|----------------------------------|---------|
| 1-CL | Beveled Clear Glass Insert | N/C |
| 1-CR | Beveled Cracked Ice Glass Insert | \$ 1565 |

W = Veneer PV = Premium Veneer

[See Jefferson Intro Section for Ordering Options](#)

| Item | Model No. | Width | Depth | Height | Ship Wt | Cubic Ft | List Price |
|--|-------------------------------|-------|-------|--------|---------|----------|-----------------------|
| VERTICAL HUTCH WITH FOUR DOORS AND MESH DOOR INSERTS | 46-1572VH4M <i>4 Doors</i> | 72 | 15 | 51 | 231 | 38.7 | W\$ 8281 PV\$ 9274 |
| | 46-1566VH4M <i>4 Doors</i> | 66 | 15 | 51 | 226 | 36.0 | W\$ 8050 PV\$ 9014 |

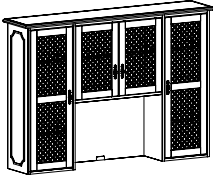

Must Specify (in this order):

- Model #
- Premium or Standard Veneer Finish
- Pull/Mesh Grille Color
- No Molding
- Locking Doors
- Glass Shelves
- Down Lighting
- Tasklights
- Upper Grommets
- Grommet Color
- Tackboard/Fabric

Description

- Standard With: Top Profiled on All Sides, Decorative Molding on Both Sides, Four (4) Wood-Framed Soft-Close Doors with Mesh Inserts, One (1) Adjustable Shelf and One (1) Fixed Shelf Behind Center Doors, Two (2) Adjustable Shelves and One (1) Fixed Middle Shelf Behind Each End Door, and Grommet in Back Panel
- Available in Premium Veneer (PV) or Standard Veneer (W); Must Specify
- Mesh Grille Inserts Available in Antique Brass and Silver; Must Specify (See Below)
- Lower, Center Grommet in Back Panel; Must Specify: Black (BLK) or Silver (SLV)
- 24 $\frac{3}{8}$ " Clearance Below Center Doors
- Additional Options: No Decorative Molding (Specify NO MOLDING); Glass Shelves ([See Glass Shelf Options](#)); Down Lighting ([See Down Lighting Options](#)); Locking Doors ([See Locking Door Options](#)); Factory-Installed Tackboard ([See Sizes](#)); Tasklights ([See Sizes](#)); Upper Wire Management Grommets ([See Grommet Options](#))

Mesh Grille Options: Specify & Add

| | | |
|------|--|---------|
| 1-BM | Antique Brass Mesh Grille Insert <i>Only available when a Brass Pull is specified</i> | N/C |
| 1-AM | Silver Mesh Grille Insert <i>Only available when Liberty Pull (ALB) is specified</i> | \$ 1173 |

| | | | | | | | |
|--|------------------------------|----|----|----|-----|------|-----------------------|
| VERTICAL OPEN HUTCH WITH TWO DOORS AND WOOD DOOR INSERTS | 46-1572VHW <i>2 Doors</i> | 72 | 15 | 51 | 231 | 38.7 | W\$ 5314 PV\$ 5953 |
| | 46-1566VHW <i>2 Doors</i> | 66 | 15 | 51 | 226 | 36.0 | W\$ 5086 PV\$ 5696 |

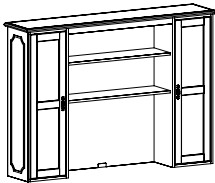

Must Specify (in this order):

- Model #
- Premium or Standard Veneer Finish
- Pull
- No Molding
- Locking Doors
- Grommet Color

Description

- Standard With: Top Profiled on All Sides, Decorative Molding on Both Sides, Two (2) Wood-Framed Soft-Close Doors with Wood Inserts, One (1) Adjustable Shelf and One (1) Fixed Shelf in Center Cabinet, Two (2) Adjustable Shelves and One (1) Fixed Middle Shelf Behind Each End Door, and Grommet in Back Panel
- Available in Premium Veneer (PV) or Standard Veneer (W); Must Specify
- Lower, Center Grommet in Back Panel; Must Specify: Black (BLK) or Silver (SLV)
- 24 $\frac{3}{8}$ " Clearance Below Center
- Additional Options: No Decorative Molding (Specify NO MOLDING); Locking Doors ([See Locking Door Options](#))

W = Veneer PV = Premium Veneer

[See Jefferson Intro Section for Ordering Options](#)

| Item | Model No. | Width | Depth | Height | Ship Wt | Cubic Ft | List Price |
|---|------------------------------|-------|-------|--------|---------|----------|-----------------------|
| VERTICAL OPEN HUTCH WITH TWO DOORS AND GLASS DOOR INSERTS | 46-1572VHG <i>2 Doors</i> | 72 | 15 | 51 | 244 | 38.7 | W\$ 5551 PV\$ 6217 |
| | 46-1566VHG <i>2 Doors</i> | 66 | 15 | 51 | 231 | 36.0 | W\$ 5314 PV\$ 5953 |

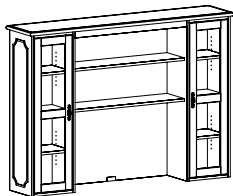

Must Specify (in this order):

- Model #
- Premium or Standard Veneer
- Finish
- Pull
- Beveled Glass Design
- No Molding
- Glass Shelves
- Down Lighting
- Grommet Color

Description

- Standard With: Top Profiled on All Sides, Decorative Molding on Both Sides, Two (2) Wood-Framed Soft-Close Doors with Glass Inserts, One (1) Adjustable Shelf and One (1) Fixed Shelf in Center Cabinet, Two (2) Adjustable Shelves and One (1) Fixed Middle Shelf Behind Each End Door, and Grommet in Back Panel
- Available in Premium Veneer (PV) or Standard Veneer (W); Must Specify
- Beveled Glass Inserts Available in Clear and Cracked Ice; Must Specify (See Below)
- Lower, Center Grommet in Back Panel; Must Specify: Black (BLK) or Silver (SLV)
- 24 $\frac{3}{8}$ " Clearance Below Center
- Additional Options: No Decorative Molding (Specify NO MOLDING); Glass Shelves ([See Glass Shelf Options](#)); Down Lighting ([See Down Lighting Options](#))

Beveled Glass Options: Specify & Add

| | | |
|------|---------------------------|---------|
| 1-CL | Clear Glass Inserts | N/C |
| 1-CR | Cracked Ice Glass Inserts | \$ 1040 |

| | | | | | | | |
|--|------------------------------|----|----|----|-----|------|-----------------------|
| VERTICAL OPEN HUTCH WITH TWO DOORS AND MESH DOOR INSERTS | 46-1572VHM <i>2 Doors</i> | 72 | 15 | 51 | 231 | 38.7 | W\$ 5782 PV\$ 6477 |
| | 46-1566VHM <i>2 Doors</i> | 66 | 15 | 51 | 226 | 36.0 | W\$ 5551 PV\$ 6217 |

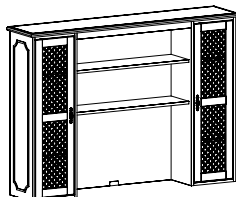

Must Specify (in this order):

- Model #
- Premium or Standard Veneer
- Finish
- Pull/Mesh Grille Color
- No Molding
- Glass Shelves
- Down Lighting
- Grommet Color

Description

- Standard With: Top Profiled on All Sides, Decorative Molding on Both Sides, Two (2) Wood-Framed Soft-Close Doors with Mesh Inserts, One (1) Adjustable Shelf and One (1) Fixed Shelf in Center Cabinet, Two (2) Adjustable Shelves and One (1) Fixed Middle Shelf Behind Each End Door, and Grommet in Back Panel
- Available in Premium Veneer (PV) or Standard Veneer (W); Must Specify
- Mesh Grille Inserts Available in Antique Brass and Silver; Must Specify (See Below)
- Lower, Center Grommet in Back Panel; Must Specify: Black (BLK) or Silver (SLV)
- 24 $\frac{3}{8}$ " Clearance Below Center
- Additional Options: No Decorative Molding (Specify NO MOLDING); Glass Shelves ([See Glass Shelf Options](#)); Down Lighting ([See Down Lighting Options](#))

Mesh Grille Options: Specify & Add

| | | |
|------|--|--------|
| 1-BM | Antique Brass Mesh Grille Insert <i>Only available when a Brass Pull is specified</i> | N/C |
| 1-AM | Silver Mesh Grille Insert <i>Only available when Liberty Pull (ALB) is specified</i> | \$ 782 |

W = Veneer PV = Premium Veneer

[See Jefferson Intro Section for Ordering Options](#)

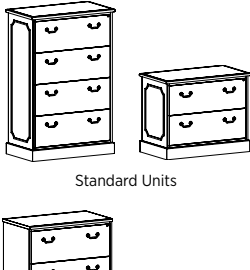
| Item | Model No. | Width | Depth | Height | Ship Wt | Cubic Ft | List Price | |
|--|--|-------|-------|------------------|---------|----------|-------------------------|--|
| LATERAL FILES | | | | | | | | |
| STANDARD: PROFILED ALL SIDES + DECORATIVE MOLDING | | | | | | | | |
|  <p>Standard Units</p> <p>Flush Units</p> | 46-2036L4 <i>4 Drawers</i> | 36 | 20 | 55½ ₂ | 290 | 27.5 | W/P\$ 6407 PV\$ 7176 | |
| | 46-2036L2 <i>2 Drawers</i> | 36 | 20 | 30 | 152 | 14.9 | W/P\$ 3915 PV\$ 4386 | |
| | FLUSH ENDS: PROFILED FRONT SIDE + NO DECORATIVE MOLDING | | | | | | | |
| | 46-2034L4FE <i>4 Drawers</i> | 34¼ | 20 | 55½ ₂ | 290 | 27.5 | W/P\$ 6152 PV\$ 6891 | |
| | 46-2034L2FE <i>2 Drawers</i> | 34¼ | 20 | 30 | 152 | 14.9 | W/P\$ 3762 PV\$ 4212 | |

Description

- Standard With: Central Locking Drawers with Legal or Letter Filing Side-to-Side or Front-to-Back, Dovetail Wood Drawer Construction, and Anti-Tilt System
- For Standard Units, Top Profiled on All Sides, Base Molding on All Sides, Decorative Molding on Both Sides
- For Flush Units, Top Profiled on Front Side, Base Molding on Front Side, No Decorative Molding
- Chassis Available with Premium Veneer (PV) or Standard Veneer (W); Must Specify
- Top Available with Premium/Standard Veneer (PV/W) or HPL (P); Must Specify
- Additional Options: No Decorative Molding (Specify NO MOLDING) on Standard Units

Must Specify (in this order):

- Model #
- Premium or Standard Veneer
- Top Material
- Finish/Color
- Pull
- No Molding (if applicable)

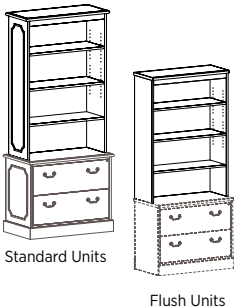
| | | | | | | | | |
|--|--|--|-----|----|-----|------|-----------------------|-----------------------|
| SURFACE MOUNT BOOKCASES | | | | | | | | |
| STANDARD: PROFILED ALL SIDES + DECORATIVE MOLDING | | | | | | | | |
|  <p>Standard Units</p> <p>Flush Units</p> | 46-1534TU <i>For Use with 46-2036L2</i> | 36 | 15 | 51 | 125 | 19.0 | W\$ 2921 PV\$ 3271 | |
| | FLUSH ENDS: PROFILED FRONT SIDE + NO DECORATIVE MOLDING | | | | | | | |
| | | 46-1534TUFE <i>For Use with 46-2034L2FE</i> | 34¼ | 15 | 51 | 125 | 19.0 | W\$ 2847 PV\$ 3188 |

Description

- Standard With: One (1) Fixed Bottom Shelf with 12" Clearance and Two (2) Adjustable Shelves
- For Standard Units, Top Profiled on All Sides and Decorative Molding on Both Sides
- For Flush Units, Top Profiled on Front Side and No Decorative Molding
- Available in Premium Veneer (PV) or Standard Veneer (W); Must Specify
- Additional Options: No Decorative Molding (Specify NO MOLDING) on Standard Units

Must Specify (in this order):

- Model #
- Premium or Standard Veneer
- Finish/Color
- No Molding (if applicable)

P = HPL W = Veneer PV = Premium Veneer

[See Jefferson Intro Section for Ordering Options](#)

| Item | Model No. | Width | Depth | Height | Ship Wt | Cubic Ft | List Price |
|---|--|-------|-------|--------|---------|----------|-----------------------|
| SURFACE MOUNT BOOKCASES WITH DOORS AND WOOD INSERTS | STANDARD: PROFILED ALL SIDES + DECORATIVE MOLDING | | | | | | |
| | 46-1534TUW | 36 | 15 | 51 | 125 | 19.0 | W\$ 4334 PV\$ 4854 |
| | <i>For Use with 46-2036L2</i> | | | | | | |
| | FLUSH ENDS: PROFILED FRONT SIDE + NO DECORATIVE MOLDING | | | | | | |
| | 46-1534TUWFE | 34¼ | 15 | 51 | 125 | 19.0 | W\$ 4258 PV\$ 4769 |
| <i>For Use with 46-2034L2FE</i> | | | | | | | |

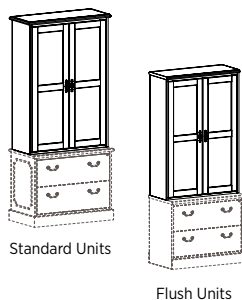

Standard Units

Flush Units

Must Specify (in this order):

- Model #
- Premium or Standard Veneer Finish
- No Molding (if applicable)

Description

- Standard With: Two (2) Wood-Framed Soft-Close Doors with Wood Inserts, One (1) Fixed Bottom Shelf with 12" Clearance, and Two (2) Adjustable Shelves
- For Standard Units, Top Profiled on All Sides and Decorative Molding on Both Sides
- For Flush Units, Top Profiled on Front Side and No Decorative Molding
- Available in Premium Veneer (PV) or Standard Veneer (W); Must Specify
- Additional Options: No Decorative Molding (Specify NO MOLDING) on Standard Units

| | | | | | | | |
|--|--|-----|----|----|-----|------|-----------------------|
| SURFACE MOUNT BOOKCASES WITH DOORS AND GLASS INSERTS | STANDARD: PROFILED ALL SIDES + DECORATIVE MOLDING | | | | | | |
| | 46-1534TUG | 36 | 15 | 51 | 125 | 19.0 | W\$ 4563 PV\$ 5112 |
| | <i>For Use with 46-2036L2</i> | | | | | | |
| | FLUSH ENDS: PROFILED FRONT SIDE + NO DECORATIVE MOLDING | | | | | | |
| | 46-1534TUGFE | 34¼ | 15 | 51 | 125 | 19.0 | W\$ 4525 PV\$ 5068 |
| <i>For Use with 46-2034L2FE</i> | | | | | | | |

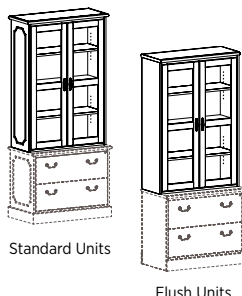

Standard Units

Flush Units

Must Specify (in this order):

- Model #
- Premium or Standard Veneer Finish
- Pull
- Beveled Glass Design
- No Molding (if applicable)
- Glass Shelves
- Down Lighting

Description

- Standard With: Two (2) Wood-Framed Soft-Close Doors with Glass Inserts, One (1) Fixed Bottom Shelf with 12" Clearance, and Two (2) Adjustable Shelves
- For Standard Units, Top Profiled on All Sides and Decorative Molding on Both Sides
- For Flush Units, Top Profiled on Front Side and No Decorative Molding
- Available in Premium Veneer (PV) or Standard Veneer (W); Must Specify
- Beveled Glass Inserts Available in Clear and Cracked Ice; Must Specify (See Below)
- Additional Options: No Decorative Molding (Specify NO MOLDING) on Standard Units; Glass Shelves ([See Glass Shelf Options](#)); Down Lighting ([See Down Lighting Options](#))

Beveled Glass Options: Specify & Add

| | | |
|------|---------------------------|---------|
| 1-CL | Clear Glass Inserts | N/C |
| 1-CR | Cracked Ice Glass Inserts | \$ 1040 |

W = Veneer PV = Premium Veneer

[See Jefferson Intro Section for Ordering Options](#)

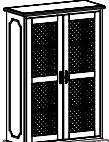
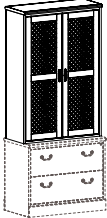
| Item | Model No. | Width | Depth | Height | Ship Wt | Cubic Ft | List Price |
|---|--|-------|-------|--------|---------|----------|-----------------------|
| SURFACE MOUNT BOOKCASES WITH DOORS AND MESH INSERTS | | | | | | | |
| STANDARD: PROFILED ALL SIDES + DECORATIVE MOLDING | | | | | | | |
|  | 46-1534TUM | 36 | 15 | 51 | 125 | 19.0 | W\$ 4791 PV\$ 5366 |
| | <i>For Use with 46-2036L2</i> | | | | | | |
|  | FLUSH ENDS: PROFILED FRONT SIDE + NO DECORATIVE MOLDING | | | | | | |
| | 46-1534TUMFE | 34¼ | 15 | 51 | 125 | 19.0 | W\$ 4718 PV\$ 5283 |
| <i>For Use with 46-2034L2FE</i> | | | | | | | |

Standard Units

Flush Units

Must Specify (in this order):
 Model #
 Premium or Standard Veneer
 Finish
 Pull/Mesh Grille Color
 No Molding (if applicable)
 Glass Shelves
 Down Lighting

Description

- Standard With: Two (2) Wood-Framed Soft-Close Doors with Mesh Inserts, One (1) Fixed Bottom Shelf with 12" Clearance, and Two (2) Adjustable Shelves
- For Standard Units, Top Profiled on All Sides and Decorative Molding on Both Sides
- For Flush Units, Top Profiled on Front Side and No Decorative Molding
- Available in Premium Veneer (PV) or Standard Veneer (W); Must Specify
- Mesh Grille Inserts Available in Antique Brass and Silver; Must Specify (See Below)
- Additional Options: No Decorative Molding (Specify NO MOLDING) on Standard Units; Glass Shelves ([See Glass Shelf Options](#)); Down Lighting ([See Down Lighting Options](#))

Mesh Grille Options: Specify & Add

| | | |
|------|--|--------|
| 1-BM | Antique Brass Mesh Grille Insert <i>Only available when a Brass Pull is specified</i> | N/C |
| 1-AM | Silver Mesh Grille Insert <i>Only available when Liberty Pull (ALB) is specified</i> | \$ 782 |

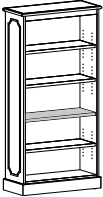
| | | | | | | | | |
|---|---------------------------------|-----------|----|----|-----|-----|------|-------------------------|
|  | BOOKCASE | 46-3470BC | 34 | 15 | 69½ | 152 | 26.1 | W\$ 3954 PV\$ 4429 |
| | <i>Three Adjustable Shelves</i> | | | | | | | |
| | | 46-3456BC | 34 | 15 | 55½ | 140 | 20.1 | W/P\$ 3374 PV\$ 3779 |
| <i>Two Adjustable Shelves</i> | | | | | | | | |

Description

- Standard With: Top Profiled on All Sides, Decorative Molding on Both Sides, Two (2) or Three (3) 1" Thick Adjustable Shelves (Depending Upon Model, See Above), and One (1) 1" Thick Fixed Shelf (Shaded in Art)
- Available with Premium Veneer (PV) or Standard Veneer (W); 56"H Bookcases Also Available with HPL (P) Tops; Must Specify
- Additional Options: No Decorative Molding (Specify NO MOLDING)

Must Specify (in this order):
 Model #
 Premium or Standard Veneer
 Top Material (for 56"H Only)
 Finish/Color
 No Molding

P = HPL W = Veneer PV = Premium Veneer

[See Jefferson Intro Section for Ordering Options](#)

| Item | Model No. | Width | Depth | Height | Ship Wt | Cubic Ft | List Price |
|--------------------------------------|------------|-------|-------|--------|---------|----------|-------------------------|
| BOOKCASE WITH DOORS AND WOOD INSERTS | 46-3656BCW | 36 | 15 | 55¼ | 140 | 20.1 | W/P\$ 5217 PV\$ 5843 |

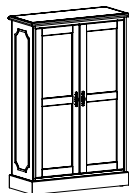

Must Specify (in this order):

Model #
Premium or Standard Veneer
Top Material
Finish/Color
Pull
No Molding
Locking Door

Description

- Standard With: Top Profiled on All Sides, Base Molding on All Sides, Decorative Molding on Both Sides, Two (2) Wood-Framed Soft-Close Doors with Wood Inserts, One (1) 1" Thick Fixed Middle Shelf, and Two (2) 1" Thick Adjustable Shelves
- Chassis Available with Premium Veneer (PV) or Standard Veneer (W); Must Specify
- Top Available with Premium/Standard Veneer (PV/W) or HPL (P); Must Specify
- Additional Options: No Decorative Molding (Specify NO MOLDING); Locking Doors ([See Locking Door Options](#))

| | | | | | | | |
|---------------------------------------|------------|----|----|-----|-----|------|-------------------------|
| BOOKCASE WITH DOORS AND GLASS INSERTS | 46-3656BCG | 36 | 15 | 55¼ | 140 | 20.1 | W/P\$ 5305 PV\$ 5942 |
|---------------------------------------|------------|----|----|-----|-----|------|-------------------------|

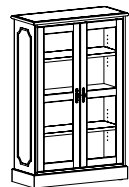

Must Specify (in this order):

Model #
Premium or Standard Veneer
Top Material
Finish/Color
Pull
Beveled Glass Design
No Molding
Locking Door

Description

- Standard With: Top Profiled on All Sides, Base Molding on All Sides, Decorative Molding on Both Sides, Two (2) Wood-Framed Soft-Close Doors with Glass Inserts, One (1) 1" Thick Fixed Middle Shelf, and Two (2) 1" Thick Adjustable Shelves
- Chassis Available with Premium Veneer (PV) or Standard Veneer (W); Must Specify
- Top Available with Premium/Standard Veneer (PV/W) or HPL (P); Must Specify
- Beveled Glass Inserts Available in Clear and Cracked Ice; Must Specify (See Below)
- Additional Options: No Decorative Molding (Specify NO MOLDING); Locking Doors ([See Locking Door Options](#))

Beveled Glass Options: Specify & Add

| | | |
|------|---------------------------|---------|
| 1-CL | Clear Glass Inserts | N/C |
| 1-CR | Cracked Ice Glass Inserts | \$ 1040 |

| | | | | | | | |
|--------------------------------------|------------|----|----|-----|-----|------|-------------------------|
| BOOKCASE WITH DOORS AND MESH INSERTS | 46-3656BCM | 36 | 15 | 55¼ | 140 | 20.1 | W/P\$ 5534 PV\$ 6197 |
|--------------------------------------|------------|----|----|-----|-----|------|-------------------------|

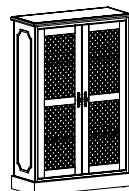

Must Specify (in this order):

Model #
Premium or Standard Veneer
Top Material
Finish
Pull/Mesh Grille Color
No Molding
Locking Door

Description

- Standard With: Top Profiled on All Sides, Base Molding on All Sides, Decorative Molding on Both Sides, Two (2) Wood-Framed Soft-Close Doors with Mesh Grille Inserts, One (1) 1" Thick Fixed Middle Shelf, and Two (2) 1" Thick Adjustable Shelves
- Chassis Available with Premium Veneer (PV) or Standard Veneer (W); Must Specify
- Top Available with Premium/Standard Veneer (PV/W) or HPL (P); Must Specify
- Mesh Grille Inserts Available in Antique Brass and Silver; Must Specify (See Below)
- Additional Options: No Decorative Molding (Specify NO MOLDING); Locking Doors ([See Locking Door Options](#))

Mesh Grille Options: Specify & Add

| | | |
|------|--|--------|
| 1-BM | Antique Brass Mesh Grille Insert <i>Only available when a Brass Pull is specified</i> | N/C |
| 1-AM | Silver Mesh Grille Insert <i>Only available when Liberty Pull (ALB) is specified</i> | \$ 782 |

P = HPL W = Veneer PV = Premium Veneer

[See Jefferson Intro Section for Ordering Options](#)

| Item | Model No. | Width | Depth | Height | Ship Wt | Cubic Ft | List Price |
|---|---------------------|-------|-------|--------|---------|----------|-----------------------|
| SINGLE WARDROBE/ STORAGE CABINET | Left Hinged | | | | | | |
| | Right Hinged | | | | | | |
| | 46-1870WL | 18 | 20 | 69½" | 155 | 17.2 | W\$ 5390 PV\$ 6036 |

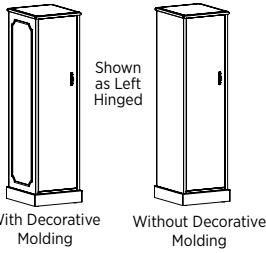

Description

- Standard With: Top Profiled on All Sides, Base Molding on All Sides, Decorative Molding on Both Sides, Fixed Top Shelf Behind Door, Coat Rod Under Fixed Shelf, Three (3) Adjustable Shelves Behind Door
- Available in Premium Veneer (PV) or Standard Veneer (W); Must Specify
- Adjustable Shelves Can Be Easily Removed for Wardrobe Application
- Additional Options: No Decorative Molding (Specify NO MOLDING); Locking Doors ([See Locking Door Options](#))

Must Specify (in this order):

- Model #
- Premium or Standard Veneer
- Finish
- Pull
- No Molding
- Locking Door

| | | | | | | | |
|---|-----------|----|----|------|-----|------|------------------------|
| DOUBLE WARDROBE/ STORAGE CABINET | 46-3670WD | 36 | 20 | 69½" | 310 | 34.2 | W\$ 9514 PV\$ 10655 |
| | 46-3270WD | 32 | 24 | 69½" | 310 | 34.2 | W\$ 9769 PV\$ 10943 |

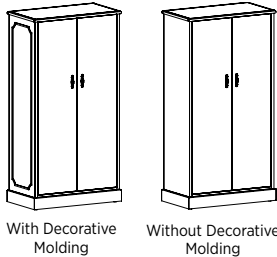

Description

- Standard With: Non-Locking, Top Profiled on All Sides, Base Molding on All Sides, Decorative Molding on Both Sides, Fixed Top Shelf Behind Each Door, Coat Rod Under Each Fixed Shelf, Three (3) Adjustable Shelves Behind Each Door
- Available in Premium Veneer (PV) or Standard Veneer (W); Must Specify
- Adjustable Shelves Can Be Easily Removed for Wardrobe Application
- Additional Options: No Decorative Molding (Specify NO MOLDING); Locking Doors ([See Locking Door Options](#))

Must Specify (in this order):

- Model #
- Premium or Standard Veneer
- Finish
- Pull
- No Molding
- Locking Door

| | | | | | | | |
|----------------------------|-----------------------|----|----|------|-----|------|-------------------------|
| COMPUTER WORK TABLE | 46-2436CW | 36 | 24 | 26½" | 115 | 17.6 | W/P\$ 2767 PV\$ 3097 |
| | <i>Kneespace 32½"</i> | | | | | | |

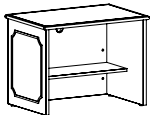

Description

- Standard With: Rectangle Top Profiled on All Sides, Decorative Molding on Both Sides, Grommet in Back Panel, Front-to-Back Grain Direction on Top, and Fixed Shelf with 15 7/8" Clearance
- Chassis Available with Premium Veneer (PV) or Standard Veneer (W); Must Specify
- Top Available with Premium/Standard Veneer (PV/W) or HPL (P); Must Specify
- Grommet in Back Panel; Must Specify: Black (BLK), Silver (SLV), or None (NONE)
- Additional Options: Kneespace Options (Order Separately, [See Multiple Units](#)); Casters (See Below); Top Grommet Options ([See Grommet Options](#)); Wire Management + Accessories (Order Separately; [See Multiple Unit Details](#))

Options: Specify & Add

| | | |
|------|---|--------|
| CAST | Optional Black Caster (Increases Height to 30") | \$ 239 |
|------|---|--------|



Braking Casters on User Side/Non-Braking Casters on Approach

Must Specify (in this order):

- Model #
- Premium or Standard Veneer
- Top Material
- Finish/Color
- No Molding
- Top Grommet Location
- Back Panel Grommet
- Grommet Color
- Kneespace Options
- Casters

P = HPL W = Veneer PV = Premium Veneer

[See Jefferson Intro Section for Ordering Options](#)

| Item | Model No. | Width | Depth | Height | Ship Wt | Cubic Ft | List Price |
|--|---|-------|-------|---------------------------------|---------|----------|-------------------------|
|  ROUND TOP & BASES | 46-4848CT <i>Accommodates Five (5) Chairs</i> | 48 | 48 | 13 ¹ / ₁₆ | 58 | 5.9 | W/P\$ 4287 PV\$ 4801 |
| | 46-4242CT <i>Accommodates Four (4) Chairs</i> | 42 | 42 | 13 ¹ / ₁₆ | 51 | 4.5 | W/P\$ 3730 PV\$ 4178 |
| | 46-3636CT <i>Accommodates Three (3) Chairs</i> | 36 | 36 | 13 ¹ / ₁₆ | 43 | 3.3 | W/P\$ 3361 PV\$ 3763 |

Top Must Specify (in this order):

Model #
Top Material
Finish/Color

Base Must Specify (in this order):

Model #
Premium or Standard Veneer
(if applicable)
Finish

Description

- Top Available with Premium/Standard Veneer (PV/W) or HPL (P); Must Specify
- See Below for Base Options, Order Separately; One (1) Required
- Power Options not Available

Base Options: Must Order & Add**Queen Anne Base**

| | | | | | | | |
|-----------|---------------------|----|----|--------------------------------|-----|------|---------|
| 01-0606QB | Must Specify Finish | 24 | 24 | 28 ³ / ₄ | 136 | 11.1 | \$ 1406 |
|-----------|---------------------|----|----|--------------------------------|-----|------|---------|

Description

- Classic Design Detail on Column
- Queen Anne Base Features Multi-Step, Hand-Finished Catalyzed Finish
- Four Legs with Adjustable Glides

Cylinder Bases

| | | | | | | | |
|-----------|-------------------------------|----|----|--------------------------------|-----|------|-----------------------|
| 01-2020CB | For Use with 48" and 42" Tops | 20 | 20 | 28 ³ / ₄ | 136 | 11.1 | W\$ 1553 PV\$ 1813 |
| 01-1616CB | For Use with 36" Tops | 16 | 16 | 28 ³ / ₄ | 101 | 7.2 | W\$ 1419 PV\$ 1660 |

Description

- Premium Veneer (PV) or Standard Veneer (W) Cylinder Base; Weighted for Stability
- Base Features Multi-Step, Hand-Finished Catalyzed Finish
- Two (2) Black Wire Management Grommets at Top and One (1) 8" Wire Management Opening in Bottom

Options: Specify & Add

| | | |
|-------|--|-----|
| GCB1S | Single Grommet at Top Edge (Factory Installed) | N/C |
| NOGC | No Grommet at Top Edge | N/C |

Height Adjustable Pneumatic X-Bases**Maximum Round 42", Maximum Square 36"**

| | | | | | | | |
|--------------|----------|----|----|----|---|-----|---------|
| 01-3232HAXBB | Black | 32 | 32 | 26 | 1 | 0.2 | \$ 1721 |
| 01-3232HAXBA | Aluminum | | | | | | |

Maximum Round 36", Maximum Square 30"

| | | | | | | | |
|--------------|----------|----|----|----|---|-----|---------|
| 01-2626HAXBB | Black | 22 | 22 | 26 | 1 | 0.2 | \$ 1687 |
| 01-2626HAXBA | Aluminum | | | | | | |

Description

- Pre-Drilled Boring Pattern May Not Match Underside of Table Top
- Steel Mounting Plate: 8"x 8"x 1/4"
- Eight (8) Bolts Included for Assembly
- Some Assembly Required

P = HPL W = Veneer PV = Premium Veneer

[See Jefferson Intro Section for Ordering Options](#)

| Item | Model No. | Width | Depth | Height | Ship Wt | Cubic Ft | List Price | |
|-----------|-----------|-------|-------|----------------------------------|---------|----------|------------|-----------|
| END TABLE | 46-1824ET | 24 | 18 | 21 ¹³ / ₁₆ | 25 | 2.0 | W/P\$ 1357 | PV\$ 1521 |

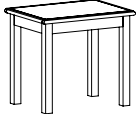

Must Specify (in this order):

Model #
Top Material
Finish/Color

Description

- Available with Premium/Standard Veneer (PV/W) or HPL (P) Top; Must Specify
- Hardwood Legs
- Apron Rails and Panel Legs Feature Multi-Step, Hand-Finished Catalyzed Finish
- Some Assembly Required

| Item | Model No. | Width | Depth | Height | Ship Wt | Cubic Ft | List Price | |
|------------|-----------|-------|-------|----------------------------------|---------|----------|------------|-----------|
| LAMP TABLE | 46-2424LT | 24 | 24 | 21 ¹³ / ₁₆ | 37 | 3.3 | W/P\$ 1728 | PV\$ 1935 |

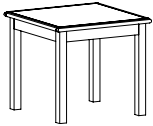

Must Specify (in this order):

Model #
Top Material
Finish/Color

Description

- Available with Premium/Standard Veneer (PV/W) or HPL (P) Top; Must Specify
- Hardwood Legs
- Apron Rails and Panel Legs Feature Multi-Step, Hand-Finished Catalyzed Finish
- Some Assembly Required

| Item | Model No. | Width | Depth | Height | Ship Wt | Cubic Ft | List Price | |
|----------------|-----------|-------|-------|--------|---------|----------|------------|-----------|
| MAGAZINE TABLE | 46-1847MT | 47 | 18 | 16 | 42 | 3.4 | W/P\$ 1632 | PV\$ 1828 |

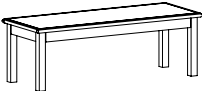

Must Specify (in this order):

Model #
Top Material
Finish/Color
Optional 30"H Leg

Description

- Available with Premium/Standard Veneer (PV/W) or HPL (P) Top; Must Specify
- Hardwood Legs
- Apron Rails and Panel Legs Feature Multi-Step, Hand-Finished Catalyzed Finish
- Optional 30"H Legs, See Below
- Some Assembly Required

Options: Specify & Add

| | | |
|-------|--------------------|--------|
| SH-46 | Optional 30"H Legs | \$ 223 |
|-------|--------------------|--------|

P = HPL W = Veneer PV = Premium Veneer

[See Jefferson Intro Section for Ordering Options](#)

| Item | Model No. | Width | Depth | Height | Ship Wt | Cubic Ft | List Price | |
|--|---|-------|-------|--------|---------|-------------------------|-------------------------|--|
| MODULAR CABINET/ CREDENZA TOPS  Must Specify (in this order): Model # Top Material Finish/Color | FOR 29"W MODULAR UNITS | | | | | | | |
| | 46-2089TP | 88½ | 20 | 1¾ | 43 | 5.8 | W/P\$ 1740 PV\$ 1948 | |
| | <i>Top for Three 29"W Modular Units</i> | | | | | | | |
| | 46-2060TP | 59½ | 20 | 1¾ | 30 | 4.0 | W/P\$ 1145 PV\$ 1281 | |
| | <i>Top for Two 29"W Modular Units</i> | | | | | | | |
| | 46-2031TP | 30½ | 20 | 1¾ | 18 | 2.1 | W/P\$ 650 PV\$ 726 | |
| | <i>Top for One 29" Modular Units</i> | | | | | | | |
| | FOR 18"W MODULAR UNITS | | | | | | | |
| | 46-2038TP | 39¾ | 20 | 1¾ | 21 | 1.7 | W/P\$ 769 PV\$ 862 | |
| | <i>Top for Two 18"W Modular Units</i> | | | | | | | |
| 46-2020TP | 19½ | 20 | 1¾ | 13 | 1.1 | W/P\$ 462 PV\$ 516 | | |
| <i>Top for One 18" W Modular Units</i> | | | | | | | | |
| FOR COMBO OF 18"W and 29"W MODULAR UNITS | | | | | | | | |
| 46-2067TP | 68¾ | 20 | 1¾ | 37 | 4.7 | W/P\$ 1290 PV\$ 1444 | | |
| <i>Top for Two 18" and One 29" Unit</i> | | | | | | | | |
| 46-2049TP | 48½ | 20 | 1¾ | 24 | 2.3 | W/P\$ 957 PV\$ 1071 | | |
| <i>Top for One 18" and One 29" Unit</i> | | | | | | | | |

Description

- Standard With: Rectangle Top Profiled on All Sides
- Available with Premium/Standard Veneer (PV/W) or HPL (P) Top; Must Specify
- **For Use with 18"W and 29"W Modular Storage Units (See Multiple Units)**
- Not For Use on Freestanding Bookcases

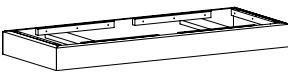
| Item | Model No. | Width | Depth | Height | Ship Wt | Cubic Ft | List Price | |
|---|---------------------------------|-------|-------|--------|---------|----------|------------|--|
| MODULAR CABINET/ CREDENZA BASES  Must Specify (in this order): Model # Finish | FOR 29"W MODULAR UNITS | | | | | | | |
| | 46-2089BS | 88½ | 19½ | 4¼ | 53 | 5.8 | W\$ 1172 | |
| | <i>Base for Three 29" Units</i> | | | | | | | |
| | 46-2060BS | 59½ | 19½ | 4¼ | 38 | 4.0 | W\$ 795 | |
| | <i>Base for Two 29" Units</i> | | | | | | | |
| | 46-2031BS | 30½ | 19½ | 4¼ | 18 | 2.1 | W\$ 513 | |
| | <i>Base for One 29" Units</i> | | | | | | | |
| | FOR 18"W MODULAR UNITS | | | | | | | |
| | 46-2038BS | 38¾ | 19½ | 4¼ | 25 | 2.7 | W\$ 581 | |
| | <i>Base for Two 18" Units</i> | | | | | | | |
| 46-2020BS | 19½ | 19½ | 4¼ | 16 | 1.5 | W\$ 406 | | |
| <i>Base for One 18" Units</i> | | | | | | | | |
| FOR COMBO OF 18"W and 29"W MODULAR UNITS | | | | | | | | |
| 46-2067BS | 66½ | 19½ | 4¼ | 45 | 4.7 | W\$ 885 | | |
| <i>Base for Two 18" and One 29" Units</i> | | | | | | | | |
| 46-2049BS | 48½ | 19½ | 4¼ | 33 | 3.0 | W\$ 687 | | |
| <i>Base for One 18" and One 29" Units</i> | | | | | | | | |

Description

- **For Use with 18"W and 29"W Modular Storage Units (See Multiple Units)**
- Bases Feature Multi-Step, Hand-Finished Catalyzed Finish
- Not For Use with Freestanding Bookcases

P = HPL W = Veneer PV = Premium Veneer

See Jefferson Intro Section for Ordering Options

| Item | Model No. | Width | Depth | Height | Ship Wt | Cubic Ft | List Price |
|---------------------------|-----------|-------|-------|--------|---------|----------|-----------------------|
| MODULAR STORAGE FILE/FILE | 46-1829MF | 29 | 18½ | 24 | 119 | 9.8 | W\$ 2924 PV\$ 3275 |

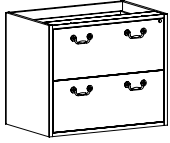

Description

- Standard With: No Molding, Central Locking File/File Ped, Legal-or-Letter Filing Side-to-Side or Letter Filing Front to Back, and Finished Back Panel
- Available with Premium Veneer (PV) or Standard Veneer (W); Must Specify
- **Must Specify Top and Base for Freestanding Applications; Order Separately (See Tops and Bases)**

Molding Options: Specify & Add

| | | |
|-------|--------------------------------|--------|
| M46L1 | Molding on Left Side Only | \$ 85 |
| M46R1 | Molding on Right Side Only | \$ 85 |
| M46LR | Molding on Left and Right Side | \$ 170 |

Must Specify (in this order):

- Model #
- Premium or Standard Veneer
- Finish
- Pull
- Molding

| | | | | | | | |
|------------------------------|-----------|----|-----|----|-----|-----|-----------------------|
| MODULAR STORAGE BOX/BOX/FILE | 46-1829MU | 29 | 18½ | 24 | 119 | 9.8 | W\$ 2924 PV\$ 3275 |
|------------------------------|-----------|----|-----|----|-----|-----|-----------------------|



Description

- Standard With: No Molding, Central Locking Box/Box/File Ped, Legal-or-Letter Filing Side-to-Side or Letter Filing Front to Back, and Finished Back Panel
- Available with Premium Veneer (PV) or Standard Veneer (W); Must Specify
- **Must Specify Top and Base for Freestanding Applications; Order Separately (See Tops and Bases)**

Molding Options: Specify & Add

| | | |
|-------|--------------------------------|--------|
| M46L1 | Molding on Left Side Only | \$ 85 |
| M46R1 | Molding on Right Side Only | \$ 85 |
| M46LR | Molding on Left and Right Side | \$ 170 |

Must Specify (in this order):

- Model #
- Premium or Standard Veneer
- Finish
- Pull
- Molding

| | | | | | | | |
|--------------------------|-----------|----|-----|----|----|-----|-----------------------|
| MODULAR STORAGE TWO DOOR | 46-1829MS | 29 | 18½ | 24 | 92 | 9.8 | W\$ 2148 PV\$ 2405 |
|--------------------------|-----------|----|-----|----|----|-----|-----------------------|

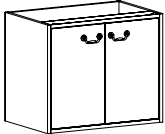

Description

- Standard With: No Molding, Two (2) Soft-Close Doors, One (1) Adjustable Shelf, and Finished Back Panel
- Available with Premium Veneer (PV) or Standard Veneer (W); Must Specify
- **Must Specify Top and Base for Freestanding Applications; Order Separately (See Tops and Bases)**

Molding Options: Specify & Add

| | | |
|-------|--------------------------------|--------|
| M46L1 | Molding on Left Side Only | \$ 85 |
| M46R1 | Molding on Right Side Only | \$ 85 |
| M46LR | Molding on Left and Right Side | \$ 170 |

Must Specify (in this order):

- Model #
- Premium or Standard Veneer
- Finish
- Pull
- Molding

| | | | | | | | |
|------------------------------|------------|----|-----|----|----|-----|-----------------------|
| MODULAR STORAGE OPEN STORAGE | 46-1829MBC | 29 | 18½ | 24 | 92 | 9.8 | W\$ 1882 PV\$ 2107 |
|------------------------------|------------|----|-----|----|----|-----|-----------------------|

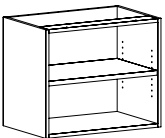

Description

- Standard With: No Molding, One (1) Adjustable 1" Thick Shelf, and Finished Back Panel
- Available with Premium Veneer (PV) or Standard Veneer (W); Must Specify
- **Must Specify Top and Base for Freestanding Applications; Order Separately (See Tops and Bases)**

Molding Options: Specify & Add

| | | |
|-------|--------------------------------|--------|
| M46L1 | Molding on Left Side Only | \$ 85 |
| M46R1 | Molding on Right Side Only | \$ 85 |
| M46LR | Molding on Left and Right Side | \$ 170 |

Must Specify (in this order):

- Model #
- Premium or Standard Veneer
- Finish
- Molding

W = Veneer PV = Premium Veneer

[See Jefferson Intro Section for Ordering Options](#)

| Item | Model No. | Width | Depth | Height | Ship Wt | Cubic Ft | List Price |
|---------------------------|-----------|----------------------------------|-------|--------|---------|----------|-----------------------|
| MODULAR STORAGE FILE/FILE | 46-1818MF | 18 ²⁷ / ₃₂ | 18½ | 24 | 98 | 4.9 | W\$ 2632 PV\$ 2948 |

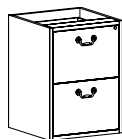

Must Specify (in this order):

- Model #
- Premium or Standard Veneer
- Finish
- Pull
- Molding

Description

- Standard With: No Molding, Central Locking File/File Ped, Legal-or-Letter Filing Side-to-Side or Letter Filing Front to Back, and Finished Back Panel
- Available with Premium Veneer (PV) or Standard Veneer (W); Must Specify
- **Must Specify Top and Base for Freestanding Applications; Order Separately (See Tops and Bases)**

Molding Options: Specify & Add

| | | |
|-------|--------------------------------|--------|
| M46L1 | Molding on Left Side Only | \$ 85 |
| M46R1 | Molding on Right Side Only | \$ 85 |
| M46LR | Molding on Left and Right Side | \$ 170 |

| | | | | | | | |
|------------------------------|-----------|----------------------------------|-----|----|----|-----|-----------------------|
| MODULAR STORAGE BOX/BOX/FILE | 46-1818MU | 18 ²⁷ / ₃₂ | 18½ | 24 | 98 | 4.9 | W\$ 2632 PV\$ 2948 |
|------------------------------|-----------|----------------------------------|-----|----|----|-----|-----------------------|



Must Specify (in this order):

- Model #
- Premium or Standard Veneer
- Finish
- Pull
- Molding

Description

- Standard With: No Molding, Central Locking Box/Box/File Ped, Legal-or-Letter Filing Side-to-Side or Letter Filing Front to Back, and Finished Back Panel
- Available with Premium Veneer (PV) or Standard Veneer (W); Must Specify
- **Must Specify Top and Base for Freestanding Applications; Order Separately (See Tops and Bases)**

Molding Options: Specify & Add

| | | |
|-------|--------------------------------|--------|
| M46L1 | Molding on Left Side Only | \$ 85 |
| M46R1 | Molding on Right Side Only | \$ 85 |
| M46LR | Molding on Left and Right Side | \$ 170 |

| MODULAR STORAGE SINGLE DOOR | Left Hinged | Right Hinged | Width | Depth | Height | Ship Wt | Cubic Ft | List Price |
|-----------------------------|-------------|--------------|----------------------------------|-------|--------|---------|----------|-----------------------|
| | 46-1818MSL | 46-1818MSR | | | | | | |
| | | | 18 ²⁷ / ₃₂ | 18½ | 24 | 80 | 9.2 | W\$ 1933 PV\$ 2165 |

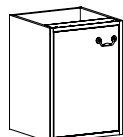

Shown as Left Hinged

Must Specify (in this order):

- Model #
- Premium or Standard Veneer
- Finish
- Pull
- Molding

Description

- Standard With: No Molding, One (1) Soft-Close Door, One (1) Adjustable Shelf, and Finished Back Panel
- Available with Premium Veneer (PV) or Standard Veneer (W); Must Specify
- **Must Specify Top and Base for Freestanding Applications; Order Separately (See Tops and Bases)**

Molding Options: Specify & Add

| | | |
|-------|--------------------------------|--------|
| M46L1 | Molding on Left Side Only | \$ 85 |
| M46R1 | Molding on Right Side Only | \$ 85 |
| M46LR | Molding on Left and Right Side | \$ 170 |

| | | | | | | | |
|----------------------|------------|----------------------------------|-----|----|----|-----|-----------------------|
| MODULAR OPEN STORAGE | 46-1818MBC | 18 ²⁷ / ₃₂ | 18½ | 24 | 45 | 4.6 | W\$ 1693 PV\$ 1896 |
|----------------------|------------|----------------------------------|-----|----|----|-----|-----------------------|

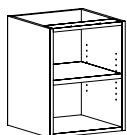

Must Specify (in this order):

- Model #
- Premium or Standard Veneer
- Finish
- Molding

Description

- Standard With: No Molding and Finished Back Panel
- Available with Premium Veneer (PV) or Standard Veneer (W); Must Specify
- **Must Specify Top and Base for Freestanding Applications; Order Separately (See Tops and Bases)**

Molding Options: Specify & Add

| | | |
|-------|--------------------------------|--------|
| M46L1 | Molding on Left Side Only | \$ 85 |
| M46R1 | Molding on Right Side Only | \$ 85 |
| M46LR | Molding on Left and Right Side | \$ 170 |

P = HPL W = Veneer PV = Premium Veneer

See Jefferson Intro Section for Ordering Options

| Item | Model No. | Width | Depth | Height | Ship Wt | Cubic Ft | List Price |
|---|---|-------|-------|--------|---------|----------|------------|
| MODULAR OVERHEAD CORNICE BOOKCASE TOP  | 46-1589FC <i>Cornice for 3 Modular Bookcases</i> | 89 | 15 | 3½ | 30 | 4.5 | W\$ 1111 |
| | 46-1560FC <i>Cornice for 2 Modular Bookcases</i> | 60 | 15 | 3½ | 18 | 3.1 | W\$ 637 |
| | 46-1531FC <i>Cornice for 1 Modular Bookcase</i> | 31 | 15 | 3½ | 10 | 3.1 | W\$ 468 |

Must Specify (in this order):

Model #
Finish

Description

- 46-1589FC Features Insert for Additional Stability
- Recommended for Use Above Line of Sight; Unfinished Open Top
- **For Use with Modular Bookcases (See Multiple Bookcase Units); Not For Use on Standard Bookcases**

| | | | | | | | |
|--|---|-----|----|-----------------|----|-----|-------------------------|
| MODULAR BOOKCASE TOP  | 46-1560TP <i>Top for 2 Modular Bookcases</i> | 59½ | 15 | 1½ ₂ | 30 | 3.1 | W/P\$ 1040 PV\$ 1166 |
| | 46-1531TP <i>Top for 1 Modular Bookcase</i> | 30½ | 15 | 1½ ₂ | 16 | 1.6 | W/P\$ 633 PV\$ 708 |

Must Specify (in this order):

Model #
Top Material
Finish/Color

Description

- Top Available with Premium/Standard Veneer (W) or HPL (P), Must Specify
- **For Use with Modular Bookcases (See Multiple Bookcase Units); Not For Use on Standard Bookcases**

| | | | | | | | |
|---|-----------------------------------|-----|-----|----|----|-----|---------|
| MODULAR BOOKCASE BASE  | 46-1560BS Base for 2 Bookcases | 59⅞ | 14⅝ | 4¼ | 15 | 3.1 | W\$ 591 |
| | 46-1531BS Base for 1 Bookcase | 30⅞ | 14⅝ | 4¼ | 10 | 1.6 | W\$ 432 |

Must Specify (in this order):

Model #
Finish

Description

- **For Use with Modular Bookcases (See Multiple Bookcase Units); Not For Use on Standard Bookcases**
- Bases Feature Multi-Step, Hand-Finished Catalyzed Finish

P = HPL W = Veneer PV = Premium Veneer

[See Jefferson Intro Section for Ordering Options](#)

| Item | Model No. | Width | Depth | Height | Ship Wt | Cubic Ft | List Price |
|------------------|-----------|-------|-------|--------|---------|----------|-----------------------|
| MODULAR BOOKCASE | 46-2952BC | 29 | 13½ | 50 | 84 | 14.6 | W\$ 1800 PV\$ 2017 |

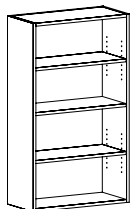

Description

- Standard With: No Molding, One (1) Fixed Shelf, and Two (2) Adjustable Shelves
- Available with Premium Veneer (PV) or Standard Veneer (W); Must Specify
- **Must Specify Top and Base for Freestanding Applications; Order Separately (See Tops and Bases)**
- Additional Options: Molding on One or Both Sides (See Below)
- Recommended for Applications Against a Wall

Molding Options: Specify & Add

| | | |
|-------|--------------------------------|--------|
| M46L1 | Molding on Left Side Only | \$ 85 |
| M46R1 | Molding on Right Side Only | \$ 85 |
| M46LR | Molding on Left and Right Side | \$ 170 |

Must Specify (in this order):

Model #
Premium or Standard Veneer
Finish
Molding

| | | | | | | | |
|--|-----------|----|-----|----|-----|------|-----------------------|
| MODULAR BOOKCASE WITH DOORS AND WOOD INSERTS | 46-2952WB | 29 | 13½ | 50 | 114 | 14.6 | W\$ 3687 PV\$ 4130 |
|--|-----------|----|-----|----|-----|------|-----------------------|

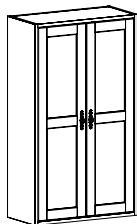

Description

- Standard With: No Molding, Two (2) Wood-Framed Soft-Close Doors with Wood Inserts, One (1) Fixed Shelf, and Two (2) Adjustable Shelves
- Available with Premium Veneer (PV) or Standard Veneer (W); Must Specify
- **Must Specify Top and Base for Freestanding Applications; Order Separately (See Tops and Bases)**
- Additional Options: Molding on One or Both Sides (See Below)
- Recommended for Applications Against a Wall

Molding Options: Specify & Add

| | | |
|-------|--------------------------------|--------|
| M46L1 | Molding on Left Side Only | \$ 85 |
| M46R1 | Molding on Right Side Only | \$ 85 |
| M46LR | Molding on Left and Right Side | \$ 170 |

Must Specify (in this order):

Model #
Premium or Standard Veneer
Finish
Pull
Molding

| Item | Model No. | Width | Depth | Height | Ship Wt | Cubic Ft | List Price |
|---|-----------|-------|-------|--------|---------|----------|-----------------------|
| MODULAR BOOKCASE WITH DOORS AND GLASS INSERTS | 46-2952GB | 29 | 13½ | 50 | 123 | 14.6 | W\$ 3687 PV\$ 4130 |



Description

- Standard With: No Molding, Two (2) Wood-Framed Soft-Close Doors with Glass Inserts, One (1) Fixed Shelf, and Two (2) Adjustable Shelves
- Available with Premium Veneer (PV) or Standard Veneer (W); Must Specify
- Beveled Glass Inserts Available in Clear and Cracked Ice; Must Specify (See Below)
- **Must Specify Top and Base for Freestanding Applications; Order Separately (See Tops and Bases)**
- Additional Options: Molding on One or Both Sides (See Below); Glass Shelves (See Glass Shelf Options)
- Recommended for Applications Against a Wall

Beveled Glass Options: Specify & Add

| | | |
|------|---------------------------|---------|
| 1-CL | Clear Glass Inserts | N/C |
| 1-CR | Cracked Ice Glass Inserts | \$ 1040 |

Molding Options: Specify & Add

| | | |
|-------|--------------------------------|--------|
| M46L1 | Molding on Left Side Only | \$ 85 |
| M46R1 | Molding on Right Side Only | \$ 85 |
| M46LR | Molding on Left and Right Side | \$ 170 |

Must Specify (in this order):

- Model #
- Premium or Standard Veneer Finish
- Pull
- Beveled Glass Design
- Molding
- Glass Shelves

| | | | | | | | |
|--|-----------|----|-----|----|----|------|-----------------------|
| MODULAR BOOKCASE WITH DOORS AND MESH INSERTS | 46-2952MB | 29 | 13½ | 50 | 97 | 14.6 | W\$ 3141 PV\$ 3519 |
|--|-----------|----|-----|----|----|------|-----------------------|

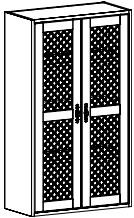

Description

- Standard With: No Molding, Two (2) Wood-Framed Soft-Close Doors with Mesh Inserts, One (1) Fixed Shelf, and Two (2) Adjustable Shelves
- Available in Premium Veneer (PV) or Standard Veneer (W); Must Specify
- Mesh Grille Inserts Available in Antique Brass and Silver; Must Specify (See Below)
- **Must Specify Top and Base for Freestanding Applications; Order Separately (See Tops and Bases)**
- Additional Options: Molding on One or Both Sides (See Below); Glass Shelves (See Glass Shelf Options)
- Recommended for Applications Against a Wall

Mesh Grille Options: Specify & Add

| | | |
|------|--|--------|
| 1-BM | Antique Brass Mesh Grille Insert <i>Only available when a Brass Pull is specified</i> | N/C |
| 1-AM | Silver Mesh Grille Insert <i>Only available when Liberty Pull (ALB) is specified</i> | \$ 782 |

Molding Options: Specify & Add

| | | |
|-------|--------------------------------|--------|
| M46L1 | Molding on Left Side Only | \$ 85 |
| M46R1 | Molding on Right Side Only | \$ 85 |
| M46LR | Molding on Left and Right Side | \$ 170 |

Must Specify (in this order):

- Model #
- Premium or Standard Veneer Finish
- Pull/Mesh Grille Color
- Molding
- Glass Shelves

[See Jefferson Intro Section for Ordering Options](#)

| Item | Model No. | Width | Depth | Height | K | R | Ship Wt | Cubic Ft | List Price |
|---|---|-------|-------|--------|----|---|---------|----------|---------------------------|
| HEIGHT ADJUSTABLE DOUBLE PED DESK TRAY/BOX/FILE | TOP OVERHANG FEATURE | | | | | | | | |
| | 46-3672DPSSTS | 72 | 36 | 30-45 | 16 | 3 | 530 | 50.4 | W/P\$ 12331 PV\$ 13812 |
| | <i>Chassis 66W x 30D - Letter Ped; Approach Overhang 6", Side Overhang 4"</i> | | | | | | | | |
|  | STANDARD TOP | | | | | | | | |
| | 46-3066DPSSTS | 66 | 30 | 30-45 | 16 | 3 | 495 | 38.7 | W/P\$ 12086 PV\$ 13538 |
| | <i>Letter Ped</i> | | | | | | | | |

Description

- Standard with: Stepped Front, Rectangle Top Profiled on All Sides, Base Molding on All Sides, Decorative Molding on Approach and Both Sides, Locking Tray/Box/File Peds, Left-to-Right Grain Direction on Top, 2-Channel Leg Configuration for Single Surface Height Adjustment, Standard Up/Down Control Switch, and Dovetail Wood Drawer Construction
- Chassis Available with Premium Veneer (PV) or Standard Veneer (W); Must Specify
- Top Available with Premium/Standard Veneer (PV/W) or HPL (P); Must Specify
- Lock Core Color will Coordinate with Pull Selection (Brass Pull with Black Lock, Silver Pull with Silver Lock)
- Wire Management Box Available; Attaches to Bottom Side of Worksurface and Moves Up/Down with Worksurface to Hide Cords/Wires from Top to Chassis ([See Top Grommet Options](#))
- Additional Options: No Decorative Molding (Specify NO MOLDING); Advanced (Memory/Up/Down) Control Switch ([See Switch Options](#)); Soft Close Drawer Closure ([See Soft Close Options](#)); Wire Management + Accessories (Order Separately; [See Multiple Unit Details](#))

Approach Side Shown with Decorative Molding and Optional No Molding

Left Shown with Wire Management Box and Center Grommet

Must Specify (in this order):

- Model #
- Premium or Standard Veneer
- Top Material
- Finish/Color
- Pull
- No Molding
- Drawer Track
- Control Switch
- Top Grommet Location/Color

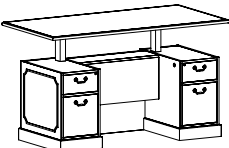
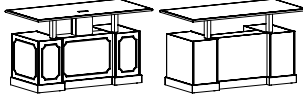
| | | | | | | | | | |
|---|---|----|----|-------|----|---|-----|------|---------------------------|
| HEIGHT ADJUSTABLE DOUBLE PED DESK BOX/FILE | RECESSED MODESTY WITH TOP OVERHANG FEATURE | | | | | | | | |
| | 46-3672DPSTS | 72 | 36 | 30-45 | 16 | 3 | 525 | 50.4 | W/P\$ 11958 PV\$ 13390 |
| | <i>Chassis 66W x 30D - Letter Ped; Approach Overhang 6", Side Overhang 4"</i> | | | | | | | | |
|  | STANDARD TOP + MODESTY | | | | | | | | |
| | 46-3672CHSTS | 72 | 36 | 30-45 | 16 | 3 | 557 | 50.4 | W/P\$ 14381 PV\$ 16108 |
| | <i>Legal Ped</i> | | | | | | | | |
|  | 46-3066DPSTS | 66 | 30 | 30-45 | 16 | 3 | 490 | 38.7 | W/P\$ 11682 PV\$ 13082 |
| | <i>Letter Ped</i> | | | | | | | | |

Description

- Standard with: Stepped Front, Rectangle Top Profiled on All Sides, Base Molding on All Sides, Decorative Molding on Approach and Both Sides, Locking Box/File Peds, Left-to-Right Grain Direction on Top, 2-Channel Leg Configuration for Single Surface Height Adjustment, Standard Up/Down Control Switch, and Dovetail Wood Drawer Construction
- Chassis Available with Premium Veneer (PV) or Standard Veneer (W); Must Specify
- Top Available with Premium/Standard Veneer (PV/W) or HPL (P); Must Specify
- Lock Core Color will Coordinate with Pull Selection (Brass Pull with Black Lock, Silver Pull with Silver Lock)
- Wire Management Box Available; Attaches to Bottom Side of Worksurface and Moves Up/Down with Worksurface to Hide Cords/Wires from Top to Chassis ([See Top Grommet Options](#))
- Additional Options: No Decorative Molding (Specify NO MOLDING); Advanced (Memory/Up/Down) Control Switch ([See Switch Options](#)); Soft Close Drawer Closure ([See Soft Close Options](#)); Wire Management + Accessories (Order Separately; [See Multiple Unit Details](#))

Approach Side Shown with Decorative Molding and Optional No Molding

Left Shown with Wire Management Box and Center Grommet

Must Specify (in this order):

- Model #
- Premium or Standard Veneer
- Top Material
- Finish/Color
- Pull
- No Molding
- Drawer Track
- Control Switch
- Top Grommet Location/Color

| Item | Model No. | Width | Depth | Height | K | R | Ship Wt | Cubic Ft | List Price | |
|--|------------------------------------|------------------|-------|--------|-------|----|---------|----------|------------|---------------------------|
| HEIGHT ADJUSTABLE SINGLE PED DESK TRAY/BOX/FILE | Left Ped | Right Ped | | | | | | | | |
| | 46-3672LPSSTS <i>Legal Ped</i> | 46-3672RPSSTS | 72 | 36 | 30-45 | 16 | 3 | 435 | 50.4 | W/P\$ 11917 PV\$ 13348 |
| | 46-3066LPSSTS <i>Letter Ped</i> | 46-3066RPSSTS | 66 | 30 | 30-45 | 16 | 3 | 285 | 38.7 | W/P\$ 11340 PV\$ 12702 |

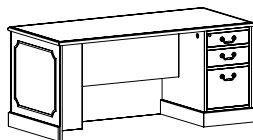

Shown as Right

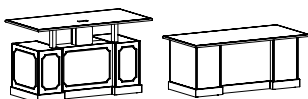

Approach Side Shown with Decorative Molding and Optional No Molding

Left Shown with Wire Management Box and Center Grommet

Must Specify (in this order):

- Model #
- Premium or Standard Veneer
- Top Material
- Finish/Color
- Pull
- No Molding
- Drawer Track
- Leg Configuration
- Control Switch
- Top Grommet Location/Color

Description

- Standard with: Stepped Front, Rectangle Top Profiled on All Sides, Base Molding on All Sides, Decorative Molding on Approach and Both Sides, Locking Tray/Box/File Ped, Left-to-Right Grain Direction on Top, 2-Channel Leg Configuration for Single Surface Height Adjustment, Standard Up/Down Control Switch, and Dovetail Wood Drawer Construction
- Chassis Available with Premium Veneer (PV) or Standard Veneer (W); Must Specify
- Top Available with Premium/Standard Veneer (PV/W) or HPL (P); Must Specify
- Lock Core Color will Coordinate with Pull Selection (Brass Pull with Black Lock, Silver Pull with Silver Lock)
- Stationary Returns and Bridges Available for Use with Single Ped Desks, [See Stationary Return](#) and [Stationary Bridge](#)
- Optional 3-Channel Leg Configuration (STS3) for Use with 3-Channel Returns; [See Option Details](#) and [See 3-Channel Units](#)
- Wire Management Box Available; Attaches to Bottom Side of Worksurface and Moves Up/Down with Worksurface to Hide Cords/Wires from Top to Chassis ([See Top Grommet Options](#))
- Additional Options: No Decorative Molding (Specify NO MOLDING); Advanced (Memory/Up/Down) Control Switch ([See Switch Options](#)); Soft Close Drawer Closure ([See Soft Close Options](#)); Wire Management + Accessories (Order Separately; [See Multiple Unit Details](#))

| Item | Model No. | Width | Depth | Height | K | R | Ship Wt | Cubic Ft | List Price | |
|---|-----------------------------------|------------------|-------|--------|-------|----|---------|----------|------------|---------------------------|
| HEIGHT ADJUSTABLE SINGLE PED DESK BOX/FILE | Left Ped | Right Ped | | | | | | | | |
| | 46-3672LPSTS <i>Legal Ped</i> | 46-3672RPSTS | 72 | 36 | 30-45 | 16 | 3 | 430 | 50.4 | W/P\$ 11552 PV\$ 12936 |
| | 46-3066LPSTS <i>Letter Ped</i> | 46-3066RPSTS | 66 | 30 | 30-45 | 16 | 3 | 280 | 38.7 | W/P\$ 10973 PV\$ 12291 |

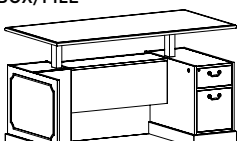

Shown as Right

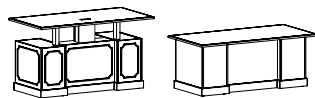

Approach Side Shown with Decorative Molding and Optional No Molding

Left Shown with Wire Management Box and Center Grommet

Must Specify (in this order):

- Model #
- Premium or Standard Veneer
- Top Material
- Finish/Color
- Pull
- No Molding
- Drawer Track
- Leg Configuration
- Control Switch
- Top Grommet Location/Color

Description

- Standard with: Stepped Front, Rectangle Top Profiled on All Sides, Base Molding on All Sides, Decorative Molding on Approach and Both Sides, Locking Box/File Ped, Left-to-Right Grain Direction on Top, 2-Channel Leg Configuration for Single Surface Height Adjustment, Standard Up/Down Control Switch, and Dovetail Wood Drawer Construction
- Chassis Available with Premium Veneer (PV) or Standard Veneer (W); Must Specify
- Top Available with Premium/Standard Veneer (PV/W) or HPL (P); Must Specify
- Lock Core Color will Coordinate with Pull Selection (Brass Pull with Black Lock, Silver Pull with Silver Lock)
- Stationary Returns and Bridges Available for Use with Single Ped Desks, [See Stationary Return](#) and [Stationary Bridge](#)
- Optional 3-Channel Leg Configuration (STS3) for Use with 3-Channel Returns; [See Option Details](#) and [See 3-Channel Units](#)
- Wire Management Box Available; Attaches to Bottom Side of Worksurface and Moves Up/Down with Worksurface to Hide Cords/Wires from Top to Chassis ([See Top Grommet Options](#))
- Additional Options: No Decorative Molding (Specify NO MOLDING); Advanced (Memory/Up/Down) Control Switch ([See Switch Options](#)); Soft Close Drawer Closure ([See Soft Close Options](#)); Wire Management + Accessories (Order Separately; [See Multiple Unit Details](#))

[See Jefferson Intro Section for Ordering Options](#)

| Item | Model No. | Width | Depth | Height | K | R | Ship Wt | Cubic Ft | List Price | |
|--|-----------------|------------------|-------|--------|-------|----|---------|----------|------------|--------------------------|
| HEIGHT ADJUSTABLE RETURN WITH FILE/FILE | Left Ped | Right Ped | | | | | | | | |
| | 46-2448LF2STS | 46-2448RF2STS | 48 | 24 | 30-45 | 13 | - | 237 | 21.8 | W/P\$ 9891 PV\$ 11080 |
| 2-CHANNEL, FOR ONE WORKSURFACE | 46-2442LF2STS | 46-2442RF2STS | 42 | 24 | 30-45 | 13 | - | 237 | 20.4 | W/P\$ 9842 PV\$ 11024 |

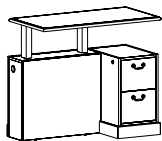

Shown as Right

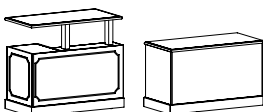

Approach Shown with and without Decorative Molding

Must Specify (in this order):

- Model #
- Premium or Standard Veneer
- Top Material
- Finish/Color
- Pull
- No Molding
- Locking
- Drawer Track
- Control Switch
- Top Grommet Location/Color
- Modesty Grommet

Description

- Standard with: Rectangle Top Profiled on All Sides, Base Molding on All Sides, Decorative Molding on Approach and Side, File/File Ped, Worksurface Grommet, Front-To-Back Grain Direction on Top, 2-Channel Leg Configuration for Single Surface Height Adjustment, Standard Up/Down Control Switch, Wire Management from Pedestal to Kneespace, and Dovetail Wood Drawer Construction
- Note: Surface is 1/8" Short on Connecting Side
- Chassis Available with Premium Veneer (PV) or Standard Veneer (W); Must Specify
- Top Available with Premium/Standard Veneer (PV/W) or HPL (P); Must Specify
- Optional Modesty Grommet for Wire Management to Wall; Must Specify: Black (GMBBL), Silver (GMBSV) or None (NONE)
- Wire Management Box Available; Attaches to Bottom Side of Worksurface and Moves Up/Down with Worksurface to Hide Cords/Wires from Top to Chassis ([See Top Grommet Options](#))
- Additional Options: No Decorative Molding (Specify NO MOLDING); Locking Pedestal ([See Locking Options](#)); Advanced (Memory/Up/Down) Control Switch ([See Switch Options](#)); Soft Close Drawer Closure ([See Soft Close Options](#)); Wire Management + Accessories (Order Separately; [See Multiple Unit Details](#))

| | | | | | | | | | | |
|--|-----------------|------------------|----|----|-------|----|---|-----|------|-------------------------|
| HEIGHT ADJUSTABLE RETURN WITH FILE/FILE FOR MULTIPLE SURFACES | Left Ped | Right Ped | | | | | | | | |
| | 46-2448LF2STS3 | 46-2448RF2STS3 | 48 | 24 | 30-45 | 22 | - | 237 | 21.8 | W/P\$ 7474 PV\$ 8372 |
| 3-CHANNEL, FOR TWO SIMULTANEOUS WORKSURFACES | 46-2442LF2STS3 | 46-2442RF2STS3 | 42 | 24 | 30-45 | 22 | - | 237 | 20.4 | W/P\$ 7424 PV\$ 8314 |

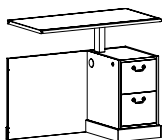

Shown as Right

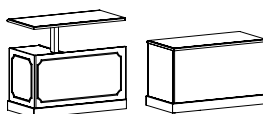

Approach Shown with and without Decorative Molding

Must Specify (in this order):

- Model #
- Premium or Standard Veneer
- Top Material
- Finish/Color
- Pull
- No Molding
- Locking
- Drawer Track
- Top Grommet Location/Color
- Modesty Grommet

Description

- Standard with: Rectangle Top Profiled on Approach and User Sides with Reverse Profile on Connecting Side, Base Molding on All Sides, Decorative Molding on Approach and Side, File/File Ped, Front-To-Back Grain Direction on Top, 3-Channel Leg Configuration for Simultaneous Surface Height Adjustment Across Two Units, Wire Management from Pedestal to Kneespace, and Dovetail Wood Drawer Construction
- Chassis Available with Premium Veneer (PV) or Standard Veneer (W); Must Specify
- Top Available with Premium/Standard Veneer (PV/W) or HPL (P); Must Specify
- **Must Be Used with Height Adjustable Single Pedestal Desk (Order Separately, [See Single Ped Desks](#))**
- Control Switch Not Included, Will Be On Adjoining Unit
- Optional Modesty Grommet for Wire Management to Wall; Must Specify: Black (GMBBL), Silver (GMBSV) or None (NONE)
- Optional Worksurface Grommet with or without Mesh Wire Management Sleeve Available Over Ped Only; 6" from Ends and 20" from User; Must Specify Location and Color: GL or GL-MESH for Left or GR or GR-MESH for Right; Color Options: Black (BLK) or Silver (SLV); [See Grommet Options](#)
- Monitor Arms not Available on this Unit
- Additional Options: No Decorative Molding (Specify NO MOLDING); Locking Pedestal ([See Locking Options](#)); Soft Close Drawer Closure ([See Soft Close Options](#)); Wire Management + Accessories (Order Separately; [See Multiple Unit Details](#))

| Item | Model No. | Width | Depth | Height | K | R | Ship Wt | Cubic Ft | List Price | |
|----------------------------------|-----------------|------------------|-------|--------|----|----|---------|----------|------------|-------------------------|
| STATIONARY RETURN WITH FILE/FILE | Left Ped | Right Ped | | | | | | | | |
| | 46-2448LF2SR | 46-2448RF2SR | 48 | 24 | 30 | 22 | - | 165 | 21.8 | W/P\$ 4888 PV\$ 5474 |
| | 46-2442LF2SR | 46-2442RF2SR | 42 | 24 | 30 | 22 | - | 110 | 20.4 | W/P\$ 4836 PV\$ 5415 |

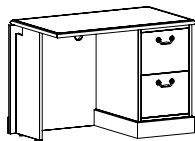

Shown as Right

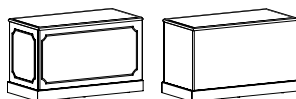

Approach Side Shown with Decorative Molding and Optional No Molding

Must Specify (in this order):

- Model #
- Premium or Standard Veneer
- Top Material
- Finish/Color
- Pull
- No Molding
- Locking
- Drawer Track
- Locking Pedestal
- Top Grommet Location/Color
- Modesty Grommet
- Kneespace Options

Description

- Standard with: Rectangle Top Profiled on All Sides, Base Molding on All Sides, Decorative Molding on Approach and Side, File/File Ped, Front-To-Back Grain Direction on Top, Wire Management from Pedestal to Kneespace, and Dovetail Wood Drawer Construction
- Note: Surface is 1/8" Short on Connecting Side
- Chassis Available with Premium Veneer (PV) or Standard Veneer (W); Must Specify
- Top Available with Premium/Standard Veneer (PV/W) or HPL (P); Must Specify
- **Must Be Used with Height Adjustable Single Pedestal Desk (Order Separately, See Single Ped Desks)**
- Additional Options: No Decorative Molding (Specify NO MOLDING); Kneespace Options (See Multiple Unit Details); Locking Pedestal (See Locking Options); Soft Close Drawer Closure (See Soft Close Options); Top Grommet Options (See Top Grommet Options); Wire Management + Accessories (Order Separately; See Multiple Unit Details)

| | | | | | | | | | |
|--------------------------------|--------------|----|----|-------|----|---|-----|------|-------------------------|
| HEIGHT ADJUSTABLE BRIDGE | 46-2448UFSTS | 48 | 24 | 30-45 | 13 | - | 250 | 24.0 | W/P\$ 7428 PV\$ 8318 |
| 2-CHANNEL, FOR ONE WORKSURFACE | 46-2442UFSTS | 42 | 24 | 30-45 | 13 | - | 230 | 21.8 | W/P\$ 7299 PV\$ 8177 |

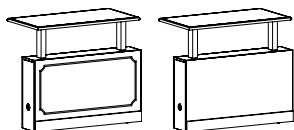
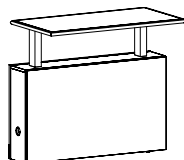

Approach Shown with and without Decorative Molding

Must Specify (in this order):

- Model #
- Premium or Standard Veneer
- Top Material
- Finish/Color
- No Molding
- Top Grommet Location/Color
- Modesty Grommet
- Control Switch
- Kneespace Options

Description

- Standard with: Rectangle Top Profiled on All Sides, Base Molding on Back Side, Decorative Molding on Approach, Front-To-Back Grain Direction on Top, 2-Channel Leg Configuration for Single Surface Height Adjustment, and Standard Up/Down Control Switch (Field Installed)
- Note: Surface is 1/8" Short on Both Connecting Sides to Prevent Contact Between Tops
- Chassis Available with Premium Veneer (PV) or Standard Veneer (W); Must Specify
- Top Available with Premium/Standard Veneer (PV/W) or HPL (P); Must Specify
- Control Switch Standard (Up/Down) or Upgrade to Advanced Switch (MSWCH-Up/Down/Memory); Switch is Field Installed; See Switch Options
- Optional Modesty Grommet for Wire Management to Wall; Must Specify: Black (GMBBL), Silver (GMBSV) or None (NONE)
- Optional Worksurface Grommet with or without Mesh Wire Management Sleeve or Wire Management Box Available On Center Only (See Top Grommet Options)
- Additional Options: No Decorative Molding (Specify NO MOLDING); Kneespace Options (See Multiple Unit Details); Advanced (Memory/Up/Down) Control Switch (See Switch Options); Soft Close Drawer Closure (See Soft Close Options); Wire Management + Accessories (Order Separately; See Multiple Unit Details)

See Jefferson Intro Section for Ordering Options

| Item | Model No. | Width | Depth | Height | K | R | Ship Wt | Cubic Ft | List Price | |
|--|----------------|----------------|-------|--------|-------|----|---------|----------|------------|-------------------------|
| HEIGHT ADJUSTABLE BRIDGE FOR MULTIPLE SURFACES | Left | Right | | | | | | | | |
| | 46-2448UFSTSL3 | 46-2448UFSTSR3 | 48 | 24 | 30-45 | 13 | - | 250 | 24.0 | W/P\$ 6238 PV\$ 7128 |
| 3-CHANNEL, FOR TWO SIMULTANEOUS WORKSURFACES | 46-2442UFSTSL3 | 46-2442UFSTSR3 | 42 | 24 | 30-45 | 13 | - | 230 | 21.8 | W/P\$ 6109 PV\$ 6986 |

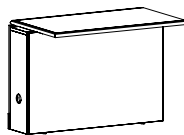

SIN PENDING

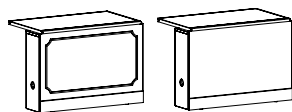

Approach Shown with and without Decorative Molding

Must Specify (in this order):

- Model #
- Premium or Standard Veneer
- Top Material
- Finish/Color
- No Molding
- Top Grommet Location/Color
- Modesty Grommet
- Control Switch
- Kneespace Options

Description

- Standard with: Rectangle Top Profiled on All Sides, Base Molding on Back Side, Decorative Molding on Approach, Front-To-Back Grain Direction on Top, 3-Channel Leg Configuration for Multiple Surface Height Adjustment
- Note: Surface is 1/8" Short on Both Connecting Sides to Prevent Contact Between Tops
- Chassis Available with Premium Veneer (PV) or Standard Veneer (W); Must Specify
- Top Available with Premium/Standard Veneer (PV/W) or HPL (P); Must Specify
- Control Switch Not Included; Control Switch will be on Adjoining Unit
- Optional Modesty Grommet for Wire Management to Wall; Must Specify: Black (GMBBL), Silver (GMBSV) or None (NONE)
- Optional Worksurface Grommet with Mesh Wire Management Sleeve or Wire Management Box Available On Center Only ([See Options](#))
- Additional Options: No Decorative Molding (Specify NO MOLDING); Wire Management + Accessories (Order Separately; [See Multiple Unit Details](#))

STATIONARY BRIDGE FULL MODESTY

| | Left Attachment | Right Attachment | Width | Depth | Height | K | R | Ship Wt | Cubic Ft | List Price |
|--|-----------------|------------------|-------|-------|--------|----|---|---------|----------|-------------------------|
| | 46-2448SUFL | 46-2448SUFR | 48 | 24 | 30 | 22 | - | 89 | 5.5 | W/P\$ 2421 PV\$ 2712 |
| | 46-2442SUFL | 46-2442SUFR | 42 | 24 | 30 | 22 | - | 89 | 5.5 | W/P\$ 2296 PV\$ 2570 |

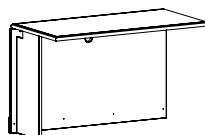

Shown as Right

Must Specify (in this order):

- Model #
- Premium or Standard Veneer
- Top Material
- Finish/Color
- No Molding
- Top Grommet Location/Color

Description

- Standard with: Rectangle Top Profiled on Approach and User Sides with Reverse Profile on Connecting Side (To Credenza), Base Molding on Back Side, Decorative Molding on Approach, and Front-To-Back Grain Direction on Top
- Note: Surface is 1/8" Short on Connecting Side to Prevent Contact Between Tops
- Chassis Available with Premium Veneer (PV) or Standard Veneer (W); Must Specify
- Top Available with Premium/Standard Veneer (PV/W) or HPL (P); Must Specify
- **Must Be Used with Height Adjustable Single Pedestal Desk (Order Separately, [See Single Ped Desks](#))**
- Additional Options: No Decorative Molding (Specify NO MOLDING); Top Grommet Options ([See Top Grommet Options](#)); Kneespace Options (Order Separately; Available for Field Installation Only; [See Multiple Unit Details](#)); Wire Management + Accessories (Order Separately; [See Multiple Unit Details](#))

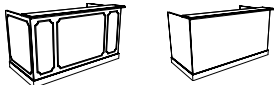
| Item | Model No. | Width | Depth | Height | K | R | Ship Wt | Cubic Ft | List Price | |
|--|--|------------------|-------|--------|----|-----|---------|----------|------------|-------------------------|
| SINGLE PED RECEPTION DESK BOX/BOX/FILE  <p>Shown as Left</p>  <p>Approach Side Shown with Decorative Molding and Optional No Molding</p> <p><u>Must Specify (in this order):</u> Model # Premium or Standard Veneer Top Material Finish/Color Pull No Molding Drawer Track Top Grommet Location/Color Flip Down Center Drawer Tackboard/Fabric</p> | Left Ped | Right Ped | | | | | | | | |
| | 46-3672RPD1L | 46-3672RPD1R | 74 | 39 | 42 | 28¼ | - | 374 | 76.3 | W/P\$ 8254 PV\$ 9245 |
| | <i>Worksurface 70W x 34½D; Legal Ped</i> | | | | | | | | | |
| | 46-3066RPD1L | 46-3066RPD1R | 68 | 33 | 42 | 25¼ | - | 327 | 59.9 | W/P\$ 7545 PV\$ 8453 |
| <i>Worksurface 64W x 28½D; Letter Ped</i> | | | | | | | | | | |

Description

- Standard with: Transaction Surface Profiled on All Sides, Rectangle User Surface with Square Profile, Base Molding on All Sides, Decorative Molding on Approach and Both Sides, Central Locking Center Drawer, Box/Box/File Ped, Left-to-Right Grain Direction on Top, and Dovetail Wood Drawer Construction
- Chassis Available with Premium Veneer (PV) or Standard Veneer (W); Must Specify
- Top/Transaction Available with Premium/Standard Veneer (PV/W) or HPL (P); Must Specify
- Lock Core Color will Coordinate with Pull Selection (Brass Pull with Black Lock, Silver Pull with Silver Lock)
- Additional Options: No Decorative Molding (Specify NO MOLDING); Keyboard Flip Down Center Drawer (Order Separately, [See Center Drawer](#)); Factory-Installed Tackboard ([See Tackboards](#)); Soft Close Drawer Closure ([See Soft Close Drawer Option](#)); Top Grommet Options ([See Grommet Options](#)); Wire Management + Accessories (Order Separately; [See Multiple Unit Details](#))

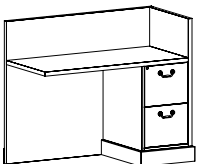
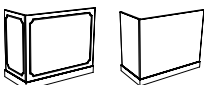
| Item | Model No. | Width | Depth | Height | K | R | Ship Wt | Cubic Ft | List Price | |
|--|--------------------------------|------------------|-------|--------|-----|-----|---------|----------|------------|-------------------------|
| RECEPTION RETURN FILE/FILE  <p>Shown as Right</p>  <p>Approach Side Shown with Decorative Molding and Optional No Molding</p> <p><u>Must Specify (in this order):</u> Model # Premium or Standard Veneer Top Material Finish/Color Pull No Molding Drawer Track Top Grommet Location/Color</p> | Left Ped | Right Ped | | | | | | | | |
| | 46-2448RPD2L | 46-2448RPD2R | 48 | 24 | 40¾ | 28¼ | - | 195 | 33.3 | W/P\$ 5520 PV\$ 6183 |
| | <i>Worksurface 46¼W x 21½D</i> | | | | | | | | | |

Description

- Standard with: Rectangle Top with Square Profile, Base Molding on All Sides, Decorative Molding on Approach and Side, Locking File/File Ped, Front-To-Back Grain Direction on Top, and Dovetail Wood Drawer Construction
- Chassis Available with Premium Veneer (PV) or Standard Veneer (W); Must Specify
- Top Available with Premium/Standard Veneer (PV/W) or HPL (P); Must Specify
- Additional Options: No Decorative Molding (Specify NO MOLDING); Soft Close Drawer Closure ([See Soft Close Drawer Option](#)); Keyboard Flip Down Center Drawer (Order Separately, [See Center Drawer](#)); Top Grommet Options ([See Grommet Options](#)); Wire Management + Accessories (Order Separately; [See Multiple Unit Details](#))

[See Jefferson Intro Section for Ordering Options](#)

| Item | Model No. | Width | Depth | Height | K | R | Ship Wt | Cubic Ft | List Price |
|------------------|---|-------|-------|--------|----|---|---------|----------|-------------------------|
| RECEPTION BRIDGE | 46-2448RUF <i>Worksurface 48W x 22¼D</i> | 48 | 24 | 40⅞ | 48 | - | 116 | 7.3 | W/P\$ 2520 PV\$ 2821 |
| | 46-2442RUF <i>Worksurface 42W x 22¼D</i> | 42 | 24 | 40⅞ | 42 | - | 104 | 6.3 | W/P\$ 2373 PV\$ 2659 |

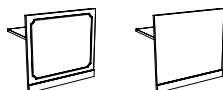
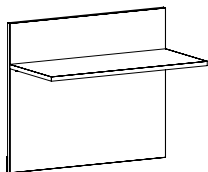

Approach Side Shown with Decorative Molding and Optional No Molding

Must Specify (in this order):

- Model #
- Premium or Standard Veneer
- Top Material
- Finish/Color
- No Molding
- Top Grommet Location/Color

Description

- Standard With: Rectangle Top with Square Profile, Front-to-Back Grain Direction on Top, and Hinged Back Panel
- Chassis Available with Premium Veneer (PV) or Standard Veneer (W); Must Specify
- Top Available with Premium/Standard Veneer (PV/W) or HPL (P); Must Specify
- Additional Options: No Decorative Molding (Specify No Molding); Kneespace Options ([See Multiple Unit Details](#); Available for Field Installation Only); Top Grommet Options ([See Grommet Options](#)); Wire Management + Accessories (Order Separately; [See Multiple Unit Details](#))

| SINGLE PED RECEPTION CREDENZA FILE/FILE | Left Ped | Right Ped | Width | Depth | Height | K | R | Ship Wt | Cubic Ft | List Price |
|---|--|------------|-------|-------|--------|-----|---|---------|----------|-------------------------|
| | Model No. | Model No. | | | | | | | | |
|  | 46-2472RCL <i>Worksurface 70W x 22D; Legal Ped</i> | 46-2472RCR | 72 | 24 | 40⅞ | 32¼ | - | 264 | 46.8 | W/P\$ 6612 PV\$ 7405 |
| | 46-2466RCL <i>Worksurface 64W x 22D; Letter Ped</i> | 46-2466RCR | 66 | 24 | 40⅞ | 26¼ | - | 249 | 43.0 | W/P\$ 6509 PV\$ 7291 |

Shown as Right

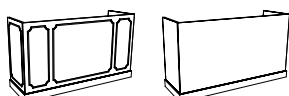

Approach Side Shown with Decorative Molding and Optional No Molding

Must Specify (in this order):

- Model #
- Premium or Standard Veneer
- Top Material
- Finish/Color
- Pull
- Back Panel Grommet Color
- No Molding
- Drawer Track
- Top Grommet Location/Color

Description

- Standard with: Rectangle Top with Square Profile, Base Molding on All Sides, Decorative Molding on Approach and Both Sides, Locking File/File Ped, Left-to-Right Grain Direction on Top, and Dovetail Wood Drawer Construction
- Chassis Available with Premium Veneer (PV) or Standard Veneer (W); Must Specify
- Top Available with Premium/Standard Veneer (PV/W) or HPL (P); Must Specify
- Lock Core Color will Coordinate with Pull Selection (Brass Pull with Black Lock, Silver Pull with Silver Lock)
- Additional Options: No Decorative Molding (Specify NO MOLDING); Soft Close Drawer Closure ([See Soft Close Drawer Option](#)); Kneespace Options ([See Multiple Unit Details](#); Available for Field Installation Only); Top Grommet Options ([See Grommet Options](#)); Wire Management + Accessories (Order Separately; [See Multiple Unit Details](#))

| Item | Model No. | | Width | Depth | Height | Ship Wt | Cubic Ft | List Price |
|---------------------|-----------|--------|-------------------|-------------------|--------|---------|----------|------------|
| ROUND GROMMET COVER | 01-GRMTBK | Black | 2 $\frac{1}{2}$ " | 2 $\frac{1}{2}$ " | - | 1 | 0.1 | \$ 11 |
| | 01-GRMTSL | Silver | | | | | | |



OPEN MARKET ONLY
(SILVER)

Must Specify (in this order):

Model #
Factory Installed

Description

- 2 $\frac{1}{2}$ " (60mm) Round Grommet Cover
- Field Installed

| | | | | | | | | |
|--------------------------|-------------|--------|---|---|---|---|-----|-------|
| SINGLE POWER SAND DOLLAR | 01-SAND60PW | White | 3 | 3 | 4 | 1 | 0.2 | \$ 98 |
| | 01-SAND60PB | Black | | | | | | |
| | 01-SAND60PS | Silver | | | | | | |

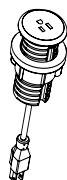

Description

- Available on Height Adjustable Desks, Returns and Bridge Units with Wire Management Box in Center Grommet Only (GC-BOX)
- Unit is 2" Diameter; Mounts in 60mm Round Grommet
- 6' Cord
- Single Power Outlet

| | | | | | | | | |
|------------------------|-------------|--------|---|---|---|---|-----|--------|
| DOUBLE USB SAND DOLLAR | 01-SAND60UW | White | 3 | 3 | 4 | 1 | 0.2 | \$ 277 |
| | 01-SAND60UB | Black | | | | | | |
| | 01-SAND60US | Silver | | | | | | |



Description

- Available on Height Adjustable Desks, Returns and Bridge Units with Wire Management Box in Center Grommet Only (GC-BOX)
- Unit is 2" Diameter; Mounts in 60mm Round Grommet
- 6' Cord
- Dual USB Outlets

| | | | | | | | | |
|--------------------------|---------------|--------|-------------------|---|---|---|-----|--------|
| DUO CLAMP WITH NEMA PLUG | 01-DUOCLAMPW | White | 5 $\frac{1}{2}$ " | 3 | 7 | 1 | 0.2 | \$ 572 |
| | 01-DUOCLAMPB | Black | | | | | | |
| | 01-DUOCLAMP S | Silver | | | | | | |

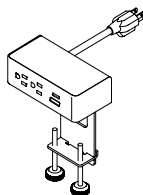

Description

- Standard with: Two (2) Power Outlet, **One (1) USB Charging Port and One (1) 60-Watt USB-C Power Delivery Port with GaN Technology with 10' Cord**
- Clamps to Top and Features Silver Metal Trim
- Independent USB Circuit Controllers Deliver up to 2.1 Amps to Each Post
- All Mounting Hardware Included
- FCC Part 15A and UL Approved for Horizontal and Vertical Applications

[See Jefferson Intro Section for Ordering Options](#)

| Item | Model No. | | Width | Depth | Height | Ship Wt | Cubic Ft | List Price |
|---------------------------|---------------|--------|-------|-------|--------|---------|----------|------------|
| TRIO CLAMP WITH NEMA PLUG | 01-TRIOCLAMPW | White | 8 | 3 | 7 | 1 | 0.2 | \$ 671 |
| | 01-TRIOCLAMPB | Black | | | | | | |
| | 01-TRIOCLAMPS | Silver | | | | | | |

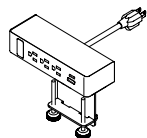

Description

- Standard with: Three (3) Power Outlets, **One (1) USB Charging Port**, **One (1) 60-Watt USB-C Power Delivery Port with GaN Technology**, One (1) Open Data, and 10' Cord
- Clamps to Top and Features Silver Metal Trim
- Independent USB Circuit Controllers Deliver up to 2.1 Amps to Each Post
- HDMI, VGA, or RJ45 Accessories Sold Separately (See Below)
- All Mounting Hardware Included
- FCC Part 15A and UL Approved for Horizontal and Vertical Applications

| | | | | | | | | |
|-------------------------|------------|--|---|---|---|---|-----|--------|
| VGA DATA PORT ACCESSORY | 01-LCOMVGA | | - | - | - | 1 | 0.2 | \$ 121 |
|-------------------------|------------|--|---|---|---|---|-----|--------|

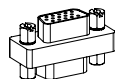

Description

- VGA Port for Trio Clamp Units

| | | | | | | | | |
|--------------------------|-------------|--|---|---|---|---|-----|--------|
| HDMI DATA PORT ACCESSORY | 01-LCOMHDMI | | - | - | - | 1 | 0.2 | \$ 166 |
|--------------------------|-------------|--|---|---|---|---|-----|--------|

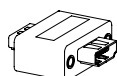

Description

- HDMI Port for Trio Clamp Units

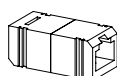

| | | | | | | | | |
|--------------------------|-------------|--|---|---|---|---|-----|-------|
| RJ45 DATA PORT ACCESSORY | 01-LCOMRJ45 | | - | - | - | 1 | 0.2 | \$ 79 |
|--------------------------|-------------|--|---|---|---|---|-----|-------|



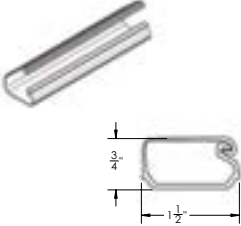
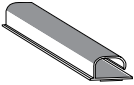
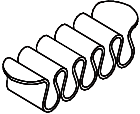
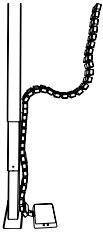

Description

- RJ45 Port for Trio Clamp Units

[See Jefferson Intro Section for Ordering Options](#)

| Item | Model No. | | Width | Depth | Height | Ship Wt | Cubic Ft | List Price |
|---|----------------|---|-------|-------|--------|---------|----------|------------|
| WIRE MANAGEMENT CHANNEL | 01-WMGR4 | | 16 | 1½ | 1 | 1 | - | \$ 116 |
|  | | <p>Description</p> <ul style="list-style-type: none"> • Set of Four (4) Black Plastic Wire Management Channels • Snap Lock Channel • Attaches with Adhesive Strips • Ships via UPS Only | | | | | | |
| WIRE CHANNEL | 01-32125 | | 24 | 1¾ | 1 | .25 | 0.3 | \$ 106 |
|  | | <p>Description</p> <ul style="list-style-type: none"> • Available in Black • Channels Attach with Two (2) Double-Sided Installation Tape • Open J Channel for Easy Storage of Cables | | | | | | |
| CABLE GRIP | 01-WMGRCB | | 5¾ | 2¾ | - | - | - | \$ 17 |
|  | | <p>Description</p> <ul style="list-style-type: none"> • Under Surface Wire Management • Black | | | | | | |
| LINK 360 CABLE MANAGER | 01-0251LINKSLV | Silver | 5¾ | 3¾ | 30-51 | 4 | 3.0 | \$ 390 |
| | 01-0251LINKBLK | Black | 5¾ | 3¾ | 30-51 | 4 | 3.0 | \$ 353 |
|  | | <p>Description</p> <ul style="list-style-type: none"> • Kit Includes: 50 Link 360™ elements, One (1) Quad Connector, One (1) Dumbbell Connector, One (1) Foot Assembly with Two (2) Magnetic Clips • Can Be Used For Height-Adjustable Mechanisms Up To 51" or Free-Standing Use | | | | | | |
| POWER STRIP | 01-PRSP | | 9 | 2 | 2 | 1 | - | \$ 205 |
|  | | <p>Description</p> <ul style="list-style-type: none"> • Four (4) Outlets and Two (2) Phone Jacks with Rocker Switch • Black Plastic with 10' Power Cord • Suitable for Surface or Recessed Mounting • 13 Amp Circuit Breaker • Two (2) 14 ft. Phone Hook Up Cords • UL and CSA Recognized • Item will ship via UPS only | | | | | | |

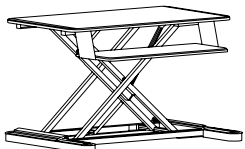
[See Jefferson Intro Section for Ordering Options](#)

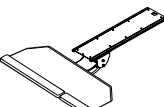
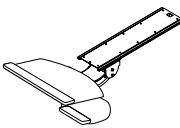
| Item | Model No. | Width | Depth | Height | Ship Wt | Cubic Ft | List Price | | |
|---|--|--------|-------------------|--------|---------|----------|----------------------|--|--|
| HEIGHT ADJUSTABLE WORKSTATION | 01-S2SBLK Black | 35½ | 25 | 6-22 | 49 | 6.5 | \$ 1503 | | |
|  | Description <ul style="list-style-type: none"> • Height Adjustable • Weight Capacity: 35lbs • One-Handed Operation; Platforms Move Simultaneously • Keyboard Platform: 10½"D x 26½"W • Worksurface: 21"D x 35½"W • Can be Used on Worksurface 24"D x 35"W | | | | | | | | |
| KEYBOARD FLIP DOWN CENTER DRAWER | 46-2410FD | 24 | 15 ¾ | 3 ⅙ | 12 | 2.0 | W\$ 988 PV\$ 1106 | | |
|  | Description <ul style="list-style-type: none"> • Flip Down Front • Available with Premium Veneer (PV) or Standard Veneer (W); Must Specify • Does Not Feature Soft Close Hinges • Use on Any Open Kneespace 24" or Larger • Field Installed <p><u>Must Specify (in this order):</u> Model # Premium or Standard Veneer Finish Pull Factory Installed</p> | | | | | | | | |
| ARTICULATING KEYBOARD CORNER PLATFORM | 01-KB2CC | 25 | 10½ | 4½ | 16 | 1.4 | \$ 832 | | |
|  | Description <ul style="list-style-type: none"> • Standard With: +/- 15° Tilt Adjustment , 360° Rotation, Independent Tilt Adjustment, 7" Lift and Lock Height Adjustment, 25" Cut Corner Platform • Keyboard and Mouse on same level; Single Palm Rest for both Left & Right Hands • Works with 17"+ Diagonal Work Surface • Cannot Be Used on 20" or 21" Deep Unit • Not Available with Optional Center Grommet • Track Measures 21" <p>Options: Specify & Add</p> <table border="0"> <tr> <td>KB2CC</td> <td>Factory Installed</td> <td>\$ 208</td> </tr> </table> | KB2CC | Factory Installed | \$ 208 | | | | | |
| KB2CC | Factory Installed | \$ 208 | | | | | | | |
| KEYBOARD MECHANISM WITH KEYBOARD CLAMP | 01-KB3 | 26½ | 14 | 4.5 | 16 | 1.4 | \$ 914 | | |
|  | Description <ul style="list-style-type: none"> • Standard With: 18.75" Platform with Swivel-Below Mouse Platform,+/- 15° Tilt Adjustment, 360° Rotation, 7" Lift and Lock Height Adjustment, Independent Tilt Adjustment, Palm Rest for Mousing Surface • Left or Right Handed Mouse Platform • Cannot Be Used on 20" or 21" Deep Unit • Not Available with Optional Center Grommet • Track Measures 21" <p>Options: Specify & Add</p> <table border="0"> <tr> <td>KB3</td> <td>Factory Installed</td> <td>\$ 208</td> </tr> </table> | KB3 | Factory Installed | \$ 208 | | | | | |
| KB3 | Factory Installed | \$ 208 | | | | | | | |

[See Jefferson Intro Section for Ordering Options](#)

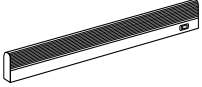
| Item | Model No. | Width | Depth | Height | Ship Wt | Cubic Ft | List Price |
|---|-------------------------------------|-------|-------|--------|---------|----------|------------|
|  | TL-0848 <i>240-LED, 18 Watts</i> | 47½ | 7/8 | 1½ | - | - | \$ 445 |
| | TL-0824 <i>84-LED, 7 Watts</i> | 22½ | 7/8 | 1½ | - | - | \$ 368 |

Description

- Includes the Power Supply and Three (3) Upper Wire Management Grommets
- Rocker Style On/Off Switch with a 10' Power Cord
- Three (3) Upper Wire Management Grommets; Must Specify Color: Black (BLK), Silver (SLV)

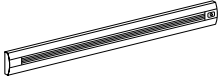
| Item | Model No. | Width | Depth | Height | Ship Wt | Cubic Ft | List Price |
|---|--|-------|-------|--------|---------|----------|------------|
|  | 01-188LED58 <i>96-LED, 33.7 Watts</i> | 57¾ | 2 | ¾ | - | - | \$ 1648 |
| | 01-94LED31 <i>48-LED, 17.6 Watts</i> | 30¾ | 2 | ¾ | - | - | \$ 1195 |
| | 01-47LED17 <i>24-LED, 9.1 Watts</i> | 16¾ | 2 | ¾ | - | - | \$ 690 |

Description

- Includes the Power Supply and Three (3) Upper Wire Management Grommets
- 12' Power Cord
- Three (3) Upper Wire Management Grommets; Must Specify Color: Black (BLK), Silver (SLV)
- Optional Occupancy Sensor Shuts Off After 30 Minutes of Inactivity and Turns On Immediately When Reentering the Detection Area

Options: Specify & Add

| | | |
|---------|------------------|--------|
| 01-OSRP | Occupancy Sensor | \$ 366 |
|---------|------------------|--------|

RECEPTION DESK TACKBOARDS
9" H



| Model # | For Units: | COM YDG | COM, 1, 2, or 3 | GRADES | | | | | | |
|---------|------------|---------|-----------------|--------|-----|-----|------|------|------|------|
| | | | | 4 | 5 | 6 | 7 | 8 | 9 | 10 |
| TB-6172 | 72"W | 2.25 | \$ 256 | 569 | 715 | 864 | 1075 | 1296 | 1552 | 1849 |
| TB-6166 | 66"W | 2.00 | \$ 232 | 510 | 640 | 772 | 960 | 1156 | 1384 | 1648 |

Must Specify (in this order):

Model #
Fabric Vendor, Pattern, and Color

Description

- Coordinates with Reception Desks
- Factory Installed

[See Jefferson Intro Section for Ordering Options](#)

SURFACE MOUNT HUTCH TACKBOARDS
20 1/2" H

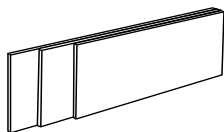

| Model # | For Units: | COM YDG | COM, 1, 2, or 3 | GRADES | | | | | | |
|----------|------------|---------|-----------------|--------|------|------|------|------|------|------|
| | | | | 4 | 5 | 6 | 7 | 8 | 9 | 10 |
| TB-4672H | 72"W | 2.25 | \$ 566 | 879 | 1025 | 1174 | 1385 | 1606 | 1862 | 2159 |
| TB-4666H | 66"W | 2.00 | \$ 533 | 811 | 941 | 1073 | 1261 | 1457 | 1685 | 1949 |

Description

- Coordinates with Standard and Tall Height Surface Mount Hutches
- Factory Installed

Must Specify (in this order):
Model #
Fabric Vendor, Pattern, and Color

VERTICAL HUTCH TACKBOARDS
21 1/2" H

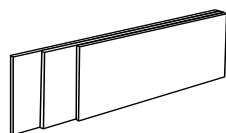

| Model # | For Units: | COM YDG | COM, 1, 2, or 3 | GRADES | | | | | | |
|-----------|------------|---------|-----------------|--------|-----|-----|-----|-----|------|------|
| | | | | 4 | 5 | 6 | 7 | 8 | 9 | 10 |
| TB-4672VH | 72"W | 1.25 | \$ 385 | 559 | 640 | 723 | 840 | 963 | 1105 | 1270 |
| TB-4666VH | 66"W | 1.25 | \$ 377 | 551 | 632 | 715 | 832 | 955 | 1097 | 1262 |

Description

- Coordinates with Vertical Hutches: TB-4672VH is compatible with 46-1572VH4G, 46-1572VH4O, 46-1572VH4W, and 46-1572VH4M; TB-4666VH is compatible with 46-1566VH4G, 46-1566VH4O, 46-1566VH4W, and 46-1566VH4M
- Factory Installed

Must Specify (in this order):
Model #
Fabric Vendor, Pattern, and Color

WALL MOUNT HUTCH TACKBOARDS
21 1/2" H

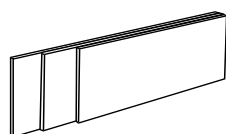

| Model # | For Units: | COM YDG | COM, 1, 2, or 3 | GRADES | | | | | | |
|----------|------------|---------|-----------------|--------|------|------|------|------|------|------|
| | | | | 4 | 5 | 6 | 7 | 8 | 9 | 10 |
| TB-0184W | 84"W | 2.50 | \$ 711 | 1059 | 1221 | 1386 | 1621 | 1866 | 2151 | 2481 |
| TB-0178W | 78"W | 2.50 | \$ 698 | 1046 | 1208 | 1373 | 1608 | 1853 | 2138 | 2468 |
| TB-0172W | 72"W | 2.25 | \$ 642 | 955 | 1101 | 1250 | 1461 | 1682 | 1938 | 2235 |
| TB-0166W | 66"W | 2.00 | \$ 609 | 887 | 1017 | 1149 | 1337 | 1533 | 1761 | 2025 |
| TB-0160W | 60"W | 2.00 | \$ 566 | 844 | 974 | 1106 | 1294 | 1490 | 1718 | 1982 |
| TB-0154W | 54"W | 1.75 | \$ 539 | 782 | 896 | 1012 | 1176 | 1348 | 1547 | 1778 |
| TB-0148W | 48"W | 1.50 | \$ 492 | 701 | 798 | 897 | 1038 | 1185 | 1356 | 1554 |
| TB-0142W | 42"W | 1.25 | \$ 446 | 620 | 701 | 784 | 901 | 1024 | 1166 | 1331 |
| TB-0136W | 36"W | 1.25 | \$ 434 | 608 | 689 | 772 | 889 | 1012 | 1154 | 1319 |

Description

- Coordinates with Wall Mount Hutches
- Factory Installed

Must Specify (in this order):
Model #
Fabric Vendor, Pattern, and Color

VESTA POWER CENTER

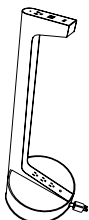

| | | | | | | |
|----------|--------|----|--------|----|-----|---------|
| 01-PDCTR | 10 3/4 | 12 | 28 3/4 | 14 | 2.5 | \$ 1776 |
|----------|--------|----|--------|----|-----|---------|

Description

- Top Includes One (1) Power Outlet, Two (2) USB Ports and One (1) USBC Port; Base Includes Three (3) Outlet
- Available in White
- 120" Power Cord
- Built with Weight Distribution for Optimal Stability
- Base is 5" Tall

[See Jefferson Intro Section for Ordering Options](#)

Madera creates a variety of looks from rich, refined transitional to fresh, modern contemporary by offering an abundance of options, including premium veneer. Finely crafted in select Cherry, Maple, Walnut, and Oak veneers, Madera features a UV topcoat on all exposed surfaces adding unsurpassed hardness and extreme durability for long lasting office applications.

CONSTRUCTION

Madera features a Veneer chassis with your choice of either a Veneer or HPL top. Units ship assembled unless otherwise noted.

VENEER

- Choose from premium veneer or select veneer on exposed surfaces in American Black Walnut, White Oak, Cherry, or Maple species
- The American Black Walnut, White Oak, and Cherry veneers are book matched veneer faces, while the Maple is a slip-matched veneer face
- These veneers are carefully selected and matched to assure proper balance and consistency

TOPS

- Tops are 1 3/16" thick
- Wood Veneer tops have a 5-ply balanced construction with hardwood rims
- High Pressure Laminate (HPL) tops have a 3-ply balanced construction with hardwood rims
- Tops featuring the Bullnose (D), Tri-Round (E), Fluted (X), and Square (Y) edge profiles have vertical profiles
- Tops featuring the Radius (A) and Bevel (B) edge profiles have the same construction, but provide a matching reverse profile on connecting edge
- Grain direction runs left to right unless otherwise noted

CHASSIS

- Chassis are securely fastened using high quality European style fastening systems and heavy-duty, 16-gauge joining brackets to assure maximum strength
- All units are equipped with heavy-duty, adjustable glides to ensure proper leveling and compensation for uneven floors
- Vertical grain direction unless otherwise noted

DRAWERS

- All drawers feature 5-sided construction allowing for easy removal of drawer fronts
- Fronts are 3-ply construction and are 3/4" thick with matched grain
- Drawer interiors are dovetail wood construction with 7/16" thick hardwood sides and backs and 5/32" thick hardboard bottoms
- The drawer interiors are sanded, sealed, and finished to provide a smooth, quality feel and appearance
- All drawers feature full extension, progressive action slides with precision steel ball bearings
- Box and file drawers are tested for 100lb capacity
- Lateral files feature 1/4" thick bottoms. Drawers are tested for 200lb of equally distributed weight (ex: hanging file folders) and 65lbs of bottom load weight (ex: stacked catalogs)
- All suspensions have a limited lifetime warranty

FILING

- All file drawers are standard with filing systems designed to accommodate a variety of filing requirements
- Letter width file drawers provide letter filing front to back and legal filing side to side
- Lateral file drawers provide legal or letter filing front to back or side to side

STORAGE

- All hinged doors include soft close hinges, unless otherwise noted
- One piece hinge and base plate combination
- Soft close hinges reduce stress placed on the cabinet when the door is closed and offers a quiet closure

LOCKING

- All units feature locking file drawers
- Removable lock cylinders allow for units to be re-keyed at a later date, if required
- Units are shipped randomly keyed as standard
- Keyed alike units available upon request at no additional charge
- Lock core color will match pull color

CORD MANAGEMENT

- Grommets are available in the tops of all units, unless noted
- Optional grommets are standard in back panels of assembled returns, bridge units, and kneespace credenzas,
- Hutch units have a rectangle grommet in bottom center of back panel
- A grommet is standard in tops of corner units
- Grommets are available in black or silver, please specify color
- [See all optional grommet locations](#)
- [Wire Manager units available for additional cord management](#)

INTERIOR DRAWER DIMENSIONS

Models

| | | | |
|-------------|-------------|-------------|-------------|
| 14-4272DP | 14-3672DP | 14-3672LP | 14-3672RP |
| 14-3072DP | 14-3072LP | 14-3072RP | 16-4272LPS |
| 16-4272DP | 16-4272DPS | 16-4272DPSO | 16-4272RPSO |
| 16-4272LPSO | 16-4272RP | 16-4272RPS | 16-3672LP |
| 16-3672DP | 16-3672DPS | 16-3672DPSO | 16-3672RPS |
| 16-3672LPS | 16-3672LPSO | 16-3672RP | 16-3072LPS |
| 16-3672RPSO | 16-3072DP | 16-3072LP | 16-3072RPSO |
| 16-3072LPSO | 16-3072RP | 16-3072RPS | |

Drawers

| | W | L | D |
|------|----------|---------|--------|
| Box | 15 1/32" | 19 3/8" | 3 3/8" |
| File | 15 1/32" | 19 3/8" | 8 7/8" |

Models

| | | | |
|-----------|-----------|------------|-------------|
| 14-3066DP | 14-3060DP | 14-3066LP | 14-3066RP |
| 16-3066DP | 16-3066LP | 16-3066LPS | 16-3066LPSO |
| 16-3060DP | 16-3066RP | 16-3066RPS | 16-3066RPSO |

Drawers

| | W | L | D |
|------|----------|---------|--------|
| Box | 12 1/32" | 19 3/8" | 3 3/8" |
| File | 12 1/32" | 19 3/8" | 8 7/8" |

INTERIOR DRAWER DIMENSIONS (CONTINUED)
Models

| | | | |
|-------------|-----------|------------|------------|
| 14-1619MP1 | 14-2448LF | 14-2448RF | 14-2442LF |
| 14-2442RF | 16-2448LF | 16-2448LF2 | 16-2448LFH |
| 16-2448LF2H | 16-2448RF | 16-2448RF2 | 16-2448RFH |
| 16-2448RF2H | 16-2442LF | 16-2442LF2 | 16-2442LFH |
| 16-2442LF2H | 16-2442RF | 16-2442RF2 | 16-2442RFH |

Drawers

| | W | L | D |
|------|------------------------------------|----------------------------------|-----------------------------------|
| Box | 12 ¹¹ / ₃₂ " | 16 ¹ / ₄ " | 3 ²⁹ / ₃₂ " |
| File | 12 ¹¹ / ₃₂ " | 16 ¹ / ₄ " | 8 ²⁹ / ₃₂ " |

Models

16-2466SC

Drawers

| | W | L | D |
|------|------------------------------------|----------------------------------|-----------------------------------|
| File | 12 ¹¹ / ₃₂ " | 16 ¹ / ₄ " | 8 ²⁹ / ₃₂ " |

Models

16-2472KC 16-2472KCH 16-2472SC 16-2072KC
16-2072SC

Drawers

| | W | L | D |
|------|------------------------------------|----------------------------------|-----------------------------------|
| File | 15 ¹¹ / ₃₂ " | 16 ¹ / ₄ " | 8 ²⁹ / ₃₂ " |

Models

14-2072SC 14-2072KC 14-2072LC 14-2072RC
16-2472LC 16-2472LC2 16-2472LCH 16-2472LC2H
16-2472RC 16-2472RC2 16-2472RCH 16-2472RC2H
16-2072LC 16-2072LC2 16-2072RC 16-2072RC2

Drawers

| | W | L | D |
|------|------------------------------------|----------------------------------|-----------------------------------|
| Box | 15 ¹¹ / ₃₂ " | 16 ¹ / ₄ " | 3 ²¹ / ₃₂ " |
| File | 15 ¹¹ / ₃₂ " | 16 ¹ / ₄ " | 8 ²⁹ / ₃₂ " |

Models

14-2066KC 14-2066LC 14-2066RC 16-2466KC
16-2466KCH 16-2466LC 16-2466LC2 16-2466LCH
16-2466LC2H 16-2466RC 16-2466RC2 16-2466RCH
16-2466RC2H 16-2066KC 16-2066LC 16-2066LC2
16-2066RC 16-2066RC2

Drawers

| | W | L | D |
|------|------------------------------------|----------------------------------|-----------------------------------|
| Box | 12 ¹¹ / ₃₂ " | 16 ¹ / ₄ " | 3 ²¹ / ₃₂ " |
| File | 12 ¹¹ / ₃₂ " | 16 ¹ / ₄ " | 8 ²⁹ / ₃₂ " |

Models

14-2472LL3 14-2472LL3H 14-2472RL3 14-2472RL3H
14-2466LL3 14-2466LL3H 14-2466RL3 14-2466RL3H
14-2430L2 14-2430L3 14-2430L4

Drawers

| | W | L | D |
|---------|----------------------------------|----------------------------------|-----------------------------------|
| Lateral | 25 ³ / ₄ " | 16 ¹ / ₄ " | 8 ²⁹ / ₃₂ " |

Models

14-2472LL 14-2472LLH 14-2472RL 14-2472RLH
14-2472DL 14-2466LL 14-2466LLH 14-2466RL
14-2466RLH 14-2436L2 14-2436L3 14-2436L4
14-2036L2 14-2036L4 14-2072LL 14-2072LL4
14-2072RL 14-2072RL4 14-2072DL

Drawers

| | W | L | D |
|---------|----------------------------------|----------------------------------|-----------------------------------|
| Lateral | 31 ³ / ₄ " | 16 ¹ / ₄ " | 8 ²⁹ / ₃₂ " |

Models

14-2418PD1 14-3670WDIL 14-3670WD1R

Drawers

| | W | L | D |
|------|-----------------------------------|----------------------------------|-----------------------------------|
| Box | 14 ⁹ / ₃₂ " | 16 ¹ / ₄ " | 3 ²¹ / ₃₂ " |
| File | 14 ⁹ / ₃₂ " | 16 ¹ / ₄ " | 8 ²⁹ / ₃₂ " |

Models

14-3618PD1 14-3018PD1

Drawers

| | W | L | D |
|------|-----------------------------------|----------------------------------|-----------------------------------|
| Box | 14 ⁹ / ₃₂ " | 19 ³ / ₈ " | 3 ²¹ / ₃₂ " |
| File | 14 ⁹ / ₃₂ " | 19 ³ / ₈ " | 8 ²⁹ / ₃₂ " |

Models
14-2418PD2 14-3618PD2 14-3018PD2 14-3670WD2L
14-3670WD2R
Drawers

| | W | L | D |
|------|-----------------------------------|----------------------------------|-----------------------------------|
| File | 14 ⁹ / ₃₂ " | 16 ¹ / ₄ " | 8 ²⁹ / ₃₂ " |

Models

14-2436LF2

Drawers

| | W | L | D |
|---------|-----------------------------------|----------------------------------|-----------------------------------|
| Box | 15 ⁵ / ₁₆ " | 16 ¹ / ₄ " | 3 ²¹ / ₃₂ " |
| File | 14 ¹ / ₂ " | 16 ¹ / ₄ " | 8 ²⁹ / ₃₂ " |
| Lateral | 32 ⁹ / ₁₆ " | 16 ¹ / ₄ " | 8 ²⁹ / ₃₂ " |

Models

14-2430LF2

Drawers

| | W | L | D |
|---------|------------------------------------|----------------------------------|-----------------------------------|
| Box | 11 ¹ / ₂ " | 16 ¹ / ₄ " | 3 ²¹ / ₃₂ " |
| File | 12 ¹¹ / ₃₂ " | 16 ¹ / ₄ " | 8 ²⁹ / ₃₂ " |
| Lateral | 26 ⁹ / ₁₆ " | 16 ¹ / ₄ " | 8 ²⁹ / ₃₂ " |

Models

14-2036MF

Drawers

| | W | L | D |
|---------|------------------------------------|----------------------------------|-----------------------------------|
| Box | 13 ²³ / ₃₂ " | 16 ¹ / ₄ " | 3 ²¹ / ₃₂ " |
| File | 15 ¹¹ / ₃₂ " | 16 ¹ / ₄ " | 8 ²⁹ / ₃₂ " |
| Lateral | 3 ³ / ₄ " | 16 ¹ / ₄ " | 8 ²⁹ / ₃₂ " |

Models

14-2436LF1 14-3670SU2

Drawers

| | W | L | D |
|---------|-----------------------------------|----------------------------------|-----------------------------------|
| Lateral | 32 ⁹ / ₁₆ " | 16 ¹ / ₄ " | 8 ²⁹ / ₃₂ " |

INTERIOR DRAWER DIMENSIONS (CONTINUED)

Models

14-2436LF1

| Drawers | W | L | D |
|---------|-----------------------------------|----------------------------------|---------------------------------|
| Lateral | 26 ³ / ₁₆ " | 16 ¹ / ₄ " | 8 ⁷ / ₈ " |

FILING CAPABILITIES

Drawers with Dimensions: 15¹/₂"W x 19³/₈"L and 14³/₂" x 19³/₈"

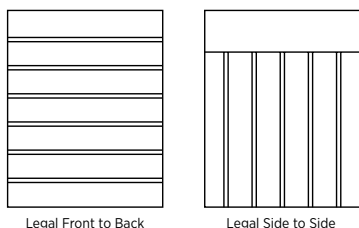

Legal Front to Back

Legal Side to Side

Drawers with Dimensions: 12¹/₂"W x 19³/₈"L

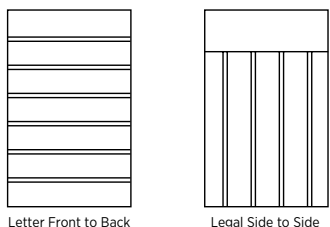

Letter Front to Back

Legal Side to Side

Drawers with Dimensions: 14¹/₂" x 16¹/₄", 14³/₂" x 16¹/₄", and 12¹/₂" x 16¹/₄"

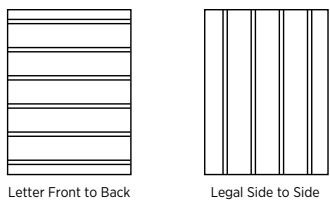

Letter Front to Back

Legal Side to Side

Drawers with Dimensions: 15¹/₂" x 16¹/₄"

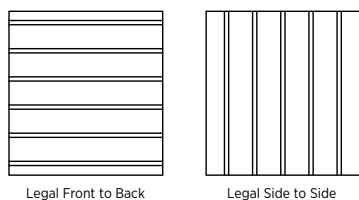

Legal Front to Back

Legal Side to Side

Drawers with Dimensions: 25³/₄" x 19³/₈"

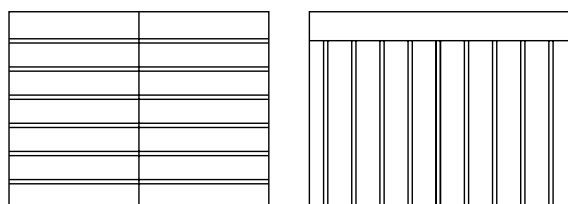

2 Rows Letter Front to Back

1 Row Letter or Legal Side to Side

Drawers with Dimensions: 32³/₁₆" x 16¹/₄", 31³/₄" x 16¹/₄", and 26³/₁₆" x 16¹/₄"

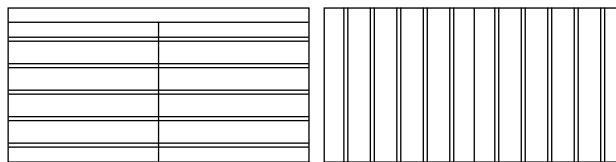

2 Rows Letter or Legal Front to Back

1 Row Letter or Legal Side to Side

HOW TO ORDER EXAMPLES

| Model No. | Description | Example |
|-----------|----------------------------------|-----------|
| 16-3672DP | Premium or Standard Veneer | Standard |
| | Top Material | W |
| | Finish/Color | AW |
| | Edge Profile | D |
| | Pull/Pull & Lock Color | BBT |
| | Writing Shelf | AS |
| | Grommet Location & Color | GR, BLK |
| | Center Drawer/Keyboard Selection | 01-2122CD |

PREMIUM VENEER (PV) AND VENEER (W) OPTIONS

Veneer features UVAdvantage, an ultra-violet finish, on all exposed surfaces by utilizing roll-coat UV technology

| | | | |
|-----|----------------------|-----|-----------------------|
| AW | Artisan Walnut** | MW | Mahogany Walnut** |
| AS | Asian Night | MAS | Mesa Sunset* |
| CO | Columbian Walnut** | MTS | Metropolis Sky |
| DC | Dark Cherry** | ORW | Oak Riftwood* |
| DFW | Dark Forest Walnut** | PNW | Pinnacle Walnut |
| EW | Espresso** | SCH | Select Cherry** |
| FO | Fawn Oak**,** | SKC | Shaker Cherry** |
| GC | Golden Cherry** | SM | Sugar Maple |
| HW | Harvest Walnut** | WTA | Weathered Ash* |
| HNW | Henna Walnut | WC | Williamsburg Cherry** |
| LW | Legacy Walnut** | | |

* Finish is Low Sheen ** Available in Premium Veneer (PV)

HPL (P) LAMINATE WORKSURFACE OPTIONS

WOODGRAIN

| | | | |
|-----|------------------|-----|---------------------|
| AS | Asian Night | PNW | Pinnacle Walnut |
| CO | Columbian Walnut | SCH | Select Cherry |
| EF | Espresso | SKC | Shaker Cherry |
| GC | Golden Cherry | SM | Sugar Maple |
| MW | Mahogany Walnut | WTA | Weathered Ash |
| ORW | Oak Riftwood | WC | Williamsburg Cherry |

EDGE PROFILES

| | | | |
|---|----------|---|-----------|
| B | Bevel | A | Radius |
| D | Bullnose | Y | Square |
| X | Flute | E | Tri-Round |



Bevel (B)

Bullnose (D)

Flute (X)



Radius (A)



Square (Y)



Tri-Round (E)

PULL OPTIONS

Note: Lock Core will match Pull Color

| | |
|----------------------|----------------------|
| AAC Arc, Aluminum | AEL Elite, Aluminum |
| BAC Arc, Black | BEL Elite, Black |
| ABM Beam, Aluminum | FPL Finger |
| BBM Beam, Black | AFL Flair, Aluminum |
| BBT Bow Tie, Black | CFL Flair, Chrome |
| NBT Bow Tie, Nickel | AFC Focus, Aluminum |
| ABU Buckle, Aluminum | BFC Focus, Black |
| BBU Buckle, Black | AQD Quadra, Aluminum |
| | BQD Quadra, Black |

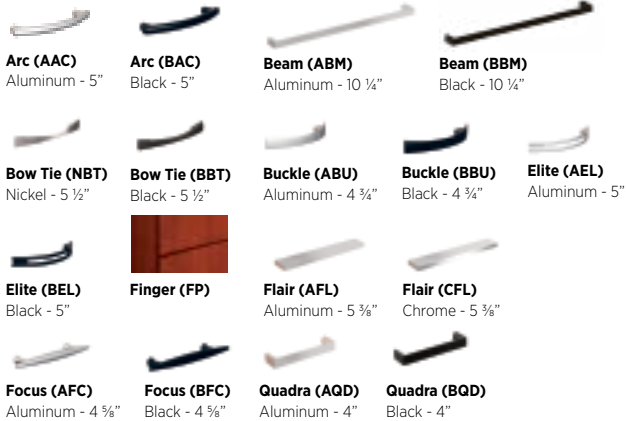

PULL-OUT WRITING SHELVES

Pull-out writing shelves are available on desks. Please specify AS on order and add upcharge.

| | | |
|----|-----------------------|--------|
| AS | Single Pedestal Desks | \$ 120 |
| AS | Double Pedestal Desks | \$ 240 |

GROMMET OPTIONS & LOCATIONS

Grommets are standard in the back panels of returns, bridges, and credenzas, and may be ordered without grommets at no additional charge. Please specify NO GROMMET on order.

Desk grommets are available in standard locations. Please specify using table below. Multiple unit locations may be selected. Only one unit per location.

| | | |
|-----|---|-------|
| GC | Grommet, Center - Specify BLK or SLV | \$ 52 |
| GL | Grommet, Left - Specify BLK or SLV | \$ 52 |
| GR | Grommet, Right - Specify BLK or SLV | \$ 52 |
| GAL | Grommet, Approach Left - P-Tops Only - Specify BLK or SLV | \$ 52 |
| GAR | Grommet, Approach Right - P-Tops Only - Specify BLK or SLV | \$ 52 |
| GSL | Grommet, Seat Side Left - P-Tops Only - Specify BLK or SLV | \$ 52 |
| GSR | Grommet, Seat Side Right - P-Tops Only - Specify BLK or SLV | \$ 52 |

Verify Grommet Option is available on the model(s) you are specifying using the following location information. Grommets may be ordered in non-standard locations. Call Customer Service to assist with specification. Note additional charges and lead times may apply.

Models

| | | | |
|------------|---------------------------|------------|-------------|
| 16-4272DPS | 16-4272DPSO | 16-4272LPS | 16-4272LPSO |
| 16-4272RPS | 16-4272RPSO | 16-3672DPS | 16-3672LPS |
| 16-3672RP | And All 42"D Modular Tops | | |

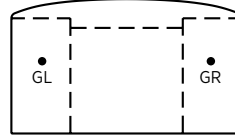

GL/GR: Located 6" from ends and 22 1/2" from user side

Models

| | | | |
|-----------|-----------|---------------------------|-----------|
| 14-4272DP | 14-4272LP | 14-4272RP | 16-4272DP |
| 16-4272LP | 16-4272RP | And All 42"D Modular Tops | |

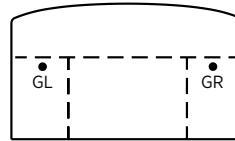

GL/GR: Located 6" from ends and 22 1/2" from user side

Models

| | | |
|---------------------------|-------------|-------------|
| 16-3672DPSO | 16-3672LPSO | 16-3672RPSO |
| And All 36"D Modular Tops | | |

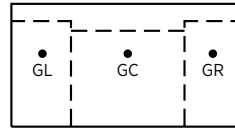

GL/GR: Located 6" from ends and 22 1/2" from user side
GC: Located 22 1/2" from user side

Models

| | | |
|---------------------------|-----------|-----------|
| 14-3672DP | 14-3672LP | 14-3672RP |
| 16-3672DP | 16-3672LP | 16-3672RP |
| And All 36"D Modular Tops | | |

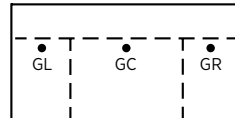

GL/GR: Located 6" from ends and 22 1/2" from user side
GC: Located 22 1/2" from user side

Models

| | | | |
|---------------------------|-------------|-------------|-------------|
| 16-3072LPSO | 16-3072RPSO | 16-3066LPSO | 16-3066RPSO |
| And All 30"D Modular Tops | | | |

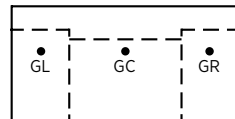

GL/GR: Located 6" from ends and 17" from user side
GC: Located 17" from user side

Models

| | | |
|-----------|-----------|---------------------------|
| 14-3060DP | 16-3060DP | And All 30"D Modular Tops |
|-----------|-----------|---------------------------|

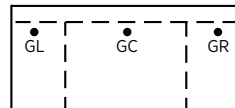

GL/GR: Located 6" from ends and 22 1/2" from user side
GC: Located 22 1/2" from user side

GROMMET OPTIONS & LOCATIONS (CONTINUED)

Models
14-3072DP 14-3072LP 14-3072RP 14-3066DP
14-3066LP 14-3066RP 16-3072DP 16-3072LP
16-3072RP 16-3066DP 16-3066LP 16-3066RP

And All 30"D Modular Tops

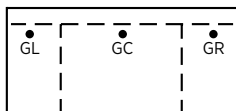

GL/GR: Located 6" from ends and 22 1/2" from user side
GC: Located 22 1/2" from user side

Models
16-3072LPS 16-3072RPS 16-3066LPS 16-3066RPS
And All 30"D Modular Tops

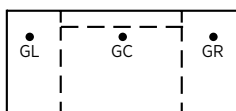

GL/GR: Located 6" from ends and 22 1/2" from user side
GC: Located 22 1/2" from user side

Models
14-2448UF 14-2448UFH 14-2442UF 14-2442UFH
14-2436UF 14-2436UFH
And All 24"D Modular Bridge Tops

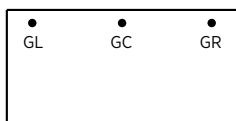

GL/GR: Located 6" from ends and 20" from user side
GC: Located 20" from user side

Models
14-2448LF 14-2448RF 14-2472LMR* 14-2472RMR*
14-2442LF 14-2442RF 16-2448LF 16-2448LF2
16-2448LFH 16-2448LF2H 16-2448RF 16-2448RF2
16-2448RFH 16-2448RF2H 16-2442LF 16-2442LF2
16-2442LFH 16-2442LF2H 16-2442RF 16-2442RF2
16-2442RFH 16-2442RF2H
And All 24"D Modular Return Tops

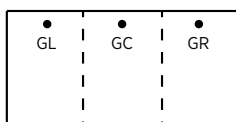

GL/GR: Located 6" from ends and 20" from user side
GC: Located 20" from user side
*Grommets are only available on opposite side of pedestal

Models
14-2072KC 14-2072LC 14-2072RC 14-2072RL
14-2072RL4* 14-2072LL 14-2072LL4* 16-2072KC
16-2072LC 16-2072LC2 16-2072RC 16-2072RC2

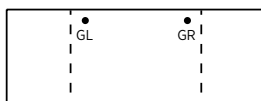

GL/GR: Located 22 1/2" from ends and 17" from user side
*Grommets are only available on opposite side of pedestal

Models
16-2472KC 16-2472KCH 16-2472LC 16-2472LC2
16-2472RC 16-2472RC2 16-2472LCH 16-2472LC2H
16-2472RCH 16-2472RC2H
And All 24"D Modular Credenza Tops

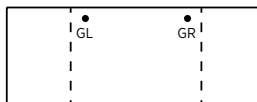

GL/GR: Located 22 1/2" from ends and 20" from user side

Models
14-2066KC 14-2066LC 14-2066RC 16-2066KC
16-2066LC 16-2066LC2 16-2066RC 16-2066RC2

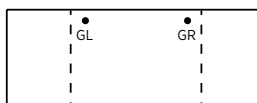

GL/GR: Located 19 1/2" from ends and 17" from user side

Models
16-2466KC 16-2466KCH 16-2466LC 16-2466LC2
16-2466RC 16-2466RC2 16-2466LCH 16-2466LC2H
16-2466RCH 16-2466RC2H
And All 24"D Modular Credenza Tops

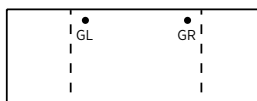

GL/GR: Located 19 1/2" from ends and 20" from user side

Models
14-2472LL 14-2472LL3 14-2472RL 14-2472RL3
14-2472LLH 14-2472LL3H 14-2472RLH 14-2472RL3H
14-2466LL 14-2466LL3 14-2466RL 14-2466RL3
14-2466LLH 14-2466LL3H 14-2466RLH 14-2466RL3H
14-2066LL4 14-2066RL4
And All 24"D Modular Credenza Top

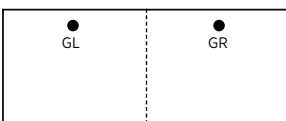

GL/GR: Located 22 1/2" from ends and 20" from user side
*Grommets are only available on opposite side of pedestal

Models
14-4272PR

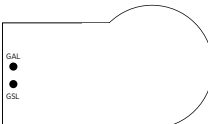

GAL/GSL: Located 12" from approach or seated side, 6" from end

14-4272PR



GAR/GSR: Located 12" from approach or seated side, 6" from end

GROMMET OPTIONS & LOCATIONS (CONTINUED)

Models

14-3672DUR 14-3072DUR



GAL/GSL: Located 12" from approach or seated side, 6" from end

14-3672DUL 14-3072DUL



GAR/GSR: Located 12" from approach or seated side, 6" from end

TABLE GROMMET & POWER UNIT OPTIONS

Power units and grommets are sold separately and must be specified separately with surface mount location. Multiple locations may be selected. Only one unit per location.

Power units and Grommets Available in Table Surfaces (See Units)

Grommet Specify Color: Black = BLK and Silver = SLV

DUO/TRIO BEZEL

01-DUOBEZEL Available in Black (B), Silver (S), or White (W)

01-TRIOBEZEL Available in Black (B), Silver (S), or White (W)

DOCK 950, DOCK 800 and DOCK 150

DOCK950 Available in Black or White

DOCK150 Available in Black or White

DOCK800 Available in Black or Silver

Other Power Units

DPORT4 Available in Aluminum or Black

INTERACTG Available in Aluminum or Black

OASISM Available in Aluminum or Black

Power/Data Location Information:

- Designate unit and location when specifying the top model. Power/Data Module need to be ordered separately.
- Power/Data Modules specified at the time of order will be routed for field installation.

E1 Unit on One End

E2 Unit on Each End

OC Unit on Center

- All power units available **On Center (OC) only** when paired with two (2) or more of the following bases:

Cylinder Base Square Base

X-Base Disc

Tubular X-Base

Grommets and Power Units may be ordered in non-standard locations. Call Customer Service to assist with specification and/or please attach a drawing to the PO showing the location of the grommet. Note additional charges and lead times may apply.

Top Locations

Power units available on Each End (E1 and E2) and On Center (OC) unless otherwise noted, when paired with any Rectangle Panel Base, Rectangle Box Base or Rectangle Accent Box Base. (See Unit Details)

Power units centered at locations below:

| | | | |
|----------|---------------|----------|---------------|
| 36" Tops | centered 18"D | 48" Tops | centered 24"D |
| 42" Tops | centered 21"D | | |

72: OC 36" from end (available with OC Only)

96: OC 48" from end; E1/E2 29" from end

120: OC 60" from end; E1/E2 29" from end

144: OC 72" from end; E1/E2 29" from end

HUTCH GROMMET OPTIONS

Surface Mount Hutches come standard with one center grommet at workstation level on back panel. Three upper wire management grommets also available. One grommet located on right, center and left. Must specify.

WMHUBL Black Lower Grommet + Three (3) Upper Grommets N/C

WMHUSV Silver Lower Grommet + Three (3) Upper Grommets N/C

LOCKING DOORS

Locking doors are available on select units. You must specify WITH LOCKING when ordering and add upcharge.

| | | |
|--------|-------------------|--------|
| LKT_HU | 94"W - 84"W Units | \$ 135 |
| LKT_HU | 78"W - 48"W Units | \$ 115 |
| LKT_HU | 42"W - 24"W Units | \$ 91 |
| LKT_HU | 18"W Unit | \$ 69 |

CERTIFICATIONS & COMPLIANCE

- Intertek Sustainability Certified
- BIFMA level® Certified
- BIFMA Compliant Certified
- TSCA Title VI (formerly CARB) Compliance
- US Green Building's LEED Contribution

Standard Components

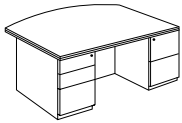

Double Ped Desks with or without Bow Tops and Overhangs
(See Multiple Unit Details)

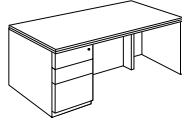

Single Ped Desks with or without Bow Tops
(See Multiple Unit Details)

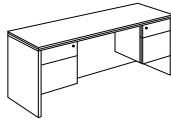

3/4 Double and Single Ped Desks with or without Bow Tops
(See Multiple Double Ped and Single Ped Details)

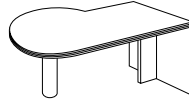

P-Tops and D-Tops
(See Multiple Unit Details)

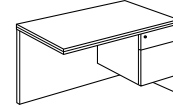

Returns
(See Multiple Unit Details)

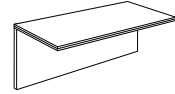

Bridges
(See Multiple Unit Details)



Corner Units
(See Multiple Unit Details)

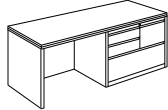

Kneespace, Storage, and Single Ped Credenzas
(See Multiple Unit Details)

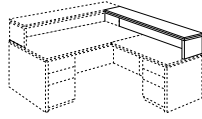

Transaction Risers
(See Multiple Unit Details)

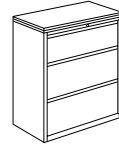

Filing
(See Multiple Unit Details)



Mobile Pedestals
(See Multiple Unit Details)

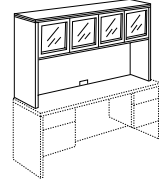

Surface Mount and Wall Mount Hutches
(See Multiple Unit Details)

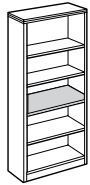

Bookcases
(See Multiple Unit Details)



Wardrobes & Storage Cabinets
(See Multiple Unit Details)

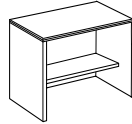

Computer and Work Tables
(See Multiple Unit Details)

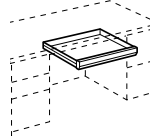

Center Drawer
(See Multiple Unit Details)

Modular Components *(See Multiple Units)*

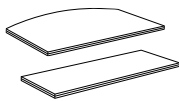

Tables + Bases *(See Multiple Units)*



Occasional Tables

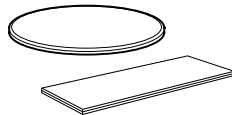
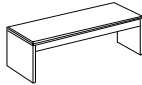

Tables and Tops

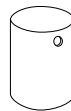

Cylinder Bases



Metal Bases

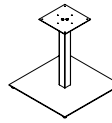

Square Bases

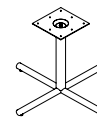

Tubular X- Bases

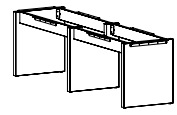

Rectangular Panel Bases with Trough

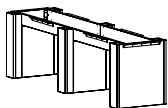

6" Rectangular Bases with Trough

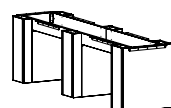

6" Rectangular Accent Bases with Trough

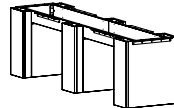

10" Rectangular Bases with Trough

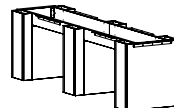

10" Rectangular Accent Bases with Trough

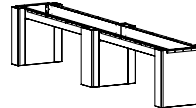

6" + 10" Combo Rectangular Bases with Trough

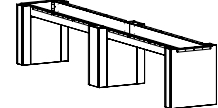

6" + 10" Combo Rectangular Accent Bases with Trough

Keyboard, Tackboard, Tasklights, and Other Accessories *(See Multiple Units)*

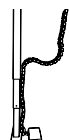
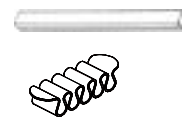
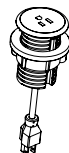
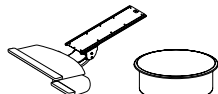
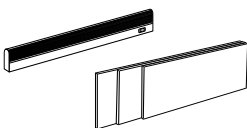

| Item | Model No. | Width | Depth | Height | K | R | Ship Wt | Cubic Ft | List Price |
|---|-----------|-------|-------|--------|---|---|---------|----------|--------------------------|
| L UNIT WITH FULL PEDS AND STEPPED FRONT | 16-1 | 72 | 84 | 30 | - | - | 402 | 74.9 | W/P\$ 9225 PV\$ 10792 |

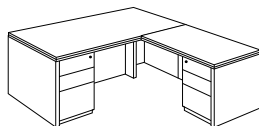

| CONSIST OF: | QTY | | | |
|-------------|-----|--------------------|-------------------------|--|
| 16-3672LPS | 1 | Left Pedestal Desk | W/P\$ 5585 PV\$ 6532 | |
| 16-2448RF | 1 | Right Return | W/P\$ 3640 PV\$ 4260 | |

Products are available as left or right, where applicable

| | | | | | | | | | |
|--|------|----|-----|----|---|---|-----|-------|---------------------------|
| U UNIT WITH BOW TOP DESK, FULL PED AND STEPPED FRONT | 16-2 | 72 | 110 | 70 | - | - | 756 | 127.2 | W/P\$ 16715 PV\$ 19555 |
|--|------|----|-----|----|---|---|-----|-------|---------------------------|

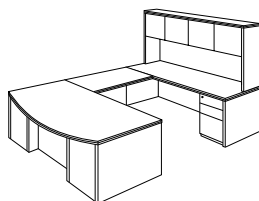

| CONSIST OF: | QTY | | | |
|-------------|-----|-----------------------------|-------------------------|--|
| 16-4272LPS | 1 | Bow Top Desk, Left Pedestal | W/P\$ 6646 PV\$ 7779 | |
| 14-2448UF | 1 | Bridge | W/P\$ 1703 PV\$ 1991 | |
| 16-2072RC | 1 | Credenza, Right Pedestal | W/P\$ 4015 PV\$ 4696 | |
| 14-1572HU | 1 | Surface Mount Hutch | W/P\$ 4351 PV\$ 5089 | |

Products are available as left or right, where applicable

Pricing Codes:

W = Wood Top

P = Laminate Top

PV = Premium Veneer

[See Madera Intro Section for Ordering Options](#)

| Item | Model No. | Width | Depth | Height | K | R | Ship Wt | Cubic Ft | List Price |
|-------------------|-----------|-------|-------|--------|---|---|---------|----------|---------------------------|
| U UNIT WITH P-TOP | 16-3 | 72 | 110 | 70 | - | - | 625 | 128.2 | W/P\$ 15914 PV\$ 18619 |

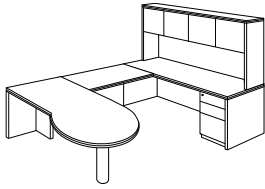

| CONSIST OF: | | QTY | | | |
|-------------|---|----------------------------|--|-------------------------|--|
| 14-4272PL | 1 | P-Top Desk, Left | | W/P\$ 5845 PV\$ 6843 | |
| 14-2448UF | 1 | Bridge | | W/P\$ 1703 PV\$ 1991 | |
| 16-2072RC | 1 | Single Ped Credenza, Right | | W/P\$ 4015 PV\$ 4696 | |
| 14-1572HU | 1 | Hutch | | W/P\$ 4351 PV\$ 5089 | |

Products are available as left or right, where applicable

| | | | | | | | | | |
|-------------------|------|----|-----|----|---|---|-----|------|--------------------------|
| U UNIT WITH D-TOP | 16-4 | 72 | 104 | 30 | - | - | 231 | 88.8 | W/P\$ 9994 PV\$ 11688 |
|-------------------|------|----|-----|----|---|---|-----|------|--------------------------|

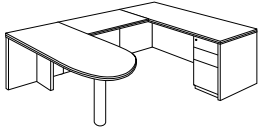

| CONSIST OF: | | QTY | | | |
|-------------|---|----------------------------|--|-------------------------|--|
| 14-3672DUL | 1 | D-Top Desk | | W/P\$ 4276 PV\$ 5001 | |
| 14-2448UF | 1 | Bridge | | W/P\$ 1703 PV\$ 1991 | |
| 16-2072RC | 1 | Single Ped Credenza, Right | | W/P\$ 4015 PV\$ 4696 | |

Products are available as left or right, where applicable

[See Madera Intro Section for Ordering Options](#)

| Item | Model No. | Width | Depth | Height | K | R | Ship Wt | Cubic Ft | List Price |
|------------------------------|-----------------------------|-------|-------|--------|-------------------|-----------------------------------|---------|----------|-------------------------|
| DOUBLE PED DESK WITH BOW TOP | 16-4272DPS Stepped Front | 72 | 42-36 | 30 | 34 $\frac{5}{16}$ | - | 326 | 58.4 | W/P\$ 7620 PV\$ 8914 |
| | 16-4272DP Recessed Front | 72 | 42-36 | 30 | 33 $\frac{1}{2}$ | 15 $\frac{7}{8}$ -9 $\frac{7}{8}$ | 326 | 58.4 | W/P\$ 6969 PV\$ 8154 |

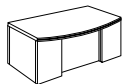
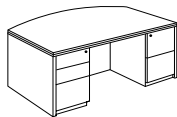

Stepped Front

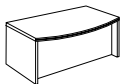

Recessed Front

Description

- Standard With: Bow Top, Letter Width Locking Box/Box/File on Left Pedestal and File/File on Right, Left to Right Grain Direction on Worksurface, Black Utility Tray for Box Drawer
- Available with Premium Veneer (PV) or Standard Veneer (W) Chassis, Must Specify
- Available with Veneer (PV/W) or HPL (P) Top, Must Specify
- Lock Core Color will Coordinate with Pull Selection
- Additional Options: Pull-Out Writing Shelf ([See Shelf Options](#)), Grommet Options ([See Grommet Options](#)), Kneespace Options (Sold Separately, [See Multiple Unit Details](#)), Wire Management + Accessories (Sold Separately, [See Multiple Unit Details](#))

Must Specify (in this order):

Model
 Premium or Standard Veneer Chassis
 Top Material
 Finish/Color
 Edge Profile
 Drawer Pull
 Pull Out Writing Shelf
 Worksurface Grommet Location
 Grommet Color
 Kneespace Options

| | | | | | | | | | |
|------------------------------------|--|----|----|----|-------------------|-------------------|-----|------|-------------------------|
| DOUBLE PED DESK WITH RECTANGLE TOP | 16-3672DPS Stepped Front - Legal Ped | 72 | 36 | 30 | 34 $\frac{5}{16}$ | 4 $\frac{13}{16}$ | 400 | 51.9 | W/P\$ 6575 PV\$ 7691 |
| | 16-3672DP Recessed Front - Legal Ped | 72 | 36 | 30 | 33 $\frac{3}{16}$ | 9 $\frac{7}{8}$ | 425 | 51.9 | W/P\$ 5968 PV\$ 6983 |
| DOUBLE PED DESK WITH RECTANGLE TOP | 16-3072DP Recessed Front - Legal Ped | 72 | 30 | 30 | 33 $\frac{3}{16}$ | 3 $\frac{7}{8}$ | 410 | 43.9 | W/P\$ 5902 PV\$ 6906 |
| | 16-3066DP Recessed Front - Letter Ped | 66 | 30 | 30 | 33 $\frac{3}{16}$ | 3 $\frac{7}{8}$ | 277 | 40.4 | W/P\$ 5567 PV\$ 6512 |
| | 16-3060DP Recessed Front - Letter Ped | 60 | 30 | 30 | 27 $\frac{1}{16}$ | 3 $\frac{7}{8}$ | 259 | 36.9 | W/P\$ 5288 PV\$ 6185 |

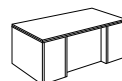
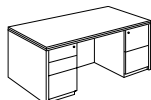

Stepped Front

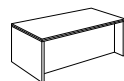

Recessed Front

Description

- Standard With: Rectangle Top, Locking Box/Box/File on Left Pedestal and File/File on Right, Left to Right Grain Direction on Worksurface, Black Utility Tray for Box Drawer
- Available with Premium Veneer (PV) or Standard Veneer (W) Chassis, Must Specify
- Available with Veneer (PV/W) or HPL (P) Top, Must Specify
- Lock Core Color will Coordinate with Pull Selection
- Additional Options: Pull-Out Writing Shelf ([See Shelf Options](#)), Grommet Options ([See Grommet Options](#)), Kneespace Options (Sold Separately, [See Multiple Unit Details](#)), Wire Management + Accessories (Sold Separately, [See Multiple Unit Details](#))

Must Specify (in this order):

Model
 Premium or Standard Veneer Chassis
 Top Material
 Finish/Color
 Edge Profile
 Drawer Pull
 Pull Out Writing Shelf
 Worksurface Grommet Location
 Grommet Color
 Kneespace Options

Pricing Codes:

W = Wood Top

P = Laminate Top

PV = Premium Veneer

[See Madera Intro Section for Ordering Options](#)

| Item | Model No. | Width | Depth | Height | K | R | Ship Wt | Cubic Ft | List Price |
|--|-------------|-------|-------|--------|-------------------|------|---------|----------|-------------------------|
| DOUBLE PED DESK WITH BOW TOP AND STEPPED FRONT | 16-4272DPSO | 72 | 42-36 | 30 | 34 $\frac{5}{16}$ | 12-6 | 310 | 58.4 | W/P\$ 7473 PV\$ 8745 |

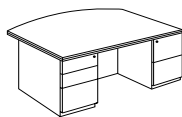

Stepped Front

Description

- Standard With: Bow Top, Stepped Front Modesty, Legal Width Locking Box/Box/File on Left Pedestal and File/File on Right, Left to Right Grain Direction on Worksurface, Black Utility Tray for Box Drawer
- Available with Premium Veneer (PV) or Standard Veneer (W) Chassis, Must Specify
- Available with Veneer (PV/W) or HPL (P) Top, Must Specify
- 16 $\frac{13}{16}$ " Overhang on Approach From Center of Arc to Center of Modesty Panel
- Lock Core Color will Coordinate with Pull Selection
- Additional Options: Pull-Out Writing Shelf ([See Shelf Options](#)), Grommet Options ([See Grommet Options](#)), Kneespace Options (Sold Separately, [See Multiple Unit Details](#)), Wire Management + Accessories (Sold Separately, [See Multiple Unit Details](#))

Must Specify (in this order):

Model
 Premium or Standard Veneer Chassis
 Top Material
 Finish/Color
 Edge Profile
 Drawer Pull
 Pull Out Writing Shelf
 Worksurface Grommet Location
 Grommet Color
 Kneespace Options

| | | | | | | | | | |
|--|-------------|----|----|----|-------------------|---|-----|------|-------------------------|
| DOUBLE PED DESK WITH RECTANGLE TOP AND STEPPED FRONT | 16-3672DPSO | 72 | 36 | 30 | 34 $\frac{5}{16}$ | 6 | 385 | 51.9 | W/P\$ 6438 PV\$ 7532 |
|--|-------------|----|----|----|-------------------|---|-----|------|-------------------------|

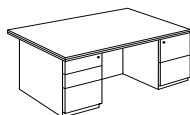

Stepped Front

Description

- Standard With: Rectangle Top, Stepped Front Modesty, Left to Right Grain Direction on Worksurface, Legal Width Locking Ped, Box/Box/File on Left Pedestal and File/File on Right, Black Utility Tray for Box Drawer
- Available with Premium Veneer (PV) or Standard Veneer (W) Chassis, Must Specify
- Available with Veneer (PV/W) or HPL (P) Top, Must Specify
- 10 $\frac{13}{16}$ " Overhang on Approach From Center of Arc to Center of Modesty Panel
- Lock Core Color will Coordinate with Pull Selection
- Additional Options: Pull-Out Writing Shelf ([See Shelf Options](#)), Grommet Options ([See Grommet Options](#)), Kneespace Options (Sold Separately, [See Multiple Unit Details](#)), Wire Management + Accessories (Sold Separately, [See Multiple Unit Details](#))

Must Specify (in this order):

Model
 Premium or Standard Veneer Chassis
 Top Material
 Finish/Color
 Edge Profile
 Drawer Pull
 Pull Out Writing Shelf
 Worksurface Grommet Location
 Grommet Color
 Kneespace Options

[See Madera Intro Section for Ordering Options](#)

| Item | Model No. | Width | Depth | Height | K | R | Ship Wt | Cubic Ft | List Price |
|------------------------------------|-----------|-------|-------|--------|-----|----------|---------|----------|-------------------------|
| DOUBLE DESK WITH ¾ PED AND BOW TOP | 14-4272DP | 72 | 42-36 | 33½ | 34⅝ | 15⅞ - 9⅞ | 318 | 60.1 | W/P\$ 6525 PV\$ 7635 |

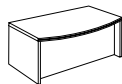
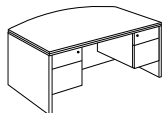

Recessed Front

Description

- Standard With: Bow Top, Recessed Front Modesty, Two (2) Legal Width Locking Box/File ¾ Pedestals, Left to Right Grain Direction on Worksurface, Black Utility Tray for Box Drawer
- Available with Premium Veneer (PV) or Standard Veneer (W) Chassis, Must Specify
- Available with Veneer (PV/W) or HPL (P) Top, Must Specify
- Lock Core Color will Coordinate with Pull Selection
- Additional Options: Pull-Out Writing Shelf ([See Shelf Options](#)), Grommet Options ([See Grommet Options](#)), Kneespace Options (Sold Separately, [See Multiple Unit Details](#)), Wire Management + Accessories (Sold Separately, [See Multiple Unit Details](#))

Must Specify (in this order):

Model
 Premium or Standard Veneer Chassis
 Top Material
 Finish/Color
 Edge Profile
 Drawer Pull
 Pull Out Writing Shelf
 Worksurface Grommet Location
 Grommet Color
 Kneespace Options

| | | | | | | | | | |
|--|--------------------------------|----|----|----|-----|----|-----|------|-------------------------|
| DOUBLE DESK WITH ¾ PED AND RECTANGLE TOP | 14-3672DP <i>Legal Ped</i> | 72 | 36 | 30 | 33⅞ | 9⅞ | 295 | 51.9 | W/P\$ 5212 PV\$ 6101 |
| | 14-3072DP <i>Legal Ped</i> | 72 | 30 | 30 | 33⅞ | 3⅞ | 264 | 43.9 | W/P\$ 5062 PV\$ 5925 |
| | 14-3066DP <i>Legal Ped</i> | 66 | 30 | 30 | 33⅞ | 3⅞ | 251 | 40.0 | W/P\$ 4732 PV\$ 5535 |
| | 14-3060DP <i>Letter Ped</i> | 60 | 30 | 30 | 27⅞ | 3⅞ | 228 | 35.3 | W/P\$ 4454 PV\$ 5209 |

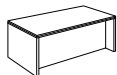
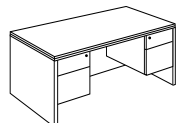

Recessed Front

Description

- Standard With: Rectangle Top, Recessed Front Modesty, Two (2) Locking Box/File ¾ Peds, Left to Right Grain Direction on Worksurface, Black Utility Tray for Box Drawer
- Available with Premium Veneer (PV) or Standard Veneer (W) Chassis, Must Specify
- Available with Veneer (PV/W) or HPL (P) Top, Must Specify
- Lock Core Color will Coordinate with Pull Selection
- Additional Options: Pull-Out Writing Shelf ([See Shelf Options](#)), Grommet Options ([See Grommet Options](#)), Kneespace Options (Sold Separately, [See Multiple Unit Details](#)), Wire Management + Accessories (Sold Separately, [See Multiple Unit Details](#))

Must Specify (in this order):

Model
 Premium or Standard Veneer Chassis
 Top Material
 Finish/Color
 Edge Profile
 Drawer Pull
 Pull Out Writing Shelf
 Worksurface Grommet Location
 Grommet Color
 Kneespace Options

Pricing Codes:

W = Wood Top

P = Laminate Top

PV = Premium Veneer

[See Madera Intro Section for Ordering Options](#)

| Item | Model No. | Width | Depth | Height | K | R | Ship Wt | Cubic Ft | List Price | |
|--|-----------------|------------|------------------|--------|----|---------------------------------|----------------------------------|----------|------------|-------------------------|
| SINGLE PED DESK WITH BOW TOP  | Left Ped | | Right Ped | | | | | | | |
| | 16-4272LPS | 16-4272RPS | 72 | 42-36 | 30 | 34 ⁵ / ₁₆ | 10 ¹³ / ₁₆ | 286 | 60.1 | W/P\$ 6646 PV\$ 7779 |
| | Stepped Front | | | | | | | | | |
| | 16-4272LP | 16-4272RP | 66 | 42-36 | 30 | 51 ⁵ / ₈ | 15 ⁵ / ₈ | 286 | 60.1 | W/P\$ 5856 PV\$ 6850 |
| Recessed Front | | | | | | | | | | |

Shown as Left

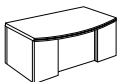

Stepped Front

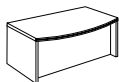

Recessed Front

Must Specify (in this order):

- Model
- Premium or Standard Veneer Chassis
- Top Material
- Finish/Color
- Edge Profile
- Drawer Pull
- Pull Out Writing Shelf
- Worksurface Grommet Location
- Grommet Color
- Kneespace Options

Description

- Standard with: Bow Top, Legal Width Locking Box/Box/File, Left to Right Grain Direction on Worksurface, Black Utility Tray for Box Drawer
- Available with Premium Veneer (PV) or Standard Veneer (W) Chassis, Must Specify
- Available with Veneer (PV/W) or HPL (P) Top, Must Specify
- Lock Core Color will Coordinate with Pull Selection
- Additional Options: Pull-Out Writing Shelf ([See Shelf Options](#)), Grommet Options ([See Grommet Options](#)), Kneespace Options (Sold Separately, [See Multiple Unit Details](#)), Wire Management + Accessories (Sold Separately, [See Multiple Unit Details](#))

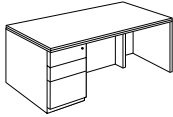
| Item | Model No. | Width | Depth | Height | K | R | Ship Wt | Cubic Ft | List Price | |
|--|----------------------------|------------|------------------|--------|---------------------------------|---------------------------------|---------------------------------|----------|-------------------------|-------------------------|
| SINGLE PED DESK WITH RECTANGLE TOP  | Left Ped | | Right Ped | | | | | | | |
| | 16-3672LPS | 16-3672RPS | 72 | 36 | 30 | 34 ⁵ / ₁₆ | 4 ¹³ / ₁₆ | 267 | 51.9 | W/P\$ 5585 PV\$ 6532 |
| | Stepped Front - Legal Ped | | | | | | | | | |
| | 16-3672LP | 16-3672RP | 72 | 36 | 30 | 51 ⁵ / ₈ | 9 ⁵ / ₈ | 267 | 51.9 | W/P\$ 4974 PV\$ 5816 |
| | Recessed Front - Legal Ped | | | | | | | | | |
| | 16-3072LPS | 16-3072RPS | 72 | 30 | 30 | 34 ⁵ / ₁₆ | 4 ¹³ / ₁₆ | 236 | 43.9 | W/P\$ 5431 PV\$ 6357 |
| | Stepped Front - Legal Ped | | | | | | | | | |
| | 16-3072LP | 16-3072RP | 72 | 30 | 30 | 51 ⁵ / ₈ | 3 ⁵ / ₈ | 236 | 43.9 | W/P\$ 4834 PV\$ 5658 |
| | Recessed Front - Legal Ped | | | | | | | | | |
| | 16-3066LPS | 16-3066RPS | 66 | 30 | 30 | 28 ⁵ / ₁₆ | 4 ¹³ / ₁₆ | 223 | 40.0 | W/P\$ 5031 PV\$ 5887 |
| Stepped Front - Letter Ped | | | | | | | | | | |
| 16-3066LP | 16-3066RP | 66 | 30 | 30 | 48 ⁵ / ₁₆ | 3 ⁵ / ₈ | 223 | 40.0 | W/P\$ 4478 PV\$ 5244 | |
| Recessed Front - Letter Ped | | | | | | | | | | |

Shown as Left

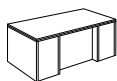

Stepped Front

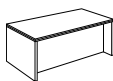

Recessed Front

Must Specify (in this order):

- Model
- Premium or Standard Veneer Chassis
- Top Material
- Finish/Color
- Edge Profile
- Drawer Pull
- Pull Out Writing Shelf
- Worksurface Grommet Location
- Grommet Color
- Kneespace Options

Description

- Standard With: Rectangle Top, Left to Right Grain Direction on Worksurface, Full Modesty, Locking Box/Box/File Pedestal, Black Utility Tray for Box Drawer
- Available with Premium Veneer (PV) or Standard Veneer (W) Chassis, Must Specify
- Available with Veneer (PV/W) or HPL (P) Top, Must Specify
- Lock Core Color will Coordinate with Pull Selection
- Additional Options: Pull-Out Writing Shelf ([See Shelf Options](#)), Grommet Options ([See Grommet Options](#)), Kneespace Options (Sold Separately, [See Multiple Unit Details](#)), Wire Management + Accessories (Sold Separately, [See Multiple Unit Details](#))

[See Madera Intro Section for Ordering Options](#)

| Item | Model No. | Width | Depth | Height | K | R | Ship Wt | Cubic Ft | List Price |
|--|-----------------|------------------|-------|--------|----|---|---------|----------|------------|
| SINGLE PED DESK WITH BOW TOP AND STEPPED FRONT | Left Ped | Right Ped | | | | | | | |
| | 16-4272LPSO | 16-4272RPSO | 72 | 42-36 | 30 | - | 12-6 | 270 | 58.4 |

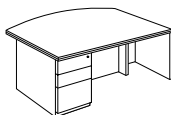

Shown as Left

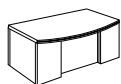

Stepped Front

Description

- Standard with: Bow Top, Stepped Front Modesty, Legal Width Locking Box/Box/File Pedestal, Left to Right Grain Direction on Worksurface, Black Utility Tray for Box Drawer
- Available with Premium Veneer (PV) or Standard Veneer (W) Chassis, Must Specify
- Available with Veneer (PV/W) or HPL (P) Top, Must Specify
- 16¹³/₁₆" Overhang on Approach From Center of Arc to Center of Modesty Panel
- Lock Core Color will Coordinate with Pull Selection
- Additional Options: Pull-Out Writing Shelf ([See Shelf Options](#)), Grommet Options ([See Grommet Options](#)), Kneespace Options (Sold Separately, [See Multiple Unit Details](#)), Wire Management + Accessories (Sold Separately, [See Multiple Unit Details](#))

Must Specify (in this order):

- Model
- Premium or Standard Veneer Chassis
- Top Material
- Finish/Color
- Edge Profile
- Drawer Pull
- Pull Out Writing Shelf
- Worksurface Grommet Location
- Grommet Color
- Kneespace Options

| SINGLE PED DESK WITH RECTANGLE TOP AND STEPPED FRONT | Left Ped | Right Ped | Width | Depth | Height | K | R | Ship Wt | Cubic Ft | List Price | |
|--|-------------|-------------|-------|-------|--------|---|---|---------|----------|-------------------------|--|
| | Model No. | Model No. | | | | | | | | | |
| | 16-3672LPSO | 16-3672RPSO | 72 | 36 | 30 | - | 6 | 251 | 51.9 | W/P\$ 5444 PV\$ 6372 | |
| | Legal Ped | | | | | | | | | | |
| | 16-3072LPSO | 16-3072RPSO | 72 | 30 | 30 | - | 6 | 220 | 43.9 | W/P\$ 5261 PV\$ 6156 | |
| | Legal Ped | | | | | | | | | | |
| | 16-3066LPSO | 16-3066RPSO | 66 | 30 | 30 | - | 6 | 207 | 40.0 | W/P\$ 4868 PV\$ 5696 | |
| | Letter Ped | | | | | | | | | | |

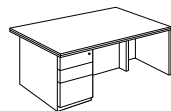

Shown as Left

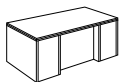

Stepped Front

Description

- Standard With: Rectangle Top, Stepped Front Modesty, Locking Box/Box/File Pedestal, Left to Right Grain Direction on Worksurface, Black Utility Tray for Box Drawer
- Available with Premium Veneer (PV) or Standard Veneer (W) Chassis, Must Specify
- Available with Veneer (PV/W) or HPL (P) Top, Must Specify
- 10¹³/₁₆" Overhang on Approach From Center of Arc to Center of Modesty Panel
- Lock Core Color will Coordinate with Pull Selection
- Additional Options: Pull-Out Writing Shelf ([See Shelf Options](#)), Grommet Options ([See Grommet Options](#)), Kneespace Options (Sold Separately, [See Multiple Unit Details](#)), Wire Management + Accessories (Sold Separately, [See Multiple Unit Details](#))

Must Specify (in this order):

- Model
- Premium or Standard Veneer Chassis
- Top Material
- Finish/Color
- Edge Profile
- Drawer Pull
- Pull Out Writing Shelf
- Worksurface Grommet Location
- Grommet Color
- Kneespace Options

Pricing Codes:

W = Wood Top

P = Laminate Top

PV = Premium Veneer

[See Madera Intro Section for Ordering Options](#)

| Item | Model No. | Width | Depth | Height | K | R | Ship Wt | Cubic Ft | List Price |
|---|-----------------|------------------|-------|--------|----|-----|---------|----------|------------|
| SINGLE DESK WITH ¾ PED AND BOW TOP | Left Ped | Right Ped | | | | | | | |
| | 14-4272LP | 14-4272RP | 72 | 42-36 | 30 | 51⅝ | 15⅞ | 268 | 60.1 |

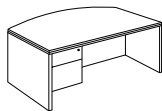

Shown as Left

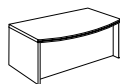

Recessed Front

Description

- Standard With: Bow Top, Recessed Front Modesty, Legal Width Locking Box/File ¾ Pedestal, Left to Right Grain Direction on Worksurface, Black Utility Tray for Box Drawer
- Available with Premium Veneer (PV) or Standard Veneer (W) Chassis, Must Specify
- Available with Veneer (PV/W) or HPL (P) Top, Must Specify
- Lock Core Color will Coordinate with Pull Selection
- Additional Options: Pull-Out Writing Shelf ([See Shelf Options](#)), Grommet Options ([See Grommet Options](#)), Kneespace Options (Sold Separately, [See Multiple Unit Details](#)), Wire Management + Accessories (Sold Separately, [See Multiple Unit Details](#))

Must Specify (in this order):

- Model
- Premium or Standard Veneer Chassis
- Top Material
- Finish/Color
- Edge Profile
- Drawer Pull
- Pull Out Writing Shelf
- Worksurface Grommet Location
- Grommet Color
- Kneespace Options

| SINGLE DESK WITH ¾ PED AND RECTANGLE TOP | Left Ped | Right Ped | | | | | | | | |
|---|-----------------|------------------|-----------|----|----|-----|-----|-----|------|-------------------------|
| | | 14-3672LP | 14-3672RP | 72 | 36 | 30 | 51⅝ | 9 ⅞ | 245 | 51.9 |
| | 14-3072LP | 14-3072RP | 72 | 30 | 30 | 51⅝ | 3 ⅞ | 214 | 43.9 | W/P\$ 4301 PV\$ 5034 |
| | 14-3066LP | 14-3066RP | 66 | 30 | 30 | 48⅝ | 3 ⅞ | 201 | 40.4 | W/P\$ 3958 PV\$ 4631 |

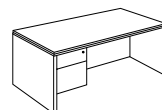

Shown as Left

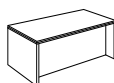

Recessed Front

Description

- Standard With: Rectangle Top, Recessed Front Modesty, Locking Box/File ¾ Pedestal, Left to Right Grain Direction on Worksurface, Black Utility Tray for Box Drawer
- Available with Premium Veneer (PV) or Standard Veneer (W) Chassis, Must Specify
- Available with Veneer (PV/W) or HPL (P) Top, Must Specify
- Lock Core Color will Coordinate with Pull Selection
- Additional Options: Pull-Out Writing Shelf ([See Shelf Options](#)), Grommet Options ([See Grommet Options](#)), Kneespace Options (Sold Separately, [See Multiple Unit Details](#)), Wire Management + Accessories (Sold Separately, [See Multiple Unit Details](#))

Must Specify (in this order):

- Model
- Premium or Standard Veneer Chassis
- Top Material
- Finish/Color
- Edge Profile
- Drawer Pull
- Pull Out Writing Shelf
- Worksurface Grommet Location
- Grommet Color
- Kneespace Options

[See Madera Intro Section for Ordering Options](#)

| Item | Model No. | Width | Depth | Height | Ship Wt | Cubic Ft | List Price |
|---|-----------------|------------------|-------|--------|---------|----------|------------|
|  | Left Ped | Right Ped | | | | | |
| | 14-4272PL | 14-4272PR | 72 | 42-36 | 30 | 155 | 58.4 |

Shown as Left

Must Specify (in this order):

Model
Premium or Standard Veneer Chassis
Top Material
Finish/Color
Edge Profile
Worksurface Grommet Location
Grommet Color
Leg Color
Kneespace Options

Description

- 4½" Diameter Metal Base; Must Specify: Black or Aluminum
- Not Recommended for Freestanding Applications
- Available with Premium Veneer (PV) or Standard Veneer (W) Chassis, Must Specify
- Available with Veneer (PV/W) or HPL (P) Top, Must Specify
- For Optional Center Drawer Used with Modesty Panel, [Use 01-1622CD](#)
- Additional Options: Grommet Options ([See Grommet Options](#)), Wire Management + Accessories (Sold Separately, [See Multiple Unit Details](#))

Options: Specify & Add

| | | |
|--------|---|---------------------|
| 14-HMD | Optional 10" Modesty Panel; Must specify Color | W\$ 335 PV\$ 390 |
| 14-FMD | Optional Full Modesty Panel; Must specify Color | W\$ 554 PV\$ 650 |

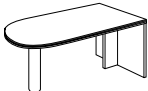
| Item | Model No. | Width | Depth | Height | Ship Wt | Cubic Ft | List Price | |
|---|-----------------|------------------|-------|--------|---------|----------|------------|-------------------------|
|  | Left Ped | Right Ped | | | | | | |
| | 14-3672DUL | 14-3672DUR | 72 | 36 | 30 | 160 | 50.1 | W/P\$ 4276 PV\$ 5001 |
| | 14-3072DUL | 14-3072DUR | 72 | 30 | 30 | 160 | 44.0 | W/P\$ 4041 PV\$ 4731 |

Shown as Left

Must Specify (in this order):

Model
Premium or Standard Veneer Chassis
Top Material
Finish/Color
Edge Profile
Worksurface Grommet Location
Grommet Color
Leg Color
Kneespace Options (14-3672DUL and 14-3672DUR only)

Description

- 4½" Diameter Metal Base; Must Specify: Black or Aluminum
- Not Recommended for Freestanding Applications
- Available with Premium Veneer (PV) or Standard Veneer (W) Chassis, Must Specify
- Available with Veneer (PV/W) or HPL (P) Top, Must Specify
- For Optional Center Drawer Used with Modesty Panel, [Use 01-1622CD](#)
- Keyboard Options and Center Drawer Only Available on 14-3672DUL or 14-3672DUR
- Additional Options: Grommet Options ([See Grommet Options](#)), Kneespace Options (Sold Separately, [See Multiple Unit Details](#)), Wire Management + Accessories (Sold Separately, [See Multiple Unit Details](#))

Options: Specify & Add

| | | |
|--------|---|---------------------|
| 14-HMD | Optional 10" Modesty Panel; Must specify Color | W\$ 335 PV\$ 390 |
| 14-FMD | Optional Full Modesty Panel; Must specify Color | W\$ 554 PV\$ 650 |

Pricing Codes:

W = Wood Top

P = Laminate Top

PV = Premium Veneer

[See Madera Intro Section for Ordering Options](#)

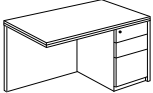
| Item | Model No. | Width | Depth | Height | K | R | Ship Wt | Cubic Ft | List Price | |
|--|-----------------|------------------|-------|--------|----|-----|---------|----------|------------|-------------------------|
| RETURN WITH FULL MODESTY BOX/BOX/FILE  | Left Ped | Right Ped | | | | | | | | |
| | 16-2448LF | 16-2448RF | 48 | 24 | 30 | 31¾ | - | 140 | 22.9 | W/P\$ 3640 PV\$ 4260 |
| | 16-2442LF | 16-2442RF | 42 | 24 | 30 | 25¾ | - | 130 | 19.9 | W/P\$ 3556 PV\$ 4161 |

Shown as Right

Must Specify (in this order):

- Model
- Premium or Standard Veneer Chassis
- Top Material
- Finish/Color
- Edge Profile
- Drawer Pull
- Worksurface Grommet Location
- Grommet Color
- Kneespace Options

Description

- Standard With: Full Modesty, Letter Width Locking Box/Box/File Pedestal, Front to Back Grain Direction on Worksurface
- Available with Premium Veneer (PV) or Standard Veneer (W) Chassis, Must Specify
- Available with Veneer (PV/W) or HPL (P) Top, Must Specify
- Grommet in Back Panel; Must Specify: Black (BLK) or Silver (SLV) or No Back Panel Grommet (NONE)
- Lock Core Color will Coordinate with Pull Selection
- Additional Options: Grommet Options ([See Grommet Options](#)), Kneespace Options (Sold Separately, [See Multiple Unit Details](#)), Wire Management + Accessories (Sold Separately, [See Multiple Unit Details](#))

| Item | Model No. | Width | Depth | Height | K | R | Ship Wt | Cubic Ft | List Price | |
|---|-----------------|------------------|-------|--------|----|-----|---------|----------|------------|-------------------------|
| RETURN WITH FULL MODESTY FILE/FILE  | Left Ped | Right Ped | | | | | | | | |
| | 16-2448LF2 | 16-2448RF2 | 48 | 24 | 30 | 31¾ | - | 140 | 22.9 | W/P\$ 3640 PV\$ 4260 |
| | 16-2442LF2 | 16-2442RF2 | 42 | 24 | 30 | 25¾ | - | 130 | 19.9 | W/P\$ 3556 PV\$ 4161 |

Shown as Right

Must Specify (in this order):

- Model
- Premium or Standard Veneer Chassis
- Top Material
- Finish/Color
- Edge Profile
- Drawer Pull
- Worksurface Grommet Location
- Grommet Color
- Kneespace Options

Description

- Standard With: Full Modesty, Letter Width Locking File/File Pedestal, Front to Back Grain Direction on Worksurface
- Available with Premium Veneer (PV) or Standard Veneer (W) Chassis, Must Specify
- Available with Veneer (PV/W) or HPL (P) Top, Must Specify
- Grommet in Back Panel; Must Specify: Black (BLK) or Silver (SLV) or No Back Panel Grommet (NONE)
- Lock Core Color will Coordinate with Pull Selection
- Additional Options: Grommet Options ([See Grommet Options](#)), Kneespace Options (Sold Separately, [See Multiple Unit Details](#)), Wire Management + Accessories (Sold Separately, [See Multiple Unit Details](#))

[See Madera Intro Section for Ordering Options](#)

| Item | Model No. | Width | Depth | Height | K | R | Ship Wt | Cubic Ft | List Price | |
|--|-----------------|------------------|-------|--------|----|-----|---------|----------|------------|-------------------------|
| RETURN WITH HALF MODESTY BOX/BOX/FILE | Left Ped | Right Ped | | | | | | | | |
| | 16-2448LFH | 16-2448RFH | 48 | 24 | 30 | 31¾ | - | 133 | 22.9 | W/P\$ 3544 PV\$ 4146 |
| | 16-2442LFH | 16-2442RFH | 42 | 24 | 30 | 25¾ | - | 122 | 19.9 | W/P\$ 3474 PV\$ 4062 |

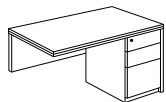

Shown as Right

Must Specify (in this order):

Model
Premium or Standard Veneer Chassis
Top Material
Finish/Color
Edge Profile
Drawer Pull
Worksurface Grommet Location
Grommet Color
Kneespace Options

Description

- Standard With: 10" Half Modesty, Letter Width Locking Box/Box/File Pedestal, Front to Back Grain Direction on Worksurface
- Available with Premium Veneer (PV) or Standard Veneer (W) Chassis, Must Specify
- Available with Veneer (PV/W) or HPL (P) Top, Must Specify
- Lock Core Color will Coordinate with Pull Selection
- Additional Options: Grommet Options ([See Grommet Options](#)), Kneespace Options (Sold Separately, [See Multiple Unit Details](#)), Wire Management + Accessories (Sold Separately, [See Multiple Unit Details](#))

| | | | | | | | | | | |
|---------------------------------------|-----------------|------------------|----|----|----|-----|---|-----|------|-------------------------|
| RETURN WITH HALF MODESTY FILE/FILE | Left Ped | Right Ped | | | | | | | | |
| | 16-2448LF2H | 16-2448RF2H | 48 | 24 | 30 | 31¾ | - | 132 | 22.9 | W/P\$ 3544 PV\$ 4146 |
| | 16-2442LF2H | 16-2442RF2H | 42 | 24 | 30 | 25¾ | - | 122 | 19.9 | W/P\$ 3474 PV\$ 4062 |

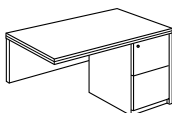

Shown as Right

Must Specify (in this order):

Model
Premium or Standard Veneer Chassis
Top Material
Finish/Color
Edge Profile
Drawer Pull
Worksurface Grommet Location
Grommet Color
Kneespace Options

Description

- Standard With: 10" Half Modesty, Letter Width Locking File/File Pedestal, Front to Back Grain Direction on Worksurface
- Available with Premium Veneer (PV) or Standard Veneer (W) Chassis, Must Specify
- Available with Veneer (PV/W) or HPL (P) Top, Must Specify
- Lock Core Color will Coordinate with Pull Selection
- Additional Options: Grommet Options ([See Grommet Options](#)), Kneespace Options (Sold Separately, [See Multiple Unit Details](#)), Wire Management + Accessories (Sold Separately, [See Multiple Unit Details](#))

Pricing Codes:

W = Wood Top

P = Laminate Top

PV = Premium Veneer

[See Madera Intro Section for Ordering Options](#)

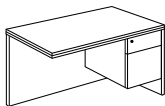
| Item | Model No. | Width | Depth | Height | K | R | Ship Wt | Cubic Ft | List Price | |
|--|-----------------|------------------|-------|--------|----|-----|---------|----------|------------|-------------------------|
| RETURN WITH ¾ BOX/FILE PED  | Left Ped | Right Ped | | | | | | | | |
| | 14-2448LF | 14-2448RF | 48 | 24 | 30 | 3¼ | - | 132 | 22.9 | W/P\$ 3344 PV\$ 3912 |
| | 14-2442LF | 14-2442RF | 42 | 24 | 30 | 25¾ | - | 122 | 19.9 | W/P\$ 3270 PV\$ 3826 |

Shown as Right

Must Specify (in this order):

- Model
- Premium or Standard Veneer Chassis
- Top Material
- Finish/Color
- Edge Profile
- Drawer Pull
- Worksurface Grommet Location
- Modesty Grommet
- Grommet Color
- Kneespace Options

Description

- Standard With: Full Modesty, Letter Width Locking Box/File ¾ Pedestal, Front to Back Grain Direction on Worksurface
- Available with Premium Veneer (PV) or Standard Veneer (W) Chassis, Must Specify
- Available with Veneer (PV/W) or HPL (P) Top, Must Specify
- Grommet in Back Panel; Must Specify: Black (BLK) or Silver (SLV) or No Back Panel Grommet (NONE)
- Lock Core Color will Coordinate with Pull Selection
- Additional Options: Grommet Options ([See Grommet Options](#)), Kneespace Options (Sold Separately, [See Multiple Unit Details](#)), Wire Management + Accessories (Sold Separately, [See Multiple Unit Details](#))

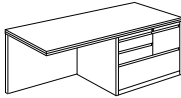
| Item | Model No. | Width | Depth | Height | K | R | Ship Wt | Cubic Ft | List Price |
|---|-----------------|------------------|-------|--------|----|----|---------|----------|------------|
| MULTI-FILE RETURN WITH FULL MODESTY  | Left Ped | Right Ped | | | | | | | |
| | 14-2472LMR | 14-2472RMR | 72 | 24 | 30 | 36 | - | 227 | 29.0 |

Shown as Right

Must Specify (in this order):

- Model
- Premium or Standard Veneer Chassis
- Top Material
- Finish/Color
- Edge Profile
- Drawer Pull
- Worksurface Grommet Location
- Modesty Grommet
- Grommet Color
- Kneespace Options

Description

- Standard With: Full Modesty, Box/Box/File/Lateral Pedestal, Locking File Drawer
- Front to Back Grain Direction on Veneer Worksurface; Left to Right Grain Direction on Laminate Worksurface
- Available with Premium Veneer (PV) or Standard Veneer (W) Chassis, Must Specify
- Available with Veneer (PV/W) or HPL (P) Top, Must Specify
- Grommet in Back Panel; Must Specify: Black (BLK) or Silver (SLV) or No Back Panel Grommet (NONE)
- Lateral File Provides Legal or Letter filing Side to Side or Front to Back
- File Drawer Lock Core Color will Coordinate with Pull Selection
- Optional Left or Right Worksurface Grommet Location Only ([See Details](#))
- Additional Options: Kneespace Options (Sold Separately, [See Multiple Unit Details](#)), Wire Management + Accessories (Sold Separately, [See Multiple Unit Details](#))

[See Madera Intro Section for Ordering Options](#)

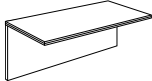
| Item | Model No. | Width | Depth | Height | K | R | Ship Wt | Cubic Ft | List Price | |
|---|--------------------------|-----------|-------|--------|----|----|---------|----------|------------|-------------------------|
|  | BRIDGE WITH FULL MODESTY | 14-2448UF | 48 | 24 | 30 | 23 | - | 82 | 6.2 | W/P\$ 1703 PV\$ 1991 |
| | | 14-2442UF | 42 | 24 | 30 | 23 | - | 68 | 5.5 | W/P\$ 1579 PV\$ 1852 |
| | | 14-2436UF | 36 | 24 | 30 | 23 | - | 68 | 4.0 | W/P\$ 1498 PV\$ 1749 |

Must Specify (in this order):

Model
 Premium or Standard Veneer Chassis
 Top Material
 Finish/Color
 Edge Profile
 Worksurface Grommet Location
 Modesty Grommet
 Grommet Color

Description

- Standard With: Hinged Full Modesty, Grain Direction Runs Front to Back on Worksurface
- Available with Premium Veneer (PV) or Standard Veneer (W) Chassis, Must Specify
- Available with Veneer (PV/W) or HPL (P) Top, Must Specify
- Grommet in Back Panel; Must Specify: Black (BLK) or Silver (SLV) or No Back Panel Grommet (NONE)
- Some Assembly Required
- Keyboard Accessories Cannot be Factory Installed but are Available for Field Installation
- Additional Options: Grommet Options ([See Grommet Options](#)), Kneespace Options (Sold Separately, [See Multiple Unit Details](#)), Wire Management + Accessories (Sold Separately, [See Multiple Unit Details](#))

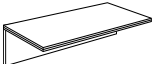
| | | | | | | | | | | |
|---|--------------------------|------------|----|----|-------------------|----|---|----|-----|-------------------------|
|  | BRIDGE WITH HALF MODESTY | 14-2448UFH | 48 | 24 | 11 $\frac{1}{16}$ | 23 | - | 62 | 6.2 | W/P\$ 1560 PV\$ 1825 |
| | | 14-2442UFH | 42 | 24 | 11 $\frac{1}{16}$ | 23 | - | 48 | 5.5 | W/P\$ 1429 PV\$ 1678 |
| | | 14-2436UFH | 36 | 24 | 11 $\frac{1}{16}$ | 23 | - | 48 | 4.0 | W/P\$ 1382 PV\$ 1619 |

Must Specify (in this order):

Model
 Premium or Standard Veneer Chassis
 Top Material
 Finish/Color
 Edge Profile
 Worksurface Grommet Location
 Grommet Color

Description

- Standard With: Hinged 10" Half Modesty, Grain Direction Runs Front to Back on Worksurface
- Available with Premium Veneer (PV) or Standard Veneer (W) Chassis, Must Specify
- Available with Veneer (PV/W) or HPL (P) Top, Must Specify
- Some Assembly Required
- Keyboard Accessories Cannot be Factory Installed but are Available for Field Installation
- Additional Options: Grommet Options ([See Grommet Options](#)), Kneespace Options (Sold Separately, [See Multiple Unit Details](#)), Wire Management + Accessories (Sold Separately, [See Multiple Unit Details](#))

| | | | | | | | | | | |
|---|-------------|-----------|----|----|----|-------------------|---|-----|------|-------------------------|
|  | CORNER UNIT | 14-4242CU | 42 | 42 | 30 | 25 $\frac{1}{16}$ | - | 145 | 34.5 | W/P\$ 3618 PV\$ 4234 |
| | | 14-3636CU | 36 | 36 | 30 | 17 | - | 135 | 25.7 | W/P\$ 3470 PV\$ 4057 |

Description

- Connects to 24" Deep Bridge and Return Units
- Available with Veneer (PV/W) or HPL (P) Top, Must Specify
- Available with Premium Veneer (PV) or Standard Veneer (W) Chassis, Must Specify
- Grain Direction Runs Front to Back on Worksurface
- Surface Grommet Standard in Top; Must Specify: Black (BLK) or Silver (SLV)
- Keyboards Accessories for 14-4242CU: 01-KB3 or 01-KB2CC (Sold Separately, [See Multiple Unit Details](#))
- Additional Options: Wire Management + Accessories (Sold Separately, [See Multiple Unit Details](#))

Must Specify (in this order):

Model
 Premium or Standard Veneer Chassis
 Top Material
 Finish/Color
 Edge Profile
 Worksurface Grommet Color

Pricing Codes:

W = Wood Top

P = Laminate Top

PV = Premium Veneer

[See Madera Intro Section for Ordering Options](#)

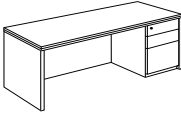
| Item | Model No. | Width | Depth | Height | K | R | Ship Wt | Cubic Ft | List Price | |
|---|-----------------|------------------|-------|--------|----|-----|---------|----------|------------|-------------------------|
| CREDENZA WITH FULL MODESTY BOX/BOX/FILE  Shown as Right | Left Ped | Right Ped | | | | | | | | |
| | 16-2472LC | 16-2472RC | 72 | 24 | 30 | 28¾ | - | 199 | 35.6 | W/P\$ 4360 PV\$ 5105 |
| | | Legal Pedestal | | | | | | | | |
| | 16-2466LC | 16-2466RC | 66 | 24 | 30 | 25¾ | - | 182 | 32.7 | W/P\$ 4087 PV\$ 4781 |
| | | Letter Pedestal | | | | | | | | |
| | 16-2072LC | 16-2072RC | 72 | 20 | 30 | 28¾ | - | 183 | 30.5 | W/P\$ 4015 PV\$ 4696 |
| | | Legal Pedestal | | | | | | | | |
| | 16-2066LC | 16-2066RC | 66 | 20 | 30 | 25¾ | - | 167 | 27.8 | W/P\$ 3759 PV\$ 4399 |
| | Letter Pedestal | | | | | | | | | |

Must Specify (in this order):

- Model
- Premium or Standard Veneer Chassis
- Top Material
- Finish/Color
- Edge Profile
- Drawer Pull
- Worksurface Grommet Location
- Back Panel Grommet
- Grommet Color
- Kneespace Options

Description

- Standard With: Full Modesty, Left to Right Grain Direction on Worksurface, Locking Box/Box/File Pedestal
- Available with Premium Veneer (PV) or Standard Veneer (W) Chassis, Must Specify
- Available with Veneer (PV/W) or HPL (P) Top, Must Specify
- Grommet in Back Panel; Must Specify: Black (BLK) or Silver (SLV) or No Back Panel Grommet (NONE)
- Lock Core Color will Coordinate with Pull Selection
- Additional Options: Grommet Options ([See Grommet Options](#)), Kneespace Options (Sold Separately, [See Multiple Unit Details](#)), Wire Management + Accessories (Sold Separately, [See Multiple Unit Details](#))

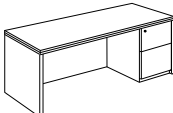
| Item | Model No. | Width | Depth | Height | K | R | Ship Wt | Cubic Ft | List Price | |
|--|-----------------|------------------|-------|--------|----|-----|---------|----------|------------|-------------------------|
| CREDENZA WITH FULL MODESTY FILE/FILE  Shown as Right | Left Ped | Right Ped | | | | | | | | |
| | 16-2472LC2 | 16-2472RC2 | 72 | 24 | 30 | 28¾ | - | 199 | 35.6 | W/P\$ 4360 PV\$ 5105 |
| | | Legal Pedestal | | | | | | | | |
| | 16-2466LC2 | 16-2466RC2 | 66 | 24 | 30 | 25¾ | - | 182 | 32.7 | W/P\$ 4087 PV\$ 4781 |
| | | Letter Pedestal | | | | | | | | |
| | 16-2072LC2 | 16-2072RC2 | 72 | 20 | 30 | 28¾ | - | 183 | 30.5 | W/P\$ 4015 PV\$ 4696 |
| | | Legal Pedestal | | | | | | | | |
| | 16-2066LC2 | 16-2066RC2 | 66 | 20 | 30 | 25¾ | - | 167 | 27.8 | W/P\$ 3759 PV\$ 4399 |
| | Letter Pedestal | | | | | | | | | |

Must Specify (in this order):

- Model
- Premium or Standard Veneer Chassis
- Top Material
- Finish/Color
- Edge Profile
- Drawer Pull
- Worksurface Grommet Location
- Back Panel Grommet
- Grommet Color
- Kneespace Options

Description

- Standard With: Full Modesty, Left to Right Grain Direction on Worksurface, Locking File/File Pedestal
- Available with Premium Veneer (PV) or Standard Veneer (W) Chassis, Must Specify
- Available with Veneer (PV/W) or HPL (P) Top, Must Specify
- Grommet in Back Panel; Must Specify: Black (BLK) or Silver (SLV) or No Back Panel Grommet (NONE)
- Lock Core Color will Coordinate with Pull Selection
- Additional Options: Grommet Options ([See Grommet Options](#)), Kneespace Options (Sold Separately, [See Multiple Unit Details](#)), Wire Management + Accessories (Sold Separately, [See Multiple Unit Details](#))

[See Madera Intro Section for Ordering Options](#)

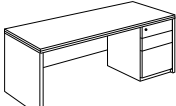
| Item | Model No. | Width | Depth | Height | K | R | Ship Wt | Cubic Ft | List Price | |
|--|-----------------|------------------|-------|--------|----|-----|---------|----------|------------|------------|
| CREENZA WITH HALF MODESTY BOX/BOX/FILE  | Left Ped | Right Ped | | | | | | | | |
| | 16-2472LCH | 16-2472RCH | 72 | 24 | 30 | 28¾ | - | 242 | 35.6 | W/P\$ 4198 |
| | | Legal Pedestal | | | | | | | | PV\$ 4911 |
| | 16-2466LCH | 16-2466RCH | 66 | 24 | 30 | 28¾ | - | 170 | 32.7 | W/P\$ 3928 |
| | Letter Pedestal | | | | | | | | PV\$ 4597 | |

Shown as Right

Must Specify (in this order):

Model
 Premium or Standard Veneer Chassis
 Top Material
 Finish/Color
 Edge Profile
 Drawer Pull
 Worksurface Grommet Location
 Grommet Color
 Kneespace Options

Description

- Standard With: 10" Half Modesty, Left to Right Grain Direction on Worksurface, Locking Box/Box/File Pedestal
- Available with Premium Veneer (PV) or Standard Veneer (W) Chassis, Must Specify
- Available with Veneer (PV/W) or HPL (P) Top, Must Specify
- Lock Core Color will Coordinate with Pull Selection
- Additional Options: Grommet Options ([See Grommet Options](#)), Kneespace Options (Sold Separately, [See Multiple Unit Details](#)), Wire Management + Accessories (Sold Separately, [See Multiple Unit Details](#))

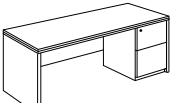
| Item | Model No. | Width | Depth | Height | K | R | Ship Wt | Cubic Ft | List Price | |
|---|-----------------|------------------|-------|--------|----|-----|---------|----------|------------|------------|
| CREENZA WITH HALF MODESTY FILE/FILE  | Left Ped | Right Ped | | | | | | | | |
| | 16-2472LC2H | 16-2472RC2H | 72 | 24 | 30 | 28¾ | - | 242 | 35.6 | W/P\$ 4198 |
| | | Legal Pedestal | | | | | | | | PV\$ 4911 |
| | 16-2466LC2H | 16-2466RC2H | 66 | 24 | 30 | 28¾ | - | 170 | 32.7 | W/P\$ 3928 |
| | Letter Pedestal | | | | | | | | PV\$ 4597 | |

Shown as Right

Must Specify (in this order):

Model
 Premium or Standard Veneer Chassis
 Top Material
 Finish/Color
 Edge Profile
 Drawer Pull
 Worksurface Grommet Location
 Grommet Color
 Kneespace Options

Description

- Standard With: 10" Half Modesty, Left to Right Grain Direction on Worksurface, Locking File/File Pedestal
- Available with Premium Veneer (PV) or Standard Veneer (W) Chassis, Must Specify
- Available with Veneer (PV/W) or HPL (P) Top, Must Specify
- Lock Core Color will Coordinate with Pull Selection
- Additional Options: Grommet Options ([See Grommet Options](#)), Kneespace Options (Sold Separately, [See Multiple Unit Details](#)), Wire Management + Accessories (Sold Separately, [See Multiple Unit Details](#))

Pricing Codes:

W = Wood Top

P = Laminate Top

PV = Premium Veneer

[See Madera Intro Section for Ordering Options](#)

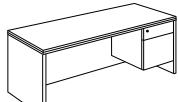
| Item | Model No. | Width | Depth | Height | K | R | Ship Wt | Cubic Ft | List Price | |
|---|-----------------|------------------|-------|--------|----|-----|---------|----------|------------|------------|
| CREDENZA WITH FULL MODESTY BOX/FILE 3/4 PED  | Left Ped | Right Ped | | | | | | | | |
| | 14-2072LC | 14-2072RC | 72 | 20 | 30 | 28¾ | - | 172 | 30.5 | W/P\$ 3670 |
| | | Legal Pedestal | | | | | | | | PV\$ 4294 |
| | 14-2066LC | 14-2066RC | 66 | 20 | 30 | 25¾ | - | 158 | 27.8 | W/P\$ 3365 |
| | Letter Pedestal | | | | | | | | PV\$ 3938 | |

Shown as Right

Must Specify (in this order):

- Model
- Premium or Standard Veneer Chassis
- Top Material
- Finish/Color
- Edge Profile
- Drawer Pull
- Worksurface Grommet Location
- Back Panel Grommet
- Grommet Color
- Kneespace Options

Description

- Standard With: Full Modesty, Left to Right Grain Direction on Worksurface, Locking Box/File ¾ Pedestal
- Available with Premium Veneer (PV) or Standard Veneer (W) Chassis, Must Specify
- Available with Veneer (PV/W) or HPL (P) Top, Must Specify
- Grommet in Back Panel; Must Specify: Black (BLK) or Silver (SLV) or No Back Panel Grommet (NONE)
- Lock Core Color will Coordinate with Pull Selection
- Additional Options: Grommet Options ([See Grommet Options](#)), Kneespace Options (Sold Separately, [See Multiple Unit Details](#)), Wire Management + Accessories (Sold Separately, [See Multiple Unit Details](#))

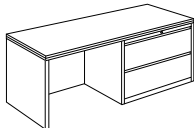
| Item | Model No. | Width | Depth | Height | K | R | Ship Wt | Cubic Ft | List Price | |
|---|-----------------|------------------|-------|--------|----|----|---------|----------|------------|------------|
| CREDENZA WITH FULL MODESTY LATERAL FILE  | Left Ped | Right Ped | | | | | | | | |
| | 14-2472LL | 14-2472RL | 72 | 24 | 30 | 12 | - | 277 | 35.6 | W/P\$ 4751 |
| | | 36" Pedestal | | | | | | | | PV\$ 5555 |
| | 14-2466LL | 14-2466RL | 66 | 24 | 30 | 6 | - | 264 | 32.7 | W/P\$ 4670 |
| | | 36" Pedestal | | | | | | | | PV\$ 5465 |
| | 14-2472LL3 | 14-2472RL3 | 72 | 24 | 30 | 12 | - | 267 | 35.6 | W/P\$ 4533 |
| | | 30" Pedestal | | | | | | | | PV\$ 5304 |
| | 14-2466LL3 | 14-2466RL3 | 66 | 24 | 30 | 6 | - | 254 | 32.7 | W/P\$ 4456 |
| | 30" Pedestal | | | | | | | | PV\$ 5212 | |
| 14-2072LL | 14-2072RL | 72 | 20 | 30 | 12 | - | 224 | 30.2 | W/P\$ 4404 | |
| | 36" Pedestal | | | | | | | | PV\$ 5154 | |
| 14-2066LL | 14-2066RL | 66 | 20 | 30 | 6 | - | 215 | 27.8 | W/P\$ 4333 | |
| | 36" Pedestal | | | | | | | | PV\$ 5070 | |

Shown as Right

Must Specify (in this order):

- Model
- Premium or Standard Veneer Chassis
- Top Material
- Finish/Color
- Edge Profile
- Drawer Pull
- Worksurface Grommet Location
- Back Panel Grommet
- Grommet Color
- Kneespace Options

Description

- Standard With: Full Modesty, Left to Right Grain Direction on Worksurface, Two (2) Central Locking Lateral Drawers
- Available with Premium Veneer (PV) or Standard Veneer (W) Chassis, Must Specify
- Available with Veneer (PV/W) or HPL (P) Top, Must Specify
- Grommet in Back Panel; Must Specify: Black (BLK) or Silver (SLV) or No Back Panel Grommet (NONE)
- Lock Core Color will Coordinate with Pull Selection
- Lateral File Provides Legal or Letter filing Side to Side or Front to Back
- Additional Options: Grommet Options ([See Grommet Options](#)), Kneespace Options (Sold Separately, [See Multiple Unit Details](#)), Wire Management + Accessories (Sold Separately, [See Multiple Unit Details](#))

[See Madera Intro Section for Ordering Options](#)

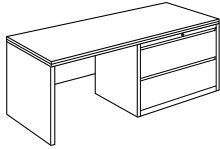
| Item | Model No. | Width | Depth | Height | K | R | Ship Wt | Cubic Ft | List Price | |
|---|-----------------|------------------|-------|--------|----|----|---------|----------|------------|-------------------------|
| CREDENZA WITH HALF MODESTY LATERAL FILE  | Left Ped | Right Ped | | | | | | | | |
| | 14-2472LLH | 14-2472RLH | 72 | 24 | 30 | 12 | - | 273 | 35.6 | W/P\$ 4634 PV\$ 5423 |
| | 14-2466LLH | 14-2466RLH | 66 | 24 | 30 | 6 | - | 260 | 32.7 | W/P\$ 4577 PV\$ 5353 |
| | 14-2472LL3H | 14-2472RL3H | 72 | 24 | 30 | 12 | - | 263 | 35.6 | W/P\$ 4402 PV\$ 5152 |
| | 14-2466LL3H | 14-2466RL3H | 66 | 24 | 30 | 6 | - | 250 | 32.7 | W/P\$ 4343 PV\$ 5080 |

Shown as Right

Must Specify (in this order):

Model
 Premium or Standard Veneer Chassis
 Top Material
 Finish/Color
 Edge Profile
 Drawer Pull
 Worksurface Grommet Location
 Grommet Color
 Kneespace Options

Description

- Standard With: 10" Half Modesty, Left to Right Grain Direction on Worksurface, Two (2) Central Locking Lateral Drawers
- Available with Premium Veneer (PV) or Standard Veneer (W) Chassis, Must Specify
- Available with Veneer (PV/W) or HPL (P) Top, Must Specify
- Lock Core Color will Coordinate with Pull Selection
- Lateral File Provides Legal or Letter filing Side to Side or Front to Back
- Additional Options: Grommet Options ([See Grommet Options](#)), Kneespace Options (Sold Separately, [See Multiple Unit Details](#)), Wire Management + Accessories (Sold Separately, [See Multiple Unit Details](#))

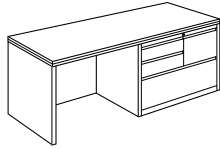
| Item | Model No. | Width | Depth | Height | K | R | Ship Wt | Cubic Ft | List Price | |
|---|-----------------|------------------|-------|--------|----|----|---------|----------|------------|-------------------------|
| MULTI-FILE CREDENZA WITH FULL MODESTY BOX/BOX/FILE/LATERAL FILE  | Left Ped | Right Ped | | | | | | | | |
| | 14-2072LL4 | 14-2072RL4 | 72 | 20 | 30 | 12 | - | 231 | 29.0 | W/P\$ 4995 PV\$ 5845 |
| | 14-2066LL4 | 14-2066RL4 | 66 | 20 | 30 | 6 | - | 219 | 27.8 | W/P\$ 4929 PV\$ 5768 |

Shown as Right

Must Specify (in this order):

Model
 Premium or Standard Veneer Chassis
 Top Material
 Finish/Color
 Edge Profile
 Drawer Pull
 Worksurface Grommet Location
 Grommet Color
 Kneespace Options

Description

- Standard With: Full Modesty, Left to Right Grain Direction on Worksurface, Box/Box/File/Lateral Pedestal, Locking File Drawer
- Available with Premium Veneer (PV) or Standard Veneer (W) Chassis, Must Specify
- Available with Veneer (PV/W) or HPL (P) Top, Must Specify
- Lock Core Color will Coordinate with Pull Selection
- Lateral File Provides Legal or Letter filing Side to Side or Front to Back
- Additional Options: Grommet Options ([See Grommet Options](#)), Kneespace Options (Sold Separately, [See Multiple Unit Details](#)), Wire Management + Accessories (Sold Separately, [See Multiple Unit Details](#))

Pricing Codes:

W = Wood Top

P = Laminate Top

PV = Premium Veneer

[See Madera Intro Section for Ordering Options](#)

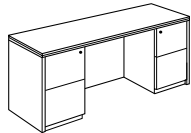
| Item | Model No. | Width | Depth | Height | K | R | Ship Wt | Cubic Ft | List Price |
|--|-------------------------|-------|-------|--------|-----|---|---------|----------|-------------------------|
|  KNEESPACE CREDENZA FULL MODESTY WITH FILE/FILE | 16-2472KC Legal Ped | 72 | 24 | 30 | 33½ | - | 240 | 35.6 | W/P\$ 5568 PV\$ 6516 |
| | 16-2466KC Letter Ped | 66 | 24 | 30 | 33½ | - | 220 | 32.7 | W/P\$ 5090 PV\$ 5955 |
| | 16-2072KC Legal Ped | 72 | 20 | 30 | 33½ | - | 223 | 30.5 | W/P\$ 5188 PV\$ 6069 |
| | 16-2066KC Letter Ped | 66 | 20 | 30 | 33½ | - | 221 | 27.8 | W/P\$ 4741 PV\$ 5549 |

Must Specify (in this order):

Model
 Premium or Standard Veneer Chassis
 Top Material
 Finish/Color
 Edge
 Drawer Pull
 Worksurface Grommet Location
 Back Panel Grommet
 Grommet Color
 Kneespace Options

Description

- Standard With: Full Modesty, Left to Right Grain Direction on Worksurface, Locking File/File Pedestals
- Available with Premium Veneer (PV) or Standard Veneer (W) Chassis, Must Specify
- Available with Veneer (PV/W) or HPL (P) Top, Must Specify
- Grommet in Back Panel; Must Specify: Black (BLK) or Silver (SLV) or No Back Panel Grommet (NONE)
- Lock Core Color will Coordinate with Pull Selection
- Additional Options: Grommet Options ([See Grommet Options](#)), Kneespace Options (Sold Separately, [See Multiple Unit Details](#)), Wire Management + Accessories (Sold Separately, [See Multiple Unit Details](#))

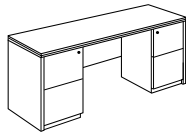
| | | | | | | | | | |
|--|--------------------------|----|----|----|-----|---|-----|------|-------------------------|
|  KNEESPACE CREDENZA HALF MODESTY WITH FILE/FILE | 16-2472KCH Legal Ped | 72 | 24 | 30 | 33½ | - | 236 | 35.6 | W/P\$ 5461 PV\$ 6391 |
| | 16-2466KCH Letter Ped | 66 | 24 | 30 | 33½ | - | 216 | 32.7 | W/P\$ 4982 PV\$ 5829 |

Must Specify (in this order):

Model
 Premium or Standard Veneer Chassis
 Top Material
 Finish/Color
 Edge
 Drawer Pull
 Worksurface Grommet Location
 Grommet Color
 Kneespace Options

Description

- Standard With: 10" Half Modesty, Left to Right Grain Direction on Worksurface, Locking File/File Pedestals
- Available with Premium Veneer (PV) or Standard Veneer (W) Chassis, Must Specify
- Available with Veneer (PV/W) or HPL (P) Top, Must Specify
- Lock Core Color will Coordinate with Pull Selection
- Additional Options: Grommet Options ([See Grommet Options](#)), Kneespace Options (Sold Separately, [See Multiple Unit Details](#)), Wire Management + Accessories (Sold Separately, [See Multiple Unit Details](#))

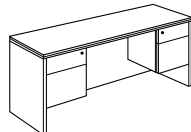
| | | | | | | | | | |
|---|-------------------------|----|----|----|-----|---|-----|------|-------------------------|
|  KNEESPACE CREDENZA FULL MODESTY WITH 3/4 PED BOX/FILE | 14-2072KC Legal Ped | 72 | 20 | 30 | 33½ | - | 295 | 51.9 | W/P\$ 4416 PV\$ 5168 |
| | 14-2066KC Letter Ped | 66 | 20 | 30 | 33½ | - | 264 | 43.9 | W/P\$ 4111 PV\$ 4807 |

Must Specify (in this order):

Model
 Premium or Standard Veneer Chassis
 Top Material
 Finish/Color
 Edge
 Drawer Pull
 Worksurface Grommet Location
 Back Panel Grommet
 Grommet Color

Description

- Standard With: Full Modesty, Left to Right Grain Direction on Worksurface, Locking Box/File Pedestals
- Available with Premium Veneer (PV) or Standard Veneer (W) Chassis, Must Specify
- Available with Veneer (PV/W) or HPL (P) Top, Must Specify
- Grommet in Back Panel; Must Specify: Black (BLK) or Silver (SLV) or No Back Panel Grommet (NONE)
- Lock Core Color will Coordinate with Pull Selection
- Additional Options: Grommet Options ([See Grommet Options](#)), Kneespace Options (Sold Separately, [See Multiple Unit Details](#)), Wire Management + Accessories (Sold Separately, [See Multiple Unit Details](#))

[See Madera Intro Section for Ordering Options](#)

| Item | Model No. | Width | Depth | Height | Ship Wt | Cubic Ft | List Price |
|---|------------------------------|------------------|-------|-------------------|---------|----------|-------------------------|
| TRANSACTION RISER FOR DESKS AND CREDENZAS | 14-1270TR | 70 $\frac{5}{8}$ | 12 | 13 $\frac{3}{16}$ | 62 | 9.7 | W/P\$ 2696 PV\$ 3153 |
| | For Use with 72" Worksurface | | | | | | |
| | 14-1264TR | 64 $\frac{5}{8}$ | 12 | 13 $\frac{3}{16}$ | 56 | 8.9 | W/P\$ 2416 PV\$ 2826 |
| | For Use with 66" Worksurface | | | | | | |

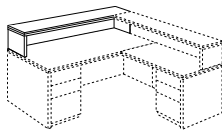

Must Specify (in this order):

Model
Premium or Standard Veneer Chassis
Top Material
Finish/Color
Edge Profile

Description

- Left to Right Grain Direction
- Freestanding Riser; May Be Used in Conjunction with Return Riser or Bridge Risers
- Available with Premium Veneer (PV) or Standard Veneer (W) Chassis, Must Specify
- Available with Veneer (PV/W) or HPL (P) Top, Must Specify

| TRANSACTION RISER FOR RETURNS | Left Ped | Right Ped | | | | | | |
|-------------------------------|--|-----------|----|---|-------------------|----|-----|-------------------------|
| | 14-0971LU | 14-0971RU | 71 | 9 | 13 $\frac{3}{16}$ | 45 | 6.8 | W/P\$ 2674 PV\$ 3131 |
| | For Use with 36" Desks and 48" Returns | | | | | | | |
| | 14-0959LU | 14-0959RU | 59 | 9 | 13 $\frac{3}{16}$ | 40 | 6.1 | W/P\$ 2207 PV\$ 2579 |
| | For Use with 30" Desks and 42" Returns | | | | | | | |

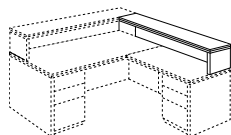

Shown as Right

Must Specify (in this order):

Model
Premium or Standard Veneer Chassis
Top Material
Finish/Color
Edge Profile

Description

- Left to Right Grain Direction
- Must Be Used in Conjunction with Desk Risers
- Available with Premium Veneer (PV) or Standard Veneer (W) Chassis, Must Specify
- Available with Veneer (PV/W) or HPL (P) Top, Must Specify

| TRANSACTION RISER FOR BRIDGES | | | | | | | | |
|-------------------------------|---|--|----|---|-------------------|----|-----|-------------------------|
| | 14-0978BU | | 78 | 9 | 13 $\frac{3}{16}$ | 48 | 7.9 | W/P\$ 2472 PV\$ 2887 |
| | For Use with 36" Desks, 48" Bridge and Credenza | | | | | | | |
| | 14-0966BU | | 66 | 9 | 13 $\frac{3}{16}$ | 43 | 6.5 | W/P\$ 2225 PV\$ 2605 |
| | For Use with 30" Desks, 42" Bridge and Credenza | | | | | | | |

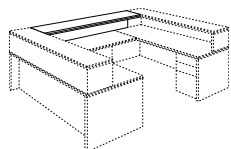

Must Specify (in this order):

Model
Premium or Standard Veneer Chassis
Top Material
Finish/Color
Edge Profile

Description

- Left to Right Grain Direction
- Must Be Used in Conjunction with Two (2) Desk/Credenza Risers
- Available with Premium Veneer (PV) or Standard Veneer (W) Chassis, Must Specify
- Available with Veneer (PV/W) or HPL (P) Top, Must Specify

Pricing Codes:

W = Wood Top

P = Laminate Top

PV = Premium Veneer

[See Madera Intro Section for Ordering Options](#)

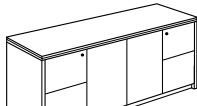
| Item | Model No. | Width | Depth | Height | Ship Wt | Cubic Ft | List Price |
|---|-------------------------------|-------|-------|--------|---------|----------|-------------------------|
| STORAGE CREDENZA FULL PEDESTAL  | 16-2472SC Legal Width Ped | 72 | 24 | 30 | 285 | 35.6 | W/P\$ 6020 PV\$ 7047 |
| | 16-2466SC Letter Width Ped | 66 | 24 | 30 | 261 | 32.7 | W/P\$ 5509 PV\$ 6443 |
| | 16-2072SC Legal Width Ped | 72 | 20 | 30 | 270 | 30.5 | W/P\$ 5682 PV\$ 6650 |

Description

- Locking File/File Pedestals
- Fixed Storage Shelf Behind Doors
- Available with Premium Veneer (PV) or Standard Veneer (W) Chassis, Must Specify
- Available with Veneer (PV/W) or HPL (P) Top, Must Specify
- Lock Core Color for Drawers will Coordinate with Pull Selection

Must Specify (in this order):

Model
Premium or Standard Veneer Chassis
Top Material
Finish/Color
Edge Profile
Drawer Pull

| | | | | | | | |
|---|-----------|----|----|----|-----|------|-------------------------|
| STORAGE CREDENZA 3/4 PEDESTAL  | 14-2072SC | 72 | 20 | 30 | 227 | 30.5 | W/P\$ 4919 PV\$ 5758 |
|---|-----------|----|----|----|-----|------|-------------------------|

Description

- Legal Width, Locking Box/File Pedestals
- Available with Premium Veneer (PV) or Standard Veneer (W) Chassis, Must Specify
- Available with Veneer (PV/W) or HPL (P) Top, Must Specify
- Lock Core Color for Drawers will Coordinate with Pull Selection

Must Specify (in this order):

Model
Premium or Standard Veneer Chassis
Top Material
Finish/Color
Edge Profile
Drawer Pull

| | | | | | | | |
|--|-----------|----|----|----|-----|------|-------------------------|
| DOUBLE LATERAL CREDENZA  | 14-2072DL | 72 | 20 | 30 | 303 | 30.2 | W/P\$ 6625 PV\$ 7753 |
|--|-----------|----|----|----|-----|------|-------------------------|

Description

- Dual Locking Lateral File Drawers Provide Legal or Letter Filing
- Available with Premium Veneer (PV) or Standard Veneer (W) Chassis, Must Specify
- Available with Veneer (PV/W) or HPL (P) Top, Must Specify
- Lock Core Color will Coordinate with Pull Selection

Must Specify (in this order):

Model
Premium or Standard Veneer Chassis
Top Material
Finish/Color
Edge Profile
Drawer Pull

[See Madera Intro Section for Ordering Options](#)

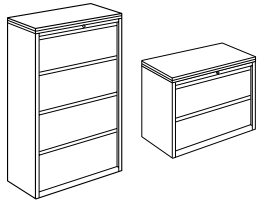
| Item | Model No. | Width | Depth | Height | Ship Wt | Cubic Ft | List Price |
|---|-------------------|-------|-------|--------|---------|-------------------------|-------------------------|
|  | LATERAL FILE | | | | | | |
| | 14-2436L4 | 36 | 24 | 55½ | 312 | 30.2 | W/P\$ 6815 PV\$ 7980 |
| | Four (4) Drawers | | | | | | |
| | 14-2430L4 | 30 | 24 | 55½ | 260 | 27.5 | W/P\$ 6413 PV\$ 7504 |
| | Four (4) Drawers | | | | | | |
| | 14-2036L4 | 36 | 20 | 55½ | 276 | 28.3 | W/P\$ 6377 PV\$ 7461 |
| | Four (4) Drawers | | | | | | |
| | 14-2436L3 | 36 | 24 | 42 | 235 | 24.9 | W/P\$ 5442 PV\$ 6367 |
| | Three (3) Drawers | | | | | | |
| | 14-2430L3 | 30 | 24 | 42 | 204 | 21.9 | W/P\$ 5118 PV\$ 5990 |
| Three (3) Drawers | | | | | | | |
| 14-2436L2 | 36 | 24 | 30 | 184 | 18.3 | W/P\$ 3614 PV\$ 4229 | |
| Two (2) Drawers | | | | | | | |
| 14-2430L2 | 30 | 24 | 30 | 153 | 15.6 | W/P\$ 3400 PV\$ 3976 | |
| Two (2) Drawers | | | | | | | |
| 14-2036L2 | 36 | 20 | 30 | 153 | 15.5 | W/P\$ 3378 PV\$ 3955 | |
| Two (2) Drawers | | | | | | | |

Must Specify (in this order):

Model
 Premium or Standard Veneer Chassis
 Top Material
 Finish/Color
 Edge Profile
 Drawer Pull

Description

- Standard with: Central Locking, Anti-Tilt System
- Available with Premium Veneer (PV) or Standard Veneer (W) Chassis, Must Specify
- Available with Veneer (PV/W) or HPL (P) Top, Must Specify
- Lock Core Color will Coordinate with Pull Selection
- File Drawers Provide Legal or Letter Filing

| | | | | | | | |
|------------|-----------|----|----|----|-----|------|-------------------------|
| MULTI-FILE | 14-2036MF | 36 | 20 | 30 | 185 | 14.9 | W/P\$ 4060 PV\$ 4754 |
|------------|-----------|----|----|----|-----|------|-------------------------|

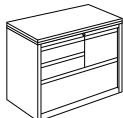

Must Specify (in this order):

Model
 Premium or Standard Veneer Chassis
 Top Material
 Finish/Color
 Edge Profile
 Drawer Pull

Description

- Standard: Box/Box/File/Lateral Pedestal, Locking File Drawer
- Available with Premium Veneer (PV) or Standard Veneer (W) Chassis, Must Specify
- Available with Veneer (PV/W) or HPL (P) Top, Must Specify
- Lock Core Color will Coordinate with Pull Selection
- File Drawers Provide Legal or Letter Filing

Pricing Codes:

W = Wood Top

P = Laminate Top

PV = Premium Veneer

[See Madera Intro Section for Ordering Options](#)

| Item | Model No. | Width | Depth | Height | Ship Wt | Cubic Ft | List Price |
|-----------------|------------|-------|-------|--------|---------|----------|-----------------------|
| MOBILE PEDESTAL | 14-1619MP1 | 16 | 19 | 28½ | 90 | 9.0 | W\$ 2924 PV\$ 3420 |



Description

- Standard with: Locking Box/Box/File Pedestal, Letter Width Pedestal, and Five Casters
- Available with Premium Veneer (PV) or Standard Veneer (W) Chassis, Must Specify
- Lock Core Color will Coordinate with Pull Selection
- Fits Underneath 30"H Worksurfaces
- Finger Pull Option Not Available

Must Specify (in this order):

Model
Premium or Standard Veneer Chassis
Finish/Color
Drawer Pull

SURFACE MOUNT HUTCH WITH WOOD DOORS

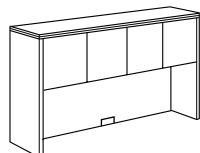

| | | | | | | |
|-------------------------|-------|-----|----|-----|------|-----------------------|
| 14-1596HU Six Doors | 96-93 | 15¼ | 40 | 305 | 41.0 | W\$ 6333 PV\$ 7413 |
| 14-1590HU Five Doors | 90-87 | 15¼ | 40 | 285 | 38.9 | W\$ 5769 PV\$ 6746 |
| 14-1584HU Five Doors | 84-81 | 15¼ | 40 | 270 | 36.8 | W\$ 5370 PV\$ 6279 |
| 14-1578HU Four Doors | 78-75 | 15¼ | 40 | 260 | 33.8 | W\$ 4786 PV\$ 5599 |
| 14-1572HU Four Doors | 72-69 | 15¼ | 40 | 205 | 33.1 | W\$ 4351 PV\$ 5089 |
| 14-1566HU Four Doors | 66-63 | 15¼ | 40 | 193 | 32.9 | W\$ 4142 PV\$ 4844 |

Must Specify (in this order):

Model
Premium or Standard Veneer Chassis
Finish/Color
Edge Profile
Door Pull
Locking Doors
Tackboard
Tackboard Fabric
Task Light
Grommet Color

Description

- Standard with: Soft-Close Hinged Doors, Vertical Grain Direction
- 22¾" Clearance Below Apron Rail
- Lower, Center Grommet on Back Panel Standard; Must Specify: Black (BLK) or Silver (SLV)
- Available in Premium Veneer (PV) or Standard Veneer (W), Must Specify
- Overall Width of Unit will be Determined by Edge Detail Selected
- Additional Options: Locking Doors ([See Locking Options](#)), Factory Installed Tackboard ([See Tackboard](#)), Tasklights ([See Tasklights](#)), Three (3) Upper Wire Management Grommets ([See Grommet Options](#))

[See Madera Intro Section for Ordering Options](#)

| Item | Model No. | Width | Depth | Height | Ship Wt | Cubic Ft | List Price |
|---|-----------|-------|-------|--------|---------|----------|-----------------------|
| SURFACE MOUNT HUTCH WITH ACRYLIC DOORS | 14-1572AH | 72-69 | 15¼ | 40 | 258 | 33.1 | W\$ 4781 PV\$ 5597 |
| | 14-1566AH | 66-63 | 15¼ | 40 | 235 | 24.3 | W\$ 4564 PV\$ 5340 |

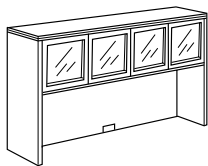

Must Specify (in this order):

Model
Premium or Standard Veneer Chassis
Finish/Color
Edge Profile
Acrylic Insert Style
Door Pull
Locking Doors
Tackboard
Tackboard Fabric
Task Light
Grommet Color

Description

- Standard with: Four (4) Wood Frame Doors with Acrylic Inserts, Soft-Close Hinges, Vertical Grain Direction
- 22 ¾" Clearance Below Apron Rail
- Lower, Center Grommet on Back Panel Standard; Must Specify: Black (BLK) or Silver (SLV)
- Available in Premium Veneer (PV) or Standard Veneer (W), Must Specify
- Overall Width of Unit will be Determined by Edge Detail Selected
- Additional Options: Locking Doors ([See Locking Options](#)), Factory Installed Tackboard ([See Tackboard](#)), Tasklights ([See Tasklights](#)), Three (3) Upper Wire Management Grommets ([See Grommet Options](#))

Options: Specify & Add

| | | |
|----|------------------------------|----------|
| CA | Clear Acrylic Door Inserts | Included |
| FA | Frosted Acrylic Door Inserts | Included |

| Item | Model No. | Width | Depth | Height | Ship Wt | Cubic Ft | List Price |
|---|-------------------------|-----------|-------|--------|---------|----------|-----------------------|
| OPTIONAL PAPER SLOTS FOR SURFACE MOUNT HUTCHES | 14-1194PS Six Slots | 93½-90½ | 11½ | 5¼ | 55 | 4.2 | W\$ 2952 PV\$ 3453 |
| | 14-1188PS Five Slots | 87½-84½ | 11½ | 5¼ | 52 | 3.9 | W\$ 2737 PV\$ 3200 |
| | 14-1182PS Five Slots | 81½-78½ | 11½ | 5¼ | 49 | 3.7 | W\$ 2526 PV\$ 2956 |
| | 14-1176PS Four Slots | 75 ½-72 ½ | 11½ | 5¼ | 45 | 3.4 | W\$ 2307 PV\$ 2701 |
| | 14-1170PS Four Slots | 69½-66½ | 11½ | 5¼ | 42 | 3.1 | W\$ 2095 PV\$ 2452 |
| | 14-1164PS Four Slots | 63½-60½ | 11½ | 5¼ | 38 | 2.9 | W\$ 1884 PV\$ 2207 |

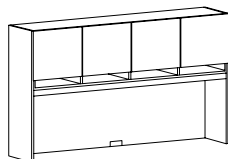
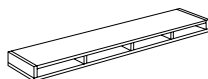

Must Specify (in this order):

Model
Premium or Standard Veneer Chassis
Finish/Color

Description

- For Use with Surface Mount Hutches
- Available in Premium Veneer (PV) or Standard Veneer (W), Must Specify
- Overall Width of Units will be Determined by Edge Detail Selected
- Ships Factory Installed

Pricing Codes:

W = Wood Top

P = Laminate Top

PV = Premium Veneer

[See Madera Intro Section for Ordering Options](#)

| Item | Model No. | Width | Depth | Height | Ship Wt | Cubic Ft | List Price |
|----------------------------------|-----------|-------|-------|--------|---------|----------|-----------------------|
| WALL MOUNT HUTCH WITH WOOD DOORS | 14-1536WD | 36 | 15¼ | 17½ | 70 | 7.6 | W\$ 2412 PV\$ 2818 |

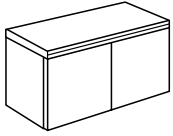

Description

- Standard with: Two (2) Soft-Close Hinge Doors, Vertical Grain Direction
- Mounts to Wall with Mounting Bracket Included
- Available in Premium Veneer (PV) or Standard Veneer (W), Must Specify
- Top Profiled on Front Only for Multiple Unit Application
- Indiana Furniture Will Not Be Liable for Wall Mount Hutch Units That are not Properly Installed
- Additional Options: Locking Doors ([See Locking Options](#))

Must Specify (in this order):

- Model
- Premium or Standard Veneer Chassis
- Finish/Color
- Edge Profile
- Door Pull
- Locking Doors

| | | | | | | | |
|-------------------------------------|-----------|----|-----|-----|----|-----|-----------------------|
| WALL MOUNT HUTCH WITH ACRYLIC DOORS | 14-1536AW | 36 | 15¼ | 17½ | 70 | 7.6 | W\$ 2594 PV\$ 3033 |
|-------------------------------------|-----------|----|-----|-----|----|-----|-----------------------|

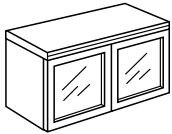

Description

- Standard with: Two (2) **Wood Frame Doors with Acrylic Inserts**, Soft-Close Hinges, and Vertical Grain Direction
- Mounts to Wall with Mounting Bracket Included
- Available in Premium Veneer (PV) or Standard Veneer (W), Must Specify
- Top Profiled on Front Only for Multiple Unit Application
- Indiana Furniture Will Not Be Liable for Wall Mount Hutch Units That are not Properly Installed
- Additional Options: Locking Doors ([See Locking Options](#))

Options: Specify & Add

| | | |
|----|------------------------------|----------|
| CA | Clear Acrylic Door Inserts | Included |
| FA | Frosted Acrylic Door Inserts | Included |

Must Specify (in this order):

- Model
- Premium or Standard Veneer Chassis
- Finish/Color
- Edge Profile
- Glass Style
- Door Pull
- Locking Doors

[See Madera Intro Section for Ordering Options](#)

| Item | Model No. | Width | Depth | Height | Ship Wt | Cubic Ft | List Price |
|------------------------|-----------|-------|-------|--------|---------|----------|-----------------------|
| SURFACE MOUNT BOOKCASE | 14-1534TU | 34 | 15¼ | 40 | 107 | 15.1 | W\$ 2160 PV\$ 2526 |
| | 14-1528TU | 28 | 15¼ | 40 | 96 | 12.6 | W\$ 1835 PV\$ 2148 |

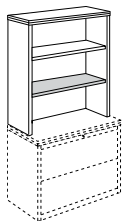

Description

- 1" Thick Shelves
- Shaded Shelf on Bottom Fixed with 12" Clearance
- One Adjustable Shelf
- Available in Premium Veneer (PV) or Standard Veneer (W), Must Specify
- For Surface Mount Use on Two (2) Drawer Lateral Files or Credenza Against a Wall

Must Specify (in this order):

Model
Premium or Standard Veneer Chassis
Finish/Color
Edge Profile

| Item | Model No. | Width | Depth | Height | Ship Wt | Cubic Ft | List Price |
|-------------------------------|--|-------|-------|--------|---------|----------|-------------------------|
| BOOKCASE | 14-3684BC | 36 | 15¼ | 84 | 205 | 31.3 | W\$ 4532 PV\$ 5303 |
| | 4 Adjustable Shelves and 1 Fixed Shelf | | | | | | |
| | 14-3670BC | 36 | 15¼ | 69¾ | 176 | 26.9 | W\$ 3763 PV\$ 4403 |
| | 3 Adjustable Shelves and 1 Fixed Shelf | | | | | | |
| | 14-3660BC | 36 | 15¼ | 60 | 147 | 23.2 | W/P\$ 3124 PV\$ 3656 |
| | 3 Adjustable Shelves | | | | | | |
| | 14-3648BC | 36 | 15¼ | 48¾ | 120 | 18.7 | W/P\$ 2821 PV\$ 3302 |
| | 2 Adjustable Shelves | | | | | | |
| | 14-3630BC | 36 | 15¼ | 30 | 75 | 11.9 | W/P\$ 2728 PV\$ 3191 |
| | 1 Adjustable Shelves | | | | | | |
| Must Specify (in this order): | 14-1570BC | 34 | 15¼ | 69¾ | 198 | 26.9 | W\$ 3554 PV\$ 4158 |
| | 3 Adjustable Shelves | | | | | | |
| | 14-1548BC | 34 | 15¼ | 48¾ | 135 | 18.6 | W/P\$ 2665 PV\$ 3117 |
| | 2 Adjustable Shelves | | | | | | |
| Must Specify (in this order): | 14-1530BC | 34 | 15¼ | 30 | 85 | 11.1 | W/P\$ 2577 PV\$ 3013 |
| | 1 Adjustable Shelves | | | | | | |

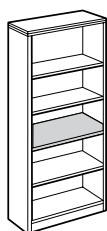

Description

- 1" Thick Shelves
- Shaded Indicates Fixed Shelf
- 84"H and 69¾"H Available in Premium Veneer (PV) or Standard Veneer (W); Must Specify
- 60"H, 48¾"H and 30"H Available in Premium Veneer (PV) or Standard Veneer (W), and HPL (P); Must Specify

Pricing Codes:

W = Wood Top

P = Laminate Top

PV = Premium Veneer

[See Madera Intro Section for Ordering Options](#)

| Item | Model No. | Width | Depth | Height | Ship Wt | Cubic Ft | List Price | |
|---|--------------------|---------------------|-------|--------|---------|----------|------------|-----------------------|
| WARDROBE/STORAGE CABINET SINGLE DOOR | Left Hinged | Right Hinged | | | | | | |
| | 14-1870WL | 14-1870WR | 18 | 24 | 69¾ | 153 | 19.2 | W\$ 5263 PV\$ 6159 |
| | 14-1870CL | 14-1870CR | 18 | 20 | 69¾ | 150 | 18.6 | W\$ 4454 PV\$ 5209 |

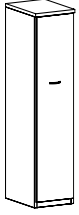

Shown as Right

Description

- Standard with: Fixed Top Shelf, Coat Rod, Three (3) Adjustable/Removable Shelves, Soft-Close Hinges, Vertical Grain Direction
- Available in Premium Veneer (PV) or Standard Veneer (W); Must Specify
- Finger Pull Not Available; Knob Pull will be Substituted
- Additional Options: Locking Doors ([See Locking Options](#))

Must Specify (in this order):

- Model
- Premium or Standard Veneer Chassis
- Finish/Color
- Edge Profile
- Pull
- Locking Door

| | | | | | | | |
|---|-----------|----|----|-----|-----|------|------------------------|
| WARDROBE/STORAGE CABINET DOUBLE DOOR | 14-3670WD | 36 | 24 | 69¾ | 290 | 42.0 | W\$ 9291 PV\$ 10875 |
|---|-----------|----|----|-----|-----|------|------------------------|

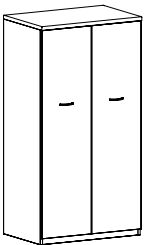

Description

- Standard with: Fixed Top Shelf Behind Each Door, Coat Rod, Three (3) Adjustable/Removable Shelves on Each Side, Soft-Close Hinges
- Available in Premium Veneer (PV) or Standard Veneer (W); Must Specify
- Finger Pull Not Available; Knob Pull will be Substituted
- Additional Options: Locking Doors ([See Locking Options](#))

Must Specify (in this order):

- Model
- Premium or Standard Veneer Chassis
- Finish/Color
- Edge Profile
- Pull
- Locking Door

[See Madera Intro Section for Ordering Options](#)

| Item | Model No. | Width | Depth | Height | Ship Wt | Cubic Ft | List Price |
|---|---------------------|----------------------|-------|--------|---------|----------|-------------------------|
| WARDROBE/STORAGE CABINET WITH FILE/FILE | Left Drawers | Right Drawers | | | | | |
| | 14-3670WD2L | 14-3670WD2R | 36 | 24 | 69¾ | 315 | 42.0 |
| | | | | | | | W\$ 10629 PV\$ 12438 |

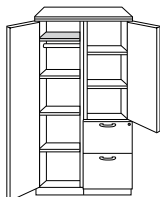

Shown as Right

Must Specify (in this order):

Model
 Premium or Standard Veneer Chassis
 Finish/Color
 Edge Profile
 Pull
 Locking Door

Description

- Standard with: Vertical Grain Direction, Soft-Close Hinged Doors, Locking File/File Drawers
- Wardrobe Side - Shaded Fixed Top Shelf, Coat Rod, and Three (3) Adjustable Shelves
- Storage Side - Top Storage with Two (2) Adjustable Shelves, Bottom Locking File/File
- Available in Premium Veneer (PV) or Standard Veneer (W); Must Specify
- Pedestal Determines Left or Right Handed Unit
- Lock Core Color will Coordinate with Pull Selection
- Finger Pull Not Available
- Additional Options: Locking Doors ([See Locking Options](#))

| Item | Model No. | Width | Depth | Height | Ship Wt | Cubic Ft | List Price |
|--|---------------------|----------------------|-------|--------|---------|----------|-------------------------|
| WARDROBE/STORAGE CABINET WITH BOX/BOX/FILE | Left Drawers | Right Drawers | | | | | |
| | 14-3670WD1L | 14-3670WD1R | 36 | 24 | 69¾ | 315 | 42.0 |
| | | | | | | | W\$ 10629 PV\$ 12438 |



Shown as Right

Must Specify (in this order):

Model
 Premium or Standard Veneer Chassis
 Finish/Color
 Edge Profile
 Pull
 Locking Door

Description

- Standard with: Vertical Grain Direction, Soft-Close Hinged Doors, Locking Box/Box/File Drawers
- Wardrobe Side - Shaded Fixed Top Shelf, Coat Rod, and Three (3) Adjustable Shelves
- Storage Side - Top Storage with Two (2) Adjustable Shelves, Bottom Locking Box/Box/File
- Available in Premium Veneer (PV) or Standard Veneer (W); Must Specify
- Pedestal Determines Left or Right Handed Unit
- Lock Core Color will Coordinate with Pull Selection
- Finger Pull Not Available
- Additional Options: Locking Doors ([See Locking Options](#))

| Item | Model No. | Width | Depth | Height | Ship Wt | Cubic Ft | List Price |
|---|------------|-------|-------|--------|---------|----------|-------------------------|
| STORAGE CABINET WITH LATERAL FILE DRAWERS | 14-3670SU2 | 36 | 24 | 69¾ | 298 | 42.0 | W\$ 10170 PV\$ 11899 |

**Must Specify (in this order):**

Model
 Premium or Standard Veneer Chassis
 Finish/Color
 Edge Profile
 Pull
 Locking Doors

Description

- Standard with: Two (2) 170° Hinged Doors, Two (2) Adjustable Shelves on Top, Two (2) Locking Lateral File Drawers on Bottom, Vertical Grain Direction
- Lateral Drawers Provide Letter or Legal Filing Capabilities
- Available in Premium Veneer (PV) or Standard Veneer (W); Must Specify
- Lock Core Color will Coordinate with Pull Selection
- Finger Pull Not Available
- Additional Options: Locking Doors ([See Locking Options](#))

Pricing Codes:

W = Wood Top

P = Laminate Top

PV = Premium Veneer

[See Madera Intro Section for Ordering Options](#)

| Item | Model No. | Width | Depth | Height | Ship Wt | Cubic Ft | List Price |
|-----------------|------------|-------|-------|------------------|---------|----------|-------------------------|
| MODULAR BOW TOP | 14-4272BWT | 72 | 42-36 | 1 $\frac{3}{16}$ | 125 | 7.1 | W/P\$ 2638 PV\$ 3083 |
| | 14-3672BWT | 72 | 36-30 | 1 $\frac{3}{16}$ | 110 | 6.2 | W/P\$ 2509 PV\$ 2935 |



Must Specify (in this order):

Model
Top Material
Finish/Color
Edge Profile
Surface Grommet
Grommet Color

Description

- Profiled on All Four (4) Sides
- Available with Premium Veneer (PV), Veneer (W) or HPL (P) Top, Must Specify
- Not Recommended for Use With Center Grommet
- Additional Options: Grommet Options ([See Grommet Options](#)), Kneespace Options (Sold Separately, [See Multiple Unit Details](#)), Wire Management + Accessories (Sold Separately, [See Multiple Unit Details](#))

| | | | | | | | |
|-----------------------------------|-----------|----|----|------------------|-----|-----|-------------------------|
| MODULAR DESK TOP 36"D AND 30"D | 14-3678TP | 78 | 36 | 1 $\frac{3}{16}$ | 125 | 7.0 | W/P\$ 2027 PV\$ 2370 |
| | 14-3672TP | 72 | 36 | 1 $\frac{3}{16}$ | 115 | 6.5 | W/P\$ 1935 PV\$ 2264 |
| | 14-3666TP | 66 | 36 | 1 $\frac{3}{16}$ | 105 | 6.0 | W/P\$ 1861 PV\$ 2175 |
| | 14-3084TP | 84 | 30 | 1 $\frac{3}{16}$ | 95 | 5.3 | W/P\$ 1887 PV\$ 2210 |
| | 14-3078TP | 78 | 30 | 1 $\frac{3}{16}$ | 90 | 4.9 | W/P\$ 1806 PV\$ 2111 |
| | 14-3072TP | 72 | 30 | 1 $\frac{3}{16}$ | 85 | 4.6 | W/P\$ 1725 PV\$ 2019 |
| | 14-3066TP | 66 | 30 | 1 $\frac{3}{16}$ | 80 | 4.2 | W/P\$ 1659 PV\$ 1940 |
| | 14-3060TP | 60 | 30 | 1 $\frac{3}{16}$ | 75 | 3.8 | W/P\$ 1587 PV\$ 1856 |
| | 14-3054TP | 54 | 30 | 1 $\frac{3}{16}$ | 70 | 3.4 | W/P\$ 1528 PV\$ 1788 |
| | 14-3048TP | 48 | 30 | 1 $\frac{3}{16}$ | 60 | 3.1 | W/P\$ 1471 PV\$ 1724 |
| | 14-3042TP | 42 | 30 | 1 $\frac{3}{16}$ | 55 | 2.7 | W/P\$ 1414 PV\$ 1654 |

Must Specify (in this order):

Model
Top Material
Finish/Color
Edge Profile
Surface Grommet
Grommet Color

Description

- Profiled on All Four (4) Sides
- Available with Premium Veneer (PV), Veneer (W) or HPL (P) Top, Must Specify
- Support Panel Required and Stiffener Bar Recommended in Kneespaces 60" or Greater and With Peninsula Application When Surface is Not Supported by a Pedestal, [See Support Options](#)
- For Table Lift Options, [See Table Lift Bases](#)
- Table Lifts to be used with Vertical Profiles - Bullnose (D), Tri-Round (E), Fluted (X), Square (Y)
- Additional Options: Grommet Options ([See Grommet Options](#)), Kneespace Options (Sold Separately, [See Multiple Unit Details](#)), Wire Management + Accessories (Sold Separately, [See Multiple Unit Details](#))

[See Madera Intro Section for Ordering Options](#)

| Item | Model No. | Width | Depth | Height | Ship Wt | Cubic Ft | List Price |
|---|------------|-------|-------|------------------|---------|----------|-------------------------|
| MODULAR CREDENZA TOP 24"D  | 14-24108TP | 108 | 24 | 1 $\frac{3}{16}$ | 110 | 6.6 | W/P\$ 2729 PV\$ 3196 |
| | 14-24102TP | 102 | 24 | 1 $\frac{3}{16}$ | 105 | 6.3 | W/P\$ 2614 PV\$ 3059 |
| | 14-2496TP | 96 | 24 | 1 $\frac{3}{16}$ | 100 | 5.0 | W/P\$ 1909 PV\$ 2232 |
| | 14-2490TP | 90 | 24 | 1 $\frac{3}{16}$ | 95 | 4.6 | W/P\$ 1796 PV\$ 2096 |
| | 14-2484TP | 84 | 24 | 1 $\frac{3}{16}$ | 90 | 4.3 | W/P\$ 1672 PV\$ 1953 |
| | 14-2478TP | 78 | 24 | 1 $\frac{3}{16}$ | 85 | 4.0 | W/P\$ 1599 PV\$ 1870 |
| | 14-2472TP | 72 | 24 | 1 $\frac{3}{16}$ | 80 | 3.7 | W/P\$ 1541 PV\$ 1805 |
| | 14-2466TP | 66 | 24 | 1 $\frac{3}{16}$ | 75 | 3.4 | W/P\$ 1484 PV\$ 1735 |
| | 14-2460TP | 60 | 24 | 1 $\frac{3}{16}$ | 70 | 3.0 | W/P\$ 1433 PV\$ 1680 |
| | 14-2454TP | 54 | 24 | 1 $\frac{3}{16}$ | 65 | 2.8 | W/P\$ 1352 PV\$ 1586 |
| | 14-2448TP | 48 | 24 | 1 $\frac{3}{16}$ | 55 | 2.5 | W/P\$ 1299 PV\$ 1518 |
| | 14-2442TP | 42 | 24 | 1 $\frac{3}{16}$ | 50 | 2.2 | W/P\$ 1239 PV\$ 1451 |
| | 14-2436TP | 36 | 24 | 1 $\frac{3}{16}$ | 45 | 2.0 | W/P\$ 1204 PV\$ 1412 |
| | 14-2430TP | 30 | 24 | 1 $\frac{3}{16}$ | 36 | 1.6 | W/P\$ 1156 PV\$ 1352 |
| | 14-2418TP | 18 | 24 | 1 $\frac{3}{16}$ | 28 | 1.0 | W/P\$ 1067 PV\$ 1247 |

Must Specify (in this order):

Model
 Top Material
 Finish/Color
 Edge Profile
 Surface Grommet
 Grommet Color

Description

- Profiled on All Four (4) Sides
- Available with Premium Veneer (PV), Veneer (W) or HPL (P) Top, Must Specify
- Support Panel Required and Stiffener Bar Recommended in Kneespaces 60" or Greater and With Peninsula Application When Surface is Not Supported by a Pedestal, [See Support Options](#)
- For Table Lift Options, [See Table Lift Bases](#)
- Table Lifts to be used with Vertical Profiles - Bullnose (D), Tri-Round (E), **Fluted (X)**, Square (Y)
- Additional Options: Grommet Options ([See Grommet Options](#)), Kneespace Options (Sold Separately, [See Multiple Unit Details](#)), Wire Management + Accessories (Sold Separately, [See Multiple Unit Details](#))

Pricing Codes:

W = Wood Top

P = Laminate Top

PV = Premium Veneer

[See Madera Intro Section for Ordering Options](#)

| Item | Model No. | Width | Depth | Height | Ship Wt | Cubic Ft | List Price | |
|--|--|------------------|-------|------------------|------------------|----------|-------------------------|-------------------------|
| MODULAR RETURN TOP 24"D  Must Specify (in this order): Model Top Material Finish/Color Edge Profile Surface Grommet Grommet Color | Left Ped | Right Ped | | | | | | |
| | 14-7224TPL | 14-7224TPR | 72 | 24 | 1 $\frac{3}{16}$ | 80 | 3.7 | W/P\$ 1541 PV\$ 1805 |
| | Grain Direction Runs Left to Right on Laminate Top | | | | | | | |
| | 14-6624TPL | 14-6624TPR | 66 | 24 | 1 $\frac{3}{16}$ | 75 | 3.4 | W/P\$ 1484 PV\$ 1735 |
| | Grain Direction Runs Left to Right on Laminate Top | | | | | | | |
| | 14-6024TPL | 14-6024TPR | 60 | 24 | 1 $\frac{3}{16}$ | 70 | 3.1 | W/P\$ 1433 PV\$ 1680 |
| | Grain Direction Runs Left to Right on Laminate Top | | | | | | | |
| | 14-5424TPL | 14-5424TPR | 54 | 24 | 1 $\frac{3}{16}$ | 65 | 2.8 | W/P\$ 1352 PV\$ 1586 |
| | 14-4824TPL | 14-4824TPR | 48 | 24 | 1 $\frac{3}{16}$ | 55 | 2.5 | W/P\$ 1299 PV\$ 1518 |
| | 14-4224TPL | 14-4224TPR | 42 | 24 | 1 $\frac{3}{16}$ | 50 | 2.2 | W/P\$ 1239 PV\$ 1451 |
| 14-3624TPL | 14-3624TPR | 36 | 24 | 1 $\frac{3}{16}$ | 45 | 1.9 | W/P\$ 1204 PV\$ 1412 | |

Description

- Profiled on All Four (4) Sides With Reverse Profile on Connecting Edge
- Available with Premium Veneer (PV), Veneer (W) or HPL (P) Top, Must Specify
- For Use on 24" Deep Pedestals/Files
- Front to Back Grain Direction on Worksurface Unless Noted Above
- Support Panel Required and Stiffener Bar Recommended in Kneespaces 60" or Greater and With Peninsula Application When Surface is Not Supported by a Pedestal, [See Support Options](#)
- For Table Lift Options, [See Table Lift Bases](#)
- Table Lifts to be used with Vertical Profiles - Bullnose (D), Tri-Round (E), Fluted (X), Square (Y)
- Additional Options: Grommet Options ([See Grommet Options](#)), Kneespace Options (Sold Separately, [See Multiple Unit Details](#)), Wire Management + Accessories (Sold Separately, [See Multiple Unit Details](#))

| | | | | | | | | |
|--|--|----|----|------------------|----|-----|-------------------------|--|
| MODULAR BRIDGE TOP 24"D  Must Specify (in this order): Model Top Material Finish/Color Edge Profile Surface Grommet Grommet Color | 14-6024TPB | 60 | 24 | 1 $\frac{3}{16}$ | 70 | 3.1 | W/P\$ 1433 PV\$ 1680 | |
| | Grain Direction Runs Left to Right on Laminate Top | | | | | | | |
| | 14-5424TPB | 54 | 24 | 1 $\frac{3}{16}$ | 65 | 2.8 | W/P\$ 1352 PV\$ 1586 | |
| | 14-4824TPB | 48 | 24 | 1 $\frac{3}{16}$ | 55 | 2.5 | W/P\$ 1299 PV\$ 1518 | |
| | 14-4224TPB | 42 | 24 | 1 $\frac{3}{16}$ | 50 | 2.2 | W/P\$ 1239 PV\$ 1451 | |
| | 14-3624TPB | 36 | 24 | 1 $\frac{3}{16}$ | 45 | 1.9 | W/P\$ 1204 PV\$ 1412 | |

Description

- Profiled on All Four (4) Sides With Reverse Profile on Connecting Edge
- Available with Premium Veneer (PV), Veneer (W) or HPL (P) Top, Must Specify
- Front to Back Grain Direction on Worksurface Unless Noted Above
- Support Panel Required and Stiffener Bar Recommended in Kneespaces 60" or Greater and With Peninsula Application When Surface is Not Supported by a Pedestal, [See Support Options](#)
- For Table Lift Options, [See Table Lift Bases](#)
- Table Lifts to be used with Vertical Profiles - Bullnose (D), Tri-Round (E), Fluted (X), Square (Y)
- Additional Options: Grommet Options ([See Grommet Options](#)), Kneespace Options (Sold Separately, [See Multiple Unit Details](#)), Wire Management + Accessories (Sold Separately, [See Multiple Unit Details](#))

[See Madera Intro Section for Ordering Options](#)

| Item | Model No. | Width | Depth | Height | Ship Wt | Cubic Ft | List Price |
|---|------------|-------|-------|--------|---------|----------|-----------------------|
| MODULAR PEDESTAL BOX/BOX/FILE  | 14-3618PD1 | 18 | 35¼ | 28¼ | 125 | 13.6 | W\$ 2846 PV\$ 3333 |
| | 14-3018PD1 | 18 | 29¼ | 28¼ | 105 | 11.6 | W\$ 2702 PV\$ 3163 |
| | 14-2418PD1 | 18 | 23¼ | 28¼ | 85 | 9.5 | W\$ 2581 PV\$ 3021 |

Must Specify (in this order):

Model
 Premium or Standard Veneer Chassis
 Finish/Color
 Pull

Description

- Available with Premium Veneer (PV) or Standard Veneer (W) Chassis, Must Specify
- Locking Box/Box/File
- Legal Width Pedestal
- Lock Core Color will Coordinate with Pull Selection
- Open Back; Optional Back Panel Sold Separately, [See Moldular Back Panels](#)
- Modular Top Required, [See Multiple Modular Tops](#)

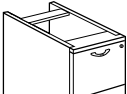
| | | | | | | | |
|---|------------|----|-----|-----|-----|------|-----------------------|
| MODULAR PEDESTAL FILE/FILE  | 14-3618PD2 | 18 | 35¼ | 28¼ | 125 | 13.6 | W\$ 2846 PV\$ 3333 |
| | 14-3018PD2 | 18 | 29¼ | 28¼ | 105 | 11.6 | W\$ 2702 PV\$ 3163 |
| | 14-2418PD2 | 18 | 23¼ | 28¼ | 85 | 9.5 | W\$ 2581 PV\$ 3021 |

Must Specify (in this order):

Model
 Premium or Standard Veneer Chassis
 Finish/Color
 Pull

Description

- Locking File/File
- Legal Width Pedestal
- Lock Core Color will Coordinate with Pull Selection
- Open Back; Optional Back Panel Sold Separately, [See Moldular Back Panels](#)
- Modular Top Required, [See Multiple Modular Tops](#)

| | | | | | | | |
|---|------------|----|------|-----|-----|------|-----------------------|
| MODULAR PEDESTAL LATERAL FILE  | 14-2436LF1 | 36 | 23 ¼ | 28¼ | 154 | 17.5 | W\$ 3195 PV\$ 3739 |
| | 14-2430LF1 | 30 | 23 ¼ | 28¼ | 128 | 14.9 | W\$ 3110 PV\$ 3635 |

Must Specify (in this order):

Model
 Premium or Standard Veneer Chassis
 Finish/Color
 Pull

Description

- Locking Lateral File/Lateral File
- Anti-Tilt System
- Lock Core Color will Coordinate with Pull Selection
- Open Back; Optional Back Panel Sold Separately, [See Moldular Back Panels](#)
- Modular Top Required, [See Multiple Modular Tops](#)

Pricing Codes:

W = Wood Top

P = Laminate Top

PV = Premium Veneer

[See Madera Intro Section for Ordering Options](#)

| Item | Model No. | Width | Depth | Height | Ship Wt | Cubic Ft | List Price |
|--------------------------------|------------|-------|-------|--------|---------|----------|-----------------------|
| MODULAR PEDESTAL MULTI-FILE | 14-2436LF2 | 36 | 23¼ | 28¼ | 154 | 17.5 | W\$ 3579 PV\$ 4189 |
| | 14-2430LF2 | 30 | 23¼ | 28¼ | 128 | 14.9 | W\$ 3483 PV\$ 4076 |

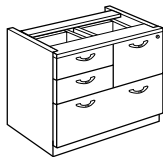

Must Specify (in this order):

Model
Premium or Standard Veneer Chassis
Finish/Color
Pull

Description

- Box/Box/File Over Lateral File
- Locking File Drawers Only
- Lock Core Color will Coordinate with Pull Selection
- Open Back; Optional Back Panel Sold Separately, [See Moldular Back Panels](#)
- Modular Top Required, [See Multiple Modular Tops](#)

| MODULAR PEDESTAL SINGLE DOOR BOOKCASE | Hinged Left | Hinged Right | Width | Depth | Height | Ship Wt | Cubic Ft | List Price |
|--|-------------|--------------|-------|-------|--------|---------|----------|------------|
| | 14-2418PD4L | 14-2418PD4R | | | | | | |

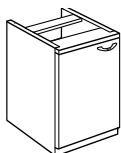

Shown as Left

Must Specify (in this order):

Model
Premium or Standard Veneer Chassis
Finish/Color
Pull

Description

- (1) Adjustable Shelf Behind Doors
- Open Back; Optional Back Panel Sold Separately, [See Moldular Back Panels](#)
- Modular Top Required, [See Multiple Modular Tops](#)
- Additional Options: Locking Door ([See Locking Options](#))

| | | | | | | | |
|--|-----------|----|-----|-----|-----|------|-----------------------|
| MODULAR PEDESTAL DOUBLE DOOR BOOKCASE | 14-2436DB | 36 | 23¼ | 28¼ | 105 | 17.5 | W\$ 2782 PV\$ 3253 |
| | 14-2430DB | 30 | 23¼ | 28¼ | 87 | 14.9 | W\$ 2704 PV\$ 3167 |

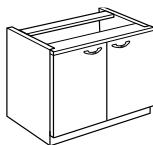

Must Specify (in this order):

Model
Premium or Standard Veneer Chassis
Finish/Color
Pull

Description

- 13" Adjustable Shelf Behind Doors
- Finger Pull Not Available
- Open Back; Optional Back Panel Sold Separately, [See Moldular Back Panels](#)
- Modular Top Required, [See Multiple Modular Tops](#)
- Additional Options: Locking Door ([See Locking Options](#))

[See Madera Intro Section for Ordering Options](#)

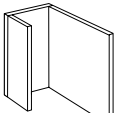
| Item | Model No. | Width | Depth | Height | Ship Wt | Cubic Ft | List Price | |
|---|-----------------|------------------|-------|--------|---------|----------|------------|-----------------------|
|  | Left Ped | Right Ped | | | | | | |
| | 14-3618PD3L | 14-3618PD3R | 18 | 36 | 28¼ | 50 | 13.6 | W\$ 1265 PV\$ 1479 |
| | 14-3018PD3L | 14-3018PD3R | 18 | 30 | 28¼ | 42 | 11.6 | W\$ 1158 PV\$ 1359 |

Shown as Right

Must Specify (in this order):

Model
Premium or Standard Veneer Chassis
Finish/Color

Description

- Used to Complete Single Pedestal Configuration
- Finished Back

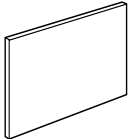
| Item | Model No. | Width | Depth | Height | Ship Wt | Cubic Ft | List Price | |
|---|---------------------------|-----------|-------|--------|---------|----------|-----------------------|-----------------------|
|  | MODULAR BACK PANEL | 14-9628BP | 96 | ¾ | 28¼ | 115 | 5.0 | W\$ 1233 PV\$ 1442 |
| | 14-9028BP | 90 | ¾ | 28¼ | 108 | 4.6 | W\$ 1201 PV\$ 1406 | |
| | 14-8428BP | 84 | ¾ | 28¼ | 101 | 4.3 | W\$ 1174 PV\$ 1374 | |
| | 14-7828BP | 78 | ¾ | 28¼ | 94 | 4.0 | W\$ 1127 PV\$ 1318 | |
| | 14-7228BP | 72 | ¾ | 28¼ | 86 | 3.7 | W\$ 960 PV\$ 1124 | |
| | 14-6628BP | 66 | ¾ | 28¼ | 79 | 3.4 | W\$ 928 PV\$ 1087 | |
| | 14-6028BP | 60 | ¾ | 28¼ | 72 | 3.0 | W\$ 887 PV\$ 1036 | |
| | 14-5428BP | 54 | ¾ | 28¼ | 65 | 2.8 | W\$ 831 PV\$ 969 | |
| | 14-4828BP | 48 | ¾ | 28¼ | 55 | 2.5 | W\$ 791 PV\$ 925 | |
| | 14-4228BP | 42 | ¾ | 28¼ | 50 | 2.2 | W\$ 747 PV\$ 878 | |
| | 14-3628BP | 36 | ¾ | 28¼ | 45 | 2.0 | W\$ 626 PV\$ 735 | |
| | 14-3028BP | 30 | ¾ | 28¼ | 30 | 1.6 | W\$ 587 PV\$ 684 | |
| | 14-2428BP | 24 | ¾ | 28¼ | 24 | 1.4 | W\$ 563 PV\$ 661 | |
| | 14-1828BP | 18 | ¾ | 28¼ | 18 | 1.0 | W\$ 545 PV\$ 637 | |

Must Specify (in this order):

Model
Premium or Standard Veneer Chassis
Finish/Color
Top Center Grommet
Grommet Color

Description

- For Use as a Modesty Panel to Create Bridges, Returns, or Credenzas

Options: Specify & Add

1-GRMT Optional Top Centered Grommet; Must Specify: Black (BLK) or Silver (SLV) \$ 52

Pricing Codes:

W = Wood Top

P = Laminate Top

PV = Premium Veneer

[See Madera Intro Section for Ordering Options](#)

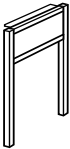
| Item | Model No. | Width | Depth | Height | Ship Wt | Cubic Ft | List Price |
|---|----------------------------------|-------|-------|--------|---------|----------|------------|
| H MODULAR PENINSULA SUPPORT SEATED HEIGHT  | 01-3628TLV Double Mount Plate | 36 | 1 | 28¼ | 30 | 2.0 | \$ 1182 |
| | 01-3028TLV Double Mount Plate | 30 | 1 | 28¼ | 25 | 1.7 | \$ 1163 |
| | 01-2428TLV Double Mount Plate | 24 | 1 | 28¼ | 25 | 1.4 | \$ 876 |
| | 01-3628HLV Single Mount Plate | 36 | 1 | 28¼ | 30 | 2.0 | \$ 1145 |
| | 01-3028HLV Single Mount Plate | 30 | 1 | 28¼ | 25 | 1.7 | \$ 1126 |
| | 01-2428HLV Single Mount Plate | 24 | 1 | 28¼ | 25 | 1.4 | \$ 847 |

Must Specify (in this order):

Model
Wood Insert
Insert Color

Description

- Metal End Support to Be Used with Modular Desk Tops at 30"H ([See Multiple Modular Tops](#))
- Aluminum Only
- Double Mount Plate Required for Freestanding Table/Desk
- Recommended to Be Used with Vertical Profiles - Bullnose (D), Tri-Round (E), **Fluted (X)**, Square (Y)

Options: Specify & Add

| | | | |
|-----|---------------|------|-----|
| HIW | Veneer Insert | W\$ | 117 |
| | | PV\$ | 135 |

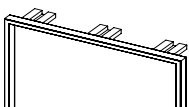
| | | | | | | | |
|---|-----------|----|---|-----|----|-----|--------|
| O MODULAR PENINSULA SUPPORT SEATED HEIGHT  | 01-3628OL | 36 | 2 | 28¼ | 30 | 2.7 | \$ 661 |
| | 01-3028OL | 30 | 2 | 28¼ | 25 | 2.3 | \$ 552 |
| | 01-2428OL | 24 | 2 | 28¼ | 20 | 1.8 | \$ 486 |

Description

- Metal End Support to Be Used with Modular Desk Tops at 30"H ([See Multiple Modular Tops](#))
- Aluminum Only

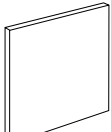
| | | | | | | | |
|---|-----------|-----|----|-----|----|-----|---------------------|
| MODULAR END PANEL  | 14-3628EP | 35¼ | 1½ | 28¼ | 41 | 2.0 | W\$ 690 PV\$ 806 |
| | 14-3028EP | 29¼ | 1½ | 28¼ | 34 | 1.6 | W\$ 646 PV\$ 755 |
| | 14-2428EP | 23¼ | 1½ | 28¼ | 27 | 1.6 | W\$ 605 PV\$ 705 |

Must Specify (in this order):

Model
Panel Material

Description

- End Panel for Worksurfaces to Create Desks, Returns, or Credenzas
- Required to be Used with a Back Panel, [See Multiple Unit Details](#)

[See Madera Intro Section for Ordering Options](#)

| Item | Model No. | Width | Depth | Height | Ship Wt | Cubic Ft | List Price |
|-----------------------|-----------|-------|--------|--------|---------|----------|---------------------|
| MODULAR SUPPORT PANEL | 14-2812SP | 12 | 1 5/32 | 28 1/4 | 12 | 0.8 | W\$ 390 PV\$ 455 |

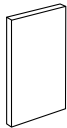
**Description**

- Used to Support Worksurfaces
- Required to be Used Perpendicular to Full Back Panels to Support Kneespace Areas Greater Than 60"

Must Specify (in this order):

Model
Panel Material

| | | | | | | | |
|-------------------|-----------|----|----|--------|----|-----|---------------------|
| MODULAR T SUPPORT | 14-1010SP | 10 | 10 | 28 1/4 | 12 | 0.9 | W\$ 534 PV\$ 625 |
|-------------------|-----------|----|----|--------|----|-----|---------------------|

**Description**

- Used to Support Worksurfaces
- Required to be Used Perpendicular to Full Back Panels to Support Kneespace Areas Greater Than 60"

Must Specify (in this order):

Model
Panel Material

| | | | | | | | |
|------------------------|-----------|---|-----|--------|---|-----|---------------------|
| MODULAR FILLER SUPPORT | 14-2803FP | 3 | 3/4 | 28 1/4 | 6 | 0.5 | W\$ 324 PV\$ 382 |
|------------------------|-----------|---|-----|--------|---|-----|---------------------|

**Description**

- Used to Fill Gap Behind Modular Pedestals When Back Panels are Not Used

Must Specify (in this order):

Model
Panel Material

| | | | | | | | |
|---------------|------------|----|-------|-----|---|-----|--------|
| STIFFENER BAR | 01-00060SB | 60 | 1 1/4 | 3/4 | 8 | 0.3 | \$ 129 |
| | 01-00048SB | 48 | 1 1/4 | 3/4 | 5 | 0.3 | \$ 121 |

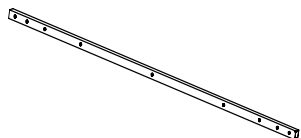
**Description**

- Reinforces Worksurfaces with Large Kneespace Widths
- Includes End Caps to Cover Sharp Edges
- Field Installed
- Recommended in Kneespaces 60" or Greater

Pricing Codes:

W = Wood Top

P = Laminate Top

PV = Premium Veneer

[See Madera Intro Section for Ordering Options](#)

| Item | Model No. | Width | Depth | Height | Ship Wt | Cubic Ft | List Price |
|-----------|-----------|-------|-------|---------------------------------|---------|----------|-------------------------|
| END TABLE | 14-1824ET | 24 | 18 | 21 ⁷ / ₁₆ | 48 | 7.6 | W/P\$ 1365 PV\$ 1599 |

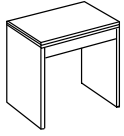

Must Specify (in this order):

- Model
- Premium or Standard Veneer Chassis
- Top Material
- Finish/Color
- Edge Profile

Description

- Standard with: Left to Right Grain Direction on Worksurface, Vertical Grain Direction on Solid End Panels
- Available in Premium Veneer (PV) or Standard Veneer (W); Must Specify
- Available with Veneer (PV/W) or HPL (P) Top; Must Specify
- Apron Rails and Panel Legs Feature Multi-Step, Hand-Finished Catalyzed Finish
- Ships Assembled

| | | | | | | | |
|------------|-----------|----|----|---------------------------------|----|------|-------------------------|
| LAMP TABLE | 14-2828LT | 28 | 28 | 21 ⁷ / ₁₆ | 56 | 12.3 | W/P\$ 1768 PV\$ 2072 |
|------------|-----------|----|----|---------------------------------|----|------|-------------------------|

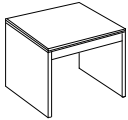

Must Specify (in this order):

- Model
- Premium or Standard Veneer Chassis
- Top Material
- Finish/Color
- Edge Profile

Description

- Standard with: Left to Right Grain Direction on Worksurface, Vertical Grain Direction on Solid End Panels
- Available in Premium Veneer (PV) or Standard Veneer (W); Must Specify
- Available with Veneer (PV/W) or HPL (P) Top; Must Specify
- Apron Rails and Panel Legs Feature Multi-Step, Hand-Finished Catalyzed Finish
- Ships Assembled

| | | | | | | | |
|----------------|-----------|----|----|---------------------------------|----|-----|-------------------------|
| MAGAZINE TABLE | 14-1847MT | 47 | 18 | 15 ⁷ / ₁₆ | 75 | 9.9 | W/P\$ 1492 PV\$ 1747 |
|----------------|-----------|----|----|---------------------------------|----|-----|-------------------------|

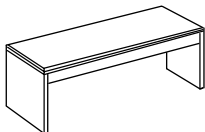

Must Specify (in this order):

- Model
- Premium or Standard Veneer Chassis
- Top Material
- Finish/Color
- Edge Profile

Description

- Standard with: Left to Right Grain Direction on Worksurface, Vertical Grain Direction on Solid End Panels
- Available in Premium Veneer (PV) or Standard Veneer (W); Must Specify
- Available with Veneer (PV/W) or HPL (P) Top; Must Specify
- Apron Rails and Panel Legs Feature Multi-Step, Hand-Finished Catalyzed Finish
- Ships Assembled

[See Madera Intro Section for Ordering Options](#)

| Item | Model No. | Width | Depth | Height | Ship Wt | Cubic Ft | List Price |
|---------------------|-----------|-------|-------|------------------|---------|----------|-------------------------|
| COMPUTER WORK TABLE | 14-2445CW | 45 | 24 | 26 $\frac{3}{8}$ | 120 | 21.8 | W/P\$ 2591 PV\$ 3029 |
| | 14-2436CW | 36 | 24 | 26 $\frac{3}{8}$ | 110 | 17.6 | W/P\$ 2479 PV\$ 2900 |

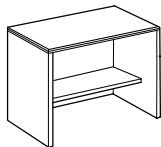

Must Specify (in this order):

Model
Premium or Standard Veneer Chassis
Top Material
Finish/Color
Edge Profile
Casters
Back Panel Grommet

Description

- Standard with: Left to Right Grain Direction on Worksurface, Vertical Grain Direction on End and Modesty Panels
- Fixed Shelf is 12" Deep with a 16" Clearance
- Available with Premium Veneer (PV) or Standard Veneer (W) Chassis; Must Specify
- Available with Veneer (PV/W) or HPL (P) Top; Must Specify
- Grommet in Back Panel; Must Specify: Black (BLK) or Silver (SLV)

Options: Specify & Add

CS-14BL Optional Black Casters (Increases Height to 28 $\frac{3}{8}$ ") \$ 239

**WORK TABLE
SEATED HEIGHT**

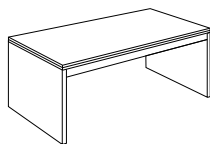

Must Specify (in this order):

Model
Premium or Standard Veneer Chassis
Top Material
Finish/Color
Edge Profile

| | | | | | | |
|-----------|----|----|----|-----|------|-------------------------|
| 14-3672WT | 72 | 36 | 30 | 195 | 50.0 | W/P\$ 3199 PV\$ 3742 |
| 14-3060WT | 60 | 30 | 30 | 134 | 35.5 | W/P\$ 2503 PV\$ 2932 |

Description

- Standard with: Left to Right Grain Direction on Worksurface, Vertical Grain Direction on Solid End Panels with Apron Rail
- Add a Purse Hook to Hold Personal Items; [See Hook Details](#)
- Available with Premium Veneer (PV) or Standard Veneer (W) Chassis; Must Specify
- Available with Veneer (PV/W) or HPL (P) Top; Must Specify
- Some Assembly Required

ROUND TABLE TOP

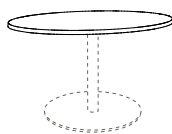

14-4242CT shown with
01-2430DBA
(Disc Base)
BASES SOLD SEPARATELY

| | | | | | | |
|-----------|----|----|----|----|-----|-------------------------|
| 14-4848CT | 48 | 48 | 30 | 60 | 5.7 | W/P\$ 2876 PV\$ 3363 |
| 14-4242CT | 42 | 42 | 30 | 40 | 4.4 | W/P\$ 2608 PV\$ 3053 |
| 14-3636CT | 36 | 36 | 30 | 35 | 3.4 | W/P\$ 2289 PV\$ 2678 |

Description

- Available with Premium/Standard Veneer (PV/W) or HPL (P) Top, Must Specify
- Single Base Required; Ordered Separately, [See Details](#)
- Bases Sold Separately
- Power Options not Available

Must Specify (in this order):

Model #
Top Material
Finish/Color
Edge Profile

Pricing Codes:

W = Wood Top

P = Laminate Top

PV = Premium Veneer

[See Madera Intro Section for Ordering Options](#)

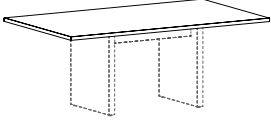
| Item | Model No. | Width | Depth | Height | Ship Wt | Cubic Ft | List Price | |
|---|-----------------------------------|-------|-------|------------------|---------|----------|-------------------------|--|
|  <p>14-3672RT shown with 88-2034RPB (Rectangle Panel Base) BASES SOLD SEPARATELY</p> <p>Must Specify (in this order): Model # Top Material Finish/Color Edge Profile</p> | RECTANGULAR TOP | | | | | | | |
| | 144" or 12' - 2 Piece Tops | | | | | | | |
| | 14-48144RT | 144 | 48 | 1 $\frac{3}{16}$ | 275 | 12.3 | W/P\$ 2323 PV\$ 2717 | |
| | 120" or 10' - 2 Piece Tops | | | | | | | |
| | 14-48120RT | 120 | 48 | 1 $\frac{3}{16}$ | 225 | 10.3 | W/P\$ 2134 PV\$ 2497 | |
| | 96" or 8' - 1 Piece Top | | | | | | | |
| | 14-4896RT | 96 | 48 | 1 $\frac{3}{16}$ | 180 | 9.4 | W/P\$ 2039 PV\$ 2386 | |
| | 72" or 6' - 1 Piece Top | | | | | | | |
| | 14-3672RT | 72 | 36 | 1 $\frac{3}{16}$ | 100 | 6.2 | W/P\$ 1282 PV\$ 1501 | |

Description

- Grain Runs the Width of the Table
- Available with Veneer (PV/W) or HPL (P) Top; Must Specify
- Heavy-Duty Ganging Mechanisms Connect Two (2) Piece Tops
- See Bases/Legs and Number Required For Each Top Size, Must Order Bases Separately
- Optional Grommets and Power/Data Units; [See Location Options](#), [See Power Units Available](#)

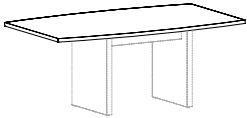
| | | | | | | | | |
|---|-----------------------------------|-----|----|------------------|-----|------|-------------------------|--|
|  <p>14-3672BT shown with 88-2034RPB (Rectangle Panel Base) BASES SOLD SEPARATELY</p> <p>Must Specify (in this order): Model # Top Material Finish/Color Edge Profile</p> | BOAT TOP | | | | | | | |
| | 144" or 12' - 2 Piece Tops | | | | | | | |
| | 14-48144BT | 144 | 48 | 1 $\frac{3}{16}$ | 275 | 12.3 | W/P\$ 4380 PV\$ 5124 | |
| | 120" or 10' - 2 Piece Tops | | | | | | | |
| | 14-48120BT | 120 | 48 | 1 $\frac{3}{16}$ | 225 | 10.3 | W/P\$ 3980 PV\$ 4656 | |
| | 96" or 8' - 1 Piece Top | | | | | | | |
| | 14-4896BT | 96 | 48 | 1 $\frac{3}{16}$ | 180 | 9.4 | W/P\$ 3228 PV\$ 3777 | |
| | 72" or 6' - 1 Piece Top | | | | | | | |
| | 14-3672BT | 72 | 36 | 1 $\frac{3}{16}$ | 100 | 6.2 | W/P\$ 1865 PV\$ 2182 | |

Description

- Grain Runs the Width of the Table
- Available with Veneer (PV/W) or HPL (P) Top; Must Specify
- Heavy-Duty Ganging Mechanisms Connect Two (2) Piece Tops
- See Bases/Legs and Number Required For Each Top Size, Must Order Bases Separately
- Optional Grommets and Power/Data Units; [See Location Options](#), [See Power Units Available](#)

[See Madera Intro Section for Ordering Options](#)

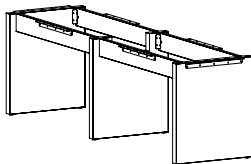
| Item | Model No. | | Width | Depth | Height | Ship Wt | Cubic Ft | List Price |
|---|---|----------|-------|-------|--------|---------|----------|------------|
| RECTANGLE PANEL BASES WITH TROUGH  | Three (3) Panel Bases - For Use With 48" x 144" Surfaces | | | | | | | |
| | 88-24106RPB | Laminate | 24 | 106 | 28¾ | 116 | 13.8 | T\$ 3000 |
| | | Veneer | | | | | | W\$ 3059 |
| | Two (2) Panel Bases - For Use With 48" x 120" Surfaces | | | | | | | |
| | 88-2482RPB | Laminate | 24 | 82 | 28¾ | 90 | 6.9 | T\$ 2150 |
| | | Veneer | | | | | | W\$ 2201 |
| | Two (2) Panel Bases - For Use With 48" x 96" Surfaces | | | | | | | |
| | 88-2458RPB | Laminate | 24 | 58 | 28¾ | 84 | 6.9 | T\$ 1880 |
| | | Veneer | | | | | | W\$ 1954 |
| | Two (2) Panel Bases - For Use With 36" x 72" Surfaces | | | | | | | |
| | 88-2034RPB | Laminate | 20 | 34 | 28¾ | 66 | 6.7 | T\$ 1575 |
| | | Veneer | | | | | | W\$ 1742 |

Must Specify (in this order):

Model #
Material
Finish / Color

Description

- 2" Panel Bases with Trough, Stretcher Rails, and L-Bracket Hardware Included
- Available with TFL (T) or Veneer (W)
- Vertical Grain Direction on Bases
- Bases Require Some Assembly; Attachment Hardware Included
- Tops Sold Separately

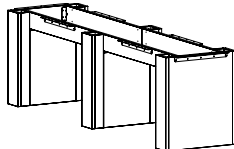
| | | | | | | | | |
|--|--|----------|----|-----|-----|-----|------|----------|
| 6" RECTANGLE BASES WITH TROUGH AND REMOVABLE PANEL  | Three (3) 6" Rectangle Bases - For Use With 48" x 144" Surfaces | | | | | | | |
| | 88-2410606RB | Laminate | 24 | 106 | 28¾ | 106 | 19.6 | T\$ 4720 |
| | | Veneer | | | | | | W\$ 6457 |
| | Two (2) 6" Rectangle Bases - For Use With 48" x 120" Surfaces | | | | | | | |
| | 88-248206RB | Laminate | 24 | 82 | 28¾ | 99 | 12.9 | T\$ 3219 |
| | | Veneer | | | | | | W\$ 4449 |
| | Two (2) 6" Rectangle Bases - For Use With 48" x 96" Surfaces | | | | | | | |
| | 88-245806RB | Laminate | 24 | 58 | 28¾ | 93 | 12.9 | T\$ 3023 |
| | | Veneer | | | | | | W\$ 4128 |
| | Two (2) 6" Rectangle Bases - For Use With 36" x 72" Surfaces | | | | | | | |
| | 88-203406RB | Laminate | 20 | 34 | 28¾ | 76 | 12.9 | T\$ 2777 |
| | | Veneer | | | | | | W\$ 3820 |

Must Specify (in this order):

Model #
Material
Finish / Color

Description

- 6" Rectangle Bases with Trough and Stretcher Rails
- Available with TFL (T) or Veneer (W)
- Vertical Grain Direction on Bases
- Bases Include Interior Removable Panel for Wire Management Access; Removable Panel is 15⅞"W for 24" Bases and 11⅞"W for 20" Bases
- Removable Panels Attached with Z Brackets
- Bases Require Some Assembly; Attachment Hardware Included
- Tops Sold Separately

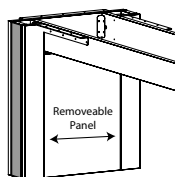

Pricing Codes:

W = Wood Top

P = Laminate Top

PV = Premium Veneer

[See Madera Intro Section for Ordering Options](#)

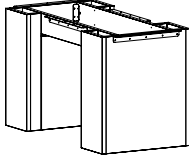
| Item | Model No. | | Width | Depth | Height | Ship Wt | Cubic Ft | List Price |
|---|---|----------|-------|-------|--------|---------|----------|------------|
| 10" RECTANGLE BASES WITH TROUGH AND REMOVABLE PANEL  | Three (3) 10" Rectangle Bases - For Use With 48" x 144" Surfaces | | | | | | | |
| | 88-241061ORB | Laminate | 24 | 106 | 28¾ | 141 | 18.2 | T\$ 4841 |
| | | Veneer | | | | | | W\$ 6551 |
| | Two (2) 10" Rectangle Bases - For Use With 48" x 120" Surfaces | | | | | | | |
| | 88-24821ORB | Laminate | 24 | 82 | 28¾ | 96 | 12.0 | T\$ 3300 |
| | | Veneer | | | | | | W\$ 4512 |
| | Two (2) 10" Rectangle Bases - For Use With 48" x 96" Surfaces | | | | | | | |
| | 88-24581ORB | Laminate | 24 | 58 | 28¾ | 89 | 12.0 | T\$ 3104 |
| | | Veneer | | | | | | W\$ 4190 |
| | Two (2) 10" Rectangle Bases - For Use With 36" x 72" Surfaces | | | | | | | |
| | 88-20341ORB | Laminate | 20 | 34 | 28¾ | 72 | 10.0 | T\$ 2857 |
| | | Veneer | | | | | | W\$ 3882 |

Must Specify (in this order):

- Model #
- Material
- Finish / Color

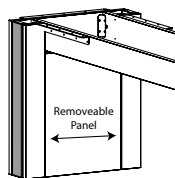

Description

- 10" Rectangle Bases with Trough and Stretcher Rails
- Available with TFL (T) or Veneer (W)
- Vertical Grain Direction on Bases
- Bases Include Interior Removable Panel for Wire Management Access; Removable Panel is 15⅞"W for 24" Bases and 11⅞"W for 20" Bases
- Removable Panels Attached with Z Brackets
- Bases Require Some Assembly Attachment Hardware Included
- Tops Sold Separately

6" + 10" COMBO RECTANGLE BASES WITH TROUGH AND REMOVABLE PANEL

| | | | | | | | | |
|---|----------|----|-----|-----|-----|------|----------|--|
| Three (3) Bases Total: Two (2) 6" and One (1) 10" Rectangle Bases - For Use With 60" / 54" / 48" x 144" Surfaces | | | | | | | | |
| 88-24106C61ORB | Laminate | 24 | 106 | 28¾ | 141 | 18.2 | T\$ 4760 | |
| | Veneer | | | | | | W\$ 6488 | |

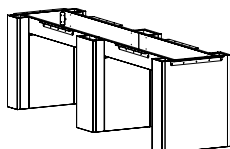

Must Specify (in this order):

- Model #
- Material
- Finish / Color

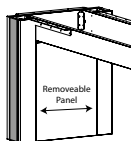

Description

- 6" + 10" Rectangle Bases with Trough and Stretcher Rails; 6" Bases on Exterior and 10" Base on Interior
- Available with TFL (T) or Veneer (W)
- Vertical Grain Direction on Bases
- Bases Include Interior Removable Panel for Wire Management; Removable Panel is 15⅞"W and Attaches with Z Brackets.
- Bases Require Some Assembly; Attachment Hardware Included
- Tops Sold Separately

[See Madera Intro Section for Ordering Options](#)

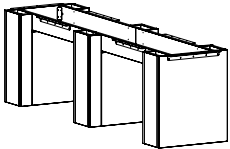
| Item | Model No. | | Width | Depth | Height | Ship Wt | Cubic Ft | List Price |
|---|--|----------|-------|-------|--------|---------|----------|------------|
| 6" RECTANGLE ACCENT BASES WITH TROUGH AND REMOVABLE PANEL  | Three (3) 6" Rectangle Bases - For Use With 48" x 144" Surfaces | | | | | | | |
| | 88-2410606RAB | Laminate | 24 | 106 | 28¾ | 106 | 19.6 | T\$ 5394 |
| | | Veneer | | | | | | W\$ 7174 |
| | Two (2) 6" Rectangle Bases - For Use With 48" x 120" Surfaces | | | | | | | |
| | 88-248206RAB | Laminate | 24 | 82 | 28¾ | 99 | 12.9 | T\$ 4745 |
| | | Veneer | | | | | | W\$ 6436 |
| | Two (2) 6" Rectangle Bases - For Use With 48" x 96" Surfaces | | | | | | | |
| | 88-245806RAB | Laminate | 24 | 58 | 28¾ | 93 | 12.9 | T\$ 3480 |
| | | Veneer | | | | | | W\$ 4610 |
| | Two (2) 6" Rectangle Bases - For Use With 36" x 72" Surfaces | | | | | | | |
| | 88-203406RAB | Laminate | 20 | 34 | 28¾ | 76 | 12.9 | T\$ 3232 |
| | | Veneer | | | | | | W\$ 4302 |

Must Specify (in this order):

- Model #
- Base Finish/Color
- Metal Accent Color
- Accent Panel Finish/Color

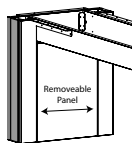

Description

- 6" Rectangle Bases with Trough and Stretcher Rails
- Available with TFL (T) or Veneer (W)
- 5/16" Metal Accent Available in Four (4) Colors: Aluminum, Black, Gold, and Platinum; Must Specify Color
- Vertical Grain Direction on Bases
- Bases Include Interior Removable Panel for Wire Management Access; Removable Panel is 15 7/8"W for 24" Bases and 11 7/8"W for 20" Bases
- Removable Panels Attached with Z Brackets
- Bases Require Some Assembly; Attachment Hardware Included
- Tops Sold Separately

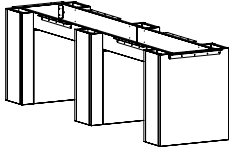
| | | | | | | | | |
|--|---|----------|----|-----|-----|-----|------|----------|
| 10" RECTANGLE ACCENT BASES WITH TROUGH AND REMOVABLE PANEL  | Three (3) 10" Rectangle Bases - For Use With 48" x 144" Surfaces | | | | | | | |
| | 88-2410610RAB | Laminate | 24 | 106 | 28¾ | 141 | 18.2 | T\$ 5462 |
| | | Veneer | | | | | | W\$ 7258 |
| | Two (2) 10" Rectangle Bases - For Use With 48" x 120" Surfaces | | | | | | | |
| | 88-248210RAB | Laminate | 24 | 82 | 28¾ | 96 | 12.0 | T\$ 3717 |
| | | Veneer | | | | | | W\$ 4986 |
| | Two (2) 10" Rectangle Bases - For Use With 48" x 96" Surfaces | | | | | | | |
| | 88-245810RAB | Laminate | 24 | 58 | 28¾ | 89 | 12.0 | T\$ 3521 |
| | | Veneer | | | | | | W\$ 4664 |
| | Two (2) 10" Rectangle Bases - For Use With 36" x 72" Surfaces | | | | | | | |
| | 88-203410RAB | Laminate | 20 | 34 | 28¾ | 72 | 10.0 | T\$ 3209 |
| | | Veneer | | | | | | W\$ 4276 |

Must Specify (in this order):

- Model #
- Base Finish/Color
- Metal Accent Color
- Accent Panel Finish/Color

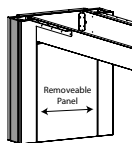

Description

- 10" Rectangle Bases with Trough and Stretcher Rails
- Available with TFL (T) or Veneer (W)
- 5/16" Metal Accent Available in Four (4) Colors: Aluminum, Black, Gold, and Platinum; Must Specify Color
- Vertical Grain Direction on Bases
- Bases Include Interior Removable Panel for Wire Management Access; Removable Panel is 15 7/8"W for 24" Bases and 11 7/8"W for 20" Bases
- Removable Panels Attached with Z Brackets
- Bases Require Some Assembly; Attachment Hardware Included
- Tops Sold Separately

Pricing Codes:

- W = Wood Top
- P = Laminate Top
- PV = Premium Veneer

[See Madera Intro Section for Ordering Options](#)

| Item | Model No. | | Width | Depth | Height | Ship Wt | Cubic Ft | List Price |
|---|--|----------|-------|-------|--------|---------|----------|------------|
| 6" + 10" COMBO RECTANGLE ACCENT BASES WITH TROUGH AND REMOVABLE PANEL | Three (3) Bases Total: Two (2) 6" and One (1) 10" Rectangle Bases - For Use With 60" / 54" / 48" x 144" Surfaces | | | | | | | |
| | 88-24106C610RAB | Laminate | 24 | 106 | 28¾ | 141 | 18.2 | T\$ 5420 |
| | | Veneer | | | | | | W\$ 7205 |

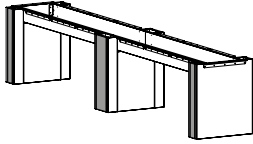

Must Specify (in this order):

- Model #
- Base Finish/Color
- Metal Accent Color
- Accent Panel Finish/Color

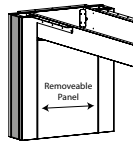

Description

- 6" + 10" Rectangle Accent Bases with Trough and Stretcher Rails; 6" Bases on Exterior and 10" Bases on Interior
- Available with TFL (T) or Veneer (W)
- 5/16" Metal Accent Available in Four (4) Colors: Aluminum, Black, Gold, and Platinum; Must Specify Color
- Vertical Grain Direction on Bases
- Bases Include Interior Removable Panel for Wire Management; Removable Panel is 15 7/8"W and Attaches with Z Brackets
- Bases Require Some Assembly; Attachment Hardware Included
- Tops Sold Separately

SQUARE BASE

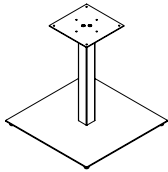

| | | | | | | | | |
|---|----------|----|----|-----|----|-----|----|------|
| For Use With Round Tops: 48" Top Surfaces: 48"x96" | | | | | | | | |
| 01-2630SBB | Black | 26 | 26 | 27¾ | 32 | 3.2 | \$ | 1163 |
| 01-2630SBA | Aluminum | | | | | | | |
| For Use With Round Tops: 42" Top Surfaces: 36"x72" | | | | | | | | |
| 01-2030SBB | Black | 20 | 20 | 27¾ | 32 | 3.2 | \$ | 956 |
| 01-2030SBA | Aluminum | | | | | | | |
| For Use With Round Tops: 36" | | | | | | | | |
| 01-1630SBB | Black | 16 | 16 | 27¾ | 32 | 3.2 | \$ | 898 |
| 01-1630SBA | Aluminum | | | | | | | |

Description

- 2¾" Diameter Column
- 12"x12" Mounting Plate at Top of Column
- Stiffener Bar Not Included; Must Order Separately (See Stiffener Bars)
- See Number of Bases Required Per Top Width Below
- Power Units Available On Center When Using Two or More Square Bases
- Some Assembly Required

| Table Widths | Round | 72" | 96" |
|---------------------------------|-------|-----|-----|
| Number of Bases Required | 1 | 2 | 2 |

[See Madera Intro Section for Ordering Options](#)

| Item | Model No. | | Width | Depth | Height | Ship Wt | Cubic Ft | List Price |
|---|-----------------------------------|----------|-------|-------|--------|---------|----------|------------|
| DISC BASE  | For 48" Round Tops | | | | | | | |
| | 01-3230DBB | Black | 30 | 30 | 27¾ | 42 | 4.1 | \$ 1842 |
| | 01-3230DBA | Aluminum | 30 | 30 | 27¾ | 42 | 4.1 | |
| | For 36" and 42" Round Tops | | | | | | | |
| | 01-2430DBB | Black | 24 | 24 | 27¾ | 32 | 3.2 | \$ 1535 |
| | 01-2430DBA | Aluminum | 24 | 24 | 27¾ | 32 | 3.2 | |

Description

- 4" Diameter 14 Gauge Steel Column
- 12"x12" Mounting Plate at Top of Column
- ¼" Thick Disc Plate with 5 Levelers
- Some Assembly Required

Table Widths**Number of Bases Required**

| Round | 72" | 96" |
|-------|-----|-----|
| 1 | 2 | 2 |

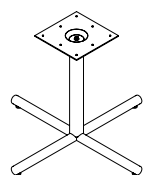
TUBULAR X-BASE

OPEN MARKET ONLY

| For Use With: 48" Round Tops and 48"x96" Top Surfaces | | | | | | | | |
|--|----------|----|----|-----|----|-----|--------|--|
| 01-3830TXB | Black | 38 | 38 | 27¾ | 40 | 4.2 | \$ 699 | |
| 01-3830TXA | Aluminum | | | | | | | |
| For Use With: 36" + 42" Round Tops and 36"x72" Top Surfaces | | | | | | | | |
| 01-3230TXB | Black | 32 | 32 | 27¾ | 32 | 3.2 | \$ 633 | |
| 01-3230TXA | Aluminum | | | | | | | |

Description

- 3" Diameter Column
- See Number of Bases Required Per Top Width Below
- Power Units Available On Center When Using Two or More Tubular X-Bases
- Some Assembly Required

Table Widths**Number of Bases Required**

| Round | 72" | 96" |
|-------|-----|-----|
| 1 | 2 | 2 |

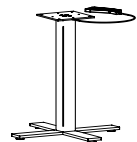
**HEIGHT ADJUSTABLE
PNEUMATIC X-BASE**

| Maximum Round 42" | | | | | | | | |
|--------------------------|----------|----|----|--------|---|-----|---------|--|
| 01-3232HAXBB | Black | 32 | 32 | 26-45¾ | 1 | 0.2 | \$ 1721 | |
| 01-3232HAXBA | Aluminum | | | | | | | |
| Maximum Round 36" | | | | | | | | |
| 01-2626HAXBB | Black | 22 | 22 | 26-45¾ | 1 | 0.2 | \$ 1687 | |
| 01-2626HAXBA | Aluminum | | | | | | | |

Description

- Pre-Drilled Boring Pattern May Not Match Underside of Table Top
- Steel Mounting Plate: 8"x 8"x ¼"
- Eight (8) Bolts Included for Assembly
- Some Assembly Required

Pricing Codes:

W = Wood Top

P = Laminate Top

PV = Premium Veneer

[See Madera Intro Section for Ordering Options](#)

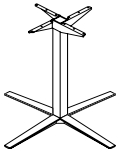
| Item | Model No. | | Width | Depth | Height | Ship Wt | Cubic Ft | List Price | |
|---|--|-----------------|----------|-------|--------|---------|----------|------------|---------|
|  | For Use With: 42" + 48" Round Tops and 48"x96" Top Surfaces | | | | | | | | |
| | 08-2642LXBB | For 42"H Tables | Black | 35½ | 35½ | 40 | 33 | 20.0 | \$ 1322 |
| | 08-2642LXBA | | Aluminum | | | | | | |
| | 08-2636LXBB | For 36"H Tables | Black | 35½ | 35½ | 34 | 30 | 17.2 | \$ 1275 |
| | 08-2636LXBA | | Aluminum | | | | | | |
| | 08-2630LXBB | For 30"H Tables | Black | 35½ | 35½ | 28 | 27 | 14.5 | \$ 1219 |
| | 08-2630LXBA | | Aluminum | | | | | | |
| | For Use With: 36" Round Tops and 36"x72" Top Surfaces | | | | | | | | |
| | 08-2042SXBB | For 42"H Tables | Black | 29 | 29 | 40 | 27 | 15.9 | \$ 1235 |
| | 08-2042SXBA | | Aluminum | | | | | | |
| | 08-2036SXBB | For 36"H Tables | Black | 29 | 29 | 34 | 24 | 13.7 | \$ 1185 |
| | 08-2036SXBA | | Aluminum | | | | | | |
| | 08-2030SXBB | For 30"H Tables | Black | 29 | 29 | 28 | 21 | 11.6 | \$ 1139 |
| | 08-2030SXBA | | Aluminum | | | | | | |

Description

- See Number of Bases Required Per Top Width Below
- Power Units Available On Center When Using Two or More Metal X-Bases
- Ships Assembled

| Table Widths | Round | 72" | 96" |
|---------------------------------|-------|-----|-----|
| Number of Bases Required | 1 | 2 | 2 |

CYLINDER BASE

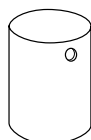

| | | | | | | | |
|-----------|--|----|----|-----|-----|------|-----------|
| 01-2020CB | | 20 | 20 | 28½ | 136 | 11.1 | W\$ 1553 |
| | <i>For Use With 42" or 48" Round Top</i> | | | | | | PV\$ 1813 |
| 01-1616CB | | 16 | 16 | 28½ | 101 | 7.2 | W\$ 1419 |
| | <i>For Use With 36" Round Top</i> | | | | | | PV\$ 1660 |

Description

- Veneer Cylinder Base Features Multi-Step, Hand-Finished Catalyzed Finish
- Weighted for Stability
- Two (2) Wire Management Black Grommets Standard at Top with 8" Opening Standard in Bottom

Options: Specify & Add

| | | |
|-------|----------------------------|-----|
| GCBIS | Single Grommet at Top Edge | N/C |
| NOGC | No Grommets | N/C |

Must Specify (in this order):

- Model
- Finish/Color
- Grommet
- Grommet Color

[See Madera Intro Section for Ordering Options](#)

| Item | Model No. | | Width | Depth | Height | Ship Wt | Cubic Ft | List Price |
|--|-----------|--------|-------|-------|--------|---------|----------|------------|
| ROUND GROMMET COVER FIELD INSTALLED | 01-GRMTBK | Black | - | - | - | - | - | \$ 11 |
| | 01-GRMTSL | Silver | | | | | | |

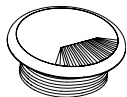

OPEN MARKET ONLY
(SILVER)

Description

- 60mm Round Grommet Cover
- Field Installed

| | | | | | | | | |
|--------------------------|-------------|--------|---|---|---|---|-----|-------|
| SINGLE POWER SAND DOLLAR | 01-SAND60PW | White | 3 | 3 | 4 | 1 | 0.2 | \$ 98 |
| | 01-SAND60PB | Black | | | | | | |
| | 01-SAND60PS | Silver | | | | | | |

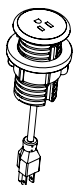

Description

- Unit is 2" Diameter; Mounts in 60mm Round Grommet
- 6' Cord
- Single Power Outlet

| | | | | | | | | |
|------------------------|-------------|--------|---|---|---|---|-----|--------|
| DOUBLE USB SAND DOLLAR | 01-SAND60UW | White | 3 | 3 | 4 | 1 | 0.2 | \$ 277 |
| | 01-SAND60UB | Black | | | | | | |
| | 01-SAND60US | Silver | | | | | | |

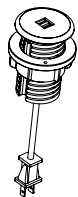

Description

- Unit is 2" Diameter; Mounts in 60mm Round Grommet
- 6' Cord
- Dual USB Outlets

| | | | | | | | | |
|------------------------------|-------------|-------|------------------|------------------|---|---|-----|--------|
| DOCK 950 WIRELESS CHARGER | 01-DOCK950W | White | 3 $\frac{1}{16}$ | 3 $\frac{3}{16}$ | - | 1 | 0.2 | \$ 265 |
| | 01-DOCK950B | Black | | | | | | |



OPEN MARKET ONLY

Description

- For Use with Wireless Charging Enabled Devices
- 5 Watts Maximum Output with a Direct Current of 5V 2A and 10 Watts Maximum with Quick Charge 2.0
- LED will Confirm Pairing with Device and Begin Wireless Charging

[See Madera Intro Section for Ordering Options](#)

| Item | Model No. | | Width | Depth | Height | Ship Wt | Cubic Ft | List Price |
|--------------------------|-------------|-------|-------|-------|--------|---------|----------|------------|
| WIRELESS AND USB CHARGER | 01-DOCK150W | White | 3 | 3 | ¾" | 1 | 0.2 | \$ 405 |
| | 01-DOCK150B | Black | | | | | | |



OPEN MARKET ONLY

Description

- For Use with Wireless Charging Enabled Devices and USB Charging Devices
- 5 Watt Maximum Output with a Direct Current Input of 5V 6A (Wireless Fast Charge)
- Pop-Up is ¾"H and Includes Three (3) USB Ports; One (1) 12 Watt Maximum with 2.4A (USB Fast Charge) and Two (2) 5 Watt with 1A (USB Standard Charge)
- LED Light will Confirm Pairing with Device and Begin Wireless Charging
- UL and cUL Certified

| | | | | | | | | |
|-----------------------|----------------|----------|---|-----|-----|---|-----|--------|
| INTERACT POWER & DATA | 01-INTERACTG2A | Aluminum | 9 | 5¾" | 2¾" | 5 | 0.2 | \$ 891 |
| | 01-INTERACTG2B | Black | | | | | | |



Description

- Includes: Two (2) Power Outlets, Two (2) USB-A Charging Ports, One (1) Telecom Plate Opening; Two (2) Keystone Openings for Voice/Data Jacks
- One (1) Telecom Plates Included with the Unit: One (1) 01-ABLAB Plate (Consists of One (1) RJ45 Cat 6, One (1) RJ11 Cat 3 Phone Jack)
- Convenience Plug on Bottom with 6' Power Cord
- UL and CSA Recognized
- See Optional Telecom Plates in the Table and Space Division Price List
- For Use with Rectangle and Boat Table Tops

| | | | | | | | | |
|-------------------------|------------|----------|----|---|---|----|-----|---------|
| OASIS MINI POWER & DATA | 01-OASISMA | Aluminum | 15 | 9 | 5 | 11 | 0.3 | \$ 3191 |
| | 01-OASISMB | Black | | | | | | |



Top View

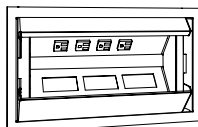

Description

- Soft Touch Hinged Lid
- Plate Includes: Two (2) Data, One (1) Voice Telecom Plates, Four (4) Power Outlets, 9' Power Cord
- Two (2) Telecom Plates Included with the Unit: One (1) 01-ABLAB Plate (Consists of One (1) RJ45 Cat 6, One (1) RJ11 Cat 3 Phone Jack); One (1) 01-ABLB Plate (Consists of One (1) RJ45 Cat 6)
- 9' Cord with Nema Plug; Fits 15A/120V AC Receptacles
- UL Listed
- See Optional Telecom Plates in the Table and Space Division Price List
- For Use with Rectangle and Boat Table Tops

| | | | | | | | | |
|---------|-------------|--------|----|---|---|--|--|---------|
| DOCK800 | 01-DOCK800S | Silver | 14 | 9 | - | | | \$ 2047 |
| | 01-DOCK800B | Black | | | | | | |

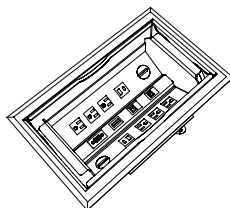



OPEN MARKET ONLY

Description

- Stylish Aluminum Housing with Beveled Edges; Soft Touch Access and Closure
- Includes: Six (6) Power Outlets, Two (2) USB-A 5V Ports, Two (2) USB-C Charging Ports, One (1) RJ45 Ethernet Port, One (1) RJ11 Port, One (1) HDMI Port, and One (1) VGA Port
- 10' Power Cord
- UL and cUL Certified
- See Optional Telecom Plates in the Table and Space Division Price List
- For Use with Rectangle and Boat Table Tops

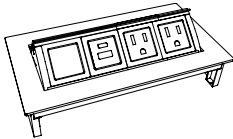
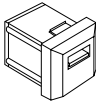
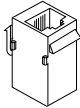

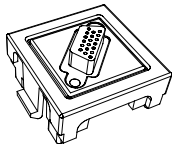
[See Madera Intro Section for Ordering Options](#)

| Item | Model No. | | Width | Depth | Height | Ship Wt | Cubic Ft | List Price |
|--|------------|----------|-------|-------|--------|---------|----------|------------|
| DPORT  | 01-DPORT4A | Aluminum | 8 | 4 | - | 7 | 0.2 | \$ 1093 |
| | 01-DPORT4B | Black | | | | | | |
| Description <ul style="list-style-type: none"> Retracts into Work Surface to Regain Productive Space; One-Touch Access to Power and Data Two (2) Power Outlets, One (1) USB A+C, and One (1) Open Port See Optional Telecom Plates in the Table and Space Division Price List Water-Proof Simplex (Outlets) Includes a Voice/Data Adapter Kit to Accept Couplers and Jacks When Required and a 10' Power Cord UL Recognized For Use with Rectangle and Boat Table Tops | | | | | | | | |
| USB PORT  | 01-USBPORT | | - | - | - | - | - | \$ 161 |
| Description <ul style="list-style-type: none"> For Use with 01-DPORT4A and 01-DPORT4B Passive USB-A Port with Increased Transfer Speed Up to 5 gbs/sec Simultaneous Read/Write Capability; Idle Device Power Saving State 6' Cord | | | | | | | | |
| VOICE COUPLER  | 01-VOICE1 | | - | - | - | - | - | \$ 73 |
| Description <ul style="list-style-type: none"> For Use with 01-DPORT4A and 01-DPORT4B 6-Pin Modular Plug Molded Black Cord Not included | | | | | | | | |
| DATA PORT  | 01-RJ4DATA | | - | - | - | - | - | \$ 167 |
| Description <ul style="list-style-type: none"> For Use with 01-DPORT4A and 01-DPORT4B 8-Pin Modular Plug; Cat6 Ethernet Cable; Pre-terminated Cable 10' Cord | | | | | | | | |
| VGA CONNECTOR ACCESSORY  | 01-VGACON | | - | - | - | 1 | 0.2 | \$ 149 |
| Description <ul style="list-style-type: none"> VGA Port for 01-DPORT4A and 01-DPORT4B Enables Devices to Remote Display on Monitors 10' Cord Male/Female Connector | | | | | | | | |

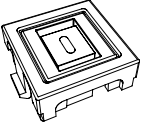
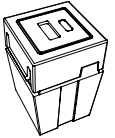
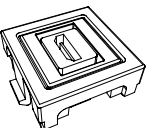
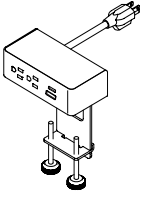
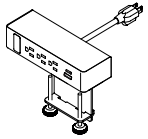
[See Madera Intro Section for Ordering Options](#)

| Item | Model No. | | Width | Depth | Height | Ship Wt | Cubic Ft | List Price |
|---|--|--------|-------|-------|--------|---------|----------|------------|
| PASSIVE USB-C ACCESSORY | 01-PUSBC | | - | - | - | 1 | 0.2 | \$ 95 |
|  | <p>Description</p> <ul style="list-style-type: none"> • Passive USB-C Port ; Unit Provides Data Connection to Transfer Data Only, No Charging Capabilities • Compatible with 01-DPORT4A and 01-DPORT4B • Male/Female Connector | | | | | | | |
| CHARGING USB-A+C ACCESSORY | 01-USBAC | | - | - | - | 1 | 0.2 | \$ 283 |
|  | <p>Description</p> <ul style="list-style-type: none"> • For Charging Devices • 20 Watt Power Supply • USB+C Charging Port for 01-DPORT4A and 01-DPORT4B | | | | | | | |
| HDMI CONNECTOR ACCESSORY | 01-HDMICON | | - | - | - | 1 | 0.2 | \$ 124 |
|  | <p>Description</p> <ul style="list-style-type: none"> • HDMI Port for 01-DPORT4A and 01-DPORT4B • Connects to High Definition Displays • Female/Female Connector • 18" Cord | | | | | | | |
| DUO CLAMP WITH NEMA PLUG | 01-DUOCLAMPW | White | 5½ | 3 | 7 | 1 | 0.2 | \$ 572 |
| | 01-DUOCLAMPB | Black | | | | | | |
| | 01-DUOCLAMP S | Silver | | | | | | |
|  | <p>Description</p> <ul style="list-style-type: none"> • Standard with: Two (2) Power Outlet, One (1) USB Charging Port and One (1) 60-Watt USB-C Power Delivery Port with GaN Technology with 10' Cord • Clamps to Top and Features Silver Metal Trim • Independent USB Circuit Controllers Deliver up to 2.1 Amps to Each Post • All Mounting Hardware Included • FCC Part 15A and UL Approved for Horizontal and Vertical Applications | | | | | | | |
| TRIO CLAMP WITH NEMA PLUG | 01-TRIOCLAMPW | White | 8 | 3 | 7 | 1 | 0.2 | \$ 671 |
| | 01-TRIOCLAMPB | Black | | | | | | |
| | 01-TRIOCLAMP S | Silver | | | | | | |
|  | <p>Description</p> <ul style="list-style-type: none"> • Standard with: Three (3) Power Outlets, One (1) USB Charging Port, One (1) 60-Watt USB-C Power Delivery Port with GaN Technology, One (1) Open Data, and 10' Cord • Clamps to Top and Features Silver Metal Trim • Independent USB Circuit Controllers Deliver up to 2.1 Amps to Each Post • HDMI, VGA, or RJ45 Accessories Sold Separately • All Mounting Hardware Included • FCC Part 15A and UL Approved for Horizontal and Vertical Applications | | | | | | | |

[See Madera Intro Section for Ordering Options](#)

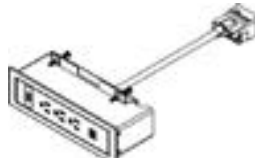
| Item | Model No. | | Width | Depth | Height | Ship Wt | Cubic Ft | List Price |
|--|---|--------|-------|-------|--------|---------|----------|------------|
| DUO BEZEL WITH NEMA PLUG  | 01-DUOBEZELW | White | 6½ | 2½ | 3¼ | 1 | 0.2 | \$ 675 |
| | 01-DUOBEZELB | Black | | | | | | |
| | 01-DUOBEZELS | Silver | | | | | | |
| | Description <ul style="list-style-type: none"> Sits on Table Top and Includes: Two (2) Power, One (1) USB Charging Port and One (1) 60-Watt USB-C Power Delivery Port with GaN Technology with 10' Cord, and All Mounting Hardware Independent USB Circuit Controllers Deliver up to 2.1 Amps to Each Post FCC Part 15A, UL Recognized for Horizontal and Vertical Applications | | | | | | | |
| TRIO BEZEL WITH NEMA PLUG  | 01-TRIOBEZELW | White | 9 | 2½ | 3 | 1 | 0.2 | \$ 725 |
| | 01-TRIOBEZELB | Black | | | | | | |
| | 01-TRIOBEZELS | Silver | | | | | | |
| | Description <ul style="list-style-type: none"> Sits on Table Top and Includes: Three (3) Power Outlets, One (1) USB Charging Port, One (1) 60-Watt USB-C Power Delivery Port with GaN Technology, One (1) Open Data Port, 10' Cord, and All Mounting Hardware HDMI, VGA, and RJ45 Accessories for Open Data Port; Sold Separately, See Accessories Independent USB Circuit Controllers Deliver up to 2.1 Amps to Each Post FCC Part 15A, UL Recognized for Horizontal and Vertical Applications | | | | | | | |
| DUO BEZEL WITH DAISY CHAIN PLUG  | 01-PDUOBEZELW | White | 6½ | 2½ | 3 | 1 | 0.2 | \$ 668 |
| | 01-PDUOBEZELB | Black | | | | | | |
| | 01-PDUOBEZELS | Silver | | | | | | |
| | Description <ul style="list-style-type: none"> Sits on Table Top and Includes: Two (2) Power, One (1) USB Charging Port and One (1) 60-Watt USB-C Power Delivery Port with GaN Technology with 12" Cord, and All Mounting Hardware Requires Daisy Chain Power Box; Sold Separately, See Power Box Details Non-Sequential System Allows up to Eight (8) Modules to be Connected with Jumper Cord, See Jumper Cord Details Independent USB Circuit Controllers Deliver up to 2.1 Amps to Each Post FCC Part 15A, RU Listed and UL Recognized for Horizontal and Vertical Applications | | | | | | | |
| TRIO BEZEL WITH DAISY CHAIN PLUG  | 01-PTRIOBEZELW | White | 9 | 2½ | 3 | 1 | 0.2 | \$ 715 |
| | 01-PTRIOBEZELB | Black | | | | | | |
| | 01-PTRIOBEZELS | Silver | | | | | | |
| | Description <ul style="list-style-type: none"> Sits on Table Top and Includes: Three (3) Power Outlets, One (1) USB Charging Port, One (1) 60-Watt USB-C Power Delivery Port with GaN Technology, One (1) Open Data Port, 12" Cord, and All Mounting Hardware HDMI, VGA, or RJ45 Accessory for Open Data Port; Sold Separately, See Accessories Requires Daisy Chain Power Box, Specified Separately, See Next Page Non-Sequential System Allows up to Eight (8) Modules to be Connected with Jumper Cord, See Jumper Cord Details Independent USB Circuit Controllers Deliver up to 2.1 Amps to Each Post FCC Part 15A, RU Listed and UL Recognized for Horizontal and Vertical Applications | | | | | | | |

[See Madera Intro Section for Ordering Options](#)

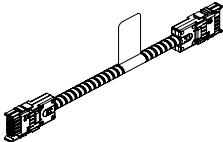
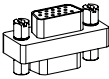
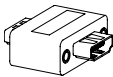
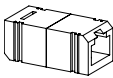
| Item | Model No. | Width | Depth | Height | Ship Wt | Cubic Ft | List Price |
|--|--|-------|-------|--------|---------|----------|------------|
| DAISY CHAIN POWER BOX  | 01-PPOWER <i>76" Perimeter, 36" Power Cord</i> | - | - | - | 1 | 0.2 | \$ 775 |
| | 01-PPOWER2 <i>24" Perimeter, 144" Power Cord</i> | - | - | - | 1 | 0.2 | \$ 796 |
| Description <ul style="list-style-type: none"> • Powers up to Eight (8) Duo and Trio Daisy Chain Units • One Nema Plug and One Daisy Chain Plug • 12-Amp System Rating • 15-Amp Over-Current Protection | | | | | | | |
| DAISY CHAIN JUMPER CORD  | 01-6JUMP <i>72" Long</i> | - | - | - | 1 | 0.2 | \$ 299 |
| | 01-5JUMP <i>60" Long</i> | - | - | - | 1 | 0.2 | \$ 284 |
| | 01-4JUMP <i>48" Long</i> | - | - | - | 1 | 0.2 | \$ 240 |
| | 01-2JUMP <i>24" Long</i> | - | - | - | 1 | 0.2 | \$ 220 |
| Description <ul style="list-style-type: none"> • Connects Duo and Trio Daisy Chain Units • Non-Sequential System Allows up to Eight (8) Modules to be Connected | | | | | | | |
| VGA DATA PORT ACCESSORY  | 01-LCOMVGA | - | - | - | 1 | 0.2 | \$ 121 |
| | Description <ul style="list-style-type: none"> • VGA Port for Trio Bezel and Trio Clamp Units | | | | | | |
| HDMI DATA PORT ACCESSORY  | 01-LCOMHDMI | - | - | - | 1 | 0.2 | \$ 166 |
| | Description <ul style="list-style-type: none"> • HDMI Port for Trio Bezel and Trio Clamp Units | | | | | | |
| OPEN MARKET ONLY | | | | | | | |
| RJ45 DATA PORT ACCESSORY  | 01-LCOMRJ45 | - | - | - | 1 | 0.2 | \$ 79 |
| | Description <ul style="list-style-type: none"> • RJ45 Port for Trio Bezel and Trio Clamp Units | | | | | | |

[See Madera Intro Section for Ordering Options](#)

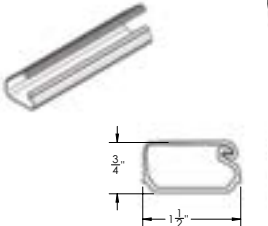
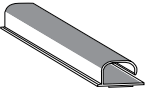
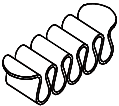
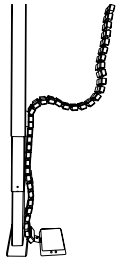
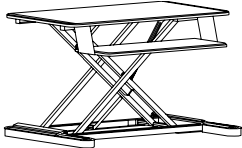
| Item | Model No. | | Width | Depth | Height | Ship Wt | Cubic Ft | List Price |
|---|---|--------|-------|-------|--------|---------|----------|------------|
| WIRE MANAGEMENT CHANNEL | 01-WMGR4 | | 16 | 1½ | 1 | 1 | - | \$ 116 |
|  | <p>Description</p> <ul style="list-style-type: none"> • Set of Four (4) Black Plastic Wire Management Channels • Snap Lock Channel • Attaches with Adhesive Strips • Ships via UPS Only | | | | | | | |
| WIRE CHANNEL | 01-32125 | | 24 | 1½ | 1 | .25 | 0.3 | \$ 106 |
|  | <p>Description</p> <ul style="list-style-type: none"> • Available in Black • Channels Attach with Two (2) Double-Sided Installation Tape • Easily Attach to an Iconic Leg to Route Wires/Cords from the Top to the Floor • Open J Channel for Easy Storage of Cables | | | | | | | |
| CABLE GRIP | 01-WMGRCB | | 5¾ | 2¾ | | - | - | \$ 17 |
|  | <p>Description</p> <ul style="list-style-type: none"> • Under Surface Wire Management • Black | | | | | | | |
| LINK 360 CABLE MANAGER | 01-0251LINKSLV | Silver | 5¾ | 3 ¾ | 30-51 | 4 | 3.0 | \$ 390 |
|  | 01-0251LINKBLK | Black | 5¾ | 3 ¾ | 30-51 | 4 | 3.0 | \$ 353 |
| | <p>Description</p> <ul style="list-style-type: none"> • Kit Includes: 50 Link 360™ elements, One (1) Quad Connector, One (1) Dumbbell Connector, and One (1) Foot Assembly with Two (2) Magnetic Clips • Can Be Used For Height-Adjustable Mechanisms Up To 51" or Free-Standing Use | | | | | | | |
| HEIGHT ADJUSTABLE WORKSTATION | 01-S2SBLK | Black | 35½ | 25 | 6-22 | 49 | 6.5 | \$ 1503 |
|  | <p>Description</p> <ul style="list-style-type: none"> • Height Adjustable • Weight Capacity: 35lbs • One-Handed Operation; Platforms Move Simultaneously • Keyboard Platform: 10½"D x 26¾"W • Worksurface: 21"D x 35½"W • Can be Used on Worksurface 24"D x 35"W | | | | | | | |

[See Madera Intro Section for Ordering Options](#)

| Item | Model No. | | Width | Depth | Height | Ship Wt | Cubic Ft | List Price |
|--|------------|--------|-------|-------|--------|---------|----------|------------|
| 28"D ELECTRIC HEIGHT ADJUSTABLE TABLE LIFT | 01-2854ELB | Black | 54-78 | 28 | 22-48 | 30 | 2.4 | \$ 1832 |
| | 01-2854ELA | Silver | | | | | | |

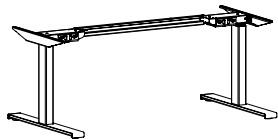

Description

- Standard with Up/Down Control Switch, 10' Power Cord, Integrated Anti-Collision Feature, Leveling Glides
- Standard Up/Down Control Switch can be Mounted for Left or Right Users; Upgrade to Advanced Memory Switch (01-MSWCH with Memory, Reminders, and Bluetooth), Must Specify and See Below for Details
- Adjusts to Accommodate Tops 54-78"W and 30"-36"D; Tops Sold Separately
- Lifting Capacity (Including Worksurface): 363 lbs
- Some Assembly Required; Installation Instructions Included

| | | | | | | | | |
|--|------------|--------|-------|----|-------|----|-----|---------|
| 22"D ELECTRIC HEIGHT ADJUSTABLE TABLE LIFT | 01-2254ELB | Black | 54-78 | 22 | 22-48 | 58 | 2.4 | \$ 1832 |
| | 01-2254ELA | Silver | | | | | | |

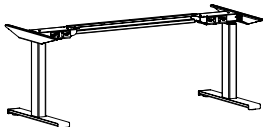

Description

- Standard with Up/Down Control Switch, 10' Power Cord, Anti-Collision Safety Feature, Leveling Glides
- Standard Up/Down Control Switch can be Mounted for Left or Right Users; Upgrade to Advanced Memory Switch (01-MSWCH with Memory, Reminders, and Bluetooth), Must Specify and See Below for Details
- Adjusts to Accommodate Tops 54-78"W and 24"D; Tops Sold Separately
- Lifting Capacity (Including Worksurface): 363 lbs
- Some Assembly Required; Installation Instructions Included

| | | | | | | | | |
|--|------------|--------|-------|----|-------|----|-----|---------|
| 22"D ELECTRIC HEIGHT ADJUSTABLE TABLE LIFT | 01-2242ELB | Black | 42-48 | 22 | 22-48 | 55 | 2.4 | \$ 1832 |
| | 01-2242ELA | Silver | | | | | | |

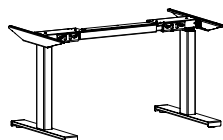

Description

- Standard with Up/Down Control Switch, 10' Power Cord, Anti-Collision Safety Feature, Leveling Glides
- Standard Up/Down Control Switch can be Mounted for Left or Right Users; Upgrade to Advanced Memory Switch (01-MSWCH with Memory, Reminders, and Bluetooth), Must Specify and See Below for Details
- Adjusts to Accommodate Tops 42-48"W and 24"D; Tops Sold Separately
- Lifting Capacity (Including Worksurface): 363 lbs
- Some Assembly Required; Installation Instructions Included

| | | | | | | | | |
|--|----------|--|----|----|----|---|-----|--------|
| ELECTRIC HEIGHT ADJUSTABLE ADVANCED SWITCH WITH MEMORY | 01-MSWCH | | 3⅝ | 4⅜ | 1⅝ | ½ | 0.8 | \$ 223 |
|--|----------|--|----|----|----|---|-----|--------|



Description

- Black Unit with Black Cord
- Bluetooth Capabilities
- Three Stand-Up Reminders
- Four Height Memory Positions

OPEN MARKET ONLY

[See Madera Intro Section for Ordering Options](#)

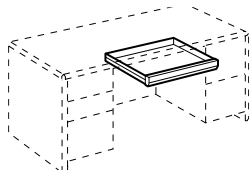
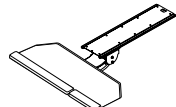
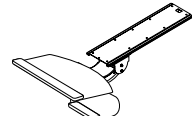
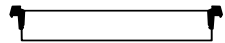
| Item | Model No. | Width | Depth | Height | Ship Wt | Cubic Ft | List Price |
|--|-----------------------------------|-------------------|------------------|-----------------|---------|----------|------------|
| CENTER DRAWER  | 01-2122CD | 22 | 20 $\frac{5}{8}$ | 2 $\frac{3}{4}$ | 13 | 1.7 | \$ 529 |
| | 01-1622CD | 22 | 16 $\frac{5}{8}$ | 2 $\frac{3}{4}$ | 7 | 1.4 | \$ 495 |
| Description <ul style="list-style-type: none"> • Beveled Drawer Front • $\frac{3}{4}$ Extension • Center Drawer Features Multi-Step, Hand-Finished Catalyzed Finish • Wood Drawer Interiors with Built in Pen Tray | | | | | | | |
| Options: Specify & Add | | | | | | | |
| CD16 Factory Installed 01-1622CD | | | | | | | \$ 208 |
| <hr/> | | | | | | | |
| ARTICULATING KEYBOARD CORNER PLATFORM  | 01-KB2CC | 25 | 10 $\frac{1}{2}$ | 4 $\frac{1}{2}$ | 16 | 1.4 | \$ 832 |
| Description <ul style="list-style-type: none"> • Standard With: +/- 15° Tilt Adjustment , 360° Rotation, Independent Tilt Adjustment, 7" Lift and Lock Height Adjustment, 25" Cut Corner Platform • Keyboard and Mouse on same level; Single Palm Rest for both Left & Right Hands • Works with 17"+ Diagonal Work Surface • Cannot Be Used on 20" or 21" Deep Unit • Not Available with Optional Center Grommet • Track Measures 21" | | | | | | | |
| Options: Specify & Add | | | | | | | |
| KB2CC Factory Installed | | | | | | | \$ 208 |
| <hr/> | | | | | | | |
| KEYBOARD MECHANISM WITH KEYBOARD CLAMP  | 01-KB3 | 26 $\frac{1}{2}$ | 14 | 4.5 | 16 | 1.4 | \$ 914 |
| Description <ul style="list-style-type: none"> • Standard With: 18.75" Platform with Swivel-Below Mouse Platform,+/- 15° Tilt Adjustment, 360° Rotation, 7" Lift and Lock Height Adjustment, Independent Tilt Adjustment, Palm Rest for Mousing Surface • Left or Right Handed Mouse Platform • Cannot Be Used on 20" or 21" Deep Unit • Not Available with Optional Center Grommet • Track Measures 21" | | | | | | | |
| Options: Specify & Add | | | | | | | |
| KB3 Factory Installed | | | | | | | \$ 208 |
| <hr/> | | | | | | | |
| BOX DRAWER DIVIDER  | 14-0316DV | 15 $\frac{7}{32}$ | $\frac{1}{4}$ | 3 $\frac{1}{2}$ | 1 | 0.5 | \$ 116 |
| | For Use in Legal Width Box Drawer | | | | | | |
| | 14-0315DV | 14 $\frac{5}{32}$ | $\frac{1}{4}$ | 3 $\frac{1}{2}$ | 1 | 0.5 | \$ 107 |
| For Use in Modular Ped Box Drawer | | | | | | | |
| 14-0313DV | 14 $\frac{5}{32}$ | $\frac{1}{4}$ | 3 $\frac{1}{2}$ | 1 | 0.5 | \$ 93 | |
| For Use in Letter Width Box Drawer | | | | | | | |
| Description <ul style="list-style-type: none"> • Clear Acrylic • Plastic Clips Mount Over Drawer Sides • Frosted Divider | | | | | | | |

[See Madera Intro Section for Ordering Options](#)

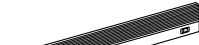
| Item | Model No. | Width | Depth | Height | Ship Wt | Cubic Ft | List Price |
|---|----------------------------------|-------|-------|--------|---------|----------|------------|
|  | TL-0848 <i>240-LED, 18 Watts</i> | 47½ | 7/8 | 1½ | - | - | \$ 445 |
| | TL-0824 <i>84-LED, 7 Watts</i> | 22½ | 7/8 | 1½ | - | - | \$ 368 |

Description

- Includes the Power Supply and Three (3) Upper Wire Management Grommets
- Rocker Style On/Off Switch with a 10' Power Cord
- Three (3) Upper Wire Management Grommets; Must Specify Color: Black (BLK), Silver (SLV)

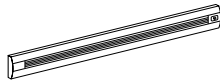
| Item | Model No. | Width | Depth | Height | Ship Wt | Cubic Ft | List Price |
|---|---------------------------------------|-------|-------|--------|---------|----------|------------|
|  | 01-188LED58 <i>96-LED, 33.7 Watts</i> | 57¾ | 2 | ¾ | - | - | \$ 1648 |
| | 01-94LED31 <i>48-LED, 17.6 Watts</i> | 30½ | 2 | ¾ | - | - | \$ 1195 |
| | 01-47LED17 <i>24-LED, 9.1 Watts</i> | 16¾ | 2 | ¾ | - | - | \$ 690 |

Description

- Includes the Power Supply and Three (3) Upper Wire Management Grommets
- 12' Power Cord
- Three (3) Upper Wire Management Grommets; Must Specify Color: Black (BLK), Silver (SLV)
- Optional Occupancy Sensor Shuts Off After 30 Minutes of Inactivity and Turns On Immediately When Reentering the Detection Area

Options: Specify & Add

| | | |
|---------|------------------|--------|
| 01-OSRP | Occupancy Sensor | \$ 366 |
|---------|------------------|--------|

SURFACE MOUNT TACKBOARDS
21" H

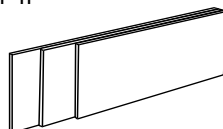

Must Specify (in this order):
Model #
Fabric Vendor, Pattern, and Color

| Model # | Size | COM ydg | COM, 1, 2 or 3 | Grades | | | | | | |
|----------|------|---------|-------------------|--------|------|------|------|------|------|------|
| | | | | 4 | 5 | 6 | 7 | 8 | 9 | 10 |
| TB-1496H | 96" | 3.00 | \$ 707 | 1124 | 1319 | 1517 | 1799 | 2093 | 2435 | 2831 |
| TB-1490H | 90" | 2.75 | \$ 673 | 1055 | 1234 | 1416 | 1674 | 1944 | 2257 | 2620 |
| TB-1484H | 84" | 2.50 | \$ 639 | 987 | 1149 | 1314 | 1549 | 1794 | 2079 | 2409 |
| TB-1478H | 78" | 2.50 | \$ 628 | 976 | 1138 | 1303 | 1538 | 1783 | 2068 | 2398 |
| TB-1472H | 72" | 2.25 | \$ 566 | 879 | 1025 | 1174 | 1385 | 1606 | 1862 | 2159 |
| TB-1466H | 66" | 2.00 | \$ 533 | 811 | 941 | 1073 | 1261 | 1457 | 1685 | 1949 |

Description

- Coordinates with Surface Mount Hutches
- Factory Installed

WALL MOUNT TACKBOARDS
21½" H

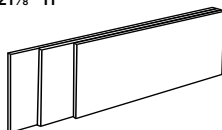

Must Specify (in this order):
Model #
Fabric Vendor, Pattern, and Color

| Model # | Size | COM ydg | COM, 1, 2 or 3 | Grades | | | | | | |
|----------|------|---------|-------------------|--------|-----|-----|-----|------|------|------|
| | | | | 4 | 5 | 6 | 7 | 8 | 9 | 10 |
| TB-0136W | 36" | 1.25 | \$ 434 | 608 | 689 | 772 | 889 | 1012 | 1154 | 1319 |

Description

- Coordinates with Wall Mount Hutches
- Factory Installed

[See Madera Intro Section for Ordering Options](#)

| Item | Model No. | Width | Depth | Height | Ship Wt | Cubic Ft | List Price |
|--------------------|-----------|-------|-------|--------|---------|----------|------------|
| VESTA POWER CENTER | 01-PDCTR | 10¾ | 12 | 28¾ | 14 | 2.5 | \$ 1776 |

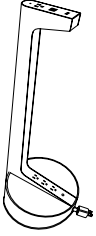

Description

- Top Includes One (1) Power Outlet, Two (2) USB Ports and One (1) USBC Port; Base Includes Three (3) Outlet
- Available in White
- 120" Power Cord
- Built with Weight Distribution for Optimal Stability
- Base is 5" Tall

| | | | | | | | |
|---------------------------|---------|---|----|----|--|--|-------|
| PURSE HOOK FOR WORK TABLE | 01-HOOK | 2 | 1¾ | 2½ | | | \$ 79 |
|---------------------------|---------|---|----|----|--|--|-------|



Description

- Black Hook Includes Mounting Hardware
- For Use with Work Tables, [See Work Tables](#)
- Field Installed

[See Madera Intro Section for Ordering Options](#)

Crafted in select solids and American veneers, Phoenix's clean, transitional styling is at ease in both contemporary and traditional settings. It is a perfect choice for value-minded companies who want a sophisticated, yet uncomplicated, furniture solution.

CONSTRUCTION

Phoenix features a Veneer chassis with your choice of a Veneer or HPL top. Units ship assembled unless otherwise noted.

VENEER

- Exposed surfaces feature select grade sliced American Black Walnut or Cherry veneer carefully selected and matched to assure proper balance and consistency

TOPS

- Veneer tops are 5-ply balanced construction and 1 5/32" thick with solid hardwood rims
- High Pressure Laminate (HPL) tops are 3-ply balanced construction and 1 5/32" thick with solid hardwood rims
- Grain direction runs left to right unless noted

CHASSIS

- Chassis is securely fastened using high quality European fastening systems and heavy-duty, 16-gauge joining brackets to assure maximum strength
- Units feature finished backs unless otherwise noted
- All units equipped with heavy-duty, adjustable glides to ensure proper leveling and compensate for uneven floors

DRAWERS

- Drawer fronts standard with matched veneer faces
- Drawer sides, back and front are woodgrain vinyl-wrapped, and are 1/2" thick
- 5-sided drawer construction for easy removal of drawer fronts
- Box and file drawers have 1/8" thick hardboard bottoms and tested for 100lb capacity
- Lateral files feature 1/4" thick bottoms. Drawers are tested for 200lb of equally distributed weight (ex: hanging file folders) and 65lbs of bottom load weight (ex: stacked catalogs)
- All drawers feature full extension, progressive action slides with precision steel ball bearings
- All suspensions have a limited lifetime warranty

FILING

- All file drawers are standard with filing systems designed to accommodate a variety of filing requirements
- Legal width file drawers provide legal filing front to back, and letter or legal filing side to side
- Letter width file drawers provide letter filing front to back, and letter or legal filing side to side

STORAGE

- All hinged doors include soft close hinges, unless noted
- One piece hinge and base plate combination
- Soft close hinges reduce stress placed on the cabinet when the door is closed and offers a quiet closure

LOCKING

- All desks, credenzas, returns, and files feature standard locking
- Lock core will coordinate with pull selection unless otherwise noted
- Removable lock cylinders allow for units to be re-keyed at a later date if required
- Units are shipped randomly keyed as standard. Keyed alike units available upon request at no additional charge.

CORD MANAGEMENT

- Grommets are standard in back panels of assembled returns, bridge units, kneespace credenzas, and hutch units
- A grommet is standard in tops of corner units
- Grommets may be ordered in the tops of desks, returns, bridge units, and credenzas worksurfaces
- Grommets are 2 3/8" in diameter and available in black or silver, please specify color
- [See grommet options and locations.](#)
- Wire Manager available for additional cord management; [See Accessories](#)

INTERIOR DRAWER DIMENSIONS

Models

| | | | |
|------------|------------|------------|------------|
| 21-3672BDP | 21-3072LP | 21-2448LF1 | 21-2066LC2 |
| 21-3672BLP | 21-3072RP | 21-2448RF1 | 21-2066RC2 |
| 21-3672BRP | 21-3066LP | 21-2442LF2 | 21-2072LC1 |
| 21-3672DP | 21-3066RP | 21-2442RF2 | 21-2072RC1 |
| 21-3072DP | 21-3060LP | 21-2442LF1 | 21-2066LC1 |
| 21-3066DP | 21-3060RP | 21-2442RF1 | 21-2066RC1 |
| 21-3060DP | 21-2448LF2 | 21-2072LC2 | 21-2072SC |
| 21-3672LP | 21-2448RF2 | 21-2072RC2 | 21-2066SC |
| 21-3672RP | 21-2072KC | 21-2066KC | |

Drawers

| | W | L | D |
|------|---------|----------|---------|
| Box | 12 1/8" | 16 3/16" | 3 1/2" |
| File | 12 1/8" | 16 3/16" | 9 5/16" |

Models

| | | | |
|-----------|-----------|-----------|-----------|
| 21-2036L4 | 21-2030L4 | 21-2036L2 | 21-2030L2 |
| 21-2072RL | 21-2072LL | 21-2066RL | 21-2066LL |

Drawers

| | W | L | D |
|----------|---------|----------|---------|
| Lat File | 30 1/2" | 15 1/16" | 9 7/32" |

Models

| | | | |
|------------|------------|------------|------------|
| 21-2472RMR | 21-2472LMR | 21-2072RMF | 21-2072LMF |
| 21-2066RMF | 21-2066LMF | | |

Drawers

| | W | L | D |
|------------|----------|----------|---------|
| Box | 16 3/16" | 12 1/8" | 3 1/2" |
| Upper File | 12 1/8" | 16 3/16" | 9 1/4" |
| Lat File | 31 1/2" | 15 1/16" | 9 7/32" |

Models

| | |
|-----------|-----------|
| 21-3672TD | 21-3066TD |
|-----------|-----------|

Drawers

| | W | L | D |
|------|-----------|----------|--------|
| Tray | 30 11/16" | 15 3/16" | 1 3/4" |

Models

| |
|-----------|
| 21-1622CD |
|-----------|

Drawers

| | W | L | D |
|--------|-----------|-----------|--------|
| Center | 18 15/16" | 14 15/16" | 1 3/4" |

FILING CAPABILITIES

Drawers with Dimensions: 12 $\frac{1}{8}$ "W x 15 $\frac{3}{16}$ "L



Letter Front to Back

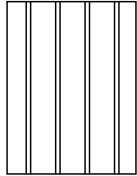

Legal Side to Side

Drawers with Dimensions: 30 $\frac{1}{2}$ "W x 15 $\frac{1}{16}$ "L

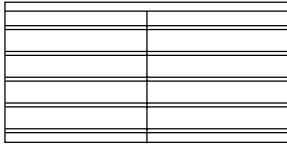

2 Rows Letter Front to Back

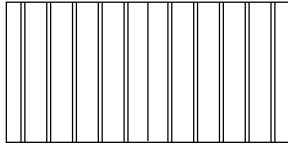

1 Row Letter or Legal Side to Side

Drawers with Dimensions: 31 $\frac{1}{2}$ "W x 15 $\frac{1}{16}$ "L

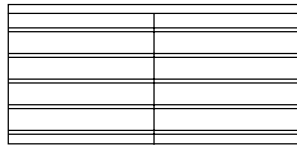

2 Rows Letter or Legal Front to Back

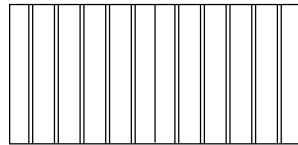

1 Row Letter or Legal Side to Side

HOW TO ORDER EXAMPLES

| Model No. | Description | Example |
|------------|--------------------------|-----------|
| 21-3672BDP | Top Material | W |
| | Finish | AW |
| | Pull/Color | AFL |
| | Grommet Location & Color | GC, SLV |
| | Center Drawer/Keyboard | 21-1622CD |

VENEER (W) OPTIONS

Veneer features UVAdvantage, an ultra-violet finish, on all exposed surfaces by utilizing roll-coat UV technology. Molding features multi-step, hand-finished catalyzed finish.

| | | | |
|-----|--------------------|-----|---------------------|
| AW | Artisan Walnut | LW | Legacy Walnut |
| CO | Columbian Walnut | MW | Mahogany Walnut |
| DC | Dark Cherry | MTS | Metropolis Sky |
| DFW | Dark Forest Walnut | PNW | Pinnacle Walnut |
| EW | Espresso | SCH | Select Cherry |
| GC | Golden Cherry | SKC | Shaker Cherry |
| HW | Harvest Walnut | WC | Williamsburg Cherry |
| HNW | Henna Walnut | | |

HPL (P) TOP OPTIONS

WOODGRAIN

| | | | |
|----|------------------|-----|---------------------|
| CO | Columbian Walnut | PNW | Pinnacle Walnut |
| EF | Espresso | SCH | Select Cherry |
| GC | Golden Cherry | SKC | Shaker Cherry |
| MW | Mahogany Walnut | WC | Williamsburg Cherry |

EDGE PROFILE

Select units feature multiple flush options allowing units to be placed next to each other. See specific units for details.

- FL Flush Left
- FR Flush Right
- FLR Flush Left and Right



(FL) Flush Left Shown

O Phoenix



Phoenix (O)

PULL OPTIONS

Note: Lock Core will match Pull Color

| | | | |
|-----|------------------|-----|------------------|
| AAC | Arc, Aluminum | AEL | Elite, Aluminum |
| BAC | Arc, Black | BEL | Elite, Black |
| ABM | Beam, Aluminum | AFL | Flair, Aluminum |
| BBM | Beam, Black | CFL | Flair, Chrome |
| BBT | Bow Tie, Black | AFC | Focus, Aluminum |
| NBT | Bow Tie, Nickel | BFC | Focus, Black |
| ABU | Buckle, Aluminum | AQD | Quadra, Aluminum |
| BBU | Buckle, Black | BQD | Quadra, Black |



Arc (AAC)
Aluminum - 5"



Arc (BAC)
Black - 5"



Beam (ABM)
Aluminum - 10 1/4"



Beam (BBM)
Black - 10 1/4"



Bow Tie (NBT)
Nickel - 5 1/2"



Bow Tie (BBT)
Black - 5 1/2"



Buckle (ABU)
Aluminum - 4 3/4"



Buckle (BBU)
Black - 4 3/4"



Elite (AEL)
Aluminum - 5"



Elite (BEL)
Black - 5"



Flair (AFL)
Aluminum - 5 3/8"



Flair (CFL)
Chrome - 5 3/8"



Focus (AFC)
Aluminum - 4 3/8"



Focus (BFC)
Black - 4 3/8"



Quadra (AQD)
Aluminum - 4"



Quadra (BQD)
Black - 4"

GROMMET OPTIONS & LOCATIONS

Select Location, then specify Black (BLK) or Silver (SLV)

| | | | |
|-----|--|----|----|
| GC | Grommet, Center | \$ | 52 |
| GL | Grommet, Left | \$ | 52 |
| GR | Grommet, Right | \$ | 52 |
| GSL | Grommet, Seat Side Left - P/D-Tops Only | \$ | 52 |
| GSR | Grommet, Seat Side Right - P/D-Tops Only | \$ | 52 |

Verify Grommet Option is available on the model(s) you are specifying using the following location information. Grommets may be ordered in non-standard locations. Call Customer Service to assist with specification. Note additional charges and lead times may apply.

Multiple unit locations may be selected. Only one unit per location.

[See locations](#)

GROMMET OPTIONS & LOCATIONS (CONTINUED)

Grommets are standard in the back panels of returns, bridges, and credenzas, and may be ordered without grommets at no additional charge. Please specify NO GROMMET on order.

Models

21-3672BDP 21-3672BLP 21-3672BRP

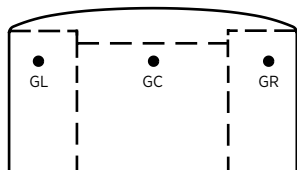

GL/GR: Located 6" from ends and 23" from user side
GC: Located 23" from user side

Models

21-3672DP 21-3672LP 21-3672RP 21-3672TD

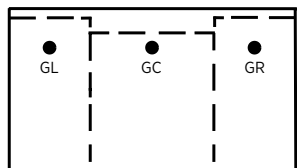

GL/GR: Located 6" from ends and 23" from user side
GC: Located 23" from user side

Models

21-3072DP 21-3072LP 21-3066LP 21-3060LP
21-3066DP 21-3072RP 21-3066RP 21-3060RP
21-3060DP 21-3066TD

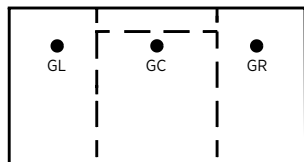

GL/GR: Located 6" from ends and 23" from user side
GC: Located 23" from user side

Models

21-2448UF 21-2448UFH 21-2442UF 21-2442UFH

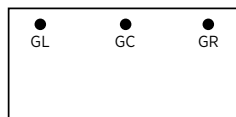

GL/GR: Located 6" from ends and 20" from user side
GC: Located 20" from user side

Models

21-2448LF1 21-2448LF2 21-2442LF1 21-2442LF2
21-2448RF1 21-2448RF2 21-2442RF1 21-2442RF2

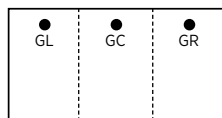

GL/GR: Located 6" from ends and 20" from user side
GC: Located 20" from user side

Models

21-2072KC 21-2072LC1 21-2072LC2 21-2072LL*
21-2066KC 21-2072RC1 21-2072RC2 21-2072RL*
21-2472LMR* 21-2072LMF* 21-2066LC1 21-2066LC2
21-2472RMR* 21-2072RMF* 21-2066RC1 21-2066RC2
21-2066LL* 21-2066RL* 21-2066LMF* 21-2066RMF*

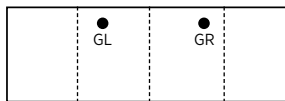

GL/GR: Located 19½" from ends and 17½" from user side
* Grommets are only available opposite the pedestal

Models

21-4272PR 21-4272PL

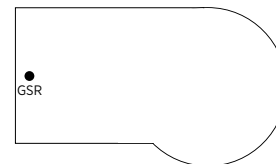
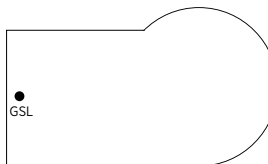

GSL/GSR: Located 18" from approach or seated side, 6" from end

Models

21-3672DL 21-3672DR 21-3072DL 21-3072DR

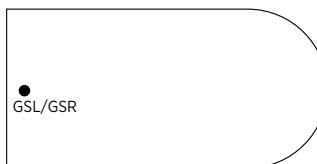

GSL/GSR: Located 18" from approach or seated side, 6" from end

Models

21-4242CU 21-3636CU

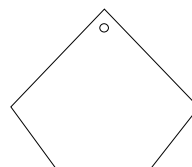

GC: Located 4" from corner edge

HUTCH GROMMET OPTIONS

Surface Mount Hutches come standard with one center grommet at workstation level on back panel. Three upper wire management grommets also are available. One grommet located on right, center and left. Must specify with color selection.

WMHUBL Black Lower Grommet + Three (3) Upper Grommets N/C
WMHUSV Silver Lower Grommet + Three (3) Upper Grommets N/C

TABLE GROMMET & POWER UNIT OPTIONS

Power units and grommets are sold separately and must be specified separately with surface mount location. Multiple locations may be selected. Only one unit per location.

Power units and Grommets Available in Table Surfaces (See Units)

Grommet Specify Color: Black = BLK and Silver = SLV

See Next Page for Additional Grommet and Power Information.

TABLE GROMMET & POWER UNIT OPTIONS CONTINUED

DUO/TRIO BEZEL

- 01-DUOBEZEL Available in Black (B), Silver (S), or White (W)
- 01-TRIOBEZEL Available in Black (B), Silver (S), or White (W)

DOCK 950, DOCK 800 and DOCK 150

- DOCK950 Available in Black or White
- DOCK150 Available in Black or White
- DOCK800 Available in Black or Silver

Other Power Units

- DPORT4 Available in Aluminum or Black
- INTERACTG Available in Aluminum or Black
- OASISM Available in Aluminum or Black

Power/Data Location Information:

- Designate unit and location when specifying the top model. Power/Data Module need to be ordered separately.
- Power/Data Modules specified at the time of order will be routed for field installation.
 - E1 Unit on One End
 - E2 Unit on Each End
 - OC Unit on Center
- All power units available **On Center (OC) only** when paired with two (2) or more of the following bases:
 - Cylinder Base Square Base
 - X-Base Disc
 - Tubular X-Base

Grommets and Power Units may be ordered in non-standard locations. Call Customer Service to assist with specification and/or please attach a drawing to the PO showing the location of the grommet. Note additional charges and lead times may apply.

Top Locations

Power units available on Each End (E1 and E2) and On Center (OC) unless otherwise noted, when paired with any Rectangle Panel Base, Rectangle Box Base or Rectangle Accent Box Base. ([See Unit Details](#))

Power units centered at locations below:

- 36" Tops centered 18"D 48" Tops centered 24"D
- 42" Tops centered 21"D

- 72: OC 36" from end (**available with OC Only**)
- 96: OC 48" from end; E1/E2 29" from end
- 120: OC 60" from end; E1/E2 29" from end
- 144: OC 72" from end; E1/E2 29" from end

LOCKING DOORS

Locking doors are available.. You must specify WITH LOCKING when ordering and add upcharge. See color Information below.

| | | | |
|--------|-------------------|----|-----|
| LKT_HU | 82"W Units | \$ | 135 |
| LKT_HU | 78"W - 46"W Units | \$ | 115 |
| LKT_HU | 42"W - 24"W Units | \$ | 91 |
| LKT_HU | 18"W - 12"W Units | \$ | 69 |

LOCK CORE OPTIONS

Lock core will coordinate with pull color unless otherwise noted.

- BLK Black
- SLV Silver



CERTIFICATIONS & COMPLIANCE

- Intertek Sustainability Certified
- BIFMA level® Certified
- BIFMA Compliant® Certified
- TSCA Title VI (formerly CARB) Compliance
- US Green Building's LEED® Contribution

Standard Components

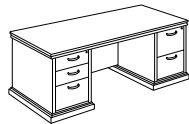

Double Ped Desks with or without Bow Tops
[\(See Multiple Unit Details\)](#)

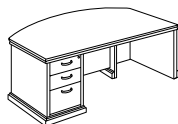

Single Ped Desks with or without Bow Tops
[\(See Multiple Unit Details\)](#)

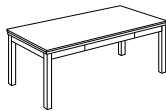
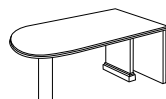
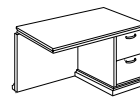

Table Desks
[\(See Details\)](#)



P-Tops and D-Tops
[\(See Multiple Unit Details\)](#)



Returns
[\(See Multiple Unit Details\)](#)

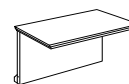

Bridges
[\(See Details\)](#)

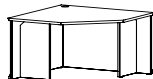

Corner Units
[\(See Details\)](#)

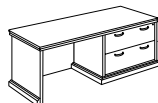

Single Ped, Storage, and Kneespace Credenzas
[\(See Multiple Unit Details\)](#)

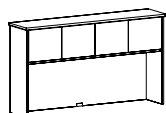

Wall Mount and Surface Mount Hutches
[\(See Multiple Unit Details\)](#)



Lateral Filing
[\(See Details\)](#)

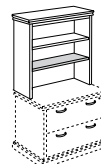

Bookcases
[\(See Multiple Unit Details\)](#)

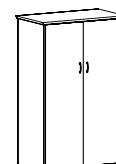

Wardrobes/Storage
[\(See Multiple Unit Details\)](#)

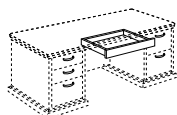

Center Drawer
[\(See Details\)](#)

Tables + Bases [\(See Multiple Units\)](#)

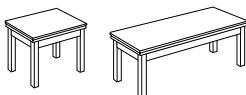

Occasional Tables



Rectangle Tops



Boat Tops



Round Tops

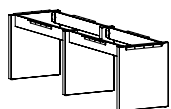

Rectangular Panel Bases with Trough

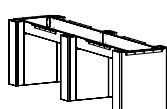

6" Rectangular Bases with Trough

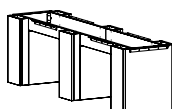

10" Rectangular Bases with Trough

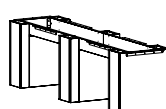

6" Rectangular Accent Bases with Trough

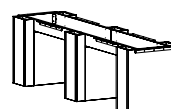

10" Rectangular Accent Bases with Trough

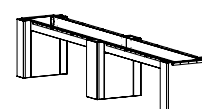

6" + 10" Combo Rectangular Bases with Trough

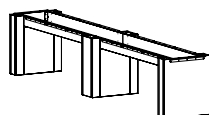

6" + 10" Combo Rectangular Accent Bases with Trough



Disc Bases

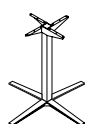

Small and Large X-Bases

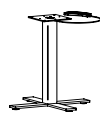

HA Pneumatic X-Base



Metal Bases

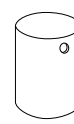

Cylinder

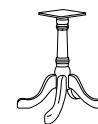

Queen Anne

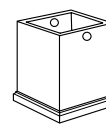

Square

Tackboard, Tasklights, Wire Management & Power/Data Accessories [\(See Multiple Units\)](#)

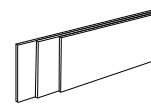
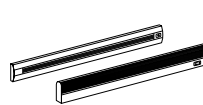
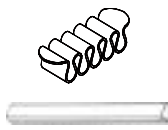

| Item | Model No. | Width | Depth | Height | K | R | Ship Wt | Cubic Ft | List Price |
|------------------|-----------|-------|-------|--------|------------------|------------------|---------|----------|----------------------|
| EXECUTIVE L UNIT | 21-1 | 72 | 84 | 30 | 31 $\frac{3}{8}$ | 10 $\frac{3}{4}$ | 372 | 73.1 | P\$ 6232 W\$ 6780 |

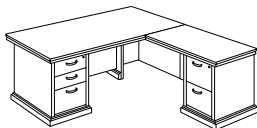

| CONSIST OF: | QTY | | | |
|-------------|-----|---------------------|--|----------------------|
| 21-3672LP | 1 | Pedestal Desk, Left | | P\$ 3624 W\$ 3959 |
| 21-2448RF2 | 1 | Return, Right | | P\$ 2608 W\$ 2821 |

Products are available as left or right, where applicable

| | | | | | | | | | |
|---|------|----|--------------------|----|------------------|------------------|-----|------|----------------------|
| EXECUTIVE U UNIT BOW TOP DESK STEPPED FRONT | 21-2 | 72 | 104 $\frac{7}{16}$ | 30 | 31 $\frac{3}{8}$ | 10 $\frac{3}{4}$ | 568 | 85.5 | P\$ 8532 W\$ 9316 |
|---|------|----|--------------------|----|------------------|------------------|-----|------|----------------------|

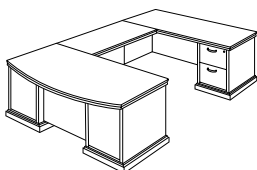

| CONSIST OF: | QTY | | | |
|-------------|-----|---------------------------------|--|----------------------|
| 21-3672BLP | 1 | Bow Desk, Left | | P\$ 4001 W\$ 4310 |
| 21-2448UF | 1 | Bridge | | P\$ 1538 W\$ 1628 |
| 21-2072RC2 | 1 | Single Pedestal Credenza, Right | | P\$ 2993 W\$ 3378 |

Products are available as left or right, where applicable

| | | | | | | | | | |
|---------------------------|------|----|--------------------|----|---|---|-----|------|----------------------|
| EXECUTIVE U UNIT P-TOP | 21-3 | 72 | 110 $\frac{7}{16}$ | 30 | - | - | 409 | 95.3 | P\$ 7762 W\$ 8306 |
|---------------------------|------|----|--------------------|----|---|---|-----|------|----------------------|

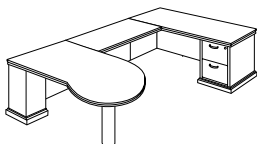

| CONSIST OF: | QTY | | | |
|-------------|-----|---------------------------------|--|----------------------|
| 21-4272PL | 1 | P-Top Unit, Left | | P\$ 3231 W\$ 3300 |
| 21-2448UF | 1 | Bridge | | P\$ 1538 W\$ 1628 |
| 21-2072RC2 | 1 | Single Pedestal Credenza, Right | | P\$ 2993 W\$ 3378 |

Products are available as left or right, where applicable

| | | | | | | | | | |
|---------------------------|------|----|--------------------|----|---|---|-----|------|----------------------|
| EXECUTIVE U UNIT D-TOP | 21-4 | 72 | 104 $\frac{7}{16}$ | 30 | - | - | 408 | 85.5 | P\$ 7241 W\$ 8048 |
|---------------------------|------|----|--------------------|----|---|---|-----|------|----------------------|

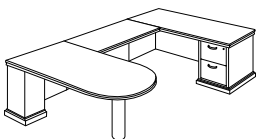

| CONSIST OF: | QTY | | | |
|-------------|-----|---------------------------------|--|----------------------|
| 21-3672DL | 1 | D-Top Unit, Left | | P\$ 2710 W\$ 3042 |
| 21-2448UF | 1 | Bridge | | P\$ 1538 W\$ 1628 |
| 21-2072RC2 | 1 | Single Pedestal Credenza, Right | | P\$ 2993 W\$ 3378 |

Products are available as left or right, where applicable

Pricing Codes:
P = Laminate Top
W = Wood Top

[See Phoenix Intro Section for Ordering Options](#)

| Item | Model No. | Width | Depth | Height | K | R | Ship Wt | Cubic Ft | List Price |
|------------------------------|------------|-------|-------|--------|-----|-----|---------|----------|----------------------|
| DOUBLE PED DESK WITH BOW TOP | 21-3672BDP | 72 | 36-30 | 30 | 38¾ | 10¾ | 360 | 50.0 | P\$ 4760 W\$ 5077 |

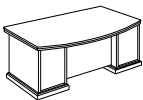
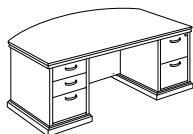

Approach

Description

- Standard with: Bow Top, Stepped Front, Locking Letter Width Box/Box/File on Left and File/File on Right, Black Utility Tray Included in Box Drawer, Wire Management from Pedestal to Kneespace
- Available with Veneer (W) or HPL (P) Top, Must Specify
- Additional Options: Grommet Options ([See Options and Locations](#)), Kneespace Options (Sold Separately, [See Unit Details](#))

Must Specify (in this order):

- Model #
- Top Material
- Finish/Color
- Drawer Pull
- Worksurface Grommet Location
- Grommet Color
- Kneespace Options

| | | | | | | | | | |
|-----------------|-----------------------|----|----|----|-----|-----|-----|------|----------|
| DOUBLE PED DESK | 21-3672DP | 72 | 36 | 30 | 38¾ | 10¾ | 360 | 50.0 | P\$ 4387 |
| | 6¾" Approach Overhang | | | | | | | | W\$ 4723 |
| | 21-3072DP | 72 | 30 | 30 | 38¾ | 4¾ | 330 | 43.8 | P\$ 4311 |
| | ¾" Approach Overhang | | | | | | | | W\$ 4697 |
| DOUBLE PED DESK | 21-3066DP | 66 | 30 | 30 | 32¾ | 4¾ | 249 | 38.7 | P\$ 4224 |
| | ¾" Approach Overhang | | | | | | | | W\$ 4601 |
| DOUBLE PED DESK | 21-3060DP | 60 | 30 | 30 | 26¾ | 4¾ | 241 | 35.3 | P\$ 4136 |
| | ¾" Approach Overhang | | | | | | | | W\$ 4519 |

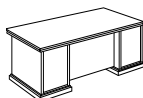
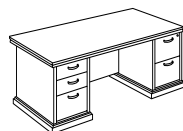

Approach

Description

- Standard with: Rectangle Top, Stepped Front, Locking Letter Width Box/Box/File on Left; File/File on Right, Black Utility Tray Included in Box Drawer, Wire Management from Pedestal to Kneespace
- ¾" Overhang on Left, Right and User Sides
- Available with Veneer (W) or HPL (P) Top, Must Specify
- Additional Options: Additional Options: Grommet Options ([See Options and Locations](#)), Kneespace Options (Sold Separately, [See Unit Details](#))

Must Specify (in this order):

- Model #
- Top Material
- Finish/Color
- Drawer Pull
- Worksurface Grommet Location
- Grommet Color
- Kneespace Options

[See Phoenix Intro Section for Ordering Options](#)

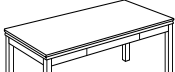
| Item | Model No. | Width | Depth | Height | K | R | Ship Wt | Cubic Ft | List Price |
|---|-----------|-------|-------|--------|-----|-----|---------|----------|----------------------|
|  | 21-3672TD | 72 | 36 | 30 | 38¾ | 10¾ | 274 | 50.0 | P\$ 2719 W\$ 3058 |
| | 21-3066TD | 66 | 30 | 30 | 32¾ | 4¾ | 249 | 38.7 | P\$ 2555 W\$ 2938 |

Description

- Includes Center Drawer
- Available with Veneer (W) or HPL (P) Top, Must Specify
- Top and Legs Ship Separately; Legs Must Be Specified, See Below
- Additional Options: Grommet Options ([See Options and Locations](#)),

Must Specify:

| | | | | |
|-----------|---------------------------|----|-----|-----|
| 21-0202TL | Table Legs - Must Specify | 20 | 0.1 | N/C |
|-----------|---------------------------|----|-----|-----|

Legs Feature Multi-Step, Hand-Finished Catalyzed Finish

Must Specify (in this order):

Model #
Top Material
Finish/Color
Table Legs
Grommet

SINGLE PED DESK WITH BOW TOP

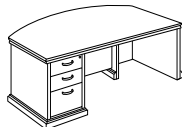

Shown as Left

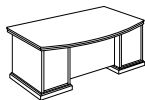

Approach

| Left | Right | Width | Depth | Height | K | R | Ship Wt | Cubic Ft | List Price |
|------------|------------|-------|-------|--------|-----|-----|---------|----------|----------------------|
| 21-3672BLP | 21-3672BRP | 72 | 36-30 | 30 | 31¾ | 10¾ | 320 | 50.0 | P\$ 4001 W\$ 4310 |

Description

- Standard with: Bow Top, Stepped Front, Locking Letter Width Box/Box/File Pedestal, Black Utility Tray Included in Box Drawer, Wire Management from Pedestal to Kneespace
- Available with Veneer (W) or HPL (P) Top, Must Specify
- Additional Options: Grommet Options ([See Options and Locations](#)), Kneespace Options (Sold Separately, [See Unit Details](#))

Must Specify (in this order):

Model #
Top Material
Finish/Color
Drawer Pull
Worksurface Grommet Location
Grommet Color
Kneespace Options

Pricing Codes:
P = Laminate Top
W = Wood Top

[See Phoenix Intro Section for Ordering Options](#)

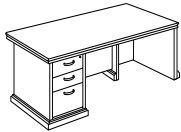
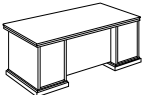
| Item | Model No. | Width | Depth | Height | K | R | Ship Wt | Cubic Ft | List Price | |
|--|-------------|--------------|-------|--------|----|--------|---------|----------|------------|----------------------|
|  <p>Shown as Left</p>  <p>Approach</p> | Left | Right | | | | | | | | |
| | 21-3672LP | 21-3672RP | 72 | 36 | 30 | 3 1/8" | 10 3/4" | 320 | 50.0 | P\$ 3624 W\$ 3959 |
| | 21-3072LP | 21-3072RP | 72 | 30 | 30 | 3 1/8" | 4 3/4" | 305 | 43.8 | P\$ 3539 W\$ 3897 |
| | 21-3066LP | 21-3066RP | 66 | 30 | 30 | 2 5/8" | 4 3/4" | 300 | 38.7 | P\$ 3454 W\$ 3836 |
| | 21-3060LP | 21-3060RP | 60 | 30 | 30 | 1 9/8" | 4 3/4" | 275 | 35.3 | P\$ 3393 W\$ 3751 |

Description

- Standard with: Rectangle Top, Stepped Front, Locking Letter Width Box/Box/File in Pedestal, Black Utility Tray Included in Box Drawer, Wire Management from Pedestal to Kneespace
- Available with Veneer (W) or HPL (P) Top, Must Specify
- 3/4" Overhang on Left, Right and User Sides
- Additional Options: Grommet Options ([See Options and Locations](#)), Kneespace Options (Sold Separately, [See Unit Details](#))

Must Specify (in this order):

- Model #
- Top Material
- Finish/Color
- Drawer Pull
- Worksurface Grommet Location
- Grommet Color
- Kneespace Options

| P-TOP | Left | Right | Width | Depth | Height | K | R | Ship Wt | Cubic Ft | List Price |
|--|-----------|-----------|-------|-------|--------|---|---|---------|----------|----------------------|
|  <p>Shown as Left</p> | 21-4272PL | 21-4272PR | 72 | 42-36 | 30 | - | - | 221 | 50.0 | P\$ 3231 W\$ 3300 |

Description

- Available with Veneer (W) or HPL (P) Top, Must Specify
- False Ped on Wing End
- Metal 4 1/2" Cylinder Base; Must Specify: Black or Aluminum
- Not Recommended for Freestanding Applications
- Additional Options: Modesty Panel (See Below), Grommet Options ([See Options and Locations](#)), Kneespace Options (Sold Separately, [See Unit Details](#))

Options: Specify & Add

| | | | |
|--------|-----------------------------|----|-----|
| 21-FMD | Optional Full Modesty Panel | \$ | 352 |
|--------|-----------------------------|----|-----|

Must Specify (in this order):

- Model #
- Top Material
- Finish/Color
- Modesty Panel
- Base Color
- Worksurface Grommet Location
- Grommet Color
- Kneespace Options

[See Phoenix Intro Section for Ordering Options](#)

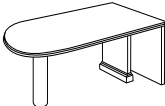
| Item | Model No. | Width | Depth | Height | K | R | Ship Wt | Cubic Ft | List Price | |
|---|-------------|-----------|--------------|--------|----|---|---------|----------|------------|----------------------|
|  | Left | | Right | | | | | | | |
| | 21-3672DL | 21-3672DR | 72 | 36 | 30 | - | - | 221 | 50.0 | P\$ 2710 W\$ 3042 |
| | 21-3072DL | 21-3072DR | 72 | 30 | 30 | - | - | 160 | 44.0 | P\$ 2575 W\$ 2888 |

Shown as Left

Must Specify (in this order):

- Model #
- Top Material
- Finish/Color
- Modesty Panel
- Leg Color
- Worksurface Grommet Location
- Grommet Color
- Kneespace Options

Description

- Available with Veneer (W) or HPL (P) Top, Must Specify
- False Ped on Wing End
- Metal 4 1/2" Cylinder Base; Must Specify: Black or Aluminum
- Not Recommended for Freestanding Applications
- Additional Options: Modesty Panel (See Below), Grommet Options ([See Options and Locations](#)), Kneespace Options (Sold Separately, [See Unit Details](#))

Options: Specify & Add

| | | |
|--------|-----------------------------|--------|
| 21-FMD | Optional Full Modesty Panel | \$ 352 |
|--------|-----------------------------|--------|

RETURN WITH FILE/FILE

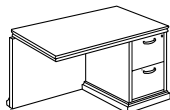

Shown as Right

Must Specify (in this order):

- Model #
- Top Material
- Finish/Color
- Drawer Pull
- Worksurface Grommet Location
- Back Panel Grommet
- Grommet Color
- Flush Edge
- Kneespace Options

| Left | Right | Width | Depth | Height | K | R | Ship Wt | Cubic Ft | List Price |
|------------|------------|-------|-------|--------|-----|---|---------|----------|----------------------|
| 21-2448LF2 | 21-2448RF2 | 48 | 24 | 30 | 31% | - | 151 | 23.1 | P\$ 2608 W\$ 2821 |
| 21-2442LF2 | 21-2442RF2 | 42 | 24 | 30 | 25% | - | 133 | 20.4 | P\$ 2562 W\$ 2742 |

Description

- Standard with: Letter Width Locking File/File Pedestal, Wire Management from Pedestal to Kneespace, Front to Back Grain Direction on Worksurface
- Available with Veneer (W) or HPL (P) Top, Must Specify
- Grommet in Back Panel; Must Specify: Black (BLK), Silver (SLV) or No Back Panel Grommet (NONE)
- Profiled on All Sides Standard; See Below for Optional Flush Feature
- Flush Feature Available; Must Specify: Flush Left (FL) or Flush Right (FR)
- Flush Option Reduces Unit by 3/4"
- Additional Options: Grommet Options ([See Options and Locations](#)), Kneespace Options (Sold Separately, [See Unit Details](#))

Pricing Codes:
P = Laminate Top
W = Wood Top

[See Phoenix Intro Section for Ordering Options](#)

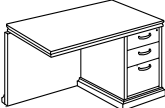
| Item | Model No. | Width | Depth | Height | K | R | Ship Wt | Cubic Ft | List Price | |
|---|---------------------------------|-------------|--------------|--------|----|------------------|---------|----------|------------|----------------------|
|  | RETURN WITH BOX/BOX/FILE | | | | | | | | | |
| | | Left | Right | | | | | | | |
| | 21-2448LF1 | 21-2448RF1 | 48 | 24 | 30 | 31 $\frac{3}{8}$ | - | 140 | 23.1 | P\$ 2608 W\$ 2821 |
| | 21-2442LF1 | 21-2442RF1 | 42 | 24 | 30 | 25 $\frac{3}{8}$ | - | 133 | 20.4 | P\$ 2562 W\$ 2742 |

Shown as Right

Must Specify (in this order):

Model #
Top Material
Finish/Color
Drawer Pull
Worksurface Grommet Location
Back Panel Grommet
Grommet Color
Flush Edge
Kneespace Options

Description

- Standard with: Letter Width Locking Box/Box/File Pedestal, Wire Management from Pedestal to Kneespace, Front to Back Grain Direction on Worksurface
- Available with Veneer (W) or HPL (P) Top, Must Specify
- Grommet in Back Panel; Must Specify: Black (BLK), Silver (SLV) or No Back Panel Grommet (NONE)
- Profiled on All Sides Standard; See Below for Optional Flush Feature
- Flush Feature Available; Must Specify: Flush Left (FL) or Flush Right (FR)
- Flush Option Reduces Unit by $\frac{3}{4}$ "
- Additional Options: Grommet Options ([See Options and Locations](#)), Kneespace Options (Sold Separately, [See Unit Details](#))

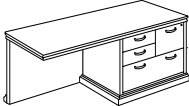
| Item | Model No. | Width | Depth | Height | K | R | Ship Wt | Cubic Ft | List Price | |
|---|---|-------------|--------------|--------|----|----|---------|----------|------------|----------------------|
|  | MULTI-RETURN PED WITH BOX/BOX/FILE/LATERAL | | | | | | | | | |
| | | Left | Right | | | | | | | |
| | 21-2472LMR | 21-2472RMR | 72 | 24 | 30 | 36 | - | 280 | 33.6 | P\$ 3671 W\$ 4065 |

Shown as Right

Must Specify (in this order):

Model #
Top Material
Finish/Color
Drawer Pull
Worksurface Grommet Location
Back Panel Grommet
Grommet Color
Flush Edge
Kneespace Options

Description

- Standard with: Box/Box/File/Lateral, Front to Back Grain Direction on Worksurface
- Available with Veneer (W) or HPL (P) Top, Must Specify
- Lateral File Provides Legal or Letter Filing Side to Side or Front to Back
- Single Lock Secures File and Lateral Drawers
- Grommet in Back Panel; Must Specify: Black (BLK), Silver (SLV) or No Back Panel Grommet (NONE)
- Profiled on All Sides Standard; See Below for Optional Flush Feature
- Flush Feature Available; Must Specify: Flush Left (FL) or Flush Right (FR)
- Flush Option Reduces Unit by $\frac{3}{4}$ "
- Additional Options: Grommet Options ([See Options and Locations](#)), Kneespace Options (Sold Separately, [See Unit Details](#))

[See Phoenix Intro Section for Ordering Options](#)

| Item | Model No. | Width | Depth | Height | K | R | Ship Wt | Cubic Ft | List Price |
|--------------------------|-----------|-------|-------|--------|----|---|---------|----------|----------------------|
| BRIDGE WITH FULL MODESTY | 21-2448UF | 48 | 24 | 30 | 48 | - | 78 | 5.3 | P\$ 1538 W\$ 1628 |
| | 21-2442UF | 42 | 24 | 30 | 42 | - | 68 | 4.7 | P\$ 1479 W\$ 1562 |

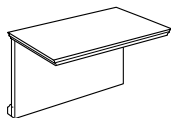

Must Specify (in this order):

Model #
Top Material
Finish/Color
Worksurface Grommet Location
Back Panel Grommet
Grommet Color

Description

- Standard with: Hinged Back Panel, Front to Back Grain Direction on Worksurface
- Available with Veneer (W) or HPL (P) Top, Must Specify
- Grommet in Back Panel; Must Specify: Black (BLK), Silver (SLV) or No Back Panel Grommet (NONE)
- Some Assembly Required
- Keyboard Accessories Cannot be Factory Installed but are Available for Field Installation (Sold Separately, [See Unit Details](#))
- Additional Options: Grommet Options ([See Options and Locations](#))

| | | | | | | | | | |
|--------------------------|------------|----|----|------------------|----|---|----|-----|----------------------|
| BRIDGE WITH HALF MODESTY | 21-2448UFH | 48 | 24 | 11½ ² | 48 | - | 82 | 5.3 | P\$ 1424 W\$ 1517 |
| | 21-2442UFH | 42 | 24 | 11½ ² | 42 | - | 62 | 4.7 | P\$ 1378 W\$ 1456 |

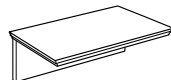

Must Specify (in this order):

Model #
Top Material
Finish/Color
Worksurface Grommet Location
Grommet Color

Description

- Standard with: 10" Hinged Back Panel, Front to Back Grain Direction on Worksurface
- Available with Veneer (W) or HPL (P) Top, Must Specify
- Some Assembly Required
- Keyboard Accessories Cannot be Factory Installed but are Available for Field Installation (Sold Separately, [See Unit Details](#))
- Additional Options: Grommet Options ([See Options and Locations](#))

| | | | | | | | | | |
|-------------|-----------|----|----|----|---------------------------------|---|-----|------|----------------------|
| CORNER UNIT | 21-4242CU | 42 | 42 | 30 | 25 ⁷ / ₁₆ | - | 145 | 34.5 | P\$ 2387 W\$ 2562 |
| | 21-3636CU | 36 | 36 | 30 | 17 | - | 135 | 25.7 | P\$ 2131 W\$ 2268 |

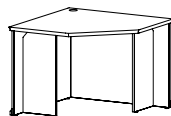

Must Specify (in this order):

Model #
Top Material
Finish/Color
Worksurface Grommet Color
Kneespace Options

Description

- Available with Veneer (W) or HPL (P) Top, Must Specify
- Freestanding Support Unit or Connects to 24" Deep Bridge and Return Units
- Surface Grommet in Top: Must Specify: Must Specify: Black (BLK) or Silver (SLV)
- Grain Direction Runs Front to Back on Veneer Worksurfaces
- Grain Direction Runs with the Long Edge on HPL Worksurface
- Keyboard Accessories for 21-4242CU Only: 01-KB2CC and 01-KB3 (Sold Separately, [See Unit Details](#))

Pricing Codes:
P = Laminate Top
W = Wood Top

[See Phoenix Intro Section for Ordering Options](#)

| Item | Model No. | Width | Depth | Height | K | R | Ship Wt | Cubic Ft | List Price | |
|---|-----------------|------------------|-------|---------------------------------|----|--------------------------------|---------|----------|------------|----------------------|
| CREDENZA WITH FILE/FILE  | Left Ped | Right Ped | | | | | | | | |
| | 21-2072LC2 | 21-2072RC2 | 72 | 20 ⁷ / ₁₆ | 30 | 31 ³ / ₈ | - | 235 | 29.0 | P\$ 2993 W\$ 3378 |
| | 21-2066LC2 | 21-2066RC2 | 66 | 20 ⁷ / ₁₆ | 30 | 25 ³ / ₈ | - | 225 | 26.6 | P\$ 2880 W\$ 3267 |

Shown as Right

Must Specify (in this order):

Model #
 Top Material
 Finish/Color
 Drawer Pull
 Worksurface Grommet Location
 Back Panel Grommet
 Grommet Color
 Flush Edge

Description

- Standard with: Letter Width Locking File/File Pedestal, Left to Right Grain Direction on Worksurface
- Available with Veneer (W) or HPL (P) Top, Must Specify
- Grommet in Back Panel; Must Specify: Black (BLK), Silver (SLV) or No Back Panel Grommet (NONE)
- Profiles on Three (3) Sides for Flush Wall Application Standard
- Flush Feature Available; Must Specify: Flush Left (FL), Flush Right (FR) or Flush Left and Right (FLR)
- Flush Option Reduces Unit by 3/4" Per Side and 1 1/2" for Both Flush Sides
- Additional Options: Grommet Options ([See Options and Locations](#)), Kneespace Options (Sold Separately, [See Unit Details](#))

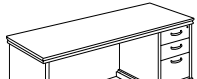
| Item | Model No. | Width | Depth | Height | K | R | Ship Wt | Cubic Ft | List Price | |
|--|-----------------|------------------|-------|---------------------------------|----|--------------------------------|---------|----------|------------|----------------------|
| CREDENZA WITH BOX/BOX/FILE  | Left Ped | Right Ped | | | | | | | | |
| | 21-2072LC1 | 21-2072RC1 | 72 | 20 ⁷ / ₁₆ | 30 | 31 ³ / ₈ | - | 235 | 29.0 | P\$ 2993 W\$ 3378 |
| | 21-2066LC1 | 21-2066RC1 | 66 | 20 ⁷ / ₁₆ | 30 | 25 ³ / ₈ | - | 225 | 26.6 | P\$ 2880 W\$ 3267 |

Shown as Right

Must Specify (in this order):

Model #
 Top Material
 Finish/Color
 Drawer Pull
 Worksurface Grommet Location
 Back Panel Grommet
 Grommet Color
 Flush Edge

Description

- Standard with: Letter Width Locking Box/Box/File Pedestal, Left to Right Grain Direction on Worksurface
- Available with Veneer (W) or HPL (P) Top, Must Specify
- Grommet in Back Panel; Must Specify: Black (BLK), Silver (SLV) or No Back Panel Grommet (NONE)
- Profiles on Three (3) Sides for Flush Wall Application Standard
- Flush Feature Available; Must Specify: Flush Left (FL), Flush Right (FR) or Flush Left and Right (FLR)
- Flush Option Reduces Unit by 3/4" Per Side and 1 1/2" for Both Flush Sides
- Additional Options: Grommet Options ([See Options and Locations](#)), Kneespace Options (Sold Separately, [See Unit Details](#))

[See Phoenix Intro Section for Ordering Options](#)

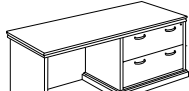
| Item | Model No. | Width | Depth | Height | K | R | Ship Wt | Cubic Ft | List Price | |
|---|-----------------|------------------|-------|---------------------------------|----|--------------------------------|---------|----------|------------|----------------------|
| CREDENZA WITH LATERAL/LATERAL  | Left Ped | Right Ped | | | | | | | | |
| | 21-2072LL | 21-2072RL | 72 | 20 ⁷ / ₁₆ | 30 | 31 ³ / ₈ | - | 255 | 29.0 | P\$ 3262 W\$ 3650 |
| | 21-2066LL | 21-2066RL | 66 | 20 ⁷ / ₁₆ | 30 | 25 ³ / ₈ | - | 220 | 26.6 | P\$ 3063 W\$ 3452 |

Shown as Right

Must Specify (in this order):

Model #
 Top Material
 Finish/Color
 Drawer Pull
 Worksurface Grommet Location
 Back Panel Grommet
 Grommet Color
 Flush Edge

Description

- Standard with: Two (2) Locking Lateral File Drawers, Left to Right Grain Direction on Worksurface
- Available with Veneer (W) or HPL (P) Top, Must Specify
- Grommet in Back Panel; Must Specify: Black (BLK), Silver (SLV) or No Back Panel Grommet (NONE)
- Profiles on Three (3) Sides for Flush Wall Application Standard
- Flush Feature Available; Must Specify: Flush Left (FL), Flush Right (FR) or Flush Left and Right (FLR)
- Flush Option Reduces Unit by 3/4" Per Side and 1 1/2" for Both Flush Sides
- Additional Options: Grommet Options ([See Options and Locations](#)), Kneespace Options (Sold Separately, [See Unit Details](#))

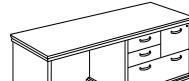
| Item | Model No. | Width | Depth | Height | K | R | Ship Wt | Cubic Ft | List Price | |
|--|-------------|--------------|-------|---------------------------------|----|----|---------|----------|------------|----------------------|
| CREDENZA WITH BOX/BOX/FILE/LATERAL  | Left | Right | | | | | | | | |
| | 21-2072LMF | 21-2072RMF | 72 | 20 ⁷ / ₁₆ | 30 | 12 | - | 255 | 29.0 | P\$ 3633 W\$ 4019 |
| | 21-2066LMF | 21-2066RMF | 66 | 20 ⁷ / ₁₆ | 30 | 6 | - | 220 | 26.6 | P\$ 3526 W\$ 3915 |

Shown as Right

Must Specify (in this order):

Model #
 Top Material
 Finish/Color
 Drawer Pull
 Worksurface Grommet Location
 Back Panel Grommet
 Grommet Color
 Flush Edge

Description

- Standard with: Box/Box/File/Lateral, Lateral File Provides Legal or Letter Filing Side to Side or Front to Back, Left to Right Grain Direction on Worksurface
- Locking File Drawer
- Available with Veneer (W) or HPL (P) Top, Must Specify
- Grommet in Back Panel; Must Specify: Black (BLK), Silver (SLV) or No Back Panel Grommet (NONE)
- Flush Feature Available; Must Specify: Flush Left (FL), Flush Right (FR) or Flush Left and Right (FLR)
- Flush Option Reduces Unit by 3/4" Per Side and 1 1/2" for Both Flush Sides
- Additional Options: Grommet Options ([See Options and Locations](#)), Kneespace Options (Sold Separately, [See Unit Details](#))

Pricing Codes:
 P = Laminate Top
 W = Wood Top

[See Phoenix Intro Section for Ordering Options](#)

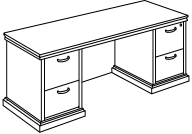
| Item | Model No. | Width | Depth | Height | K | R | Ship Wt | Cubic Ft | List Price |
|---|-----------|-------|---------------------------------|--------|--------------------------------|---|---------|----------|----------------------|
|  | 21-2072KC | 72 | 20 ⁷ / ₁₆ | 30 | 38 ³ / ₄ | - | 300 | 29.0 | P\$ 3763 W\$ 4147 |
| | 21-2066KC | 66 | 20 ⁷ / ₁₆ | 30 | 32 ³ / ₄ | - | 285 | 26.6 | P\$ 3637 W\$ 4023 |

Description

- Letter Width Locking File/File Pedestal
- Available with Veneer (W) or HPL (P) Top, Must Specify
- Grommet in Back Panel; Must Specify: Black (BLK), Silver (SLV) or No Back Panel Grommet (NONE)
- Profiles on Three (3) Sides for Flush Wall Application Standard
- Flush Feature Available; Must Specify: Flush Left (FL), Flush Right (FR) or Flush Left and Right (FLR)
- Flush Option Reduces Unit by ³/₄" Per Side and 1¹/₂" for Both Flush Sides
- Additional Options: Grommet Options ([See Options and Locations](#)), Kneespace Options (Sold Separately, [See Unit Details](#))

Must Specify (in this order):

Model #
Top Material
Finish/Color
Drawer Pull
Worksurface Grommet Location
Back Panel Grommet
Grommet Color
Flush Edge

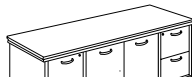
| | | | | | | | | | |
|---|-----------|----|---------------------------------|----|---|---|-----|------|----------------------|
|  | 21-2072SC | 72 | 20 ⁷ / ₁₆ | 30 | - | - | 349 | 29.0 | P\$ 4360 W\$ 4754 |
| | 21-2066SC | 66 | 20 ⁷ / ₁₆ | 30 | - | - | 320 | 26.6 | P\$ 4206 W\$ 4589 |

Description

- Letter Width Locking File/File Pedestals
- Available with Veneer (W) or HPL (P) Top, Must Specify
- Fixed Storage Shelf Behind Doors
- Profiles on Three (3) Sides for Flush Wall Application Standard
- Flush Feature Available; Must Specify: Flush Left (FL), Flush Right (FR) or Flush Left and Right (FLR)
- Flush Option Reduces Unit by ³/₄" Per Side and 1¹/₂" for Both Flush Sides

Must Specify (in this order):

Model #
Top Material
Finish/Color
Drawer Pull
Flush Edge

[See Phoenix Intro Section for Ordering Options](#)

| Item | Model No. | Width | Depth | Height | Ship Wt | Cubic Ft | List Price |
|---|-------------------------------|-------|---------------------------------|--------|---------|----------|----------------------|
|  | 21-2036L4 Four (4) Drawers | 36 | 20 ⁷ / ₁₆ | 55 | 260 | 27.5 | P\$ 4178 W\$ 4397 |
| | 21-2030L4 Four (4) Drawers | 30 | 20 ⁷ / ₁₆ | 55 | 230 | 24.5 | P\$ 3864 W\$ 4065 |
| | 21-2036L2 Two (2) Drawers | 36 | 20 ⁷ / ₁₆ | 30 | 185 | 14.9 | P\$ 2802 W\$ 3015 |
| | 21-2030L2 Two (2) Drawers | 30 | 20 ⁷ / ₁₆ | 30 | 175 | 13.1 | P\$ 2592 W\$ 2788 |

Description

- Central Locking Drawers Provide Legal or Letter Filing Front to Back or Side to Side
- Available with Veneer (W) or HPL (P) Top, Must Specify
- Anti-Tilt Mechanism
- ¼" Thick Drawer Bottoms for Added Support
- Profiles on Three (3) Sides for Flush Wall Application Standard
- Flush Feature Available; Must Specify: Flush Left (FL), Flush Right (FR) or Flush on Both Sides (FLR)
- Flush Option Reduces Unit by ¾" Per Side and 1½" if Both Sides Are Selected to be Flush

Must Specify (in this order):

Model #
Top Material
Finish/Color
Drawer Pull
Flush Edge

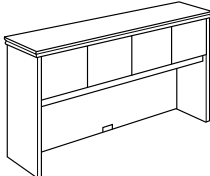
| Item | Model No. | Doors | Width | Depth | Height | Ship Wt | Cubic Ft | List Price |
|---|-----------|----------------|-------|--------------------------------|---------------------------------|---------|----------|------------|
|  | 21-1684HU | Five (5) Doors | 84 | 15 ³ / ₄ | 40 ⁷ / ₁₆ | 268 | 40.0 | \$ 3801 |
| | 21-1678HU | Four (4) Doors | 78 | 15 ³ / ₄ | 40 ⁷ / ₁₆ | 258 | 36.7 | \$ 3451 |
| | 21-1672HU | Four (4) Doors | 72 | 15 ³ / ₄ | 40 ⁷ / ₁₆ | 258 | 30.7 | \$ 3060 |
| | 21-1666HU | Four (4) Doors | 66 | 15 ³ / ₄ | 40 ⁷ / ₁₆ | 235 | 28.1 | \$ 3020 |

Description

- Standard with: Soft-Close Hinged Doors, Vertical Grain Direction
- 23¾" Clearance Below Doors
- Top Profiled on Three (3) Sides for Flush Wall Application Standard
- Lower, Center Grommet on Back Panel Standard; Must Specify: Black (BLK) or Silver (SLV)
- Flush Feature Available; Must Specify: Flush Left (FL), Flush Right (FR) or Flush on Both Sides (FLR)
- Flush Option Reduces Unit by ¾" Per Side and 1½" if Both Sides Are Selected to be Flush
- Additional Options: Locking Doors ([See Locking Options](#)), Factory-Installed Tackboard ([See Tackboards](#)), Tasklights ([See Tasklights](#)), Glass Marker Boards ([See Marker Board Sizes](#)), Three (3) Upper Wire Management Grommets ([See Grommet Options](#))

Must Specify (in this order):

Model #
Finish
Tackboard
Tackboard Fabric
Tasklight
Grommet Color
Locking Doors
Lock Core Color
Flush Edge

Pricing Codes:
P = Laminate Top
W = Wood Top

[See Phoenix Intro Section for Ordering Options](#)

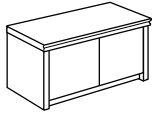
| Item | Model No. | | Width | Depth | Height | Ship Wt | Cubic Ft | List Price |
|---|-----------|-----------------|-------|-------|-------------------|---------|----------|------------|
|  | 21-1682WD | Five (5) Doors | 82 | 15¾ | 17½ ₃₂ | 138 | 15.5 | \$ 3486 |
| | 21-1676WD | Four (4) Doors | 76 | 15¾ | 17½ ₃₂ | 128 | 14.1 | \$ 3026 |
| | 21-1670WD | Four (4) Doors | 70 | 15¾ | 17½ ₃₂ | 118 | 13.1 | \$ 2980 |
| | 21-1664WD | Four (4) Doors | 66 | 15¾ | 17½ ₃₂ | 105 | 12.0 | \$ 2887 |
| | 21-1658WD | Four (4) Doors | 58 | 15¾ | 17½ ₃₂ | 96 | 11.0 | \$ 2835 |
| | 21-1652WD | Three (3) Doors | 52 | 15¾ | 17½ ₃₂ | 87 | 9.9 | \$ 2640 |
| | 21-1646WD | Three (3) Doors | 46 | 15¾ | 17½ ₃₂ | 77 | 8.9 | \$ 2525 |
| | 21-1640WD | Two (2) Doors | 40 | 15¾ | 17½ ₃₂ | 67 | 7.8 | \$ 2401 |
| | 21-1634WD | Two (2) Doors | 34 | 15¾ | 17½ ₃₂ | 58 | 6.7 | \$ 2263 |
| | 21-1628WD | Two (2) Doors | 28 | 15¾ | 17½ ₃₂ | 48 | 5.6 | \$ 2098 |

Must Specify (in this order):

Model #
Finish
Locking Doors
Lock Core Color

Description

- Standard with: Soft-Close Hinged Doors, Vertical Grain Direction
- Top Profiled on Front Standard for Flush Side and Wall Applications
- Mounts to Wall with Mounting Bracket Included
- Indiana Furniture Will Not Be Liable for Wall Mounted Hutches That Are Not Properly Installed
- Additional Options: Locking Doors ([See Locking Options](#)), Tackboards ([See Tackboards](#)), Tasklights ([See Tasklights](#)), Glass Marker Boards ([See Marker Board Sizes](#))

SURFACE MOUNT BOOKCASE

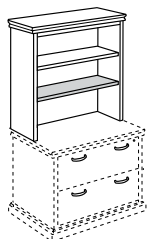

| | | | | | | |
|-----------|----|------|--------|-----|------|---------|
| 21-1636TU | 36 | 15 ¾ | 40 7/8 | 125 | 15.8 | \$ 1798 |
| 21-1630TU | 30 | 15 ¾ | 40 7/8 | 98 | 15.8 | \$ 1619 |

Description

- 1" Thick Shelves; One (1) Adjustable and One (1) Fixed Shaded
- 12" Clearance Below Fixed Shelf
- For Surface Mount Use on Two (2) Drawer Lateral File or Credenza Against a Wall
- Top Profiled on Three (3) Sides for Flush Wall Application Standard
- Flush Feature Available; Must Specify: Flush Left (FL), Flush Right (FR) or Flush on Both Sides (FLR)
- Flush Option Reduces Unit by ¾" Per Side and 1 ½" if Both Sides Are Selected to be Flush

Must Specify (in this order):

Model #
Finish
Flush Edge

[See Phoenix Intro Section for Ordering Options](#)

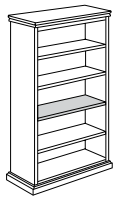
| Item | Model No. | Width | Depth | Height | Ship Wt | Cubic Ft | List Price |
|---|---|-------|-------|--------|---------|----------|----------------------|
|  | 21-3672BC Three (3) Adjustable and One (1) Fixed Shelf | 36 | 15¾ | 70⅞ | 205 | 36.5 | W\$ 2759 |
| | 21-3648BC Two (2) Adjustable Shelves, No Fixed Shelf | 36 | 15¾ | 48⅜½ | 104 | 19.9 | P\$ 2071 W\$ 2176 |
| | 21-3630BC One (1) Adjustable Shelf, No Fixed Shelf | 36 | 15¾ | 30 | 85 | 11.1 | P\$ 1862 W\$ 1970 |
| | 21-3072BC Three (3) Adjustable and One (1) Fixed Shelf | 30 | 15¾ | 70⅞ | 190 | 30.0 | W\$ 2237 |
| | 21-3048BC Two (2) Adjustable Shelves, No Fixed Shelf | 30 | 15¾ | 48⅜½ | 94 | 19.9 | P\$ 1679 W\$ 1764 |
| | 21-3030BC One (1) Adjustable Shelf, No Fixed Shelf | 30 | 15¾ | 30 | 85 | 11.1 | P\$ 1508 W\$ 1597 |

Must Specify (in this order):

Model #
Top Material (48"H & 30"H Only)
Edge Profile (48"H & 30"H Only)
Finish/Color
Flush Edge

Description

- Fixed Shelf Shaded
- 48"H and 30"H Available with Veneer (W) or HPL (P) Top, Must Specify Material and Edge Profile
- Profiled on Three (3) Sides for Flush Wall Application Standard
- Flush Feature Available; Must Specify: Flush Left (FL), Flush Right (FR) or Flush on Both Sides (FLR)
- Flush Option Reduces Unit by ¾" Per Side and 1 ½" if Both Sides Are Selected to be Flush

| DOUBLE WARDROBE/STORAGE | Model No. | Width | Depth | Height | Ship Wt | Cubic Ft | List Price |
|--|-----------|-------|-------|--------|---------|----------|------------|
|  | 21-3672WC | 36 | 20⅞ | 70⅞ | 290 | 42.0 | \$ 4139 |
| | 21-3072WC | 30 | 20⅞ | 70⅞ | 240 | 35.7 | \$ 4030 |

Must Specify (in this order):

Model #
Finish
Pull
Locking Doors
Flush Edge

Description

- Fixed Top Shelf Behind Each Door
- Three (3) Adjustable Shelves on Left Side; Coat Rod Under Fixed Shelf on Right Side
- Profiled on Three (3) Sides for Flush Wall Applications Standard
- Flush Feature Available; Must Specify: Flush Left (FL), Flush Right (FR) or Flush on Both Sides (FLR)
- Flush Option Reduces Unit by ¾" Per Side and 1 ½" if Both Sides Are Selected to be Flush
- Optional Locking Doors ([See Locking Options](#)), Lock Core will Coordinate with Pull Color

| WARDROBE/STORAGE CABINET | Left | Right | Width | Depth | Height | Ship Wt | Cubic Ft | List Price |
|---|-----------|-----------|-------|-------|--------|---------|----------|------------|
|  | 21-1872WL | 21-1872WR | 18 | 20⅞ | 70⅞ | 152 | 19.2 | \$ 2981 |

Shown as Right

Must Specify (in this order):

Model #
Finish
Pull
Locking Doors
Flush Edge

Description

- Coat Rod Under Top Fixed Shelf
- Three (3) Adjustable Shelves; Adjustable Shelves can be Removed for Wardrobe Application
- Profiles on Three (3) Sides for Flush Wall Application Standard
- Pull Installed Vertically; Capsule Pull will be Substituted for Elite, Buckle, and Flair Pulls
- Flush Feature Available; Must Specify: Flush Left (FL), Flush Right (FR) or Flush on Both Sides (FLR)
- Flush Option Reduces Unit by ¾" Per Side and 1 ½" if Both Sides Are Selected to be Flush
- Optional Locking Doors ([See Locking Options](#)), Lock Core will Coordinate with Pull Color

Pricing Codes:
P = Laminate Top
W = Wood Top

[See Phoenix Intro Section for Ordering Options](#)

| Item | Model No. | Width | Depth | Height | Ship Wt | Cubic Ft | List Price |
|-----------|-----------|-------|-------|--------|---------|----------|--------------------|
| END TABLE | 21-1824ET | 18 | 24 | 22 | 25 | 2.0 | P\$ 928 W\$ 980 |

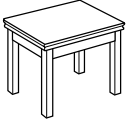

Must Specify (in this order):

Model #
Top Material
Finish/Color

Description

- Available with Veneer (W) or HPL (P) Top, Must Specify
- Apron Rails and Panel Legs Feature Multi-Step, Hand-Finished Catalyzed Finish
- Some Assembly Required

| | | | | | | | |
|----------------|-----------|----|----|----|----|-----|----------------------|
| MAGAZINE TABLE | 21-1847MT | 47 | 18 | 16 | 42 | 3.4 | P\$ 1210 W\$ 1322 |
|----------------|-----------|----|----|----|----|-----|----------------------|

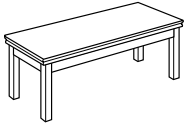

Must Specify (in this order):

Model #
Top Material
Finish/Color
Leg Option

Description

- Available with Veneer (W) or HPL (P) Top, Must Specify
- Apron Rails and Panel Legs Feature Multi-Step, Hand-Finished Catalyzed Finish
- Some Assembly Required
- Optional 30" Leg; See Below

Options: Specify & Add

| | | | | |
|---------|--------------------|----|-----|--------|
| 30H-2SQ | Optional 30"H Legs | 20 | 0.9 | \$ 223 |
|---------|--------------------|----|-----|--------|

[See Phoenix Intro Section for Ordering Options](#)

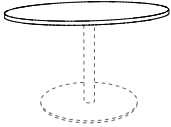
| Item | Model No. | | Width | Depth | Height | Ship Wt | Cubic Ft | List Price |
|---|-----------|--|-------|-------|--------|---------|----------|----------------------|
|  | 21-4848CT | <i>Accommodates Five (5) Chairs</i> | 48 | 48 | 30 | 60 | 5.7 | P\$ 1587 W\$ 2048 |
| | 21-4242CT | <i>Accommodates Four (4) Chairs</i> | 42 | 42 | 30 | 40 | 4.4 | P\$ 1471 W\$ 1891 |
| | 21-3636CT | <i>Accommodates Three (3) to Four (4) Chairs</i> | 36 | 36 | 30 | 35 | 3.4 | P\$ 1363 W\$ 1735 |

21-4242CT shown with 01-2430DBA
(Disc Base)
BASES SOLD SEPARATELY

Must Specify (in this order):

Model #
Top Material
Finish/Color
Edge Profile

Description

- Available with Premium/Standard Veneer (PV/W) or HPL (P) Top, Must Specify
- Single Base Required; Ordered Separately, [See Details](#)
- Power Options not Available

RECTANGULAR TOP

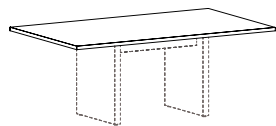

21-3672RT shown with 88-2034RPB
(Rectangle Panel Base)
BASES SOLD SEPARATELY

| 144" or 12' - 2 Piece Tops | | | | | | | | |
|----------------------------|--|--|-----|----|-----------------|-----|------|----------------------|
| 21-48144RT | | | 144 | 48 | 1 $\frac{1}{6}$ | 275 | 12.3 | P\$ 4423 W\$ 4724 |
| 120" or 10' - 2 Piece Tops | | | | | | | | |
| 21-48120RT | | | 120 | 48 | 1 $\frac{1}{6}$ | 225 | 10.3 | P\$ 4043 W\$ 4270 |
| 96" or 8' - 1 Piece Top | | | | | | | | |
| 21-4896RT | | | 96 | 48 | 1 $\frac{1}{6}$ | 180 | 9.4 | P\$ 2564 W\$ 2805 |
| 72" or 6' - 1 Piece Top | | | | | | | | |
| 21-3672RT | | | 72 | 36 | 1 $\frac{1}{6}$ | 100 | 6.2 | P\$ 1679 W\$ 1778 |

Description

- Grain Runs the Width of the Table
- Available with Veneer (PV/W) or HPL (P) Top; Must Specify
- Heavy-Duty Ganging Mechanisms Connect Two (2) Piece Tops
- See Bases/Legs and Number Required For Each Top Size, [See Multiple Base Options](#); Must Order Separately
- Optional Grommets and Power/Data Units; [See Location Options](#), [See Power Units Available](#)

Pricing Codes:
P = Laminate Top
W = Wood Top

[See Phoenix Intro Section for Ordering Options](#)

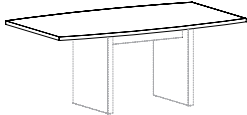
| Item | Model No. | Width | Depth | Height | Ship Wt | Cubic Ft | List Price |
|---|-----------------------------------|-------|-------|------------------|---------|----------|----------------------|
|  <p>21-3672BT shown with 88-2034RPB (Rectangle Panel Base) BASES SOLD SEPARATELY</p> | 144" or 12' - 2 Piece Tops | | | | | | |
| | 21-48144BT | 144 | 48 | 1 $\frac{3}{16}$ | 275 | 12.3 | P\$ 5141 W\$ 5533 |
| | 120" or 10' - 2 Piece Tops | | | | | | |
| | 21-48120BT | 120 | 48 | 1 $\frac{3}{16}$ | 225 | 10.3 | P\$ 4680 W\$ 4986 |
| | 96" or 8' - 1 Piece Top | | | | | | |
| | 21-4896BT | 96 | 48 | 1 $\frac{3}{16}$ | 180 | 9.4 | P\$ 3737 W\$ 4041 |
| | 72" or 6' - 1 Piece Top | | | | | | |
| | 21-3672BT | 72 | 36 | 1 $\frac{3}{16}$ | 100 | 6.2 | P\$ 2279 W\$ 2357 |

Description

- Grain Runs the Width of the Table
- Available with Veneer (PV/W) or HPL (P) Top; Must Specify
- Heavy-Duty Ganging Mechanisms Connect Two (2) Piece Tops
- See Bases/Legs and Number Required For Each Top Size, See Below for Multiple Base Options; Must Order Separately
- Optional Grommets and Power/Data Units; [See Location Options](#), [See Power Units Available](#)

RECTANGLE PANEL BASES WITH TROUGH

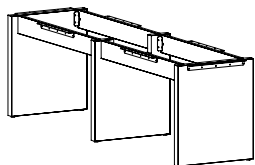

| Three (3) Panel Bases - For Use With 48" x 144" Surfaces | | | | | | | |
|---|----------|----|-----|------------------|-----|------|----------------------|
| 88-24106RPB | Laminate | 24 | 106 | 28 $\frac{3}{4}$ | 116 | 13.8 | T\$ 3000 W\$ 3059 |
| | Veneer | | | | | | |
| Two (2) Panel Bases - For Use With 48" x 120" Surfaces | | | | | | | |
| 88-2482RPB | Laminate | 24 | 82 | 28 $\frac{3}{4}$ | 90 | 6.9 | T\$ 2150 W\$ 2201 |
| | Veneer | | | | | | |
| Two (2) Panel Bases - For Use With 48" x 96" Surfaces | | | | | | | |
| 88-2458RPB | Laminate | 24 | 58 | 28 $\frac{3}{4}$ | 84 | 6.9 | T\$ 1880 W\$ 1954 |
| | Veneer | | | | | | |
| Two (2) Panel Bases - For Use With 36" x 72" Surfaces | | | | | | | |
| 88-2034RPB | Laminate | 20 | 34 | 28 $\frac{3}{4}$ | 66 | 6.7 | T\$ 1575 W\$ 1742 |
| | Veneer | | | | | | |

Must Specify (in this order):

- Model #
- Material
- Finish / Color

Description

- 2" Panel Bases with Trough, Stretcher Rails, and L-Bracket Hardware Included
- Available with TFL (T) or Veneer (W)
- Vertical Grain Direction on Bases
- Bases Require Some Assembly; Attachment Hardware Included
- Tops Sold Separately

[See Phoenix Intro Section for Ordering Options](#)

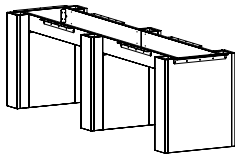
| Item | Model No. | | Width | Depth | Height | Ship Wt | Cubic Ft | List Price |
|--|--|----------|-------|-------|--------|---------|----------|------------|
| 6" RECTANGLE BASES WITH TROUGH AND REMOVABLE PANEL  | Three (3) 6" Rectangle Bases - For Use With 48" x 144" Surfaces | | | | | | | |
| | 88-2410606RB | Laminate | 24 | 106 | 28¾ | 106 | 19.6 | T\$ 4720 |
| | | Veneer | | | | | | W\$ 6457 |
| | Two (2) 6" Rectangle Bases - For Use With 48" x 120" Surfaces | | | | | | | |
| | 88-248206RB | Laminate | 24 | 82 | 28¾ | 99 | 12.9 | T\$ 3219 |
| | | Veneer | | | | | | W\$ 4449 |
| | Two (2) 6" Rectangle Bases - For Use With 48" x 96" Surfaces | | | | | | | |
| | 88-245806RB | Laminate | 24 | 58 | 28¾ | 93 | 12.9 | T\$ 3023 |
| | | Veneer | | | | | | W\$ 4128 |
| | Two (2) 6" Rectangle Bases - For Use With 36" x 72" Surfaces | | | | | | | |
| | 88-203406RB | Laminate | 20 | 34 | 28¾ | 76 | 12.9 | T\$ 2777 |
| | | Veneer | | | | | | W\$ 3820 |

Must Specify (in this order):

- Model #
- Material
- Finish / Color

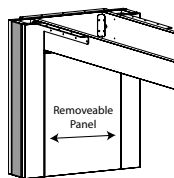

Description

- 6" Rectangle Bases with Trough and Stretcher Rails
- Available with TFL (T) or Veneer (W)
- 5/16" Metal Accent Available in Four (4) Colors: Aluminum, Black, Gold, and Platinum; Must Specify Color
- Vertical Grain Direction on Bases
- Bases Include Interior Removable Panel for Wire Management Access. Removable Panel is 15 7/8"W for 24" Bases and 11 7/8"W for 20" Bases
- Removable Panels Attached with Z Brackets
- Bases Require Some Assembly; Attachment Hardware Included
- Tops Sold Separately

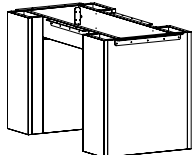
| | | | | | | | | |
|---|---|----------|----|-----|-----|-----|------|----------|
| 10" RECTANGLE BASES WITH TROUGH AND REMOVABLE PANEL  | Three (3) 10" Rectangle Bases - For Use With 48" x 144" Surfaces | | | | | | | |
| | 88-2410610RB | Laminate | 24 | 106 | 28¾ | 141 | 18.2 | T\$ 4841 |
| | | Veneer | | | | | | W\$ 6551 |
| | Two (2) 10" Rectangle Bases - For Use With 48" x 120" Surfaces | | | | | | | |
| | 88-248210RB | Laminate | 24 | 82 | 28¾ | 96 | 12.0 | T\$ 3300 |
| | | Veneer | | | | | | W\$ 4512 |
| | Two (2) 10" Rectangle Bases - For Use With 48" x 96" Surfaces | | | | | | | |
| | 88-245810RB | Laminate | 24 | 58 | 28¾ | 89 | 12.0 | T\$ 3104 |
| | | Veneer | | | | | | W\$ 4190 |
| | Two (2) 10" Rectangle Bases - For Use With 36" x 72" Surfaces | | | | | | | |
| | 88-203410RB | Laminate | 20 | 34 | 28¾ | 72 | 10.0 | T\$ 2857 |
| | | Veneer | | | | | | W\$ 3882 |

Must Specify (in this order):

- Model #
- Material
- Finish / Color

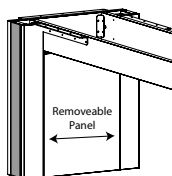

Description

- 6" Rectangle Bases with Trough and Stretcher Rails
- Available with TFL (T) or Veneer (W)
- 5/16" Metal Accent Available in Four (4) Colors: Aluminum, Black, Gold, and Platinum; Must Specify Color
- Vertical Grain Direction on Bases
- Bases Include Interior Removable Panel for Wire Management Access. Removable Panel is 15 7/8"W for 24" Bases and 11 7/8"W for 20" Bases
- Removable Panels Attached with Z Brackets
- Bases Require Some Assembly; Attachment Hardware Included
- Tops Sold Separately

Pricing Codes:
P = Laminate Top
W = Wood Top

[See Phoenix Intro Section for Ordering Options](#)

| Item | Model No. | | Width | Depth | Height | Ship Wt | Cubic Ft | List Price |
|--|---|----------|-------|-------|--------|---------|----------|------------|
| 6" + 10" COMBO RECTANGLE BASES WITH TROUGH AND REMOVABLE PANEL | Three (3) Bases Total: Two (2) 6" and One (1) 10" Rectangle Bases - For Use With 60" / 54" / 48" x 144" Surfaces | | | | | | | |
| | 88-24106C610RB | Laminate | 24 | 106 | 28¾ | 141 | 18.2 | T\$ 4760 |
| | | Veneer | | | | | | W\$ 6488 |

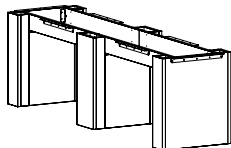

Must Specify (in this order):

- Model #
- Material
- Finish / Color

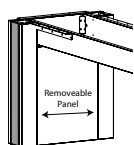

Description

- 6" + 10" Rectangle Bases with Trough and Stretcher Rails; 6" Bases on Exterior and 10" Bases on Interior
- Available with TFL (T) or Veneer (W)
- Vertical Grain Direction on Bases
- Bases Include Interior Removable Panel for Wire Management. Removable Panel is 15⅞"W and Attaches with Z Brackets.
- Bases Require Some Assembly; Attachment Hardware Included
- Tops Sold Separately

6" RECTANGLE ACCENT BASES WITH TROUGH AND REMOVABLE PANEL

| | | | | | | | | |
|---|--|----------|----|-----|-----|-----|------|----------|
| 6" RECTANGLE ACCENT BASES WITH TROUGH AND REMOVABLE PANEL | Three (3) 6" Rectangle Bases - For Use With 48" x 144" Surfaces | | | | | | | |
| | 88-2410606RAB | Laminate | 24 | 106 | 28¾ | 106 | 19.6 | T\$ 5394 |
| | | Veneer | | | | | | W\$ 7174 |
| | Two (2) 6" Rectangle Bases - For Use With 48" x 120" Surfaces | | | | | | | |
| | 88-248206RAB | Laminate | 24 | 82 | 28¾ | 99 | 12.9 | T\$ 4745 |
| | | Veneer | | | | | | W\$ 6436 |
| | Two (2) 6" Rectangle Bases - For Use With 48" x 96" Surfaces | | | | | | | |
| | 88-245806RAB | Laminate | 24 | 58 | 28¾ | 93 | 12.9 | T\$ 3480 |
| | | Veneer | | | | | | W\$ 4610 |
| | Two (2) 6" Rectangle Bases - For Use With 36" x 72" Surfaces | | | | | | | |
| | 88-203406RAB | Laminate | 20 | 34 | 28¾ | 76 | 12.9 | T\$ 3232 |
| | | Veneer | | | | | | W\$ 4302 |

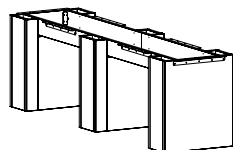

Must Specify (in this order):

- Model #
- Base Finish/Color
- Metal Accent Color
- Accent Panel Finish/Color

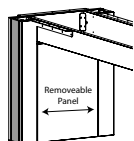

Description

- 6" Rectangle Bases with Trough and Stretcher Rails
- Available with TFL (T) or Veneer (W)
- ⅝" Metal Accent Available in Four (4) Colors: Aluminum, Black, Gold, and Platinum; Must Specify Color
- Vertical Grain Direction on Bases
- Bases Include Interior Removable Panel for Wire Management Access. Removable Panel is 15⅞"W for 24" Bases and 11⅞"W for 20" Bases
- Removable Panels Attached with Z Brackets
- Bases Require Some Assembly; Attachment Hardware Included
- Tops Sold Separately

[See Phoenix Intro Section for Ordering Options](#)

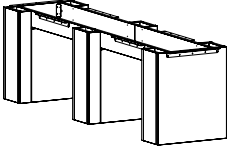
| Item | Model No. | | Width | Depth | Height | Ship Wt | Cubic Ft | List Price |
|--|---|----------|-------|-------|--------|---------|----------|------------|
| 10" RECTANGLE ACCENT BASES WITH TROUGH AND REMOVABLE PANEL  | Three (3) 10" Rectangle Bases - For Use With 48" x 144" Surfaces | | | | | | | |
| | 88-241061ORAB | Laminate | 24 | 106 | 28¾ | 141 | 18.2 | T\$ 5462 |
| | | Veneer | | | | | | W\$ 7258 |
| | Two (2) 10" Rectangle Bases - For Use With 48" x 120" Surfaces | | | | | | | |
| | 88-248210RAB | Laminate | 24 | 82 | 28¾ | 96 | 12.0 | T\$ 3717 |
| | | Veneer | | | | | | W\$ 4986 |
| | Two (2) 10" Rectangle Bases - For Use With 48" x 96" Surfaces | | | | | | | |
| | 88-245810RAB | Laminate | 24 | 58 | 28¾ | 89 | 12.0 | T\$ 3521 |
| | | Veneer | | | | | | W\$ 4664 |
| | Two (2) 10" Rectangle Bases - For Use With 36" x 72" Surfaces | | | | | | | |
| | 88-203410RAB | Laminate | 20 | 34 | 28¾ | 72 | 10.0 | T\$ 3209 |
| | | Veneer | | | | | | W\$ 4276 |

Must Specify (in this order):

- Model #
- Base Finish/Color
- Metal Accent Color
- Accent Panel Finish/Color

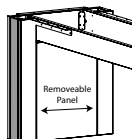

Description

- 10" Rectangle Bases with Trough and Stretcher Rails
- Available with TFL (T) or Veneer (W)
- 5/16" Metal Accent Available in Four (4) Colors: Aluminum, Black, Gold, and Platinum; Must Specify Color
- Vertical Grain Direction on Bases
- Bases Include Interior Removable Panel for Wire Management Access. Removable Panel is 15 7/8"W for 24" Bases and 11 7/8"W for 20" Bases
- Removable Panels Attached with Z Brackets
- Bases Require Some Assembly; Attachment Hardware Included
- Tops Sold Separately

6" + 10" COMBO RECTANGLE ACCENT BASES WITH TROUGH AND REMOVABLE PANEL

| | | | | | | | | |
|---|----------|----|-----|-----|-----|------|----------|--|
| Three (3) Bases Total: Two (2) 6" and One (1) 10" Rectangle Bases - For Use With 60" / 54" / 48" x 144" Surfaces | | | | | | | | |
| 88-24106C610RAB | Laminate | 24 | 106 | 28¾ | 141 | 18.2 | T\$ 5420 | |
| | Veneer | | | | | | W\$ 7205 | |

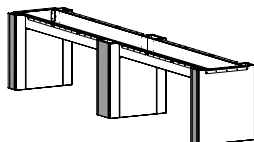

Must Specify (in this order):

- Model #
- Base Finish/Color
- Metal Accent Color
- Accent Panel Finish/Color

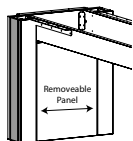

Description

- 6" + 10" Rectangle Accent Bases with Trough and Stretcher Rails; 6" Bases on Exterior and 10" Bases on Interior
- Available with TFL (T) or Veneer (W)
- 5/16" Metal Accent Available in Four (4) Colors: Aluminum, Black, Gold, and Platinum; Must Specify Color
- Vertical Grain Direction on Bases
- Bases Include Interior Removable Panel for Wire Management. Removable Panel is 15 7/8"W and Attaches with Z Brackets
- Bases Require Some Assembly; Attachment Hardware Included
- Tops Sold Separately

Pricing Codes:
P = Laminate Top
W = Wood Top

[See Phoenix Intro Section for Ordering Options](#)

| Item | Model No. | | Width | Depth | Height | Ship Wt | Cubic Ft | List Price |
|---|-----------------------------------|----------|-------|-------|--------|---------|----------|------------|
| DISC BASE  | For 48" Round Tops | | | | | | | |
| | 01-3230DBB | Black | 30 | 30 | 27¾ | 42 | 4.1 | \$ 1842 |
| | 01-3230DBA | Aluminum | 30 | 30 | 27¾ | 42 | 4.1 | |
| | For 36" and 42" Round Tops | | | | | | | |
| | 01-2430DBB | Black | 24 | 24 | 27¾ | 32 | 3.2 | \$ 1535 |
| | 01-2430DBA | Aluminum | 24 | 24 | 27¾ | 32 | 3.2 | |

Description

- 4" Diameter 14 Gauge Steel Column
- 12"x12" Mounting Plate at Top of Column
- ¼" Thick Disc Plate with 5 Levelers
- Some Assembly Required

Table Widths**Number of Bases Required****Round+Square 72" 96"**

1 2 2

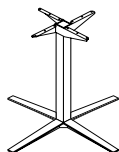
METAL X-BASE

| For Use With Round Tops: 42" + 48" Top Surfaces: 48"x96" | | | | | | | | | |
|---|-----------------|----------|-----|-----|----|----|------|---------|--|
| 08-2642LXBB | For 42"H Tables | Black | 35½ | 35½ | 40 | 33 | 20.0 | \$ 1322 | |
| 08-2642LXBA | | Aluminum | | | | | | | |
| 08-2636LXBB | For 36"H Tables | Black | 35½ | 35½ | 34 | 30 | 17.2 | \$ 1275 | |
| 08-2636LXBA | | Aluminum | | | | | | | |
| 08-2630LXBB | For 30"H Tables | Black | 35½ | 35½ | 28 | 27 | 14.5 | \$ 1219 | |
| 08-2630LXBA | | Aluminum | | | | | | | |
| For Use With Round: 36" Top Surfaces: 36"x72" | | | | | | | | | |
| 08-2042SXBB | For 42"H Tables | Black | 29 | 29 | 40 | 27 | 15.9 | \$ 1235 | |
| 08-2042SXBA | | Aluminum | | | | | | | |
| 08-2036SXBB | For 36"H Tables | Black | 29 | 29 | 34 | 24 | 13.7 | \$ 1185 | |
| 08-2036SXBA | | Aluminum | | | | | | | |
| 08-2030SXBB | For 30"H Tables | Black | 29 | 29 | 28 | 21 | 11.6 | \$ 1139 | |
| 08-2030SXBA | | Aluminum | | | | | | | |

Description

- See Number of Bases Required Per Top Width Below
- Power Units Available On Center When Using Two or More Metal X-Bases
- Ships Assembled

Table Widths**Number of Bases Required****Round 72" 96"**

1 2 2

[See Phoenix Intro Section for Ordering Options](#)

| Item | Model No. | | Width | Depth | Height | Ship Wt | Cubic Ft | List Price |
|--|--------------------------|----------|-------|-------|--------|---------|----------|------------|
| HEIGHT ADJUSTABLE PNEUMATIC X-BASE  | Maximum Round 42" | | | | | | | |
| | 01-3232HAXBB | Black | 32 | 32 | 26-45¾ | 1 | 0.2 | \$ 1721 |
| | 01-3232HAXBA | Aluminum | 32 | 32 | 26-45¾ | 1 | 0.2 | |
| | Maximum Round 36" | | | | | | | |
| | 01-2626HAXBB | Black | 22 | 22 | 26-45¾ | 1 | 0.2 | \$ 1687 |
| | 01-2626HAXBA | Aluminum | 22 | 22 | 26-45¾ | 1 | 0.2 | |

Description

- Pre-Drilled Boring Pattern May Not Match Underside of Table Top
- Steel Mounting Plate: 8"x 8"x ¼"
- Eight (8) Bolts Included for Assembly
- Some Assembly Required

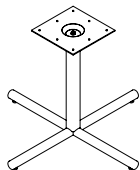
TUBULAR X-BASE

| | | | | | | | | |
|--|----------|----|----|-----|----|-----|--------|--|
| For Use With Round Tops: 48" Top Surfaces: 48"x96" | | | | | | | | |
| 01-3830TXB | Black | 38 | 38 | 27¾ | 40 | 4.2 | \$ 699 | |
| 01-3830TXA | Aluminum | | | | | | | |
| For Use With Round Tops: 36", 42" Top Surfaces: 36"x72" | | | | | | | | |
| 01-3230TXB | Black | 32 | 32 | 27¾ | 32 | 3.2 | \$ 633 | |
| 01-3230TXA | Aluminum | | | | | | | |

Description

- 3" Diameter Column
- See Number of Bases Required Per Top Width Below
- Power Units Available On Center When Using Two or More Tubular X-Bases
- Some Assembly Required

| Table Widths | Round | 72" | 96" |
|---------------------------------|-------|-----|-----|
| Number of Bases Required | 1 | 2 | 2 |

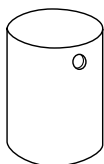
CYLINDER BASE

| | | | | | | | | |
|--------------------------------|--|----|----|-----|-----|------|----------|--|
| For Tables 42"D to 48"D | | | | | | | | |
| 01-2020CB | | 20 | 20 | 28½ | 136 | 10.9 | W\$ 1553 | |
| For Tables 36"D | | | | | | | | |
| 01-1616CB | | 16 | 16 | 28½ | 101 | 7.2 | W\$ 1419 | |

Description

- Veneer Base Features Multi-Step, Hand-Finished Catalyzed Finish
- Weighted for Stability
- Two (2) Wire Management Black Grommets Standard at Top Edge; 8" Opening Standard at Bottom

Additional Grommet Options: Specify & Add

| | | | |
|-------|----------------------------------|----|-----|
| GCB1S | Only One (1) Grommet At Top Edge | \$ | N/C |
| NOGC | No Grommets At Top Edge | \$ | N/C |

Must Specify (in this order):

Model #

Finish

Grommet Options

Pricing Codes:
P = Laminate Top
W = Wood Top

[See Phoenix Intro Section for Ordering Options](#)

| Item | Model No. | Width | Depth | Height | Ship Wt | Cubic Ft | List Price |
|-----------------|-----------|-------|-------|--------|---------|----------|------------|
| QUEEN ANNE BASE | 01-0606QB | 24 | 24 | 28¾ | 136 | 11.1 | W\$ 1406 |

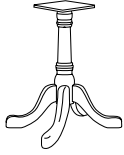

Description

- Classic Design Detail on Column
- Base Features Multi-Step, Hand-Finished Catalyzed Finish
- Four (4) Legs with Adjustable Glides

Must Specify (in this order):

Model #
Finish

| | | | | | | | |
|-------------|-----------|----|----|-----|----|-----|----------|
| SQUARE BASE | 21-2020SB | 20 | 20 | 28¾ | 57 | 8.4 | W\$ 1183 |
|-------------|-----------|----|----|-----|----|-----|----------|

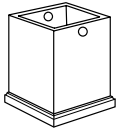

For Use with 48" or 42" Tops

| | | | | | | | |
|--|-----------|----|----|-----|----|-----|----------|
| | 21-1616SB | 16 | 16 | 28¾ | 41 | 6.0 | W\$ 1100 |
|--|-----------|----|----|-----|----|-----|----------|

For Use with 36" Top

Description

- Veneer Base
- Two (2) Wire Management Black Grommets Standard at Top and 8" Wire Management Opening in Bottom

Must Specify (in this order):

Model #
Finish
Grommet Options



Options: Specify & Add

| | | | |
|------|------------------------|----|-----|
| NOGC | No Grommet at Top Edge | \$ | N/C |
|------|------------------------|----|-----|

[See Phoenix Intro Section for Ordering Options](#)

| Item | Model No. | | Width | Depth | Height | Ship Wt | Cubic Ft | List Price |
|--|-----------|--------|-------|-------|--------|---------|----------|------------|
| ROUND GROMMET COVER FIELD INSTALLED | 01-GRMTBK | Black | - | - | - | - | - | \$ 11 |
| | 01-GRMTSL | Silver | | | | | | |



OPEN MARKET ONLY
(SILVER)

Description

- 60mm Round Grommet Cover
- Field Installed

| | | | | | | | | |
|--------------------------|-------------|--------|---|---|---|---|-----|-------|
| SINGLE POWER SAND DOLLAR | 01-SAND60PW | White | 3 | 3 | 4 | 1 | 0.2 | \$ 98 |
| | 01-SAND60PB | Black | | | | | | |
| | 01-SAND60PS | Silver | | | | | | |

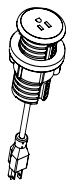

Description

- Unit is 2" Diameter; Mounts in 60mm Round Grommet
- 6' Cord
- Single Power Outlet

| | | | | | | | | |
|------------------------|-------------|--------|---|---|---|---|-----|--------|
| DOUBLE USB SAND DOLLAR | 01-SAND60UW | White | 3 | 3 | 4 | 1 | 0.2 | \$ 277 |
| | 01-SAND60UB | Black | | | | | | |
| | 01-SAND60US | Silver | | | | | | |



Description

- Unit is 2" Diameter; Mounts in 60mm Round Grommet
- 6' Cord
- Dual USB Outlets

| | | | | | | | | |
|------------------------------|-------------|-------|------------------|------------------|---|---|-----|--------|
| DOCK 950 WIRELESS CHARGER | 01-DOCK950W | White | 3 $\frac{3}{10}$ | 3 $\frac{3}{10}$ | - | 1 | 0.2 | \$ 265 |
| | 01-DOCK950B | Black | | | | | | |



OPEN MARKET ONLY

Description

- For Use with Wireless Charging Enabled Devices
- 5 Watts Maximum Output with a Direct Current of 5V 2A and 10 Watts Maximum with Quick Charge 2.0
- LED will Confirm Pairing with Device and Begin Wireless Charging

[See Phoenix Intro Section for Ordering Options](#)

| Item | Model No. | | Width | Depth | Height | Ship Wt | Cubic Ft | List Price |
|--------------------------|-------------|-------|-------|-------|--------|---------|----------|------------|
| WIRELESS AND USB CHARGER | 01-DOCK150W | White | 3 | 3 | ¾" | 1 | 0.2 | \$ 405 |
| | 01-DOCK150B | Black | | | | | | |



OPEN MARKET ONLY

Description

- For Use with Wireless Charging Enabled Devices and USB Charging Devices
- 5 Watt Maximum Output with a Direct Current Input of 5V 6A (Wireless Fast Charge)
- Pop-Up is ¾"H and Includes Three (3) USB Ports; One (1) 12 Watt Maximum with 2.4A (USB Fast Charge) and Two (2) 5 Watt with 1A (USB Standard Charge)
- LED Light will Confirm Pairing with Device and Begin Wireless Charging
- UL and cUL Certified

| | | | | | | | | |
|-------------------------|------------|----------|----|---|---|----|-----|---------|
| OASIS MINI POWER & DATA | 01-OASISMA | Aluminum | 15 | 9 | 5 | 11 | 0.3 | \$ 3191 |
| | 01-OASISMB | Black | | | | | | |

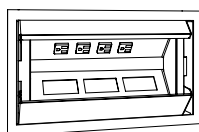

Top View

**Description**

- Soft Touch Hinged Lid
- Four (4) Power Outlets, Three (3) Telecom Plate Openings
- Two (2) Telecom Plates Included with the Unit: One (1) 01-ABLAB Plate (Consists of One (1) RJ45 Cat 6, One (1) RJ11 Cat 3 Phone Jack); One (1) 01-ABLB Plate (Consists of One (1) RJ45 Cat 6)
- 9' Cord with Nema Plug; Fits 15A/120V AC Receptacles
- UL Listed
- See Optional Telecom Plates in the Table and Space Division Price List
- For Use with Rectangle and Boat Table Tops

| | | | | | | | | |
|-----------------------|----------------|----------|---|----|----|---|-----|--------|
| INTERACT POWER & DATA | 01-INTERACTG2A | Aluminum | 9 | 5⅞ | 2¾ | 5 | 0.2 | \$ 891 |
| | 01-INTERACTG2B | Black | | | | | | |

**Description**

- Includes: Two (2) Power Outlets, Two (2) USB-A Charging Ports, One (1) Telecom Plate Opening; Two (2) Keystone Openings for Voice/Data Jacks
- One (1) Telecom Plates Included with the Unit: One (1) 01-ABLAB Plate (Consists of One (1) RJ45 Cat 6, One (1) RJ11 Cat 3 Phone Jack)
- Convenience Plug on Bottom
- 6' Power Cord
- UL and CSA Recognized
- See Optional Telecom Plates in the Table and Space Division Price List

[See Phoenix Intro Section for Ordering Options](#)

| Item | Model No. | | Width | Depth | Height | Ship Wt | Cubic Ft | List Price |
|---------|-------------|--------|-------|-------|--------|---------|----------|------------|
| DOCK800 | 01-DOCK800S | Silver | 14 | 9 | - | | | \$ 2047 |
| | 01-DOCK800B | Black | | | | | | |

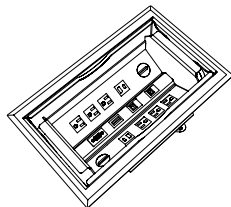

OPEN MARKET ONLY

Description

- Stylish Aluminum Housing with Beveled Edges; Soft Touch Access and Closure
- Includes: Six (6) Power Outlets, Two (2) USB-A 5V Ports, Two (2) USB-C Charging Ports, One (1) RJ45 Ethernet Port, One (1) RJ11 Port, One (1) HDMI Port, and One (1) VGA Port
- 10' Power Cord
- UL and cUL Certified
- See Optional Telecom Plates in the Table and Space Division Price List

| | | | | | | | | |
|-------|------------|----------|---|---|---|---|-----|---------|
| DPORT | 01-DPORT4A | Aluminum | 8 | 4 | - | 7 | 0.2 | \$ 1093 |
| | 01-DPORT4B | Black | | | | | | |

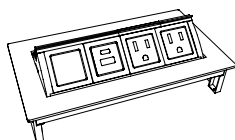

Description

- Retracts into Work Surface to Regain Productive Space; One-Touch Access to Power and Data
- Two (2) Power Outlets, One (1) USB A+C, and One (1) Open Port
- See Optional Telecom Plates in the Table and Space Division Price List
- Water-Proof Simplex (Outlets)
- Includes a Voice/Data Adapter Kit to Accept Couplers and Jacks When Required and a 10' Power Cord
- UL Recognized
- For Use with Rectangle and Boat Table Tops

| | | | | | | | | |
|----------|------------|--|---|---|---|---|---|--------|
| USB PORT | 01-USBPORT | | - | - | - | - | - | \$ 161 |
|----------|------------|--|---|---|---|---|---|--------|

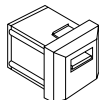

Description

- For Use with 01-DPORT4A and 01-DPORT4B
- Passive USB-A Port with Increased Transfer Speed Up to 5 gbs/sec
- Simultaneous Read/Write Capability; Idle Device Power Saving State
- 6' Cord

| | | | | | | | | |
|---------------|-----------|--|---|---|---|---|---|-------|
| VOICE COUPLER | 01-VOICE1 | | - | - | - | - | - | \$ 73 |
|---------------|-----------|--|---|---|---|---|---|-------|

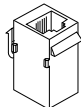

Description

- For Use with 01-DPORT4A and 01-DPORT4B
- 6-Pin Modular Plug
- Molded Black; Cord Not included

[See Phoenix Intro Section for Ordering Options](#)

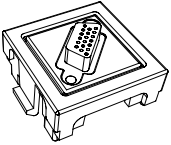
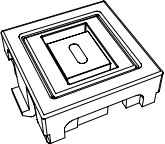
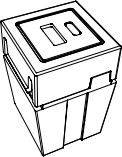
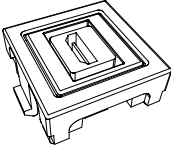
| Item | Model No. | Width | Depth | Height | Ship Wt | Cubic Ft | List Price |
|---|--|-------|-------|--------|---------|----------|------------|
| DATA PORT | 01-RJ4DATA | - | - | - | - | - | \$ 167 |
|  | <p>Description</p> <ul style="list-style-type: none"> • For Use with 01-DPORT4A and 01-DPORT4B • 8-Pin Modular Plug; Cat6 Ethernet Cable; Pre-terminated Cable • 9' Cord | | | | | | |
| VGA CONNECTOR ACCESSORY | 01-VGACON | - | - | - | 1 | 0.2 | \$ 149 |
|  | <p>Description</p> <ul style="list-style-type: none"> • VGA Port for 01-DPORT4A and 01-DPORT4B • Enables Devices to Remote Display on Monitors • 10' Cord • Male/Female Connector | | | | | | |
| PASSIVE USB-C ACCESSORY | 01-PUSBC | - | - | - | 1 | 0.2 | \$ 95 |
|  | <p>Description</p> <ul style="list-style-type: none"> • Passive USB-C Port ; Unit Provides Data Connection to Transfer Data Only, No Charging Capabilities • Compatible with 01-DPORT4A and 01-DPORT4B • Male/Female Connector | | | | | | |
| CHARGING USB-A+C ACCESSORY | 01-USBAC | - | - | - | 1 | 0.2 | \$ 283 |
|  | <p>Description</p> <ul style="list-style-type: none"> • For Charging Devices • 20 Watt Power Supply • USB+C Charging Port for 01-DPORT4A and 01-DPORT4B | | | | | | |
| HDMI CONNECTOR ACCESSORY | 01-HDMICON | - | - | - | 1 | 0.2 | \$ 124 |
|  | <p>Description</p> <ul style="list-style-type: none"> • HDMI Port for 01-DPORT4A and 01-DPORT4B • Connects to High Definition Displays • Female/Female Connector • 18" Cord | | | | | | |

[See Phoenix Intro Section for Ordering Options](#)

| Item | Model No. | | Width | Depth | Height | Ship Wt | Cubic Ft | List Price |
|------------------------------|----------------|--------|-------|-------|--------|---------|----------|------------|
| DUO CLAMP WITH NEMA PLUG | 01-DUOCLAMPW | White | 5½ | 3 | 7 | 1 | 0.2 | \$ 572 |
| | 01-DUOCLAMPB | Black | | | | | | |
| | 01-DUOCLAMP S | Silver | | | | | | |
| TRIO CLAMP WITH NEMA PLUG | 01-TRIOCLAMPW | White | 8 | 3 | 7 | 1 | 0.2 | \$ 671 |
| | 01-TRIOCLAMPB | Black | | | | | | |
| | 01-TRIOCLAMP S | Silver | | | | | | |
| DUO BEZEL WITH NEMA PLUG | 01-DUOBEZELW | White | 6½ | 2½ | 3¼ | 1 | 0.2 | \$ 675 |
| | 01-DUOBEZELB | Black | | | | | | |
| | 01-DUOBEZEL S | Silver | | | | | | |
| TRIO BEZEL WITH NEMA PLUG | 01-TRIOBEZELW | White | 9 | 2½ | 3 | 1 | 0.2 | \$ 725 |
| | 01-TRIOBEZELB | Black | | | | | | |
| | 01-TRIOBEZEL S | Silver | | | | | | |

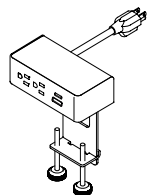

Description

- Standard with: Two (2) Power Outlet, **One (1) USB Charging Port and One (1) 60-Watt USB-C Power Delivery Port with GaN Technology with 10' Cord**
- Clamps to Top and Features Silver Metal Trim
- Independent USB Circuit Controllers Deliver up to 2.1 Amps to Each Post
- All Mounting Hardware Included
- FCC Part 15A and UL Approved for Horizontal and Vertical Applications

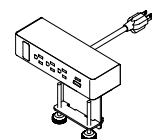

Description

- Standard with: Three (3) Power Outlets, **One (1) USB Charging Port, One (1) 60-Watt USB-C Power Delivery Port with GaN Technology, One (1) Open Data, and 10' Cord**
- Clamps to Top and Features Silver Metal Trim
- Independent USB Circuit Controllers Deliver up to 2.1 Amps to Each Post
- HDMI, VGA, or RJ45 Accessories Sold Separately
- All Mounting Hardware Included
- FCC Part 15A and UL Approved for Horizontal and Vertical Applications



Description

- Sits on Table Top and Includes: Two (2) Power, **One (1) USB Charging Port and One (1) 60-Watt USB-C Power Delivery Port with GaN Technology with 10' Cord, and All Mounting Hardware**
- Independent USB Circuit Controllers Deliver up to 2.1 Amps to Each Post
- FCC Part 15A, UL Recognized for Horizontal and Vertical Applications



Description

- Sits on Table Top and Includes: Three (3) Power Outlets, **One (1) USB Charging Port, One (1) 60-Watt USB-C Power Delivery Port with GaN Technology, One (1) Open Data Port, 10' Cord, and All Mounting Hardware**
- HDMI, VGA, and RJ45 Accessories for Open Data Port; Sold Separately, [See Accessories](#)
- Independent USB Circuit Controllers Deliver up to 2.1 Amps to Each Post
- FCC Part 15A, UL Recognized for Horizontal and Vertical Applications

Pricing Codes:
P = Laminate Top
W = Wood Top

[See Phoenix Intro Section for Ordering Options](#)

| Item | Model No. | | Width | Depth | Height | Ship Wt | Cubic Ft | List Price |
|--|----------------|---------------------------------------|-------|-------|--------|---------|----------|------------|
| DUO BEZEL WITH DAISY CHAIN PLUG | 01-PDUOBEZELW | White | 6½ | 2½ | 3 | 1 | 0.2 | \$ 668 |
| | 01-PDUOBEZELB | Black | | | | | | |
| | 01-PDUOBEZELS | Silver | | | | | | |
| Description | | | | | | | | |
| <ul style="list-style-type: none"> Sits on Table Top and Includes: Two (2) Power, One (1) USB Charging Port and One (1) 60-Watt USB-C Power Delivery Port with GaN Technology with 12" Cord, and All Mounting Hardware Requires Daisy Chain Power Box; Sold Separately, See Power Box Details Non-Sequential System Allows up to Eight (8) Modules to be Connected with Jumper Cord, See Jumper Cord Details Independent USB Circuit Controllers Deliver up to 2.1 Amps to Each Post FCC Part 15A, RU Listed and UL Recognized for Horizontal and Vertical Applications | | | | | | | | |
| TRIO BEZEL WITH DAISY CHAIN PLUG | 01-PTRIOBEZELW | White | 9 | 2½ | 3 | 1 | 0.2 | \$ 715 |
| | 01-PTRIOBEZELB | Black | | | | | | |
| | 01-PTRIOBEZELS | Silver | | | | | | |
| Description | | | | | | | | |
| <ul style="list-style-type: none"> Sits on Table Top and Includes: Three (3) Power Outlets, One (1) USB Charging Port, One (1) 60-Watt USB-C Power Delivery Port with GaN Technology, One (1) Open Data Port, 12" Cord, and All Mounting Hardware HDMI, VGA, or RJ45 Accessory for Open Data Port; Sold Separately, See Accessories Requires Daisy Chain Power Box, Specified Separately, See Next Page Non-Sequential System Allows up to Eight (8) Modules to be Connected with Jumper Cord, See Jumper Cord Details Independent USB Circuit Controllers Deliver up to 2.1 Amps to Each Post FCC Part 15A, RU Listed and UL Recognized for Horizontal and Vertical Applications | | | | | | | | |
| DAISY CHAIN POWER BOX | 01-PPOWER | | - | - | - | 1 | 0.2 | \$ 775 |
| | | <i>76" Perimeter, 36" Power Cord</i> | | | | | | |
| | 01-PPOWER2 | | - | - | - | 1 | 0.2 | \$ 796 |
| | | <i>24" Perimeter, 144" Power Cord</i> | | | | | | |
| Description | | | | | | | | |
| <ul style="list-style-type: none"> Powers up to Eight (8) Duo and Trio Daisy Chain Units One Nema Plug and One Daisy Chain Plug 12-Amp System Rating 15-Amp Over-Current Protection | | | | | | | | |
| DAISY CHAIN JUMPER CORD | 01-6JUMP | <i>72" Long</i> | - | - | - | 1 | 0.2 | \$ 299 |
| | 01-5JUMP | <i>60" Long</i> | - | - | - | 1 | 0.2 | \$ 284 |
| | 01-4JUMP | <i>48" Long</i> | - | - | - | 1 | 0.2 | \$ 240 |
| | 01-2JUMP | <i>24" Long</i> | - | - | - | 1 | 0.2 | \$ 220 |
| Description | | | | | | | | |
| <ul style="list-style-type: none"> Connects Duo and Trio Daisy Chain Units Non-Sequential System Allows up to Eight (8) Modules to be Connected | | | | | | | | |

[See Phoenix Intro Section for Ordering Options](#)

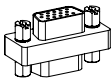
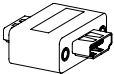
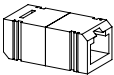
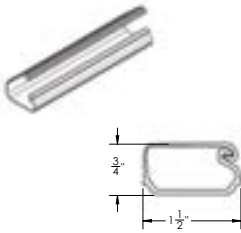
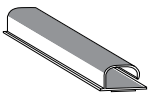
| Item | Model No. | Width | Depth | Height | Ship Wt | Cubic Ft | List Price |
|---|--------------------|---|-------|--------|---------|----------|------------|
| VGA DATA PORT ACCESSORY | 01-LCOMVGA | - | - | - | 1 | 0.2 | \$ 121 |
|  | Description | <ul style="list-style-type: none"> VGA Port for Trio Bezel and Trio Clamp Units | | | | | |
| HDMI DATA PORT ACCESSORY | 01-LCOMHDMI | - | - | - | 1 | 0.2 | \$ 166 |
|  | Description | <ul style="list-style-type: none"> HDMI Port for Trio Bezel and Trio Clamp Units | | | | | |
| OPEN MARKET ONLY | | | | | | | |
| RJ45 DATA PORT ACCESSORY | 01-LCOMRJ45 | - | - | - | 1 | 0.2 | \$ 79 |
|  | Description | <ul style="list-style-type: none"> RJ45 Port for Trio Bezel and Trio Clamp Units | | | | | |
| WIRE MANAGEMENT CHANNEL | 01-WMGR4 | 16 | 1½ | 1 | 1 | - | \$ 116 |
|  | Description | <ul style="list-style-type: none"> Set of Four (4) Black Plastic Wire Management Channels Snap Lock Channel Attaches with Adhesive Strips Ships via UPS Only | | | | | |
| WIRE CHANNEL | 01-32125 | 24 | 1¾ | 1 | .25 | 0.3 | \$ 106 |
|  | Description | <ul style="list-style-type: none"> Available in Black Channels Attach with Two (2) Double-Sided Installation Tape Easily Attach to an Iconic Leg to Route Wires/Cords from the Top to the Floor Open J Channel for Easy Storage of Cables | | | | | |

Pricing Codes:
P = Laminate Top
W = Wood Top

[See Phoenix Intro Section for Ordering Options](#)

| Item | Model No. | | Width | Depth | Height | Ship Wt | Cubic Ft | List Price |
|------------|-----------|--|-------|-------|--------|---------|----------|------------|
| CABLE GRIP | 01-WMGRCB | | 5 3/8 | 2 5/8 | | - | - | \$ 17 |

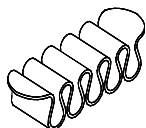

Description

- Under Surface Wire Management
- Black

| | | | | | | | | |
|------------------------|----------------|--------|--------|--------|-------|---|-----|--------|
| LINK 360 CABLE MANAGER | 01-0251LINKSLV | Silver | 5 3/16 | 3 3/16 | 30-51 | 4 | 3.0 | \$ 390 |
| | 01-0251LINKBLK | Black | 5 3/16 | 3 3/16 | 30-51 | 4 | 3.0 | \$ 353 |

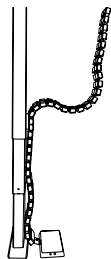

Description

- Kit Includes: 50 Link 360™ elements, One (1) Quad Connector, One (1) Dumbbell Connector, and One (1) Foot Assembly with Two (2) Magnetic Clips
- Can Be Used For Height-Adjustable Mechanisms Up To 51" or Free-Standing Use

| | | | | | | | | |
|-------------------------------|-----------|-------|--------|----|------|----|-----|---------|
| HEIGHT ADJUSTABLE WORKSTATION | 01-S2SBLK | Black | 35 1/2 | 25 | 6-22 | 49 | 6.5 | \$ 1503 |
|-------------------------------|-----------|-------|--------|----|------|----|-----|---------|

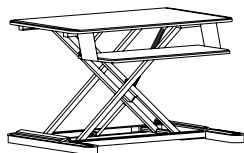

Description

- Height Adjustable
- Weight Capacity: 35lbs
- One-Handed Operation; Platforms Move Simultaneously
- Keyboard Platform: 10 1/2"D x 26 5/8"W
- Worksurface: 21"D x 35 1/2"W
- Can be Used on Worksurface 24"D x 35"W

| | | | | | | | | |
|---------------|-----------|--|----|--------|-------|---|-----|--------|
| CENTER DRAWER | 21-1622CD | | 22 | 16 3/4 | 2 3/4 | 7 | 1.4 | \$ 495 |
|---------------|-----------|--|----|--------|-------|---|-----|--------|

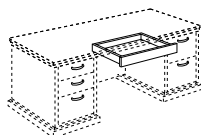

Description

- Drawer Features Multi-Step, Hand-Finished Catalyzed Finish
- Built in Pen Tray

Options: Specify & Add

Must Specify (in this order):

- Model #
- Finish
- Factory Installation

| | | |
|------|-----------------------------|--------|
| CD16 | Factory Installed 01-1622CD | \$ 208 |
|------|-----------------------------|--------|

[See Phoenix Intro Section for Ordering Options](#)

| Item | Model No. | Width | Depth | Height | Ship Wt | Cubic Ft | List Price |
|--|-----------|-------|-------|--------|---------|----------|------------|
| ARTICULATING KEYBOARD CORNER PLATFORM | 01-KB2CC | 25 | 10½ | 4½ | 16 | 1.4 | \$ 832 |

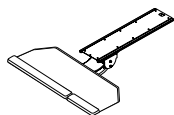

Description

- Standard With: +/- 15° Tilt Adjustment , 360° Rotation, Independent Tilt Adjustment, 7" Lift and Lock Height Adjustment, 25" Cut Corner Platform
- Keyboard and Mouse on same level; Single Palm Rest for both Left & Right Hands
- Works with 17"+ Diagonal Work Surface
- Cannot Be Used on 20" or 21" Deep Unit
- Not Available with Optional Center Grommet
- Track Measures 21"

Options: Specify & Add

| | | |
|-------|-------------------|--------|
| KB2CC | Factory Installed | \$ 208 |
|-------|-------------------|--------|

| | | | | | | | |
|---|--------|-----|----|-----|----|-----|--------|
| KEYBOARD MECHANISM WITH KEYBOARD CLAMP | 01-KB3 | 26½ | 14 | 4.5 | 16 | 1.4 | \$ 914 |
|---|--------|-----|----|-----|----|-----|--------|

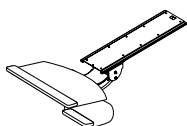

Description

- Standard With: 18.75" Platform with Swivel-Below Mouse Platform, +/- 15° Tilt Adjustment, 360° Rotation, 7" Lift and Lock Height Adjustment, Independent Tilt Adjustment, Palm Rest for Mousing Surface
- Left or Right Handed Mouse Platform
- Cannot Be Used on 20" or 21" Deep Unit
- Not Available with Optional Center Grommet
- Track Measures 21"

Options: Specify & Add

| | | |
|-----|-------------------|--------|
| KB3 | Factory Installed | \$ 208 |
|-----|-------------------|--------|

| | | | | | | | |
|---------------|--------------------------|-----|-----|------|---|---|--------|
| LED TASKLIGHT | TL-0848 | 47½ | 7/8 | 15/8 | - | - | \$ 445 |
| | <i>240-LED, 18 Watts</i> | | | | | | |
| | TL-0824 | 22½ | 7/8 | 15/8 | - | - | \$ 368 |
| | <i>84-LED, 7 Watts</i> | | | | | | |

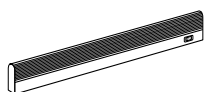

Description

- Includes the Power Supply and Three Upper Wire Management Grommets
- Rocker Style On/Off Switch with a 10' Power Cord
- Grommet Color will Match Lower Grommet Color

Pricing Codes:
P = Laminate Top
W = Wood Top

[See Phoenix Intro Section for Ordering Options](#)

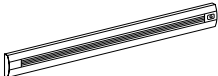

| Item | Model No. | Width | Depth | Height | Ship Wt | Cubic Ft | List Price |
|---|-------------|--------------------|-------|--------|---------|----------|------------|
|  | 01-188LED58 | 96-LED, 33.7 Watts | 57% | 2 | ¾ | - | \$ 1648 |
| | 01-94LED31 | 48-LED, 17.6 Watts | 30% | 2 | ¾ | - | \$ 1195 |
| | 01-47LED17 | 24-LED, 9.1 Watts | 16% | 2 | ¾ | - | \$ 690 |

Description

- Includes the Power Supply and Three Upper Wire Management Grommets
- 12' Power Cord
- Grommet Color will Match Lower Grommet Color
- Optional Occupancy Sensor Shuts Off After 30 Minutes of Inactivity and Turns On Immediately When Reentering the Detection Area

Options: Specify & Add

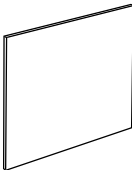
| | | |
|---------|------------------|--------|
| 01-OSRP | Occupancy Sensor | \$ 366 |
|---------|------------------|--------|

| | | | | | | | |
|--|-----------|----|---|-----|----|------|---------|
| MAGNETIC GLASS MARKER BOARD FOR USE WITH 30"H DESKS, CREDENZA AND WALL MOUNT HUTCHES OR SHELVING   | GMB-4048W | 48 | ½ | 40% | 67 | 11.0 | \$ 3128 |
| | GMB-4042W | 42 | ½ | 40% | 58 | 9.9 | \$ 2644 |
| | GMB-4036W | 36 | ½ | 40% | 50 | 8.8 | \$ 2285 |
| | GMB-4030W | 30 | ½ | 40% | 42 | 7.7 | \$ 1924 |

Description

- Available in Black (BLMKR) or White (WHMKR), Must Specify
- Mounting Brackets Included
- For Use over 30"H Desks and Credenzas with Wall Mount Hutches or Shelving
- For Rare Earth Magnets, Marker and Eraser Sets; [See Set Options](#)

Must Specify (in this order):

Model #
Color

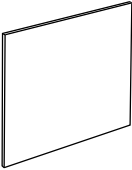
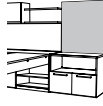

Rare Earth Magnet, Marker and Eraser sets available, [See Set Options](#)

| | | | | | | | |
|--|-----------|----|---|-----|----|------|---------|
| MAGNETIC GLASS MARKER BOARD FOR USE WITH 30"H DESKS, CREDENZA AND TALL WALL MOUNT HUTCHES OR SHELVING   | GMB-5248W | 48 | ½ | 52% | 86 | 13.5 | \$ 3988 |
| | GMB-5242W | 42 | ½ | 52% | 76 | 12.2 | \$ 3369 |
| | GMB-5236W | 36 | ½ | 52% | 65 | 10.8 | \$ 2904 |
| | GMB-5230W | 30 | ½ | 52% | 54 | 9.5 | \$ 2441 |

Description

- Available in Black (BLMKR) or White (WHMKR), Must Specify
- Mounting Brackets Included
- For Use Next to Tall Surface or Wall Mount Hutches
- For Rare Earth Magnets, Marker and Eraser Sets; [See Set Options](#)

Must Specify (in this order):

Model #
Color



Rare Earth Magnet, Marker and Eraser sets available, [See Set Options](#)

[See Phoenix Intro Section for Ordering Options](#)

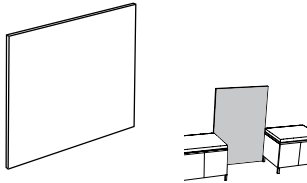
| Item | Model No. | Width | Depth | Height | Ship Wt | Cubic Ft | List Price |
|--|-----------|-------|-------|--------|---------|----------|------------|
| MAGNETIC GLASS MARKER BOARD FOR USE FROM FLOOR TO TOP OF UNIT  | GMB-8236W | 36 | ½ | 82⅞ | 102 | 15.8 | \$ 4453 |
| | GMB-7036W | 36 | ½ | 70⅞ | 87 | 13.8 | \$ 3834 |
| | GMB-5136W | 36 | ½ | 51⅞ | 63 | 10.6 | \$ 2802 |
| | GMB-8230W | 30 | ½ | 82⅞ | 85 | 13.8 | \$ 3730 |
| | GMB-7030W | 30 | ½ | 70⅞ | 72 | 12.1 | \$ 3215 |
| | GMB-5130W | 30 | ½ | 51⅞ | 53 | 9.3 | \$ 2354 |

Must Specify (in this order):

Model #

Color



Rare Earth Magnet, Marker and Eraser sets available. [See Set Options](#)

Description

- Available in Black (BLMKR) or White (WHMKR), Must Specify
- Marker Boards Are One (1) Piece with No Seams
- Mounting Brackets Included
- For Use From Floor to Top of Unit
- For Rare Earth Magnets, Marker and Eraser Sets; [See Set Options](#)

| | | | |
|-----------------------|--------------|--|--------|
| MARKER AND ERASER SET | 01-MRKRSETBL | For Use with Black Marker Boards and Black Glass Doors | \$ 123 |
|-----------------------|--------------|--|--------|



| | | | |
|--|--------------|--|--|
| | 01-MRKRSETWH | For Use with White Marker Boards and White Glass Doors | |
|--|--------------|--|--|

Description

- 01-MRKRSETWH May Also be Used with Standard Dry Erase Doors and Boards
- Includes Four (4) Markers and an Eraser

| | | | |
|------------|----------|----------------------------------|--------|
| MAGNET SET | 01-MAGBL | For Use with White Marker Boards | \$ 114 |
|------------|----------|----------------------------------|--------|



| | | | |
|--|----------|----------------------------------|--|
| | 01-MAGWH | For Use with Black Marker Boards | |
|--|----------|----------------------------------|--|

Description

- Includes Set of Five (5) Magnets

[See Phoenix Intro Section for Ordering Options](#)

SURFACE MOUNT TACKBOARDS
20 1/8" H

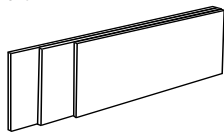

Must Specify (in this order):
Model #
Tackboard Fabric Vendor, Pattern,
and Color

| Model # | Size | COM ydg | COM, 1, 2 or 3 | Grades | | | | | | |
|----------|------|---------|-------------------|--------|------|------|------|------|------|------|
| | | | | 4 | 5 | 6 | 7 | 8 | 9 | 10 |
| TB-2184H | 84" | 2.50 | \$ 639 | 987 | 1149 | 1314 | 1549 | 1794 | 2079 | 2409 |
| TB-2178H | 78" | 2.50 | \$ 628 | 976 | 1138 | 1303 | 1538 | 1783 | 2068 | 2398 |
| TB-2172H | 72" | 2.25 | \$ 566 | 879 | 1025 | 1174 | 1385 | 1606 | 1862 | 2159 |
| TB-2166H | 66" | 2.00 | \$ 533 | 811 | 941 | 1073 | 1261 | 1457 | 1685 | 1949 |

- Description**
- Coordinates with Surface Mount Hitches
 - Factory Installed

WALL MOUNT TACKBOARDS
21 1/8" H

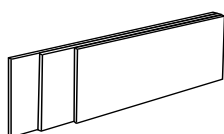

Must Specify (in this order):
Model #
Tackboard Fabric Vendor, Pattern,
and Color

| Model # | Size | COM ydg | COM, 1, 2 or 3 | Grades | | | | | | |
|----------|------|---------|-------------------|--------|------|------|------|------|------|------|
| | | | | 4 | 5 | 6 | 7 | 8 | 9 | 10 |
| TB-2182W | 82" | 2.50 | \$ 711 | 1059 | 1221 | 1386 | 1621 | 1866 | 2151 | 2481 |
| TB-2176W | 76" | 2.50 | \$ 698 | 1046 | 1208 | 1373 | 1608 | 1853 | 2138 | 2468 |
| TB-2170W | 70" | 2.25 | \$ 642 | 955 | 1101 | 1250 | 1461 | 1682 | 1938 | 2235 |
| TB-2164W | 64" | 2.00 | \$ 609 | 887 | 1017 | 1149 | 1337 | 1533 | 1761 | 2025 |
| TB-2158W | 58" | 2.00 | \$ 566 | 844 | 974 | 1106 | 1294 | 1490 | 1718 | 1982 |
| TB-2152W | 52" | 1.75 | \$ 539 | 782 | 896 | 1012 | 1176 | 1348 | 1547 | 1778 |
| TB-2146W | 46" | 1.50 | \$ 492 | 701 | 798 | 897 | 1038 | 1185 | 1356 | 1554 |
| TB-2140W | 40" | 1.25 | \$ 446 | 620 | 701 | 784 | 901 | 1024 | 1166 | 1331 |
| TB-2134W | 34" | 1.25 | \$ 434 | 608 | 689 | 772 | 889 | 1012 | 1154 | 1319 |
| TB-2128W | 28" | 1.00 | \$ 394 | 533 | 598 | 664 | 758 | 856 | 970 | 1102 |

- Description**
- Coordinates with Wall Mount Hitches
 - Field Installed

| Item | Model No. | Width | Depth | Height | Ship Wt | Cubic Ft | List Price |
|--------------------|-----------|--------|-------|--------|---------|----------|------------|
| VESTA POWER CENTER | 01-PDCTR | 10 3/4 | 12 | 28 3/4 | 14 | 2.5 | \$ 1776 |



- Description**
- Top Includes One (1) Power Outlet, Two (2) USB Ports and One (1) USBC Port; Base Includes Three (3) Outlet
 - Available in White
 - 120" Power Cord
 - Built with Weight Distribution for Optimal Stability
 - Base is 5" Tall

[See Phoenix Intro Section for Ordering Options](#)

Reception



Welcoming environments start with furniture that's warm and inviting. Create a customized work environment through flexible combinations of shells, components, and work surfaces that address multiple configuration options. Subtle details, including multiple pull styles, edge options, overlay panels and molding options allow for a personalized look or seamless blending with any of our standard casegood offerings.

CONSTRUCTION

Aura Reception features a Veneer chassis with your choice of either a Veneer, HPL, or Solid Surface transaction counter. Units ship assembled unless otherwise noted.

VENEER

- Exposed surfaces feature select grade plain sliced hardwood Cherry, Maple, American Black Walnut, or composite veneers
- Veneers are carefully selected and matched to assure proper balance and consistency

TOPS

- Veneer worksurface tops are 3-ply balanced construction and 1 5/32" thick with a self-edge
- Transaction tops are 1 1/2" thick with a 5-ply balanced construction in Veneer, 3-ply balanced construction in High Pressure Laminate
- Transaction tops in Cherry, Maple, and American Black Walnut have solid hardwood rims and are profiled on all sides with mitered corners.
- Optional 3/8" thick glass accent top with 1 1/4" silver standoffs
- Transaction tops in solid surface materials are 1 1/2" thick and available in 6 standard colors
- Grain runs left to right unless otherwise stated

CHASSIS

- Tops and end panels are securely fastened using high quality European fastening systems to ensure maximum strength
- All units have finished backs unless noted
- All pedestals offer optional wire management access from pedestal to kneespace
- All units ship with heavy-duty, adjustable leveling glides to ensure proper leveling and compensation for uneven floors

DRAWERS

- Drawer fronts are 3-ply construction, 3/4" thick with matched grain
- Drawer sides, back, and front are 1/2" thick, woodgrain vinyl wrapped construction with mitered corners
- Box and file drawers have 1/8" thick hardboard bottoms and tested for 100lb capacity
- Lateral files feature 1/4" thick bottoms. Drawers are tested for 200lb of equally distributed weight (ex: hanging file folders) and 65lbs of bottom load weight (ex: stacked catalogs)
- 5-Sided drawer construction for easy removal of drawer fronts
- All drawers feature full extension, progressive action slides with precision steel ball bearings
- All suspensions have a limited lifetime warranty

FILING

- All file drawers are standard with filing systems designed to accommodate a variety of filing requirements
- Modular component pedestals provide letter filing front to back and legal filing side to side
- Lateral file drawers provide legal or letter filing front to back or side to side

STORAGE

- All hinged doors include soft close hinges, unless noted
- One piece hinge and base plate combination
- Soft close hinges reduce stress placed on the cabinet when the door is closed and offers a quiet closure

LOCKING

- All units with file drawers feature locking
- Removable lock cylinders allow for units to be re-keyed at a later date, if required
- Units are shipped randomly keyed as standard
- Keyed alike units available upon request at no additional charge
- Lock core will match pull color

CORD MANAGEMENT

- Grommets may be ordered in the tops
- [See grommet options and locations](#)
- Wire Managers available for additional cord management; [See Accessories](#)

INTERIOR DRAWER DIMENSIONS

Model

62-2418PD1

Drawers

| | W | L | D |
|------|----------|---------|--------|
| Box | 14 9/32" | 15 1/8" | 3 1/2" |
| File | 14 9/32" | 15 1/8" | 9 1/4" |

Model

62-2418PD2

Drawers

| | W | L | D |
|------|----------|---------|--------|
| File | 14 9/32" | 15 1/8" | 9 1/4" |

Model

62-2436LF1

Drawers

| | W | L | D |
|----------|----------|----------|--------|
| Lat File | 32 9/32" | 15 1/16" | 9 1/4" |

Model

62-2430LF1

Drawers

| | W | L | D |
|----------|----------|----------|--------|
| Lat File | 26 9/32" | 15 1/16" | 9 1/4" |

Model

62-2436MF1

Drawers

| | W | L | D |
|----------|----------|----------|--------|
| Box | 14 9/32" | 15 1/8" | 3 1/2" |
| File | 14 9/32" | 15 1/8" | 9 1/4" |
| Lat File | 32 9/32" | 15 1/16" | 9 1/4" |

Model

62-2430MF1

Drawers

| | W | L | D |
|----------|----------|----------|--------|
| Box | 11 5/16" | 16 3/16" | 3 1/2" |
| File | 12 1/8" | 16 3/16" | 9 1/4" |
| Lat File | 26 9/32" | 15 1/16" | 9 1/4" |

| | | | | |
|-----------|--------|----|----|--------|
| 62-1622CD | Center | 19 | 15 | 1 1/8" |
|-----------|--------|----|----|--------|

FILING CAPABILITIES

Drawers with Dimensions: 11⁵/₁₆" W x 16³/₁₆" L

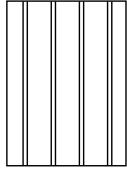

Letter or Legal Side to Side

Drawers with Dimensions: 12¹/₈" W x 16⁵/₃₂" L



Letter Front to Back

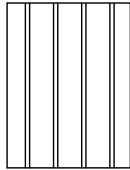

Letter or Legal Side to Side

Drawers with Dimensions: 14³/₃₂" W x 15¹/₈" L

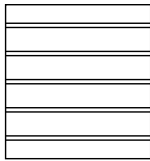

Letter Front to Back

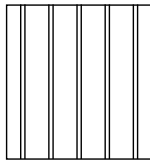

Legal Side to Side

Drawers with Dimensions: 32³/₃₂" W x 15¹/₈" L

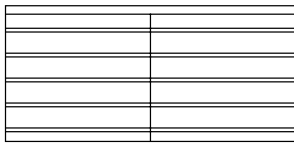

2 Rows Letter Front to Back

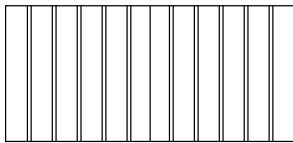

1 Row Legal Side to Side

Drawers with Dimensions: 26³/₃₂" W x 15¹/₈" L

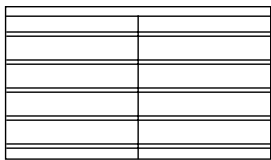

2 Rows Letter Front to Back

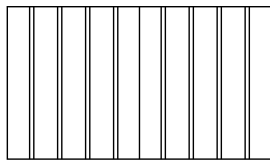

1 Row Legal Side to Side

HOW TO ORDER EXAMPLES

| | QTY | MODEL NO. | DESCRIPTION | EXAMPLE |
|-------------------|-----|------------|-----------------|-------------------------|
| DESK SHELL | 1 | 62-3696RS | Top Material | W |
| | | | Finish/Color | AW |
| | | | Edge Profile | E |
| | | | Tackboard | YES |
| | | | Upholstery | Momentum Grid Chrome |
| | | | Grommet | GLR |
| | | | Grommet Color | SLV |
| | | | Glass Top | YES |
| | | | Overlay | YES |
| | | | Overlay Color | SC |
| PEDESTAL | 2 | 62-2418PD1 | Finish | AW |
| | | | Pull/Color | AAC |
| | | | Wire Management | WMENDS |
| | | | | |

VENEER (W) OPTIONS AVAILABLE

Veneer features UV Advantage, an ultra-violet finish, on all exposed surfaces by utilizing roll-coat UV technology

| | | | |
|-----|--------------------|-----|---------------------|
| AW | Artisan Walnut | MW | Mahogany Walnut |
| AS | Asian Night* | MAS | Mesa Sunset*,** |
| CO | Columbian Walnut | MTS | Metropolis Sky* |
| DC | Dark Cherry | ORW | Oak Riftwood*,** |
| DFW | Dark Forest Walnut | PNW | Pinnacle Walnut* |
| EW | Espresso | SCH | Select Cherry |
| FO | Fawn Oak** | SKC | Shaker Cherry |
| GC | Golden Cherry | SM | Sugar Maple* |
| HW | Harvest Walnut | WTA | Weathered Ash*,** |
| HNW | Henna Walnut* | WC | Williamsburg Cherry |
| LW | Legacy Walnut | | |

* Composite Veneer/ ** Finish is Low Sheen

ADDITIONAL OVERLAY COLOR OPTIONS

| | | | |
|----|--------------|----|-------|
| SC | Sugar Cookie | WH | White |
|----|--------------|----|-------|

HPL (P) LAMINATE TRANSACTION TOP OPTIONS

WOODGRAIN

| | | | |
|-----|------------------|-----|---------------------|
| AS | Asian Night | PNW | Pinnacle Walnut |
| CO | Columbian Walnut | SCH | Select Cherry |
| EF | Espresso | SKC | Shaker Cherry |
| GC | Golden Cherry | SM | Sugar Maple |
| MW | Mahogany Walnut | WTA | Weathered Ash |
| ORW | Oak Riftwood | WC | Williamsburg Cherry |

SOLID SURFACE (S) TRANSACTION TOP OPTIONS

| | | | |
|----|--------------|-----|--------------|
| AR | Arroyo | SNW | Snow White |
| PE | Pebble Beach | SN | Starry Night |
| SE | Sedona | TN | Tundra |

EDGE PROFILES

CHASSIS/WORKSURFACES

| | | | |
|-------------------------|----------|---|-----------|
| Y | Square | | |
| TRANSACTION TOPS | | | |
| B | Bevel | Y | Square* |
| D | Bullnose | Z | Tail |
| X | Flute* | E | Tri-Round |
| O | Phoenix | N | Waterfall |
| A | Radius | | |

* Composite Veneers available only in Square (Y) profile

SOLID SURFACE TRANSACTION TOPS

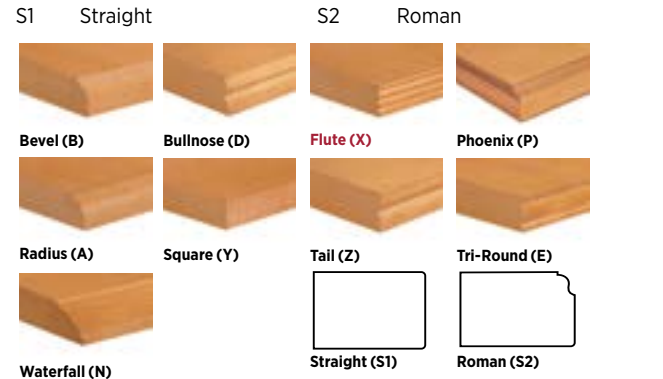

PULL OPTIONS

Note: Lock Core will match Pull Color

| | | | |
|-----|------------------|-----|------------------|
| AAV | Alcove, Aluminum | AEL | Elite, Aluminum |
| CAV | Alcove, Chrome | BEL | Elite, Black |
| AAC | Arc, Aluminum | AFL | Flair, Aluminum |
| BAC | Arc, Black | CFL | Flair, Chrome |
| ABM | Beam, Aluminum | AFC | Focus, Aluminum |
| BBM | Beam, Black | BFC | Focus, Black |
| BBT | Bow Tie, Black | AQD | Quadra, Aluminum |
| NBT | Bow Tie, Nickel | BQD | Quadra, Black |
| ABU | Buckle, Aluminum | | |
| BBU | Buckle, Black | | |



GROMMET OPTIONS & LOCATIONS

Multiple locations may be selected. Black = BLK and Silver = SLV

| | | | |
|----|--------------------------------------|----|----|
| GC | Grommet, Center - Specify BLK or SLV | \$ | 52 |
| GL | Grommet, Left - Specify BLK or SLV | \$ | 52 |
| GR | Grommet, Right - Specify BLK or SLV | \$ | 52 |

Verify Grommet Option is available on the model(s) you are specifying using the following location information. Grommets may be ordered in non-standard locations. Call Customer Service to assist with specification and/or please attach a drawing to the PO showing the location of the grommet. Note additional charges and lead times may apply.

Models

| | | | |
|------------|------------|------------|------------|
| 62-3696RSS | 62-3690RSS | 62-3684RSS | 62-3678RSS |
| 62-3672RSS | 62-3666RSS | 62-3660RSS | 62-3696RS |
| 62-3690RS | 62-3684RS | 62-3678RS | 62-3672RS |
| 62-3666RS | 62-3660RS | | |

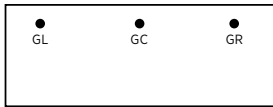

GL/GR: Located 6" from ends and 32¾" from user side
GC: Located 32¾" from user side

Models

| | | | |
|------------|------------|------------|------------|
| 62-3096RSS | 62-3090RSS | 62-3084RSS | 62-3078RSS |
| 62-3072RSS | 62-3066RSS | 62-3060RSS | 62-3096RS |
| 62-3090RS | 62-3084RS | 62-3078RS | 62-3072RS |
| 62-3066RS | 62-3060RS | | |

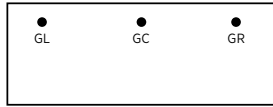

GL/GR: Located 6" from ends and 26¾" from user side
GC: Located 26¾" from user side

Models

| | | | |
|-------------|-------------|-------------|-------------|
| 62-2560RSLF | 62-2560RSRF | 62-2554RSLF | 62-2554RSRF |
| 62-2548RSLF | 62-2548RSRF | 62-2542RSLF | 62-2542RSRF |
| 62-2536RSLF | 62-2536RSRF | | |

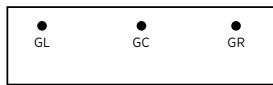

GL/GR: Located 6" from ends and 20" from user side
GC: Located 20" from user side

CERTIFICATIONS & COMPLIANCE

- Intertek Sustainability Certified
- BIFMA level® Certified
- BIFMA Compliant Certified
- TSCA Title VI (formerly CARB) Compliance
- US Green Building's LEED Contribution

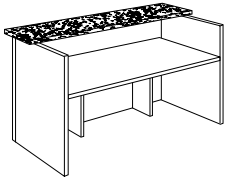

Reception Desk Shells with Solid Surface Transaction Counters
[\(See Details\)](#)

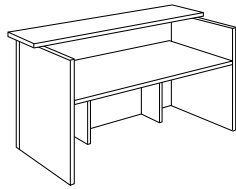

Reception Desk Shells with Veneer/HPL Transaction Counters
[\(See Details\)](#)

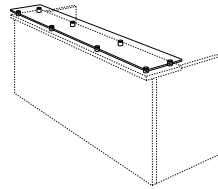

Optional Glass Transaction Top for Desk Shells with Wood Transaction Counters
[\(See Details\)](#)

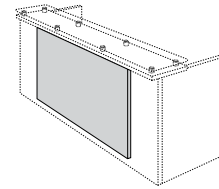

Optional Modesty Panel Overlay for Desk Shells
[\(See Details\)](#)

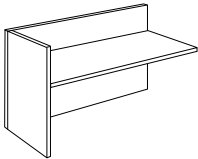

Reception Station Return Shell
[\(See Details\)](#)

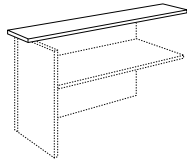

Return Transaction Counter
[\(See Details\)](#)

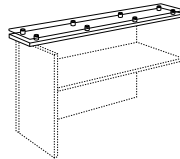

Optional Glass Transaction Top for Return Shells with Wood Transaction Counters
[\(See Details\)](#)

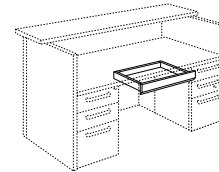

Optional Center Drawer
[\(See Details\)](#)

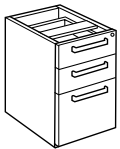

Component Ped Box/Box/File
[\(See Details\)](#)

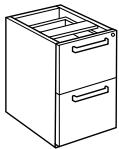

Component Ped File/File
[\(See Details\)](#)

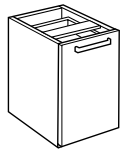

Component Ped Door Bookcase
[\(See Details\)](#)

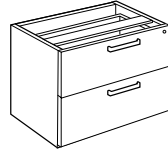

Component Ped Lateral File
[\(See Details\)](#)

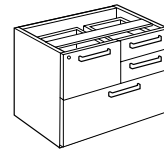

Component Ped Multi-File
[\(See Details\)](#)

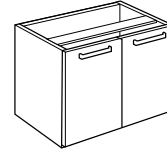

Component Ped Double Door Bookcase
[\(See Details\)](#)

[Power + Wire Management Accessories](#)

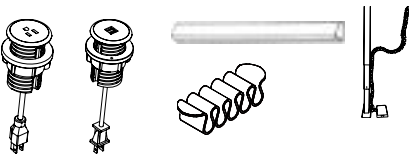

[Reception Desk Shell Tackboards](#)



| Item | Model No. | Width | Depth | Height | Ship Wt | Cubic Ft | List Price |
|--|-----------|-------|-------|--------|---------|----------|------------------------|
| RECEPTION DESK DOUBLE PED WITH GLASS TOP | 62-1 | 74 | 39 | 42 | 472 | 97.2 | P\$ 13748 W\$ 13822 |

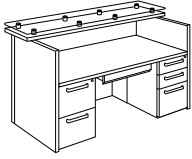

| CONSIST OF: | QTY | | |
|-------------|-----|------------------------------------|----------------------|
| 62-3672RS | 1 | Reception Station Shell | P\$ 5319 W\$ 5393 |
| 62-72SOG | 1 | Optional Glass Top | \$ 2604 |
| 62-2418PD1 | 1 | Modular Pedestal with Box/Box/File | \$ 2665 |
| 62-2418PD2 | 1 | Modular Pedestal with File/File | \$ 2665 |
| 62-1622CD | 1 | Center Drawer | \$ 495 |

Products are available as left or right, where applicable

| | | | | | | | |
|--------------------------|------|----|----|----|-----|-------|------------------------|
| RECEPTION STATION L-UNIT | 62-2 | 80 | 82 | 42 | 587 | 141.3 | P\$ 14288 W\$ 14458 |
|--------------------------|------|----|----|----|-----|-------|------------------------|

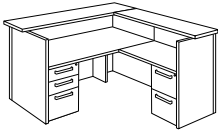

| CONSIST OF: | QTY | | |
|-------------|-----|--|----------------------|
| 62-3678RS | 1 | Reception Station Shell | P\$ 5586 W\$ 5661 |
| 62-2418PD1 | 1 | Modular Pedestal with Box/Box/File | \$ 2665 |
| 62-2542RSRF | 1 | Reception Station Return Shell - Right | \$ 2137 |
| 62-1270RTP | 1 | Return Shell Transaction Top | P\$ 1235 W\$ 1330 |
| 62-2418PD2 | 1 | Modular Pedestal with File/File | \$ 2665 |

Products are available as left or right, where applicable

| | | | | | | | |
|---|------|-----|-----|----|-----|-------|----------|
| RECEPTION STATION L-UNIT WITH SOLID SURFACE | 62-3 | 96¾ | 96¾ | 42 | 664 | 161.9 | \$ 16821 |
|---|------|-----|-----|----|-----|-------|----------|

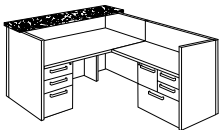

| CONSIST OF: | QTY | | |
|-------------|-----|--|---------|
| 62-3672RSS | 1 | Reception Station Shell with Solid Surface Top | \$ 7428 |
| 62-2418PD1 | 1 | Modular Pedestal with Box/Box/File | \$ 2665 |
| 62-2560RSRF | 1 | Reception Station Return Shell - Right | \$ 2564 |
| 62-2436MF1 | 1 | Modular Pedestal with Multi-File | \$ 4164 |

Products are available as left or right, where applicable

Pricing Codes:
P= Laminate Top
W= Wood Top

[See Aura Reception Intro Section for Ordering Options](#)

| Item | Model No. | Width | Depth | Height | Ship Wt | Cubic Ft | List Price |
|--------------------------|-----------|-------|-------|--------|---------|----------|------------------------|
| RECEPTION STATION U-UNIT | 62-4 | 86 | 88 | 42 | 755 | 187.2 | P\$ 18185 W\$ 18468 |

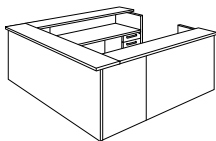

| CONSIST OF: | QTY | | |
|-----------------|-----|--|----------------------|
| 62-3084RS | 1 | Reception Station Shell | P\$ 5393 W\$ 5478 |
| 62-2554RSLF | 1 | Reception Station Return Shell - Left | \$ 2437 |
| 62-2554RSRF | 1 | Reception Station Return Shell - Right | \$ 2437 |
| 62-1276RTP_62-4 | 2 | Transaction Riser for Return Shell | P\$ 2588 |
| 62-1276RTP_62-4 | | | W\$ 2786 |
| 62-2418PD1 | 1 | Modular Pedestal with Box/Box/File | \$ 2665 |
| 62-2418PD2 | 1 | Modular Pedestal with File/File | \$ 2665 |

Products are available as left or right, where applicable

| | | | | | | | |
|--|------|----|----|----|-----|------|------------------------|
| RECEPTION STATION U-UNIT WITH GLASS TOPS | 62-5 | 86 | 94 | 42 | 804 | 19.8 | P\$ 28967 W\$ 29191 |
|--|------|----|----|----|-----|------|------------------------|

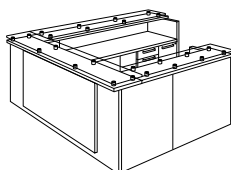

| CONSIST OF: | QTY | | |
|-------------|-----|--|----------------------|
| 62-3084RS | 1 | Reception Station Shell | P\$ 5393 W\$ 5478 |
| 62-84SOG | 1 | Optional Glass Top | \$ 3092 |
| 62-2542RSLF | 1 | Reception Station Return Shell - Left | \$ 2137 |
| 62-2560RSRF | 1 | Reception Station Return Shell - Right | \$ 2564 |
| 62-2418PD1 | 1 | Modular Pedestal with Box/Box/File | \$ 2665 |
| 62-2436MF1 | 1 | Modular Pedestal with Multi-File | \$ 4164 |
| 62-1264RTP | 1 | Transaction Riser for Return Shell | P\$ 1185 W\$ 1250 |
| 62-64SOG | 1 | Optional Glass Top | \$ 2511 |
| 62-1282RTP | 1 | Transaction Riser for Return Shell | P\$ 1364 W\$ 1438 |
| 62-82SOG | 1 | Optional Glass Top | \$ 3033 |
| 62-OV84 | 1 | Modesty Panel Overlay | \$ 859 |

Products are available as left or right, where applicable

Pricing Codes:

P= Laminate Top

W= Wood Top

[See Aura Reception Intro Section for Ordering Options](#)

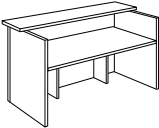
| Item | Model No. | Width | Depth | Height | K | R | Ship Wt | Cubic Ft | List Price |
|---|------------------------------|-------|-------|--------|-----|---|---------|----------|----------------------|
| RECEPTION DESK SHELL WITH TRANSACTION TOP  | 62-3696RS 94" Worksurface | 96 | 39 | 42 | 93¾ | 3 | 359 | 108.0 | P\$ 6325 W\$ 6378 |
| | 62-3690RS 88" Worksurface | 90 | 39 | 42 | 87¾ | 3 | 377 | 101.0 | P\$ 5990 W\$ 6056 |
| | 62-3684RS 82" Worksurface | 84 | 39 | 42 | 81¾ | 3 | 315 | 93.0 | P\$ 5816 W\$ 5894 |
| | 62-3678RS 76" Worksurface | 78 | 39 | 42 | 75¾ | 3 | 285 | 90.0 | P\$ 5586 W\$ 5661 |
| | 62-3672RS 70" Worksurface | 72 | 39 | 42 | 69¾ | 3 | 271 | 77.0 | P\$ 5319 W\$ 5393 |
| | 62-3666RS 64" Worksurface | 66 | 39 | 42 | 63¾ | 3 | 249 | 72.0 | P\$ 5073 W\$ 5175 |
| | 62-3660RS 58" Worksurface | 60 | 39 | 42 | 57¾ | 3 | 220 | 65.0 | P\$ 4962 W\$ 5054 |
| | 62-3096RS 94" Worksurface | 96 | 33 | 42 | 93¾ | 3 | 299 | 108.0 | P\$ 5864 W\$ 5934 |
| | 62-3090RS 88" Worksurface | 90 | 33 | 42 | 87¾ | 3 | 281 | 101.0 | P\$ 5540 W\$ 5616 |
| | 62-3084RS 82" Worksurface | 84 | 33 | 42 | 81¾ | 3 | 263 | 93.0 | P\$ 5393 W\$ 5478 |
| | 62-3078RS 76" Worksurface | 78 | 33 | 42 | 75¾ | 3 | 238 | 90.0 | P\$ 5182 W\$ 5287 |
| | 62-3072RS 70" Worksurface | 72 | 33 | 42 | 69¾ | 3 | 226 | 77.0 | P\$ 4982 W\$ 5053 |
| | 62-3066RS 64" Worksurface | 66 | 33 | 42 | 63¾ | 3 | 207 | 72.0 | P\$ 4741 W\$ 4856 |
| | 62-3060RS 58" Worksurface | 60 | 33 | 42 | 57¾ | 3 | 183 | 65.0 | P\$ 4626 W\$ 4725 |

Must Specify (in this order):

- Model #
- Transaction Top Material
- Finish/Color
- Edge Profile
- Tackboard
- Tackboard Fabric
- Grommet Location
- Grommet Color
- Overlay
- Overlay Color

Description

- Vertical Woodgrain on Chassis; Side-to-Side Woodgrain on Worksurface
- Available with Veneer (W) or HPL (P) Transaction Top, Must Specify
- Veneer Worksurface and Shell Desk with 12"D Veneer or HPL Transaction Top
- Worksurface Features Square Profiled Edge
- Transaction Top Profiled on All 4 Sides
- Stiffener Bar ([See Sizes](#)) Recommended Surfaces Not Supported by a Pedestal
- Optional Contrasting Modesty Panel Overlay ([See Overlay Options](#))
- Additional Options: Worksurface Grommet ([See Options and Locations](#)), Glass Transaction Top ([See Glass Sizes](#)), Center Drawer ([See Center Drawer](#)), Tackboard ([See Tackboards](#)), Wire Management, Sand Dollar Power and USB (Sold Separately, [See Accessories](#))

Pricing Codes:
P= Laminate Top
W= Wood Top

[See Aura Reception Intro Section for Ordering Options](#)

| Item | Model No. | Width | Depth | Height | K | R | Ship Wt | Cubic Ft | List Price |
|---|-------------------------------|-------|-------|--------|-----|---|---------|----------|------------|
|  <p>RECEPTION DESK SHELL WITH SOLID SURFACE TRANSACTION TOP</p> <p>Must Specify (in this order): Model # Finish Solid Surface Color Solid Surface Edge Tackboard Tackboard Fabric Grommet Location Grommet Color Overlay Overlay Color</p> | 62-3696RSS 94" Worksurface | 96 | 39 | 42 | 93¾ | 3 | 389 | 108.0 | \$ 9201 |
| | 62-3690RSS 88" Worksurface | 90 | 39 | 42 | 87¾ | 3 | 367 | 101.0 | \$ 8651 |
| | 62-3684RSS 82" Worksurface | 84 | 39 | 42 | 81¾ | 3 | 345 | 93.0 | \$ 8304 |
| | 62-3678RSS 76" Worksurface | 78 | 39 | 42 | 75¾ | 3 | 315 | 90.0 | \$ 7948 |
| | 62-3672RSS 70" Worksurface | 72 | 39 | 42 | 69¾ | 3 | 301 | 77.0 | \$ 7428 |
| | 62-3666RSS 64" Worksurface | 66 | 39 | 42 | 63¾ | 3 | 279 | 72.0 | \$ 7104 |
| | 62-3660RSS 58" Worksurface | 60 | 39 | 42 | 57¾ | 3 | 250 | 65.0 | \$ 6833 |
| | 62-3096RSS 94" Worksurface | 96 | 33 | 42 | 93¾ | 3 | 329 | 108.0 | \$ 8835 |
| | 62-3090RSS 88" Worksurface | 90 | 33 | 42 | 87¾ | 3 | 311 | 101.0 | \$ 8294 |
| | 62-3084RSS 82" Worksurface | 84 | 33 | 42 | 81¾ | 3 | 293 | 93.0 | \$ 7966 |
| | 62-3078RSS 76" Worksurface | 78 | 33 | 42 | 75¾ | 3 | 267 | 90.0 | \$ 7620 |
| | 62-3072RSS 70" Worksurface | 72 | 33 | 42 | 69¾ | 3 | 256 | 77.0 | \$ 7136 |
| | 62-3066RSS 64" Worksurface | 66 | 33 | 42 | 63¾ | 3 | 237 | 72.0 | \$ 6820 |
| | 62-3060RSS 58" Worksurface | 60 | 33 | 42 | 57¾ | 3 | 213 | 65.0 | \$ 6541 |

Description

- Vertical Woodgrain on Chassis; Side-to-Side Woodgrain on Worksurface
- Veneer Shell Desk with 12"D Solid Surface Transaction Top
- Worksurface Features Square Profiled Edge
- Transaction Top Profiled on All 4 Sides
- Optional Contrasting Modesty Panel Overlay ([See Overlay Options](#))
- Additional Options: Worksurface Grommet ([See Options and Locations](#)), Glass Transaction Top ([See Glass Sizes](#)), Center Drawer ([See Center Drawer](#)), Tackboard ([See Tackboards](#)), Wire Management, Sand Dollar Power and USB (Sold Separately, [See Accessories](#))

Pricing Codes:

P= Laminate Top
W= Wood Top

[See Aura Reception Intro Section for Ordering Options](#)

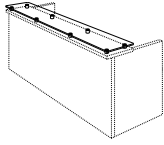
| Item | Model No. | Width | Depth | Height | Ship Wt | Cubic Ft | List Price |
|---|---|-------|-------|--------|---------|----------|------------|
| GLASS TRANSACTION TOP FOR DESK SHELLS  | 62-96SOG For Use With 96"W Reception Desk Shells | 98 | 12 | 3/8 | - | - | \$ 3200 |
| | 62-90SOG For Use With 90"W Reception Desk Shells | 92 | 12 | 3/8 | - | - | \$ 3148 |
| | 62-84SOG For Use With 84"W Reception Desk Shells | 86 | 12 | 3/8 | - | - | \$ 3092 |
| | 62-78SOG For Use With 78"W Reception Desk Shells | 80 | 12 | 3/8 | - | - | \$ 2660 |
| | 62-72SOG For Use With 72"W Reception Desk Shells | 74 | 12 | 3/8 | - | - | \$ 2604 |
| | 62-66SOG For Use With 66"W Reception Desk Shells | 68 | 12 | 3/8 | - | - | \$ 2549 |
| | 62-60SOG For Use With 60"W Reception Desk Shells | 62 | 12 | 3/8 | - | - | \$ 2496 |

Description

- For Desks with Veneer (W) or HPL (P) Transaction Tops
- Glass Top Featured a Self-Edge on All 4 Sides with 1/4" Silver Standoff
- Must be Field Installed
- Only Available on Bullnose, Tri-Round, Fluted, Square, or Tail Edge Tops ([See Edge Profiles](#))

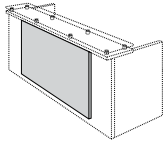
| | | | | | | | |
|---|--|----|---|--------|---|---|--------|
| MODESTY PANEL OVERLAY FOR DESK SHELLS  | 62-OV96 For Use With 96"W Reception Desk Shells | 72 | 1 | 37 1/2 | - | - | \$ 976 |
| | 62-OV90 For Use With 90"W Reception Desk Shells | 66 | 1 | 37 1/2 | - | - | \$ 922 |
| | 62-OV84 For Use With 84"W Reception Desk Shells | 60 | 1 | 37 1/2 | - | - | \$ 859 |
| | 62-OV78 For Use With 78"W Reception Desk Shells | 54 | 1 | 37 1/2 | - | - | \$ 783 |
| | 62-OV72 For Use With 72"W Reception Desk Shells | 48 | 1 | 37 1/2 | - | - | \$ 705 |
| | 62-OV66 For Use With 66"W Reception Desk Shells | 42 | 1 | 37 1/2 | - | - | \$ 643 |
| | 62-OV60 For Use With 60"W Reception Desk Shells | 36 | 1 | 37 1/2 | - | - | \$ 559 |

Must Specify (in this order):

Model #
Color

Description

- Veneer (W) Finish Color, Sugar Cookie (SC) or White (WH) Painted Accent Panel Creates Contemporary Modern Style
- Ships Factory Installed on Corresponding Width Reception Station Desk Shells

Pricing Codes:
P= Laminate Top
W= Wood Top

[See Aura Reception Intro Section for Ordering Options](#)

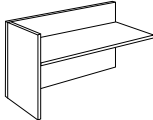
| Item | Model No. | Width | Depth | Height | K | Ship Wt | Cubic Ft | List Price | |
|---|-------------|--------------|-------|--------------------------------|--------------------------------|----------------------------------|----------|------------|---------|
| RECEPTION STATION RETURN SHELL  Shown as Left | Left | Right | | | | | | | |
| | 62-2560RSLF | 62-2560RSRF | 60 | 25 ³ / ₈ | 40 ¹ / ₂ | 58 ¹³ / ₁₆ | 139 | 39.0 | \$ 2564 |
| | 62-2554RSLF | 62-2554RSRF | 54 | 25 ³ / ₈ | 40 ¹ / ₂ | 52 ¹³ / ₁₆ | 125 | 35.0 | \$ 2437 |
| | 62-2548RSLF | 62-2548RSRF | 48 | 25 ³ / ₈ | 40 ¹ / ₂ | 46 ¹³ / ₁₆ | 116 | 32.0 | \$ 2243 |
| | 62-2542RSLF | 62-2542RSRF | 42 | 25 ³ / ₈ | 40 ¹ / ₂ | 40 ¹³ / ₁₆ | 102 | 30.0 | \$ 2137 |
| | 62-2536RSLF | 62-2536RSRF | 36 | 25 ³ / ₈ | 40 ¹ / ₂ | 34 ¹³ / ₁₆ | 87 | 26.0 | \$ 1999 |

Must Specify (in this order):

Model #

Finish

Grommet Location

Grommet Color

Description

- Vertical Woodgrain on Chassis; Front to Back on Worksurface
- Worksurface Features Square Edge
- See Below for Coordinating Optional Transaction Top and Glass Top (See Below and Page 565)
- Stiffener Bar ([See Sizes](#)) Recommended Surfaces Not Supported by a Pedestal
- Additional Options: Worksurface Grommet ([See Options and Locations](#)), Transaction Top (See Below), Wire Management, Sand Dollar Power and USB (Sold Separately, [See Accessories](#))

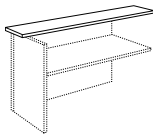
| Item | Model No. | Width | Depth | Height | K | Ship Wt | Cubic Ft | List Price | |
|---|---|-------|-------------------------------|-------------------------------|----|---------|----------------------|----------------------|--|
| WOOD TRANSACTION TOP FOR RETURN SHELL  Must Specify (in this order): Model # Material Finish/Color Edge Profile | 62-1288RTP | 88 | 12 | 1 ¹ / ₂ | - | 45 | 3.5 | P\$ 1396 W\$ 1484 | |
| | For Use with 36"D Desks and 60"W Returns | | | | | | | | |
| | 62-1282RTP | 82 | 12 | 1 ¹ / ₂ | - | 42 | 2.9 | P\$ 1364 W\$ 1438 | |
| | For Use with 36"D Desks and 54"W Returns or 33"D Desks and 60"W Returns | | | | | | | | |
| | 62-1276RTP | 76 | 12 | 1 ¹ / ₂ | - | 39 | 2.7 | P\$ 1294 W\$ 1393 | |
| | For Use with 36"D Desks and 48"W Returns or 33"D Desks and 54"W Returns | | | | | | | | |
| 62-1270RTP | 70 | 12 | 1 ¹ / ₂ | - | 36 | 2.5 | P\$ 1235 W\$ 1330 | | |
| For Use with 36"D Desks and 42"W Returns or 33"D Desks and 48"W Returns | | | | | | | | | |
| 62-1264RTP | 64 | 12 | 1 ¹ / ₂ | - | 33 | 2.3 | P\$ 1185 W\$ 1250 | | |
| For Use with 36"D Desks and 36"W Returns or 33"D Desks and 42"W Returns | | | | | | | | | |
| 62-1258RTP | 58 | 12 | 1 ¹ / ₂ | - | 30 | 2.1 | P\$ 1153 W\$ 1213 | | |
| For Use with 30"D Desks and 36"W Returns | | | | | | | | | |

Description

- Transaction Top for Use on the Return Shell (See Above)
- Profiled on All 4 Sides with Reverse Shape on Joining End
- Grain Runs Front to Back on Veneer Top; Side to Side on HPL (P) Top
- Optional Glass Transaction Top ([See Glass Sizes](#))

Pricing Codes:

P= Laminate Top

W= Wood Top

[See Aura Reception Intro Section for Ordering Options](#)

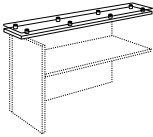
| Item | Model No. | Width | Depth | Height | Ship Wt | Cubic Ft | List Price |
|--|--|-------|-------|--------|---------|----------|------------|
| GLASS TOP FOR WOOD TRANSACTION TOPS FOR RETURN SHELL  | 62-88SOG For Use with 88"W Wood Transaction Top | 88 | 12 | ¾ | - | - | \$ 3117 |
| | 62-82SOG For Use with 82"W Wood Transaction Top | 82 | 12 | ¾ | - | - | \$ 3033 |
| | 62-76SOG For Use with 76"W Wood Transaction Top | 76 | 12 | ¾ | - | - | \$ 2626 |
| | 62-70SOG For Use with 70"W Wood Transaction Top | 70 | 12 | ¾ | - | - | \$ 2566 |
| | 62-64SOG For Use with 64"W Wood Transaction Top | 64 | 12 | ¾ | - | - | \$ 2511 |
| | 62-58SOG For Use with 58"W Wood Transaction Top | 58 | 12 | ¾ | - | - | \$ 2455 |

Must Specify (in this order):
Model #
Edge Profile

Description

- Glass Top Featured a Self-Edge on All 4 Sides with 1 ¼" Silver Standoff
- Field Installed on Corresponding Width Return Risers
- Only Available on Bullnose, Tri-Round, **Fluted**, Square, or Tail Edge Tops ([See Edge Profiles](#))

| | | | | | | | |
|---|------------|----|----|-----|----|-----|---------|
| MODULAR PEDESTAL WITH BOX/BOX/FILE | 62-2418PD1 | 18 | 24 | 28¼ | 82 | 9.4 | \$ 2665 |
|---|------------|----|----|-----|----|-----|---------|

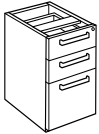

Must Specify (in this order):
Model #
Finish
Pull
Wire Management

Description

- Box/Box/File Locking Modular Pedestal; Legal Width Provides Legal or Letter Filing
- Lock Core Color will Coordinate with Pull Selection
- Vertical Grain on Chassis and Drawer Fronts

Options: Specify & Add

| | | |
|--------|-------------------------------------|--------|
| WMENDS | Wire Management on Both Side Panels | \$ 161 |
|--------|-------------------------------------|--------|

| | | | | | | | |
|--|------------|----|----|-----|----|-----|---------|
| MODULAR PEDESTAL WITH FILE/FILE | 62-2418PD2 | 18 | 24 | 28¼ | 82 | 9.4 | \$ 2665 |
|--|------------|----|----|-----|----|-----|---------|



Must Specify (in this order):
Model #
Finish
Pull
Wire Management

Description

- File/File Locking Modular Pedestal; Legal Width Provides Legal or Letter Filing
- Lock Core Color will Coordinate with Pull Selection
- Vertical Grain on Chassis and Drawer Fronts

Options: Specify & Add

| | | |
|--------|-------------------------------------|--------|
| WMENDS | Wire Management on Both Side Panels | \$ 161 |
|--------|-------------------------------------|--------|

Pricing Codes:
P= Laminate Top
W= Wood Top

[See Aura Reception Intro Section for Ordering Options](#)

| Item | Model No. | Width | Depth | Height | Ship Wt | Cubic Ft | List Price |
|---------------------------------------|-------------|-------------|-------|--------|---------|----------|------------|
| MODULAR PEDESTAL SINGLE DOOR BOOKCASE | Left | Right | | | | | |
| | 62-2418PD4L | 62-2418PD4R | 18 | 24 | 28¼ | 82 | 9.4 |

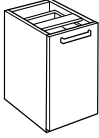
**Description**

- One Door with a 12"D Adjustable Shelf Inside Cabinet
- Vertical Grain on Chassis and Drawer Fronts

Must Specify (in this order):

Model #
Finish
Pull
Wire Management

Options: Specify & Add

| | | |
|--------|--|--------|
| LKT | Optional Locking Doors (Lock Core Color will Coordinate with Pull) | \$ 69 |
| WMENDS | Wire Management on Both Side Panels | \$ 161 |

| | | | | | | | |
|-------------------------------|------------|----|----|-----|-----|------|---------|
| MODULAR PEDESTAL LATERAL FILE | 62-2436LF1 | 36 | 24 | 28¼ | 143 | 17.2 | \$ 3381 |
| | 62-2430LF1 | 30 | 24 | 28¼ | 119 | 14.4 | \$ 3332 |

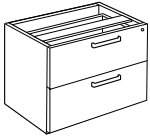
Must Specify (in this order):

Model #
Finish
Pull
Wire Management

Description

- Double Lateral File Locking Modular Pedestal; Drawers Provides Legal or Letter Filing
- Lock Core Color will Coordinate with Pull Selection
- Vertical Grain on Chassis and Drawer Fronts

Options: Specify & Add

| | | |
|--------|-------------------------------------|--------|
| WMENDS | Wire Management on Both Side Panels | \$ 161 |
|--------|-------------------------------------|--------|

| | | | | | | | |
|-----------------------------|------------|----|----|-----|-----|------|---------|
| MODULAR PEDESTAL MULTI-FILE | 62-2436MF1 | 36 | 24 | 28¼ | 143 | 17.2 | \$ 4164 |
| | 62-2430MF1 | 30 | 24 | 28¼ | 119 | 14.4 | \$ 4103 |

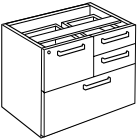
Must Specify (in this order):

Model #
Finish
Pull
Wire Management

Description

- Box/Box/File Over Lateral File
- Locking File Drawer Provides Legal or Letter Filing
- Lock Core Color will Coordinate with Pull Selection
- Vertical Grain on Chassis and Drawer Fronts

Options: Specify & Add

| | | |
|--------|-------------------------------------|--------|
| WMENDS | Wire Management on Both Side Panels | \$ 161 |
|--------|-------------------------------------|--------|

| | | | | | | | |
|---------------------------------------|-----------|----|----|-----|-----|------|---------|
| MODULAR PEDESTAL DOUBLE DOOR BOOKCASE | 62-2436DB | 36 | 24 | 28¼ | 145 | 17.2 | \$ 3081 |
| | 62-2430DB | 30 | 24 | 28¼ | 105 | 14.4 | \$ 2965 |

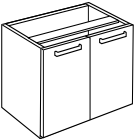
Must Specify (in this order):

Model #
Finish
Pull
Locking Door
Wire Management

Description

- Adjustable 12"D Shelf Inside Cabinet
- Vertical Grain on Chassis and Drawer Fronts
- Optional Locking Doors (See Below)

Options: Specify & Add

| | | |
|--------|--|--------|
| LKT | Optional Locking Doors (Lock Core Color will Coordinate with Pull) | \$ 91 |
| WMENDS | Wire Management on Both Side Panels | \$ 161 |

Pricing Codes:

P= Laminate Top
W= Wood Top

[See Aura Reception Intro Section for Ordering Options](#)

| Item | Model No. | Width | Depth | Height | Ship Wt | Cubic Ft | List Price |
|--|------------|-------|-------|--------|---------|----------|------------|
| STIFFENER BAR  | 01-00060SB | 60 | 1¾ | ¾ | 8 | 0.3 | \$ 129 |
| | 01-00048SB | 48 | 1¾ | ¾ | 5 | 0.3 | \$ 121 |

- Description**
- Reinforces Worksurfaces with Large Kneespace Widths
 - Includes End Caps to Cover Sharp Edges
 - Recommended in Kneespaces 60" or Greater
 - Field Installed

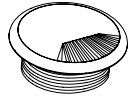
| | | | | | | | |
|---|-----------|--------|---|---|---|---|-------|
| ROUND GROMMET COVER FIELD INSTALLED  | 01-GRMTBK | Black | - | - | - | - | \$ 11 |
| | 01-GRMTSL | Silver | - | - | - | - | |

OPEN MARKET ONLY
(SILVER)

- Description**
- 60mm Round Grommet Cover
 - Field Installed

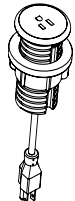
| | | | | | | | |
|---|-------------|--------|---|---|---|---|-------|
| SINGLE POWER SAND DOLLAR  | 01-SAND60PW | White | 3 | 3 | 4 | 1 | \$ 98 |
| | 01-SAND60PB | Black | | | | | |
| | 01-SAND60PS | Silver | | | | | |

- Description**
- Unit is 2" Diameter; Mounts in 60mm Round Grommet Cutout
 - 6' Cord
 - Single Power Outlet

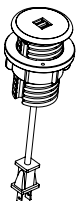
| | | | | | | | |
|---|-------------|--------|---|---|---|---|--------|
| DOUBLE USB SAND DOLLAR  | 01-SAND60UW | White | 3 | 3 | 4 | 1 | \$ 277 |
| | 01-SAND60UB | Black | | | | | |
| | 01-SAND60US | Silver | | | | | |

- Description**
- Unit is 2" Diameter; Mounts in 60mm Round Grommet Cutout
 - 6' Cord
 - Dual USB Outlets

Pricing Codes:
P= Laminate Top
W= Wood Top

[See Aura Reception Intro Section for Ordering Options](#)

| Item | Model No. | Width | Depth | Height | Ship Wt | Cubic Ft | List Price |
|-------------------------|-----------|-------|-------|--------|---------|----------|------------|
| WIRE MANAGEMENT CHANNEL | 01-WMGR4 | 16 | 1½ | ¾ | 1 | - | \$ 116 |

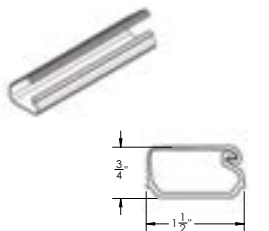
**Description**

- Set of Four (4) Black Plastic Wire Management Channels
- Snap Lock Channel
- Attaches with Adhesive Strips
- Ships via UPS Only

| | | | | | | | |
|--------------|----------|----|-------|---|-----|-----|--------|
| WIRE CHANNEL | 01-32125 | 24 | 1 5/8 | 1 | .25 | 0.3 | \$ 106 |
|--------------|----------|----|-------|---|-----|-----|--------|

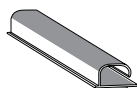
**Description**

- Available in Black
- Channels Attach with 2 Double-Sided Installation Tape
- Open J Channel for Easy Storage of Cables

| | | | | | | | |
|------------|-----------|-------|-------|--|---|---|-------|
| CABLE GRIP | 01-WMGRCB | 5 3/8 | 2 5/8 | | - | - | \$ 17 |
|------------|-----------|-------|-------|--|---|---|-------|

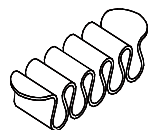
**Description**

- Under Surface Wire Management
- Black

| | | | | | | | |
|------------------------|--------------------------|-------|-------|-------|---|-----|--------|
| LINK 360 CABLE MANAGER | 01-0251LINKSLV Silver | 5 3/8 | 3 3/8 | 30-51 | 4 | 3.0 | \$ 390 |
| | 01-0251LINKBLK Black | 5 3/8 | 3 3/8 | 30-51 | 4 | 3.0 | \$ 353 |

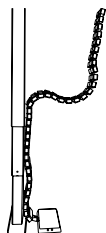
**Description**

- Kit Includes: 50 Link 360™ elements, 1 Quad Connector, 1 Dumbbell Connector, 1 Foot Assembly with Two (2) Magnetic Clips
- Can Be Used For Height-Adjustable Mechanisms Up To 51" or Free-Standing Use

Pricing Codes:

P= Laminate Top
W= Wood Top

[See Aura Reception Intro Section for Ordering Options](#)

| Item | Model No. | Width | Depth | Height | Ship Wt | Cubic Ft | List Price |
|---------------|-----------|-------|-------|--------|---------|----------|------------|
| CENTER DRAWER | 62-1622CD | 22 | 16 | 2¾ | 7 | 1.4 | \$ 495 |

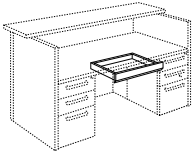

- Description**
- Fits Desks and Returns
 - Built in Pen Tray
 - Field Installed Only

Must Specify (in this order):
Model #
Finish

RECEPTION DESK SHELL TACKBOARDS
9" H

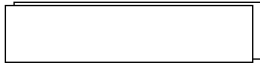

| Model # | Size | COM ydg | COM, 1, 2 or 3 | Grades | | | | | | | | | |
|---------|------|---------|-------------------|--------|-----|------|------|------|------|------|--|--|--|
| | | | | 4 | 5 | 6 | 7 | 8 | 9 | 10 | | | |
| TB-6296 | 96" | 3.00 | \$ 351 | 768 | 963 | 1161 | 1443 | 1737 | 2079 | 2475 | | | |
| TB-6290 | 90" | 2.75 | \$ 335 | 717 | 896 | 1078 | 1336 | 1606 | 1919 | 2282 | | | |
| TB-6284 | 84" | 2.50 | \$ 317 | 665 | 827 | 992 | 1227 | 1472 | 1757 | 2087 | | | |
| TB-6278 | 78" | 2.50 | \$ 311 | 659 | 821 | 986 | 1221 | 1466 | 1751 | 2081 | | | |
| TB-6272 | 72" | 2.25 | \$ 256 | 569 | 715 | 864 | 1075 | 1296 | 1552 | 1849 | | | |
| TB-6266 | 66" | 2.00 | \$ 232 | 510 | 640 | 772 | 960 | 1156 | 1384 | 1648 | | | |
| TB-6260 | 60" | 1.75 | \$ 219 | 462 | 576 | 692 | 856 | 1028 | 1227 | 1458 | | | |

Must Specify (in this order):
Model #
Tackboard Fabric Vendor, Pattern,
and Color

- Description**
- Coordinates with Reception Desk Shells
 - Factory Installed

Pricing Codes:
P= Laminate Top
W= Wood Top

[See Aura Reception Intro Section for Ordering Options](#)

The traditional stylings of Cameo echo history and create a timeless foundation for welcoming environments that complement our Jefferson, Wilmington, and Arlington casegoods collections, as well as Cameo Conferencing. Create a customized work environment through combinations of shells, components, and work surfaces that address multiple configuration options.

CONSTRUCTION

Cameo Reception features a veneer chassis with your choice of either a Veneer or HPL transaction counter.

VENEER

- Exposed surfaces are select grade sliced American Black Walnut and **Cherry** veneers carefully selected and matched to assure proper balance and consistency

TOPS

- Work surface tops are 3-ply balanced construction and 1½” thick with a self-edge
- Transaction tops are 1½” thick and have a 5-ply balanced construction in Veneer or 3-ply balanced construction in High Pressure Laminate
- Transaction tops have solid hardwood rims and are profiled on all sides with mitered corners
- Grain runs left to right unless otherwise stated

CHASSIS

- Tops and end panels are securely fastened using high quality European fastening systems to assure maximum strength
- All units have finished backs unless noted
- All pedestals have wire management access from pedestal to kneespace
- Decorative moldings are hand applied
- All units are equipped with heavy-duty, adjustable leveling glides to ensure proper leveling and compensation for uneven floors

DRAWERS

- Drawer fronts are 3-ply construction, ¾” thick with matched grain
- Drawer sides, back, and front are ½” thick, woodgrain vinyl wrapped construction with mitered corners
- Box and file drawers have ½” thick hardboard bottoms and tested for 100lb capacity
- Lateral files feature ¼” thick bottoms. Drawers are tested for 200lb of equally distributed weight (ex: hanging file folders) and 65lbs of bottom load weight (ex: stacked catalogs)
- 5-Sided drawer construction for easy removal of drawer fronts
- All drawers feature full extension, progressive action slides with precision steel ball bearings
- All suspensions have a limited lifetime warranty

FILING

- All file drawers are standard with filing systems designed to accommodate a variety of filing requirements
- Modular component pedestals provide letter filing front to back and legal filing side to side
- Lateral file drawers provide legal or letter filing front to back or side to side

STORAGE

- All hinged doors include soft close hinges, unless otherwise noted
- One piece hinge and base plate combination
- Soft close hinges reduce stress placed on the cabinet when the door is closed and offers a quiet closure

LOCKING

- All units with file drawers feature locking
- Removable black lock cylinders allow for units to be re-keyed at a later date if required
- Units are shipped randomly keyed as standard. Keyed alike units available upon request at no additional charge
- Keyed alike units available upon request at no additional charge

CORD MANAGEMENT

- Grommets may be ordered in the tops
- [See all grommet options and locations](#)
- Wire Managers available for additional cord management; [See Accessories](#)

INTERIOR DRAWER DIMENSIONS

Models

61-2418PDI

| Drawers | W | L | D |
|---------|------|------|-----|
| Box | 14½” | 15½” | 3½” |
| File | 14½” | 15½” | 9¼” |

Models

61-2418PD2

| Drawers | W | L | D |
|---------|------|------|-----|
| File | 14½” | 15½” | 9¼” |

Models

61-2436LFI

| Drawers | W | L | D |
|----------|------|------|-----|
| Lat File | 32½” | 15½” | 9¼” |

Models

61-2430LFI

| Drawers | W | L | D |
|----------|------|------|-----|
| Lat File | 26½” | 15½” | 9¼” |

Models

61-2436MF1

| Drawers | W | L | D |
|----------|------|------|-----|
| Box | 14½” | 15½” | 3½” |
| File | 14½” | 15½” | 9¼” |
| Lat File | 32½” | 15½” | 9¼” |

Models

61-2430MF1

| Drawers | W | L | D |
|----------|------|------|-----|
| Box | 11½” | 16¾” | 3½” |
| File | 12½” | 16¾” | 9¼” |
| Lat File | 26½” | 15½” | 9¼” |

Models

61-1622CD

| Drawers | W | L | D |
|---------|---|----|-----|
| Box | 1 | 15 | 1½” |

FILING CAPABILITIES

Drawers with Dimensions: 11¹/₁₆"W x 16³/₁₆"L

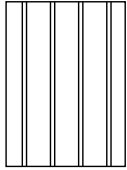

Letter or Legal Side to Side

Drawers with Dimensions: 12¹/₈"W x 16⁵/₃₂"L

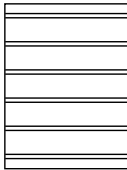

Letter Front to Back

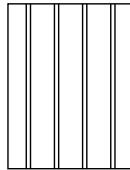

Letter or Legal Side to Side

Drawers with Dimensions: 14⁹/₃₂"W x 15¹/₁₆"L

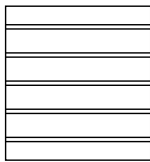

Letter Front to Back

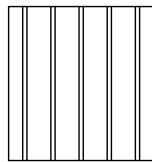

Legal Side to Side

Drawers with Dimensions: 32⁹/₃₂"W x 15¹/₁₆"L

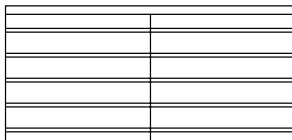

2 Rows Letter Front to Back

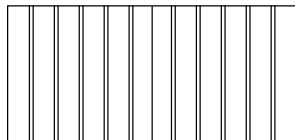

1 Row Legal Side to Side

Drawers with Dimensions: 26⁹/₃₂"W x 15¹/₁₆"L

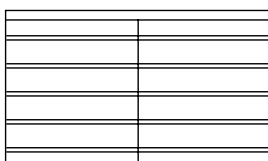

2 Rows Letter Front to Back

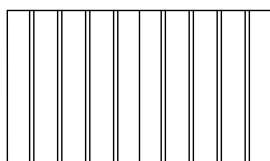

1 Row Legal Side to Side

HOW TO ORDER EXAMPLES

| | QTY | MODEL NO. | DESCRIPTION | EXAMPLE |
|-------------------|-----|-----------|------------------|----------------------|
| DESK SHELL | 1 | 61-3684RS | Top Material | P |
| | | | Finish/Color | CO |
| | | | Grommet/Location | GR |
| | | | Grommet Color | SLV |
| | | | Tackboard | YES |
| | | | Upholstery | Momentum Graph Alloy |

HOW TO ORDER EXAMPLES CONTINUED

| | | | | |
|---------------------|---|-------------|------------------|-----|
| RETURN SHELL | 1 | 61-2554RSRF | Finish | GO |
| | | | Grommet/Location | GR |
| | | | Grommet Color | SLV |

| | | | | |
|-----------------|---|------------|-----------------|--------|
| PEDESTAL | 1 | 61-2418PD2 | Finish | CO |
| | | | Pull | ALB |
| | | | Wire Management | WMENDS |

VENEER (W) OPTIONS

Veneer tops feature UVAdvantage, an ultra-violet finish, on all exposed surfaces by utilizing roll-coat UV technology

| | | | |
|-----|--------------------|-----|---------------------|
| AW | Artisan Walnut | LW | Legacy Walnut |
| CO | Columbian Walnut | MW | Mahogany Walnut |
| DC | Dark Cherry | MTS | Metropolis Sky |
| DFW | Dark Forest Walnut | PNW | Pinnacle Walnut |
| EW | Espresso | SCH | Select Cherry |
| GC | Golden Cherry | SKC | Shaker Cherry |
| HW | Harvest Walnut | WC | Williamsburg Cherry |
| HNW | Henna Walnut | | |

HPL (P) LAMINATE WORKSURFACE OPTIONS

WOODGRAIN

| | | | |
|----|------------------|-----|---------------------|
| CO | Columbian Walnut | PNW | Pinnacle Walnut |
| EF | Espresso | SCH | Select Cherry |
| GC | Golden Cherry | SKC | Shaker Cherry |
| MW | Mahogany Walnut | WC | Williamsburg Cherry |

EDGE PROFILES

CHASSIS/WORKSURFACES

Y Square

WOOD TRANSACTION COUNTERS

C2 Jefferson



Jefferson (C2)

PULL OPTIONS

| | | | |
|-----|----------------------------|-----|---------------------------|
| ARA | Arlington A, Antique Brass | ALB | Liberty, Aluminum |
| ARB | Arlington B, Antique Brass | WLM | Wilmington, Antique Brass |
| JEF | Jefferson, Antique Brass | | |



Arlington A
Antique Brass - 5/4"



Arlington B
Antique Brass - 5/4"



Jefferson
Antique Brass - 5/4"



Liberty
Aluminum - 5/4"



Wilmington
Antique Brass - 5/4"

GROMMET OPTIONS & LOCATIONS

Multiple locations may be selected. Black = BLK and Silver = SLV

| | | | |
|----|--------------------------------------|----|----|
| GC | Grommet, Center - Specify BLK or SLV | \$ | 52 |
| GL | Grommet, Left - Specify BLK or SLV | \$ | 52 |
| GR | Grommet, Right - Specify BLK or SLV | \$ | 52 |

Verify Grommet Option is available on the model(s) you are specifying using the following location information. Grommets may be ordered in non-standard locations. Call Customer Service to assist with specification and/or please attach a drawing to the PO showing the location of the grommet. Note additional charges and lead times may apply.

Models

| | | | |
|-----------|-----------|-----------|-----------|
| 61-3696RS | 61-3690RS | 61-3684RS | 61-3678RS |
| 61-3672RS | 61-3666RS | 61-3660RS | |

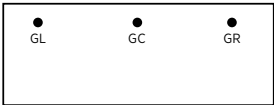

GL/GR: Located 6" from ends and 32 3/8" from user side
GC: Located 32 3/8" from user side

Models

| | | | |
|-----------|-----------|-----------|-----------|
| 61-3096RS | 61-3090RS | 61-3084RS | 61-3078RS |
| 61-3072RS | 61-3066RS | 61-3060RS | |



GL/GR: Located 6" from ends and 26 3/8" from user side
GC: Located 26 3/8" from user side

Models

| | | | |
|-------------|-------------|-------------|-------------|
| 61-2560RSLF | 61-2560RSRF | 61-2554RSLF | 61-2554RSRF |
| 61-2548RSLF | 61-2548RSRF | 61-2542RSLF | 61-2542RSRF |
| 61-2536RSLF | 61-2536RSRF | | |



GL/GR: Located 6" from ends and 21 3/8" from user side
GC: Located 21 3/8" from user side

CERTIFICATIONS & COMPLIANCE

- Intertek Sustainability Certified
- BIFMA level® Certified
- BIFMA Compliant Certified
- TSCA Title VI (formerly CARB) Compliance
- US Green Building's LEED Contribution

STATEMENT OF LINE

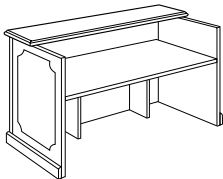

Reception Desk Shells with Transaction Counters
[\(See Details\)](#)

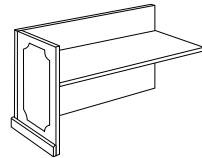

Reception Station Return Shell
[\(See Details\)](#)

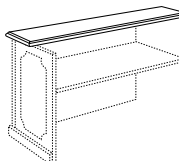

Return Transaction Counter
[\(See Details\)](#)

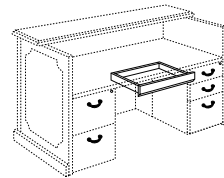

Optional Center Drawer
[\(See Details\)](#)



Component Ped Box/Box/File
[\(See Details\)](#)

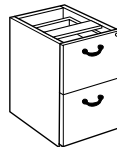

Component Ped File/File
[\(See Details\)](#)

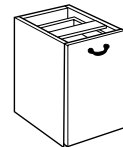

Component Ped Door Bookcase
[\(See Details\)](#)

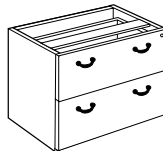

Component Ped Lateral File
[\(See Details\)](#)

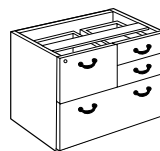

Component Ped Multi-File
[\(See Details\)](#)

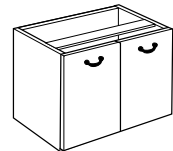

Component Ped Double Door Bookcase
[\(See Details\)](#)

[Sand Dollar Power/Data + Wire Management Accessories](#)

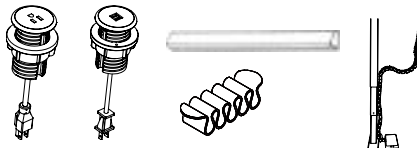

[Reception Desk Shell Tackboards](#)



| Item | Model No. | Width | Depth | Height | Ship Wt | Cubic Ft | List Price |
|---------------------------|-----------|-------|-------|--------|---------|----------|------------------------|
| RECEPTION DESK DOUBLE PED | 61-1 | 74 | 39 | 42 | 442 | 97.2 | P\$ 11625 W\$ 11847 |

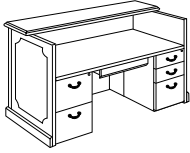

| CONSIST OF: | QTY | | |
|-------------|-----|------------------------------------|----------------------|
| 61-3672RS | 1 | Reception Station Shell | P\$ 5842 W\$ 6064 |
| 61-1622CD | 1 | Center Drawer | \$ 495 |
| 61-2418PD1 | 1 | Modular Pedestal with Box/Box/File | \$ 2644 |
| 61-2418PD2 | 1 | Modular Pedestal with File/File | \$ 2644 |

Products are available as left or right, where applicable

| Item | Model No. | Width | Depth | Height | Ship Wt | Cubic Ft | List Price |
|--------------------------|-----------|-------|-------|--------|---------|----------|------------------------|
| RECEPTION STATION L-UNIT | 61-2 | 74 | 82 | 42 | 590 | 130.5 | P\$ 14903 W\$ 15303 |

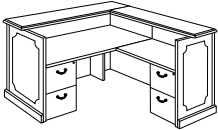

| CONSIST OF: | QTY | | |
|-------------|-----|--|----------------------|
| 61-3672RS | 1 | Reception Station Shell | P\$ 5842 W\$ 6064 |
| 61-2548RSRF | 1 | Reception Station Return Shell - Right | \$ 2524 |
| 61-1276RTP | 1 | Return Shell Transaction Riser | P\$ 1249 W\$ 1427 |
| 61-2418PD2 | 2 | Modular Pedestal with File/File | \$ 5288 |

Products are available as left or right, where applicable

| Item | Model No. | Width | Depth | Height | Ship Wt | Cubic Ft | List Price |
|--------------------------|-----------|-------|-------|--------|---------|----------|------------------------|
| RECEPTION STATION U-UNIT | 61-3 | 86 | 88 | 42 | 796 | 182.6 | P\$ 19766 W\$ 20203 |

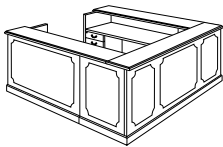

| CONSIST OF: | QTY | | |
|----------------|-----|--|----------------------|
| 61-3684RS | 1 | Reception Station Shell | P\$ 6437 W\$ 6518 |
| 61-2548RSLF | 1 | Reception Station Return Shell - Left | \$ 2524 |
| 61-2548RSRF | 1 | Reception Station Return Shell - Right | \$ 2524 |
| 61-1276RTP_613 | 2 | Transaction Riser for Return Shell | P\$ 2498 W\$ 2854 |
| 61-2418PD1 | 1 | Modular Pedestal with Box/Box/File | \$ 2644 |
| 61-2418PD2 | 1 | Modular Pedestal with File/File | \$ 2644 |
| 61-1622CD | 1 | Center Drawer | \$ 495 |

Products are available as left or right, where applicable

Pricing Codes:

P= Laminate Top
W= Wood Top

[See Cameo Reception Intro Section for Ordering Options](#)

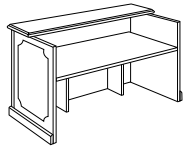
| Item | Model No. | Width | Depth | Height | K | R | Ship Wt | Cubic Ft | List Price |
|---|------------------------------|-------|-------|--------|-----|---|---------|----------|----------------------|
| RECEPTION DESK SHELL WITH TRANSACTION TOP  | 61-3696RS 94" Worksurface | 96 | 39 | 42 | 93¾ | 3 | 359 | 108.0 | P\$ 6980 W\$ 7162 |
| | 61-3690RS 88" Worksurface | 90 | 39 | 42 | 87¾ | 3 | 377 | 101.0 | P\$ 6720 W\$ 6806 |
| | 61-3684RS 82" Worksurface | 84 | 39 | 42 | 81¾ | 3 | 315 | 93.0 | P\$ 6437 W\$ 6518 |
| | 61-3678RS 76" Worksurface | 78 | 39 | 42 | 75¾ | 3 | 285 | 90.0 | P\$ 6221 W\$ 6228 |
| | 61-3672RS 70" Worksurface | 72 | 39 | 42 | 69¾ | 3 | 271 | 77.0 | P\$ 5842 W\$ 6064 |
| | 61-3666RS 64" Worksurface | 66 | 39 | 42 | 63¾ | 3 | 249 | 72.0 | P\$ 5645 W\$ 5782 |
| | 61-3660RS 58" Worksurface | 60 | 39 | 42 | 57¾ | 3 | 220 | 65.0 | P\$ 5474 W\$ 5621 |
| | 61-3096RS 94" Worksurface | 96 | 33 | 42 | 93¾ | 3 | 299 | 108.0 | P\$ 6322 W\$ 6469 |
| | 61-3090RS 88" Worksurface | 90 | 33 | 42 | 87¾ | 3 | 281 | 101.0 | P\$ 6196 W\$ 6296 |
| | 61-3084RS 82" Worksurface | 84 | 33 | 42 | 81¾ | 3 | 263 | 93.0 | P\$ 5949 W\$ 6037 |
| | 61-3078RS 76" Worksurface | 78 | 33 | 42 | 75¾ | 3 | 238 | 90.0 | P\$ 5747 W\$ 5850 |
| | 61-3072RS 70" Worksurface | 72 | 33 | 42 | 69¾ | 3 | 226 | 77.0 | P\$ 5432 W\$ 5665 |
| | 61-3066RS 64" Worksurface | 66 | 33 | 42 | 63¾ | 3 | 207 | 72.0 | P\$ 5236 W\$ 5381 |
| | 61-3060RS 58" Worksurface | 60 | 33 | 42 | 57¾ | 3 | 183 | 65.0 | P\$ 5074 W\$ 5232 |

Must Specify (in this order):
 Model #
 Transaction Top Material
 Finish/Color
 Transaction Top Edge
 Grommet Location
 Grommet Color
 Tackboard
 Tackboard Fabric

Description

- Vertical Woodgrain on Chassis; Side-to-Side Woodgrain on Worksurface
- Available with Veneer (W) or HPL (P) Transaction Top, Must Specify
- Veneer Worksurface and Shell Desk with 12"D Veneer or HPL Transaction Top
- Worksurface Features Square Profiled Edge
- Transaction Top Profiled on All 4 Sides
- Stiffener Bar ([See Sizes](#)) Recommended for Surfaces Not Supported by a Pedestal
- Additional Options: Center Drawer ([See Center Drawer](#)), Tackboard ([See Tackboards](#)), Sand Dollar Power and USB + Wire Management (Sold Separately, [See Accessories](#))

Pricing Codes:
 P= Laminate Top
 W= Wood Top

[See Cameo Reception Intro Section for Ordering Options](#)

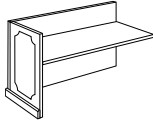
| Item | Model No. | Width | Depth | Height | K | R | Ship Wt | Cubic Ft | List Price | |
|--|-------------|--------------|-------|----------------------------------|-----|----------------------------------|---------|----------|------------|---------|
| RECEPTION STATION RETURN SHELL  | Left | Right | | | | | | | | |
| | 61-2560RSLF | 61-2560RSRF | 60½ | 25 ¹⁵ / ₁₆ | 40½ | 58 ¹³ / ₁₆ | - | 139 | 39.0 | \$ 2831 |
| | 61-2554RSLF | 61-2554RSRF | 54½ | 25 ¹⁵ / ₁₆ | 40½ | 52 ¹³ / ₁₆ | - | 125 | 35.0 | \$ 2694 |
| | 61-2548RSLF | 61-2548RSRF | 48½ | 25 ¹⁵ / ₁₆ | 40½ | 46 ¹³ / ₁₆ | - | 116 | 32.0 | \$ 2524 |
| | 61-2542RSLF | 61-2542RSRF | 42½ | 25 ¹⁵ / ₁₆ | 40½ | 40 ¹³ / ₁₆ | - | 102 | 30.0 | \$ 2428 |
| | 61-2536RSLF | 61-2536RSRF | 36½ | 25 ¹⁵ / ₁₆ | 40½ | 34 ¹³ / ₁₆ | - | 87 | 26.0 | \$ 2276 |

Shown as Left

Must Specify (in this order):

Model #
 Finish/Color
 Grommet Location
 Grommet Color

Description

- Vertical Woodgrain on Chassis; Front-to-Back Woodgrain on Worksurface
- Worksurface Features Square Profiled Edge
- Stiffener Bar ([See Sizes](#)) Recommended for Surfaces Not Supported by a Pedestal
- See Below for Coordinating Optional Transaction Top
- Additional Options: Tackboard ([See Tackboards](#)), Sand Dollar Power and USB + Wire Management (Sold Separately, [See Accessories](#))

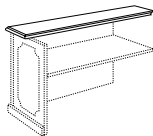
| Item | Model No. | Width | Depth | Height | K | R | Ship Wt | Cubic Ft | List Price | |
|---|---|-------|------------------|------------------|---|----|---------|----------------------|----------------------|--|
| WOOD TRANSACTION TOP FOR RETURN SHELL  | 61-1288RTP | 88 | 12 | 1½ ₃₂ | - | - | 45 | 3.5 | P\$ 1335 W\$ 1499 | |
| | For Use with 39" Desks and 60" Returns | | | | | | | | | |
| | 61-1282RTP | 82 | 12 | 1½ ₃₂ | - | - | 42 | 2.9 | P\$ 1308 W\$ 1473 | |
| | For Use with 39" Desks and 54" Returns or 33" Desks and 60" Returns | | | | | | | | | |
| | 61-1276RTP | 76 | 12 | 1½ ₃₂ | - | - | 39 | 2.7 | P\$ 1249 W\$ 1427 | |
| | For Use with 39" Desks and 48" Returns or 33" Desks and 54" Returns | | | | | | | | | |
| 61-1270RTP | 70 | 12 | 1½ ₃₂ | - | - | 36 | 2.5 | P\$ 1199 W\$ 1402 | | |
| For Use with 39" Desks and 42" Returns or 33" Desks and 48" Returns | | | | | | | | | | |
| 61-1264RTP | 64 | 12 | 1½ ₃₂ | - | - | 33 | 2.3 | P\$ 1159 W\$ 1341 | | |
| For Use with 39" Desks and 36" Returns or 33" Desks and 42" Returns | | | | | | | | | | |
| 61-1258RTP | 58 | 12 | 1½ ₃₂ | - | - | 30 | 2.1 | P\$ 1125 W\$ 1318 | | |
| For Use with 39" Desks and 36" Returns or 33" Desks and 42" Returns | | | | | | | | | | |

Description

- For Use with Return Shell, See Above
- Profiled on All 4 Sides with Reverse Shape on Joining End
- Grain Runs Front to Back on Veneer Top; Side to Side on HPL Top

Pricing Codes:

P= Laminate Top
 W= Wood Top

[See Cameo Reception Intro Section for Ordering Options](#)

| Item | Model No. | Width | Depth | Height | Ship Wt | Cubic Ft | List Price |
|---|------------|-------|-------|--------|---------|----------|------------|
| MODULAR PEDESTAL WITH BOX/BOX/FILE | 61-2418PD1 | 18 | 24 | 28¾ | 82 | 9.4 | \$ 2644 |

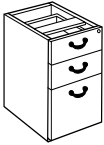

Description

- Box/Box/File Locking Modular Pedestal
- Black Lock Core
- File Drawer Provides Legal or Letter Filing
- Vertical Grain on Chassis and Drawer Fronts

Must Specify (in this order):

- Model #
- Finish
- Pull/Pull Color
- Wire Management

Options: Specify & Add

| | | |
|--------|-------------------------------------|--------|
| WMENDS | Wire Management on Both Side Panels | \$ 161 |
|--------|-------------------------------------|--------|

| | | | | | | | |
|--|------------|----|----|-----|----|-----|---------|
| MODULAR PEDESTAL WITH FILE/FILE | 61-2418PD2 | 18 | 24 | 28¾ | 82 | 9.4 | \$ 2644 |
|--|------------|----|----|-----|----|-----|---------|

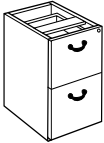

Description

- File/File Locking Modular Pedestal
- Black Lock Core
- File Drawer Provides Legal or Letter Filing
- Vertical Grain on Chassis and Drawer Fronts

Must Specify (in this order):

- Model #
- Finish
- Pull/Pull Color
- Wire Management

Options: Specify & Add

| | | |
|--------|-------------------------------------|--------|
| WMENDS | Wire Management on Both Side Panels | \$ 161 |
|--------|-------------------------------------|--------|

| MODULAR PEDESTAL SINGLE DOOR BOOKCASE | Left | Right | Width | Depth | Height | Ship Wt | Cubic Ft | List Price |
|---------------------------------------|-------------|-------------|-------|-------|--------|---------|----------|------------|
| | 61-2418PD4L | 61-2418PD4R | | | | | | |

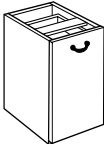

Description

- One Door with 12"D Adjustable Shelf Inside Cabinet
- Vertical Grain on Chassis and Door Front

Options: Specify & Add

| | | |
|--------|-------------------------------------|--------|
| LKT | Optional Locking | \$ 69 |
| WMENDS | Wire Management on Both Side Panels | \$ 161 |

Must Specify (in this order):

- Model #
- Finish
- Pull/Pull Color
- Locking Door
- Wire Management

Pricing Codes:
P= Laminate Top
W= Wood Top

[See Cameo Reception Intro Section for Ordering Options](#)

| Item | Model No. | Width | Depth | Height | Ship Wt | Cubic Ft | List Price |
|--|------------|-------|-------|--------|---------|----------|------------|
| MODULAR PEDESTAL WITH LATERAL FILE | 61-2436LF1 | 36 | 24 | 28¼ | 143 | 17.2 | \$ 3346 |
| | 61-2430LF1 | 30 | 24 | 28¼ | 119 | 14.4 | \$ 3295 |
| Description | | | | | | | |
| <ul style="list-style-type: none"> • Double Lateral File Locking Modular Pedestal • Black Lock Core • Lateral File Drawers Provides Legal or Letter Filing • Vertical Grain on Chassis and Drawer Fronts | | | | | | | |
| Options: Specify & Add | | | | | | | |
| WMENDS Wire Management on Both Side Panels | | | | | | | \$ 161 |

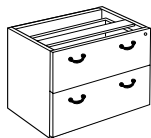

Must Specify (in this order):

Model #
Finish
Pull
Wire Management

| | | | | | | | |
|---|------------|----|----|-----|-----|------|---------|
| MODULAR PEDESTAL WITH MULTI-FILE | 61-2436MF1 | 36 | 24 | 28¼ | 143 | 17.2 | \$ 4147 |
| | 61-2430MF1 | 30 | 24 | 28¼ | 119 | 14.4 | \$ 4074 |
| Description | | | | | | | |
| <ul style="list-style-type: none"> • Box/Box/File Over Lateral File • Black Lock Core • Locking File Drawer Provides Legal or Letter Filing • Vertical Grain on Chassis and Drawer Fronts | | | | | | | |
| Options: Specify & Add | | | | | | | |
| WMENDS Wire Management on Both Side Panels | | | | | | | \$ 161 |

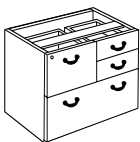

Must Specify (in this order):

Model #
Finish
Pull
Wire Management

| | | | | | | | |
|--|-----------|----|----|-----|-----|------|---------|
| MODULAR PEDESTAL DOUBLE DOOR BOOKCASE | 61-2436DB | 36 | 24 | 28¼ | 145 | 17.2 | \$ 3045 |
| | 61-2430DB | 30 | 24 | 28¼ | 105 | 14.4 | \$ 2920 |
| Description | | | | | | | |
| <ul style="list-style-type: none"> • Adjustable 12"D Shelf Inside Cabinet • Vertical Grain on Chassis and Door Fronts • Optional Locking Door (See Below) | | | | | | | |
| Options: Specify & Add | | | | | | | |
| LKT Optional Locking | | | | | | | \$ 91 |
| WMENDS Wire Management on Both Side Panels | | | | | | | \$ 161 |

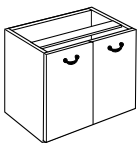

Must Specify (in this order):

Model #
Finish
Pull
Locking Door
Wire Management

Pricing Codes:

P= Laminate Top
W= Wood Top

[See Cameo Reception Intro Section for Ordering Options](#)

| Item | Model No. | Width | Depth | Height | Ship Wt | Cubic Ft | List Price |
|--|------------|-------|-------|--------|---------|----------|------------|
| STIFFENER BAR  | 01-00060SB | 60 | 1¾ | ¾ | 8 | 0.3 | \$ 129 |
| | 01-00048SB | 48 | 1¾ | ¾ | 5 | 0.3 | \$ 121 |

- Description**
- Reinforces Worksurfaces with Large Kneespace Widths
 - Includes End Caps to Cover Sharp Edges
 - Recommended in Kneespaces 60" or Greater
 - Field Installed

| | | | | | | | |
|---|-----------|--------|---|---|---|---|-------|
| ROUND GROMMET COVER FIELD INSTALLED  | 01-GRMTBK | Black | - | - | - | - | \$ 11 |
| | 01-GRMTSL | Silver | - | - | - | - | |

OPEN MARKET ONLY
(SILVER)

- Description**
- 60mm Round Grommet Cover
 - Field Installed

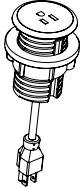
| | | | | | | | |
|---|-------------|--------|---|---|---|---|-------|
| SINGLE POWER SAND DOLLAR  | 01-SAND60PW | White | 3 | 3 | 4 | 1 | \$ 98 |
| | 01-SAND60PB | Black | | | | | |
| | 01-SAND60PS | Silver | | | | | |

- Description**
- Unit is 2" Diameter; Mounts in 60mm Round Grommet
 - 6' Cord
 - Single Power Outlet

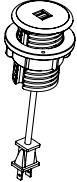
| | | | | | | | |
|---|-------------|--------|---|---|---|---|--------|
| DOUBLE USB SAND DOLLAR  | 01-SAND60UW | White | 3 | 3 | 4 | 1 | \$ 277 |
| | 01-SAND60UB | Black | | | | | |
| | 01-SAND60US | Silver | | | | | |

- Description**
- Unit is 2" Diameter; Mounts in 60mm Round Grommet
 - 6' Cord
 - Dual USB Outlets

Pricing Codes:
P= Laminate Top
W= Wood Top

[See Cameo Reception Intro Section for Ordering Options](#)

| Item | Model No. | Width | Depth | Height | Ship Wt | Cubic Ft | List Price |
|-------------------------|-----------|-------|-------|--------|---------|----------|------------|
| WIRE MANAGEMENT CHANNEL | 01-WMGR4 | 16 | 1½ | ¾ | 1 | - | \$ 116 |

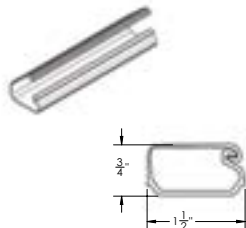
**Description**

- Set of Four (4) Black Plastic Wire Management Channels
- Snap Lock Channel
- Attaches with Adhesive Strips
- Ships via UPS Only

| | | | | | | | |
|--------------|----------|----|-------|---|-----|-----|--------|
| WIRE CHANNEL | 01-32125 | 24 | 1 5/8 | 1 | .25 | 0.3 | \$ 106 |
|--------------|----------|----|-------|---|-----|-----|--------|

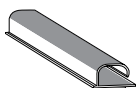
**Description**

- Available in Black
- Channels Attach with 2 Double-Sided Installation Tape
- Open J Channel for Easy Storage of Cables

| | | | | | | | |
|------------|-----------|-------|-------|---|---|---|--------|
| CABLE GRIP | 01-WMGRCB | 5 3/8 | 2 5/8 | - | - | - | \$ 117 |
|------------|-----------|-------|-------|---|---|---|--------|

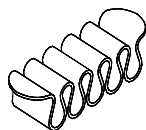
**Description**

- Under Surface Wire Management
- Black

| | | | | | | | |
|------------------------|--------------------------|--------|--------|-------|---|-----|--------|
| LINK 360 CABLE MANAGER | 01-0251LINKSLV Silver | 5 3/16 | 3 3/16 | 30-51 | 4 | 3.0 | \$ 390 |
| | 01-0251LINKBLK Black | 5 3/16 | 3 3/16 | 30-51 | 4 | 3.0 | \$ 353 |

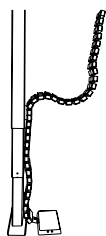
**Description**

- Kit Includes: 50 Link 360™ elements, 1 Quad Connector, 1 Dumbbell Connector, 1 Foot Assembly with Two (2) Magnetic Clips
- Can Be Used For Height-Adjustable Mechanisms Up To 51" or Free-Standing Use

Pricing Codes:

P= Laminate Top
W= Wood Top

[See Cameo Reception Intro Section for Ordering Options](#)

| Item | Model No. | Width | Depth | Height | Ship Wt | Cubic Ft | List Price |
|---------------|-----------|-------|-------|--------|---------|----------|------------|
| CENTER DRAWER | 61-1622CD | 22 | 16 | 2¾ | 7 | 1.4 | \$ 495 |

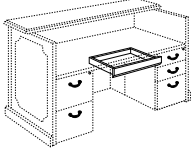

- Description**
- Attaches to Under Side of Worksurface
 - Built in Pen Tray
 - Field Installed Only

Must Specify (in this order):
Model #
Finish

RECEPTION DESK SHELL TACKBOARDS
9" H



| Model # | Size | COM ydg | COM, 1, 2 or 3 | Grades | | | | | | | | | |
|---------|------|---------|-------------------|--------|-----|------|------|------|------|------|--|--|--|
| | | | | 4 | 5 | 6 | 7 | 8 | 9 | 10 | | | |
| TB-6196 | 96" | 3.00 | \$ 351 | 768 | 963 | 1161 | 1443 | 1737 | 2079 | 2475 | | | |
| TB-6190 | 90" | 2.75 | \$ 335 | 717 | 896 | 1078 | 1336 | 1606 | 1919 | 2282 | | | |
| TB-6184 | 84" | 2.50 | \$ 317 | 665 | 827 | 992 | 1227 | 1472 | 1757 | 2087 | | | |
| TB-6178 | 78" | 2.50 | \$ 311 | 659 | 821 | 986 | 1221 | 1466 | 1751 | 2081 | | | |
| TB-6172 | 72" | 2.25 | \$ 256 | 569 | 715 | 864 | 1075 | 1296 | 1552 | 1849 | | | |
| TB-6166 | 66" | 2.00 | \$ 232 | 510 | 640 | 772 | 960 | 1156 | 1384 | 1648 | | | |
| TB-6160 | 60" | 1.75 | \$ 219 | 462 | 576 | 692 | 856 | 1028 | 1227 | 1458 | | | |

Must Specify (in this order):
Model #
Tackboard Fabric Vendor, Pattern,
and Color

- Description**
- Coordinates with Reception Desk Shells
 - Factory Installed

Pricing Codes:
P= Laminate Top
W= Wood Top

[See Cameo Reception Intro Section for Ordering Options](#)

Explore Canvas Reception models, sizes, and premium details to heighten function and luxury for the user, the environment, and all of your visitors. Choose from waterfall transaction counters with paper slots, conventional transaction counters available in a variety of materials, matching or contrasting overlays, backlighting, extended gallery returns with storage, ADA returns, and more!

CONSTRUCTION

Canvas Reception features a TFL chassis with your choice of TFL or HPL Top and TFL, HPL, or Solid Surface transaction counters. Units ship assembled unless otherwise noted.

LAMINATES

- Exposed surfaces are woodgrain and solid color laminates
- Worksurfaces are bonded to the core with a PVA adhesive in a cold press to prevent separation of the laminate from the core
- Each laminate offers lasting beauty, superior resistance to normal wear, and easy maintenance

TOPS

- Worksurfaces are 1" thick thermally-fused laminate (TFL) or High Pressure Laminate (HPL) with 1mm matching PVC rims in a square profile; Designer White, Sugar Maple, Williamsburg Cherry feature ABS edge bands
- Worksurfaces are shaped on all four sides and fit flush with adjoining worksurfaces for a clean aesthetic
- Transaction tops in TFL or HPL are edge-banded and have a self-edge on all sides
- Accent tops of 3/8" glass with 1/4" silver standoffs are available
- Transaction tops in Solid Surface materials are 1/2" thick and available in 6 standard colors

CHASSIS/COMPONENTS

- TFL chassis and storage components
- Worksurfaces, storage components and end panels are securely fastened using high quality European fastening systems, 16-gauge joining brackets and wooden dowels to assure maximum strength
- Exposed edges have matching PVC edge band
- All units are equipped with heavy-duty glides featuring 1 1/4" adjustment to ensure proper leveling and compensation for uneven floors
- All modular components have standard wire openings from inside the pedestal to the kneespace allowing quick access to technology below

DRAWERS

- Drawers feature 5-sided construction allowing for easy removal of drawer fronts
- Drawer fronts are 3-ply, 3/4" thick thermally fused laminate on both faces with matching PVC banded edges
- All drawer sides are 1/2" thick woodgrain vinyl-wrapped construction with mitered corners
- Box and file drawers have 1/8" thick hardboard bottoms and tested for 100lb capacity
- Lateral files feature 1/4" thick bottoms. Drawers are tested for 200lb of equally distributed weight (ex: hanging file folders) and 65lbs of bottom load weight (ex: stacked catalogs)
- All drawers feature full extension, progressive action slides with precision steel ball bearings
- All suspensions have a limited lifetime warranty

FILING

- All file drawers are standard with filing systems designed to accommodate a variety of filing requirements
- Letter width file drawers provide letter filing front to back and legal filing side to side
- Lateral file drawers provide legal or letter filing front to back or side to side

LOCKING

- All units with file drawers feature locking
- Removable lock cylinders allow for units to be re-keyed at a later date, if required
- Units are shipped randomly keyed as standard
- Keyed alike units available upon request at no additional charge
- Lock core will match pull color (if applicable, otherwise specify)

INTERIOR DRAWER DIMENSIONS

Model

66-2415PD1

Drawers

| | W | L | D |
|------|---------|----------|---------|
| Box | 12 1/8" | 16 3/16" | 3 1/2" |
| File | 12 1/8" | 16 3/16" | 9 5/16" |

Model

66-2418PD1

Drawers

| | W | L | D |
|------|----------|---------|---------|
| Box | 14 9/32" | 15 1/8" | 3 1/2" |
| File | 14 9/32" | 15 1/8" | 9 5/16" |

Model

66-2436LF1

Drawers

| | W | L | D |
|----------|----------|----------|---------|
| Lat File | 32 7/32" | 15 1/16" | 9 7/32" |

Model

66-2430LF1

Drawers

| | W | L | D |
|----------|----------|----------|---------|
| Lat File | 26 7/32" | 15 1/16" | 9 7/32" |

Model

66-2430LF2

Drawers

| | W | L | D |
|----------|----------|----------|---------|
| Box | 11 5/16" | 16 3/16" | 3 1/2" |
| File | 12 1/8" | 16 3/16" | 9 5/16" |
| Lat File | 26 7/32" | 15 1/16" | 9 1/4" |

Model

66-2436LF2

Drawers

| | W | L | D |
|----------|----------|----------|---------|
| Box | 14 9/32" | 15 1/8" | 3 1/2" |
| File | 14 9/32" | 15 1/8" | 9 5/16" |
| Lat File | 32 7/32" | 15 1/16" | 9 7/32" |

Model

66-2415PD2

Drawers

| | W | L | D |
|------|---------|----------|---------|
| File | 12 1/8" | 16 3/16" | 9 5/16" |

Model

66-2418PD2

Drawers

| | W | L | D |
|------|----------|---------|---------|
| File | 14 9/32" | 15 1/8" | 9 5/16" |

INTERIOR DRAWER DIMENSIONS (CONTINUED)

Model

66-2436OMF

| Drawers | W | L | D |
|----------|-----------------------------------|-----------------------------------|----------------------------------|
| File | 14 ⁹ / ₃₂ " | 15 ¹ / ₈ " | 3 ¹ / ₂ " |
| Lat File | 32 ⁹ / ₃₂ " | 15 ¹ / ₁₆ " | 9 ⁷ / ₃₂ " |

Model

66-2430OMF

| Drawers | W | L | D |
|----------|-----------------------------------|-----------------------------------|---------------------------------|
| Box | 11 ⁵ / ₁₆ " | 16 ³ / ₁₆ " | 3 ¹ / ₂ " |
| Lat File | 26 ⁹ / ₃₂ " | 15 ¹ / ₁₆ " | 9 ¹ / ₄ " |

Model

64-2595ERSWD2L46 64-2595ERSWD2L41 64-2583ERSWD2L23

64-2595ERSWD2L35 64-2583ERSWD2L34 64-2583ERSWD2L29

| Drawers | W | L | D |
|---------|-----------------------------------|----------------------------------|----------------------------------|
| Box | 14 ⁹ / ₃₂ " | 15 ¹ / ₈ " | 3 ¹ / ₂ " |
| File | 14 ⁹ / ₃₂ " | 15 ¹ / ₈ " | 9 ⁵ / ₁₆ " |

FILING CAPABILITIES

Drawers with Dimensions: 11⁵/₁₆"W x 16³/₁₆"L

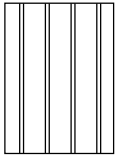

Letter or Legal Side to Side

Drawers with Dimensions: 12¹/₈"W x 16⁵/₃₂"L



Letter Front to Back

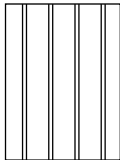

Letter or Legal Side to Side

Drawers with Dimensions: 12¹/₈"W x 16³/₁₆"L



Letter Front to Back

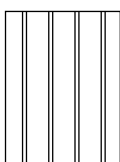

Legal Side to Side

Drawers with Dimensions: 14⁹/₃₂"W x 15¹/₈"L

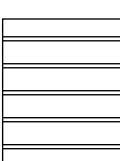

Letter Front to Back

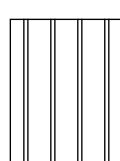

Legal Side to Side

Drawers with Dimensions: 26⁹/₃₂"W x 15¹/₁₆"L

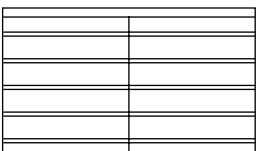

2 Rows Letter Front to Back

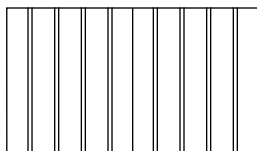

1 Row Legal Side to Side

Drawers with Dimensions: 32⁹/₃₂"W x 15¹/₁₆"L

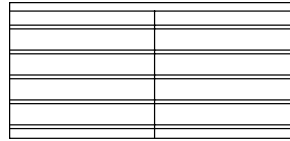

2 Rows Letter Front to Back

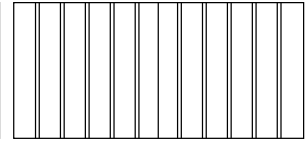

1 Row Legal Side to Side

HOW TO ORDER EXAMPLES

| | QTY | MODEL NO. | DESCRIPTION | EXAMPLE |
|-------------------|---------------------|-------------|--------------------|-------------|
| DESK SHELL | 1 | 64-3066RSRL | Color | AS |
| | | | Overlay | HGA |
| | | | Overlay Color | WHA |
| | | | Back Lighting | YES |
| | | | Grommet | GL |
| | | | Grommet Color | BLK |
| | | | PDC Type | CHGSP |
| | | | PDC Location | C |
| | | | PDC Color | N/A |
| | RETURN SHELL | 1 | 64-2583ERSWD1R41 | Color |
| | | | Overlay | NO |
| | | | Grommet | GL |
| | | | Grommet Color | BLK |
| | | | PDC Type | HWDUO-BEZEL |
| | | | PDC Location | C |
| | | | PDC Color/Circuits | S3 |
| | | | Door Style | DEB |
| | | | Grain Direction | N/A |
| | | | Door Lock | YES |
| | | Lock Color | BLK | |
| PED | 2 | 66-2418PD2 | Color | AS |
| | | | Drawer Color | AS |
| | | | Grain Direction | VERTICAL |
| | | | Pull/Color | AAV |
| | | | Wire Management | WMLR |

TFL (T) AND HPL (P) LAMINATE OPTIONS

WOODGRAIN

| | | | |
|--------------|------------------|-----|---------------------|
| AS | Asian Night | PNW | Pinnacle Walnut |
| BW | Beigewood | PTK | Portico Teak |
| CO | Columbian Walnut | RC | River Cherry |
| EF | Espresso | SCH | Select Cherry |
| FLW | Florence Walnut | SPW | Sepia Walnut |
| GC | Golden Cherry | SKC | Shaker Cherry |
| HVM | Harvest Maple | SBP | Smoky Brown Pear |
| KHE | Kirsche | TK | Studio Teak |
| MW | Mahogany Walnut | SM | Sugar Maple |
| MNR | Midnight Run | WTA | Weathered Ash |
| NTM | Natural Marrone | WNB | White Nebbia |
| ORW | Oak Riftwood | WC | Williamsburg Cherry |
| SOLID | | | |
| BL | Black | FHG | Fashion Grey |
| WH | Designer White | SG | Slate Grey |

SOLID SURFACE (S) TRANSACTION COUNTER OPTIONS

| | | | |
|----|--------------|-----|--------------|
| AR | Arroyo | SNW | Snow White |
| PE | Pebble Beach | SN | Starry Night |
| SE | Sedona | TN | Tundra |

ACRYLIC OVERLAY OPTIONS

| | | | |
|-----|----------|-----|---------------|
| FST | Frosted | WHA | White |
| BLA | Black | WMA | Wired Mercury |
| GPA | Graphite | | |

EDGE PROFILES

CHASSIS/WORKSURFACES/TRANSACTION COUNTERS

H Square

SOLID SURFACE TRANSACTION COUNTERS

S1 Straight



Square

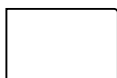

Straight

PULL OPTIONS

Note: Lock Core will match Pull Color

| | | | |
|-----|------------------|-----|------------------|
| AAV | Alcove, Aluminum | AEL | Elite, Aluminum |
| CAV | Alcove, Chrome | BEL | Elite, Black |
| AAC | Arc, Aluminum | AFL | Flair, Aluminum |
| BAC | Arc, Black | CFL | Flair, Chrome |
| ABM | Beam, Aluminum | AFC | Focus, Aluminum |
| BBM | Beam, Black | BFC | Focus, Black |
| BBT | Bow Tie, Black | AQD | Quadra, Aluminum |
| NBT | Bow Tie, Nickel | BQD | Quadra, Black |
| ABU | Buckle, Aluminum | AST | Studio, Aluminum |
| BBU | Buckle, Black | BST | Studio, Black |
| | | CST | Studio, Chrome |



GROMMET OPTIONS & POWER UNIT LOCATIONS

Desk grommets are available in standard locations. Please specify using table below. Multiple unit locations may be selected. Only one unit per location.

Grommets are available on hutches in standard locations for task light management at no additional charge. Please specify HUGRMT.

Multiple locations may be selected. Only one unit per location.

GROMMET LOCATIONS (Black = BLK and Silver = SLV)

| | | | |
|----|--------------------------------------|----|----|
| GC | Grommet, Center - Specify BLK or SLV | \$ | 52 |
| GL | Grommet, Left - Specify BLK or SLV | \$ | 52 |
| GR | Grommet, Right - Specify BLK or SLV | \$ | 52 |

DUO/TRIO BEZEL LOCATIONS

| | |
|-------|---------------|
| PDC-C | Bezel, Center |
| PDC-L | Bezel, Left |
| PDC-R | Bezel, Right |

DOCK 950 and DOCK 150 LOCATIONS (See Dock Units)

| | | | |
|-----------|---------------------------------------|----|-----|
| DOCK950-L | D950 Wireless Charger, Left | \$ | 265 |
| DOCK950-C | D950 Wireless Charger, Center | \$ | 265 |
| DOCK950-R | D950 Wireless Charger, Right | \$ | 265 |
| DOCK150-L | D150 Wireless and USB Charger, Left | \$ | 405 |
| DOCK150-C | D150 Wireless and USB Charger, Center | \$ | 405 |
| DOCK150-R | D150 Wireless and USB Charger, Right | \$ | 405 |

Verify Grommet Option is available on the model(s) you are specifying using the following location information. Grommets, Power Units, Dock 950 and Dock 150 may be ordered in non-standard locations. Call Customer Service to assist with specification and/or please attach a drawing to the PO showing the location of the grommet. Note additional charges and lead times may apply.

Power Units, Dock 950 and Dock 150 must be specified separately with surface mount location.

Models

| | | |
|-------------|--------------|--------------|
| 64-3696RSRL | 64-3672RSRL | 64-3660ARSRR |
| 64-3696RSRR | 64-3672RSRR | 64-3654ARSRL |
| 64-3696RS | 64-3672RS | 64-3654ARSRR |
| 64-3694B46 | 64-3672ARSRL | 64-3648ARSRL |
| 64-3690RSRL | 64-3672ARSRR | 64-3648ARSRR |
| 64-3690RSRR | 64-3666RSRL | 64-3642ARSRL |
| 64-3690RS | 64-3666RSRR | 64-3642ARSRR |
| 64-3688B40 | 64-3666RS | 64-3636ARSRL |
| 64-3684RSRL | 64-3666ARSRL | 64-3636ARSRR |
| 64-3684RSRR | 64-3666ARSRR | 64-3630ARSRL |
| 64-3684RS | 64-3660RSRL | 64-3630ARSRR |
| 64-3678RSRL | 64-3660RSRR | |
| 64-3678RSRR | 64-3660RS | |
| 64-3678RS | 64-3660ARSRL | |

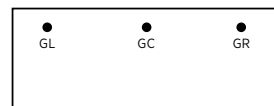

GL/GR/PDC-L/PDC-R/DOCK950-L/DOCK950-R/DOCK150-L/DOCK150-R: Located 6" from ends and 32" from user side

GC/PDC-C/DOCK950-C/DOCK150-C: Located 32" from user side

See additional units and locations on the next page.

GROMMET OPTIONS & POWER UNIT LOCATIONS (CONTINUED)

Models

| | | |
|-------------|-------------|--------------|
| 64-3096RSRL | 64-3084RSRL | 64-3066RSRL |
| 64-3096RSRR | 64-3084RSRR | 64-3066RSRR |
| 64-3096RS | 64-3084RS | 64-3066RS |
| 64-3094B46 | 64-3078RSRL | 64-3060RSRL |
| 64-3090RSRL | 64-3078RSRR | 64-3060RSRR |
| 64-3090RSRR | 64-3078RS | 64-3060RSPDC |
| 64-3090RS | 64-3072RSRL | 64-3060RS |
| 64-3090RS | 64-3072RSRR | |
| 64-3088B40 | 64-3072RS | |



GL/GR/PDC-L/PDC-R/CHGSP-L/
CHGSP-R: Located 6" from ends
and 26" from user side

GC/PDC-C/CHGSP-C: Located 26"
from user side

Models

| | | |
|------------------|------------------|---------------|
| 64-2596RSRL | 64-2584RSRR | 64-2566RS |
| 64-2596RSRR | 64-2583ERSL58 | 64-2560RSRL |
| 64-2596RS | 64-2583ERSR58 | 64-2560RSRR |
| 64-2595ERSWD2L46 | 64-2583ERSL53 | 64-2560RS |
| 64-2595ERSWD2R46 | 64-2583ERSR53 | 64-2559ERSL34 |
| 64-2595ERSWD2L41 | 64-2583ERSL47 | 64-2559ERSR34 |
| 64-2595ERSWD2R41 | 64-2583ERSR47 | 64-2559ERSL29 |
| 64-2595ERSWD2L35 | 64-2578RSRL | 64-2559ERSR29 |
| 64-2595ERSWD2R35 | 64-2578RSRR | 64-2559ERSL23 |
| 64-2595ERSWD1L58 | 64-2578RS | 64-2559ERSR23 |
| 64-2595ERSWD1R58 | 64-2572RSRL | 64-3072ARSRL |
| 64-2595ERSWD1L53 | 64-2572RSRR | 64-3072ARSRR |
| 64-2595ERSWD1R53 | 64-2572RS | 64-3066ARSRL |
| 64-2595ERSWD1L47 | 64-2571ERSWD1L34 | 64-3066ARSRR |
| 64-2595ERSWD1R47 | 64-2571ERSWD1R34 | 64-3060ARSRL |
| 64-2595ERSL70 | 64-2571ERSWD1L29 | 64-3060ARSRR |
| 64-2595ERSR70 | 64-2571ERSWD1R29 | 64-3054ARSRL |
| 64-2595ERSL65 | 64-2571ERSWD1L23 | 64-3054ARSRR |
| 64-2595ERSR65 | 64-2571ERSWD1R23 | 64-3048ARSRL |
| 64-2595ERSL59 | 64-2571ERSL46 | 64-3048ARSRR |
| 64-2595ERSR59 | 64-2571ERSR46 | 64-3042ARSRL |
| 64-2594B46 | 64-2571ERSL41 | 64-3042ARSRR |
| 64-2590RSRL | 64-2571ERSR41 | 64-3036ARSRL |
| 64-2590RSRR | 64-2571ERSL35 | 64-3036ARSRR |
| 64-2590RS | 64-2571ERSR35 | 64-3030ARSRL |
| 64-2588B40 | 64-2566RSRL | 64-3030ARSRR |
| 64-2584RSRL | 64-2566RSRR | |



GL/GR/PDC-L/PDC-R/CHGSP-L/
CHGSP-R: Located 6" from ends
and 20" from user side

GC/PDC-C/CHGSP-C: Located 20"
from user side

LOCKING DOORS

Locking doors are available. You must specify WITH LOCKING when ordering and add upcharge.

| | | | |
|-----|--------------------|----|----|
| LKT | 42"W to 24"W Units | \$ | 91 |
| LKT | 18"W to 12"W Units | \$ | 69 |

CERTIFICATIONS & COMPLIANCE

- Intertek Sustainability Certified
- BIFMA Level® Certified
- BIFMA Compliant Certified
- TSCA Title VI (formerly CARB) Compliance
- US Green Building's LEED Contribution

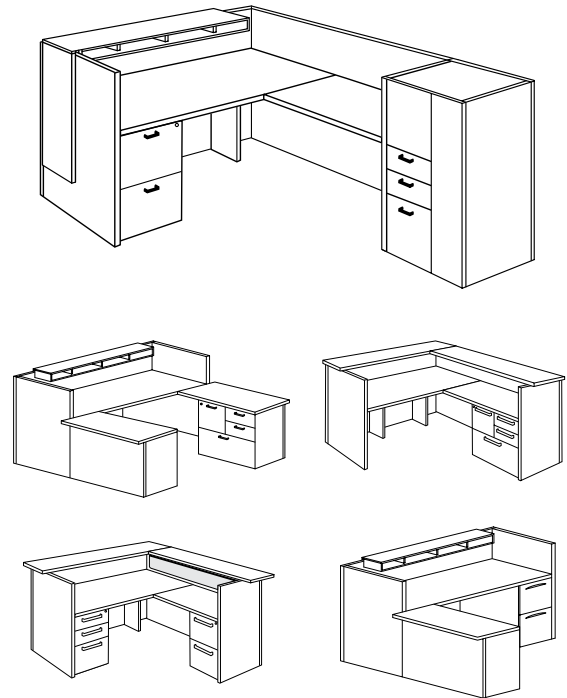

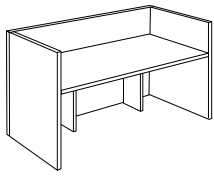

Reception Desk Shell with Gallery Screen
[\(See Details\)](#)

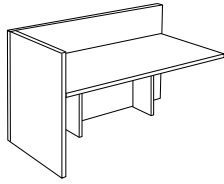

Single Reception Desk Shell with Gallery Screen
[\(See Details\)](#)

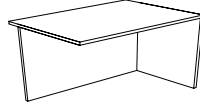

ADA Reception Return Shell
[\(See Details\)](#)

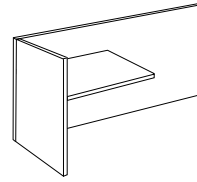

Return Shell with Extended Gallery Screen
[\(See Details\)](#)

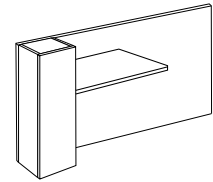

Narrow Tower Storage Return with Extended Gallery Screen
[\(See Details\)](#)

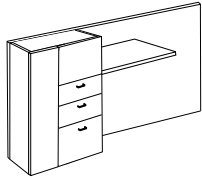

Tower Storage Return with Gallery Screen
[\(See Details\)](#)

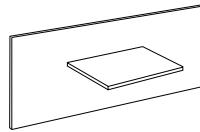

Reception Bridge with Gallery Screen
[\(See Details\)](#)

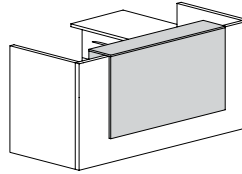

Waterfall Transaction Kits with Paper Slots
[\(See Details\)](#)

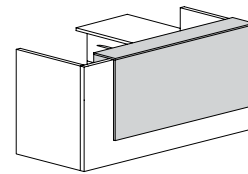

Corner Waterfall Transaction Kits with Paper Slots
[\(See Details\)](#)

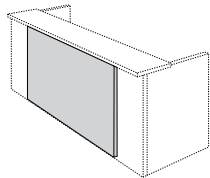

Overlay Panels
TFL [\(See Details\)](#)
High Gloss Acrylic [\(See Details\)](#)
Frosted Acrylic [\(See Details\)](#)

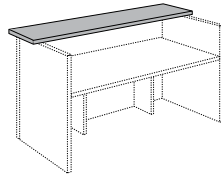

Transaction Top
[\(See Multiple Unit Details\)](#)

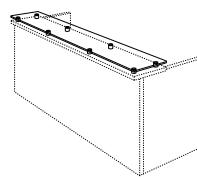

Optional Glass Transaction Top
[\(See Multiple Unit Details\)](#)

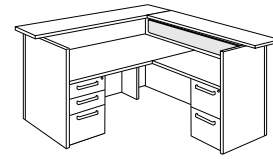

Tackboards for use under Transaction Counters
[\(See Details\)](#)

Modular Component Pedestals



Box/Box/File Pedestal
[\(See Details\)](#)



File/File Pedestal
[\(See Details\)](#)

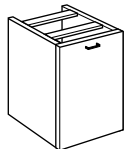

Door Bookcase Pedestal
[\(See Details\)](#)

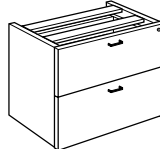

Lateral File Pedestal
[\(See Details\)](#)

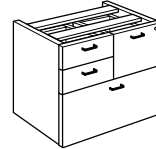

Multi-File Pedestal
[\(See Details\)](#)

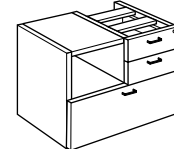

Open Multi-File Pedestal
[\(See Details\)](#)

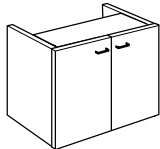

Pedestal with Doors
[\(See Details\)](#)

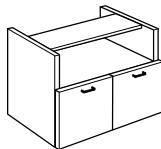

Pedestal with Doors and Open Compartment
[\(See Details\)](#)

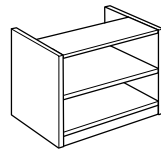

Pedestal Open Storage
[\(See Details\)](#)

Accessories + Power Options

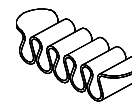
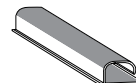
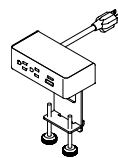
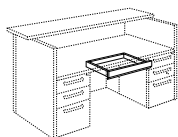

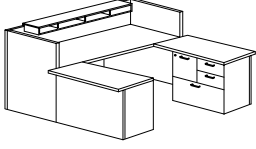
| Item | Model No. | Width | Depth | Height | Ship Wt | Cubic Ft | List Price |
|---|--------------------|-------|--|--------|----------------------|----------|-----------------------|
|  | 64-1 | 106 | 97 | 42 | 813 | 199.2 | T\$ 9291 P\$ 10091 |
| | CONSIST OF: | | QTY | | | | |
| | 64-3096RS | 1 | Reception Desk Shell with Gallery Screen | | T\$ 2262 P\$ 2580 | | |
| | 64-1284TKS | 1 | Waterfall Transaction Kit with Paper Slots | | T\$ 1952 | | |
| | 64-3060ARSRL | 1 | ADA Reception Return Shell - Left | | T\$ 1025 P\$ 1266 | | |
| | 66-2430LF1 | 1 | Modular Pedestal with Lateral File | | T\$ 1384 | | |
| | 64-3060ARSRR | 1 | ADA Reception Return Shell - Right | | T\$ 1025 P\$ 1266 | | |
| | 66-2430LF2 | 1 | Modular Pedestal with Multi-File | | T\$ 1643 | | |

Products are available as left or right, where applicable

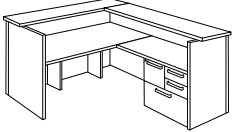
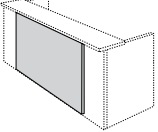
| | | | | | | | |
|---|--------------------|-----|---|----|---|-------------------------------------|---|
|   Optional Overlay | 64-2 | 102 | 87 | 42 | 596 | 154.6 | T\$ 6500 P\$ 7424 Add Optional Glass Top to TFL or HPL Pricing +Glass \$ 3401 |
| | CONSIST OF: | | QTY | | | | |
| | 64-3090RSRL | 1 | Single Reception Desk Shell with Gallery Screen | | T\$ 1961 P\$ 2273 | | |
| | 64-2583ERSR53 | 1 | Return Shell with Extended Gallery Screen | | T\$ 1228 P\$ 1426 | | |
| | 66-2430LF2 | 1 | Modular Pedestal with Multi-File | | T\$ 1643 | | |
| | 64-1296TP | 1 | Transaction Top - 99" Wide | | T\$ 545 P\$ 763 Add Optional Glass Top to TFL or HPL Pricing +Glass \$ 1905 | | |
| | 64-1275TP | 1 | Transaction Top - 75" Wide | | T\$ 491 P\$ 687 Add Optional Glass Top to TFL or HPL Pricing +Glass \$ 1496 | | |
| | 64-OT90 | 1 | Overlay Panel - For Use With 90" Desks | | \$ 632 | Optional Back Lighting Not Included | |

Products are available as left or right, where applicable

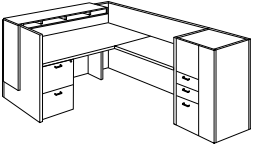
| | | | | | | | |
|---|--------------------|---------------------------------|---|----------|----------------------|-------|----------------------|
|  | 64-3 | 96¾ | 96¾ | 42 | 664 | 161.9 | T\$ 8261 P\$ 8748 |
| | CONSIST OF: | | QTY | | | | |
| | 64-3096RSRL | 1 | Single Reception Desk Shell with Gallery Screen | | T\$ 2013 P\$ 2332 | | |
| | 64-1284CTKSL | 1 | Corner Waterfall Transaction Kit with Paper Slots | | T\$ 2073 | | |
| | 64-2595ERSWD2R41 | 1 | Tower Storage Return with Gallery Screen | | T\$ 2928 P\$ 3096 | | |
| 66-2418PD2 | 1 | Modular Pedestal with File/File | | T\$ 1247 | | | |

Products are available as left or right, where applicable

Pricing Codes:

T= TFL
P= HPL

[See Canvas Reception Overview for Ordering Options](#)

CANVAS™

LAMINATE RECEPTION + COMPONENTS (6400 SERIES)

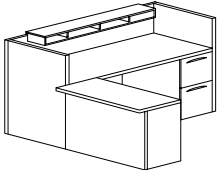
| Item | Model No. | Width | Depth | Height | Ship Wt | Cubic Ft | List Price |
|---|-----------|-------|-------|--------|---------|----------|----------------------|
|  | 64-4 | 89 | 96 | 42 | 604 | 139.6 | T\$ 7679 P\$ 8207 |

CONSIST OF:**QTY**

| | | | |
|--------------|---|---|----------------------|
| 64-3084RS | 1 | Single Reception Desk Shell with Gallery Screen | T\$ 2151 P\$ 2438 |
| 64-3060ARSRL | 1 | ADA Reception Return Shell - Left | T\$ 1025 P\$ 1266 |
| 64-1272TKS | 1 | Waterfall Transaction Kit with Paper Slots | T\$ 1613 |
| 66-2430LF2 | 1 | Modular Pedestal with Multi-File | T\$ 1643 |
| 66-2418PD2 | 1 | Modular Pedestal with File/File | T\$ 1247 |

Products are available as left or right, where applicable

| | | | | | | | |
|---|------|----|----|----|-----|-------|---|
|  | 64-5 | 78 | 87 | 42 | 559 | 135.9 | T\$ 6501 P\$ 7362 |
| | | | | | | | <i>Add Optional Glass Top to TFL or HPL Pricing</i> Glass \$ 2992 |

CONSIST OF:**QTY**

| | | | |
|---------------|---|---|----------------------|
| 64-3072RSRL | 1 | Single Reception Desk Shell with Gallery Screen | T\$ 1480 P\$ 1751 |
| 64-2583ERSR53 | 1 | Return Shell with Extended Gallery Screen | T\$ 1228 P\$ 1426 |
| 64-1275TP | 2 | Transaction Top - 75" Wide | T\$ 982 P\$ 1374 |
| | | <i>Add Optional Glass Top to TFL or HPL Pricing</i> | +Glass \$ 2992 |
| 66-2418PD1 | 1 | Modular Pedestal with Box/Box/File | T\$ 1247 |
| 66-2418PD2 | 1 | Modular Pedestal with File/File | T\$ 1247 |
| TB-6284 | 1 | Tackboard (Optional) | G1\$ 317 |

Products are available as left or right, where applicable

Pricing Codes:

T= TFL
P= HPL

[See Canvas Reception Overview for Ordering Options](#)

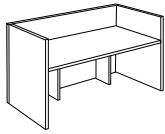
| Item | Model No. | | Width | Depth | Height | Ship Wt | Cubic Ft | List Price |
|---|-----------|-----------------|-------|-------|--------|---------|----------|----------------------|
| RECEPTION DESK SHELL WITH GALLERY SCREEN | 64-3696RS | 94" Worksurface | 96 | 36 | 41 | 272 | 90.3 | T\$ 2464 P\$ 2802 |
| | 64-3690RS | 88" Worksurface | 90 | 36 | 41 | 261 | 84.8 | T\$ 2394 P\$ 2726 |
|  | 64-3684RS | 82" Worksurface | 84 | 36 | 41 | 249 | 79.3 | T\$ 2338 P\$ 2642 |
| | 64-3678RS | 76" Worksurface | 78 | 36 | 41 | 237 | 73.8 | T\$ 2269 P\$ 2564 |
| Must Specify (in this order): Model # Top Material Top Color Chassis Color Overlay Overlay Color Back Lighting Grommet Location Grommet Color PDC Type PDC Location PDC Color | 64-3672RS | 70" Worksurface | 72 | 36 | 41 | 226 | 68.3 | T\$ 1933 P\$ 2223 |
| | 64-3666RS | 64" Worksurface | 66 | 36 | 41 | 214 | 62.8 | T\$ 1861 P\$ 2137 |
| | 64-3660RS | 58" Worksurface | 60 | 36 | 41 | 203 | 57.3 | T\$ 1792 P\$ 2056 |
| | 64-3096RS | 94" Worksurface | 96 | 30 | 41 | 245 | 80.3 | T\$ 2262 P\$ 2580 |
| | 64-3090RS | 88" Worksurface | 90 | 30 | 41 | 234 | 75.8 | T\$ 2205 P\$ 2517 |
| | 64-3084RS | 82" Worksurface | 84 | 30 | 41 | 223 | 71.3 | T\$ 2151 P\$ 2438 |
| | 64-3078RS | 76" Worksurface | 78 | 30 | 41 | 213 | 66.7 | T\$ 2076 P\$ 2355 |
| | 64-3072RS | 70" Worksurface | 72 | 30 | 41 | 202 | 62.1 | T\$ 1727 P\$ 1996 |
| | 64-3066RS | 64" Worksurface | 66 | 30 | 41 | 192 | 57.5 | T\$ 1663 P\$ 1921 |
| | 64-3060RS | 58" Worksurface | 60 | 30 | 41 | 181 | 48.2 | T\$ 1596 P\$ 1836 |
| | 64-2596RS | 94" Worksurface | 96 | 25 | 41 | 245 | 80.3 | T\$ 1685 P\$ 1965 |
| | 64-2590RS | 88" Worksurface | 90 | 25 | 41 | 234 | 75.8 | T\$ 1625 P\$ 1899 |
| | 64-2584RS | 82" Worksurface | 84 | 25 | 41 | 198 | 58.4 | T\$ 1567 P\$ 1820 |
| | 64-2578RS | 76" Worksurface | 78 | 25 | 41 | 188 | 53.8 | T\$ 1502 P\$ 1745 |
| | 64-2572RS | 70" Worksurface | 72 | 25 | 41 | 177 | 49.2 | T\$ 1439 P\$ 1675 |
| | 64-2566RS | 64" Worksurface | 66 | 25 | 41 | 167 | 44.6 | T\$ 1383 P\$ 1606 |
| | 64-2560RS | 58" Worksurface | 60 | 25 | 41 | 156 | 40.0 | T\$ 1280 P\$ 1501 |

Kneespace 58"; No Additional Support Needed

Description

- Horizontal Woodgrain on Chassis; Side-to-Side Woodgrain on Top
- Available with TFL (T) or HPL (P) Top; Must Specify
- Top and Chassis Available in Contrasting Colors; Must Specify Color of Each Component
- Stiffener Bar Recommended in Kneespaces 60" or Greater When Unsupported by Pedestal, [See Stiffener Bar](#)
- Optional Overlay Panel for Approach Side of Gallery Screen, [See Overlay Options](#)
- Additional Options: Waterfall Transaction Kit ([See Kit Options](#)), TFL, HPL, or Solid Surface Transaction Tops ([See Multiple Unit Details](#)), Power Options (Sold Separately, [See Accessories](#))

Pricing Codes:

T= TFL
P= HPL

[See Canvas Reception Overview for Ordering Options](#)

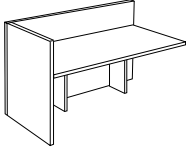
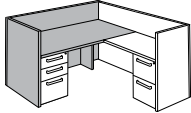
| Item | Model No. | Width | Depth | Height | Ship Wt | Cubic Ft | List Price | |
|---|--------------------------------|--------------|-------|--------|---------|----------|------------|----------------------|
| SINGLE RECEPTION DESK SHELL WITH GALLERY SCREEN | Left | Right | | | | | | |
| | 64-3696RSRL 94" Worksurface | 64-3696RSRR | 96 | 36 | 41 | 326 | 91.6 | T\$ 2171 P\$ 2509 |
|  | 64-3690RSRL 88" Worksurface | 64-3690RSRR | 90 | 36 | 41 | 315 | 86.0 | T\$ 2120 P\$ 2452 |
|  | 64-3684RSRL 82" Worksurface | 64-3684RSRR | 84 | 36 | 41 | 303 | 80.4 | T\$ 2067 P\$ 2372 |
| | 64-3678RSRL 76" Worksurface | 64-3678RSRR | 78 | 36 | 41 | 291 | 74.7 | T\$ 1997 P\$ 2292 |
| Desk Shell Shaded (Shown as Left) | 64-3672RSRL 70" Worksurface | 64-3672RSRR | 72 | 36 | 41 | 201 | 69.2 | T\$ 1665 P\$ 1955 |
| | 64-3666RSRL 64" Worksurface | 64-3666RSRR | 66 | 36 | 41 | 190 | 63.5 | T\$ 1590 P\$ 1865 |
| Must Specify (in this order): Model # Top Material Top Color Chassis Color Overlay Overlay Color Back Lighting Grommet Location Grommet Color PDC Type PDC Location PDC Color | 64-3660RSRL 58" Worksurface | 64-3660RSRR | 60 | 36 | 41 | 179 | 57.9 | T\$ 1524 P\$ 1789 |
| | 64-3096RSRL 94" Worksurface | 64-3096RSRR | 96 | 30 | 41 | 206 | 73.2 | T\$ 2013 P\$ 2332 |
| | 64-3090RSRL 88" Worksurface | 64-3090RSRR | 90 | 30 | 41 | 196 | 69.3 | T\$ 1961 P\$ 2273 |
| | 64-3084RSRL 82" Worksurface | 64-3084RSRR | 84 | 30 | 41 | 186 | 65.4 | T\$ 1902 P\$ 2189 |
| | 64-3078RSRL 76" Worksurface | 64-3078RSRR | 78 | 30 | 41 | 176 | 61.5 | T\$ 1830 P\$ 2109 |
| | 64-3072RSRL 70" Worksurface | 64-3072RSRR | 72 | 30 | 41 | 165 | 57.6 | T\$ 1480 P\$ 1751 |
| | 64-3066RSRL 64" Worksurface | 64-3066RSRR | 66 | 30 | 41 | 155 | 53.0 | T\$ 1419 P\$ 1676 |
| | 64-3060RSRL 58" Worksurface | 64-3060RSRR | 60 | 30 | 41 | 144 | 48.2 | T\$ 1353 P\$ 1594 |
| | 64-2596RSRL 94" Worksurface | 64-2596RSRR | 96 | 25 | 41 | 184 | 64.1 | T\$ 1461 P\$ 1741 |
| | 64-2590RSRL 88" Worksurface | 64-2590RSRR | 90 | 25 | 41 | 174 | 60.2 | T\$ 1400 P\$ 1674 |
| | 64-2584RSRL 82" Worksurface | 64-2584RSRR | 84 | 25 | 41 | 163 | 56.3 | T\$ 1338 P\$ 1591 |
| | 64-2578RSRL 76" Worksurface | 64-2578RSRR | 78 | 25 | 41 | 153 | 52.4 | T\$ 1277 P\$ 1521 |
| | 64-2572RSRL 70" Worksurface | 64-2572RSRR | 72 | 25 | 41 | 143 | 48.5 | T\$ 1216 P\$ 1452 |
| | 64-2566RSRL 64" Worksurface | 64-2566RSRR | 66 | 25 | 41 | 133 | 44.6 | T\$ 1162 P\$ 1386 |
| | 64-2560RSRL 58" Worksurface | 64-2560RSRR | 60 | 25 | 41 | 123 | 40.7 | T\$ 1062 P\$ 1281 |

Kneespace 58"; No Additional Support Needed

Description

- Horizontal Woodgrain on Chassis; Side-to-Side Woodgrain on Top
- Available with TFL (T) or HPL (P) Top; Must Specify
- Top and Chassis Available in Contrasting Colors; Must Specify Color of Each Component
- Stiffener Bar Recommended in Kneespaces 60" or Greater When Surface is Not Supported By Pedestal, [See Stiffener Bar](#)
- Not for Freestanding, Must Attach to Return or Bridge Components
- Optional Overlay Panel for Approach Side of Gallery Screen, [See Overlay Options](#)
- Additional Options: Waterfall Transaction Kit ([See Kit Options](#)), TFL, HPL, or Solid Surface Transaction Tops ([See Multiple Unit Details](#)), Power Options (Sold Separately, [See Accessories](#))

Pricing Codes:

T= TFL
P= HPL

[See Canvas Reception Overview for Ordering Options](#)

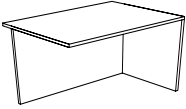
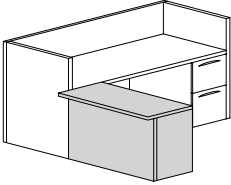
| Item | Model No. | Width | Depth | Height | Ship Wt | Cubic Ft | List Price |
|--|--------------|--------------|-------|--------|---------|----------|----------------------|
| ADA RECEPTION RETURN SHELL | Left | Right | | | | | |
| | 64-3672ARSRL | 64-3672ARSRR | 72 | 36 | 30 | 144 | T\$ 1228 P\$ 1518 |
|  | 64-3666ARSRL | 64-3666ARSRR | 66 | 36 | 30 | 134 | T\$ 1176 P\$ 1452 |
| | 64-3660ARSRL | 64-3660ARSRR | 60 | 36 | 30 | 123 | T\$ 1124 P\$ 1389 |
| Shown as Right | 64-3654ARSRL | 64-3654ARSRR | 54 | 36 | 30 | 113 | T\$ 1056 P\$ 1300 |
|  | 64-3648ARSRL | 64-3648ARSRR | 48 | 36 | 30 | 102 | T\$ 999 P\$ 1222 |
| | 64-3642ARSRL | 64-3642ARSRR | 42 | 36 | 30 | 92 | T\$ 935 P\$ 1140 |
| Return Shell Shaded (Shown as Left) | 64-3636ARSRL | 64-3636ARSRR | 36 | 36 | 30 | 81 | T\$ 876 P\$ 1063 |
| Must Specify (in this order): Model # Top Material Top Color Chassis Color Grommet Location Grommet Color PDC Type PDC Location PDC Color | 64-3630ARSRL | 64-3630ARSRR | 30 | 36 | 30 | 71 | T\$ 817 P\$ 986 |
| | 64-3072ARSRL | 64-3072ARSRR | 72 | 30 | 30 | 125 | T\$ 1181 P\$ 1452 |
| | 64-3066ARSRL | 64-3066ARSRR | 66 | 30 | 30 | 116 | T\$ 1086 P\$ 1343 |
| | 64-3060ARSRL | 64-3060ARSRR | 60 | 30 | 30 | 107 | T\$ 1025 P\$ 1266 |
| | 64-3054ARSRL | 64-3054ARSRR | 54 | 30 | 30 | 98 | T\$ 969 P\$ 1195 |
| | 64-3048ARSRL | 64-3048ARSRR | 48 | 30 | 30 | 89 | T\$ 913 P\$ 1123 |
| | 64-3042ARSRL | 64-3042ARSRR | 42 | 30 | 30 | 80 | T\$ 857 P\$ 1048 |
| | 64-3036ARSRL | 64-3036ARSRR | 36 | 30 | 30 | 71 | T\$ 797 P\$ 966 |
| | 64-3030ARSRL | 64-3030ARSRR | 30 | 30 | 30 | 62 | T\$ 755 P\$ 918 |

Description

- Horizontal Woodgrain on Chassis; Side-to-Side Woodgrain on Top
- Available with TFL (T) or HPL (P) Top; Must Specify
- Top and Chassis Available in Contrasting Colors; Must Specify Color of Each Component
- Stiffener Bar Recommended in Kneespaces 60" or Greater When Unsupported By Pedestal, [See Stiffener Bar](#)
- 5" Overhang on Approach Side
- Must Attach to Reception Desk Shell or Panel End of Single Reception Desk Shell

Pricing Codes:

T= TFL
P= HPL

[See Canvas Reception Overview for Ordering Options](#)

| Item | Model No. | Width | Depth | Height | Ship Wt | Cubic Ft | List Price |
|--|---|---------------|-------|--------|---------|----------|----------------------|
| RETURN SHELL WITH EXTENDED GALLERY SCREEN | Left | Right | | | | | |
| | 64-2595ERSL70 | 64-2595ERSR70 | 95 | 25 | 41 | 176 | T\$ 1332 P\$ 1568 |
| | 70" Worksurface; To Connect to 25" Deep Single Desk Shell | | | | | | |
| | 64-2595ERSL65 | 64-2595ERSR65 | 95 | 25 | 41 | 174 | T\$ 1316 P\$ 1539 |
| | 65" Worksurface; To Connect to 30" Deep Single Desk Shell | | | | | | |
| | 64-2595ERSL59 | 64-2595ERSR59 | 95 | 25 | 41 | 172 | T\$ 1301 P\$ 1521 |
| | 59" Worksurface; To Connect to 36" Deep Single Desk Shell | | | | | | |
| | 64-2583ERSL58 | 64-2583ERSR58 | 83 | 25 | 41 | 154 | T\$ 1245 P\$ 1465 |
| | 58" Worksurface; To Connect to 25" Deep Single Desk Shell | | | | | | |
| | 64-2583ERSL53 | 64-2583ERSR53 | 83 | 25 | 41 | 151 | T\$ 1228 P\$ 1426 |
| | 53" Worksurface; To Connect to 30" Deep Single Desk Shell | | | | | | |
| | 64-2583ERSL47 | 64-2583ERSR47 | 83 | 25 | 41 | 148 | T\$ 1209 P\$ 1395 |
| | 47" Worksurface; To Connect to 36" Deep Single Desk Shell | | | | | | |
| | 64-2571ERSL46 | 64-2571ERSR46 | 71 | 25 | 41 | 131 | T\$ 1154 P\$ 1340 |
| | 46" Worksurface; To Connect to 25" Deep Single Desk Shell | | | | | | |
| | 64-2571ERSL41 | 64-2571ERSR41 | 71 | 25 | 41 | 129 | T\$ 1138 P\$ 1306 |
| | 41" Worksurface; To Connect to 30" Deep Single Desk Shell | | | | | | |
| | 64-2571ERSL35 | 64-2571ERSR35 | 71 | 25 | 41 | 127 | T\$ 1117 P\$ 1265 |
| | 35" Worksurface; To Connect to 36" Deep Single Desk Shell | | | | | | |
| | 64-2559ERSL34 | 64-2559ERSR34 | 59 | 25 | 41 | 112 | T\$ 1019 P\$ 1167 |
| | 34" Worksurface; To Connect to 25" Deep Single Desk Shell | | | | | | |
| | 64-2559ERSL29 | 64-2559ERSR29 | 59 | 25 | 41 | 109 | T\$ 1003 P\$ 1146 |
| | 29" Worksurface; To Connect to 30" Deep Single Desk Shell | | | | | | |
| | 64-2559ERSL23 | 64-2559ERSR23 | 59 | 25 | 41 | 107 | T\$ 985 P\$ 1122 |
| | 23" Worksurface; To Connect to 36" Deep Single Desk Shell | | | | | | |

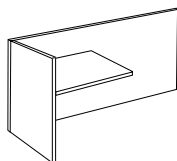

Shown as Left

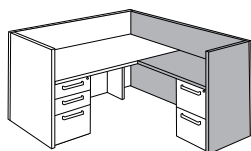
Return Shell Shaded
(Shown as Right)**Must Specify (in this order):**

Model #
Top Material
Top Color
Chassis Color
Overlay
Overlay Color
Overlay Back Lighting
Grommet Location
Grommet Color
PDC Type
PDC Location
PDC Color

Description

- Horizontal Woodgrain on Chassis; Front to Back Woodgrain on Top
- Top and Chassis Available in Contrasting Colors; Must Specify Color of Each Component
- Available with TFL (T) or HPL (P) Top; Must Specify
- 24" Deep Worksurfaces
- Side-to-Side Woodgrain on Top over 60"
- Stiffener Bar Recommended in Kneespaces 60" or Greater When Unsupported By Pedestal, [See Stiffener Bar](#)
- Optional Overlay Panel for Approach Side of Gallery Screen, [See Overlay Options](#)
- Additional Options: Waterfall Transaction Kit ([See Kit Options](#)), TFL, HPL, or Solid Surface Transaction Tops ([See Multiple Unit Details](#)), Power Options (Sold Separately, [See Accessories](#))

Pricing Codes:

T= TFL
P= HPL

[See Canvas Reception Overview for Ordering Options](#)

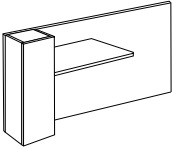
| Item | Model No. | Width | Depth | Height | Ship Wt | Cubic Ft | List Price | |
|---|---|------------------|-------|--------|---------|----------------------|----------------------|--|
| NARROW TOWER STORAGE RETURN WITH EXTENDED GALLERY SCREEN  Shown as Left Must Specify (in this order): Model # Top Material Top Color Chassis Color Overlay Overlay Color Overlay Back Lighting Grommet Location Grommet Color PDC Type PDC Location PDC Color Door Style/Color Door Grain Direction Locking Door Lock Core Color | Left | Right | | | | | | |
| | 64-2595ERSWD1L58 | 64-2595ERSWD1R58 | 95 | 25 | 41 | 208 | T\$ 1942 P\$ 2162 | |
| | 58" Worksurface; To Connect to 25" Deep Single Desk Shell | | | | | | | |
| | 64-2595ERSWD1L53 | 64-2595ERSWD1R53 | 95 | 25 | 41 | 204 | T\$ 1926 P\$ 2124 | |
| | 53" Worksurface; To Connect to 30" Deep Single Desk Shell | | | | | | | |
| | 64-2595ERSWD1L47 | 64-2595ERSWD1R47 | 95 | 25 | 41 | 201 | T\$ 1906 P\$ 2092 | |
| | 47" Worksurface; To Connect to 36" Deep Single Desk Shell | | | | | | | |
| | 64-2583ERSWD1L46 | 64-2583ERSWD1R46 | 83 | 25 | 41 | 188 | T\$ 1850 P\$ 2035 | |
| | 46" Worksurface; To Connect to 25" Deep Single Desk Shell | | | | | | | |
| | 64-2583ERSWD1L41 | 64-2583ERSWD1R41 | 83 | 25 | 41 | 184 | T\$ 1832 P\$ 2000 | |
| | 41" Worksurface; To Connect to 30" Deep Single Desk Shell | | | | | | | |
| | 64-2583ERSWD1L35 | 64-2583ERSWD1R35 | 83 | 25 | 41 | 181 | T\$ 1814 P\$ 1962 | |
| 35" Worksurface; To Connect to 36" Deep Single Desk Shell | | | | | | | | |
| 64-2571ERSWD1L34 | 64-2571ERSWD1R34 | 71 | 25 | 41 | 167 | T\$ 1757 P\$ 1904 | | |
| 34" Worksurface; To Connect to 25" Deep Single Desk Shell | | | | | | | | |
| 64-2571ERSWD1L29 | 64-2571ERSWD1R29 | 71 | 25 | 41 | 164 | T\$ 1739 P\$ 1883 | | |
| 29" Worksurface; To Connect to 30" Deep Single Desk Shell | | | | | | | | |
| 64-2571ERSWD1L23 | 64-2571ERSWD1R23 | 71 | 25 | 41 | 161 | T\$ 1720 P\$ 1858 | | |
| 23" Worksurface; To Connect to 36" Deep Single Desk Shell | | | | | | | | |

Description

- Standard with Horizontal Woodgrain on Chassis; Front to Back Woodgrain on Worksurface Top; Vertical Woodgrain on Door Fronts
- Worksurface Top and Chassis Available in Contrasting Colors; Must Specify Color of Each Component
- Available with TFL (T) or HPL (P) Worksurface Top; Must Specify
- Worksurface Top Flush with Storage Cabinet Door Front
- 12" Wide Tower Features Touch Latch Door, Coat Rod, and Two (2) Adjustable Shelves Behind Door
- For Use with Single Reception Desk Shell
- Door Options: Dry Erase (See below), High Gloss Acrylic (See Below), Panel Door with Horizontal Grain Direction on Door Front ([See Color Options](#)); Must Specify
- Optional Locking Door ([See Options](#)); Must Specify and Add
- Optional Overlay Panel for Approach Side of Gallery Screen, [See Overlay Options](#)
- Additional Options: Waterfall Transaction Kit ([See Kit Options](#)), TFL, HPL, or Solid Surface Transaction Tops ([See Multiple Unit Details](#)), Power Options (Sold Separately, [See Accessories](#))

Door Options: Specify & Add

| | | |
|-------|---|--------|
| 1-DEB | Dry Erase Board | \$ 122 |
| 1-HGA | High Gloss Acrylic; Must Specify Color | |
| | GPA Graphite Acrylic | \$ 462 |
| | BLA Black, Wired Mercury or White Acrylic | \$ 418 |

Pricing Codes:

T= TFL
P= HPL

[See Canvas Reception Overview for Ordering Options](#)

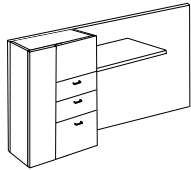
| Item | Model No. | Width | Depth | Height | Ship Wt | Cubic Ft | List Price |
|---|---|------------------|-------|--------|---------|----------------------|----------------------|
| TOWER STORAGE RETURN WITH GALLERY SCREEN  Shown as Left <u>Must Specify (in this order):</u> Model # Top Material Top Color Chassis Color Overlay Overlay Color Overlay Back Lighting Drawer Pull Door/Drawer Color Door/Drawer Grain Direction Locking Door Lock Core Color Grommet Location Grommet Color PDC Type PDC Location PDC Color | Left | Right | | | | | |
| | 64-2595ERSWD2L46 | 64-2595ERSWD2R46 | 95 | 25 | 41 | 258 | T\$ 2944 P\$ 3130 |
| | 46" Worksurface; To Connect to 25" Deep Single Desk Shell | | | | | | |
| | 64-2595ERSWD2L41 | 64-2595ERSWD2R41 | 95 | 25 | 41 | 254 | T\$ 2928 P\$ 3096 |
| | 41" Worksurface; To Connect to 30" Deep Single Desk Shell | | | | | | |
| | 64-2595ERSWD2L35 | 64-2595ERSWD2R35 | 95 | 25 | 41 | 251 | T\$ 2907 P\$ 3056 |
| | 35" Worksurface; To Connect to 36" Deep Single Desk Shell | | | | | | |
| | 64-2583ERSWD2L34 | 64-2583ERSWD2R34 | 83 | 25 | 41 | 238 | T\$ 2854 P\$ 3001 |
| 34" Worksurface; To Connect to 25" Deep Single Desk Shell | | | | | | | |
| 64-2583ERSWD2L29 | 64-2583ERSWD2R29 | 83 | 25 | 41 | 234 | T\$ 2837 P\$ 2980 | |
| 29" Worksurface; To Connect to 30" Deep Single Desk Shell | | | | | | | |
| 64-2583ERSWD2L23 | 64-2583ERSWD2R23 | 83 | 25 | 41 | 230 | T\$ 2819 P\$ 2957 | |
| 23" Worksurface; To Connect to 36" Deep Single Desk Shell | | | | | | | |

Description

- Standard with Horizontal Woodgrain on Chassis; Front to Back Woodgrain on Worksurface Top; Vertical Woodgrain on Door Fronts
- Worksurface Top and Chassis Available in Contrasting Colors; Must Specify Color of Each Component
- Must Select Drawer Pull Options, [See Pull Options](#)
- Worksurface Top Flush with Storage Cabinet Door Front
- Tower Features Touch Latch Door and 6 $\frac{7}{8}$ " Coat Rod
- Box/Box/File Locking Pedestal Provides Legal or Letter Filing
- For Use With Single Reception Desk Shell
- Optional Horizontal Grain Direction on Door and Drawer Fronts; Must Specify
- Optional Locking Doors ([See Options](#)); Must Specify and Add
- Optional Overlay Panel for Approach Side of Gallery Screen, [See Overlay Options](#)
- Additional Options: Waterfall Transaction Kit ([See Kit Options](#)), TFL, HPL, or Solid Surface Transaction Tops ([See Multiple Unit Details](#)), Power Options (Sold Separately, [See Accessories](#))

Pricing Codes:

T= TFL
P= HPL

[See Canvas Reception Overview for Ordering Options](#)

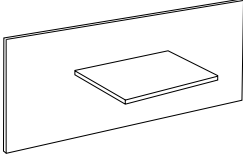
| Item | Model No. | | Width | Depth | Height | Ship Wt | Cubic Ft | List Price |
|--|------------|-----------------|-------|-------|--------|---------|----------|----------------------|
| RECEPTION BRIDGE WITH GALLERY SCREEN  | 64-3694B46 | 46" Worksurface | 96 | 36 | 41 | 139 | 11.7 | T\$ 1109 P\$ 1332 |
| | 64-3688B40 | 40" Worksurface | 90 | 36 | 41 | 127 | 10.9 | T\$ 1062 P\$ 1267 |
| | 64-3094B46 | 46" Worksurface | 96 | 30 | 41 | 132 | 11.7 | T\$ 1081 P\$ 1291 |
| | 64-3088B40 | 40" Worksurface | 90 | 30 | 41 | 121 | 10.9 | T\$ 1036 P\$ 1228 |
| | 64-2594B46 | 46" Worksurface | 96 | 25 | 41 | 126 | 11.7 | T\$ 1055 P\$ 1241 |
| | 64-2588B40 | 40" Worksurface | 90 | 25 | 41 | 116 | 10.9 | T\$ 1015 P\$ 1183 |

Must Specify (in this order):

Model #
 Top Material
 Top Color
 Chassis Color
 Overlay
 Overlay Color
 Overlay Back Lighting
 Grommet Location
 Grommet Color
 PDC Type
 PDC Location
 PDC Color

Description

- For Use With Two 25" Deep Single Reception Desk Shells; Must Attach to Open End of Shells
- Cannot Be Used with 30" or 36" Reception Desk Shells
- Available with TFL (T) or HPL (P) Worksurface Top; Must Specify
- Worksurface Top and Chassis Available in Contrasting Colors; Must Specify Color of Each Component
- Optional Overlay Panel for Approach Side of Gallery Screen, [See Overlay Options](#)
- Some Assembly Required
- Additional Options: Waterfall Transaction Kit ([See Kit Options](#)), TFL, HPL, or Solid Surface Transaction Tops ([See Multiple Unit Details](#)), Power Options (Sold Separately, [See Accessories](#))

Pricing Codes:

T= TFL
 P= HPL

[See Canvas Reception Overview for Ordering Options](#)

| Item | Model No. | Width | Depth | Height | Ship Wt | Cubic Ft | List Price |
|---|------------|-------|-------|--------|---------|----------|------------|
| MODULAR PEDESTAL WITH BOX/BOX/FILE | 66-2418PD1 | 18 | 23¼ | 28¼ | 93 | 7.8 | T\$ 1247 |
| | 66-2415PD1 | 15¾ | 23¼ | 28¼ | 98 | 8.9 | T\$ 1181 |

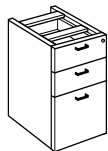

Description

- Box/Box/File Locking Modular Pedestal; Letter Width
- For Use With Desk and Return Shells
- Open Back
- Grain Runs Vertical on Drawer Fronts. Optional Horizontal Grain Direction on Drawer Fronts; Must Specify

Must Specify (in this order):

- Model #
- Chassis Color
- Drawer Front Color
- Drawer Front Grain Direction
- Pull
- Wire Management

Options: Specify & Add

| | | |
|------|--|--------|
| WML | Wire Management - Left Panel | \$ 80 |
| WMR | Wire Management - Right Panel | \$ 80 |
| WMLR | Wire Management - Left and Right Panel | \$ 160 |

| | | | | | | | |
|--|------------|-----|-----|-----|----|-----|----------|
| MODULAR PEDESTAL WITH FILE/FILE | 66-2418PD2 | 18 | 23¼ | 28¼ | 93 | 7.8 | T\$ 1247 |
| | 66-2415PD2 | 15¾ | 23¼ | 28¼ | 98 | 8.9 | T\$ 1181 |

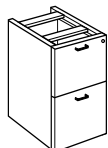

Description

- File/File Locking Modular Pedestal; Letter Width
- For Use With Desk and Return Shells
- Open Back
- Grain Runs Vertical on Drawer Fronts. Optional Horizontal Grain Direction on Drawer Fronts; Must Specify

Must Specify (in this order):

- Model #
- Chassis Color
- Drawer Front Color
- Drawer Front Grain Direction
- Pull
- Wire Management

Options: Specify & Add

| | | |
|------|--|--------|
| WML | Wire Management - Left Panel | \$ 80 |
| WMR | Wire Management - Right Panel | \$ 80 |
| WMLR | Wire Management - Left and Right Panel | \$ 160 |

| MODULAR PEDESTAL WITH DOOR BOOKCASE | Left | Right | Width | Depth | Height | Ship Wt | Cubic Ft | List Price |
|-------------------------------------|-------------|-------------|-------|-------|--------|---------|----------|------------|
| | 66-2418PD4L | 66-2418PD4R | | | | | | |

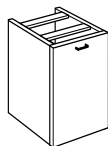

Description

- Adjustable Shelf Inside Cabinet
- For Use With Desk and Return Shells
- Open Back
- Grain Runs Vertical on Door Front. Optional Horizontal Grain Direction on Door Fronts; Must Specify
- Optional Locking Doors ([See Options](#)); [Must Specify](#) and Add

Must Specify (in this order):

- Model #
- Chassis Color
- Drawer Front Color
- Drawer Front Grain Direction
- Pull
- Wire Management

Options: Specify & Add

| | | |
|------|--|--------|
| WML | Wire Management - Left Panel | \$ 80 |
| WMR | Wire Management - Right Panel | \$ 80 |
| WMLR | Wire Management - Left and Right Panel | \$ 160 |

Pricing Codes:

- T= TFL
- P= HPL

[See Canvas Reception Overview for Ordering Options](#)

| Item | Model No. | Width | Depth | Height | Ship Wt | Cubic Ft | List Price |
|---|------------|-------|-------|--------|---------|----------|------------|
| MODULAR PEDESTAL WITH LATERAL FILE | 66-2436LF1 | 36 | 23¼ | 28¼ | 154 | 18.5 | T\$ 1489 |
| | 66-2430LF1 | 30 | 23¼ | 28¼ | 128 | 14.9 | T\$ 1384 |

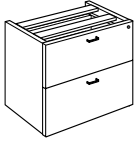

Must Specify (in this order):
 Model #
 Chassis Color
 Drawer Front Color
 Drawer Front Grain Direction
 Pull
 Wire Management

Description

- Lateral/Lateral Locking Modular Pedestal
- For Use With Desk and Return Shells
- Open Back
- Legal or Letter Filing Front to Back or Side to Side
- Grain Runs Vertical on Drawer Fronts. Optional Horizontal Grain Direction on Drawer Fronts; Must Specify

Options: Specify & Add

| | | |
|------|--|--------|
| WML | Wire Management - Left Panel | \$ 80 |
| WMR | Wire Management - Right Panel | \$ 80 |
| WMLR | Wire Management - Left and Right Panel | \$ 160 |

| | | | | | | | |
|---|------------|----|-----|-----|-----|------|----------|
| MODULAR PEDESTAL WITH MULTI-FILE | 66-2436LF2 | 36 | 23¼ | 28¼ | 153 | 18.5 | T\$ 1710 |
| | 66-2430LF2 | 30 | 23¼ | 28¼ | 128 | 14.9 | T\$ 1643 |

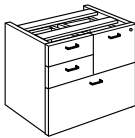

Must Specify (in this order):
 Model #
 Chassis Color
 Drawer Front Color
 Drawer Front Grain Direction
 Pull
 Wire Management

Description

- Box/Box/File/Lateral Locking Modular Pedestal
- For Use With Desk and Return Shells
- Open Back
- Lateral File Drawer Provides Legal or Letter Filing Front to Back or Side to Side
- Grain Runs Vertical on Drawer Fronts. Optional Horizontal Grain Direction on Drawer Fronts; Must Specify

Options: Specify & Add

| | | |
|------|--|--------|
| WML | Wire Management - Left Panel | \$ 80 |
| WMR | Wire Management - Right Panel | \$ 80 |
| WMLR | Wire Management - Left and Right Panel | \$ 160 |

| | | | | | | | |
|--|------------|----|-----|-----|-----|------|----------|
| MODULAR PEDESTAL WITH OPEN MULTI-FILE | 66-2436OMF | 36 | 23¼ | 28¼ | 128 | 18.5 | T\$ 1641 |
| | 66-2430OMF | 30 | 23¼ | 28¼ | 118 | 14.9 | T\$ 1575 |

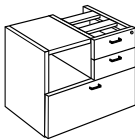

Must Specify (in this order):
 Model #
 Chassis Color
 Drawer Front Color
 Drawer Front Grain Direction
 Pull
 Wire Management

Description

- Box/Box/Lateral Locking Modular Pedestal
- Upper Section Provides 12¾" Clearance for Open Storage
- For Use With Desk and Return Shells
- Open Back
- Lateral File Drawer Provides Legal or Letter Filing Front to Back or Side to Side
- Grain Runs Vertical on Drawer Fronts. Optional Horizontal Grain Direction on Drawer Fronts; Must Specify

Options: Specify & Add

| | | |
|------|--|--------|
| WML | Wire Management - Left Panel | \$ 80 |
| WMR | Wire Management - Right Panel | \$ 80 |
| WMLR | Wire Management - Left and Right Panel | \$ 160 |

Pricing Codes:

T= TFL
 P= HPL

[See Canvas Reception Overview for Ordering Options](#)

| Item | Model No. | Width | Depth | Height | Ship Wt | Cubic Ft | List Price |
|------------------------------------|-----------|-------|-------|--------|---------|----------|------------|
| MODULAR PEDESTAL WITH DOORS | 66-2436DB | 36 | 23¼ | 28¼ | 105 | 18.5 | T\$ 1412 |
| | 66-2430DB | 30 | 23¼ | 28¼ | 87 | 14.9 | T\$ 1116 |

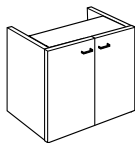

Must Specify (in this order):
 Model #
 Chassis Color
 Drawer Front Color
 Drawer Front Grain Direction
 Pull
 Wire Management

Description

- 12" Deep Adjustable Shelf Behind Doors
- For Use With Desk and Return Shells
- Open Back
- Grain Runs Vertical on Door Fronts. Optional Horizontal Grain Direction on Door Fronts; Must Specify
- Optional Locking Doors ([See Options](#)); Must Specify and Add

Options: Specify & Add

| | | |
|------|--|--------|
| WML | Wire Management - Left Panel | \$ 80 |
| WMR | Wire Management - Right Panel | \$ 80 |
| WMLR | Wire Management - Left and Right Panel | \$ 160 |

| | | | | | | | |
|---|------------|----|-----|-----|-----|------|----------|
| MODULAR PEDESTAL WITH DOORS AND OPEN COMPARTMENT | 66-2436ODB | 36 | 23¼ | 28¼ | 118 | 18.5 | T\$ 1334 |
| | 66-2430ODB | 30 | 23¼ | 28¼ | 108 | 14.9 | T\$ 1032 |

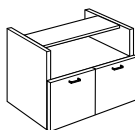

Must Specify (in this order):
 Model #
 Chassis Color
 Drawer Front Color
 Drawer Front Grain Direction
 Pull
 Wire Management

Description

- Upper Section Provides 12¾" Clearance for Open Storage
- Lower Section Provides Storage Behind Two (2) Doors
- For Use With Desk and Return Shells
- Open Back
- Grain Runs Vertical on Door Fronts. Optional Horizontal Grain Direction on Door Fronts; Must Specify
- Optional Locking Doors ([See Options](#)); Must Specify and Add

Options: Specify & Add

| | | |
|------|--|--------|
| WML | Wire Management - Left Panel | \$ 80 |
| WMR | Wire Management - Right Panel | \$ 80 |
| WMLR | Wire Management - Left and Right Panel | \$ 160 |

| | | | | | | | |
|---|------------|----|--------------------------------|-----|-----|------|----------|
| MODULAR PEDESTAL WITH OPEN STORAGE | 66-2436MBC | 36 | 22 ¹ / ₂ | 28¼ | 118 | 18.5 | T\$ 1154 |
| | 66-2430MBC | 30 | 22 ¹ / ₂ | 28¼ | 108 | 14.9 | T\$ 979 |

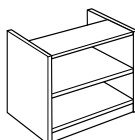

Must Specify (in this order):
 Model #
 Chassis Color
 Wire Management

Description

- For Use With Desk and Return Shells
- Open Back
- One (1) Adjustable Shelf

Options: Specify & Add

| | | |
|------|--|--------|
| WML | Wire Management - Left Panel | \$ 80 |
| WMR | Wire Management - Right Panel | \$ 80 |
| WMLR | Wire Management - Left and Right Panel | \$ 160 |

Pricing Codes:
 T= TFL
 P= HPL

[See Canvas Reception Overview for Ordering Options](#)

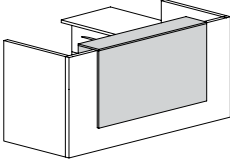
| Item | Model No. | Width | Depth | Height | Ship Wt | Cubic Ft | List Price |
|--|---|-------|-------|--------|---------|----------|------------|
| WATERFALL TRANSACTION KIT WITH PAPER SLOTS  | 64-1284TKS Five Slots; For Use With 96" Gallery | 84 | 12 | 38 | 98 | 16.1 | T\$ 1952 |
| | 64-1278TKS Four Slots; For Use With 90" Gallery | 78 | 12 | 38 | 91 | 15.0 | T\$ 1899 |
| | 64-1272TKS Four Slots; For Use With 84" Gallery | 72 | 12 | 38 | 85 | 13.9 | T\$ 1613 |
| | 64-1266TKS Four Slots; For Use With 78" Gallery | 66 | 12 | 38 | 78 | 12.8 | T\$ 1563 |
| | 64-1260TKS Four Slots; For Use With 72" Gallery | 60 | 12 | 38 | 71 | 11.7 | T\$ 1517 |
| | 64-1254TKS Three Slots; For Use With 66" Gallery | 54 | 12 | 38 | 64 | 10.6 | T\$ 1462 |
| | 64-1248TKS Three Slots; For Use With 60" Gallery | 48 | 12 | 38 | 57 | 9.5 | T\$ 1412 |
| | 64-1242TKS Two Slots | 42 | 12 | 38 | 50 | 8.4 | T\$ 1361 |
| | 64-1236TKS Two Slots | 36 | 12 | 38 | 43 | 7.3 | T\$ 1260 |
| | 64-1230TKS Two Slots | 30 | 12 | 38 | 36 | 6.2 | T\$ 1212 |
| | 64-1224TKS Two Slots | 24 | 12 | 38 | 29 | 5.1 | T\$ 1164 |

Must Specify (in this order):

Model #
Color
Paper Slot Divider Color
Support Bracket Color

Description

- Two (2) Support Brackets Included; Must Specify: Black (BLK) or Silver (SLV)
- Paper Slot Divider; Must Specify Color: Chrome or Laminate in Matching or Contrasting Color
- Some Assembly Required

Pricing Codes:

T= TFL
P= HPL

[See Canvas Reception Overview for Ordering Options](#)

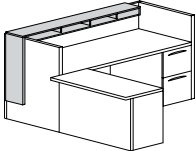
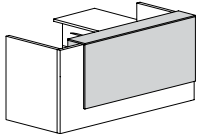
| Item | Model No. | Width | Depth | Height | Ship Wt | Cubic Ft | List Price | |
|---|---------------------------------------|--------------|-------|--------|---------|----------|------------|----------|
| CORNER WATERFALL TRANSACTION KIT WITH PAPER SLOTS  Shown as Left  | Left | Right | | | | | | |
| | 64-1290CTKSL | 64-1290CTKSR | 90 | 12 | 38 | 113 | 17.2 | T\$ 2124 |
| | Five Slots; For Use With 96" Gallery | | | | | | | |
| | 64-1284CTKSL | 64-1284CTKSR | 84 | 12 | 38 | 106 | 16.1 | T\$ 2073 |
| | Five Slots; For Use With 90" Gallery | | | | | | | |
| | 64-1278CTKSL | 64-1278CTKSR | 78 | 12 | 38 | 99 | 15.0 | T\$ 2021 |
| | Four Slots; For Use With 84" Gallery | | | | | | | |
| | 64-1272CTKSL | 64-1272CTKSR | 72 | 12 | 38 | 92 | 13.9 | T\$ 1734 |
| | Four Slots; For Use With 78" Gallery | | | | | | | |
| | 64-1266CTKSL | 64-1266CTKSR | 66 | 12 | 38 | 85 | 12.8 | T\$ 1684 |
| | Four Slots; For Use With 72" Gallery | | | | | | | |
| | 64-1260CTKSL | 64-1260CTKSR | 60 | 12 | 38 | 78 | 11.7 | T\$ 1635 |
| | Four Slots; For Use With 66" Gallery | | | | | | | |
| | 64-1254CTKSL | 64-1254CTKSR | 54 | 12 | 38 | 71 | 10.6 | T\$ 1578 |
| | Three Slots; For Use With 60" Gallery | | | | | | | |
| 64-1248CTKSL | 64-1248CTKSR | 48 | 12 | 38 | 65 | 9.5 | T\$ 1531 | |
| Three Slots | | | | | | | | |
| 64-1242CTKSL | 64-1242CTKSR | 42 | 12 | 38 | 58 | 8.4 | T\$ 1475 | |
| Two Slots | | | | | | | | |
| 64-1236CTKSL | 64-1236CTKSR | 36 | 12 | 38 | 51 | 7.3 | T\$ 1376 | |
| Two Slots | | | | | | | | |
| 64-1230CTKSL | 64-1230CTKSR | 30 | 12 | 38 | 44 | 6.2 | T\$ 1328 | |
| Two Slots | | | | | | | | |
| 64-1224CTKSL | 64-1224CTKSR | 24 | 12 | 38 | 37 | 5.1 | T\$ 1277 | |
| Two Slots | | | | | | | | |

Must Specify (in this order):

Model #
 Color
 Paper Slot Divider Color
 Support Bracket Color



Description

- One (1) Support Brackets Included; Must Specify: Black (BLK) or Silver (SLV)
- Paper Slot Divider; Must Specify Color: Chrome or Laminate in Matching or Contrasting Color
- Some Assembly Required

Pricing Codes:

T= TFL
 P= HPL

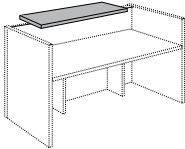
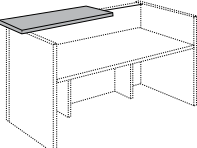
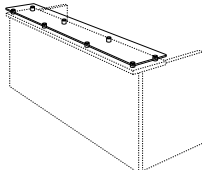
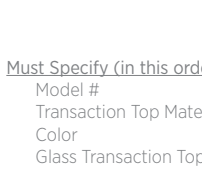
[See Canvas Reception Overview for Ordering Options](#)

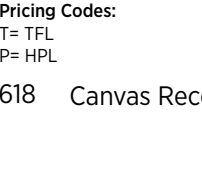
| Item | Model No. | Width | Depth | Height | Ship Wt | Cubic Ft | List Price |
|---|---------------------|-------|-------|--------|---------|----------|--------------------------------|
|  | 64-6012TP | 60 | 12 | 1 | 18 | 1.8 | T\$ 425 |
| | Front to Back Grain | | | | | | P\$ 597 |
| | | | | | | | Optional Glass Top Add \$ 1362 |
|  | 64-5712TP | 57 | 12 | 1 | 17 | 1.7 | T\$ 418 |
| | Front to Back Grain | | | | | | P\$ 587 |
| | | | | | | | Optional Glass Top Add \$ 1323 |
|  | 64-5412TP | 54 | 12 | 1 | 16 | 1.6 | T\$ 414 |
| | Front to Back Grain | | | | | | P\$ 579 |
| | | | | | | | Optional Glass Top Add \$ 1304 |
|  | 64-5112TP | 51 | 12 | 1 | 16 | 1.5 | T\$ 407 |
| | Front to Back Grain | | | | | | P\$ 571 |
| | | | | | | | Optional Glass Top Add \$ 1099 |
|  | 64-4812TP | 48 | 12 | 1 | 15 | 1.4 | T\$ 403 |
| | Front to Back Grain | | | | | | P\$ 564 |
| | | | | | | | Optional Glass Top Add \$ 1082 |
|  | 64-4512TP | 45 | 12 | 1 | 14 | 1.3 | T\$ 384 |
| | Front to Back Grain | | | | | | P\$ 536 |
| | | | | | | | Optional Glass Top Add \$ 1043 |
|  | 64-4212TP | 42 | 12 | 1 | 13 | 1.2 | T\$ 376 |
| | Front to Back Grain | | | | | | P\$ 528 |
| | | | | | | | Optional Glass Top Add \$ 1023 |
| | 64-3912TP | 39 | 12 | 1 | 12 | 1.1 | T\$ 372 |
| | Front to Back Grain | | | | | | P\$ 520 |
| | | | | | | | Optional Glass Top Add \$ 986 |
| | 64-3612TP | 36 | 12 | 1 | 11 | 1.0 | T\$ 366 |
| | Front to Back Grain | | | | | | P\$ 513 |
| | | | | | | | Optional Glass Top Add \$ 967 |
| | 64-3312TP | 33 | 12 | 1 | 10 | 0.9 | T\$ 361 |
| | Front to Back Grain | | | | | | P\$ 505 |
| | | | | | | | Optional Glass Top Add \$ 927 |
| | 64-3012TP | 30 | 12 | 1 | 9 | 0.8 | T\$ 357 |
| | Front to Back Grain | | | | | | P\$ 500 |
| | | | | | | | Optional Glass Top Add \$ 906 |
| | 64-2712TP | 27 | 12 | 1 | 8 | 0.7 | T\$ 348 |
| | Front to Back Grain | | | | | | P\$ 489 |
| | | | | | | | Optional Glass Top Add \$ 702 |
| | 64-2412TP | 24 | 12 | 1 | 7 | 0.6 | T\$ 341 |
| | Front to Back Grain | | | | | | P\$ 474 |
| | | | | | | | Optional Glass Top Add \$ 684 |

Two (2) Support Bracket Required

One (1) Support Bracket Required

Optional Glass Transaction Top for TFL or HPL Transaction Tops

Must Specify (in this order):
Model #
Transaction Top Material Color
Glass Transaction Top
Support Bracket Color

Additional Transaction Tops on next page.

Description

- Square (H) Edge Profile On All Sides
- 1½" Overhang on Approach and Side Depending on Placement
- If Top is Not Supported By An End Panel, Support Bracket is Required (Not Included)
- Support Brackets Required; See Below and Must Specify: Black (BLK) or Silver (SLV)
- Optional Glass Transaction Top with ¼" Silver Standoff, See "Optional Glass Top Add" Pricing and Specify (SOG)
- Optional Glass Transaction Top Field Installed

Support Brackets Required for Non-Supported End: Specify & Add

| | | |
|------------|--------|-------|
| 01-0607SSB | Black | \$ 49 |
| 01-0607SSS | Silver | \$ 49 |



Pricing Codes:

T= TFL
P= HPL

[See Canvas Reception Overview for Ordering Options](#)

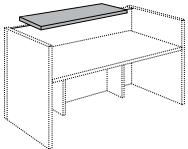
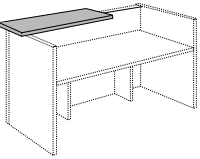
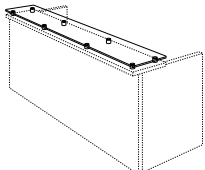
| Item | Model No. | Width | Depth | Height | Ship Wt | Cubic Ft | List Price |
|---|---------------------------------|-------|-------|--------|---------|----------|--|
|  Two (2) Support Bracket Required | 64-1296TP Side to Side Grain | 96 | 12 | 1 | 29 | 3.0 | T\$ 545 P\$ 763 Optional Glass Top Add \$ 1905 |
| | 64-1293TP Side to Side Grain | 93 | 12 | 1 | 28 | 2.9 | T\$ 524 P\$ 733 Optional Glass Top Add \$ 1832 |
| | 64-1290TP Side to Side Grain | 90 | 12 | 1 | 27 | 2.8 | T\$ 519 P\$ 726 Optional Glass Top Add \$ 1816 |
|  One (1) Support Bracket Required | 64-1287TP Side to Side Grain | 87 | 12 | 1 | 26 | 2.7 | T\$ 513 P\$ 719 Optional Glass Top Add \$ 1776 |
| | 64-1284TP Side to Side Grain | 84 | 12 | 1 | 26 | 2.6 | T\$ 508 P\$ 710 Optional Glass Top Add \$ 1757 |
| | 64-1281TP Side to Side Grain | 81 | 12 | 1 | 25 | 2.5 | T\$ 501 P\$ 704 Optional Glass Top Add \$ 1720 |
|  Optional Glass Transaction Top for TFL or HPL Transaction Tops | 64-1278TP Side to Side Grain | 78 | 12 | 1 | 24 | 2.4 | T\$ 497 P\$ 695 Optional Glass Top Add \$ 1534 |
| | 64-1275TP Side to Side Grain | 75 | 12 | 1 | 23 | 2.3 | T\$ 491 P\$ 687 Optional Glass Top Add \$ 1496 |
| | 64-1272TP Side to Side Grain | 72 | 12 | 1 | 22 | 2.2 | T\$ 486 P\$ 679 Optional Glass Top Add \$ 1457 |
| Must Specify (in this order): Model # Transaction Top Material Color Glass Transaction Top Support Bracket Color | 64-1269TP Side to Side Grain | 69 | 12 | 1 | 21 | 2.1 | T\$ 441 P\$ 618 Optional Glass Top Add \$ 1439 |
| | 64-1266TP Side to Side Grain | 66 | 12 | 1 | 21 | 2.1 | T\$ 437 P\$ 611 Optional Glass Top Add \$ 1419 |

Additional Transaction Tops on next page.

Description

- Square (H) Edge Profile On All Sides
- 1½" Overhang on Approach and Side Depending on Placement
- If Top is Not Supported By An End Panel, Support Bracket is Required (Not Included)
- Support Brackets Required; See Below and Must Specify: Black (BLK) or Silver (SLV)
- Optional Glass Transaction Top with 1¼" Silver Standoff, See "Optional Glass Top Add" Pricing and Specify (SOG)
- Optional Glass Transaction Top Field Installed

Support Brackets Required for Non-Supported End: Specify & Add

| | | |
|------------|--------|-------|
| 01-0607SSB | Black | \$ 49 |
| 01-0607SSS | Silver | \$ 49 |



Pricing Codes:

T= TFL
P= HPL

[See Canvas Reception Overview for Ordering Options](#)

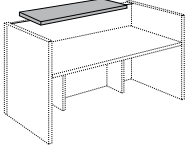
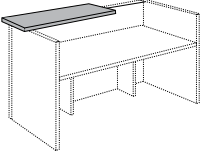
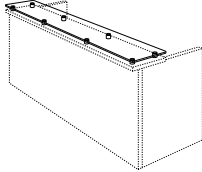
| Item | Model No. | Width | Depth | Height | Ship Wt | Cubic Ft | List Price |
|---|---------------------------------|-------|-------|--------|---------|----------|--|
|  Two (2) Support Bracket Required | 64-1263TP Side to Side Grain | 63 | 12 | 1 | 19 | 1.9 | T\$ 432 P\$ 602 Optional Glass Top Add \$ 1379 |
| | 64-1260TP Side to Side Grain | 60 | 12 | 1 | 18 | 1.8 | T\$ 425 P\$ 597 Optional Glass Top Add \$ 1362 |
| | 64-1257TP Side to Side Grain | 57 | 12 | 1 | 17 | 1.7 | T\$ 419 P\$ 588 Optional Glass Top Add \$ 1323 |
|  One (1) Support Bracket Required | 64-1254TP Side to Side Grain | 54 | 12 | 1 | 16 | 1.6 | T\$ 414 P\$ 579 Optional Glass Top Add \$ 1304 |
| | 64-1251TP Side to Side Grain | 51 | 12 | 1 | 16 | 1.5 | T\$ 407 P\$ 571 Optional Glass Top Add \$ 1099 |
|  Optional Glass Transaction Top for TFL or HPL Transaction Tops | 64-1248TP Side to Side Grain | 48 | 12 | 1 | 15 | 1.4 | T\$ 403 P\$ 564 Optional Glass Top Add \$ 1082 |
| | 64-1245TP Side to Side Grain | 45 | 12 | 1 | 14 | 1.3 | T\$ 384 P\$ 536 Optional Glass Top Add \$ 1043 |
| | 64-1242TP Side to Side Grain | 42 | 12 | 1 | 13 | 1.2 | T\$ 376 P\$ 528 Optional Glass Top Add \$ 1023 |
| Must Specify (in this order): Model # Transaction Top Material Color Glass Transaction Top Support Bracket Color | 64-1239TP Side to Side Grain | 39 | 12 | 1 | 12 | 1.1 | T\$ 372 P\$ 520 Optional Glass Top Add \$ 986 |
| | 64-1236TP Side to Side Grain | 36 | 12 | 1 | 11 | 1.0 | T\$ 366 P\$ 513 Optional Glass Top Add \$ 967 |
| Additional Transaction Tops on next page. | 64-1233TP Side to Side Grain | 33 | 12 | 1 | 10 | 0.9 | T\$ 361 P\$ 505 Optional Glass Top Add \$ 927 |
| | 64-1230TP Side to Side Grain | 30 | 12 | 1 | 9 | 0.8 | T\$ 357 P\$ 500 Optional Glass Top Add \$ 906 |
| | 64-1227TP Side to Side Grain | 27 | 12 | 1 | 8 | 0.7 | T\$ 348 P\$ 489 Optional Glass Top Add \$ 702 |
| | 64-1224TP Side to Side Grain | 24 | 12 | 1 | 7 | 0.6 | T\$ 341 P\$ 474 Optional Glass Top Add \$ 684 |

Description

- Square (H) Edge Profile On All Sides
- 1½" Overhang on Approach and Side Depending on Placement
- If Top is Not Supported By An End Panel, Support Bracket is Required (Not Included)
- Support Brackets Required; See Below and Must Specify: Black (BLK) or Silver (SLV)
- Optional Glass Transaction Top with 1 ¼" Silver Standoff, See "Optional Glass Top Add" Pricing and Specify (SOG)
- Optional Glass Transaction Top Field Installed

Support Brackets Required for Non-Supported End: Specify & Add

| | | |
|------------|--------|-------|
| 01-0607SSB | Black | \$ 49 |
| 01-0607SSS | Silver | \$ 49 |

Pricing Codes:

T= TFL
P= HPL

[See Canvas Reception Overview for Ordering Options](#)

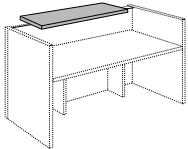
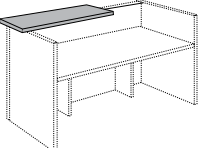
| Item | Model No. | Width | Depth | Height | Ship Wt | Cubic Ft | List Price |
|---|--------------|-------|-------|--------|---------|----------|------------|
| TRANSACTION TOP WITH SOLID SURFACE | 64-1296SSSTP | 96 | 12 | 1½ | 102 | 3.0 | \$ 2884 |
| | 64-1293SSSTP | 93 | 12 | 1½ | 99 | 2.9 | \$ 2824 |
|  | 64-1290SSSTP | 90 | 12 | 1½ | 96 | 2.8 | \$ 2770 |
| | 64-1287SSSTP | 87 | 12 | 1½ | 92 | 2.7 | \$ 2724 |
| | 64-1284SSSTP | 84 | 12 | 1½ | 89 | 2.5 | \$ 2561 |
| | 64-1281SSSTP | 81 | 12 | 1½ | 86 | 2.5 | \$ 2506 |
| | 64-1278SSSTP | 78 | 12 | 1½ | 83 | 2.4 | \$ 2460 |
| | 64-1275SSSTP | 75 | 12 | 1½ | 80 | 2.3 | \$ 2419 |
| | 64-1272SSSTP | 72 | 12 | 1½ | 76 | 2.2 | \$ 2203 |
| | 64-1269SSSTP | 69 | 12 | 1½ | 73 | 2.1 | \$ 2155 |
| | 64-1266SSSTP | 66 | 12 | 1½ | 70 | 2.0 | \$ 2114 |
| | 64-1263SSSTP | 63 | 12 | 1½ | 67 | 1.9 | \$ 2076 |
|  | 64-1260SSSTP | 60 | 12 | 1½ | 64 | 1.8 | \$ 1891 |
| | 64-1257SSSTP | 57 | 12 | 1½ | 60 | 1.7 | \$ 1846 |
| | 64-1254SSSTP | 54 | 12 | 1½ | 57 | 1.6 | \$ 1807 |
| | 64-1251SSSTP | 51 | 12 | 1½ | 54 | 1.5 | \$ 1773 |
| | 64-1248SSSTP | 48 | 12 | 1½ | 51 | 1.4 | \$ 1563 |
| | 64-1245SSSTP | 45 | 12 | 1½ | 48 | 1.3 | \$ 1522 |
| | 64-1242SSSTP | 42 | 12 | 1½ | 44 | 1.2 | \$ 1486 |
| | 64-1239SSSTP | 39 | 12 | 1½ | 41 | 1.1 | \$ 1455 |
| | 64-1236SSSTP | 36 | 12 | 1½ | 38 | 1.0 | \$ 1247 |
| | 64-1233SSSTP | 33 | 12 | 1½ | 35 | 0.9 | \$ 1212 |
| 64-1230SSSTP | 30 | 12 | 1½ | 32 | 0.8 | \$ 1177 | |
| 64-1227SSSTP | 27 | 12 | 1½ | 28 | 0.7 | \$ 1151 | |
| 64-1224SSSTP | 24 | 12 | 1½ | 25 | 0.6 | \$ 845 | |

Two (2) Support Bracket Required

One (1) Support Bracket Required

Must Specify (in this order):

Model #

Color

Support Bracket Color

Description

- Straight (S1) Edge Profile On All Sides
- 1½" Overhang on Approach and Side Depending on Placement
- If Top is Not Supported By An End Panel, Support Bracket is Required (Not Included)
- Support Brackets Available in Black or Silver: See Below and Must Specify

**Support Brackets Required for Non-Supported End: Specify & Add**

| | | |
|------------|--------|-------|
| 01-0607SSB | Black | \$ 49 |
| 01-0607SSS | Silver | \$ 49 |

Pricing Codes:

T= TFL

P= HPL

[See Canvas Reception Overview for Ordering Options](#)

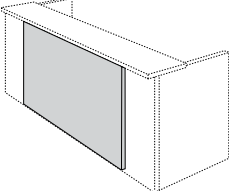
| Item | Model No. | Width | Depth | Height | Ship Wt | Cubic Ft | List Price | |
|--|-------------------------------------|-------|-------|--------|---------|----------|------------|--|
|  <p>Shaded Overlay Panel (Shown with Optional Transactional Top)</p> <p>Must Specify (in this order): Model # Color Overlay Back Lighting</p> | 64-OT96 | 72 | ¾ | 41 | 57 | 5.2 | T\$ 666 | |
| | For Use With 96" Desk or 95" Return | | | | | | | |
| | 64-OT90 | 66 | ¾ | 41 | 52 | 4.8 | T\$ 632 | |
| | For Use With 90" Desk | | | | | | | |
| | 64-OT84 | 60 | ¾ | 41 | 47 | 4.4 | T\$ 599 | |
| | For Use With 84" Desk or 83" Return | | | | | | | |
| | 64-OT78 | 54 | ¾ | 41 | 42 | 4.0 | T\$ 564 | |
| | For Use With 78" Desk | | | | | | | |
| | 64-OT72 | 48 | ¾ | 41 | 38 | 3.6 | T\$ 526 | |
| | For Use With 72" Desk or 71" Return | | | | | | | |
| 64-OT66 | 42 | ¾ | 41 | 33 | 3.2 | T\$ 486 | | |
| For Use With 66" Desk | | | | | | | | |
| 64-OT60 | 36 | ¾ | 41 | 28 | 2.8 | T\$ 443 | | |
| For Use With 60" Desk or 58" Return | | | | | | | | |
| Description | | | | | | | | |
| <ul style="list-style-type: none"> • Horizontal Woodgrain • Designed to be Used with a Transaction Top • Not Compatible with Waterfall Transaction Kit • Optional Back Lighting | | | | | | | | |
| Options: Specify & Add | | | | | | | | |
| BKLIT | Back Lighting | | | | | | \$ 1568 | |

Pricing Codes:

T= TFL

P= HPL

[See Canvas Reception Overview for Ordering Options](#)

CANVAS™

LAMINATE RECEPTION + COMPONENTS (6400 SERIES)

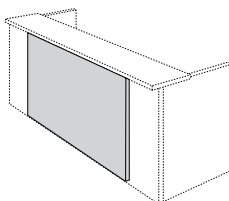
| Item | Model No. | Width | Depth | Height | Ship Wt | Cubic Ft | List Price | |
|---|---|-------|-------|--------|---------|----------|-----------------------|--|
|  <p>Shaded Overlay Panel (Shown with Optional Transactional Top)</p> | 64-OHGA96 For Use With 96" Desk or 95" Return | 72 | ¼ | 41 | 57 | 5.2 | \$ 2511 GPA\$ 3370 | |
| | 64-OHGA90 For Use With 90" Desk | 66 | ¼ | 41 | 52 | 4.8 | \$ 2329 GPA\$ 3111 | |
| | 64-OHGA84 For Use With 84" Desk or 83" Return | 60 | ¼ | 41 | 47 | 4.4 | \$ 2141 GPA\$ 2854 | |
| | 64-OHGA78 For Use With 78" Desk | 54 | ¼ | 41 | 42 | 4.0 | \$ 1951 GPA\$ 2595 | |
| | 64-OHGA72 For Use With 72" Desk or 71" Return | 48 | ¼ | 41 | 38 | 3.6 | \$ 1765 GPA\$ 2336 | |
| | 64-OHGA66 For Use With 66" Desk | 42 | ¼ | 41 | 33 | 3.2 | \$ 1571 GPA\$ 2071 | |
| | 64-OHGA60 For Use With 60" Desk or 58" Return | 36 | ¼ | 41 | 28 | 2.8 | \$ 1376 GPA\$ 1803 | |
| | Description | | | | | | | |
| | <ul style="list-style-type: none"> • Must Specify Color: Black (BLA), Wired Mercury (WMA), White (WHA) or Graphite Acrylic (GPA); Graphite Acrylic Pricing (GPA\$) • Optional Back Lighting | | | | | | | |
| | Options: Specify & Add | | | | | | | |
| BKLIT | Back Lighting | | | | | | \$ 1568 | |

Must Specify (in this order):

Model #
Color
Overlay Back Lighting

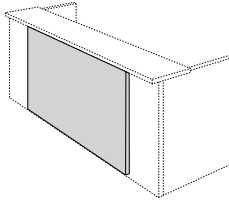
| | | | | | | | |
|---|---|----|---|----|----|-----|---------|
|  <p>Shaded Overlay Panel (Shown with Optional Transactional Top)</p> | 64-OFA96 For Use With 96" Desk or 95" Return | 72 | ¼ | 41 | 21 | 5.2 | \$ 2218 |
| | 64-OFA90 For Use With 90" Desk | 66 | ¼ | 41 | 19 | 4.8 | \$ 2120 |
| | 64-OFA84 For Use With 84" Desk or 83" Return | 60 | ¼ | 41 | 17 | 4.4 | \$ 1947 |
| | 64-OFA78 For Use With 78" Desk | 54 | ¼ | 41 | 15 | 4.0 | \$ 1796 |
| | 64-OFA72 For Use With 72" Desk or 71" Return | 48 | ¼ | 41 | 13 | 3.6 | \$ 1652 |
| | 64-OFA66 For Use With 66" Desk | 42 | ¼ | 41 | 11 | 3.2 | \$ 1498 |
| | 64-OFA60 For Use With 60" Desk or 58" Return | 36 | ¼ | 41 | 9 | 2.8 | \$ 1304 |

Description

- Features Decorative Hardware, 1¼" Silver Standoffs
- Optional Custom Engraving Available; Call Customer Service For Lead Times and Pricing

Pricing Codes:

T= TFL
P= HPL

[See Canvas Reception Overview for Ordering Options](#)

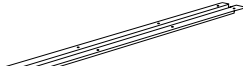
| Item | Model No. | Width | Depth | Height | Ship Wt | Cubic Ft | List Price |
|---|------------|-------|-------|--------|---------|----------|------------|
|  | 01-00060SB | 60 | 1¾ | ¾ | 8 | 0.3 | \$ 129 |
| | 01-00048SB | 48 | 1¾ | ¾ | 5 | 0.3 | \$ 121 |

Description

- Reinforces Worksurfaces with Large Kneespace Widths
- Includes End Caps to Cover Sharp Edges
- Field Installed
- Recommended in Kneespaces 60" or Greater

| | | | | | | | | | |
|---|-----------------------------|------------|--------|---|---|---|---|-----|-------|
|  | TRANSACTION SUPPORT BRACKET | 01-0607SSB | Black | 6 | - | - | 1 | 1.0 | \$ 49 |
| | | 01-0607SSS | Silver | | | | | | |

Description

- For Use With Unsupported Transaction Tops and Waterfall Transaction Kits

| | | | | | | | | | |
|---|---------------------|-----------|--------|---|---|---|---|---|-------|
|  | ROUND GROMMET COVER | 01-GRMTBK | Black | - | - | - | - | - | \$ 11 |
| | FIELD INSTALLED | 01-GRMTSL | Silver | | | | | | |

Description

- 60mm Round Grommet Cover
- Field Installed

OPEN MARKET ONLY
(SILVER)

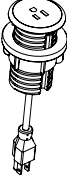
| | | | | | | | | | |
|---|--------------------------|-------------|--------|---|---|---|---|-----|-------|
|  | SINGLE POWER SAND DOLLAR | 01-SAND60PW | White | 3 | 3 | 4 | 1 | 0.2 | \$ 98 |
| | | 01-SAND60PB | Black | | | | | | |
| | | 01-SAND60PS | Silver | | | | | | |

Description

- Available on Height Adjustable Desks, Returns and Bridge Units with Wire Management Box in Center Grommet Only (GC-BOX)
- Unit is 2" Diameter; Mounts in 60mm Round Grommet
- 6' Cord
- Single Power Outlet

| Item | Model No. | | Width | Depth | Height | Ship Wt | Cubic Ft | List Price |
|------------------------|-------------|--------|-------|-------|--------|---------|----------|------------|
| DOUBLE USB SAND DOLLAR | 01-SAND60UW | White | 3 | 3 | 4 | 1 | 0.2 | \$ 277 |
| | 01-SAND60UB | Black | | | | | | |
| | 01-SAND60US | Silver | | | | | | |

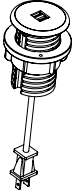

Description

- Available on Height Adjustable Desks, Returns and Bridge Units with Wire Management Box in Center Grommet Only (GC-BOX)
- Unit is 2" Diameter; Mounts in 60mm Round Grommet
- 6' Cord
- Dual USB Outlets

| | | | | | | | | |
|------------------------------|-------------|-------|--------------------|--------------------|---|---|-----|--------|
| DOCK 950 WIRELESS CHARGER | 01-DOCK950W | White | 3 $\frac{3}{16}$ " | 3 $\frac{3}{16}$ " | - | 1 | 0.2 | \$ 265 |
| | 01-DOCK950B | Black | | | | | | |

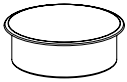

OPEN MARKET ONLY

Description

- For Use with Wireless Charging Enabled Devices
- 5 Watts Maximum Output with a Direct Current of 5V 2A and 10 Watts Maximum with Quick Charge 2.0
- Mounts in 76mm Round Cut-Out
- LED will Confirm Pairing with Device and Begin Wireless Charging



| | | | | | | | | |
|--------------------------------------|-------------|-------|---|---|-----------------|---|-----|--------|
| DOCK 150 WIRELESS AND USB CHARGER | 01-DOCK150W | White | 3 | 3 | $\frac{3}{4}$ " | 1 | 0.2 | \$ 405 |
| | 01-DOCK150B | Black | | | | | | |



OPEN MARKET ONLY

Description

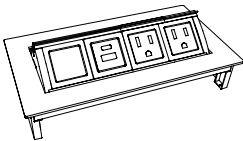
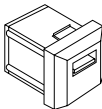
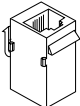
- For Use with Wireless Charging Enabled Devices and USB Charging Devices
- 5 Watt Maximum Output with a Direct Current Input of 5V 6A (Wireless Fast Charge)
- Mounts in 76mm Round Cut-Out
- Pop-Up is $\frac{3}{4}$ "H and Includes Three (3) USB Ports; One (1) 12 Watt Maximum with 2.4A (USB Fast Charge) and Two (2) 5 Watt with 1A (USB Standard Charge)
- LED Light will Confirm Pairing with Device and Begin Wireless Charging
- UL and cUL Certified

| Item | Model No. | | Width | Depth | Height | Ship Wt | Cubic Ft | List Price |
|--|------------|----------|-------|-------|--------|---------|----------|------------|
| POWER DATA PORT  | 01-DPORT4A | Aluminum | 8 | 4 | - | 7 | 0.2 | \$ 1093 |
| | 01-DPORT4B | Black | 8 | 4 | - | 7 | 0.2 | \$ 1093 |
| Description | | | | | | | | |
| <ul style="list-style-type: none"> • Retracts into Work Surface to Regain Productive Space • One-Touch Access to Power and Data • Two Power Outlets and Two Open Ports for Data • Water-Proof Simplex (Outlets) • Includes a Voice/Data Adapter Kit to Accept Couplers and Jacks When Required • 6' Power Cord | | | | | | | | |
| USB PORT  | 01-USBPORT | | - | - | - | - | - | \$ 161 |
| Description | | | | | | | | |
| <ul style="list-style-type: none"> • For Use with 01-DPORT4A and 01-DPORT4B • Passive USB-A Port with Increased Transfer Speed Up to 5 gbs/sec • Simultaneous Read/Write Capability • Idle Device Power Saving State • 6' Cord | | | | | | | | |
| VOICE COUPLER  | 01-VOICE1 | | - | - | - | - | - | \$ 73 |
| Description | | | | | | | | |
| <ul style="list-style-type: none"> • For Use with 01-DPORT4A and 01-DPORT4B • 6-Pin Modular Plug • Molded Black • Cord Not included | | | | | | | | |
| DATA PORT  | 01-RJ4DATA | | - | - | - | - | - | \$ 167 |
| Description | | | | | | | | |
| <ul style="list-style-type: none"> • For Use with 01-DPORT4A and 01-DPORT4B • 8-Pin Modular Plug • Cat6 Ethernet Cable • Pre-terminated Cable • 10' Cord | | | | | | | | |
| PASSIVE USB-C ACCESSORY  | 01-PUSBC | | - | - | - | 1 | 0.2 | \$ 95 |
| Description | | | | | | | | |
| <ul style="list-style-type: none"> • Passive USB-C Port ; Unit Provides Data Connection to Transfer Data Only, No Charging Capabilities • Compatible with 01-DPORT4A and 01-DPORT4B • Male/Female Connector | | | | | | | | |

| Item | Model No. | Width | Depth | Height | Ship Wt | Cubic Ft | List Price |
|----------------------------|-----------|-------|-------|--------|---------|----------|------------|
| CHARGING USB-A+C ACCESSORY | 01-USBAC | - | - | - | 1 | 0.2 | \$ 283 |

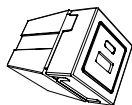
Description

- For Charging Devices
- 20 Watt Power Supply
- USB+C Charging Port for 01-DPORT4A and 01-DPORT4B

| | | | | | | | |
|--------------------------|------------|---|---|---|---|-----|--------|
| HDMI CONNECTOR ACCESSORY | 01-HDMICON | - | - | - | 1 | 0.2 | \$ 124 |
|--------------------------|------------|---|---|---|---|-----|--------|

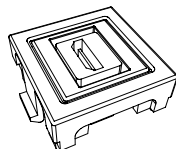
Description

- HDMI Port for 01-DPORT4A and 01-DPORT4B
- Connects to High Definition Displays
- Female/Female Connector
- 18" Cord

| | | | | | | | |
|-------------------------|-----------|---|---|---|---|-----|--------|
| VGA CONNECTOR ACCESSORY | 01-VGACON | - | - | - | 1 | 0.2 | \$ 149 |
|-------------------------|-----------|---|---|---|---|-----|--------|

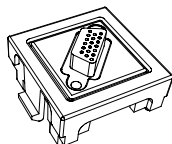
Description

- VGA Port for 01-DPORT4A and 01-DPORT4B
- Enables Devices to Remote Display on Monitors
- 10' Cord
- Male/Female Connector

| | | | | | | | | |
|-----------------------------|---------------|--------|-----|---|---|---|-----|--------|
| DUO CLAMP WITH NEMA PLUG | 01-DUOCLAMPW | White | 5 ½ | 3 | 7 | 1 | 0.2 | \$ 572 |
| | 01-DUOCLAMPB | Black | | | | | | |
| | 01-DUOCLAMP S | Silver | | | | | | |

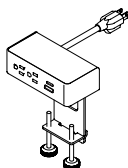
Description

- Clamps to Top and Includes: Two (2) Power, **One (1) USB Charging Port and One (1) 60-Watt USB-C Power Delivery Port with GaN Technology with 10' Cord**
- Silver Metal Trim
- Independent USB Circuit Controllers Deliver up to 2.1 Amps to Each Post
- All Mounting Hardware Included
- FCC Part 15A and UL Approved for Horizontal and Vertical Applications

| Item | Model No. | | Width | Depth | Height | Ship Wt | Cubic Ft | List Price |
|------------------------------|---------------|--------|-------|-------|--------|---------|----------|------------|
| TRIO CLAMP WITH NEMA PLUG | 01-TRIOCLAMPW | White | 8 | 3 | 7 | 1 | 0.2 | \$ 671 |
| | 01-TRIOCLAMPB | Black | | | | | | |
| | 01-TRIOCLAMPS | Silver | | | | | | |

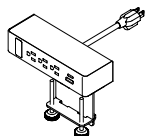

Description

- Silver Metal Trim
- Clamps to Top and Includes: Three (3) Power, **One (1) USB Charging Port, One (1) 60-Watt USB-C Power Delivery Port with GaN Technology**, One (1) Open Data and 10' Cord
- Independent USB Circuit Controllers Deliver up to 2.1 Amps to Each Post
- HDMI, VGA, or RJ45 Sold Separately; [See Accessories](#)
- All Mounting Hardware Included
- FCC Part 15A and UL Approved for Horizontal and Vertical Applications

| | | | | | | | | |
|----------------------------------|-------------|--------|----|----|---|---|-----|--------|
| UNDERMOUNT DUO WITH NEMA PLUG | 01-DUUNDERW | White | 6½ | 2½ | 3 | 1 | 0.2 | \$ 546 |
| | 01-DUUNDERB | Black | | | | | | |
| | 01-DUUNDERS | Silver | | | | | | |



Description

- Two (2) Power, **One (1) USB Charging Port and One (1) 60-Watt USB-C Power Delivery Port with GaN Technology with 10' Cord**
- Sits Under the Worksurface
- Independent USB Circuit Controllers Deliver up to 2.1 Amps to Each Post
- All Mounting Hardware Included
- FCC Part 15A and UL Approved for Horizontal and Vertical Applications

| | | | | | | | | |
|-----------------------------------|---------------|--------|----|----|---|---|-----|--------|
| UNDERMOUNT TRIO WITH NEMA PLUG | 01-TRIOUNDERW | White | 6½ | 2½ | 3 | 1 | 0.2 | \$ 655 |
| | 01-TRIOUNDERB | Black | | | | | | |
| | 01-TRIOUNDERS | Silver | | | | | | |



Description

- Sits On Top of the Worksurface and Includes: Three (3) Power, **One (1) USB Charging Port, One (1) 60-Watt USB-C Power Delivery Port with GaN Technology**, One (1) Open Data with 10' Cord
- Independent USB Circuit Controllers Deliver up to 2.1 Amps to Each Post
- HDMI, VGA, or RJ45 Sold Separately; [See Accessories](#)
- All Mounting Hardware Included
- FCC Part 15A and UL Approved for Horizontal and Vertical Applications

| Item | Model No. | | Width | Depth | Height | Ship Wt | Cubic Ft | List Price |
|-----------------------------|--------------|--------|-------|-------|--------|---------|----------|------------|
| DUO BEZEL WITH NEMA PLUG | 01-DUOBEZELW | White | 9 | 2½ | 3 | 1 | 0.2 | \$ 675 |
| | 01-DUOBEZELB | Black | | | | | | |
| | 01-DUOBEZELS | Silver | | | | | | |



Description

- Sits On Top of the Worksurface and Includes: Two (2) Power, **One (1) USB Charging Port and One (1) 60-Watt USB-C Power Delivery Port with GaN Technology with 10' Cord**
- Independent USB Circuit Controllers Deliver up to 2.1 Amps to Each Post
- All Mounting Hardware Included
- FCC Part 15A and UL Approved for Horizontal and Vertical Applications

| | | | | | | | | |
|------------------------------|---------------|--------|----|----|---|---|-----|--------|
| TRIO BEZEL WITH NEMA PLUG | 01-TRIOBEZELW | White | 6½ | 2½ | 3 | 1 | 0.2 | \$ 725 |
| | 01-TRIOBEZELB | Black | | | | | | |
| | 01-TRIOBEZELS | Silver | | | | | | |



Description

- Sits On Top of the Worksurface and Includes: Three (3) Power **One (1) USB Charging Port, One (1) 60-Watt USB-C Power Delivery Port with GaN Technology, One (1) Open Data with 10' Cord**
- Independent USB Circuit Controllers Deliver up to 2.1 Amps to Each Post
- HDMI, VGA, or RJ45 Sold Separately; [See Accessories](#)
- All Mounting Hardware Included
- FCC Part 15A and UL Approved for Horizontal and Vertical Applications

| | | | | | | | | |
|-------------------------|------------|--|---|---|---|---|-----|--------|
| VGA DATA PORT ACCESSORY | 01-LCOMVGA | | - | - | - | 1 | 0.2 | \$ 121 |
|-------------------------|------------|--|---|---|---|---|-----|--------|

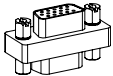

Description

- VGA Port for Trio Clamp, Trio Bezel and Undermount Trio Units

| | | | | | | | | |
|--------------------------|-------------|--|---|---|---|---|-----|--------|
| HDMI DATA PORT ACCESSORY | 01-LCOMHDMI | | - | - | - | 1 | 0.2 | \$ 166 |
|--------------------------|-------------|--|---|---|---|---|-----|--------|

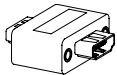

OPEN MARKET ONLY

Description

- HDMI Port for Trio Clamp, Trio Bezel and Undermount Trio Units

| | | | | | | | | |
|--------------------------|-------------|--|---|---|---|---|-----|-------|
| RJ45 DATA PORT ACCESSORY | 01-LCOMRJ45 | | - | - | - | 1 | 0.2 | \$ 79 |
|--------------------------|-------------|--|---|---|---|---|-----|-------|

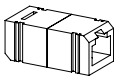

Description

- RJ45 Port for Trio Clamp, Trio Bezel and Undermount Trio Units

| Item | Model No. | Width | Depth | Height | Ship Wt | Cubic Ft | List Price |
|-------------------------|-----------|-------|-------|--------|---------|----------|------------|
| WIRE MANAGEMENT CHANNEL | 01-WMGR4 | 16 | 1½ | ¾ | 1 | - | \$ 116 |

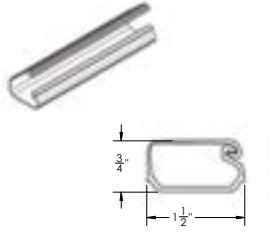
**Description**

- Set of Four (4) Black Plastic Wire Management Channels
- Snap Lock Channel
- Attaches with Adhesive Strips
- Ships via UPS Only

| | | | | | | | |
|--------------|----------|----|----|---|-----|-----|--------|
| WIRE CHANNEL | 01-32125 | 24 | 1⅝ | 1 | .25 | 0.3 | \$ 106 |
|--------------|----------|----|----|---|-----|-----|--------|

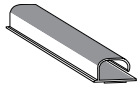
**Description**

- Available in Black
- Channels Attach with Two (2) Double-Sided Installation Tape
- Open J Channel for Easy Storage of Cables

| | | | | | | | |
|------------|-----------|-----|-----|---|---|---|-------|
| CABLE GRIP | 01-WMGRCB | 5 ¾ | 2 ⅝ | - | - | - | \$ 17 |
|------------|-----------|-----|-----|---|---|---|-------|

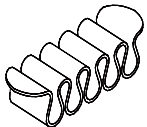
**Description**

- Under Surface Wire Management
- Black

| | | | | | | | | |
|------------------------|----------------|--------|----|-----|-------|---|-----|--------|
| LINK 360 CABLE MANAGER | 01-0251LINKSLV | Silver | 5¾ | 3 ⅝ | 30-51 | 4 | 3.0 | \$ 390 |
| | 01-0251LINKBLK | Black | 5¾ | 3 ⅝ | 30-51 | 4 | 3.0 | \$ 353 |

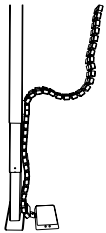
**Description**

- Kit Includes: 50 Link 360™ elements, One (1) Quad Connector, One (1) Dumbbell Connector, One (1) Foot Assembly with Two (2) Magnetic Clips
- Can Be Used For Height-Adjustable Mechanisms Up To 51" or Free-Standing Use

Pricing Codes:

T= TFL
P= HPL

[See Canvas Reception Overview for Ordering Options](#)

| Item | Model No. | Width | Depth | Height | Ship Wt | Cubic Ft | List Price |
|---------------|-----------|-------|-------|--------|---------|----------|------------|
| CENTER DRAWER | 66-1622CD | 22 | 16 | 2 | 7 | 1.4 | T\$ 401 |

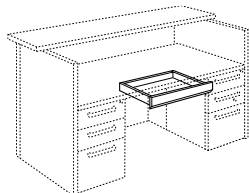

Description

- Attaches Under Worksurfaces
- Built in Pen Tray
- Field Installed Only
- Grain Runs Vertical on Drawer Fronts. Optional Horizontal Grain Direction on Drawer Fronts; Must Specify

Must Specify (in this order):

- Model #
- Color
- Grain Direction

DESK SHELL TACKBOARDS
9" H

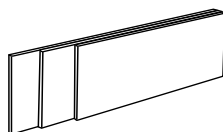

| Model # | Size | COM ydg | COM, 1, 2 or 3 | Grades | | | | | | |
|---------|------|---------|-------------------|--------|-----|------|------|------|------|------|
| | | | | 4 | 5 | 6 | 7 | 8 | 9 | 10 |
| TB-6296 | 96" | 3.00 | \$ 351 | 768 | 963 | 1161 | 1443 | 1737 | 2079 | 2475 |
| TB-6290 | 90" | 2.75 | \$ 335 | 717 | 896 | 1078 | 1336 | 1606 | 1919 | 2282 |
| TB-6284 | 84" | 2.50 | \$ 317 | 665 | 827 | 992 | 1227 | 1472 | 1757 | 2087 |
| TB-6278 | 78" | 2.50 | \$ 311 | 659 | 821 | 986 | 1221 | 1466 | 1751 | 2081 |
| TB-6272 | 72" | 2.25 | \$ 256 | 569 | 715 | 864 | 1075 | 1296 | 1552 | 1849 |
| TB-6266 | 66" | 2.00 | \$ 232 | 510 | 640 | 772 | 960 | 1156 | 1384 | 1648 |
| TB-6260 | 60" | 1.75 | \$ 219 | 462 | 576 | 692 | 856 | 1028 | 1227 | 1458 |

Description

- All tackboards 78" and longer are Two (2) pieces
- Field Installed
- For Use with Transaction Tops
- Not Compatible with Waterfall Transaction Kit

Must Specify (in this order):

- Model #
- Tackboard Fabric Vendor, Pattern, and Color

| | | | | | | | |
|--------------------|----------|-----|----|-----|----|-----|---------|
| VESTA POWER CENTER | 01-PDCTR | 10¾ | 12 | 28¾ | 14 | 2.5 | \$ 1776 |
|--------------------|----------|-----|----|-----|----|-----|---------|



Description

- Top Includes One (1) Power Outlet, Two (2) USB Ports and One (1) USBC Port; Base Includes Three (3) Outlet
- Available in White
- 120" Power Cord
- Built with Weight Distribution for Optimal Stability
- Base is 5" Tall

Pricing Codes:

- T= TFL
- P= HPL

[See Canvas Reception Overview for Ordering Options](#)

Jefferson echoes history and creates a timeless foundation for today's sophisticated work place. Finely crafted in select solids with Walnut and Cherry veneers, the tailored details of this collection accentuate our expert craftsmanship and perfect attention to detail.

Jefferson forges traditional styling with modern sensibility with new Height Adjustable options and coordinating reception models, allowing the premium feel and flexibility of Jefferson to easily function throughout entire facilities.

CONSTRUCTION

Jefferson features a Veneer chassis with your choice of a Veneer or HPL top. Units ship assembled unless otherwise noted.

VENEER

- Choose from premium or select veneer on exposed surfaces in American Black Walnut or Cherry species in bookmatched veneer faces
- Veneers are carefully selected and matched to assure proper balance and consistency

TOPS

- Veneer tops offer a 5-ply balanced construction, 1 $\frac{3}{16}$ " thick with solid hardwood mitered rims
- High Pressure Laminate (HPL) tops offer a 3-ply balanced construction, 1 $\frac{3}{16}$ " thick with solid hardwood mitered rims
- Grain direction runs left-to-right unless otherwise noted
- All Jefferson tops are standard with the Jefferson edge profile (C2), unless otherwise noted.



CHASSIS

- Chassis is securely fastened using high quality European fastening systems, heavy-duty, 16-gauge joining brackets and wood dowels to assure maximum strength
- Bases are solid hardwood with mitered corners
- All units have finished veneer backs
- Construction offers tight tolerances and long term durability
- All units equipped with heavy-duty, adjustable glides to ensure proper leveling and compensate for uneven floors
- Vertical grain direction on chassis

DRAWERS

- Drawer fronts standard with bookmatched veneer faces
- Fronts are 3-ply construction and $\frac{3}{4}$ " thick
- Drawer interiors are dovetail, wood constructed with $\frac{7}{16}$ " hardwood sides and backs and $\frac{5}{32}$ " thick hardboard bottoms
- All drawers feature full extension, progressive action slides with precision steel ball bearings
- Box and file drawers are tested for 100lb capacity
- All suspensions have a limited lifetime warranty
- Optional soft close is available on center, box, and file drawers, unless otherwise noted ([see option details](#)): **File drawers with the soft close option feature front-to-back filing.**

FILING

- All file drawers are standard with filing systems designed to accommodate a variety of filing requirements
- Optional soft close on box and file drawers allows front-to-back filing in file drawer**

FILING (CONT)

- Legal width file drawers provide legal filing front to back, and letter or legal filing side to side
- Letter width file drawers provide letter filing front to back, and letter or legal filing side to side

LOCKING

- Central locking is standard on all desks; one key in the lock cylinder locks all drawers in the desk
- Pedestal locking for credenzas and returns
- Lock core color will coordinate with pull selection (brass pulls will have black cores, while aluminum pulls will have silver cores)
- Removable lock cylinders allow for units to be re-keyed at a later date if required
- Units are shipped randomly keyed as standard. Keyed alike units available upon request at no additional charge.

CORD MANAGEMENT

- Grommets may be ordered in the tops of desks, returns, bridges, and credenzas
- [See all grommet options and locations](#)
- Wire Managers available for additional cord management; [See Accessories](#)

INTERIOR DRAWER DIMENSIONS

Models

| | | | |
|--------------|------------|------------|--------------|
| 46-2472RCR | 46-2466RCL | 46-2466RCR | 46-2448RPD2L |
| 46-2448RPD2R | 46-2472RCL | | |

Drawers

| | W | L | D |
|------|--------------------|---------------------|---------------------|
| File | 12 $\frac{3}{8}$ " | 16 $\frac{7}{32}$ " | 8 $\frac{29}{32}$ " |

Models

| | |
|--------------|--------------|
| 46-3672RPD1L | 46-3672RPD1R |
|--------------|--------------|

Drawers

| | W | L | D |
|--------|--------------------|--------------------|---------------------|
| Box | 15 $\frac{3}{8}$ " | 19 $\frac{3}{8}$ " | 3 $\frac{21}{32}$ " |
| File | 15 $\frac{3}{8}$ " | 25 $\frac{3}{4}$ " | 8 $\frac{29}{32}$ " |
| Center | 25 $\frac{3}{4}$ " | 19 $\frac{3}{8}$ " | 1 $\frac{27}{32}$ " |

Models

| | |
|--------------|--------------|
| 46-3066RPD1L | 46-3066RPD1R |
|--------------|--------------|

Drawers

| | W | L | D |
|--------|--------------------|--------------------|---------------------|
| Box | 12 $\frac{3}{8}$ " | 19 $\frac{3}{8}$ " | 3 $\frac{21}{32}$ " |
| File | 12 $\frac{3}{8}$ " | 25 $\frac{3}{4}$ " | 8 $\frac{29}{32}$ " |
| Center | 22 $\frac{7}{8}$ " | 19 $\frac{3}{8}$ " | 1 $\frac{27}{32}$ " |

FILING CAPABILITIES

Drawers with Dimensions: 15³/₈"W x 25³/₄"L

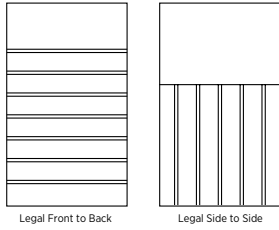

Drawers with Dimensions: 12³/₈"W x 25³/₄"L

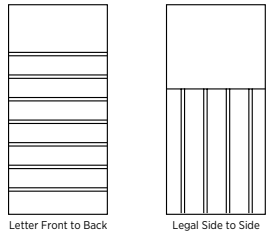

Drawers with Dimensions: 12³/₈"W x 16⁷/₃₂"L

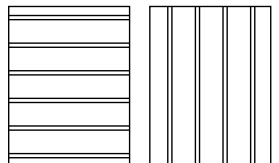

HOW TO ORDER EXAMPLES

RECEPTION L-UNIT

| | | | |
|--------------|---|----------------------------|---------------------------|
| 46-3672RPD1L | 1 | Premium or Standard Veneer | W |
| | | Top Material | P |
| | | Finish/Color | GC |
| | | Pull | ARA |
| | | No Molding | - |
| | | Drawer Track | SOFT |
| | | Top Grommet Loc./Color | GC/BLK |
| | | Flip Down Center Drawer | LFD |
| | | Tackboard/Fabric | CF Stinson Nikko Beach |

| | | | |
|--------------|---|----------------------------|--------|
| 46-2448RPD2R | 1 | Premium or Standard Veneer | W |
| | | Top Material | P |
| | | Finish/Color | GC |
| | | Pull | ARA |
| | | No Molding | - |
| | | Drawer Track | SOFT |
| | | Top Grommet Loc./Color | GC/BLK |

PREMIUM AND STANDARD VENEER (W) OPTIONS

The multi-step, finish process used by Indiana Furniture provides years of lasting beauty. High quality finish materials offer distinctive grain clarity, superior resistance to normal wear, and easy maintenance. Wood veneer tops are shipped standard with satin sheen finish.

| | | | |
|-----|--------------------|-----|---------------------|
| AW | Artisan Walnut | LW | Legacy Walnut |
| CO | Columbian Walnut | MW | Mahogany Walnut |
| DC | Dark Cherry | MTS | Metropolis Sky** |
| DFW | Dark Forest Walnut | PNW | Pinnacle Walnut** |
| EW | Espresso | SCH | Select Cherry |
| GC | Golden Cherry | SKC | Shaker Cherry |
| HW | Harvest Walnut | WC | Williamsburg Cherry |
| HNW | Henna Walnut** | | |

** Available in Standard Veneer Only

HPL (P) TOP OPTIONS

WOODGRAIN

| | | | |
|----|------------------|-----|---------------------|
| CO | Columbian Walnut | PNW | Pinnacle Walnut |
| EF | Espresso | SCH | Select Cherry |
| GC | Golden Cherry | SKC | Shaker Cherry |
| MW | Mahogany Walnut | WC | Williamsburg Cherry |

DRAWER AND DOOR PULL OPTIONS

Units with doors and drawers will feature coordinating pulls however door and drawer pulls cannot be intermixed.

| | | | |
|-----|----------------------------|-----|--------------------------|
| ARA | Arlington A, Antique Brass | JEF | Jefferson, Antique Brass |
| ARB | Arlington B, Antique Brass | ALB | Liberty, Aluminum |
| WLM | Wilmington, Antique Brass | | |

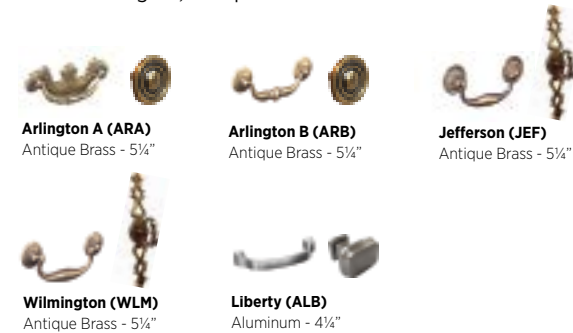

DRAWER TRACK OPTIONS

Soft close tracks are available on center, tray, box, and file drawers in Jefferson. Soft close drawer tracks have many benefits including reduced stress on the unit, extends the life of the drawer, and ensures a gentle close so fingers don't accidentally get hurt. File drawers with the soft close option feature front-to-back filing. Must specify when ordering.

Pricing is per Drawer, not per Model/Unit

| | | | |
|-------|-------------------------|----|----|
| SFTCL | Soft Close Drawer Track | \$ | 34 |
|-------|-------------------------|----|----|

LOCKING FLIP DOWN CENTER DRAWER

Single and double pedestal desks and kneespace credenzas standard with a center drawer have an optional central locking, keyboard flip down drawer. Drawer front is wood veneer with laminate drawer interior.

LFD Locking Flip Down Front Center Drawer \$ 82

MOLDING OPTIONS

All standard, height adjustable, and reception units ship with decorative pencil molding. If you do not want molding, please specify "NO MOLDING" when ordering each model.

Modular components come standard with no molding. To accommodate for flush ends, molding is offered as an option. Specify one of the following codes when ordering.

| | | | |
|--------|--------------------------------------|----|-----|
| STD | No Molding | \$ | Std |
| MR46R1 | Molding on Right Side Only | \$ | 85 |
| MR46L1 | Molding on Left Side Only | \$ | 85 |
| M46LR | Molding on Both Right and Left Sides | \$ | 170 |

Note: Left or right is determined when facing the front of the unit.

WORKSURFACE GROMMETS FOR RECEPTION

| | | | |
|----|---|----|----|
| GC | Grommet, Center; Must Specify Black (BLK) or Silver (SLV) | \$ | 52 |
| GL | Grommet, Left; Must Specify Black (BLK) or Silver (SLV) | \$ | 52 |
| GR | Grommet, Right; Must Specify Black (BLK) or Silver (SLV) | \$ | 52 |

Verify Grommet Option is available on the model(s) you are specifying using the location.

Grommets may be ordered in non-standard locations. Call Customer Service to assist with specification. Note additional charges and lead times may apply.

Multiple locations may be selected.

Models

46-3672RPD1L 46-3672RPDIR

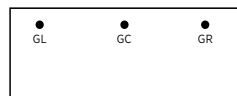

GL/GR: Located 6" from sides and 3 1/4" from user side

GC: 3 1/4" from user side

Models

46-3066RPD1L 46-3066RPDIR



GL/GR: Located 6" from sides and 26 5/8" from user side

GC: 26 5/8" from user side

Models

46-2448RPD2L 46-2448RPD2R 46-2448RUF 46-2442RUF
46-2472RCL 46-2472RCR 46-2466RCL 46-2466RCR

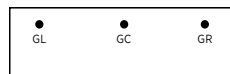

GL/GR: Located 6" from sides and 19" from user

GC: 19" from user side

CERTIFICATIONS & COMPLIANCE

- Intertek Sustainability Certified
- BIFMA level® Certified
- BIFMA Compliant Certified
- TSCA Title VI (formerly CARB) Compliance
- US Green Building's LEED Contribution

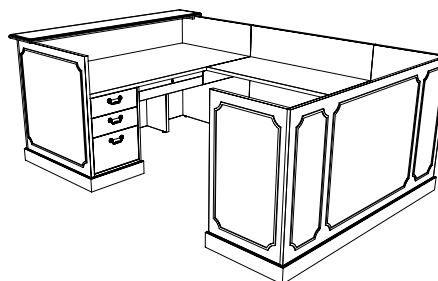
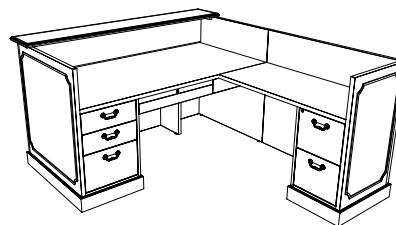

Reception Units

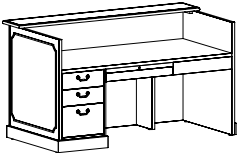

Reception Desks
(See Details)

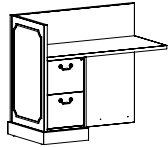

Reception Returns
(See Details)

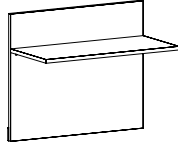

Reception Bridges
(See Details)

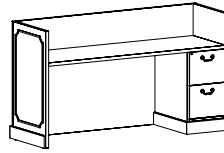

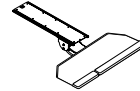
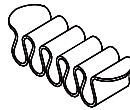
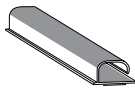
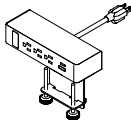

Reception Credenzas
(See Details)

Kneespace Options, Wire Management + Accessories

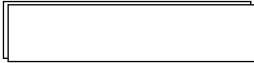

Tackboards



| Item | Model No. | Width | Depth | Height | K | R | Ship Wt | Cubic Ft | List Price | | |
|---|--|------------------|-------|--------|----|-----|---------|----------|------------|-------------------------|--|
| SINGLE PED RECEPTION DESK BOX/BOX/FILE  Shown as Left  Approach Side Shown with Decorative Molding and Optional No Molding | Left Ped | Right Ped | | | | | | | | | |
| | 46-3672RPD1L | 46-3672RPD1R | 74 | 39 | 42 | 28¼ | - | 374 | 76.3 | W/P\$ 8254 PV\$ 9245 | |
| | <i>Worksurface 70W x 34¾D; Legal Ped</i> | | | | | | | | | | |
| | 46-3066RPD1L | 46-3066RPD1R | 68 | 33 | 42 | 25¼ | - | 327 | 59.9 | W/P\$ 7545 PV\$ 8453 | |
| <i>Worksurface 64W x 28¾D; Letter Ped</i> | | | | | | | | | | | |

Description

- Standard with: Transaction Surface Profiled on All Sides, Rectangle User Surface with Square Profile, Base Molding on All Sides, Decorative Molding on Approach and Both Sides, Central Locking Center Drawer, Box/Box/File Ped, Left-to-Right Grain Direction on Top, and Dovetail Wood Drawer Construction
- Chassis Available with Premium Veneer (PV) or Standard Veneer (W); Must Specify
- Top/Transaction Available with Premium/Standard Veneer (PV/W) or HPL (P); Must Specify
- Lock Core Color will Coordinate with Pull Selection (Brass Pull with Black Lock, Silver Pull with Silver Lock)
- Additional Options: No Decorative Molding (Specify NO MOLDING); Keyboard Flip Down Center Drawer ([See Center Drawer Options](#)); Factory-Installed Tackboard ([See Tackboards](#)); Soft Close Drawer Closure ([See Soft Close Options](#)); Top Grommet Options ([See Grommet Options](#)); Wire Management + Accessories (Sold Separately; [See Accessories](#))

Must Specify (in this order):

- Model #
- Premium or Standard Veneer
- Top Material
- Finish/Color
- Pull
- No Molding
- Drawer Track
- Top Grommet Location/Color
- Flip Down Center Drawer
- Tackboard/Fabric

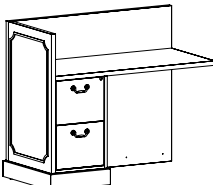
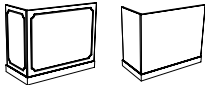
| Item | Model No. | Width | Depth | Height | K | R | Ship Wt | Cubic Ft | List Price | |
|---|--------------------------------|------------------|-------|--------|-----|-----|---------|----------|------------|-------------------------|
| RECEPTION RETURN FILE/FILE  Shown as Left  Approach Side Shown with Decorative Molding and Optional No Molding | Left Ped | Right Ped | | | | | | | | |
| | 46-2448RPD2L | 46-2448RPD2R | 48 | 24 | 40⅞ | 28¼ | - | 195 | 33.3 | W/P\$ 5520 PV\$ 6183 |
| | <i>Worksurface 46¼W x 21¾D</i> | | | | | | | | | |

Description

- Standard with: Rectangle Top with Square Profile, Base Molding on All Sides, Decorative Molding on Approach and Side, Locking File/File Ped, Front-To-Back Grain Direction on Top, and Dovetail Wood Drawer Construction
- Chassis Available with Premium Veneer (PV) or Standard Veneer (W); Must Specify
- Top Available with Premium/Standard Veneer (PV/W) or HPL (P); Must Specify
- Additional Options: No Decorative Molding (Specify NO MOLDING); Keyboard Flip Down Center Drawer ([See Center Drawer Options](#)); Keyboard Flip Down Center Drawer ([See Center Drawer Options](#)); Soft Close Drawer Closure ([See Soft Close Options](#)); Top Grommet Options ([See Grommet Options](#)); Kneespace Options (Sold Separately, [See Units](#)), Wire Management + Accessories (Sold Separately; [See Accessories](#))

Must Specify (in this order):

- Model #
- Premium or Standard Veneer
- Top Material
- Finish/Color
- Pull
- No Molding
- Drawer Track
- Top Grommet Location/Color
- Kneespace Options

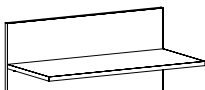
| Item | Model No. | Width | Depth | Height | K | R | Ship Wt | Cubic Ft | List Price |
|---|---|-------|-------|--------|----|---|---------|----------|-------------------------|
|  | 46-2448RUF <i>Worksurface 48W x 22½D</i> | 48 | 24 | 40⅞ | 48 | - | 116 | 7.3 | W/P\$ 2520 PV\$ 2821 |
| | 46-2442RUF <i>Worksurface 42W x 22½D</i> | 42 | 24 | 40⅞ | 42 | - | 104 | 6.3 | W/P\$ 2373 PV\$ 2659 |

Description

- Standard With: Rectangle Top with Square Profile, Front-to-Back Grain Direction on Top, and Hinged Back Panel
- Chassis Available with Premium Veneer (PV) or Standard Veneer (W); Must Specify
- Top Available with Premium/Standard Veneer (PV/W) or HPL (P); Must Specify
- Additional Options: No Decorative Molding (Specify NO MOLDING); Top Grommet Options ([See Grommet Options](#)); Wire Management + Accessories (Sold Separately; [See Accessories](#))

Approach Side Shown with Decorative Molding and Optional No Molding

Must Specify (in this order):

- Model #
- Premium or Standard Veneer
- Top Material
- Finish/Color
- No Molding
- Top Grommet Location/Color

| SINGLE PED RECEPTION CREENZA FILE/FILE | Left Ped | Right Ped | Width | Depth | Height | K | R | Ship Wt | Cubic Ft | List Price |
|--|---|------------|-------|-------|--------|---|-----|---------|-------------------------|------------|
| | 46-2472RCL <i>Worksurface 70W x 22D; Legal Ped</i> | 46-2472RCR | | | | | | | | |
| 46-2466RCL <i>Worksurface 64W x 22D; Letter Ped</i> | 46-2466RCR | 66 | 24 | 40⅞ | 26¼ | - | 249 | 43.0 | W/P\$ 6509 PV\$ 7291 | |

Description

- Standard with: Rectangle Top with Square Profile, Base Molding on All Sides, Decorative Molding on Approach and Both Sides, Locking File/File Ped, Left-to-Right Grain Direction on Top, and Dovetail Wood Drawer Construction
- Chassis Available with Premium Veneer (PV) or Standard Veneer (W); Must Specify
- Top Available with Premium/Standard Veneer (PV/W) or HPL (P); Must Specify
- Lock Core Color will Coordinate with Pull Selection (Brass Pull with Black Lock, Silver Pull with Silver Lock)
- Additional Options: No Decorative Molding (Specify NO MOLDING); Soft Close Drawer Closure ([See Soft Close Options](#)); Top Grommet Options ([See Grommet Options](#)); Wire Management + Accessories (Sold Separately; [See Accessories](#))

Shown as Right

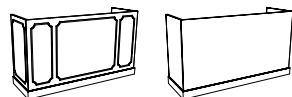

Approach Side Shown with Decorative Molding and Optional No Molding

Must Specify (in this order):

- Model #
- Premium or Standard Veneer
- Top Material
- Finish/Color
- Pull
- Back Panel Grommet Color
- No Molding
- Drawer Track
- Top Grommet Location/Color

[See Jefferson Reception Intro For Ordering Options](#)

| Item | Model No. | | Width | Depth | Height | Ship Wt | Cubic Ft | List Price |
|---------------------|-----------|--------|--------------------------------|--------------------------------|--------|---------|----------|------------|
| ROUND GROMMET COVER | 01-GRMTBK | Black | 2 ⁷ / ₂₅ | 2 ⁷ / ₂₅ | - | 1 | 0.1 | \$ 11 |
| | 01-GRMTSL | Silver | | | | | | |



OPEN MARKET ONLY
(SILVER)

Must Specify (in this order):
Model #
Factory Installed

Description

- 2⁷/₂₅" (60mm) Round Grommet Cover
- Field Installed

| | | | | | | | | |
|--------------------------|-------------|-------|---|---|---|---|-----|-------|
| SINGLE POWER SAND DOLLAR | 01-SAND60PW | White | 3 | 3 | 4 | 1 | 0.2 | \$ 98 |
|--------------------------|-------------|-------|---|---|---|---|-----|-------|

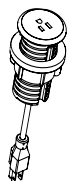

| | |
|-------------|--------|
| 01-SAND60PB | Black |
| 01-SAND60PS | Silver |

Description

- Unit is 2" Diameter; Mounts in 60mm Round Grommet
- 6' Cord
- Single Power Outlet

| | | | | | | | | |
|------------------------|-------------|-------|---|---|---|---|-----|--------|
| DOUBLE USB SAND DOLLAR | 01-SAND60UW | White | 3 | 3 | 4 | 1 | 0.2 | \$ 277 |
|------------------------|-------------|-------|---|---|---|---|-----|--------|



| | |
|-------------|--------|
| 01-SAND60UB | Black |
| 01-SAND60US | Silver |

Description

- Unit is 2" Diameter; Mounts in 60mm Round Grommet
- 6' Cord
- Dual USB Outlets

| Item | Model No. | | Width | Depth | Height | Ship Wt | Cubic Ft | List Price |
|--------------------------|--------------|--------|-------|-------|--------|---------|----------|------------|
| DUO CLAMP WITH NEMA PLUG | 01-DUOCLAMPW | White | 5½ | 3 | 7 | 1 | 0.2 | \$ 572 |
| | 01-DUOCLAMPB | Black | | | | | | |
| | 01-DUOCLAMPS | Silver | | | | | | |

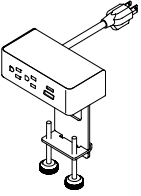

Description

- Standard with: Two (2) Power Outlet, **One (1) USB Charging Port and One (1) 60-Watt USB-C Power Delivery Port with GaN Technology with 10' Cord**
- Clamps to Top and Features Silver Metal Trim
- Independent USB Circuit Controllers Deliver up to 2.1 Amps to Each Post
- All Mounting Hardware Included
- FCC Part 15A and UL Approved for Horizontal and Vertical Applications

| | | | | | | | | |
|---------------------------|---------------|--------|---|---|---|---|-----|--------|
| TRIO CLAMP WITH NEMA PLUG | 01-TRIOCLAMPW | White | 8 | 3 | 7 | 1 | 0.2 | \$ 671 |
| | 01-TRIOCLAMPB | Black | | | | | | |
| | 01-TRIOCLAMPS | Silver | | | | | | |

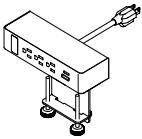

Description

- Standard with: Three (3) Power Outlets, **One (1) USB Charging Port, One (1) 60-Watt USB-C Power Delivery Port with GaN Technology, One (1) Open Data with 10' Cord**
- Clamps to Top and Features Silver Metal Trim
- Independent USB Circuit Controllers Deliver up to 2.1 Amps to Each Post
- HDMI, VGA, or RJ45 Accessories Sold Separately (See Below)
- All Mounting Hardware Included
- FCC Part 15A and UL Approved for Horizontal and Vertical Applications

| | | | | | | | | |
|-------------------------|------------|--|---|---|---|---|-----|--------|
| VGA DATA PORT ACCESSORY | 01-LCOMVGA | | - | - | - | 1 | 0.2 | \$ 121 |
|-------------------------|------------|--|---|---|---|---|-----|--------|

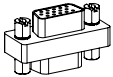

Description

- VGA Port for Trio Clamp Units

| | | | | | | | | |
|--------------------------|-------------|--|---|---|---|---|-----|--------|
| HDMI DATA PORT ACCESSORY | 01-LCOMHDMI | | - | - | - | 1 | 0.2 | \$ 166 |
|--------------------------|-------------|--|---|---|---|---|-----|--------|

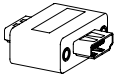

Description

- HDMI Port for Trio Clamp Units

OPEN MARKET ONLY

| | | | | | | | | |
|--------------------------|-------------|--|---|---|---|---|-----|-------|
| RJ45 DATA PORT ACCESSORY | 01-LCOMRJ45 | | - | - | - | 1 | 0.2 | \$ 79 |
|--------------------------|-------------|--|---|---|---|---|-----|-------|

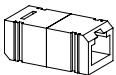

Description

- RJ45 Port for Trio Clamp Units

[See Jefferson Reception Intro For Ordering Options](#)

| Item | Model No. | Width | Depth | Height | Ship Wt | Cubic Ft | List Price |
|-------------------------|-----------|-------|-------|--------|---------|----------|------------|
| WIRE MANAGEMENT CHANNEL | 01-WMGR4 | 16 | 1½ | 1 | 1 | - | \$ 116 |

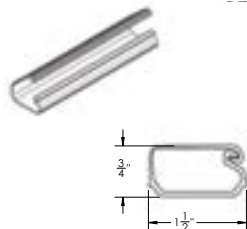

Description

- Set of Four (4) Black Plastic Wire Management Channels
- Snap Lock Channel
- Attaches with Adhesive Strips
- Ships via UPS Only

| | | | | | | | |
|--------------|----------|----|-------|---|-----|-----|--------|
| WIRE CHANNEL | 01-32125 | 24 | 1 5/8 | 1 | .25 | 0.3 | \$ 106 |
|--------------|----------|----|-------|---|-----|-----|--------|

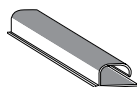

Description

- Available in Black
- Channels Attach with Two (2) Double-Sided Installation Tape
- Open J Channel for Easy Storage of Cables

| | | | | | | | |
|------------|-----------|-------|-------|---|---|---|-------|
| CABLE GRIP | 01-WMGRCB | 5 5/8 | 2 5/8 | - | - | - | \$ 17 |
|------------|-----------|-------|-------|---|---|---|-------|

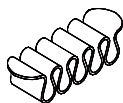

Description

- Under Surface Wire Management
- Black

| | | | | | | | | |
|------------------------|----------------|--------|-------|-------|-------|---|-----|--------|
| LINK 360 CABLE MANAGER | 01-0251LINKSLV | Silver | 5 3/8 | 3 3/8 | 30-51 | 4 | 3.0 | \$ 390 |
| | 01-0251LINKBLK | Black | 5 3/8 | 3 3/8 | 30-51 | 4 | 3.0 | \$ 353 |

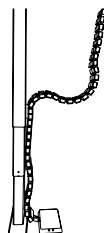

Description

- Kit Includes: 50 Link 360™ elements, One (1) Quad Connector, One (1) Dumbbell Connector, One (1) Foot Assembly with Two (2) Magnetic Clips
- Can Be Used For Height-Adjustable Mechanisms Up To 51" or Free-Standing Use

| Item | Model No. | Width | Depth | Height | Ship Wt | Cubic Ft | List Price |
|-------------------------------|--------------------|-------|-------|--------|---------|----------|------------|
| HEIGHT ADJUSTABLE WORKSTATION | 01-S2SBLK Black | 35½ | 25 | 6-22 | 49 | 6.5 | \$ 1503 |

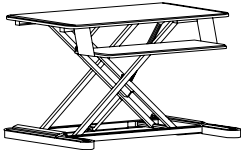

Description

- Height Adjustable
- Weight Capacity: 35lbs
- One-Handed Operation; Platforms Move Simultaneously
- Keyboard Platform: 10½"D x 26½"W
- Worksurface: 21"D x 35½"W
- Can be Used on Worksurface 24"D x 35"W

| | | | | | | | |
|-------------|---------|---|---|---|---|---|--------|
| POWER STRIP | 01-PRSP | 9 | 2 | 2 | 1 | - | \$ 205 |
|-------------|---------|---|---|---|---|---|--------|



Description

- Includes Four (4) Outlets, Two (2) Phone Jacks, and Rocker On/Off Switch
- Black Plastic with 10' Power Cord
- Suitable for Surface or Recessed Mounting
- 13 Amp Circuit Breaker
- Two (2) 14 ft. Phone Hook Up Cords
- UL and CSA Recognized
- Item will ship via UPS only

| | | | | | | | |
|----------------------------------|-----------|----|-----|----|----|-----|----------------------|
| KEYBOARD FLIP DOWN CENTER DRAWER | 46-2410FD | 24 | 15¾ | 3⅞ | 12 | 2.0 | W\$ 988 PV\$ 1106 |
|----------------------------------|-----------|----|-----|----|----|-----|----------------------|



Must Specify (in this order):

- Model #
- Premium or Standard Veneer
- Finish
- Pull
- Factory Installed

Description

- Flip Down Front
- Available with Premium Veneer (PV) or Standard Veneer (W); Must Specify
- Does Not Feature Soft Close Hinges
- Use on Any Open Kneespace 24" or Larger

Options: Specify & Add

| | |
|----------------------------------|--------|
| Factory Installed - Must Specify | \$ 208 |
|----------------------------------|--------|

| | | | | | | | |
|---------------------------------------|----------|----|-----|----|----|-----|--------|
| ARTICULATING KEYBOARD CORNER PLATFORM | 01-KB2CC | 25 | 10½ | 4½ | 16 | 1.4 | \$ 832 |
|---------------------------------------|----------|----|-----|----|----|-----|--------|

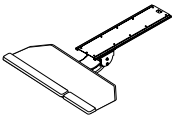

Must Specify (in this order):

- Model #
- Factory Installed

Description

- Standard With: 25" Cut Corner Platform, +/- 15° Tilt Adjustment, 360 Rotation, 21" Track, Independent Tilt Adjustment, 7" Locking Height Adjustment
- Keyboard and Mouse on Same Level
- Single Palm Rest for Both Left and Right Hands
- Works with 17"+ Diagonal Work Surface
- Cannot Be Used on 20" or 21" Deep Unit
- Not Available with Optional Center Grommet

[See Jefferson Reception Intro For Ordering Options](#)

| Item | Model No. | Width | Depth | Height | Ship Wt | Cubic Ft | List Price |
|--|-----------|-------|-------|--------|---------|----------|------------|
| KEYBOARD MECHANISM WITH KEYBOARD CLAMP | 01-KB3 | 9 | 17 | 6 | 13 | 1.0 | \$ 914 |

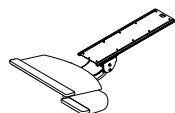

Description

- Standard With: 18.75" Platform, Left or Right Handed Swivel Mouse Platform, Palm Rest, 7" Locking Height Adjustment, +/- 15° Tilt Adjustment, 360° Rotation, Independent Tilt Adjustment, 21" Track
- Cannot Be Used on 20" or 21" Deep Unit
- Not Available with Optional Center Grommet

Must Specify (in this order):
Model #
Factory Installed

RECEPTION DESK TACKBOARDS
9" H



| Model # | For Units: | COM YDG | COM, 1, 2, or 3 | GRADES | | | | | | |
|---------|------------|---------|-----------------|--------|-----|-----|------|------|------|------|
| | | | | 4 | 5 | 6 | 7 | 8 | 9 | 10 |
| TB-6172 | 72" | 2.25 | \$ 256 | 569 | 715 | 864 | 1075 | 1296 | 1552 | 1849 |
| TB-6166 | 66" | 2.00 | \$ 232 | 510 | 640 | 772 | 960 | 1156 | 1384 | 1648 |

Must Specify (in this order):
Model #
Fabric Vendor, Pattern, and Color

Description

- Coordinates with Reception Desks
- Factory Installed

VESTA POWER CENTER

| | | | | | | |
|----------|-----|----|-----|----|-----|---------|
| 01-PDCTR | 10¾ | 12 | 28¼ | 14 | 2.5 | \$ 1776 |
|----------|-----|----|-----|----|-----|---------|



Description

- Top Includes One (1) Power Outlet, Two (2) USB Ports and One (1) USBC Port; Base Includes Three (3) Outlet
- Available in White
- 120" Power Cord
- Built with Weight Distribution for Optimal Stability
- Base is 5" Tall

Accessories

Grommets



Power + Coordinating Accessories

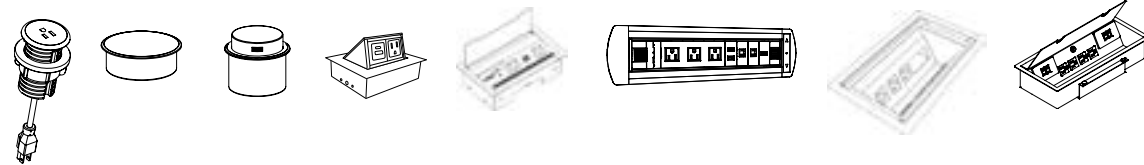

Power Units with Accessories

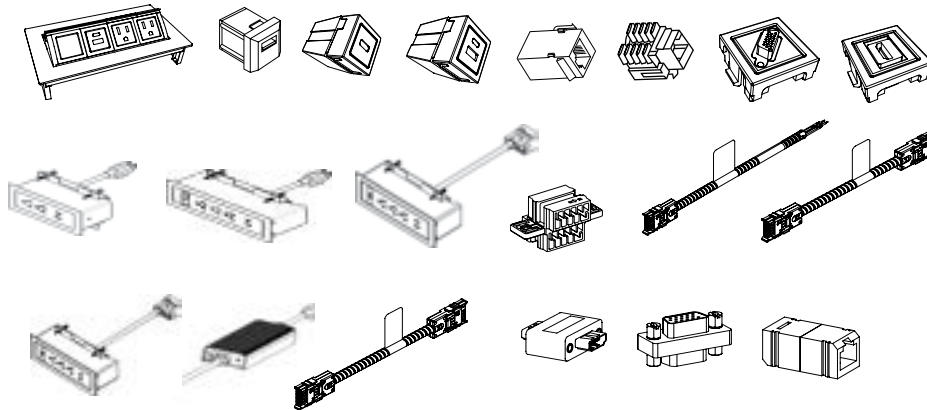

Wire Management

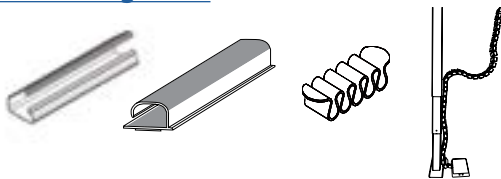

Height Adjust Components

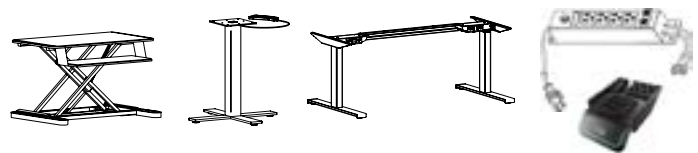

Additional Accessories

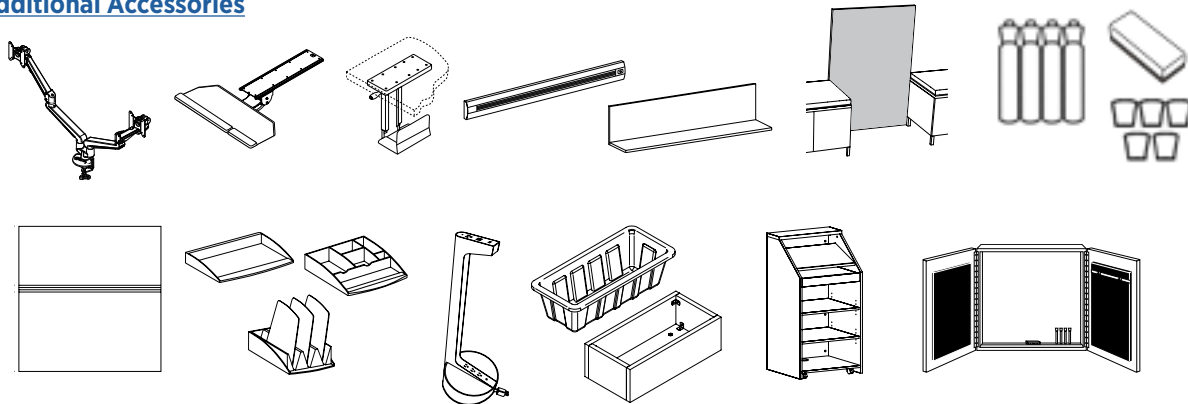

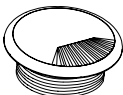
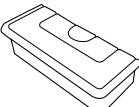
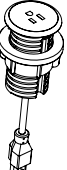
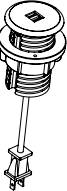
| Item | Model No. | | Width | Depth | Height | Ship Wt | Cubic Ft | List Price |
|---|--|--------|-------|-------|--------|---------|----------|------------|
| ROUND GROMMET COVER FIELD INSTALLED | 01-GRMTBK | Black | - | - | - | - | - | \$ 11 |
| | 01-GRMTSL | Silver | | | | | | |
|  OPEN MARKET ONLY (SILVER) | Description <ul style="list-style-type: none"> • 60mm Round Grommet Cover • Field Installed | | | | | | | |
| | | | | | | | | |
| RECTANGULAR GROMMET | 01-HUGRMTSL | Silver | - | - | - | 1 | .1 | \$ 11 |
|  OPEN MARKET ONLY | Description <ul style="list-style-type: none"> • For Use with Surface Mount Hatches Only • 70mm x 30mm Silver Rectangular Grommet with Cover • Field Installed | | | | | | | |
| | | | | | | | | |
| SINGLE POWER SAND DOLLAR | 01-SAND60PW | White | 3 | 3 | 4 | 1 | 0.2 | \$ 98 |
| | 01-SAND60PB | Black | | | | | | |
| | 01-SAND60PS | Silver | | | | | | |
|  | Description <ul style="list-style-type: none"> • Unit is 2" Diameter; Mounts in 60mm Round Grommet • 6' Cord • Single Power Outlet | | | | | | | |
| | | | | | | | | |
| | | | | | | | | |
| DOUBLE USB SAND DOLLAR | 01-SAND60UW | White | 3 | 3 | 4 | 1 | 0.2 | \$ 277 |
| | 01-SAND60UB | Black | | | | | | |
| | 01-SAND60US | Silver | | | | | | |
|  | Description <ul style="list-style-type: none"> • Unit is 2" Diameter; Mounts in 60mm Round Grommet • 6' Cord • Dual USB Outlets | | | | | | | |
| | | | | | | | | |
| | | | | | | | | |

| Item | Model No. | | Width | Depth | Height | Ship Wt | Cubic Ft | List Price |
|--------------------------------------|----------------|----------|------------------|------------------|-----------------|---------|----------|------------|
| DOCK 950 WIRELESS CHARGER | 01-DOCK950W | White | 3 $\frac{3}{16}$ | 3 $\frac{3}{16}$ | - | 1 | 0.2 | \$ 265 |
| | 01-DOCK950B | Black | | | | | | |
| DOCK 150 WIRELESS AND USB CHARGER | 01-DOCK150W | White | 3 | 3 | $\frac{3}{4}$ | 1 | 0.2 | \$ 405 |
| | 01-DOCK150B | Black | | | | | | |
| POWER 440 | 01-DATA440A | Aluminum | 5 $\frac{5}{16}$ | 4 $\frac{3}{8}$ | — | 5 | 0.2 | \$ 964 |
| | 01-DATA440B | Black | | | | | | |
| INTERACT POWER AND DATA | 01-INTERACTG2A | Aluminum | 9 | 5 $\frac{5}{8}$ | 2 $\frac{3}{4}$ | 5 | 0.2 | \$ 891 |
| | 01-INTERACTG2B | Black | | | | | | |



OPEN MARKET ONLY

Description

- For Use with Wireless Charging Enabled Devices
- 5 Watts Maximum Output with a Direct Current of 5V 2A and 10 Watts Maximum with Quick Charge 2.0
- Mounts in 76mm Round Cut-Out
- LED will Confirm Pairing with Device and Begin Wireless Charging

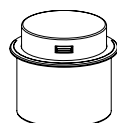

OPEN MARKET ONLY

Description

- For Use with Wireless Charging Enabled Devices and USB Charging Devices
- 5 Watt Maximum Output with a Direct Current Input of 5V 6A (Wireless Fast Charge)
- Mounts in 76mm Round Cut-Out
- Pop-Up is $\frac{3}{4}$ "H and Includes Three (3) USB Ports; One (1) 12 Watt Maximum with 2.4A (USB Fast Charge) and Two (2) 5 Watt with 1A (USB Standard Charge)
- LED Light will Confirm Pairing with Device and Begin Wireless Charging
- UL and cUL Certified

**Description**

- One (1) USB A+C and One (1) Power Outlets
- Soft Touch Hinged Lid
- 6' Power Cord

**Description**

- Two (2) Power Outlets, Two (2) USB Connections, One (1) Data, One (1) Voice Telecom Plate Included
- Shown with Optional Telecom Plates; Sold Separately ([See Telecom Plates](#))
- Convenience Plug on Bottom
- 6' Power Cord
- UL and CSA Recognized

| Item | Model No. | | Width | Depth | Height | Ship Wt | Cubic Ft | List Price |
|----------------------|--------------|--------|-----------------|------------------|------------------|---------|----------|------------|
| POWER AND DATA VAULT | 01-CVAULTG2A | Silver | 4 $\frac{1}{3}$ | 15 $\frac{7}{8}$ | 4 $\frac{1}{16}$ | 10 | 0.4 | \$ 1944 |



OPEN MARKET ONLY

Description

- Electric Drive Motor Rotates the Surface Technology 180° to the Proper Position
- Photo-Electronic Eye Prevents Rotation When Obstructed
- Two (2) Data Ports, Three (3) Power Outlets, One (1) HDMI and Two (2) 5V USB
- 6' Power Cord

OASIS MINI POWER & DATA

| | | | | | | | |
|------------|----------|----|---|------------------|---|-----|---------|
| 01-OASISMA | Aluminum | 15 | 9 | 4 $\frac{1}{16}$ | 7 | 0.7 | \$ 3191 |
| 01-OASISMB | Black | | | | | | |

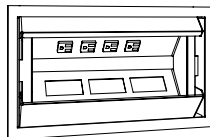

Top View

**Description**

- Includes Four (4) Power Outlets, Two (2) Data Ports, and One (1) Voice Telecom Plate
- Soft Touch Hinged Lid
- 9' Cord with Nema Plug; Fits 15A/120V AC Receptacles
- UL Listed
- Opening for One (1) Additional Telecom Plate; Sold Separately ([See Telecom Plates](#))

POWER CENTER

| | | | | | | | |
|-------------|----------|------------------|-----------------|-----------------|----|-----|---------|
| 01-INTRFC1A | Aluminum | 14 $\frac{1}{4}$ | 6 $\frac{3}{8}$ | 3 $\frac{3}{8}$ | 11 | 0.3 | \$ 2064 |
| 01-INTRFC1B | Black | | | | | | |

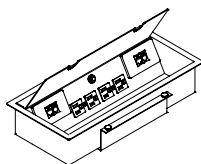
**Description**

- Four (4) Power Receptacles in Two (2) 15 Amp Duplexes
- One (1) 15 Amp Circuit Breaker
- One (1) Voice Port and Three (3) Data Ports
- One (1) Convenience Plug on Bottom
- 6' Foot Cord
- UL Listed/CSA Certified

NOTE: To order voice/data modules for your specific requirements contact the local computer or telecommunications installation service in your area.

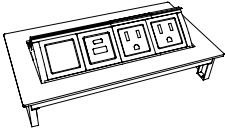
| Item | Model No. | | Width | Depth | Height | Ship Wt | Cubic Ft | List Price |
|---|------------|----------|-------|-------|--------|---------|----------|------------|
|  | 01-DPORT4A | Aluminum | 8 | 4 | — | 7 | 0.2 | \$ 1093 |
| | 01-DPORT4B | Black | | | | | | |

Description

- Retracts into Work Surface to Regain Productive Space
- One-Touch Access to Power and Data
- Two (2) Water-Proof Simplex Power Outlets, One (1) USB A+C, and One (1) Open Port
- Optional Telecom Port Components, See Below and Following Page
- Includes a Voice/Data Adapter Kit to Accept Couplers and Jacks When Required
- 10' Power Cord

| | | | | | | | | |
|----------|------------|--|---|---|---|---|---|--------|
| USB PORT | 01-USBPORT | | - | - | - | - | - | \$ 161 |
|----------|------------|--|---|---|---|---|---|--------|

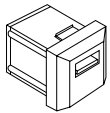

Description

- Passive USB-A Port with Increased Transfer Speed Up to 5 gbs/sec
- For Use with 01-DPORT4A and 01-DPORT4B
- Simultaneous Read/Write Capability
- Idle Device Power Saving State

| | | | | | | | | |
|-------------------------|----------|--|---|---|---|---|-----|-------|
| PASSIVE USB-C ACCESSORY | 01-PUSBC | | - | - | - | 1 | 0.2 | \$ 95 |
|-------------------------|----------|--|---|---|---|---|-----|-------|



Description

- Passive USB-C Port ; Unit Provides Data Connection to Transfer Data Only, No Charging Capabilities
- Compatible with 01-DPORT4A and 01-DPORT4B
- Male/Female Connector

| | | | | | | | | |
|----------------------------|----------|--|---|---|---|---|-----|--------|
| CHARGING USB-A+C ACCESSORY | 01-USBAC | | - | - | - | 1 | 0.2 | \$ 283 |
|----------------------------|----------|--|---|---|---|---|-----|--------|



Description

- For Charging Devices
- 20 Watt Power Supply
- USB+C Charging Port for 01-DPORT4A and 01-DPORT4B

| Item | Model No. | Width | Depth | Height | Ship Wt | Cubic Ft | List Price |
|-------------------------|-----------|-------|-------|--------|---------|----------|------------|
| VGA CONNECTOR ACCESSORY | 01-VGACON | - | - | - | 1 | 0.2 | \$ 149 |

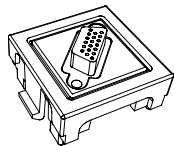
Description

- VGA Port for 01-DPORT4A and 01-DPORT4B
- Enables Devices to Remote Display on Monitors
- 10' Cord
- Male/Female Connector

| | | | | | | | |
|--------------------------|------------|---|---|---|---|-----|--------|
| HDMI CONNECTOR ACCESSORY | 01-HDMICON | - | - | - | 1 | 0.2 | \$ 124 |
|--------------------------|------------|---|---|---|---|-----|--------|

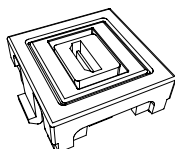
Description

- HDMI Port for 01-DPORT4A and 01-DPORT4B
- Connects to High Definition Displays
- Female/Female Connector
- 18" Cord

| | | | | | | | |
|---------------|-----------|---|---|---|---|---|-------|
| VOICE COUPLER | 01-VOICE1 | - | - | - | - | - | \$ 73 |
|---------------|-----------|---|---|---|---|---|-------|

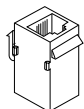
Description

- For Use with 01-DPORT4A and 01-DPORT4B
- 6-Pin Modular Plug
- Molded Black
- Cord Not included

| | | | | | | | |
|-----------|------------|---|---|---|---|---|--------|
| DATA PORT | 01-RJ4DATA | - | - | - | - | - | \$ 167 |
|-----------|------------|---|---|---|---|---|--------|



Description

- For Use with 01-DPORT4A and 01-DPORT4B
- 8-Pin Modular Plug, Cat6 Ethernet Cable, Pre-terminated Cable
- 10' Cord

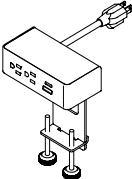
| Item | Model No. | | Width | Depth | Height | Ship Wt | Cubic Ft | List Price |
|--------------------------------|---------------|--------|-------|-------|--------|---------|----------|------------|
| DUO CLAMP WITH NEMA PLUG | 01-DUOCLAMPW | White | 6½ | 3 | 7 | 1 | 0.2 | \$ 572 |
| | 01-DUOCLAMPB | Black | | | | | | |
| | 01-DUOCLAMPS | Silver | | | | | | |
| TRIO CLAMP WITH NEMA PLUG | 01-TRIOCLAMPW | White | 9 | 3 | 7 | 1 | 0.2 | \$ 671 |
| | 01-TRIOCLAMPB | Black | | | | | | |
| | 01-TRIOCLAMPS | Silver | | | | | | |
| UNDERMOUNT DUO WITH NEMA PLUG | 01-DUOUNDERW | White | 6½ | 2½ | 3 | 1 | 0.2 | \$ 546 |
| | 01-DUOUNDERB | Black | | | | | | |
| | 01-DUOUNDERS | Silver | | | | | | |
| UNDERMOUNT TRIO WITH NEMA PLUG | 01-TRIOUNDERW | White | 9 | 2½ | 3 | 1 | 0.2 | \$ 655 |
| | 01-TRIOUNDERB | Black | | | | | | |
| | 01-TRIOUNDERS | Silver | | | | | | |

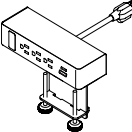
| | |
|---|---|
|  | <p>Description</p> <ul style="list-style-type: none"> Standard with: Two (2) Power Outlet, One (1) USB Charging Port and One (1) 60-Watt USB-C Power Delivery Port with GaN Technology with 10' Cord Clamps to Top and Features Silver Metal Trim Independent USB Circuit Controllers Deliver up to 2.1 Amps to Each Post All Mounting Hardware Included FCC Part 15A and UL Approved for Horizontal and Vertical Applications |
|---|---|

| | |
|---|---|
|  | <p>Description</p> <ul style="list-style-type: none"> Standard with: Three (3) Power Outlets, One (1) USB Charging Port, One (1) 60-Watt USB-C Power Delivery Port with GaN Technology, One (1) Open Data with 10' Cord Clamps to Top and Features Silver Metal Trim Independent USB Circuit Controllers Deliver up to 2.1 Amps to Each Post HDMI, VGA, or RJ45 Sold Separately; See Accessories All Mounting Hardware Included FCC Part 15A and UL Approved for Horizontal and Vertical Applications |
|---|---|

| | |
|---|--|
|  | <p>Description</p> <ul style="list-style-type: none"> Sits Under Worksurface and Includes: Two (2) Power, One (1) USB Charging Port and One (1) 60-Watt USB-C Power Delivery Port with GaN Technology with 10' Cord All Mounting Hardware Independent USB Circuit Controllers Deliver up to 2.1 Amps to Each Post FCC Part 15A, UL Approved for Horizontal and Vertical Applications |
|---|--|

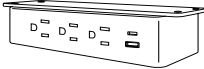
| | |
|---|---|
|  | <p>Description</p> <ul style="list-style-type: none"> Sits Under Worksurfaces and Includes: Three (3) Power, One (1) USB Charging Port, One (1) 60-Watt USB-C Power Delivery Port with GaN Technology, One (1) Open Port and 10' Cord, All Mounting Hardware HDMI, VGA, or RJ45 Accessory for Open Port Specified Separately, See Accessories Independent USB Circuit Controllers Deliver up to 2.1 Amps to Each Post FCC Part 15A, UL Approved for Horizontal and Vertical Applications |
|---|---|

| Item | Model No. | | Width | Depth | Height | Ship Wt | Cubic Ft | List Price |
|--------------------------|--------------|--------|-------|-------|--------|---------|----------|------------|
| DUO BEZEL WITH NEMA PLUG | 01-DUOBEZELW | White | 6½ | 2¼ | 3 | 1 | 0.2 | \$ 675 |
| | 01-DUOBEZELB | Black | | | | | | |
| | 01-DUOBEZELS | Silver | | | | | | |



Description

- Sits On Top of the Worksurface and Includes: Two (2) Power, **One (1) USB Charging Port and One (1) 60-Watt USB-C Power Delivery Port with GaN Technology with 10' Cord**
- Independent USB Circuit Controllers Deliver up to 2.1 Amps to Each Post
- All Mounting Hardware Included
- FCC Part 15A and UL Approved for Horizontal and Vertical Applications

| | | | | | | | | |
|---------------------------|---------------|--------|---|----|---|---|-----|--------|
| TRIO BEZEL WITH NEMA PLUG | 01-TRIOBEZELW | White | 9 | 2¼ | 3 | 1 | 0.2 | \$ 725 |
| | 01-TRIOBEZELB | Black | | | | | | |
| | 01-TRIOBEZELS | Silver | | | | | | |



Description

- Sits On Top of the Worksurface and Includes: Three (3) Power, **One (1) USB Charging Port and One (1) 60-Watt USB-C Power Delivery Port with GaN Technology**, One (1) Open Data, and 10' Cord
- Independent USB Circuit Controllers Deliver up to 2.1 Amps to Each Post
- HDMI, VGA, or RJ45 Sold Separately; [See Accessories](#)
- All Mounting Hardware Included
- FCC Part 15A and UL Approved for Horizontal and Vertical Applications

| DUO BEZEL WITH HARD WIRE CONNECTION | Circuit 1 | | Width | Depth | Height | Ship Wt | Cubic Ft | List Price | | | | | | |
|-------------------------------------|-----------------|-------|-------|-------|--------|---------|----------|------------|----|----|---|---|-----|--------|
| | 01-HWDUOBEZELW1 | White | | | | | | | 6½ | 2¼ | 3 | 1 | 0.2 | \$ 730 |
| | 01-HWDUOBEZELB1 | Black | | | | | | | | | | | | |
| 01-HWDUOBEZELS1 | Silver | | | | | | | | | | | | | |
| Circuit 2 | | | | | | | | | | | | | | |
| 01-HWDUOBEZELW2 | White | 6½ | 2¼ | 3 | 1 | 0.2 | \$ 730 | | | | | | | |
| 01-HWDUOBEZELB2 | Black | | | | | | | | | | | | | |
| 01-HWDUOBEZELS2 | Silver | | | | | | | | | | | | | |
| Circuit 3 | | | | | | | | | | | | | | |
| 01-HWDUOBEZELW3 | White | 6½ | 2¼ | 3 | 1 | 0.2 | \$ 730 | | | | | | | |
| 01-HWDUOBEZELB3 | Black | | | | | | | | | | | | | |
| 01-HWDUOBEZELS3 | Silver | | | | | | | | | | | | | |
| Circuit 4 | | | | | | | | | | | | | | |
| 01-HWDUOBEZELW4 | White | 6½ | 2¼ | 3 | 1 | 0.2 | \$ 730 | | | | | | | |
| 01-HWDUOBEZELB4 | Black | | | | | | | | | | | | | |
| 01-HWDUOBEZELS4 | Silver | | | | | | | | | | | | | |



Description

- Must Specify Color and Circuit
- Sits on worksurface and Includes: Two (2) Power, **One (1) USB Charging Port and One (1) 60-Watt USB-C Power Delivery Port with GaN Technology**, and All Mounting Hardware
- Independent USB Circuit Controllers Deliver up to 2.1 Amps to Each Post
- FCC Part 15A and UL Approved for Horizontal and Vertical Applications
- Maximum 10 Duo Units per Circuit
- Eight (8) Wire/Four (4) Circuit Hard Wire Power Unit
- See Power Entry, Jumper Cable, and Quad Block on Next Page

| Item | Model No. | | Width | Depth | Height | Ship Wt | Cubic Ft | List Price | |
|--|------------------|--------|-------|-------|--------|---------|----------|------------|--|
| TRIO BEZEL WITH HARD WIRE CONNECTION  | Circuit 1 | | | | | | | | |
| | 01-HWTRIOBEZELW1 | White | 9 | 2½ | 3 | 1 | 0.2 | \$ 749 | |
| | 01-HWTRIOBEZELB1 | Black | | | | | | | |
| | 01-HWTRIOBEZELS1 | Silver | | | | | | | |
| | Circuit 2 | | | | | | | | |
| | 01-HWTRIOBEZELW2 | White | 9 | 2½ | 3 | 1 | 0.2 | \$ 749 | |
| | 01-HWTRIOBEZELB2 | Black | | | | | | | |
| | 01-HWTRIOBEZELS2 | Silver | | | | | | | |
| | Circuit 3 | | | | | | | | |
| | 01-HWTRIOBEZELW3 | White | 9 | 2½ | 3 | 1 | 0.2 | \$ 749 | |
| | 01-HWTRIOBEZELB3 | Black | | | | | | | |
| | 01-HWTRIOBEZELS3 | Silver | | | | | | | |
| | Circuit 4 | | | | | | | | |
| | 01-HWTRIOBEZELW4 | White | 9 | 2½ | 3 | 1 | 0.2 | \$ 749 | |
| | 01-HWTRIOBEZELB4 | Black | | | | | | | |
| | 01-HWTRIOBEZELS4 | Silver | | | | | | | |

Description

- Must Specify Color and Circuit
- Sits on Worksurface and Includes: Three (3) Power, **One (1) USB Charging Port and One (1) 60-Watt USB-C Power Delivery Port with GaN Technology**, and All Mounting Hardware
- Independent USB Circuit Controllers Deliver up to 2.1 Amps to Each Post
- FCC Part 15A and UL Approved for Horizontal and Vertical Applications
- Maximum 6 Trio Units per Circuit
- Eight (8) Wire/Four (4) Circuit Hard Wire Power Unit
- HDMI, VGA, or RJ45 Sold Separately; [See Accessories](#)
- See Power Entry, Jumper Cable, and Quad Block Below and on Next Page

| | | | | | | | | |
|---|-----------------|--|----|---|---|---|-----|--------|
| POWER ENTRY FOR HARD WIRE CONNECTION | 01-HWPOWERENTRY | | 72 | - | - | 1 | 0.2 | \$ 322 |
|---|-----------------|--|----|---|---|---|-----|--------|

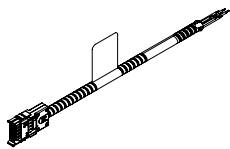

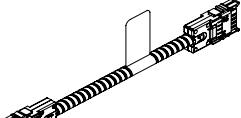

**Description**

- Eight (8) Wire/Four (4) Circuit Hard Wire Infeed
- UL183 Compliant

| | | | | | | | | |
|---|------------|--|----|---|---|---|-----|--------|
| JUMPER CABLE FOR HARD WIRE CONNECTION  | 01-HW6JUMP | | 72 | - | - | 1 | 0.2 | \$ 270 |
| | 01-HW5JUMP | | 60 | - | - | 1 | 0.2 | \$ 255 |
| | 01-HW4JUMP | | 48 | - | - | 1 | 0.2 | \$ 212 |
| | 01-HW3JUMP | | 36 | - | - | 1 | 0.2 | \$ 206 |
| | 01-HW2JUMP | | 24 | - | - | 1 | 0.2 | \$ 193 |

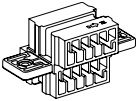
Description

- Eight (8) Wire/Four (4) Circuit Hard Wire Jumper
- UL183 Compliant

| Item | Model No. | | Width | Depth | Height | Ship Wt | Cubic Ft | List Price |
|---|--|--------|-------|-------|--------|---------|----------|------------|
| QUAD BLOCK FOR HARD WIRE CONNECTION | 01-HWQUADBLOCK | | | | | 1 | 0.2 | \$ 62 |
|  | Description | | | | | | | |
| | <ul style="list-style-type: none"> • Eight (8) Wire/Four (4) Circuit Hard Wire Connector • UL183 Compliant • For Connecting Jumpers and Power Units • Quantity of Four (4) Female Inputs | | | | | | | |
| DUO BEZEL WITH DAISY CHAIN PLUG | 01-PDUOBEZELW | White | 6½ | 2¼ | 3 | 1 | 0.2 | \$ 668 |
|  | 01-PDUOBEZELB | Black | | | | | | |
| | 01-PDUOBEZELS | Silver | | | | | | |
| | Description | | | | | | | |
| | <ul style="list-style-type: none"> • Sits On Top of the Worksurface and Includes: Two (2) Power, One (1) USB Charging Port and One (1) 60-Watt USB-C Power Delivery Port with GaN Technology with 12" Cord • Independent USB Circuit Controllers Deliver up to 2.1 Amps to Each Post • All Mounting Hardware Included • FCC Part 15A, RU Listed and UL Recognized for Horizontal and Vertical Applications • Non Sequential System Allows Up to Eight (8) Modules To Be Connected With Jumper Cord • Requires Power Box, See Below; See Jumper Cable on Next Page | | | | | | | |
| TRIO BEZEL WITH DAISY CHAIN PLUG | 01-PTRIOBEZELW | White | 9 | 2¼ | 3 | 1 | 0.2 | \$ 715 |
|  | 01-PTRIOBEZELB | Black | | | | | | |
| | 01-PTRIOBEZELS | Silver | | | | | | |
| | Description | | | | | | | |
| | <ul style="list-style-type: none"> • Sits On Top of the Worksurface and Includes: Three (3) Power, One (1) USB Charging Port, One (1) 60-Watt USB-C Power Delivery Port with GaN Technology, and One (1) Open Data with 12" Cord • HDMI, VGA, or RJ45 Sold Separately; See Accessories • All Mounting Hardware Included • FCC Part 15A, RU Listed and UL Recognized for Horizontal and Vertical Applications • Non Sequential System Allows Up to Eight (8) Modules To Be Connected With Jumper Cord • Requires Power Box, See Below; See Jumper Cable on Next Page | | | | | | | |
| DAISY CHAIN POWER BOX | 01-PPOWER2 | | - | - | - | 1 | 0.2 | \$ 796 |
|  | 24" Perimeter, 144" Power Cord | | | | | | | |
| | 01-PPOWER | | - | - | - | 1 | 0.2 | \$ 775 |
| | 76" Perimeter, 36" Power Cord | | | | | | | |
| | Description | | | | | | | |
| | <ul style="list-style-type: none"> • Powers up to Eight (8) Duo and Trio Daisy Chain Units • One (1) Nema Plug and One (1) Daisy Chain Plug • 12 Amp System Rating • 15 Amp Over-Current Protection | | | | | | | |

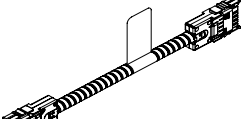
| Item | Model No. | | Width | Depth | Height | Ship Wt | Cubic Ft | List Price |
|---|-----------|----------|-------|-------|--------|---------|----------|------------|
|  | 01-6JUMP | 72" Long | - | - | - | 1 | 0.2 | \$ 299 |
| | 01-5JUMP | 60" Long | - | - | - | 1 | 0.2 | \$ 284 |
| | 01-4JUMP | 48" Long | - | - | - | 1 | 0.2 | \$ 240 |
| | 01-2JUMP | 24" Long | - | - | - | 1 | 0.2 | \$ 220 |

Description

- Connects Duo and Trio Daisy Chain Units
- Non Sequential System Allows up to Eight (8) Modules to be Connected

| | | | | | | | | |
|--------------------------|-------------|--|---|---|---|---|-----|--------|
| HDMI DATA PORT ACCESSORY | 01-LCOMHDMI | | - | - | - | 1 | 0.2 | \$ 166 |
|--------------------------|-------------|--|---|---|---|---|-----|--------|

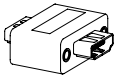

Description

- HDMI Port for Trio Clamp and Trio Bezel Units

OPEN MARKET ONLY

| | | | | | | | | |
|-------------------------|------------|--|---|---|---|---|-----|--------|
| VGA DATA PORT ACCESSORY | 01-LCOMVGA | | - | - | - | 1 | 0.2 | \$ 121 |
|-------------------------|------------|--|---|---|---|---|-----|--------|

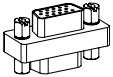

Description

- VGA Port for Trio Clamp and Trio Bezel Units

| | | | | | | | | |
|--------------------------|-------------|--|---|---|---|---|-----|-------|
| RJ45 DATA PORT ACCESSORY | 01-LCOMRJ45 | | - | - | - | 1 | 0.2 | \$ 79 |
|--------------------------|-------------|--|---|---|---|---|-----|-------|

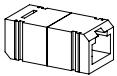

Description

- RJ45 Port for Trio Clamp and Trio Bezel Units

| Item | Model No. | Width | Depth | Height | Ship Wt | Cubic Ft | List Price |
|-------------------------|-----------|-------|-------|--------|---------|----------|------------|
| WIRE MANAGEMENT CHANNEL | 01-WMGR4 | 16 | 1½ | 1 | 1 | - | \$ 116 |

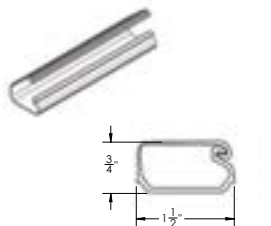

Description

- Set of Four (4) Black Plastic Wire Management Channels
- Snap Lock Channel
- Attaches with Adhesive Strips
- Ships via UPS Only

| | | | | | | | |
|--------------|----------|----|-------|---|-----|-----|--------|
| WIRE CHANNEL | 01-32125 | 24 | 1 5/8 | 1 | .25 | 0.3 | \$ 106 |
|--------------|----------|----|-------|---|-----|-----|--------|

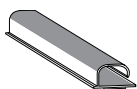

Description

- Available in Black
- Channels Attach with Two (2) Double-Sided Installation Tape
- Open J Channel for Easy Storage of Cables

| | | | | | | | |
|------------|-----------|-------|-------|--|---|---|-------|
| CABLE GRIP | 01-WMGRCB | 5 3/8 | 2 3/8 | | - | - | \$ 17 |
|------------|-----------|-------|-------|--|---|---|-------|

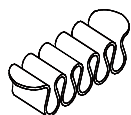

Description

- Under Surface Wire Management
- Black

| | | | | | | | | |
|------------------------|----------------|--------|--------|--------|-------|---|-----|--------|
| LINK 360 CABLE MANAGER | 01-0251LINKSLV | Silver | 5 3/16 | 3 9/16 | 30-51 | 4 | 3.0 | \$ 390 |
| | 01-0251LINKBLK | Black | 5 3/16 | 3 9/16 | 30-51 | 4 | 3.0 | \$ 353 |

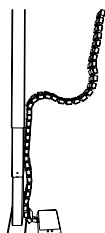

Description

- Kit Includes: 50 Link 360™ elements, One (1) Quad Connector, One (1) Dumbbell Connector, One (1) Foot Assembly with Two (2) Magnetic Clips
- Can Be Used For Height-Adjustable Mechanisms Up To 51" or Free-Standing Use

| Item | Model No. | Width | Depth | Height | Ship Wt | Cubic Ft | List Price |
|-------------------------------|--------------------|-------|-------|--------|---------|----------|------------|
| HEIGHT ADJUSTABLE WORKSTATION | 01-S2SBLK Black | 35 ½ | 25 | 6-22 | 49 | 6.5 | \$ 1503 |

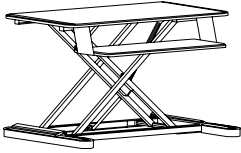

Description

- Height Adjustable
- Weight Capacity: 35lbs
- One-Handed Operation; Platforms Move Simultaneously
- Keyboard Platform: 10½"D x 26½"W
- Worksurface: 21"D x 35½"W
- Can be Used on Worksurface 24"D x 35"W

HEIGHT ADJUSTABLE PNEUMATIC X-BASE

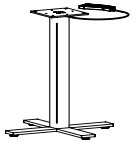

| Maximum Round 42", Maximum Square 36" | | Width | Depth | Height | Ship Wt | Cubic Ft | List Price |
|---------------------------------------|----------|-------|-------|--------|---------|----------|------------|
| 01-3232HAXBB | Black | 32 | 32 | 26 | 1 | 0.2 | \$ 1721 |
| 01-3232HAXBA | Aluminum | | | | | | |
| Maximum Round 36", Maximum Square 30" | | Width | Depth | Height | Ship Wt | Cubic Ft | List Price |
| 01-2626HAXBB | Black | 22 | 22 | 26 | 1 | 0.2 | \$ 1687 |
| 01-2626HAXBA | Aluminum | | | | | | |

Description

- Pre-Drilled Boring Pattern May Not Match Underside of Table Top
- Steel Mounting Plate: 8"x 8"x ¼"
- Some Assembly Required; Hardware Included

28"D ELECTRIC HEIGHT ADJUSTABLE TABLE LIFT

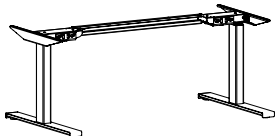

| | | | | | | | |
|------------|--------|-------|----|-------|----|-----|---------|
| 01-2854ELB | Black | 54-78 | 28 | 22-48 | 30 | 2.4 | \$ 1832 |
| 01-2854ELA | Silver | | | | | | |

Description

- Standard with Up/Down Control Switch, 10' Power Cord, Integrated Anti-Collision Feature, Leveling Glides
- Standard Up/Down Control Switch can be Mounted for Left or Right Users; Upgrade to Advanced Memory Switch (01-MSWCH with Memory, Reminders, and Bluetooth), Must Specify and See Below for Details
- Adjusts to Accommodate Tops 54-78"W and 30"-36"D; Tops Sold Separately
- Lifting Capacity (Including Worksurface): 363 lbs
- Some Assembly Required; Installation Instructions Included

| Item | Model No. | | Width | Depth | Height | Ship Wt | Cubic Ft | List Price |
|--|------------|--------|-------|-------|--------|---------|----------|------------|
| 22"D ELECTRIC HEIGHT ADJUSTABLE TABLE LIFT | 01-2254ELB | Black | 54-78 | 22 | 22-48 | 58 | 2.4 | \$ 1832 |
| | 01-2254ELA | Silver | | | | | | |

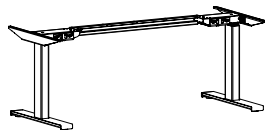

Description

- Standard with Up/Down Control Switch, 10' Power Cord, Anti-Collision Safety Feature, Leveling Glides
- Standard Up/Down Control Switch can be Mounted for Left or Right Users; Upgrade to Advanced Memory Switch (01-MSWCH with Memory, Reminders, and Bluetooth), Must Specify and See Below for Details
- Adjusts to Accommodate Tops 54-78"W and 24"D; Tops Sold Separately
- Lifting Capacity (Including Worksurface): 363 lbs
- Some Assembly Required; Installation Instructions Included

| | | | | | | | | |
|--|------------|--------|-------|----|-------|----|-----|---------|
| 22"D ELECTRIC HEIGHT ADJUSTABLE TABLE LIFT | 01-2242ELB | Black | 42-48 | 22 | 22-48 | 55 | 2.4 | \$ 1832 |
| | 01-2242ELA | Silver | | | | | | |

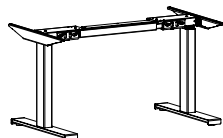

Description

- Standard with Up/Down Control Switch, 10' Power Cord, Anti-Collision Safety Feature, Leveling Glides
- Standard Up/Down Control Switch can be Mounted for Left or Right Users; Upgrade to Advanced Memory Switch (01-MSWCH with Memory, Reminders, and Bluetooth), Must Specify and See Below for Details
- Adjusts to Accommodate Tops 42-48"W and 24"-30"D; Tops Sold Separately
- Lifting Capacity (Including Worksurface): 363 lbs
- Some Assembly Required; Installation Instructions Included

| | | | | | | | | |
|--|----------|--|-------|-------|-------|-----|-----|--------|
| ELECTRIC HEIGHT ADJUSTABLE ADVANCED SWITCH WITH MEMORY | 01-MSWCH | | 3 1/8 | 4 3/8 | 1 1/8 | 1/2 | 0.8 | \$ 223 |
|--|----------|--|-------|-------|-------|-----|-----|--------|



OPEN MARKET ONLY

Description

- Black Unit with Black Cord
- Bluetooth Capabilities
- Three Stand-Up Reminders
- Four Height Memory Positions

| | | | | | | | | |
|-------------|---------|--|---|---|---|---|---|--------|
| POWER STRIP | 01-PRSP | | 9 | 2 | 2 | 1 | - | \$ 205 |
|-------------|---------|--|---|---|---|---|---|--------|



Description

- Includes Four (4) Outlets and Two (2) Phone Jacks
- Black Plastic with Rocker On/Off Switch
- 13 Amp Circuit Breaker
- 10' Power Cord and Two (2) 14' Phone Hook Up Cords
- UL Listed and CSA Certified
- Suitable for Surface or Recessed Mounting
- Ships via UPS Only

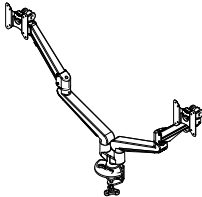
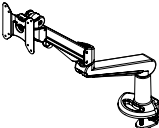
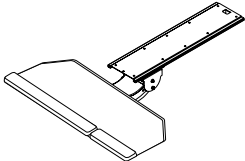
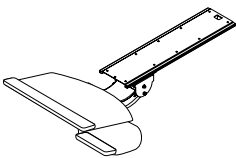
| Item | Model No. | | Width | Depth | Height | Ship Wt | Cubic Ft | List Price |
|---|--|-------------------|-------|-------|--------|---------|----------|------------|
| DUAL ARTICULATING MONITOR ARM | 01-MLEDGE2A | Aluminum | - | - | - | 15 | 1.4 | \$ 1313 |
| | 01-MLEDGE2B | Black | | | | | | |
|  | Description | | | | | | | |
| | <ul style="list-style-type: none"> • Includes Desk Clamp and Grommet Mount • Dual Mount with Independent Adjustment • 180° Lockout Feature. 6.5"H to 19.5"H Adjustment • 21" Monitor Extension, 3.5" Monitor Retraction • +30/-25° Monitor Tilt; 360° Swivel at Two Points • 17.6lb Weight Capacity per Arm • Enclosed Cable Management • VESA 75mm and VESA 100mm Compatible with Quick Monitor Release | | | | | | | |
| SINGLE MONITOR ARM | 01-MLEDGE1A | Aluminum | - | - | - | 13 | 2.2 | \$ 773 |
| | 01-MLEDGE1B | Black | | | | | | |
|  | Description | | | | | | | |
| | <ul style="list-style-type: none"> • Includes Desk Clamp and Grommet Mount • 180° Lockout Feature, 6.5"H to 19.5"H Adjustment • 21" Monitor Extension, 3.5" Monitor Retraction • +30/-25° Monitor Tilt • 17.6lb Weight Capacity • Enclosed Cable Management • VESA 75mm and VESA 100mm Compatible with Quick Monitor Release | | | | | | | |
| ARTICULATING KEYBOARD CORNER PLATFORM | 01-KB2CC | | 25 | 10½ | 4½ | 16 | 1.4 | \$ 832 |
| | Description | | | | | | | |
|  | <ul style="list-style-type: none"> • Works with 17"+ Diagonal Work Surface; 25" Cut Corner Platform • Keyboard and Mouse on Same Level with Single Palm Rest on Both Sides • +/- 15° Tilt Adjustment & 360° Rotation • Independent Tilt Adjustment; Lift & Lock 7"H Adjustment • Cannot Be Used on 20"D Unit • Not Available with Optional Center Grommet • Track Measures 21" | | | | | | | |
| | Options: Specify & Add | | | | | | | |
| | KB2CC | Factory Installed | | | | | | \$ 208 |
| KEYBOARD MECHANISM WITH KEYBOARD PLATFORM AND MOUSE TRAY AND PALM REST | 01-KB3 | | 26½ | 14 | 4.5 | 16 | 1.4 | \$ 914 |
| | Description | | | | | | | |
|  | <ul style="list-style-type: none"> • 18¾" Platform with Swivel-Below Mouse Platform • Palm Rest for Mousing Surface • +/- 15° Tilt Adjustment & 360° Rotation • Independent Tilt Adjustment; Lift & Lock 7"H Adjustment • Cannot Be Used on 20" Deep Unit • Left or Right Handed Mouse Platform • Not Available with Optional Center Grommet • Track Measures 21" | | | | | | | |
| | Options: Specify & Add | | | | | | | |
| | KB3 | Factory Installed | | | | | | \$ 208 |

| Item | Model No. | | Width | Depth | Height | Ship Wt | Cubic Ft | List Price |
|------------|-------------|----------|-------|-------|--------|---------|----------|------------|
| CPU HOLDER | 01-CPUMINIA | Aluminum | - | - | - | 16 | .4 | \$ 387 |

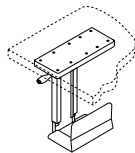

Description

- Vertically Mounts to Undersurface; No Tools Required for Adjustment
- 360° Swivel
- 13 $\frac{3}{8}$ " Ball Bearing Glide Track
- 3 $\frac{1}{4}$ "W-6"W and 16"H - 23"H Adjustment
- 55lb Load Capacity
- Fits CPU's 5"H - 20"H Overall Height

| | | | | | | | | |
|---------------|---------|-------------------|------------------|-----------------|-----------------|---|---|--------|
| LED TASKLIGHT | TL-0848 | | 47 $\frac{1}{2}$ | 7 $\frac{1}{8}$ | 1 $\frac{5}{8}$ | - | - | \$ 445 |
| | | 240-LED, 18 Watts | | | | | | |
| LED TASKLIGHT | TL-0824 | | 22 $\frac{1}{2}$ | 7 $\frac{1}{8}$ | 1 $\frac{5}{8}$ | - | - | \$ 368 |
| | | 84-LED, 7 Watts | | | | | | |

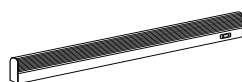

Description

- Includes the Power Supply and Three (3) Upper Wire Management Grommet
- Rocker Style On/Off Switch with 10' Power Cord
- Grommet Color will Match Lower Grommet Color

| | | | | | | | | |
|---------------|-------------|--------------------|------------------|---|---------------|---|---|---------|
| LED TASKLIGHT | 01-188LED58 | | 57 $\frac{3}{8}$ | 2 | $\frac{3}{4}$ | - | - | \$ 1648 |
| | | 96-LED, 33.7 Watts | | | | | | |
| | 01-94LED31 | | 30 $\frac{1}{8}$ | 2 | $\frac{3}{4}$ | - | - | \$ 1195 |
| | | 48-LED, 17.6 Watts | | | | | | |
| | 01-47LED17 | | 16 $\frac{3}{8}$ | 2 | $\frac{3}{4}$ | - | - | \$ 690 |
| | | 24-LED, 9.1 Watts | | | | | | |

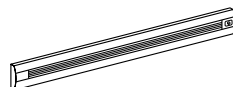

Description

- Includes the Power Supply and Three (3) Upper Wire Management Grommet
- 12' Power Cord
- Grommet Color will Match Lower Grommet Color
- Optional Occupancy Sensor Shuts Off After 30 Minutes of Inactivity and Turns On Immediately When Reentering the Detection Area

Options: Specify & Add

| | | | | | | | | |
|---------|------------------|--|--|--|--|--|--|--------|
| 01-OSRP | Occupancy Sensor | | | | | | | \$ 366 |
|---------|------------------|--|--|--|--|--|--|--------|

| Item | Model No. | | Width | Depth | Height | Ship Wt | Cubic Ft | List Price |
|--|-----------|----------------------|-------|-------|--------|---------|----------|------------|
| L SHELF  Must Specify (in this order): Model # Color | 66-1596LS | 192 lbs Weight Limit | 96 | 15 | 17 | 85 | 18.3 | T\$ 1147 |
| | 66-1590LS | 192 lbs Weight Limit | 90 | 15 | 17 | 80 | 17.2 | T\$ 1090 |
| | 66-1584LS | 154 lbs Weight Limit | 84 | 15 | 17 | 75 | 16.0 | T\$ 1034 |
| | 66-1578LS | 154 lbs Weight Limit | 78 | 15 | 17 | 70 | 14.9 | T\$ 979 |
| | 66-1572LS | 154 lbs Weight Limit | 72 | 15 | 17 | 65 | 13.8 | T\$ 922 |
| | 66-1566LS | 128lbs Weight Limit | 66 | 15 | 17 | 60 | 12.7 | T\$ 869 |
| | 66-1560LS | 128 lbs Weight Limit | 60 | 15 | 17 | 55 | 11.6 | T\$ 815 |
| | 66-1554LS | 90 lbs Weight Limit | 54 | 15 | 17 | 50 | 10.5 | T\$ 761 |
| | 66-1548LS | 90 lbs Weight Limit | 48 | 15 | 17 | 45 | 9.3 | T\$ 709 |
| | 66-1542LS | 90 lbs Weight Limit | 42 | 15 | 17 | 40 | 8.2 | T\$ 656 |
| | 66-1536LS | 64 lbs Weight Limit | 36 | 15 | 17 | 35 | 7.1 | T\$ 601 |
| | 66-1530LS | 64 lbs Weight Limit | 30 | 15 | 17 | 30 | 6.0 | T\$ 546 |

Description

- Weight Capacity is a Distributed Load
- Not Liable for Wall Mount Units that are not Properly Installed

| Item | Model No. | | Width | Depth | Height | Ship Wt | Cubic Ft | List Price |
|---|-----------|----------------------|-------|-------|--------|---------|----------|------------|
| FLOATING SHELF  Must Specify (in this order): Model # Color | 66-0996FS | 123 lbs Weight Limit | 96 | 9 | 1 | 20 | 2.2 | T\$ 785 |
| | 66-0990FS | 123 lbs Weight Limit | 90 | 9 | 1 | 19 | 2.1 | T\$ 753 |
| | 66-0984FS | 99 lbs Weight Limit | 84 | 9 | 1 | 18 | 1.9 | T\$ 719 |
| | 66-0978FS | 99 lbs Weight Limit | 78 | 9 | 1 | 16 | 1.8 | T\$ 687 |
| | 66-0972FS | 99 lbs Weight Limit | 72 | 9 | 1 | 16 | 1.6 | T\$ 655 |
| | 66-0966FS | 82 lbs Weight Limit | 66 | 9 | 1 | 14 | 1.5 | T\$ 614 |
| | 66-0960FS | 82 lbs Weight Limit | 60 | 9 | 1 | 13 | 1.4 | T\$ 572 |
| | 66-0954FS | 57 lbs Weight Limit | 54 | 9 | 1 | 12 | 1.3 | T\$ 534 |
| | 66-0948FS | 57 lbs Weight Limit | 48 | 9 | 1 | 10 | 1.1 | T\$ 494 |
| | 66-0942FS | 57 lbs Weight Limit | 42 | 9 | 1 | 9 | 0.9 | T\$ 454 |
| | 66-0936FS | 40 lbs Weight Limit | 36 | 9 | 1 | 8 | 0.8 | T\$ 411 |
| | 66-0930FS | 40 lbs Weight Limit | 30 | 9 | 1 | 6 | 0.7 | T\$ 372 |

Description

- Weight Capacity is a Distributed Load
- Not Liable for Wall Mount Units that are not Properly Installed

| Item | Model No. | Width | Depth | Height | Ship Wt | Cubic Ft | List Price |
|--|-----------|-------|-------|--------|---------|----------|------------|
| MAGNETIC GLASS MARKER BOARD | GMB-5248W | 48 | ½ | 52⅞ | 86 | 13.5 | \$ 3988 |
| COORDINATES WITH 30"H DESKS AND CREDENZA AND TALL WALL MOUNT HUTCHES OR SHELVING | GMB-5242W | 42 | ½ | 52⅞ | 76 | 12.2 | \$ 3369 |
| | GMB-5236W | 36 | ½ | 52⅞ | 65 | 10.8 | \$ 2904 |
| | GMB-5230W | 30 | ½ | 52⅞ | 54 | 9.5 | \$ 2441 |

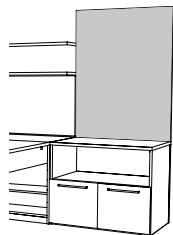
**Description**

- Available in Black (BLMKR) or White (WHMKR), Must Specify
- Mounting Brackets Included
- Coordinates With Tall Surface or Wall Mount Hutches
- See Rare Earth Magnets, Marker and Eraser Sets Below
- Find Additional Magnetic Glass Marker Boards in Casgoods Collections

Must Specify (in this order):

Model #
Color

| | | | | | | | |
|-----------------------------------|-----------|----|---|-----|-----|------|---------|
| MAGNETIC GLASS MARKER BOARD | GMB-8236W | 36 | ½ | 82⅞ | 102 | 15.8 | \$ 4453 |
| FOR USE FROM FLOOR TO TOP OF UNIT | GMB-7036W | 36 | ½ | 70⅞ | 87 | 13.8 | \$ 3834 |
| | GMB-5136W | 36 | ½ | 51⅞ | 63 | 10.6 | \$ 2802 |
| | GMB-8230W | 30 | ½ | 82⅞ | 85 | 13.8 | \$ 3730 |
| | GMB-7030W | 30 | ½ | 70⅞ | 72 | 12.1 | \$ 3215 |
| | GMB-5130W | 30 | ½ | 51⅞ | 53 | 9.3 | \$ 2354 |

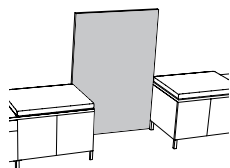
**Description**

- Available in Black (BLMKR) or White (WHMKR), Must Specify
- Marker Boards Are One (1) Piece with No Seams
- Mounting Brackets Included
- See Rare Earth Magnets, Marker and Eraser Sets Below
- Find Additional Magnetic Glass Marker Boards in Casgoods Collections

Must Specify (in this order):

Model #
Color

| | | | |
|-----------------------|--------------|--|--------|
| MARKER AND ERASER SET | 01-MRKRSETBL | For Use with Black Marker Boards and Black Glass Doors | \$ 123 |
| | 01-MRKRSETWH | For Use with White Marker Boards and White Glass Doors | |

**Description**

- 01-MRKRSETWH May Also be Used with Standard Dry Erase Doors and Boards
- Includes Four (4) Markers and an Eraser

| | | | |
|------------|----------|-------|--------|
| MAGNET SET | 01-MAGBL | Black | \$ 114 |
| | 01-MAGWH | White | |

**Description**

- Includes Set of Five (5) Rare Earth Magnets
- To be Used with Tempered Glass Magnetic Marker Boards
- Comfort Grip with Stylish Protective Plastic Coating

23" TALL TOOL RAIL WORK WALL

FOR SURFACE OR WALL MOUNT HUTCHES AND 30"H CRENZENZA



Must Specify (in this order):

- Model #
- Tackboard on Top or Bottom
- Dry Erase on Top or Bottom
- Tackboard Fabric Vendor, Pattern, and Color

Tackboard/Dry Erase Locations

- TB-TB: Tackboard Over Tackboard (Use Grade Prices)
- DEB-TB: Dry Erase Over Tackboard (Use Grade Prices)
- DEB-DEB: Dry Erase Over Dry Erase (Use Grade 1 Prices)

| Model # | Size | COM ydg | COM, 1, 2 or 3 | Grades | | | | | | |
|-------------|------|---------|-------------------|--------|------|------|------|------|------|------|
| | | | | 4 | 5 | 6 | 7 | 8 | 9 | 10 |
| WW-23108TRH | 108" | 3.50 | \$ 1715 | 2202 | 2429 | 2660 | 2989 | 3332 | 3731 | 4193 |
| WW-23102TRH | 102" | 3.25 | \$ 1635 | 2087 | 2298 | 2513 | 2818 | 3137 | 3507 | 3936 |
| WW-2396TRH | 96" | 3.00 | \$ 1565 | 1982 | 2177 | 2375 | 2657 | 2951 | 3293 | 3689 |
| WW-2390TRH | 90" | 2.75 | \$ 1471 | 1853 | 2032 | 2214 | 2472 | 2742 | 3055 | 3418 |
| WW-2384TRH | 84" | 2.50 | \$ 1334 | 1682 | 1844 | 2009 | 2244 | 2489 | 2774 | 3104 |
| WW-2378TRH | 78" | 2.50 | \$ 1285 | 1633 | 1795 | 1960 | 2195 | 2440 | 2725 | 3055 |
| WW-2372TRH | 72" | 2.25 | \$ 1023 | 1336 | 1482 | 1631 | 1842 | 2063 | 2319 | 2616 |
| WW-2366TRH | 66" | 2.00 | \$ 967 | 1245 | 1375 | 1507 | 1695 | 1891 | 2119 | 2383 |
| WW-2360TRH | 60" | 2.00 | \$ 910 | 1188 | 1318 | 1450 | 1638 | 1834 | 2062 | 2326 |
| WW-2354TRH | 54" | 1.75 | \$ 887 | 1130 | 1244 | 1360 | 1524 | 1696 | 1895 | 2126 |
| WW-2348TRH | 48" | 1.50 | \$ 806 | 1015 | 1112 | 1211 | 1352 | 1499 | 1670 | 1868 |
| WW-2342TRH | 42" | 1.25 | \$ 745 | 919 | 1000 | 1083 | 1200 | 1323 | 1465 | 1630 |
| WW-2336TRH | 36" | 1.25 | \$ 727 | 901 | 982 | 1065 | 1182 | 1305 | 1447 | 1612 |
| WW-2330TRH | 30" | 1.00 | \$ 671 | 810 | 875 | 941 | 1035 | 1133 | 1247 | 1379 |

Description

- Aluminum Tool Rail
- Work Walls 78" and Larger will Ship in 4 Pieces
- See Work Wall Accessories on Next Page

31" TALL TOOL RAIL WORK WALL

FOR USE WITH WALL MOUNT HUTCHES AND 21"H CRENZENZA

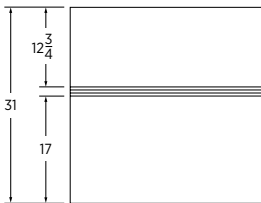

Must Specify (in this order):

- Model #
- Tackboard on Top or Bottom
- Dry Erase on Top or Bottom
- Tackboard Fabric Vendor, Pattern, and Color

Tackboard/Dry Erase Locations

- TB-TB: Tackboard Over Tackboard (Use Grade Prices)
- DEB-TB: Dry Erase Over Tackboard (Use Grade Prices)
- DEB-DEB: Dry Erase Over Dry Erase (Use Grade 1 Prices)

| Model # | Size | COM ydg | COM, 1, 2 or 3 | Grades | | | | | | |
|--------------|------|---------|-------------------|--------|------|------|------|------|------|------|
| | | | | 4 | 5 | 6 | 7 | 8 | 9 | 10 |
| WW-31108TTRW | 108" | 3.50 | \$ 2159 | 2646 | 2873 | 3104 | 3433 | 3776 | 4175 | 4637 |
| WW-31102TTRW | 102" | 3.25 | \$ 2044 | 2496 | 2707 | 2922 | 3227 | 3546 | 3916 | 4345 |
| WW-3196TTRW | 96" | 3.00 | \$ 1969 | 2386 | 2581 | 2779 | 3061 | 3355 | 3697 | 4093 |
| WW-3190TTRW | 90" | 2.75 | \$ 1854 | 2236 | 2415 | 2597 | 2855 | 3125 | 3438 | 3801 |
| WW-3184TTRW | 84" | 2.50 | \$ 1658 | 2006 | 2168 | 2333 | 2568 | 2813 | 3098 | 3428 |
| WW-3178TTRW | 78" | 2.50 | \$ 1585 | 1933 | 2095 | 2260 | 2495 | 2740 | 3025 | 3355 |
| WW-3172TTRW | 72" | 2.25 | \$ 1318 | 1631 | 1777 | 1926 | 2137 | 2358 | 2614 | 2911 |
| WW-3166TTRW | 66" | 2.00 | \$ 1265 | 1543 | 1673 | 1805 | 1993 | 2189 | 2417 | 2681 |
| WW-3160TTRW | 60" | 2.00 | \$ 1191 | 1469 | 1599 | 1731 | 1919 | 2115 | 2343 | 2607 |
| WW-3154TTRW | 54" | 1.75 | \$ 1137 | 1380 | 1494 | 1610 | 1774 | 1946 | 2145 | 2376 |
| WW-3148TTRW | 48" | 1.50 | \$ 1044 | 1253 | 1350 | 1449 | 1590 | 1737 | 1908 | 2106 |
| WW-3142TTRW | 42" | 1.25 | \$ 960 | 1134 | 1215 | 1298 | 1415 | 1538 | 1680 | 1845 |
| WW-3136TTRW | 36" | 1.25 | \$ 940 | 1114 | 1195 | 1278 | 1395 | 1518 | 1660 | 1825 |
| WW-3130TTRW | 30" | 1.00 | \$ 865 | 1004 | 1069 | 1135 | 1229 | 1327 | 1441 | 1573 |

Description

- Aluminum Tool Rail
- Work Walls 78" and Larger will Ship in 4 Pieces
- See Work Wall Accessories on Next Page

| Item | Model No. | | Width | Depth | Height | Ship Wt | Cubic Ft | List Price |
|------------|-------------|-------|--------|--------|--------|---------|----------|------------|
| LEGAL TRAY | 01-LGLTRAYC | Clear | 14 7/8 | 10 1/2 | 1 7/8 | | | \$ 115 |

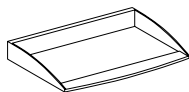

| | | | | | | | | |
|---------------|--------------|-------|-------|--------|-------|--|--|--------|
| FOLDER SORTER | 01-FLDRSRTRC | Clear | 7 1/4 | 12 3/8 | 7 1/8 | | | \$ 129 |
|---------------|--------------|-------|-------|--------|-------|--|--|--------|

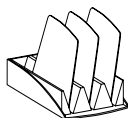

| | | | | | | | | |
|------------------|-------------|-------|-------|--------|-------|--|--|--------|
| ACCESSORIES TRAY | 01-ACCTRAYC | Clear | 9 1/4 | 10 1/8 | 1 1/8 | | | \$ 125 |
|------------------|-------------|-------|-------|--------|-------|--|--|--------|

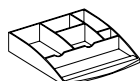

| | | | | | | | | |
|--------------------|----------|--|--------|----|--------|----|-----|---------|
| VESTA POWER CENTER | 01-PDCTR | | 10 3/4 | 12 | 28 1/4 | 14 | 2.5 | \$ 1776 |
|--------------------|----------|--|--------|----|--------|----|-----|---------|



Description

- Top Includes One (1) Power Outlet, Two (2) USB Ports and One (1) USBC Port; Base Includes Three (3) Outlet
- Available in White
- 120" Power Cord
- Built with Weight Distribution for Optimal Stability
- Base is 5" Tall

| Item | Model No. | Width | Depth | Height | Ship Wt | Cubic Ft | List Price |
|-------------|-----------|-------|-------|--------|---------|----------|------------|
| PLANTER BOX | 01-1909PL | 19¼ | 9½ | 6 | 16 | 2.0 | T\$ 572 |

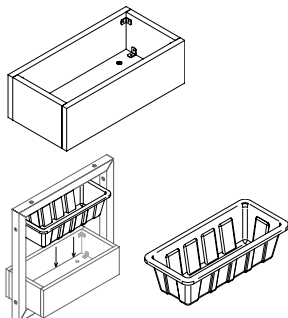

Description

- Material is TFL. Must Specify TFL (T) Color; [See Colors and Specify](#)
- Planter Will Ship with Attachment Hardware: Two (2) Black and Two (2) Nickel Bolts
- Horizontal Grain
- Planter Boxes Cannot be Installed on Both Sides of a Corner
- Optional Planter Box Insert Sold Separately

Option: Specify & Add

| | | | | | | | |
|-----|-----------------------------------|--|--|--|--|--|-------|
| PBI | Planter Box Insert, Black Plastic | | | | | | \$ 52 |
|-----|-----------------------------------|--|--|--|--|--|-------|

Must Specify (in this order):

- Model #
- TFL Color
- Optional Planter Insert

| | | | | | | | |
|--------------|-----------|----|---|----|-----|------|----------|
| VISUAL BOARD | 66-4848VB | 48 | 5 | 48 | 150 | 11.0 | T\$ 2770 |
|--------------|-----------|----|---|----|-----|------|----------|

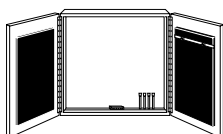

Description

- Standard with: Flipchart, Set of Four Dry Erase Markers, Eraser, Mounting Hardware, Tackboard on Each Door in Black Fabric, Display Rail with Adjustable Hooks for Flipchart
- Price Valid for Fabric Grades 1, 2, and 3, See Below For Higher Grade Fabric Pricing
- Does Not Feature Soft Close Hinges
- Magnetic Porcelain Non-Glare Writing Surface
- Find Textile Partners on Our Website; [Click Here](#)
- TFL Laminate Colors and Pulls can be Found Under Coordinating Caseloads Collections

Must Specify (in this order):

- Model #
- Color
- Tackboard Fabric Vendor, Pattern, and Color
- Pull
- Projection Screen Installation

| Options: Specify & Add | | GRADE | 4 | 5 | 6 | 7 | 8 | 9 | 10 |
|------------------------|--|-------|-----|-----|-----|-----|-----|------|---------|
| TB-4214 | Tackboard | \$ | 278 | 408 | 540 | 728 | 924 | 1152 | 1416 |
| 1-PS | Optional Factory Installed Projection Screen | | | | | | | | \$ 1062 |

| | | | | | | | | | |
|---------------|-----------|---------|----|----|----|-----|------|-----------------|------|
| LECTERN STAND | 88-2650LS | TFL+HPL | 24 | 23 | 49 | 130 | 21.9 | F, G, Y / T+P\$ | 1911 |
|---------------|-----------|---------|----|----|----|-----|------|-----------------|------|

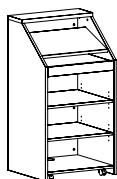



| | | | | | | | | | |
|--|--|------------|--|--|--|--|--|-----------------|------|
| | | | | | | | | H / T+P\$ | 1921 |
| | | Veneer+HPL | | | | | | F, G, Y / W+P\$ | 3451 |
| | | | | | | | | H / W+P\$ | 3477 |
| | | Veneer | | | | | | F, G, Y / W\$ | 3587 |
| | | | | | | | | H / W\$ | 3601 |

Must Specify (in this order):

- Model #
- Color





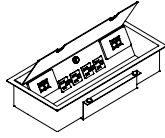





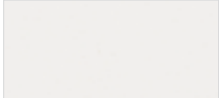

























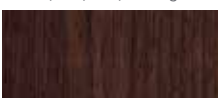
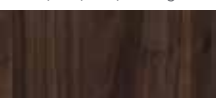

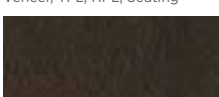



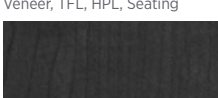
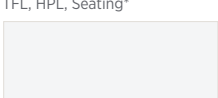
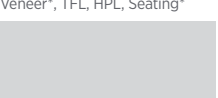

Description

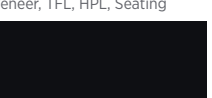
- Top Edge Profiled on Approach Side Only (See Edge Options); Must Specify Edge Selection
- Fixed Shelf Angled for User Comfort, One (1) Pullout Shelf, and Two (2) Adjustable Shelves
- Two (2) Locking and Two (2) Non-Locking Casters
- Wire Management Grommet on Second and Bottom Shelf, Middle Shelf Features Wire Management Grommet Cut Out

| Item | Model No. | | List Price |
|---|---------------|--|------------|
| ECA TELECOM PLATES | 01-ABL | Telecom Plate, Blank Plate | \$ 41 |
| COMPATIBLE WITH: | 01-ABL737373 | Telecom Plate, (3) RJ45 Cat 5e | \$ 367 |
|  | 01-ABLAB | Telecom Plate, (1) RJ45 Cat 6, (1) RJ11 Cat 3 Phone | \$ 206 |
| Oasis Mini Power & Data 01-OASISMA, 01-OASISMB | 01-ABLAB102 | Telecom Plate, (1) RJ45 Cat 6, (1) RJ11 Cat 3, (1) USB W/72" Patch Cord | \$ 320 |
|  | 01-ABLBB | Telecom Plate, (2) RJ45 Cat 6, (1) RJ11 Cat 3 Phone | \$ 320 |
| Interact Power & Data 01-INTERACTG2A, 01-INTERACTG2B | 01-ABLB | Telecom Plate, (1) RJ45 Cat 6 | \$ 149 |
|  | 01-ABLBBB | Telecom Plate, (2) RJ45 Cat 6 | \$ 260 |
| Worksurface Power Center 01-INTRFCIA, 01-INTRFCIB | 01-ABLBBB | Telecom Plate, (3) RJ45 Cat 6 | \$ 367 |
| | 01-ABLBBB | Telecom Plate, (4) RJ45 Cat 6 | \$ 476 |
| | 01-ABLBBBC51 | Telecom Plate, (2) RJ45 Cat 6, (1) 15 Pin HD VGA w/72" Patch Cord | \$ 446 |
| | 01-ABLBC51L | Telecom Plate, (1) RJ45 Cat 6, (1) Mini Stereo Inline, (1) 15 Pin HD VGA w/72" Patch Cord | \$ 410 |
| | 01-ABLC3811 | Telecom Plate, (1) RJ45 Cat 6 Data Inline, (1) RJ11 Cat 3 Phone Inline | \$ 197 |
| | 01-ABLC45 | Telecom Plate, (1) HDMI w/36" Patch Cord | \$ 295 |
| | 01-ABLC45C51L | Telecom Plate, (1) Mini Stereo Inline, (1) HDMI w/36" Patch Cord, (1) 15 Pin HD VGA w/72" Patch Cord | \$ 558 |
| | 01-ABLC51L | Telecom Plate, (1) 15 Pin HD VGA & (1) Mini Stereo Inline Jack | \$ 298 |
| | 01-ABLCRDM | Telecom Plate, (3) Cord Bushings | \$ 96 |





Surface Materials

Wood Finishes and Woodgrain, Solid, and 3D Laminates

| | | | | | |
|---|---|---|--|---|---|
|  |  |  |  |  |  |
| Aspen White (AWH) SQ1 | White Nebbia (WNB) TFL, HPL, Seating | Beigewood (BW) TFL, HPL, Seating* | Natural Beech (NB) SQ1 | Sugar Maple (SM) Veneer, TFL, HPL, Seating | Oak Riftwood (ORW) Veneer*, TFL, HPL, Seating* |
|  |  |  |  |  |  |
| Kirsche (KHE) TFL, HPL, Seating | Fawn Oak (FO) Veneer*, Seating* | Truffle Rain (TR) SQ1 | River Cherry (RC) TFL, HPL, Seating* | Mesa Sunset (MAS) Veneer*, Seating* | Natural Marrone (NTM) TFL, HPL, Seating* |
|  |  |  |  |  |  |
| Studio Teak (TK) TFL, HPL, Seating | Pinnacle Walnut (PNW) Veneer, TFL, HPL, Seating | Harvest Maple (HVM) TFL, HPL, Seating* | Golden Cherry (GC) Veneer, TFL, HPL, Seating | Legacy Walnut (LW) Veneer, Seating | Artisan Walnut (AW) Veneer, Seating |
|  |  |  |  |  |  |
| Orchard (OR) SQ1 | Shaker Cherry (SKC) Veneer, TFL, HPL, Seating | Select Cherry (SCH) Veneer, TFL, HPL, Seating | Williamsburg Cherry (WC) Veneer, TFL, HPL, Seating | Harvest Walnut (HW) Veneer, Seating | Dark Cherry (DC) Veneer, Seating |
|  |  |  |  |  |  |
| Mahogany Walnut (MW) Veneer, TFL, HPL, Seating | Henna Walnut (HNW) Veneer, Seating | Columbian Walnut (CO) Veneer, TFL, HPL, Seating | Sepia Walnut (SPW) TFL, HPL, Seating* | Florence Walnut (FLW) TFL, HPL, Seating* | Dark Forest Walnut (DFW) Veneer, Seating* |
|  |  |  |  |  |  |
| Ember Gray (EG) SQ1 | Espresso (EW/EF) Veneer, TFL, HPL, Seating | Portico Teak (PTK) TFL, HPL, Seating* | Weathered Ash (WTA) Veneer*, TFL, HPL, Seating* | Smoky Brown Pear (SBP) TFL, HPL, Seating* | Asian Night (AS) Veneer, TFL, HPL, Seating |
|  |  |  |  |  |  |
| Midnight Run (MNR) TFL, HPL, Seating | Metropolis Sky (MTS) Veneer, Seating | Designer White (WH) TFL, HPL, Seating | Fashion Grey (FHG) TFL, HPL | Slate Grey (SG) TFL, HPL | Black (BL) TFL, HPL, Seating |
|  |  |  |  |  |  |
| Matte White (WH3) 3D Laminate (Iconic Only) | Concrete (CR3) 3D Laminate (Iconic Only) | Matte Black (BL3) 3D Laminate (Iconic Only) | Blush (BSH) HPL Accent (Iconic+Plush Only) | First Kiss (FK) HPL Accent (Iconic+Plush Only) | Surfin USA (SUS) HPL Accent (Iconic+Plush Only) |
|  | | | | | |
| Summer Vacation (SV) HPL Accent (Iconic+Plush Only) | | | | | |

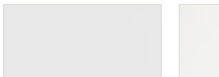
* Finish is Low Sheen









Frosted & High Gloss Acrylics

| | | | | |
|---|---|---|--|---|
|  |  |  |  |  |
| Frosted (FSTA) | White (WHA) | Wired Mercury (WMA) | Graphite (GPA) | Black (BLA) |



Solid Surfaces

| | | | | | |
|---|---|---|--|---|---|
|  |  |  |  |  |  |
| Snow White (SNW) | Pebble Beach (PE) | Sedona (SE) | Arroyo (AR) | Tundra (TN) | Starry Night (SN) |

Metal Options

| | | | | |
|---|---|---|--|---|
|  |  |  |  |  |
| Snow (SNOW) | Oyster White (OYST) | Sugar Cookie (SUGC) | Aluminum (ALUM) | Chrome (CHRM) |
|  |  |  |  | |
| Gold (GOLD) | Platinum (PLAT) | Mist (MIST) | Black (BLK) | |

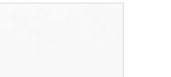
Glass Options

| | |
|---|---|
|  |  |
| Gloss White (GWHG) (Catalyst + Strut) | Acid Etched White (GWAH) (Catalyst + Strut) |
|  |  |
| Gloss Black (GBLG) (Catalyst + Strut) | Acid Etched Black (GBLA) (Catalyst + Strut) |

Colors represented are high-resolution reproductions and may vary slightly from the actual product. To order samples, please contact our Customer Service team or order online at www.indianafurniture.com. Graining and finish colors may vary, yet will continue to complement, across Veneer, HPL, TFL, and Seating products due to the inherent differences of these materials.

Indiana[®] FURNITURE

1919 Hospitality Drive, Suite A
PO Box 270
Jasper, Indiana 47547-0270

Tel 812.482.5727

Toll 800.422.5727

Fax 812.482.9035

sales@indianafurniture.com

www.indianafurniture.com

Federal Classification: Small Business

©2024 Indiana Furniture 5/24

