

Indiana
FURNITURE

CASEGOODS + RECEPTION

PRICING EFFECTIVE MAY 13, 2024

Being over a century old hasn't slowed us down! Sure, we are still the reliable, ethical company that was born in southern Indiana, steeped in quality, craftsmanship, and service. But have you seen our latest introductions? We are making a splash with design and challenging the concept of modern offices. Go ahead. Take a look. You know you want to.

Our Pledge to People + Our Planet.

We've been making wood furniture longer than just about anyone...and we want to be doing so for a long time to come. That's a large part of why we take a stewardship approach to our resources. We believe that environmental sustainability and business profits need not be mutually exclusive. They can and should exist side by side in a mutually beneficial relationship. And for more than a century, we've been showing how it's done.

We've proven our commitment to a sustainable future by supporting the standards and programs that protect our home planet and human health. Whether it's local sourcing, reducing contaminants, implementing wellness and safety programs, or diverting waste from landfills, social responsibility is a part of every decision we make at Indiana Furniture.

One of the surest ways to reduce our impact on the planet is to make and buy things that last. And this one's a natural for us. Our products are made with craftsmanship and attention to detail that are a part of our more than a century-long legacy in wood manufacturing. And our products are backed by our 12-year warranty, which facilitates maintenance, servicing and reassembly.

All of our product lines:

- Are manufactured and assembled in the USA,
- Meet or exceed Indoor Air quality standards*,
- Meet or exceed BIFMA level® Sustainability standards and certification*,
- Conform to the BIFMA Compliance standards*,
- Comply with TSCA Title VI (CARB) standards,
- and can contribute to U.S. Green Building's LEED Program.

To learn more, simply go to www.IndianaFurniture.com/resources.



Ease of Specification

Whether you're looking to specify your office spaces or simply to visualize them in the options and surface materials you are desiring, we make it easy. You can find the entire Indiana Furniture portfolio on the following third-party, space-planning platforms.



* Recently launched or new products may still be in testing; Cush Pillows is currently not BIFMA Compliant due to no available compliance test.

<u>General Information + Conditions of Sale</u>	<u>2</u>
<u>Warranty</u>	<u>3</u>
<u>Casegoods</u>	<u>4</u>
<u>Arlington (2900 Series)</u>	<u>7</u>
<u>Canvas (6600/6800 Series)</u>	<u>47</u>
<u>Gesso (6500/6700 Series)</u>	<u>207</u>
<u>Iconic (5000 Series)</u>	<u>365</u>
<u>Jefferson (4600 Series)</u>	<u>411</u>
<u>Madera (1400/1600 Series)</u>	<u>461</u>
<u>Phoenix (2100 Series)</u>	<u>525</u>
<u>Reception</u>	<u>565</u>
<u>Aura (6200 Series)</u>	<u>567</u>
<u>Cameo (6100 Series)</u>	<u>581</u>
<u>Canvas (6400 Series)</u>	<u>591</u>
<u>Jefferson (4600 Series)</u>	<u>623</u>
<u>Accessories</u>	<u>635</u>

ORDERING INFORMATION

All orders should be emailed to neworders@indianafurniture.com.
Orders can be faxed to 812-482-9035 or mailed to:

Indiana Furniture
P.O. Box 270, 1919 Hospitality Dr., Ste. A
Jasper, IN 47547-0270

ORDER PROCEDURE

All orders must include purchase order number, billing address, ship-to address and phone number, and any special instructions.

When ordering casegoods or tables, give complete quantity, model number, finish and any other options.

When ordering seating, give complete quantity, model number, finish, fabric and any other options.

Within each series, an example of "How to Order" is illustrated at the beginning of each series section. For further clarification of order procedure, contact Customer Service.

PRICING

All prices shown are suggested retail prices F.O.B. Point of Origin, freight prepaid and allowed to one continental US destination. Prices, specifications and materials are subject to change without notice. Possession and/or distribution of this price list does not in itself constitute an offer to sell. Orders can be received only from authorized Indiana Furniture dealers. Orders will be billed at prices prevailing at time of shipment, unless acknowledged prior to the effective date of the price change, in which case billing will be at the price acknowledged.

ACKNOWLEDGMENT

All orders will be acknowledged promptly, showing how the order was entered, its approximate shipping date and other pertinent information. This acknowledgment is the final agreement between the customer and Indiana Furniture and is the exclusive statement of the terms thereof. Please examine this acknowledgment carefully and advise Indiana Furniture immediately of any discrepancies.
Note: Shipping fees will not be listed on the acknowledgment.

BUYER'S OBLIGATION: RIGHTS OF SELLER

If Indiana Furniture shall at any time doubt Buyer's financial responsibility, Indiana Furniture may decline to make shipments hereunder except upon receipt of cash payment in advance or security or other proof of responsibility satisfactory to Indiana Furniture. If buyer fails in any way to fulfill the terms and conditions set forth herein, Indiana Furniture may defer shipments until such default is corrected. Remedies provided herein shall be in addition to, and not in lieu of other remedies. Buyer agrees to abide by payment terms as listed on invoice. Buyer shall pay all reasonable costs and expenses, including attorney and collection fees, and late fees, incurred by Seller in connection with any amounts due for goods ordered.

CANCELLATIONS AND CHANGES

Due to immediate production on build-to-order items, all orders are considered firm and are not subject to cancellation or change without approval from Indiana Furniture. All approved changes are subject to additional charges and revised lead times.

PRODUCT DESIGN AND SPECIFICATION CHANGES

Indiana Furniture reserves the right to make changes in design and construction or discontinue products without prior notice.

REPAIR CHARGES

Indiana Furniture will only pay repair charges if Customer Service gives prior written authorization. No repair charge will be paid without advance approval at which time you will be issued a repair authorization number that will allow you to invoice Indiana Furniture for the completed work.

WAREHOUSE STORAGE CHARGES

If a shipment is held beyond 14 calendar days at your request, a **.084% per calendar day** (2.52% per month) storage charge will be assessed. The effective date will be 14 calendar days after the acknowledged ship date. Further, the prices applied to the order will be those in effect at the time of shipment.

DAMAGED MERCHANDISE

The consignee is responsible for filing claims with the carrier for damage and shortages. Claims for both obvious and concealed damage must be filed within 15 calendar days, and the damaged merchandise must not have been moved from the original receiving location. All damaged merchandise, including the cartons and packing materials, must be retained for inspection by either the carrier or by an Indiana Furniture Sales Representative. Indiana Furniture reserves the right to select the most cost effective way to repair or replace the damaged item. Once you have notified the carrier, please contact Customer Service for further assistance.

Obvious Damage/Missing Cartons — Do not refuse merchandise damaged in transit. Indiana Furniture recommends the consignee inspect all merchandise upon arrival. If a shipment is received damaged or short, note all information on carrier's copy and your copy of freight bill and delivery receipt. Notify the delivering carrier and file a claim immediately. Pending the results of your claim, either Indiana Furniture or the carrier will cover 100% of the cost to repair or replace the damaged or missing item.

Concealed Damage — If concealed damage is discovered, notify the delivering carrier at once and request an inspection. This must be done within 15 calendar days of delivery. If the carrier will not perform the inspection, you should prepare an affidavit that you contacted them, noting the time and date, and that they failed to comply with your request. This, along with the other papers in your possession, will support the claim. Pending the results of your claim, the cost to repair or replace the item will be covered 1/3 by the carrier and 2/3 by Indiana Furniture for shipments less than a full truckload and 100% by Indiana Furniture for shipments of full truck loads.

RETURN MERCHANDISE

Merchandise will not be accepted for return without a RGA (Return Goods Authorization) issued by Indiana Furniture. We will consider issuing RGAs for the following reasons:

1. Manufacturing defect (inspected by Indiana Furniture representative)
2. Indiana Furniture order processing error
3. Shipping error
4. Mis-marked cartons
5. Duplicated shipments

If you have any questions as to whether your reason for return qualifies for consideration, please contact your Customer Service Representative. Merchandise must be returned within 60 days of the RGA issued date, or within 60 days upon receipt of replacement product to receive credit. Returns due to mis-marked cartons must also be returned in the original cartoning, with shipping labels intact, to receive credit.

All merchandise being returned must be properly packed and protected to ensure no further damage is incurred during transportation back to an Indiana Furniture facility. Upon receipt, all returned merchandise will be thoroughly inspected and the results compared to the reason for return stated on the RGA. Any discrepancies, such as additional damage, signs of usage, missing parts, etc., will result in an adjustment to the amount of credit issued.

DELIVERY AND FREIGHT CHARGES

All shipments are F.O.B. Point of Origin, Jasper, IN, freight prepaid and allowed dock to dock on 53' trailer. Ownership and responsibility of the merchandise becomes that of the buyer upon delivery to the freight company. Shipments into Alaska, Hawaii, Canada, Mexico, Puerto Rico and other exports are freight prepaid and allowed to port of exit.

Indiana Furniture reserves the right to select the most appropriate carrier and routing on all shipments. Indiana Furniture will attempt to accommodate requests for favored carriers and delivery times. Deliveries requested Monday through Thursday, after 3pm, will be assessed a \$300 per truck after hours fee. Deliveries requested after 3pm on Friday or on weekends, will be assessed a \$600 per truck weekend delivery fee.

Inside delivery and installation services are not included in the pricing shown. Any deviation from dock-to-dock delivery, such as but not limited to, non-dock, residential, or inside delivery must be specified on the order. Should these services be requested or required, all charges incurred will be charged to the "Sold To" of the order.

Shipments totaling less than \$3000 (net value, product only) will be assessed a small order fee of \$300 net per shipment. This fee will be reduced for items shipped via small package carriers. For order shipments of \$100 or less, shipped by small package carrier, the fee is \$18. For order shipments over \$100, shipped by small package carrier, the fee is \$40. All shipping fees will be added at the time of invoicing.

BIFMA AND ANSI TESTING

Indiana Furniture is a member of the Business and Institutional Furniture Manufacturer's Association (BIFMA). Tests developed by the BIFMA and approved by the American National Standards Institute (ANSI) determine the strength and durability of casegoods and seating in its everyday use. Although this testing does not serve as a warranty or guarantee, Indiana Furniture products within this price list have been tested by an independent verifying body and meet or exceed applicable BIFMA and ANSI standards.

Subject to the limitations set forth in this warranty, Indiana Furniture Industries, Inc. (“**Indiana Furniture**”) warrants to the original purchaser all product in this price list (“**Product**”) to be free from defects in material and workmanship given normal use for a 12-year period from the date of manufacture. During the applicable warranty period, Indiana Furniture, as its sole obligation, will repair or replace (in Indiana Furniture’s sole discretion) any Product, part, or component covered by this warranty and sold after May 13, 2024, which fails under normal use as a result of a defect in material or workmanship. Normal use is defined as the equivalent of a single shift, 40-hour work week. Indiana Furniture will repair or replace the defective Product, part, or component with a comparable Product, part, or component.

Warranty periods are limited for certain Products and parts as follows:

12-year Warranty (from the date of manufacture)

- Seating Mechanisms
- Veneers
- Laminates
- Casters and Glides

7-year Warranty (from the date of shipment)

- Pneumatic Table Lift
- Electric Table Lift

5-year Warranty (from the date of manufacture)

- Triple Play Series
- Electrical Components
- Pneumatic Cylinders
- Textiles, Foam, and Decorative Trim
- Swivel Arm Pads
- Keyboard Kits
- Lighting
- All Height Adjustable Mechanisms

3-year Warranty (from date of shipment)

- Dock 950 Wireless Charger
- Dock 150 Wireless and USB Charger

THIS WARRANTY DOES NOT COVER:

- Damage caused by a carrier or third party
- Normal or routine wear and tear
- Appearance, durability, quality, behavior, colorfastness, or any other attribute of customer’s own materials or any non-standard Indiana Furniture material (including CF Stinson, Maharam, Momentum, Mayer, UltraFabrics, Architex, and other alliance programs) specified by the customer and applied to a Product
- Color, grain or texture of wood, laminate and other covering materials
- Changes in wood or fabric color due to aging or exposure to light

As the manufacturer of the Product, Indiana Furniture stands behind its craftsmanship and pledges to do everything it can to reasonably resolve, as quickly as possible, any problems you may have with the Product within the terms and conditions of this warranty.

If you encounter a defect covered by the foregoing warranty, contact the dealer from whom you purchased the Product. If the dealer is unable to resolve your warranty issues, you should contact Indiana Furniture. Please ensure that you have all of the pertinent facts when contacting the dealer or Indiana Furniture, including the model number and factory order number from the inspection label attached to the Product.

INDIANA FURNITURE IS NOT PROVIDING, AND SPECIFICALLY DISCLAIMS, ANY OTHER WARRANTIES FOR THE PRODUCTS, EXPRESS OR IMPLIED, INCLUDING ANY IMPLIED WARRANTY OF MERCHANTABILITY OR FITNESS FOR A PARTICULAR PURPOSE. INDIANA FURNITURE SHALL NOT BE LIABLE TO THE PURCHASER OR ANY THIRD PARTY FOR CONSEQUENTIAL, INCIDENTAL, INDIRECT, OR SPECIAL DAMAGES, INCLUDING, WITHOUT LIMITATION, DAMAGES ARISING OUT OF OR RESULTING IN ANY MALFUNCTIONS, DELAYS, LOSS OF PROFIT, INTERRUPTION OF BUSINESS, PERSONAL INJURY, BODILY INJURY, DEATH, DISMEMBERMENT, OR PROPERTY DAMAGE.

Indiana Furniture Industries, Inc.
Attn: Customer Service
1919 Hospitality Dr., Ste A
P.O. Box 270
Jasper, Indiana
47547-0270
800.422.5727
Fax 812.482.9035
custserv@indianafurniture.com

Casegoods

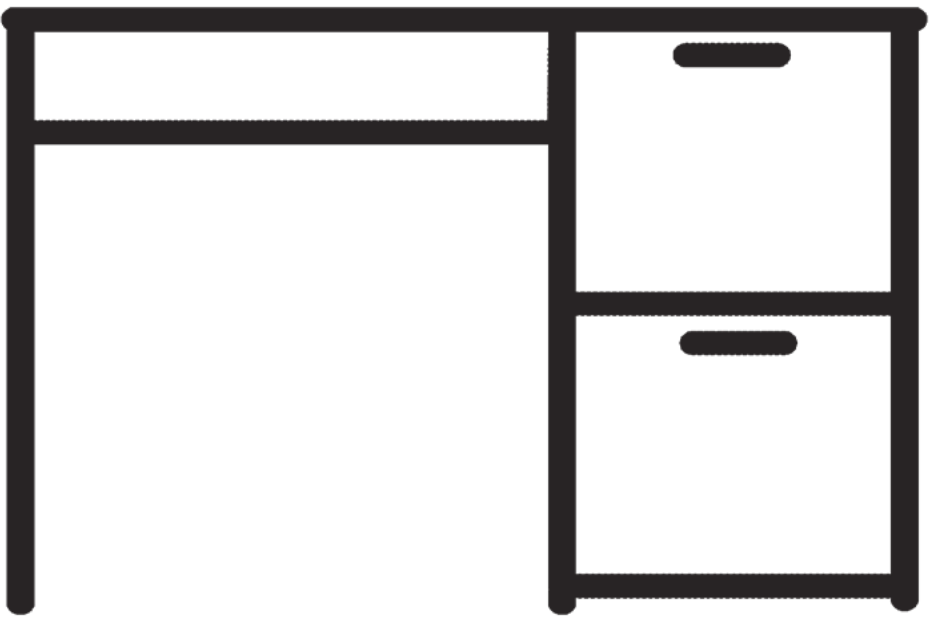

Arlington ensures quality and expert craftsmanship with a selection of configurations for today's functional workspaces including new Height Adjustable options. Providing all the grace and embellishments associated with traditional styling, Arlington features multiple worksurface materials and hand placed decorative and base molding to create a value driven collection with high end elegance.

CONSTRUCTION

Arlington features a Veneer chassis with your choice of a Veneer or HPL top. Units ship assembled unless otherwise noted.

VENEER

- Exposed surfaces feature select grade, plain sliced American Black Walnut or Cherry veneers, carefully selected and matched to assure proper balance and consistency

TOPS

- Veneer tops are 5-ply balanced construction and 1 3/16" thick with solid hardwood rims with butt corners
- High Pressure Laminate (HPL) tops are 3-ply balanced construction and 1 3/16" thick with solid hardwood rims with butt corners
- Grain direction runs left to right unless noted

CHASSIS

- Chassis is securely fastened using high quality European fastening systems and heavy-duty, 16-gauge joining brackets to assure maximum strength
- All units ship with heavy-duty, adjustable leveling glides to ensure proper leveling and compensation for uneven floors
- Bases are solid hardwood with mitered corners
- Construction offers tight tolerances and long term durability
- Vertical grain direction on chassis

DRAWERS

- Drawer fronts standard with matched veneer faces
- Drawer sides, back and front are woodgrain vinyl-wrapped, and are 1/2" thick
- 5-sided drawer construction for easy removal of drawer fronts
- Box and file drawers are tested for 100lb capacity
- Lateral files feature 1/4" thick bottoms. Drawers are tested for 200lb of equally distributed weight (ex: hanging file folders) and 65lbs of bottom load weight (ex: stacked catalogs)
- All drawers feature full extension, progressive action slides with precision steel ball bearings
- All suspensions have a limited lifetime warranty

FILING

- All file drawers are standard with filing systems designed to accommodate a variety of filing requirements
- Letter width file drawers provide letter filing front to back and legal filing side to side
- Lateral file drawers provide legal or letter filing front to back or side to side

STORAGE

- All hinged doors include soft close hinges, unless noted
- One piece hinge and base plate combination
- Soft close hinges reduce stress placed on the cabinet when the door is closed and offers a quiet closure

LOCKING

- Central locking is standard on all desks and optional for credenzas and returns; one key in the lock cylinder locks all drawers in the desk
- Lock core available in black or silver and will coordinate with pull selection; [See option details](#)
- Removable lock cylinders allow for units to be re-keyed at a later date if required

LOCKING CON'T

- Units are shipped randomly keyed as standard. Keyed alike units available upon request at no additional charge

CORD MANAGEMENT

- Grommets are standard in back panels of returns, bridge units, credenzas, and hutch units
- Grommets may be ordered in the tops of desks, returns, bridge units, and credenzas
- Grommets are 2 3/8" in diameter and available in black or silver, please specify color
- [See all grommet options and locations](#)
- Undersurface Wire Manager (O1-WMGR4) is available for additional cord management; See Accessories

HEIGHT ADJUSTABILITY

- Electric-powered height adjustable mechanisms are offered in 2-channel for single surface height adjustment and 3-channel for simultaneous, two surface height adjustment
- Height adjustable legs available in black finish only
- Height adjustment range 30"H to 45"H
- 5-year warranty
- Recommended load capacity of 180lbs
- Two control switches are available, including an up/down switch (standard with product, unless noted) and an advanced switch with Bluetooth capabilities, position memory, three stand up reminder intervals, and more; gently adjust worksurface with a one second stop at each memory position
- The standard control switch is factory installed on all units except bridges and 3-channel units
- Bridges and returns will not have a standard grommet on the back panel
- New wire management mesh wrap included when worksurface grommet is selected
- Grommets and one wire management channel provided within kneespace to manage wires from switch and control box; two wire management channels will be shipped with desk shells

INTERIOR DRAWER DIMENSIONS

Models

29-3672DP	29-3072DP	29-3066DP	29-3066DPSTS
29-3672DPSTS	29-3072DPSTS		

Drawers

	W	L	D
Box	12 3/8"	19 1/2"	3 21/32"
File	12 3/8"	19 1/2"	8 29/32"
Center	29 5/8"	19 1/2"	1 29/32"

Models

29-3672LP	29-3672RP	29-3072LP	29-3072RP
29-3672LPSTS	29-3672RPSTS	29-3072LPSTS	29-3072RPSTS

Drawers

	W	L	D
Box	12 3/8"	19 1/2"	3 21/32"
File	12 3/8"	19 1/2"	8 29/32"
Center	27 5/8"	19 1/2"	1 29/32"

INTERIOR DRAWER DIMENSIONS (CONTINUED)

Models			
29-3066LP	29-3066RP	29-3066LPSTS	29-3066RPSTS

Drawers	W	L	D
Box	12 ³ / ₈ "	19 ⁹ / ₃₂ "	3 ²¹ / ₃₂ "
File	12 ³ / ₈ "	19 ⁹ / ₃₂ "	8 ²⁹ / ₃₂ "
Center	21 ¹ / ₈ "	19 ⁹ / ₃₂ "	1 ²⁹ / ₃₂ "

Models			
29-3060DP	29-3060DPSTS		

Drawers	W	L	D
Box	12 ³ / ₈ "	19 ⁹ / ₃₂ "	3 ²¹ / ₃₂ "
File	12 ³ / ₈ "	19 ⁹ / ₃₂ "	8 ²⁹ / ₃₂ "
Center	23 ⁵ / ₈ "	19 ⁹ / ₃₂ "	1 ²⁹ / ₃₂ "

Models			
29-3060LP	29-3060RP	29-3060LPSTS	29-3060RPSTS

Drawers	W	L	D
Box	12 ³ / ₈ "	19 ⁹ / ₃₂ "	3 ²¹ / ₃₂ "
File	12 ³ / ₈ "	19 ⁹ / ₃₂ "	8 ²⁹ / ₃₂ "
Center	18 ⁵ / ₈ "	19 ⁹ / ₃₂ "	1 ²⁹ / ₃₂ "

Models			
29-2448LF	29-2448RF	29-2442LF	29-2442RF
29-2448LFSTS	29-2448RFSTS	29-2442LFSTS	29-2442RFSTS

Drawers	W	L	D
Box	12 ³ / ₈ "	16 ⁵ / ₃₂ "	3 ²¹ / ₃₂ "
File	12 ³ / ₈ "	16 ⁵ / ₃₂ "	8 ²⁹ / ₃₂ "

Models			
29-2448LF2	29-2448RF2	29-2442LF2	29-2442RF2
29-2448LF2STS	29-2448RF2STS	29-2442LF2STS	29-2442RF2STS
29-2448LF2SR	29-2448RF2SR	29-2442LF2SR	29-2442RF2SR

Drawers	W	L	D
File	12 ³ / ₈ "	16 ⁵ / ₃₂ "	8 ²⁹ / ₃₂ "

Models			
29-2448LF2STS3	29-2448RF2STS3	29-2442LF2STS3	
29-2442RF2STS3			

Drawers	W	L	D
File	12 ³ / ₈ "	12 ⁷ / ₈ "	8 ²⁹ / ₃₂ "

Models			
29-2072SC	29-2072KC	29-2072LC	29-2072RC
29-2066SC	29-2066KC	29-2066LC	29-2066RC
29-2060LC	29-2060RC	29-2060KC	

Drawers	W	L	D
Box	15 ³ / ₈ "	16 ⁵ / ₃₂ "	3 ²¹ / ₃₂ "
File	15 ³ / ₈ "	16 ⁵ / ₃₂ "	8 ²⁹ / ₃₂ "

Models			
29-2072LC2	29-2072RC2	29-2066LC2	29-2066RC2
29-2060LC2	29-2060RC2		

Drawers	W	L	D
File	15 ³ / ₈ "	16 ⁵ / ₃₂ "	8 ²⁹ / ₃₂ "

Models			
29-2036L4	29-2036L2	29-2072DL	29-2072LL
29-2072RL			

Drawers	W	L	D
File	30 ³ / ₄ "	16 ⁵ / ₃₂ "	8 ¹³ / ₃₂ "

Models			
29-2448LP	29-2448RP		

Drawers	W	L	D
Box	12 ³ / ₈ "	19 ⁹ / ₃₂ "	3 ²¹ / ₃₂ "
File	12 ³ / ₈ "	19 ⁹ / ₃₂ "	8 ²⁹ / ₃₂ "

FILING CAPABILITIES

Drawers with Dimensions: 12³/₈"W x 12⁷/₈"L

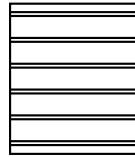

Letter Front to Back

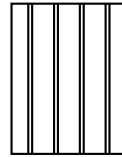

Legal Side to Side

Drawers with Dimensions: 12³/₈"W x 19⁹/₃₂"L



Letter Front to Back

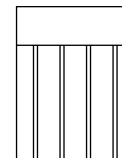

Legal Side to Side

Drawers with Dimensions: 12³/₈"W x 16⁵/₃₂"L

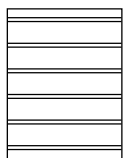

Letter Front to Back

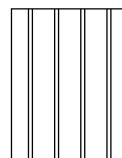

Legal Side to Side

FILING CAPABILITIES (CONTINUED)

Drawers with Dimensions: 15³/₈"W x 16⁵/₂"L

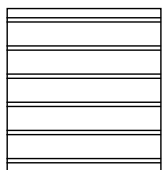

Legal Front to Back

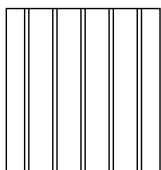

Legal Side to Side

Drawers with Dimensions: 30³/₄"W x 16⁵/₂"L

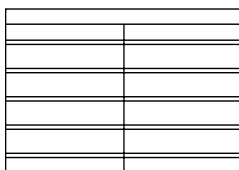

2 Rows Letter Front to Back

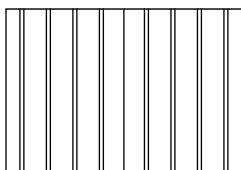

1 Row Letter or Legal Side to Side

HOW TO ORDER EXAMPLES

Model No.	Description	Example
29-3672DP	Top Material	W
	Finish	CO
	Base Molding	BM3600
	Decorative Molding	M3600
	Pull	ARA
	Drawer Construction	STD
	Surface Grommet Location/Color	GC, BLK
29-2448LF	Top Material	HPL
	Finish	CO
	Base Molding	BM2900
	Decorative Molding	-
	Pull	ARA
	Locking	LKT
	Drawer Construction	DOVE
	Surface Grommet Location	GR
	Back Panel Grommet Grommet Color	YES BLK
29-1572HU	Finish	CO
	Door Pull	ARA
	Locking	NO
	Tackboard	Momentum/Marathon/Caravel
	Tasklight	TL-0848
	Grommets/Color	WMHU, BLK

VENEER (W) OPTIONS

Veneer features UVAdvantage, an ultra-violet finish, on all exposed surfaces by utilizing roll-coat UV technology.

AW	Artisan Walnut	HW	Harvest Walnut
CO	Columbian Walnut	LW	Legacy Walnut
DC	Dark Cherry	MW	Mahogany Walnut
DFW	Dark Forest Walnut	PNW	Pinnacle Walnut
EW	Espresso	SCH	Select Cherry
GC	Golden Cherry	SKC	Shaker Cherry
HNW	Henna Walnut	WC	Williamsburg Cherry

HPL (P) TOP OPTIONS

WOODGRAIN

CO	Columbian Walnut	PNW	Pinnacle Walnut
EF	Espresso	SCH	Select Cherry
GC	Golden Cherry	SKC	Shaker Cherry
MW	Mahogany Walnut	WC	Williamsburg Cherry

EDGE PROFILES

R Arlington



MOLDING LOCATIONS AND OPTIONS

Styles of Base Molding and Decorative Molding cannot be intermixed. For example, when Arlington Base Molding is selected, only the Arlington Decorative may be ordered, while Wilmington Base Molding must also be ordered with Wilmington Decorative Molding.

Base Molding

Arlington and Wilmington Base Molding are skillfully applied on the approach, sides, and user side of Desks and Returns. Lateral Files and Credenzas feature molding on front and both sides with no molding on back for flush wall applications. Bridges will feature molding on approach. Storage Cabinets, Bookcases and Wardrobe/Storage Cabinets will feature base molding on front of unit only.

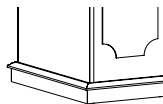

Arlington Base Molding



Wilmington Base Molding

Decorative Molding

Units come standard with no decorative molding. See below for details and locations of optional Arlington or Wilmington Decorative Molding. See next page for ordering options and pricing.

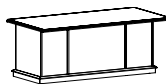

No Decorative Molding Standard

See next page for additional molding information

MOLDING LOCATIONS AND OPTIONS CONTINUED

Arlington Decorative Molding will be featured on the approach side of Desks only and is not available on Bridges, Returns, Lateral Files, and Credenzas.

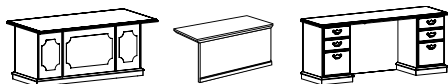

Arlington Molding

Wilmington Decorative Molding will be on the approach and sides of Desks. Returns and Bridges will have decorative molding on the approach side. Credenzas will feature decorative molding on left and right sides only

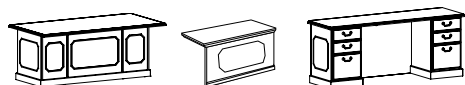

Wilmington Molding

Surface Mount Hutches, Wall Mount Hutches, Freestanding Bookcases, and Surface Mount Bookcases have no decorative molding. See next page for ordering options and pricing.

Molding selection must be specified on order. *Note: Base and Decorative Molding feature multi-step, hand-finished catalyzed finish*

Arlington Molding

BM2900	Arlington Base Molding	\$	N/C
M2900	Optional Arlington Decorative Molding	\$	83

Wilmington Molding

BM3600	Wilmington Base Molding	\$	N/C
M3600	Optional Wilmington Decorative Molding	\$	139

DRAWER AND DOOR PULL OPTIONS

Units with doors and drawers will feature coordinating pulls however door and drawer pulls cannot be intermixed.

ARA	Arlington A, Antique Brass	JEF	Jefferson, Antique Brass
ARB	Arlington B, Antique Brass	ALB	Liberty, Aluminum
WLM	Wilmington, Antique Brass		



Arlington A (ARA)
Antique Brass - 5 1/4"



Arlington B (ARB)
Antique Brass - 5 1/4"



Jefferson (JEF)
Antique Brass - 5 1/4"



Wilmington (WLM)
Antique Brass - 5 1/4"



Liberty (ALB)
Aluminum - 4 1/4"

LOCK CORE OPTIONS

Lock core will be black if Arlington, Wilmington or Jefferson pulls are selected. Lock core will be silver if Liberty Pulls are selected.

BLK	Black	SLV	Silver
-----	-------	-----	--------



Black (BLK)

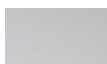

Silver (SLV)

LOCKING PEDESTALS ON RETURNS/CREDENZAS

Locking doors and drawers are available on returns and credenzas. Please specify applicable code on order with model/unit and add upcharge.

LKT-P	Single Pedestal or Return Lock	\$	205
-------	--------------------------------	----	-----

Lock positioned in drawer face nearest the kneespace

LKT-P	Double Pedestal Credenza Lock	\$	410
-------	-------------------------------	----	-----

Lock positioned in drawer face nearest the kneespace or in drawer face nearest to doors on Storage Credenzas

LKT-HU	Double Pedestal and Double Door Credenza Locking	\$	492
--------	--	----	-----

Drawer lock is positioned in drawer face nearest to doors and door lock is in top right corner of left door.

LOCKING DOORS

Locking is available on select doors. You must specify LKT_HU when ordering and add upcharge.

LKT_HU	72"W to 48"W Units	\$	115
LKT_HU	42"W to 24"W Units	\$	91
LKT_HU	18"W Units	\$	69

DRAWER OPTIONS

Units with drawers come standard with woodgrain vinyl-wrapped drawers with mitered corners. Optional dove tail construction for all center, box, file, and lateral file drawers is available. Must specify when ordering.

Pricing is per Drawer, not per Model/Unit.

MITER	Mitered Fold Construction		STD
DOVE	Wood Dove Tail Construction	\$	45

HEIGHT ADJUST LEG CONFIGURATION

The 2-channel leg configuration is standard on height adjustable Desks, Returns, and Bridges for one height adjustable worksurface. Desk models offer an optional 3-channel leg configuration for use with 3-channel Return to allow two worksurfaces to raise and lower simultaneously.

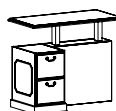

2-Channel Configuration

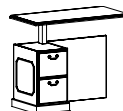

3-Channel Configuration

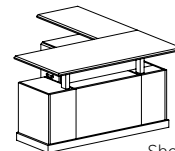

Shown with 3-Channel Configuration on Desk and Return

STS2	2-Channel Configuration (For one height adjustable worksurface)		STD
STS3	3-Channel Configuration (For two height adjustable worksurfaces)		N/C

HEIGHT ADJUSTABLE CONTROL OPTIONS

Height adjustable units offer two switch options. The standard switch is a simple up and down switch to move your worksurface from seated to standing height. This comes standard with height adjustable units, unless otherwise noted. The advanced switch features Bluetooth capabilities to connect to smart devices, three stand-up reminder intervals, height adjustment memory positions, and more.

Please specify desired Control Switch when ordering applicable Height Adjustable units.

SWCH	Standard Up/Down Switch	\$	STD
MSWCH	Advanced Up/Down with Memory Switch	\$	135



SWCH (standard)

MSWCH

GROMMET OPTIONS & LOCATIONS

GC	Grommet, Center - Specify BLK or SLV	\$	52
GL	Grommet, Left - Specify BLK or SLV	\$	52
GR	Grommet, Right - Specify BLK or SLV	\$	52

Verify Grommet Option is available on the model(s) you are specifying using the following location information. Grommets may be ordered in non-standard locations. Call Customer Service to assist with specification. Note additional charges and lead times may apply.

Multiple locations may be selected.

Models

29-3672DP	29-3672LP	29-3672RP	29-3072DP
29-3072LP	29-3072RP	29-3672WT	

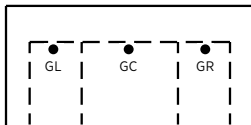

GL/GR: Located 12" from ends and 23" from user side

GC: Located 23" from user side

Models

29-3066DP	29-3066LP	29-3066RP
-----------	-----------	-----------

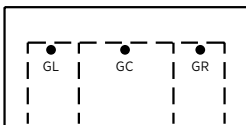

GL/GR: Located 9" from ends and 23" from user side

GC: Located 23" from user side

Models

29-3060DP	29-3060LP	29-3060RP	29-3060WT
-----------	-----------	-----------	-----------

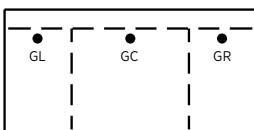

GL/GR: Located 9" from ends and 23" from user side

GC: Located 23" from user side

GROMMET OPTIONS & LOCATIONS (CONTINUED)

Models

29-2448UF	29-2448UFH	29-2442UF	29-2442UFH
-----------	------------	-----------	------------

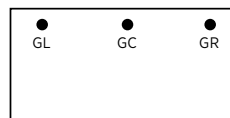

GL/GR: Located 4" from ends and 19½" from user side

GC: Located 19½" from user side

Models

29-2448LF2	29-2448RF2	29-2448LF	29-2448RF
29-2448LP	29-2448RP		

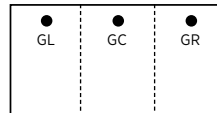

GL/GR: Located 5" from ends and 20" from user side

GC: Located 20" from user side

Models

29-2442LF2	29-2442RF2	29-2442LF	29-2442RF
------------	------------	-----------	-----------

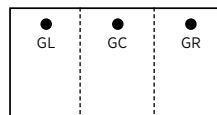

GL/GR: Located 5" from ends and 17" from user side

GC: Located 17" from user side

Models

29-2072KC	29-2072LC	29-2072RC	29-2072LL*
29-2072RL*	29-2072LC2	29-2072RC2	29-2066KC
29-2066LC	29-2066RC	29-2066LC2	29-2066RC2
29-2060KC	29-2060LC	29-2060RC	29-2060LC2
29-2060RC2			

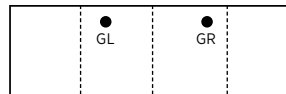

GL/GR: Located 22½" from ends and 17½" from user side

* Grommets are only available on opposite side of pedestal

WORKSURFACE GROMMETS FOR HEIGHT ADJUSTABILITY UNITS

When you select a grommet for use with Height Adjustable worksurfaces, it will automatically come with a wire management sleeve. One grommet per worksurface. Must specify Left, Right, or Center. See below for specific location availability by model. You may also choose to add the Wire Management Box, which will automatically come with a center grommet.

Grommet with Mesh Wire Management Sleeve \$ 142
Specify Black (BLK) or Silver (SLV) and Location

HA Desks>Returns	Choose Left, Right, or Center (See Below)
HA Bridges	Center Only

GC-MESH	Grommet, Center
GL-MESH	Grommet, Left
GR-MESH	Grommet, Right
GCKS-MESH	Grommet, Centered Between Legs



Black wire management mesh sleeve

Wire Management Box with Center Grommet \$ 485

Available on All HA Desks, Returns and Bridges

GC-BOX	Grommet, Center; Specify Black (BLK) or Silver (SLV)
--------	--

See next page for additional grommet information.

WORKSURFACE GROMMETS FOR HEIGHT ADJUSTABILITY UNITS (CONT'D)

Verify Grommet Option is available on the model(s) you are specifying using the following location information.

Grommets may be ordered in non-standard locations. Call Customer Service to assist with specification. Note additional charges and lead times may apply.

Models

29-3672DPSTS 29-3072DPSTS

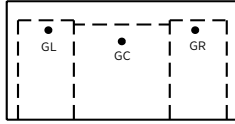

GL or GR: Located 9" from ends and 22½" from user side
GC: Located 20" from user side

Models

29-3066DPSTS 29-3060DPSTS 29-3672LPSTS 29-3672RPSTS
29-3072LPSTS 29-3072RPSTS 29-3066LPSTS 29-3066RPSTS
29-3060LPSTS 29-3060RPSTS

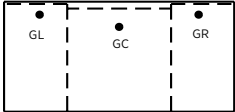

GL or GR: Located 6" from ends and 22½" from user side
GC: Located 20" from user side

Models

29-2448LF2STS 29-2448RF2STS 29-2448LFSTS 29-2448RFSTS
29-2448LP 29-2448RP

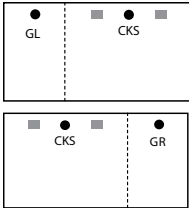

GL or GR: Located 6" from ends and 20" from user side
CKS: Located 18" from user side

Models

29-2442LF2STS3 29-2442RF2STS3
29-2442LFSTS3 29-2442RFSTS3

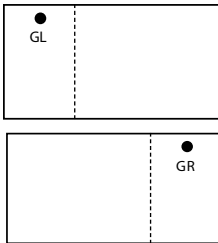

Grommet with Mesh Wire Management Sleeve only available in ped space

GL-MESH or GR-MESH: Located 6" from ends and 20" from user side

Models

29-2448SUFL 29-2448SUFR 29-2442SUFL 29-2442SUFR

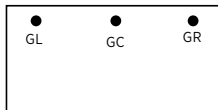

GL/GR: Located 4" from ends and 20" from user side
GC: Located 20" from user side

Models

29-2448UFSTS 29-2442UFSTS 29-2448UFSTSL3
29-2448UFSTSR3 29-2442UFSTSL3 29-2442UFSTSR3

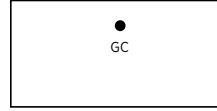

GC: Located 18" from user side

HUTCH GROMMET OPTIONS

Surface Mount Hutches come standard with one center grommet at workstation level on back panel. Three upper wire management grommets also are available. One grommet located on right, center and left. Must specify with color selection.

WMHUBL Black Lower Grommet + Three Upper Grommets N/C
WMHUSV Silver Lower Grommet + Three Upper Grommets N/C

CONFERENCE AND MEETING TABLE GROMMET OPTIONS

Arlington Meeting and Conference Tables offer power and grommet locations at multiple locations.

Must Specify Black (BLK) or Silver (SLV)

Grommet Locations

OC On Center CL 5½" Left of Center
EL 24½" from Left End CR 5½" Right of Center
ER 24½" from Right End BB Centered Between Bases

Location Availability by Top Size

96"W Tops OC, EL+ER
120"W Tops BB, CL, CR, CL+EL+ER, CR+EL+ER
144"W Tops BB, CL, CR, CL+CR, EL+ER, CL+EL+ER, CR+EL+ER

CERTIFICATIONS & COMPLIANCE

- Intertek Sustainability Certified
- BIFMA level® Certified
- BIFMA Compliant® Certified
- TSCA Title VI (formerly CARB) Compliance
- US Green Building's LEED® Contribution

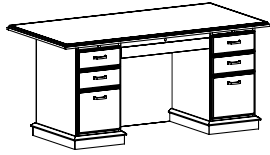

Double Ped Desks
(See Multiple Unit Details)

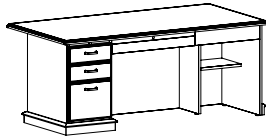

Single Ped Desks
(See Multiple Unit Details)

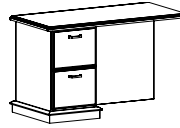

Returns
(See Multiple Unit Details)



Bridges
(See Multiple Unit Details)

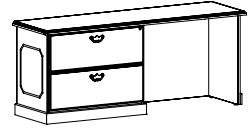

Kneespace, Storage, and Single Ped Credenzas
(See Multiple Unit Details)

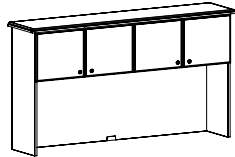

Surface Mount and Wall Mount Hutches
(See Multiple Unit Details)

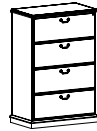

Filing
(See Multiple Unit Details)

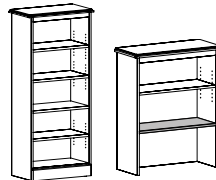

Bookcases
(See Multiple Unit Details)

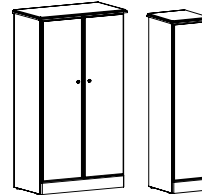

Wardrobe/Storage
(See Multiple Unit Details)

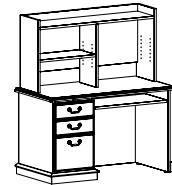

Computer Desks with Hutches
(See Multiple Unit Details)

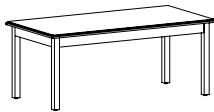

Work Tables
(See Details)

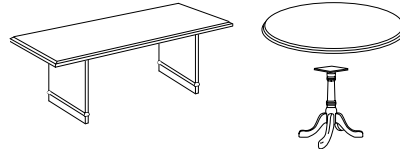

Conference and Round Tables
(See Multiple Unit Details)

Occasional Tables

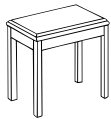

End Tables
(See Details)

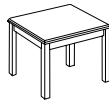

Lamp Tables
(See Details)

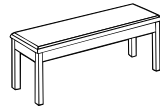

Magazine Tables
(See Details)

Height Adjustable (HA) Units

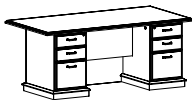

HA Double Ped Desks
(See Details)

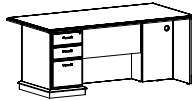

HA Single Ped Desks
(See Details)



HA & Stationary Returns
(See Multiple Unit Details)

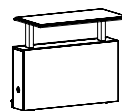

HA Bridges
(See Multiple Unit Details)

Tackboards + Tasklights

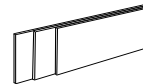

Tackboards
(See Details)



Tasklights
(See Details)

Accessories

Keyboard Accessories *(See Details)*

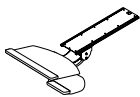

Power Options *(See Multiple Unit Details)*

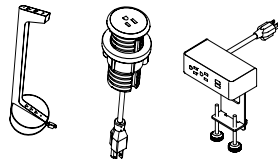

Accessories and Wire Management
(See Multiple Unit Details)

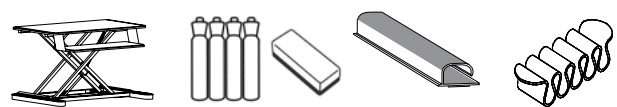

Item	Model No.	Width	Depth	Height	Ship Wt	Cubic Ft	List Price
L UNIT	29-1	72	84	30	440	73.3	P\$ 6802 W\$ 7474

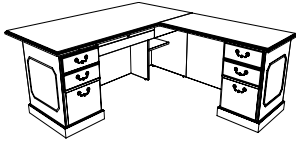

Shown with Wilmington Base and Decorative Molding

CONSIST OF:	QTY			
29-3672LP	1	Single Ped Desk, Left	P\$ 3945 W\$ 4349	
29-2448RF	1	Return, Right	P\$ 2857 W\$ 3125	

Products are available as left or right, where applicable
List prices do not include optional Wilmington decorative molding

U UNIT	29-3	72	104	30	540	87.1	P\$ 8886 W\$ 9920
--------	------	----	-----	----	-----	------	----------------------

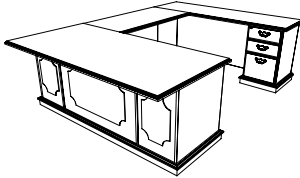

Shown with Arlington Base and Decorative Molding

CONSIST OF:	QTY			
29-3672LP	1	Single Ped Desk, Left	P\$ 3945 W\$ 4349	
29-2448UF	1	Bridge	P\$ 1530 W\$ 1797	
29-2072RC	1	Credenza, Right	P\$ 3411 W\$ 3774	

Products are available as left or right, where applicable
List prices do not include optional Arlington decorative molding

U UNIT	29-4	66	91 $\frac{1}{16}$	30	401	72.9	P\$ 11912 W\$ 12855
--------	------	----	-------------------	----	-----	------	------------------------

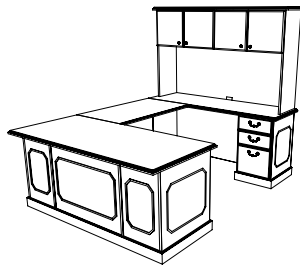

CONSIST OF:	QTY			
29-3066LP	1	Single Ped Desk, Left	P\$ 3444 W\$ 3777	
29-2442UF	1	Bridge	P\$ 1458 W\$ 1722	
29-2066RC	1	Credenza, Right	P\$ 3022 W\$ 3368	
29-1566HU	1	Hutch	\$ 3988	

Products are available as left or right, where applicable
List prices do not include optional Wilmington decorative molding

Pricing Codes:
P = HPL Top
W = Veneer Top

[See Arlington Intro Section for Ordering Options](#)

Item	Model No.	Width	Depth	Height	Ship Wt	Cubic Ft	List Price
HEIGHT ADJUSTABLE PRIVATE OFFICE	29-9	140 7/16	98 7/16	70 7/8	975	146.8	P\$ 21724 W\$ 22848

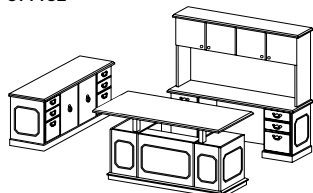

Shown with Wilmington Base and Decorative Molding

CONSIST OF:	QTY		
29-3672DPSTS	1	Height Adjustable Double Ped Desk	P\$ 9226 W\$ 9629
29-1572HU	1	Surface Mount Hutch	\$ 4461
29-2072KC	1	Kneespace Credenza	P\$ 3792 W\$ 4151
29-2072SC	1	Storage Credenza	P\$ 4245 W\$ 4607

Products are available as left or right, where applicable
 Width includes 48" between Desk and Storage Credenza
 Depth includes 42" between Desk and Kneespace Credenza
 List prices do not include optional Wilmington decorative molding

HEIGHT ADJUSTABLE U UNIT	29-10	140 7/16	104 7/16	70 7/8	1178	170.8	P\$ 28021 W\$ 29416
--------------------------	-------	----------	----------	--------	------	-------	------------------------

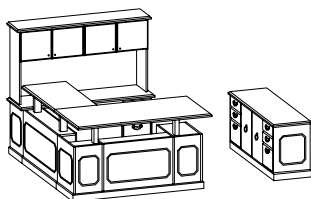

Shown with Wilmington Base and Decorative Molding

CONSIST OF:	QTY		
29-3672LPSTS	1	Height Adjustable Single Ped Desk, Left	P\$ 9160 W\$ 9563
29-2448UFSTS	1	Height Adjustable Bridge	P\$ 6744 W\$ 7011
29-2072RC2	1	Credenza, Right	P\$ 3411 W\$ 3774
29-1572HU	1	Surface Mount Hutch	\$ 4461
29-2072SC	1	Storage Credenza	P\$ 4245 W\$ 4607

Products are available as left or right, where applicable
 Width includes 48" between Desk and Storage Credenza
 List prices do not include optional Wilmington decorative molding

HEIGHT ADJUSTABLE L UNIT	29-11	108	146	70 7/8	1178	170.8	P\$ 29357 W\$ 30391
--------------------------	-------	-----	-----	--------	------	-------	------------------------

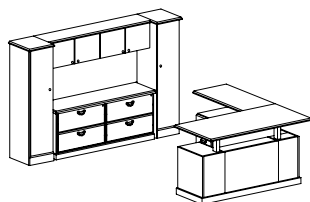

Shown with Arlington Base Molding

CONSIST OF:	QTY		
29-3672RPSTS	1	Height Adjustable Single Ped Desk, Right	P\$ 9160 W\$ 9563
29-2448LF2STS3	1	Height Adjustable Return, Left	P\$ 5651 W\$ 5920
29-2072DL	1	Credenza with Double Lateral File	P\$ 4880 W\$ 5242
29-1572WD	1	Wall Mounted Hutch	\$ 3560
29-1870WL	1	Wardrobe/Storage Cabinet, Left	\$ 3053
29-1870WR	1	Wardrobe/Storage Cabinet, Right	\$ 3053

Products are available as left or right, where applicable
 Depth includes 42" between Return and Wardrobe

[See Arlington Intro Section for Ordering Options](#)

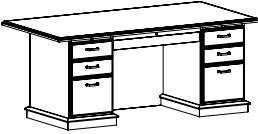
Item	Model No.	Width	Depth	Height	K	Ship Wt	Cubic Ft	List Price	
	29-3672DP	72	36	30	31½	266	51.7	P\$ 4013 W\$ 4414	
	Chassis 64W x 24D, 10" Approach Overhang								
	29-3072DP	72	30	30	31½	255	43.9	P\$ 3980 W\$ 4334	
	Chassis 64W x 24D, 4" Approach Overhang								
	29-3066DP	66	30	30	31½	249	40.3	P\$ 3945 W\$ 4276	
	Chassis 64W x 24D, 4" Approach Overhang								
	29-3060DP	60	30	30	25½	241	35.3	P\$ 3772 W\$ 4083	
	Chassis 58W x 24D, 4" Approach Overhang								

Must Specify (in this order):

- Model #
- Surface Material
- Finish/Color
- Base Molding
- Decorative Molding
- Drawer Pull
- Drawer Construction
- Worksurface Grommet Location
- Grommet Color

Description

- Standard with: Rectangle Top, Central Locking, Letter Width Locking Box/Box/File Pedestals, Left to Right Grain Direction on Worksurface, Pull Out Writing Shelves on User Side and Center Drawer with Pen Tray
- Available with Veneer (W) or HPL (P) Top, Must Specify
- Top Profiled on All 4 Sides
- Lock Core Color will Coordinate with Pull Selection, [See Option Details](#)
- Base Molding on Approach, Sides and User Side. Must Specify: Arlington or Wilmington (See Below)
- Standard with No Decorative Molding; Optional Decorative Molding, [See Option Details](#); Must Specify (See Below)
- [Height Adjustable Units Available](#)
- Additional Options: Dove Tail Drawer Construction ([See Construction Details](#)); Grommet Options ([See Option Details](#)); Glass Marker Boards ([See Sizes and Details](#))

Molding Options: Must Specify and Add

Arlington Molding Options

BM2900	Arlington Base Molding	N/C
M2900	Optional Arlington Decorative Molding	\$ 83

Wilmington Molding Options

BM3600	Wilmington Base Molding	N/C
M3600	Optional Wilmington Decorative Molding	\$ 139

Note: Arlington Decorative Molding may only be used with Arlington Base Molding and Wilmington Decorative Molding may only be used with Wilmington Base Molding

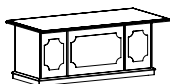

Approach View for all Double and Single Ped Desks with Arlington Molding

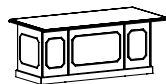

Approach View for all Double and Single Ped Desks with Wilmington Molding

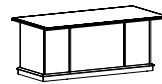

Approach View for all Double and Single Ped Desks with No Molding

Pricing Codes:
P = HPL Top
W = Veneer Top

[See Arlington Intro Section for Ordering Options](#)

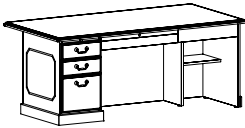
Item	Model No.	Width	Depth	Height	K	Ship Wt	Cubic Ft	List Price	
 Shown as Left	Left Ped	Right Ped							
	29-3672LP	29-3672RP	72	36	30	30¾	315	P\$ 3945 W\$ 4349	
	Chassis 70W x 24D, 10" Approach Overhang								
	29-3072LP	29-3072RP	72	30	30	30¾	189	P\$ 3696 W\$ 4050	
	Chassis 70W x 24D, 4" Approach Overhang								
	29-3066LP	29-3066RP	66	30	30	24¾	189	P\$ 3444 W\$ 3777	
	Chassis 64W x 24D, 4" Approach Overhang								
	29-3060LP	29-3060RP	60	30	30	18¾	186	P\$ 3195 W\$ 3506	
	Chassis 58W x 24D, 4" Approach Overhang								

Must Specify (in this order):

- Model #
- Surface Material
- Finish/Color
- Base Molding
- Decorative Molding
- Drawer Pull
- Drawer Construction
- Worksurface Grommet Location
- Grommet Color

Description

- Standard with: Rectangle Top, Central Locking, Letter Width Locking Box/Box/File Pedestal, Left to Right Grain Direction on Worksurface, Pull Out Writing Shelf on User Side and Center Drawer with Pen Tray
- Available with Veneer (W) or HPL (P) Top, Must Specify
- Top Profiled on All 4 Sides
- Lock Core Color will Coordinate with Pull Selection, [See Option Details](#)
- Base Molding on Approach, Sides and User Side. Must Specify: Arlington or Wilmington (See Below)
- Standard with No Decorative Molding; Optional Decorative Molding, [See Option Details](#); Must Specify (See Below)
- [Height Adjustable Units Available](#)
- Additional Options: Dove Tail Drawer Construction ([See Construction Details](#)); Grommet Options ([See Option Details](#)); Glass Marker Boards ([See Sizes and Details](#))

Molding Options: Must Specify and Add

Arlington Molding Options		
BM2900	Arlington Base Molding	N/C
M2900	Optional Arlington Decorative Molding	\$ 83
Wilmington Molding Options		
BM3600	Wilmington Base Molding	N/C
M3600	Optional Wilmington Decorative Molding	\$ 139

Note: Arlington Decorative Molding may only be used with Arlington Base Molding and Wilmington Decorative Molding may only be used with Wilmington Base Molding

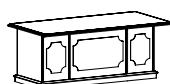

Approach View for all Double and Single Ped Desks with Arlington Molding

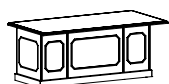

Approach View for all Double and Single Ped Desks with Wilmington Molding

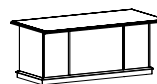

Approach View for all Double and Single Ped Desks with No Molding

[See Arlington Intro Section for Ordering Options](#)

Item	Model No.	Width	Depth	Height	K	Ship Wt	Cubic Ft	List Price	
	Left Ped	Right Ped							
	29-2448LF2	29-2448RF2	48	24	30	30¼	125	22.9	P\$ 2857 W\$ 3125
	29-2442LF2	29-2442RF2	42	24	30	26¼	113	18.8	P\$ 2477 W\$ 2738

Shown as Left with
Optional Locking

Must Specify (in this order):

- Model #
- Surface Material
- Finish/Color
- Base Molding
- Decorative Molding
- Drawer Pull
- Locking
- Drawer Construction
- Worksurface Grommet Location
- Back Panel Grommet
- Grommet Color

Description

- Standard With: Letter Width File/File in Pedestal, Front to Back Grain Direction on Worksurface
- Top Profiled on 3 Sides with Reverse Profile on Connecting Edge
- Available with Veneer (W) or HPL (P) Top, Must Specify
- Grommet in Back Panel; Must Specify: Black (BLK), Silver (SLV) or No Back Panel Grommet (NONE)
- Base Molding on Approach, Side, and User Side. Must Specify: Arlington or Wilmington (See Below)
- Standard with No Decorative Molding; Optional Decorative Molding, [See Option Details](#); Must Specify (See Below)
- [Height Adjustable Units Available](#)
- Additional Options: Locking Pedestal ([See Locking Details](#)); Dove Tail Drawer Construction ([See Construction Details](#)); Worksurface Grommet Options ([See Option Details](#))

Molding Options: Must Specify and Add

Arlington Molding Options

BM2900	Arlington Base Molding	N/C
--------	------------------------	-----

Wilmington Molding Options

BM3600	Wilmington Base Molding	N/C
M3600	Optional Wilmington Decorative Molding	\$ 139



Note: Wilmington Decorative Molding may only be used with Wilmington Base Molding

Item	Model No.	Width	Depth	Height	K	Ship Wt	Cubic Ft	List Price	
	Left Ped	Right Ped							
	29-2448LF	29-2448RF	48	24	30	30¼	125	22.9	P\$ 2857 W\$ 3125
	29-2442LF	29-2442RF	42	24	30	26¼	113	18.8	P\$ 2477 W\$ 2738

Shown as Left with
Optional Locking

Must Specify (in this order):

- Model #
- Surface Material
- Finish/Color
- Base Molding
- Decorative Molding
- Drawer Pull
- Locking
- Drawer Construction
- Worksurface Grommet Location
- Back Panel Grommet
- Grommet Color

Description

- Standard With: Letter Width Box/Box/File in Pedestal, Front to Back Grain Direction on Worksurface
- Top Profiled on 3 Sides with Reverse Profile on Connecting Edge
- Available with Veneer (W) or HPL (P) Top, Must Specify
- Grommet in Back Panel; Must Specify: Black (BLK) or Silver (SLV) or No Back Panel Grommet (NONE)
- Base Molding on Approach, Side, and User Side. Must Specify: Arlington or Wilmington (See Below)
- Standard with No Decorative Molding; Optional Decorative Molding, [See Option Details](#); Must Specify (See Below)
- [Height Adjustable Units Available](#)
- Additional Options: Locking Pedestal ([See Locking Details](#)); Dove Tail Drawer Construction ([See Construction Details](#)); Worksurface Grommet Options ([See Option Details](#))

Molding Options: Must Specify and Add

Arlington Molding Options

BM2900	Arlington Base Molding	N/C
--------	------------------------	-----

Wilmington Molding Options

BM3600	Wilmington Base Molding	N/C
M3600	Optional Wilmington Decorative Molding	\$ 139

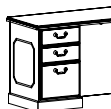

Note: Wilmington Decorative Molding may only be used with Wilmington Base Molding

Pricing Codes:
P = HPL Top
W = Veneer Top

[See Arlington Intro Section for Ordering Options](#)

Item	Model No.	Width	Depth	Height	K	Ship Wt	Cubic Ft	List Price
BRIDGE WITH FULL MODESTY	29-2448UF	48	24	30	46 $\frac{7}{8}$	75	6.2	P\$ 1530 W\$ 1797
	29-2442UF	42	24	30	40 $\frac{7}{8}$	73	4.7	P\$ 1458 W\$ 1722

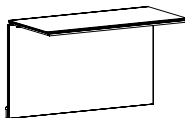

Must Specify (in this order):

Model #
Surface Material
Finish/Color
Base Molding
Decorative Molding
Worksurface Grommet Location
Back Panel Grommet
Grommet Color

Description

- Standard With: Hinged Back Panel, Front to Back Grain Direction on Worksurface
- Available with Veneer (W) or HPL (P) Top, Must Specify
- Grommet in Back Panel; Must Specify: Black (BLK) or Silver (SLV) or No Back Panel Grommet (NONE)
- Base Molding on Approach, Must Specify: Arlington or Wilmington (See Below)
- Standard with No Decorative Molding; Optional Decorative Molding, [See Option Details](#); Must Specify (See Below)
- [Height Adjustable Units Available](#)
- Additional Options: Worksurface Grommet Options ([See Option Details](#))
- Keyboard Accessories Cannot be Factory Installed but are Available for Field Installation (Sold Separately, [See 01-KB3 for Details](#))

Molding Options: Must Specify and Add

Arlington Molding Options

BM2900	Arlington Base Molding	N/C
--------	------------------------	-----

Wilmington Molding Options

BM3600	Wilmington Base Molding	N/C
M3600	Optional Wilmington Decorative Molding	\$ 139

Note: Wilmington Decorative Molding may only be used with Wilmington Base Molding

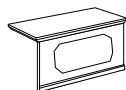

Item	Model No.	Width	Depth	Height	K	Ship Wt	Cubic Ft	List Price
BRIDGE WITH HALF MODESTY	29-2448UFH	48	24	11 $\frac{1}{2}$	46 $\frac{7}{8}$	89	5.4	P\$ 1350 W\$ 1618
	29-2442UFH	42	24	11 $\frac{1}{2}$	40 $\frac{7}{8}$	85	4.6	P\$ 1285 W\$ 1548

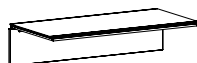

Must Specify (in this order):

Model #
Surface Material
Finish / Color
Worksurface Grommet Location
Grommet Color

Description

- Standard With: Hinged Back Panel, Front to Back Grain Direction on Worksurface
- Available with Veneer (W) or HPL (P) Top, Must Specify
- Keyboard Accessories Cannot be Factory Installed but are Available for Field Installation (Sold Separately, [See 01-KB3 for Details](#))
- No Base or Decorative Molding

[See Arlington Intro Section for Ordering Options](#)

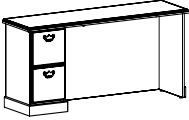
Item	Model No.	Width	Depth	Height	K	Ship Wt	Cubic Ft	List Price	
 <p>Shown as Left with Optional Locking</p>	Left Ped	Right Ped							
	29-2072LC2	29-2072RC2	72	20 ⁷ / ₁₆	30	52 ¹ / ₄	150	30.5	P\$ 3411 W\$ 3774
	29-2066LC2	29-2066RC2	66	20 ⁷ / ₁₆	30	46 ¹ / ₄	139	27.9	P\$ 3022 W\$ 3368
	29-2060LC2	29-2060RC2	60	20 ⁷ / ₁₆	30	40 ¹ / ₄	129	25.3	P\$ 2978 W\$ 3303

Description

- Standard With: Letter Width File/File in Pedestal, Left to Right Grain Direction on Worksurface
- Available with Veneer (W) or HPL (P) Top, Must Specify
- Grommet in Back Panel; Must Specify: Black (BLK) or Silver (SLV) or No Back Panel Grommet (NONE)
- Top Profiled on only Three (3) Sides for Flush Wall Application
- Base Molding on Sides and User Side, Must Specify: Arlington or Wilmington (See Below)
- Standard with No Decorative Molding; Optional Decorative Molding, [See Option Details](#); Must Specify (See Below)
- Additional Options: Locking Pedestal ([See Locking Details](#)); Dove Tail Drawer Construction ([See Construction Details](#)); Grommet Options ([See Option Details](#)); Glass Marker Boards ([See Sizes and Details](#))

Must Specify (in this order):

- Model #
- Surface Material
- Finish/Color
- Base Molding
- Decorative Molding
- Drawer Pull
- Locking
- Drawer Construction
- Worksurface Grommet Location
- Back Panel Grommet
- Grommet Color

Molding Options: Must Specify and Add

Arlington Molding Options

BM2900	Arlington Base Molding	N/C
--------	------------------------	-----

Wilmington Molding Options

BM3600	Wilmington Base Molding	N/C
M3600	Optional Wilmington Decorative Molding	\$ 139

Note: Wilmington Decorative Molding may only be used with Wilmington Base Molding

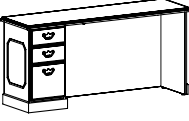

Item	Model No.	Width	Depth	Height	K	Ship Wt	Cubic Ft	List Price	
 <p>Shown as Left with Optional Locking and Optional Wilmington Decorative Molding</p>	Left Ped	Right Ped							
	29-2072LC	29-2072RC	72	20 ⁷ / ₁₆	30	52 ¹ / ₄	150	30.5	P\$ 3411 W\$ 3774
	29-2066LC	29-2066RC	66	20 ⁷ / ₁₆	30	46 ¹ / ₄	139	27.9	P\$ 3022 W\$ 3368
	29-2060LC	29-2060RC	60	20 ⁷ / ₁₆	30	40 ¹ / ₄	129	25.3	P\$ 2978 W\$ 3303

Description

- Standard With: Letter Width Box/Box/File in Pedestal, Left to Right Grain Direction on Worksurface
- Available with Veneer (W) or HPL (P) Top, Must Specify
- Grommet in Back Panel; Must Specify: Black (BLK) or Silver (SLV) or No Back Panel Grommet (NONE)
- Top Profiled on only Three (3) Sides for Flush Wall Application
- Base Molding on Sides and User Side, Must Specify: Arlington or Wilmington (See Below)
- Standard with No Decorative Molding; Optional Wilmington Decorative Molding, [See Option Details](#) for Details; Must Specify (See Below)
- Additional Options: Locking Pedestal ([See Locking Details](#)); Dove Tail Drawer Construction ([See Construction Details](#)); Grommet Options ([See Option Details](#)); Glass Marker Boards ([See Sizes and Details](#)); Kneespace Options (Sold Separately, [See 01-KB3 for Details](#))

Must Specify (in this order):

- Model #
- Surface Material
- Finish/Color
- Base Molding
- Decorative Molding
- Drawer Pull
- Locking
- Drawer Construction
- Worksurface Grommet Location
- Back Panel Grommet
- Grommet Color

Molding Options: Must Specify and Add

Arlington Molding Options

BM2900	Arlington Base Molding	N/C
--------	------------------------	-----

Wilmington Molding Options

BM3600	Wilmington Base Molding	N/C
M3600	Optional Wilmington Decorative Molding	\$ 139

Note: Wilmington Decorative Molding may only be used with Wilmington Base Molding

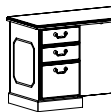

Pricing Codes:
P = HPL Top
W = Veneer Top

[See Arlington Intro Section for Ordering Options](#)

Item	Model No.	Width	Depth	Height	K	Ship Wt	Cubic Ft	List Price	
CREDENZA WITH LATERAL/LATERAL	Left Ped								
	Right Ped								
	29-2072LL	29-2072RL	72	20 ⁷ / ₁₆	30	32 ² / ₃	182	30.5	P\$ 3608 W\$ 3970

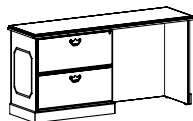

Shown as Left with Optional Locking and Optional Wilmington Decorative Molding

Must Specify (in this order):

- Model #
- Surface Material
- Finish/Color
- Base Molding
- Decorative Molding
- Drawer Pull
- Drawer Construction
- Worksurface Grommet Location
- Back Panel Grommet
- Grommet Color



Description

- Standard With: Two (2) Locking Lateral Files in Pedestal, Left to Right Grain Direction on Worksurface
- Available with Veneer (W) or HPL (P) Top, Must Specify
- Grommet in Back Panel; Must Specify: Black (BLK) or Silver (SLV) or No Back Panel Grommet (NONE)
- Top Profiled on only Three (3) Sides for Flush Wall Application
- Lock Core Color will Coordinate with Pull Selection, [See Option Details](#)
- Legal or Letter Filing Side to Side or Front to Back
- Base Molding on Sides and User Side, Must Specify: Arlington or Wilmington (See Below)
- Standard with No Decorative Molding; Optional Wilmington Decorative Molding, [See Option Details](#) for Details; Must Specify (See Below)
- Additional Options: Dove Tail Drawer Construction ([See Construction Details](#)); Grommet Options ([See Option Details](#)); Glass Marker Boards ([See Sizes and Details](#))

Molding Options: Must Specify and Add

Arlington Molding Options

BM2900	Arlington Base Molding	N/C
--------	------------------------	-----

Wilmington Molding Options

BM3600	Wilmington Base Molding	N/C
M3600	Optional Wilmington Decorative Molding	\$ 139

Note: Wilmington Decorative Molding may only be used with Wilmington Base Molding

Item	Model No.	Width	Depth	Height	K	Ship Wt	Cubic Ft	List Price	
KNEESPACE CREDENZA	29-2072KC		72	20 ⁷ / ₁₆	30	34 ¹ / ₂	197	30.5	P\$ 3792 W\$ 4151
	29-2066KC		66	20 ⁷ / ₁₆	30	28 ¹ / ₂	185	27.9	P\$ 3444 W\$ 3793
	29-2060KC		60	20 ⁷ / ₁₆	30	22 ¹ / ₂	173	25.3	P\$ 3419 W\$ 3745

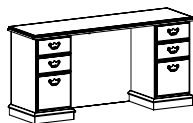

Shown with Optional Locking

Must Specify (in this order):

- Model #
- Surface Material
- Finish/Color
- Base Molding
- Decorative Molding
- Drawer Pull
- Locking
- Drawer Construction
- Worksurface Grommet Location
- Back Panel Grommet
- Grommet Color



Description

- Standard With: Letter Width Box/Box/File in Pedestals, Left to Right Grain Direction on Worksurface
- Available with Veneer (W) or HPL (P) Top, Must Specify
- Grommet in Back Panel; Must Specify: Black (BLK) or Silver (SLV) or No Back Panel Grommet (NONE)
- Top Profiled on only Three (3) Sides for Flush Wall Application
- Base Molding on Sides and User Side, Must Specify: Arlington or Wilmington (See Below)
- Standard with No Decorative Molding; Optional Wilmington Decorative Molding, [See Option Details](#) for Details; Must Specify (See Below)
- Additional Options: Locking Pedestal ([See Locking Details](#)); Dove Tail Drawer Construction ([See Construction Details](#)); Grommet Options ([See Option Details](#)); Glass Marker Boards ([See Sizes and Details](#))

Molding Options: Must Specify and Add

Arlington Molding Options

BM2900	Arlington Base Molding	N/C
--------	------------------------	-----

Wilmington Molding Options

BM3600	Wilmington Base Molding	N/C
M3600	Optional Wilmington Decorative Molding	\$ 139

Note: Wilmington Decorative Molding may only be used with Wilmington Base Molding

[See Arlington Intro Section for Ordering Options](#)

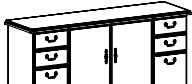
Item	Model No.	Width	Depth	Height	Ship Wt	Cubic Ft	List Price
	29-2072SC	72	20 ⁷ / ₁₆	30	237	30.5	P\$ 4245 W\$ 4607
	29-2066SC	66	20 ⁷ / ₁₆	30	217	30.5	P\$ 3687 W\$ 4032

Shown with Jefferson Drawer and Door Pulls (JEF)

Must Specify (in this order):

- Model #
- Surface Material
- Finish/Color
- Base Molding
- Decorative Molding
- Drawer / Door Pull
- Locking
- Drawer Construction

Description

- Standard With: Letter Width Box/Box/File in Pedestals, Left to Right Grain Direction on Worksurface
- Available with Veneer (W) or HPL (P) Top, Must Specify
- Top Profiled on only Three (3) Sides for Flush Wall Application
- Door Pull will Coordinate with Drawer Pull, [See Pull Details](#)
- Base Molding on Sides and User Side, Must Specify: Arlington or Wilmington (See Below)
- Standard with No Decorative Molding; Optional Wilmington Decorative Molding, [See Option Details](#) for Details; Must Specify (See Below)
- Optional Locking Pedestals (LKT-P) or Locking Pedestals and Doors (LKT-HU), [See Locking Details](#)
- Additional Options: Dove Tail Drawer Construction ([See Construction Details](#))

Molding Options: Must Specify and Add

Arlington Molding Options

BM2900	Arlington Base Molding	N/C
--------	------------------------	-----

Wilmington Molding Options

BM3600	Wilmington Base Molding	N/C
M3600	Optional Wilmington Decorative Molding	\$ 139

Note: Wilmington Decorative Molding may only be used with Wilmington Base Molding



CREDENZA WITH DOUBLE LATERAL FILE	29-2072DL	72	20 ⁷ / ₁₆	30	270	30.5	P\$ 4880 W\$ 5242
--	-----------	----	---------------------------------	----	-----	------	----------------------

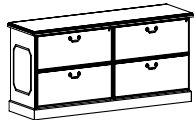

Shown with Jefferson Drawer and Door Pulls (JEF) and Optional Wilmington Decorative Molding

Must Specify (in this order):

- Model #
- Surface Material
- Finish/Color
- Base Molding
- Decorative Molding
- Drawer Pull
- Drawer Construction

Description

- Standard With: Four (4) Locking Lateral File Drawers, Left to Right Grain Direction on Worksurface
- Available with Veneer (W) or HPL (P) Top, Must Specify
- Top Profiled on only Three (3) Sides for Flush Wall Application
- Legal or Letter Filing Side to Side or Front to Back
- Base Molding on Sides and User Side, Must Specify: Arlington or Wilmington (See Below)
- Standard with No Decorative Molding; Optional Wilmington Decorative Molding, [See Option Details](#) for Details; Must Specify (See Below)
- Additional Options: Dove Tail Drawer Construction ([See Construction Details](#))

Molding Options: Must Specify and Add

Arlington Molding Options

BM2900	Arlington Base Molding	N/C
--------	------------------------	-----

Wilmington Molding Options

BM3600	Wilmington Base Molding	N/C
M3600	Optional Wilmington Decorative Molding	\$ 139

Note: Wilmington Decorative Molding may only be used with Wilmington Base Molding



Pricing Codes:
P = HPL Top
W = Veneer Top

[See Arlington Intro Section for Ordering Options](#)

Item	Model No.	Width	Depth	Height	Ship Wt	Cubic Ft	List Price
LATERAL FILE	29-2036L4 <i>Four (4) Drawers</i>	36	20 $\frac{1}{16}$	54	224	27.3	P\$ 5112 W\$ 5307
	29-2036L2 <i>Two (2) Drawers</i>	36	20 $\frac{1}{16}$	30	135	15.9	P\$ 2934 W\$ 3131

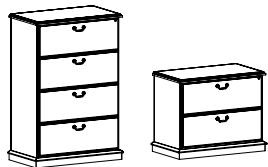

Must Specify (in this order):

Model #
Surface Material
Finish/Color
Base Molding
Drawer Pull
Drawer Construction

Description

- Central Locking Lateral File Drawers provide Legal or Letter Filing Front to Back or Side to Side
- Anti-Tilt Mechanism
- Available with Veneer (W) or HPL (P) Top, Must Specify
- Top Profiled on only Three (3) Sides for Flush Wall Application
- Base Molding on Sides and User Side, Must Specify: Arlington or Wilmington (See Below)
- No Decorative Molding Available
- Additional Options: Dove Tail Drawer Construction ([See Construction Details](#))

Base Molding Options: Must Specify

BM2900	Arlington Base Molding Only	N/C
BM3600	Wilmington Base Molding Only	N/C

Item	Model No.	Width	Depth	Height	Ship Wt	Cubic Ft	List Price
SURFACE MOUNT HUTCH	29-1572HU <i>Four (4) Doors</i>	72	15	40 $\frac{1}{8}$	203	34.1	\$ 4461
	29-1566HU <i>Four (4) Doors</i>	66	15	40 $\frac{1}{8}$	166	32.1	\$ 3988
	29-1560HU <i>Four (4) Doors</i>	60	15	40 $\frac{1}{8}$	129	28.4	\$ 3831

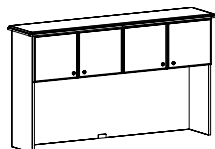

Must Specify (in this order):

Model #
Finish
Door Pull
Locking
Tackboard Fabric
Tasklight
Grommet Color

Description

- Standard with: Soft-Close Hinged Wood Doors, Vertical Grain Direction,
- 25 $\frac{3}{4}$ " Clearance Below Doors
- Top Profiled on Three (3) Sides for Flush Wall Application Standard
- Lower, Center Grommet on Back Panel Standard; Must Specify: Black (BLK) or Silver (SLV)
- Additional Options: Locking Doors ([See Option Details](#)); Three (3) Upper Wire Management Grommets ([See Option Details](#)); Factory-Installed Tackboard ([See Unit Details](#)); Tasklights ([See Multiple Units Details](#))

[See Arlington Intro Section for Ordering Options](#)

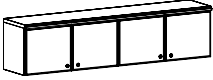
Item	Model No.	Width	Depth	Height	Ship Wt	Cubic Ft	List Price
WALL MOUNT HUTCH 	29-1572WD <i>Four (4) Doors</i>	72	15	17 $\frac{3}{16}$	118	13.1	\$ 3560
	29-1566WD <i>Four (4) Doors</i>	66	15	17 $\frac{3}{16}$	105	12.0	\$ 3483
	29-1560WD <i>Four (4) Doors</i>	60	15	17 $\frac{3}{16}$	96	11.0	\$ 3333
	29-1554WD <i>Three (3) Doors</i>	54	15	17 $\frac{3}{16}$	87	9.9	\$ 3118
	29-1548WD <i>Three (3) Doors</i>	48	15	17 $\frac{3}{16}$	77	8.9	\$ 2904
	29-1542WD <i>Two (2) Doors</i>	42	15	17 $\frac{3}{16}$	67	7.8	\$ 2673
	29-1536WD <i>Two (2) Doors</i>	36	15	17 $\frac{3}{16}$	58	6.7	\$ 2386
	29-1530WD <i>Two (2) Doors</i>	30	15	17 $\frac{3}{16}$	48	5.6	\$ 2306

Must Specify (in this order):

Model #
Finish
Door Pull
Locking

Description

- Standard with: Soft-Close Hinged Wood Doors, Vertical Grain Direction,
- Top Profiled on Front only
- Optional Locking Doors, [See Option Details](#)
- Additional Options: Tackboards ([See Multiple Unit Details](#)); Tasklights ([See Multiple Units Details](#)); Magnetic Glass Marker Boards ([See Sizes and Details](#))

SURFACE MOUNT BOOKCASE	29-1534TU	34	15	40 $\frac{7}{16}$	78	17.8	\$ 1874
-------------------------------	-----------	----	----	-------------------	----	------	---------

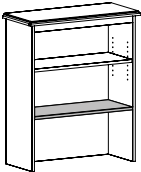

Description

- Top Profiled on Three (3) Sides for Flush Wall Application
- 1" Thick Shelves; One (1) Adjustable and One (1) Fixed (Shaded)
- Vertical Woodgrain
- 12" Clearance Below Fixed Shelf
- For Surface Mount Use on Two (2) Drawer Lateral File

Must Specify (in this order):

Model #
Finish

Pricing Codes:
P = HPL Top
W = Veneer Top

[See Arlington Intro Section for Ordering Options](#)

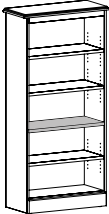
Item	Model No.	Width	Depth	Height	Ship Wt	Cubic Ft	List Price
	29-3470BC <i>Three (3) Adjustable Shelves and One (1) Fixed Shelf</i>	34	15	70 $\frac{1}{8}$	165	25.0	W\$ 2593
	29-3460BC <i>Two (2) Adjustable Shelves and One (1) Fixed Shelf</i>	34	15	60	155	21.9	W\$ 2495
	29-3448BC <i>Two (2) Adjustable Shelves</i>	34	15	48	125	18.0	P\$ 1835 W\$ 2276
	29-2870BC <i>Three (3) Adjustable Shelves and One (1) Fixed Shelf</i>	28	15	70 $\frac{1}{8}$	125	23.8	W\$ 2303
	29-2860BC <i>Two (2) Adjustable Shelves and One (1) Fixed Shelf</i>	28	15	60	115	18.3	W\$ 2253
	29-2848BC <i>Two (2) Adjustable Shelves</i>	28	15	48	93	16.0	P\$ 1823 W\$ 2204

Must Specify (in this order):
 Model #
 Surface Material (48"H Only)
 Finish/Color

Description

- Fixed Shelf (Shaded)
- Vertical Woodgrain
- 48"H Available with Veneer (W) or HPL (P) Top, Must Specify
- Top Profiled on only Three (3) Sides for Flush Wall Application

DOOR BOOKCASE	29-2870DB	28	15	70 $\frac{1}{8}$	78	17.8	\$ 2592
----------------------	-----------	----	----	------------------	----	------	---------

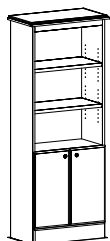

Shown with Arlington (ARB) Door Pull

Description

- Open Bookcase with Two (2) 1" Thick Adjustable Shelves
- Vertical Woodgrain
- Storage Behind Doors; One (1) Adjustable Shelf
- Top Profiled on only Three (3) Sides for Flush Wall Application
- Optional Locking Doors, [See Option Details](#)

Must Specify (in this order):
 Model #
 Finish
 Door Pull
 Locking

[See Arlington Intro Section for Ordering Options](#)

Item	Model No.	Width	Depth	Height	Ship Wt	Cubic Ft	List Price
WARDROBE/STORAGE CABINET	Hinged Left	Hinged Right					
	29-1870WL	29-1870WR	18	20	70 $\frac{1}{8}$	153	19.2

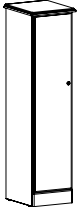

Shown as Left

Must Specify (in this order):

Model #
Finish
Locking
Door Pull

Description

- Coat Rod Under Top Fixed Shelf and Three (3) Adjustable Shelves
- Adjustable Shelves can be Removed for Wardrobe Application
- Vertical Woodgrain
- Top Profiled on only Three (3) Sides for Flush Wall Application
- Must Specify Door Pull: Arlington B (ARB), Jefferson (JEF), and Liberty (ALB)
- Optional Locking Doors, [See Option Details](#)

DOUBLE WARDROBE/STORAGE	29-3670WD	36	20	70 $\frac{1}{8}$	310	34.2	\$ 5391
-------------------------	-----------	----	----	------------------	-----	------	---------

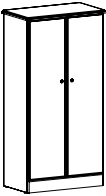

Must Specify (in this order):

Model #
Finish
Locking
Door Pull

Description

- Three (3) Adjustable Shelves on Both Sides; Coat Rod Under Top Fixed Shelf on Right
- Vertical Woodgrain
- Recommended Against Wall
- Top Profiled on only Three (3) Sides for Flush Wall Application
- Must Specify Door Pull: Arlington B (ARB), Jefferson (JEF), and Liberty (ALB)
- Optional Locking Doors, [See Option Details](#)

Pricing Codes:
P = HPL Top
W = Veneer Top

[See Arlington Intro Section for Ordering Options](#)

Item	Model No.	Width	Depth	Height	Ship Wt	Cubic Ft	List Price
	29-3672WT <i>64" Kneespace</i>	72	36	30	125	11.4	P\$ 2235 W\$ 2636
	29-3060WT <i>52" Kneespace</i>	60	30	30	89	8.0	P\$ 1839 W\$ 2151

Description

- Available with Veneer (W) or HPL (P) Top, Must Specify
- Left to Right Grain Direction on Worksurface
- Some Assembly Required
- Optional Worksurface Grommet, [See Option Details](#); Must Specify: Black (BLK) or Silver (SLV)

Must Specify (in this order):

- Model #
- Surface Material
- Finish/Color
- Worksurface Grommet Location
- Grommet Color

COMPUTER DESK WITH HUTCH

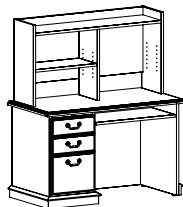

	Left	Right	Width	Depth	Height	Ship Wt	Cubic Ft	List Price
	29-2448LP	29-2448RP	48	24	30	148	23.1	P\$ 2889 W\$ 3157
	29-1246HU		46	12	29½	54	10.3	\$ 1142

Single Ped Desk Description (29-2448LP/29-2448RP)

- Standard With: Letter Width Box/Box/File Pedestal, Pull-Out Writing Shelf, Pull-Out Keyboard Shelf
- Available with Veneer (W) or HPL (P) Top, Must Specify
- Top Profiled on only Three (3) Sides for Flush Wall Application
- Grommet in Back Panel; Must Specify: Black (BLK) or Silver (SLV) or No Back Panel Grommet (NONE)
- Base Molding on Sides and User Side. Must Specify: Arlington or Wilmington (See Below)
- Additional Options: Dove Tail Drawer Construction ([See Construction Details](#)); Worksurface Grommet Options ([See Option Details](#))

Hutch Description (29-1246HU)

- One (1) Adjustable Shelf; Non-Handed
- Back Panel with Open Clearance for Wire Management

Must Specify for Desk (in this order):

- Model #
- Surface Material
- Finish/Color
- Base Molding
- Drawer Pull
- Drawer Construction
- Worksurface Grommet Location
- Back Panel Grommet
- Grommet Color

Must Specify for Hutch (in this order):

- Model #
- Finish Color

Desk Base Molding Options: Must Specify and Add

BM2900	Arlington Base Molding	N/C
BM3600	Wilmington Base Molding	N/C

[See Arlington Intro Section for Ordering Options](#)

Item	Model No.	Width	Depth	Height	Ship Wt	Cubic Ft	List Price
END TABLE	29-2124ET	21	24	21½	25	2.0	P\$ 1027 W\$ 1197

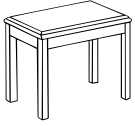

Description

- Available with Veneer (W) or HPL (P) Top, Must Specify
- Hardwood Legs
- Apron Rails and Legs Feature Multi-Step, Hand-Finished Catalyzed Finish
- Some Assembly Required

Must Specify (in this order):

Model #
Surface Material
Finish/Color

LAMP TABLE	29-2424LT	24	24	21½	25	2.0	P\$ 1149 W\$ 1233
------------	-----------	----	----	-----	----	-----	----------------------

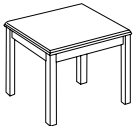

Description

- Available with Veneer (W) or HPL (P) Top, Must Specify
- Hardwood Legs
- Apron Rails and Legs Feature Multi-Step, Hand-Finished Catalyzed Finish
- Some Assembly Required

Must Specify (in this order):

Model #
Surface Material
Finish/Color

MAGAZINE TABLE	29-1847MT	47	18	16	47	3.4	P\$ 1233 W\$ 1438
----------------	-----------	----	----	----	----	-----	----------------------

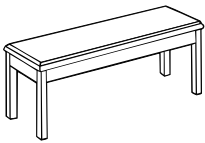

Description

- Available with Veneer (W) or HPL (P) Top, Must Specify
- Left to Right Grain Direction on Worksurface
- Hardwood Legs
- Apron Rails and Legs Feature Multi-Step, Hand-Finished Catalyzed Finish
- Some Assembly Required
- Optional 30" Legs; See Below

Must Specify (in this order):

Model #
Surface Material
Finish/Color
Leg

Desk Base Molding Options: Must Specify and Add

SH-36	Optional 30" H Legs	\$ 223
-------	---------------------	--------

Pricing Codes:
P = HPL Top
W = Veneer Top

[See Arlington Intro Section for Ordering Options](#)

Item	Model No.	Width	Depth	Height	Ship Wt	Cubic Ft	List Price
SQUARE MAGAZINE TABLE	29-3636MT	36	36	16	60	5.5	P\$ 1317 W\$ 1538

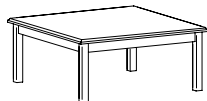

Description

- Available with Veneer (W) or HPL (P) Top, Must Specify
- Hardwood Legs
- Apron Rails and Legs Feature Multi-Step, Hand-Finished Catalyzed Finish
- Some Assembly Required

Must Specify (in this order):

Model #
Surface Material
Finish/Color

Item	Model No.	Width	Depth	Height	Ship Wt	Cubic Ft	List Price
ROUND TABLE TOP	29-4848CT	48	48	30	58	5.9	P\$ 2625 W\$ 3083
	<i>Accommodates Five (5) Chairs</i>						
	29-4242CT	42	42	30	51	4.5	P\$ 1829 W\$ 2247
	<i>Accommodates Four (4) Chairs</i>						
	29-3636CT	36	36	30	50	3.3	P\$ 1590 W\$ 1959
	<i>Accommodates Three (3) Chairs</i>						

Must Specify for Top (in this order):

Model #
Surface Material
Finish/Color
Base

Must Specify for Base (in this order):

Model #
Finish

Description

- Available with Veneer (W) or HPL (P) Top, Must Specify
- See Below for Queen Anne Base; One (1) Base Required
- Queen Anne Base Features Multi-Step, Hand-Finished Catalyzed Finish
- Power Options not Available

Base Options: Must Order & Add

Queen Anne Base

01-0606QB	Optional Queen Anne Base (1 Required)	54	22.4	\$ 1406
-----------	---------------------------------------	----	------	---------



Height Adjustable Pneumatic X-Bases

Maximum Round 42", Maximum Square 36"							
01-3232HAXBB	Black	32	32	26-45¾	1	0.2	\$ 1721
01-3232HAXBA	Aluminum						
Maximum Round 36", Maximum Square 30"							
01-2626HAXBB	Black	22	22	26-45¾	1	0.2	\$ 1687
01-2626HAXBA	Aluminum						



Description

- Pre-Drilled Boring Pattern May Not Match Underside of Table Top
- Steel Mounting Plate: 8"x 8"x ¼"
- Eight (8) Bolts Included for Assembly
- Some Assembly Required

[See Arlington Intro Section for Ordering Options](#)

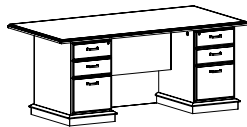
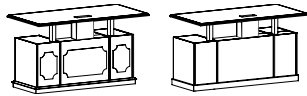
Item	Model No.	Width	Depth	Height	K	Ship Wt	Cubic Ft	List Price	
HEIGHT ADJUSTABLE DOUBLE PED DESK BOX/BOX/FILE  	29-3672DPSTS	72	36	30-45	31½	338	51.7	P\$ 9226 W\$ 9629	
	Chassis 64W x 24D, 10" Approach Overhang								
	29-3072DPSTS	72	30	30-45	31½	327	43.9	P\$ 9194 W\$ 9549	
	Chassis 64W x 24D, 4" Approach Overhang								
	29-3066DPSTS	66	30	30-45	16	321	40.3	P\$ 9160 W\$ 9490	
	Chassis 64W x 24D, 4" Approach Overhang								
	29-3060DPSTS	60	30	30-45	16	321	35.3	P\$ 8987 W\$ 9297	
	Chassis 58W x 24D, 4" Approach Overhang								

Approach Side Shown with Wire Management Box/Decorative Molding and Optional No Molding

Must Specify (in this order):

- Model #
- Surface Material
- Finish/Color
- Base Molding
- Decorative Molding
- Drawer Pull
- Drawer Construction
- Control Switch
- Top Grommet Location/Color

Description

- Standard with: Rectangle Top, Locking Letter Width Locking Box/Box/File Pedestals, Left to Right Grain Direction on Worksurface, 2-Channel Leg Configuration for Single Surface Height Adjustment, and Standard Up/Down Control Switch
- Available with Veneer (W) or HPL (P) Top, Must Specify
- Top Profiled on All 4 Sides
- Lock Core Color will Coordinate with Pull Selection, [See Option Details](#)
- Base Molding on Approach, Sides and User Side. Must Specify: Arlington or Wilmington (See Below)
- Standard with No Decorative Molding; Optional Wilmington Decorative Molding, [See Option Details](#) for Details; Must Specify (See Below)
- Wire Management Box Available; Attaches to Bottom Side of Worksurface and Moves Up/Down with Worksurface to Hide Cords/Wires from Top to Chassis ([See Option Details](#))
- Additional Options: Dove Tail Drawer Construction ([See Construction Details](#)); Grommet Options ([See Option Details](#)); Glass Marker Boards ([See Sizes and Details](#)); Advanced (Memory/Up/Down) Control Switch ([See Option Details](#)) Wire Management and Accessories (Order Separately; [See Multiple Unit Details](#))

Molding Options: Must Specify and Add

Arlington Molding Options

BM2900	Arlington Base Molding	N/C
M2900	Optional Arlington Decorative Molding	\$ 83

Wilmington Molding Options

BM3600	Wilmington Base Molding	N/C
M3600	Optional Wilmington Decorative Molding	\$ 139

Note: Arlington Decorative Molding may only be used with Arlington Base Molding and Wilmington Decorative Molding may only be used with Wilmington Base Molding

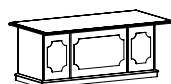

Approach View for all Double and Single Ped Desks with Arlington Molding

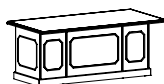

Approach View for all Double and Single Ped Desks with Wilmington Molding

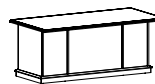

Approach View for all Double and Single Ped Desks with No Molding

Pricing Codes:
P = HPL Top
W = Veneer Top

[See Arlington Intro Section for Ordering Options](#)

Item	Model No.	Width	Depth	Height	K	Ship Wt	Cubic Ft	List Price	
HEIGHT ADJUSTABLE SINGLE PED DESK BOX/BOX/FILE	Left Ped	Right Ped							
	29-3672LPSTS	29-3672RPSTS	72	36	30-45	30¾	338	51.7	P\$ 9160 W\$ 9563
	Chassis 70W x 24D, 10" Approach Overhang								
	29-3072LPSTS	29-3072RPSTS	72	30	30-45	30¾	283	43.9	P\$ 8910 W\$ 9264
	Chassis 70W x 24D, 4" Approach Overhang								
	29-3066LPSTS	29-3066RPSTS	66	30	30-45	24¾	283	43.9	P\$ 8660 W\$ 8992
	Chassis 64W x 24D, 4" Approach Overhang								
	29-3060LPSTS	29-3060RPSTS	66	30	30-45	18¾	258	35.3	P\$ 8409 W\$ 8719
	Chassis 58W x 24D, 4" Approach Overhang								

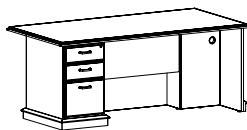

Shown as Left

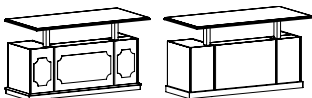

Approach Side Shown with Decorative Molding and Optional No Molding

Must Specify (in this order):

- Model #
- Premium or Standard Veneer
- Top Material
- Finish/Color
- Pull
- No Molding
- Drawer Track
- Leg Configuration
- Control Switch
- Top Grommet Location/Color

Description

- Standard with: Rectangle Top, Locking Letter Width Locking Box/Box/File Pedestal, Left to Right Grain Direction on Worksurface, 2-Channel Leg Configuration for Single Surface Height Adjustment, and Standard Up/Down Control Switch
- Available with Veneer (W) or HPL (P) Top, Must Specify
- Top Profiled on All 4 Sides
- Lock Core Color will Coordinate with Pull Selection, [See Option Details](#)
- Optional 3-Channel Leg Configuration (STS3) for Use with 3-Channel Returns; [See Option Details](#) and [3-Channel Returns](#)
- Stationary Returns Available for Use with Single Ped Desks, [See Stationary Return](#)
- Base Molding on Approach, Sides and User Side. Must Specify: Arlington or Wilmington (See Below)
- Standard with No Decorative Molding; Optional Wilmington Decorative Molding, [See Option Details](#) for Details; Must Specify (See Below)
- Wire Management Box Available; Attaches to Bottom Side of Worksurface and Moves Up/Down with Worksurface to Hide Cords/Wires from Top to Chassis ([See Option Details](#))
- Additional Options: Dove Tail Drawer Construction ([See Construction Details](#)); Grommet Options ([See Option Details](#)); Glass Marker Boards ([See Sizes and Details](#)); Advanced (Memory/Up/Down) Control Switch ([See Option Details](#)) Wire Management and Accessories (Order Separately; [See Multiple Unit Details](#))

Molding Options: Must Specify and Add

Arlington Molding Options		
BM2900	Arlington Base Molding	N/C
M2900	Optional Arlington Decorative Molding	\$ 83
Wilmington Molding Options		
BM3600	Wilmington Base Molding	N/C
M3600	Optional Wilmington Decorative Molding	\$ 139

Note: Arlington Decorative Molding may only be used with Arlington Base Molding and Wilmington Decorative Molding may only be used with Wilmington Base Molding

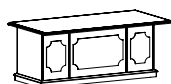

Approach View for all Double and Single Ped Desks with Arlington Molding

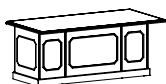

Approach View for all Double and Single Ped Desks with Wilmington Molding

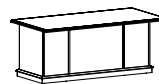

Approach View for all Double and Single Ped Desks with No Molding

[See Arlington Intro Section for Ordering Options](#)

Item	Model No.	Width	Depth	Height	K	Ship Wt	Cubic Ft	List Price	
HEIGHT ADJUSTABLE RETURN WITH FILE/FILE	Left Ped	Right Ped							
	29-2448LF2STS	29-2448RF2STS	48	24	30-45	30¼	197	23.1	P\$ 8071 W\$ 8340
2-CHANNEL, FOR ONE WORKSURFACE	29-2442LF2STS	29-2442RF2STS	42	24	30-45	30¼	182	20.4	P\$ 7690 W\$ 7951

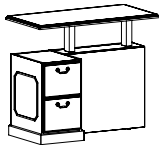

Shown as Left

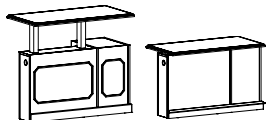

Approach Shown with and without Decorative Molding

Must Specify (in this order):

- Model #
- Surface Material
- Finish/Color
- Base Molding
- Decorative Molding
- Drawer Pull
- Locking
- Drawer Construction
- Control Switch
- Top Grommet Location/Color
- Modesty Grommet

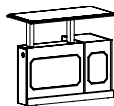

Description

- Standard with: Rectangle Top, Base Molding on All Sides, Decorative Molding on Approach and Side, Letter Width File/File Ped, Worksurface Grommet, Front-To-Back Grain Direction on Top, 2-Channel Leg Configuration for Single Surface Height Adjustment, Standard Up/Down Control Switch, and Wire Management from Pedestal to Kneespace
- Top Profiled on 4 Sides with Reverse Profile on Connecting Edge; Surface is ¼” Short on Connecting Side
- Available with Veneer (W) or HPL (P) Top, Must Specify
- Base Molding on Approach, Side, and User Side. Must Specify: Arlington or Wilmington (See Below)
- Standard with No Decorative Molding; Optional Wilmington Decorative Molding, [See Option Details](#) for Details; Must Specify (See Below)
- Control Switch Standard (Up/Down) or Upgrade to Advanced Switch (MSWCH-Up/Down/Memory); Switch is Field Installed; [See Switch Options](#)
- Optional Modesty Grommet for Wire Management to Wall; Must Specify: Black (GMBBL), Silver (GMBSV) or None (NONE)
- Wire Management Box Available; Attaches to Bottom Side of Worksurface and Moves Up/Down with Worksurface to Hide Cords/Wires from Top to Chassis ([See Option Details](#))
- Additional Options: Locking Pedestal ([See Locking Details](#)); Dove Tail Drawer Construction ([See Construction Details](#)); Grommet Options ([See Option Details](#)); Glass Marker Boards ([See Sizes and Details](#)); Advanced (Memory/Up/Down) Control Switch ([See Option Details](#)) Wire Management and Accessories (Order Separately; [See Multiple Unit Details](#))

Molding Options: Must Specify and Add

Arlington Molding Options		
BM2900	Arlington Base Molding	N/C
Wilmington Molding Options		
BM3600	Wilmington Base Molding	N/C
M3600	Optional Wilmington Decorative Molding	\$ 139

Note: Wilmington Decorative Molding may only be used with Wilmington Base Molding

Pricing Codes:
P = HPL Top
W = Veneer Top

[See Arlington Intro Section for Ordering Options](#)

Item	Model No.	Width	Depth	Height	K	Ship Wt	Cubic Ft	List Price	
HEIGHT ADJUSTABLE RETURN WITH BOX/BOX/FILE	Left Ped								
	Right Ped								
	29-2448LFSTS	29-2448RFSTS	48	24	30-45	30¼	197	23.1	P\$ 8071 W\$ 8340
2-CHANNEL, FOR ONE WORKSURFACE	29-2442LFSTS	29-2442RFSTS	42	24	30-45	30¼	182	20.4	P\$ 7690 W\$ 7951

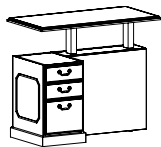

Shown as Left

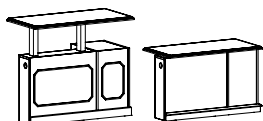

Approach Shown with and without Decorative Molding

Must Specify (in this order):

- Model #
- Surface Material
- Finish/Color
- Base Molding
- Decorative Molding
- Drawer Pull
- Locking
- Drawer Construction
- Control Switch
- Top Grommet Location/Color
- Modesty Grommet

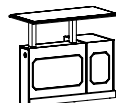

Description

- Standard with: Rectangle Top, Base Molding on All Sides, Decorative Molding on Approach and Side, Letter Width Box/Box/File Ped, Worksurface Grommet, Front-To-Back Grain Direction on Top, 2-Channel Leg Configuration for Single Surface Height Adjustment, Standard Up/Down Control Switch, and Wire Management from Pedestal to Kneespace
- Top Profiled on 4 Sides with Reverse Profile on Connecting Edge; Surface is 1/8" Short on Connecting Side
- Available with Veneer (W) or HPL (P) Top, Must Specify
- Base Molding on Approach, Side, and User Side. Must Specify: Arlington or Wilmington (See Below)
- Standard with No Decorative Molding; Optional Wilmington Decorative Molding, [See Option Details](#) for Details; Must Specify (See Below)
- Control Switch Standard (Up/Down) or Upgrade to Advanced Switch (MSWCH-Up/Down/Memory); Switch is Field Installed; [See Switch Options](#)
- Optional Modesty Grommet for Wire Management to Wall; Must Specify: Black (GMBBL), Silver (GMBSV) or None (NONE)
- Wire Management Box Available; Attaches to Bottom Side of Worksurface and Moves Up/Down with Worksurface to Hide Cords/Wires from Top to Chassis ([See Option Details](#))
- Additional Options: Locking Pedestal ([See Locking Details](#)); Dove Tail Drawer Construction ([See Construction Details](#)); Grommet Options ([See Option Details](#)); Glass Marker Boards ([See Sizes and Details](#)); Advanced (Memory/Up/Down) Control Switch ([See Option Details](#)) Wire Management and Accessories (Order Separately; [See Multiple Unit Details](#))

Molding Options: Must Specify and Add

Arlington Molding Options		
BM2900	Arlington Base Molding	N/C
Wilmington Molding Options		
BM3600	Wilmington Base Molding	N/C
M3600	Optional Wilmington Decorative Molding	\$ 139

Note: Wilmington Decorative Molding may only be used with Wilmington Base Molding

[See Arlington Intro Section for Ordering Options](#)

Item	Model No.	Width	Depth	Height	K	Ship Wt	Cubic Ft	List Price	
HEIGHT ADJUSTABLE RETURN WITH FILE/FILE FOR MULTIPLE SURFACES	Left Ped	Right Ped							
	29-2448LF2STS3	29-2448RF2STS3	48	24	30-45	30¼	197	23.1	P\$ 5651 W\$ 5920
3-CHANNEL, FOR TWO SIMULTANEOUS WORKSURFACES	29-2442LF2STS3	29-2442RF2STS3	42	24	30-45	30¼	182	20.4	P\$ 5271 W\$ 5532

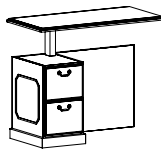

Shown as Left

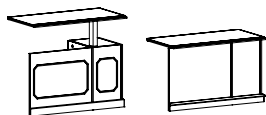

Approach Shown with and without Decorative Molding

Must Specify (in this order):

- Model #
- Surface Material Finish/Color
- Base Molding
- Decorative Molding
- Drawer Pull
- Locking
- Drawer Construction
- Top Grommet Location/Color
- Modesty Grommet

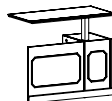

Description

- Standard with: Rectangle Top Profiled on Approach and User Sides with Reverse Profile on Connecting Side, Base Molding on All Sides, Decorative Molding on Approach and Side, File/File Ped, Front-To-Back Grain Direction on Top, 3-Channel Leg Configuration for Simultaneous Surface Height Adjustment Across Two Units, and Wire Management from Pedestal to Kneespace
- Available with Veneer (W) or HPL (P) Top, Must Specify
- **Must Be Used with Height Adjustable Single Pedestal Desk (Order Separately, [See Single Ped Desk](#))**
- Control Switch Not Included, Will Be On Adjoining Unit
- Optional Worksurface Grommet with or without Mesh Wire Management Sleeve Available Over Ped Only; 6" from Ends and 20" from User; Must Specify Location and Color: GL or GL-MESH for Left or GR or GR-MESH for Right; Color Options: Black (BLK) or Silver (SLV)
- Optional Modesty Grommet for Wire Management to Wall; Must Specify: Black (GMBBL), Silver (GMBSV) or None (NONE)
- Monitor Arms not Available on this Unit
- Additional Options: Locking Pedestal ([See Locking Details](#)); Dove Tail Drawer Construction ([See Construction Details](#)); Grommet Options ([See Option Details](#)); Glass Marker Boards ([See Sizes and Details](#)); Wire Management and Accessories (Order Separately; [See Multiple Unit Details](#))

Molding Options: Must Specify and Add

Arlington Molding Options

BM2900	Arlington Base Molding	N/C
--------	------------------------	-----

Wilmington Molding Options

BM3600	Wilmington Base Molding	N/C
M3600	Optional Wilmington Decorative Molding	\$ 139

Note: Wilmington Decorative Molding may only be used with Wilmington Base Molding

Pricing Codes:
P = HPL Top
W = Veneer Top

[See Arlington Intro Section for Ordering Options](#)

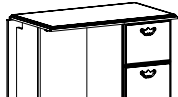
Item	Model No.		Width	Depth	Height	K	Ship Wt	Cubic Ft	List Price	
STATIONARY RETURN WITH FILE/FILE 	Left Ped	Right Ped								
	29-2448LF2SR	29-2448RF2SR	48	24	30-45	30¼	125	23.1	P\$ 3065	W\$ 3333
	29-2442LF2SR	29-2442RF2SR	42	24	30-45	30¼	110	20.4	P\$ 2684	W\$ 2945

Shown as Right

Must Specify (in this order):

- Model #
- Surface Material
- Finish/Color
- Base Molding
- Decorative Molding
- Drawer Pull
- Locking
- Drawer Construction
- Top Grommet Location/Color
- Modesty Grommet

Description

- Standard with: Rectangle Top, Decorative Molding on Approach and Side, File/File Ped, Front-To-Back Grain Direction on Top, 2-Channel Leg Configuration for Single Surface Height Adjustment, and Wire Management from Pedestal to Kneespace
- Top Profiled on 4 Sides; Surface is ¼" Short on Connecting Side
- Available with Veneer (W) or HPL (P) Top, Must Specify
- **Must Be Used with Height Adjustable Single Pedestal Desk (Order Separately, [See Single Ped Desk](#))**
- Control Switch Not Included, Will Be On Adjoining Unit
- Optional Modesty Grommet for Wire Management to Wall; Must Specify: Black (GMBBL), Silver (GMBSV) or None (NONE)
- Monitor Arms not Available on this Unit
- Additional Options: Locking Pedestal ([See Locking Details](#)); Dove Tail Drawer Construction ([See Construction Details](#)); Grommet Options ([See Option Details](#)); Glass Marker Boards ([See Sizes and Details](#)); Wire Management and Accessories (Order Separately; [See Multiple Unit Details](#))

Molding Options: Must Specify and Add

Arlington Molding Options

BM2900	Arlington Base Molding	N/C
--------	------------------------	-----

Wilmington Molding Options

BM3600	Wilmington Base Molding	N/C
M3600	Optional Wilmington Decorative Molding	\$ 139

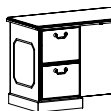

Note: Wilmington Decorative Molding may only be used with Wilmington Base Molding

[See Arlington Intro Section for Ordering Options](#)

Item	Model No.	Width	Depth	Height	K	Ship Wt	Cubic Ft	List Price
HEIGHT ADJUSTABLE BRIDGE	29-2448UFSTS	48	24	30-45	30	250	24.0	P\$ 6744 W\$ 7011
2-CHANNEL, FOR ONE WORKSURFACE	29-2442UFSTS	42	24	30-45	30	230	21.8	P\$ 6673 W\$ 6938

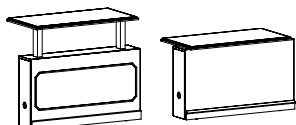
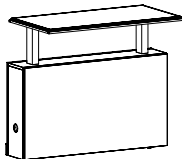

Approach Shown with and without Decorative Molding

Must Specify (in this order):

- Model #
- Surface Material
- Finish/Color
- Base Molding
- Decorative Molding
- Top Grommet Location/Color
- Back Panel Grommet
- Control Switch

Description

- Standard with: Rectangle Top Profiled on All Sides, Base Molding on Back Side, Decorative Molding on Approach, Front-To-Back Grain Direction on Top, 2-Channel Leg Configuration for Single Surface Height Adjustment, and Standard Up/Down Control Switch (Field Installed)
- Available with Veneer (W) or HPL (P) Top, Must Specify
- Optional Worksurface Grommet with or without Mesh Wire Management Sleeve or Wire Management Box Available On Center Only ([See Option Details](#))
- Optional Modesty Grommet for Wire Management to Wall; Must Specify: Black (GMBBL), Silver (GMBSV) or None (NONE)
- Control Switch Standard (Up/Down) or Upgrade to Advanced Switch (MSWCH-Up/Down/Memory); Switch is Field Installed; [See Switch Options](#)
- Base Molding on Approach, Must Specify: Arlington or Wilmington (See Below)
- Standard with No Decorative Molding; Optional Wilmington Decorative Molding, [See Option Details](#); Must Specify (See Below)
- Additional Options: Worksurface Grommet Options ([See Option Details](#)); Kneespace Options Available for Field Installation Only ([See 01-KB3](#)); Wire Management and Accessories (Order Separately; [See Multiple Unit Details](#))
- Note: Surface is 1/8" Short on Both Connecting Sides to Prevent Contact Between Tops

Molding Options: Must Specify and Add

Arlington Molding Options

BM2900	Arlington Base Molding	N/C
--------	------------------------	-----

Wilmington Molding Options

BM3600	Wilmington Base Molding	N/C
M3600	Optional Wilmington Decorative Molding	\$ 139

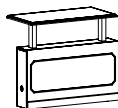

Note: Wilmington Decorative Molding may only be used with Wilmington Base Molding

Pricing Codes:
P = HPL Top
W = Veneer Top

[See Arlington Intro Section for Ordering Options](#)

Item	Model No.	Width	Depth	Height	K	Ship Wt	Cubic Ft	List Price
HEIGHT ADJUSTABLE BRIDGE FOR MULTIPLE SURFACES	Left Ped	Right Ped						
	29-2448UFSTSL3	29-2448UFSTSR3	48	24	30-45	30	24.0	P\$ 5554 W\$ 5821
3-CHANNEL, FOR TWO SIMULTANEOUS WORKSURFACES	29-2442UFSTSL3	29-2442UFSTSR3	42	24	30-45	30	22.0	P\$ 5482 W\$ 5747

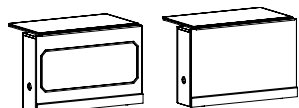

Approach Shown with and without Decorative Molding

Must Specify (in this order):

- Model #
- Surface Material
- Finish/Color
- Base Molding
- Decorative Molding
- Top Grommet Location/Color
- Back Panel Grommet
- Grommet Color

Description

- Standard with: Rectangle Top Profiled on All Sides, Base Molding on Back Side, Front-To-Back Grain Direction on Top, 3-Channel Leg Configuration for Multiple Surface Height Adjustment
- Available with Veneer (W) or HPL (P) Top, Must Specify
- Control Switch Not Included; Control Switch will be on Adjoining Worksurface
- Optional Worksurface Grommet with Mesh Wire Management Sleeve or Wire Management Box Available On Center Only ([See Option Details](#))
- Optional Modesty Grommet for Wire Management to Wall; Must Specify: Black (GMBBL), Silver (GMBSV) or None (NONE)
- Base Molding on Approach, Must Specify: Arlington or Wilmington (See Below)
- Standard with No Decorative Molding; Optional Wilmington Decorative Molding, [See Option Details](#); Must Specify (See Below)
- Additional Options: Wire Management and Accessories (Order Separately; [See Multiple Unit Details](#))
- Note: Surface is 1/8" Short on Both Connecting Sides to Prevent Contact Between Tops

Molding Options: Must Specify and Add

Arlington Molding Options

BM2900	Arlington Base Molding	N/C
--------	------------------------	-----

Wilmington Molding Options

BM3600	Wilmington Base Molding	N/C
M3600	Optional Wilmington Decorative Molding	\$ 139

Note: Wilmington Decorative Molding may only be used with Wilmington Base Molding

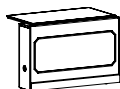

[See Arlington Intro Section for Ordering Options](#)

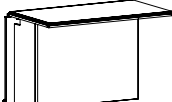
Item	Model No.		Width	Depth	Height	K	Ship Wt	Cubic Ft	List Price
STATIONARY BRIDGE FULL MODESTY 	Left Attachment	Right Attachment							
	29-2448SUFL	29-2448SUFR	48	24	30	22	89	5.5	P\$ 1736 W\$ 2004
	29-2442SUFL	29-2442SUFR	42	24	30	22	89	5.5	P\$ 1666 W\$ 1930

Shown as Right

Must Specify (in this order):

- Model #
- Top Material
- Finish/Color
- No Molding
- Top Grommet Location/Color
- Back Panel Grommet

Description

- Standard with: Rectangle Top Profiled on All Sides with Reverse Profile on Connecting Side (To Credenza), Base Molding on Back Side, Decorative Molding on Approach, and Front-To-Back Grain Direction on Top
- Available with Veneer (W) or HPL (P) Top, Must Specify
- **Must Be Used with Height Adjustable Single Pedestal Desk (Order Separately, [See Single Ped Desk](#))**
- Optional Modesty Grommet for Wire Management to Wall; Must Specify: Black (GMBBL), Silver (GMBSV) or None (NONE)
- Base Molding on Approach, Must Specify: Arlington or Wilmington (See Below)
- Standard with No Decorative Molding; Optional Wilmington Decorative Molding, [See Option Details](#) for Details; Must Specify (See Below)
- Additional Options: Worksurface Grommet Options ([See Option Details](#)); Kneespace Options Available for Field Installation Only ([See 01-KB3](#)); Wire Management and Accessories (Order Separately; [See Multiple Unit Details](#))
- Note: Surface is 1/8" Short on Connecting Side (To Height Adjustable Desk)

Molding Options: Must Specify and Add

Arlington Molding Options

BM2900	Arlington Base Molding	N/C
--------	------------------------	-----

Wilmington Molding Options

BM3600	Wilmington Base Molding	N/C
M3600	Optional Wilmington Decorative Molding	\$ 139

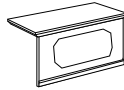

Note: Wilmington Decorative Molding may only be used with Wilmington Base Molding

Pricing Codes:
P = HPL Top
W = Veneer Top

[See Arlington Intro Section for Ordering Options](#)

Item	Model No.	Width	Depth	Height	Ship Wt	Cubic Ft	List Price
CONFERENCE TABLE ONE PIECE TOP	29-4296RT	96	42	30	140	12.5	P\$ 3724 W\$ 4387
	<i>Accommodates Eight (8) Chairs</i>						
	29-3672RT	72	36	30	91	6.6	P\$ 3085 W\$ 3596
	<i>Accommodates Six (6) Chairs</i>						

Description

- One (1) Piece Top
- Available with Veneer (W) or HPL (P) Top, Must Specify
- Top and Bases Shipped Separately
- Bases Must e Specified. Top Price Includes Standard Two (2) Rectangle Bases with Two (2) Stretchers, Optional Queen Anne Bases Available (See Below)
- Queen Anne Base Features Multi-Step, Hand-Finished Catalyzed Finish
- Additional Options: Grommet Options ([See Options and Locations](#)), Power Options ([See Multiple Unit Details](#))

Must Specify for Top (in this order):

Model #
Surface Material
Finish/Color
PDC Style / Location
Base

Must Specify for Base (in this order):

Model #
Finish

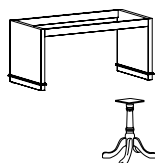

Options: Must Specify and Add

29-2828TB	Rectangular Bases (Includes 2 Bases and 2 Stretchers)	104	7.0	Included
01-0606QB	Upgrade Queen Anne Base (Includes 2 Bases)	54	22.4	\$ 943

Arlington Meeting and Conference Tables offer additional power and grommet options. See the Tables and Space Division Price List for more details.

CONFERENCE TABLE TWO PIECE TOP	29-48144RT	144	48	30	315	22.0	P\$ 7711 W\$ 8820
	<i>Accommodates Twelve (12) Chairs</i>						
	29-48120RT	120	48	30	198	22.0	P\$ 4696 W\$ 5584
	<i>Accommodates Ten (10) Chairs</i>						

Description

- Two (2) Piece Top
- Available with Veneer (W) or HPL (P) Top, Must Specify
- Top and Bases Shipped Separately
- Bases Must Be Specified. Top Price Includes Standard Two (2) Rectangle Bases with Two (2) Stretchers, Optional Queen Anne Bases Available (See Below)
- Queen Anne Base Features Multi-Step, Hand-Finished Catalyzed Finish
- Additional Options: Grommet Options ([See Options and Locations](#)), Power Options ([See Multiple Unit Details](#))

Must Specify for Top (in this order):

Model #
Finish Color
PDC Style / Location
Base

Must Specify for Base (in this order):

Model #
Finish Color

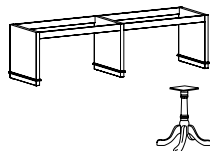

Options: Must Specify and Add

29-2828TB	Rectangular Bases (Includes 3 Bases and 4 Stretchers)	104	7.0	Included
01-0606QB	Upgrade Queen Anne Base (Includes 3 Bases)	80	33.6	\$ 1414

Arlington Meeting and Conference Tables offer additional power and grommet options. See the Tables and Space Division Price List for more details.

[See Arlington Intro Section for Ordering Options](#)

Item	Model No.	Width	Depth	Height	Ship Wt	Cubic Ft	List Price
MAGNETIC GLASS MARKER BOARD	GMB-2372W	72	½	23	56	10.2	\$ 2595
FOR USE WITH 30"H DESKS, CREDENZA AND WALL MOUNT HUTCHES	GMB-2366W	66	½	23	52	9.5	\$ 2458
	GMB-2360W	60	½	23	47	8.8	\$ 2182
	GMB-2354W	54	½	23	42	8.0	\$ 1976
	GMB-2348W	48	½	23	38	7.3	\$ 1838
	GMB-2342W	42	½	23	33	6.6	\$ 1563
	GMB-2336W	36	½	23	28	5.8	\$ 1357
	GMB-2330W	30	½	23	23	5.1	\$ 1151

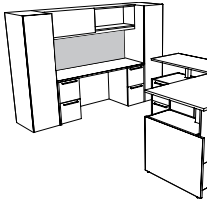
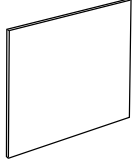

Must Specify (in this order):

Model #
Color

Description

- Available in Black (BLMKR) or White (WHMKR), Must Specify
- Tempered Glass Magnetic Marker Boards Are One (1) Piece with No Seams
- Mounting Brackets Included
- For Use over 30"H Desks and Credenzas with Wall Mount Hutches
- For Magnet, Marker and Eraser Sets Available; [See Set Details](#)



Magnet, Marker and Eraser Sets Available. [See Set Details](#)

MAGNETIC GLASS MARKER BOARD	GMB-4048W	48	½	40%	67	11.0	\$ 3128
FOR USE WITH 30"H DESKS, CREDENZA AND WALL MOUNT HUTCHES	GMB-4042W	42	½	40%	58	9.9	\$ 2644
	GMB-4036W	36	½	40%	50	8.8	\$ 2285
	GMB-4030W	30	½	40%	42	7.7	\$ 1924

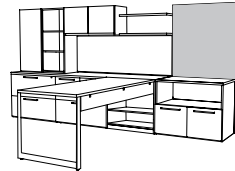

Must Specify (in this order):

Model #
Color

Description

- Available in Black (BLMKR) or White (WHMKR), Must Specify
- Tempered Glass Magnetic Marker Board Includes Mounting Brackets
- For Use over 30"H Desks and Credenzas with Wall Mount Hutches or Shelving
- For Magnet, Marker and Eraser Sets Available; [See Set Details](#)



Magnet, Marker and Eraser Sets Available. [See Set Details](#)

[See Arlington Intro Section for Ordering Options](#)

Item	Model No.	Width	Depth	Height	Ship Wt	Cubic Ft	List Price
GLASS MARKER BOARD	GMB-7036W	36	½	70⅞	87	13.8	\$ 3834
FOR USE FROM FLOOR TO TOP OF UNIT	GMB-7030W	30	½	70⅞	72	12.1	\$ 3215

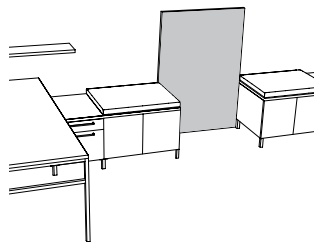

Description

- Available in Black (BLMKR) or White (WHMKR), Must Specify
- Tempered Glass Magnetic Marker Boards Marker Boards Are One (1) Piece with No Seams
- Mounting Brackets Included
- For Use From Floor to Top of Unit
- For Magnet, Marker and Eraser Sets Available; [See Set Details](#)

Must Specify (in this order):

Model #
Color



Magnet, Marker and Eraser Sets Available; [See Set Details](#)

SURFACE MOUNT TACKBOARDS
23" H

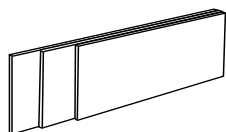

Model #	Size	COM ydg	COM, 1, 2 or 3	Grades						
				4	5	6	7	8	9	10
TB-2972H	72"	2.25	\$ 566	879	1025	1174	1385	1606	1862	2159
TB-2966H	66"	2.00	\$ 533	811	941	1073	1261	1457	1685	1949
TB-2960H	60"	2.00	\$ 498	776	906	1038	1226	1422	1650	1914

Description

- Coordinates with Surface Mount Hitches
- Factory Installed

WALL MOUNT TACKBOARDS
23" H

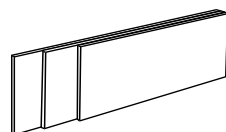

Model #	Size	COM ydg	COM, 1, 2 or 3	Grades						
				4	5	6	7	8	9	10
TB-6572W	72"	2.25	\$ 642	955	1101	1250	1461	1682	1938	2235
TB-6566W	66"	2.00	\$ 609	887	1017	1149	1337	1533	1761	2025
TB-6560W	60"	2.00	\$ 566	844	974	1106	1294	1490	1718	1982
TB-6554W	54"	1.75	\$ 539	782	896	1012	1176	1348	1547	1778
TB-6548W	48"	1.50	\$ 492	701	798	897	1038	1185	1356	1554
TB-6542W	42"	1.25	\$ 446	620	701	784	901	1024	1166	1331
TB-6536W	36"	1.25	\$ 434	608	689	772	889	1012	1154	1319
TB-6530W	30"	1.00	\$ 394	533	598	664	758	856	970	1102

Description

- Coordinates with Wall Mount Hitches
- Field Installed

[See Arlington Intro Section for Ordering Options](#)

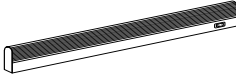
Item	Model No.		Width	Depth	Height	Ship Wt	Cubic Ft	List Price
LED TASKLIGHTS 	TL-0848	240-LED, 18 Watts	47½	7⁄8	1½	-	-	\$ 445
	TL-0824	84-LED, 7 Watts	22½	7⁄8	1½	-	-	\$ 368

Description

- Includes the Power Supply and Three (3) Upper Wire Management Grommet
- Rocker Style On/Off Switch with a 10' Power Cord
- Grommet Color will Match Lower Grommet Color

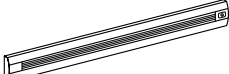
LED TASKLIGHTS 	01-188LED58	96-LED, 33.7 Watts	57¾	2	¾	-	-	\$ 1648
	01-94LED31	48-LED, 17.6 Watts	30¾	2	¾	-	-	\$ 1195
	01-47LED17	24-LED, 9.1 Watts	16¾	2	¾	-	-	\$ 690

Description

- Includes the Power Supply and Three (3) Upper Wire Management Grommet
- 12' Power Cord
- Grommet Color will Match Lower Grommet Color
- Optional Occupancy Sensor Shuts Off After 30 Minutes of Inactivity and Turns On Immediately When Reentering the Detection Area

Options: Specify & Add

01-OSRP	Occupancy Sensor							\$ 366
---------	------------------	--	--	--	--	--	--	--------

KEYBOARD MECHANISM WITH KEYBOARD CLAMP 	01-KB3		26½	14	4.5	16	1.4	\$ 914
---	--------	--	-----	----	-----	----	-----	--------

Description

- Standard With: 18.75" Platform with Swivel-Below Mouse Platform, +/- 15° Tilt Adjustment, 360° Rotation, 7" Lift and Lock Height Adjustment, Independent Tilt Adjustment, Palm Rest for Mousing Surface
- Left or Right Handed Mouse Platform
- Cannot Be Used on 20" or 21" Deep Unit
- Not Available with Optional Center Grommet
- Track Measures 21"

Options: Specify & Add

KB3	Factory Installed							\$ 208
-----	-------------------	--	--	--	--	--	--	--------

ROUND GROMMET COVER 	01-GRMTBK	Black	2¾	2¾	-	1	0.1	\$ 11
	01-GRMTSL	Silver						

Description

- 2¾" (60mm) Round Grommet Cover
- Field Installed

OPEN MARKET ONLY
(SILVER)

[See Arlington Intro Section for Ordering Options](#)

Item	Model No.		Width	Depth	Height	Ship Wt	Cubic Ft	List Price
------	-----------	--	-------	-------	--------	---------	----------	------------

SINGLE POWER SAND DOLLAR

01-SAND60PW	White
01-SAND60PB	Black
01-SAND60PS	Silver

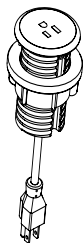
**Description**

- Unit is 2" Diameter; Mounts in 60mm Round Grommet
- 6' Cord
- Single Power Outlet

DOUBLE USB SAND DOLLAR

01-SAND60UW	White
01-SAND60UB	Black
01-SAND60US	Silver

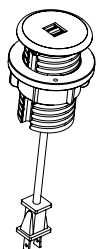
**Description**

- Unit is 2" Diameter; Mounts in 60mm Round Grommet
- 6' Cord
- Dual USB Outlets

WORKSURFACE POWER CENTER

01-INTRFC1A	Aluminum	14¼	6¾	3¾	11	0.3	\$ 2064
01-INTRFC1B	Black						

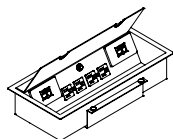
**Description**

- For Use with Conference Tables
- Includes: Four (4) Power Receptacles in Two (2) 15 Amp Duplexes, One (1) 15 Amp Circuit Breaker, One (1) Voice Port and Three (3) Data Ports, 6' Power Cord
- One (1) Convenience Plug on Bottom
- UL Listed/CSA Certified
- Optional Telecom Plates, See Arlington Tables in the Table and Space Division Price List

OASIS MINI POWER & DATA

01-OASISMA	Aluminum	14¼	6¾	2¾	11	0.3	\$ 3191
01-OASISMB	Black						



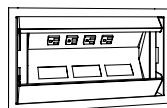

Top View

**Description**

- For Use with Conference Tables
- Plate Includes: Two (2) Data and Four (4) Power Outlets, 9' Power Cord
- Two (2) Telecom Plates Included with the Unit: One (1) 01-ABLAB Plate (Consists of One (1) RJ45 Cat 6, One (1) RJ11 Cat 3 Phone Jack); One (1) 01-ABLB Plate (Consists of One (1) RJ45 Cat 6)
- 9' Cord with Nema Plug; Fits 15A/120V AC Receptacles
- Soft Touch Hinged Lid
- UL Listed
- See Optional Telecom Plates in the Table and Space Division Price List

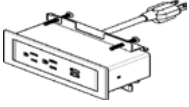
[See Arlington Intro Section for Ordering Options](#)

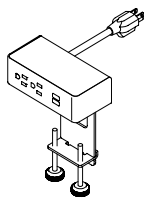
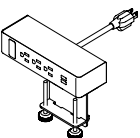
Item	Model No.		Width	Depth	Height	Ship Wt	Cubic Ft	List Price
	01-DUOBEZELW	White	6½	2½	3¼	1	0.2	\$ 675
	01-DUOBEZELB	Black						
	01-DUOBEZELS	Silver						
	<p>Description</p> <ul style="list-style-type: none"> • For Use with Conference Tables • Sits on Worksurface and Includes: Two (2) Power Outlet, Two (2) USB Ports, 10' Cord, and All Mounting Hardware • Independent USB Circuit Controllers Deliver up to 2.1 Amps to Each Post • FCC Part 15A, UL Approved for Horizontal and Vertical Applications 							
	01-TRIOBEZELW	White	9	2½	3	1	0.2	\$ 725
	01-TRIOBEZELB	Black						
	01-TRIOBEZELS	Silver						
	<p>Description</p> <ul style="list-style-type: none"> • For Use with Conference Tables • Sits on Worksurface and Includes: Three (3) Power Outlets, Two (2) USB Ports, One (1) Open Data, 10' Cord, and All Mounting Hardware • HDMI, VGA, or RJ45 Accessory for Open Data Port Specified Separately, See Below • Independent USB Circuit Controllers Deliver up to 2.1 Amps to Each Post • FCC Part 15A, UL Approved for Horizontal and Vertical Applications 							
	01-DUOCLAMPW	White	5½	3	7	1	0.2	\$ 572
	01-DUOCLAMPB	Black						
	01-DUOCLAMPS	Silver						
	<p>Description</p> <ul style="list-style-type: none"> • Standard with: Two (2) Power Outlet, Two (2) USB Ports, 10' Cord • Clamps to Top and Features Silver Metal Trim • Independent USB Circuit Controllers Deliver up to 2.1 Amps to Each Post • All Mounting Hardware Included • FCC Part 15A and UL Approved for Horizontal and Vertical Applications 							
	01-TRIOCLAMPW	White	8	3	7	1	0.2	\$ 671
	01-TRIOCLAMPB	Black						
	01-TRIOCLAMPS	Silver						
	<p>Description</p> <ul style="list-style-type: none"> • Standard with: Three (3) Power Outlets, Two (2) USB Ports, One (1) Open Data, 10' Cord • Clamps to Top and Features Silver Metal Trim • Independent USB Circuit Controllers Deliver up to 2.1 Amps to Each Post • HDMI, VGA, or RJ45 Accessories Sold Separately • All Mounting Hardware Included • FCC Part 15A and UL Approved for Horizontal and Vertical Applications 							

[See Arlington Intro Section for Ordering Options](#)

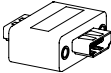
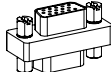
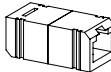
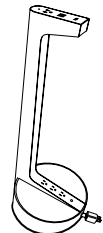
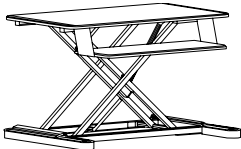
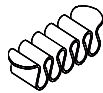
Item	Model No.	Width	Depth	Height	Ship Wt	Cubic Ft	List Price
TRIO HDMI DATA PORT ACCESSORY	01-LCOMHDMI	-	-	-	1	0.2	\$ 166
	Description						
	• HDMI Port for Trio Bezel Units						
OPEN MARKET ONLY							
TRIO VGA DATA PORT ACCESSORY	01-LCOMVGA	-	-	-	1	0.2	\$ 121
	Description						
	• VGA Port for Trio Bezel Units						
TRIO RJ45 DATA PORT ACCESSORY	01-LCOMRJ45	-	-	-	1	0.2	\$ 79
	Description						
	• RJ45 Port for Trio Bezel Units						
VESTA POWER CENTER	01-PDCTR	10¾	12	28¾	14	2.5	\$ 1776
	Description						
	• Top Includes One (1) Power Outlet, Two (2) USB Ports and One (1) USBC Port; Base Includes Three (3) Outlet						
	• Available in White						
	• 120" Power Cord						
	• Built with Weight Distribution for Optimal Stability						
	• Base is 5" Tall						
HEIGHT ADJUSTABLE WORKSTATION	01-S2SBLK Black	35½	25	6-22	49	6.5	\$ 1503
	Description						
	• Height Adjustable						
	• Weight Capacity: 35lbs						
	• One-Handed Operation; Platforms Move Simultaneously						
	• Keyboard Platform: 10½"D x 26⅝"W						
	• Worksurface: 21"D x 35½"W						
	• Can be Used on Worksurface 24"D x 35"W						
CABLE GRIP	01-WMGRCB	5¾	2¾	-	-	-	\$ 17
	Description						
	• Under Surface Wire Management						
	• Black						

[See Arlington Intro Section for Ordering Options](#)

Item	Model No.		Width	Depth	Height	Ship Wt	Cubic Ft	List Price
LINK 360 CABLE MANAGER	01-0251LINKSLV	Silver	5 $\frac{3}{16}$	3 $\frac{3}{16}$	30-51	4	3.0	\$ 390
	01-0251LINKBLK	Black	5 $\frac{3}{16}$	3 $\frac{3}{16}$	30-51	4	3.0	\$ 353

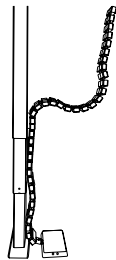

Description

- Kit Includes: 50 Link 360™ elements, One (1) Quad Connector, One (1) Dumbbell Connector, and One (1) Foot Assembly with Two (2) Magnetic Clips
- Can Be Used For Height-Adjustable Mechanisms Up To 51" or Free-Standing Use

WIRE CHANNEL	01-32125		24	1 $\frac{5}{8}$	1	.25	0.3	\$ 106
--------------	----------	--	----	-----------------	---	-----	-----	--------

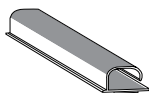

Description

- Available in Black
- Channels Attach with Two (2) Double-Sided Installation Tape
- Easily Attach to an Iconic Leg to Route Wires/Cords from the Top to the Floor
- Open J Channel for Easy Storage of Cables

WIRE MANAGEMENT CHANNEL	01-WMGR4		16	1 $\frac{1}{2}$	1	1	-	\$ 116
-------------------------	----------	--	----	-----------------	---	---	---	--------

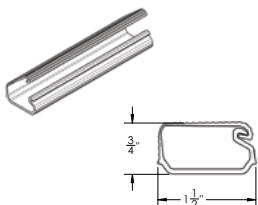

Description

- Set of Four (4) Black Plastic Wire Management Channels
- Snap Lock Channel
- Attaches with Adhesive Strips
- Ships via UPS Only

MARKER AND ERASER SET	01-MRKRSETBL	For Use with Black Marker Boards and Black Glass Doors						\$ 123
	01-MRKRSETWH	For Use with White Marker Boards and White Glass Doors						

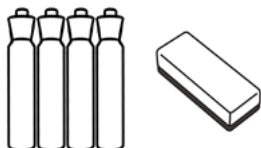

Description

- 01-MRKRSETWH May Also be Used with Standard Dry Erase Doors and Boards
- Includes Four (4) Markers and an Eraser

MAGNET SET	01-MAGBL	For Use with White Marker Boards						\$ 114
	01-MAGWH	For Use with Black Marker Boards						



Description

- Includes Set of Five (5) Magnets

[See Arlington Intro Section for Ordering Options](#)

Always stylish, comfortable, and effortlessly adaptable, Canvas enlivens environments with refined aesthetics born from an appealing mix of materials, finishes, and components. The redesign and expansion of integrated height adjustable units, white and black glass door options on hutch and storage units as well as a full line of white and black glass marker boards provide opportunities for more elegant and clean styling. Metal accents within the line include a broad scope of aluminum and black finishes with coordinating black, aluminum, chrome, and gold pull give you multiple choices to customize a look and feel for modern office environments.

CONSTRUCTION

Canvas Casegoods feature a TFL chassis with your choice of either a TFL or HPL top. Units ship assembled unless otherwise noted.

LAMINATES

- Exposed surfaces are woodgrain and solid color laminates fused to particle-board core
- Each laminate offers lasting beauty, superior resistance to normal wear, and easy maintenance

TOPS

- Worksurfaces are 1" thick Thermally-Fused Laminate (TFL) or High Pressure Laminate (HPL) with 3mm matching PVC rims on profiled edges and 1mm PVC rims on self edges HPL tops are 1 $\frac{3}{16}$ " thick with a 3mm PVC edge bands and TFL tops are 1" thick with a 3mm PVC edge bands; Designer White, Sugar Maple, Williamsburg Cherry feature ABS edge bands
- Optional 1 $\frac{1}{2}$ " thick HPL worksurfaces are available in select colors. Please contact Customer Service or your local Sales Rep for pricing and lead times.
- Grain direction runs left-to-right unless otherwise noted

CHASSIS

- Chassis is securely fastened using high-quality European fastening systems and heavy-duty, 16-gauge joining brackets to assure maximum strength
- All units ship with heavy-duty, adjustable leveling glides to ensure proper leveling and compensation for uneven floors
- All desks, non-lateral credenzas, and returns have wire management access from pedestal to kneespace

DRAWERS

- Drawers feature 5-sided construction allowing for easy removal of drawer fronts
- Drawer fronts are 3-ply construction, $\frac{3}{4}$ " thick with matched grain
- Drawer sides, back, and front are $\frac{1}{2}$ " thick, woodgrain vinyl wrapped construction with mitered corners
- Box and file drawers feature full extension, progressive action slides with precision steel ball bearings allowing side-to-side and front-to-back
- Optional soft close on box and file drawers allows front-to-back filing in file drawers**
- Optional wood dovetail construction with $\frac{7}{16}$ " thick hardwood sides and backs, and $\frac{5}{32}$ " thick hardboard bottoms
- Box and file drawers have $\frac{1}{8}$ " thick hardboard bottoms and tested for 100lb capacity
- Lateral files feature $\frac{1}{4}$ " thick bottoms. Drawers are tested for 200lb of equally distributed weight (ex: hanging file folders) and 65lbs of bottom load weight (ex: stacked catalogs)
- All suspensions have a limited lifetime warranty

FILING

- All file drawers are standard with filing systems designed to accommodate a variety of filing requirements
- Optional soft close on box and file drawers allows front-to-back filing in file drawer**
- Letter width file drawers provide letter filing front-to-back and legal filing side-to-side
- Lateral file drawers provide legal or letter filing front-to-back or side-to-side

STORAGE

- All hinged doors include soft close hinges, unless noted
- Soft close hinges reduce stress placed on the cabinet when the door is closed and offers a quiet closure

LOCKING

- All units with file drawers feature locking
- Removable lock cylinders allow for units to be re-keyed at a later date, if required
- Units are shipped randomly keyed as standard
- Keyed alike units available upon request at no additional charge
- Lock core is predetermined by pull color. Black lock cores are used with black and gold pulls while silver lock cores are used with chrome and aluminum pulls

CORD MANAGEMENT

- Grommets may be ordered in the tops of all assembled desks, returns, bridges, credenzas, and component worksurfaces
- All desks, returns, and credenzas (except lateral pedestals) have standard wire openings from inside the pedestal to the kneespace allowing quick access to technology below
- Additionally, returns, bridge units, kneespace credenzas, and hutch units have standard grommets in back panels
- Grommets are also standard in the tops of corner units and extended corner units
- Grommets are 2 $\frac{3}{8}$ " and are available in black or silver, must specify color
- [See all grommet options and locations](#)
- Undersurface Wire Manager ([Q1-WMGR4](#)) is available for additional cord management; See Accessories

HEIGHT ADJUSTABLE MECHANISMS

- Optional center drawer, Dock 950 and Dock 150, $\frac{3}{4}$ modesty panels, and kneespace options are not available with height adjustable units
- Height adjustment range 30"H-45"H
- 5-year warranty
- [See additional Height Adjust information](#)
- Height Adjustable units begin on [here](#)

STUDIO LEGS

- For each of the Studio models, standard or shared legs will need to be specified
- Choose to use four standard, a combination of standard or shared, or all shared legs on each unit
- The below images will provide a guide to the aesthetics of single, double, and shared legs
- Studio components begin on [here](#)

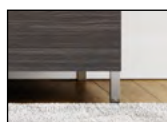

Single Standard Leg



Shared Leg (used between two models)



Double Standard Leg (standard legs used on each model)

INTERIOR DRAWER DIMENSIONS

Models

66-2515SHDP1	68-3672DP	68-3672BRPSTS
66-2415PD1	68-3672DPSTS	68-3672BDPS
66-1519MP	68-3672LPS	68-3672BDPSSTS
66-1519MP1	68-3672LPSSTS	68-3666BDP
68-4872CBLP	68-3672RPS	68-3666BDPSTS
68-4872CBRP	68-3672RPSSTS	68-3072DP
68-4272CLP	68-3672DPS	68-3072DPSTS
68-4272CRP	68-3672DPSSTS	68-3066DP
68-3672BDP	68-3672BLPS	68-3066DPSTS
68-3672BDPSTS	68-3672BLPSSTS	68-3066RP
68-3672LP	68-3672BRPS	68-3066RPSTS
68-3672LPSTS	68-3672BRPSSTS	68-3060DP
68-3672RP	68-3672BLP	68-3060DPSTS
68-3672RPSTS	68-3672BLPSTS	68-3060LP
68-3072LP	68-3066LP	68-3060LPSTS
68-3072LPSTS	68-3066LPSTS	68-3060RP
68-3072RP	68-3072RPSTS	68-3060RPSTS

Drawers

	W	L	D
Box	12 ¹ / ₈ "	16 ³ / ₁₆ "	3 ¹ / ₂ "
File	12 ¹ / ₈ "	16 ³ / ₁₆ "	9 ⁵ / ₁₆ "

Models

68-4824RF2	68-2466RC2	68-2448RF2
68-4824RF2STS	68-2466RC2STS	68-2448RF2STS
68-4824LF2	68-2466LC2	68-2448RF2STS3
68-4824LF2STS	68-2466LC2STS	68-2448LF2
68-4224RF2	68-2472SC	68-2448LF2STS
68-4224RF2STS	68-2472RC2	68-2448LF2STS3
68-4224RF2STS3	68-2472RC2STS	68-2442RF2
68-4224LF2	68-2472LC2	68-2442RF2STS
68-4224LF2STS	68-2472LC2STS	68-2442RF2STS3
66-1519MP2	68-2472KC	68-2442LF2
68-2466KC	68-2472KCSTS	68-2442LF2STS
68-2466KCSTS	66-2415PD2	68-2442LF2STS3
66-2515SHPD2		

Drawer

	W	L	D
File	12 ¹ / ₈ "	16 ³ / ₁₆ "	9 ⁵ / ₁₆ "

Models

68-4824RF1	68-2472RC1STS	68-2448LF1
68-4824RF1STS	68-2472LC1	68-2448LF1STS
68-4824LF1	68-2472LC1STS	68-2448LF1STS3
68-4824LF1STS	68-2466RC1	68-2442RF1
68-4224RF1	68-2466RC1STS	68-2442RF1STS
68-4224RF1STS	68-2466LC1	68-2442RF1STS3
68-4224RF1STS3	68-2466LC1STS	68-2442LF1
68-4224LF1	68-2448RF1	68-2442LF1STS
68-4224LF1STS	68-2448RF1STS	68-2442LF1STS3
68-2472RC1	68-2448RF1STS3	

Drawers

	W	L	D
Box	12 ¹ / ₈ "	16 ³ / ₁₆ "	3 ¹ / ₂ "
File	12 ¹ / ₈ "	16 ³ / ₁₆ "	9 ¹⁵ / ₁₆ "

Models

66-3684WDS2L	66-3672WDS2R	66-2430LF3
66-3684WDS2R	66-3084SU2	66-2430LF1
66-3672WDS2L	66-3072SU2	

Drawer

	W	L	D
Lat File	26 ³ / ₃₂ "	15 ¹ / ₁₆ "	9 ⁷ / ₃₂ "

Models

66-3684SU2	66-2466RL	66-2436LF3
66-3672SU2	66-2466LL	66-2436LF1

Drawer

	W	L	D
Lat File	32 ⁹ / ₃₂ "	15 ¹ / ₁₆ "	9 ⁷ / ₃₂ "

Models

66-2472L21OBFL	66-2072L21OBFL	66-2436L21BF
66-2472L21OBFR	66-2072L21OBFR	66-2036L21BF
66-2472L21DBF	66-2072L21DBF	

Drawers

	W	L	D
Box	32 ⁹ / ₃₂ "	13 ⁵ / ₈ "	3 ¹ / ₂ "
File	32 ⁹ / ₃₂ "	15 ¹ / ₁₆ "	9 ⁷ / ₃₂ "

Models

66-2460L21OBL	66-2060OBFL	66-2430L21BF
66-2460L21OBR	66-2060OBFR	66-2030L21BF
66-2460L21DBF	66-2060L21DBF	

Drawers

	W	L	D
Box	26 ⁹ / ₃₂ "	13 ³ / ₈ "	3 ¹ / ₂ "
File	26 ⁹ / ₃₂ "	15 ¹ / ₁₆ "	9 ⁷ / ₃₂ "

Models

66-2418L21BF	66-2018L21BF
--------------	--------------

Drawers

	W	L	D
Box	14 ⁹ / ₃₂ "	13 ³ / ₈ "	3 ¹ / ₂ "
File	14 ⁹ / ₃₂ "	15 ¹ / ₈ "	9 ⁷ / ₃₂ "

Model

66-2436OMF

Drawers

	W	L	D
Box	14 ⁹ / ₃₂ "	15 ¹ / ₈ "	3 ¹ / ₂ "
Lateral File	32 ⁹ / ₃₂ "	15 ¹ / ₁₆ "	9 ⁷ / ₃₂ "

Model

66-2430OMF

Drawers

	W	L	D
Box	11 ³ / ₄ "	16 ³ / ₁₆ "	3 ¹ / ₂ "
Lateral File	26 ⁹ / ₃₂ "	15 ¹ / ₁₆ "	9 ⁷ / ₃₂ "

Model

66-2472BF

Drawer

	W	L	D
Box	32 ¹ / ₈ "	16 ³ / ₁₆ "	3 ¹ / ₂ "

Models

66-2472RMR	66-2472LMF	66-2436MF
66-2472LMR	66-2466RMF	66-2436LF2
66-2472RMF	66-2466LMF	

Drawers

	W	L	D
Box	14 ⁹ / ₃₂ "	15 ¹ / ₈ "	3 ¹ / ₂ "
File	14 ⁹ / ₃₂ "	15 ¹ / ₈ "	9 ⁵ / ₁₆ "
Lat File	32 ⁹ / ₃₂ "	15 ¹ / ₁₆ "	9 ⁷ / ₃₂ "

INTERIOR DRAWER DIMENSIONS (CONTINUED)

Models			
66-2430LF2	66-2430MF		
Drawers			
	W	L	D
Box	11 ⁵ / ₁₆ "	16 ³ / ₁₆ "	3 ¹ / ₂ "
File	12 ¹ / ₈ "	16 ³ / ₁₆ "	9 ⁵ / ₁₆ "
Lat File	26 ⁷ / ₃₂ "	15 ¹ / ₁₆ "	9 ¹ / ₄ "

Models			
66-2418PD2	66-2451WD2L	66-1884WFO	
66-3018PD2	66-2451WD2R	66-1872DS2L	
66-3618PD2	66-1884DS2L	66-1872DS2R	
66-2484WD2L	66-1884DS2R	66-1872WFL	
66-2484WD2R	66-1884WFL	66-1872WFR	
66-2472WD2L	66-1884WFR	66-1872WFO	
66-2472WD2R			

Drawer	W	L	D
File	14 ⁹ / ₃₂ "	15 ¹ / ₈ "	9 ⁵ / ₁₆ "

Models			
66-3018PD1	66-2451WD1R	66-1884WBO	
66-2484WD1L	66-2418PD1	66-1872DS1L	
66-2484WD1R	66-1884DS1L	66-1872DS1R	
66-2472WD1L	66-1884DS1R	66-1872WBL	
66-2472WD1R	66-1884WBL	66-1872WBR	
66-2451WD1L	66-1884WBR	66-1872WBO	

Drawers	W	L	D
Box	14 ⁹ / ₃₂ "	15 ¹ / ₈ "	3 ¹ / ₂ "
File	14 ⁹ / ₃₂ "	15 ¹ / ₈ "	9 ⁵ / ₁₆ "

Models			
66-2415PD2	66-2515SHPD2	66-1519MP2	

Drawer	W	L	D
File	12 ¹ / ₈ "	16 ³ / ₁₆ "	9 ¹⁵ / ₁₆ "

Models			
66-2430L4	66-2430L3	66-2430L2	

Drawer	W	L	D
Lat File	25 ¹⁷ / ₃₂ "	15 ¹ / ₁₆ "	9 ⁷ / ₃₂ "

Models			
66-2472RL	66-2472DL	66-2436L3	
66-2472LL	66-2436L4	66-2436L2	

Drawer	W	L	D
Lat File	31 ¹ / ₂ "	15 ¹ / ₁₆ "	9 ⁷ / ₃₂ "

Model			
66-1622CD			

Drawer	W	L	D
Center	18 ¹ / ₁₆ "	14 ¹⁵ / ₁₆ "	1 ³ / ₄ "

FILING CAPABILITIES

Drawers with Dimensions: 11⁵/₁₆"W x 16³/₁₆"L

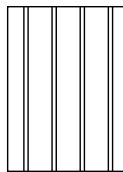

Letter or Legal Side to Side

Drawers with Dimensions: 12¹/₈"W x 16³/₁₆"L

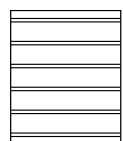

Letter Front to Back

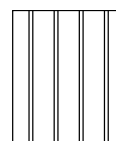

Legal Side to Side

Drawers with Dimensions: 14⁹/₃₂"W x 15¹/₈"L

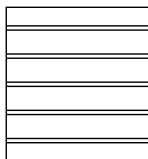

Letter Front to Back

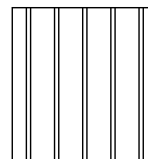

Legal Side to Side

Drawers with Dimensions: 25¹⁷/₃₂"W x 15¹/₁₆"L

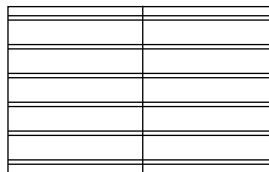

2 Rows Letter Front to Back

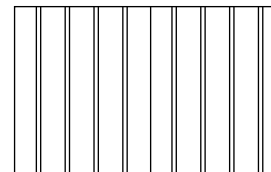

1 Row Letter or Legal Side to Side

Drawers with Dimensions: 26⁷/₃₂"W x 15¹/₁₆"L

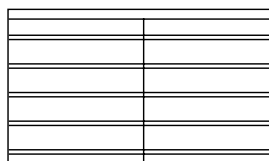

2 Rows Letter Front to Back

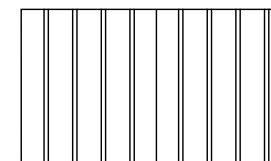

1 Row Legal Side to Side

Drawers with Dimensions: 31¹/₂"W x 15¹/₁₆"L

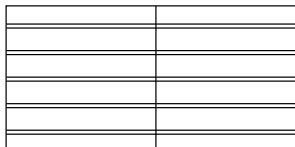

2 Rows Letter or Legal Front to Back

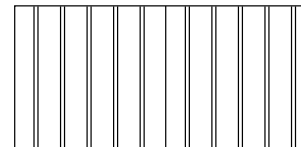

1 Row Letter or Legal Side to Side

Drawers with Dimensions: 32⁷/₃₂"W x 15¹/₁₆"L

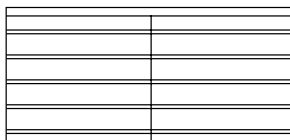

2 Rows Letter Front to Back

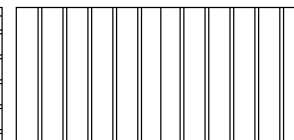

1 Row Legal Side to Side

HOW TO ORDER EXAMPLES

DESK WITH CREDENZA & HUTCH

	QTY	MODEL NO.	DESCRIPTION	EXAMPLE
DESK	1	68-3672DPS	Top Material	P
			Top Color	WC
			Edge Profile	X
			Chassis Color	WC
			Drawer Construction	DOV
			Drawer Track	SFTCL
			Grain Direction	VERTICAL
			Drawer Color	WC
			Modesty Panel	66-HGAF
			Modesty Color	GPA
			Grommet Location/ Wire Management	GL
			Grommet Color	BLK
			Power/Data	DOCK950B-R
Pull/Color	CFL			
Keyboard Option	N/A			
CREDENZA	1	68-2472KC	Top Material	P
			Top Color	WC
			Edge Profile	X
			Chassis Color	WC
			Drawer Construction	DOV
			Drawer Track	SFTCL
			Drawer Color	WC
			Grain Direction	VERTICAL
			Pull/Color	CFL
			Back Panel Grommet	SVR
			Grommets	LR
			Power/Data	NONE
			Grommet Color	SVR
Keyboard Option	N/A			
HUTCH	1	66-1572TWDS	Chassis Color	WC
			Door Style	HGA
			Door Color	GPA
			Locking	NO
			Paper Slot Color	WC
			Paper Slot Divider	CHROME

STUDIO DESK

	QTY	MODEL NO.	DESCRIPTION	EXAMPLE
DESK TOP	1	66-3672TP	Top Material	P
			Top Color	WTA
			Edge Profile	Y
			Grommet	GL
			PDC Type	01-DUO BEZELW
			PDC Location	PDC-C
			Grommet Color	BLK
			PEDESTAL	2
Drawer Color	WTA			
Grain Direction	VERTICAL			
Pull/Color	CST			
Drawer Construction	DOV			
Drawer Track	SFTCL			
Wire Management	NONE			

STUDIO DESK (CONTINUED)

	QTY	MODEL NO.	DESCRIPTION	EXAMPLE
MODESTY	1	66-3624MDHGA	HGA Color	WMA
			Grommet	GRMT
			Grommet Color	BLK
LEGS	2	01-0404SL4	Color	CHRM

HEIGHT ADJUSTABLE

	QTY	MODEL NO.	DESCRIPTION	EXAMPLE
DESK	1	68-3672LPSTS	Top Material	P
			Top Color	SBP
			Edge Profile	X
			Chassis Color	WTA
			Drawer Color	WTA
			Grain Direction	VERTICAL
			Pull/Color	CFL
			Drawer	DOV
			Construction	
			Drawer Track	SFTCL
			Moving Modesty	MOVMOD
			Height Adjust	MSWCH
			Switch	
			Wire Management	GL
			Grommet Color	BLK
			BRIDGE	1
Top Color	SBP			
Edge Profile	X			
Chassis Color	WTA			
Height Adjust	MSWCH			
Switch				
Wire Management	GR			
Grommet Color	SLV			
CREDENZA RIGHT	1	68-2472RC2STS	Modesty	GMBSV
			Grommet/Color	
			Top Material	P
			Top Color	SBP
			Edge Profile	X
DESK	1	68-2472RC2STS	Chassis Color	WTA
			Drawer Color	WTA
			Grain Direction	VERTICAL
			Pull/Color	CFL
			Drawer	DOV
			Construction	
			Drawer Track	SFTCL
			Height Adjust	MSWCH
			Switch	
			Wire Management	GL
			Grommet Color	SLV
			Modesty	GMBSV
			Grommet/Color	

TFL (T) AND HPL (P) LAMINATE OPTIONS

WOODGRAIN

AS Asian Night	PNW Pinnacle Walnut
BW Beigewood	PTK Portico Teak
CO Columbian Walnut	RC River Cherry
EF Espresso	SCH Select Cherry
FLW Florence Walnut	SPW Sepia Walnut
GC Golden Cherry	SKC Shaker Cherry
HVM Harvest Maple	SBP Smoky Brown Pear
KHE Kirsche	TK Studio Teak
MW Mahogany Walnut	SM Sugar Maple
MNR Midnight Run	WTA Weathered Ash
NTM Natural Marrone	WNB White Nebbia
ORW Oak Riftwood	WC Williamsburg Cherry

SOLID

BL Black	FHG Fashion Grey*
WH Designer White	SG Slate Grey*

* Not available on cylinder bases

1½" THICK WORKSURFACE HPL (P) LAMINATE OPTIONS

Tops 1½" thick are available in the following HPL colors. Top thickness will affect overall height of other units such as surface mounted hutches. Please contact Customer Service or your local Sales Representative for pricing and lead times.

WOODGRAIN

AS Asian Night	PNW Pinnacle Walnut
BW Beigewood	PTK Portico Teak
CO Columbian Walnut	RC River Cherry
EF Espresso	SCH Select Cherry
FLW Florence Walnut	SPW Sepia Walnut
GC Golden Cherry	SKC Shaker Cherry
HVM Harvest Maple	SBP Smoky Brown Pear
KHE Kirsche	TK Studio Teak
MW Mahogany Walnut	SM Sugar Maple
MNR Midnight Run	WTA Weathered Ash
NTM Natural Marrone	WNB White Nebbia
ORW Oak Riftwood	WC Williamsburg Cherry

SOLID

BL Black	FHG Fashion Grey
WH Designer White	SG Slate Grey

EDGE PROFILES

F Double Kerf	X Flute
G Duo	Y Square



Double Kerf (F) Duo (G) **Flute (X)** Square (Y)

METAL FINISH OPTIONS

ALUM Aluminum	CHRM Chrome
BLK Black	

ACRYLIC OPTIONS

FSTA Frosted Acrylic	BLA Black High Gloss Acrylic
WHA White High Gloss Acrylic	GPA Graphite High Gloss Acrylic
WMA Wired Mercury High Gloss Acrylic	

PULL OPTIONS

Lock core color is predetermined by pull color.

AAV Alcove, Aluminum	BEL Elite, Black
CAV Alcove, Chrome	AFL Flair, Aluminum
AAC Arc, Aluminum	CFL Flair, Chrome
BAC Arc, Black	AFC Focus, Aluminum
ABM Beam, Aluminum	BFC Focus, Black
BBM Beam, Black	AQD Quadra, Aluminum
BBT Bow Tie, Black	BQD Quadra, Black
NBT Bow Tie, Nickel	AST Studio, Aluminum
ABU Buckle, Aluminum	BST Studio, Black
BBU Buckle, Black	CST Studio, Chrome
AEL Elite, Aluminum	GST Studio, Gold



DRAWER CONSTRUCTION OPTIONS

Drawers come standard with woodgrain vinyl-wrapping and mitered corners. Optional wood dovetail construction for all box, file, and lateral file drawers is available. Must Specify when ordering.

Pricing is per Drawer, not per Model/Unit

MITER Mitered Fold Construction	STD
DOVE Wood Dove Tail Construction	\$ 45

DRAWER TRACK OPTIONS

Soft close tracks are available on box and file drawers only. Soft close drawer tracks have many benefits including reduced stress on the unit, extends the life of the drawer, and ensures a gentle close so fingers don't accidentally get hurt. **File drawers with the soft close option feature front-to-back filing.** Must specify when ordering.

Pricing is per Drawer, not per Model/Unit

SFTCL Soft Close Drawer Track (Box & File Drawers Only)	\$ 34
---	-------

LOCK CORE COLOR OPTIONS

BLK Black (Used with Black and Gold Pulls)
SLV Silver (Used with Aluminum and Chrome Pulls)



Grommet options on next page.

GROMMET OPTIONS & POWER UNIT LOCATIONS

Note: Wire Management Options for Integrated and Modular Height Adjustable Models may be found in their specific area within this section.

Grommets are standard in the back panels of returns, bridges, and credenzas, and may be ordered without grommets at no additional charge. Please specify NO GROMMET on order.

Grommets are available on hutches in standard locations for task light management at no additional charge. Please specify WMHUBL (Black) or WMHUSV (Silver).

Power units, Dock 950 and Dock 150 must be specified separately with surface mount location. Dock 950 and Dock 150 are available on Modular Benching Desk Tops, Modular Cabinet Tops, Work Tables, and Media Peninsula Tops, and where otherwise noted.

Grommets are available in standard locations. Please specify using info below. Multiple locations may be selected. Only one unit per location.

GROMMET LOCATIONS (Black = BLK and Silver = SLV)

GC	Grommet, Center	\$	52
GL	Grommet, Left	\$	52
GR	Grommet, Right	\$	52
GAL	Grommet, Approach Left - D-Tops Only	\$	52
GAR	Grommet, Approach Right - D-Tops Only	\$	52
GSL	Grommet, Seat Side Left - D-Tops Only	\$	52
GSR	Grommet, Seat Side Right - D-Tops Only	\$	52

DUO/TRIO BEZEL LOCATIONS

PDC-C	Bezel, Center
PDC-L	Bezel, Left
PDC-R	Bezel, Right

DOCK 950 and DOCK 150 LOCATIONS (See Dock Units)

DOCK950-L	D950 Wireless Charger, Left	\$	265
DOCK950-C	D950 Wireless Charger, Center	\$	265
DOCK950-R	D950 Wireless Charger, Right	\$	265
DOCK150-L	D150 Wireless and USB Charger, Left	\$	405
DOCK150-C	D150 Wireless and USB Charger, Center	\$	405
DOCK150-R	D150 Wireless and USB Charger, Right	\$	405

Verify Grommet Option is available on the model(s) you are specifying using the following location information. Grommets, Power Units, Dock 950 and Dock 150 may be ordered in non-standard locations. Call Customer Service to assist with specification and/or please attach a drawing to the PO showing the location of the grommet. Note additional charges and lead times may apply.

Models

68-4872CBLP	68-3672BLPS	68-3672BDP
68-4872CBRP	68-3672BRPS	68-3666BDP
68-3672BDPS	68-3672BRP	68-3672BLP

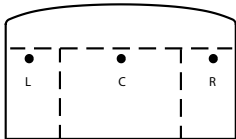

GL/GR: Located 6" from ends and 22½" from user side
GC: Located 22½" from user side

Models

68-4272CLP	68-3672RPS	66-3672SH*
68-4272CRP	68-3672LP	66-3666SH*
68-3672DPS	68-3672RP	66-3660SH*
68-3672LPS	68-3672DP	

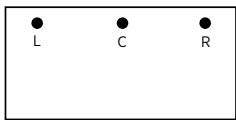

GL/GR: Located 6" from ends and 22½" from user side
GC: Located 22½" from user side

*PDC-L/PDC-R/DOCK950-L/DOCK950-R/DOCK150-L/DOCK150-R/PDC-C/DOCK950-C/DOCK150-C available only on Shell (SH) units in same locations

Models

68-3072DP	68-3060RP	66-3072SH*
68-3066DP	68-3066LP	66-3066SH*
68-3060DP	68-3066RP	66-3060SH*
68-3060LP	68-3072RP	68-3072LP

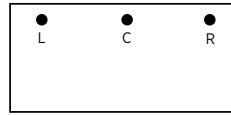

GL/GR: Located 6" from ends and 22½" from user side

GC: Located 22½" from user side

*PDC-L/PDC-R/DOCK950-L/DOCK950-R/DOCK150-L/DOCK150-R/PDC-C/DOCK950-C/DOCK150-C available only on Shell (SH) units in same locations

Models

68-2448LF1	66-2448UF	68-4824LF1
68-2448RF1	66-2448UFH	68-4824RF1
68-2448LF2	66-2442UF	68-4824LF2
68-2448RF2	66-2442UFH	68-4824RF2
68-2442LF1	66-2448RSHL	68-4224LF1
68-2442RF1	66-2448RSHR	68-4224RF1
68-2442LF2	66-2442RSHL	68-4224LF2
68-2442RF2	66-2442RSHR	68-4224RF2
66-2436UF	66-2436UFH	

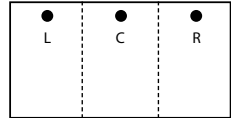

GL/GR: Located 6" from ends and 20" from user side

GC: Located 20" from user side

Models

66-2472LMR	66-2472LL	66-2472RMF
66-2472RMR	66-2472RL	66-2472LMF
66-2466LL	66-2466RL	66-2466LMF
66-2466RMF		

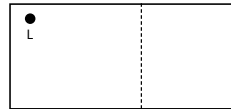

GL/GR: Located 6" from ends and 20" from user side

Grommets are only available on opposite side of pedestal

Models

68-2472KC	68-2472RC2	68-2466RC1
68-2472LC1	68-2466KC	68-2466LC2
68-2472RC1	68-2466LC1	68-2466RC2
68-2472LC2		

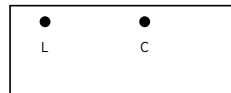

GL/GR: Located 6" from ends and 20" from user side

GC: Located 20" from user side

Models

66-2472SH	66-2466SH	66-2460SH
-----------	-----------	-----------

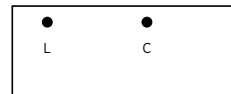

GL/GR/DOCK950-L/DOCK950-R/DOCK150-L/DOCK150-R: Located 6" from ends and 20" from user side

GC/DOCK950-C/DOCK150-C: Located 20" from user side

PDC-L/PDC-R: Located 6" from ends and 21" from user side

PDC-C: Located 21" from user side

GROMMET OPTIONS & POWER UNIT LOCATIONS (CONTINUED)

Models

66-2048UF 66-2042UF 66-2036UF
66-2048UFH 66-2042UFH 66-2036UFH

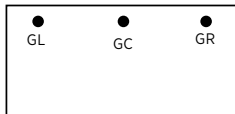

GL/GR: Located 6" from ends and 16" from user side
GC: Located 16" from user side

Models

66-2472L21DBF 66-2472L21OBFR 66-2472L21DO
66-2460L21DBF 66-2460L21OBFL 66-2460L21DO
66-2472L21OBFL 66-2460L21OBFR

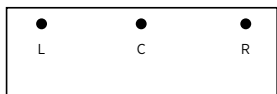

PDC-L/PDC-R: Located 11" from ends and 21½" from user side
PDC-C: Located 21½" from user side
GL/GR/DOCK950-L/DOCK950-R/DOCK150-L/DOCK150-R: Located 6" from ends and 20" from user side
GC/DOCK950-C/DOCK150-C: Located 20" from user side

Models

66-2072L21DBF 66-2072L21OBFR 66-2060L21OBFR
66-2060L21DBF 66-2060L21OBFL 66-2072L21DO
66-2072L21OBFL 66-2060L21DO

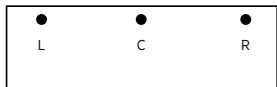

PDC-L/PDC-R: Located 11" from ends and 17½" from user side
PDC-C: Located 17½" from user side
GL/GR/DOCK950-L/DOCK950-R/DOCK150-L/DOCK150-R: Located 6" from ends and 16" from user side
GC/DOCK950-C/DOCK150-C: Located 16" from user side

Models

66-4284PR 66-4272PR
66-4284TR 66-4272TR

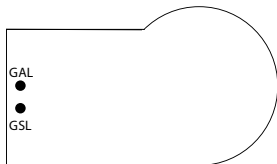

GAL/GSL: Located 12" from approach or seated side and 6" from end

Models

66-4284PL 66-4272PL
66-4284TL 66-4272TL

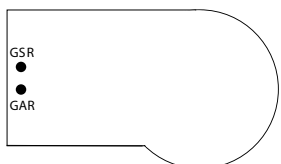

GAR/GSR: Located 12" from approach or seated side and 6" from end

Models

66-4272EDR



GAL: Located 12" from approach, 6" from end
GSL: Located 18" from approach, 6" from end

Model

66-4272EDL

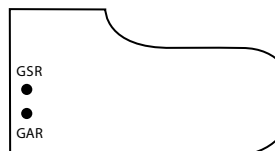

GAR: Located 12" from approach, 6" from end
GSR: Located 18" from approach, 6" from end

Models

66-3684DUR 66-3084DUR 66-3066DUR
66-3672DUR 66-3072DUR



GAL/GSL: Located 12" from approach or seated side and 6" from end

Models

66-3684DUL 66-3672DR 66-3066DUL
66-3672DUL 66-3084DUL 66-3066DR
66-3684DR 66-3072DUL



GAR/GSR: Located 12" from approach or seated side and 6" from end

MODULAR DESK TOPS

Models

66-3684TP 66-3648TP 66-3066TP
66-3678TP 66-3642TP 66-3060TP
66-3672TP 66-3084TP 66-3054TP
66-3666TP 66-3078TP 66-3048TP
66-3660TP 66-3072TP 66-3042TP
66-3654TP

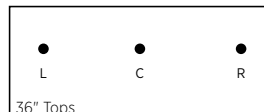
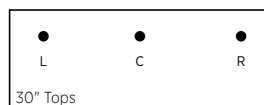
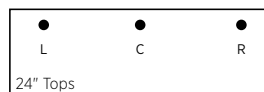

GL/GR/PDC-L/PDC-R/DOCK950-L/DOCK950-R/DOCK150-L/DOCK150-R: Located 11" from ends and 22½" from user side
GC/DOCK950-C/DOCK150-C: Located 22½" from user side

Additional grommet options on next page.

GROMMET OPTIONS & POWER UNIT LOCATIONS (CONTINUED)

MODULAR CABINET TOPS

Models

66-2496TP	66-2472TP	66-2448TP
66-2490TP	66-2466TP	66-2442TP
66-2484TP	66-2460TP	66-2436TP
66-2478TP	66-2454TP	66-2430TP

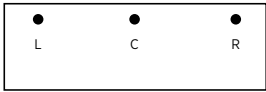

PDC-L/PDC-R: Located 11" from ends and 21½" from user side

PDC-C: Located 21½" from user side

GL/GR/DOCK950-L/DOCK950-R/DOCK150-L/DOCK150-R: Located 11" from ends and 20" from user side

GC/DOCK950-C/DOCK150-C: Located 20" from user side

Models

66-2096TP	66-2072TP	66-2048TP
66-2090TP	66-2066TP	66-2042TP
66-2084TP	66-2060TP	66-2036TP
66-2078TP	66-2054TP	66-2030TP

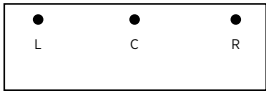

PDC-L/PDC-R: Located 11" from ends and 17½" from user side

PDC-C: Located 17½" from user side

GL/GR/DOCK950-L/DOCK950-R/DOCK150-L/DOCK150-R: Located 11" from ends and 16" from user side

GC/DOCK950-C/DOCK150-C: Located 16" from user side

Model

66-2418TP

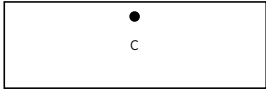

PDC-C: Located 21½" from user side

GC/DOCK950-C/DOCK150-C: Located 20" from user side

Model

66-2018TP

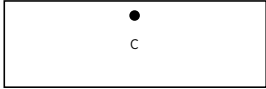

PDC-C: Located 17½" from user side

GC/DOCK950-C/DOCK150-C: Located 16" from user side

WORK TABLES

Models

66-4896WT	66-4860CWT	66-4260TWT
66-4896TWT	66-4296WT	66-4260CWT
66-4896CWT	66-4296TWT	66-3696TWT
66-4884WT	66-4296CWT	66-3696CWT
66-4884TWT	66-4284WT	66-3684TWT
66-4884CWT	66-4284TWT	66-3684CWT
66-4872WT	66-4284CWT	66-3672TWT
66-4872TWT	66-4272WT	66-3672CWT
66-4872CWT	66-4272TWT	66-3660TWT
66-4860WT	66-4272CWT	66-3660CWT
66-4860TWT	66-4260WT	

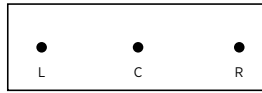

42" Work Tables

GL/GR/PDC-L/PDC-R/DOCK950-L/DOCK950-R/DOCK150-L/DOCK150-R: Located 6" from ends and 21" from user side

GC/PDC-C/DOCK950-C/DOCK150-C: Located 21" from user side

48" Work Tables

GL/GR/PDC-L/PDC-R/DOCK950-L/DOCK950-R/DOCK150-L/DOCK150-R: Located 6" from ends and 24" from user side

GC/PDC-C/DOCK950-C/DOCK150-C: Located 24" from user side

36" Work Tables

GL/GR/PDC-L/PDC-R/DOCK950-L/DOCK950-R/DOCK150-L/DOCK150-R: Located 6" from ends and 18" from user side

GC/PDC-C/DOCK950-C/DOCK150-C: Located 18" from user side

Models

66-2496WT	66-2484TWT	66-2472CWT
66-2496TWT	66-2484CWT	66-2460WT
66-2496CWT	66-2472WT	66-2460TWT
66-2484WT	66-2472TWT	66-2460CWT

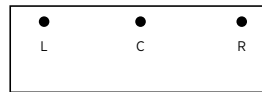

GL/GR/PDC-L/PDC-R/DOCK950-L/DOCK950-R/DOCK150-L/DOCK150-R: Located 6" from ends and 21½" from user side

GC/PDC-C/DOCK950-C/DOCK150-C: Located 21½" from user side

MODULAR BENCHING DESK TOPS

Models

66-6072TP	66-6066TP	66-6060TP
-----------	-----------	-----------

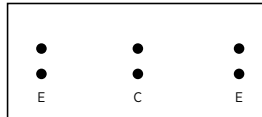

E = 11" from end
C = 25¼" from user

Only one style of unit per location.

Locations:

- 1C: 2 Center Cutouts
- 1E: 2 End Cutouts
- 2E: 4 End Cutouts
- C1E: 2 Center and 2 End Cutouts
- C2E: 2 Center and 4 End Cutouts

Models

66-4872TP	66-4866TP	66-4860TP
-----------	-----------	-----------

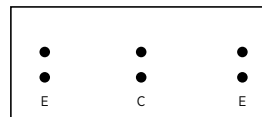

E = 11" from end
C = 19¾" from user

Only one style of unit per location.

Locations:

- 1C: 2 Center Cutouts
- 1E: 2 End Cutouts
- 2E: 4 End Cutouts
- C1E: 2 Center and 2 End Cutouts
- C2E: 2 Center and 4 End Cutouts

GROMMET OPTIONS & POWER UNIT LOCATIONS (CONTINUED)

Models

66-3672MPS
66-3672MP

66-3066MPS
66-3066MP

66-3060MPS
66-3060MP

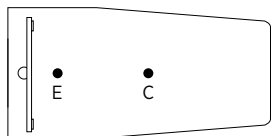

E = 12" from monitor end
C = Centered

DUO/TRIO BEZEL, Dock 950 and Dock 150. Only one style of unit per location.

Locations:

- C: Center Cutout
- E: End Cutout
- EC: End and Center Cutouts

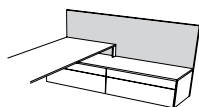

51" Gallery Screens Grommet Options

- DGL: Desk Height Left; 6" from ends and 25¼" from bottom
- DGR: Desk Height Right; 6" from ends and 25¼" from bottom
- DGC: Desk Height Center; 25¼" from bottom
- BGL: Bench Height Left; 6" from ends and 15" from bottom
- BGR: Bench Height Right; 6" from ends and 15" from bottom
- BGC: Bench Height Center; 15" from bottom

HEIGHT ADJUSTABLE MECHANISMS

Height Adjust method that increases user kneespace, offers more stability for overall unit and top construction, and two worksurfaces can move from sitting to standing simultaneously with or without moving modesty panel.

- Maximum height is 45"
- Recommended load capacity of 180lbs
- Gently adjust worksurface with a 1 second stop at each memory position
- Two leg configuration options include the standard 2-channel for Desks, Desk Shells, D-top and P-Top units for one height adjustable worksurface or 3-channel option for two height adjustable worksurfaces to raise simultaneously
- Two height adjustable switches available. Standard up/down switch (SWCH) and advanced switch features Bluetooth capabilities, three stand-up reminder intervals and four height memory positions (MSWCH)
- Moving Modesty (MOVMOD) option creates a clean aesthetic when seated or standing
- Height adjust control switch is factory installed on all units except Desk and Credenza Shells or 3-Channel units
- Bridges, returns, and credenzas will have an optional grommet on the back panel
- Black wire management mesh wrap included when worksurface grommet is selected
- Black wire management mesh wrap is made of polyester braided fabric, 10' long, expands up to 1¼"
- Grommets and one Latch Duct wire management channel provided within kneespace to manage wires from switch and control box. Two Latch Duct wire management channels will be shipped with Desk Shells

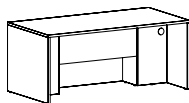

Height Adjustable User Side

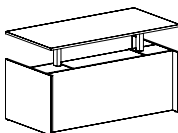

2-channel Configuration

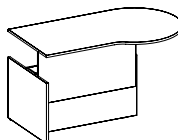

Moving Modesty



Black wire management mesh sleeve

HEIGHT ADJUST LEG CONFIGURATION

The 2-channel leg configuration is standard on height adjustable Desks, Desk Shells, D-top and P-Top units for one height adjustable worksurface. Select models offer an optional 3-channel leg configuration for use with 3-channel Returns to allow two worksurfaces to raise and lower simultaneously.

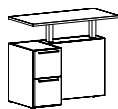

2-channel Configuration
Raise Single Surface

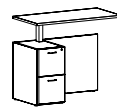

3-channel Configuration
Raise Multiple Surface

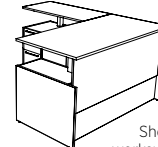

Shown with two worksurfaces raised and optional moving modesty.

STS2	2-channel configuration (For one height adjustable worksurface)	STD
STS3	3-channel configuration (For two height adjustable worksurfaces)	\$ N/C

HEIGHT ADJUST MOVING MODESTY PANEL

Height adjustable moving modesty panel available on double and single pedestal, D-top and P-Top desks. Moving modesty panels offer a clean aesthetic when seated or standing while giving more privacy to the user.

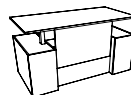

Stepped Front Desk with Moving Modesty

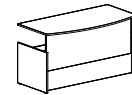

Recessed Front Desk with Moving Modesty

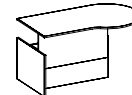

P-Top with Moving Modesty

MOVMOD	Moving Modesty Panel	\$ 219
--------	----------------------	--------

HEIGHT ADJUST MODESTY PANEL GROMMET

Height adjustable credenza, bridge and return units feature a modesty panel grommet option for accessing power to a wall.

2-Channel units feature grommet centered on modesty only, 3" down from top. 3-Channel units feature grommets centered on pedestal only, 3" down from top.

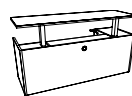

Credenza with Modesty Grommet

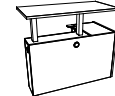

Return with Modesty Grommet

GMBL	Black Modesty Grommet	\$ N/C
GMBSV	Silver Modesty Grommet	\$ N/C

HEIGHT ADJUST SWITCH CONTROL OPTIONS

Height adjust units offer two switch options. The standard switch is a simple up and down paddle style switch to move your worksurface from seated to standing height. The advanced switch features Bluetooth capabilities to connect to smart devices, three stand-up reminder intervals and four height adjustment memory positions.

SWCH	Standard Up/Down Switch	STD
MSWCH	Advanced Up/Down with Memory	\$ 135



SWCH (standard)



MSWCH

Height adjustable grommet options on next page.

HEIGHT ADJUST GROMMET OPTIONS & POWER UNIT LOCATIONS

Ports, Locations and Wire Management:

- One data or wire management location per unit
- Order the port and then specify the location

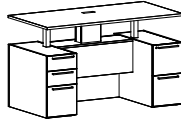

Shown with Wire Management Box with Grommet

Wire Management Box with Grommet **Add \$ 417**

Specify Location and Grommet Color (Black = BLK or Silver = SLV)

Specify	Units	Locations
GC-BOX	Desks/Credenzas/Bridges	Center
GC-BOX	Return (2-Channel Only)	Center

Grommet with Mesh Sleeve **Add \$ 142**

Specify Location and Grommet Color (Black = BLK or Silver = SLV)

Specify	Units	Locations
GL-MESH	Desks/Credenzas/Return	Left
GR-MESH	Desks/Credenzas/Return	Right
GC-MESH	Desks/Credenzas/Bridges	Center
GCKS-MESH	Return/Return Shell	Centered Between Legs

Wire Management Box with DUOBEZEL **Add \$ 1128**

Units	Locations
Desks/Credenzas/Bridges	Center
Return	Centered Between Legs

Specify

01-DUOBEZELB	DUOBEZEL Black
01-DUOBEZELS	DUOBEZEL Silver
01-DUOBEZELW	DUOBEZEL White

Wire Management Box with TRIOBEZEL **Add \$ 1173**

Units	Locations
Desks/Credenzas/Bridges	Center
Return	Centered Between Legs

Specify Color

01-TRIOBEZELB	TRIOBEZEL Black
01-TRIOBEZELS	TRIOBEZEL Silver
01-TRIOBEZELW	TRIOBEZEL White

Port Options for TRIOBEZEL - Must Specify

Port Options for TRIOBEZEL - Must Specify		Add
01-LCOMVGA	VGA Date Port	\$ 121
01-LCOMHDMI	HDMI Data Port (Open Market Only)	\$ 166
01-LCOMRJ45	RJ45 Data Port	\$ 79

Wire Management Box with DPORT4 **Add \$ 1499**

Units	Locations
Desks/Credenzas/Bridges	Center
Return	Centered Between Legs

Specify Color

01-DPORT4A	DPORT Aluminum
01-DPORT4B	DPORT Black

Port Options for DPORT - Must Specify

Port Options for DPORT - Must Specify		Add
01-USBPORT	USB Port	\$ 161
01-VOICE1	Voice Coupler	\$ 73
01-RJ4DATA	Data Port	\$ 167

Models

66-2048UFSTS	66-2042UFSTS	66-2036UFSTS
66-2048UFSTSL3	66-2048UFSTSR3	66-2042UFSTSL3
66-2042UFSTSR3	66-2036UFSTSL3	66-2036UFSTSR3

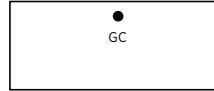

Center: Located 16" from user side

Models

66-2448UFSTS	66-2442UFSTS	66-2436UFSTS
66-2448UFSTSL3	66-2448UFSTSR3	66-2442UFSTSL3
66-2442UFSTSR3	66-2436UFSTSL3	66-2436UFSTSR3

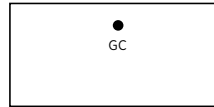

Center: Located 20" from user side

Models

66-2472SHSTS	68-3072LPSTS	68-3072DPSTS
66-2466SHSTS	68-2472RC2STS	68-3066RPSTS
66-2460SHSTS	68-2472LC2STS	68-3066LPSTS
66-3072SHSTS	68-2466RC2STS	68-3066DPSTS
66-3066SHSTS	68-2466LC2STS	68-3060RPSTS
68-2466KCSTS	68-2472RC1STS	68-3060LPSTS
68-2472KCSTS	68-2472LC1STS	68-3060DPSTS
66-3060SHSTS	68-2466RC1STS	
68-3072RPSTS	68-2466LC1STS	

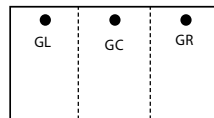

L/R: Located 6" from ends and 20" from user side

Center: Located 20" from user side

Models

68-4824RF2STS	66-2448RSHRSTS*	68-2448RF1STS
68-4824LF2STS	66-2448RSHLSTS*	68-2448LF1STS
68-4224RF2STS	66-2442RSHRSTS*	68-2442RF1STS
68-4224LF2STS	66-2442RSHLSTS*	68-2442LF1STS
68-2448RF2STS	68-4824RF1STS	68-4224LF1STS
68-2448LF2STS	68-4824LF1STS	68-4224RF1STS
68-2442RF2STS	68-2442LF2STS	

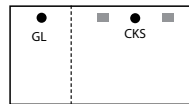

L/R: Located 6" from ends and 20" from user side

CKS: Centered between legs and 20" from user side

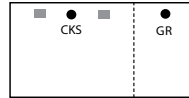

* = Only Available with Centered Grommet CKS

Models (Grommet only available in ped space)

68-2448RF2STS3	68-2442LF2STS3	68-2442RF1STS3
68-2448LF2STS3	68-2448LF1STS3	68-2442LF1STS3
68-2442RF2STS3	68-2448RF1STS3	

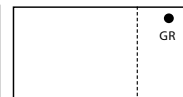
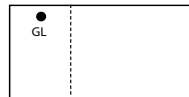

Grommet only available in ped space 6" from end

L/R: Located 6" from ends and 20" from user side

HEIGHT ADJUST GROMMET OPTIONS & POWER UNIT LOCATIONS (CONTINUED)

Models

68-3672BDPSTS	68-3672BLPSTS	68-3672BRPSSTS
68-3666BDPSTS	68-3672BRPSTS	68-3672BLPSSTS
		68-3672BDPSSTS

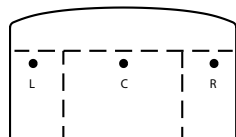

L/R: Located 6" from ends and 20" from user side
Center: Located 20" from user side

Models

68-3672DPSTS	68-3672RPSTS	66-3672SHSTS
68-3672DPSSTS	68-3672RPSSTS	66-3666SHSTS
68-3672LPSTS	68-3672LPSSTS	66-3660SHSTS

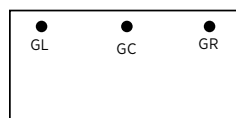

Left/Right: Located 6" from ends and 24" from user side
Center: Located 24" from user side

Models

66-3684DURSTS	66-3072DURSTS	66-4284PLSTS
66-3684DULSTS	66-3072DULSTS	66-4284PRSTS
66-3672DURSTS	66-3066DURSTS	66-4272PLSTS
66-3672DULSTS	66-3066DULSTS	66-4272PRSTS
66-3084DURSTS	66-3084DULSTS	



Center: Located 18 3/8" from seated side and centered between legs

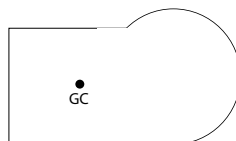

Left Unit / Center: Located 18 3/8" from seated side and centered between legs

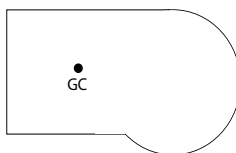

Right Unit / Center: Located 18 3/8" from seated side and centered between legs

MODULAR HEIGHT ADJUSTABLE GROMMET OPTIONS & POWER UNIT LOCATIONS

Grommets are standard in tops of cabinets and credenzas in Black (BLK) or Silver (SLV).

Grommets are available in locations shown below. Please specify and add upcharge for each grommet. Multiple locations may be selected. Only one unit per location.

GROMMET LOCATIONS (Black = BLK and Silver = SLV)

GC	Grommet, Center - Specify BLK or SLV	\$	52
GL	Grommet, Left - Specify BLK or SLV	\$	52
GR	Grommet, Right - Specify BLK or SLV	\$	52

DUO/TRIO BEZEL LOCATIONS

PDC-C	Bezel, Center
PDC-L	Bezel, Left
PDC-R	Bezel, Right

DOCK 950 and DOCK 150 LOCATIONS (See Dock Units)

DOCK950-L	D950 Wireless Charger, Left	\$	265
DOCK950-C	D950 Wireless Charger, Center	\$	265
DOCK950-R	D950 Wireless Charger, Right	\$	265
DOCK150-L	D150 Wireless and USB Charger, Left	\$	405
DOCK150-C	D150 Wireless and USB Charger, Center	\$	405
DOCK150-R	D150 Wireless and USB Charger, Right	\$	405

Verify Grommet Option is available on the model(s) you are specifying using the following location information. Grommets, Power Units, Dock 950 and Dock 150 may be ordered in non-standard locations. Call Customer Service to assist with specification and/or please attach a drawing to the PO showing the location of the grommet. Note additional charges and lead times may apply.

Models

66-3470HTP	66-3462HTP	66-3456HTP
66-3464HTP	66-3458HTP	66-2850HTP
66-2870HTP	66-2858HTP	66-2846HTP
66-2864HTP	66-2856HTP	
66-2862HTP	66-2852HTP	

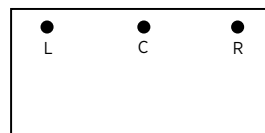

GL/GR/PDC-L/PDC-R/DOCK950-L/DOCK950-R/DOCK150-L/DOCK150-R: 18" from ends and 22 1/2" from user

GC/PDC-C/DOCK950-C/DOCK150-C: 22 1/2" from user

Models

66-2270HTP	66-2258HTP	66-2250HTP
66-2264HTP	66-2256HTP	66-2246HTP
66-2262HTP	66-2252HTP	

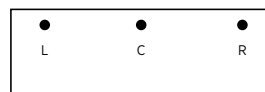

GL/GR/PDC-L/PDC-R/DOCK950-L/DOCK950-R/DOCK150-L/DOCK150-R: 18" from ends and user

GC/PDC-C/DOCK950-C/DOCK150-C: 18" from user

Models

66-2472HDFL	66-2472HMFR	66-2466HMOL
66-2472HDFR	66-2472HMOL	66-2466HMOR
66-2472HMFL	66-2472HMOR	66-2466HMFL
66-2472HDOL	66-2466HDFL	66-2466HMFR
66-2472HDOR	66-2466HDFR	66-2460HDFR
66-2460HDOL	66-2466HDOL	66-2460HDFL
66-2460HDOR	66-2466HDOR	66-2460HMFR
66-2460HMOL	66-2460HMOR	66-2460HMFL

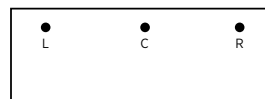

PDC-L/PDC-R: Located 11" from ends and 21 1/8" from user side

PDC-C: Located 21 1/8" from user side

GL/GR/DOCK950-L/DOCK950-R/DOCK150-L/DOCK150-R: Located 6" from ends and 20" from user side

GC/DOCK950-C/DOCK150-C: Located 20" from user side

GROMMET OPTIONS & POWER UNIT LOCATIONS

Models

66-2072HDFL	66-2072HMFR	66-2066HMOL
66-2072HDFR	66-2072HMOL	66-2066HMOR
66-2072HMFL	66-2072HMOR	66-2066HMFL
66-2072HDOL	66-2066HDFL	66-2066HMFR
66-2072HDOR	66-2066HDFR	66-2060HDFR
66-2060HDOL	66-2066HDOL	66-2060HDFL
66-2060HDOR	66-2066HDOR	66-2060HMFR
66-2060HMOL	66-2060HMOR	66-2060HMFL



PDC-L/PDC-R: Located 11" from ends and 17½" from user side

PDC-C: Located 17½" from user side

GL/GR/DOCK950-L/DOCK950-R/DOCK150-L/DOCK150-R: Located 6" from ends and 16" from user side

GC/DOCK950-C/DOCK150-C: Located 16" from user side

Models

66-2436HM	66-2436HDL	66-2430HDL
66-2430HM	66-2436HDR	66-2430HDR
66-2424HM		

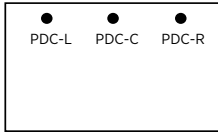

PDC-L/PDC-R: Located 11" from ends and 21½" from user side

PDC-C: Located 21½" from user side

Models

66-2036HM	66-2036HDL	66-2030HDL
66-2030HM	66-2036HDR	66-2030HDR
66-2024HM		

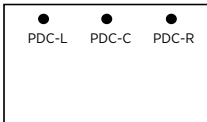

PDC-L/PDC-R: Located 11" from ends and 17½" from user side

PDC-C: Located 17½" from user side

HEIGHT ADJUSTABLE WORKSURFACE MONITOR ARM LOCATIONS

Monitor Arm Grommets are available in locations shown below. Please specify and add upcharge for each grommet. [Dual Monitor and Single Monitor Arms sold separately](#)

Monitor Arm Grommet available in one location per unit; grommet is 2¾".

MONITOR ARM GROMMET LOCATIONS

MGRMT-C	Monitor Grommet, Center	\$	52
MGRMT-L	Monitor Grommet, Left	\$	52
MGRMT-R	Monitor Grommet, Right	\$	52

Models

66-3470HTP	66-3462HTP	66-3456HTP
66-3464HTP	66-3458HTP	



MGRMT-L/MGRMT-R: Located 18" from ends and 31" from user side

MGRMT-C: Located 31" from user side

Models

66-2870HTP	66-2858HTP	66-2850HTP
66-2864HTP	66-2856HTP	66-2846HTP
66-2862HTP	66-2852HTP	



MGRMT-L/MGRMT-R: Located 18" from ends and 25" from user side

MGRMT-C: Located 25" from user side

Models

66-2270HTP	66-2258HTP	66-2250HTP
66-2264HTP	66-2256HTP	66-2246HTP
66-2262HTP	66-2252HTP	

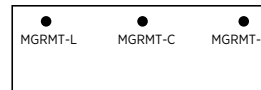

MGRMT-L/MGRMT-R: Located 18" from ends and 19" from user side

MGRMT-C: Located 19" from user side

CONFERENCE AND MEETING TABLE GROMMET OPTIONS

Meeting and Conference Tables offer power and grommet locations at multiple locations.

Must Specify Black (BLK) or Silver (SLV)

Grommet

Factory Installed Grommet	\$	52
Field Installed Grommet Cover	\$	11

Grommet + Power Locations

OC	On Center	CL	5½" Left of Center
EL	24½" from Left End)	CR	5½" Right of Center
ER	24½" from Right End	BB	Centered Between Bases

Location Availability by Top Size

72" + 96"W Tops	OC, EL+ER
120"W Tops	BB, CL, CR, CL+EL+ER, CR+EL+ER

LOCKING DOORS

Locking doors are available on select hinged doors. You must specify WITH LOCKING when ordering and add upcharge.

LKT_HU	108"W to 84"W Units	\$	135
LKT_HU	78"W to 48"W Units	\$	115
LKT_HU	42"W to 24"W Units	\$	91
LKT_HU	18"W to 12"W Units	\$	69

WIRE MANAGEMENT

Wire Management openings available for modular pedestals.

WML	Left Panel	\$	80
WMR	Right Panel	\$	80
WMLR	Left and Right Panel	\$	160

CERTIFICATIONS & COMPLIANCE

- Intertek Sustainability Certified
- BIFMA level® Certified
- BIFMA Compliant® Certified
- TSCA Title VI (formerly CARB) Compliance
- US Green Building's LEED® Contribution

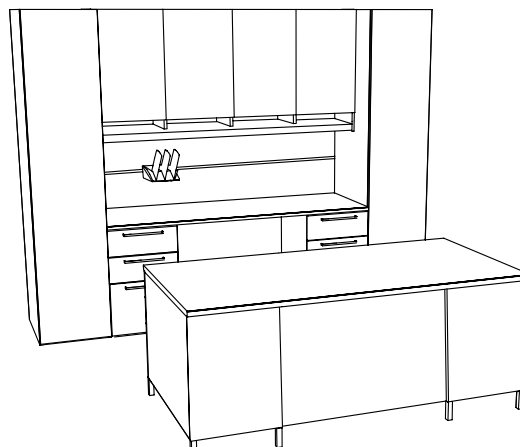
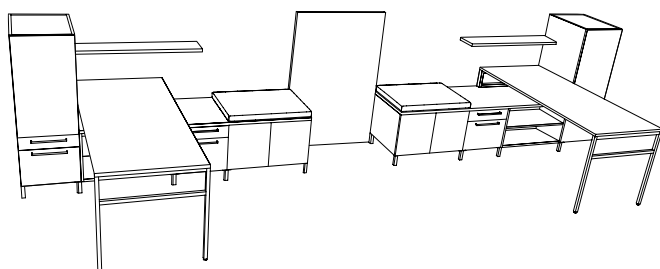
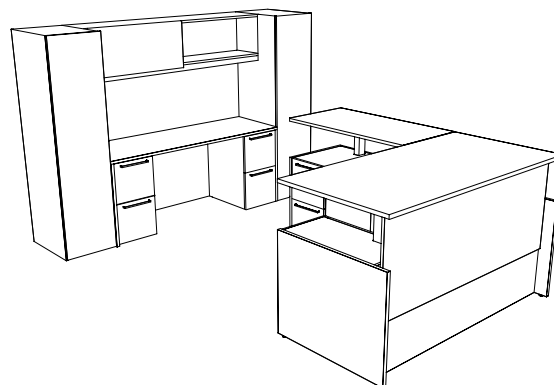
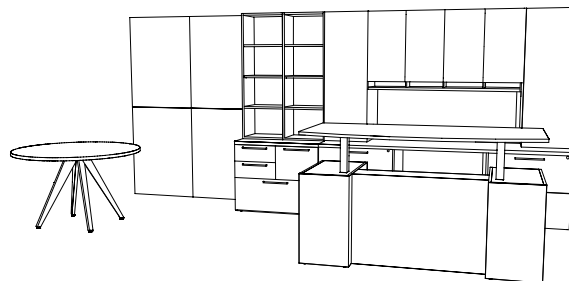

Standard Components



Double Ped Desks with or without Bow Tops
[\(See Multiple Unit Details\)](#)

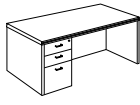

Single Ped Desks with or without Bow Tops
[\(See Multiple Unit Details\)](#)

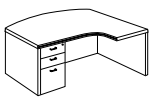

Curved Single Ped Desks with or without Bow Tops
[\(See Multiple Unit Details\)](#)

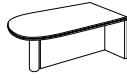

P-Top and D-Tops
[\(See Multiple Unit Details\)](#)

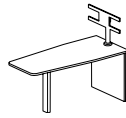

Media Peninsula
[\(See Multiple Unit Details\)](#)

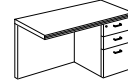

Returns
[\(See Multiple Unit Details\)](#)

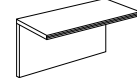

Bridges
[\(See Multiple Unit Details\)](#)

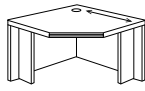

Corner Units
[\(See Multiple Unit Details\)](#)

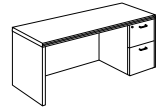

Kneespace, Storage, and Single Ped Credenzas
[\(See Multiple Unit Details\)](#)

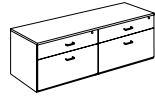

21" Low Storage and Open Credenzas
[\(See Multiple Unit Details\)](#)



Filing
[\(See Multiple Unit Details\)](#)

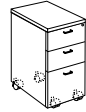

Mobile Pedestals
[\(See Multiple Unit Details\)](#)

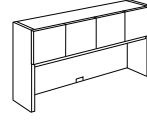

Surface Mount and Wall Mount Hutches
[\(See Multiple Unit Details\)](#)

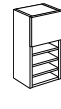

Surface Mount Storage Towers
[\(See Multiple Unit Details\)](#)



Surface Mount Bookcases
[\(See Multiple Unit Details\)](#)

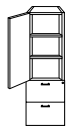

Storage Cabinets
[\(See Multiple Unit Details\)](#)

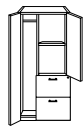

Tower Wardrobe
[\(See Multiple Unit Details\)](#)



Wardrobe/Storage Cabinet
[\(See Multiple Unit Details\)](#)

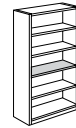

Bookcases
[\(See Multiple Unit Details\)](#)

Tables

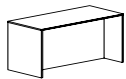

Work Tables
[\(See Multiple Unit Details\)](#)

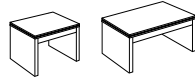

Occasional Tables
[\(See Multiple Unit Details\)](#)



Rectangular Tops
[\(See Details\)](#)
Round Tops
[\(See Multiple Unit Details\)](#)



Strut Bases
[\(See Details\)](#)



Cylinder Bases
[\(See Details\)](#)



Metal Bases
[\(See Details\)](#)



Height Adjustable Bases and Lifts
[\(See Details\)](#)



Rectangular with Door
[\(See Details\)](#)

Modular Components

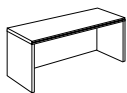

Desk, Credenza and Return Shells
[\(See Multiple Unit Details\)](#)



P-Tops, D-Tops And Media Peninsula
[\(See Multiple Unit Details\)](#)



Pedestals
[\(See Multiple Unit Details\)](#)

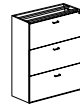

Filing
[\(See Multiple Unit Details\)](#)

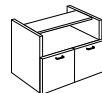

Door and Open Bookcase Pedestals
[\(See Multiple Unit Details\)](#)

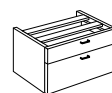

21" Low Storage
[\(See Multiple Unit Details\)](#)



Seated and Low Height Metal Supports
[\(See Seated Height and Low Height\)](#)

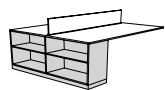

Desk End Bookcases
[\(See Multiple Unit Details\)](#)



Support Panels
[\(See Standard Height and Low Height\)](#)

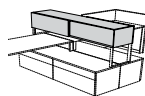

Dual and Single Access Hutches
[\(See Multiple Unit Details\)](#)

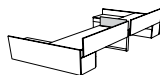

Privacy Panels
[\(See Multiple Unit Details\)](#)

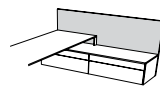

Floorstanding Gallery Screens
[\(See Multiple Unit Details\)](#)

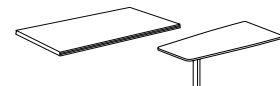

Modular Tops - Table, Desk, Benching Tops
[\(See Multiple Unit Details\)](#)

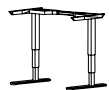

Height Adjustable Worksurface Lifts
[\(See Multiple Unit Details\)](#)

Studio Components

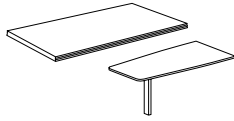

Modular Tops - Table, Desk, Benching Tops [\(See Multiple Unit Details\)](#)



Studio Pedestals [\(See Details\)](#)

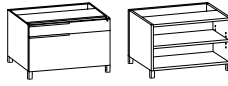

Studio Low Pedestals [\(See Multiple Unit Details\)](#)

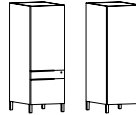

Studio Storage Cabinets [\(See Multiple Unit Details\)](#)



Kneespace Modesty Panels [\(See Multiple Unit Details\)](#)



Single and Shared Stanchions [\(See Details\)](#)



Studio Single and Shared Legs [\(See Details\)](#)

Height Adjustable Units and Components

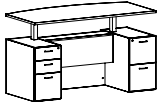

Double Ped Desks [\(See Details\)](#)

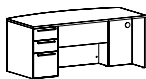

Single Ped Desks [\(See Multiple Unit Details\)](#)

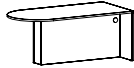

P and D-Top [\(See Multiple Unit Details\)](#)

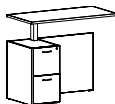

Returns [\(See Multiple Unit Details\)](#)

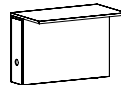

Bridge [\(See Multiple Unit Details\)](#)

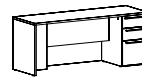

Credenzas [\(See Multiple Unit Details\)](#)

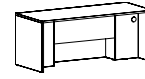

Desk Shell [\(See Details\)](#), Return Shell [\(See Details\)](#) and Credenza Shell [\(See Details\)](#)



Height Adjustable Worksurfaces [\(See Multiple Unit Details\)](#)



Height Adjustable Legs [\(See Multiple Unit Details\)](#)



Height Adjustable Cabinets [\(See Multiple Unit Details\)](#)



Height Adjustable Credenzas [\(See Multiple Unit Details\)](#)



Height Adjustable Modesty Panels [\(See Multiple Unit Details\)](#)



Height Adjustable Privacy Screens [\(See Multiple Unit Details\)](#)



Height Adjustable Worksurface Lifts [\(See Multiple Unit Details\)](#)

Tackboards, Work Walls, Marker Boards and Other Accessories

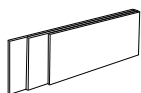

Tackboards [\(See Multiple Unit Details\)](#)



Work Walls and Accessories [\(See Multiple Unit Details\)](#)

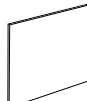

Marker Boards [\(See Multiple Unit Details\)](#)



Marker, Eraser and Magnet Sets [\(See Details\)](#)



Tasklights [\(See Multiple Unit Details\)](#)

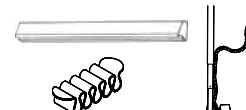

Wire Management [\(See Multiple Unit Details\)](#)



Power Options [\(See Multiple Unit Details\)](#)

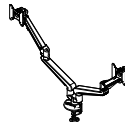
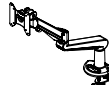

Monitor Arms [\(See Multiple Unit Details\)](#)

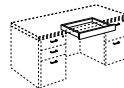

Kneespace Accessories [\(See Multiple Unit Details\)](#)



Cushion [\(See Details\)](#)

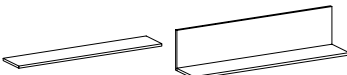

Floating and L Shelf [\(See Multiple Unit Details\)](#)

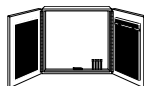

Visual Board [\(See Details\)](#)

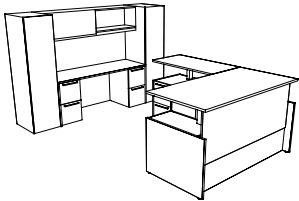
Item	Model No.	Width	Depth	Height	Ship Wt	Cubic Ft	List Price
	66-21	108	105	70 $\frac{1}{2}$	1418	200.5	T\$ 21184 P\$ 21899
	CONSIST OF:		QTY				
	68-3672RPSTS	1	Height Adjustable Single Ped Desk with Box/Box/File with Moving Modesty Option		T\$ 5998 P\$ 6288		
	68-2448LF2STS3	1	Height Adjustable Return with File/File, 3-Channel		T\$ 3436 P\$ 3623		
	GMB-2372W	1	72"W Glass Marker Board for Wall Mount Hutch		\$ 2595		
	68-2472KC	1	Kneespace Credenza Full Pedestal		T\$ 2697 P\$ 2935		
	66-1572SWD	1	72"W Wall Mount Hutch with Sliding Door		T\$ 2352		
	66-1872WR	1	Wardrobe Storage Cabinet, Right		T\$ 2053		
	66-1872WL	1	Wardrobe Storage Cabinet, Left		T\$ 2053		
	<p><i>Products are available as left or right, where applicable</i> <i>Depth includes 42" between Double Ped Desk and Kneespace Credenza</i> <i>List price does not include optional moving modesty</i></p>						

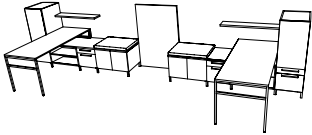
	66-25	228	72	51 $\frac{1}{2}$	1121	121.8	T\$ 20801 P\$ 21831	
	CONSIST OF:		QTY					
	66-3072TP	2	Modular Desk Top		T\$ 1354 P\$ 1894			
	01-3028HL	2	H Modular Peninsula Support Seated Height		\$ 2252			
	01-3007OL	2	Layer Support for Desk Top		T\$ 1114			
	66-2430SBC	2	30"W Studio Low Mod Open Bookcase		T\$ 2102			
	66-2418STF	2	18"W Studio Low Mod Tray/File Ped		T\$ 2030			
	66-1851SWBL	1	Studio Storage Cabinet Door/Tray/File, Left		T\$ 1588			
	66-1851SWBR	1	Studio Storage Cabinet Door/Tray/File, Right		T\$ 1588			
	66-2430SDB	2	30"W Studio Low Mod Door Bookcase		T\$ 1836			
	66-2478TP	2	78" Modular Top for Storage		T\$ 1222 P\$ 1712			
	66-2430CUSHION	2	30"W Component Cushion for Door Bookcase		GR1\$ 770			
	01-0404SSL4	3	Studio Shared Leg, 4 Pack		ALUM\$ 741			
	01-0404SL4	2	Studio Leg, 4 Pack		ALUM\$ 494			
	GMB-5136W	1	36"W Glass Marker Board From Floor		\$ 2802			
	66-0942FS	2	42"W Floating Shelf		T\$ 908			
	<p><i>Products are available as left or right, where applicable</i></p>							

Pricing Codes:

T= TFL
P= HPL

[See Canvas Intro Section for Ordering Options](#)

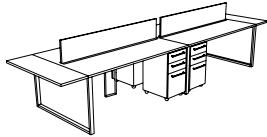
Item	Model No.	Width	Depth	Height	Ship Wt	Cubic Ft	List Price
	66-12	174	60	41¾	986	86.8	T\$ 13448 P\$ 14638

CONSIST OF:	QTY			
01-3028OLS	2	Seated Height Shared Metal Leg	A\$	1258
01-6028OL	2	Seated Height Modular Peninsula Support	A\$	1834
01-00060SB	4	Stiffener Bar	\$	516
01-1228OL	2	O Leg Support	A\$	884
66-1519MP1	4	Mobile Pedestal Box/Box/File	T\$	5108
66-1560DTP	2	Desk Top Extensions	T\$	772
			P\$	1078
66-6072TP	2	Modular Desk Top	T\$	2216
			P\$	3100
66-6812PP	2	12" TFL Privacy Panel	T\$	860

Products are available as left or right, where applicable

	66-23	108	102	82¾	1127	152.3	T\$ 17478 P+GPA\$ 18002
---	-------	-----	-----	-----	------	-------	----------------------------

CONSIST OF:	QTY			
66-3672TP	1	Modular Desk Top	T\$	726
			P\$	1015
66-2472TP	1	Modular Cabinet Top	T\$	595
			P\$	830
01-0404SL4	2	Single Studio Leg 4-Pack	ALUM\$	494
66-3618SPD1	2	Studio Modular Desk Pedestal, Box/Box/File	T\$	2982
66-3624MDHGA	1	Studio Kneespace Modesty Panel, High Gloss Acrylic	\$	589
			GPA\$	676
66-1572TWDS	1	Tall Wall Mount Door Hutch with Paper Slots	T\$	3242
66-2418PD1	2	Modular Desk Pedestal, Box/Box/File	T\$	2494
66-7228BP	1	Modular Modesty Panel	T\$	492
66-1884WL	1	Tall Wardrobe/Storage Cabinet, Left	T\$	2143
66-1884WR	1	Tall Wardrobe/Storage Cabinet, Right	T\$	2143
WW-1972TRWPS	1	Tool Rail Work Wall	GRI\$	1004
01-FLDRSRTRC	1	Folder Sorter for Tool Rail Work Wall, Clear	\$	129

Products are available as left or right, where applicable

Depth includes 42" between Modular Double Ped Desk and Modular Credenza

Pricing Codes:

T= TFL
P= HPL

[See Canvas Intro Section for Ordering Options](#)

CANVAS™
LAMINATE CASEGOODS + TABLES (6600/6800 SERIES)

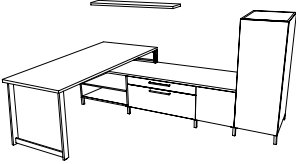
Item	Model No.	Width	Depth	Height	Ship Wt	Cubic Ft	List Price
	66-22	102	72	47½	508	56.9	T\$ 8153 P\$ 8675
	CONSIST OF:		QTY				
	66-3072TP	1	Modular Desk Top		T\$ 677 P\$ 947		
	66-2484TP	1	Modular Cabinet Top		T\$ 624 P\$ 876		
	01-3028BL	1	Bar Modular Peninsula Support		ALUM\$ 644		
	66-2430SBC	1	Studio Modular Low Storage, Open Bookcase		T\$ 1051		
	66-2436STF	1	Studio Modular Low Storage, Tray/File		T\$ 1257		
	66-2418SDBR	1	Studio Modular Low Door Bookcase, Right Hinged		T\$ 825		
	01-3007OL	1	Layer Support for 21" Low Credenzas		\$ 557		
	66-1851SWR	1	Studio Wardrobe, Right Hinged		\$ 1387		
	01-0404SL4	1	Single Studio Leg 4-Pack		ALUM\$ 247		
	01-0404SSL2	1	Shared Studio Leg 2-Pack		ALUM\$ 143		
	01-0404SSL4	1	Shared Studio Leg 4-Pack		ALUM\$ 247		
	66-0948FS	1	48" Canvas Floating Shelf Display		T\$ 494		

Products are available as left or right, where applicable

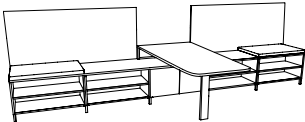
	66-24	180	72	47¾	769	118.6	T\$ 13997 P\$ 15367
	CONSIST OF:		QTY				
	66-2436SBC	4	Studio Modular Low Storage, Open Bookcase		T\$ 4380		
	66-2436SDB	1	Studio Modular Low Door Bookcase		T\$ 1047		
	01-0404SL4	1	Single Studio Leg 4-Pack		ALUM\$ 247		
	01-0404SSL4	2	Shared Studio Leg 4-Pack		ALUM\$ 494		
	66-2472TP	2	Modular Cabinet Top		T\$ 1190 P\$ 1660		
	66-2436TP	1	Modular Cabinet Top		T\$ 371 P\$ 519		
	66-2436CUSHION	2	Component Cushion		GR1\$ 890		
	01-3607OL	1	Layer Support For 21" Low Credenza		\$ 576		
	66-3672MP	1	Media Peninsula		T\$ 2166 P\$ 2918		
	WW-3172TTRW	2	Tool Rail Work Wall		GR1\$ 2636		

Products are available as left or right, where applicable

Pricing Codes:

T= TFL
P= HPL

[See Canvas Intro Section for Ordering Options](#)

Item	Model No.	Width	Depth	Height	K	R	Ship Wt	Cubic Ft	List Price
DOUBLE PED DESK BOW TOP STEPPED FRONT	68-3672BDPS	72	36-30	30	40½	-	410	50.0	T\$ 3311 P\$ 3609

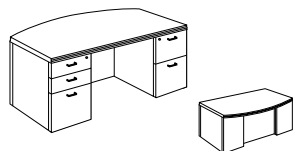

Stepped Front

Must Specify (in this order):

- Model #
- Top Material
- Top Color
- Edge Profile
- Chassis Color
- Drawer
 - Construction
 - Track
- Drawer Front
 - Color
 - Grain Direction (if applicable)
- Modesty/Color
- Grommet Location
- Wire Management
- Grommet Style/Color
- Power/Data Options
- Drawer Pull
- Kneespace Options

Description

- Standard With: Bow Top, Stepped Front, Full Modesty, Letter Width Locking Box/Box/File on Left Pedestal and File/File on Right, Left to Right Grain Direction on Worksurface, Wire Management from Pedestal to Kneespace, Black Utility Tray for Box Drawer
- Available with TFL (T) or HPL (P) Top; Must Specify
- Drawer Front Grain Direction Vertical Standard; Optional Horizontal Grain Direction
- Top, Chassis, Modesty and Drawer Fronts Available in Contrasting Colors; Must Specify Color of Each Component
- [Height Adjustable Units Available](#)
- Additional Options: Dove Tail Drawer Construction and Soft Close Drawers ([See Drawer Details](#)); Power and Grommet Options ([See Options and Locations](#)); Kneespace Options (Sold Separately, [See Unit Details](#))

Options: Specify & Add



66-TMD	18¼"H Laminat ¾ Modesty Panel - Must Specify Laminat Color	Included
66-TSC	18¼"H Aluminum Framed Satin Frosted Tempered Glass ¾ Modesty Panel	\$ 969
66-HGAF	High Gloss Acrylic Full Modesty Panel; Must Specify Color	
	(GPA) Graphite Acrylic	\$ 1914
	(BLA) Black, (WMA) Wired Mercury, or (WHA) White Acrylic	\$ 1748

DOUBLE PED DESK RECTANGLE TOP STEPPED FRONT	68-3672DPS	72	36	30	40½	-	425	50.0	T\$ 3574 P\$ 3866
--	------------	----	----	----	-----	---	-----	------	----------------------

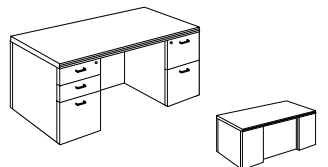

Stepped Front

Must Specify (in this order):

- Model #
- Top Material
- Top Color
- Edge Profile
- Chassis Color
- Drawer
 - Construction
 - Track
- Drawer Front
 - Color
 - Grain Direction (if applicable)
- Modesty/Color
- Grommet Location
- Wire Management
- Grommet Style/Color
- Power/Data Options
- Drawer Pull
- Kneespace Options

Description

- Standard With: Rectangle Top, Stepped Front, Full Modesty, Letter Width Locking Box/Box/File on Left Pedestal and File/File on Right, Left to Right Grain Direction on Worksurface, Wire Management from Pedestal to Kneespace, Black Utility Tray for Box Drawer
- Available with TFL (T) or HPL (P) Top; Must Specify
- Drawer Front Grain Direction Vertical Standard; Optional Horizontal Grain Direction
- Top, Chassis, Modesty and Drawer Fronts Available in Contrasting Colors; Must Specify Color of Each Component
- [Height Adjustable Units Available](#)
- Additional Options: Dove Tail Drawer Construction and Soft Close Drawers ([See Drawer Details](#)); Power and Grommet Options ([See Options and Locations](#)); Kneespace Options (Sold Separately, [See Unit Details](#))

Options: Specify & Add

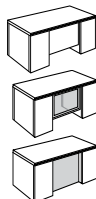

66-TMD	18¼"H Laminat ¾ Modesty Panel - Must Specify Laminat Color	Included
66-TSC	18¼"H Aluminum Framed Satin Frosted Tempered Glass ¾ Modesty Panel	\$ 969
66-HGAF	High Gloss Acrylic Full Modesty Panel; Must Specify Color	
	(GPA) Graphite Acrylic	\$ 1914
	(BLA) Black, (WMA) Wired Mercury, or (WHA) White Acrylic	\$ 1748

Pricing Codes:

- T= TFL
- P= HPL

[See Canvas Intro Section for Ordering Options](#)

Item	Model No.	Width	Depth	Height	K	R	Ship Wt	Cubic Ft	List Price
DOUBLE PED DESK BOW TOP RECESSED FRONT	68-3672BDP	72	36-30	30	40½	10	410	50.0	T\$ 3180 P\$ 3474
	68-3666BDP	66	30-36	30	34½	10	380	48.0	T\$ 3064 P\$ 3401

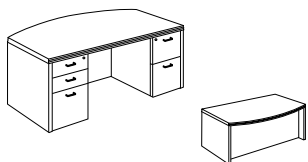

Recessed Front

Must Specify (in this order):

- Model #
- Top Material
- Top Color
- Edge Profile
- Chassis Color
- Drawer
 - Construction
 - Track
- Drawer Front
 - Color
 - Grain Direction (if applicable)
- Modesty/Color
- Grommet Location
- Wire Management
- Grommet Style/Color
- Power/Data Options
- Drawer Pull
- Kneespace Options

Description

- Standard With: Bow Top, Recessed Front, Letter Width Locking Box/Box/File on Left Pedestal and File/File on Right, Left to Right Grain Direction on Worksurface, Wire Management from Pedestal to Kneespace, Black Utility Tray for Box Drawer
- Available with TFL (T) or HPL (P) Top; Must Specify
- Drawer Front Grain Direction Vertical Standard; Optional Horizontal Grain Direction
- Top, Chassis, and Drawer Fronts Available in Contrasting Colors; Must Specify Color of Each Component
- [Height Adjustable Units Available](#)
- Additional Options: Dove Tail Drawer Construction and Soft Close Drawers ([See Drawer Details](#)); Power and Grommet Options ([See Options and Locations](#)); Kneespace Options (Sold Separately, [See Unit Details](#))

DOUBLE PED DESK RECTANGLE TOP RECESSED FRONT	68-3672DP	72	36	30	40½	10	425	50.0	T\$ 2774 P\$ 3060
	68-3072DP	72	30	30	40½	4	410	43.9	T\$ 2676 P\$ 2945
	68-3066DP	66	30	30	34½	4	390	38.7	T\$ 2579 P\$ 2839
	68-3060DP	60	30	30	28½	4	358	35.3	T\$ 2468 P\$ 2710

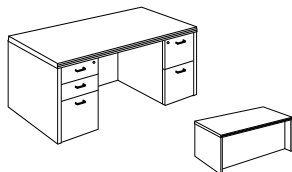

Recessed Front

Must Specify (in this order):

- Model #
- Top Material
- Top Color
- Edge Profile
- Chassis Color
- Drawer
 - Construction
 - Track
- Drawer Front
 - Color
 - Grain Direction (if applicable)
- Modesty/Color
- Grommet Location
- Wire Management
- Grommet Style/Color
- Power/Data Options
- Drawer Pull
- Kneespace Options

Description

- Standard With: Rectangle Top, Recessed Front, Letter Width Locking Box/Box/File on Left Pedestal and File/File on Right, Left to Right Grain Direction on Worksurface, Wire Management from Pedestal to Kneespace, Black Utility Tray for Box Drawer
- Available with TFL (T) or HPL (P) Top; Must Specify
- Drawer Front Grain Direction Vertical Standard; Optional Horizontal Grain Direction
- Top, Chassis, and Drawer Fronts Available in Contrasting Colors; Must Specify Color of Each Component
- [Height Adjustable Units Available](#)
- Additional Options: Dove Tail Drawer Construction and Soft Close Drawers ([See Drawer Details](#)); Power and Grommet Options ([See Options and Locations](#)); Kneespace Options (Sold Separately, [See Unit Details](#))

Pricing Codes:

T= TFL
P= HPL

[See Canvas Intro Section for Ordering Options](#)

Item	Model No.	Width	Depth	Height	K	R	Ship Wt	Cubic Ft	List Price
SINGLE PED DESK BOW TOP STEPPED FRONT	Left Ped	Right Ped							
	68-3672BLPS	68-3672BRPS	72	30-36	30	32¼	-	320	50.0
									T\$ 2971 P\$ 3267

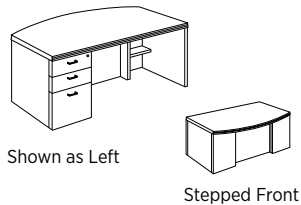

Must Specify (in this order):

- Model #
- Top Material
- Top Color
- Edge Profile
- Chassis Color
- Drawer
- Construction Track
- Drawer Front Color
- Grain Direction (if applicable)
- Modesty/Color
- Grommet Location
- Wire Management
- Grommet Style/Color
- Power/Data Options
- Drawer Pull
- Kneespace Options

Description

- Standard With: Bow Top, Stepped Front, Full Modesty, Letter Width Locking Box/Box/File in Pedestal, Left to Right Grain Direction on Worksurface, Wire Management from Pedestal to Kneespace, Black Utility Tray for Box Drawer
- Available with TFL (T) or HPL (P) Top; Must Specify
- Drawer Front Grain Direction Vertical Standard; Optional Horizontal Grain Direction
- Top, Chassis, Modesty and Drawer Fronts Available in Contrasting Colors; Must Specify Color of Each Component
- [Height Adjustable Units Available](#)
- Additional Options: Dove Tail Drawer Construction and Soft Close Drawers ([See Drawer Details](#)); Power and Grommet Options ([See Options and Locations](#)); Kneespace Options (Sold Separately, [See Unit Details](#))

Options: Specify & Add

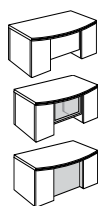

66-TMD	18¼"H Laminate ¾ Modesty Panel - Must Specify Laminate Color	Included
66-TSC	18¼"H Aluminum Framed Satin Frosted Tempered Glass ¾ Modesty Panel	\$ 969
66-HGAF	High Gloss Acrylic Full Modesty Panel; Must Specify Color	
	(GPA) Graphite Acrylic	\$ 1914
	(BLA) Black, (WMA) Wired Mercury, or (WHA) White Acrylic	\$ 1748

Item	Model No.	Width	Depth	Height	K	R	Ship Wt	Cubic Ft	List Price
SINGLE PED DESK RECTANGLE TOP STEPPED FRONT	Left Ped	Right Ped							
	68-3672LPS	68-3672RPS	72	36	30	32¼	-	330	50.0
									T\$ 2575 P\$ 2865

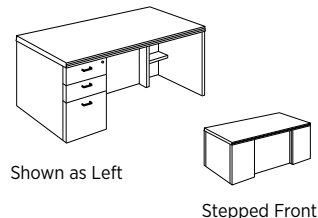

Must Specify (in this order):

- Model #
- Top Material
- Top Color
- Edge Profile
- Chassis Color
- Drawer
- Construction Track
- Drawer Front Color
- Grain Direction (if applicable)
- Modesty/Color
- Grommet Location
- Wire Management
- Grommet Style/Color
- Power/Data Options
- Drawer Pull
- Kneespace Options

Description

- Standard With: Rectangle Top, Stepped Front, Full Modesty, Letter Width Locking Box/Box/File in Pedestal, Left to Right Grain Direction on Worksurface, Wire Management from Pedestal to Kneespace, Black Utility Tray for Box Drawer
- Available with TFL (T) or HPL (P) Top; Must Specify
- Drawer Front Grain Direction Vertical Standard; Optional Horizontal Grain Direction
- Top, Chassis, Modesty and Drawer Fronts Available in Contrasting Colors; Must Specify Color of Each Component
- [Height Adjustable Units Available](#)
- Additional Options: Dove Tail Drawer Construction and Soft Close Drawers ([See Drawer Details](#)); Power and Grommet Options ([See Options and Locations](#)); Kneespace Options (Sold Separately, [See Unit Details](#))

Options: Specify & Add

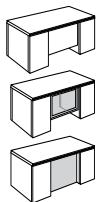

66-TMD	18¼"H Laminate ¾ Modesty Panel - Must Specify Laminate Color	Included
66-TSC	18¼"H Aluminum Framed Satin Frosted Tempered Glass ¾ Modesty Panel	\$ 969
66-HGAF	High Gloss Acrylic Full Modesty Panel; Must Specify Color	
	(GPA) Graphite Acrylic	\$ 1914
	(BLA) Black, (WMA) Wired Mercury, or (WHA) White Acrylic	\$ 1748

Pricing Codes:

T= TFL
P= HPL

[See Canvas Intro Section for Ordering Options](#)

Item	Model No.	Width	Depth	Height	K	R	Ship Wt	Cubic Ft	List Price
SINGLE PED DESK BOW TOP RECESSED FRONT	Left Ped	Right Ped							
	68-3672BLP	68-3672BRP	72	30-36	30	32¼	10	320	50.0

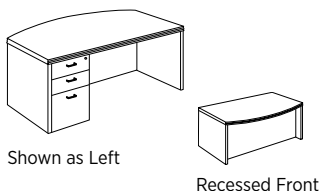

- Must Specify (in this order):
- Model #
 - Top Material
 - Top Color
 - Edge Profile
 - Chassis Color
 - Drawer
 - Construction
 - Track
 - Drawer Front
 - Color
 - Grain Direction (if applicable)
 - Grommet Location
 - Wire Management
 - Grommet Style/Color
 - Power/Data Options
 - Drawer Pull
 - Kneespace Options

Description

- Standard With: Bow Top, Recessed Front, Letter Width Locking Box/Box/File in Pedestal, Left to Right Grain Direction on Worksurface, Wire Management from Pedestal to Kneespace, Black Utility Tray for Box Drawer
- Available with TFL (T) or HPL (P) Top; Must Specify
- Drawer Front Grain Direction Vertical Standard; Optional Horizontal Grain Direction
- Top, Chassis, and Drawer Fronts Available in Contrasting Colors; Must Specify Color of Each Component
- [Height Adjustable Units Available](#)
- Additional Options: Dove Tail Drawer Construction and Soft Close Drawers ([See Drawer Details](#)); Power and Grommet Options ([See Options and Locations](#)); Kneespace Options (Sold Separately, [See Unit Details](#))

SINGLE PED DESK RECTANGLE TOP RECESSED FRONT	Left Ped	Right Ped								
	68-3672LP	68-3672RP	72	36	30	32¼	10	330	50.0	T\$ 2357 P\$ 2645
	68-3072LP	68-3072RP	72	30	30	32¼	4	210	43.0	T\$ 2322 P\$ 2595
	68-3066LP	68-3066RP	66	30	30	26¼	4	180	38.7	T\$ 2229 P\$ 2486
	68-3060LP	68-3060RP	60	30	30	20¼	4	150	35.0	T\$ 2140 P\$ 2395

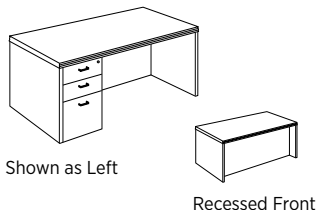

- Must Specify (in this order):
- Model #
 - Top Material
 - Top Color
 - Edge Profile
 - Chassis Color
 - Drawer
 - Construction
 - Track
 - Drawer Front
 - Color
 - Grain Direction (if applicable)
 - Grommet Location
 - Wire Management
 - Grommet Style/Color
 - Power/Data Options
 - Drawer Pull
 - Kneespace Options

Description

- Standard With: Rectangle Top, Recessed Front, Letter Width Locking Box/Box/File on Pedestal, Left to Right Grain Direction on Worksurface, Wire Management from Pedestal to Kneespace, Black Utility Tray for Box Drawer
- Available with TFL (T) or HPL (P) Top; Must Specify
- Drawer Front Grain Direction Vertical Standard; Optional Horizontal Grain Direction
- Top, Chassis, and Drawer Fronts Available in Contrasting Colors; Must Specify Color of Each Component
- [Height Adjustable Units Available](#)
- Additional Options: Dove Tail Drawer Construction and Soft Close Drawers ([See Drawer Details](#)); Power and Grommet Options ([See Options and Locations](#)); Kneespace Options (Sold Separately, [See Unit Details](#))

Pricing Codes:

T= TFL
P= HPL

[See Canvas Intro Section for Ordering Options](#)

Item	Model No.	Width	Depth	Height	K	R	Ship Wt	Cubic Ft	List Price
CURVED SINGLE PED DESK BOW TOP RECESSED FRONT	Left Ped	Right Ped							
	68-4872CBLP	68-4872CBRP	72	48-30	30	-	-	365	68.5

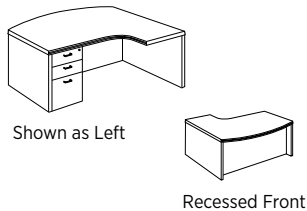

Must Specify (in this order):

- Model #
- Top Material
- Top Color
- Edge Profile
- Chassis Color
- Drawer
 - Construction
 - Track
- Drawer Front
 - Color
 - Grain Direction (if applicable)
- Grommet Location
- Wire Management
- Grommet Style/Color
- Power/Data Options
- Drawer Pull
- Kneespace Options

Description

- Standard With: Bow Top, Recessed Front, Full Modesty, Letter Width Locking Box/Box/File in Pedestal, Left to Right Grain Direction on Worksurface, Wire Management from Pedestal to Kneespace, Black Utility Tray for Box Drawer
- Available with TFL (T) or HPL (P) Top; Must Specify
- Drawer Front Grain Direction Vertical Standard; Optional Horizontal Grain Direction
- Top, Chassis, and Drawer Fronts Available in Contrasting Colors; Must Specify Color of Each Component
- Additional Options: Dove Tail Drawer Construction and Soft Close Drawers ([See Drawer Details](#)); Power and Grommet Options ([See Options and Locations](#)); Kneespace Options (Sold Separately, [See Unit Details](#))

Item	Model No.	Width	Depth	Height	K	R	Ship Wt	Cubic Ft	List Price
CURVED SINGLE PED DESK RECTANGLE TOP RECESSED FRONT	Left Ped	Right Ped							
	68-4272CLP	68-4272CRP	72	42-30	30	-	-	350	65.8

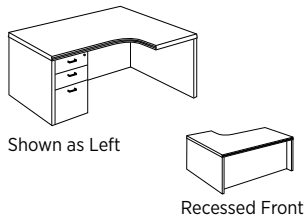

Must Specify (in this order):

- Model #
- Top Material
- Top Color
- Edge Profile
- Chassis Color
- Drawer
 - Construction
 - Track
- Drawer Front
 - Color
 - Grain Direction (if applicable)
- Grommet Location
- Wire Management
- Grommet Style/Color
- Power/Data Options
- Drawer Pull
- Kneespace Options

Description

- Standard With: Rectangle Top, Recessed Front, Full Modesty, Letter Width Locking Box/Box/File in Pedestal, Left to Right Grain Direction on Worksurface, Wire Management from Pedestal to Kneespace, Black Utility Tray for Box Drawer
- Available with TFL (T) or HPL (P) Top; Must Specify
- Drawer Front Grain Direction Vertical Standard; Optional Horizontal Grain Direction
- Top, Chassis, and Drawer Fronts Available in Contrasting Colors; Must Specify Color of Each Component
- Additional Options: Dove Tail Drawer Construction and Soft Close Drawers ([See Drawer Details](#)); Power and Grommet Options ([See Options and Locations](#)); Kneespace Options (Sold Separately, [See Unit Details](#))

Pricing Codes:

- T= TFL
- P= HPL

[See Canvas Intro Section for Ordering Options](#)

Item	Model No.	Width	Depth	Height	Ship Wt	Cubic Ft	List Price
P-TOP CYLINDER BASE	Left	Right					
	66-4284PL	66-4284PR	84	42-36	30	161	T\$ 2662 P\$ 3335
	66-4272PL	66-4272PR	72	42-36	30	161	T\$ 2442 P\$ 2966

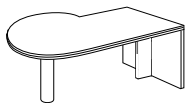

Shown as Left

Description

- Standard with: Left to Right Grain Direction on Worksurface, End Panel Support
- Available with TFL (T) or HPL (P) Top; Must Specify
- Metal Cylinder Base - 4½" Diameter. Must Specify: Black or Aluminum
- Not Recommended for Freestanding Applications
- [Height Adjustable Units Available](#)
- Additional Options: Power and Grommet Options ([See Options and Locations](#)); Kneespace Options (Sold Separately, Sold Separately, [See Unit Details](#))

Options: Specify & Add

	66-HMD	10"H Half Modesty Panel - Must Specify Laminate Color	84" \$ 90 72" \$ 81
	66-FMD	Full Modesty Panel - Must Specify Laminate Color	84" \$ 167 72" \$ 152
	66-HSC	10"H Aluminum Framed Satin Frosted Tempered Glass Half Modesty Panel	84" \$ 1091 72" \$ 983
	66-HGAH	10"H High Gloss Acrylic Half Modesty Panel; Must Specify Color	
		(GPA) Graphite Acrylic	84" \$ 1366
		(BLA) Black, (WMA) Wired Mercury, or (WHA) White Acrylic	84" \$ 1247
		(GPA) Graphite Acrylic	72" \$ 1228
		(BLA) Black, (WMA) Wired Mercury, or (WHA) White Acrylic	72" \$ 1117

Must Specify (in this order):

- Model #
- Top Material
- Top Color
- Edge Profile
- Chassis Color
- Modesty/Color
- Power/Data Options
- Kneespace Options
- Leg Color
- Worksurface Grommet
- Location
- Grommet Color

Pricing Codes:

- T= TFL
- P= HPL

[See Canvas Intro Section for Ordering Options](#)

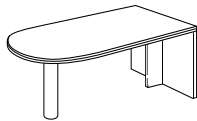
Item	Model No.	Width	Depth	Height	Ship Wt	Cubic Ft	List Price
D-TOP CYLINDER BASE  Shown as Left	Left	Right					
	66-3684DUL	66-3684DUR	84	36	30	187	T\$ 2392 P\$ 3046
	66-3672DUL	66-3672DUR	72	36	30	160	T\$ 2036 P\$ 2565
	66-3084DUL	66-3084DUR	84	30	30	190	T\$ 2316 P\$ 2905
	66-3072DUL	66-3072DUR	72	30	30	160	T\$ 1971 P\$ 2492
	66-3066DUL	66-3066DUR	66	30	30	146	T\$ 1885 P\$ 2389





Must Specify (in this order):

- Model #
- Top Material
- Top Color
- Edge Profile
- Chassis Color
- Modesty/Color
- Power/Data Options
- Kneespace Options
- Leg Color
- Worksurface Grommet Location
- Grommet Color

Description

- Standard with: Left to Right Grain Direction on Worksurface, End Panel Support
- Available with TFL (T) or HPL (P) Top; Must Specify
- Metal Cylinder Base - 4½" Diameter. Must Specify: Black or Aluminum
- Not Recommended for Freestanding Applications
- [Height Adjustable Units Available](#)
- Additional Options: Power and Grommet Options ([See Options and Locations](#)); Kneespace Options (Sold Separately, [See Unit Details](#))

Options: Specify & Add

	66-HMD	10"H Half Modesty Panel - Must Specify Laminate Color	84" \$ 90 72" \$ 81 66" \$ 71	
		66-FMD	Full Modesty Panel - Must Specify Laminate Color	84" \$ 167 72" \$ 152 66" \$ 136
			66-HSC	10"H Aluminum Framed Satin Frosted Tempered Glass Half Modesty Panel
			66-HGAH	10"H High Gloss Acrylic Half Modesty Panel; Must Specify Color
			(GPA) Graphite Acrylic	84" \$ 1366
		(BLA) Black, (WMA) Wired Mercury, or (WHA) White Acrylic	84" \$ 1247	
		(GPA) Graphite Acrylic	72" \$ 1228	
		(BLA) Black, (WMA) Wired Mercury, or (WHA) White Acrylic	72" \$ 1117	
		(GPA) Graphite Acrylic	66" \$ 1093	
	(BLA) Black, (WMA) Wired Mercury, or (WHA) White Acrylic	66" \$ 996		

Pricing Codes:

- T= TFL
- P= HPL

[See Canvas Intro Section for Ordering Options](#)

Item	Model No.	Width	Depth	Height	Ship Wt	Cubic Ft	List Price
EXTENDED D-TOP CYLINDER BASE	Left	Right					
	66-4272EDL	66-4272EDR	72	42-36	30	163	T\$ 2053 P\$ 2623

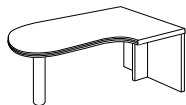

Shown as Left

Must Specify (in this order):

- Model #
- Top Material
- Top Color
- Edge Profile
- Chassis Color
- Modesty/Color
- Power/Data Options
- Kneespace Options
- Leg Color
- Worksurface Grommet Location
- Grommet Color

Description

- Standard with: Left to Right Grain Direction on Worksurface, End Panel Support
- Available with TFL (T) or HPL (P) Top; Must Specify
- Metal Cylinder Base - 4½" Diameter. Must Specify: Black or Aluminum
- Not Recommended for Freestanding Applications
- [Height Adjustable Units Available](#)
- Additional Options: Power and Grommet Options ([See Options and Locations](#)); Kneespace Options (Sold Separately, [See Unit Details](#))

Options: Specify & Add

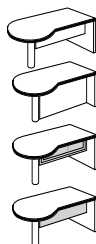

66-HMD	10"H Half Modesty Panel - Must Specify Laminate Color	\$ 81
66-FMD	Full Modesty Panel - Must Specify Laminate Color	\$ 152
66-HSC	10"H Aluminum Framed Satin Frosted Tempered Glass Half Modesty Panel	\$ 983
66-HGAH	10"H High Gloss Acrylic Half Modesty Panel; Must Specify Color (GPA) Graphite Acrylic	\$ 1228
	(BLA) Black, (WMA) Wired Mercury, or (WHA) White Acrylic	\$ 1117

MEDIA PENINSULA	66-3672MPS	72	36	30	164	52.1	T\$ 3349 P\$ 4101
	66-3066MPS	66	30	30	148	40.3	T\$ 3180 P\$ 3866
	66-3060MPS	60	30	30	143	36.7	T\$ 3093 P\$ 3740

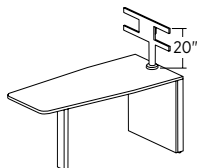

Must Specify (in this order):

- Model #
- Top Material
- Top Color
- Edge Profile
- Chassis Color
- Leg
- Power/Data Options
- Kneespace Options

Description

- Left to Right Grain Direction on Worksurface
- Available with TFL (T) or HPL (P) Top; Must Specify
- Not Recommended for Freestanding Applications Due to Open Back. May be Used with Component Gallery Screens
- Some Assembly Required
- Open Back for Wire Management
- Prevent Screen from Colliding with Walls or Furniture by Setting Rotation Limits at 15°, 30°, 45° or 90°
- Easily Route and Conceal Cables Through a Wide, In-column Channel for a Clean Finish
- Fits Most Screens 32" - 52"; Mounting Pattern Range: VESA® 100 x 100 mm - 600 x 400 mm
- Standard with Aluminum Rectangle Leg to be Installed 17¾" from Front to Allow for Kneespace Area
- Wire Management Trough Included; 4¼"W x 46⅜"L x 3½"H
- Additional Options: Leg Option (See Below); Power and Grommet Options ([See Options and Locations](#))

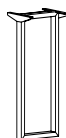

Leg Options: Specify & Add

OLEGA	12" Aluminum Tube Leg	\$ 112
OLEGB	12" Black Tube Leg	\$ 112

Pricing Codes:

- T= TFL
- P= HPL

[See Canvas Intro Section for Ordering Options](#)

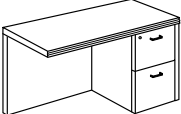
Item	Model No.	Width	Depth	Height	K	R	Ship Wt	Cubic Ft	List Price	
 RETURN WITH FILE/FILE Shown as Right	Left Ped	Right Ped								
	68-2448LF2	68-2448RF2	48	24	30	32¼	-	151	23.1	T\$ 1531 P\$ 1714
	Front to Back Grain Direction on Worksurface									
	68-4824LF2	68-4824RF2	48	24	30	32¼	-	151	23.1	T\$ 1531 P\$ 1714
For Use with Extended Corner and Standard Corner Units; Left to Right Grain Direction										
	68-2442LF2	68-2442RF2	42	24	30	26¼	-	133	20.4	T\$ 1469 P\$ 1635
Front to Back Grain Direction on Worksurface										
	68-4224LF2	68-4224RF2	42	24	30	26¼	-	133	20.4	T\$ 1469 P\$ 1635
For Use with Extended Corner and Standard Corner Units; Left to Right Grain Direction										

Must Specify (in this order):

- Model #
- Top Material
- Top Color
- Edge Profile
- Chassis Color
- Drawer
 - Color
 - Grain Direction (if applicable)
 - Construction
 - Track
- Pull
- Back Panel Grommet Color
- Worksurface Grommet Location
- Grommet Color
- Power/Data Options
- Kneespace Options

Description

- Standard with: Letter Width Locking File/File Pedestal, Wire Management from Pedestal to Kneespace
- Available with TFL (T) or HPL (P) Top; Must Specify
- Back Panel Grommet Standard; Must Specify: Black (BLK), Silver (SLV) or No Back Panel Grommet (NONE)
- Drawer Front Grain Direction Vertical Standard; Optional Horizontal Grain Direction
- Top, Chassis, and Drawer Fronts Available in Contrasting Colors; Must Specify Color of Each Component
- [Height Adjustable Units Available](#)
- Additional Options: Dove Tail Drawer Construction and Soft Close Drawers ([See Drawer Details](#)); Power and Grommet Options ([See Options and Locations](#)); Kneespace Options (Sold Separately, [See Unit Details](#))

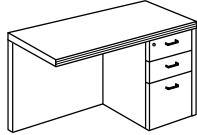
Item	Model No.	Width	Depth	Height	K	R	Ship Wt	Cubic Ft	List Price	
 RETURN WITH BOX/BOX/FILE Shown as Right	Left Ped	Right Ped								
	68-2448LF1	68-2448RF1	48	24	30	32¼	-	151	23.1	T\$ 1531 P\$ 1714
	Front to Back Grain Direction on Worksurface									
	68-4824LF1	68-4824RF1	48	24	30	32¼	-	151	23.1	T\$ 1531 P\$ 1714
For Use with Extended Corner and Standard Corner Units; Left to Right Grain Direction										
	68-2442LF1	68-2442RF1	42	24	30	26¼	-	133	20.4	T\$ 1469 P\$ 1635
Front to Back Grain Direction on Worksurface										
	68-4224LF1	68-4224RF1	42	24	30	26¼	-	133	20.4	T\$ 1469 P\$ 1635
For Use with Extended Corner and Standard Corner Units; Left to Right Grain Direction										

Must Specify (in this order):

- Model #
- Top Material
- Top Color
- Edge Profile
- Chassis Color
- Drawer
 - Color
 - Grain Direction (if applicable)
 - Construction
 - Track
- Pull
- Back Panel Grommet Color
- Worksurface Grommet Location
- Grommet Color
- Power/Data Options
- Kneespace Options

Description

- Standard with: Letter Width Locking Box/Box/File Pedestal, Wire Management from Pedestal to Kneespace
- Available with TFL (T) or HPL (P) Top; Must Specify
- Back Panel Grommet Standard; Must Specify: Black (BLK), Silver (SLV) or No Back Panel Grommet (NONE)
- Drawer Front Grain Direction Vertical Standard; Optional Horizontal Grain Direction
- Top, Chassis, and Drawer Fronts Available in Contrasting Colors; Must Specify Color of Each Component
- [Height Adjustable Units Available](#)
- Additional Options: Dove Tail Drawer Construction and Soft Close Drawers ([See Drawer Details](#)); Power and Grommet Options ([See Options and Locations](#)); Kneespace Options (Sold Separately, [See Unit Details](#))

Pricing Codes:

- T= TFL
- P= HPL

[See Canvas Intro Section for Ordering Options](#)

Item	Model No.	Width	Depth	Height	K	R	Ship Wt	Cubic Ft	List Price	
MULTI-FILE RETURN WITH BOX/BOX/FILE/LATERAL	Left Ped									
	Right Ped									
	66-2472LMR	66-2472RMR	72	24	30	36	-	280	33.6	T\$ 2902 P\$ 3141

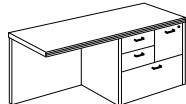

Shown as Right

Must Specify (in this order):

- Model #
- Top Material
- Top Color
- Edge Profile
- Chassis Color
- Drawer
 - Color
 - Grain Direction (if applicable)
 - Construction
 - Track
- Pull
- Back Panel Grommet Color
- Worksurface Grommet Location
- Grommet Color
- Power/Data Options
- Kneespace Options

Description

- Standard with: Box/Box/File/Lateral Pedestal, Locking File Drawer, Side-to-Side Grain Direction on Worksurface, Wire Management from Pedestal to Kneespace
- Available with TFL (T) or HPL (P) Top; Must Specify
- Back Panel Grommet Standard; Must Specify: Black (BLK), Silver (SLV) or No Back Panel Grommet (NONE)
- Drawer Front Grain Direction Vertical Standard; Optional Horizontal Grain Direction
- Top, Chassis, and Drawer Fronts Available in Contrasting Colors; Must Specify Color of Each Component
- [Height Adjustable Units Available](#)
- Additional Options: Dove Tail Drawer Construction and Soft Close Drawers ([See Drawer Details](#)); Power and Grommet Options ([See Options and Locations](#)); Kneespace Options (Sold Separately, [See Unit Details](#))

BRIDGE WITH FULL MODESTY	66-2448UF	48	24	30	48	-	82	5.3	T\$ 698 P\$ 884
	66-2442UF	42	24	30	42	-	68	4.7	T\$ 673 P\$ 839
	66-2436UF	36	24	30	36	-	46	4.1	T\$ 637 P\$ 788
	66-2048UF	48	20	30	48	-	77	5.3	T\$ 650 P\$ 812
	66-2042UF	42	20	30	42	-	64	4.7	T\$ 628 P\$ 778
	66-2036UF	36	20	30	36	-	43	4.1	T\$ 597 P\$ 728

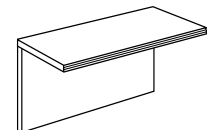

Must Specify (in this order):

- Model #
- Top Material
- Top Color
- Edge Profile
- Chassis Color
- Back Panel Grommet Color
- Worksurface Grommet Location
- Grommet Color
- Power/Data Options
- Kneespace Options

Description

- Standard with: Front to Back Grain Direction on Worksurface, Hinged Back Panel
- Available with TFL (T) or HPL (P) Top; Must Specify
- Back Panel Grommet Standard; Must Specify: Black (BLK), Silver (SLV) or No Back Panel Grommet (NONE)
- Top and Chassis Available in Contrasting Colors; Must Specify Color of Each Component
- [Height Adjustable Units Available](#)
- Keyboard Accessories Cannot be Factory Installed but are Available for Field Installation ([See Multiple Unit Details](#))
- Additional Options: Power and Grommet Options ([See Options and Locations](#))

Pricing Codes:

T= TFL
P= HPL

[See Canvas Intro Section for Ordering Options](#)

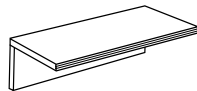
Item	Model No.	Width	Depth	Height	K	R	Ship Wt	Cubic Ft	List Price
 <p>BRIDGE WITH HALF MODESTY</p> <p>Must Specify (in this order): Model # Top Material Top Color Edge Profile Chassis Color Worksurface Grommet Location Grommet Color Power/Data Options Kneespace Options</p>	66-2448UFH	48	24	11	48	-	78	5.3	T\$ 661 P\$ 843
	66-2442UFH	42	24	11	42	-	74	4.6	T\$ 632 P\$ 799
	66-2436UFH	36	24	11	36	-	35	4.1	T\$ 598 P\$ 750
	66-2048UFH	48	20	11	48	-	73	5.3	T\$ 610 P\$ 774
	66-2042UFH	42	20	11	42	-	61	4.7	T\$ 588 P\$ 735
	66-2036UFH	36	20	11	36	-	32	4.1	T\$ 561 P\$ 692

Description

- Standard with: Front to Back Grain Direction on Worksurface, Hinged Back Panel
- Available with TFL (T) or HPL (P) Top; Must Specify
- Top and Chassis Available in Contrasting Colors; Must Specify Color of Each Component
- Keyboard Accessories Cannot be Factory Installed but are Available for Field Installation ([See Multiple Unit Details](#))
- Additional Options: Power and Grommet Options ([See Options and Locations](#))

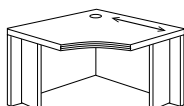
Item	Model No.	Width	Depth	Height	K	R	Ship Wt	Cubic Ft	List Price
 <p>CORNER UNITS</p> <p>Shown as Curved</p> <p>Must Specify (in this order): Model # Top Material Top Color Edge Profile Chassis Color Worksurface Grommet Color</p>	66-4242CU	42	42	30	25 ⁷ / ₁₆	-	145	34.5	T\$ 1495 P\$ 1720
	66-4242CCU Curved Corner Unit	42	42	30	25 ⁷ / ₁₆	-	145	34.5	T\$ 1846 P\$ 2120
	66-3636CU	36	36	30	17	-	109	26.3	T\$ 1241 P\$ 1422
	66-3636CCU Curved Corner Unit	36	36	30	17	-	109	26.3	T\$ 1601 P\$ 1821

Description

- Available with TFL (T) or HPL (P) Top; Must Specify
- Freestanding Support Unit
- Connects to 24" Deep Worksurfaces
- Surface Grommet Standard in Top; Must Specify: Black (BLK) or Silver (SLV)
- Top and Chassis Available in Contrasting Colors; Must Specify Color of Each Component
- Grain Direction Runs as Shown on Worksurface

Pricing Codes:

T= TFL
P= HPL

[See Canvas Intro Section for Ordering Options](#)

Item	Model No.	Width	Depth	Height	K	R	Ship Wt	Cubic Ft	List Price
EXTENDED CORNER UNIT	Left	Right							
	66-4854ECCL	66-4854ECCR	48	54	30	-	-	174	41.1

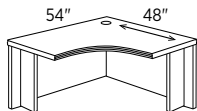

Shown as Right

Description

- Available with TFL (T) or HPL (P) Top; Must Specify
- Surface Grommet Standard in Top; Must Specify: Black (BLK), Silver (SLV)
- Top and Chassis Available in Contrasting Colors; Must Specify Color of Each Component
- Grain Direction Runs as Shown on Worksurface

Must Specify (in this order):

- Model #
- Top Material
- Top Color
- Edge Profile
- Chassis Color
- Worksurface Grommet Color

SINGLE PED CREENZA FILE/FILE	Left Ped	Right Ped								
	68-2472LC2	68-2472RC2	72	24	30	32¼	-	199	35.6	T\$ 1929 P\$ 2166
68-2466LC2	68-2466RC2	66	24	30	26¼	-	182	32.7	T\$ 1909 P\$ 2135	

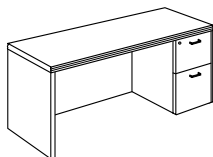

Shown as Right

Description

- Standard with: Letter Width Locking File/File Pedestal, Left to Right Grain Direction on Worksurface, Wire Management from Pedestal to Kneespace
- Available with TFL (T) or HPL (P) Top; Must Specify
- Back Panel Grommet Standard; Must Specify: Black (BLK), Silver (SLV) or No Back Panel Grommet (NONE)
- Drawer Front Grain Direction Vertical Standard; Optional Horizontal Grain Direction
- Top, Chassis, and Drawer Fronts Available in Contrasting Colors; Must Specify Color of Each Component
- [Height Adjustable Units Available](#)
- Additional Options: Dove Tail Drawer Construction and Soft Close Drawers ([See Drawer Details](#)); Power and Grommet Options ([See Options and Locations](#)); Kneespace Options (Sold Separately, [See Unit Details](#))

Must Specify (in this order):

- Model #
- Top Material
- Top Color
- Edge Profile
- Chassis Color
- Drawer
 - Color
 - Grain Direction (if applicable)
 - Construction
 - Track
- Pull
- Back Panel Grommet Color
- Worksurface Grommet Location
- Grommet Color
- Power/Data Options
- Kneespace Options

Pricing Codes:

- T= TFL
- P= HPL

[See Canvas Intro Section for Ordering Options](#)

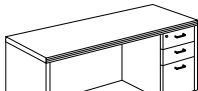
Item	Model No.	Width	Depth	Height	K	R	Ship Wt	Cubic Ft	List Price	
SINGLE PED CREDENZA BOX/BOX/FILE 	Left Ped	Right Ped								
	68-2472LC1	68-2472RC1	72	24	30	32¼	-	199	35.6	T\$ 1929 P\$ 2166
	68-2466LC1	68-2466RC1	66	24	30	26¼	-	182	32.7	T\$ 1909 P\$ 2135

Shown as Right

Must Specify (in this order):

- Model #
- Top Material
- Top Color
- Edge Profile
- Chassis Color
- Drawer
 - Color
 - Grain Direction (if applicable)
 - Construction
 - Track
- Pull
- Back Panel Grommet Color
- Worksurface Grommet Location
- Grommet Color
- Power/Data Options
- Kneespace Options

Description

- Standard with: Letter Width Locking Box/Box/File Pedestal, Left to Right Grain Direction on Worksurface, Wire Management from Pedestal to Kneespace
- Available with TFL (T) or HPL (P) Top; Must Specify
- Back Panel Grommet Standard; Must Specify: Black (BLK), Silver (SLV) or No Back Panel Grommet (NONE)
- Drawer Front Grain Direction Vertical Standard; Optional Horizontal Grain Direction
- Top, Chassis, and Drawer Fronts Available in Contrasting Colors; Must Specify Color of Each Component
- [Height Adjustable Units Available](#)
- Additional Options: Dove Tail Drawer Construction and Soft Close Drawers ([See Drawer Details](#)); Power and Grommet Options ([See Options and Locations](#)); Kneespace Options (Sold Separately, [See Unit Details](#))

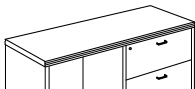
Item	Model No.	Width	Depth	Height	K	R	Ship Wt	Cubic Ft	List Price	
SINGLE PED CREDENZA LATERAL FILE 	Left Ped	Right Ped								
	66-2472LL	66-2472RL	72	24	30	12	-	277	35.6	T\$ 2533 P\$ 2773
	66-2466LL	66-2466RL	66	24	30	6	-	264	32.7	T\$ 2500 P\$ 2726

Shown as Right

Must Specify (in this order):

- Model #
- Top Material
- Top Color
- Edge Profile
- Chassis Color
- Drawer
 - Color
 - Grain Direction (if applicable)
 - Construction
- Pull
- Back Panel Grommet Color
- Worksurface Grommet Location
- Grommet Color
- Power/Data Options

Description

- Standard with: Central Locking Lateral File, Left to Right Grain Direction on Worksurface
- Available with TFL (T) or HPL (P) Top; Must Specify
- Back Panel Grommet Standard; Must Specify: Black (BLK), Silver (SLV) or No Back Panel Grommet (NONE)
- Drawer Front Grain Direction Vertical Standard; Optional Horizontal Grain Direction
- Top, Chassis, and Drawer Fronts Available in Contrasting Colors; Must Specify Color of Each Component
- Additional Options: Dove Tail Drawer Construction ([See Drawer Details](#)); Power and Grommet Options ([See Options and Locations](#)); Kneespace Options (Sold Separately, [See Unit Details](#))

Pricing Codes:

- T= TFL
- P= HPL

[See Canvas Intro Section for Ordering Options](#)

Item	Model No.	Width	Depth	Height	K	R	Ship Wt	Cubic Ft	List Price	
MULTI-FILE CREDENZA WITH BOX/BOX/FILE/LATERAL	Left Ped	Right Ped								
	66-2472LMF	66-2472RMF	72	24	30	12	-	277	35.6	T\$ 2658 P\$ 2895
	66-2466LMF	66-2466RMF	66	24	30	6	-	264	32.7	T\$ 2623 P\$ 2851

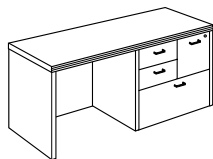

Shown as Right

Must Specify (in this order):

Model #
Top Material
Top Color
Edge Profile
Chassis Color
Drawer
Color
Grain Direction (if applicable)
Construction
Box and File Drawer Track
Pull
Back Panel Grommet Color
Worksurface Grommet Location
Grommet Color
Power/Data Options

Description

- Standard with: Letter Width Locking Box/Box/File/Lateral Pedestal, Left to Right Grain Direction on Worksurface, Wire Management from Pedestal to Kneespace
- Available with TFL (T) or HPL (P) Top; Must Specify
- Back Panel Grommet Standard; Must Specify: Black (BLK), Silver (SLV) or No Back Panel Grommet (NONE)
- Drawer Front Grain Direction Vertical Standard; Optional Horizontal Grain Direction
- Top, Chassis, and Drawer Fronts Available in Contrasting Colors; Must Specify Color of Each Component
- Additional Options: Dove Tail Drawer Construction and Soft Close Box and File Drawers ([See Drawer Details](#)); Power and Grommet Options ([See Options and Locations](#)); Kneespace Options (Sold Separately, [See Unit Details](#))

KNEESPACE CREDENZA	68-2472KC	72	24	30	39	-	240	35.6	T\$ 2697 P\$ 2935
	68-2466KC	66	24	30	33	-	220	32.7	T\$ 2508 P\$ 2733

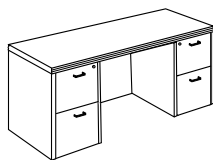

Must Specify (in this order):

Model #
Top Material
Top Color
Edge Profile
Chassis Color
Drawer
Color
Grain Direction (if applicable)
Construction
Track
Pull
Back Panel Grommet Color
Worksurface Grommet Location
Grommet Color
Power/Data Options
Kneespace Options

Description

- Standard with: Letter Width Locking File/File Pedestals, Left to Right Grain Direction on Worksurface, Wire Management from Pedestal to Kneespace
- Available with TFL (T) or HPL (P) Top; Must Specify
- Modesty Panel Grommet Standard; Must Specify: Black (BLK), Silver (SLV) or No Back Panel Grommet (NONE)
- Drawer Front Grain Direction Vertical Standard; Optional Horizontal Grain Direction
- Top, Chassis, and Drawer Fronts Available in Contrasting Colors; Must Specify Color of Each Component
- [Height Adjustable Units Available](#)
- Additional Options: Dove Tail Drawer Construction and Soft Close Drawers ([See Drawer Details](#)); Power and Grommet Options ([See Options and Locations](#)); Kneespace Options (Sold Separately, [See Unit Details](#))

Pricing Codes:

T= TFL
P= HPL

[See Canvas Intro Section for Ordering Options](#)

Item	Model No.	Width	Depth	Height	K	R	Ship Wt	Cubic Ft	List Price
STORAGE CREDENZA	68-2472SC	72	24	30	-	-	285	35.6	T\$ 2913 P\$ 3151
	68-2466SC	66	24	30	-	-	261	32.7	T\$ 2797 P\$ 3020

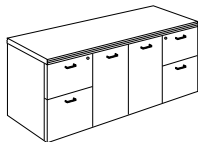

Must Specify (in this order):

Model #
Top Material
Top Color
Edge Profile
Chassis Color
Drawer
Color
Grain Direction (if applicable)
Construction
Track
Pull
Locking Doors

Description

- Standard with: Letter Width, File/File Locking Pedestals, One (1) Fixed Shelf Behind Doors, Top Profiles on Front Only Left to Right Grain Direction on Top Surface
- Available with TFL (T) or HPL (P) Top; Must Specify
- Drawer/Door Front Grain Direction Vertical Standard; Optional Horizontal Grain Direction
- Top, Chassis, and Drawer/Door Fronts Available in Contrasting Colors; Must Specify Color of Each Component
- Optional Locking Doors, Must Specify (LKT-DB) and Add \$108; [See Locking Options](#) For More Details
- Additional Options: Dove Tail Drawer Construction and Soft Close Drawers ([See Drawer Options](#))

FOUR DOOR CREDENZA	66-2472CC	72	24	30	-	-	290	34.2	T\$ 2692 P\$ 2911
	66-2466CC	66	24	30	-	-	246	33.0	T\$ 2574 P\$ 2782

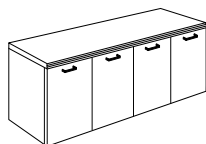

Must Specify (in this order):

Model #
Top Material
Top Color
Edge Profile
Chassis Color
Door
Color
Grain Direction (if applicable)
Pull
Locking Doors

Description

- Standard with: Four (4) Doors, One (1) Adjustable Shelf Behind Each Set of Doors, Top Profiles on Front Only, Left to Right Grain Direction on Top Surface
- Available with TFL (T) or HPL (P) Top; Must Specify
- Door Front Grain Direction Vertical Standard; Optional Horizontal Grain Direction
- Top, Chassis, and Door Fronts Available in Contrasting Colors; Must Specify Color of Each Component
- Optional Locking Doors Available; [See Locking Options](#)

BUFFET CREDENZA	66-2472BF	72	24	36	-	-	342	45.5	T\$ 3388 P\$ 3625
-----------------	-----------	----	----	----	---	---	-----	------	----------------------

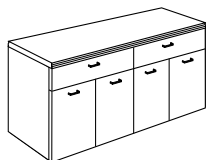

Must Specify (in this order):

Model #
Top Material
Top Color
Edge Profile
Chassis Color
Drawer
Color
Grain Direction (if applicable)
Construction
Track
Pull
Locking Doors

Description

- Standard with: Two (2) Drawers, Four (4) Doors, One (1) Adjustable Shelf Behind Doors Each Set of Doors, Left to Right Grain Direction on Top Surface
- Available with TFL (T) or HPL (P) Top; Must Specify
- Drawer/Door Front Grain Direction Vertical Standard; Optional Horizontal Grain Direction
- Top, Chassis, and Drawer/Door Fronts Available in Contrasting Colors; Must Specify Color of Each Component
- Optional Locking Doors Available; [See Locking Options](#) For More Details
- Additional Options: Dove Tail Drawer Construction and Soft Close Box Drawers ([See Drawer Options](#))

Pricing Codes:

T= TFL
P= HPL

[See Canvas Intro Section for Ordering Options](#)

Item	Model No.	Width	Depth	Height	K	R	Ship Wt	Cubic Ft	List Price
DOUBLE LATERAL CREDENZA	66-2472DL	72	24	30	-	-	360	35.7	T\$ 3507 P\$ 3747

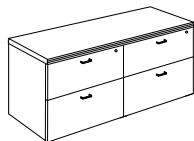

Must Specify (in this order):

- Model #
- Top Material
- Top Color
- Edge Profile
- Chassis Color
- Drawer Color
- Grain Direction (if applicable)
- Construction
- Pull

Description

- Standard with: Legal or Letter Filing, Dual Locking, Left to Right Grain Direction on Top Surface
- Available with TFL (T) or HPL (P) Top; Must Specify
- ¼" Thick Drawer Bottoms Allow for Storage Applications
- Drawer Front Grain Direction Vertical Standard; Optional Horizontal Grain Direction
- Top, Chassis, Drawer Fronts Available in Contrasting Colors; Must Specify Color of Each Component

21" LOW CREDENZA DOUBLE BOX/FILE	66-2472L2IDBF			72	24	21¾	250	25.6	T\$ 3332 P\$ 3568
	66-2460L2IDBF			60	24	21¾	230	22.4	T\$ 2968 P\$ 3187
	66-2072L2IDBF			72	20	21¾	240	21.1	T\$ 3223 P\$ 3435
	66-2060L2IDBF			60	20	21¾	210	18.9	T\$ 2935 P\$ 3125

Must Specify (in this order):

- Model #
- Top Material
- Top Color
- Edge Profile
- Chassis Color
- Drawer Color
- Grain Direction (if applicable)
- Construction
- Box Drawer Track
- Pull
- Power/Data Options
- Grommet Location/Color

Description

- Standard with: Legal or Letter Filing, Dual Locking Box/File Drawers, Left to Right Grain Direction on Top Surface
- Available with TFL (T) or HPL (P) Top; Must Specify
- ¼" Thick Drawer Bottoms Allow for Storage Applications
- Drawer Front Grain Direction Vertical Standard; Optional Horizontal Grain Direction
- Top, Chassis, Drawer Fronts Available in Contrasting Colors; Must Specify Color of Each Component
- Additional Options: Dove Tail Drawer Construction ([See Drawer Options](#)), Soft Close Box Drawers ([See Soft Close Option](#)), Power and Grommet Options ([See Options and Locations](#)); Dock 950 and Dock 150 Wireless Chargers ([See Multiple Unit Details](#))

21" LOW CREDENZA BOX/FILE/OPEN BOOKCASE	Left Box/File	Right Box/File	Width	Depth	Height	K	R	Ship Wt	Cubic Ft	List Price
	66-2472L21OBFL	66-2472L21OBFR	72	24	21¾	230	25.6	T\$ 2535 P\$ 2775		
	66-2460L21OBFL	66-2460L21OBFR	60	24	21¾	210	22.4	T\$ 2320 P\$ 2538		
	66-2072L21OBFL	66-2072L21OBFR	72	20	21¾	220	21.1	T\$ 2419 P\$ 2631		
	66-2060L21OBFL	66-2060L21OBFR	60	20	21¾	200	18.9	T\$ 2199 P\$ 2391		

Shown as Right

Must Specify (in this order):

- Model #
- Top Material
- Top Color
- Edge Profile
- Chassis Color
- Drawer Color
- Grain Direction (if applicable)
- Construction
- Box Drawer Track
- Pull
- Power/Data Options
- Grommet Location/Color

Description

- Standard with: Legal or Letter Filing, Locking Box/File with Open Bookcase, Adjustable Bookcase Shelf on Open Side, Left to Right Grain Direction on Top Surface
- Available with TFL (T) or HPL (P) Top; Must Specify
- ¼" Thick Drawer Bottoms Allow for Storage Applications
- Back Panel Grommet Standard; Must Specify Black or Silver
- Drawer Front Grain Direction Vertical Standard; Optional Horizontal Grain Direction
- Top, Chassis, Drawer Fronts Available in Contrasting Colors; Must Specify Color of Each Component
- Additional Options: Dove Tail Drawer Construction ([See Drawer Options](#)), Soft Close Box Drawers ([See Soft Close Option](#)), Power and Grommet Options ([See Options and Locations](#)); Dock 950 and Dock 150 Wireless Chargers ([See Multiple Unit Details](#))

Pricing Codes:

T= TFL
P= HPL

[See Canvas Intro Section for Ordering Options](#)

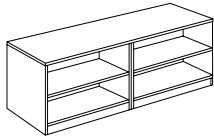
Item	Model No.	Width	Depth	Height	Ship Wt	Cubic Ft	List Price
21" LOW CREDENZA DOUBLE OPEN BOOKCASE 	66-2472L21DO	72	24	21¾	210	25.6	T\$ 2072 P\$ 2310
	66-2460L21DO	60	24	21¾	200	22.4	T\$ 1873 P\$ 2065
	66-2072L21DO	72	20	21¾	200	21.1	T\$ 1931 P\$ 2142
	66-2060L21DO	60	20	21¾	190	18.9	T\$ 1762 P\$ 1951

Must Specify (in this order):

- Model #
- Top Material
- Top Color
- Edge Profile
- Chassis Color
- Power/Data Options
- Grommet Location/Color

Description

- Standard with: Open Bookcases, One Adjustable Shelf on Each Side, Left to Right Grain Direction on Top Surface
- Available with TFL (T) or HPL (P) Top; Must Specify
- Back Panel Grommet Standard; Must Specify Black or Silver
- Top and Chassis Available in Contrasting Colors; Must Specify Color of Each Component
- Additional Options: Power and Grommet Options ([See Options and Locations](#)); Dock 950 and Dock 150 Wireless Chargers ([See Multiple Unit Details](#))

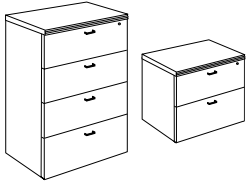
Item	Model No.	Width	Depth	Height	Ship Wt	Cubic Ft	List Price
LATERAL FILE 	66-2436L4 Four Lateral Drawers	36	24	57½	312	32.6	T\$ 3018 P\$ 3165
	66-2430L4 Four Lateral Drawers	30	24	57½	260	27.5	T\$ 2877 P\$ 3018
	66-2436L3 Three Lateral Drawers	36	24	43¾	170	24.2	T\$ 2419 P\$ 2567
	66-2430L3 Three Lateral Drawers	30	24	43¾	155	20.4	T\$ 2294 P\$ 2437
	66-2436L2 Two Lateral Drawers	36	24	30	184	18.3	T\$ 1598 P\$ 1744
	66-2430L2 Two Lateral Drawers	30	24	30	153	15.6	T\$ 1517 P\$ 1659

Must Specify (in this order):

- Model #
- Top Material
- Top Color
- Edge Profile
- Chassis Color
- Drawer Color
- Grain Direction (if applicable)
- Construction
- Pull

Description

- Standard with: Central Locking, Anti-Tilt System, Legal or Letter Filing Front to Back or Side to Side
- Available with TFL (T) or HPL (P) Top; Must Specify
- ¼" Thick Drawer Bottoms Allow for Storage Applications
- Drawer Front Grain Direction Vertical Standard; Optional Horizontal Grain Direction
- Top, Chassis, Drawer Fronts Available in Contrasting Colors; Must Specify Color of Each Component
- Additional Options: Dove Tail Drawer Construction ([See Drawer Options](#))

Item	Model No.	Width	Depth	Height	Ship Wt	Cubic Ft	List Price
MULTI-FILE 	66-2436MF	36	24	30	184	18.3	T\$ 1714 P\$ 1864
	66-2430MF	30	24	30	148	15.6	T\$ 1626 P\$ 1770

Must Specify (in this order):

- Model #
- Top Material
- Top Color
- Edge Profile
- Chassis Color
- Drawer Color
- Grain Direction (if applicable)
- Construction
- Box and File Drawer Track
- Pull

Description

- Standard with: Box/Box/File/Lateral File, Locking File Drawer, Lateral File Provides Legal or Letter Filing
- Available with TFL (T) or HPL (P) Top; Must Specify
- Drawer Front Grain Direction Vertical Standard; Optional Horizontal Grain Direction
- Top, Chassis, Drawer Fronts Available in Contrasting Colors; Must Specify Color of Each Component
- Additional Options: Dove Tail Drawer Construction ([See Drawer Options](#)), Soft Close Box and File Drawers ([See Soft Close Option](#))

Pricing Codes:

- T= TFL
- P= HPL

[See Canvas Intro Section for Ordering Options](#)

Item	Model No.	Width	Depth	Height	Ship Wt	Cubic Ft	List Price
MOBILE PEDESTAL BOX/FILE	66-1519MP	15¾	19	23	85	9.0	T\$ 1226

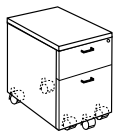

Must Specify (in this order):

Model #
Chassis and Top Color
Drawer
Color
Grain Direction (if applicable)
Construction
Track
Pull

Description

- Standard with: Locking Box/File Drawers, Black Plastic Pen Tray, Letter Width Pedestal, and Five Casters
- Fits Underneath 30"H Worksurface with Optional Cushion
- Optional Cushion Increases Height 2¼"; See [66-1519CUSHION](#)
- Drawer Front Grain Direction Vertical Standard; Optional Horizontal Grain Direction
- Drawer Fronts Available in Contrasting Colors; Must Specify
- Additional Options: Dove Tail Drawer Construction and Soft Close Drawers ([See Drawer Options](#))

MOBILE PEDESTAL BOX/BOX/FILE	66-1519MP1	15¾	19	27½	90	9.0	T\$ 1277
---------------------------------	------------	-----	----	-----	----	-----	----------



Must Specify (in this order):

Model #
Chassis and Top Color
Drawer
Color
Grain Direction (if applicable)
Construction
Track
Pull

Description

- Standard with: Locking Box/Box/File Drawers, Black Plastic Pen Tray, Letter Width Pedestal, and Five Casters
- Optional Cushion Increases Height 2¼"; See [66-1519CUSHION](#)
- Fits Underneath 30"H Worksurface without Optional Cushion
- Drawer Front Grain Direction Vertical Standard; Optional Horizontal Grain Direction
- Drawer Fronts Available in Contrasting Colors; Must Specify
- Additional Options: Dove Tail Drawer Construction and Soft Close Drawers ([See Drawer Options](#))

MOBILE PEDESTAL FILE/FILE	66-1519MP2	15¾	19	27½	90	9.0	T\$ 1277
------------------------------	------------	-----	----	-----	----	-----	----------

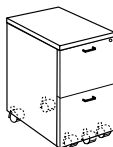

Must Specify (in this order):

Model #
Chassis and Top Color
Drawer
Color
Grain Direction (if applicable)
Construction
Track
Pull

Description

- Standard with: Locking File/File Drawers, Black Plastic Pen Tray, Letter Width Pedestal, and Five Casters
- Optional Cushion Increases Height 2¼"; See [66-1519CUSHION](#)
- Fits Underneath 30"H Worksurface without Optional Cushion
- Drawer Front Grain Direction Vertical Standard; Optional Horizontal Grain Direction
- Drawer Fronts Available in Contrasting Colors; Must Specify
- Additional Options: Dove Tail Drawer Construction and Soft Close Drawers ([See Drawer Options](#))

Pricing Codes:

T= TFL
P= HPL



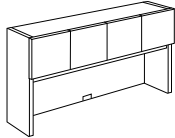
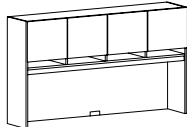

[See Canvas Intro Section for Ordering Options](#)

Item	Model No.	Width	Depth	Height	Ship Wt	Cubic Ft	List Price
SURFACE MOUNT HUTCH HINGED DOOR  Must Specify (in this order): Model # Chassis and Top Color Door Style/Color Grain (if applicable) Locking Doors Paperslots Paperslot Divider Material/Color Tasklights Grommet Color Tackboard Fabric  Optional Paper Slots in laminate or chrome available; See Paper Slot Options Also available as 52 7/8" H Tall Surface Mount	66-1596HU Six (6) Doors	96	15	40 7/8	260	46.5	T\$ 3019
	66-1590HU Five (5) Doors	90	15	40 7/8	243	44.3	T\$ 2822
	66-1584HU Five (5) Doors	84	15	40 7/8	228	40.0	T\$ 2433
	66-1578HU Four (4) Doors	78	15	40 7/8	210	36.7	T\$ 2371
	66-1572HU Four (4) Doors	72	15	40 7/8	203	34.1	T\$ 1998
	66-1566HU Four (4) Doors	66	15	40 7/8	175	32.1	T\$ 1930
	66-1560HU Four (4) Doors	60	15	40 7/8	167	28.4	T\$ 1895
	66-1554HU Three (3) Doors	54	15	40 7/8	150	25.7	T\$ 1763
	66-1548HU Three (3) Doors	48	15	40 7/8	133	22.9	T\$ 1627
	66-1542HU Two (2) Doors	42	15	40 7/8	116	20.2	T\$ 1222
	66-1536HU Two (2) Doors	36	15	40 7/8	99	17.4	T\$ 1064
	66-1530HU Two (2) Doors	30	15	40 7/8	85	14.6	T\$ 923

Description

- 23 3/4" Clearance Below Apron Rail
- Lower Center Grommet Standard; Must Specify: Black (BLK) or Silver (SLV)
- Safely Write on Dry Erase, White and Black Tempered Glass Doors with Our Dry Erase Marker Set; [See Sets](#)
- Door Fronts Available in Contrasting Colors; Must Specify Color
- Additional Support is Required when Surface Mounted Hutches Do Not Sit Directly Over an End Panel or Pedestal; [See 66-2812SP](#)
- Component Hutch Tops with Profiles are Available; [See Top Sizes](#)
- If Applicable, Door Front Grain Direction Vertical Standard; Optional Horizontal Grain Direction
- Additional Options: Paper Slots ([See Paper Slot Options](#)), Locking Doors ([See Locking Door Options](#)), Marker Boards, Work Wall, Tackboards, and Tasklights ([See Units](#)), Marker and Eraser Sets ([See Sets](#))

Options: Specify & Add

		Per Door
	1-AD Aluminum Framed Satin Frosted Tempered Glass Doors (Non-Locking)	\$ 438
	1-DEB Dry Erase Board Doors	\$ 28
	WHGLS Aluminum Framed Doors with White Tempered Glass (Non-locking)	\$ 652
	BLGLS Black Matte Framed Doors with Black Tempered Glass (Non-locking)	\$ 868
	1-HGA High Gloss Acrylic Doors; Must Specify Color	
	(GPA) Graphite Acrylic	\$ 269
	(BLA) Black, (WMA) Wired Mercury, or (WHA) White Acrylic	\$ 247

Pricing Codes:

T= TFL
P= HPL

[See Canvas Intro Section for Ordering Options](#)

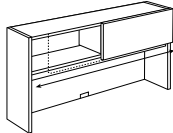
Item	Model No.	Width	Depth	Height	Ship Wt	Cubic Ft	List Price
SURFACE MOUNT HUTCH WITH SLIDING DOOR 	66-1596SHU Two (2) Doors	96	15	40 7/8	278	57.7	T\$ 3288
	66-1590SHU Two (2) Doors	90	15	40 7/8	260	53.7	T\$ 3210
	66-1584SHU Two (2) Doors	84	15	40 7/8	243	50.2	T\$ 2757
	66-1578SHU One (1) Door	78	15	40 7/8	226	46.7	T\$ 2640
	66-1572SHU One (1) Door	72	15	40 7/8	208	43.3	T\$ 2311
	66-1566SHU One (1) Door	66	15	40 7/8	190	39.7	T\$ 2240
	66-1560SHU One (1) Door	60	15	40 7/8	172	28.4	T\$ 2223

Must Specify (in this order):
 Model #
 Chassis and Top Color
 Door
 Style/Color
 Grain (if applicable)
 Paperslots
 Paperslot Divider Material/Color
 Tasklights
 Grommet Color
 Tackboard Fabric

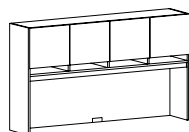

Optional Paper Slots in laminate or chrome available; [See Paper Slot Options](#)

Description

- Non-Locking Sliding Doors
- 23 3/4" Clearance Below Apron Rail
- Lower Center Grommet Standard; Must Specify: Black (BLK) or Silver (SLV)
- Safely Write on Dry Erase with Our Dry Erase Marker Set; [See Sets](#)
- Additional Support is Required when Surface Mounted Hutches Do Not Sit Directly Over an End Panel or Pedestal; [See 66-2812SP](#)
- Component Hutch Tops with Profiles are Available; [See Top Sizes](#)
- If Applicable, Door Front Grain Direction Vertical Standard; Optional Horizontal Grain Direction
- Door Fronts Available in Contrasting Colors; Must Specify Color
- Additional Options: Paper Slots ([See Paper Slot Options](#)), Marker Boards, Work Wall, Tackboards, and Tasklights ([See Units](#)), Marker and Eraser Sets ([See Sets](#))

Options: Specify & Add

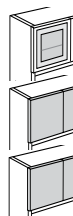

		Per Door
1-AD	Aluminum Framed Satin Frosted Tempered Glass Doors (Non-Locking)	\$ 745
1-DEB	Dry Erase Board Door (Non-Locking)	\$ 77
1-HGA	High Gloss Acrylic Door (Non-Locking); Must Specify Color	
	(GPA) Graphite Acrylic	\$ 773
	(BLA) Black, (WMA) Wired Mercury, or (WHA) White Acrylic	\$ 705

Pricing Codes:

T= TFL
 P= HPL

[See Canvas Intro Section for Ordering Options](#)

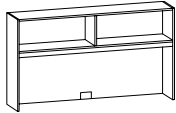
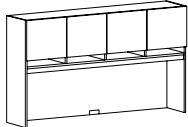
Item	Model No.	Width	Depth	Height	Ship Wt	Cubic Ft	List Price
SURFACE MOUNT HUTCH OPEN  Must Specify (in this order): Model # Chassis and Top Color Paperslots Paperslot Divider Material/Color Tasklights Grommet Color Tackboard Fabric  Optional Paper Slots in laminate or chrome available; See Paper Slot Options Also available as 52 $\frac{7}{8}$ " H Tall Surface Mount	66-1596OH Three (3) Compartments	96	15	40 $\frac{3}{8}$	158	41.5	T\$ 2475
	66-1590OH Three (3) Compartments	90	15	40 $\frac{3}{8}$	150	39.0	T\$ 2316
	66-1584OH Three (3) Compartments	84	15	40 $\frac{3}{8}$	142	36.7	T\$ 1995
	66-1578OH Two (2) Compartments	78	15	40 $\frac{3}{8}$	130	33.8	T\$ 1944
	66-1572OH Two (2) Compartments	72	15	40 $\frac{3}{8}$	121	30.7	T\$ 1640
	66-1566OH Two (2) Compartments	66	15	40 $\frac{3}{8}$	114	30.7	T\$ 1581
	66-1560OH Two (2) Compartments	60	15	40 $\frac{3}{8}$	106	28.4	T\$ 1556
	66-1554OH Two (2) Compartments	54	15	40 $\frac{3}{8}$	98	25.7	T\$ 1443
	66-1548OH Two (2) Compartments	48	15	40 $\frac{3}{8}$	89	21.2	T\$ 1334
	66-1542OH One (1) Compartment	42	15	40 $\frac{3}{8}$	77	18.6	T\$ 1198
	66-1536OH One (1) Compartment	36	15	40 $\frac{3}{8}$	69	16.0	T\$ 1039
	66-1530OH One (1) Compartment	30	15	40 $\frac{3}{8}$	61	13.5	T\$ 904

Description

- 23 $\frac{3}{4}$ " Clearance Below Apron Rail
- Lower Center Grommet Standard; Must Specify: Black (BLK) or Silver (SLV)
- Additional Support is Required when Surface Mounted Hutches Do Not Sit Directly Over an End Panel or Pedestal; [See 66-2812SP](#)
- Component Hutch Tops with Profiles are Available; [See Top Sizes](#)
- Additional Options: Paper Slots ([See Paper Slot Options](#)), Marker Boards, Work Wall, Tackboards, and Tasklights ([See Units](#)), Marker and Eraser Sets ([See Set](#))

Pricing Codes:

T= TFL
P= HPL



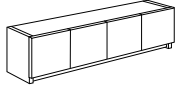

[See Canvas Intro Section for Ordering Options](#)

Item	Model No.	Width	Depth	Height	Ship Wt	Cubic Ft	List Price
WALL MOUNT HUTCH HINGED DOORS  Must Specify (in this order): Model # Chassis and Top Color Door Style/Color Grain (if applicable) Locking Doors Also available as 29 3/16"H Tall Wall Mount	66-1596WD Six (6) Doors	96	15	17 3/16	158	17.3	T\$ 2719
	66-1590WD Five (5) Doors	90	15	17 3/16	148	16.2	T\$ 2538
	66-1584WD Five (5) Doors	84	15	17 3/16	138	15.2	T\$ 2190
	66-1578WD Five (5) Doors	78	15	17 3/16	128	14.1	T\$ 2139
	66-1572WD Four (4) Doors	72	15	17 3/16	118	13.1	T\$ 1795
	66-1566WD Four (4) Doors	66	15	17 3/16	105	12.0	T\$ 1736
	66-1560WD Four (4) Doors	60	15	17 3/16	96	11.0	T\$ 1708
	66-1554WD Three (3) Doors	54	15	17 3/16	87	9.9	T\$ 1585
	66-1548WD Three (3) Doors	48	15	17 3/16	77	8.9	T\$ 1469
	66-1542WD Two (2) Doors	42	15	17 3/16	67	7.8	T\$ 1100
	66-1536WD Two (2) Doors	36	15	17 3/16	58	6.7	T\$ 958
	66-1530WD Two (2) Doors	30	15	17 3/16	48	5.6	T\$ 830

Description

- Component Hutch Tops with Profiles are Available; [See Top Sizes](#)
- If Applicable, Door Front Grain Direction Vertical Standard; Optional Horizontal Grain Direction
- Door Fronts Available in Contrasting Colors; Must Specify Color
- Safely Write on Dry Erase, White and Black Tempered Glass Doors with Our Dry Erase Marker Set; [See Sets](#)
- Indiana Furniture Will Not be Liable for Wall Mount Hutches that are not Properly Installed
- Additional Options: Locking Doors ([See Locking Door Options](#)), Marker Boards, Work Wall, Tackboards, and Tasklights ([See Units](#)), Marker and Eraser Sets ([See Sets](#))

Options: Specify & Add

		Per Door
	1-AD Aluminum Framed Satin Frosted Tempered Glass Doors (Non-Locking)	\$ 438
	1-DEB Dry Erase Board Doors	\$ 28
	WHGLS Aluminum Framed Doors with White Tempered Glass (Non-locking)	\$ 652
	BLGLS Black Matte Framed Doors with Black Tempered Glass (Non-locking)	\$ 868
	1-HGA High Gloss Acrylic Doors; Must Specify Color	
	(GPA) Graphite Acrylic	\$ 269
	(BLA) Black, (WMA) Wired Mercury, or (WHA) White Acrylic	\$ 247

Pricing Codes:

T= TFL
P= HPL

[See Canvas Intro Section for Ordering Options](#)

Item	Model No.	Width	Depth	Height	Ship Wt	Cubic Ft	List Price
WALL MOUNT HUTCH DOORS WITH PAPER SLOTS 	66-1596WDS Six (6) Doors / Six (6) Paper Slots	96	15	21½	186	24.6	T\$ 3838
	66-1590WDS Five (5) Doors / Five (5) Paper Slots	90	15	21½	172	23.1	T\$ 3611
	66-1584WDS Five (5) Doors / Five (5) Paper Slots	84	15	21½	162	21.6	T\$ 3198
	66-1578WDS Four (4) Doors / Four (4) Paper Slots	78	15	21½	149	20.0	T\$ 3090
	66-1572WDS Four (4) Doors / Four (4) Paper Slots	72	15	21½	140	18.5	T\$ 2687
	66-1566WDS Four (4) Doors / Four (4) Paper Slots	66	15	21½	131	16.9	T\$ 2577
	66-1560WDS Four (4) Doors / Four (4) Paper Slots	60	15	21½	121	15.4	T\$ 2497
	66-1554WDS Three (3) Doors / Three (3) Paper Slots	54	15	21½	108	13.9	T\$ 2321
	66-1548WDS Three (3) Doors / Three (3) Paper Slots	48	15	21½	99	12.3	T\$ 2150
	66-1542WDS Two (2) Doors / Two (2) Paper Slots	42	15	21½	86	10.8	T\$ 1734
	66-1536WDS Two (2) Doors / Two (2) Paper Slots	36	15	21½	76	9.2	T\$ 1541
	66-1530WDS Two (2) Doors / Two (2) Paper Slots	30	15	21½	67	7.7	T\$ 1364





Must Specify (in this order):

Model #
Chassis and Top Color
Door
Style/Color
Grain (if applicable)
Paperslot Divider Material/Color

Also available as 33%^H
Tall Wall Mount

Description

- Paper Slot Divider Color Must Specify: Chrome (CHRM) or Laminate (T) and Color
- Component Hutch Tops with Profiles are Available; [See Top Sizes](#)
- If Applicable, Door Front Grain Direction Vertical Standard; Optional Horizontal Grain Direction
- Door Fronts Available in Contrasting Colors; Must Specify Color
- Safely Write on Dry Erase, White and Black Tempered Glass Doors with Our Dry Erase Marker Set; [See Sets](#)
- Indiana Furniture Will Not be Liable for Wall Mount Hutches that are not Properly Installed
- Additional Options: Locking Doors ([See Locking Door Options](#)), Work Wall, Tackboards, and Tasklights ([See Units](#)), Marker and Eraser Sets ([See Sets](#))

Options: Specify & Add			Per Door
	1-AD	Aluminum Framed Satin Frosted Tempered Glass Doors (Non-Locking)	\$ 438
	1-DEB	Dry Erase Board Doors	\$ 28
	WHGLS	Aluminum Framed Doors with White Tempered Glass (Non-locking)	\$ 652
	BLGLS	Black Matte Framed Doors with Black Tempered Glass (Non-locking)	\$ 868
	1-HGA	High Gloss Acrylic Doors; Must Specify Color	
	(GPA)	Graphite Acrylic	\$ 269
	(BLA)	Black, (WMA) Wired Mercury, or (WHA) White Acrylic	\$ 247

Pricing Codes:

T= TFL
P= HPL

[See Canvas Intro Section for Ordering Options](#)

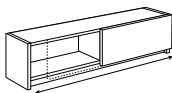
Item	Model No.	Width	Depth	Height	Ship Wt	Cubic Ft	List Price
WALL MOUNT HUTCH WITH SLIDING DOOR 	66-1596SWD Two (2) Doors	96	15	17 $\frac{3}{16}$	249	55.1	T\$ 3130
	66-1590SWD Two (2) Doors	90	15	17 $\frac{3}{16}$	233	53.7	T\$ 2930
	66-1584SWD Two (2) Doors	84	15	17 $\frac{3}{16}$	217	50.2	T\$ 2662
	66-1578SWD One (1) Door	78	15	17 $\frac{3}{16}$	201	46.7	T\$ 2533
	66-1572SWD One (1) Door	72	15	17 $\frac{3}{16}$	185	43.2	T\$ 2352
	66-1566SWD One (1) Door	66	15	17 $\frac{3}{16}$	170	39.7	T\$ 2260
	66-1560SWD One (1) Door	60	15	17 $\frac{3}{16}$	100	36.2	T\$ 2203



Must Specify (in this order):

Model #
Chassis and Top Color
Door
Style/Color
Grain (if applicable)

Description

- Non-Locking Sliding Doors
- Component Hutch Tops with Profiles are Available; [See Top Sizes](#)
- If Applicable, Door Front Grain Direction Vertical Standard; Optional Horizontal Grain Direction
- Door Fronts Available in Contrasting Colors; Must Specify Color
- Safely Write on Dry Erase with Our Dry Erase Marker Set; [See Sets](#)
- Indiana Furniture Will Not be Liable for Wall Mount Hutches That are not Properly Installed
- Additional Options: Marker Boards, Work Wall, Tackboards, and Tasklights ([See Units](#)), Marker and Eraser Sets ([See Sets](#))

Options: Specify & Add

		Per Door
	1-AD Aluminum Framed Satin Frosted Tempered Glass Doors (Non-Locking)	\$ 745
	1-DEB Dry Erase Board Door (Non-Locking)	\$ 77
	1-HGA High Gloss Acrylic Door (Non-Locking); Must Specify Color	
	(GPA) Graphite Acrylic	\$ 773
	(BLA) Black, (WMA) Wired Mercury, or (WHA) White Acrylic	\$ 705

Pricing Codes:

T= TFL
P= HPL

[See Canvas Intro Section for Ordering Options](#)

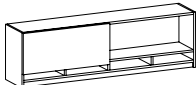
Item	Model No.	Width	Depth	Height	Ship Wt	Cubic Ft	List Price
WALL MOUNT HUTCH SLIDING DOOR WITH PAPER SLOTS 	66-1596SWDS Two (2) Doors / Six (6) Paper Slots	96	15	21	186	24.6	T\$ 4252
	66-1590SWDS Two (2) Doors / Five (5) Paper Slots	90	15	21	172	23.1	T\$ 4002
	66-1584SWDS Two (2) Doors / Five (5) Paper Slots	84	15	21	162	21.6	T\$ 3672
	66-1578SWDS One (1) Door / Five (5) Paper Slots	78	15	21	149	20.0	T\$ 3486
	66-1572SWDS One (1) Door / Four (4) Paper Slots	72	15	21	140	18.5	T\$ 3243
	66-1566SWDS One (1) Door / Four (4) Paper Slots	66	15	21	131	16.9	T\$ 3100
	66-1560SWDS One (1) Door / Four (4) Paper Slots	60	15	21	121	15.4	T\$ 2991

Must Specify (in this order):
 Model #
 Chassis and Top Color
 Door
 Style/Color
 Grain (if applicable)
 Paperslot Divider Material/Color

Description

- Non-Locking Sliding Doors
- Paper Slot Divider Color Must Specify: Chrome (CHRM) or Laminate (T) and Color
- Component Hutch Tops with Profiles are Available; [See Top Sizes](#)
- If Applicable, Door Front Grain Direction Vertical Standard; Optional Horizontal Grain Direction
- Door Fronts Available in Contrasting Colors; Must Specify Color
- Safely Write on Dry Erase, White and Black Glass Doors with Our Dry Erase Marker Set; [See Sets](#)
- Indiana Furniture Will Not be Liable for Wall Mount Hutches That are not Properly Installed
- Additional Options: Work Wall, Tackboards, and Tasklights ([See Units](#)), Marker and Eraser Sets ([See Sets](#))

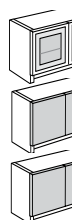

Options: Specify & Add		Per Door
1-AD	Aluminum Framed Satin Frosted Tempered Glass Doors (Non-Locking)	\$ 745
1-DEB	Dry Erase Board Door (Non-Locking)	\$ 77
1-HGA	High Gloss Acrylic Door (Non-Locking); Must Specify Color	
	(GPA) Graphite Acrylic	\$ 773
	(BLA) Black, (WMA) Wired Mercury, or (WHA) White Acrylic	\$ 705

Pricing Codes:
 T= TFL
 P= HPL

[See Canvas Intro Section for Ordering Options](#)

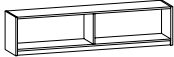
Item	Model No.	Width	Depth	Height	Ship Wt	Cubic Ft	List Price
WALL MOUNT HUTCH OPEN 	66-1596OW Three (3) Compartments	96	14¼	17¾ ₁₆	150	19.2	T\$ 2173
	66-1590OW Three (3) Compartments	90	14¼	17¾ ₁₆	140	17.9	T\$ 2031
	66-1584OW Three (3) Compartments	84	14¼	17¾ ₁₆	130	16.8	T\$ 1751
	66-1578OW Two (2) Compartments	78	14¼	17¾ ₁₆	122	15.7	T\$ 1711
	66-1572OW Two (2) Compartments	72	14¼	17¾ ₁₆	112	14.5	T\$ 1437
	66-1566OW Two (2) Compartments	66	14¼	17¾ ₁₆	100	13.3	T\$ 1391
	66-1560OW Two (2) Compartments	60	14¼	17¾ ₁₆	92	12.1	T\$ 1366
	66-1554OW Two (2) Compartments	54	14¼	17¾ ₁₆	83	10.5	T\$ 1269
	66-1548OW Two (2) Compartments	48	14¼	17¾ ₁₆	73	9.7	T\$ 1172
	66-1542OW One (1) Compartment	42	14¼	17¾ ₁₆	63	8.6	T\$ 1077
	66-1536OW One (1) Compartment	36	14¼	17¾ ₁₆	54	7.5	T\$ 935
	66-1530OW One (1) Compartment	30	14¼	17¾ ₁₆	45	5.7	T\$ 815

Must Specify (in this order):
Model #
Color

Also available as 29¾" H
Tall Wall Mount

Description

- Component Hutch Tops with Profiles are Available; [See Top Sizes](#)
- Indiana Furniture Will Not be Liable for Wall Mount Hutches that are not Properly Installed
- Additional Options: Marker Boards, Work Wall, Tackboards, and Tasklights ([See Units](#)), Marker and Eraser Sets ([See Sets](#))

Pricing Codes:

T= TFL
P= HPL

[See Canvas Intro Section for Ordering Options](#)

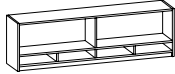
Item	Model No.	Width	Depth	Height	Ship Wt	Cubic Ft	List Price
WALL MOUNT HUTCH OPEN WITH PAPER SLOTS  Must Specify (in this order): Model # Color Paperslot Divider Material/Color Also available as 33 3/4" H Tall Wall Mount	66-1596OWS Three (3) Compartments	96	14 1/4	21	150	22.2	T\$ 3296
	66-1590OWS Three (3) Compartments	90	14 1/4	21	145	20.8	T\$ 3103
	66-1584OWS Three (3) Compartments	84	14 1/4	21	135	195	T\$ 2761
	66-1578OWS Two (2) Compartments	78	14 1/4	21	124	18.1	T\$ 2662
	66-1572OWS Two (2) Compartments	72	14 1/4	21	114	16.7	T\$ 2330
	66-1566OWS Two (2) Compartments	66	14 1/4	21	105	15.4	T\$ 2232
	66-1560OWS Two (2) Compartments	60	14 1/4	21	95	14.1	T\$ 2154
	66-1554OWS Two (2) Compartments	54	14 1/4	21	88	12.7	T\$ 2003
	66-1548OWS Two (2) Compartments	48	14 1/4	21	80	11.3	T\$ 1856
	66-1542OWS One (1) Compartment	42	14 1/4	21	72	10.0	T\$ 1710
	66-1536OWS One (1) Compartment	36	14 1/4	21	64	8.6	T\$ 1520
	66-1530OWS One (1) Compartment	30	14 1/4	21	56	7.2	T\$ 1349

Description

- Paper Slot Divider Color Must Specify: Chrome (CHRM) or Laminate (T) and Color
- Component Hutch Tops with Profiles are Available; [See Top Sizes](#)
- Indiana Furniture Will Not be Liable for Wall Mount Hutches that are not Properly Installed
- Also Available: Work Wall, Tackboards, and Tasklights ([See Units](#)), Marker and Eraser Sets ([See Sets](#))

Pricing Codes:

T= TFL
P= HPL

[See Canvas Intro Section for Ordering Options](#)

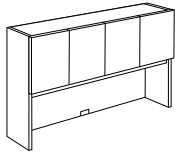
Item	Model No.	Width	Depth	Height	Ship Wt	Cubic Ft	List Price
TALL SURFACE MOUNT HUTCH HINGED DOOR 	66-1596THU Six (6) Doors	96	15	52 $\frac{7}{8}$	278	57.7	T\$ 3483
	66-1590THU Five (5) Doors	90	15	52 $\frac{7}{8}$	260	53.7	T\$ 3305
	66-1584THU Five (5) Doors	84	15	52 $\frac{7}{8}$	243	50.2	T\$ 2959
	66-1578THU Four (4) Doors	78	15	52 $\frac{7}{8}$	226	46.7	T\$ 2901
	66-1572THU Four (4) Doors	72	15	52 $\frac{7}{8}$	264	43.3	T\$ 2551
	66-1566THU Four (4) Doors	66	15	52 $\frac{7}{8}$	242	39.7	T\$ 2468
	66-1560THU Four (4) Doors	60	15	52 $\frac{7}{8}$	220	36.1	T\$ 2427

Must Specify (in this order):

- Model #
- Chassis and Top Color
- Door
- Style/Color
- Grain (if applicable)
- Locking Doors
- Paperslots
- Paperslot Divider Material/Color
- Tasklights
- Grommet Color
- Tackboard Fabric

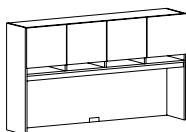

Optional Paper Slots in laminate or chrome available; See Paper Slot Options

Also available as 40 $\frac{7}{8}$ " H Standard Surface Mount

Description

- 23 $\frac{3}{4}$ " Clearance Below Apron Rail
- One (1) Fixed Shelf Behind Doors
- Lower Center Grommet Standard; Must Specify: Black (BLK) or Silver (SLV)
- Component Hutch Tops with Profiles are Available; [See Top Sizes](#)
- Safely Write on Dry Erase, White and Black Tempered Glass Doors with Our Dry Erase Marker Set; [See Sets](#)
- Additional Support is Required when Surface Mounted Hutches Do Not Sit Directly Over an End Panel or Pedestal; [See 66-2812SP](#)
- If Applicable, Door Front Grain Direction Vertical Standard; Optional Horizontal Grain Direction
- Door Fronts Available in Contrasting Colors; Must Specify
- Additional Options: Paper Slots ([See Paper Slot Options](#)), Locking Doors ([See Locking Door Options](#)), Marker Boards, Work Wall, Tackboards, and Tasklights ([See Units](#)), Marker and Eraser Sets ([See Sets](#))

Options: Specify & Add

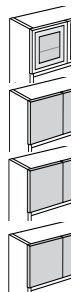

	Per Door
1-AD Aluminum Framed Satin Frosted Tempered Glass Doors (Non-Locking)	\$ 621
1-DEB Dry Erase Board Doors	\$ 60
WHGLS Aluminum Framed Doors with White Tempered Glass (Non-locking)	\$ 917
BLGLS Black Matte Framed Doors with Black Tempered Glass (Non-locking)	\$ 1210
1-HGA High Gloss Acrylic Doors; Must Specify Color	
(GPA) Graphite Acrylic	\$ 602
(BLA) Black, (WMA) Wired Mercury, or (WHA) White Acrylic	\$ 546

Pricing Codes:

- T= TFL
- P= HPL

[See Canvas Intro Section for Ordering Options](#)

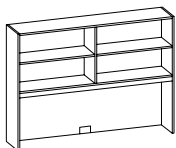
Item	Model No.	Width	Depth	Height	Ship Wt	Cubic Ft	List Price
TALL SURFACE MOUNT HUTCH OPEN 	66-1596TOH Six (6) Compartments	96	14¼	52⅞	217	57.7	T\$ 2849
	66-1590TOH Six (6) Compartments	90	14¼	52⅞	206	50.2	T\$ 2728
	66-1584TOH Six (6) Compartments	84	14¼	52⅞	195	48.3	T\$ 2415
	66-1578TOH Four (4) Compartments	78	14¼	52⅞	177	46.7	T\$ 2368
	66-1572TOH Four (4) Compartments	72	14¼	52⅞	166	43.3	T\$ 2080
	66-1566TOH Four (4) Compartments	66	14¼	52⅞	149	39.7	T\$ 2004
	66-1560TOH Four (4) Compartments	60	14¼	52⅞	144	36.1	T\$ 1995

Must Specify (in this order):

Model #
Color
Paperslots
Paperslot Divider Material/Color
Tasklights
Grommet Color
Tackboard Fabric

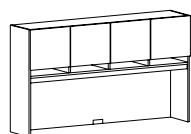

Optional Paper Slots in laminate or chrome available;
[See Paper Slot Options](#)

Also available as 40⅞" H
Standard Surface Mount

Description

- 23¾" Clearance Below Apron Rail
- Lower Center Grommet Standard; Must Specify: Black (BLK) or Silver (SLV)
- Additional Support is Required when Surface Mounted Hutches Do Not Sit Directly Over an End Panel or Pedestal; [See 66-2812SP](#)
- Component Hutch Tops with Profiles are Available; [See Top Sizes](#)
- Additional Options: Paper Slots ([See Paper Slot Options](#)), Marker Boards, Work Wall, Tackboards, and Tasklights ([See Units](#)), Marker and Eraser Sets ([See Sets](#))

Pricing Codes:

T= TFL
P= HPL



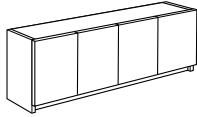

[See Canvas Intro Section for Ordering Options](#)

Item	Model No.	Width	Depth	Height	Ship Wt	Cubic Ft	List Price
TALL WALL MOUNT HUTCH HINGED DOOR  Must Specify (in this order): Model # Chassis and Top Color Door Style/Color Grain (if applicable) Locking Doors Also available as 17 3/16" H Standard Wall Mount	66-1596TWD Six (6) Doors	96	15	29 3/16	249	57.2	T\$ 3182
	66-1590TWD Five (5) Doors	90	15	29 3/16	233	53.7	T\$ 2892
	66-1584TWD Five (5) Doors	84	15	29 3/16	217	50.2	T\$ 2722
	66-1578TWD Four (4) Doors	78	15	29 3/16	201	46.7	T\$ 2669
	66-1572TWD Four (4) Doors	72	15	29 3/16	185	43.2	T\$ 2351
	66-1566TWD Four (4) Doors	66	15	29 3/16	170	22.0	T\$ 2249
	66-1560TWD Four (4) Doors	60	15	29 3/16	155	20.1	T\$ 2139
	66-1554TWD Three (3) Doors	54	15	29 3/16	140	18.1	T\$ 1975
	66-1548TWD Three (3) Doors	48	15	29 3/16	124	16.2	T\$ 1844
	66-1542TWD Two (2) Doors	42	15	29 3/16	109	12.3	T\$ 1497
	66-1536TWD Two (2) Doors	36	15	29 3/16	93	12.3	T\$ 1410
	66-1530TWD Two (2) Doors	30	15	29 3/16	77	9.1	T\$ 1322

Description

- One (1) Fixed Shelf Behind Doors
- Component Hutch Tops with Profiles are Available; [See Top Sizes](#)
- If Applicable, Door Front Grain Direction Vertical Standard; Optional Horizontal Grain Direction
- Door Fronts Available in Contrasting Colors; Must Specify
- Safely Write on Dry Erase, White and Black Tempered Glass Doors with Our Dry Erase Marker Set; [See Sets](#)
- Indiana Furniture Will Not be Liable for Wall Mount Hutches that are not Properly Installed
- Additional Options: Locking Doors ([See Locking Door Options](#)), Marker Boards, Work Wall, Tackboards, and Tasklights ([See Units](#)), Marker and Eraser Sets ([See Sets](#))

Options: Specify & Add

		Per Door
	1-AD Aluminum Framed Satin Frosted Tempered Glass Doors (Non-Locking)	\$ 621
	1-DEB Dry Erase Board Doors	\$ 60
	WHGLS Aluminum Framed Doors with White Tempered Glass (Non-locking)	\$ 917
	BLGLS Black Matte Framed Doors with Black Tempered Glass (Non-locking)	\$ 1210
	1-HGA High Gloss Acrylic Doors; Must Specify Color	
	(GPA) Graphite Acrylic	\$ 602
	(BLA) Black, (WMA) Wired Mercury, or (WHA) White Acrylic	\$ 546

Pricing Codes:

T= TFL
P= HPL



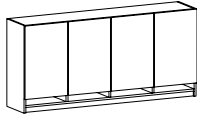

[See Canvas Intro Section for Ordering Options](#)

Item	Model No.	Width	Depth	Height	Ship Wt	Cubic Ft	List Price
 <p>TALL WALL MOUNT HUTCH HINGED DOOR WITH PAPER SLOTS</p> <p><i>Must Specify (in this order):</i> Model # Chassis and Top Color Door Style/Color Grain (if applicable) Paperslot Divider Material/Color</p> <p>Also available as 21$\frac{1}{4}$" H Standard Wall Mount</p>	66-1596TWDS Six (6) Doors / Six (6) Paper Slots	96	15	33 $\frac{1}{2}$ "	320	57.2	T\$ 4301
	66-1590TWDS Five (5) Doors / Five (5) Paper Slots	90	15	33 $\frac{1}{2}$ "	290	53.7	T\$ 3967
	66-1584TWDS Five (5) Doors / Five (5) Paper Slots	84	15	33 $\frac{1}{2}$ "	217	50.2	T\$ 3732
	66-1578TWDS Four (4) Doors / Four (4) Paper Slots	78	15	33 $\frac{1}{2}$ "	201	46.0	T\$ 3621
	66-1572TWDS Four (4) Doors / Four (4) Paper Slots	72	15	33 $\frac{1}{2}$ "	185	43.2	T\$ 3242
	66-1566TWDS Four (4) Doors / Four (4) Paper Slots	66	15	33 $\frac{1}{2}$ "	170	22.0	T\$ 3092
	66-1560TWDS Four (4) Doors / Four (4) Paper Slots	60	15	33 $\frac{1}{2}$ "	155	20.1	T\$ 2928
	66-1554TWDS Three (3) Doors / Three (3) Paper Slots	54	15	33 $\frac{1}{2}$ "	140	18.1	T\$ 2706
	66-1548TWDS Three (3) Doors / Three (3) Paper Slots	48	15	33 $\frac{1}{2}$ "	124	16.2	T\$ 2526
	66-1542TWDS Two (2) Doors / Two (2) Paper Slots	42	15	33 $\frac{1}{2}$ "	109	14.2	T\$ 2131
	66-1536TWDS Two (2) Doors / Two (2) Paper Slots	36	15	33 $\frac{1}{2}$ "	93	12.3	T\$ 1992
	66-1530TWDS Two (2) Doors / Two (2) Paper Slots	30	15	33 $\frac{1}{2}$ "	81	12.3	T\$ 1852

Description

- One (1) Fixed Shelf Behind Doors
- Paper Slot Divider Color Must Specify: Chrome (CHRM) or Laminate (T) and Color
- Component Hutch Tops with Profiles are Available; [See Top Sizes](#)
- If Applicable, Door Front Grain Direction Vertical Standard; Optional Horizontal Grain Direction
- Door Fronts Available in Contrasting Colors; Must Specify
- Safely Write on Dry Erase, White and Black Tempered Glass Doors with Our Dry Erase Marker Set; [See Sets](#)
- Indiana Furniture Will Not be Liable for Wall Mount Hutches that are not Properly Installed
- Additional Options: Locking Doors ([See Locking Door Options](#)), Work Wall, Tackboards, and Tasklights ([See Units](#)), Marker and Eraser Sets ([See Sets](#))

Options: Specify & Add

		Per Door
	1-AD Aluminum Framed Satin Frosted Tempered Glass Doors (Non-Locking)	\$ 621
	1-DEB Dry Erase Board Doors	\$ 60
	WHGLS Aluminum Framed Doors with White Tempered Glass (Non-locking)	\$ 917
	BLGLS Black Matte Framed Doors with Black Tempered Glass (Non-locking)	\$ 1210
	1-HGA High Gloss Acrylic Doors; Must Specify Color	
	(GPA) Graphite Acrylic	\$ 602
	(BLA) Black, (WMA) Wired Mercury, or (WHA) White Acrylic	\$ 546

Pricing Codes:

T= TFL
P= HPL

[See Canvas Intro Section for Ordering Options](#)

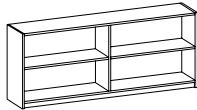
Item	Model No.	Width	Depth	Height	Ship Wt	Cubic Ft	List Price
TALL WALL MOUNT HUTCH OPEN 	66-1596TOW Six (6) Compartments	96	14¼	29¾ ¹ / ₁₆	200	30.8	T\$ 2541
	66-1590TOW Six (6) Compartments	90	14¼	29¾ ¹ / ₁₆	186	29.0	T\$ 2312
	66-1584TOW Six (6) Compartments	84	14¼	29¾ ¹ / ₁₆	173	27.1	T\$ 2179
	66-1578TOW Four (4) Compartments	78	14¼	29¾ ¹ / ₁₆	161	25.2	T\$ 2137
	66-1572TOW Four (4) Compartments	72	14¼	29¾ ¹ / ₁₆	147	23.3	T\$ 1879
	66-1566TOW Four (4) Compartments	66	14¼	29¾ ¹ / ₁₆	135	21.4	T\$ 1799
	66-1560TOW Four (4) Compartments	60	14¼	29¾ ¹ / ₁₆	122	20.1	T\$ 1710

Must Specify (in this order):

Model #
Color

Also available as 17¾" H
Standard Wall Mount

Description

- Component Hutch Tops with Profiles are Available; [See Top Sizes](#)
- Indiana Furniture Will Not be Liable for Wall Mount Hutches that are not Properly Installed
- Also Available: Marker Boards, Work Wall, Tackboards, and Tasklights ([See Units](#)), Marker and Eraser Sets ([See Set Options](#))

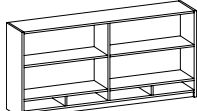
TALL WALL MOUNT HUTCH OPEN WITH PAPER SLOTS 	66-1596TOWS Six (6) Compartments/Six (6) Paper Slots	96	14¼	33 ⅝	220	30.8	T\$ 3666
	66-1590TOWS Six (6) Compartments/Six (6) Paper Slots	90	14¼	33 ⅝	206	29.0	T\$ 3388
	66-1584TOWS Six (6) Compartments/Six (6) Paper Slots	84	14¼	33 ⅝	193	27.1	T\$ 3187
	66-1578TOWS Four (4) Compartments/Four (4) Paper Slots	78	14¼	33 ⅝	181	25.2	T\$ 3088
	66-1572TOWS Four (4) Compartments/Four (4) Paper Slots	72	14¼	33 ⅝	167	23.2	T\$ 2774
	66-1566TOWS Four (4) Compartments/Four (4) Paper Slots	66	14¼	33 ⅝	155	21.4	T\$ 2641
	66-1560TOWS Four (4) Compartments/Four (4) Paper Slots	60	14¼	33 ⅝	142	20.1	T\$ 2498

Must Specify (in this order):

Model #
Color
Paperslot Divider Material/Color

Also available as 21¼" H
Standard Wall Mount

Description

- Paper Slot Divider Color Must Specify: Chrome (CHRM) or Laminate (T) and Color
- Component Hutch Tops with Profiles are Available; [See Top Sizes](#)
- Indiana Furniture Will Not be Liable for Wall Mount Hutches that are not Properly Installed
- Also Available: Work Wall, Tackboards, and Tasklights ([See Units](#)), Marker and Eraser Sets ([See Set Options](#))

Pricing Codes:

T= TFL
P= HPL

[See Canvas Intro Section for Ordering Options](#)

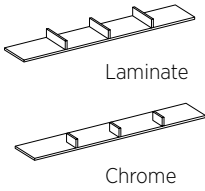
Item	Model No.	For Use With	Width	Depth	Height	Ship Wt	Cubic Ft	List Price
OPTIONAL PAPER SLOTS FOR SURFACE MOUNT HUTCH 	01-PAPERSLOT 96	For Use with 96" Unit Six (6) Slots	94½	11⅞	5¼	-	-	\$ 1092
	01-PAPERSLOT 90	For Use with 90" Unit Five (5) Slots	88½	11⅞	5¼	-	-	\$ 1043
	01-PAPERSLOT 84	For Use with 84" Unit Five (5) Slots	82½	11⅞	¼	-	-	\$ 986
	01-PAPERSLOT 78	For Use with 78" Unit Four (4) Slots	76½	11⅞	5¼	-	-	\$ 927
	01-PAPERSLOT 72	For Use with 72" Unit Four (4) Slots	70½	11⅞	5¼	-	-	\$ 870
	01-PAPERSLOT 66	For Use with 66" Unit Four (4) Slots	64½	11⅞	5¼	-	-	\$ 822
	01-PAPERSLOT 60	For Use with 60" Unit Four (4) Slots	58½	11⅞	5¼	-	-	\$ 766
	01-PAPERSLOT 54	For Use with 54" Unit Three (3) Slots	52½	11⅞	5¼	-	-	\$ 717
	01-PAPERSLOT 48	For Use with 48" Unit Three (3) Slots	46½	11⅞	5¼	-	-	\$ 663
	01-PAPERSLOT 42	For Use with 42" Unit Two (2) Slots	40½	11⅞	5¼	-	-	\$ 617
	01-PAPERSLOT 36	For Use with 36" Unit Two (2) Slots	34½	11⅞	5¼	-	-	\$ 569
	01-PAPERSLOT 30	For Use with 30" Unit Two (2) Slots	28½	11⅞	5¼	-	-	\$ 520

Must Specify (in this order):

Model #
Paperslot Divider Material
Paperslot Divider Color

Description

- Ships Factory Installed
- Paper Slot Divider Material and Color Must Specify: Chrome (CHRM) or Laminate (T) and Color

Pricing Codes:

T= TFL
P= HPL

[See Canvas Intro Section for Ordering Options](#)

Item	Model No.	Width	Depth	Height	Ship Wt	Cubic Ft	List Price
MODULAR TOP FOR 15" DEEP HUTCHES & BOOKCASES  Must Specify (in this order): Model # Color Edge Profile	66-1596HT	96	15	1	61	5.1	T\$ 572
	66-1590HT	90	15	1	57	4.8	T\$ 552
	66-1584HT	84	15	1	53	4.5	T\$ 525
	66-1578HT	78	15	1	50	4.2	T\$ 513
	66-1572HT	72	15	1	48	3.9	T\$ 478
	66-1566HT	66	15	1	42	3.5	T\$ 456
	66-1560HT	60	15	1	38	3.2	T\$ 444
	66-1554HT	54	15	1	34	2.9	T\$ 437
	66-1548HT	48	15	1	30	2.6	T\$ 425
	66-1542HT	42	15	1	27	2.3	T\$ 410
	66-1536HT	36	15	1	23	2.0	T\$ 400
	66-1530HT	30	15	1	11	1.0	T\$ 384

Description

- Provides an Edge Profile on Overhead Units While Giving Multiple Overhead Units a Cohesive Appearance
- Profiled on Front Edge Only

SURFACE MOUNT PAPER SLOT TOWER

66-1218HH	18	12	21	45	4.4	T\$ 828
-----------	----	----	----	----	-----	---------

**Description**

- Four (4) Adjustable Shelves

Must Specify (in this order):

Model #
Color

Pricing Codes:

T= TFL
P= HPL

[See Canvas Intro Section for Ordering Options](#)

Item	Model No.	Width	Depth	Height	Ship Wt	Cubic Ft	List Price
SURFACE MOUNT STORAGE TOWER WITH DOOR AND OPEN SHELVING	Hinged Left	Hinged Right					
	66-1518HL1	66-1518HR1	18	15	40 $\frac{1}{2}$	78	8.6

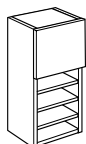

Shown as Left

Must Specify (in this order):

- Model #
- Color
- Door
- Style/Color
- Grain (if applicable)
- Locking Doors

Description

- Storage Behind Door in Upper Section
- Three (3) Adjustable Shelves
- If Applicable, Door Front Grain Direction Vertical Standard; Optional Horizontal Grain Direction
- Door Front Available in Contrasting Colors; Must Specify
- Safely Write on Dry Erase, White and Black Tempered Glass Doors with Our Dry Erase Marker Set; [See Sets](#)
- Additional Options: Locking Doors ([See Locking Options](#))

Options: Specify & Add

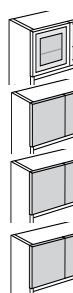

		Per Door
1-AD	Aluminum Framed Satin Frosted Tempered Glass Doors (Non-Locking)	\$ 438
1-DEB	Dry Erase Board Doors	\$ 28
WHGLS	Aluminum Framed Doors with White Tempered Glass (Non-locking)	\$ 652
BLGLS	Black Matte Framed Doors with Black Tempered Glass (Non-locking)	\$ 868
1-HGA	High Gloss Acrylic Doors; Must Specify Color	
	(GPA) Graphite Acrylic	\$ 269
	(BLA) Black, (WMA) Wired Mercury, or (WHA) White Acrylic	\$ 247

SURFACE MOUNT
TALL STORAGE TOWER WITH
DOOR AND OPEN SHELVING

Hinged Left	Hinged Right	Width	Depth	Height	Ship Wt	Cubic Ft	List Price
66-1518THL1	66-1518THR1	18	15	52 $\frac{1}{2}$	95	11.0	T\$ 1361

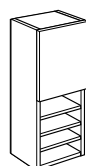

Shown as Left

Must Specify (in this order):

- Model #
- Color
- Door
- Style/Color
- Grain (if applicable)
- Locking Doors

Description

- Storage Behind Door in Upper Section with One (1) Adjustable Shelf
- Three (3) Adjustable Shelves
- If Applicable, Door Front Grain Direction Vertical Standard; Optional Horizontal Grain Direction
- Door Front Available in Contrasting Colors; Must Specify
- Safely Write on Dry Erase, White and Black Tempered Glass Doors with Our Dry Erase Marker Set; [See Set Options](#)
- Additional Options: Locking Doors ([See Locking Options](#))

Options: Specify & Add

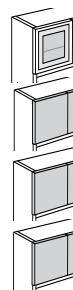

		Per Door
1-AD	Aluminum Framed Satin Frosted Tempered Glass Doors (Non-Locking)	\$ 621
1-DEB	Dry Erase Board Doors	\$ 60
WHGLS	Aluminum Framed Doors with White Tempered Glass (Non-locking)	\$ 917
BLGLS	Black Matte Framed Doors with Black Tempered Glass (Non-locking)	\$ 1210
1-HGA	High Gloss Acrylic Doors; Must Specify Color	
	(GPA) Graphite Acrylic	\$ 602
	(BLA) Black, (WMA) Wired Mercury, or (WHA) White Acrylic	\$ 546

Pricing Codes:

- T= TFL
- P= HPL

[See Canvas Intro Section for Ordering Options](#)

Item	Model No.	Width	Depth	Height	Ship Wt	Cubic Ft	List Price
SURFACE MOUNT STORAGE TOWER OPEN BOOKCASE	66-1518HB	18	14¼	40⅞	62	8.6	T\$ 810

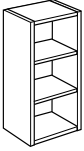

Description

- Two (2) Adjustable Shelves

Must Specify (in this order):

Model #
Color

SURFACE MOUNT TALL STORAGE TOWER OPEN BOOKCASE	66-1518THB	18	14½	52⅞	68	11.0	T\$ 961
--	------------	----	-----	-----	----	------	---------

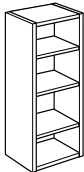

Description

- Three (3) Adjustable Shelves

Must Specify (in this order):

Model #
Color

Pricing Codes:

T= TFL
P= HPL

100 Canvas

[See Canvas Intro Section for Ordering Options](#)

Item	Model No.	Width	Depth	Height	Ship Wt	Cubic Ft	List Price
SURFACE MOUNT STORAGE TOWER WITH FULL DOOR	Hinged Left	Hinged Right					
	66-1518HL3	66-1518HR3	18	15	40 $\frac{1}{2}$	78	8.6

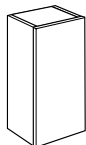

Shown as Left

Must Specify (in this order):

- Model #
- Color
- Door
- Style/Color
- Grain (if applicable)
- Locking Doors

Description

- Touch Latch Door with One (1) Fixed Shelf/Two (2) Adjustable Shelves Behind Door
- If Applicable, Door Front Grain Direction Vertical Standard; Optional Horizontal Grain Direction
- Door Front Available in Contrasting Colors; Must Specify
- Safely Write on Dry Erase, White and Black Tempered Glass Doors with Our Dry Erase Marker Set; [See Sets](#)
- Additional Options: Locking Door ([See Locking Options](#))

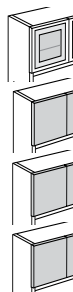

Options: Specify & Add		Per Unit
1-AD	Aluminum Framed Satin Frosted Tempered Glass Door (Non-Locking)	\$ 710
1-DEB	Dry Erase Board Door	\$ 77
WHGLS	Aluminum Framed Door with White Tempered Glass (Non-locking)	\$ 1113
BLGLS	Black Matte Framed Door with Black Tempered Glass (Non-locking)	\$ 1486
1-HGA	High Gloss Acrylic Door; Must Specify Color	
	(GPA) Graphite Acrylic	\$ 733
	(BLA) Black, (WMA) Wired Mercury, or (WHA) White Acrylic	\$ 668

Item	Model No.	Width	Depth	Height	Ship Wt	Cubic Ft	List Price
SURFACE MOUNT TALL STORAGE TOWER WITH FULL DOOR	Hinged Left	Hinged Right					
	66-1518THL3	66-1518THR3	18	15	52 $\frac{1}{2}$	95	11.0



Shown as Left

Must Specify (in this order):

- Model #
- Color
- Door
- Style/Color
- Grain (if applicable)
- Locking Doors

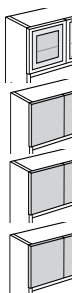

Options: Specify & Add		Per Unit
1-AD	Aluminum Framed Satin Frosted Tempered Glass Door (Non-Locking)	\$ 849
1-DEB	Dry Erase Board Door	\$ 96
WHGLS	Aluminum Framed Door with White Tempered Glass (Non-locking)	\$ 1347
BLGLS	Black Matte Framed Door with Black Tempered Glass (Non-locking)	\$ 1796
1-HGA	High Gloss Acrylic; Must Specify Color	
	(GPA) Graphite Acrylic	\$ 960
	(BLA) Black, (WMA) Wired Mercury, or (WHA) White Acrylic	\$ 876

Pricing Codes:

- T= TFL
- P= HPL

[See Canvas Intro Section for Ordering Options](#)

Item	Model No.	Width	Depth	Height	Ship Wt	Cubic Ft	List Price
SURFACE MOUNT DOOR BOOKCASE	66-1536TUDB	36	15	40 $\frac{1}{2}$	168	16.1	T\$ 1528
	66-1530TUDB	30	15	40 $\frac{1}{2}$	140	13.4	T\$ 1416

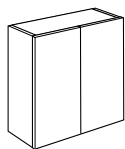

Must Specify (in this order):

- Model #
- Color
- Door
- Style/Color
- Grain (if applicable)
- Locking Doors

Description

- Touch Latch Door with One (1) Fixed Shelf/Two (2) Adjustable Shelves Behind Door
- If Applicable, Door Front Grain Direction Vertical Standard; Optional Horizontal Grain Direction
- Door Fronts Available in Contrasting Colors; Must Specify
- Safely Write on Dry Erase, White and Black Tempered Glass Doors with Our Dry Erase Marker Set; [See Sets](#)
- Additional Options: Locking Doors ([See Locking Options](#))

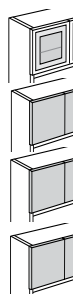

Options: Specify & Add			Per Unit
1-AD	Aluminum Framed Satin Frosted Tempered Glass Doors (Non-Locking)		\$ 1420
1-DEB	Dry Erase Board Doors		\$ 148
WHGLS	Aluminum Framed Doors with White Tempered Glass (Non-locking)		\$ 2228
BLGLS	Black Matte Framed Doors with Black Tempered Glass (Non-locking)		\$ 2975
1-HGA	High Gloss Acrylic; Must Specify Color		
	(GPA) Graphite Acrylic		\$ 1462
	(BLA) Black, (WMA) Wired Mercury, or (WHA) White Acrylic		\$ 1334

SURFACE MOUNT TALL DOOR BOOKCASE	66-1536TTUDB	36	15	52 $\frac{1}{2}$	216	20.5	T\$ 1792
	66-1530TTUDB	30	15	52 $\frac{1}{2}$	180	17.3	T\$ 1627

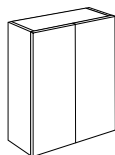

Must Specify (in this order):

- Model #
- Color
- Door
- Style/Color
- Grain (if applicable)
- Locking Doors

Description

- Touch Latch Door with One (1) Fixed Shelf/Three (3) Adjustable Shelves Behind Door
- If Applicable, Door Front Grain Direction Vertical Standard; Optional Horizontal Grain Direction
- Door Fronts Available in Contrasting Colors; Must Specify
- Safely Write on Dry Erase, White and Black Tempered Glass Doors with Our Dry Erase Marker Set; [See Sets](#)
- Additional Options: Locking Doors ([See Locking Options](#))

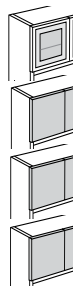

Options: Specify & Add			Per Unit
1-AD	Aluminum Framed Satin Frosted Tempered Glass Doors (Non-Locking)		\$ 1697
1-DEB	Dry Erase Board Doors		\$ 193
WHGLS	Aluminum Framed Doors with White Tempered Glass (Non-locking)		\$ 2692
BLGLS	Black Matte Framed Doors with Black Tempered Glass (Non-locking)		\$ 3589
1-HGA	High Gloss Acrylic; Must Specify Color		
	(GPA) Graphite Acrylic		\$ 1914
	(BLA) Black, (WMA) Wired Mercury, or (WHA) White Acrylic		\$ 1747

Pricing Codes:

- T= TFL
- P= HPL

[See Canvas Intro Section for Ordering Options](#)

Item	Model No.	Width	Depth	Height	Ship Wt	Cubic Ft	List Price
SURFACE MOUNT DOOR BOOKCASE WITH SIDE SHELVING	Shelves Left	Shelves Right					
	66-3615TUDBL	66-3615TUDBR	36	15	40 $\frac{1}{2}$	157	T\$ 2080
	66-3015TUDBL	66-3015TUDBR	30	15	40 $\frac{1}{2}$	140	T\$ 2007

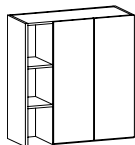

Shown as Left

Must Specify (in this order):

- Model #
- Color
- Door
 - Style/Color
 - Grain (if applicable)
 - Locking Doors

Description

- Touch Latch Door with Two (2) Adjustable Shelves Behind Doors
- Side Fixed Shelves; Top Shelf with 15" Clearance, Two (2) Remaining Shelves with 11 $\frac{1}{2}$ " Clearance
- If Applicable, Door Front Grain Direction Vertical Standard; Optional Horizontal Grain Direction
- Door Fronts Available in Contrasting Colors; Must Specify
- Safely Write on Dry Erase, White and Black Tempered Glass Doors with Our Dry Erase Marker Set; [See Sets](#)
- Additional Options: Locking Doors ([See Locking Options](#))

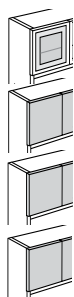

Options: Specify & Add

		Per Unit
1-AD	Aluminum Framed Satin Frosted Tempered Glass Doors (Non-Locking)	\$ 1420
1-DEB	Dry Erase Board Doors	\$ 148
WHGLS	Aluminum Framed Doors with White Tempered Glass (Non-locking)	\$ 2228
BLGLS	Black Matte Framed Doors with Black Tempered Glass (Non-locking)	\$ 2975
1-HGA	High Gloss Acrylic; Must Specify Color	
	(GPA) Graphite Acrylic	\$ 1462
	(BLA) Black, (WMA) Wired Mercury, or (WHA) White Acrylic	\$ 1334

Item	Model No.	Width	Depth	Height	Ship Wt	Cubic Ft	List Price
SURFACE MOUNT DOOR BOOKCASE WITH SIDE SHELVING	Shelves Left	Shelves Right					
	66-3615TTUDBL	66-3615TTUDBR	36	15	52	157	T\$ 2368
	66-3015TTUDBL	66-3015TTUDBR	30	15	52	140	T\$ 2285

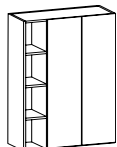

Shown as Left

Must Specify (in this order):

- Model #
- Color
- Door
 - Style/Color
 - Grain (if applicable)
 - Locking Doors

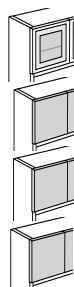

Options: Specify & Add

		Per Unit
1-AD	Aluminum Framed Satin Frosted Tempered Glass Doors (Non-Locking)	\$ 1697
1-DEB	Dry Erase Board Doors	\$ 193
WHGLS	Aluminum Framed Doors with White Tempered Glass (Non-locking)	\$ 2692
BLGLS	Black Matte Framed Doors with Black Tempered Glass (Non-locking)	\$ 3589
1-HGA	High Gloss Acrylic; Must Specify Color	
	(GPA) Graphite Acrylic	\$ 1914
	(BLA) Black, (WMA) Wired Mercury, or (WHA) White Acrylic	\$ 1747

Pricing Codes:

- T= TFL
- P= HPL

[See Canvas Intro Section for Ordering Options](#)

Item	Model No.	Width	Depth	Height	Ship Wt	Cubic Ft	List Price
STORAGE CABINET WITH OPEN SHELVES AND FILE/FILE	Hinged Left	Hinged Right					
	66-1872DS2L	66-1872DS2R	18	24	70 $\frac{1}{2}$	145	22.0

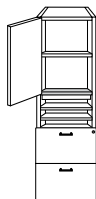

Shown as Left

Description

- One (1) Adjustable Shelf Behind Touch Latch Door; Two (2) Adjustable Shelves in Center
- Locking File Drawers Provide Legal or Letter Filing
- Safely Write on Dry Erase Doors with Our Dry Erase Marker Set; [See Sets](#)
- If Applicable, Drawer/Door Fronts Grain Direction Vertical Standard; Optional Horizontal Grain Direction
- If Applicable, Drawer/Door Fronts Available in Contrasting Colors; Must Specify
- Additional Options: Dove Tail Drawer Construction and Soft Close Drawers ([See Drawer Options](#)), Locking Door ([See Locking Options](#))

Must Specify (in this order):

- Model #
- Color
- Door Style/Color
- Door/Drawer Grain (if applicable)
- Locking Doors
- Drawer Construction
- Track
- Color
- Pull

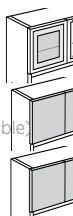

Options: Specify & Add

	Per Door
1-AD Aluminum Framed Satin Frosted Tempered Glass Doors (Non-Locking)	\$ 621
1-DEB Dry Erase Board Doors	\$ 60
1-HGA High Gloss Acrylic Doors; Must Specify Color	
(GPA) Graphite Acrylic	\$ 602
(BLA) Black, (WMA) Wired Mercury, or (WHA) White Acrylic	\$ 546

Item	Model No.	Width	Depth	Height	Ship Wt	Cubic Ft	List Price
TALL STORAGE CABINET WITH OPEN SHELVES AND FILE/FILE	Hinged Left	Hinged Right					
	66-1884DS2L	66-1884DS2R	18	24	82 $\frac{1}{2}$	196	25.8

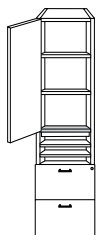

Shown as Left

Description

- Two (2) Adjustable Shelf Behind Touch Latch Door; Two (2) Adjustable Shelves in Center
- Safely Write on Dry Erase Doors with Our Dry Erase Marker Set; [See Sets](#)
- Locking File Drawers Provide Legal or Letter Filing
- If Applicable, Drawer/Door Fronts Grain Direction Vertical Standard; Optional Horizontal Grain Direction
- If Applicable, Drawer/Door Fronts Available in Contrasting Colors; Must Specify
- Additional Options: Dove Tail Drawer Construction and Soft Close Drawers ([See Drawer Options](#)), Locking Door ([See Locking Options](#))

Must Specify (in this order):

- Model #
- Color
- Door Style/Color
- Grain (if applicable)
- Locking Doors
- Drawer Construction
- Track
- Color
- Grain (if applicable)
- Pull

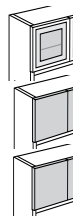

Options: Specify & Add

	Per Unit
1-AD Aluminum Framed Satin Frosted Tempered Glass Door (Non-Locking)	\$ 710
1-DEB Dry Erase Board Door	\$ 77
1-HGA High Gloss Acrylic Door; Must Specify Color	
(GPA) Graphite Acrylic	\$ 733
(BLA) Black, (WMA) Wired Mercury, or (WHA) White Acrylic	\$ 668

Pricing Codes:

- T= TFL
- P= HPL

[See Canvas Intro Section for Ordering Options](#)

Item	Model No.	Width	Depth	Height	Ship Wt	Cubic Ft	List Price
STORAGE CABINET WITH OPEN SHELVES AND BOX/BOX/FILE	Hinged Left	Hinged Right					
	66-1872DSIL	66-1872DS1R	18	24	70 $\frac{1}{2}$	145	22.0

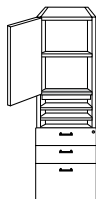

Shown as Left

Description

- One (1) Adjustable Shelf Behind Touch Latch Door; Two (2) Adjustable Shelves in Center
- Safely Write on Dry Erase Doors with Our Dry Erase Marker Set; [See Sets](#)
- Locking Drawers; File Drawer Provides Legal or Letter Filing
- If Applicable, Drawer/Door Fronts Grain Direction Vertical Standard; Optional Horizontal Grain Direction
- If Applicable, Drawer/Door Fronts Available in Contrasting Colors; Must Specify
- Additional Options: Dove Tail Drawer Construction and Soft Close Drawers ([See Drawer Options](#)), Locking Door ([See Locking Options](#))

Must Specify (in this order):

- Model #
- Color
- Door
 - Style/Color
 - Grain (if applicable)
- Locking Doors
- Drawer
 - Construction
 - Track
 - Color
 - Grain (if applicable)
- Pull

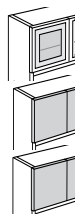

Options: Specify & Add

	Per Door
1-AD Aluminum Framed Satin Frosted Tempered Glass Doors (Non-Locking)	\$ 621
1-DEB Dry Erase Board Doors	\$ 60
1-HGA High Gloss Acrylic Doors; Must Specify Color	
(GPA) Graphite Acrylic	\$ 602
(BLA) Black, (WMA) Wired Mercury, or (WHA) White Acrylic	\$ 546

Item	Model No.	Width	Depth	Height	Ship Wt	Cubic Ft	List Price
TALL STORAGE CABINET WITH OPEN SHELVES AND BOX/BOX/FILE	Hinged Left	Hinged Right					
	66-1884DSIL	66-1884DS1R	18	24	82 $\frac{1}{2}$	196	25.8

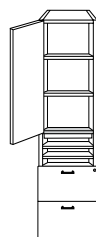

Shown as Left

Description

- Two (2) Adjustable Shelf Behind Touch Latch Door; Two (2) Adjustable Shelves in Center
- Safely Write on Dry Erase Doors with Our Dry Erase Marker Set; [See Sets](#)
- Locking Drawers; File Provide Legal or Letter Filing
- If Applicable, Drawer/Door Fronts Grain Direction Vertical Standard; Optional Horizontal Grain Direction
- If Applicable, Drawer/Door Fronts Available in Contrasting Colors; Must Specify
- Additional Options: Dove Tail Drawer Construction and Soft Close Drawers ([See Drawer Options](#)), Locking Door ([See Locking Options](#))

Must Specify (in this order):

- Model #
- Color
- Door
 - Style/Color
 - Grain (if applicable)
- Locking Doors
- Drawer
 - Construction
 - Track
 - Color
 - Grain (if applicable)
- Pull

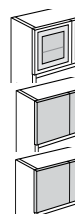

Options: Specify & Add

	Per Unit
1-AD Aluminum Framed Satin Frosted Tempered Glass Door (Non-Locking)	\$ 710
1-DEB Dry Erase Board Door	\$ 77
1-HGA High Gloss Acrylic Door; Must Specify Color	
(GPA) Graphite Acrylic	\$ 733
(BLA) Black, (WMA) Wired Mercury, or (WHA) White Acrylic	\$ 668

Pricing Codes:

- T= TFL
- P= HPL

[See Canvas Intro Section for Ordering Options](#)

Item	Model No.	Width	Depth	Height	Ship Wt	Cubic Ft	List Price	
STORAGE CABINET FILE/FILE	Hinged Left	Hinged Right						
	66-1884WFL	66-1884WFR	18	24	82 $\frac{1}{2}$ "	166	25.7	T\$ 2370
	Three (3) Adjustable Shelves Behind Door							
	66-1872WFL	66-1872WFR	18	24	70 $\frac{1}{2}$ "	145	22.0	T\$ 2270
	Two (2) Adjustable Shelves Behind Door							

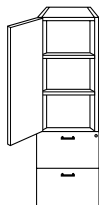

Shown as Left

Description

- Touch Latch Door
- Locking File Drawers Provide Legal or Letter Filing
- If Applicable, Drawer/Door Fronts Grain Direction Vertical Standard; Optional Horizontal Grain Direction
- If Applicable, Drawer/Door Fronts Available in Contrasting Colors; Must Specify
- Additional Options: Dove Tail Drawer Construction and Soft Close Drawers ([See Drawer Options](#)), Locking Door ([See Locking Options](#))

Must Specify (in this order):

- Model #
- Color
- Door/Drawer Grain (if applicable)
- Door/Drawer Color
- Locking Doors
- Drawer
 - Construction
 - Track
 - Pull

OPEN STORAGE CABINET FILE/FILE	66-1884WFO	18	24	82 $\frac{1}{2}$ "	166	25.7	T\$ 2181
	Three (3) Adjustable Shelves						
	66-1872WFO	18	24	70 $\frac{1}{2}$ "	145	22.0	T\$ 2087
	Two (2) Adjustable Shelves						



Description

- Locking File Drawers Provide Legal or Letter Filing
- If Applicable, Drawer Fronts Grain Direction Vertical Standard; Optional Horizontal Grain Direction
- If Applicable, Drawer Fronts Available in Contrasting Colors; Must Specify
- Additional Options: Dove Tail Drawer Construction and Soft Close Drawers ([See Drawer Options](#))

Must Specify (in this order):

- Model #
- Color
- Drawer
 - Construction
 - Track
 - Color
 - Grain (if applicable)
 - Pull

Pricing Codes:

T= TFL
P= HPL

[See Canvas Intro Section for Ordering Options](#)

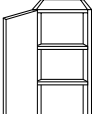
Item	Model No.	Width	Depth	Height	Ship Wt	Cubic Ft	List Price	
STORAGE CABINET BOX/BOX/FILE 	Hinged Left	Hinged Right						
	66-1884WBL	66-1884WBR	18	24	82 $\frac{7}{8}$	166	25.7	T\$ 2370
	Three (3) Adjustable Shelves Behind Door							
	66-1872WBL	66-1872WBR	18	24	70 $\frac{7}{8}$	145	22.0	T\$ 2270
Two (2) Adjustable Shelves Behind Door								

Description

- Touch Latch Door
- Locking File Drawers Provide Legal or Letter Filing
- If Applicable, Drawer/Door Fronts Grain Direction Vertical Standard; Optional Horizontal Grain Direction
- If Applicable, Drawer/Door Fronts Available in Contrasting Colors; Must Specify
- Additional Options: Dove Tail Drawer Construction and Soft Close Drawers ([See Drawer Options](#)), Locking Door ([See Locking Options](#))

Shown as Left

Must Specify (in this order):

- Model #
- Color
- Door/Drawer Grain (if applicable)
- Door/Drawer Color
- Locking Doors
- Drawer
 - Construction
 - Track
 - Pull

OPEN STORAGE CABINET BOX/BOX/FILE 	66-1884WBO	18	24	82 $\frac{7}{8}$	166	25.7	T\$ 2181	
	Three (3) Adjustable Shelves							
	66-1872WBO	18	24	70 $\frac{7}{8}$	145	22.0	T\$ 2087	
	Two (2) Adjustable Shelves							

Description

- Locking File Drawers Provide Legal or Letter Filing
- If Applicable, Drawer Fronts Grain Direction Vertical Standard; Optional Horizontal Grain Direction
- If Applicable, Drawer Fronts Available in Contrasting Colors; Must Specify
- Additional Options: Dove Tail Drawer Construction and Soft Close Drawers ([See Drawer Options](#))

Must Specify (in this order):

- Model #
- Color
- Drawer
 - Construction
 - Track
 - Color
 - Grain (if applicable)
 - Pull

Pricing Codes:

- T= TFL
- P= HPL

[See Canvas Intro Section for Ordering Options](#)

Item	Model No.	Width	Depth	Height	Ship Wt	Cubic Ft	List Price
NARROW TOWER	Hinged Left	Hinged Right					
	66-1251WDIL	66-1251WD1R	12	24	51½	85	11.2

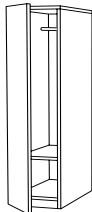

Shown as Left

Must Specify (in this order):

- Model #
- Color
- Door
- Style/Color
- Grain (if applicable)
- Locking Doors

Description

- 10" Coat Rod; One (1) Adjustable Shelf
- Touch Latch Door
- Safely Write on Dry Erase Doors with Our Dry Erase Marker Set; [See Set Options](#)
- If Applicable, Door Front Grain Direction Vertical Standard; Optional Horizontal Grain Direction
- If Applicable, Door Front Available in Contrasting Colors; Must Specify
- Additional Options: Locking Door ([See Locking Options](#))

Options: Specify & Add

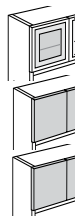

1-AD	Aluminum Framed Satin Frosted Tempered Glass Door (Non-Locking)	\$ 678
1-DEB	Dry Erase Board Door	\$ 60
1-HGA	High Gloss Acrylic Door; Must Specify Color	
	(GPA) Graphite Acrylic	\$ 614
	(BLA) Black, Wired Mercury (WMA), or White (WHA) Acrylic	\$ 560

WARDROBE/STORAGE CABINET	Hinged Left	Hinged Right	Width	Depth	Height	Ship Wt	Cubic Ft	List Price
	66-1884WL	66-1884WR	18	24	82¾	162	25.7	T\$ 2143
	Four (4) Adjustable Shelves Behind Door							
	66-1872WL	66-1872WR	18	24	70¾	153	19.2	T\$ 2053
	Three (3) Adjustable Shelves Behind Door							

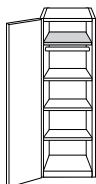

Shown as Left

Must Specify (in this order):

- Model #
- Color
- Door
- Style/Color
- Grain (if applicable)
- Locking Doors

Description

- Coat Rod Under Top Fixed Shelf
- Adjustable Shelves can be Removed for Wardrobe Application
- Touch Latch Door
- Safely Write on Dry Erase Doors with Our Dry Erase Marker Set; [See Set Options](#)
- If Applicable, Door Front Available in Contrasting Colors; Must Specify
- Additional Options: Locking Door ([See Locking Options](#))

Options: Specify & Add

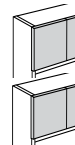

1-DEB	Dry Erase Board Door	\$ 129
1-HGA	High Gloss Acrylic Door; Must Specify Color	
	(GPA) Graphite Acrylic	\$ 1275
	(BLA) Black, Wired Mercury (WMA), or White (WHA) Acrylic	\$ 1162

Pricing Codes:

- T= TFL
- P= HPL

[See Canvas Intro Section for Ordering Options](#)

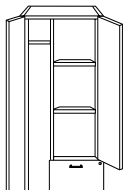
Item	Model No.	Width	Depth	Height	Ship Wt	Cubic Ft	List Price
TOWER WARDROBE FILE/FILE 	Wardrobe Left	Wardrobe Right					
	66-2484WD2L	66-2484WD2R	24	24	82 $\frac{7}{8}$	252	T\$ 3226
	Three (3) Adjustable Shelves Behind Door						
	66-2472WD2L	66-2472WD2R	24	24	70 $\frac{7}{8}$	242	T\$ 2997
Two (2) Adjustable Shelves Behind Door							
	66-2451WD2L	66-2451WD2R	24	24	51 $\frac{1}{2}$	172	T\$ 2658
One (1) Adjustable Shelf Behind Door							

Shown as Left

Must Specify (in this order):

- Model #
- Chassis Color
- 51 $\frac{1}{2}$ "H Door/Drawer Color
- Locking Doors
- Drawer Construction
- Track
- Pull

Description

- Wardrobe Door Features Coat Rod and Knob Pull; Knob Color will Coordinate with Drawer Pull
- If Black or Gold Pull is Selected, Knob will be Black; If Chrome or Aluminum Pull is Selected, Knob will be Aluminum
- Cabinet Door Features Touch Latch Door
- Locking File Drawers Provides Legal or Letter Filing
- Door/Drawer Fronts Available in Contrasting Colors; Must Specify
- Additional Options: Dove Tail Drawer Construction and Soft Close Drawers ([See Drawer Options](#)), Locking Doors ([See Locking Options](#))

Item	Model No.	Width	Depth	Height	Ship Wt	Cubic Ft	List Price
TOWER WARDROBE BOX/BOX/FILE 	Wardrobe Left	Wardrobe Right					
	66-2484WD1L	66-2484WD1R	24	24	82 $\frac{7}{8}$	252	T\$ 3226
	Three (3) Adjustable Shelves Behind Door						
	66-2472WD1L	66-2472WD1R	24	24	70 $\frac{7}{8}$	242	T\$ 2997
Two (2) Adjustable Shelves Behind Door							
	66-2451WD1L	66-2451WD1R	24	24	51 $\frac{1}{2}$	172	T\$ 2658
One (1) Adjustable Shelf Behind Door							

Shown as Left

Must Specify (in this order):

- Model #
- Chassis Color
- 51 $\frac{1}{2}$ "H Door/Drawer Color
- Locking Doors
- Drawer Construction
- Track
- Pull

Description

- Wardrobe Door Features Coat Rod and Knob Pull; Knob Color will Coordinate with Drawer Pull
- If Black or Gold Pull is Selected, Knob will be Black; If Chrome or Aluminum Pull is Selected, Knob will be Aluminum
- Cabinet Door Features Touch Latch Door
- Locking File Drawers Provides Legal or Letter Filing
- Door/Drawer Fronts Available in Contrasting Colors; Must Specify
- Additional Options: Dove Tail Drawer Construction and Soft Close Drawers ([See Drawer Options](#)), Locking Doors ([See Locking Options](#))

Pricing Codes:

T= TFL
P= HPL

[See Canvas Intro Section for Ordering Options](#)

Item	Model No.	Width	Depth	Height	Ship Wt	Cubic Ft	List Price
TALL WARDROBE/STORAGE CABINET	Wardrobe Left	Wardrobe Right					
	66-3684WDS2L	66-3684WDS2R	36	24	82 $\frac{1}{2}$	368	49.2

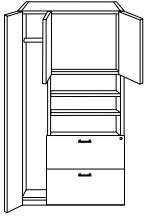

Shown as Left

Must Specify (in this order):

- Model #
- Chassis Color
- Door Style/Color
- Drawer Front Color
- Drawer Construction
- Locking Doors
- Pull

Description

- TFL Wardrobe Door Features Coat Rod and Knob Pull; Knob Color will Coordinate with Drawer Pull
- If Black or Gold Pull is Selected, Knob will be Black; If Chrome or Aluminum Pull is Selected, Knob will be Aluminum
- Hutch Doors Standard with Touch Latch; See Door Options Below
- Two (2) Adjustable Shelves
- Locking Lateral Drawers Provides Legal or Letter Filing
- Door/Drawer Fronts Available in Contrasting Colors; Must Specify
- Safely Write on Dry Erase Doors with Our Dry Erase Marker Set; [See Sets](#)
- Additional Options: Dove Tail Drawer Construction ([See Drawer Options](#)), Locking Doors ([See Locking Options](#))

Hutch Door Options: Specify & Add

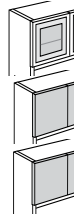

1-AD	Aluminum Framed Satin Frosted Tempered Glass Doors (Non-Locking)	\$ 1243
1-DEB	Dry Erase Board Doors	\$ 121
1-HGA	High Gloss Acrylic Doors; Must Specify Color (Non-Locking)	
	(GPA) Graphite Acrylic	\$ 1200
	(BLA) Black, (WMA), Wired Mercury or (WHA) White Acrylic	\$ 1095

WARDROBE/STORAGE CABINET	Wardrobe Left	Wardrobe Right	Width	Depth	Height	Ship Wt	Cubic Ft	List Price
	66-3672WDS2L	66-3672WDS2R	36	24	70 $\frac{1}{2}$	368	42.0	T\$ 3370

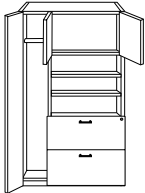

Shown as Left

Must Specify (in this order):

- Model #
- Chassis Color
- Door Style/Color
- Drawer Front Color
- Drawer Construction
- Locking Doors
- Pull

Description

- TFL Wardrobe Door Features Coat Rod and Knob Pull; Knob Color will Coordinate with Drawer Pull
- If Black or Gold Pull is Selected, Knob will be Black; If Chrome or Aluminum Pull is Selected, Knob will be Aluminum
- Hutch Doors Standard with Touch Latch; See Door Options Below
- Two (2) Adjustable Shelves
- Locking Lateral Drawers Provides Legal or Letter Filing
- Door/Drawer Fronts Available in Contrasting Colors; Must Specify
- Safely Write on Dry Erase Doors with Our Dry Erase Marker Set; [See Sets](#)
- Additional Options: Dove Tail Drawer Construction ([See Drawer Options](#)), Locking Doors ([See Locking Options](#))

Hutch Door Options: Specify & Add

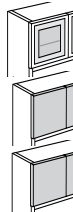

1-AD	Aluminum Framed Satin Frosted Tempered Glass Doors (Non-Locking)	\$ 877
1-DEB	Dry Erase Board Doors	\$ 54
1-HGA	High Gloss Acrylic Doors; Must Specify Color (Non-Locking)	
	(GPA) Graphite Acrylic	\$ 535
	(BLA) Black, (WMA), Wired Mercury or (WHA) White Acrylic	\$ 487

Pricing Codes:

- T= TFL
- P= HPL

[See Canvas Intro Section for Ordering Options](#)

Item	Model No.	Width	Depth	Height	Ship Wt	Cubic Ft	List Price
STORAGE CABINET WITH LATERAL FILES 	66-3684SU2 Three Adjustable Shelves	36	24	82 $\frac{7}{8}$	318	49.2	T\$ 3656
	66-3084SU2 Three Adjustable Shelves	30	24	82 $\frac{7}{8}$	271	42.9	T\$ 3568
	66-3672SU2 Two Adjustable Shelves	36	24	70 $\frac{7}{8}$	298	42.0	T\$ 3457
	66-3072SU2 Two Adjustable Shelves	30	24	70 $\frac{7}{8}$	251	35.7	T\$ 3375

Description

- Top - Two (2) Doors with Adjustable Shelves
- Bottom - File/File Locking Drawers Provide Legal or Letter Filing
- Touch Latch Doors
- Door/Drawer Fronts Available in Contrasting Colors; Must Specify
- Additional Options: Locking Doors ([See Locking Options](#))

Must Specify (in this order):

- Model #
- Chassis Color
- Door/Drawer Front Color
- Drawer Construction
- Locking Doors

WARDROBE/STORAGE CABINET 	66-3672WC	36	24	70 $\frac{7}{8}$	320	42.0	T\$ 2850
	66-3072WC	30	24	70 $\frac{7}{8}$	240	35.7	T\$ 2774



Description

- Left Side: One (1) Fixed Shelf at Top and Three (3) Adjustable Shelves below
- Right Side: One (1) Fixed Shelf at Top and Coat Rod below
- Touch Latch Door
- Safely Write on Dry Erase Doors with Our Dry Erase Marker Set; [See Sets](#)
- If Applicable, Door Fronts Available in Contrasting Colors; Must Specify
- Additional Options: Locking Doors ([See Locking Options](#))

Must Specify (in this order):

- Model #
- Chassis Color
- Door Style/Color
- Locking Doors

Options: Specify & Add

	1-DEB	Dry Erase Board Doors	\$ 257
	1-HGA	High Gloss Acrylic Doors; Must Specify Color	
		(GPA) Graphite Acrylic	\$ 2551
		(BLA) Black, (WMA), Wired Mercury or (WHA) White Acrylic	\$ 2329

Pricing Codes:

- T= TFL
- P= HPL

[See Canvas Intro Section for Ordering Options](#)

Item	Model No.	Width	Depth	Height	Ship Wt	Cubic Ft	List Price
TALL WARDROBE/STORAGE CABINET	66-3684WC	36	24	82 $\frac{7}{8}$	340	49.2	T\$ 2974
	66-3084WC	30	24	82 $\frac{7}{8}$	320	41.4	T\$ 2894

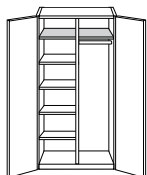

Must Specify (in this order):

- Model #
- Color
- Door Style/Color
- Locking Doors

Description

- Left Side: One (1) Fixed Shelf at Top and Four (4) Adjustable Shelves below
- Right Side: One (1) Fixed Shelf at Top and Coat Rod below
- Touch Latch Doors
- Safely Write on Dry Erase Doors with Our Dry Erase Marker Set; [See Sets](#)
- If Applicable, Door Fronts Available in Contrasting Colors; Must Specify
- Additional Options: Locking Doors ([See Locking Options](#))

Options: Specify & Add

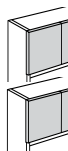

1-DEB	Dry Erase Board Doors	\$ 257
1-HGA	High Gloss Acrylic Doors; Must Specify Color	
	(GPA) Graphite Acrylic	\$ 2551
	(BLA) Black, (WMA), Wired Mercury or (WHA) White Acrylic	\$ 2329

END BOOKCASE

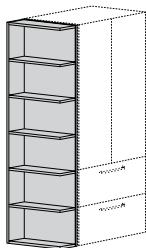

Shown as Left

Must Specify (in this order):

- Model #
- Color

Mounts Left	Mounts Right	Width	Depth	Height	Ship Wt	Cubic Ft	List Price
66-0984BEL	66-0984BER	9	23 $\frac{1}{2}$	82 $\frac{7}{8}$	90	13.6	T\$ 1480
Five (5) Fixed 8" Shelves							
66-0972BEL	66-0972BER	9	23 $\frac{1}{2}$	70 $\frac{7}{8}$	75	11.7	T\$ 1308
Four (4) Fixed 8" Shelves							

Description

- Top Shelf Clearance 15"
- Remaining Shelves 12 $\frac{1}{2}$ " Clearance Between Shelves
- Not for Freestanding, Must Mount to Other Storage Component

Pricing Codes:

- T= TFL
- P= HPL

[See Canvas Intro Section for Ordering Options](#)

Item	Model No.	Width	Depth	Height	Ship Wt	Cubic Ft	List Price
	66-3684BC Four (4) Adjustable Shelves - One (1) Fixed Shelf	36	14¼	82⅞	200	30.3	T\$ 2114
	66-3672BC Three (3) Adjustable Shelves - One (1) Fixed Shelf	36	14¼	70⅞	176	26.9	T\$ 1822
	66-3660BC Three (3) Adjustable Shelves	36	14¼	58⅞	147	23.2	T\$ 1570
	66-3648BC Two (2) Adjustable Shelves	36	14¼	46⅞	120	18.7	T\$ 1451
	66-3630BC One (1) Adjustable Shelf - Top Front Edge Profiled	36	14¼	30	75	11.9	T\$ 1099 P\$ 1234
	66-3084BC Four (4) Adjustable Shelves - One (1) Fixed Shelf	30	14¼	82⅞	175	25.5	T\$ 1730
	66-3072BC Three (3) Adjustable Shelves - One (1) Fixed Shelf	30	14¼	70⅞	146	23.3	T\$ 1490
	66-3060BC Three (3) Adjustable Shelves	30	14¼	58⅞	122	19.5	T\$ 1308
	66-3048BC Two (2) Adjustable Shelves	30	14¼	46⅞	100	15.7	T\$ 1127
	66-3030BC One (1) Adjustable Shelf - Top Front Edge Profiled	30	14¼	30	62	10.1	T\$ 927 P\$ 1057

Must Specify (in this order):

Model #
Top Material
Color
Edge

Description

- 1" Thick Shelf

SURFACE MOUNT BOOKCASE

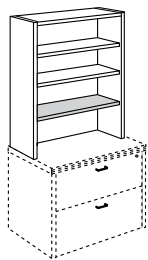

Must Specify (in this order):

Model #
Color

66-1536TTU Two (2) Adjustable and One (1) Fixed Shelf	36	14¼	52⅞	169	22.2	T\$ 1269
66-1530TTU Two (2) Adjustable and One (1) Fixed Shelf	30	14¼	52⅞	141	17.3	T\$ 1157
66-1536TU One (1) Adjustable and One (1) Fixed Shelf	36	14¼	40⅞	127	16.4	T\$ 1004
66-1530TU One (1) Adjustable and One (1) Fixed Shelf	30	14¼	40⅞	98	15.9	T\$ 927

Description

- For Use on Two (2) Drawer Lateral Files
- 1" Thick Shelves

Pricing Codes:

T= TFL
P= HPL

[See Canvas Intro Section for Ordering Options](#)

Item	Model No.	Width	Depth	Height	Ship Wt	Cubic Ft	List Price
WORK TABLES STANDING HEIGHT	66-4896TWT	96	48	42	402	14.2	T\$ 2401
							P\$ 2826
							Wire Management Upcharge \$ 470
	66-4884TWT	84	48	42	368	12.4	T\$ 2240
							P\$ 2626
							Wire Management Upcharge \$ 426
	66-4872TWT	72	48	42	332	10.7	T\$ 2085
							P\$ 2445
							Wire Management Upcharge \$ 377
	66-4860TWT	60	48	42	300	9.0	T\$ 1926
							P\$ 2256
							Wire Management Upcharge \$ 335
	66-4296TWT	96	42	42	374	12.5	T\$ 2166
							P\$ 2551
							Wire Management Upcharge \$ 470
	66-4284TWT	84	42	42	342	10.9	T\$ 2031
							P\$ 2375
							Wire Management Upcharge \$ 426
	66-4272TWT	72	42	42	308	9.4	T\$ 1895
							P\$ 2223
							Wire Management Upcharge \$ 377
	66-4260TWT	60	42	42	278	7.9	T\$ 1763
							P\$ 2060
							Wire Management Upcharge \$ 335
	66-3696TWT	96	36	42	346	10.8	T\$ 2043
							P\$ 2386
							Wire Management Upcharge \$ 470
	66-3684TWT	84	36	42	315	9.5	T\$ 1920
							P\$ 2224
							Wire Management Upcharge \$ 426
	66-3672TWT	72	36	42	283	8.1	T\$ 1794
							P\$ 2081
							Wire Management Upcharge \$ 377
	66-3660TWT	60	36	42	255	6.8	T\$ 1669
							P\$ 1933
							Wire Management Upcharge \$ 335
	66-2496TWT Modesty Recessed 5¼"	96	24	42	211	64.9	T\$ 1828
							P\$ 2111
	66-2484TWT Modesty Recessed 5¼"	84	24	42	193	57.0	T\$ 1722
							P\$ 1976
	66-2472TWT Modesty Recessed 5¼"	72	24	42	176	49.0	T\$ 1614
							P\$ 1851
	66-2460TWT Modesty Recessed 5¼"	60	24	42	158	41.1	T\$ 1505
							P\$ 1727

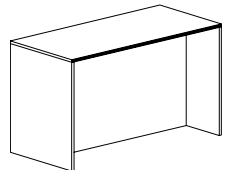

Must Specify (in this order):
 Model #
 Top Material
 Top Color
 Edge Profile
 Chassis Color
 Modesty/Color
 Grommet Location
 Wire Management
 Grommet Style/Color
 Power/Data Options

Description

- Available with TFL (T) or HPL (P) Top; Must Specify
- Centered Modesty Available in Contrasting Colors
- Double Modesty/Wire Management Upcharge Included when Grommet, Dock 950, Dock 150 or Power is Ordered
- Add a Purse Hook to Hold Personal Items; [See Hook Details](#)
- Duo/Trio and Power Data Port Units ([01-DPORT4A/B](#)); [See PDC Locations](#)
- 24"D Units Ship Assembled; Other Sizes Require Some Assembly
- 24"D Units Are Meant to be Used Against a Wall; Modesty Panel is Recessed 5¼"
- Additional Options: Power and Grommet Options ([See Options and Locations](#))

Pricing Codes:
 T= TFL
 P= HPL

[See Canvas Intro Section for Ordering Options](#)

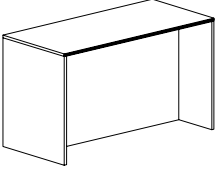
Item	Model No.	Width	Depth	Height	Ship Wt	Cubic Ft	List Price
WORK TABLES	66-4896CWT	96	48	36	326	14.2	T\$ 2291
							P\$ 2719
COUNTER HEIGHT	66-4884CWT	84	48	36	298	12.4	Wire Management Upcharge \$ 437
							T\$ 2141
	66-4872CWT	72	48	36	268	10.7	P\$ 2525
							Wire Management Upcharge \$ 391
	66-4860CWT	60	48	36	242	9.0	T\$ 1989
							P\$ 2352
	66-4296CWT	96	42	36	338	12.5	Wire Management Upcharge \$ 350
							T\$ 1837
<i>Must Specify (in this order):</i>	66-4284CWT	84	42	36	309	10.9	P\$ 2169
							Wire Management Upcharge \$ 306
Model #	66-4272CWT	72	42	36	278	9.4	T\$ 2067
Top Material							P\$ 2448
Top Color	66-4260CWT	60	42	36	251	7.9	Wire Management Upcharge \$ 437
Edge Profile							T\$ 1939
Chassis Color	66-3696CWT	96	36	36	312	10.8	P\$ 2283
Modesty/Color							Wire Management Upcharge \$ 391
Grommet Location	66-3684CWT	84	36	36	285	9.5	T\$ 1811
Wire Management							P\$ 2135
Grommet Style/Color	66-3672CWT	72	36	36	256	8.1	Wire Management Upcharge \$ 350
Power/Data Options							T\$ 1681
	66-3660CWT	60	36	36	231	6.8	P\$ 1979
							Wire Management Upcharge \$ 306
	66-2496CWT	96	24	36	192	56.0	T\$ 1934
							P\$ 2278
	66-2484CWT	84	24	36	176	49.2	Wire Management Upcharge \$ 437
							T\$ 1819
	66-2472CWT	72	24	36	160	42.3	P\$ 2122
							Wire Management Upcharge \$ 391
	66-2460CWT	60	24	36	143	35.5	T\$ 1698
							P\$ 1988
	66-2484CWT	84	24	36	176	49.2	Wire Management Upcharge \$ 350
							T\$ 1575
	66-2472CWT	72	24	36	160	42.3	P\$ 1829
							T\$ 1476
	66-2460CWT	60	24	36	143	35.5	P\$ 1714
							T\$ 1379
	66-2496CWT	96	24	36	192	56.0	P\$ 1601
							T\$ 1675
	66-2484CWT	84	24	36	176	49.2	P\$ 1956
							T\$ 1575
	66-2472CWT	72	24	36	160	42.3	P\$ 1829
							T\$ 1476
	66-2460CWT	60	24	36	143	35.5	P\$ 1714
							T\$ 1379
	66-2496CWT	96	24	36	192	56.0	P\$ 1601
							T\$ 1675
	66-2484CWT	84	24	36	176	49.2	P\$ 1956
							T\$ 1575
	66-2472CWT	72	24	36	160	42.3	P\$ 1829
							T\$ 1476
	66-2460CWT	60	24	36	143	35.5	P\$ 1714
							T\$ 1379
	66-2496CWT	96	24	36	192	56.0	P\$ 1601
							T\$ 1675
	66-2484CWT	84	24	36	176	49.2	P\$ 1956
							T\$ 1575
	66-2472CWT	72	24	36	160	42.3	P\$ 1829
							T\$ 1476
	66-2460CWT	60	24	36	143	35.5	P\$ 1714
							T\$ 1379
	66-2496CWT	96	24	36	192	56.0	P\$ 1601
							T\$ 1675
	66-2484CWT	84	24	36	176	49.2	P\$ 1956
							T\$ 1575
	66-2472CWT	72	24	36	160	42.3	P\$ 1829
							T\$ 1476
	66-2460CWT	60	24	36	143	35.5	P\$ 1714
							T\$ 1379
	66-2496CWT	96	24	36	192	56.0	P\$ 1601
							T\$ 1675
	66-2484CWT	84	24	36	176	49.2	P\$ 1956
							T\$ 1575
	66-2472CWT	72	24	36	160	42.3	P\$ 1829
							T\$ 1476
	66-2460CWT	60	24	36	143	35.5	P\$ 1714
							T\$ 1379
	66-2496CWT	96	24	36	192	56.0	P\$ 1601
							T\$ 1675
	66-2484CWT	84	24	36	176	49.2	P\$ 1956
							T\$ 1575
	66-2472CWT	72	24	36	160	42.3	P\$ 1829
							T\$ 1476
	66-2460CWT	60	24	36	143	35.5	P\$ 1714
							T\$ 1379
	66-2496CWT	96	24	36	192	56.0	P\$ 1601
							T\$ 1675
	66-2484CWT	84	24	36	176	49.2	P\$ 1956
							T\$ 1575
	66-2472CWT	72	24	36	160	42.3	P\$ 1829
							T\$ 1476
	66-2460CWT	60	24	36	143	35.5	P\$ 1714
							T\$ 1379
	66-2496CWT	96	24	36	192	56.0	P\$ 1601
							T\$ 1675
	66-2484CWT	84	24	36	176	49.2	P\$ 1956
							T\$ 1575
	66-2472CWT	72	24	36	160	42.3	P\$ 1829
							T\$ 1476
	66-2460CWT	60	24	36	143	35.5	P\$ 1714
							T\$ 1379
	66-2496CWT	96	24	36	192	56.0	P\$ 1601
							T\$ 1675
	66-2484CWT	84	24	36	176	49.2	P\$ 1956
							T\$ 1575
	66-2472CWT	72	24	36	160	42.3	P\$ 1829
							T\$ 1476
	66-2460CWT	60	24	36	143	35.5	P\$ 1714
							T\$ 1379
	66-2496CWT	96	24	36	192	56.0	P\$ 1601
							T\$ 1675
	66-2484CWT	84	24	36	176	49.2	P\$ 1956
							T\$ 1575
	66-2472CWT	72	24	36	160	42.3	P\$ 1829
							T\$ 1476
	66-2460CWT	60	24	36	143	35.5	P\$ 1714
							T\$ 1379
	66-2496CWT	96	24	36	192	56.0	P\$ 1601
							T\$ 1675
	66-2484CWT	84	24	36	176	49.2	P\$ 1956
							T\$ 1575
	66-2472CWT	72	24	36	160	42.3	P\$ 1829
							T\$ 1476
	66-2460CWT	60	24	36	143	35.5	P\$ 1714
							T\$ 1379
	66-2496CWT	96	24	36	192	56.0	P\$ 1601
							T\$ 1675
	66-2484CWT	84	24	36	176	49.2	P\$ 1956
							T\$ 1575
	66-2472CWT	72	24	36	160	42.3	P\$ 1829
							T\$ 1476
	66-2460CWT	60	24	36	143	35.5	P\$ 1714
							T\$ 1379
	66-2496CWT	96	24	36	192	56.0	P\$ 1601
							T\$ 1675
	66-2484CWT	84	24	36	176	49.2	P\$ 1956
							T\$ 1575
	66-2472CWT	72	24	36	160	42.3	P\$ 1829
							T\$ 1476
	66-2460CWT	60	24	36	143	35.5	P\$ 1714
							T\$ 1379
	66-2496CWT	96	24	36	192	56.0	P\$ 1601
							T\$ 1675
	66-2484CWT	84	24	36	176	49.2	P\$ 1956
							T\$ 1575
	66-2472CWT	72	24	36	160	42.3	P\$ 1829
							T\$ 1476
	66-2460CWT	60	24	36	143	35.5	P\$ 1714
							T\$ 1379
	66-2496CWT	96	24	36	192	56.0	P\$ 1601
							T\$ 1675
	66-2484CWT	84	24	36	176	49.2	P\$ 1956
							T\$ 1575
	66-2472CWT	72	24	36	160	42.3	P\$ 1829
							T\$ 1476
	66-2460CWT	60	24	36	143	35.5	P\$ 1714
							T\$ 1379
	66-2496CWT	96	24	36	192	56.0	P\$ 1601
							T\$ 1675
	66-2484CWT	84	24	36	176	49.2	P\$ 1956
							T\$ 1575
	66-2472CWT	72	24	36	160	42.3	P\$ 1829
							T\$ 1476
	66-2460CWT	60	24	36	143	35.5	P\$ 1714
							T\$ 1379
	66-2496CWT	96	24	36	192	56.0	P\$ 1601
							T\$ 1675
	66-2484CWT	84	24	36	176	49.2	P\$ 1956
							T\$ 1575
	66-2472CWT	72	24	36	160	42.3	P\$ 1829
							T\$ 1476
	66-2460CWT	60	24	36	143	35.5	P\$ 1714
							T\$ 1379
	66-2496CWT	96	24	36	192	56.0	P\$ 1601
							T\$ 1675
	66-2484CWT	84	24	36	176	49.2	P\$ 1956
							T\$ 1575
	66-2472CWT	72	24	36	160	42.3	P\$ 1829
							T\$ 1476
	66-2460CWT	60	24	36	143	35.5	P\$ 1714
							T\$ 1379
	66-2496CWT	96	24	36	192	56.0	P\$ 1601
							T\$ 1675
	66-2484CWT	84	24	36	176	49.2	P\$ 1956
							T\$ 1575
	66-2472CWT	72	24	36	160	42.3	P\$ 1829
							T\$ 1476
	66-2460CWT	60	24	36	143	35.5	P\$ 1714
							T\$ 1379
	66-2496CWT	96	24	36	192	56.0	P\$ 1601
							T\$ 1675
	66-2484CWT	84	24	36	176	49.2	

Item	Model No.	Width	Depth	Height	Ship Wt	Cubic Ft	List Price
WORK TABLES SEATED HEIGHT	66-4896WT	96	48	30	326	14.2	T\$ 2217
							P\$ 2641
							Wire Management Upcharge \$ 391
	66-4884WT	84	48	30	298	12.4	T\$ 2069
							P\$ 2449
							Wire Management Upcharge \$ 357
	66-4872WT	72	48	30	268	10.7	T\$ 1923
							P\$ 2285
							Wire Management Upcharge \$ 318
	66-4860WT	60	48	30	242	9.0	T\$ 1776
							P\$ 2106
							Wire Management Upcharge \$ 279
	66-4296WT	96	42	30	374	12.5	T\$ 1962
							P\$ 2345
							Wire Management Upcharge \$ 391
	66-4284WT	84	42	30	342	10.9	T\$ 1843
							P\$ 2186
							Wire Management Upcharge \$ 357
	66-4272WT	72	42	30	308	9.4	T\$ 1718
							P\$ 2043
							Wire Management Upcharge \$ 318
	66-4260WT	60	42	30	278	7.9	T\$ 1598
							P\$ 1894
							Wire Management Upcharge \$ 279
	66-2496WT	96	24	30	173	47.2	T\$ 1543
	Modesty Recessed 5¼"						P\$ 1827
	66-2484WT	84	24	30	158	41.4	T\$ 1457
	Modesty Recessed 5¼"						P\$ 1708
	66-2472WT	72	24	30	143	35.6	T\$ 1364
	Modesty Recessed 5¼"						P\$ 1603
	66-2460WT	60	24	30	129	29.8	T\$ 1275
	Modesty Recessed 5¼"						P\$ 1495

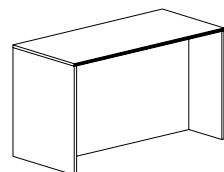

Must Specify (in this order):

Model #
Top Material
Top Color
Edge Profile
Chassis Color
Modesty/Color
Grommet Location
Wire Management
Grommet Style/Color
Power/Data Options

Description

- Available with TFL (T) or HPL (P) Top; Must Specify
- Centered Modesty Available in Contrasting Colors
- Double Modesty/Wire Management Upcharge will be Included when Grommet, Dock 950, Dock 150 or Power is Ordered
- Add a Purse Hook to Hold Personal Items; [See Hook Details](#)
- Duo/Trio and Power Data Port Units (01-DPORT4A/B); [See PDC Locations](#)
- 24"D Units Ship Assembled; Other Sizes Require Some Assembly
- 24"D Units Are Meant to be Used Against a Wall; Modesty Panel is Recessed 5¼"
- Additional Options: Power and Grommet Options ([See Options and Locations](#))

Pricing Codes:

T= TFL
P= HPL

[See Canvas Intro Section for Ordering Options](#)

Item	Model No.	Width	Depth	Height	Ship Wt	Cubic Ft	List Price
COMPUTER WORK TABLE	66-2442CW	42	24	27	115	19.2	T\$ 1168 P\$ 1336
	66-2436CW	36	24	27	99	16.6	T\$ 1150 P\$ 1296

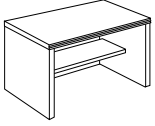

Must Specify (in this order):

Model #
Top Material
Top Color
Edge Profile
Grommet Color
Casters

Description

- Available with TFL (T) or HPL (P) Top; Must Specify
- Fixed Shelf
- Grommet Standard; Must Specify: Black (BLK), Silver (SLV)

Options: Specify & Add

CS-66BL Optional Black Casters (Increases Height to 29") \$ 239



Braking Casters on User Side/Non-Braking Casters on Approach

MAGAZINE TABLE	66-2442MT	42	24	16	70	11.9	T\$ 970 P\$ 1136
----------------	-----------	----	----	----	----	------	---------------------

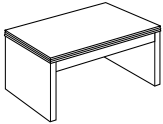

Must Specify (in this order):

Model #
Top Material
Top Color
Edge Profile

Description

- Available with TFL (T) or HPL (P) Top; Must Specify
- Slab Ends
- Apron Rail

END TABLE	66-2424ET	24	24	22	65	9.4	T\$ 921 P\$ 1057
-----------	-----------	----	----	----	----	-----	---------------------

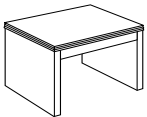

Must Specify (in this order):

Model #
Top Material
Top Color
Edge Profile

Description

- Available with TFL (T) or HPL (P) Top; Must Specify
- Slab Ends
- Apron Rail

Pricing Codes:

T= TFL
P= HPL

[See Canvas Intro Section for Ordering Options](#)

Item	Model No.	Width	Depth	Height	Ship Wt	Cubic Ft	List Price
	66-4848CT <i>Accommodates Five (5) Chairs</i>	48	48	1	95	4.3	T\$ 732 P\$ 1026
	66-4242CT <i>Accommodates Four (4) Chairs</i>	42	42	1	70	3.4	T\$ 709 P\$ 989
	66-3636CT <i>Accommodates Three (3) Chairs</i>	36	36	1	37	2.5	T\$ 620 P\$ 869

Must Specify (in this order):

- Model #
- Top Material
- Color
- Edge Profile

Description

- Single Base or Four (4) Strut Legs (on 48" Top Only) Required; Ordered Separately, See Next Page
- Power Options not Available

METAL X-BASE

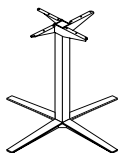

For Use With		Round Tops: 42" + 48"		Top Surfaces: 42"x96"				
08-2642LXBB	For 42"H Tables	Black	35%	35%	40	33	20.0	\$ 1322
08-2642LXBA		Aluminum						
08-2636LXBB	For 36"H Tables	Black	35%	35%	34	30	17.2	\$ 1275
08-2636LXBA		Aluminum						
08-2630LXBB	For 30"H Tables	Black	35%	35%	28	27	14.5	\$ 1219
08-2630LXBA		Aluminum						
For Use With		Round Tops: 30" + 36"		Top Surfaces: 36"x84", 36"x72"				
08-2042SXBB	For 42"H Tables	Black	29	29	40	27	15.9	\$ 1235
08-2042SXBA		Aluminum						
08-2036SXBB	For 36"H Tables	Black	29	29	34	24	13.7	\$ 1185
08-2036SXBA		Aluminum						
08-2030SXBB	For 30"H Tables	Black	29	29	28	21	11.6	\$ 1139
08-2030SXBA		Aluminum						

Description

- See Number of Bases Required Per Top Width Below
- Power Units Available On Center When Using Two or More Metal X-Bases
- Not Available to be Sold Separately
- Some Assembly Required

Table Widths	Round	72"	84"	96"
Number of Bases Required	1	2	2	2

HEIGHT ADJUSTABLE PNEUMATIC X-BASE

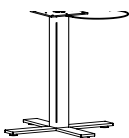

Maximum Round 42", Maximum Square 36"							
01-3232HAXBB	Black	32	32	26	1	0.2	\$ 1721
01-3232HAXBA	Aluminum						
Maximum Round 36", Maximum Square 30"							
01-2626HAXBB	Black	22	22	26	1	0.2	\$ 1687
01-2626HAXBA	Aluminum						



Description

- Pre-Drilled Boring Pattern May Not Match Underside of Table Top
- Steel Mounting Plate: 8"x 8"x 1/4"
- Eight (8) Bolts Included for Assembly
- Some Assembly Required; Hardware Included

Pricing Codes:

- T= TFL
- P= HPL

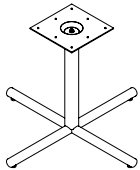
[See Canvas Intro Section for Ordering Options](#)

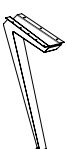
Item	Model No.		Width	Depth	Height	Ship Wt	Cubic Ft	List Price		
TUBULAR X-BASE 	For Use With Round Tops: 48" Square Tops: 42"									
	01-3830TXB	Black	38	38	27¾	40	4.2	\$ 699		
	01-3830TXA	Aluminum								
	For Use With Round Tops: 30", 36", 42" Square Tops: 36" Top Surfaces: 36"x84", 36"x72"									
	01-3230TXB	Black	32	32	27¾	32	3.2	\$ 633		
	01-3230TXA	Aluminum								
	Description									
	<ul style="list-style-type: none"> • 3" Diameter Column • See Number of Bases Required Per Top Width Below • Power Units Available On Center When Using Two or More Tubular X-Bases • Some Assembly Required 									
	Table Widths						Round	72"	84"	96"
	Number of Bases Required						1	2	2	2
DISC BASE 	For 48" Round Tops									
	01-3230DBB	Black	30	30	27¾	42	4.1	\$ 1842		
	01-3230DBA	Aluminum	30	30	27¾	42	4.1			
	For 36" and 42" Round Tops									
	01-2430DBB	Black	24	24	27¾	32	3.2	\$ 1535		
	01-2430DBA	Aluminum	24	24	27¾	32	3.2			
	Description									
	<ul style="list-style-type: none"> • 4" Diameter 14 Gauge Steel Column with 12"x12" Mounting Plate at Top of Column • ¼" Thick Disc Plate with 5 Levelers • Stiffener Bar Not Included; Must Order Separately (See Stiffener Bars) • Some Assembly Required 									
	Table Widths						Round	72"	84"	96"
	Number of Bases Required						1	2	2	2
STRUT TABLE LEGS 	01-2228STR2	1 Pair (2 Legs)	1½	22½	28⅝	32	4.5	\$ 1278		
	01-2228STR4	2 Pair (4 Legs)	1½	22½	28⅝	64	9.0	\$ 2556		
	Description									
	<ul style="list-style-type: none"> • Available in Aluminum (ALUM) or Black (BLK); Must Specify Color • Built-In Wire Management Cover on Inside of Legs • Each Leg has Adjustable Glides • Legs not Available To Be Sold Separately • For Use with Indiana Furniture 48" Round Tops Only 									
	Options: Specify & Add									
	01-00048SB	Stiffener Bar							\$ 121	
	<i>See Individual Tops for Recommended Number of Stiffener Bars</i>									
	Table Widths						48" CT	72"	84"	120"
	Number of Bases Required						4	4	4	6

Must Specify (in this order):

Model # and Quantity

Color

Optional Stiffener Bar and Quantity

Pricing Codes:

T= TFL

P= HPL

[See Canvas Intro Section for Ordering Options](#)

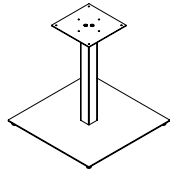
Item	Model No.		Width	Depth	Height	Ship Wt	Cubic Ft	List Price	
SQUARE BASE 	For Use With Round Tops: 48" Square Tops: 42"								
	01-2630SBB	Black	26	26	27¾	32	3.2	\$ 1163	
	01-2630SBA	Aluminum							
	For Use With Round Tops: 42" Square Tops: 36" Top Surfaces: 36"x84", 36"x72"								
	01-2030SBB	Black	20	20	27¾	32	3.2	\$ 956	
	01-2030SBA	Aluminum							
For Use With Round Tops: 36" Square Tops: 30"									
01-1630SBB	Black	16	16	27¾	32	3.2	\$ 898		
01-1630SBA	Aluminum								

Description

- 2¾" Diameter Column
- 12"x12" Mounting Plate at Top of Column
- Stiffener Bar Not Included; Must Order Separately (See Stiffener Bars)
- See Number of Bases Required Per Top Width Below
- Power Units Available On Center When Using Two or More Square Bases
- Some Assembly Required

Table Widths	Round	72"	84"	96"
Number of Bases Required	1	2	2	2

CYLINDER BASE

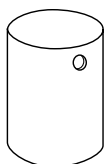

For Tables 42"D to 48"D								
01-2020CB		20	20	28½	136	10.9	W\$	1553
For Tables 36"D								
01-1616CB		16	16	28½	101	7.2	W\$	1419

Description

- Veneer Base Features Multi-Step, Hand-Finished Catalyzed Finish
- Weighted for Stability
- Two (2) Wire Management Black Grommets Standard at Top Edge; 8" Opening Standard at Bottom
- See Number of Bases Required Per Table Width Below

Additional Grommet Options: Specify & Add

GCB1S	Only One (1) Grommet At Top Edge	\$	N/C
NOGC	No Grommets At Top Edge	\$	N/C

Table Widths	Round	72"	96"	120"
Number of Bases Required	1	2	2	3

Must Specify (in this order):

Model # and Quantity
Finish
Grommet Options

Pricing Codes:

T= TFL
P= HPL

120 Canvas

[See Canvas Intro Section for Ordering Options](#)

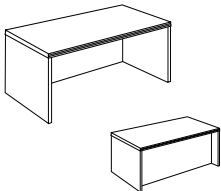
Item	Model No.	Width	Depth	Height	Ship Wt	Cubic Ft	List Price
 Recessed Front	66-3672SH	72	36	30	154	50.0	T\$ 1720 P\$ 2007
	66-3666SH	66	36	30	148	48.0	T\$ 1668 P\$ 1944
	66-3660SH	60	36	30	139	43.7	T\$ 1624 P\$ 1890
	66-3072SH	72	30	30	145	43.8	T\$ 1643 P\$ 1914
	66-3066SH	66	30	30	141	39.0	T\$ 1606 P\$ 1862
	66-3060SH	60	30	30	136	35.3	T\$ 1540 P\$ 1780

Must Specify (in this order):

- Model #
- Top Material
- Top Color
- Edge Profile
- Chassis Color
- Grommet Location
- Grommet Color

Description

- Available with TFL (T) or HPL (P) Top; Must Specify
- For Use With or Without Modular Pedestals
- Support Panel Required ([See 66-2812SP](#)), Stiffener Bar ([See Sizes](#)) Recommended in Kneespaces 60" or Greater When Surface is Not Supported by a Pedestal
- 10" Recessed Front on 36" Deep Units; 4" Recessed Front on 30" Deep Units
- If Using with Pedestal, Surface Grommet Only Available Opposite Pedestal
- Top and Chassis Available in Contrasting Colors; Must Specify Color of Each Component
- [Height Adjustable Units Available](#)
- Additional Options: Power and Grommet Options ([See Options and Locations](#))

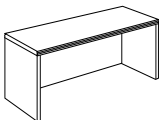
	66-2472SH <i>Kneespace 70"</i>	72	24	30	125	34.6	T\$ 1489 P\$ 1725
	66-2466SH <i>Kneespace 64"</i>	66	24	30	118	32.7	T\$ 1446 P\$ 1671
	66-2460SH <i>Kneespace 58"; No Additional Support Needed</i>	60	24	30	111	29.8	T\$ 1411 P\$ 1632

Must Specify (in this order):

- Model #
- Top Material
- Top Color
- Edge Profile
- Chassis Color
- Grommet Location
- Grommet Color

Description

- Available with TFL (T) or HPL (P) Top; Must Specify
- For Use With or Without Modular Pedestals
- Support Panel Required ([See 66-2812SP](#)), Stiffener Bar ([See Sizes](#)) Recommended in Kneespaces 60" or Greater When Surface is Not Supported by a Pedestal
- [Height Adjustable Units Available](#)
- If Using with Pedestal, Surface Grommet Only Available Opposite Pedestal
- Top and Chassis Available in Contrasting Colors; Must Specify Color of Each Component
- Modesty Panel Grommet Standard; Must Specify: Black (BLK), Silver (SLV) or No Modesty Panel Grommet (NONE)
- Additional Options: Power and Grommet Options ([See Options and Locations](#))

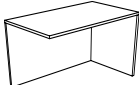
RETURN SHELL	Left Shell	Right Shell	Width	Depth	Height	Ship Wt	Cubic Ft	List Price
		66-2448RSHL						
66-2442RSHL		66-2442RSHR	42	24	30	60	20.4	T\$ 942 P\$ 1108

Shown as Right

Must Specify (in this order):

- Model #
- Top Material
- Top Color
- Edge Profile
- Chassis Color
- Grommet Location
- Grommet Color

Description

- Available with TFL (T) or HPL (P) Top; Must Specify
- For Use With or Without Modular Pedestals
- Optional Surface Grommet; Must Specify Black or Silver.
- Modesty Panel Grommet is Standard; Must Specify: Black (BLK), Silver (SLV) or No Modesty Panel Grommet (NONE)
- Top and Chassis Available in Contrasting Colors; Must Specify Color of Each Component
- Additional Options: Power and Grommet Options ([See Options and Locations](#))

Pricing Codes:

T= TFL
P= HPL

[See Canvas Intro Section for Ordering Options](#)

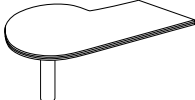
Item	Model No.	Width	Depth	Height	Ship Wt	Cubic Ft	List Price
P-TOP PENINSULA WITH CYLINDER BASE 	Left Top		Right Top				
	66-4284TL	66-4284TR	84	42-36	30	120	T\$ 2044 P\$ 2718
	66-4272TL	66-4272TR	72	42-36	30	115	T\$ 1678 P\$ 2200

Shown as Left

Must Specify (in this order):

- Model #
- Top Material
- Top Color
- Edge Profile
- Leg Color
- Grommet
- Grommet Color

Description

- Metal Cylinder Base Standard - 4" Diameter; Must Specify: Black or Aluminum
- 48" Stiffener Bar Required on 84" Units if Used as Runoff; [See Stiffener Bar Sizes](#)
- Some Assembly Required

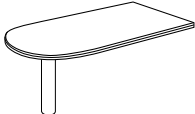
D-TOP PENINSULA WITH CYLINDER BASE 	66-3684DR	84	36	30	134	13.2	T\$ 2004 P\$ 2662
	66-3672DR	72	36	30	115	9.8	T\$ 1692 P\$ 2224
	66-3066DR	66	30	30	120	7.5	T\$ 1626 P\$ 2133

Must Specify (in this order):

- Model #
- Top Material
- Top Color
- Edge Profile
- Leg Color
- Grommet
- Grommet Color

Description

- Metal Cylinder Base Standard - 4" Diameter; Must Specify: Black or Aluminum
- 48" Stiffener Bar Required on 84" Units if Used as Runoff; [See Stiffener Bar Sizes](#)
- Some Assembly Required

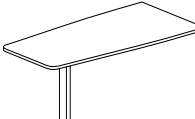
MEDIA PENINSULA WITH RECTANGLE LEG 	66-3672MP	36	72	30	90	52.1	T\$ 2166 P\$ 2918
	66-3066MP	30	66	30	77	40.3	T\$ 1996 P\$ 2684
	66-3060MP	30	60	30	70	36.7	T\$ 1909 P\$ 2560

Must Specify (in this order):

- Model #
- Top Material
- Top Color
- Edge Profile
- Leg Option
- Power Option
- Grommet Color

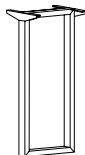

Description

- Aluminum Rectangular Post Standard
- Standard with Aluminum Rectangle Leg to be Installed 17¾" from Front to Allow for Kneespace Area
- Wire Management Trough Included; 4¼" W x 46⅜" L x 3½" H
- Some Assembly Required

Leg Options: Specify & Add

OLEGA	12" Aluminum Tube Leg	\$ 112
OLEGB	12" Black Tube Leg	\$ 112

Pricing Codes:

T= TFL
P= HPL

[See Canvas Intro Section for Ordering Options](#)

Item	Model No.	Width	Depth	Height	Ship Wt	Cubic Ft	List Price
MODULAR DESK TOPS	66-6072TP	72	60	1	120	10.6	T\$ 1108
	For Use as a Desk Top With Benching Units						P\$ 1550
	66-6066TP	66	60	1	110	9.8	T\$ 1056
	For Use as a Desk Top With Benching Units						P\$ 1476
	66-6060TP	60	60	1	100	9.0	T\$ 1008
	For Use as a Desk Top With Benching Units						P\$ 1411
	66-4872TP	72	48	1	102	8.6	T\$ 905
	For Use as a Desk Top With Benching Units						P\$ 1270
	66-4866TP	66	48	1	94	7.8	T\$ 867
	For Use as a Desk Top With Benching Units						P\$ 1213
	66-4860TP	60	48	1	86	7.0	T\$ 825
	For Use as a Desk Top With Benching Units						P\$ 1159
	66-3684TP	84	36	1	85	6.6	T\$ 761
							P\$ 1066
	66-3678TP	78	36	1	80	6.2	T\$ 745
							P\$ 1040
	66-3672TP	72	36	1	74	5.7	T\$ 726
							P\$ 1015
	66-3666TP	66	36	1	68	5.2	T\$ 692
							P\$ 967
	66-3660TP	60	36	1	63	4.8	T\$ 661
							P\$ 925
	66-3654TP	54	36	1	57	4.3	T\$ 606
							P\$ 851
	66-3648TP	48	36	1	51	3.8	T\$ 565
							P\$ 788
	66-3642TP	42	36	1	45	3.4	T\$ 512
							P\$ 718
	66-3084TP	84	30	1	72	5.6	T\$ 713
							P\$ 1000
	66-3078TP	78	30	1	67	5.2	T\$ 696
							P\$ 975
	66-3072TP	72	30	1	62	4.8	T\$ 677
							P\$ 947
	66-3066TP	66	30	1	58	4.4	T\$ 654
							P\$ 911
	66-3060TP	60	30	1	75	3.8	T\$ 601
							P\$ 842
	66-3054TP	54	30	1	48	3.6	T\$ 568
							P\$ 794
	66-3048TP	48	30	1	43	3.2	T\$ 525
							P\$ 734
	66-3042TP	42	30	1	38	2.9	T\$ 478
							P\$ 670

Description

- Left to Right Grain Direction on Top; For Front to Back Grain Direction See Next Page
- Optional Surface Grommet; Must Specify: Black (BLK) or Silver (SLV)
- Profiled on Approach and User Side
- Support Panel Required ([See 66-2812SP](#)), Stiffener Bar ([See Sizes](#)) Recommended in Kneespaces 60" or Greater and With Peninsula Application When Surface is Not Supported by a Pedestal
- Additional Options: Power and Grommet Options ([See Options and Locations](#))

Pricing Codes:

T= TFL
P= HPL

[See Canvas Intro Section for Ordering Options](#)

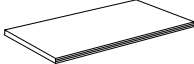
Item	Model No.	Width	Depth	Height	Ship Wt	Cubic Ft	List Price
MODULAR DESK TOPS  Must Specify (in this order): Model # Top Material Color Edge Profile Grommet Location Grommet Color	66-6036TP	60	36	1	63	4.8	T\$ 661 P\$ 925
	66-5436TP	54	36	1	57	4.3	T\$ 606 P\$ 851
	66-4836TP	48	36	1	51	3.8	T\$ 565 P\$ 788
	66-4236TP	42	36	1	45	3.4	T\$ 512 P\$ 718
	66-6030TP	60	30	1	75	3.8	T\$ 601 P\$ 842
	66-5430TP	54	30	1	48	3.6	T\$ 568 P\$ 794
	66-4830TP	48	30	1	43	3.2	T\$ 525 P\$ 734
	66-4230TP	42	30	1	38	2.9	T\$ 478 P\$ 670

Description

- Front to Back Grain Direction on Top
- Optional Surface Grommet; Must Specify: Black (BLK) or Silver (SLV)
- Profiled on Approach and User Side
- Support Panel Required ([See 66-2812SP](#)), Stiffener Bar ([See Sizes](#)) Recommended in Kneespaces 60" or Greater and With Peninsula Application When Surface is Not Supported by a Pedestal
- Additional Options: Power and Grommet Options ([See Options and Locations](#))

Pricing Codes:

T= TFL
P= HPL

[See Canvas Intro Section for Ordering Options](#)

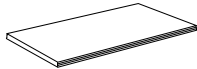
Item	Model No.	Width	Depth	Height	Ship Wt	Cubic Ft	List Price
24"D MODULAR BRIDGE, RETURN AND CREDENZA TOPS	66-2496TP	96	24	1	100	4.9	T\$ 698 P\$ 979
LEFT TO RIGHT GRAIN DIRECTION	66-2490TP	90	24	1	95	4.6	T\$ 680 P\$ 955
	66-2484TP	84	24	1	90	4.3	T\$ 624 P\$ 876
	66-2478TP	78	24	1	85	4.0	T\$ 611 P\$ 856
Must Specify (in this order): Model # Top Material Color Edge Profile Grommet Location Grommet Color	66-2472TP	72	24	1	80	3.7	T\$ 595 P\$ 830
	66-2466TP	66	24	1	75	3.4	T\$ 568 P\$ 792
	66-2460TP	60	24	1	70	3.0	T\$ 540 P\$ 760
	66-2454TP	54	24	1	65	2.8	T\$ 497 P\$ 695
	66-2448TP	48	24	1	44	2.5	T\$ 460 P\$ 645
	66-2442TP	42	24	1	50	2.2	T\$ 419 P\$ 587
	66-2436TP	36	24	1	45	2.0	T\$ 371 P\$ 519
	66-2430TP	30	24	1	36	1.6	T\$ 358 P\$ 501
	66-2418TP	18	24	1	28	1.0	T\$ 329 P\$ 461

Description

- Left to Right Grain Direction on Top; [See Tops with Front to Back Grain Direction](#)
- For 24"D Bridge, Return and Credenza Modular Tops
- Optional Surface Grommet; Must Specify: Black (BLK) or Silver (SLV)
- Profiled on User Side
- Support Panel Required ([See 66-2812SP](#)), Stiffener Bar ([See Sizes](#)) Recommended in Kneespaces 60" or Greater and With Peninsula Application When Surface is Not Supported by a Pedestal
- Additional Options: Power and Grommet Options ([See Options and Locations](#))

Pricing Codes:

T= TFL
P= HPL

[See Canvas Intro Section for Ordering Options](#)

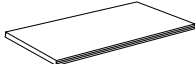
Item	Model No.	Width	Depth	Height	Ship Wt	Cubic Ft	List Price
20"D MODULAR BRIDGE, RETURN AND CREDENZA TOPS	66-2096TP	96	20	1	65	4.3	T\$ 621 P\$ 870
	66-2090TP	90	20	1	61	4.1	T\$ 609 P\$ 854
LEFT TO RIGHT GRAIN DIRECTION 	66-2084TP	84	20	1	57	3.8	T\$ 556 P\$ 780
	66-2078TP	78	20	1	53	3.6	T\$ 543 P\$ 760
	66-2072TP	72	20	1	49	3.3	T\$ 528 P\$ 740
	66-2066TP	66	20	1	45	2.7	T\$ 505 P\$ 708
	66-2060TP	60	20	1	41	2.7	T\$ 482 P\$ 673
	66-2054TP	54	20	1	37	2.5	T\$ 441 P\$ 618
	66-2048TP	48	20	1	33	2.3	T\$ 410 P\$ 573
	66-2042TP	42	20	1	29	1.9	T\$ 373 P\$ 523
	66-2036TP	36	20	1	25	1.7	T\$ 328 P\$ 459
	66-2030TP	30	20	1	21	1.4	T\$ 318 P\$ 444
	66-2018TP	18	20	1	15	0.9	T\$ 295 P\$ 411

Must Specify (in this order):

Model #
Top Material
Color
Edge Profile
Grommet Location
Grommet Color

Description

- Left to Right Grain Direction on Top; [See Tops with Front to Back Grain Direction](#)
- For 20"D Bridge, Return and Credenza Modular Tops
- Optional Surface Grommet; Must Specify: Black (BLK) or Silver (SLV)
- Profiled on User Side
- Support Panel Required ([See 66-2812SP](#)), Stiffener Bar ([See Sizes](#)) Recommended in Kneespaces 60" or Greater and With Peninsula Application When Surface is Not Supported by a Pedestal
- Additional Options: Power and Grommet Options ([See Options and Locations](#))

Pricing Codes:

T= TFL
P= HPL

[See Canvas Intro Section for Ordering Options](#)

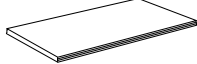
Item	Model No.	Width	Depth	Height	Ship Wt	Cubic Ft	List Price
24"D AND 20"D MODULAR BRIDGE, RETURN AND CREENZA TOPS	66-6024TP	60	24	1	70	3.0	T\$ 540 P\$ 760
	66-5424TP	54	24	1	65	2.8	T\$ 497 P\$ 695
FRONT AND BACK GRAIN DIRECTION	66-4824TP	48	24	1	44	2.5	T\$ 460 P\$ 645
	66-4224TP	42	24	1	50	2.2	T\$ 419 P\$ 587
 <p>Must Specify (in this order): Model # Top Material Top Color Edge Profile Grommet Location Grommet Color</p>	66-3624TP	36	24	1	45	2.0	T\$ 371 P\$ 519
	66-3024TP	30	24	1	36	1.6	T\$ 358 P\$ 501
	66-6020TP	60	20	1	41	2.7	T\$ 482 P\$ 673
	66-5420TP	54	20	1	37	2.5	T\$ 441 P\$ 618
	66-4820TP	48	20	1	33	2.3	T\$ 410 P\$ 573
	66-4220TP	42	20	1	29	1.9	T\$ 373 P\$ 523
	66-3620TP	36	20	1	25	1.7	T\$ 328 P\$ 459
	66-3020TP	30	20	1	21	1.4	T\$ 318 P\$ 444

Description

- Front to Back Grain Direction on Top
- For 24" Bridge, Return and Credenza Modular Tops
- Optional Surface Grommet; Must Specify: Black (BLK) or Silver (SLV)
- Profiled on User Side
- Support Panel Required ([See 66-2812SP](#)), Stiffener Bar (See Below) Recommended in Kneespaces 60" or Greater and With Peninsula Application When Surface is Not Supported by a Pedestal
- Additional Options: Power and Grommet Options ([See Options and Locations](#))

Item	Model No.	Width	Depth	Height	Ship Wt	Cubic Ft	List Price
STIFFENER BAR	01-00060SB	60	1¼	¾	8	0.3	\$ 129
	01-00048SB	48	1¼	¾	5	0.3	\$ 121

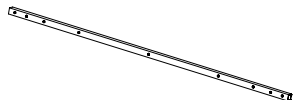

Description

- Reinforces Worksurfaces with Large Kneespace Widths
- Includes End Caps to Cover Sharp Edges
- Recommended in Kneespaces 60" or Greater
- Field Installed

Pricing Codes:

T= TFL
P= HPL

[See Canvas Intro Section for Ordering Options](#)

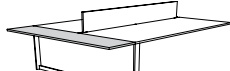
Item	Model No.	Width	Depth	Height	Ship Wt	Cubic Ft	List Price
	66-1560DTP	60	15	1	21	1.7	T\$ 386 P\$ 539
	66-1548DTP	48	15	1	21	1.7	T\$ 361 P\$ 505

Must Specify (in this order):

Model #
Top Material
Top Color
Edge Profile

Description

- Use as Extension of Top
- Profiled on Three Sides

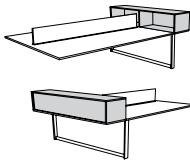
Item	Model No.	Width	Depth	Height	Ship Wt	Cubic Ft	List Price
	66-1560OBEA Two Compartments	60	15	15	75	9.8	T\$ 1171 P\$ 1326
	66-1548OBEA Two Compartments	48	15	15	63	7.9	T\$ 1043 P\$ 1189
	66-1530OBEA One Compartments	30	15	15	40	4.8	T\$ 854 P\$ 962
	66-1524OBEA One Compartments	24	15	15	35	4.1	T\$ 788 P\$ 895

Must Specify (in this order):

Model #
Top Material
Color
Edge Profile

Description

- Profiled on Two Short Sides Edges
- Attached with 11 Gauge Undermount Brackets
- Only Compatible with the O Modular Peninsula Support Seated Height; [See Supports](#)

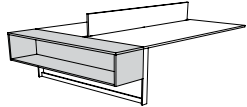
Item	Model No.	Width	Depth	Height	Ship Wt	Cubic Ft	List Price
	66-1560OBEB Two Compartments	60	15	15	75	9.8	T\$ 1171 P\$ 1326
	66-1548OBEB Two Compartments	48	15	15	63	7.9	T\$ 1043 P\$ 1189
	66-1530OBEB One Compartments	30	15	15	40	4.8	T\$ 854 P\$ 962
	66-1524OBEB One Compartments	24	15	15	35	4.1	T\$ 788 P\$ 895

Must Specify (in this order):

Model #
Top Material
Color
Edge Profile

Description

- Profiled on Three Edges
- Only Compatible with the O Modular Peninsula Support Seated Height; [See Supports](#)

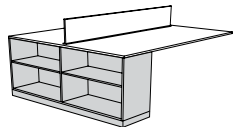
Item	Model No.	Width	Depth	Height	Ship Wt	Cubic Ft	List Price
	66-1560OBE	60	15	28¼	115	19.5	T\$ 1377
	66-1548OBE	48	15	28¼	95	15.7	T\$ 1234
	66-1530OBE	30	15	28¼	60	10.1	T\$ 1019
	66-1524OBE	24	15	28¼	55	8.2	T\$ 946

Must Specify (in this order):

Model #
Color

Description

- Adjustable Shelf
- To Be Used with Modular Benching Desk Top ([See Desk Tops](#)) or Can Be Used as Freestanding Unit with or without Hutch or Bookcase Modular Top ([See Bookcase Tops](#))

Pricing Codes:

T= TFL
P= HPL

[See Canvas Intro Section for Ordering Options](#)

Item	Model No.	Width	Depth	Height	Ship Wt	Cubic Ft	List Price
MODULAR PEDESTAL BOX/BOX/FILE 	66-3618PD1 Use with 36"D Modular Desk Tops	18	35¼	28¼	125	13.6	T\$ 1443
	66-3018PD1 Use with 30"D Modular Desk Tops	18	29¼	28¼	105	11.6	T\$ 1336
	66-2418PD1 Use with 24"D Modular Cabinet Tops and Shells	18	23¼	28¼	98	8.9	T\$ 1247
	66-2515SHPD1 Use with Desk Shells Only	15¾	25	28¼	96	8.4	T\$ 1139
	66-2415PD1 Use with 24"D Modular Cabinet Tops and Shells	15¾	23¼	28¼	93	7.8	T\$ 1181

Must Specify (in this order):

- Model #
- Chassis Color
- Drawer Color
- Grain (if applicable)
- Construction
- Track
- Pull
- Wire Management

Description

- Open Back; [See Back Panel Options](#)
- Top is Required; [See Top Sizes](#)
- Letter Width Locking Pedestal
- Drawer Front Grain Direction Vertical Standard; Optional Horizontal Grain Direction
- Chassis and Drawer Fronts Available in Contrasting Colors; Must Specify Color of Each Component
- Additional Options: Dove Tail Drawer Construction and Soft Close Drawers ([See Drawer Options](#)), Wire Management ([See Option Details](#))

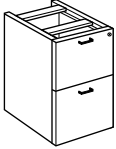
MODULAR PEDESTAL FILE/FILE 	66-3618PD2 Use with 36"D Modular Desk Tops	18	35¼	28¼	125	13.6	T\$ 1443
	66-3018PD2 Use with 30"D Modular Desk Tops	18	29¼	28¼	105	11.6	T\$ 1336
	66-2418PD2 Use with 24"D Modular Cabinet Tops and Shells	18	23¼	28¼	98	8.9	T\$ 1247
	66-2515SHPD2 Use with Desk Shells Only	15¾	25	28¼	96	8.4	T\$ 1139
	66-2415PD2 Use with 24"D Modular Cabinet Tops and Shells	15¾	23¼	28¼	93	7.8	T\$ 1181

Must Specify (in this order):

- Model #
- Chassis Color
- Drawer Color
- Grain (if applicable)
- Construction
- Track
- Pull
- Wire Management

Description

- Open Back; [See Back Panel Options](#)
- Top is Required; [See Top Sizes](#)
- Letter Width Locking Pedestal
- Drawer Front Grain Direction Vertical Standard; Optional Horizontal Grain Direction
- Chassis and Drawer Fronts Available in Contrasting Colors; Must Specify Color of Each Component
- Additional Options: Dove Tail Drawer Construction and Soft Close Drawers ([See Drawer Options](#)), Wire Management ([See Option Details](#))

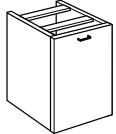
MODULAR PEDESTAL DOOR BOOKCASE	Left Shell	Right Shell	Width	Depth	Height	Ship Wt	Cubic Ft	List Price
	66-2418PD4L	66-2418PD4R	18	23¼	28¼	90	8.9	T\$ 1004

Must Specify (in this order):

- Model #
- Chassis Color
- Door Color
- Grain (if applicable)
- Pull
- Wire Management

Description

- Open Back; [See Back Panel Options](#)
- For Use with 24"D Tops; Top is Required; [See 24"/Left-to-Right Grain Tops](#) and [See 24"/Front-to-Back Grain Tops](#)
- Adjustable Shelf
- Door Front Grain Direction Vertical Standard; Optional Horizontal Grain Direction
- Chassis and Door Fronts Available in Contrasting Colors; Must Specify Color of Each Component
- Additional Options: Locking Door ([See Locking Options](#)) and Wire Management ([See Option Details](#))

Pricing Codes:

T= TFL
P= HPL

[See Canvas Intro Section for Ordering Options](#)

Item	Model No.	Width	Depth	Height	Ship Wt	Cubic Ft	List Price
MODULAR PEDESTAL MULTI-FILE	66-2436LF2	36	23¼	28¼	153	18.5	T\$ 1710
	66-2430LF2	30	23¼	28¼	128	14.9	T\$ 1643

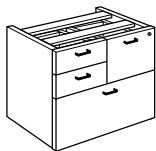

Must Specify (in this order):

Model #
 Chassis Color
 Drawer Front Color
 Grain (if applicable)
 Construction
 Box and File Drawer Track
 Pull
 Wire Management

Description

- Open Back; [See Back Panel Options](#)
- For Use with 24"D Tops; Top is Required; [See 24"/Left-to-Right Grain Tops](#) and [See 24"/Front-to-Back Grain Tops](#)
- Locking File Drawers; File and Lateral Drawer Provides Legal or Letter Filing Front to Back or Side to Side
- Drawer Front Grain Direction Vertical Standard; Optional Horizontal Grain Direction
- Chassis and Drawer Fronts Available in Contrasting Colors; Must Specify Color of Each Component
- Additional Options: Dove Tail Drawer Construction ([See Drawer Construction Options](#)), Soft Close Box and File Drawers ([See Soft Close Options](#)), Wire Management ([See Option Details](#))

MODULAR PEDESTAL OPEN MULTI-FILE	66-2436OMF	36	23¼	28¼	118	14.9	T\$ 1641
	66-2430OMF	30	23¼	28¼	128	18.5	T\$ 1575

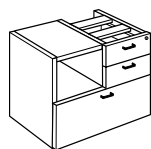

Must Specify (in this order):

Model #
 Chassis Color
 Drawer Front Color
 Grain (if applicable)
 Construction
 Box Drawer Track
 Pull
 Wire Management

Description

- Open Back; [See Back Panel Options](#)
- For Use with 24"D Tops; Top is Required; [See 24"/Left-to-Right Grain Tops](#) and [See 24"/Front-to-Back Grain Tops](#)
- Upper Section Provides Open Storage and Two Locking Box Drawers
- 13½" Open Storage Clearance for 66-2430OMF and 12¾" Open Storage Clearance for 66-2436OMF
- Locking Lateral Drawers Provide Legal or Letter Filing Front to Back or Side to Side
- Drawer Front Grain Direction Vertical Standard; Optional Horizontal Grain Direction
- Chassis and Drawer Fronts Available in Contrasting Colors; Must Specify Color of Each Component
- Additional Options: Dove Tail Drawer Construction ([See Drawer Construction Options](#)), Soft Close Box and File Drawers ([See Soft Close Options](#)), Wire Management ([See Option Details](#))

MODULAR PEDESTAL DOOR BOOKCASE	66-2436DB	36	23¼	28¼	105	18.5	T\$ 1412
	66-2430DB	30	23¼	28¼	87	14.9	T\$ 1116

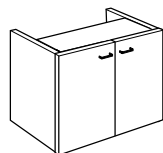

Must Specify (in this order):

Model #
 Chassis Color
 Door Color
 Grain (if applicable)
 Pull
 Locking Doors
 Wire Management

Description

- Open Back; [See Back Panel Options](#)
- For Use with 24"D Tops; Top is Required; [See 24"/Left-to-Right Grain Tops](#) and [See 24"/Front-to-Back Grain Tops](#)
- 12" Deep Adjustable Shelf Behind Doors
- Door Front Grain Direction Vertical Standard; Optional Horizontal Grain Direction
- Chassis and Door Fronts Available in Contrasting Colors; Must Specify Color of Each Component
- Additional Options: Locking Door ([See Locking Options](#)) and Wire Management ([See Option Details](#))

Pricing Codes:

T= TFL
 P= HPL

[See Canvas Intro Section for Ordering Options](#)

Item	Model No.	Width	Depth	Height	Ship Wt	Cubic Ft	List Price
MODULAR PEDESTAL DOOR BOOKCASE W/OPEN COMPARTMENT	66-2436ODB	36	23¼	28¼	118	18.5	T\$ 1334
	66-2430ODB	30	23¼	28¼	108	14.9	T\$ 1032

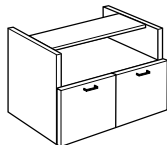

Must Specify (in this order):

Model #
Chassis Color
Door Color
Grain (if applicable)
Pull
Locking Doors
Wire Management

Description

- Open Back; [See Back Panel Options](#)
- For Use with 24"D Tops; Top is Required; [See 24"/Left-to-Right Grain Tops](#) and [See 24"/Front-to-Back Grain Tops](#)
- Upper Section Provides 12¾" Clearance for Open Storage
- Lower Section Provides Storage Behind Two Doors
- Chassis and Door Fronts Available in Contrasting Colors; Must Specify Color of Each Component
- Door Front Grain Direction Vertical Standard; Optional Horizontal Grain Direction
- Additional Options: Locking Door and Wire Management ([See Option Details](#))

MODULAR PEDESTAL OPEN STORAGE	66-2436MBC	36	22½½	28¼	118	18.5	T\$ 1154
	66-2430MBC	30	22½½	28¼	108	14.9	T\$ 979

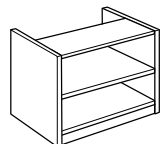

Must Specify (in this order):

Model #
Chassis Color
Wire Management

Description

- Open Back; [See Back Panel Options](#)
- For Use with 24"D Tops; Top is Required; [See 24"/Left-to-Right Grain Tops](#) and [See 24"/Front-to-Back Grain Tops](#)
- One Adjustable Shelf
- Optional Wire Management ([See Option Details](#))

MODULAR PEDESTAL LATERAL FILE	66-2436LF1	36	23¼	28¼	154	18.5	T\$ 1489
	66-2430LF1	30	23¼	28¼	128	14.9	T\$ 1384

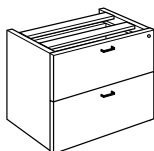

Must Specify (in this order):

Model #
Chassis Color
Drawer Front Color
Grain (if applicable)
Drawer Construction
Pull
Wire Management

Description

- Open Back; [See Back Panel Options](#)
- For Use with 24"D Tops; Top is Required; [See 24"/Left-to-Right Grain Tops](#) and [See 24"/Front-to-Back Grain Tops](#)
- Locking Lateral Drawers Provide Legal or Letter Filing Front to Back or Side to Side
- Drawer Front Grain Direction Vertical Standard; Optional Horizontal Grain Direction
- Chassis and Drawer Fronts Available in Contrasting Colors; Must Specify Color of Each Component
- Additional Options: Dove Tail Drawer Construction ([See Drawer Construction Options](#)), Wire Management ([See Option Details](#))

Pricing Codes:

T= TFL
P= HPL

[See Canvas Intro Section for Ordering Options](#)

Item	Model No.	Width	Depth	Height	Ship Wt	Cubic Ft	List Price
MODULAR THREE DRAWER LATERAL FILE	66-2436LF3	36	24	42¾	130	24.2	T\$ 2257
	66-2430LF3	30	24	42¾	120	20.4	T\$ 2141

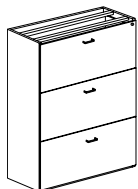

Must Specify (in this order):

Model #
 Chassis Color
 Drawer Front
 Color
 Grain (if applicable)
 Construction
 Pull
 Wire Management

Description

- Finished Back Panel Included
- For Use with 24"D Tops; Top is Required; [See 24"/Left-to-Right Grain Tops](#) and [See 24"/Front-to-Back Grain Tops](#)
- Locking Lateral Drawers Provide Legal or Letter Filing Front to Back or Side to Side
- Drawer Front Grain Direction Vertical Standard; Optional Horizontal Grain Direction
- Chassis and Drawer Fronts Available in Contrasting Colors; Must Specify Color of Each Component
- Additional Options: Dove Tail Drawer Construction ([See Drawer Construction Options](#))

21" LOW MODULAR BOX/FILE	66-2436L21BF	36	23¼	20¾	84	13.2	T\$ 1344
	66-2430L21BF	30	23¼	20¾	76	11.1	T\$ 1290
	66-2418L21BF	18	23¼	20¾	42	6.6	T\$ 1095
	66-2036L21BF	36	19¼	20¾	80	11.2	T\$ 1277
	66-2030L21BF	30	19¼	20¾	72	9.4	T\$ 1227
	66-2018L21BF	18	19¼	20¾	40	5.6	T\$ 1038

Must Specify (in this order):

Model #
 Chassis Color
 Drawer Front
 Color
 Grain (if applicable)
 Construction
 Box Drawer Track
 Pull
 Wire Management

Description

- Open Back; [See Low Height Back Panel Options](#)
- For Low Height Credenzas or Benching Applications
- Locking Tray/File Drawers; File Provides Legal or Letter Filing
- Drawer Front Grain Direction Vertical Standard; Optional Horizontal Grain Direction
- Chassis and Drawer Fronts Available in Contrasting Colors; Must Specify Color of Each Component
- Additional Options: Dove Tail Drawer Construction ([See Drawer Construction Options](#)), Soft Close Box and File Drawers ([See Soft Close Options](#)), Wire Management ([See Option Details](#))

Pricing Codes:

T= TFL
 P= HPL

[See Canvas Intro Section for Ordering Options](#)

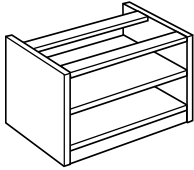
Item	Model No.	Width	Depth	Height	Ship Wt	Cubic Ft	List Price
21" LOW MODULAR OPEN STORAGE 	66-2436L21BC	36	22½	20¾	78	13.2	T\$ 1105
	66-2430L21BC	30	22½	20¾	74	11.1	T\$ 1065
	66-2418L21BC	18	22½	20¾	54	6.9	T\$ 970
	66-2036L21BC	36	18 ½	20¾	74	11.2	T\$ 1051
	66-2030L21BC	30	18 ½	20¾	70	9.4	T\$ 1010
	66-2018L21BC	18	18 ½	20¾	50	5.9	T\$ 921

Must Specify (in this order):

Model #
Color
Wire Management

Description

- Open Back; [See Low Height Back Panel Options](#)
- For Low Height Credenzas or Benching Applications
- Removable Wire Management Panel
- One Adjustable Shelf
- Optional Wire Management ([See Option Details](#))

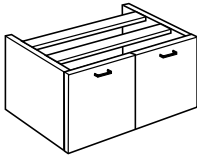
21" LOW MODULAR DOOR BOOKCASE 	66-2436L21DB	36	23¼	20¾	93	13.2	T\$ 1259
	66-2430L21DB	30	23¼	20¾	86	11.1	T\$ 1122
	66-2036L21DB	36	19¼	20¾	89	11.2	T\$ 1197
	66-2030L21DB	30	19¼	20¾	82	9.4	T\$ 1066

Must Specify (in this order):

Model #
Chassis Color
Door
Color
Grain (if applicable)
Pull
Locking Doors
Wire Management

Description

- Open Back; [See Low Height Back Panel Options](#)
- For Low Height Credenzas or Benching Applications
- Removable Wire Management Panel
- One Adjustable Shelf Behind Doors
- Door Front Grain Direction Vertical Standard; Optional Horizontal Grain Direction
- Chassis and Door Fronts Available in Contrasting Colors; Must Specify Color of Each Component
- Additional Options: Locking Doors ([See Locking Options](#)), Wire Management ([See Option Details](#))

Pricing Codes:

T= TFL
P= HPL

[See Canvas Intro Section for Ordering Options](#)

Item	Model No.	Width	Depth	Height	Ship Wt	Cubic Ft	List Price
21" LOW MODULAR SLIDING DOOR BOOKCASE 	66-2436L21SD	36	23¼	20¾	93	13.2	T\$ 1439
	66-2430L21SD	30	23¼	20¾	86	11.1	T\$ 1264
	66-2036L21SD	36	19¼	20¾	89	11.2	T\$ 1367
	66-2030L21SD	30	19¼	20¾	82	9.4	T\$ 1200

Description

- One Non-Locking Sliding Door
- Open Back; [See Low Height Back Panel Options](#)
- For Low Height Credenzas or Benching Applications
- Removable Wire Management Panel
- Storage Behind Sliding Door
- Door Front Grain Direction Vertical Standard; Optional Horizontal Grain Direction
- Chassis and Door Front Available in Contrasting Colors; Must Specify Color of Each Component
- Optional Wire Management ([See Option Details](#))

Must Specify (in this order):

Model #
 Chassis Color
 Door Color
 Grain (if applicable)
 Wire Management

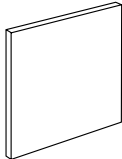
MODULAR PENINSULA SUPPORT SEATED HEIGHT 	66-3630EP	36	1	28¼	40	2.0	T\$ 401
	66-3030EP	30	1	28¼	34	1.6	T\$ 375
	66-2812SP	12	1	28¼	12	0.8	T\$ 245

Description

- To Be Used with Modular Desk Tops at 30" High
- Required to Be Used with T Support or the Support Panel Perpendicular to 36" and 30" Unit

Must Specify (in this order):

Model #
 Color

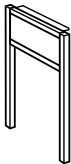
H MODULAR PENINSULA SUPPORT SEATED HEIGHT 	01-3628HL Single Mounted Plate	36	1	28¼	30	2.0	\$ 1145
	01-3028HL Single Mounted Plate	30	1	28¼	25	1.7	\$ 1126
	01-2428HL Single Mounted Plate	24	1	28¼	20	1.4	\$ 847
	01-3628TL Double Mounted Plate	36	1	28¼	30	2.0	\$ 1182
	01-3028TL Double Mounted Plate	30	1	28¼	25	1.7	\$ 1163
	01-2428TL Double Mounted Plate	24	1	28¼	20	1.4	\$ 876

Must Specify (in this order):

Model #
 Laminate Insert
 Support Color

Description

- Available in Aluminum (ALUM) or Black (BLK), Must Specify
- Constructed of Tubular Steel
- Metal End Support to Be Used with Modular Desk Tops at 30" High - Not Available to be Sold Separately
- Double Mount Plate Required for Freestanding Table/Desk

Leg Options: Specify & Add

HIM	TFL Insert	T\$ 62
-----	------------	--------

Pricing Codes:

T= TFL
 P= HPL

[See Canvas Intro Section for Ordering Options](#)

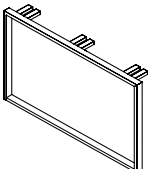
Item	Model No.	Width	Depth	Height	Ship Wt	Cubic Ft	List Price
O MODULAR PENINSULA SUPPORT SEATED HEIGHT 	01-6028OL	60	2	28¼	60	6.0	\$ 917
	01-4828OL	48	2	28¼	55	4.7	\$ 790
	01-3628OL	36	2	28¼	30	2.7	\$ 661
	01-3028OL	30	2	28¼	25	2.3	\$ 552
	01-2428OL	24	2	28¼	20	1.8	\$ 486

Must Specify (in this order):

Model #

Support Color

Description

- Available in Aluminum (ALUM) or Black (BLK), Must Specify
- Constructed of Tubular Steel
- Metal End Support to Be Used with Modular Desk Tops at 30" High - Not Available to be Sold Separately

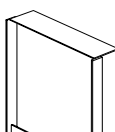
BAR MODULAR PENINSULA SUPPORT SEATED HEIGHT 	01-3628BL	36	2 ½	28¼	30	2.7	ALUM/BLK\$ 715 CHRM\$ 1239
	01-3028BL	30	2 ½	28¼	25	2.3	ALUM/BLK\$ 644 CHRM\$ 1039
	01-2428BL	24	2 ½	28¼	20	1.8	ALUM/BLK\$ 601 CHRM\$ 998

Must Specify (in this order):

Model #

Support Color

Description

- Available in Aluminum (ALUM), Black (BLK) or Chrome (CHRM)
- Constructed of Tubular Steel
- Metal End Support to Be Used with Modular Desk Tops at 30" High - Not Available to be Sold Separately

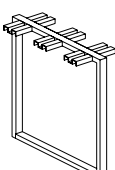
O SHARED METAL LEG SEATED HEIGHT 	01-3028OLS	30	2	28¼	50	3.1	\$ 629
	01-2428OLS	24	2	28¼	45	2.5	\$ 554

Must Specify (in this order):

Model #

Support Color

Description

- Available in Aluminum (ALUM) or Black (BLK), Must Specify
- Constructed of Tubular Steel
- Metal End Support to Be Used with Modular Desk Tops at 30" High - Not Available to be Sold Separately

Pricing Codes:

T= TFL

P= HPL

[See Canvas Intro Section for Ordering Options](#)

Item	Model No.		Width	Depth	Height	Ship Wt	Cubic Ft	List Price
28"D ELECTRIC HEIGHT ADJUSTABLE TABLE LIFT	01-2854ELB	Black	54-78	28	22-48	30	2.4	\$ 1832
	01-2854ELA	Silver						

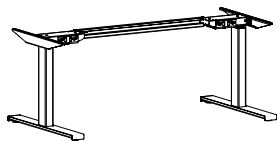

Description

- Standard with Up/Down Control Switch, 10' Power Cord, Integrated Anti-Collision Feature, Leveling Glides
- Standard Up/Down Control Switch can be Mounted for Left or Right Users; Upgrade to Advanced Memory Switch (01-MSWCH with Memory, Reminders, and Bluetooth), Must Specify and See Below for Details
- Adjusts to Accommodate Tops 54-78"W and 30"-36"D; Tops Sold Separately
- Lifting Capacity (Including Worksurface): 363 lbs
- Some Assembly Required; Installation Instructions Included

22"D ELECTRIC HEIGHT ADJUSTABLE TABLE LIFT	01-2254ELB	Black	54-78	22	22-48	58	2.4	\$ 1832
	01-2254ELA	Silver						

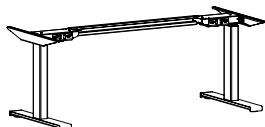

Description

- Standard with Up/Down Control Switch, 10' Power Cord, Anti-Collision Safety Feature, Leveling Glides
- Standard Up/Down Control Switch can be Mounted for Left or Right Users; Upgrade to Advanced Memory Switch (01-MSWCH with Memory, Reminders, and Bluetooth), Must Specify and See Below for Details
- Adjusts to Accommodate Tops 54-78"W and 24"D; Tops Sold Separately
- Lifting Capacity (Including Worksurface): 363 lbs
- Some Assembly Required; Installation Instructions Included

22"D ELECTRIC HEIGHT ADJUSTABLE TABLE LIFT	01-2242ELB	Black	42-48	22	22-48	55	2.4	\$ 1832
	01-2242ELA	Silver						

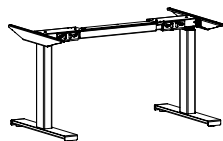

Description

- Standard with Up/Down Control Switch, 10' Power Cord, Anti-Collision Safety Feature, Leveling Glides
- Standard Up/Down Control Switch can be Mounted for Left or Right Users; Upgrade to Advanced Memory Switch (01-MSWCH with Memory, Reminders, and Bluetooth), Must Specify and See Below for Details
- Adjusts to Accommodate Tops 42-48"W and 24"-30"D; Tops Sold Separately
- Lifting Capacity (Including Worksurface): 363 lbs
- Some Assembly Required; Installation Instructions Included

ELECTRIC HEIGHT ADJUSTABLE ADVANCED SWITCH WITH MEMORY	01-MSWCH		3%	4%	1%	½	0.8	\$ 223
---	----------	--	----	----	----	---	-----	--------



Description

- Black Unit with Black Cord
- Bluetooth Capabilities
- Three Stand-Up Reminders
- Four Height Memory Positions

OPEN MARKET ONLY

Pricing Codes:

T= TFL
P= HPL

[See Canvas Intro Section for Ordering Options](#)

Item	Model No.	Width	Depth	Height	Ship Wt	Cubic Ft	List Price
LAYER SUPPORT FOR 21" LOW CREDENZA 	01-3607OL	36	2	7	25	1.1	\$ 576
	01-3007OL	30	2	7	20	0.9	\$ 557
	01-2407OL	24	2	7	15	0.7	\$ 523

Description

- Available in Aluminum (ALUM) or Black (BLK), Must Specify
- Supports 30" High Worksurfaces Over Low Height Components - Not Available to be Sold Separately

Must Specify (in this order):

Model #

Support Color

LAYER SUPPORT OVER LOW HEIGHT CABINETS	66-1807USP21	18	5¾	7	20	1.2	T\$ 260
---	--------------	----	----	---	----	-----	---------

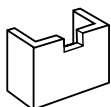
**Description**

- Supports 30"H Worksurfaces Over Low Height Components - Not Available to be Sold Separately
- Open Throughout and On Back Side to Manage Cables
- Rectangle Grommet Cover Included; Must Specify: Black (BLK) or Silver (SLV)

Must Specify (in this order):

Model #

Color

Grommet Color

FILLER PANEL 	66-2803FP	3	¾	28¼	6	0.5	T\$ 199
	For Standard Height Modular Pedestals and Credenzas						
	66-2003FP	3	¾	20¾	4	0.9	T\$ 184
	For Low Height Credenzas or Benching Applications						

Description

- Used to Fill Gap Behind Modular Pedestals with a Modular Top

Must Specify (in this order):

Model #

Color

Pricing Codes:

T= TFL

P= HPL

[See Canvas Intro Section for Ordering Options](#)

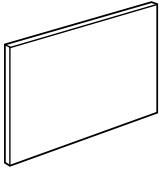
Item	Model No.	Width	Depth	Height	Ship Wt	Cubic Ft	List Price
	MODULAR MODESTY/BACK PANEL 66-9628BP	96	¾	28¼	115	5.0	T\$ 555
	66-9028BP	90	¾	28¼	108	4.6	T\$ 539
	66-8428BP	84	¾	28¼	101	4.3	T\$ 522
	66-7828BP	78	¾	28¼	94	4.0	T\$ 508
	66-7228BP	72	¾	28¼	86	3.7	T\$ 492
	66-6628BP	66	¾	28¼	79	3.4	T\$ 478
	66-6028BP	60	¾	28¼	65	3.7	T\$ 469
	66-5428BP	54	¾	28¼	60	2.8	T\$ 447
	66-4828BP	48	¾	28¼	55	2.5	T\$ 427
	66-4228BP	42	¾	28¼	50	2.2	T\$ 372
	66-3628BP	36	¾	28¼	45	2.0	T\$ 320
	66-3028BP	30	¾	28¼	30	1.6	T\$ 295
	66-1828BP	18	¾	28¼	19	1.0	T\$ 252
66-1528BP	15¾	¾	28¼	18	1.0	T\$ 232	

Must Specify (in this order):

Model #
Color
Grommet
Grommet Color

Description

- For Use as a Modesty Panel to Create Bridges, Returns, or Credenzas, or as a Back Panel on Modular Units
- Grain Runs Vertically Up to 60" - All Larger Sizes are Horizontal Grain Patterns

Leg Options: Specify & Add

1-GRMT	Optional Top-Center Grommet, Must Specify: Black (BLK) or Silver (SLV)	\$ 52
--------	--	-------

	FLIPDOWN MODESTY PANEL 66-2836FDM	36	3½	28¼	35	3.3	T\$ 904
	66-2830FDM	30	3½	28¼	30	2.7	T\$ 799

Description

- Modesty Panel with 3" Deep Case Allows Room for Plugs
- Does Not Feature Soft Close Hinges
- Upper Panel: Open at Top, Hinged and Opens Fully for Easy Access to Ports and Cord Management

Must Specify (in this order):

Model #
Color

Pricing Codes:

T= TFL
P= HPL

[See Canvas Intro Section for Ordering Options](#)

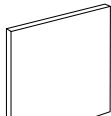
Item	Model No.	Width	Depth	Height	Ship Wt	Cubic Ft	List Price
	66-3530EP	35¼	1	28¼	41	2.6	T\$ 396
	66-2930EP	29¼	1	28¼	34	2.2	T\$ 373
	66-2330EP	23¼	1	28¼	27	1.6	T\$ 355

Must Specify (in this order):
Model #
Color

Description

- Must Be Used with a Back Panel

SUPPORT PANEL	66-2812SP	12	1	28¼	12	0.8	T\$ 245
----------------------	-----------	----	---	-----	----	-----	---------



Must Specify (in this order):
Model #
Color

Description

- Required to be Used Perpendicular to Full Back Panels to Support Kneespace Areas of 60" or Longer

	66-1010SP	10	10	28¼	20	0.8	T\$ 358
	66-1010SPW Support T with Wire Management	10	10	28¼	20	0.8	T\$ 358

Must Specify (in this order):
Model #
Color

Description

- Supports Worksurfaces
- Required on Kneespace Areas of 60" or More Where Back Panels are Not Used

O LEG SUPPORT	01-1228OL	12	2	28¼	20	1.2	\$ 442
----------------------	-----------	----	---	-----	----	-----	--------

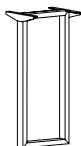

Must Specify (in this order):
Model #
Color
Wire Management Cover

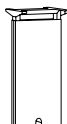

Description

- Available in Aluminum or Black; Must Specify Color
- Provides Additional Support Under Tops Greater Than 60" - Not Available to be Sold Separately

Leg Options: Specify & Add

01-1228OLWM	Wire Management Cover - Available in Aluminum or Black; Must Specify Color	\$ 291
-------------	--	--------

Pricing Codes:

T= TFL
P= HPL

[See Canvas Intro Section for Ordering Options](#)

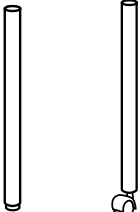
Item	Model No.	Width	Depth	Height	Ship Wt	Cubic Ft	List Price
	01-0401MLA Aluminum Leg with Leveler	2	2	28¾	10	0.5	\$ 320
	01-0401MLB Black Leg with Leveler						
	01-0400MLA Aluminum Leg with Caster	2	2	28¾	10	0.5	\$ 272
	01-0400MLB Black Leg with Caster						
Description							
<ul style="list-style-type: none"> Available in Adjustable Black Leveler or Locking Black Caster 							

LOW HEIGHT BACK PANEL

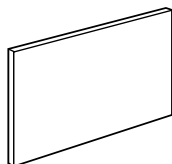

Must Specify (in this order):

Model #
Color
Grommet
Grommet Color

66-9620BP	96	¾	20¾	40	3.4	T\$ 490
66-9020BP	90	¾	20¾	38	3.3	T\$ 476
66-8420BP	84	¾	20¾	36	3.2	T\$ 464
66-7820BP	78	¾	20¾	34	3.1	T\$ 443
66-7220BP	72	¾	20¾	31	3.0	T\$ 427
66-6620BP	66	¾	20¾	29	2.9	T\$ 417
66-6020BP	60	¾	20¾	27	2.8	T\$ 371
66-5420BP	54	¾	20¾	24	2.7	T\$ 348
66-4820BP	48	¾	20¾	22	2.6	T\$ 339
66-4220BP	42	¾	20¾	20	2.5	T\$ 307
66-3620BP	36	¾	20¾	17	2.4	T\$ 287
66-3020BP	30	¾	20¾	15	2.3	T\$ 267
66-2420BP	24	¾	20¾	15	2.3	T\$ 243
66-1820BP	18	¾	20¾	15	2.3	T\$ 237

Description

- For Use as a Back Panels to Create Low Height Returns, Credenzas, or Benches
- Grain Runs Vertically Up to 60" - All Larger Sizes are Horizontal Grain Patterns

Leg Options: Specify & Add



1-GRMT	Optional Top-Center Grommet, Must Specify: Black or Silver	\$ 52
--------	--	-------

Pricing Codes:

T= TFL
P= HPL

[See Canvas Intro Section for Ordering Options](#)

Item	Model No.	Width	Depth	Height	Ship Wt	Cubic Ft	List Price
LOW HEIGHT END PANEL	66-2420EP	23¾	1	20¾	15	0.8	T\$ 310
	66-2020EP	19¾	1	20¾	15	0.8	T\$ 254

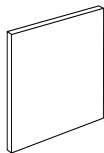
Description

- Must Be Used with a Back Panel

Must Specify (in this order):

Model #
Color

LOW HEIGHT SUPPORT PANEL	66-2012SP	12	1	20¾	7	0.4	T\$ 222
--------------------------	-----------	----	---	-----	---	-----	---------



Description

- Required to be Used Perpendicular to Full Back Panels to Support Kneespace Areas of 60" or Longer

Must Specify (in this order):

Model #
Color

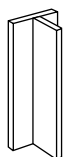
LOW HEIGHT SUPPORT T	66-2010SP	10	10	20¾	11	2.3	T\$ 317
	66-2010SPW Support T with Wire Management	10	10	20¾	11	2.3	T\$ 319

Description

- Supports Worksurfaces
- Required on Kneespace Areas of 60" or More Where Back Panels are Not Used

Must Specify (in this order):

Model #
Color

Pricing Codes:

T= TFL
P= HPL

[See Canvas Intro Section for Ordering Options](#)

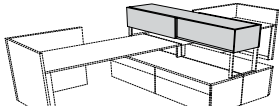
Item	Model No.	Width	Depth	Height	Ship Wt	Cubic Ft	List Price
 DUAL ACCESS SLIDING DOOR HUTCH	66-1572DAHS	72	16½	15	117	14.5	T\$ 2378
	66-1566DAHS	66	16½	15	111	13.4	T\$ 2285
	66-1560DAHS	60	16½	15	104	12.2	T\$ 2203



Must Specify (in this order):

Model #
Color
Door Style
Door Color
Dry Erase Back Panel

Description

- One Non-Locking Sliding Door
- Used with Shared Office Application
- Metal Stanchion Leg Sold Separately; [See Stanchion Sizes](#)
- Safely Write on Dry Erase Door and Dry Erase Back Panel with Our Dry Erase Marker Set; [See Set Options](#)
- If Applicable, Door Front Grain Direction Vertical Standard; Optional Horizontal Grain Direction
- If Applicable, Door Front Available in Contrasting Colors; Must Specify

Options: Specify & Add

	1-AD	Aluminum Framed Satin Frosted Tempered Glass Doors (Non-Locking)	\$ 1490
	1-DEB	Dry Erase Board Door (Non-Locking)	\$ 154
	1-HGA	High Gloss Acrylic Door (Non-Locking); Must Specify Color	
		(GPA) Graphite Acrylic	\$ 1542
		(BLA) Black, (WMA) Wired Mercury, or (WHA) White Acrylic	\$ 1411
	DEF	Dry Erase Fixed Back Panel	\$ 646

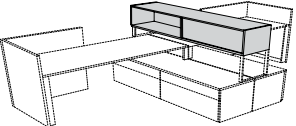
 DUAL ACCESS OPEN HUTCH	66-1572DAOH	72	15	15	95	14.5	T\$ 1326
	66-1566DAOH	66	15	15	90	13.4	T\$ 1278
	66-1560DAOH	60	15	15	85	12.2	T\$ 1261

Must Specify (in this order):

Model #
Color
Dry Erase Back Panel
Tackboard
Tackboard Fabric

Description

- Right Side - Fixed/Left Side - Open
- Used with Shared Office Application
- Safely Write on Dry Erase Back Panel with Our Dry Erase Marker Set; [See Set Options](#)
- Metal Stanchion Leg Sold Separately; [See Stanchion Sizes](#)
- Optional Dry Erase Fixed Backs, See Below or Tackboard Fixed Backs; [See Tackboards](#)

Options: Specify & Add

	DEF	Dry Erase Fixed Back Panel	\$ 646
--	-----	----------------------------	--------

Pricing Codes:

T= TFL
P= HPL

[See Canvas Intro Section for Ordering Options](#)

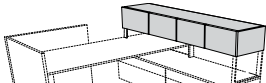
Item	Model No.	Width	Depth	Height	Ship Wt	Cubic Ft	List Price
SINGLE SIDED FOUR DOOR HUTCH 	66-1572SSHU	72	15¾	15	98	12.4	T\$ 1632
	66-1566SSHU	66	15¾	15	93	11.4	T\$ 1574
	66-1560SSHU	60	15¾	15	88	10.4	T\$ 1542

Description

- Storage Behind Doors
- Safely Write on Dry Erase, White and Black Tempered Glass Doors with Our Dry Erase Marker Set; [See Sets](#)
- Single or Shared Stanchions Must be Ordered Separately; See Next Page
- Optional Locking Doors Available; [See Locking Door Options](#) and Specify Lock Color

Must Specify (in this order):

- Model #
- Color
- Door Style
- Door Color
- Dry Erase Back Panel
- Locking Doors

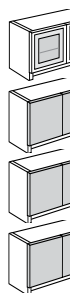

Options: Specify & Add

	Per Door
1-AD Aluminum Framed Satin Frosted Tempered Glass Doors (Non-Locking)	\$ 438
1-DEB Dry Erase Board Doors	\$ 28
WHGLS Aluminum Framed Doors with White Tempered Glass (Non-locking)	\$ 652
BLGLS Black Matte Framed Doors with Black Tempered Glass (Non-locking)	\$ 868
1-HGA High Gloss Acrylic Doors; Must Specify Color	
(GPA) Graphite Acrylic	\$ 269
(BLA) Black, (WMA) Wired Mercury, or (WHA) White Acrylic	\$ 247

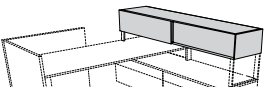
SINGLE SIDED SLIDING DOOR HUTCH 	66-1572SSHS	72	15¾	15	89	12.4	T\$ 1765
	66-1566SSHS	66	15¾	15	84	11.4	T\$ 1720
	66-1560SSHS	60	15¾	15	79	10.4	T\$ 1656

Description

- One Non-Locking Sliding Door
- Safely Write on Dry Erase Doors with Our Dry Erase Marker Set; [See Set Options](#)
- Storage Behind Sliding Door
- Single or Shared Stanchions Must be Ordered Separately; See Next Page

Must Specify (in this order):

- Model #
- Color
- Door Style
- Door Color

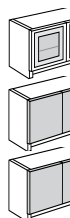

Options: Specify & Add

	Per Door
1-AD Aluminum Framed Satin Frosted Tempered Glass Doors (Non-Locking)	\$ 745
1-DEB Dry Erase Board Door (Non-Locking)	\$ 77
1-HGA High Gloss Acrylic Door (Non-Locking); Must Specify Color	
(GPA) Graphite Acrylic	\$ 773
(BLA) Black, (WMA) Wired Mercury, or (WHA) White Acrylic	\$ 705

Pricing Codes:

- T= TFL
- P= HPL

[See Canvas Intro Section for Ordering Options](#)

Item	Model No.	Width	Depth	Height	Ship Wt	Cubic Ft	List Price
METAL STANCHION FOR USE WITH LOW STORAGE AND SINGLE OR DUAL HUTCHES	01-1515OS For Use Over 21" Low Modular Ped	15	2	15	25	0.5	\$ 331
	01-1507OS For Use Over 30" Low Modular Ped	15	2	7	15	0.3	\$ 305

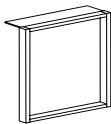

Must Specify (in this order):

Model #
Support Color

Description

- Available in Aluminum (ALUM) or Black (BLK), Must Specify
- For Use With Single Sided and Dual Access Hutches - Not Available to be Sold Separately

SHARED METAL STANCHION FOR USE WITH LOW STORAGE AND SINGLE OR DUAL HUTCHES	01-1515OSS For Use Over 21" Low Modular Ped	15	2	15	25	0.5	\$ 339
	01-1507OSS For Use Over 30" Low Modular Ped	15	2	7	15	0.3	\$ 327

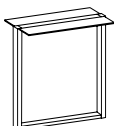

Must Specify (in this order):

Model #
Support Color

Description

- Available in Aluminum (ALUM) or Black (BLK), Must Specify
- For Use With Single Sided and Dual Access Hutches - Not Available to be Sold Separately
- Connects Two Dual Access Hutches

21" ABOVE AND BELOW SCREEN TFL	66-6821AB	68	¾	21	41	3.3	T\$ 471
	66-6221AB	62	¾	21	39	3.0	T\$ 459
	66-5621AB	56	¾	21	36	2.7	T\$ 441
	66-5021AB	50	¾	21	34	2.4	T\$ 425
	66-4421AB	44	¾	21	31	2.2	T\$ 408

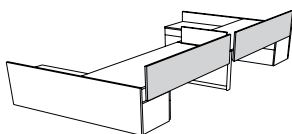

Must Specify (in this order):

Model #
Color

Description

- Mounts to Worksurface
- Provides Privacy 12" Above and 10¾" Modesty Below

Pricing Codes:

T= TFL
P= HPL

[See Canvas Intro Section for Ordering Options](#)

Item	Model No.	Width	Depth	Height	Ship Wt	Cubic Ft	List Price
21" ABOVE AND BELOW SCREEN FROSTED ACRYLIC 	66-6821ABA	68	¼	21	14	3.3	\$ 1352
	66-6221ABA	62	¼	21	12	2.8	\$ 1265
	66-5621ABA	56	¼	21	10	2.8	\$ 1177
	66-5021ABA	50	¼	21	9	2.2	\$ 1088
	66-4421ABA	44	¼	21	8	1.2	\$ 998

Must Specify (in this order):
Model #
Decorative Hardware Color

Description

- Mounts to Worksurface
- Provides Privacy 12" Above and 10 ¾" Modesty Below
- Decorative Hardware; Must Specify: Aluminum (ALUM) or Chrome (CHRM)

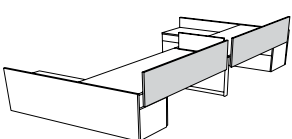
21" ABOVE AND BELOW SCREEN HIGH GLOSS ACRYLIC 	66-6821ABGA	68	¾	21	44	3.3	\$ 1447 GPA\$ 1886
	66-6221ABGA	62	¾	21	41	3.0	\$ 1344 GPA\$ 1747
	66-5621ABGA	56	¾	21	38	2.7	\$ 1246 GPA\$ 1606
	66-5021ABGA	50	¾	21	36	2.4	\$ 1147 GPA\$ 1470
	66-4421ABGA	44	¾	21	33	2.2	\$ 1051 GPA\$ 1333

Must Specify (in this order):
Model #
Color

Description

- Mounts to Worksurface
- Provides Privacy 12" Above and 10 ¾" Modesty Below
- Available in Black (BLA), White (WHA) or Graphite Acrylic (GPA); Graphite Acrylic Pricing (GPA\$)

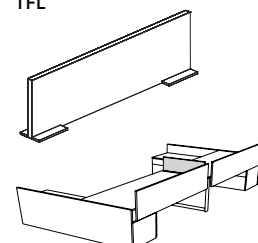
12" PRIVACY PANEL TFL 	66-2812PP	28	¾	12	12	0.9	T\$ 355
	66-2212PP	22	¾	12	10	0.7	T\$ 345

Must Specify (in this order):
Model #
Finish
Decorative Hardware Color

Description

- Mounts to Surface to Create Division Between Workstations
- Decorative Hardware; Must Specify: Aluminum (ALUM) or Chrome (CHRM)

Pricing Codes:

T= TFL
P= HPL

[See Canvas Intro Section for Ordering Options](#)

Item	Model No.	Width	Depth	Height	Ship Wt	Cubic Ft	List Price
12" PRIVACY PANEL FROSTED ACRYLIC	66-2812PPA	28	¼	12	8	0.7	\$ 580
	66-2212PPA	22	¼	12	7	0.6	\$ 523

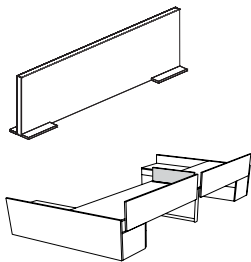
**Description**

- Mounts to Surface to Create Division Between Workstations
- Decorative Hardware; Must Specify: Aluminum (ALUM) or Chrome (CHRM)

Must Specify (in this order):

Model #
Decorative Hardware Color

12" PRIVACY PANEL HIGH GLOSS ACRYLIC	66-2812PPGA	68	¾	12	13	0.9	\$ 609 GPA\$ 686
	66-2212PPGA	62	¾	12	11	0.7	\$ 546 GPA\$ 605

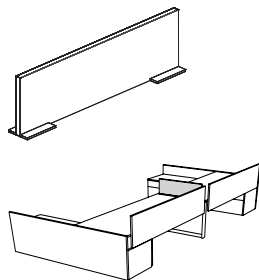
**Description**

- Mounts to Surface to Create Division Between Workstations
- Decorative Hardware; Must Specify: Aluminum (ALUM) or Chrome (CHRM)
- Available in Black (BLA), White (WHA) or Graphite Acrylic (GPA); Graphite Acrylic Pricing (GPA\$)

Must Specify (in this order):

Model #
Color
Decorative Hardware Color

12" FREESTANDING PRIVACY PANEL TFL	66-6812PP	68	¾	12	26	2.2	T\$ 430
	66-6212PP	62	¾	12	25	2.0	T\$ 419
	66-5612PP	56	¾	12	23	1.8	T\$ 408

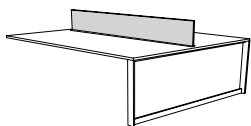
**Description**

- Freestanding on Surface to Create Division Between Workstations
- Decorative Hardware; Must Specify: Aluminum (ALUM) or Chrome (CHRM)

Must Specify (in this order):

Model #
Color
Decorative Hardware Color

Pricing Codes:

T= TFL
P= HPL

[See Canvas Intro Section for Ordering Options](#)

Item	Model No.	Width	Depth	Height	Ship Wt	Cubic Ft	List Price
12" FREESTANDING PRIVACY PANEL FROSTED ACRYLIC	66-6812PPA	68	¼	12	8	2.2	\$ 982
	66-6212PPA	62	¼	12	7	2.0	\$ 925
	66-5612PPA	56	¼	12	6	1.8	\$ 854

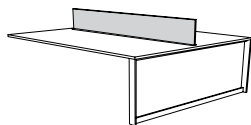

Must Specify (in this order):

Model #
Decorative Hardware Color

Description

- Freestanding on Surface to Create Division Between Workstations
- Decorative Hardware; Must Specify: Aluminum (ALUM) or Chrome (CHRM)

12" FREESTANDING PRIVACY PANEL HIGH GLOSS ACRYLIC	66-6812PPGA	68	¾	12	25	3.3	\$ 1051 GPA\$ 1233
	66-6212PPGA	62	¾	12	23	3.0	\$ 979 GPA\$ 1154
	66-5612PPGA	56	¾	12	22	2.7	\$ 886 GPA\$ 1073

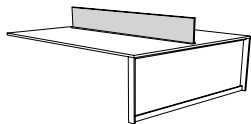

Must Specify (in this order):

Model #
Color
Decorative Hardware Color

Description

- Freestanding on Surface to Create Division Between Workstations
- Decorative Hardware; Must Specify: Aluminum (ALUM) or Chrome (CHRM)
- Available in Black (BLA), White (WHA) or Graphite Acrylic (GPA); Graphite Acrylic Pricing (GPA\$)

7" MODESTY PANEL TFL	66-6807MOD	68	¾	7	17	1.3	T\$ 406
	66-6207MOD	62	¾	7	16	1.2	T\$ 401
	66-5607MOD	56	¾	7	16	1.1	T\$ 390

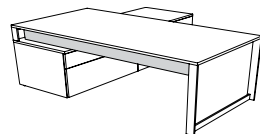

Must Specify (in this order):

Model #
Color

Description

- Works With Low Storage; [See Low Credenzas](#) and Modular Units; [See Modular Units](#)
- Attaches with Aluminum Mounting Brackets

Pricing Codes:

T= TFL
P= HPL

[See Canvas Intro Section for Ordering Options](#)

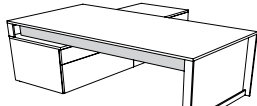
Item	Model No.	Width	Depth	Height	Ship Wt	Cubic Ft	List Price
7" MODESTY PANEL FROSTED ACRYLIC 	66-6807MODA	68	¼	7	12	1.3	\$ 705
	66-6207MODA	62	¼	7	11	1.2	\$ 652
	66-5607MODA	56	¼	7	10	1.1	\$ 620

Description

- Works With Low Storage; [See Low Credenzas](#) and Modular Units; [See Modular Units](#)
- Exposed Decorative Hardware; Must Specify: Aluminum (ALUM) or Chrome (CHRM)

Must Specify (in this order):

Model #

Decorative Hardware Color

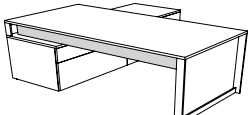
7" MODESTY PANEL HIGH GLOSS ACRYLIC 	66-6807MODGA	68	¾	7	17	1.3	\$ 725 GPA\$ 826
	66-6207MODGA	62	¾	7	16	1.2	\$ 707 GPA\$ 780
	66-5607MODGA	56	¾	7	16	1.1	\$ 690 GPA\$ 738

Description

- Works With Low Storage; [See Low Credenzas](#) and Modular Units; [See Modular Units](#)
- Attaches with Aluminum Mounting Brackets
- Available in Black (BLA), Wired Mercury (WMA), White (WHA) or Graphite Acrylic (GPA); Graphite Acrylic Pricing (GPA\$)

Must Specify (in this order):

Model #

Color

Pricing Codes:

T= TFL

P= HPL

[See Canvas Intro Section for Ordering Options](#)

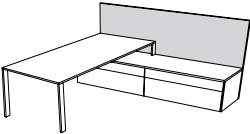
Item	Model No.	Width	Depth	Height	Ship Wt	Cubic Ft	List Price
51" GALLERY SCREEN STRAIGHT FLOORSTANDING 	66-5173GS	73	1	51¼	110	7.9	T\$ 1147
	66-5172GS	72	1	51¼	110	7.9	T\$ 1139
	66-5167GS	67	1	51¼	104	7.3	T\$ 1103
	66-5166GS	66	1	51¼	104	7.3	T\$ 1096
	66-5161GS	61	1	51¼	98	6.7	T\$ 1057
	66-5160GS	60	1	51¼	98	6.7	T\$ 1051
	66-5155GS	55	1	51¼	92	6.1	T\$ 1010
	66-5154GS	54	1	51¼	92	6.1	T\$ 1003
	66-5149GS	49	1	51¼	86	5.4	T\$ 964
	66-5148GS	48	1	51¼	86	5.4	T\$ 957
	66-5143GS	43	1	51¼	80	4.7	T\$ 920
	66-5142GS	42	1	51¼	80	4.7	T\$ 913
	66-5137GS	37	1	51¼	60	4.1	T\$ 795
	66-5136GS	36	1	51¼	60	4.1	T\$ 772
	66-5131GS	31	1	51¼	54	3.5	T\$ 724
	66-5130GS	30	1	51¼	54	3.5	T\$ 713
	66-5125GS	25	1	51¼	48	2.8	T\$ 662
	66-5124GS	24	1	51¼	48	2.8	T\$ 652
	66-5119GS	19	1	51¼	42	2.2	T\$ 613
	66-5118GS	18	1	51¼	42	2.2	T\$ 603

Must Specify (in this order):

Model #
Color
Grommet
Grommet Color

Description

- Horizontal Woodgrain
- Mounts to Back of Modular Credenza for Space Division
- Extend up to 24" Beyond Workstation without Additional Support
- Six (6) Wire Management Grommet Location Options: [See Locations](#) and Specify Location Selections

Pricing Codes:

T= TFL
P= HPL

[See Canvas Intro Section for Ordering Options](#)

Studio Components

Boutique-inspired options to give all your working environments a fresh look with a subtle touch of home. Integrated into our ever-popular Canvas and Gesso Casegood lines, Studio models build upon simplicity and flexibility while allowing you to create eye-catching spaces. Whether you're looking to outfit an executive's office, team space, collaborative area, or anything in between, our Studio desk and storage components have the look and feel you desire.

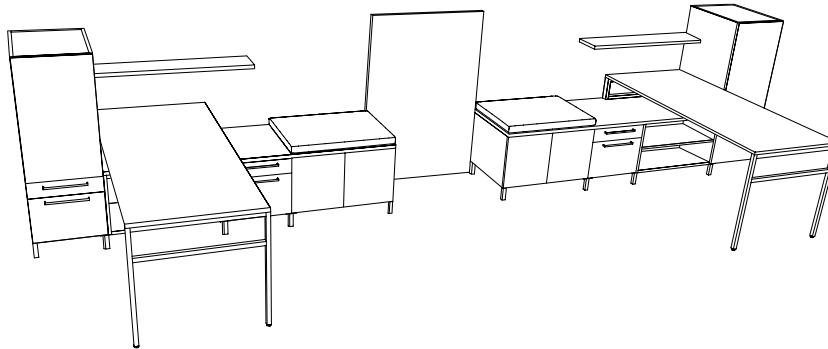

Studio components work with existing Canvas Tops, Peninsula Tops, and accessories such as Tackboards, Work Walls, Marker Boards, and Cushions to build the perfect workspace. The slim leg design provides an upscale feel for all of the Studio components. Storage units such as standard height pedestals offer the flexibility to build single or double pedestal desks or credenzas and low height pedestals allow you to create bench style credenzas.

The Studio pull features a clean application.



How to Use Studio

Start with a Modular Top to build a Desk, Peninsula Desk, Benching or Credenza
([See Modular Tops](#))



Next, choose from a number of Studio Pedestals options in Standard or Low Height. ([See Studio Peds](#))



Kneespace Modesty Panels are available in standard height in TFL or High Gloss Acrylic or low height in TFL ([See Modesty Panels](#))

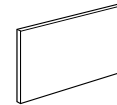

Add additional storage with Studio Storage Cabinets and the full door storage cabinet features high gloss acrylic and dry erase door options ([See Storage Cabinets](#))

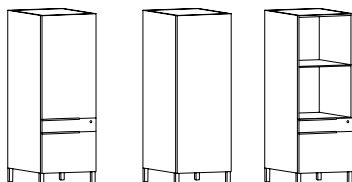

Single and Shared Stanchions offer a layer of support for workstations and single or dual sided hutches ([See Stanchions](#))

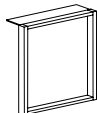

Studio Single and Shared Legs images below provide a simple and clean aesthetic. See below for a guide to the aesthetics of single, double, and shared legs ([See Leg Options](#))

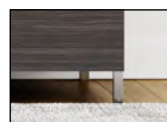

Single Standard Leg



Shared Leg (used between two models)



Double Standard Leg (standard legs used on each model)

Item	Model No.	Width	Depth	Height	Ship Wt	Cubic Ft	List Price
STUDIO COMPONENT, MODULAR PEDESTAL BOX/BOX/FILE	66-3618SPD1	18	36	24¼	68	11.4	T\$ 1491
	66-3018SPD1	18	30	24¼	61	10.4	T\$ 1368
	66-2418SPD1	18	24	24¼	54	8.4	T\$ 1263



Must Specify (in this order):

Model #
Chassis Color
Drawer Front
Color
Grain (if applicable)
Pull
Drawer Construction
Drawer Track
Wire Management

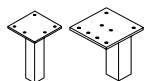

Legs Must be Ordered Separately; [See Leg Options](#)

Description

- For Use With Other Studio Components
- Standard Locking Pedestal; File Drawer Provides Legal or Letter Filing
- Studio Pulls Are Installed on Left Aligned Position; Drawers Feature a ¾ Extension
- Drawer Front Grain Direction Vertical Standard; Optional Horizontal Grain Direction
- Chassis and Drawer Fronts Available in Contrasting Colors; Must Specify Color of Each Component
- Finished Back Panel Included
- Height of Unit with Legs: 28¼; **Legs Must be Ordered Separately; [See Leg Options](#)**
- Worksurface Required; [See Worksurface Sizes](#)
- Additional Options: Dove Tail Drawer Construction and Soft Close Drawers ([See Drawer Options](#)), Wire Management ([See Option Details](#))

STUDIO COMPONENT, LOW MODULAR PEDESTAL TRAY/FILE	66-2436STF	36	24	16¾	59	10.6	T\$ 1257
	66-2430STF	30	24	16¾	51	8.9	T\$ 1213
	66-2418STF	18	24	16¾	37	5.6	T\$ 1015



Must Specify (in this order):

Model #
Chassis Color
Drawer Front
Color
Grain (if applicable)
Pull
Drawer Construction
Drawer Track
Wire Management

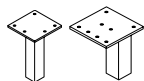

Legs Must be Ordered Separately; [See Leg Options](#)

Description

- For Use With Other Studio Components
- Standard Locking Pedestal; File Drawer Provides Legal or Letter Filing
- Studio Pulls Are Installed on Left Aligned Position; Drawers Feature a ¾ Extension
- Drawer Front Grain Direction Vertical Standard; Optional Horizontal Grain Direction
- Chassis and Drawer Fronts Available in Contrasting Colors; Must Specify Color of Each Component
- Finished Back Panel Included
- Height of Unit with Legs: 20¾; **Legs Must be Ordered Separately; [See Leg Options](#)**
- Worksurface Required; [See Worksurface Sizes](#)
- Additional Options: Dove Tail Drawer Construction and Soft Close Drawers ([See Drawer Options](#)), Wire Management ([See Option Details](#))

Pricing Codes:

T= TFL
P= HPL

[See Canvas Intro Section for Ordering Options](#)

Item	Model No.	Width	Depth	Height	Ship Wt	Cubic Ft	List Price
STUDIO COMPONENT, LOW MODULAR PEDESTAL OPEN BOOKCASE	66-2436SBC	36	24	16¾	67	10.6	T\$ 1095
	66-2430SBC	30	24	16¾	59	8.9	T\$ 1051
	66-2418SBC	18	24	16¾	45	5.6	T\$ 960

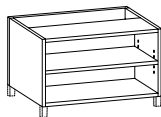

Must Specify (in this order):

Model #
Chassis Color
Wire Management

Description

- For Use With Other Studio Components
- One Adjustable Shelf
- Finished Back Panel Included
- Removable Wire Management Panel
- Height of Unit with Legs: 20¾; **Legs Must be Ordered Separately; [See Leg Options](#)**
- Worksurface Required; [See Worksurface Sizes](#)
- Optional Wire Management ([See Option Details](#))

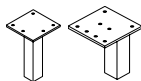

Legs Must be Ordered Separately; [See Leg Options](#)

STUDIO COMPONENT, LOW MODULAR PEDESTAL DOUBLE DOOR BOOKCASE	66-2436SDB	36	24	16¾	77	10.6	T\$ 1047
	66-2430SDB	30	24	16¾	67	8.9	T\$ 918

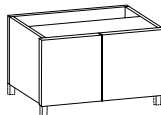

Must Specify (in this order):

Model #
Chassis Color
Door Color
Grain (if applicable)
Pull
Locking Doors
Wire Management

Description

- For Use With Other Studio Components
- 16" Deep Adjustable Shelf Behind Touch Latch Doors
- Finished Back Panel Included
- Removable Wire Management Panel
- Drawer Front Grain Direction Vertical Standard; Optional Horizontal Grain Direction
- Chassis and Door Fronts Available in Contrasting Colors; Must Specify Color of Each Component
- Height of Unit with Legs: 20¾; **Legs Must be Ordered Separately; [See Leg Options](#)**
- Worksurface Required; [See Worksurface Sizes](#)
- Optional Locking Door Available; [See Locking Options](#) and Specify Lock Color
- Optional Wire Management ([See Option Details](#))

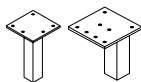

Legs Must be Ordered Separately; [See Leg Options](#)

Pricing Codes:

T= TFL
P= HPL

[See Canvas Intro Section for Ordering Options](#)

Item	Model No.		Width	Depth	Height	Ship Wt	Cubic Ft	List Price
STUDIO COMPONENT, LOW MODULAR PEDESTAL SINGLE DOOR BOOKCASE	Left	Right						
	66-2418SDBL	66-2418SDBR	18	24	16¾	51	5.6	T\$ 825

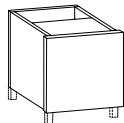

Must Specify (in this order):

- Model #
- Chassis Color
- Door Color
- Grain (if applicable)
- Pull
- Wire Management

Description

- For Use With Other Studio Components
- 16" Deep Adjustable Shelf Behind Touch Latch Door
- Finished Back Panel Included
- Removable Wire Management Panel
- Door Front Grain Direction Vertical Standard; Optional Horizontal Grain Direction
- Door Front Available in Contrasting Colors; Must Specify
- Height of Unit with Legs: 20¾; **Legs Must be Ordered Separately; See Leg Options**
- Worksurface Required; [See Worksurface Sizes](#)
- Optional Locking Door Available; [See Locking Options](#) and Specify Lock Color
- Optional Wire Management ([See Option Details](#))

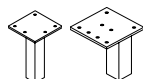

Legs Must be Ordered Separately; [See Leg Options](#)

Item	Model No.		Width	Depth	Height	Ship Wt	Cubic Ft	List Price
STUDIO COMPONENT, STORAGE CABINET DOOR/TRAY/FILE	Left	Right						
	66-1851SWBL	66-1851SWBR	18	24	47½	120	15.9	T\$ 1588

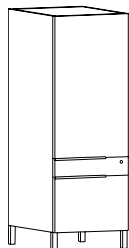

Must Specify (in this order):

- Model #
- Chassis Color
- Drawer Front/Door Color
- Grain (if applicable)
- Door Locking
- Pull

Description

- For Use With Other Studio Components
- One Adjustable Shelf Behind Touch Latch Door
- Locking File Drawer Provides Legal or Letter Filing
- Studio Pulls Are Installed on Left Aligned Position; Drawers Feature a ¾ Extension
- Drawer/Door Front Grain Direction Vertical Standard; Optional Horizontal Grain Direction
- Drawer/Door Fronts Available in Contrasting Colors; Must Specify
- Height of Unit with Legs: 51½; **Legs Must be Ordered Separately; See Leg Options**
- Optional Locking Door Available; [See Locking Options](#) and Specify Lock Color
- Additional Options: Dove Tail Drawer Construction and Soft Close Drawers ([See Drawer Options](#))

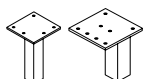

Legs Must be Ordered Separately; [See Leg Options](#)

Pricing Codes:

- T= TFL
- P= HPL

[See Canvas Intro Section for Ordering Options](#)

Item	Model No.	Width	Depth	Height	Ship Wt	Cubic Ft	List Price
STUDIO COMPONENT, OPEN STORAGE CABINET TRAY/FILE	66-1851SWBO	18	24	47½	109	15.9	T\$ 1517

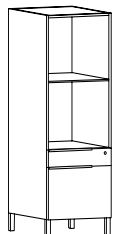

Description

- For Use With Other Studio Components
- One Adjustable Shelf
- Locking File Drawer Provides Legal or Letter Filing
- Studio Pulls Are Installed on Left Aligned Position; Drawers Feature a ¾ Extension
- Drawer Front Grain Direction Vertical Standard; Optional Horizontal Grain Direction
- Drawer Fronts Available in Contrasting Colors; Must Specify
- Height of Unit with Legs: 51½; **Legs Must be Ordered Separately**; [See Leg Options](#)
- Additional Options: Dove Tail Drawer Construction and Soft Close Drawers ([See Drawer Options](#))

Must Specify (in this order):

- Model #
- Chassis Color
- Drawer Front Color
- Grain (if applicable)
- Pull

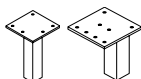

Legs Must be Ordered Separately; [See Leg Options](#)

STUDIO COMPONENT, WARDROBE	Left	Right	Width	Depth	Height	Ship Wt	Cubic Ft	List Price
	66-1851SWL	66-1851SWR	18	24	47½	108	15.9	T\$ 1387

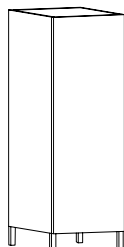

Description

- For Use With Other Studio Components
- Includes Coat Rod and (2) Adjustable Shelves Behind Touch Latch Door
- TFL Door Front Grain Direction Vertical Standard; Optional Horizontal Grain Direction
- Door Fronts Available in Contrasting Colors; Must Specify
- Safely Write on Dry Erase Doors with Our Dry Erase Marker Set; [See Set Options](#)
- Height of Unit with Legs: 51½; **Legs Must be Ordered Separately**; [See Leg Options](#)
- Optional Locking Door Available; [See Locking Options](#) and Specify Lock Color
- Optional Wire Management ([See Option Details](#))



Options: Specify & Add

1-DEB	Dry Erase Board	\$ 96
1-HGA	High Gloss Acrylic; Must Specify Color	
	(GPA) Graphite Acrylic	\$ 960
	(BLA) Black, (WMA) Wired Mercury, or (WHA) White Acrylic	\$ 876



Must Specify (in this order):

- Model #
- Chassis Color
- Door Color
- Grain (if applicable)
- Door Locking
- Pull

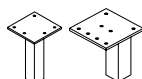

Legs Must be Ordered Separately; [See Leg Options](#)

Pricing Codes:

- T= TFL
- P= HPL

[See Canvas Intro Section for Ordering Options](#)

Item	Model No.	Width	Depth	Height	Ship Wt	Cubic Ft	List Price
STUDIO COMPONENT, KNEESPACE MODESTY PANEL, TFL	66-6024MD	60	¾	24½	37	2.9	T\$ 419
	66-5424MD	54	¾	24½	33	2.6	T\$ 401
	66-4824MD	48	¾	24½	30	2.3	T\$ 385
	66-4224MD	42	¾	24½	26	2.0	T\$ 341
	66-3624MD	36	¾	24½	22	1.7	T\$ 304
	66-3024MD	30	¾	24½	19	1.4	T\$ 280

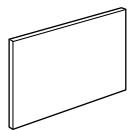

Must Specify (in this order):

Model #
Color
Grommet

Description

- For Use Between Two Studio Pedestals
- Attaches with L Bracket (Included)
- Optional Center Panel Grommet; Must Specify

STUDIO COMPONENT, KNEESPACE MODESTY PANEL, HIGH GLOSS ACRYLIC	66-4824MDHGA	48	¾	24½	30	2.3	\$ 774 GPA\$ 893
	66-4224MDHGA	42	¾	24½	30	2.1	\$ 700 GPA\$ 805
	66-3624MDHGA	36	¾	24½	26	2.0	\$ 589 GPA\$ 676
	66-3024MDHGA	30	¾	24½	19	1.4	\$ 513 GPA\$ 589

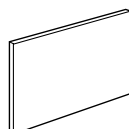

Must Specify (in this order):

Model #
Color
Grommet

Description

- For Use Between Two Studio Pedestals
- Attaches with L Bracket (Included)
- Available in Black (BLA), Wired Mercury (WMA), White (WHA) or Graphite Acrylic (GPA); Graphite Acrylic Pricing (GPA\$)

STUDIO COMPONENT, KNEESPACE MODESTY PANEL, FOR LOW STORAGE, TFL	66-6016MD	60	¾	16¼	25	2.0	T\$ 319
	66-5416MD	54	¾	16¼	23	1.8	T\$ 300
	66-4816MD	48	¾	16¼	20	1.6	T\$ 295
	66-4216MD	42	¾	16¼	18	1.4	T\$ 275
	66-3616MD	36	¾	16¼	15	1.2	T\$ 267
	66-3016MD	30	¾	16¼	13	1.0	T\$ 255

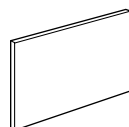

Must Specify (in this order):

Model #
Color
Grommet

Description

- For Use Between Two Studio Pedestals
- Attaches with L Bracket (Included)
- Optional Center Panel Grommet; Must Specify

Pricing Codes:

T= TFL
P= HPL

[See Canvas Intro Section for Ordering Options](#)

Item	Model No.	Width	Depth	Height	Ship Wt	Cubic Ft	List Price
METAL STANCHION SINGLE	01-1515SOS	15	1	15	25	0.5	ALUM \$ 219
							BLK \$ 219
							CHRM \$ 271

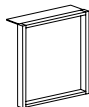

Must Specify (in this order):

Model #
Color

Description

- For Use With Single Sided Hutches ([See Hutches](#)) on Low Studio Components
- Available in Aluminum (ALUM), Black (BLK) or Chrome (CHRM); Must Specify

METAL STANCHION SHARED	01-1515SOSS	35¼	1	28¼	41	2.6	ALUM \$ 273
							BLK \$ 273
							CHRM \$ 338

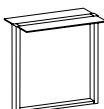

Must Specify (in this order):

Model #
Color

Description

- Connects Two Single Sided Hutches ([See Hutches](#)) on Low Studio Components
- Available in Aluminum (ALUM), Black (BLK) or Chrome (CHRM); Must Specify

STUDIO COMPONENT, SINGLE LEG	01-0404SL4	4-pack	1	1	4	10	1	ALUM \$ 273
								BLK \$ 273
								CHRM \$ 338
	01-0404SL2	2-pack	1	1	4	5	0.5	ALUM \$ 143
								BLK \$ 143
								CHRM \$ 176

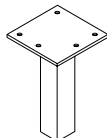

Must Specify (in this order):

Model #
Color

Description

- For Use With Studio Components
- Available in Aluminum (ALUM), Black (BLK) or Chrome (CHRM); Must Specify

STUDIO COMPONENT, SHARED LEG	01-0404SSL4	4-pack	1	1	4	10	1	ALUM \$ 247
								BLK \$ 247
								CHRM \$ 303
	01-0404SSL2	2-pack	1	1	4	5	0.5	ALUM \$ 143
								BLK \$ 143
								CHRM \$ 176

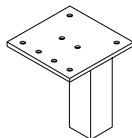

Must Specify (in this order):

Model #
Color

Description

- For Use With Studio Components
- Available in Aluminum (ALUM), Black (BLK) or Chrome (CHRM); Must Specify
- Connects Two Storage or Pedestal Units Together

Pricing Codes:

T= TFL
P= HPL

[See Canvas Intro Section for Ordering Options](#)

Height Adjustable Components

We've enhanced our height adjustable options to include a better integrated and easier to specify solution. These new models coupled with our existing modular height adjustable, and all of our standard models and storage options, provide you with the ultimate flexibility to meet the needs of your space and, more importantly, the needs of the user. And, we've made these new models more cost effective for you and more functional and spacious for the user.

Some Highlights of Our Integrated Solutions:

- Adjustable from 30"H to 45"H, with a load capacity up to 180lbs
- Gently adjust one worksurface or multiple worksurfaces with a 1 second stop at each memory position
- Two leg configuration options include the standard 2-channel for Desks, Desk Shells, D-top and P-Top units for one height adjustable worksurface or a 3-channel option for two height adjustable worksurfaces to raise simultaneously
- Two height adjustable control switches available. Standard up/down switch (SWCH) and advanced switch features Bluetooth capabilities, three stand-up reminder intervals and four height memory positions (MSWCH)
- Moving Modesty (MOVMOD) option creates a clean aesthetic when seated or standing
- Height adjust control switch is factory installed on all units except Desk Shells, Bridges or 3-Channel units
- Bridges, returns, and credenzas have an optional grommet on the back panel
- New black wire management mesh wrap included when worksurface grommet is selected
- Grommets and one Latch Duct wire management channel provided within kneespace to manage wires from switch and control box. Two Latch Duct wire management channels will be shipped with Desk Shells



Black wire management mesh sleeve included with worksurface grommet

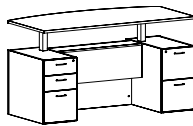

Standard 2-Channel Height Adjustable

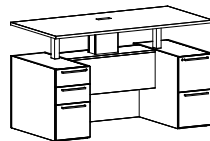

2-Channel Height Adjustable with Box



Standard (SWCH) and Advanced Switch (MSWCH)



Bring the Open Plan and Shared Spaces to Life!

Modular Height Adjustable components make it easy to create the perfect work environment for any space. Select from an array of sizes of worksurfaces, pedestals, filing units and more to connect teams together so collaborating can be easy and productive.

If you prefer our original solution or have specified it previously, and would like to do so again, simply contact our Customer Service team for assistance. We can make that happen for you!

Item	Model No.	Width	Depth	Height	K	R	Ship Wt	Cubic Ft	List Price
HEIGHT ADJUSTABLE DOUBLE PED BOW TOP DESK	68-3672BDPSSTS Stepped Front	72	36-42	30-45	40½	-	510	50.0	T\$ 6952 P\$ 7247
	68-3672BDPSTS Recessed Front	72	36-42	30-45	40½	10	510	50.0	T\$ 6823 P\$ 7115
	68-3666BDPSTS Recessed Front	66	36-42	30-45	34½	4	480	48.0	T\$ 6707 P\$ 7042

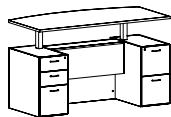

Shown with
Rectangle Top,
Stepped Front,
Moving Modesty
and Top Up

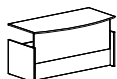

Shown with
Bow Top,
Recessed Front,
Moving Modesty
and Top Up

Must Specify (in this order):

- Model #
- Top Material
- Top Color
- Edge Profile
- Chassis Color
- Drawer Front Color
- Grain Direction (if applicable)
- Drawer Pull
- Drawer Construction
- Drawer Track
- Moving Modesty
- Height Adjust Switch
- Grommet Location
- Power/Data/Wire Management

Description

- Standard with: 2-Channel Leg Configuration for Single Surface Height Adjustment, Includes Controls, Letter Width Locking Box/Box/File on Left and File/File on Right, Bow Top Profiled on Approach and User Side, Left to Right Grain Direction on Worksurface, Wire Management from Pedestal to Kneespace
- Optional Moving Modesty; Must Specify; Some Assembly Required, [See Below and Options](#)
- Top, Chassis, and Drawer Fronts Available in Contrasting Colors; Must Specify Color of Each Component
- Stepped Front Units Available with Contrasting Modesty Panel; See High Gloss Acrylic Below or [TFL Color Options](#)
- Drawer Front Grain Direction Vertical Standard; Optional Horizontal Grain Direction
- Control Switch Standard (SWCH-Up/Down) or Upgrade to Advanced Switch (MSWCH-Up/Down/Memory); [See Switch Options](#)
- Optional Dove Tail Drawer Construction and Soft Close Drawers ([See Drawer Options](#))
- For Additional Information Including Worksurface Materials, Grommets and Wire Management Boxes, Power Locations, and More can be Found in the [Intro Section](#)

High Gloss Acrylic Modesty Options for Stepped Front Desks (68-3672BDPSSTS Only): Specify & Add

66-HGAF	High Gloss Acrylic Full Modesty Panel; Must Specify Color (<i>Not Available as Moving Modesty</i>)	
	(GPA) Graphite Acrylic	\$ 1914
	(BLA) Black, (WMA) Wired Mercury, or White (WHA)	\$ 1748

Moving Modesty Options: Specify & Add

MOVMOD	Moving Modesty (Available in Contrasting Colors; Must Specify)	\$ 219
--------	--	--------

Pricing Codes:

- T= TFL
- P= HPL

[See Canvas Intro Section for Ordering Options](#)

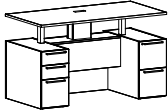
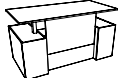
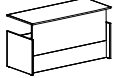
Item	Model No.	Width	Depth	Height	K	R	Ship Wt	Cubic Ft	List Price
HEIGHT ADJUSTABLE DOUBLE PED DESK  <p>Shown with Wire Management Box and Top Up</p>  <p>Shown with Rectangle Top, Stepped Front, Moving Modesty and Top Up</p>  <p>Shown with Rectangle Top, Recessed Front, Moving Modesty and Top Up</p>	68-3672DPSSTS Stepped Front	72	36	30-45	40½	-	525	50.0	T\$ 7218 P\$ 7506
	68-3672DPSTS Recessed Front	72	36	30-45	40½	10	525	50.0	T\$ 6418 P\$ 6705
	68-3072DPSTS Recessed Front	72	30	30-45	40½	4	510	43.9	T\$ 6320 P\$ 6590
	68-3066DPSTS Recessed Front	66	30	30-45	34½	4	490	38.7	T\$ 6223 P\$ 6480
	68-3060DPSTS Recessed Front	60	30	30-45	28½	4	458	35.3	T\$ 6109 P\$ 6350

Description

- Standard with: 2-Channel Leg Configuration for Single Surface Height Adjustment, Includes Controls, Letter Width Locking Box/Box/File on Left and File/File on Right, Rectangle Top Profiled on Approach and User Side, Left to Right Grain Direction on Worksurface, Wire Management from Pedestal to Kneespace
- Optional Moving Modesty; Must Specify; Some Assembly Required, [See Below and Option Details](#)
- Top, Chassis, and Drawer Fronts Available in Contrasting Colors; Must Specify Color of Each Component
- Drawer Front Grain Direction Vertical Standard; Optional Horizontal Grain Direction
- Stepped Front Units Available with Contrasting Modesty Panel; See High Gloss Acrylic Below or [TFL Color Options](#)
- Control Switch Standard (SWCH-Up/Down) or Upgrade to Advanced Switch (MSWCH-Up/Down/Memory); [See Switch Options](#)
- Optional Dove Tail Drawer Construction and Soft Close Drawers ([See Drawer Options](#))
- For Additional Information Including Worksurface Materials, Grommets and Wire Management Boxes, Power Locations, and More can be Found in the [Intro Section](#)

High Gloss Acrylic Modesty Options for Stepped Front Desks (68-3672DPSSTS Only): Specify & Add

66-HGAF	High Gloss Acrylic Full Modesty Panel; Must Specify Color (<i>Not Available as Moving Modesty</i>)	
	(GPA) Graphite Acrylic	\$ 1914
	(BLA) Black, (WMA) Wired Mercury, or White (WHA)	\$ 1748

Moving Modesty Options: Specify & Add

MOVMOD	Moving Modesty (Available in Contrasting Colors; Must Specify)	\$ 219
--------	--	--------

Must Specify (in this order):

- Model #
- Top Material
- Top Color
- Edge Profile
- Chassis Color
- Drawer Front Color
- Grain Direction (if applicable)
- Drawer Pull
- Drawer Construction
- Drawer Track
- Moving Modesty
- Height Adjust Switch
- Grommet Location
- Power/Data/Wire Management

Pricing Codes:

- T= TFL
- P= HPL

[See Canvas Intro Section for Ordering Options](#)

Item	Model No.		Width	Depth	Height	K	R	Ship Wt	Cubic Ft	List Price	
HEIGHT ADJUSTABLE SINGLE PED, BOW TOP DESK WITH BOX/BOX/FILE	Left	Right									
	68-3672BLPSSTS	68-3672BRPSSTS	72	30-36	30-45	32¼	10	420	50.0	T\$ 6614 P\$ 6906	
	Stepped Front										
	68-3672BLPSTS	68-3672BRPSTS	72	30-36	30-45	32¼	10	420	50.0	T\$ 6446 P\$ 6738	
Recessed Front											

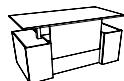
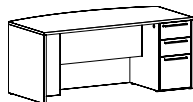

Shown with Rectangle Top, Stepped Front, Moving Modesty and Top Up

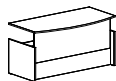

Shown with Bow Top, Recessed Front, Moving Modesty and Top Up



Support Panel (66-2812RSP) Needed When Connecting to Standard Return or Bridge

Must Specify (in this order):

- Model #
- Top Material
- Top Color
- Edge Profile
- Chassis Color
- Drawer Front Color
- Grain Direction (if applicable)
- Drawer Pull
- Drawer Construction
- Track
- Moving Modesty
- Modesty Color
- Height Adjust Switch
- Grommet Location
- Power/Data/Wire Management

Description

- Standard with: 2-Channel Leg Configuration for Single Surface Height Adjustment, Includes Controls, Letter Width Locking Box/Box/File in Pedestal, Bow Top Profiled on Approach and User Side, Left to Right Grain Direction on Worksurface, Wire Management from Pedestal to Kneespace
- Support Panel ([66-2812RSP](#)) Needed When Connecting to Stationary Return or Bridge
- Control Switch Standard (SWCH-Up/Down) or Upgrade to Advanced Switch (MSWCH-Up/Down/Memory); [See Switch Options](#)
- Optional Moving Modesty; Must Specify; Some Assembly Required, [See Below and Option Details](#)
- Optional 3-Channel Leg Configuration (STS3) for Use with 3-Channel Returns and Bridges; [See Option Details and 3-Channel Units](#)
- Top, Chassis, and Drawer Fronts Available in Contrasting Colors; Must Specify Color of Each Component
- Stepped Front Units Available with Contrasting Modesty Panel; See High Gloss Acrylic Below or [TFL Color Options](#)
- Optional Dove Tail Drawer Construction and Soft Close Drawers ([See Drawer Options](#))
- For Additional Information Including Worksurface Materials, Grommets and Wire Management Boxes, Power Locations, and More can be Found in the [Intro Section](#)

High Gloss Acrylic Modesty Options for Stepped Front Desks (68-3672BDPSSTS Only): Specify & Add

66-HGAF	High Gloss Acrylic Full Modesty Panel; Must Specify Color (<i>Not Available as Moving Modesty</i>)	
	(GPA) Graphite Acrylic	\$ 1914
	(BLA) Black, (WMA) Wired Mercury, or White (WHA)	\$ 1748

Moving Modesty Options: Specify & Add

MOVMOD	Moving Modesty (Available in Contrasting Colors; Must Specify)	\$ 219
--------	--	--------

Pricing Codes:

- T= TFL
- P= HPL

[See Canvas Intro Section for Ordering Options](#)

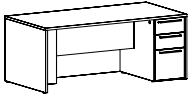
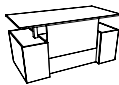
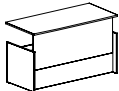
Item	Model No.	Width	Depth	Height	K	R	Ship Wt	Cubic Ft	List Price	
HEIGHT ADJUSTABLE SINGLE PED DESK WITH BOX/BOX/FILE   	Left	Right								
	68-3672LPSSTS Stepped Front	68-3672RPSSTS	72	36	30-45	32¼	10	420	50.0	T\$ 6218 P\$ 6507
	68-3672LPSTS Recessed Front	68-3672RPSTS	72	36	30-45	32¼	10	430	50.0	T\$ 5998 P\$ 6288
	68-3072LPSTS Recessed Front	68-3072RPSTS	72	30	30-45	32¼	4	310	43.0	T\$ 5965 P\$ 6236
	68-3066LPSTS Recessed Front	68-3066RPSTS	66	30	30-45	26¼	4	280	38.7	T\$ 5870 P\$ 6127
	68-3060LPSTS Recessed Front	68-3060RPSTS	60	30	30-45	20¼	4	250	35.0	T\$ 5782 P\$ 6022

Shown with Rectangle Top, Stepped Front, Moving Modesty and Top Up

Shown with Rectangle Top, Recessed Front, Moving Modesty and Top Up



Support Panel (66-2812RSP) Needed When Connecting to Standard Return or Bridge

Must Specify (in this order):

- Model #
- Top Material
- Top Color
- Edge Profile
- Chassis Color
- Drawer Front Color
- Grain Direction (if applicable)
- Drawer Pull
- Drawer Construction
- Track
- Moving Modesty
- Modesty Color
- Height Adjust Switch
- Grommet Location
- Power/Data/Wire Management

Description

- Standard with: 2-Channel Leg Configuration for Single Surface Height Adjustment, Includes Controls, Letter Width Locking Box/Box/File in Pedestal, Rectangle Top Profiled on Approach and User Side, Left to Right Grain Direction on Worksurface, Wire Management from Pedestal to Kneespace
- Control Switch Standard (SWCH-Up/Down) or Upgrade to Advanced Switch (MSWCH-Up/Down/Memory); [See Switch Options](#)
- Support Panel (66-2812RSP) Needed When Connecting to Stationary Return or Bridge
- Optional Moving Modesty; Must Specify; Some Assembly Required, [See Below and Option Details](#)
- Optional 3-Channel Leg Configuration (STS3) for Use with 3-Channel Returns and Bridges; [See Option Details and 3-Channel Units](#)
- Top, Chassis, and Drawer Fronts Available in Contrasting Colors; Must Specify Color of Each Component
- Stepped Front Units Available with Contrasting Modesty Panel; See High Gloss Acrylic Below and TFL Colors ([See Color Options](#))
- Optional Dove Tail Drawer Construction and Soft Close Drawers ([See Drawer Options](#))
- For Additional Information Including Worksurface Materials, Grommets and Wire Management Boxes, Power Locations, and More can be Found in the [Intro Section](#)

High Gloss Acrylic Modesty Options for Stepped Front Desks: Specify & Add

66-HGAF	High Gloss Acrylic Full Modesty Panel; Must Specify Color (<i>Not Available as Moving Modesty</i>)	
	(GPA) Graphite Acrylic	\$ 1914
	(BLA) Black, (WMA) Wired Mercury, or White (WHA)	\$ 1748

Moving Modesty Options: Specify & Add

MOVMOD	Moving Modesty (Available in Contrasting Colors; Must Specify)	\$ 219
--------	--	--------

Pricing Codes:

T= TFL
P= HPL

[See Canvas Intro Section for Ordering Options](#)

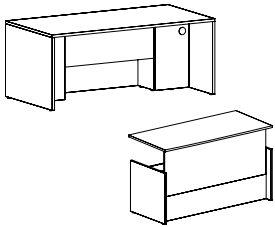
Item	Model No.	Width	Depth	Height	Ship Wt	Cubic Ft	List Price
HEIGHT ADJUSTABLE DESK SHELL  Shown with Rectangle Top, Recessed Front, Moving Modesty and Top Up	66-3672SHSTS	72	36	30-45	274	50.0	T\$ 5361 P\$ 5652
	66-3666SHSTS	66	36	30-45	268	48.0	T\$ 5311 P\$ 5586
	66-3660SHSTS	60	36	30-45	259	43.7	T\$ 5266 P\$ 5530
	66-3072SHSTS	72	30	30-45	265	43.0	T\$ 5286 P\$ 5557
	66-3066SHSTS	66	30	30-45	261	39.0	T\$ 5250 P\$ 5506
	66-3060SHSTS	60	30	30-45	256	35.3	T\$ 5182 P\$ 5421

Must Specify (in this order):

- Model #
- Top Material
- Top Color
- Edge Profile
- Chassis Color
- Moving Modesty
- Leg Configuration
- Height Adjust Switch
- Grommet Color
- Power/Data/Wire Management



Support Panel (66-2812RSP) Needed When Connecting to Standard Return or Bridge

Description

- Standard with: 2-Channel Leg Configuration for Single Surface Height Adjustment, Includes Controls, Recessed Front, Left to Right Grain Direction on Worksurface, Profiled on Approach and User Side
- Top and Chassis Available in Contrasting Colors; Must Specify Color of Each Component
- Modular Pedestals not Applicable
- Support Panel (66-2812RSP) Needed When Connecting to Stationary Return or Bridge
- Optional 3-Channel Leg Configuration (STS3) for Use with 3-Channel Returns and Bridges; [See Option Details](#) and [3-Channel Units](#)
- Optional Moving Modesty; Must Specify; Some Assembly Required, [See Below and Option Details](#)
- Control Switch Standard (Up/Down) or Upgrade to Advanced Switch (MSWCH-Up/Down/Memory); Switch is Field Installed; [See Switch Options](#)
- For Additional Information Including Worksurface Materials, Grommets and Wire Management Boxes, Power Locations, and More can be Found in the [Intro Section](#)

Moving Modesty Options: Specify & Add

MOVMOD	Moving Modesty	\$ 219
--------	----------------	--------

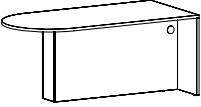
HEIGHT ADJUSTABLE D-TOP	Left	Right	Width	Depth	Height	Ship Wt	Cubic Ft	List Price
	Model No.	Model No.						
 Shown as Left	66-3684DULSTS	66-3684DURSTS	84	36	30-45	287	60.5	T\$ 6033 P\$ 6692
	66-3672DULSTS	66-3672DURSTS	72	36	30-45	260	50.0	T\$ 5677 P\$ 6209
	66-3084DULSTS	66-3084DURSTS	84	30	30-45	290	51.0	T\$ 5959 P\$ 6548
	66-3072DULSTS	66-3072DURSTS	72	30	30-45	260	50.0	T\$ 5614 P\$ 6132
	66-3066DULSTS	66-3066DURSTS	66	30	30-45	246	40.0	T\$ 5526 P\$ 6032

Must Specify (in this order):

- Model #
- Top Material
- Top Color
- Edge Profile
- Chassis Color
- Moving Modesty
- Leg Configuration
- Height Adjust Switch
- Grommet Location
- Power/Data/Wire Management

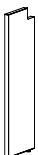

Support Panel (66-2812RSP) Needed When Connecting to Standard Return or Bridge

Description

- Standard with: 2-Channel Leg Configuration for Single Surface Height Adjustment, Includes Controls, Left to Right Grain Direction on Worksurface
- Must be Used with Stationary or Height Adjustable Return or Bridge with Credenza
- Support Panel (66-2812RSP) Needed When Connecting to Stationary Return or Bridge
- Control Switch Standard (Up/Down) or Upgrade to Advanced Switch (MSWCH-Up/Down/Memory); Switch is Field Installed; [See Switch Options](#)
- Optional Moving Modesty; Must Specify; Some Assembly Required, [See Below and Option Details](#)
- Optional 3-Channel Leg Configuration (STS3) for Use with 3-Channel Returns and Bridges; [See Option Details](#) and [3-Channel Units](#)
- Top and Chassis Available in Contrasting Colors; Must Specify Color of Each Component
- For Additional Information Including Worksurface Materials, Grommets and Wire Management Boxes, Power Locations, and More can be Found in the [Intro Section](#)

Moving Modesty Options: Specify & Add

MOVMOD	Moving Modesty	\$ 219
--------	----------------	--------

Pricing Codes:

- T= TFL
- P= HPL

[See Canvas Intro Section for Ordering Options](#)

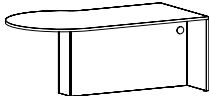
Item	Model No.	Width	Depth	Height	Ship Wt	Cubic Ft	List Price
HEIGHT ADJUSTABLE P-TOP 	Left	Right					
	66-4284PLSTS	66-4284PRSTS	84	42-36	30-45	270	T\$ 6304 P\$ 6974
	66-4272PLSTS	66-4272PRSTS	72	42-36	30-45	261	T\$ 6086 P\$ 6608

Shown as Left

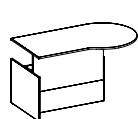

Shown as Left with Moving Modesty

Support Panel (66-2812RSP) Needed When Connecting to Standard Return or Bridge

Description

- Standard with: 2-Channel Leg Configuration for Single Surface Height Adjustment, Includes Controls, Left to Right Grain Direction on Worksurface
- Must be Used with Stationary or Height Adjustable Return, Bridge or Credenza
- Support Panel (66-2812RSP) Needed When Connecting to Stationary Return or Bridge
- Optional Worksurface Center Grommet Only; Must Specify: Black (BLK), Silver (SLV) or None (NONE)
- Control Switch Standard (Up/Down) or Upgrade to Advanced Switch (MSWCH-Up/Down/Memory); Switch is Field Installed; [See Switch Options](#)
- Optional Moving Modesty; Must Specify; Some Assembly Required, [See Below and Option Details](#)
- Optional 3-Channel Leg Configuration (STS3) for Use with 3-Channel Returns and Bridges; [See Option Details and 3-Channel Units](#)
- Top and Chassis Available in Contrasting Colors; Must Specify Color of Each Component
- For Additional Information Including Worksurface Materials, Worksurface Center Grommet and Wire Management Boxes, Power Locations, and More can be Found in the [Intro Section](#)

Must Specify (in this order):

- Model #
- Top Material
- Top Color
- Edge Profile
- Chassis Color
- Moving Modesty
- Leg Configuration
- Height Adjust Switch
- Grommet Location
- Power/Data/Wire Management

Moving Modesty Options: Specify & Add

MOVMOD	Moving Modesty	\$	219
--------	----------------	----	-----

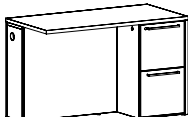
Item	Model No.	Width	Depth	Height	Ship Wt	Cubic Ft	List Price	
HEIGHT ADJUSTABLE RETURN WITH FILE/FILE 2-CHANNEL, FOR ONE WORKSURFACE 	Left	Right						
	68-2448LF2STS	68-2448RF2STS	48	24	30-45	251	T\$ 5173 P\$ 5359	
	Front to Back Grain Direction on Worksurface							
	68-2442LF2STS	68-2442RF2STS	42	24	30-45	233	T\$ 5110 P\$ 5278	
	Front to Back Grain Direction on Worksurface							
	68-4824LF2STS	68-4824RF2STS	48	24	30-45	251	T\$ 5173 P\$ 5359	
Left to Right Grain Direction on Worksurface								
68-4224LF2STS	68-4224RF2STS	42	24	30-45	233	T\$ 5110 P\$ 5278		
Left to Right Grain Direction on Worksurface								

Shown as Right

Must Specify (in this order):

- Model #
- Top Material
- Top Color
- Edge Profile
- Chassis Color
- Drawer Front Color
- Grain Direction (if applicable)
- Drawer Pull Construction
- Drawer Track
- Moving Modesty
- Height Adjust Switch
- Grommet Location
- Power/Data/Wire Management
- Modesty Grommet
- Grommet Color

Description

- Standard with: 2-Channel Leg Configuration for Single Surface Height Adjustment, Includes Controls, Letter Width Locking File/File in Pedestal, Top Profiled on User Side, Wire Management from Pedestal to Kneespace
- Control Switch Standard (SWCH-Up/Down) or Upgrade to Advanced Switch (MSWCH-Up/Down/Memory); [See Switch Options](#)
- Top, Chassis, and Drawer Fronts Available in Contrasting Colors; Must Specify Color of Each Component
- Optional Modesty Grommet for Wire Management to Wall; Must Specify: Black (GMBBL), Silver (GMBSV) or None (NONE); [See Wire Management Options](#)
- Optional Worksurface Grommet with Mesh Wire Management Sleeve or Wire Management Boxes Available Centered Between Height Adjustable Legs (CKS) and Over Peds and 6" from End (GL or GR); Must Specify Location and Color: GL or GL-MESH for Left or GR or GR-MESH for Right; Color Options: Black (BLK) or Silver (SLV); [See Grommet Options](#)
- Optional Dove Tail Drawer Construction and Soft Close Drawers ([See Drawer Options](#))
- For Additional Information Including Worksurface Materials, Grommets and Wire Management Boxes, Power Locations, and More can be Found in the [Intro Section](#)

Pricing Codes:

T= TFL
P= HPL

[See Canvas Intro Section for Ordering Options](#)

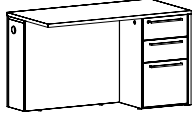
Item	Model No.	Width	Depth	Height	Ship Wt	Cubic Ft	List Price
HEIGHT ADJUSTABLE RETURN WITH BOX/BOX/FILE	Left						
	Right						
2-CHANNEL, FOR ONE WORKSURFACE	68-2448LF1STS	68-2448RF1STS	48	24	30-45	251	T\$ 5173 P\$ 5359
	Front to Back Grain Direction on Worksurface						
	68-2442LF1STS	68-2442RF1STS	42	24	30-45	233	T\$ 5110 P\$ 5278
	Front to Back Grain Direction on Worksurface						
	68-4824LF1STS	68-4824RF1STS	48	24	30-45	251	T\$ 5173 P\$ 5359
	Left to Right Grain Direction on Worksurface						
Shown as Right	68-4224LF1STS	68-4224RF1STS	42	24	30-45	233	T\$ 5110 P\$ 5278
	Left to Right Grain Direction on Worksurface						

Must Specify (in this order):

- Model #
- Top Material
- Top Color
- Edge Profile
- Chassis Color
- Drawer Front
- Color
- Grain Direction (if applicable)
- Drawer Pull
- Drawer
- Construction
- Track
- Height Adjust Switch
- Grommet Location
- Power/Data/Wire Management
- Modesty Grommet
- Grommet Color

Description

- Standard with: 2-Channel Leg Configuration for Single Surface Height Adjustment, Includes Controls, Letter Width Locking Box/Box/File in Pedestal, Top Profiled on User Side, Wire Management from Pedestal to Kneespace
- Control Switch Standard (SWCH-Up/Down) or Upgrade to Advanced Switch (MSWCH-Up/Down/Memory); [See Switch Options](#)
- Top, Chassis, and Drawer Fronts Available in Contrasting Colors; Must Specify Color of Each Component
- Optional Modesty Grommet for Wire Management to Wall; Must Specify: Black (GMBBL), Silver (GMBSV) or None (NONE); [See Wire Management Options](#)
- Optional Worksurface Grommet with Mesh Wire Management Sleeve or Wire Management Boxes Available Centered Between Height Adjustable Legs (CKS) and Over Peds and 6" from End (GL or GR); Must Specify Location and Color: GL or GL-MESH for Left or GR or GR-MESH for Right; Color Options: Black (BLK) or Silver (SLV); [See Grommet Options](#)
- Optional Dove Tail Drawer Construction and Soft Close Drawers ([See Drawer Options](#))
- For Additional Information Including Worksurface Materials, Grommets and Wire Management Boxes, Power Locations, and More can be Found in the [Intro Section](#)

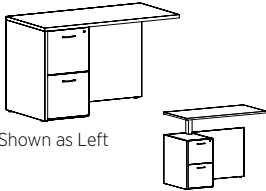
Item	Model No.	Width	Depth	Height	Ship Wt	Cubic Ft	List Price
HEIGHT ADJUSTABLE RETURN WITH FILE/FILE	Left						
	Right						
3-CHANNEL, FOR TWO SIMULTANEOUS WORKSURFACES	68-2448LF2STS3	68-2448RF2STS3	48	24	30-45	201	T\$ 3436 P\$ 3623
	Front to Back Grain Direction on Worksurface						
	68-2442LF2STS3	68-2442RF2STS3	42	24	30-45	183	T\$ 3373 P\$ 3540
	Front to Back Grain Direction on Worksurface						

Shown as Left

Shown as Left
Top Up

Must Specify (in this order):

- Model #
- Top Material
- Top Color
- Edge Profile
- Chassis Color
- Drawer Front
- Color
- Grain Direction (if applicable)
- Drawer Pull
- Drawer
- Construction
- Track
- Height Adjust Switch
- Grommet
- Power/Data/Wire Management
- Modesty Grommet
- Grommet Color

Description

- Standard with: 3-Channel Leg Configuration for Multiple Worksurface Height Adjustment, Letter Width Locking File/File in Pedestal, Top Profiled on User Side, Wire Management from Pedestal to Kneespace
- Must be Used with Height Adjustable Single Ped Desk, Height Adjustable D-Top or P-Top
- Control Switch Not Included; Control Switch will be on Adjoining Worksurface
- Top, Chassis, and Drawer Fronts Available in Contrasting Colors; Must Specify Color of Each Component
- Optional Worksurface Grommet with Mesh Wire Management Sleeve Available Over Ped Only; 6" from Ends and 20" from User; Must Specify Location and Color: GL or GL-MESH for Left or GR or GR-MESH for Right; Color Options: Black (BLK) or Silver (SLV); [See Grommet Options](#)
- Monitor Arms not Available on this Unit
- Optional Modesty Grommet for Wire Management to Wall; Must Specify: Black (GMBBL), Silver (GMBSV) or None (NONE); [See Wire Management Options](#)
- Optional Dove Tail Drawer Construction and Soft Close Drawers ([See Drawer Options](#))
- For Additional Information Including Worksurface Materials, Grommets and Wire Management Boxes, Power Locations, and More can be Found in the [Intro Section](#)

Pricing Codes:

- T= TFL
- P= HPL

[See Canvas Intro Section for Ordering Options](#)

Item	Model No.	Width	Depth	Height	Ship Wt	Cubic Ft	List Price	
HEIGHT ADJUSTABLE RETURN WITH BOX/BOX/FILE	Left							
	Right							
	68-2448LF1STS3	68-2448RF1STS3	48	24	30-45	201	T\$ 3436	
	Front to Back Grain Direction on Worksurface							P\$ 3623
3-CHANNEL, FOR TWO SIMULTANEOUS WORKSURFACES	68-2442LF1STS3	68-2442RF1STS3	42	24	30-45	183	T\$ 3373	
	Front to Back Grain Direction on Worksurface							P\$ 3540

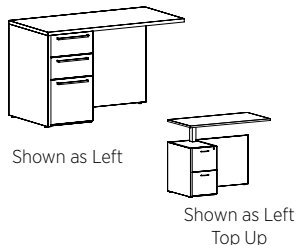

Must Specify (in this order):

- Model #
- Top Material
- Top Color
- Edge Profile
- Chassis Color
- Drawer Front Color
- Grain Direction (if applicable)
- Drawer Pull
- Drawer Construction
- Track
- Height Adjust Switch
- Grommet
- Power/Data/Wire Management
- Modesty Grommet
- Grommet Colors.

Description

- Standard with: 3-Channel Leg Configuration for Multiple Worksurface Height Adjustment, Letter Width Locking Box/Box/File in Pedestal, Top Profiled on User Side
- Must be Used with Height Adjustable Single Ped Desk, Height Adjustable D-Top or P-Top
- Control Switch Not Included; Control Switch will be on Adjoining Worksurface
- Top, Chassis, and Drawer Fronts Available in Contrasting Colors; Must Specify Color of Each Component
- Optional Modesty Grommet for Wire Management to Wall; Must Specify: Black (GMBBL), Silver (GMBSV) or None (NONE); [See Wire Management Options](#)
- Optional Worksurface Grommet with Mesh Wire Management Sleeve Available Over Ped Only; 6” from Ends and 20” from User; Must Specify Location and Color: GL or GL-MESH for Left or GR or GR-MESH for Right; Color Options: Black (BLK) or Silver (SLV); [See Grommet Options](#)
- Monitor Arms not Available on this Unit
- Optional Dove Tail Drawer Construction and Soft Close Drawers ([See Drawer Options](#))
- For Additional Information Including Worksurface Materials, Pulls, Grommets, Power Locations, and More can be Found in the [Intro Section](#)

HEIGHT ADJUSTABLE RETURN SHELL	End Panel Left	End Panel Right	Width	Depth	Height	Ship Wt	Cubic Ft	List Price
	66-2448RSHLSTS	66-2448RSHRSTS	48	24	30-45	280	24.0	T\$ 4649
								P\$ 4833
	66-2442RSHLSTS	66-2442RSHRSTS	42	24	30-45	250	24.0	T\$ 4585
								P\$ 4753

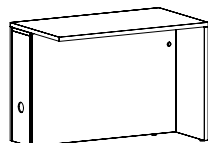

Must Specify (in this order):

- Model #
- Top Material
- Top Color
- Edge Profile
- Chassis Color
- Height Adjust Switch
- Grommet
- Power/Data/Wire Management
- Modesty Grommet
- Grommet Color

Description

- Standard with: 2-Channel Leg Configuration for Single Surface Height Adjustment, Includes Controls, Top Profiled on User Side
- Optional Worksurface Center Grommet Only; Must Specify: Black (BLK), Silver (SLV) or None (NONE); [See Grommet Options](#)
- Control Switch Standard (SWCH-Up/Down) or Upgrade to Advanced Switch (MSWCH-Up/Down/Memory); [See Switch Options](#)
- Top and Chassis Available in Contrasting Colors; Must Specify Color of Each Component
- Optional Modesty Grommet for Wire Management to Wall; Must Specify: Black (GMBBL), Silver (GMBSV) or None (NONE); [See Wire Management Options](#)
- For Additional Information Including Worksurface Materials, Grommets and Wire Management Boxes, Power Locations, and More can be Found in the [Intro Section](#)

Pricing Codes:

T= TFL
P= HPL

[See Canvas Intro Section for Ordering Options](#)

Item	Model No.	Width	Depth	Height	Ship Wt	Cubic Ft	List Price
HEIGHT ADJUSTABLE BRIDGE 2-CHANNEL, FOR ONE WORKSURFACE	66-2448UFSTS	48	24	30-45	182	24.0	T\$ 4340 P\$ 4526
	66-2442UFSTS	42	24	30-45	168	21.0	T\$ 4317 P\$ 4484
	66-2436UFSTS	36	24	30-45	146	18.0	T\$ 4281 P\$ 4430
	66-2048UFSTS	48	20	30-45	177	20.0	T\$ 4292 P\$ 4456
	66-2042UFSTS	42	20	30-45	167	18.0	T\$ 4271 P\$ 4420
	66-2036UFSTS	36	20	30-45	143	15.0	T\$ 4240 P\$ 4371

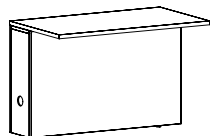

Must Specify (in this order):

Model #
 Top Material
 Top Color
 Edge Profile
 Chassis Color
 Height Adjust Switch
 Grommet
 Power/Data/Wire Management
 Modesty Grommet
 Grommet Color

Description

- Standard with: 2-Channel Leg Configuration for Single Surface Height Adjustment, Includes Controls, Top Profiled on User Side, Front to Back Grain Direction on Worksurface
- Optional Worksurface Grommet and Power Units Available on Center Only; [See Options](#)
- Control Switch Standard (Up/Down) or Upgrade to Advanced Switch (MSWCH-Up/Down/Memory); Switch is Field Installed; [See Switch Options](#)
- Top and Chassis Available in Contrasting Colors; Must Specify Color of Each Component
- Optional Modesty Grommet for Wire Management to Wall; Must Specify: Black (GMBBL), Silver (GMBSV) or None (NONE); [See Wire Management Options](#)
- For Additional Information Including Worksurface Materials, Grommet and Power/Data Options, and More can be Found in the [Intro Section](#)

HEIGHT ADJUSTABLE BRIDGE FOR MULTIPLE SURFACES									
	Left	Right	Width	Depth	Height	Ship Wt	Cubic Ft	List Price	
3-CHANNEL, FOR TWO SIMULTANEOUS WORKSURFACES	66-2448UFSTSL3	66-2448UFSTSR3	48	24	30-45	172	24.0	T\$ 3190 P\$ 3376	
	66-2442UFSTSL3	66-2442UFSTSR3	42	24	30-45	158	21.0	T\$ 3167 P\$ 3334	
	66-2436UFSTSL3	66-2436UFSTSR3	36	24	30-45	136	18.0	T\$ 3131 P\$ 3280	
	66-2048UFSTSL3	66-2048UFSTSR3	48	20	30-45	167	20.0	T\$ 3142 P\$ 3306	
	66-2042UFSTSL3	66-2042UFSTSR3	42	20	30-45	154	18.0	T\$ 3121 P\$ 3270	
	66-2036UFSTSL3	66-2036UFSTSR3	36	20	30-45	133	15.0	T\$ 3090 P\$ 3221	

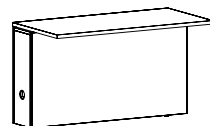

SIN PENDING

Must Specify (in this order):

Model #
 Top Material
 Top Color
 Edge Profile
 Chassis Color
 Grommet
 Power/Data/Wire Management
 Modesty Grommet
 Grommet Color

Description

- Standard with: 3-Channel Leg Configuration for Multiple Surface Height Adjustment, Top Profiled on User Side, Front to Back Grain Direction on Worksurface
- Optional Worksurface Grommet and Power Units Available on Center Only; [See Options](#)
- Control Switch Not Included; Control Switch will be on Adjoining Worksurface
- Top and Chassis Available in Contrasting Colors; Must Specify Color of Each Component
- Optional Modesty Grommet for Wire Management to Wall; Must Specify: Black (GMBBL), Silver (GMBSV) or None (NONE); [See Wire Management Options](#)
- For Additional Information Including Worksurface Materials, Grommet and Power/Data Options, and More can be Found in the [Intro Section](#)

Pricing Codes:

T= TFL
 P= HPL

[See Canvas Intro Section for Ordering Options](#)

Item	Model No.	Width	Depth	Height	Ship Wt	Cubic Ft	List Price
HEIGHT ADJUSTABLE SINGLE PED CREDENZA WITH BOX/BOX/FILE	End Panel Left	End Panel Right					
	68-2472LC1STS	68-2472RC1STS	72	24	30-45	300	T\$ 5571 P\$ 5806
	68-2466LC1STS	68-2466RC1STS	66	24	30-45	282	T\$ 5553 P\$ 5775

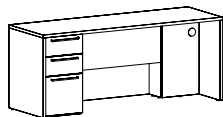

Shown as Left



Support Panel (66-2812RSP) Needed When Connecting to Standard Return or Bridge

Must Specify (in this order):

- Model #
- Top Material
- Top Color
- Edge Profile
- Chassis Color
- Drawer Front Color
- Grain Direction (if applicable)
- Drawer Pull
- Drawer Construction
- Track
- Height Adjust Switch
- Grommet Color
- Power/Data/Wire Management

Description

- Standard with: 2-Channel Leg Configuration for Single Surface Height Adjustment, Includes Controls, Letter Width Locking Box/Box/File in Pedestal, Top Profiled on Approach and User Side, Left to Right Grain Direction on Worksurface
- Support Panel (66-2812RSP) Needed When Connecting to Standard Return or Bridge
- Control Switch Standard (SWCH-Up/Down) or Upgrade to Advanced Switch (MSWCH-Up/Down/Memory); [See Switch Options](#)
- Optional 3-Channel Leg Configuration (STS3) for Use with 3-Channel Returns; [See Option Details](#) and [3-Channel Units](#)
- Top, Chassis, and Drawer Fronts Available in Contrasting Colors; Must Specify Color of Each Component
- Optional Modesty Grommet on Approach for Wire Management to Wall; Must Specify: Black (GMBBL), Silver (GMBSV); [See Wire Management Options](#)
- Optional Dove Tail Drawer Construction and Soft Close Drawers ([See Drawer Options](#))
- For Additional Information Including Worksurface Grommet and Wire Management Box Locations, Pulls, Power Availability, and More can be Found in the [Intro Section](#)

HEIGHT ADJUSTABLE SINGLE PED CREDENZA WITH FILE/FILE	End Panel Left	End Panel Right					
	68-2472LC2STS	68-2472RC2STS	72	24	30-45	300	T\$ 5571 P\$ 5806
	68-2466LC2STS	68-2466RC2STS	66	24	30-45	282	T\$ 5553 P\$ 5775

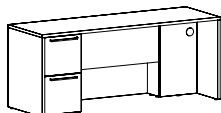

Shown as Left

Must Specify (in this order):

- Model #
- Top Material
- Top Color
- Edge Profile
- Chassis Color
- Drawer Front Color
- Grain Direction (if applicable)
- Drawer Pull
- Drawer Construction
- Track
- Height Adjust Switch
- Grommet Color
- Power/Data/Wire Management



Support Panel (66-2812RSP) Needed When Connecting to Standard Return or Bridge

Description

- Standard with: 2-Channel Leg Configuration for Single Surface Height Adjustment, Letter Width Locking File/File in Pedestal, Top Profiled on Approach and User Side, Left to Right Grain Direction on Worksurface
- Support Panel (66-2812RSP) Needed When Connecting to Standard Return or Bridge
- Control Switch Standard (SWCH-Up/Down) or Upgrade to Advanced Switch (MSWCH-Up/Down/Memory); [See Switch Options](#)
- Top, Chassis, and Drawer Fronts Available in Contrasting Colors; Must Specify Color of Each Component
- Optional 3-Channel Leg Configuration (STS3) for Use with 3-Channel Returns; [See Option Details](#) and [3-Channel Units](#)
- Optional Modesty Grommet for Wire Management to Wall; Must Specify: Black (GMBBL), Silver (GMBSV) or None (NONE); [See Wire Management Options](#)
- Optional Dove Tail Drawer Construction and Soft Close Drawers ([See Drawer Options](#))
- For Additional Information Including Worksurface Materials, Grommets, Power Locations, and More can be Found in the [Intro Section](#)

Pricing Codes:

T= TFL
P= HPL

[See Canvas Intro Section for Ordering Options](#)

Item	Model No.	Width	Depth	Height	Ship Wt	Cubic Ft	List Price
HEIGHT ADJUSTABLE KNEESPACE CREDENZA WITH FILE/FILE PEDS	68-2472KCSTS	72	24	30-45	340	35.6	T\$ 6338 P\$ 6576
	68-2466KCSTS	66	24	30-45	320	32.7	T\$ 6152 P\$ 6375

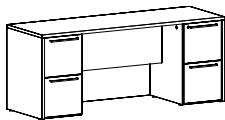

Must Specify (in this order):

Model #
Top Material
Top Color
Edge Profile
Chassis Color
Drawer Front
Color
Grain Direction (if applicable)
Drawer Pull
Drawer
Construction
Track
Height Adjust Switch
Grommet Color
Power/Data/Wire Management

Description

- Standard with: 2-Channel Leg Configuration for Single Surface Height Adjustment, Includes Controls, Letter Width Locking File/File in Pedestals, Top Profiled on Approach and User Side, Left to Right Grain Direction on Worksurface
- Control Switch Standard (SWCH-Up/Down) or Upgrade to Advanced Switch (MSWCH-Up/Down/Memory); [See Switch Options](#)
- Top, Chassis, and Drawer Fronts Available in Contrasting Colors; Must Specify Color of Each Component
- Optional Modesty Grommet for Wire Management to Wall; Must Specify: Black (GMBBL), Silver (GMSBV) or None (NONE); [See Wire Management Options](#)
- Optional Dove Tail Drawer Construction and Soft Close Drawers ([See Drawer Options](#))
- For Additional Information Including Worksurface Grommet and Wire Management Box Locations, Pulls, Power Availability, and More can be Found in the [Intro Section](#)

HEIGHT ADJUSTABLE CREDENZA SHELL	66-2472SHSTS	72	24	30-45	294	36.0	T\$ 5132 P\$ 5367
	66-2466SHSTS	66	24	30-45	287	33.0	T\$ 5090 P\$ 5316
	66-2460SHSTS	60	24	30-45	280	30.0	T\$ 5055 P\$ 5273

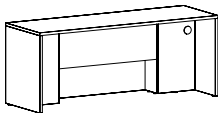

Support Panel
([66-2812RSP](#))
Needed When
Connecting to
Standard Return
or Bridge

Must Specify (in this order):

Model #
Top Material
Top Color
Edge Profile
Chassis Color
Leg Configuration
Height Adjust Switch
Grommet Color
Power/Data/Wire Management

Description

- Standard with: 2-Channel Leg Configuration for Single Surface Height Adjustment, Includes Controls, Profiled on User Side, and Modesty Grommet
- Modular Pedestals not Applicable
- Top and Chassis Available in Contrasting Colors; Must Specify Color of Each Component
- Support Panel ([66-2812RSP](#)) Needed When Connecting to Standard Return or Bridge
- Optional Worksurface Grommet; Must Specify: Black (BLK), Silver (SLV) or None (NONE); [See Grommet Options](#)
- Optional 3-Channel Leg Configuration (STS3) for Use with 3-Channel Returns; [See Option Details](#) and [3-Channel Units](#)
- Control Switch Standard (Up/Down) or Upgrade to Advanced Switch (MSWCH-Up/Down/Memory); Switch is Field Installed
- For Additional Information Including Worksurface Grommet and Wire Management Box Locations, Power Availability, and More can be Found in the [Intro Section](#)

SUPPORT PANEL	66-2812RSP	12	1	28½	12	0.8	T\$ 245
---------------	------------	----	---	-----	----	-----	---------



Description

- To be Used to Support Stationary Returns and Bridges Worksurfaces with Height Adjustable Units
- Required to be Used Perpendicular to Full Back Panels for Support of Kneespace Areas 60" or Longer

Must Specify (in this order):

Model #
Color

Pricing Codes:

T= TFL
P= HPL

[See Canvas Intro Section for Ordering Options](#)

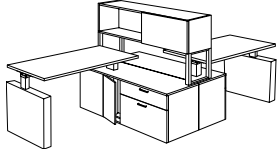
Item	Model No.	Width	Depth	Height	Ship Wt	Cubic Ft	List Price
HEIGHT ADJUSTABLE WORK SURFACE FOR OVERHEAD STORAGE  	66-3462HTP For 72" Footprint	62	34	1	84	5.3	T\$ 650 P\$ 906
	66-3456HTP For 66" Footprint	56	34	1	78	4.8	T\$ 620 P\$ 867
	66-2862HTP For 72" Footprint	62	28	1	79	4.2	T\$ 613 P\$ 858
	66-2856HTP For 66" Footprint	56	28	1	75	3.8	T\$ 565 P\$ 791
	66-2850HTP For 60" Footprint	50	28	1	71	3.4	T\$ 534 P\$ 746
	66-2262HTP For 72" Footprint	62	22	1	42	3.3	T\$ 531 P\$ 745
	66-2256HTP For 66" Footprint	56	22	1	36	3.0	T\$ 506 P\$ 709
	66-2250HTP For 60" Footprint	50	22	1	33	2.7	T\$ 465 P\$ 651

Must Specify (in this order):

Model #
Top Material
Color
Edge Profile
Grommet Location
Grommet Color
Power/Data/Wire Management

Description

- Profiled on Approach and User Side
- 10" Width Offset to Provide Clearance for Overhead Storage and Access to Optional Power in Credenza
- Depth Allows for Use With Gallery Screens
- Not Available for Use with Height Adjustable Open Bookcase with Controls
- [See Height Adjustable Legs and Cabinets](#)
- Additional Options: Power, Monitor Arm and Grommet Options ([See Options](#))

HEIGHT ADJUSTABLE WORK SURFACE FOR INDIVIDUAL WORKSTATIONS 	66-3470HTP Stiffener Bar Included	70	34	1	115	6.2	T\$ 902 P\$ 1263
	66-3464HTP	64	34	1	68	5.2	T\$ 692 P\$ 967
	66-3458HTP	58	34	1	62	4.8	T\$ 659 P\$ 922
	66-2870HTP Stiffener Bar Included	70	28	1	85	4.6	T\$ 779 P\$ 1089
	66-2864HTP	64	28	1	81	4.3	T\$ 597 P\$ 835
	66-2858HTP	58	28	1	77	3.9	T\$ 569 P\$ 795
	66-2852HTP	52	28	1	73	3.5	T\$ 522 P\$ 730
	66-2846HTP	46	28	1	69	3.1	T\$ 486 P\$ 678

Must Specify (in this order):

Model #
Top Material
Color
Edge Profile
Grommet Location
Grommet Color
Power/Data/Wire Management

Description

- Profiled on Approach and User Side
- [See Height Adjustable Legs and Cabinets](#)
- Additional Options: Power, Monitor Arm and Grommet Options ([See Options](#))

Pricing Codes:

T= TFL
P= HPL

[See Canvas Intro Section for Ordering Options](#)

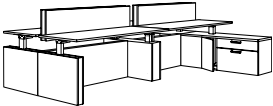
Item	Model No.	Width	Depth	Height	Ship Wt	Cubic Ft	List Price
HEIGHT ADJUSTABLE WORK SURFACE FOR MULTIPLE AND INDIVIDUAL WORKSTATIONS 	66-2270HTP Stiffener Bar Included	70	22	1	50	3.8	T\$ 702 P\$ 985
	66-2264HTP	64	22	1	44	3.4	T\$ 538 P\$ 752
	66-2258HTP	58	22	1	38	3.1	T\$ 512 P\$ 718
	66-2252HTP	52	22	1	35	2.8	T\$ 469 P\$ 658
	66-2246HTP	46	22	1	31	2.5	T\$ 438 P\$ 613

Must Specify (in this order):

Model #
Top Material
Color
Edge Profile
Grommet Location
Grommet Color
Power/Data/Wire Management

Description

- Profiled on Approach and User Side
- Can Also be Used in Individual Workstations Applications
- [See Height Adjustable Legs and Cabinets](#)
- Additional Options: Power, Monitor Arm and Grommet Options ([See Options](#))

Item	Model No.	Width	Depth	Height	Ship Wt	Cubic Ft	List Price
HEIGHT ADJUSTABLE T-LEG 	01-2245HTLC Includes Control, Motor Cable and Keypad	22	2	28¼	40	0.5	\$ 2077
	01-2245HTL Does Not Include Control, Requires a Unit with Control	22	2	28¼	40	0.5	\$ 1442

Description

- Available in Black or Silver; Must Specify
- 16" Adjustable Range

Must Specify (in this order):

Model #
Color

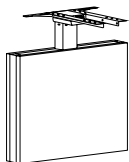
Item	Model No.	Width	Depth	Height	Ship Wt	Cubic Ft	List Price
HEIGHT ADJUSTABLE PANEL LEG 	66-0536HPC For Use With 34"D Top Includes Control, Motor Cable and Keypad	36	5%	28¼	50	4.5	T\$ 2394
	66-0530HPC For Use With 28"D Top Includes Control, Motor Cable and Keypad	30	5%	28¼	49	4.5	T\$ 2356
	66-0524HPC For Use With 22"D Top Includes Control, Motor Cable and Keypad	24	5%	28¼	48	4.5	T\$ 2252
	66-0536HP For Use With 34"D Top Does Not Include Control, Requires a Unit with Control	36	5%	28¼	50	4.5	T\$ 1834
	66-0530HP For Use With 28"D Top Does Not Include Control, Requires a Unit with Control	30	5%	28¼	49	4.5	T\$ 1799
	66-0524HP For Use With 22"D Top Does Not Include Control, Requires a Unit with Control	24	5%	28¼	48	4.5	T\$ 1696

Description

- Available in Black or Silver; Must Specify
- 16" Adjustable Range

Pricing Codes:

T= TFL
P= HPL

[See Canvas Intro Section for Ordering Options](#)

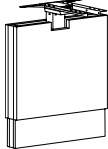
Item	Model No.	Width	Depth	Height	Ship Wt	Cubic Ft	List Price
HEIGHT ADJUSTABLE PANEL LEG WITH SLEEVE 	66-0536HPSC For Use With 34"D Top Includes Control, Motor Cable and Keypad	34	5½"	28¼"	50	4.5	T\$ 2928
	66-0530HPSC For Use With 28"D Top Includes Control, Motor Cable and Keypad	28	5½"	28¼"	49	4.5	T\$ 2857
	66-0524HPSC For Use With 22"D Top Includes Control, Motor Cable and Keypad	22	5½"	28¼"	48	4.5	T\$ 2717
	66-0536HPS For Use With 34"D Top Does Not Include Control, Requires a Unit with Control	34	5½"	28¼"	50	4.5	T\$ 2371
	66-0530HPS For Use With 28"D Top Does Not Include Control, Requires a Unit with Control	28	5½"	28¼"	49	4.5	T\$ 2302
	66-0524HPS For Use With 22"D Top Does Not Include Control, Requires a Unit with Control	22	5½"	28¼"	48	4.5	T\$ 2158

Must Specify (in this order):

Model #
Color

Description

- For Use in Place of Cabinet
- 16" Adjustable Range
- Not Compatible with 4" Modesty Panels

HEIGHT ADJUSTABLE PANEL LEG FOR SHARED WORKSTATION 	66-1124HP	24	10 ¼"	28¼"	50	4.5	T\$ 2686
--	-----------	----	-------	------	----	-----	----------

Description

- Available in Black or Silver; Must Specify
- 16" Adjustable Range
- Shared Cabinet with Dual Legs For Multi-Workstation Footprints
- Required to be Used with a Unit Including Controls
- For Use with 24"D Worksurfaces

Must Specify (in this order):

Model #
Color

Pricing Codes:

T= TFL
P= HPL

[See Canvas Intro Section for Ordering Options](#)

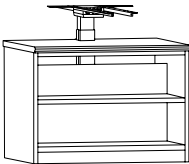
Item	Model No.	Width	Depth	Height	Ship Wt	Cubic Ft	List Price
 <p>HEIGHT ADJUSTABLE OPEN BOOKCASE WITH CONTROL</p>	66-2436HBM	36	24	21¾	99	18.3	T\$ 3223 P\$ 3373
	66-2430HBM	30	24	21¾	89	15.4	T\$ 3176 P\$ 3318
	66-2424HBM	24	24	21¾	79	12.5	T\$ 3119 P\$ 3259
	66-2036HBM	36	20	21¾	89	15.5	T\$ 3164 P\$ 3296
	66-2030HBM	30	20	21¾	79	13.1	T\$ 3122 P\$ 3251
	66-2024HBM	24	20	21¾	69	10.6	T\$ 3065 P\$ 3190

Must Specify (in this order):

- Model #
- Top Material
- Top Color
- Edge Profile
- Chassis Color
- Leg Color
- Wire Management Sleeve
- Wire Management Kneespace Access

Description

- Open Back; [See Back Panel Options](#)
- Open Book Case with Controls; Profiled on User Side
- One Adjustable Shelf; 13" Deep Shelf on 24" Units/9" Deep Shelf on 20" Units
- Not Available for Use with Overhead Storage
- When Used as Peninsula Desk, Additional Height Adjustable Panel Leg (Without Control) Must be Used on Opposite Side for Support; [See Panel Legs](#) 01-2245HTL, 66-0536HP, 66-0530HP, 66-0524HP, 66-0536HPS, 66-0530HPS, or 66-0524HPS
- Leg Available in Black or Silver; Must Specify
- Top and Chassis Available in Contrasting Colors; Must Specify Color of Each Component
- Worksurface Grommet Standard; Must Specify: Black (BLK), Silver (SLV)
- Optional Wire Management Sleeve Available (See Below); Wire Management Sleeve Replaces Standard Work Surface Grommet
- Wire Management Access from Pedestal to Kneespace; Specify Left (WML), Right (WMR) or Left and Right (WMLR)



Options: Specify & Add

WM Sleeve	Wire Management Sleeve	T\$ 405
-----------	------------------------	---------

Pricing Codes:

- T= TFL
- P= HPL

[See Canvas Intro Section for Ordering Options](#)

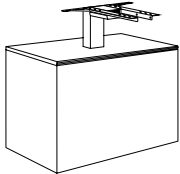
Item	Model No.	Width	Depth	Height	Ship Wt	Cubic Ft	List Price
HEIGHT ADJUSTABLE CABINET WITH CONTROL 	66-2436HM	36	24	21¾	99	18.3	T\$ 2922 P\$ 3072
	66-2430HM	30	24	21¾	89	15.4	T\$ 2879 P\$ 3020
	66-2424HM	24	24	21¾	79	12.5	T\$ 2830 P\$ 2968
	66-2036HM	36	20	21¾	89	15.5	T\$ 2867 P\$ 3000
	66-2030HM	30	20	21¾	79	13.1	T\$ 2831 P\$ 2959
	66-2024HM	24	20	21¾	69	10.6	T\$ 2779 P\$ 2902

Must Specify (in this order):

- Model #
- Top Material
- Top Color
- Edge Profile
- Chassis Color
- Leg Color
- Wire Management Sleeve
- Wire Management Kneespace Access

Description

- Open Back; [See Back Panel Options](#)
- Cabinet with Controls; Profiled on User Side
- Open Bottom Allows for Wire Management
- Removable Access Front Panel Available in Contrasting Color; Must Specify
- Top and Chassis Available in Contrasting Colors; Must Specify Color of Each Component
- When Used as Peninsula Desk, Additional Height Adjustable Panel Leg (Without Control) Must be Used on Opposite Side for Support; [See Panel Legs](#) for Panel Legs 01-2245HTL, 66-0536HP, 66-0530HP, 66-0524HP, 66-0536HPS, 66-0530HPS, or 66-0524HPS
- Leg Available in Black or Silver; Must Specify
- Work Surface Grommet Standard; Must Specify: Black (BLK), Silver (SLV)
- Optional Wire Management Sleeve Available (See Below); Wire Management Sleeve Replaces Standard Work Surface Grommet
- Wire Management Access from Pedestal to Kneespace; Specify Left (WML), Right (WMR) or Left and Right (WMLR)

Options: Specify & Add

WM Sleeve	Wire Management Sleeve	T\$ 405
-----------	------------------------	---------

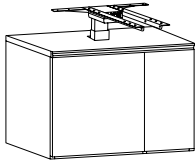

Item	Leg Left of Door		Leg Right of Door		Width	Depth	Height	Ship Wt	Cubic Ft	List Price
	Model No.	Model No.	Model No.	Model No.						
HEIGHT ADJUSTABLE CABINET WITH DOOR AND CONTROL 	66-2436HDL	66-2436HDR	30	24	21¾	95	18.3	95	18.3	T\$ 3254 P\$ 3402
	66-2430HDL	66-2430HDR	24	24	21¾	75	15.4	75	15.4	T\$ 3200 P\$ 3345
	66-2036HDL	66-2036HDR	36	20	21¾	85	15.5	85	15.5	T\$ 3193 P\$ 3324
	66-2030HDL	66-2030HDR	30	20	21¾	65	13.1	65	13.1	T\$ 3149 P\$ 3273

Shown as Left
(Leg is Left of Door)

Must Specify (in this order):

- Model #
- Top Material
- Top Color
- Edge Profile
- Chassis Color
- Leg Color
- Wire Management Sleeve
- Wire Management Kneespace Access

Description

- Open Back; [See Back Panel Options](#)
- Handed Based on Facing the Unit
- Cabinet with Controls; Profiled on User Side
- Open Bottom Allows for Wire Management
- 9" Door Opening With Touch Latch and Includes Bottom Panel, Storage Behind Door
- When Used as Peninsula Desk, Additional Height Adjustable Panel Leg (Without Control) Must be Used on Opposite Side for Support; [See Panel Legs](#) for Panel Legs 01-2245HTL, 66-0536HP, 66-0530HP, 66-0524HP, 66-0536HPS, 66-0530HPS, or 66-0524HPS
- Door and Removable Access Front Panel Available in Contrasting Color; Must Specify
- Top and Chassis Available in Contrasting Colors; Must Specify Color of Each Component
- Leg Available in Black or Silver; Must Specify
- Worksurface Grommet Standard; Must Specify: Black (BLK), Silver (SLV)
- Wire Management Access from Pedestal to Kneespace; Specify Left (WML), Right (WMR) or Left and Right (WMLR)

Pricing Codes:

T= TFL
P= HPL

[See Canvas Intro Section for Ordering Options](#)

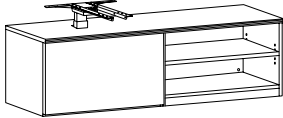
Item	Model No.	Width	Depth	Height	Ship Wt	Cubic Ft	List Price	
HEIGHT ADJUSTABLE CREDENZA WITH OPEN BOOKCASE AND CONTROL  Shown as Left	Leg in Left Cabinet	Leg in Right Cabinet						
	66-2472HMOL	66-2472HMOR	72	24	21¾	240	T\$ 3875 P\$ 4114	
	66-2466HMOL	66-2466HMOR	66	24	21¾	220	T\$ 3806 P\$ 4029	
	66-2460HMOL	66-2460HMOR	60	24	21¾	220	T\$ 3734 P\$ 3956	
	66-2072HMOL	66-2072HMOR	72	20	21¾	220	T\$ 3757 P\$ 3968	
	66-2066HMOL	66-2066HMOR	66	20	21¾	210	T\$ 3691 P\$ 3891	
	66-2060HMOL	66-2060HMOR	60	20	21¾	210	T\$ 3618 P\$ 3809	
	Description							
	<ul style="list-style-type: none"> • Standard with: Controls, Back Panel, One Adjustable Shelf in Bookcase End, Profiled on User Side • Bottom Panel Not Included Behind Removable Access Front Panel for Wire Management • Designed for 28" Deep Worksurfaces Only (See Worksurfaces) • Handed Based on Height Adjust Cabinet and Facing the Unit • Removable Access Front Panel Available in Contrasting Color; Must Specify • Top and Chassis Available in Contrasting Colors; Must Specify Color of Each Component • When Used as Peninsula Desk, Additional Height Adjustable Panel Leg (Without Control) Must be Used on Opposite Side for Support; See Panel Legs for Panel Legs 01-2245HTL, 66-0536HPS, 66-0530HPS, or 66-0524HPS • Leg Available in Black or Silver; Must Specify • Worksurface Grommet Standard; Must Specify: Black (BLK), Silver (SLV) • Optional Back Panel Grommet, Must Specify: Black (GMBBL), Silver (GMBSV); Color Must Match Worksurface Grommet • Optional Wire Management Sleeve Available (See Below); Wire Management Sleeve Replaces Standard Work Surface Grommet • Optional Power Locations (See Power Options) 							
Options: Specify & Add								
WM Sleeve	Wire Management Sleeve						T\$ 405	

Must Specify (in this order):

- Model #
- Top Material
- Top Color
- Edge Profile
- Wire Management Sleeve
- Chassis Color
- Front Panel Color
- Grain Direction (if applicable)
- Leg Color
- Worksurface Grommet
- Grommet Color
- Power/Data/Wire Management
- Back Panel Grommet



Pricing Codes:

T= TFL
P= HPL

[See Canvas Intro Section for Ordering Options](#)

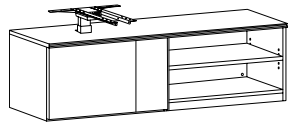
Item	Model No.	Width	Depth	Height	Ship Wt	Cubic Ft	List Price
HEIGHT ADJUSTABLE CREDENZA WITH DOOR, OPEN BOOKCASE AND CONTROL  Shown as Left	Leg in Left Cabinet	Leg in Right Cabinet					
	66-2472HDOL	66-2472HDOR	72	24	21¾	240	T\$ 4251 P\$ 4488
	66-2466HDOL	66-2466HDOR	66	24	21¾	230	T\$ 4171 P\$ 4394
	66-2460HDOL	66-2460HDOR	60	24	21¾	220	T\$ 4095 P\$ 4317
	66-2072HDOL	66-2072HDOR	72	20	21¾	240	T\$ 4118 P\$ 4330
	66-2066HDOL	66-2066HDOR	66	20	21¾	230	T\$ 4045 P\$ 4247
	66-2060HDOL	66-2060HDOR	60	20	21¾	220	T\$ 3968 P\$ 4159

Must Specify (in this order):

Model #
 Top Material
 Top Color
 Edge Profile
 Wire Management Sleeve
 Chassis Color
 Front Panel
 Color
 Grain Direction (if applicable)
 Leg Color
 Worksurface Grommet
 Grommet Color
 Power/Data/Wire Management
 Back Panel Grommet

Description

- Credenza with Controls; Profiled on User Side; Back Panel Included, One Adjustable Shelf in Bookcase End
- Bottom Panel Not Included Behind Removable Access Front Panel for Wire Management
- 9" Door Opening With Touch Latch and Includes Bottom Panel, Storage Behind Door
- Designed for 28" Deep Worksurfaces Only ([See Worksurfaces](#))
- Handed Based on Height Adjust Cabinet and Facing the Unit
- Door and Removable Access Front Panel Available in Contrasting Color; Must Specify
- Top and Chassis Available in Contrasting Colors; Must Specify Color of Each Component
- When Used as Peninsula Desk, Additional Height Adjustable Panel Leg (Without Control) Must be Used on Opposite Side for Support; [See Panel Legs](#) 01-2245HTL, 66-0536HPS, or 66-0530HPS
- Leg Available in Black or Silver; Must Specify
- Worksurface Grommet Standard; Must Specify: Black (BLK), Silver (SLV)
- Optional Back Panel Grommet, Must Specify: Black (GMBBL), Silver (GMBSV); Color Must Match Worksurface Grommet
- Optional Power Locations ([See Power Options](#))

Pricing Codes:

T= TFL
 P= HPL

[See Canvas Intro Section for Ordering Options](#)

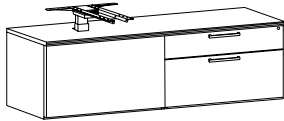
Item	Model No.	Width	Depth	Height	Ship Wt	Cubic Ft	List Price	
HEIGHT ADJUSTABLE CREDENZA WITH BOX/FILE AND CONTROL  Shown as Left Must Specify (in this order): Model # Top Material Top Color Edge Profile Wire Management Sleeve Chassis Color Drawer Front/Front Panel Color Grain Direction (if applicable) Leg Color Worksurface Grommet Grommet Color Power/Data/Wire Management Back Panel Grommet	Leg in Left Cabinet 66-2472HMFL 66-2466HMFL 66-2460HMFL 66-2072HMFL 66-2066HMFL 66-2060HMFL	Leg in Right Cabinet 66-2472HMFR 66-2466HMFR 66-2460HMFR 66-2072HMFR 66-2066HMFR 66-2060HMFR	72	24	21¾	260	35.6	T\$ 4228 P\$ 4468
	66	24	21¾	240	32.7	T\$ 4153 P\$ 4377		
	60	24	21¾	240	29.9	T\$ 4078 P\$ 4295		
	72	20	21¾	220	30.2	T\$ 4098 P\$ 4309		
	66	20	21¾	210	27.7	T\$ 4024 P\$ 4226		
	60	20	21¾	210	25.3	T\$ 3949 P\$ 4139		
	Description <ul style="list-style-type: none"> Cabinet with Controls; Profiled on User Side; Back Panel Included Bottom Panel Not Included Behind Removable Access Front Panel for Wire Management Locking Box/File; File Drawers Provide Legal or Letter Filing Designed for 28" Deep Worksurfaces Only (See Worksurfaces) Handed Based on Height Adjust Cabinet and Facing the Unit When Used as Peninsula Desk, Additional Height Adjustable Panel Leg (Without Control) Must be Used on Opposite Side for Support; See Panel Legs 01-2245HTL, 66-0536HPS, or 66-0530HPS Drawer Fronts and Removable Access Front Panel Available in Contrasting Color; Must Specify Top and Chassis Available in Contrasting Colors; Must Specify Color of Each Component If Black or Gold Pull is Selected, Leg and Lock Core will be Black; If Chrome or Aluminum Pull is Selected, Leg and Lock Core will be Silver Worksurface Grommet Standard; Must Specify: Black (BLK), Silver (SLV) Optional Back Panel Grommet, Must Specify: Black (GMBBL), Silver (GMBSV); Color Must Match Worksurface Grommet Optional Wire Management Sleeve Available (See Below); Wire Management Sleeve Replaces Standard Work Surface Grommet Additional Options: Dove Tail Drawer Construction and Soft Close Drawers (See Drawer Options), Power Locations (See Power Options) 							
	Options: Specify & Add							
	WM Sleeve Wire Management Sleeve							T\$ 405

Pricing Codes:

 T= TFL
 P= HPL

[See Canvas Intro Section for Ordering Options](#)

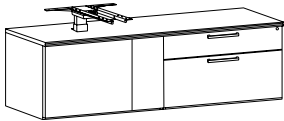
Item	Model No.	Width	Depth	Height	Ship Wt	Cubic Ft	List Price
HEIGHT ADJUSTABLE CREDENZA WITH DOOR, WITH BOX/FILE AND CONTROL  Shown as Left	Leg in Left Cabinet	Leg in Right Cabinet					
	66-2472HDFL	66-2472HDFR	72	24	21¾	260	T\$ 4515 P\$ 4752
	66-2466HDFL	66-2466HDFR	66	24	21¾	250	T\$ 4429 P\$ 4655
	66-2460HDFL	66-2460HDFR	60	24	21¾	240	T\$ 4350 P\$ 4570
	66-2072HDFL	66-2072HDFR	72	20	21¾	240	T\$ 4375 P\$ 4585
	66-2066HDFL	66-2066HDFR	66	20	21¾	230	T\$ 4293 P\$ 4496
	66-2060HDFL	66-2060HDFR	60	20	21¾	220	T\$ 4215 P\$ 4406

Must Specify (in this order):

Model #
 Top Material
 Top Color
 Edge Profile
 Wire Management Sleeve
 Chassis Color
 Drawer Front/Front Panel
 Color
 Grain Direction (if applicable)
 Leg Color
 Worksurface Grommet
 Grommet Color
 Power/Data/Wire Management
 Back Panel Grommet

Description

- Credenza with Controls; Profiled on User Side; Back Panel Included
- Bottom Panel Not Included Behind Removable Access Front Panel for Wire Management
- 9" Door Opening With Touch Latch and Includes Bottom Panel, Storage Behind Door
- Locking Box/File; File Drawers Provide Legal or Letter Filing
- Designed for 28" Deep Worksurfaces Only ([See Worksurfaces](#))
- Handed Based on Height Adjust Cabinet and Facing the Unit
- When Used as Peninsula Desk, Additional Height Adjustable Panel Leg (Without Control) Must be Used on Opposite Side for Support; [See Panel Legs](#) 01-2245HTL, 66-0536HPS, or 66-0530HPS
- Door, Drawers and Removable Access Front Panel Available in Contrasting Color; Must Specify
- Top and Chassis Available in Contrasting Colors; Must Specify Color of Each Component
- If Black or Gold Pull is Selected, Leg and Lock Core will be Black; If Chrome or Aluminum Pull is Selected, Leg and Lock Core will be Silver
- Worksurface Grommet Standard; Must Specify: Black (BLK), Silver (SLV)
- Optional Back Panel Grommet, Must Specify: Black (GMBBL), Silver (GMBSV); Color Must Match Worksurface Grommet
- Additional Options: Dove Tail Drawer Construction and Soft Close Drawers ([See Drawer Options](#)), Power Locations ([See Power Options](#))

Pricing Codes:

T= TFL
P= HPL

[See Canvas Intro Section for Ordering Options](#)

CANVAS™

HEIGHT ADJUSTABLE COMPONENTS (6600/6800 SERIES)

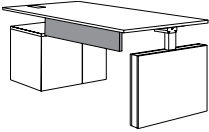
Item	Model No.	Width	Depth	Height	Ship Wt	Cubic Ft	List Price
 <p><u>Must Specify (in this order):</u> Model # Modesty Color</p>	66-5707MOD For Use with 70" Surface with Panel Leg	57	¾	7	16	1.1	T\$ 396
	66-5107MOD For Use with 64" Surface with Panel Leg	51	¾	7	16	1.1	T\$ 388
	66-4507MOD For Use with 70" Surface with 20" Credenza	45	¾	7	15	1	T\$ 378
	66-4107MOD For Use with 70" Surface with 24" Credenza	41	¾	7	15	1	T\$ 376
	66-3907MOD For Use with 64" Surface with 20" Credenza	39	¾	7	15	0.9	T\$ 373
	66-3507MOD For Use with 64" Surface with 24" Credenza	35	¾	7	15	0.9	T\$ 370
	66-3307MOD For Use with 58" Surface with 20" Credenza	33	¾	7	15	0.8	T\$ 363
	66-2907MOD For Use with 58" Surface with 24" Credenza	29	¾	7	15	0.8	T\$ 358

Description

- Works With Low Storage; [See Low Storage](#) and Modular Units; [See Modular Units](#)
- Attaches with Aluminum Mounting Brackets

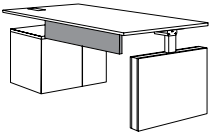
 <p><u>Must Specify (in this order):</u> Model # Decorative Hardware Color</p>	MD-5707FA For Use with 70" Surface with Panel Leg	57	¾	7	10	1.1	\$ 623
	MD-5107FA For Use with 64" Surface with Panel Leg	51	¾	7	9	1	\$ 612
	MD-4507FA For Use with 70" Surface with 20" Credenza	45	¾	7	9	1	\$ 602
	MD-4107FA For Use with 70" Surface with 24" Credenza	41	¾	7	8	0.9	\$ 597
	MD-3907FA For Use with 64" Surface with 20" Credenza	39	¾	7	8	0.8	\$ 590
	MD-3507FA For Use with 64" Surface with 24" Credenza	35	¾	7	7	0.7	\$ 581
	MD-3307FA For Use with 58" Surface with 20" Credenza	33	¾	7	7	0.6	\$ 574
	MD-2907FA For Use with 58" Surface with 24" Credenza	29	¾	7	6	0.5	\$ 564

Description

- Works With Low Storage; [See Low Storage](#) and Modular Units; [See Modular Units](#)
- Exposed Decorative Hardware; Must Specify: Aluminum (ALUM) or Chrome (CHRM)

Pricing Codes:

T= TFL
P= HPL

[See Canvas Intro Section for Ordering Options](#)

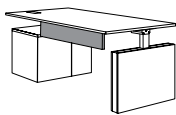
Item	Model No.		Width	Depth	Height	Ship Wt	Cubic Ft	List Price
7" MODESTY PANEL, HIGH GLOSS ACRYLIC 	MD-5707HGA	For Use with 70" Surface with Panel Leg	57	¾	7	16	1.1	\$ 693 GPA\$ 741
	MD-5107HGA	For Use with 64" Surface with Panel Leg	51	¾	7	15	1	\$ 680 GPA\$ 730
	MD-4507HGA	For Use with 70" Surface with 20" Credenza	45	¾	7	15	1	\$ 668 GPA\$ 714
	MD-4107HGA	For Use with 70" Surface with 24" Credenza	41	¾	7	14	0.9	\$ 661 GPA\$ 707
	MD-3907HGA	For Use with 64" Surface with 20" Credenza	39	¾	7	14	0.8	\$ 655 GPA\$ 702
	MD-3507HGA	For Use with 64" Surface with 24" Credenza	35	¾	7	13	0.7	\$ 644 GPA\$ 690
	MD-3307HGA	For Use with 58" Surface with 20" Credenza	33	¾	7	13	0.6	\$ 637 GPA\$ 680
	MD-2907HGA	For Use with 58" Surface with 24" Credenza	29	¾	7	12	0.5	\$ 627 GPA\$ 670

Must Specify (in this order):
 Model #
 Modesty Color
 Decorative Hardware Color

Description

- Works With Low Storage; [See Low Storage](#) and Modular Units; [See Modular Units](#)
- Attaches with Aluminum Mounting Brackets
- Available in Black (BLA), Wired Mercury (WMA), White (WHA) or Graphite (GPA); Graphite Acrylic Pricing (GPA\$)

4" MODESTY PANEL, TFL 	66-6804MOD		68	¾	4	17	1.3	T\$ 388
	66-6204MOD		62	¾	4	16	1.2	T\$ 377
	66-5604MOD		56	¾	4	16	1.1	T\$ 373

Must Specify (in this order):
 Model #
 Modesty Color

Description

- Attaches with Aluminum Mounting Brackets
- Not Compatible with Height Adjustable Panel Leg with Sleeve

4" MODESTY PANEL, FROSTED ACRYLIC 	MD-6804FA		68	¾	4	12	1.3	\$ 669
	MD-6204FA		62	¾	4	11	1.2	\$ 619
	MD-5604FA		56	¾	4	10	1.1	\$ 589

Must Specify (in this order):
 Model #
 Modesty Color
 Decorative Hardware Color

Description

- Attaches with Aluminum Mounting Brackets
- Exposed Decorative Hardware; Must Specify (ALUM) Aluminum or (CHRM) Chrome
- Not Compatible with Height Adjustable Panel Leg with Sleeve

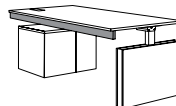
4" MODESTY PANEL, HIGH GLOSS ACRYLIC 	MD-6804HGA		68	¾	4	17	1.3	\$ 730 GPA\$ 781
	MD-6204HGA		62	¾	4	16	1.2	\$ 693 GPA\$ 742
	MD-5604HGA		56	¾	4	16	1.1	\$ 654 GPA\$ 699

Must Specify (in this order):
 Model #
 Modesty Color

Description

- Attaches with Aluminum Mounting Brackets
- Available in Black (BLA), Wired Mercury (WMA), White (WHA) or Graphite (GPA); Graphite Acrylic Pricing (GPA\$)
- Not Compatible with Height Adjustable Panel Leg with Sleeve

Pricing Codes:

T= TFL
 P= HPL

[See Canvas Intro Section for Ordering Options](#)

Item	Model No.	Width	Depth	Height	Ship Wt	Cubic Ft	List Price
20" H ABOVE/BELOW PRIVACY SCREEN, TFL 	66-5720PS For Use with 70" Surface with Panel Leg	57	¾	20	36	2.7	\$ 438
	66-5120PS For Use with 64" Surface with Panel Leg	51	¾	20	34	2.5	\$ 420
	66-4520PS For Use with 70" Surface with 20" Credenza	45	¾	20	32	2.3	\$ 405
	66-4120PS For Use with 70" Surface with 24" Credenza	41	¾	20	30	2.2	\$ 389
	66-3920PS For Use with 64" Surface with 20" Credenza	39	¾	20	29	2.2	\$ 375
	66-3520PS For Use with 64" Surface with 24" Credenza	35	¾	20	28	2.1	\$ 362
	66-3320PS For Use with 58" Surface with 20" Credenza	33	¾	20	27	2.1	\$ 348
	66-2920PS For Use with 58" Surface with 24" Credenza	29	¾	20	26	1.9	\$ 335

Must Specify (in this order):
Model #
Modesty Color

Description

- Mounts to Worksurface
- Provides Privacy 12" Above and 7" Modesty Below

Item	Model No.	Width	Depth	Height	Ship Wt	Cubic Ft	List Price
20" H ABOVE/BELOW PRIVACY SCREEN, TACKBOARD 	PS-5720TB For Use with 70" Surface with Panel Leg	57	⅝	20	14	2.2	\$ See Below
	PS-5120TB For Use with 64" Surface with Panel Leg	51	⅝	20	13	2.2	\$ See Below
	PS-4520TB For Use with 70" Surface with 20" Credenza	45	⅝	20	12	2	\$ See Below
	PS-4120TB For Use with 70" Surface with 24" Credenza	41	⅝	20	12	1.8	\$ See Below
	PS-3920TB For Use with 64" Surface with 20" Credenza	39	⅝	20	11	1.8	\$ See Below
	PS-3520TB For Use with 64" Surface with 24" Credenza	35	⅝	20	11	1.5	\$ See Below
	PS-3320TB For Use with 58" Surface with 20" Credenza	33	⅝	20	10	1.5	\$ See Below
	PS-2920TB For Use with 58" Surface with 24" Credenza	29	⅝	20	10	1.5	\$ See Below

Must Specify (in this order):
Model #
Fabric Vendor, Pattern, and Color

Description

- Mounts to Worksurface
- Provides Privacy 12" Above and 7" Modesty Below

Model	Ydg	Grades 1,2,3	Grade 4	Grade 5	Grade 6	Grade 7	Grade 8	Grade 9	Grade 10
PS-5720TB	2.00 \$	623	901	1031	1163	1351	1547	1775	2039
PS-5120TB	2.00 \$	578	856	986	1118	1306	1502	1730	1994
PS-4520TB	1.75 \$	513	756	870	986	1150	1322	1521	1752
PS-4120TB	1.50 \$	473	682	779	878	1019	1166	1337	1535
PS-3920TB	1.50 \$	459	668	765	864	1005	1152	1323	1521
PS-3520TB	1.50 \$	443	652	749	848	989	1136	1307	1505
PS-3320TB	1.25 \$	404	578	659	742	859	982	1124	1289
PS-2920TB	1.25 \$	383	557	638	721	838	961	1103	1268

Pricing Codes:
T= TFL
P= HPL

[See Canvas Intro Section for Ordering Options](#)

Item	Model No.	Width	Depth	Height	Ship Wt	Cubic Ft	List Price
20"H ABOVE/BELOW PRIVACY SCREEN, FROSTED ACRYLIC 	PS-5720FA For Use with 70" Surface with Panel Leg	57	¼	20	20	2.2	\$ 1163
	PS-5120FA For Use with 64" Surface with Panel Leg	51	¼	20	19	2.1	\$ 1075
	PS-5120FA For Use with 64" Surface with Panel Leg	51	¼	20	19	2.1	\$ 1075
	PS-4520FA For Use with 70" Surface with 20" Credenza	45	¼	20	19	2	\$ 988
	PS-4120FA For Use with 70" Surface with 24" Credenza	41	¼	20	18	1.9	\$ 951
	PS-3920FA For Use with 64" Surface with 20" Credenza	39	¼	20	18	1.8	\$ 918
	PS-3520FA For Use with 64" Surface with 24" Credenza	35	¼	20	17	1.7	\$ 881
	PS-3320FA For Use with 58" Surface with 20" Credenza	33	¼	20	17	1.6	\$ 849
	PS-2920FA For Use with 58" Surface with 24" Credenza	29	¼	20	16	1.5	\$ 814

Must Specify (in this order):

Model #

Description

- Mounts to Worksurface
- Provides Privacy 12" Above and 7" Modesty Below

20"H ABOVE/BELOW PRIVACY SCREEN, HIGH GLOSS ACRYLIC 	PS-5720HGA For Use with 70" Surface with Panel Leg	57	⅝	20	36	2.7	\$ 1230 GPA\$ 1586
	PS-5120HGA For Use with 64" Surface with Panel Leg	51	⅝	20	34	2.5	\$ 1131 GPA\$ 1451
	PS-4520HGA For Use with 70" Surface with 20" Credenza	45	⅝	20	32	2.3	\$ 1032 GPA\$ 1313
	PS-4120HGA For Use with 70" Surface with 24" Credenza	41	⅝	20	30	2.2	\$ 990 GPA\$ 1261
	PS-3920HGA For Use with 64" Surface with 20" Credenza	39	⅝	20	29	2.2	\$ 960 GPA\$ 1219
	PS-3520HGA For Use with 64" Surface with 24" Credenza	35	⅝	20	29	2.2	\$ 922 GPA\$ 1174
	PS-3320HGA For Use with 58" Surface with 20" Credenza	33	⅝	20	27	2.1	\$ 889 GPA\$ 1133
	PS-2920HGA For Use with 58" Surface with 24" Credenza	29	⅝	20	26	1.9	\$ 851 GPA\$ 1087

Description

- Mounts to Worksurface
- Provides Privacy 12" Above and 7" Modesty Below
- Available in Available in Black (BLA), White (WHA) or Graphite (GPA); Graphite Acrylic Pricing (GPA\$)

Pricing Codes:

T= TFL

P= HPL

[See Canvas Intro Section for Ordering Options](#)

Item	Model No.	Width	Depth	Height	Ship Wt	Cubic Ft	List Price
17"H ABOVE/BELOW PRIVACY SCREEN, TFL 	66-6817PS	68	¾	17	24	3.3	\$ 450
	66-6217PS	62	¾	17	22	3.1	\$ 437
	66-5617PS	56	¾	17	20	2.7	\$ 419
	66-5017PS	50	¾	17	18	2.5	\$ 405
	66-4417PS	44	¾	17	16	2.3	\$ 390

Must Specify (in this order):
Model #
Modesty Color

Description

- Aluminum Hardware Used to Mount Screen to Worksurface
- Provides Privacy 12" Above and 4" Modesty Below

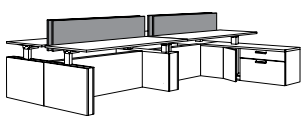
17"H ABOVE/BELOW PRIVACY SCREEN, TACKBOARD 	PS-6817TB	68	⅝	17	15	2.5	\$ See Below
	PS-6217TB	62	⅝	17	14	2.5	\$ See Below
	PS-5617TB	56	⅝	17	13	2.2	\$ See Below
	PS-5017TB	50	⅝	17	12	2	\$ See Below
	PS-4417TB	44	⅝	17	11	1.8	\$ See Below

Must Specify (in this order):
Model #
Fabric Vendor, Pattern, and Color

Description

- Mounts to Worksurface
- Provides Privacy 12" Above and 4" Modesty Below
- Decorative Hardware; Must Specify: Aluminum (ALUM) or Chrome (CHRM)

Model	Ydg	Grades 1,2,3	Grade 4	Grade 5	Grade 6	Grade 7	Grade 8	Grade 9	Grade 10
PS-6817TB	2.00 \$	642	920	1050	1182	1370	1566	1794	2058
PS-6217TB	2.00 \$	602	880	1010	1142	1330	1526	1754	2018
PS-5617TB	2.00 \$	549	827	957	1089	1277	1473	1701	1965
PS-5017TB	2.00 \$	520	798	928	1060	1248	1444	1672	1936
PS-4417TB	1.75 \$	468	711	825	941	1105	1277	1476	1707

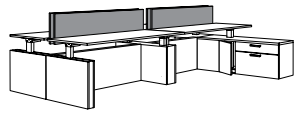
17"H ABOVE/BELOW PRIVACY SCREEN, FROSTED ACRYLIC 	PS-6817FA	68	¼	17	14	3.3	\$ 1196
	PS-6217FA	62	¼	17	14	3.1	\$ 1160
	PS-5617FA	56	¼	17	13	2.9	\$ 1121
	PS-5017FA	50	¼	17	13	2.7	\$ 1036
	PS-4417FA	44	¼	17	12	2.5	\$ 954

Must Specify (in this order):
Model #

Description

- Mounts to Worksurface
- Provides Privacy 12" Above and 4" Modesty Below
- Decorative Hardware; Must Specify: Aluminum (ALUM) or Chrome (CHRM)

Pricing Codes:

T= TFL
P= HPL

[See Canvas Intro Section for Ordering Options](#)

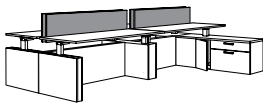
Item	Model No.	Width	Depth	Height	Ship Wt	Cubic Ft	List Price
17"H ABOVE/BELOW PRIVACY SCREEN, HIGH GLOSS ACRYLIC 	PS-6817HGA	68	¾	17	24	3.3	\$ 1260
							GPA\$ 1627
	PS-6217HGA	62	¾	17	22	3.1	\$ 1223
							GPA\$ 1579
	PS-5617HGA	56	¾	17	20	2.7	\$ 1180
							GPA\$ 1521
	PS-5017HGA	50	¾	17	18	2.5	\$ 1088
							GPA\$ 1395
	PS-4417HGA	44	¾	17	16	2.3	\$ 995
							GPA\$ 1267

Must Specify (in this order):

Model #

Modesty Color

Description

- Mounts to Worksurface
- Provides Privacy 12" Above and 4" Modesty Below
- Available in Available in Black (BLA), White (WHA) or Graphite Acrylic (GPA); Graphite Acrylic Pricing (GPA\$)

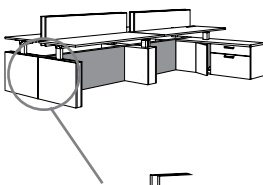
Item	Model No.	Width	Depth	Height	Ship Wt	Cubic Ft	List Price
GALLERY SCREEN, TFL 	66-2272GS	72	1	22	31	3	T\$ 489
	66-2266GS	66	1	22	29	2.9	T\$ 469
	66-2260GS	60	1	22	27	2.8	T\$ 450
	66-2254GS	54	1	22	24	2.7	T\$ 430

Gallery Screen is
Positioned Between
Height Adjustable Legs

Must Specify (in this order):

Model #

Modesty Color

Description

- Not Compatible with Optional Wire Management Sleeve
- Gallery Screens are Visible and Can Provide an Accent Between Users in Multi-Station Settings by Selecting a Contrasting Color
- When Used with Height Adjustable Legs, Gallery Screen is Positioned Between Height Adjustable Legs

Pricing Codes:

T= TFL

P= HPL

[See Canvas Intro Section for Ordering Options](#)

Item	Model No.	Width	Depth	Height	Ship Wt	Cubic Ft	List Price
RECTANGULAR TOP	72" or 6' - 1 Piece Top						
	94-3672RT	72	36	1 $\frac{3}{16}$	100	6.2	P\$ 1570

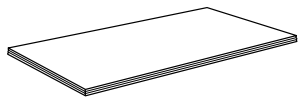

Must Specify (in this order):

Model #
Color
Edge Profile
Grommet/Power/Data Location

Description

- Grain Runs the Width of the Table
- Heavy-Duty Ganging Mechanisms Connect Two (2) Piece Tops
- See Rectangle Box Base and Number Required For Each Top Size Below; Must Order Bases/Legs Separately
- When Using with Strut Legs, We Recommend Using Two (2) Stiffener Bars on Tops 96"W; Must Order Separately, [See Strut Details](#)
- Tops 120"W Do Not Need Stretcher Rails When Used with Strut Legs, the Location and Number of Strut Legs Required Offer Sufficient Support
- Optional Grommets and Power/Data Units; [See Location Options](#), [See Power Units Available](#)

BOAT TOP	120" or 10' - 2 Piece Tops						
	94-48120BT	120	48	1 $\frac{3}{16}$	225	10.3	P\$ 3823
	96" or 8' - 1 Piece Top						
	94-4296BT	96	42	1 $\frac{3}{16}$	180	9.4	P\$ 2476

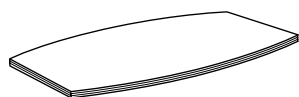

Must Specify (in this order):

Model #
Color
Edge Profile
Grommet/Power/Data Location

Description

- Grain Runs the Width of the Table
- Heavy-Duty Ganging Mechanisms Connect Two (2) Piece Tops
- See Rectangle Box Base and Number Required For Each Top Size Below; Must Order Bases/Legs Separately
- When Using with Strut Legs, We Recommend Using Two (2) Stiffener Bars on Tops 96"W; Must Order Separately, [See Strut Details](#)
- Tops 120"W Do Not Need Stretcher Rails When Used with Strut Legs, the Location and Number of Strut Legs Required Offer Sufficient Support
- Optional Grommets and Power/Data Units; [See Location Options](#), [See Power Units Available](#)

RECTANGULAR BOX BASE WITH DOOR	01-1220RBD	20	12	28 $\frac{1}{2}$	50	5.4	T\$ 617
--------------------------------	------------	----	----	------------------	----	-----	---------

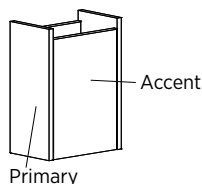

Must Specify (in this order):

Model # and Quantity
Primary Color
Accent Color

Description

- Rectangular Base with Lift-Off Removable Panel
- Available in Single or Contrasting Colors; Must Indicate Accent Selection and Primary Selection on Order ([See Color Options](#))
- 2" Wire Management Access Across Both Sides
- Fully Open for Wire Management at the Bottom

Table Widths	72"	96"	120"
Number of Bases Required	2	2	3

Pricing Codes:

T= TFL
P= HPL

[See Canvas Intro Section for Ordering Options](#)

Item	Model No.	Width	Depth	Height	Ship Wt	Cubic Ft	List Price
MAGNETIC GLASS MARKER BOARD FOR USE WITH 30"H DESKS AND CREDENZA AND SURFACE MOUNT HUTCHES WITHOUT PAPERSLOTS	GMB-23108H	106½	½	23	83	14.3	\$ 3834
	GMB-23102H	100½	½	23	78	13.6	\$ 3558
	GMB-2396H	94½	½	23	74	12.9	\$ 3351
	GMB-2390H	88½	½	23	69	12.2	\$ 3145
	GMB-2384H	82½	½	23	64	11.4	\$ 3009
	GMB-2378H	76½	½	23	59	10.7	\$ 2802
	GMB-2372H	70½	½	23	55	10.0	\$ 2526
	GMB-2366H	64½	½	23	50	9.2	\$ 2318
	GMB-2360H	58½	½	23	45	8.5	\$ 2182
	GMB-2354H	52½	½	23	41	7.8	\$ 1908
	GMB-2348H	46½	½	23	36	7.0	\$ 1770
	GMB-2342H	40½	½	23	31	6.3	\$ 1494
	GMB-2336H	34½	½	23	27	5.6	\$ 1287
	GMB-2330H	28½	½	23	22	4.9	\$ 1151

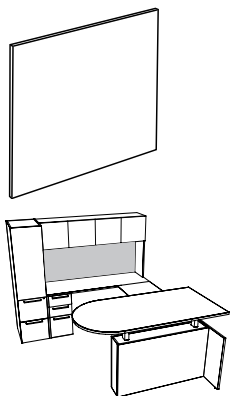

Must Specify (in this order):

Model #
Color



Rare Earth Magnets, Marker and Eraser set available; [See Set Options](#)

Description

- Available in Black (BLMKR) or White (WHMKR), Must Specify
- Tempered Glass Magnetic Marker Boards Are One (1) Piece with No Seams
- Mounting Brackets Included
- For Use with 30"H Desks and Credenzas with Surface Mount Hutches Without Paperslots
- For Rare Earth Magnets, Marker and Eraser Sets; [See Set Options](#)

Item	Model No.	Width	Depth	Height	Ship Wt	Cubic Ft	List Price
MAGNETIC GLASS MARKER BOARD FOR USE WITH 30"H DESKS AND CREDENZA AND WALL MOUNT HUTCHES WITHOUT PAPERSLOTS	GMB-23108W	108	½	23	85	14.6	\$ 3834
	GMB-23102W	102	½	23	80	13.9	\$ 3696
	GMB-2396W	96	½	23	75	13.1	\$ 3489
	GMB-2390W	90	½	23	70	12.4	\$ 3215
	GMB-2384W	84	½	23	66	11.7	\$ 3009
	GMB-2378W	78	½	23	61	10.9	\$ 2802
	GMB-2372W	72	½	23	56	10.2	\$ 2595
	GMB-2366W	66	½	23	52	9.5	\$ 2458
	GMB-2360W	60	½	23	47	8.8	\$ 2182
	GMB-2354W	54	½	23	42	8.0	\$ 1976
	GMB-2348W	48	½	23	38	7.3	\$ 1838
	GMB-2342W	42	½	23	33	6.6	\$ 1563
	GMB-2336W	36	½	23	28	5.8	\$ 1357
	GMB-2330W	30	½	23	23	5.1	\$ 1151

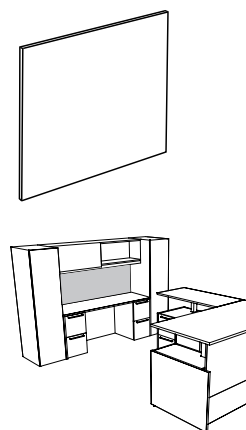

Must Specify (in this order):

Model #
Color



Rare Earth Magnets, Marker and Eraser set available; [See Set Options](#)

Description

- Available in Black (BLMKR) or White (WHMKR), Must Specify
- Tempered Glass Magnetic Marker Boards Are One (1) Piece with No Seams
- Mounting Brackets Included
- For Use over 30"H Desks and Credenzas with Wall Mount Hutches Without Paperslots
- For Rare Earth Magnets, Marker and Eraser Sets; [See Set Options](#)

[See Canvas Intro Section for Ordering Options](#)

Item	Model No.	Width	Depth	Height	Ship Wt	Cubic Ft	List Price
MAGNETIC GLASS MARKER BOARD	GMB-31108W	108	½	31	114	17.9	\$ 5073
FOR USE WITH 21" LOW CREDENZA AND WALL MOUNT HUTCHES	GMB-31102W	102	½	31	108	17.0	\$ 4889
	GMB-3196W	96	½	31	101	16.1	\$ 4613
	GMB-3190W	90	½	31	95	15.2	\$ 4246
	GMB-3184W	84	½	31	89	14.3	\$ 3972
	GMB-3178W	78	½	31	82	13.4	\$ 3696
	GMB-3172W	72	½	31	76	12.5	\$ 3421
	GMB-3166W	66	½	31	70	11.6	\$ 3235
	GMB-3160W	60	½	31	63	10.8	\$ 2870
	GMB-3154W	54	½	31	57	9.9	\$ 2595
	GMB-3148W	48	½	31	51	9.0	\$ 2414
	GMB-3142W	42	½	31	44	8.1	\$ 2045
	GMB-3136W	36	½	31	38	7.2	\$ 1770
	GMB-3130W	30	½	31	32	6.3	\$ 1494

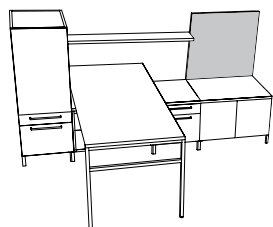
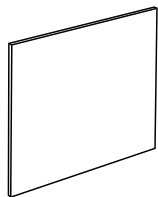

Must Specify (in this order):

Model #
Color



Rare Earth Magnets, Marker and Eraser set available; [See Set Options](#)

Description

- Available in Black (BLMKR) or White (WHMKR), Must Specify
- Tempered Glass Magnetic Marker Boards Are One (1) Piece with No Seams
- Mounting Brackets Included
- For Use over 21"H Desks and Credenzas with Wall Mount Hutches
- For Rare Earth Magnets, Marker and Eraser Sets; [See Set Options](#)

MAGNETIC GLASS MARKER BOARD	GMB-4048W	48	½	40%	67	11.0	\$ 3128
FOR USE WITH 30"H DESKS AND CREDENZA AND WALL MOUNT HUTCHES OR SHELVING	GMB-4042W	42	½	40%	58	9.9	\$ 2644
	GMB-4036W	36	½	40%	50	8.8	\$ 2285
	GMB-4030W	30	½	40%	42	7.7	\$ 1924

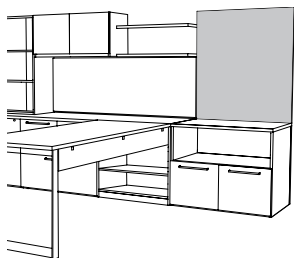

Must Specify (in this order):

Model #
Color



Rare Earth Magnets, Marker and Eraser set available; [See Set Options](#)

Description

- Available in Black (BLMKR) or White (WHMKR), Must Specify
- Tempered Glass Magnetic Marker Boards Include Mounting Brackets
- For Use over 30"H Desks and Credenzas with Wall Mount Hutches or Shelving
- For Rare Earth Magnets, Marker and Eraser Sets; [See Set Options](#)

[See Canvas Intro Section for Ordering Options](#)

Item	Model No.	Width	Depth	Height	Ship Wt	Cubic Ft	List Price
MAGNETIC GLASS MARKER BOARD	GMB-5248W	48	½	52⅞	86	13.5	\$ 3988
FOR USE WITH 30"H DESKS AND CREDENZA AND TALL WALL MOUNT HUTCHES OR SHELVING	GMB-5242W	42	½	52⅞	76	12.2	\$ 3369
	GMB-5236W	36	½	52⅞	65	10.8	\$ 2904
	GMB-5230W	30	½	52⅞	54	9.5	\$ 2441

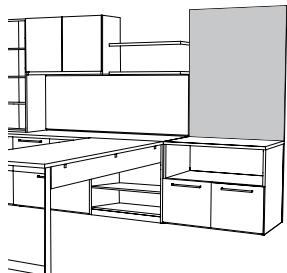

Description

- Available in Black (BLMKR) or White (WHMKR), Must Specify
- Tempered Glass Magnetic Marker Boards Include Mounting Brackets
- For Use Next to Tall Surface or Wall Mount Hutches
- For Rare Earth Magnets, Marker and Eraser Sets; [See Set Options](#)

Must Specify (in this order):

Model #
Color



Rare Earth Magnets, Marker and Eraser set available; [See Set Options](#)

MAGNETIC GLASS MARKER BOARD	GMB-8236W	36	½	82⅞	102	15.8	\$ 4453
FOR USE FROM FLOOR TO TOP OF UNIT	GMB-7036W	36	½	70⅞	87	13.8	\$ 3834
	GMB-5136W	36	½	51⅞	63	10.6	\$ 2802
	GMB-8230W	30	½	82⅞	85	13.8	\$ 3730
	GMB-7030W	30	½	70⅞	72	12.1	\$ 3215
	GMB-5130W	30	½	51⅞	53	9.3	\$ 2354

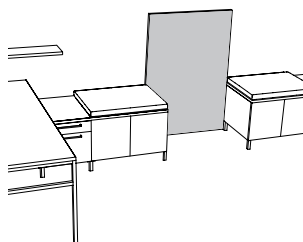

Description

- Available in Black (BLMKR) or White (WHMKR), Must Specify
- Tempered Glass Magnetic Marker Boards Are One (1) Piece with No Seams
- Mounting Brackets Included
- For Use From Floor to Top of Unit
- For Rare Earth Magnets, Marker and Eraser Sets; [See Set Options](#)

Must Specify (in this order):

Model #
Color



Rare Earth Magnets, Marker and Eraser set available; [See Set Options](#)

[See Canvas Intro Section for Ordering Options](#)

**TALL TOOL RAIL WORK WALL
FOR SURFACE MOUNT HUTCHES**

**USE OVER 30"H CREDENZA
23" TALL**

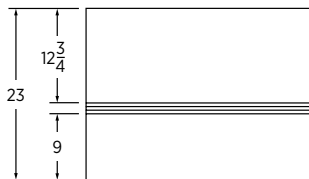

Must Specify (in this order):

- Model #
- Tackboard on Top or Bottom
- Dry Erase on Top or Bottom
- Tackboard Fabric Vendor, Pattern, and Color

Tackboard/Dry Erase Locations

- TB-TB: Tackboard Over Tackboard (Use Grade Prices)
- DEB-TB: Dry Erase Over Tackboard (Use Grade Prices)
- DEB-DEB: Dry Erase Over Dry Erase (Use Grade 1 Prices)

Model #	Size	COM ydg	COM, 1, 2 or 3	Grades						
				4	5	6	7	8	9	10
WW-23108TRH	108"	3.50	\$ 1715	2202	2429	2660	2989	3332	3731	4193
WW-23102TRH	102"	3.25	\$ 1635	2087	2298	2513	2818	3137	3507	3936
WW-2396TRH	96"	3.00	\$ 1565	1982	2177	2375	2657	2951	3293	3689
WW-2390TRH	90"	2.75	\$ 1471	1853	2032	2214	2472	2742	3055	3418
WW-2384TRH	84"	2.50	\$ 1334	1682	1844	2009	2244	2489	2774	3104
WW-2378TRH	78"	2.50	\$ 1285	1633	1795	1960	2195	2440	2725	3055
WW-2372TRH	72"	2.25	\$ 1023	1336	1482	1631	1842	2063	2319	2616
WW-2366TRH	66"	2.00	\$ 967	1245	1375	1507	1695	1891	2119	2383
WW-2360TRH	60"	2.00	\$ 910	1188	1318	1450	1638	1834	2062	2326
WW-2354TRH	54"	1.75	\$ 887	1130	1244	1360	1524	1696	1895	2126
WW-2348TRH	48"	1.50	\$ 806	1015	1112	1211	1352	1499	1670	1868
WW-2342TRH	42"	1.25	\$ 745	919	1000	1083	1200	1323	1465	1630
WW-2336TRH	36"	1.25	\$ 727	901	982	1065	1182	1305	1447	1612
WW-2330TRH	30"	1.00	\$ 671	810	875	941	1035	1133	1247	1379

Description

- Aluminum Tool Rail
- Work Walls 78" and Larger will Ship in 4 Pieces
- [See Work Wall Accessories](#)

**TALL TOOL RAIL WORK WALL
FOR SURFACE MOUNT HUTCHES
WITH PAPER SLOTS**

**USE OVER 30"H CREDENZA
19" TALL**

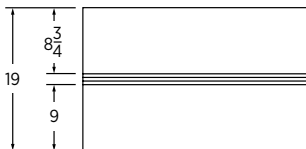

Must Specify (in this order):

- Model #
- Tackboard on Top or Bottom
- Dry Erase on Top or Bottom
- Tackboard Fabric Vendor, Pattern, and Color

Tackboard/Dry Erase Locations

- TB-TB: Tackboard Over Tackboard (Use Grade Prices)
- DEB-TB: Dry Erase Over Tackboard (Use Grade Prices)
- DEB-DEB: Dry Erase Over Dry Erase (Use Grade 1 Prices)

Model #	Size	COM ydg	COM, 1, 2 or 3	Grades						
				4	5	6	7	8	9	10
WW-19108TRHPS	108"	3.50	\$ 1579	2066	2293	2524	2853	3196	3595	4057
WW-19102TRHPS	102"	3.25	\$ 1505	1957	2168	2383	2688	3007	3377	3806
WW-1996TRHPS	96"	3.00	\$ 1440	1857	2052	2250	2532	2826	3168	3564
WW-1990TRHPS	90"	2.75	\$ 1349	1731	1910	2092	2350	2620	2933	3296
WW-1984TRHPS	84"	2.50	\$ 1215	1563	1725	1890	2125	2370	2655	2985
WW-1978TRHPS	78"	2.50	\$ 1173	1521	1683	1848	2083	2328	2613	2943
WW-1972TRHPS	72"	2.25	\$ 935	1248	1394	1543	1754	1975	2231	2528
WW-1966TRHPS	66"	2.00	\$ 887	1165	1295	1427	1615	1811	2039	2303
WW-1960TRHPS	60"	2.00	\$ 845	1123	1253	1385	1573	1769	1997	2261
WW-1954TRHPS	54"	1.75	\$ 830	1073	1187	1303	1467	1639	1838	2069
WW-1948TRHPS	48"	1.50	\$ 771	980	1077	1176	1317	1464	1635	1833
WW-1942TRHPS	42"	1.25	\$ 709	883	964	1047	1164	1287	1429	1594
WW-1936TRHPS	36"	1.25	\$ 698	872	953	1036	1153	1276	1418	1583
WW-1930TRHPS	30"	1.00	\$ 643	782	847	913	1007	1105	1219	1351

Description

- Aluminum Tool Rail
- Work Walls 78" and Larger will Ship in 4 Pieces
- [See Work Wall Accessories](#)

[See Canvas Intro Section for Ordering Options](#)

TALL TOOL RAIL WORK WALL FOR WALL MOUNT HUTCHES

USE OVER 21" H CREDENZA 31" TALL

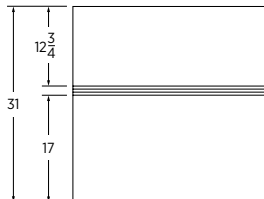

Must Specify (in this order):

- Model #
- Tackboard on Top or Bottom
- Dry Erase on Top or Bottom
- Tackboard Fabric Vendor, Pattern, and Color

Tackboard/Dry Erase Locations

- TB-TB: Tackboard Over Tackboard (Use Grade Prices)
- DEB-TB: Dry Erase Over Tackboard (Use Grade Prices)
- DEB-DEB: Dry Erase Over Dry Erase (Use Grade 1 Prices)

Model #	Size	COM ydg	COM, 1, 2 or 3	Grades						
				4	5	6	7	8	9	10
WW-31108TTRW	108"	3.50	\$ 2159	2646	2873	3104	3433	3776	4175	4637
WW-31102TTRW	102"	3.25	\$ 2044	2496	2707	2922	3227	3546	3916	4345
WW-3196TTRW	96"	3.00	\$ 1969	2386	2581	2779	3061	3355	3697	4093
WW-3190TTRW	90"	2.75	\$ 1854	2236	2415	2597	2855	3125	3438	3801
WW-3184TTRW	84"	2.50	\$ 1658	2006	2168	2333	2568	2813	3098	3428
WW-3178TTRW	78"	2.50	\$ 1585	1933	2095	2260	2495	2740	3025	3355
WW-3172TTRW	72"	2.25	\$ 1318	1631	1777	1926	2137	2358	2614	2911
WW-3166TTRW	66"	2.00	\$ 1265	1543	1673	1805	1993	2189	2417	2681
WW-3160TTRW	60"	2.00	\$ 1191	1469	1599	1731	1919	2115	2343	2607
WW-3154TTRW	54"	1.75	\$ 1137	1380	1494	1610	1774	1946	2145	2376
WW-3148TTRW	48"	1.50	\$ 1044	1253	1350	1449	1590	1737	1908	2106
WW-3142TTRW	42"	1.25	\$ 960	1134	1215	1298	1415	1538	1680	1845
WW-3136TTRW	36"	1.25	\$ 940	1114	1195	1278	1395	1518	1660	1825
WW-3130TTRW	30"	1.00	\$ 865	1004	1069	1135	1229	1327	1441	1573

Description

- Aluminum Tool Rail
- Work Walls 78" and Larger will Ship in 4 Pieces
- [See Work Wall Accessories](#)

TALL TOOL RAIL WORK WALL FOR WALL MOUNT HUTCHES WITH PAPER SLOTS

USE OVER 21" H CREDENZA 27" TALL

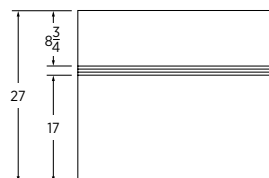

Must Specify (in this order):

- Model #
- Tackboard on Top or Bottom
- Dry Erase on Top or Bottom
- Tackboard Fabric Vendor, Pattern, and Color

Tackboard/Dry Erase Locations

- TB-TB: Tackboard Over Tackboard (Use Grade Prices)
- DEB-TB: Dry Erase Over Tackboard (Use Grade Prices)
- DEB-DEB: Dry Erase Over Dry Erase (Use Grade 1 Prices)

Model #	Size	COM ydg	COM, 1, 2 or 3	Grades						
				4	5	6	7	8	9	10
WW-27108TTRWPS	108"	3.50	\$ 1978	2465	2692	2923	3252	3595	3994	4456
WW-27102TTRWPS	102"	3.25	\$ 1867	2319	2530	2745	3050	3369	3739	4168
WW-2796TTRWPS	96"	3.00	\$ 1805	2222	2417	2615	2897	3191	3533	3929
WW-2790TTRWPS	90"	2.75	\$ 1699	2081	2260	2442	2700	2970	3283	3646
WW-2784TTRWPS	84"	2.50	\$ 1518	1866	2028	2193	2428	2673	2958	3288
WW-2778TTRWPS	78"	2.50	\$ 1454	1802	1964	2129	2364	2609	2894	3224
WW-2772TTRWPS	72"	2.25	\$ 1204	1517	1663	1812	2023	2244	2500	2797
WW-2766TTRWPS	66"	2.00	\$ 1153	1431	1561	1693	1881	2077	2305	2569
WW-2760TTRWPS	60"	2.00	\$ 1085	1363	1493	1625	1813	2009	2237	2501
WW-2754TTRWPS	54"	1.75	\$ 1035	1278	1392	1508	1672	1844	2043	2274
WW-2748TTRWPS	48"	1.50	\$ 954	1163	1260	1359	1500	1647	1818	2016
WW-2742TTRWPS	42"	1.25	\$ 879	1053	1134	1217	1334	1457	1599	1764
WW-2736TTRWPS	36"	1.25	\$ 859	1033	1114	1197	1314	1437	1579	1744
WW-2730TTRWPS	30"	1.00	\$ 791	930	995	1061	1155	1253	1367	1499

Description

- Aluminum Tool Rail
- Work Walls 78" and Larger will Ship in 4 Pieces
- [See Work Wall Accessories](#)

[See Canvas Intro Section for Ordering Options](#)

**TOOL RAIL WORK WALL
FOR WALL MOUNT HUTCHES**

**USE OVER 30”H CREDENZA
23” TALL**



Must Specify (in this order):
 Model #
 Tackboard on Top or Bottom
 Dry Erase on Top or Bottom
 Tackboard Fabric Vendor, Pattern,
 and Color

Tackboard/Dry Erase Locations

- TB-TB: Tackboard Over Tackboard (Use Grade Prices)
- DEB-TB: Dry Erase Over Tackboard (Use Grade Prices)
- DEB-DEB: Dry Erase Over Dry Erase (Use Grade 1 Prices)

Model #	Size	COM ydg	COM, 1, 2 or 3	Grades						
				4	5	6	7	8	9	10
WW-23108TRW	108"	3.50	\$ 1797	2284	2511	2742	3071	3414	3813	4275
WW-23102TRW	102"	3.25	\$ 1693	2145	2356	2571	2876	3195	3565	3994
WW-2396TRW	96"	3.00	\$ 1643	2060	2255	2453	2735	3029	3371	3767
WW-2390TRW	90"	2.75	\$ 1548	1930	2109	2291	2549	2819	3132	3495
WW-2384TRW	84"	2.50	\$ 1379	1727	1889	2054	2289	2534	2819	3149
WW-2378TRW	78"	2.50	\$ 1319	1667	1829	1994	2229	2474	2759	3089
WW-2372TRW	72"	2.25	\$ 1099	1412	1558	1707	1918	2139	2395	2692
WW-2366TRW	66"	2.00	\$ 1040	1318	1448	1580	1768	1964	2192	2456
WW-2360TRW	60"	2.00	\$ 976	1254	1384	1516	1704	1900	2128	2392
WW-2354TRW	54"	1.75	\$ 934	1177	1291	1407	1571	1743	1942	2173
WW-2348TRW	48"	1.50	\$ 863	1072	1169	1268	1409	1556	1727	1925
WW-2342TRW	42"	1.25	\$ 795	969	1050	1133	1250	1373	1515	1680
WW-2336TRW	36"	1.25	\$ 780	954	1035	1118	1235	1358	1500	1665
WW-2330TRW	30"	1.00	\$ 716	855	920	986	1080	1178	1292	1424

Description

- Aluminum Tool Rail
- Work Walls 78" and Larger will Ship in 4 Pieces
- See Accessories on Next Page

**TALL TOOL RAIL WORK WALL
FOR WALL MOUNT HUTCHES
WITH PAPER SLOTS**

**USE OVER 30”H CREDENZA
19” TALL**



Must Specify (in this order):
 Model #
 Tackboard on Top or Bottom
 Dry Erase on Top or Bottom
 Tackboard Fabric Vendor, Pattern,
 and Color

Tackboard/Dry Erase Locations

- TB-TB: Tackboard Over Tackboard (Use Grade Prices)
- DEB-TB: Dry Erase Over Tackboard (Use Grade Prices)
- DEB-DEB: Dry Erase Over Dry Erase (Use Grade 1 Prices)

Model #	Size	COM ydg	COM, 1, 2 or 3	Grades						
				4	5	6	7	8	9	10
WW-19108TRWPS	108"	3.50	\$ 1654	2141	2368	2599	2928	3271	3670	4132
WW-19102TRWPS	102"	3.25	\$ 1555	2007	2218	2433	2738	3057	3427	3856
WW-1996TRWPS	96"	3.00	\$ 1507	1924	2119	2317	2599	2893	3235	3631
WW-1990TRWPS	90"	2.75	\$ 1419	1801	1980	2162	2420	2690	3003	3366
WW-1984TRWPS	84"	2.50	\$ 1258	1606	1768	1933	2168	2413	2698	3028
WW-1978TRWPS	78"	2.50	\$ 1203	1551	1713	1878	2113	2358	2643	2973
WW-1972TRWPS	72"	2.25	\$ 1004	1317	1463	1612	1823	2044	2300	2597
WW-1966TRWPS	66"	2.00	\$ 953	1231	1361	1493	1681	1877	2105	2369
WW-1960TRWPS	60"	2.00	\$ 901	1179	1309	1441	1629	1825	2053	2317
WW-1954TRWPS	54"	1.75	\$ 871	1114	1228	1344	1508	1680	1879	2110
WW-1948TRWPS	48"	1.50	\$ 818	1027	1124	1223	1364	1511	1682	1880
WW-1942TRWPS	42"	1.25	\$ 756	930	1011	1094	1211	1334	1476	1641
WW-1936TRWPS	36"	1.25	\$ 741	915	996	1079	1196	1319	1461	1626
WW-1930TRWPS	30"	1.00	\$ 684	823	888	954	1048	1146	1260	1392

Description

- Aluminum Tool Rail
- Work Walls 78" and Larger will Ship in 4 Pieces
- See Accessories on Next Page

[See Canvas Intro Section for Ordering Options](#)

Item	Model No.		Width	Depth	Height	Ship Wt	Cubic Ft	List Price
LEGAL TRAY	01-LGLTRAYC	Clear	14 $\frac{7}{8}$	10 $\frac{1}{2}$	1 $\frac{1}{8}$			\$ 115

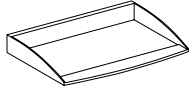

FOLDER SORTER	01-FLDRSRTRC	Clear	7 $\frac{1}{4}$	12 $\frac{3}{8}$	7 $\frac{1}{8}$			\$ 129
---------------	--------------	-------	-----------------	------------------	-----------------	--	--	--------

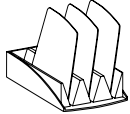

ACCESSORIES TRAY	01-ACCTRAYC	Clear	9 $\frac{1}{4}$	10 $\frac{1}{8}$	1 $\frac{1}{8}$			\$ 125
------------------	-------------	-------	-----------------	------------------	-----------------	--	--	--------

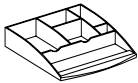

[See Canvas Intro Section for Ordering Options](#)

**TACKBOARDS
FOR SURFACE MOUNT HUTCHES**

23" TALL

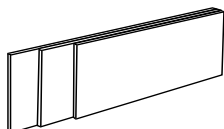

Must Specify (in this order):
Model #
Fabric Vendor, Pattern, and Color

Model #	Size	COM ydg	COM, 1, 2 or 3	Grades						
				4	5	6	7	8	9	10
TB-6696H	96"	3.00	\$ 707	1124	1319	1517	1799	2093	2435	2831
TB-6690H	90"	2.75	\$ 673	1055	1234	1416	1674	1944	2257	2620
TB-6684H	84"	2.50	\$ 639	987	1149	1314	1549	1794	2079	2409
TB-6678H	78"	2.50	\$ 628	976	1138	1303	1538	1783	2068	2398
TB-6672H	72"	2.25	\$ 566	879	1025	1174	1385	1606	1862	2159
TB-6666H	66"	2.00	\$ 533	811	941	1073	1261	1457	1685	1949
TB-6660H	60"	2.00	\$ 498	776	906	1038	1226	1422	1650	1914
TB-6654H	54"	1.75	\$ 485	728	842	958	1122	1294	1493	1724
TB-6648H	48"	1.50	\$ 436	645	742	841	982	1129	1300	1498
TB-6642H	42"	1.25	\$ 396	570	651	734	851	974	1116	1281
TB-6636H	36"	1.25	\$ 385	559	640	723	840	963	1105	1270
TB-6630H	30"	1.00	\$ 346	485	550	616	710	808	922	1054

Description
• All Tackboards 78" and Longer will Ship in 2 Pieces

**TACKBOARDS
FOR SURFACE MOUNT HUTCHES
WITH PAPER SLOTS**

19" TALL

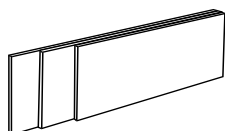

Must Specify (in this order):
Model #
Fabric Vendor, Pattern, and Color

Model #	Size	COM ydg	COM, 1, 2 or 3	Grades						
				4	5	6	7	8	9	10
TB-1996HPS	96"	3.00	\$ 635	1052	1247	1445	1727	2021	2363	2759
TB-1990HPS	90"	2.75	\$ 609	991	1170	1352	1610	1880	2193	2556
TB-1984HPS	84"	2.50	\$ 575	923	1085	1250	1485	1730	2015	2345
TB-1978HPS	78"	2.50	\$ 566	914	1076	1241	1476	1721	2006	2336
TB-1972HPS	72"	2.25	\$ 510	823	969	1118	1329	1550	1806	2103
TB-1966HPS	66"	2.00	\$ 476	754	884	1016	1204	1400	1628	1892
TB-1960HPS	60"	2.00	\$ 445	723	853	985	1173	1369	1597	1861
TB-1954HPS	54"	1.75	\$ 433	676	790	906	1070	1242	1441	1672
TB-1948HPS	48"	1.50	\$ 390	599	696	795	936	1083	1254	1452
TB-1942HPS	42"	1.25	\$ 352	526	607	690	807	930	1072	1237
TB-1936HPS	36"	1.25	\$ 343	517	598	681	798	921	1063	1228
TB-1930HPS	30"	1.00	\$ 311	450	515	581	675	773	887	1019

Description
• All Tackboards 78" and Longer will Ship in 2 Pieces

[See Canvas Intro Section for Ordering Options](#)

TACKBOARDS FOR WALL MOUNT HUTCHES

USE OVER 21"H CREDENZA
31" TALL

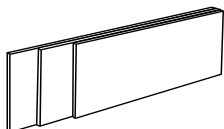

Must Specify (in this order):
Model #
Fabric Vendor, Pattern, and Color

Model #	Size	COM ydg	COM, 1, 2 or 3	Grades						
				4	5	6	7	8	9	10
TB-31108W	108"	3.50	\$ 1014	1501	1728	1959	2288	2631	3030	3492
TB-31102W	102"	3.25	\$ 969	1421	1632	1847	2152	2471	2841	3270
TB-3196W	96"	3.00	\$ 943	1360	1555	1753	2035	2329	2671	3067
TB-3190W	90"	2.75	\$ 899	1281	1460	1642	1900	2170	2483	2846
TB-3184W	84"	2.50	\$ 851	1199	1361	1526	1761	2006	2291	2621
TB-3178W	78"	2.50	\$ 836	1184	1346	1511	1746	1991	2276	2606
TB-3172W	72"	2.25	\$ 772	1085	1231	1380	1591	1812	2068	2365
TB-3166W	66"	2.00	\$ 738	1016	1146	1278	1466	1662	1890	2154
TB-3160W	60"	2.00	\$ 691	969	1099	1231	1419	1615	1843	2107
TB-3154W	54"	1.75	\$ 656	899	1013	1129	1293	1465	1664	1895
TB-3148W	48"	1.50	\$ 598	807	904	1003	1144	1291	1462	1660
TB-3142W	42"	1.25	\$ 539	713	794	877	994	1117	1259	1424
TB-3136W	36"	1.25	\$ 525	699	780	863	980	1103	1245	1410
TB-3130W	30"	1.00	\$ 473	612	677	743	837	935	1049	1181

Description

- All Tackboards 78" and Longer will Ship in 2 Pieces

TACKBOARDS FOR WALL MOUNT HUTCHES WITH PAPER SLOTS

USE OVER 21"H CREDENZA
27" TALL

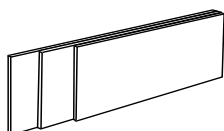

Must Specify (in this order):
Model #
Fabric Vendor, Pattern, and Color

Model #	Size	COM ydg	COM, 1, 2 or 3	Grades						
				4	5	6	7	8	9	10
TB-27108WPS	108"	3.50	\$ 929	1416	1643	1874	2203	2546	2945	3407
TB-27102WPS	102"	3.25	\$ 887	1339	1550	1765	2070	2389	2759	3188
TB-2796WPS	96"	3.00	\$ 864	1281	1476	1674	1956	2250	2592	2988
TB-2790WPS	90"	2.75	\$ 829	1211	1390	1572	1830	2100	2413	2776
TB-2784WPS	84"	2.50	\$ 783	1131	1293	1458	1693	1938	2223	2553
TB-2778WPS	78"	2.50	\$ 767	1115	1277	1442	1677	1922	2207	2537
TB-2772WPS	72"	2.25	\$ 707	1020	1166	1315	1526	1747	2003	2300
TB-2766WPS	66"	2.00	\$ 671	949	1079	1211	1399	1595	1823	2087
TB-2760WPS	60"	2.00	\$ 627	905	1035	1167	1355	1551	1779	2043
TB-2754WPS	54"	1.75	\$ 598	841	955	1071	1235	1407	1606	1837
TB-2748WPS	48"	1.50	\$ 545	754	851	950	1091	1238	1409	1607
TB-2742WPS	42"	1.25	\$ 492	666	747	830	947	1070	1212	1377
TB-2736WPS	36"	1.25	\$ 481	655	736	819	936	1059	1201	1366
TB-2730WPS	30"	1.00	\$ 433	572	637	703	797	895	1009	1141

Description

- All Tackboards 78" and Longer will Ship in 2 Pieces

[See Canvas Intro Section for Ordering Options](#)

**TACKBOARDS
FOR WALL MOUNT HUTCHES**

23" TALL

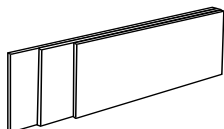

Must Specify (in this order):
Model #
Fabric Vendor, Pattern, and Color

Model #	Size	COM ydg	COM, 1, 2 or 3	Grades												
				4	5	6	7	8	9	10						
TB-66108W	108"	3.50	\$ 845	1332	1559	1790	2119	2462	2861	3323						
TB-66102W	102"	3.25	\$ 805	1257	1468	1683	1988	2307	2677	3106						
TB-6696W	96"	3.00	\$ 788	1205	1400	1598	1880	2174	2516	2912						
TB-6690W	90"	2.75	\$ 751	1133	1312	1494	1752	2022	2335	2698						
TB-6684W	84"	2.50	\$ 711	1059	1221	1386	1621	1866	2151	2481						
TB-6678W	78"	2.50	\$ 698	1046	1208	1373	1608	1853	2138	2468						
TB-6672W	72"	2.25	\$ 642	955	1101	1250	1461	1682	1938	2235						
TB-6666W	66"	2.00	\$ 609	887	1017	1149	1337	1533	1761	2025						
TB-6660W	60"	2.00	\$ 566	844	974	1106	1294	1490	1718	1982						
TB-6654W	54"	1.75	\$ 539	782	896	1012	1176	1348	1547	1778						
TB-6648W	48"	1.50	\$ 492	701	798	897	1038	1185	1356	1554						
TB-6642W	42"	1.25	\$ 446	620	701	784	901	1024	1166	1331						
TB-6636W	36"	1.25	\$ 434	608	689	772	889	1012	1154	1319						
TB-6630W	30"	1.00	\$ 394	533	598	664	758	856	970	1102						

Description

- All Tackboards 78" and Longer will Ship in 2 Pieces
- Not Compatible with Gallery Screens; Consider Work Wall Applications

**TACKBOARDS
FOR WALL MOUNT HUTCHES
WITH PAPER SLOTS**

19" TALL

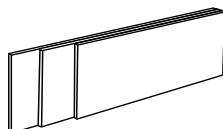

Must Specify (in this order):
Model #
Fabric Vendor, Pattern, and Color

Model #	Size	COM ydg	COM, 1, 2 or 3	Grades												
				4	5	6	7	8	9	10						
TB-19108WPS	108"	3.50	\$ 758	1245	1472	1703	2032	2375	2774	3236						
TB-19102WPS	102"	3.25	\$ 723	1175	1386	1601	1906	2225	2595	3024						
TB-1996WPS	96"	3.00	\$ 708	1125	1320	1518	1800	2094	2436	2832						
TB-1990WPS	90"	2.75	\$ 676	1058	1237	1419	1677	1947	2260	2623						
TB-1984WPS	84"	2.50	\$ 638	986	1148	1313	1548	1793	2078	2408						
TB-1978WPS	78"	2.50	\$ 626	974	1136	1301	1536	1781	2066	2396						
TB-1972WPS	72"	2.25	\$ 578	891	1037	1186	1397	1618	1874	2171						
TB-1966WPS	66"	2.00	\$ 542	820	950	1082	1270	1466	1694	1958						
TB-1960WPS	60"	2.00	\$ 502	780	910	1042	1230	1426	1654	1918						
TB-1954WPS	54"	1.75	\$ 481	724	838	954	1118	1290	1489	1720						
TB-1948WPS	48"	1.50	\$ 442	651	748	847	988	1135	1306	1504						
TB-1942WPS	42"	1.25	\$ 398	572	653	736	853	976	1118	1283						
TB-1936WPS	36"	1.25	\$ 388	562	643	726	843	966	1108	1273						
TB-1930WPS	30"	1.00	\$ 351	490	555	621	715	813	927	1059						

Description

- All Tackboards 78" and Longer will Ship in 2 Pieces
- Not Compatible with Gallery Screens; Consider Work Wall Applications

[See Canvas Intro Section for Ordering Options](#)

**TACKBOARDS
FOR DUAL ACCESS OPEN HUTCHES**

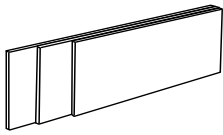

Model #	Coordinating Unit	COM ydg	COM, 1, 2 or 3	Grades									
				4	5	6	7	8	9	10			
TB-1334	66-1572DAOH	1.25	\$ 446	620	701	784	901	1024	1166	1331			
TB-1331	66-1566DAOH	1.00	\$ 377	516	581	647	741	839	953	1085			
TB-1328	66-1560DAOH	1.00	\$ 351	490	555	621	715	813	927	1059			

Description

- Includes 2 Tackboards

Must Specify (in this order):

Model #
Fabric Vendor, Pattern, and Color

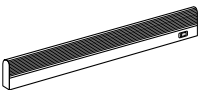
Item	Model No.	Width	Depth	Height	Ship Wt	Cubic Ft	List Price
LED TASKLIGHT 	TL-0848 <i>240-LED, 18 Watts</i>	47½	7/8	1½	-	-	\$ 445
	TL-0824 <i>84-LED, 7 Watts</i>	22½	7/8	1½	-	-	\$ 368

Description

- Includes the Power Supply and Three Upper Wire Management Grommets
- Rocker Style On/Off Switch with a 10' Power Cord
- Grommet Color will Match Lower Grommet Color

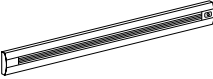
LED TASKLIGHT 	01-188LED58 <i>96-LED, 33.7 Watts</i>	57¾	2	¾	-	-	\$ 1648
	01-94LED31 <i>48-LED, 17.6 Watts</i>	30½	2	¾	-	-	\$ 1195
	01-47LED17 <i>24-LED, 9.1 Watts</i>	16¾	2	¾	-	-	\$ 690

Description

- Includes the Power Supply and Three Upper Wire Management Grommets
- 12' Power Cord
- Grommet Color will Match Lower Grommet Color
- Optional Occupancy Sensor Shuts Off After 30 Minutes of Inactivity and Turns On Immediately When Reentering the Detection Area

Options: Specify & Add

01-OSRP	Occupancy Sensor	\$ 366
---------	------------------	--------

See next page for Accessories, Power, Data, Communication

[See Canvas Intro Section for Ordering Options](#)

Item	Model No.		Width	Depth	Height	Ship Wt	Cubic Ft	List Price	
 <p>Must Specify (in this order): Model # Color</p>	L SHELF	66-1596LS	192 lbs Weight Limit	96	15	17	85	18.3	T\$ 1147
	66-1590LS	192 lbs Weight Limit	90	15	17	80	17.2	T\$ 1090	
	66-1584LS	154 lbs Weight Limit	84	15	17	75	16.0	T\$ 1034	
	66-1578LS	154 lbs Weight Limit	78	15	17	70	14.9	T\$ 979	
	66-1572LS	154 lbs Weight Limit	72	15	17	65	13.8	T\$ 922	
	66-1566LS	128lbs Weight Limit	66	15	17	60	12.7	T\$ 869	
	66-1560LS	128 lbs Weight Limit	60	15	17	55	11.6	T\$ 815	
	66-1554LS	90 lbs Weight Limit	54	15	17	50	10.5	T\$ 761	
	66-1548LS	90 lbs Weight Limit	48	15	17	45	9.3	T\$ 709	
	66-1542LS	90 lbs Weight Limit	42	15	17	40	8.2	T\$ 656	
	66-1536LS	64 lbs Weight Limit	36	15	17	35	7.1	T\$ 601	
	66-1530LS	64 lbs Weight Limit	30	15	17	30	6.0	T\$ 546	

Description

- Weight Capacity is a Distributed Load
- Not Liable for Wall Mount Units that are not Properly Installed

Item	Model No.		Width	Depth	Height	Ship Wt	Cubic Ft	List Price	
 <p>Must Specify (in this order): Model # Color</p>	FLOATING SHELF	66-0996FS	123 lbs Weight Limit	96	9	1	20	2.2	T\$ 785
	66-0990FS	123 lbs Weight Limit	90	9	1	19	2.1	T\$ 753	
	66-0984FS	99 lbs Weight Limit	84	9	1	18	1.9	T\$ 719	
	66-0978FS	99 lbs Weight Limit	78	9	1	16	1.8	T\$ 687	
	66-0972FS	99 lbs Weight Limit	72	9	1	16	1.6	T\$ 655	
	66-0966FS	82 lbs Weight Limit	66	9	1	14	1.5	T\$ 614	
	66-0960FS	82 lbs Weight Limit	60	9	1	13	1.4	T\$ 572	
	66-0954FS	57 lbs Weight Limit	54	9	1	12	1.3	T\$ 534	
	66-0948FS	57 lbs Weight Limit	48	9	1	10	1.1	T\$ 494	
	66-0942FS	57 lbs Weight Limit	42	9	1	9	0.9	T\$ 454	
	66-0936FS	40 lbs Weight Limit	36	9	1	8	0.8	T\$ 411	
	66-0930FS	40 lbs Weight Limit	30	9	1	6	0.7	T\$ 372	

Description

- Weight Capacity is a Distributed Load
- Not Liable for Wall Mount Units that are not Properly Installed

[See Canvas Intro Section for Ordering Options](#)

Item	Model No.	Width	Depth	Height	Ship Wt	Cubic Ft	List Price
VISUAL BOARD	66-4848VB	48	5	48	150	11.0	T\$ 2770

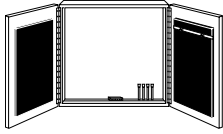

Description

- Standard with: Flipchart, Set of Four Dry Erase Markers, Eraser, Mounting Hardware, Tackboard on Each Door in Black Fabric, Display Rail with Adjustable Hooks for Flipchart
- Price Valid for Fabric Grades 1, 2, and 3
- Does Not Feature Soft Close Hinges
- Magnetic Porcelain Non-Glare Writing Surface

Must Specify (in this order):

- Model #
- Color
- Door Grain Direction
- Tackboard Fabric Vendor, Pattern, and Color
- Pull
- Projection Screen Installation

Options: Specify & Add

	GRADE	4	5	6	7	8	9	10
TB-4214 Tackboard		\$ 278	408	540	728	924	1152	1416
1-PS Optional Factory Installed Projection Screen								\$ 1062

CUSHIONS

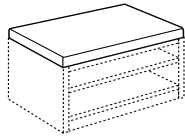

Must Specify (in this order):

- Model #
- Fabric Vendor, Pattern, and Color

Model #	Size	COM Ydg	COM, 1, 2 or 3	Grades									
				4	5	6	7	8	9	10	L1	L2	
66-24108CUSHION	108"	3.25	\$ 790	1242	1453	1668	1973	2292	2662	3091	1863	2321	
66-2490CUSHION	90"	2.75	\$ 715	1097	1276	1458	1716	1986	2299	2662	1623	2010	
66-2472CUSHION	72"	2.25	\$ 604	917	1063	1212	1423	1644	1900	2197	1347	1664	
66-2460CUSHION	60"	2.00	\$ 523	801	931	1063	1251	1447	1675	1939	1183	1465	
66-2436CUSHION	36"	1.25	\$ 445	619	700	783	900	1023	1165	1330	858	1034	
66-2430CUSHION	30"	1.25	\$ 385	559	640	723	840	963	1105	1270	798	974	
66-20108CUSHION	108"	3.25	\$ 746	1198	1409	1624	1929	2248	2618	3047	1819	2277	
66-2090CUSHION	90"	2.75	\$ 675	1057	1236	1418	1676	1946	2259	2622	1583	1970	
66-2072CUSHION	72"	2.25	\$ 569	882	1028	1177	1388	1609	1865	2162	1312	1629	
66-2060CUSHION	60"	2.00	\$ 495	773	903	1035	1223	1419	1647	1911	1155	1437	
66-2036CUSHION	36"	1.25	\$ 416	590	671	754	871	994	1136	1301	829	1005	
66-2030CUSHION	30"	1.25	\$ 361	535	616	699	816	939	1081	1246	774	950	
66-1519CUSHION	15"	0.75	\$ 331	435	484	534	604	678	763	862	579	684	

Description

- For Use with Mobile Pedestals; [See Mobile Peds](#)
- Increases Height of Mobile Pedestal 2 1/4"

CENTER DRAWER

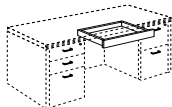

Must Specify (in this order):

- Model #
- Color
- Drawer Front Grain
- Factory Installed

66-1622CD	22	16	2	7	1.4	T\$ 401
-----------	----	----	---	---	-----	---------

Description

- Fits Desks, P-Top Units, and D-Top Units
- Will Not Work in Conjunction with Height Adjustable Mechanisms or Modesty Panels on 30" D-Top Units



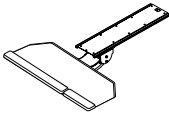
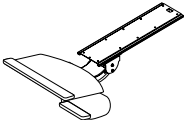
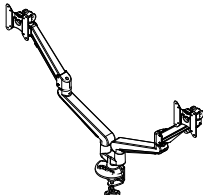
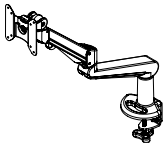

Options: Specify & Add

CD16 Factory Installed	\$ 208
------------------------	--------

[See Canvas Intro Section for Ordering Options](#)

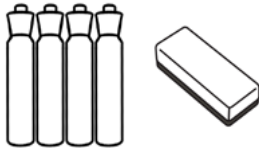
Item	Model No.		Width	Depth	Height	Ship Wt	Cubic Ft	List Price									
ARTICULATING KEYBOARD CORNER PLATFORM	01-KB2CC		25	10½	4½	16	1.4	\$ 832									
	<p>Description</p> <ul style="list-style-type: none"> • Standard With: +/- 15° Tilt Adjustment , 360° Rotation, Independent Tilt Adjustment, 7" Lift and Lock Height Adjustment, 25" Cut Corner Platform • Keyboard and Mouse on same level; Single Palm Rest for both Left & Right Hands • Works with 17"+ Diagonal Work Surface • Cannot Be Used on 20" or 21" Deep Unit • Not Available with Optional Center Grommet • Track Measures 21" <p>Options: Specify & Add</p> <table border="1"> <tr> <td>KB2CC</td> <td>Factory Installed</td> <td></td> <td></td> <td></td> <td></td> <td></td> <td></td> <td>\$ 208</td> </tr> </table>								KB2CC	Factory Installed							\$ 208
KB2CC	Factory Installed							\$ 208									
KEYBOARD MECHANISM WITH KEYBOARD CLAMP	01-KB3		26½	14	4.5	16	1.4	\$ 914									
	<p>Description</p> <ul style="list-style-type: none"> • Standard With: 18.75" Platform with Swivel-Below Mouse Platform,+/- 15° Tilt Adjustment, 360° Rotation, 7" Lift and Lock Height Adjustment, Independent Tilt Adjustment, Palm Rest for Mousing Surface • Left or Right Handed Mouse Platform • Cannot Be Used on 20" or 21" Deep Unit • Not Available with Optional Center Grommet • Track Measures 21" <p>Options: Specify & Add</p> <table border="1"> <tr> <td>KB3</td> <td>Factory Installed</td> <td></td> <td></td> <td></td> <td></td> <td></td> <td></td> <td>\$ 208</td> </tr> </table>								KB3	Factory Installed							\$ 208
KB3	Factory Installed							\$ 208									
DUAL ARTICULATING MONITOR ARM	01-MLEDGE2A	Aluminum	-	-	6½-19½	15	1.4	\$ 1313									
	01-MLEDGE2B	Black															
	<p>Description</p> <ul style="list-style-type: none"> • Dual Mount with Independent Adjustment Includes Desk Clamp, Grommet Mount, and Enclosed Cable Management • 180° Lockout Feature • 21" Monitor Extension; 3.5" Monitor Retraction • +30/-25° Monitor Tilt; 360° Swivel at Two Points with 17.6lb Weight Capacity per Arm • VESA 75mm and VESA 100mm Compatible with Quick Monitor Release 																
SINGLE MONITOR ARM	01-MLEDGE1A	Aluminum	-	-	6½-19½	13	2.2	\$ 773									
	01-MLEDGE1B	Black															
	<p>Description</p> <ul style="list-style-type: none"> • Includes Desk Clamp, Grommet Mount, and Enclosed Cable Management • 180° Lockout Feature • 21" Monitor Extension; 3.5" Monitor Retraction • +30/-25° Monitor Tilt; 17.6lb Weight Capacity • VESA 75mm and VESA 100mm Compatible with Quick Monitor Release 																

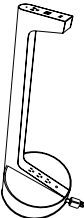
[See Canvas Intro Section for Ordering Options](#)

Item	Model No.	Width	Depth	Height	Ship Wt	Cubic Ft	List Price
PURSE HOOK FOR WORK TABLE	01-HOOK	2	1¼	2½ ₂₅			\$ 79
	Description	<ul style="list-style-type: none"> • Black Hook Includes Mounting Hardware • For Use with Work Tables, See Work Tables • Field Installed 					
MARKER AND ERASER SET	01-MRKRSETBL For Use with Black Marker Boards and Black Glass Doors						\$ 123
	01-MRKRSETWH For Use with White Marker Boards and White Glass Doors	Description					
		<ul style="list-style-type: none"> • 01-MRKRSETWH May Also be Used with Dry Erase Doors and Boards • Includes 4 Markers and an Eraser 					
RARE EARTH MAGNET SET	01-MAGBL For Use with White Marker Boards						\$ 114
	01-MAGWH For Use with Black Marker Boards	Description					
		<ul style="list-style-type: none"> • Includes Set of Five (5) Rare Earth Magnets • To be Used with Tempered Glass Magnetic Marker Boards • Comfort Grip with Stylish Protective Plastic Coating 					
VESTA POWER CENTER	01-PDCTR	10¾	12	28¼	14	2.5	\$ 1776
	Description	<ul style="list-style-type: none"> • Top Includes One (1) Power Outlet, Two (2) USB Ports and One (1) USBC Port; Base Includes Three (3) Outlet • Available in White • 120" Power Cord • Built with Weight Distribution for Optimal Stability • Base is 5" Tall 					
INTERACT POWER & DATA	01-INTERACTG2A Aluminum	9	5¾	2¾	5	0.2	\$ 891
	01-INTERACTG2B Black	Description					
		<ul style="list-style-type: none"> • Includes: Two (2) Power Outlets, Two (2) USB-A Charging Ports, One (1) Telecom Plate Opening; Two (2) Keystone Openings for Voice/Data Jacks • One (1) Telecom Plates Included with the Unit: One (1) 01-ABLAB Plate (Consists of One (1) RJ45 Cat 6, One (1) RJ11 Cat 3 Phone Jack) • Convenience Plug on Bottom with 6' Power Cord • UL and CSA Recognized • See Optional Telecom Plates in the Table and Space Division Price List • For Use with Rectangle and Boat Table Tops 					

[See Canvas Intro Section for Ordering Options](#)

Item	Model No.		Width	Depth	Height	Ship Wt	Cubic Ft	List Price
POWER DATA PORT	01-DPORT4A	Aluminum	8	4	-	7	0.2	\$ 1093
	01-DPORT4B	Black	8	4	-	7	0.2	\$ 1093

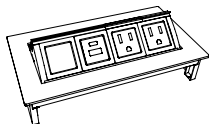

Description

- Retracts into Worksurface to Regain Productive Space
- One-Touch Access to Power and Data
- Two Power Outlets and Two Open Ports for Data
- Water-Proof Simplex (Outlets)
- Includes a Voice/Data Adapter Kit to Accept Couplers and Jacks When Required 6' Power Cord
- Only Available on 66-4872TP, 66-4866TP, 66-4860TP, 66-3672TP, 66-3072TP, 66-3066TP and 66-3060TP Modular Desktops ([See Modular Tops](#)) Centered, One End

USB PORT	01-USBPORT		-	-	-	-	-	\$ 161
----------	------------	--	---	---	---	---	---	--------

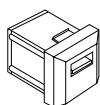

Description

- Passive USB-A Port with Increased Transfer Speed Up to 5 gbs/sec
- Simultaneous Read/Write Capability
- Idle Device Power Saving State
- 6' Cord

VOICE COUPLER	01-VOICE1		-	-	-	-	-	\$ 73
---------------	-----------	--	---	---	---	---	---	-------

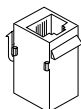

Description

- For Use with 01-DPORT4A and 01-DPORT4B
- 6-Pin Modular Plug
- Molded Black
- Cord Not included

DATA PORT	01-RJ4DATA		-	-	-	-	-	\$ 167
-----------	------------	--	---	---	---	---	---	--------



OPEN MARKET ONLY

Description

- For Use with 01-DPORT4A and 01-DPORT4B
- 8-Pin Modular Plug; Cat6 Ethernet Cable; Pre-terminated Cable
- 10' Cord

DOCK 950 WIRELESS CHARGER	01-DOCK950W	White		3¾"	3¾"	-	1	0.2	\$ 265
	01-DOCK950B	Black							



OPEN MARKET ONLY

Description

- For Use with Wireless Charging Enabled Devices
- 5 Watts Maximum Output with a Direct Current of 5V 2A and 10 Watts Maximum with Quick Charge 2.0
- Mounts in 76mm Round Cut-Out
- LED will Confirm Pairing with Device and Begin Wireless Charging

[See Canvas Intro Section for Ordering Options](#)

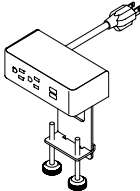
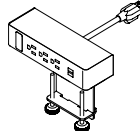
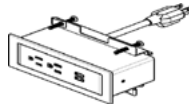
Item	Model No.		Width	Depth	Height	Ship Wt	Cubic Ft	List Price	
DOCK 150 WIRELESS AND USB CHARGER	01-DOCK150W	White	3	3	¾	1	0.2	\$ 405	
	01-DOCK150B	Black							
		 <p>OPEN MARKET ONLY</p> <p>Description</p> <ul style="list-style-type: none"> • For Use with Wireless Charging Enabled Devices and USB Charging Devices • 5 Watt Maximum Output with a Direct Current Input of 5V 6A (Wireless Fast Charge) • Mounts in 76mm Round Cut-Out • Pop-Up is ¾"H and Includes Three (3) USB Ports; One (1) 12 Watt Maximum with 2.4A (USB Fast Charge) and Two (2) 5 Watt with 1A (USB Standard Charge) • LED Light will Confirm Pairing with Device and Begin Wireless Charging • UL and cUL Certified 							
DUO CLAMP NEMA PLUG	01-DUOCLAMPW	White	5½	3	7	1	0.2	\$ 572	
	01-DUOCLAMPB	Black							
	01-DUOCLAMP S	Silver							
		 <p>Description</p> <ul style="list-style-type: none"> • Clamps to Top; All Mounting Hardware Included • Silver Metal Trim • Two (2) Power/Two (2) USB Power • Independent USB Circuit Controllers Deliver up to 2.1 Amps to Each Post • FCC Part 15A and UL Approved for Horizontal and Vertical Applications • 10' Cord 							
TRIO CLAMP NEMA PLUG	01-TRIOCLAMPW	White	8	3	7	1	0.2	\$ 671	
	01-TRIOCLAMPB	Black							
	01-TRIOCLAMP S	Silver							
		 <p>Description</p> <ul style="list-style-type: none"> • Clamps to Top; All Mounting Hardware Included • Silver Metal Trim • Three (3) Power/Two (2) USB Power/One (1) Open Data • Independent USB Circuit Controllers Deliver up to 2.1 Amps to Each Post • HDMI, VGA, or RJ45 Accessories Sold Separately • FCC Part 15A and UL Approved for Horizontal and Vertical Applications • 10' Cord 							
DUO BEZEL NEMA PLUG	01-DUOBEZELW	White	6½	2 ¼	3	1	0.2	\$ 675	
	01-DUOBEZELB	Black							
	01-DUOBEZEL S	Silver							
		 <p>Description</p> <ul style="list-style-type: none"> • Sits On Top of the Worksurface; All Mounting Hardware Included • Two (2) Power/Two (2) USB Power • Independent USB Circuit Controllers Deliver up to 2.1 Amps to Each Post • FCC Part 15A and UL Approved for Horizontal and Vertical Applications • 10' Cord 							

[See Canvas Intro Section for Ordering Options](#)

Item	Model No.		Width	Depth	Height	Ship Wt	Cubic Ft	List Price
	01-TRIOBEZELW	White	9	2½	3	1	0.2	\$ 725
	01-TRIOBEZELB	Black						
	01-TRIOBEZELS	Silver						

Description

- Sits On Top of the Worksurface
- Three (3) Power/Two (2) USB Power/One (1) Open Data
- Independent USB Circuit Controllers Deliver up to 2.1 Amps to Each Post
- HDMI, VGA, or RJ45 Accessories Sold Separately
- All Mounting Hardware Included
- FCC Part 15A and UL Approved for Horizontal and Vertical Applications
- 10' Cord

DUO BEZEL HARD WIRE

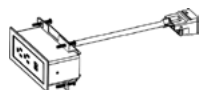

Circuit 1								
01-HWDUOBEZELW1	White	6½	2½	3	1	0.2	\$	730
01-HWDUOBEZELB1	Black							
01-HWDUOBEZELS1	Silver							
Circuit 2								
01-HWDUOBEZELW2	White	6½	2½	3	1	0.2	\$	730
01-HWDUOBEZELB2	Black							
01-HWDUOBEZELS2	Silver							
Circuit 3								
01-HWDUOBEZELW3	White	6½	2½	3	1	0.2	\$	730
01-HWDUOBEZELB3	Black							
01-HWDUOBEZELS3	Silver							
Circuit 4								
01-HWDUOBEZELW4	White	6½	2½	3	1	0.2	\$	730
01-HWDUOBEZELB4	Black							
01-HWDUOBEZELS4	Silver							

Description

- Must Specify Color and Circuit
- Sits on worksurface and includes: Two (2) Power, Two (2) USB Power, and all mounting hardware
- Independent USB Circuit Controllers Deliver up to 2.1 Amps to Each Post
- FCC Part 15A and UL Approved for Horizontal and Vertical Applications
- Maximum 10 Duo Units per Circuit
- Eight (8) Wire/Four (4) Circuit Hard Wire Power Unit

[See Canvas Intro Section for Ordering Options](#)

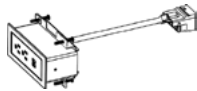
Item	Model No.		Width	Depth	Height	Ship Wt	Cubic Ft	List Price	
TRIO BEZEL HARD WIRE 	Circuit 1								
	01-HWTRIOBEZELW1	White	9	2½	3	1	0.2	\$ 749	
	01-HWTRIOBEZELB1	Black							
	01-HWTRIOBEZELS1	Silver							
	Circuit 2								
	01-HWTRIOBEZELW2	White	9	2½	3	1	0.2	\$ 749	
	01-HWTRIOBEZELB2	Black							
	01-HWTRIOBEZELS2	Silver							
	Circuit 3								
	01-HWTRIOBEZELW3	White	9	2½	3	1	0.2	\$ 749	
	01-HWTRIOBEZELB3	Black							
	01-HWTRIOBEZELS3	Silver							
Circuit 4									
01-HWTRIOBEZELW4	White	9	2½	3	1	0.2	\$ 749		
01-HWTRIOBEZELB4	Black								
01-HWTRIOBEZELS4	Silver								

Description

- Must Specify Color and Circuit
- Sits on worksurface and includes: Three (3) Power, Two (2) USB Power, and all mounting hardware
- Independent USB Circuit Controllers Deliver up to 2.1 Amps to Each Post
- FCC Part 15A and UL Approved for Horizontal and Vertical Applications
- Maximum 6 Trio Units per Circuit
- Eight (8) Wire/Four (4) Circuit Hard Wire Power Unit

QUAD BLOCK HARD WIRED	01-HWQUADBLOCK		-	-	-	1	0.2	\$ 62
------------------------------	----------------	--	---	---	---	---	-----	-------

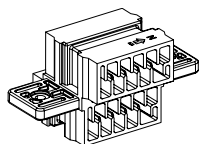
**Description**

- Eight (8) Wire/Four (4) Circuit Hard Wire Connector
- UL183 Compliant
- For Connecting Jumpers and Power Units
- Quantity of Four (4) Female Inputs

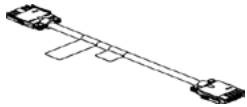
JUMPER HARD WIRE CABLE 	01-HW2JUMP		24	-	-	1	0.2	\$ 193
	01-HW3JUMP		36	-	-	1	0.2	\$ 206
	01-HW4JUMP		48	-	-	1	0.2	\$ 212
	01-HW5JUMP		60	-	-	1	0.2	\$ 255
	01-HW6JUMP		72	-	-	1	0.2	\$ 270

Description

- Eight (8) Wire/Four (4) Circuit Hard Wire Jumper
- UL183 Compliant

[See Canvas Intro Section for Ordering Options](#)

Item	Model No.	Width	Depth	Height	Ship Wt	Cubic Ft	List Price
POWER ENTRY HARD WIRED	01-HWPOWERENTRY	72	-	-	1	0.2	\$ 322

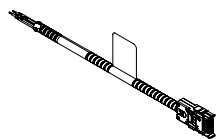

Description

- Eight (8) Wire/Four (4) Circuit Hard Wire Infeed
- UL183 Compliant

OASIS MINI POWER & DATA	01-OASISMA	Aluminum	14¼	6¾	2⅞	11	0.3	\$ 3191
	01-OASISMB	Black						



Top View

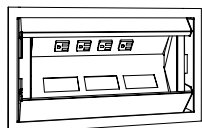

Description

- For Use with Conference Tables
- Plate Includes: Two (2) Data, One (1) Voice Telecom Plates, Four (4) Power Outlets, 9' Power Cord
- Opening for One (1) Additional Plate Sold Separately
- Soft Touch Hinged Lid
- 9' Cord with Nema Plug; Fits 15A/120V AC Receptacles
- UL Listed
- See Optional Telecom Plates in the Table and Space Division Price List

DUO BEZEL DAISY CHAIN PLUG	01-PDUOBEZELW	White	6½	2½	3	1	0.2	\$ 668
	01-PDUOBEZELB	Black						
	01-PDUOBEZELS	Silver						

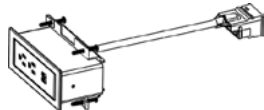

Description

- Sits On Top of the Worksurface
- Unit Includes Two (2) Power/Two (2) USB Power with a 12" Cord
- Independent USB Circuit Controllers Deliver up to 2.1 Amps to Each Post
- All Mounting Hardware Included
- FCC Part 15A, RU Listed and UL Recognized for Horizontal and Vertical Applications
- Non Sequential System Allows Up to Eight (8) Modules To Be Connected With Jumper Cord
- Requires Power Box

TRIO BEZEL DAISY CHAIN PLUG	01-PTRIOBEZELW	White	9	2½	3	1	0.2	\$ 715
	01-PTRIOBEZELB	Black						
	01-PTRIOBEZELS	Silver						

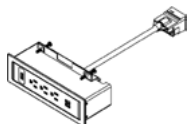

Description

- Sits On Top of the Worksurface
- Unit Includes Three (3) Power/Two (2) USB Power/One (1) Open Data with a 12" Cord
- HDMI, VGA, or RJ45 Accessories Sold Separately
- All Mounting Hardware Included
- FCC Part 15A, RU Listed and UL Recognized for Horizontal and Vertical Applications
- Non Sequential System Allows Up to Eight (8) Modules To Be Connected With Jumper Cord
- Requires Power Box

[See Canvas Intro Section for Ordering Options](#)

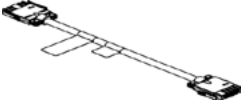
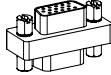
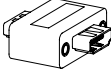
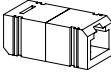
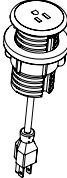
Item	Model No.		Width	Depth	Height	Ship Wt	Cubic Ft	List Price
DAISY CHAIN POWER BOX 	01-PPOWER 76" Perimeter, 36" Power Cord		-	-	-	1	0.2	\$ 775
	01-PPOWER2 24" Perimeter, 144" Power Cord		-	-	-	1	0.2	\$ 796
Description <ul style="list-style-type: none"> • Powers up to Eight (8) Duo and Trio Daisy Chain Units • One (1) Nema Plug and One (1) Daisy Chain Plug • 12 Amp System Rating • 15 Amp Over-Current Protection 								
DAISY CHAIN JUMPER CORD 	01-6JUMP 72" Long		-	-	-	1	0.2	\$ 299
	01-5JUMP 60" Long		-	-	-	1	0.2	\$ 284
	01-4JUMP 48" Long		-	-	-	1	0.2	\$ 240
	01-2JUMP 24" Long		-	-	-	1	0.2	\$ 220
Description <ul style="list-style-type: none"> • Connects Duo and Trio Daisy Chain Units • Non Sequential System Allows up to Eight (8) Modules to be Connected 								
TRIO VGA DATA PORT ACCESSORY 	01-LCOMVGA		-	-	-	1	0.2	\$ 121
Description <ul style="list-style-type: none"> • VGA Port for Trio Bezel Units 								
TRIO HDMI DATA PORT ACCESSORY 	01-LCOMHDMI		-	-	-	1	0.2	\$ 166
Description <ul style="list-style-type: none"> • HDMI Port for Trio Bezel Units 								
OPEN MARKET ONLY								
TRIO RJ45 DATA PORT ACCESSORY 	01-LCOMRJ45		-	-	-	1	0.2	\$ 79
Description <ul style="list-style-type: none"> • RJ45 Port for Trio Bezel Units 								
SINGLE POWER SAND DOLLAR 	01-SAND60PW	White	3	3	4	1	0.2	\$ 98
	01-SAND60PB	Black						
	01-SAND60PS	Silver						
Description <ul style="list-style-type: none"> • Available on Height Adjustable Desks, Returns and Bridge Units with Wire Management Box in Center Grommet Only (GC-BOX) • Unit is 2" Diameter; Mounts in 60mm Round Grommet • Single Power Outlet with a 6' Cord 								

[See Canvas Intro Section for Ordering Options](#)

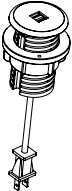
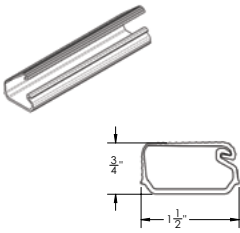
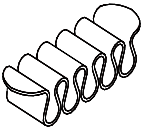
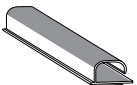
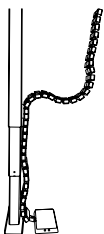
Item	Model No.		Width	Depth	Height	Ship Wt	Cubic Ft	List Price
	01-SAND60UW	White	3	3	4	1	0.2	\$ 277
	01-SAND60UB	Black						
	01-SAND60US	Silver						
	<p>Description</p> <ul style="list-style-type: none"> • Available on Height Adjustable Desks, Returns and Bridge Units with Wire Management Box in Center Grommet Only (GC-BOX) • Unit is 2" Diameter; Mounts in 60mm Round Grommet • Dual USB Outlets with a 6' Cord 							
	01-WMGR4		16	1½	¾	1	-	\$ 116
	<p>Description</p> <ul style="list-style-type: none"> • Set of Four (4) Black Plastic Wire Management Channels • Snap Lock Channel • Attaches with Adhesive Strips • Ships via UPS Only 							
	01-WMGRCB		5 ⅝	2 ⅝		-	-	\$ 17
	<p>Description</p> <ul style="list-style-type: none"> • Under Surface Wire Management • Black 							
	01-32125		24	1⅝	1	.25	0.3	\$ 106
	<p>Description</p> <ul style="list-style-type: none"> • Available in Black • Channels Attach with Two (2) Double-Sided Installation Tape • Open J Channel for Easy Storage of Cables 							
	01-0251LINKSLV	Silver	5⅝	3 ⅝	30-51	4	3.0	\$ 390
	01-0251LINKBLK	Black	5⅝	3 ⅝	30-51	4	3.0	\$ 353
	<p>Description</p> <ul style="list-style-type: none"> • Kit Includes: 50 Link 360™ elements, One (1) Quad Connector, One (1) Dumbbell Connector, One (1) Foot Assembly with Two (2) Magnetic Clips • Can Be Used For Height-Adjustable Mechanisms Up To 51" or Free-Standing Use 							

[See Canvas Intro Section for Ordering Options](#)

A foundational suite of casegoods primed to evolve with your needs. Gesso allows you to combine luxurious veneers, top grade laminates, metal accents, and other materials to create stylish, reconfigurable work spaces and storage options. With integrated height adjustable units, white and black glass door options on hutch and storage units as well as a full line of white and black glass marker boards provide opportunities for more elegant and clean aesthetic.

CONSTRUCTION

Gesso Casegoods feature a Veneer chassis with your choice of either a Veneer or HPL top. Units ship assembled unless otherwise noted.

VENEERS

- Exposed surfaces feature select grade plain sliced hardwood Cherry, Maple, American Black Walnut, White Oak, or composite veneers
- Veneers are carefully selected and matched to assure proper balance and consistency

TOPS

- Veneer and standard High Pressure Laminate (HPL) tops are 3-ply balanced construction and 1 $\frac{3}{16}$ " thick, with 3mm wood edge-banded rims contoured to the selected profile
- Optional 1 $\frac{1}{2}$ " thick HPL worksurfaces are available in select colors. Please contact Customer Service or your local Sales Rep for pricing and lead times. Sugar Maple and Williamsburg Cherry feature ABS edge bands
- Tops are shaped on user and approach sides
- Grain direction runs left to right unless otherwise noted

CHASSIS

- Chassis is securely fastened using high quality European fastening systems and heavy-duty, 16-gauge joining brackets to assure maximum strength
- All units ship with heavy-duty, adjustable leveling glides to ensure proper leveling and compensation for uneven floors
- All desks, non-lateral credenzas, and returns have wire management access from pedestal to kneespace

DRAWERS

- Drawers feature 5-sided construction allowing for easy removal of drawer fronts
- Drawer fronts are 3-ply construction, $\frac{3}{4}$ " thick with matched grain
- Drawer sides, back, and front are $\frac{1}{2}$ " thick, woodgrain vinyl wrapped construction with mitered corners
- Box and file drawers feature full extension, progressive action slides with precision steel ball bearings allowing side-to-side and front-to-back
- Optional soft close on box and file drawers allows front-to-back filing in file drawers
- Optional wood dovetail construction with $\frac{7}{16}$ " thick hardwood sides and backs, and $\frac{5}{32}$ " thick hardboard bottoms
- Box and file drawers have $\frac{1}{8}$ " thick hardboard bottoms and tested for 100lb capacity
- Lateral files feature $\frac{1}{4}$ " thick bottoms. Drawers are tested for 200lb of equally distributed weight (ex: hanging file folders) and 65lbs of bottom load weight (ex: stacked catalogs)
- All suspensions have a limited lifetime warranty

FILING

- All file drawers are standard with filing systems designed to accommodate a variety of filing requirements
- Optional soft close on box and file drawers allows front-to-back filing in file drawer
- Letter width file drawers provide letter filing front-to-back and legal filing side-to-side
- Lateral file drawers provide legal or letter filing front-to-back or side-to-side

STORAGE

- All hinged doors include soft close hinges, unless noted
- Soft close hinges reduce stress placed on the cabinet when the door is closed and offers a quiet closure

LOCKING

- All units with file drawers feature locking
- Removable lock cylinders allow for units to be re-keyed at a later date, if required
- Units are shipped randomly keyed as standard
- Keyed alike units available upon request at no additional charge
- Lock core is predetermined by pull color. Black lock cores are used with black and gold pulls while silver lock cores are used with chrome and aluminum pulls

CORD MANAGEMENT

- Grommets may be ordered in the tops of all assembled desks, returns, bridges, credenzas, and component worksurfaces
- All desks, returns, and credenzas (except lateral pedestals) have standard wire openings from inside the pedestal to the kneespace allowing quick access to technology below
- Additionally, returns, bridge units, kneespace credenzas, and hutch units have standard grommets in back panels
- Grommets are also standard in the tops of corner units and extended corner units
- Grommets are 2 $\frac{3}{8}$ " and are available in black or silver, must specify color
- [See all grommet options](#)
- Undersurface Wire Manager (01-WMGR4) is available for additional cord management; See Accessories

HEIGHT ADJUSTABLE MECHANISMS

- Optional center drawer, Dock 950 and Dock 150, $\frac{3}{4}$ " modesty panels, and kneespace options are not available with height adjustable units
- Height adjustment range 30"H-45"H
- 5-year warranty
- [See Height Adjust Information and Options](#)
- Height Adjustable units begin [here](#)

STUDIO LEGS

- For each of the Studio models, standard or shared legs will need to be specified
- Choose to use four standard, a combination of standard or shared, or all shared legs on each unit
- The below images will provide a guide to the aesthetics of single, double, and shared legs
- Studio components begin [here](#)

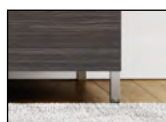

Single Standard Leg



Shared Leg (used between two models)



Double Standard Leg (standard legs used on each model)

INTERIOR DRAWER DIMENSIONS

Models

65-2515SHPD1	67-3672DP	67-3672BRP
65-2415PD1	67-3672LPS	67-3672BDPS
65-1519MP	67-3672RPS	67-3072LP
65-1519MPI	67-3672LP	67-3072RP
67-4872CBLP	67-3672RP	67-3072DP
67-4872CBRP	67-3672DPS	67-3066DP
67-4272CLP	67-3672BLPS	67-3066LP
67-4272CRP	67-3672BRPS	67-3066RP
67-3672BDP	67-3672BLP	67-3066DP

Drawers

	W	L	D
Box	12 $\frac{1}{8}$ "	16 $\frac{3}{16}$ "	3 $\frac{1}{2}$ "
File	12 $\frac{1}{8}$ "	16 $\frac{3}{16}$ "	9 $\frac{5}{16}$ "

Models

65-2415PD2	67-2472SC	67-2466LC2
65-2515SHPD2	67-2472RC2	67-2466KC
65-1519MP2	67-2472LC2	67-2448RF2
67-4824RF2	67-2472KC	67-2448LF2
67-4824LF2	67-2466SC	67-2442RF2
67-4224RF2	67-2466RC2	67-2442LF2

Drawer

	W	L	D
File	12 $\frac{1}{8}$ "	16 $\frac{3}{16}$ "	9 $\frac{5}{16}$ "

Models

67-4824RF1	67-2472RC1	67-2448RF1
67-4824LF1	67-2472LC1	67-2448LF1
67-4224RF1	67-2466RC1	67-2442RF1
67-4224LF1	67-2466LC1	67-2442LF1

Drawers

	W	L	D
Box	12 $\frac{1}{8}$ "	16 $\frac{3}{16}$ "	3 $\frac{1}{2}$ "
File	12 $\frac{1}{8}$ "	16 $\frac{3}{16}$ "	9 $\frac{15}{16}$ "

Models

65-3684WDS2L	65-3672WDS2R	65-2430LF3
65-3684WDS2R	65-3084SU2	65-2430LF1
65-3672WDS2L	65-3072SU2	

Drawer

	W	L	D
Lat File	26 $\frac{3}{32}$ "	15 $\frac{1}{16}$ "	9 $\frac{7}{32}$ "

Models

65-3684SU2	65-2466RL	65-2436LF3
65-3672SU2	65-2466LL	65-2436LF1

Drawer

	W	L	D
Lat File	32 $\frac{3}{32}$ "	15 $\frac{1}{16}$ "	9 $\frac{7}{32}$ "

Models

65-2472L21OBFL	65-2072L21OBFL	65-2436L21BF
65-2472L21OBFR	65-2072L21OBFR	65-2036L21BF
65-2472L21DBF	65-2072L21DBF	

Drawers

	W	L	D
Box	32 $\frac{3}{32}$ "	13 $\frac{3}{8}$ "	3 $\frac{1}{2}$ "
File	32 $\frac{3}{32}$ "	15 $\frac{1}{16}$ "	9 $\frac{7}{32}$ "

Models

65-2460L21OBL	65-2060OBFL	65-2430L21BF
65-2460L21OBR	65-2060OBFR	65-2030L21BF
65-2460L21DBF	65-2060L21DBF	

Drawers

	W	L	D
Box	26 $\frac{3}{32}$ "	13 $\frac{3}{8}$ "	3 $\frac{1}{2}$ "
File	26 $\frac{3}{32}$ "	15 $\frac{1}{16}$ "	9 $\frac{7}{32}$ "

Models

65-2418L21BF	65-2018L21BF
--------------	--------------

Drawers

	W	L	D
Box	14 $\frac{9}{32}$ "	13 $\frac{3}{8}$ "	3 $\frac{1}{2}$ "
File	14 $\frac{9}{32}$ "	15 $\frac{1}{16}$ "	9 $\frac{7}{32}$ "

Model

65-2436OMF

Drawers

	W	L	D
Box	14 $\frac{9}{32}$ "	15 $\frac{1}{8}$ "	3 $\frac{1}{2}$ "
Lateral File	32 $\frac{3}{32}$ "	15 $\frac{1}{16}$ "	9 $\frac{7}{32}$ "

Model

65-2430OMF

Drawers

	W	L	D
Box	11 $\frac{3}{4}$ "	16 $\frac{3}{16}$ "	3 $\frac{1}{2}$ "
Lateral File	26 $\frac{3}{32}$ "	15 $\frac{1}{16}$ "	9 $\frac{7}{32}$ "

Model

65-2472BF

Drawer

	W	L	D
Box	32 $\frac{1}{8}$ "	16 $\frac{3}{16}$ "	3 $\frac{1}{2}$ "

Models

65-2472RMR	65-2472LMF	65-2436MF
65-2472LMR	65-2466RMF	65-2466LMF
65-2472RMF		

Drawers

	W	L	D
Box	14 $\frac{9}{32}$ "	15 $\frac{1}{8}$ "	3 $\frac{1}{2}$ "
File	14 $\frac{9}{32}$ "	15 $\frac{1}{8}$ "	9 $\frac{5}{16}$ "
Lat File	32 $\frac{3}{32}$ "	15 $\frac{1}{16}$ "	9 $\frac{7}{32}$ "

Model

65-2436LF2

Drawers

	W	L	D
Box	14 $\frac{9}{32}$ "	15 $\frac{1}{8}$ "	3 $\frac{1}{2}$ "
File	14 $\frac{9}{32}$ "	15 $\frac{1}{8}$ "	9 $\frac{1}{4}$ "
Lat File	32 $\frac{3}{32}$ "	15 $\frac{1}{16}$ "	9 $\frac{1}{4}$ "

Model

65-2430LF2 65-2430MF

Drawers

	W	L	D
Box	11 $\frac{5}{16}$ "	16 $\frac{3}{16}$ "	3 $\frac{1}{2}$ "
File	12 $\frac{1}{8}$ "	16 $\frac{3}{16}$ "	9 $\frac{5}{16}$ "
Lat File	26 $\frac{3}{32}$ "	15 $\frac{1}{16}$ "	9 $\frac{1}{4}$ "

INTERIOR DRAWER DIMENSIONS (CONTINUED)

Models

65-2418PD2	65-2451WD2L	65-1884WFO
65-3018PD2	65-2451WD2R	65-1872DS2L
65-3618PD2	65-1884DS2L	65-1872DS2R
65-2484WD2L	65-1884DS2R	65-1872WFL
65-2484WD2R	65-1884WFL	65-1872WFR
65-2472WD2L	65-1884WFR	65-1872WFO
65-2472WD2R		

Drawer	W	L	D
File	14 ⁹ / ₃₂ "	15 ¹ / ₈ "	9 ⁵ / ₁₆ "

Models

65-3018PD1	65-2451WD1R	65-1884WBO
65-2484WD1L	65-2418PD1	65-1872DS1L
65-2484WD1R	65-1884DS1L	65-1872DS1R
65-2472WD1L	65-1884DS1R	65-1872WBL
65-2472WD1R	65-1884WBL	65-1872WBR
65-2451WD1L	65-1884WBR	65-1872WBO

Drawers

	W	L	D
Box	14 ⁹ / ₃₂ "	15 ¹ / ₈ "	3 ¹ / ₂ "
File	14 ⁹ / ₃₂ "	15 ¹ / ₈ "	9 ⁵ / ₁₆ "

Models

65-2415PD2	65-2515SHPD2	65-1519MP2
------------	--------------	------------

Drawer

	W	L	D
File	12 ¹ / ₈ "	16 ³ / ₁₆ "	9 ¹⁵ / ₁₆ "

Models

65-2430L4	65-2430L3	65-2430L2
-----------	-----------	-----------

Drawer

	W	L	D
Lat File	25 ¹⁷ / ₃₂ "	15 ¹ / ₈ "	9 ⁷ / ₃₂ "

Models

65-2472RL	65-2472DL	65-2436L3
65-2472LL	65-2436L4	65-2436L2

Drawer

	W	L	D
Lat File	31 ¹ / ₂ "	15 ¹ / ₈ "	9 ⁷ / ₃₂ "

Model

65-1622CD

Drawer

	W	L	D
Center	18 ¹⁵ / ₁₆ "	14 ¹⁵ / ₁₆ "	1 ³ / ₄ "

FILING CAPABILITIES

Drawers with Dimensions: 11¹/₁₆"W x 16³/₁₆"L

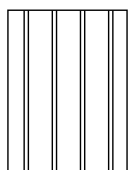

Letter or Legal Side to Side

Drawers with Dimensions: 12¹/₈"W x 16³/₁₆"L



Letter Front to Back

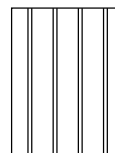

Legal Side to Side

Drawers with Dimensions: 14⁹/₃₂"W x 15¹/₈"L

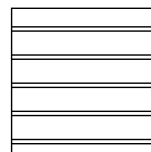

Letter Front to Back

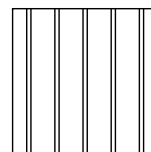

Legal Side to Side

Drawers with Dimensions: 25¹⁷/₃₂"W x 15¹/₈"L

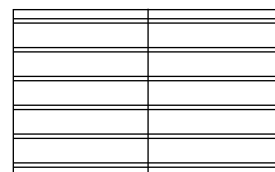

2 Rows Letter Front to Back

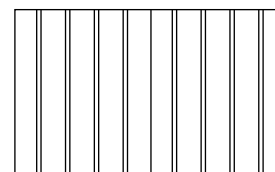

1 Row Letter or Legal Side to Side

Drawers with Dimensions: 26³/₃₂"W x 15¹/₈"L

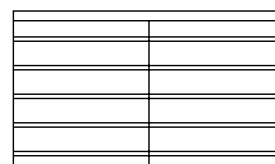

2 Rows Letter Front to Back

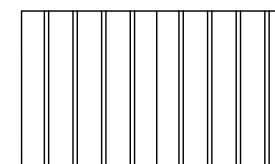

1 Row Legal Side to Side

Drawers with Dimensions: 31¹/₂"W x 15¹/₈"L

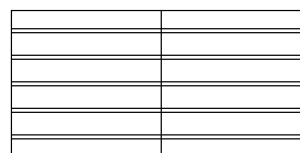

2 Rows Letter or Legal Front to Back

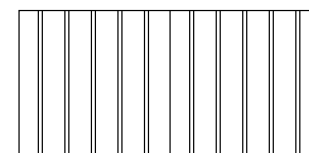

1 Row Letter or Legal Side to Side

Drawers with Dimensions: 32³/₃₂"W x 15¹/₈"L

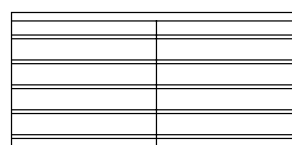

2 Rows Letter Front to Back

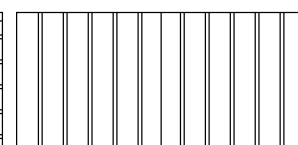

1 Row Legal Side to Side

HOW TO ORDER EXAMPLES

DESK WITH CREDENZA & HUTCH

	QTY	MODEL NO.	DESCRIPTION	EXAMPLE
DESK	1	67-3672DPS	Top Material	P
			Finish	WC
			Edge Profile	X
			Drawer Construction	DOV
			Drawer Track	SFTCL
			Grain Direction	VERTICAL
			Modesty Panel	65-HGAF
			Modesty Color	GPA
			Grommet Location/ Wire Management	GL
			Grommet Color	BLK
			Power/Data	DOCK950B-R
			Pull/Color	CFL
			Keyboard Option	N/A
CREDENZA	1	67-2472KC	Top Material	P
			Finish	WC
			Edge Profile	X
			Drawer Construction	DOV
			Drawer Track	SFTCL
			Drawer Color	WC
			Grain Direction	VERTICAL
			Pull/Color	CFL
			Back Panel Grommet	SVR
			Grommets	LR
			Power/Data	NONE
			Grommet Color	SVR
			Keyboard Option	N/A
HUTCH	1	65-1572TWDS	Finish	WC
			Door Style	HGA
			Door Color	GPA
			Locking	NO
			Paper Slot Color	WC
			Paper Slot Divider	CHROME

STUDIO DESK

	QTY	MODEL NO.	DESCRIPTION	EXAMPLE
DESK TOP	1	65-3672TP	Top Material	P
			Finish	WTA
			Edge Profile	Y
			Grommet	GL
			PDC Type	01-DUO BEZELW
			PDC Location	PDC-C
			Grommet Color	BLK
			PEDESTAL	2
			Grain Direction	VERTICAL
			Pull/Color	CST
			Drawer Construction	DOV
			Drawer Track	SFTCL
			Wire Management	NONE

STUDIO DESK (CONTINUED)

	QTY	MODEL NO.	DESCRIPTION	EXAMPLE
MODESTY	1	65-3624MDHGA	HGA Color	WMA
			Grommet	GRMT
			Grommet Color	BLK
LEGS	2	01-0404SL4	Color	CHRM

HEIGHT ADJUSTABLE

	QTY	MODEL NO.	DESCRIPTION	EXAMPLE
DESK	1	67-3672LPSTS	Top Material	P
			Top Color	SBP
			Edge Profile	X
			Chassis Color	WTA
			Drawer Color	WTA
			Grain Direction	VERTICAL
			Pull/Color	CFL
			Drawer	DOV
			Construction	
			Drawer Track	SFTCL
			Moving Modesty	MOVMOD
			Height Adjust Switch	MSWCH
			Wire Management	GL
			Grommet Color	BLK

BRIDGE	1	67-2448LF2STS	Top Material	P
			Top Color	SBP
			Edge Profile	X
			Chassis Color	WTA
			Height Adjust Switch	MSWCH
			Wire Management	GR
			Grommet Color	SLV
			Modesty	GMBSV
			Grommet/Color	

CREDENZA RIGHT	1	67-2472RC2STS	Top Material	P
			Top Color	SBP
			Edge Profile	X
			Chassis Color	WTA
			Drawer Color	WTA
			Grain Direction	VERTICAL
			Pull/Color	CFL
			Drawer	DOV
			Construction	
			Drawer Track	SFTCL
			Height Adjust Switch	MSWCH
			Wire Management	GL
			Grommet Color	SLV
Modesty	GMBSV			
Grommet/Color				

VENEER (W) OPTIONS

Veneer features UVAdvantage, an ultra-violet finish, on all exposed surfaces by utilizing roll-coat UV technology.

AW	Artisan Walnut	MW	Mahogany Walnut
AS	Asian Night	MAS	Mesa Sunset*
CO	Columbian Walnut	MTS	Metropolis Sky
DC	Dark Cherry	PNW	Pinnacle Walnut
DFW	Dark Forest Walnut	ORW	Oak Riftwood*
EW	Espresso	SCH	Select Cherry
FO	Fawn Oak*	SKC	Shaker Cherry
GC	Golden Cherry	SM	Sugar Maple
HW	Harvest Walnut	WTA	Weathered Ash*
HNW	Henna Walnut	WC	Williamsburg Cherry
LW	Legacy Walnut		

* Finish is Low Sheen

HPL (P) LAMINATE OPTIONS

WOODGRAIN

AS	Asian Night	PNW	Pinnacle Walnut
CO	Columbian Walnut	SCH	Select Cherry
EF	Espresso	SKC	Shaker Cherry
GC	Golden Cherry	SM	Sugar Maple
MW	Mahogany Walnut	WTA	Weathered Ash
ORW	Oak Riftwood	WC	Williamsburg Cherry

1½" thick tops also available in above HPL colors only. Top thickness will affect overall height of other units such as surface mounted hutches. Please contact Customer Service or your local Sales Representative for pricing and extended lead times.

EDGE PROFILES

F	Double Kerf	X	Flute
G	Duo	Y	Square



Double Kerf (F) Duo (G) Flute (X) Square (Y)

METAL FINISH OPTIONS

ALUM	Aluminum
BLK	Black (Height Adjustable, Studio Components)
CHRM	Chrome

ACRYLIC OPTIONS

FSTA	Frosted Acrylic	BLA	Black High Gloss Acrylic
WHA	White High Gloss Acrylic	GPA	Graphite High Gloss Acrylic
WMA	Wired Mercury High Gloss Acrylic		

PULL OPTIONS

Lock core color is predetermined by pull color.

AAV	Alcove, Aluminum	BEL	Elite, Black
CAV	Alcove, Chrome	AFL	Flair, Aluminum
AAC	Arc, Aluminum	CFL	Flair, Chrome
BAC	Arc, Black	AFC	Focus, Aluminum
ABM	Beam, Aluminum	BFC	Focus, Black
BBM	Beam, Black	AQD	Quadra, Aluminum
BBT	Bow Tie, Black	BQD	Quadra, Black
NBT	Bow Tie, Nickel	AST	Studio, Aluminum
ABU	Buckle, Aluminum	BST	Studio, Black
BBU	Buckle, Black	CST	Studio, Chrome
AEL	Elite, Aluminum	GST	Studio, Gold



DRAWER CONSTRUCTION OPTIONS

Drawers come standard with woodgrain vinyl-wrapping and mitered corners. Optional wood dovetail construction for all box, file, and lateral file drawers is available. Must Specify when ordering.

Pricing is per Drawer, not per Model/Unit

MITER	Mitered Fold Construction	STD
DOVE	Wood Dove Tail Construction	\$ 45

DRAWER TRACK OPTIONS

Soft close tracks are available on box and file drawers only. Soft close drawer tracks have many benefits including reduced stress on the unit, extends the life of the drawer, and ensures a gentle close so fingers don't accidentally get hurt. **File drawers with the soft close option feature front-to-back filing.** Must specify when ordering.

Pricing is per Drawer, not per Model/Unit

SFTCL	Soft Close Drawer Track (Box & File Drawers Only)	\$ 34
-------	---	-------

LOCK CORE COLOR OPTIONS

BLK	Black (Used with Black and Gold Pulls)
SLV	Silver (Used with Aluminum and Chrome Pulls)

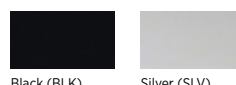

Grommet options on next page.

GROMMET OPTIONS & POWER UNIT LOCATIONS

Note: Wire Management Options for Integrated and Modular Height Adjustable Models may be found in their specific area within this section.

Grommets are standard in the back panels of returns, bridges, and credenzas, and may be ordered without grommets at no additional charge. Please specify NO GROMMET on order.

Grommets are available on hutches in standard locations for task light management at no additional charge. Please specify WMHUBL (Black) or WMHUSV (Silver).

Power units, Dock 950 and Dock 150 must be specified separately with surface mount location. Dock 950 and Dock 150 are available on Modular Benching Desk Tops, Modular Cabinet Tops, Work Tables, and Media Peninsula Tops, and where otherwise noted.

Grommets are available in standard locations. Please specify using info below. Multiple locations may be selected. Only one unit per location.

GROMMET LOCATIONS (Black = BLK and Silver = SLV)

GC	Grommet, Center	\$	52
GL	Grommet, Left	\$	52
GR	Grommet, Right	\$	52
GAL	Grommet, Approach Left - D-Tops Only	\$	52
GAR	Grommet, Approach Right - D-Tops Only	\$	52
GSL	Grommet, Seat Side Left - D-Tops Only	\$	52
GSR	Grommet, Seat Side Right - D-Tops Only	\$	52

DUO/TRIO BEZEL LOCATIONS

PDC-C	Bezel, Center
PDC-L	Bezel, Left
PDC-R	Bezel, Right

DOCK 950 and DOCK 150 LOCATIONS (See Dock Units)

DOCK950-L	D950 Wireless Charger, Left	\$	265
DOCK950-C	D950 Wireless Charger, Center	\$	265
DOCK950-R	D950 Wireless Charger, Right	\$	265
DOCK150-L	D150 Wireless and USB Charger, Left	\$	405
DOCK150-C	D150 Wireless and USB Charger, Center	\$	405
DOCK150-R	D150 Wireless and USB Charger, Right	\$	405

Verify Grommet Option is available on the model(s) you are specifying using the following location information. Grommets, Power Units, Dock 950 and Dock 150 may be ordered in non-standard locations. Call Customer Service to assist with specification and/or please attach a drawing to the PO showing the location of the grommet. Note additional charges and lead times may apply.

Models

67-4872CBLP	67-3672BLPS	67-3672BDP
67-4872CBRP	67-3672BRPS	67-3666BDP
67-3672BDPS	67-3672BRP	67-3672BLP

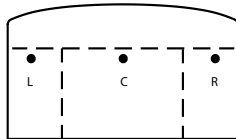

GL/GR: Located 6" from ends and 22½" from user side
GC: Located 22½" from user side

Models

67-4272CLP	67-3672RPS	65-3672SH*
67-4272CRP	67-3672LP	65-3666SH*
67-3672DPS	67-3672RP	65-3660SH*
67-3672LPS	67-3672DP	

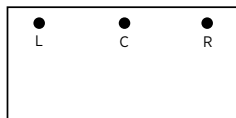

GL/GR: Located 6" from ends and 22½" from user side
GC: Located 22½" from user side

*PDC-L/PDC-R/DOCK950-L/DOCK950-R/DOCK150-L/DOCK150-R/PDC-C/DOCK950-C/DOCK150-C available only on Shell (SH) units in same locations

Models

67-3072DP	67-3060RP	65-3072SH*
67-3066DP	67-3066LP	65-3066SH*
67-3060DP	67-3066RP	65-3060SH*
67-3060LP	67-3072RP	67-3072LP

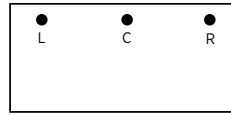

GL/GR: Located 6" from ends and 22½" from user side

GC: Located 22½" from user side

*PDC-L/PDC-R/DOCK950-L/DOCK950-R/DOCK150-L/DOCK150-R/PDC-C/DOCK950-C/DOCK150-C available only on Shell (SH) units in same locations

Models

67-2448LF1	65-2448UF	67-4824LF1
67-2448RF1	65-2448UFH	67-4824RF1
67-2448LF2	65-2442UF	67-4824LF2
67-2448RF2	65-2442UFH	67-4824RF2
67-2442LF1	65-2448RSHL	67-4224LF1
67-2442RF1	65-2448RSHR	67-4224RF1
67-2442LF2	65-2442RSHL	67-4224LF2
67-2442RF2	65-2442RSHR	67-4224RF2
65-2436UF	65-2436UFH	

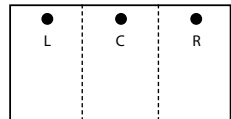

GL/GR: Located 6" from ends and 20" from user side

GC: Located 20" from user side

Models

65-2472LMR	65-2472LL	65-2472RMF
65-2472RMR	65-2472RL	65-2472LMF
65-2466LL	65-2466RL	65-2466LMF
65-2466RMF		

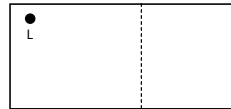

GL/GR: Located 6" from ends and 20" from user side

Grommets are only available on opposite side of pedestal

Models

67-2472KC	67-2472RC2	67-2466RC1
67-2472LC1	67-2466KC	67-2466LC2
67-2472RC1	67-2466LC1	67-2466RC2
67-2472LC2		

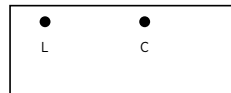

GL/GR: Located 6" from ends and 20" from user side

GC: Located 20" from user side

Models

65-2472SH	65-2466SH	65-2460SH
-----------	-----------	-----------

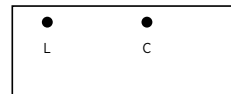

GL/GR/DOCK950-L/DOCK950-R/DOCK150-L/DOCK150-R: Located 6" from ends and 20" from user side

GC/DOCK950-C/DOCK150-C: Located 20" from user side

PDC-L/PDC-R: Located 6" from ends and 21" from user side

PDC-C: Located 21" from user side

GROMMET OPTIONS & POWER UNIT LOCATIONS (CONTINUED)

Models

65-2048UF 65-2042UF 65-2036UF
65-2048UFH 65-2042UFH 65-2036UFH

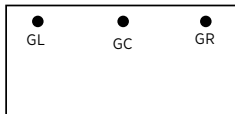

GL/GR: Located 6" from ends and 16" from user side
GC: Located 16" from user side

Models

65-2472L21DBF 65-2472L21OBFR 65-2472L21DO
65-2460L21DBF 65-2460L21OBFL 65-2460L21DO
65-2472L21OBFL 65-2460L21OBFR

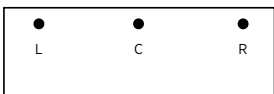

PDC-L/PDC-R: Located 11" from ends and 21½" from user side
PDC-C: Located 21½" from user side
GL/GR/DOCK950-L/DOCK950-R/DOCK150-L/DOCK150-R: Located 6" from ends and 20" from user side
GC/DOCK950-C/DOCK150-C: Located 20" from user side

Models

65-2072L21DBF 65-2072L21OBFR 65-2060L21OBFR
65-2060L21DBF 65-2060L21OBFL 65-2072L21DO
65-2072L21OBFL 65-2060L21DO

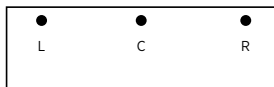

PDC-L/PDC-R: Located 11" from ends and 17½" from user side
PDC-C: Located 17½" from user side
GL/GR/DOCK950-L/DOCK950-R/DOCK150-L/DOCK150-R: Located 6" from ends and 16" from user side
GC/DOCK950-C/DOCK150-C: Located 16" from user side

Models

65-4284PR 65-4272PR
65-4284TR 65-4272TR

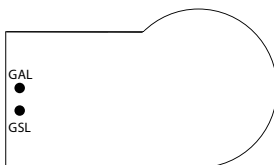

GAL/GSL: Located 12" from approach or seated side and 6" from end

Models

65-4284PL 65-4272PL
65-4284TL 65-4272TL

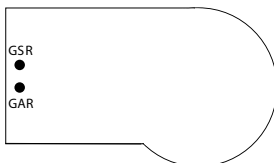

GAR/GSR: Located 12" from approach or seated side and 6" from end

Models

65-4272EDR



GAL: Located 12" from approach, 6" from end
GSL: Located 18" from approach, 6" from end

Model

65-4272EDL

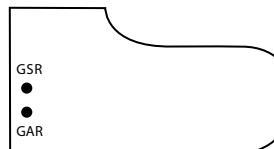

GAR: Located 12" from approach, 6" from end
GSR: Located 18" from approach, 6" from end

Models

65-3684DUR 65-3084DUR 65-3066DUR
65-3672DUR 65-3072DUR

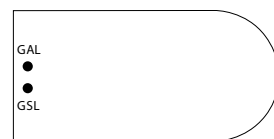

GAL/GSL: Located 12" from approach or seated side and 6" from end

Models

65-3684DUL 65-3672DR 65-3066DUL
65-3672DUL 65-3084DUL 65-3066DR
65-3684DR 65-3072DUL

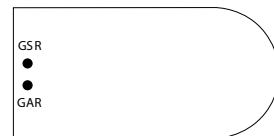

GAR/GSR: Located 12" from approach or seated side and 6" from end

MODULAR DESK TOPS

Models

65-3684TP 65-3648TP 65-3066TP
65-3678TP 65-3642TP 65-3060TP
65-3672TP 65-3084TP 65-3054TP
65-3666TP 65-3078TP 65-3048TP
65-3660TP 65-3072TP 65-3042TP
65-3654TP

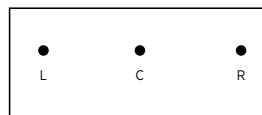
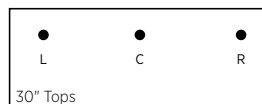
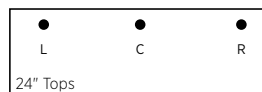

GL/GR/PDC-L/PDC-R/DOCK950-L/DOCK950-R/DOCK150-L/DOCK150-R: Located 11" from ends and 22½" from user side
GC/DOCK950-C/DOCK150-C: Located 22½" from user side

Additional grommet options on next page.

GROMMET OPTIONS & POWER UNIT LOCATIONS (CONTINUED)

MODULAR CABINET TOPS

Models

65-24108TP	65-2478TP	65-2448TP
65-24102TP	65-2472TP	65-2442TP
65-2496TP	65-2466TP	65-2436TP
65-2490TP	65-2460TP	65-2430TP
65-2484TP	65-2454TP	

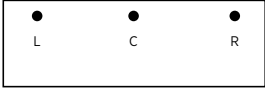

PDC-L/PDC-R: Located 11" from ends and 21½" from user side

PDC-C: Located 21½" from user side

GL/GR/DOCK950-L/DOCK950-R/DOCK150-L/DOCK150-R: Located 11" from ends and 20" from user side

GC/DOCK950-C/DOCK150-C: Located 20" from user side

Models

65-20108TP	65-2078TP	65-2048TP
65-20102TP	65-2072TP	65-2042TP
65-2096TP	65-2066TP	65-2036TP
65-2090TP	65-2060TP	65-2030TP
65-2084TP	65-2054TP	

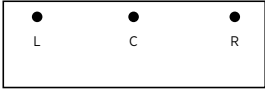

PDC-L/PDC-R: Located 11" from ends and 17½" from user side

PDC-C: Located 17½" from user side

GL/GR/DOCK950-L/DOCK950-R/DOCK150-L/DOCK150-R: Located 11" from ends and 16" from user side

GC/DOCK950-C/DOCK150-C: Located 16" from user side

Model

65-2418TP

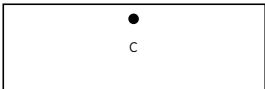

PDC-C: Located 21½" from user side

GC/DOCK950-C/DOCK150-C: Located 20" from user side

Model

65-2018TP

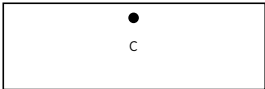

PDC-C: Located 17½" from user side

GC/DOCK950-C/DOCK150-C: Located 16" from user side

WORK TABLES

Models

65-4896WT	65-4860CWT	65-4260TWT
65-4896TWT	65-4296WT	65-4260CWT
65-4896CWT	65-4296TWT	65-3696TWT
65-4884WT	65-4296CWT	65-3696CWT
65-4884TWT	65-4284WT	65-3684TWT
65-4884CWT	65-4284TWT	65-3684CWT
65-4872WT	65-4284CWT	65-3672TWT
65-4872TWT	65-4272WT	65-3672CWT
65-4872CWT	65-4272TWT	65-3660TWT
65-4860WT	65-4272CWT	65-3660CWT
65-4860TWT	65-4260WT	

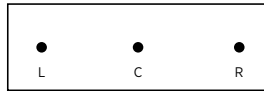

42" Work Tables

GL/GR/PDC-L/PDC-R/DOCK950-L/DOCK950-R/DOCK150-L/DOCK150-R: Located 6" from ends and 21" from user side

GC/PDC-C/DOCK950-C/DOCK150-C: Located 21" from user side

48" Work Tables

GL/GR/PDC-L/PDC-R/DOCK950-L/DOCK950-R/DOCK150-L/DOCK150-R: Located 6" from ends and 24" from user side

GC/PDC-C/DOCK950-C/DOCK150-C: Located 24" from user side

36" Work Tables

GL/GR/PDC-L/PDC-R/DOCK950-L/DOCK950-R/DOCK150-L/DOCK150-R: Located 6" from ends and 18" from user side

GC/PDC-C/DOCK950-C/DOCK150-C: Located 18" from user side

Models

65-2496WT	65-2484TWT	65-2472CWT
65-2496TWT	65-2484CWT	65-2460WT
65-2496CWT	65-2472WT	65-2460TWT
65-2484WT	65-2472TWT	65-2460CWT

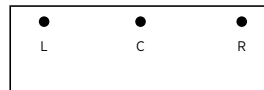

GL/GR/PDC-L/PDC-R/DOCK950-L/DOCK950-R/DOCK150-L/DOCK150-R: Located 6" from ends and 21½" from user side

GC/PDC-C/DOCK950-C/DOCK150-C: Located 21½" from user side

MODULAR BENCHING DESK TOPS

Models

65-6072TP	65-6066TP	65-6060TP
-----------	-----------	-----------

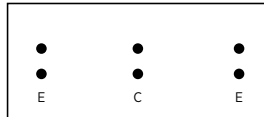

E = 11" from end
C = 25¼" from user

Only one style of unit per location.

Locations:

- 1C: 2 Center Cutouts
- 1E: 2 End Cutouts
- 2E: 4 End Cutouts
- C1E: 2 Center and 2 End Cutouts
- C2E: 2 Center and 4 End Cutouts

Models

65-4872TP	65-4866TP	65-4860TP
-----------	-----------	-----------

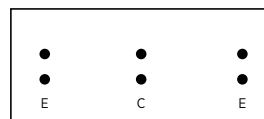

E = 11" from end
C = 19¾" from user

Only one style of unit per location.

Locations:

- 1C: 2 Center Cutouts
- 1E: 2 End Cutouts
- 2E: 4 End Cutouts
- C1E: 2 Center and 2 End Cutouts
- C2E: 2 Center and 4 End Cutouts

GROMMET OPTIONS & POWER UNIT LOCATIONS (CONTINUED)

Models

65-3672MPS
65-3672MP

65-3066MPS
65-3066MP

65-3060MPS
65-3060MP

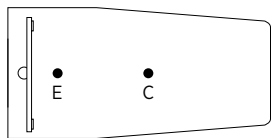

E = 12" from monitor end
C = Centered

DUO/TRIO BEZEL, Dock 950 and Dock 150. Only one style of unit per location.

Locations:

- C: Center Cutout
- E: End Cutout
- EC: End and Center Cutouts

GALLERY SCREENS

51" and 42" Gallery Screens

- DGL: Desk Height Left; 6" from ends and 25/4" from bottom
- DGR: Desk Height Right; 6" from ends and 25/4" from bottom
- DGC: Desk Height Center; 25/4" from bottom
- BGL: Bench Height Left; 6" from ends and 15" from bottom
- BGR: Bench Height Right; 6" from ends and 15" from bottom
- BGC: Bench Height Center; 15" from bottom

30" Gallery Screens

- BGL: Bench Height Left; 6" from ends and 15" from bottom
- BGR: Bench Height Right; 6" from ends and 15" from bottom
- BGC: Bench Height Center; 15" from bottom

HEIGHT ADJUSTABLE MECHANISMS

Height Adjust method that increases user kneespace, offers more stability for overall unit and top construction, and two worksurfaces can move from sitting to standing simultaneously with or without moving modesty panel.

- Maximum height is 45"
- Recommended load capacity of 180lbs
- Gently adjust worksurface with a 1 second stop at each memory position
- Two leg configuration options include the standard 2-channel for Desks, Desk Shells, D-top and P-Top units for one height adjustable worksurface or 3-channel option for two height adjustable worksurfaces to raise simultaneously
- Two height adjustable switches available. Standard up/down switch (SWCH) and advanced switch features Bluetooth capabilities, three stand-up reminder intervals and four height memory positions (MSWCH)
- Moving Modesty (MOVMOD) option creates a clean aesthetic when seated or standing
- Height adjust control switch is factory installed on all units except Desk Shells, Bridges or 3-Channel units
- Bridges, returns, and credenzas will have an optional grommet on the back panel
- Black wire management mesh wrap included when worksurface grommet is selected
- Black wire management mesh wrap is made of polyester braided fabric, 10' long, expands up to 1 3/4"
- Grommets and one Latch Duct wire management channel provided within kneespace to manage wires from switch and control box. Two Latch Duct wire management channels will be shipped with Desk Shells

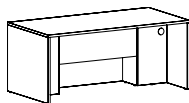

Height Adjustable User Side

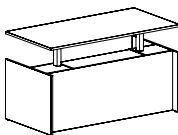

2-channel Configuration

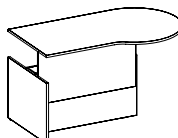

Moving Modesty



Black wire management mesh sleeve

HEIGHT ADJUST LEG CONFIGURATION

The 2-channel leg configuration is standard on height adjustable Desks, Desk Shells, D-top and P-Top units for one height adjustable worksurface. Select models offer an optional 3-channel leg configuration for use with 3-channel Returns to allow two worksurfaces to raise and lower simultaneously.

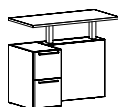

2-channel Configuration
Raise Single Surface

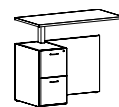

3-channel Configuration
Raise Multiple Surface

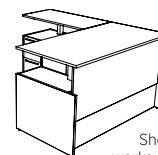

Shown with two worksurfaces raised and optional moving modesty.

STS2	2-channel configuration (for one height adjustable worksurface)	STD
STS3	3-channel configuration (for two height adjustable worksurfaces)	\$ N/C

HEIGHT ADJUST MOVING MODESTY PANEL

Height adjustable moving modesty panel available on double and single pedestal, D-top and P-Top desks. Moving modesty panels offer a clean aesthetic when seated or standing while giving more privacy to the user.

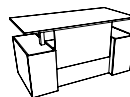

Stepped Front Desk with Moving Modesty

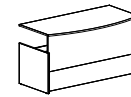

Recessed Front Desk with Moving Modesty

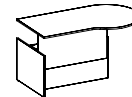

P-Top with Moving Modesty

MOVMOD	Moving Modesty Panel	\$ 219
--------	----------------------	--------

HEIGHT ADJUST MODESTY PANEL GROMMET

Height adjustable credenza, bridge and return units feature a modesty panel grommet option for accessing power to a wall.

2-Channel units feature grommet centered on modesty only, 3" down from top. 3-Channel units feature grommets centered on pedestal only, 3" down from top.

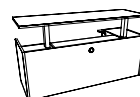

Credenza with Modesty Grommet



Return with Modesty Grommet

GMBBL	Black Modesty Grommet	\$ N/C
GMBSV	Silver Modesty Grommet	\$ N/C

HEIGHT ADJUST SWITCH CONTROL OPTIONS

Height adjust units offer two switch options. The standard switch is a simple up and down paddle style switch to move your worksurface from seated to standing height. The advanced switch features Bluetooth capabilities to connect to smart devices, three stand-up reminder intervals and four height adjustment memory positions.

SWCH	Standard Up/Down Switch	STD
MSWCH	Advanced Up/Down with Memory	\$ 135



SWCH (standard)



MSWCH

Height adjustable grommet options on next page.

HEIGHT ADJUST GROMMET OPTIONS & POWER UNIT LOCATIONS

Ports, Locations and Wire Management:

- One data or wire management location per unit
- Order the port and then specify the location

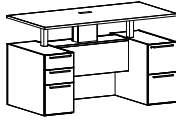

Shown with Wire Management Box with Grommet

Wire Management Box with Center Grommet *Add \$ 485*

Specify Location and Grommet Color (Black = BLK or Silver = SLV)

Specify	Units	Locations
GC-BOX	Desks/Credenzas/Bridges	Center
GC-BOX	Return (2-Channel Only)	Center

Grommet with Mesh Sleeve *Add \$ 142*

Specify Location and Grommet Color (Black = BLK or Silver = SLV)

Specify	Units	Locations
GL-MESH	Desks/Credenzas/Return	Left
GR-MESH	Desks/Credenzas/Return	Right
GC-MESH	Desks/Credenzas/Bridges	Center
GCKS-MESH	Return/Return Shell	Centered Between Legs

Wire Management Box with DUOBEZEL *Add \$ 1398*

Units	Locations
Desks/Credenzas/Bridges	Center
Return	Centered Between Legs

Specify

01-DUOBEZELB	DUOBEZEL Black
01-DUOBEZELS	DUOBEZEL Silver
01-DUOBEZELW	DUOBEZEL White

Wire Management Box with TRIOBEZEL *Add \$ 1452*

Units	Locations
Desks/Credenzas/Bridges	Center
Return	Centered Between Legs

Specify Color

01-TRIOBEZELB	TRIOBEZEL Black
01-TRIOBEZELS	TRIOBEZEL Silver
01-TRIOBEZELW	TRIOBEZEL White

Port Options for TRIOBEZEL - Must Specify *Add*

01-LCOMVGA	VGA Date Port	\$ 121
01-LCOMHDMI	HDMI Data Port (Open Market Only)	\$ 166
01-LCOMRJ45	RJ45 Data Port	\$ 79

Wire Management Box with DPORT4 *Add \$ 1755*

Units	Locations
Desks/Credenzas/Bridges	Center
Return	Centered Between Legs

Specify Color

01-DPORT4A	DPORT Aluminum
01-DPORT4B	DPORT Black

Port Options for DPORT - Must Specify *Add*

01-USBPORT	USB Port	\$ 161
01-VOICE1	Voice Coupler	\$ 73
01-RJ4DATA	Data Port	\$ 167

Models

65-2048UFSTS	65-2042UFSTS	65-2036UFSTS
65-2048UFSTSL3	65-2048UFSTSR3	65-2042UFSTSL3
65-2042UFSTSR3	65-2036UFSTSL3	65-2036UFSTSR3

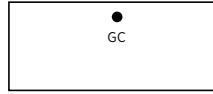

Center Located 16" from user side

Models

65-2448UFSTS	65-2442UFSTS	65-2436UFSTS
65-2448UFSTSL3	65-2448UFSTSR3	65-2442UFSTSL3
65-2442UFSTSR3	65-2436UFSTSL3	65-2436UFSTSR3

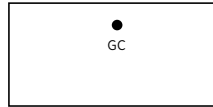

Center Located 20" from user side

Models

65-2472SHSTS	67-3072DPSTS	67-2466LCISTS
65-2466SHSTS	67-2472RC2STS	67-3066RPSTS
65-2460SHSTS	67-2472LC2STS	67-3066LPSTS
65-3072SHSTS	67-2466RC2STS	67-3066DPSTS
65-3066SHSTS	67-2466LC2STS	67-3060RPSTS
65-3060SHSTS	67-2472RC1STS	67-3060LPSTS
67-3072RPSTS	67-2472LC1STS	67-3060DPSTS
67-3072LPSTS	67-2466RC1STS	

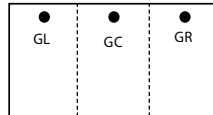

L/R: Located 6" from ends and 20" from user side
Center: Located 20" from user side

Models

67-4824RF2STS	65-2448RSHRSTS*	67-2448RF1STS
67-4824LF2STS	65-2448RSHLSTS*	67-2448LF1STS
67-4224RF2STS	65-2442RSHRSTS*	67-2442RF1STS
67-4224LF2STS	65-2442RSHLSTS*	67-2442LF1STS
67-2448RF2STS	67-4824RF1STS	67-2466KCSTS
67-2448LF2STS	67-4824LF1STS	67-2472KCSTS
67-2442RF2STS	67-4224RF1STS	67-4224LF1STS
67-2442LF2STS		

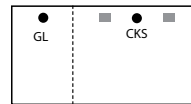

L/R: Located 6" from ends and 20" from user side
CKS: Centered between legs and 20" from user side

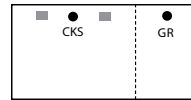

* = Only Available with Centered Grommet CKS

Models (Grommet only available in ped space)

67-2448RF2STS3	67-2442LF2STS3	67-2442RF1STS3
67-2448LF2STS3	67-2448LF1STS3	67-2442LF1STS3
67-2442RF2STS3	67-2448RF1STS3	

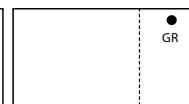
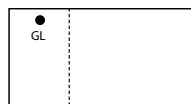

Grommet with Mesh Wire Management Sleeve only available in ped space

L/R: Located 6" from ends and 20" from user side

HEIGHT ADJUST GROMMET OPTIONS & POWER UNIT LOCATIONS (CONTINUED)

Models

67-3672BDPSTS	67-3672BLPSTS	67-3672BDPSSTS
67-3666BDPSTS	67-3672BRPSTS	67-3672BLPSSTS
		67-3672BRPSSTS

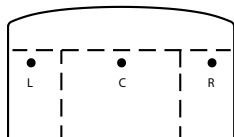

L/R: Located 6" from ends and 20" from user side
Center: Located 20" from user side

Models

67-3672DPSTS	67-3672RPSTS	67-3672LPSTS
67-3672DPSSTS	67-3672RPSSTS	67-3672LPSSTS
65-3672SHSTS	65-3666SHSTS	65-3660SHSTS

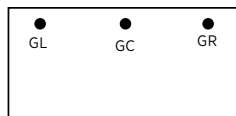

Left/Right: Located 6" from ends and 24" from user side
Center: Located 24" from user side

Models

65-3684DURSTS	65-3072DURSTS	65-4284PLSTS
65-3684DULSTS	65-3072DULSTS	65-4284PRSTS
65-3672DURSTS	65-3066DURSTS	65-4272PLSTS
65-3672DULSTS	65-3066DULSTS	65-4272PRSTS
65-3084DURSTS	65-3084DULSTS	

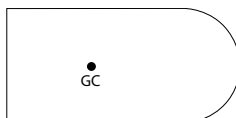

Center: Located 18 7/8" from seated side and centered between legs

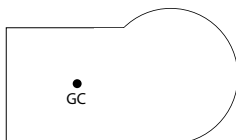

Left Unit / Center: Located 18 7/8" from seated side and centered between legs

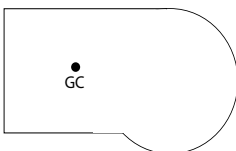

Right Unit / Center: Located 18 7/8" from seated side and centered between legs

MODULAR HEIGHT ADJUSTABLE GROMMET OPTIONS & POWER UNIT LOCATIONS

Grommets are standard in tops of cabinets and credenzas in Black (BLK) or Silver (SLV).

Grommets are available in locations shown below. Please specify and add upcharge for each grommet. Multiple locations may be selected. Only one unit per location.

GROMMET LOCATIONS (Black = BLK and Silver = SLV)

GC	Grommet, Center - Specify BLK or SLV	\$	52
GL	Grommet, Left - Specify BLK or SLV	\$	52
GR	Grommet, Right - Specify BLK or SLV	\$	52

DUO/TRIO BEZEL LOCATIONS

PDC-C	Bezel, Center
PDC-L	Bezel, Left
PDC-R	Bezel, Right

DOCK 950 and DOCK 150 LOCATIONS (See Dock Units)

DOCK950-L	D950 Wireless Charger, Left	\$	265
DOCK950-C	D950 Wireless Charger, Center	\$	265
DOCK950-R	D950 Wireless Charger, Right	\$	265
DOCK150-L	D150 Wireless and USB Charger, Left	\$	405
DOCK150-C	D150 Wireless and USB Charger, Center	\$	405
DOCK150-R	D150 Wireless and USB Charger, Right	\$	405

Verify Grommet Option is available on the model(s) you are specifying using the following location information. Grommets, Power Units, Dock 950 and Dock 150 may be ordered in non-standard locations. Call Customer Service to assist with specification and/or please attach a drawing to the PO showing the location of the grommet. Note additional charges and lead times may apply.

Models

65-3470HTP	65-3462HTP	65-3456HTP
65-3464HTP	65-3458HTP	65-2850HTP
65-2870HTP	65-2858HTP	65-2846HTP
65-2864HTP	65-2856HTP	
65-2862HTP	65-2852HTP	

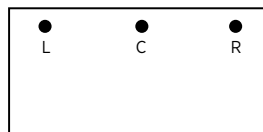

GL/GR/PDC-L/PDC-R/DOCK950-L/DOCK950-R/DOCK150-L/DOCK150-R: 18" from ends and 22 1/2" from user

GC/PDC-C/DOCK950-C/DOCK150-C: 22 1/2" from user

Models

65-2270HTP	65-2258HTP	65-2250HTP
65-2264HTP	65-2256HTP	65-2246HTP
65-2262HTP	65-2252HTP	

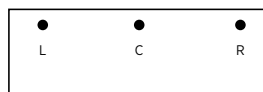

GL/GR/PDC-L/PDC-R/DOCK950-L/DOCK950-R/DOCK150-L/DOCK150-R: 18" from ends and user

GC/PDC-C/DOCK950-C/DOCK150-C: 18" from user

Models

65-2472HDFL	65-2472HMFR	65-2466HMOL
65-2472HDFR	65-2472HMOL	65-2466HMOR
65-2472HMFL	65-2472HMOR	65-2466HMFL
65-2472HDOL	65-2466HDFL	65-2466HMFR
65-2472HDOR	65-2466HDFR	65-2460HDFR
65-2460HDOL	65-2466HDOL	65-2460HDFL
65-2460HDOR	65-2466HDOR	65-2460HMFR
65-2460HMOL	65-2460HMOR	65-2460HMFL

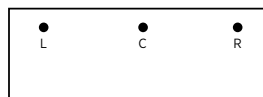

PDC-L/PDC-R: Located 11" from ends and 21 1/8" from user side

PDC-C: Located 21 1/8" from user side

GL/GR/DOCK950-L/DOCK950-R/DOCK150-L/DOCK150-R: Located 6" from ends and 20" from user side

GC/DOCK950-C/DOCK150-C: Located 20" from user side

GROMMET OPTIONS & POWER UNIT LOCATIONS

Models

65-2072HDFL	65-2072HMFR	65-2066HMOL
65-2072HDFR	65-2072HMOL	65-2066HMOR
65-2072HMFL	65-2072HMOR	65-2066HMFL
65-2072HDOL	65-2066HDFL	65-2066HMFR
65-2072HDOR	65-2066HDFR	65-2060HDFR
65-2060HDOL	65-2066HDOL	65-2060HDFL
65-2060HDOR	65-2066HDOR	65-2060HMFR
65-2060HMOL	65-2060HMOR	65-2060HMFL

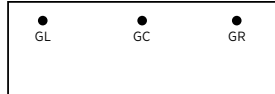

PDC-L/PDC-R: Located 11" from ends and 17½" from user side

PDC-C: Located 17½" from user side

GL/GR/DOCK950-L/DOCK950-R/DOCK150-L/DOCK150-R: Located 6" from ends and 16" from user side

GC/DOCK950-C/DOCK150-C: Located 16" from user side

Models

65-2436HM	65-2436HDL	65-2430HDL
65-2430HM	65-2436HDR	65-2430HDR
65-2424HM		

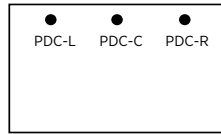

PDC-L/PDC-R: Located 11" from ends and 21½" from user side

PDC-C: Located 21½" from user side

Models

65-2036HM	65-2036HDL	65-2030HDL
65-2030HM	65-2036HDR	65-2030HDR
65-2024HM		

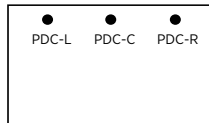

PDC-L/PDC-R: Located 11" from ends and 17½" from user side

PDC-C: Located 17½" from user side

HEIGHT ADJUSTABLE WORKSURFACE MONITOR ARM LOCATIONS

Monitor Arm Grommets are available in locations shown below. Please specify and add upcharge for each grommet. [Dual Monitor and Single Monitor Arms sold separately.](#)

Monitor Arm Grommet available in one location per unit; grommet is 2½".

MONITOR ARM GROMMET LOCATIONS

MGRMT-C	Monitor Grommet, Center	\$	52
MGRMT-L	Monitor Grommet, Left	\$	52
MGRMT-R	Monitor Grommet, Right	\$	52

Models

65-3470HTP	65-3462HTP	65-3456HTP
65-3464HTP	65-3458HTP	



MGRMT-L/MGRMT-R: Located 18" from ends and 31" from user side

MGRMT-C: Located 31" from user side

Models

65-2870HTP	65-2858HTP	65-2850HTP
65-2864HTP	65-2856HTP	65-2846HTP
65-2862HTP	65-2852HTP	

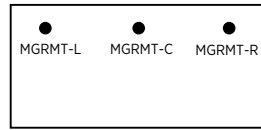

MGRMT-L/MGRMT-R: Located 18" from ends and 25" from user side

MGRMT-C: Located 25" from user side

Models

65-2270HTP	65-2258HTP	65-2250HTP
65-2264HTP	65-2256HTP	65-2246HTP
65-2262HTP	65-2252HTP	



MGRMT-L/MGRMT-R: Located 18" from ends and 19" from user side

MGRMT-C: Located 19" from user side

LOCKING DOORS

Locking doors are available on select hinged doors. You must specify WITH LOCKING when ordering and add upcharge.

LKT_HU	108"W to 84"W Units	\$	135
LKT_HU	78"W to 48"W Units	\$	115
LKT_HU	42"W to 24"W Units	\$	91
LKT_HU	18"W to 12"W Units	\$	69

WIRE MANAGEMENT

Wire Management openings available for modular pedestals.

WML	Left Panel	\$	80
WMR	Right Panel	\$	80
WMLR	Left and Right Panel	\$	160

CERTIFICATIONS & COMPLIANCE

- Intertek Sustainability Certified
- BIFMA level® Certified
- BIFMA Compliant Certified
- TSCA Title VI (formerly CARB) Compliance
- US Green Building's LEED Contribution

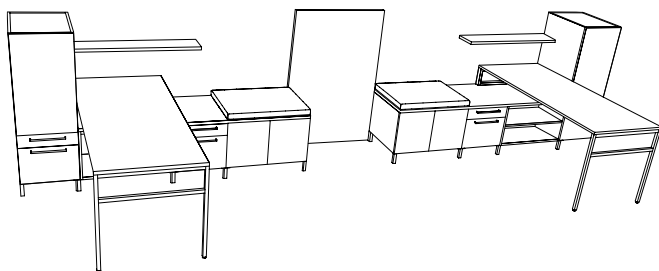
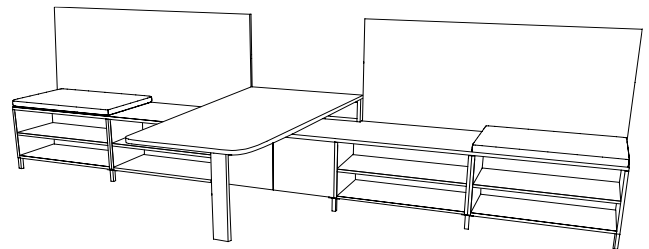
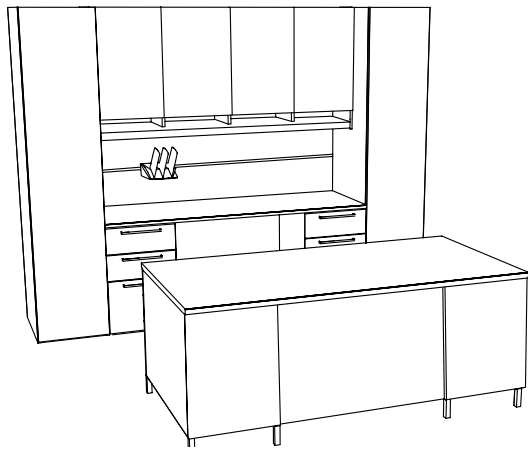
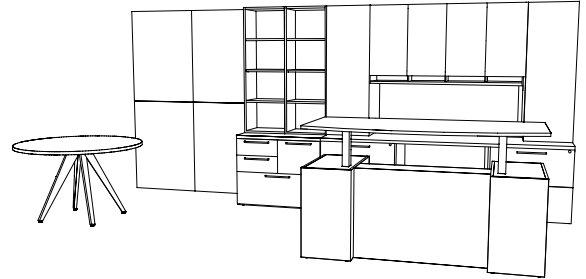
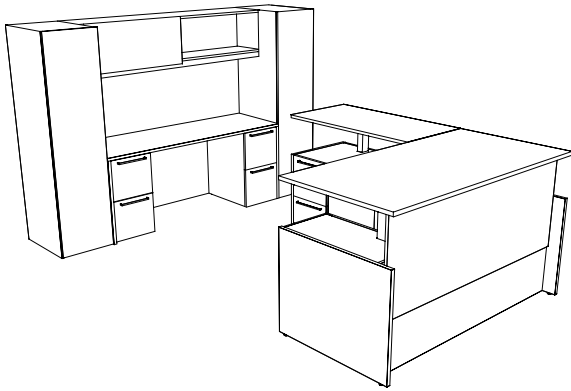

Standard Components



Double Ped Desks with or without Bow Tops
[\(See Multiple Unit Details\)](#)

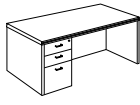

Single Ped Desks with or without Bow Tops
[\(See Multiple Unit Details\)](#)

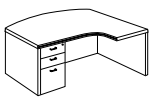

Curved Single Ped Desks with or without Bow Tops
[\(See Multiple Unit Details\)](#)

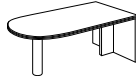

P-Top and D-Tops
[\(See Multiple Unit Details\)](#)

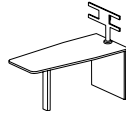

Media Peninsula
[\(See Multiple Unit Details\)](#)

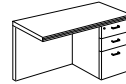

Returns
[\(See Multiple Unit Details\)](#)

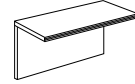

Bridges
[\(See Multiple Unit Details\)](#)

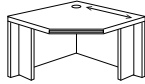

Corner Units
[\(See Multiple Unit Details\)](#)

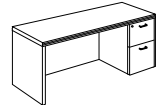

Kneespace, Storage, and Single Ped Credenzas
[\(See Multiple Unit Details\)](#)

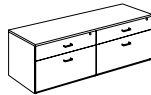

21" Low Storage and Open Credenzas
[\(See Multiple Unit Details\)](#)



Filing
[\(See Multiple Unit Details\)](#)

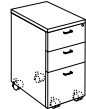

Mobile Pedestals
[\(See Multiple Unit Details\)](#)

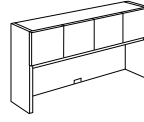

Surface Mount and Wall Mount Hutches
[\(See Multiple Unit Details\)](#)



Surface Mount Storage Towers
[\(See Multiple Unit Details\)](#)



Surface Mount Bookcases
[\(See Multiple Unit Details\)](#)



Storage Cabinets
[\(See Multiple Unit Details\)](#)

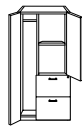

Tower Wardrobe
[\(See Multiple Unit Details\)](#)

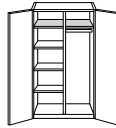

Wardrobe/Storage Cabinet
[\(See Multiple Unit Details\)](#)

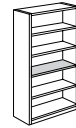

Bookcases
[\(See Multiple Unit Details\)](#)

Tables

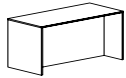

Work Tables
[\(See Multiple Unit Details\)](#)

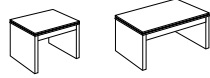

Occasional Tables
[\(See Multiple Unit Details\)](#)



Round Tops
[\(See Details\)](#)



Strut Bases
[\(See Details\)](#)



Cylinder Bases
[\(See Details\)](#)



Metal Bases
[\(See Details\)](#)



Height Adjustable Bases and Lifts
[\(See Details\)](#)

Modular Components

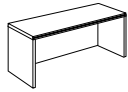

Desk, Credenza and Return Shells
[\(See Multiple Unit Details\)](#)

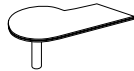

P-Tops, D-Tops And Media Peninsula
[\(See Multiple Unit Details\)](#)



Pedestals
[\(See Details\)](#)



Filing
[\(See Multiple Unit Details\)](#)

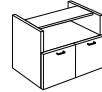

Door and Open Bookcase Pedestals
[\(See Multiple Unit Details\)](#)

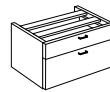

21" Low Storage
[\(See Multiple Unit Details\)](#)



Seated and Low Height Metal Supports
[\(See Seated Height and Low Height\)](#)

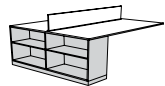

Desk End Bookcases
[\(See Details\)](#)



Support Panels
[\(See Standard Height and Low Height\)](#)

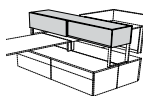

Dual and Single Access Hutches
[\(See Multiple Unit Details\)](#)

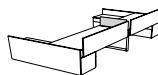

Privacy Panels
[\(See Multiple Unit Details\)](#)

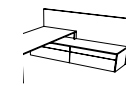

Floorstanding Gallery Screens
[\(See Multiple Unit Details\)](#)

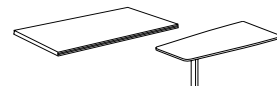

Modular Tops - Table, Desk, Benching Tops
[\(See Multiple Unit Details\)](#)



Height Adjustable Worksurface Lifts
[\(See Multiple Unit Details\)](#)

Studio Components

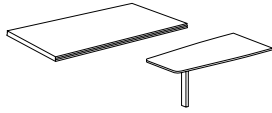

Modular Tops - Table, Desk, Benching
Tops *(See Multiple Unit Details)*



Studio Pedestals
(See Details)

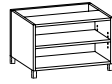

Studio Low Pedestals
(See Multiple Unit Details)

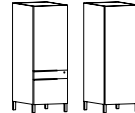

Studio Storage
Cabinets
(See Multiple Unit Details)



Kneespace
Modesty Panels
(See Multiple Unit Details)



Single and Shared
Stanchions
(See Details)



Studio Single and
Shared Legs
(See Details)

Height Adjustable Units and Components



Double Ped Desks
(See Details)

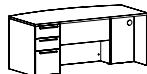

Single Ped Desks
(See Details)

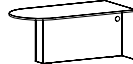

P and D-Top
(See Details)

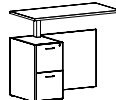

Returns
(See Multiple Unit Details)

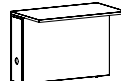

Bridge
(See Details)

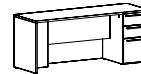

Credenzas
(See Multiple Unit Details)

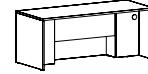

Desk Shell *(See Details)*
Return Shell *(See Details)*
Credenza Shell *(See Details)*



Height Adjustable
Worksurfaces
(See Multiple Unit Details)



Height Adjustable
Legs
(See Multiple Unit Details)



Height Adjustable
Cabinets
(See Multiple Unit Details)

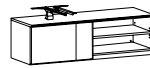

Height Adjustable
Credenzas
(See Multiple Unit Details)



Height Adjustable
Modesty Panels
(See Multiple Unit Details)



Height Adjustable
Privacy Screens
(See Multiple Unit Details)



Height Adjustable
Worksurface Lifts
(See Multiple Unit Details)

Tackboards, Work Walls, Marker Boards and Other Accessories

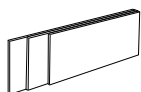

Tackboards
(See Multiple Unit Details)



Work Walls
(See Multiple Unit Details)

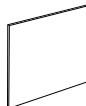

Marker Boards
(See Multiple Unit Details)



Marker, Eraser and
Magnet Sets
(See Details)



Tasklights
(See Multiple Unit Details)

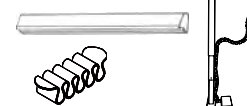

Wire Management
(See Multiple Unit Details)



Power Options *(See Multiple Unit Details)*

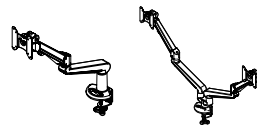

Monitor Arms *(See Multiple Unit Details)*

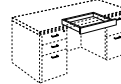

Kneespace
Accessories
(See Multiple Unit Details)



Cushion
(See Details)

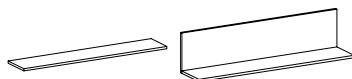

Floating and L Shelf
(See Multiple Unit Details)

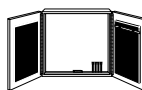

Visual Board
(See Details)

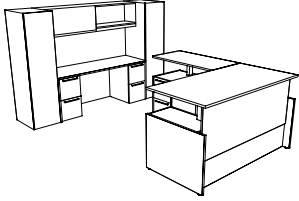
Item	Model No.	Width	Depth	Height	Ship Wt	Cubic Ft	List Price
	65-21	108	105	70 7/8	1418	200.5	W/P 33806
CONSIST OF:		QTY					
	67-3672RPSTS	1	Height Adjustable Single Ped Desk with Box/Box/File with Moving Modesty Option				W/P\$ 9398
	67-2448LF2STS3	1	Height Adjustable Return with File/File, 3-Channel				W/P\$ 5570
	GMB-2372W	1	72"W Glass Marker Board for Wall Mount Hutch				\$ 2595
	67-2472KC	1	Kneespace Credenza Full Pedestal				W/P\$ 4785
	65-1572SWD	1	72"W Wall Mount Hutch with Sliding Door				W\$ 4168
	65-1872WR	1	Wardrobe Storage Cabinet, Right				W\$ 3645
	65-1872WL	1	Wardrobe Storage Cabinet, Left				W\$ 3645

Products are available as left or right, where applicable
 Depth includes 42" between Double Ped Desk and Kneespace Credenza
 List price does not include optional moving modesty

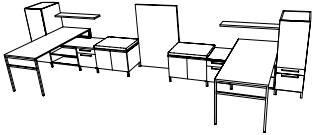
	65-25	198	72	51 1/2	1121	121.8	W/P\$ 30545
CONSIST OF:		QTY					
	65-3072TP	2	Modular Desk Top				W/P\$ 2394
	01-3028HLV	2	H Modular Peninsula Support Seated Height				\$ 2252
	01-3007OL	2	Layer Support for Desk Top				\$ 1114
	65-2430SBC	2	30"W Studio Low Mod Open Bookcase				W\$ 3714
	65-2418STF	2	18"W Studio Low Mod Tray/File Ped				W\$ 3596
	65-1851SWBL	1	Studio Storage Cabinet Door/Tray/File, Left				W\$ 2818
	65-1851SWBR	1	Studio Storage Cabinet Door/Tray/File, Right				W\$ 2818
	65-2430SDB	2	30"W Studio Low Mod Door Bookcase				W\$ 3252
	65-2478TP	2	78" Modular Top for Storage				W/P\$ 2170
	65-2430CUSHION	2	30"W Component Cushion for Door Bookcase				GR1\$ 770
	01-0404SSL4	3	Studio Shared Leg, 4 Pack				ALUM\$ 741
	01-0404SL4	2	Studio Leg, 4 Pack				ALUM\$ 494
	GMB-5136W	1	36"W Glass Marker Board From Floor				\$ 2802
	65-0942FS	2	42"W Floating Shelf				W\$ 1610

Products are available as left or right, where applicable

Pricing Codes:

W= Wood Top

P= HPL Top

[See Gesso Intro Section for Ordering Options](#)

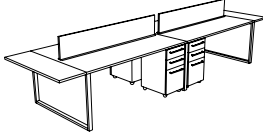
Item	Model No.	Width	Depth	Height	Ship Wt	Cubic Ft	List Price
	65-12	174	60	41¾	954	85.6	W/P\$ 20392
	CONSIST OF:		QTY				
	01-3028OLS_6512	2	Seated Height Shared Metal Leg		A\$	1258	
	01-6028OL_6512	2	Seated Height Modular Peninsula Support		A\$	1834	
	01-00060SB_6512	4	Stiffener Bar		\$	516	
	01-1228OL_6512	2	O Leg Support		A\$	884	
	65-1519MP1_6512	4	Mobile Pedestal BoxBoxFile		W\$	9072	
	65-1560DTP_6512	2	Desk Top Extensions		W/P\$	1372	
	65-6072TP_6512	2	Modular Desk Top		W/P\$	3934	
	65-6812PP_6512	2	12" Privacy Panel		W\$	1522	

Products are available as left or right, where applicable

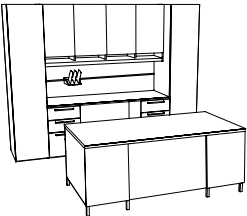
	65-23	108	102	82¾	1127	152.3	W/P\$ 28944
	CONSIST OF:		QTY				
	65-3672TP	1	Modular Desk Top		W/P\$	1281	
	65-2472TP	1	Modular Cabinet Top		W/P\$	1054	
	01-0404SL4_6523	2	Single Studio Leg 4-Pack		ALUM\$	494	
	65-3618SPD1_6523	2	Studio Modular Desk Pedestal, Box/Box/File		W\$	5292	
	65-3624MDHGA	1	Studio Kneespace Modesty Panel, High Gloss Acrylic, Wired Mercury		\$	589	
					GPA\$	676	
	65-1572TWDS	1	Tall Wall Mount Door Hutch with Paper Slots		W\$	5750	
	65-2418PD1_6523	2	Modular Desk Pedestal, Box/Box/File		W\$	4420	
	65-7228BP	1	Modular Modesty Panel		W\$	878	
	65-1884WL	1	Tall Wardrobe/Storage Cabinet, Left		W\$	3804	
	65-1884WR	1	Tall Wardrobe/Storage Cabinet, Right		W\$	3804	
	WW-1972TRWPS	1	Tool Rail Work Wall		GR1\$	1004	
	01-FLDRSRTRC	1	Folder Sorter for Tool Rail Work Wall, Clear		\$	129	

Products are available as left or right, where applicable

Depth includes 42" between Modular Double Ped Desk and Modular Credenza

Modesty Panel High Gloss Acrylic Color Pricing, \$ = Black, White, Wired Mercury and GPA\$ = Graphite

Pricing Codes:
W= Wood Top
P= HPL Top

[See Gesso Intro Section for Ordering Options](#)

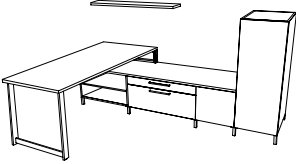
Item	Model No.	Width	Depth	Height	Ship Wt	Cubic Ft	List Price
	65-22	102	72	47½	508	56.9	W/P\$ 13031
CONSIST OF:		QTY					
	65-3072TP	1	Modular Desk Top				W/P\$ 1197
	65-2484TP	1	Modular Cabinet Top				W/P\$ 1107
	01-3028BL	1	Bar Modular Peninsula Support				ALUM\$ 644
	65-2430SBC	1	Studio Modular Low Storage, Open Bookcase				W\$ 1857
	65-2436STF	1	Studio Modular Low Storage, Tray/File				W\$ 2228
	65-2418SDBR	1	Studio Modular Low Door Bookcase, Right Hinged				W\$ 1468
	01-3007OL	1	Layer Support for 21" Low Credenzas				\$ 557
	65-1851SWR	1	Studio Wardrobe, Right Hinged				W\$ 2460
	01-0404SL4_6522	1	Single Studio Leg 4-Pack				ALUM\$ 247
	01-0404SSL2_6522	1	Shared Studio Leg 2-Pack				ALUM\$ 143
	01-0404SSL4_6522	1	Shared Studio Leg 4-Pack				ALUM\$ 247
	65-0948FS	1	48" Floating Shelf Display				W\$ 876

Products are available as left or right, where applicable

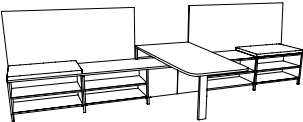
	65-24	180	72	47¾	769	118.6	W/P\$ 21067
CONSIST OF:		QTY					
	65-2436SBC_6524	4	Studio Modular Low Storage, Open Bookcase				W\$ 7764
	65-2436SDB	1	Studio Modular Low Door Bookcase				W\$ 1856
	01-0404SL4_6524	1	Single Studio Leg 4-Pack				ALUM\$ 247
	01-0404SSL4_6524	2	Shared Studio Leg 4-Pack				ALUM\$ 494
	65-2472TP_6524	2	Modular Cabinet Top				W/P\$ 2108
	65-2436TP	1	Modular Cabinet Top				W/P\$ 655
	65-2436CUSHION_6524	2	Component Cushion				GR1\$ 890
	01-3607OL	1	Layer Support For 21" Low Credenza				\$ 576
	65-3672MP	1	Media Peninsula				W/P\$ 3841
	WW-3172TTRW_6524	2	Tool Rail Work Wall				GR1\$ 2636

Products are available as left or right, where applicable

Pricing Codes:

W= Wood Top

P= HPL Top

[See Gesso Intro Section for Ordering Options](#)

Item	Model No.	Width	Depth	Height	K	R	Ship Wt	Cubic Ft	List Price
DOUBLE PED DESK BOW TOP STEPPED FRONT	67-3672BDPS	72	36-30	30	40½	-	410	50.0	W/P\$ 5873

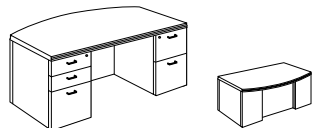

Stepped Front

Description

- Standard With: Bow Top, Stepped Front, Full Modesty, Letter Width Locking Box/Box/File on Left Pedestal and File/File on Right, Left to Right Grain Direction on Worksurface, Wire Management from Pedestal to Kneespace, Black Utility Tray for Box Drawer
- Available with Veneer (W) or HPL (P) Top; Must Specify
- Drawer Front Grain Direction Vertical Standard; Optional Horizontal Grain Direction
- [Height Adjustable Units Available](#)
- Additional Options: Dove Tail Drawer Construction and Soft Close Drawers ([See Drawer Details](#)), Power and Grommet Options ([See Options and Locations](#)), Kneespace Options (Sold Separately, [See Unit Details](#))

Must Specify (in this order):

- Model #
- Top Material
- Finish
- Edge Profile
- Drawer Construction
- Drawer Track
- Drawer Front Grain Direction
- Modesty Finish/Color
- Grommet Location
- Wire Management
- Grommet Style/Color
- Power/Data Options
- Drawer Pull
- Kneespace Options

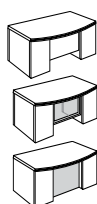

Options: Specify & Add

65-TMD	18¼"H Veneer ¾ Modesty Panel - Must Specify Finish Color	Included
65-TSC	18¼"H Aluminum Framed Satin Frosted Tempered Glass ¾ Modesty Panel	\$ 969
65-HGAF	High Gloss Acrylic Full Modesty Panel; Must Specify Color	
	(GPA) Graphite Acrylic	\$ 1846
	(BLA) Black, (WMA) Wired Mercury, or (WHA) White Acrylic	\$ 1687

DOUBLE PED DESK RECTANGLE TOP STEPPED FRONT	67-3672DPS	72	36	30	40½	-	425	50.0	W/P\$ 5783
--	------------	----	----	----	-----	---	-----	------	------------

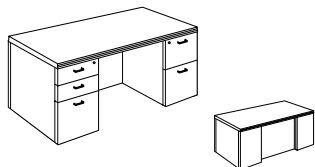

Stepped Front

Description

- Standard With: Rectangle Top, Stepped Front, Full Modesty, Letter Width Locking Box/Box/File on Left Pedestal and File/File on Right, Left to Right Grain Direction on Worksurface, Wire Management from Pedestal to Kneespace, Black Utility Tray for Box Drawer
- Available with Veneer (W) or HPL (P) Top; Must Specify
- Drawer Front Grain Direction Vertical Standard; Optional Horizontal Grain Direction
- [Height Adjustable Units Available](#)
- Additional Options: Dove Tail Drawer Construction and Soft Close Drawers ([See Drawer Details](#)), Power and Grommet Options ([See Options and Locations](#)), Kneespace Options (Sold Separately, [See Unit Details](#))

Must Specify (in this order):

- Model #
- Top Material
- Finish
- Edge Profile
- Drawer Construction
- Drawer Track
- Drawer Front Grain Direction
- Modesty Finish/Color
- Grommet Location
- Wire Management
- Grommet Style/Color
- Power/Data Options
- Drawer Pull
- Kneespace Options

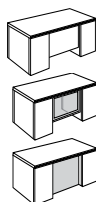

Options: Specify & Add

65-TMD	18¼"H Veneer ¾ Modesty Panel - Must Specify Finish Color	Included
65-TSC	18¼"H Aluminum Framed Satin Frosted Tempered Glass ¾ Modesty Panel	\$ 969
65-HGAF	High Gloss Acrylic Full Modesty Panel; Must Specify Color	
	(GPA) Graphite Acrylic	\$ 1846
	(BLA) Black, (WMA) Wired Mercury, or (WHA) White Acrylic	\$ 1687

Pricing Codes:

W= Wood Top
P= HPL Top

[See Gesso Intro Section for Ordering Options](#)

Item	Model No.	Width	Depth	Height	K	R	Ship Wt	Cubic Ft	List Price
DOUBLE PED DESK BOW TOP RECESSED FRONT	67-3672BDP	72	36-30	30	40½	10	410	50.0	W/P\$ 5637
	67-3666BDP	66	30-36	30	34½	10	380	48.0	W/P\$ 5432

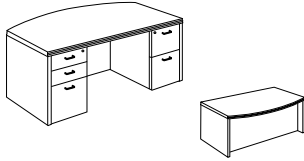

Recessed Front

Must Specify (in this order):

Model #
Top Material
Finish
Edge Profile
Drawer Construction
Drawer Track
Drawer Front Grain Direction
Grommet Location
Wire Management
Grommet Style/Color
Power/Data Options
Drawer Pull
Kneespace Options

Description

- Standard With: Bow Top, Recessed Front, Letter Width Locking Box/Box/File on Left Pedestal and File/File on Right, Left to Right Grain Direction on Worksurface, Wire Management from Pedestal to Kneespace, Black Utility Tray for Box Drawer
- Available with Veneer (W) or HPL (P) Top; Must Specify
- Drawer Front Grain Direction Vertical Standard; Optional Horizontal Grain Direction
- [Height Adjustable Units Available](#)
- Additional Options: Dove Tail Drawer Construction and Soft Close Drawers ([See Drawer Details](#)), Power and Grommet Options ([See Options and Locations](#)), Kneespace Options (Sold Separately, [See Unit Details](#))

DOUBLE PED DESK RECTANGLE TOP RECESSED FRONT	67-3672DP	72	36	30	40½	10	425	50.0	W/P\$ 4916
	67-3072DP	72	30	30	40½	4	410	43.9	W/P\$ 4753
	67-3066DP	66	30	30	34½	4	390	38.7	W/P\$ 4578
	67-3060DP	60	30	30	28½	4	358	35.3	W/P\$ 4375

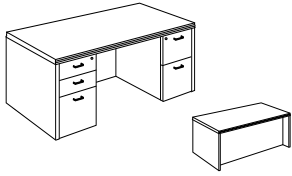

Recessed Front

Must Specify (in this order):

Model #
Top Material
Finish
Edge Profile
Drawer Construction
Drawer Track
Drawer Front Grain Direction
Grommet Location
Wire Management
Grommet Style/Color
Power/Data Options
Drawer Pull
Kneespace Options

Description

- Standard With: Rectangle Top, Recessed Front, Letter Width Locking Box/Box/File on Left Pedestal and File/File on Right, Left to Right Grain Direction on Worksurface, Wire Management from Pedestal to Kneespace, Black Utility Tray for Box Drawer
- Available with Veneer (W) or HPL (P) Top; Must Specify
- Drawer Front Grain Direction Vertical Standard; Optional Horizontal Grain Direction
- [Height Adjustable Units Available](#)
- Additional Options: Dove Tail Drawer Construction and Soft Close Drawers ([See Drawer Details](#)), Power and Grommet Options ([See Options and Locations](#)), Kneespace Options (Sold Separately, [See Unit Details](#))

Pricing Codes:

W= Wood Top

P= HPL Top

[See Gesso Intro Section for Ordering Options](#)

Item	Model No.	Width	Depth	Height	K	R	Ship Wt	Cubic Ft	List Price
SINGLE PED DESK BOW TOP STEPPED FRONT	Left Ped	Right Ped							
	67-3672BLPS	67-3672BRPS	72	30-36	30	32¼	-	320	50.0

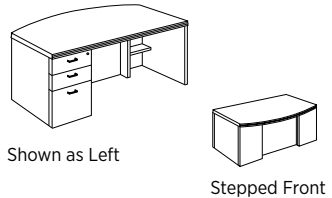

- Must Specify (in this order):
- Model #
 - Top Material
 - Finish
 - Edge Profile
 - Drawer Construction
 - Drawer Track
 - Drawer Front
 - Grain Direction
 - Modesty Finish/Color
 - Grommet Location
 - Wire Management
 - Grommet Style/Color
 - Power/Data Options
 - Drawer Pull
 - Kneespace Options

Description

- Standard With: Bow Top, Stepped Front, Full Modesty, Letter Width Locking Box/Box/File in Pedestal, Left to Right Grain Direction on Worksurface, Wire Management from Pedestal to Kneespace, Black Utility Tray for Box Drawer
- Available with Veneer (W) or HPL (P) Top; Must Specify
- Drawer Front Grain Direction Vertical Standard; Optional Horizontal Grain Direction
- [Height Adjustable Units Available](#)
- Additional Options: Dove Tail Drawer Construction and Soft Close Drawers ([See Drawer Details](#)), Power and Grommet Options ([See Options and Locations](#)), Kneespace Options (Sold Separately, [See Unit Details](#))

Options: Specify & Add

65-TMD	18¼"H Veneer ¾ Modesty Panel - Must Specify Finish Color	Included
65-TSC	18¼"H Aluminum Framed Satin Frosted Tempered Glass ¾ Modesty Panel	\$ 969
65-HGAF	High Gloss Acrylic Full Modesty Panel; Must Specify Color	
	(GPA) Graphite Acrylic	\$ 1846
	(BLA) Black, (WMA) Wired Mercury, or (WHA) White Acrylic	\$ 1687

SINGLE PED DESK RECTANGLE TOP STEPPED FRONT	Left Ped	Right Ped							
	67-3672LPS	67-3672RPS	72	36	30	32¼	-	330	50.0

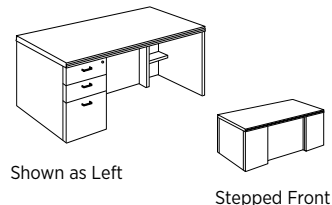

- Must Specify (in this order):
- Model #
 - Top Material
 - Finish
 - Edge Profile
 - Drawer Construction
 - Drawer Track
 - Drawer Front
 - Grain Direction
 - Modesty Finish/Color
 - Grommet Location
 - Wire Management
 - Grommet Style/Color
 - Power/Data Options
 - Drawer Pull
 - Kneespace Options

Description

- Standard With: Rectangle Top, Stepped Front, Full Modesty, Letter Width Locking Box/Box/File in Pedestal, Left to Right Grain Direction on Worksurface, Wire Management from Pedestal to Kneespace, Black Utility Tray for Box Drawer
- Available with Veneer (W) or HPL (P) Top; Must Specify
- Drawer Front Grain Direction Vertical Standard; Optional Horizontal Grain Direction
- [Height Adjustable Units Available](#)
- Additional Options: Dove Tail Drawer Construction and Soft Close Drawers ([See Drawer Details](#)), Power and Grommet Options ([See Options and Locations](#)), Kneespace Options (Sold Separately, [See Unit Details](#))

Options: Specify & Add

65-TMD	18¼"H Veneer ¾ Modesty Panel - Must Specify Finish Color	Included
65-TSC	18¼"H Aluminum Framed Satin Frosted Tempered Glass ¾ Modesty Panel	\$ 969
65-HGAF	High Gloss Acrylic Full Modesty Panel; Must Specify Color	
	(GPA) Graphite Acrylic	\$ 1846
	(BLA) Black, (WMA) Wired Mercury, or (WHA) White Acrylic	\$ 1687

Pricing Codes:
W= Wood Top
P= HPL Top

[See Gesso Intro Section for Ordering Options](#)

Item	Model No.	Width	Depth	Height	K	R	Ship Wt	Cubic Ft	List Price	
SINGLE PED DESK BOW TOP RECESSED FRONT	Left Ped									
	Right Ped									
	67-3672BLP	67-3672BRP	72	30-36	30	32¼	10	320	50.0	W/P\$ 4967

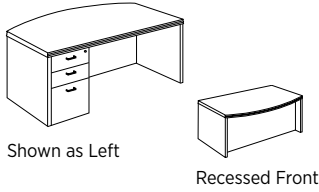

Shown as Left

Recessed Front

Description

- Standard With: Bow Top, Recessed Front, Letter Width Locking Box/Box/File in Pedestal, Left to Right Grain Direction on Worksurface, Wire Management from Pedestal to Kneespace, Black Utility Tray for Box Drawer
- Available with Veneer (W) or HPL (P) Top; Must Specify
- Drawer Front Grain Direction Vertical Standard; Optional Horizontal Grain Direction
- [Height Adjustable Units Available](#)
- Additional Options: Dove Tail Drawer Construction and Soft Close Drawers ([See Drawer Details](#)), Power and Grommet Options ([See Options and Locations](#)), Kneespace Options (Sold Separately, [See Unit Details](#))

Must Specify (in this order):

- Model #
- Top Material
- Finish
- Edge Profile
- Drawer Construction
- Drawer Track
- Drawer Front Grain Direction
- Grommet Location
- Wire Management
- Grommet Style/Color
- Power/Data Options
- Drawer Pull
- Kneespace Options

SINGLE PED DESK RECTANGLE TOP RECESSED FRONT	Left Ped	Right Ped								
	67-3672LP	67-3672RP	72	36	30	32¼	10	330	50.0	W/P\$ 4180
	67-3072LP	67-3072RP	72	30	30	32¼	4	210	43.0	W/P\$ 4116
	67-3066LP	67-3066RP	66	30	30	26¼	4	180	38.7	W/P\$ 3945
	67-3060LP	67-3060RP	60	30	30	20¼	4	150	35.0	W/P\$ 3796

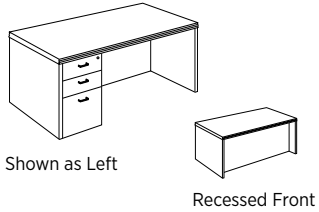

Shown as Left

Recessed Front

Description

- Standard With: Rectangle Top, Recessed Front, Letter Width Locking Box/Box/File in Pedestal, Left to Right Grain Direction on Worksurface, Wire Management from Pedestal to Kneespace, Black Utility Tray for Box Drawer
- Available with Veneer (W) or HPL (P) Top; Must Specify
- Drawer Front Grain Direction Vertical Standard; Optional Horizontal Grain Direction
- [Height Adjustable Units Available](#)
- Additional Options: Dove Tail Drawer Construction and Soft Close Drawers ([See Drawer Details](#)), Power and Grommet Options ([See Options and Locations](#)), Kneespace Options (Sold Separately, [See Unit Details](#))

Must Specify (in this order):

- Model #
- Top Material
- Finish
- Edge Profile
- Drawer Construction
- Drawer Track
- Drawer Front Grain Direction
- Grommet Location
- Wire Management
- Grommet Style/Color
- Power/Data Options
- Drawer Pull
- Kneespace Options

Pricing Codes:

W= Wood Top
P= HPL Top

[See Gesso Intro Section for Ordering Options](#)

Item	Model No.	Width	Depth	Height	K	R	Ship Wt	Cubic Ft	List Price
CURVED SINGLE PED DESK BOW TOP RECESSED FRONT	Left Ped	Right Ped							
	67-4872CBLP	67-4872CBRP	72	48-30	30	-	-	365	68.5

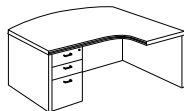

Shown as Left



Recessed Front

Description

- Standard With: Bow Top, Recessed Front, Full Modesty, Letter Width Locking Box/Box/File in Pedestal, Left to Right Grain Direction on Worksurface, Wire Management from Pedestal to Kneespace, Black Utility Tray for Box Drawer
- Available with Veneer (W) or HPL (P) Top; Must Specify
- Drawer Front Grain Direction Vertical Standard; Optional Horizontal Grain Direction
- Additional Options: Dove Tail Drawer Construction and Soft Close Drawers ([See Drawer Details](#)), Power and Grommet Options ([See Options and Locations](#)), Kneespace Options (Sold Separately, [See Unit Details](#))

Must Specify (in this order):

- Model #
- Top Material
- Finish
- Edge Profile
- Drawer Construction
- Drawer Track
- Drawer Front Grain Direction
- Grommet Location
- Wire Management
- Grommet Style/Color
- Power/Data Options
- Drawer Pull
- Kneespace Options

Item	Model No.	Width	Depth	Height	K	R	Ship Wt	Cubic Ft	List Price
CURVED SINGLE PED DESK RECTANGLE TOP RECESSED FRONT	Left Ped	Right Ped							
	67-4272CLP	67-4272CRP	72	42-30	30	-	-	350	65.8

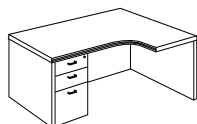

Shown as Left

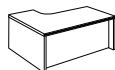

Recessed Front

Description

- Standard With: Rectangle Top, Recessed Front, Full Modesty, Letter Width Locking Box/Box/File in Pedestal, Left to Right Grain Direction on Worksurface, Wire Management from Pedestal to Kneespace, Black Utility Tray for Box Drawer
- Available with Veneer (W) or HPL (P) Top; Must Specify
- Drawer Front Grain Direction Vertical Standard; Optional Horizontal Grain Direction
- Additional Options: Dove Tail Drawer Construction and Soft Close Drawers ([See Drawer Details](#)), Power and Grommet Options ([See Options and Locations](#)), Kneespace Options (Sold Separately, [See Unit Details](#))

Must Specify (in this order):

- Model #
- Top Material
- Finish
- Edge Profile
- Drawer Construction
- Drawer Track
- Drawer Front Grain Direction
- Grommet Location
- Wire Management
- Grommet Style/Color
- Power/Data Options
- Drawer Pull
- Kneespace Options

Pricing Codes:
W= Wood Top
P= HPL Top

[See Gesso Intro Section for Ordering Options](#)

Item	Model No.	Width	Depth	Height	Ship Wt	Cubic Ft	List Price
P-TOP CYLINDER BASE	Left Ped	Right Ped					
	65-4284PL	65-4284PR	84	42-36	30	161	59.8 W/P\$ 4721
	65-4272PL	65-4272PR	72	42-36	30	161	59.8 W/P\$ 4326

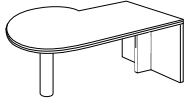

Shown as Left

Description

- Standard with: Left to Right Grain Direction on Worksurface, End Panel Support
- Available with Veneer (W) or HPL (P) Top; Must Specify
- Metal Cylinder Base - 4½" Diameter. Must Specify: Black or Aluminum
- Not Recommended for Freestanding Applications
- [Height Adjustable Units Available](#)
- Additional Options: Power and Grommet Options ([See Options and Locations](#)), Kneespace Options (Sold Separately, [See Unit Details](#))

Must Specify (in this order):

- Model #
- Top Material
- Finish
- Edge Profile
- Modesty Finish/Color
- Power/Data Options
- Kneespace Options
- Leg Color
- Worksurface Grommet Location
- Grommet Color

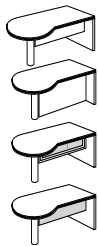

Options: Specify & Add

65-HMD	10"H Half Modesty Panel - Must Specify Laminate Color	84" \$ 320
		72" \$ 285
65-FMD	Full Modesty Panel - Must Specify Laminate Color	84" \$ 380
		72" \$ 341
65-HSC	10"H Aluminum Framed Satin Frosted Tempered Glass Half Modesty Panel	84" \$ 1091
		72" \$ 983
65-HGAH	10"H High Gloss Acrylic Half Modesty Panel; Must Specify Color	
	(GPA) Graphite Acrylic	84" \$ 1319
	(BLA) Black, (WMA) Wired Mercury, or (WHA) White Acrylic	84" \$ 1203
	(GPA) Graphite Acrylic	72" \$ 1182
	(BLA) Black, (WMA) Wired Mercury, or (WHA) White Acrylic	72" \$ 1076

Pricing Codes:

W= Wood Top
P= HPL Top

[See Gesso Intro Section for Ordering Options](#)

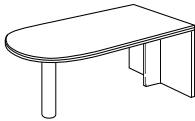
Item	Model No.	Width	Depth	Height	Ship Wt	Cubic Ft	List Price
D-TOP CYLINDER BASE  Shown as Left	Left Ped	Right Ped					
	65-3684DUL	65-3684DUR	84	36	30	187	W/P\$ 4237
	65-3672DUL	65-3672DUR	72	36	30	160	W/P\$ 3606
	65-3084DUL	65-3084DUR	84	30	30	190	W/P\$ 4109
	65-3072DUL	65-3072DUR	72	30	30	160	W/P\$ 3493
	65-3066DUL	65-3066DUR	66	30	30	146	W/P\$ 3340





Must Specify (in this order):

- Model #
- Top Material
- Finish
- Edge Profile
- Modesty Finish/Color
- Power/Data Options
- Kneespace Options
- Leg Color
- Worksurface Grommet Location
- Grommet Color

Description

- Standard with: Left to Right Grain Direction on Worksurface, End Panel Support
- Available with Veneer (W) or HPL (P) Top; Must Specify
- Metal Cylinder Base - 4½" Diameter. Must Specify: Black or Aluminum
- Not Recommended for Freestanding Applications
- [Height Adjustable Units Available](#)
- Additional Options: Power and Grommet Options ([See Options and Locations](#)), Kneespace Options (Sold Separately, [See Unit Details](#))

Options: Specify & Add

	65-HMD	10"H Half Modesty Panel - Must Specify Laminate Color	84" \$ 320
			72" \$ 285
			66" \$ 258
	65-FMD	Full Modesty Panel - Must Specify Laminate Color	84" \$ 380
			72" \$ 341
			66" \$ 306
	65-HSC	10"H Aluminum Framed Satin Frosted Tempered Glass Half Modesty Panel	84" \$ 1091
			72" \$ 983
			66" \$ 901
	65-HGAH	10"H High Gloss Acrylic Half Modesty Panel; Must Specify Color	
		(GPA) Graphite Acrylic	84" \$ 1319
		(BLA) Black, (WMA) Wired Mercury, or (WHA) White Acrylic	84" \$ 1203
		(GPA) Graphite Acrylic	72" \$ 1182
		(BLA) Black, (WMA) Wired Mercury, or (WHA) White Acrylic	72" \$ 1076
		(GPA) Graphite Acrylic	66" \$ 1054
	(BLA) Black, (WMA) Wired Mercury, or (WHA) White Acrylic	66" \$ 962	

Pricing Codes:

- W= Wood Top
- P= HPL Top

[See Gesso Intro Section for Ordering Options](#)

Item	Model No.	Width	Depth	Height	Ship Wt	Cubic Ft	List Price
EXTENDED D-TOP CYLINDER BASE	Left Ped	Right Ped					
	65-4272EDL	65-4272EDR	72	42-36	30	163	58.0 W/P\$ 3645

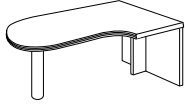

Shown as Left

Must Specify (in this order):

- Model #
- Top Material
- Finish
- Edge Profile
- Modesty Finish/Color
- Power/Data Options
- Kneespace Options
- Leg Color
- Worksurface Grommet Location
- Grommet Color

Description

- Standard with: Left to Right Grain Direction on Worksurface, End Panel Support
- Available with Veneer (W) or HPL (P) Top; Must Specify
- Metal Cylinder Base - 4 1/2" Diameter. Must Specify: Black or Aluminum
- Not Recommended for Freestanding Applications
- [Height Adjustable Units Available](#)
- Additional Options: Power and Grommet Options ([See Options and Locations](#)), Kneespace Options (Sold Separately, [See Unit Details](#))

Options: Specify & Add

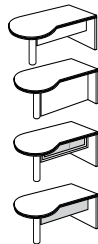

65-HMD	10"H Half Modesty Panel - Must Specify Laminate Color	\$ 285
65-FMD	Full Modesty Panel - Must Specify Laminate Color	\$ 341
65-HSC	10"H Aluminum Framed Satin Frosted Tempered Glass Half Modesty Panel	\$ 983
65-HGAH	10"H High Gloss Acrylic Half Modesty Panel; Must Specify Color	
	(GPA) Graphite Acrylic	\$ 1182
	(BLA) Black, (WMA) Wired Mercury, or (WHA) White Acrylic	\$ 1076

MEDIA PENINSULA	65-3672MPS	72	36	30	164	52.1	W/P\$ 5938
	65-3066MPS	66	30	30	148	40.3	W/P\$ 5640
	65-3060MPS	60	30	30	143	36.7	W/P\$ 5482

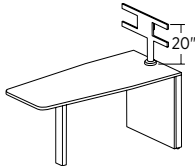

Must Specify (in this order):

- Model #
- Top Material
- Finish
- Edge Profile
- Leg
- Power/Data Options
- Kneespace Options

Description

- Left to Right Grain Direction on Worksurface
- Available with Veneer (W) or HPL (P) Top; Must Specify
- Not Recommended for Freestanding Applications Due to Open Back. May be Used with Component Gallery Screens
- Some Assembly Required
- Open Back for Wire Management
- Prevent Screen from Colliding with Walls or Furniture by Setting Rotation Limits at 15°, 30°, 45° or 90°
- Easily Route and Conceal Cables Through a Wide, In-column Channel for a Clean Finish
- Fits Most Screens 32"- 52"; Mounting Pattern Range: VESA® 100 x 100 mm - 600 x 400 mm
- Standard with Aluminum Rectangle Leg to be Installed 17 3/4" from Front to Allow for Kneespace Area
- Wire Management Trough Included; 4 1/4" W x 46 3/8" L x 3 1/2" H
- Additional Options: Leg Option (See Below), Power and Grommet Options ([See Options and Locations](#))



Leg Options: Specify & Add

OLEGA	12" Aluminum Tube Leg	\$ 112
OLEGB	12" Black Tube Leg	\$ 112

Pricing Codes:

W= Wood Top
P= HPL Top

[See Gesso Intro Section for Ordering Options](#)

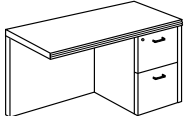
Item	Model No.	Width	Depth	Height	K	R	Ship Wt	Cubic Ft	List Price	
 RETURN WITH FILE/FILE Shown as Right	Left Ped	Right Ped								
	67-2448LF2	67-2448RF2	48	24	30	32¼	-	151	23.1	W/P\$ 2717
	Front to Back Grain Direction on Worksurface									
	67-4824LF2	67-4824RF2	48	24	30	32¼	-	151	23.1	W/P\$ 2717
For Use with Extended Corner and Standard Corner Units; Left to Right Grain Direction on Worksurface										
	67-2442LF2	67-2442RF2	42	24	30	26¼	-	133	20.4	W/P\$ 2600
Front to Back Grain Direction on Worksurface										
	67-4224LF2	67-4224RF2	42	24	30	26¼	-	133	20.4	W/P\$ 2600
For Use with Extended Corner and Standard Corner Units; Left to Right Grain Direction										

Must Specify (in this order):

- Model #
- Top Material
- Finish
- Edge Profile
- Drawer Front Grain Direction
- Pull
- Drawer Construction
- Drawer Track
- Back Panel Grommet Color
- Worksurface Grommet Location
- Grommet Color
- Power/Data Options
- Kneespace Options

Description

- Standard with: Letter Width Locking File/File Pedestal, Wire Management from Pedestal to Kneespace
- Available with Veneer (W) or HPL (P) Top; Must Specify
- Back Panel Grommet Standard; Must Specify: Black (BLK), Silver (SLV) or No Back Panel Grommet (NONE)
- Drawer Front Grain Direction Vertical Standard; Optional Horizontal Grain Direction
- [Height Adjustable Units Available](#)
- Additional Options: Dove Tail Drawer Construction and Soft Close Drawers ([See Drawer Details](#)), Power and Grommet Options ([See Options and Locations](#)), Kneespace Options (Sold Separately, [See Unit Details](#))

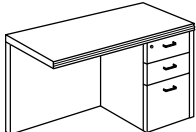
Item	Model No.	Width	Depth	Height	K	R	Ship Wt	Cubic Ft	List Price	
 RETURN WITH BOX/BOX/FILE Shown as Right	Left Ped	Right Ped								
	67-2448LF1	67-2448RF1	48	24	30	32¼	-	151	23.1	W/P\$ 2717
	Front to Back Grain Direction on Worksurface									
	67-4824LF1	67-4824RF1	48	24	30	32¼	-	151	23.1	W/P\$ 2717
For Use with Extended Corner and Standard Corner Units; Left to Right Grain Direction										
	67-2442LF1	67-2442RF1	42	24	30	26¼	-	133	20.4	W/P\$ 2600
Front to Back Grain Direction on Worksurface										
	67-4224LF1	67-4224RF1	42	24	30	26¼	-	133	20.4	W/P\$ 2600
For Use with Extended Corner and Standard Corner Units; Left to Right Grain Direction										

Must Specify (in this order):

- Model #
- Top Material
- Finish
- Edge Profile
- Drawer Front Grain Direction
- Pull
- Drawer Construction
- Drawer Track
- Back Panel Grommet Color
- Worksurface Grommet Location
- Grommet Color
- Power/Data Options
- Kneespace Options

Description

- Standard with: Letter Width Locking Box/Box/File Pedestal, Wire Management from Pedestal to Kneespace
- Available with Veneer (W) or HPL (P) Top; Must Specify
- Back Panel Grommet Standard; Must Specify: Black (BLK), Silver (SLV) or No Back Panel Grommet (NONE)
- Drawer Front Grain Direction Vertical Standard; Optional Horizontal Grain Direction
- [Height Adjustable Units Available](#)
- Additional Options: Dove Tail Drawer Construction and Soft Close Drawers ([See Drawer Details](#)), Power and Grommet Options ([See Options and Locations](#)), Kneespace Options (Sold Separately, [See Unit Details](#))

Pricing Codes:

- W= Wood Top
- P= HPL Top

[See Gesso Intro Section for Ordering Options](#)

Item	Model No.	Width	Depth	Height	K	R	Ship Wt	Cubic Ft	List Price
MULTI-FILE RETURN WITH BOX/BOX/FILE/LATERAL	Left Ped	Right Ped							
	65-2472LMR	65-2472RMR	72	24	30	36	-	280	33.6

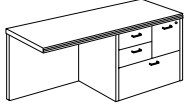

Shown as Right

Must Specify (in this order):

- Model #
- Top Material
- Finish
- Edge Profile
- Drawer Construction
- Drawer Track
- Drawer Front Grain Direction
- Pull
- Back Panel Grommet Color
- Worksurface Grommet Location
- Grommet Color
- Power/Data Options
- Kneespace Options

Description

- Standard with: Box/Box/File/Lateral Pedestal, Locking File Drawer, Side to Side Grain Direction on Worksurface, Wire Management from Pedestal to Kneespace
- Available with Veneer (W) or HPL (P) Top; Must Specify
- Back Panel Grommet Standard; Must Specify: Black (BLK), Silver (SLV) or No Back Panel Grommet (NONE)
- Drawer Front Grain Direction Vertical Standard; Optional Horizontal Grain Direction
- [Height Adjustable Units Available](#)
- Additional Options: Dove Tail Drawer Construction and Soft Close Drawers ([See Drawer Details](#)), Power and Grommet Options ([See Options and Locations](#)), Kneespace Options (Sold Separately, [See Unit Details](#))

BRIDGE WITH FULL MODESTY	65-2448UF	48	24	30	48	-	82	5.3	W/P\$ 1242
	65-2442UF	42	24	30	42	-	68	4.7	W/P\$ 1192
	65-2436UF	36	24	30	36	-	46	4.1	W/P\$ 1133
	65-2048UF	48	20	30	48	-	77	5.3	W/P\$ 1149
	65-2042UF	42	20	30	42	-	64	4.7	W/P\$ 1113
	65-2036UF	36	20	30	36	-	43	4.1	W/P\$ 1057

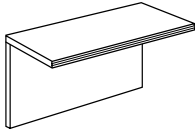

Must Specify (in this order):

- Model #
- Top Material
- Finish
- Edge Profile
- Back Panel Grommet Color
- Worksurface Grommet Location
- Grommet Color
- Power/Data Options
- Kneespace Options

Description

- Standard with: Front to Back Grain Direction on Worksurface, Hinged Back Panel
- Available with Veneer (W) or HPL (P) Top; Must Specify
- Back Panel Grommet Standard; Must Specify: Black (BLK), Silver (SLV) or No Back Panel Grommet (NONE)
- [Height Adjustable Units Available](#)
- Keyboard Accessories Cannot be Factory Installed but are Available for Field Installation ([See Unit Details](#))
- Additional Options: Power and Grommet Options ([See Options and Locations](#))

Pricing Codes:

W= Wood Top
P= HPL Top

[See Gesso Intro Section for Ordering Options](#)

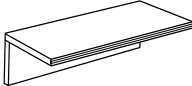
Item	Model No.	Width	Depth	Height	K	R	Ship Wt	Cubic Ft	List Price
 <p>BRIDGE WITH HALF MODESTY</p>	65-2448UFH	48	24	11	48	-	78	5.3	W/P\$ 1170
	65-2442UFH	42	24	11	42	-	74	4.6	W/P\$ 1122
	65-2436UFH	36	24	11	36	-	35	4.1	W/P\$ 1066
	65-2048UFH	48	20	11	48	-	73	5.3	W/P\$ 1083
	65-2042UFH	42	20	11	42	-	61	4.7	W/P\$ 1040
	65-2036UFH	36	20	11	36	-	32	4.1	W/P\$ 993

Must Specify (in this order):

Model #
 Top Material
 Finish
 Edge Profile
 Worksurface Grommet Location
 Grommet Color
 Power/Data Options
 Kneespace Options

Description

- Standard with: Front to Back Grain Direction on Worksurface, Hinged Back Panel
- Available with Veneer (W) or HPL (P) Top; Must Specify
- Keyboard Accessories Cannot be Factory Installed but are Available for Field Installation ([See Unit Details](#))
- Additional Options: Power and Grommet Options ([See Options and Locations](#))

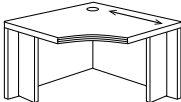
Item	Model No.	Width	Depth	Height	K	R	Ship Wt	Cubic Ft	List Price
 <p>CORNER UNITS</p>	65-4242CU	42	42	30	25 $\frac{1}{16}$	-	145	34.5	W/P\$ 2643
	65-4242CCU Curved Corner Unit	42	42	30	25 $\frac{1}{16}$	-	145	34.5	W/P\$ 3273
	65-3636CU	36	36	30	17	-	109	26.3	W/P\$ 2204
	65-3636CCU Curved Corner Unit	36	36	30	17	-	109	26.3	W/P\$ 2833

Shown as Curved

Must Specify (in this order):

Model #
 Top Material
 Finish
 Edge Profile
 Worksurface Grommet Color

Description

- Available with Veneer (W) or HPL (P) Top; Must Specify
- Freestanding Support Unit
- Connects to 24" Deep Worksurfaces
- Surface Grommet Standard in Top; Must Specify: Black (BLK) or Silver (SLV)
- Grain Direction Runs as Shown on Worksurface

Pricing Codes:

W= Wood Top
 P= HPL Top

[See Gesso Intro Section for Ordering Options](#)

Item	Model No.	Width	Depth	Height	K	R	Ship Wt	Cubic Ft	List Price
EXTENDED CORNER UNIT	Left Ped	Right Ped							
	65-4854ECCL	65-4854ECCR	48	54	30	-	-	174	41.1

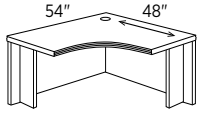

Shown as Right

Description

- Available with Veneer (W) or HPL (P) Top; Must Specify
- Surface Grommet Standard in Top; Must Specify: Black (BLK), Silver (SLV)
- Grain Direction Runs as Shown on Worksurface

Must Specify (in this order):

- Model #
- Top Material
- Finish
- Edge Profile
- Worksurface Grommet Color

SINGLE PED CREDENZA FILE/FILE	Left Ped	Right Ped	Width	Depth	Height	K	R	Ship Wt	Cubic Ft	List Price
	67-2472LC2	67-2472RC2								
	67-2472LC2	67-2472RC2	72	24	30	32¼	-	199	35.6	W/P\$ 3420
	67-2466LC2	67-2466RC2	66	24	30	26¼	-	182	32.7	W/P\$ 3383

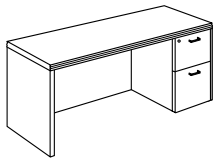

Shown as Right

Description

- Standard with: Letter Width Locking File/File Pedestal, Left to Right Grain Direction on Worksurface, Wire Management from Pedestal to Kneespace
- Available with Veneer (W) or HPL (P) Top; Must Specify
- Back Panel Grommet Standard; Must Specify: Black (BLK), Silver (SLV) or No Back Panel Grommet (NONE)
- Drawer Front Grain Direction Vertical Standard; Optional Horizontal Grain Direction
- [Height Adjustable Units Available](#)
- Additional Options: Dove Tail Drawer Construction and Soft Close Drawers ([See Drawer Details](#)), Power and Grommet Options ([See Options and Locations](#)), Kneespace Options (Sold Separately, [See Unit Details](#))

Must Specify (in this order):

- Model #
- Top Material
- Finish
- Edge Profile
- Drawer Construction
- Drawer Track
- Drawer Front Grain Direction
- Pull
- Back Panel Grommet Color
- Worksurface Grommet Location
- Grommet Color
- Power/Data Options
- Kneespace Options

Pricing Codes:

- W= Wood Top
- P= HPL Top

[See Gesso Intro Section for Ordering Options](#)

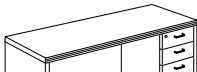
Item	Model No.	Width	Depth	Height	K	R	Ship Wt	Cubic Ft	List Price	
SINGLE PED CREDENZA BOX/BOX/FILE 	Left Ped	Right Ped								
	67-2472LC1	67-2472RC1	72	24	30	32¼	-	199	35.6	W/P\$ 3420
	67-2466LC1	67-2466RC1	66	24	30	26¼	-	182	32.7	W/P\$ 3383

Shown as Right

Must Specify (in this order):

- Model #
- Top Material
- Finish
- Edge Profile
- Drawer Construction
- Drawer Track
- Drawer Front Grain Direction
- Pull
- Back Panel Grommet Color
- Worksurface Grommet Location
- Grommet Color
- Power/Data Options
- Kneespace Options

Description

- Standard with: Letter Width Locking Box/Box/File Pedestal, Left to Right Grain Direction on Worksurface, Wire Management from Pedestal to Kneespace
- Available with Veneer (W) or HPL (P) Top; Must Specify
- Back Panel Grommet Standard; Must Specify: Black (BLK), Silver (SLV) or No Back Panel Grommet (NONE)
- Drawer Front Grain Direction Vertical Standard; Optional Horizontal Grain Direction
- [Height Adjustable Units Available](#)
- Additional Options: Dove Tail Drawer Construction and Soft Close Drawers ([See Drawer Details](#)), Power and Grommet Options ([See Options and Locations](#)), Kneespace Options (Sold Separately, [See Unit Details](#))

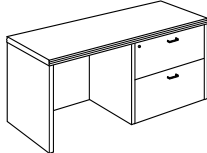
Item	Model No.	Width	Depth	Height	K	R	Ship Wt	Cubic Ft	List Price	
SINGLE PED CREDENZA LATERAL FILE 	Left Ped	Right Ped								
	65-2472LL	65-2472RL	72	24	30	12	-	277	35.6	W/P\$ 4496
	65-2466LL	65-2466RL	66	24	30	6	-	264	32.7	W/P\$ 4433

Shown as Right

Must Specify (in this order):

- Model #
- Top Material
- Finish
- Edge Profile
- Drawer Construction
- Drawer Front Grain Direction
- Pull
- Back Panel Grommet Color
- Worksurface Grommet Location
- Grommet Color
- Power/Data Options

Description

- Standard with: Central Locking Lateral File, Left to Right Grain Direction on Worksurface
- Available with Veneer (W) or HPL (P) Top; Must Specify
- Back Panel Grommet Standard; Must Specify: Black (BLK), Silver (SLV) or No Back Panel Grommet (NONE)
- Drawer Front Grain Direction Vertical Standard; Optional Horizontal Grain Direction
- Additional Options: Dove Tail Drawer Construction ([See Drawer Details](#)), Power and Grommet Options ([See Options and Locations](#)), Kneespace Options (Sold Separately, [See Unit Details](#))

Pricing Codes:
W= Wood Top
P= HPL Top

[See Gesso Intro Section for Ordering Options](#)

Item	Model No.	Width	Depth	Height	K	R	Ship Wt	Cubic Ft	List Price	
MULTI-FILE CREDENZA WITH BOX/BOX/FILE/LATERAL	Left Ped	Right Ped								
	65-2472LMF	65-2472RMF	72	24	30	12	-	277	35.6	W/P\$ 4713
	65-2466LMF	65-2466RMF	66	24	30	6	-	264	32.7	W/P\$ 4654

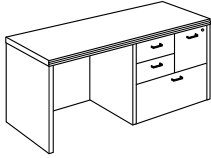

Shown as Right

Must Specify (in this order):

- Model #
- Top Material
- Finish
- Edge Profile
- Drawer Construction
- Drawer Track
- Drawer Front Grain Direction
- Pull
- Back Panel Grommet Color
- Worksurface Grommet Location
- Grommet Color
- Power/Data Options

Description

- Standard with: Letter Width Locking Box/Box/File/Lateral Pedestal, Left to Right Grain Direction on Worksurface, Wire Management from Pedestal to Kneespace
- Available with Veneer (W) or HPL (P) Top; Must Specify
- Back Panel Grommet Standard; Must Specify: Black (BLK), Silver (SLV) or No Back Panel Grommet (NONE)
- Drawer Front Grain Direction Vertical Standard; Optional Horizontal Grain Direction
- Additional Options: Dove Tail Drawer Construction ([See Drawer Details](#)), Soft Close Box and File Drawers ([See Soft Close Options](#)), Power and Grommet Options ([See Options and Locations](#)), Kneespace Options (Sold Separately, [See Unit Details](#))

KNEESPACE CREDENZA	67-2472KC	72	24	30	39	-	240	35.6	W/P\$ 4785
	67-2466KC	66	24	30	33	-	220	32.7	W/P\$ 4444

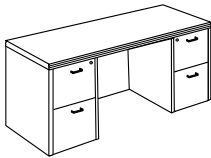

Must Specify (in this order):

- Model #
- Top Material
- Finish
- Edge Profile
- Drawer Construction
- Drawer Track
- Drawer Front Grain Direction
- Pull
- Back Panel Grommet Color
- Worksurface Grommet Location
- Grommet Color
- Power/Data Options
- Kneespace Options

Description

- Standard with: Letter Width Locking File/File Pedestals, Left to Right Grain Direction on Worksurface, Wire Management from Pedestal to Kneespace
- Available with Veneer (W) or HPL (P) Top; Must Specify
- Modesty Panel Grommet Standard; Must Specify: Black (BLK), Silver (SLV) or No Back Panel Grommet (NONE)
- Drawer Front Grain Direction Vertical Standard; Optional Horizontal Grain Direction
- [Height Adjustable Units Available](#)
- Additional Options: Dove Tail Drawer Construction and Soft Close Drawers ([See Drawer Details](#)), Power and Grommet Options ([See Options and Locations](#)), Kneespace Options (Sold Separately, [See Unit Details](#))

Pricing Codes:

W= Wood Top
P= HPL Top

[See Gesso Intro Section for Ordering Options](#)

Item	Model No.	Width	Depth	Height	K	R	Ship Wt	Cubic Ft	List Price
STORAGE CREDENZA	67-2472SC	72	24	30	-	-	285	35.6	W/P\$ 5165
	67-2466SC	66	24	30	-	-	261	32.7	W/P\$ 4951

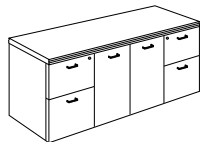

Must Specify (in this order):

Model #
Top Material
Finish
Edge Profile
Drawer Construction
Drawer Track
Drawer/Door Grain Direction
Pull
Locking Doors

Description

- Standard with: Letter Width, File/File Locking Pedestals, One (1) Fixed Shelf Behind Doors, Top Profiles on Front Only Left to Right Grain Direction on Top Surface
- Available with Veneer (W) or HPL (P) Top; Must Specify
- Drawer/Door Front Grain Direction Vertical Standard; Optional Horizontal Grain Direction
- Optional Locking Doors, Must Specify (LKT-DB) and Add \$108; [See Locking Option](#) For More Details
- Additional Options: Dove Tail Drawer Construction and Soft Close Drawers ([See Drawer Details](#))

FOUR DOOR CREDENZA	65-2472CC	72	24	30	-	-	290	34.2	W/P\$ 4773
	65-2466CC	66	24	30	-	-	246	33.0	W/P\$ 4563

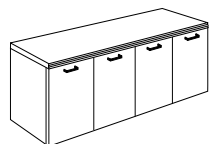

Must Specify (in this order):

Model #
Top Material
Finish
Edge Profile
Door Front Grain Direction
Pull
Locking Doors

Description

- Standard with: Four (4) Doors, One (1) Adjustable Shelf Behind Each Set of Doors, Top Profiles on Front Only, Left to Right Grain Direction on Top Surface
- Available with Veneer (W) or HPL (P) Top; Must Specify
- Door Front Grain Direction Vertical Standard; Optional Horizontal Grain Direction
- Optional Locking Doors Available; [See Locking Option](#) For More Details

BUFFET CREDENZA	65-2472BF	72	24	36	-	-	342	45.5	W/P\$ 6004
-----------------	-----------	----	----	----	---	---	-----	------	------------

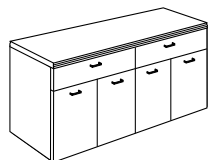

Must Specify (in this order):

Model #
Top Material
Finish
Edge Profile
Drawer Construction
Drawer Track
Drawer/Door Grain Direction
Pull
Locking Doors

Description

- Standard with: Two (2) Drawers, Four (4) Doors, One (1) Adjustable Shelf Behind Doors Each Set of Doors, Left to Right Grain Direction on Top Surface
- Available with Veneer (W) or HPL (P) Top; Must Specify
- Drawer/Door Front Grain Direction Vertical Standard; Optional Horizontal Grain Direction
- Optional Locking Doors Available; [See Locking Option](#) For More Details
- Additional Options: Dove Tail Drawer Construction and Soft Close Box Drawers ([See Drawer Options](#))

Pricing Codes:

W= Wood Top
P= HPL Top

[See Gesso Intro Section for Ordering Options](#)

Item	Model No.	Width	Depth	Height	K	R	Ship Wt	Cubic Ft	List Price
DOUBLE LATERAL CREDENZA	65-2472DL	72	24	30	-	-	360	35.7	W/P\$ 6221



Must Specify (in this order):
 Model #
 Top Material
 Finish
 Edge Profile
 Drawer Construction
 Drawer Front Grain Direction
 Pull

Description

- Standard with: Legal or Letter Filing, Dual Locking, Left to Right Grain Direction on Top Surface
- Available with Veneer (W) or HPL (P) Top; Must Specify
- ¼" Thick Drawer Bottoms Allow for Storage Applications
- Drawer Front Grain Direction Vertical Standard; Optional Horizontal Grain Direction

21" LOW CREDENZA DOUBLE BOX/FILE	65-2472L2IDBF			72	24	21¾	250	25.6	W/P\$ 5906
	65-2460L2IDBF			60	24	21¾	230	22.4	W/P\$ 5263
	65-2072L2IDBF			72	20	21¾	240	21.1	W/P\$ 5717
	65-2060L2IDBF			60	20	21¾	210	18.9	W/P\$ 5202

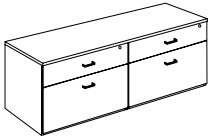

Must Specify (in this order):
 Model #
 Top Material
 Finish
 Edge Profile
 Drawer Construction
 Drawer Track
 Drawer Front Grain Direction
 Pull
 Power/Data Options
 Grommet Location/Color

Description

- Standard with: Legal or Letter Filing, Dual Locking Box/File Drawers, Left to Right Grain Direction on Top Surface
- Available with Veneer (W) or HPL (P) Top; Must Specify
- ¼" Thick Drawer Bottoms Allow for Storage Applications
- Drawer Front Grain Direction Vertical Standard; Optional Horizontal Grain Direction
- Additional Options: Dove Tail Drawer Construction ([See Drawer Options](#)), Soft Close Box Drawers ([See Soft Close Options](#)), Power and Grommet Options ([See Options and Locations](#)), Dock 950 and Dock 150 Wireless Chargers ([See Multiple Unit Details](#))

21" LOW CREDENZA BOX/FILE/OPEN BOOKCASE	Left Box/File	Right Box/File	Width	Depth	Height	K	R	Ship Wt	Cubic Ft	List Price
	65-2472L21OBFL	65-2472L21OBFR	72	24	21¾	230	25.6	W/P\$ 4500		
	65-2460L21OBFL	65-2460L21OBFR	60	24	21¾	210	22.4	W/P\$ 4114		
	65-2072L21OBFL	65-2072L21OBFR	72	20	21¾	220	21.1	W/P\$ 4289		
	65-2060L21OBFL	65-2060L21OBFR	60	20	21¾	200	18.9	W/P\$ 3901		

Shown as Right

Must Specify (in this order):
 Model #
 Top Material
 Finish
 Edge Profile
 Drawer Construction
 Drawer Track
 Drawer Front Grain Direction
 Pull
 Power/Data Options
 Grommet Location/Color

Description

- Standard with: Legal or Letter Filing, Locking Box/File with Open Bookcase, Adjustable Bookcase Shelf on Open Side, Left to Right Grain Direction on Top Surface
- Available with Veneer (W) or HPL (P) Top; Must Specify
- ¼" Thick Drawer Bottoms Allow for Storage Applications
- Back Panel Grommet Standard; Must Specify Black or Silver
- Drawer Front Grain Direction Vertical Standard; Optional Horizontal Grain Direction
- Additional Options: Dove Tail Drawer Construction ([See Drawer Options](#)), Soft Close Box Drawers ([See Soft Close Options](#)), Power and Grommet Options ([See Options and Locations](#)), Dock 950 and Dock 150 Wireless Chargers ([See Multiple Unit Details](#))

Pricing Codes:

W= Wood Top
 P= HPL Top

[See Gesso Intro Section for Ordering Options](#)

Item	Model No.	Width	Depth	Height	Ship Wt	Cubic Ft	List Price
21" LOW CREDENZA DOUBLE OPEN BOOKCASE	65-2472L21DO	72	24	21¾	210	25.6	W/P\$ 3676
	65-2460L21DO	60	24	21¾	200	22.4	W/P\$ 3318
	65-2072L21DO	72	20	21¾	200	21.1	W/P\$ 3425
	65-2060L21DO	60	20	21¾	190	18.9	W/P\$ 3124

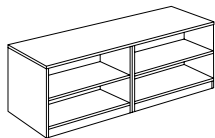

Must Specify (in this order):

- Model #
- Top Material
- Finish
- Edge Profile
- Power/Data Options
- Grommet Location/Color

Description

- Standard with: Open Bookcases, One Adjustable Shelf on Each Side, Left to Right Grain Direction on Top Surface
- Available with Veneer (W) or HPL (P) Top; Must Specify
- Back Panel Grommet Standard; Must Specify Black or Silver
- Additional Options: Power and Grommet Options ([See Options and Locations](#)), Dock 950 and Dock 150 Wireless Chargers ([See Multiple Unit Details](#))

Item	Model No.	Width	Depth	Height	Ship Wt	Cubic Ft	List Price
LATERAL FILE	65-2436L4 Four Lateral Drawers	36	24	57½	312	32.6	W/P\$ 5349
	65-2430L4 Four Lateral Drawers	30	24	57½	260	27.5	W/P\$ 5100
	65-2436L3 Three Lateral Drawers	36	24	43¾	170	24.2	W/P\$ 4289
	65-2430L3 Three Lateral Drawers	30	24	43¾	155	20.4	W/P\$ 4067
	65-2436L2 Two Lateral Drawers	36	24	30	184	18.3	W/P\$ 2829
	65-2430L2 Two Lateral Drawers	30	24	30	153	15.6	W/P\$ 2687

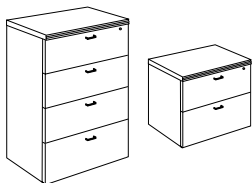

Must Specify (in this order):

- Model #
- Top Material
- Finish
- Edge Profile
- Drawer Construction
- Drawer Front Grain Direction
- Pull

Description

- Standard with: Central Locking, Anti-Tilt System, Legal or Letter Filing Front to Back or Side to Side
- Available with Veneer (W) or HPL (P) Top; Must Specify
- ¼" Thick Drawer Bottoms Allow for Storage Applications
- Drawer Front Grain Direction Vertical Standard; Optional Horizontal Grain Direction
- Additional Options: Dove Tail Drawer Construction ([See Drawer Options](#))

MULTI-FILE	65-2436MF	36	24	30	184	18.3	W/P\$ 3248
	65-2430MF	30	24	30	148	15.6	W/P\$ 2886

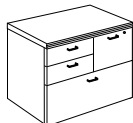

Must Specify (in this order):

- Model #
- Top Material
- Finish
- Edge Profile
- Drawer Construction
- Box and File Drawer Track
- Drawer Front Grain Direction
- Pull

Description

- Standard with: Box/Box/File/Lateral File, Locking File Drawer, Lateral File Provides Legal or Letter Filing
- Available with Veneer (W) or HPL (P) Top; Must Specify
- Drawer Front Grain Direction Vertical Standard; Optional Horizontal Grain Direction
- Additional Options: Dove Tail Drawer Construction ([See Drawer Options](#)), Soft Close Box and File Drawers ([See Soft Close Options](#))

Pricing Codes:

- W= Wood Top
- P= HPL Top

[See Gesso Intro Section for Ordering Options](#)

Item	Model No.	Width	Depth	Height	Ship Wt	Cubic Ft	List Price
MOBILE PEDESTAL BOX/FILE	65-1519MP	15¾	19	23	85	9.0	W\$ 2172

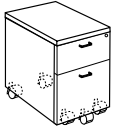

Must Specify (in this order):

Model #
Finish
Drawer Construction
Drawer Track
Drawer Front Grain Direction
Pull

Description

- Standard with: Locking Box/File Drawers, Black Plastic Pen Tray, Letter Width Pedestal, and Five Casters
- Fits Underneath 30"H Worksurface with Optional Cushion
- Optional Cushion Increases Height 2¼"; See [65-1519CUSHION](#)
- Drawer Front Grain Direction Vertical Standard; Optional Horizontal Grain Direction
- Additional Options: Dove Tail Drawer Construction and Soft Close Drawers ([See Drawer Details](#))

MOBILE PEDESTAL BOX/BOX/FILE	65-1519MP1	15¾	19	27½	90	9.0	W\$ 2268
---------------------------------	------------	-----	----	-----	----	-----	----------

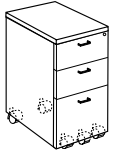

Must Specify (in this order):

Model #
Finish
Drawer Construction
Drawer Track
Drawer Front Grain Direction
Pull

Description

- Standard with: Locking Box/Box/File Drawers, Black Plastic Pen Tray, Letter Width Pedestal, and Five Casters
- Optional Cushion Increases Height 2¼"; See [65-1519CUSHION](#)
- Fits Underneath 30"H Worksurface without Optional Cushion
- Drawer Front Grain Direction Vertical Standard; Optional Horizontal Grain Direction
- Additional Options: Dove Tail Drawer Construction and Soft Close Drawers ([See Drawer Details](#))

MOBILE PEDESTAL FILE/FILE	65-1519MP2	15¾	19	27½	90	9.0	W\$ 2268
------------------------------	------------	-----	----	-----	----	-----	----------

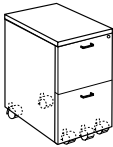

Must Specify (in this order):

Model #
Finish
Drawer Construction
Drawer Track
Drawer Front Grain Direction
Pull

Description

- Standard with: Locking File/File Drawers, Black Plastic Pen Tray, Letter Width Pedestal, and Five Casters
- Optional Cushion Increases Height 2¼"; See [65-1519CUSHION](#)
- Fits Underneath 30"H Worksurface without Optional Cushion
- Drawer Front Grain Direction Vertical Standard; Optional Horizontal Grain Direction
- Additional Options: Dove Tail Drawer Construction and Soft Close Drawers ([See Drawer Details](#))

Pricing Codes:

W= Wood Top
P= HPL Top

[See Gesso Intro Section for Ordering Options](#)

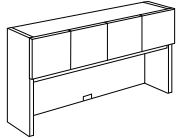
Item	Model No.	Width	Depth	Height	Ship Wt	Cubic Ft	List Price
SURFACE MOUNT HUTCH HINGED DOOR 	65-15108HU Six (6) Doors	108	15	40 $\frac{3}{8}$	301	51.7	W\$ 5681
	65-15102HU Six (6) Doors	102	15	40 $\frac{3}{8}$	283	48.3	W\$ 5441
	65-1596HU Six (6) Doors	96	15	40 $\frac{3}{8}$	260	46.5	W\$ 5354
	65-1590HU Five (5) Doors	90	15	40 $\frac{3}{8}$	243	44.3	W\$ 5005
	65-1584HU Five (5) Doors	84	15	40 $\frac{3}{8}$	228	40.0	W\$ 4311
	65-1578HU Four (4) Doors	78	15	40 $\frac{3}{8}$	210	36.7	W\$ 4212
	65-1572HU Four (4) Doors	72	15	40 $\frac{3}{8}$	203	34.1	W\$ 3549
	65-1566HU Four (4) Doors	66	15	40 $\frac{3}{8}$	175	32.1	W\$ 3424
	65-1560HU Four (4) Doors	60	15	40 $\frac{3}{8}$	167	28.4	W\$ 3363
	65-1554HU Three (3) Doors	54	15	40 $\frac{3}{8}$	150	25.7	W\$ 3125
	65-1548HU Three (3) Doors	48	15	40 $\frac{3}{8}$	133	22.9	W\$ 2887
	65-1542HU Two (2) Doors	42	15	40 $\frac{3}{8}$	116	20.2	W\$ 2165
	65-1536HU Two (2) Doors	36	15	40 $\frac{3}{8}$	99	17.4	W\$ 1887
	65-1530HU Two (2) Doors	30	15	40 $\frac{3}{8}$	85	14.6	W\$ 1636

Must Specify (in this order):

- Model #
- Finish
- Door
 - Style/Finish
 - Grain Direction (if applicable)
- Locking Doors
- Paperslots
- Paperslot Divider Material/Color
- Tasklights
- Grommet Color
- Tackboard Fabric

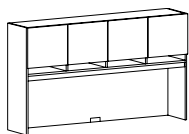





Optional Paper Slots in veneer or chrome available; [See Paper Slot Options](#)

Also available as 52 $\frac{3}{8}$ " H Tall Surface Mount

Description

- 23 $\frac{3}{4}$ " Clearance Below Apron Rail
- Lower Center Grommet Standard; Must Specify: Black (BLK) or Silver (SLV)
- Safely Write on Dry Erase, White and Black Tempered Glass Doors with Our Dry Erase Marker Set; [See Sets](#)
- Additional Support is Required when Surface Mounted Hutches Do Not Sit Directly Over an End Panel or Pedestal; [See 65-2812SP](#)
- Component Hutch Tops with Profiles are Available; [See Top Sizes](#)
- If Applicable, Door Front Grain Direction Vertical Standard; Optional Horizontal Grain Direction
- Additional Options: Paper Slots ([See Paper Slot Options](#)), Locking Doors ([See Locking Door Options](#)), Marker Boards, Work Wall, Tackboards, and Tasklights ([See Units](#)), Marker and Eraser Sets ([See Sets](#))

Options: Specify & Add			Per Door
	1-AD	Aluminum Framed Satin Frosted Tempered Glass Doors (Non-Locking)	\$ 438
	1-DEB	Dry Erase Board Doors	\$ 28
	WHGLS	Aluminum Framed Doors with White Tempered Glass (Non-locking)	\$ 652
	BLGLS	Black Matte Framed Doors with Black Tempered Glass (Non-locking)	\$ 868
	1-HGA	High Gloss Acrylic Doors; Must Specify Color	
		(GPA) Graphite Acrylic	\$ 269
		(BLA) Black, (WMA) Wired Mercury, or (WHA) White Acrylic	\$ 247

Pricing Codes:
W= Wood Top
P= HPL Top

[See Gesso Intro Section for Ordering Options](#)

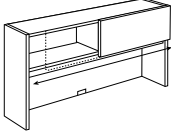
Item	Model No.	Width	Depth	Height	Ship Wt	Cubic Ft	List Price
SURFACE MOUNT HUTCH WITH SLIDING DOOR 	65-15108SHU Two (2) Doors	108	15	40 $\frac{7}{8}$	313	64.2	W\$ 6586
	65-15102SHU Two (2) Doors	102	15	40 $\frac{7}{8}$	296	60.7	W\$ 6122
	65-1596SHU Two (2) Doors	96	15	40 $\frac{7}{8}$	278	57.7	W\$ 5827
	65-1590SHU Two (2) Doors	90	15	40 $\frac{7}{8}$	260	53.7	W\$ 5689
	65-1584SHU Two (2) Doors	84	15	40 $\frac{7}{8}$	243	50.2	W\$ 4889
	65-1578SHU One (1) Door	78	15	40 $\frac{7}{8}$	226	46.7	W\$ 4679
	65-1572SHU One (1) Door	72	15	40 $\frac{7}{8}$	208	43.3	W\$ 4102
	65-1566SHU One (1) Door	66	15	40 $\frac{7}{8}$	190	39.7	W\$ 3978
	65-1560SHU One (1) Door	60	15	40 $\frac{7}{8}$	172	28.4	W\$ 3941

Must Specify (in this order):

- Model #
- Finish
- Door
 - Style/Color
 - Grain Direction (if applicable)
- Paperslots
- Paperslot Divider Material/Color
- Tasklights
- Grommet Color
- Tackboard Fabric

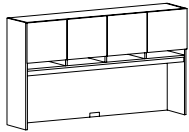

Optional Paper Slots in veneer or chrome available; [See Paper Slot Options](#)

Description

- Non-Locking Sliding Doors
- 2 $\frac{3}{4}$ " Clearance Below Apron Rail
- Lower Center Grommet Standard; Must Specify: Black (BLK) or Silver (SLV)
- Safely Write on Dry Erase Doors with Our Dry Erase Marker Set; [See Sets](#)
- Additional Support is Required when Surface Mounted Hutches Do Not Sit Directly Over an End Panel or Pedestal; [See 65-2812SP](#)
- Component Hutch Tops with Profiles are Available; [See Top Sizes](#)
- If Applicable, Door Front Grain Direction Vertical Standard; Optional Horizontal Grain Direction
- Additional Options: Paper Slots ([See Paper Slot Options](#)), Marker Boards, Work Wall, Tackboards, and Tasklights ([See Units](#)), Marker and Eraser Sets ([See Sets](#))

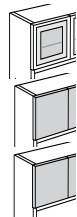

Options: Specify & Add		Per Door
1-AD	Aluminum Framed Satin Frosted Tempered Glass Doors (Non-Locking)	\$ 745
1-DEB	Dry Erase Board Door (Non-Locking)	\$ 77
1-HGA	High Gloss Acrylic Door (Non-Locking); Must Specify Color	
	(GPA) Graphite Acrylic	\$ 773
	(BLA) Black, (WMA) Wired Mercury, or (WHA) White Acrylic	\$ 705

Pricing Codes:

W= Wood Top
P= HPL Top

[See Gesso Intro Section for Ordering Options](#)

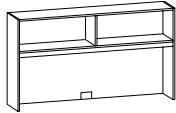
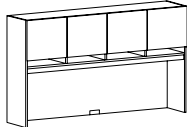
Item	Model No.	Width	Depth	Height	Ship Wt	Cubic Ft	List Price
SURFACE MOUNT HUTCH OPEN  <p>Must Specify (in this order): Model # Finish Paperslots Paperslot Divider Material/Color Tasklights Grommet Color Tackboard Fabric</p>  <p>Optional Paper Slots in veneer or chrome available; See Paper Slot Options</p> <p>Also available as 52$\frac{1}{8}$" H Tall Surface Mount</p>	65-15108OH Three Compartments	108	15	40 $\frac{7}{8}$	192	46.5	W\$ 4656
	65-15102OH Three Compartments	102	15	40 $\frac{7}{8}$	173	44.0	W\$ 4462
	65-1596OH Three Compartments	96	15	40 $\frac{7}{8}$	158	41.5	W\$ 4387
	65-1590OH Three Compartments	90	15	40 $\frac{7}{8}$	150	39.0	W\$ 4105
	65-1584OH Three Compartments	84	15	40 $\frac{7}{8}$	142	36.7	W\$ 3541
	65-1578OH Two Compartments	78	15	40 $\frac{7}{8}$	130	33.8	W\$ 3448
	65-1572OH Two Compartments	72	15	40 $\frac{7}{8}$	121	30.7	W\$ 2911
	65-1566OH Two Compartments	66	15	40 $\frac{7}{8}$	114	30.7	W\$ 2807
	65-1560OH Two Compartments	60	15	40 $\frac{7}{8}$	106	28.4	W\$ 2759
	65-1554OH Two Compartments	54	15	40 $\frac{7}{8}$	98	25.7	W\$ 2561
	65-1548OH Two Compartments	48	15	40 $\frac{7}{8}$	89	21.2	W\$ 2369
	65-1542OH One Compartment	42	15	40 $\frac{7}{8}$	77	18.6	W\$ 2124
	65-1536OH One Compartment	36	15	40 $\frac{7}{8}$	69	16.0	W\$ 1846
	65-1530OH One Compartment	30	15	40 $\frac{7}{8}$	61	13.5	W\$ 1604

Description

- 23 $\frac{3}{4}$ " Clearance Below Apron Rail
- Lower Center Grommet Standard; Must Specify: Black (BLK) or Silver (SLV)
- Additional Support is Required when Surface Mounted Hutches Do Not Sit Directly Over an End Panel or Pedestal; [See 65-2812SP](#)
- Component Hutch Tops with Profiles are Available; [See Top Sizes](#)
- Additional Options: Paper Slots ([See Paper Slot Options](#)), Locking Doors ([See Locking Door Options](#)), Marker Boards, Work Wall, Tackboards, and Tasklights ([See Units](#)), Marker and Eraser Sets ([See Sets](#))

Pricing Codes:

W= Wood Top
P= HPL Top



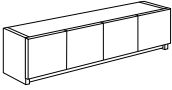

[See Gesso Intro Section for Ordering Options](#)

Item	Model No.	Width	Depth	Height	Ship Wt	Cubic Ft	List Price
WALL MOUNT HUTCH HINGED DOORS  Must Specify (in this order): Model # Finish Door Style/Color Grain Direction (if applicable) Locking Doors Also available as 33 1/2" H Tall Wall Mount	65-15108WD Six (6) Doors	108	15	17 3/16	178	19.4	W\$ 5112
	65-15102WD Six (6) Doors	102	15	17 3/16	168	18.3	W\$ 4893
	65-1596WD Six (6) Doors	96	15	17 3/16	158	17.3	W\$ 4820
	65-1590WD Five (5) Doors	90	15	17 3/16	148	16.2	W\$ 4502
	65-1584WD Five (5) Doors	84	15	17 3/16	138	15.2	W\$ 3883
	65-1578WD Four (4) Doors	78	15	17 3/16	128	14.1	W\$ 3790
	65-1572WD Four (4) Doors	72	15	17 3/16	118	13.1	W\$ 3186
	65-1566WD Four (4) Doors	66	15	17 3/16	105	12.0	W\$ 3078
	65-1560WD Four (4) Doors	60	15	17 3/16	96	11.0	W\$ 3027
	65-1554WD Three (3) Doors	54	15	17 3/16	87	9.9	W\$ 2815
	65-1548WD Three (3) Doors	48	15	17 3/16	77	8.9	W\$ 2600
	65-1542WD Two (2) Doors	42	15	17 3/16	67	7.8	W\$ 1951
	65-1536WD Two (2) Doors	36	15	17 3/16	58	6.7	W\$ 1701
	65-1530WD Two (2) Doors	30	15	17 3/16	48	5.6	W\$ 1471

Description

- Component Hutch Tops with Profiles are Available; [See Top Sizes](#)
- If Applicable, Door Front Grain Direction Vertical Standard; Optional Horizontal Grain Direction
- Safely Write on Dry Erase, White and Black Tempered Glass Doors with Our Dry Erase Marker Set; [See Sets](#)
- Indiana Furniture Will Not be Liable for Wall Mount Hutches that are not Properly Installed
- Additional Options: Locking Doors ([See Locking Door Options](#)), Marker Boards, Work Wall, Tackboards, and Tasklights ([See Units](#)), Marker and Eraser Sets ([See Sets](#))

Options: Specify & Add

		Per Door
	1-AD Aluminum Framed Satin Frosted Tempered Glass Doors (Non-Locking)	\$ 438
	1-DEB Dry Erase Board Doors	\$ 28
	WHGLS Aluminum Framed Doors with White Tempered Glass (Non-locking)	\$ 652
	BLGLS Black Matte Framed Doors with Black Tempered Glass (Non-locking)	\$ 868
	1-HGA High Gloss Acrylic Doors; Must Specify Color	
	(GPA) Graphite Acrylic	\$ 269
	(BLA) Black, (WMA) Wired Mercury, or (WHA) White Acrylic	\$ 247

Pricing Codes:



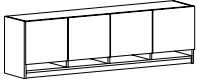

W= Wood Top
P= HPL Top

[See Gesso Intro Section for Ordering Options](#)

Item	Model No.	Width	Depth	Height	Ship Wt	Cubic Ft	List Price
WALL MOUNT HUTCH DOORS WITH PAPER SLOTS  Must Specify (in this order): Model # Finish Door Style/Color Grain Direction (if applicable) Locking Doors Paperslot Divider Material/Color Also available as 29 3/16" H Tall Wall Mount	65-15108WDS Six (6) Doors / Six (6) Paper Slots	108	15	21 1/16	204	27.7	W\$ 7273
	65-15102WDS Six (6) Doors / Six (6) Paper Slots	102	15	21 1/16	194	26.2	W\$ 6967
	65-1596WDS Six (6) Doors / Six (6) Paper Slots	96	15	21 1/16	186	24.6	W\$ 6807
	65-1590WDS Five (5) Doors / Five (5) Paper Slots	90	15	21 1/16	172	23.1	W\$ 6405
	65-1584WDS Five (5) Doors / Five (5) Paper Slots	84	15	21 1/16	162	21.6	W\$ 5675
	65-1578WDS Four (4) Doors / Four (4) Paper Slots	78	15	21 1/16	149	20.0	W\$ 5479
	65-1572WDS Four (4) Doors / Four (4) Paper Slots	72	15	21 1/16	140	18.5	W\$ 4766
	65-1566WDS Four (4) Doors / Four (4) Paper Slots	66	15	21 1/16	131	16.9	W\$ 4568
	65-1560WDS Four (4) Doors / Four (4) Paper Slots	60	15	21 1/16	121	15.4	W\$ 4429
	65-1554WDS Three (3) Doors / Three (3) Paper Slots	54	15	21 1/16	108	13.9	W\$ 4116
	65-1548WDS Three (3) Doors / Three (3) Paper Slots	48	15	21 1/16	99	12.3	W\$ 3810
	65-1542WDS Two (2) Doors / Two (2) Paper Slots	42	15	21 1/16	86	10.8	W\$ 3077
	65-1536WDS Two (2) Doors / Two (2) Paper Slots	36	15	21 1/16	76	9.2	W\$ 2733
	65-1530WDS Two (2) Doors / Two (2) Paper Slots	30	15	21 1/16	67	7.7	W\$ 2419

Description

- Paper Slot Divider Material and Color Must Specify: Chrome (CHRM) or Veneer (W) and Finish Color
- Component Hutch Tops with Profiles are Available; [See Top Sizes](#)
- Safely Write on Dry Erase, White and Black Tempered Glass Doors with Our Dry Erase Marker Set; [See Sets](#)
- If Applicable, Door Front Grain Direction Vertical Standard; Optional Horizontal Grain Direction
- Indiana Furniture Will Not be Liable for Wall Mount Hutches that are not Properly Installed
- Additional Options: Locking Doors ([See Locking Door Options](#)), Work Wall, Tackboards, and Tasklights ([See Units](#)), Marker and Eraser Sets ([See Sets](#))

Options: Specify & Add			Per Door
	1-AD	Aluminum Framed Satin Frosted Tempered Glass Doors (Non-Locking)	\$ 438
	1-DEB	Dry Erase Board Doors	\$ 28
	WHGLS	Aluminum Framed Doors with White Tempered Glass (Non-locking)	\$ 652
	BLGLS	Black Matte Framed Doors with Black Tempered Glass (Non-locking)	\$ 868
	1-HGA	High Gloss Acrylic Doors; Must Specify Color	
		(GPA) Graphite Acrylic	\$ 269
		(BLA) Black, (WMA) Wired Mercury, or (WHA) White Acrylic	\$ 247

Pricing Codes:
W= Wood Top
P= HPL Top

[See Gesso Intro Section for Ordering Options](#)

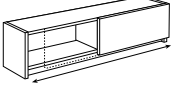
Item	Model No.	Width	Depth	Height	Ship Wt	Cubic Ft	List Price
WALL MOUNT HUTCH WITH SLIDING DOOR 	65-15108SWD Two (2) Doors	108	15	17 $\frac{3}{16}$	281	60.7	W\$ 6090
	65-15102SWD Two (2) Doors	102	15	17 $\frac{3}{16}$	265	57.2	W\$ 5800
	65-1596SWD Two (2) Doors	96	15	17 $\frac{3}{16}$	249	55.1	W\$ 5550
	65-1590SWD Two (2) Doors	90	15	17 $\frac{3}{16}$	233	53.7	W\$ 5199
	65-1584SWD Two (2) Doors	84	15	17 $\frac{3}{16}$	217	50.2	W\$ 4721
	65-1578SWD One (1) Door	78	15	17 $\frac{3}{16}$	201	46.7	W\$ 4496
	65-1572SWD One (1) Door	72	15	17 $\frac{3}{16}$	185	43.2	W\$ 4168
	65-1566SWD One (1) Door	66	15	17 $\frac{3}{16}$	170	39.7	W\$ 4006
	65-1560SWD One (1) Door	60	15	17 $\frac{3}{16}$	155	36.2	W\$ 3909



Must Specify (in this order):

Model #
Finish
Door
Style/Color
Grain Direction (if applicable)

Description

- Non-Locking Sliding Doors
- Component Hutch Tops with Profiles are Available; [See Top Sizes](#)
- If Applicable, Door Front Grain Direction Vertical Standard; Optional Horizontal Grain Direction
- Safely Write on Dry Erase Doors with Our Dry Erase Marker Set; [See Sets](#)
- Indiana Furniture Will Not be Liable for Wall Mount Hutches that are not Properly Installed
- Additional Options: Marker Boards, Work Wall, Tackboards, and Tasklights ([See Units](#)), Marker and Eraser Sets ([See Sets](#))

Options: Specify & Add

		Per Door
	1-AD Aluminum Framed Satin Frosted Tempered Glass Doors (Non-Locking)	\$ 745
	1-DEB Dry Erase Board Door (Non-Locking)	\$ 77
	1-HGA High Gloss Acrylic Door (Non-Locking); Must Specify Color	
	(GPA) Graphite Acrylic	\$ 773
	(BLA) Black, (WMA) Wired Mercury, or (WHA) White Acrylic	\$ 705

Pricing Codes:

W= Wood Top
P= HPL Top

[See Gesso Intro Section for Ordering Options](#)

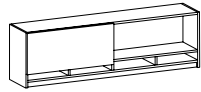
Item	Model No.	Width	Depth	Height	Ship Wt	Cubic Ft	List Price
WALL MOUNT HUTCH SLIDING DOOR WITH PAPER SLOTS 	65-15108SWDS Two (2) Doors / Six (6) Paper Slots	108	15	21	204	27.7	W\$ 8255
	65-15102SWDS Two (2) Doors / Six (6) Paper Slots	102	15	21	194	26.2	W\$ 7874
	65-1596SWDS Two (2) Doors / Six (6) Paper Slots	96	15	21	186	24.6	W\$ 7540
	65-1590SWDS Two (2) Doors / Five (5) Paper Slots	90	15	21	172	23.1	W\$ 7096
	65-1584SWDS Two (2) Doors / Five (5) Paper Slots	84	15	21	162	21.6	W\$ 6512
	65-1578SWDS One (1) Door / Five (5) Paper Slots	78	15	21	149	20.0	W\$ 6183
	65-1572SWDS One (1) Door / Four (4) Paper Slots	72	15	21	140	18.5	W\$ 5753
	65-1566SWDS One (1) Door / Four (4) Paper Slots	66	15	21	131	16.9	W\$ 5498
	65-1560SWDS One (1) Door / Four (4) Paper Slots	60	15	21	121	15.4	W\$ 5305



Must Specify (in this order):

- Model #
- Finish
- Door
 - Style/Color
 - Grain Direction (if applicable)
 - Paperslot Divider Material/Color

Description

- Non-Locking Sliding Doors
- Paper Slot Divider Material and Color Must Specify: Chrome (CHRM) or Veneer (W) and Finish Color
- Component Hutch Tops with Profiles are Available; [See Top Sizes](#)
- Safely Write on Dry Erase Doors with Our Dry Erase Marker Set; [See Sets](#)
- If Applicable, Door Front Grain Direction Vertical Standard; Optional Horizontal Grain Direction
- Indiana Furniture Will Not be Liable for Wall Mount Hutches that are not Properly Installed
- Additional Options: Work Wall, Tackboards, and Tasklights ([See Units](#)), Marker and Eraser Sets ([See Sets](#))

Options: Specify & Add

		Per Door
	1-AD Aluminum Framed Satin Frosted Tempered Glass Doors (Non-Locking)	\$ 745
	1-DEB Dry Erase Board Door (Non-Locking)	\$ 77
	1-HGA High Gloss Acrylic Door (Non-Locking); Must Specify Color	
	(GPA) Graphite Acrylic	\$ 773
	(BLA) Black, (WMA) Wired Mercury, or (WHA) White Acrylic	\$ 705

Pricing Codes:
W= Wood Top
P= HPL Top

[See Gesso Intro Section for Ordering Options](#)

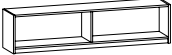
Item	Model No.	Width	Depth	Height	Ship Wt	Cubic Ft	List Price
WALL MOUNT HUTCH OPEN  Must Specify (in this order): Model # Finish Also available as 29 3/16" H Tall Wall Mount	65-15108OW Three Compartments	108	14 1/4	17 3/16	168	21.5	W\$ 4092
	65-15102OW Three Compartments	102	14 1/4	17 3/16	158	20.3	W\$ 3915
	65-1596OW Three Compartments	96	14 1/4	17 3/16	150	19.2	W\$ 3854
	65-1590OW Three Compartments	90	14 1/4	17 3/16	140	17.9	W\$ 3602
	65-1584OW Three Compartments	84	14 1/4	17 3/16	130	16.8	W\$ 3106
	65-1578OW Two Compartments	78	14 1/4	17 3/16	122	15.7	W\$ 3037
	65-1572OW Two Compartments	72	14 1/4	17 3/16	112	14.5	W\$ 2548
	65-1566OW Two Compartments	66	14 1/4	17 3/16	100	13.3	W\$ 2462
	65-1560OW Two Compartments	60	14 1/4	17 3/16	92	12.1	W\$ 2421
	65-1554OW Two Compartments	54	14 1/4	17 3/16	83	10.5	W\$ 2248
	65-1548OW Two Compartments	48	14 1/4	17 3/16	73	9.7	W\$ 2081
	65-1542OW One Compartments	42	14 1/4	17 3/16	63	8.6	W\$ 1909
	65-1536OW One Compartments	36	14 1/4	17 3/16	54	7.5	W\$ 1661
65-1530OW One Compartments	30	14 1/4	17 3/16	45	5.7	W\$ 1448	

Description

- Component Hutch Tops with Profiles are Available; [See Top Sizes](#)
- Indiana Furniture Will Not be Liable for Wall Mount Hutches that are not Properly Installed
- Additional Options: Marker Boards, Work Wall, Tackboards, and Tasklights ([See Units](#)), Marker and Eraser Sets ([See Sets](#))

Pricing Codes:

W= Wood Top

P= HPL Top

[See Gesso Intro Section for Ordering Options](#)

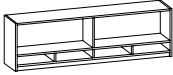
Item	Model No.	Width	Depth	Height	Ship Wt	Cubic Ft	List Price
WALL MOUNT HUTCH OPEN WITH PAPER SLOTS  Must Specify (in this order): Model # Finish Paperslot Divider Material/Color Also available as 29 3/16" H Tall Wall Mount	65-15108OWS Three Compartments	108	14 1/4	21	160	24.9	W\$ 6251
	65-15102OWS Three Compartments	102	14 1/4	21	155	23.5	W\$ 5990
	65-1596OWS Three Compartments	96	14 1/4	21	150	22.2	W\$ 5844
	65-1590OWS Three Compartments	90	14 1/4	21	145	20.8	W\$ 5504
	65-1584OWS Three Compartments	84	14 1/4	21	135	19.5	W\$ 4899
	65-1578OWS Two Compartments	78	14 1/4	21	124	18.1	W\$ 4723
	65-1572OWS Two Compartments	72	14 1/4	21	114	16.7	W\$ 4130
	65-1566OWS Two Compartments	66	14 1/4	21	105	15.4	W\$ 3956
	65-1560OWS Two Compartments	60	14 1/4	21	95	14.1	W\$ 3821
	65-1554OWS Two Compartments	54	14 1/4	21	88	12.7	W\$ 3552
	65-1548OWS Two Compartments	48	14 1/4	21	80	11.3	W\$ 3292
	65-1542OWS One Compartment	42	14 1/4	21	72	10.0	W\$ 3030
	65-1536OWS One Compartment	36	14 1/4	21	64	8.6	W\$ 2696
	65-1530OWS One Compartment	30	14 1/4	21	56	7.2	W\$ 2389

Description

- Paper Slot Divider Material and Color Must Specify: Chrome (CHRM) or Veneer (W) and Finish Color
- Component Hutch Tops with Profiles are Available; [See Top Sizes](#)
- Indiana Furniture Will Not be Liable for Wall Mount Hutches that are not Properly Installed
- Additional Options: Work Wall, Tackboards, and Tasklights ([See Units](#)), Marker and Eraser Sets ([See Sets](#))

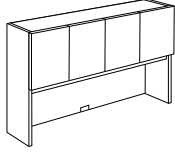
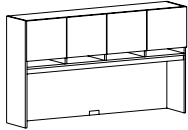
Item	Model No.	Width	Depth	Height	Ship Wt	Cubic Ft	List Price
 <p>TALL SURFACE MOUNT HUTCH HINGED DOOR</p> <p>Must Specify (in this order): Model # Finish Door Style/Color Grain Direction (if applicable) Locking Doors Paperslots Paperslot Divider Material/Color Tasklights Grommet Color Tackboard Fabric</p>  <p>Optional Paper Slots in veneer or chrome available; See Paper Slot Options</p> <p>Also available as 40 7/8" H Standard Surface Mount</p>	65-15108THU Six (6) Doors	108	15	52 7/8	313	64.2	W\$ 6496
	65-15102THU Six (6) Doors	102	15	52 7/8	296	60.7	W\$ 6292
	65-1596THU Six (6) Doors	96	15	52 7/8	278	57.7	W\$ 6179
	65-1590THU Five (5) Doors	90	15	52 7/8	260	53.7	W\$ 5863
	65-1584THU Five (5) Doors	84	15	52 7/8	243	50.2	W\$ 5246
	65-1578THU Four (4) Doors	78	15	52 7/8	226	46.7	W\$ 5145
	65-1572THU Four (4) Doors	72	15	52 7/8	264	43.3	W\$ 4518
	65-1566THU Four (4) Doors	66	15	52 7/8	242	39.7	W\$ 4375
	65-1560THU Four (4) Doors	60	15	52 7/8	220	36.1	W\$ 4299

Description

- 23 3/4" Clearance Below Apron Rail
- One Fixed Shelf Behind Doors
- Lower Center Grommet Standard; Must Specify: Black (BLK) or Silver (SLV)
- Additional Support is Required when Surface Mounted Hutches Do Not Sit Directly Over an End Panel or Pedestal; [See 65-2812SP](#)
- Component Hutch Tops with Profiles are Available; [See Top Sizes](#)
- Safely Write on Dry Erase, White and Black Tempered Glass Doors with Our Dry Erase Marker Set; [See Sets](#)
- If Applicable, Door Front Grain Direction Vertical Standard; Optional Horizontal Grain Direction
- Additional Options: Paper Slots ([See Paper Slot Options](#)), Locking Doors ([See Locking Door Options](#)), Marker Boards, Work Wall, Tackboards, and Tasklights ([See Units](#)), Marker and Eraser Sets ([See Sets](#))

Options: Specify & Add

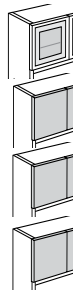

	Per Door
1-AD Aluminum Framed Satin Frosted Tempered Glass Doors (Non-Locking)	\$ 621
1-DEB Dry Erase Board Doors	\$ 60
WHGLS Aluminum Framed Doors with White Tempered Glass (Non-locking)	\$ 917
BLGLS Black Matte Framed Doors with Black Tempered Glass (Non-locking)	\$ 1210
1-HGA High Gloss Acrylic Doors; Must Specify Color	
(GPA) Graphite Acrylic	\$ 602
(BLA) Black, (WMA) Wired Mercury, or (WHA) White Acrylic	\$ 546

Pricing Codes:

W= Wood Top
P= HPL Top

[See Gesso Intro Section for Ordering Options](#)

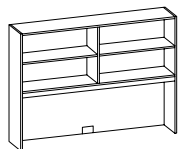
Item	Model No.	Width	Depth	Height	Ship Wt	Cubic Ft	List Price
TALL SURFACE MOUNT HUTCH OPEN 	65-15108TOH Six Compartments	108	14¼	52⅞	239	64.2	W\$ 5295
	65-15102TOH Six Compartments	102	14¼	52⅞	228	60.7	W\$ 5117
	65-1596TOH Six Compartments	96	14¼	52⅞	217	57.7	W\$ 5049
	65-1590TOH Five Compartments	90	14¼	52⅞	206	50.2	W\$ 4837
	65-1584TOH Five Compartments	84	14¼	52⅞	195	48.3	W\$ 4286
	65-1578TOH Four Compartments	78	14¼	52⅞	177	46.7	W\$ 4199
	65-1572TOH Four Compartments	72	14¼	52⅞	166	43.3	W\$ 3689
	65-1566TOH Four Compartments	66	14¼	52⅞	149	39.7	W\$ 3583
65-1560TOH Four Compartments	60	14¼	52⅞	144	36.1	W\$ 3541	

Must Specify (in this order):

Model #
Finish
Paperslots
Paperslot Divider Material/Color
Tasklights
Grommet Color
Tackboard Fabric

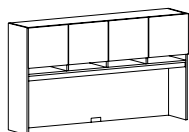

Optional Paper Slots in veneer or chrome available; [See Paper Slot Options](#)

Also available as 40⅞" H Standard Surface Mount



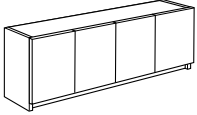

Description

- 23¾" Clearance Below Apron Rail
- Lower Center Grommet Standard; Must Specify: Black (BLK) or Silver (SLV)
- Additional Support is Required when Surface Mounted Hutches Do Not Sit Directly Over an End Panel or Pedestal; [See 65-2812SP](#)
- Component Hutch Tops with Profiles are Available; [See Top Sizes](#)
- Additional Options: Paper Slots ([See Paper Slot Options](#)), Locking Doors ([See Locking Door Options](#)), Marker Boards, Work Wall, Tackboards, and Tasklights ([See Units](#)), Marker and Eraser Sets ([See Sets](#))

Item	Model No.	Width	Depth	Height	Ship Wt	Cubic Ft	List Price
 <p>TALL WALL MOUNT HUTCH HINGED DOOR</p> <p><i>Must Specify (in this order):</i> Model # Finish Door Style/Color Grain Direction (if applicable) Locking Doors</p> <p>Also available as 17$\frac{3}{16}$" H Standard Wall Mount</p>	65-15108TWD Six (6) Doors	108	15	29 $\frac{3}{16}$	281	55.1	W\$ 6009
	65-15102TWD Six (6) Doors	102	15	29 $\frac{3}{16}$	265	60.7	W\$ 5868
	65-1596TWD Six (6) Doors	96	15	29 $\frac{3}{16}$	249	57.2	W\$ 5638
	65-1590TWD Five (5) Doors	90	15	29 $\frac{3}{16}$	233	53.7	W\$ 5129
	65-1584TWD Five (5) Doors	84	15	29 $\frac{3}{16}$	217	50.2	W\$ 4826
	65-1578TWD Four (4) Doors	78	15	29 $\frac{3}{16}$	201	46.7	W\$ 4732
	65-1572TWD Four (4) Doors	72	15	29 $\frac{3}{16}$	185	43.2	W\$ 4166
	65-1566TWD Four (4) Doors	66	15	29 $\frac{3}{16}$	170	22.0	W\$ 3987
	65-1560TWD Four (4) Doors	60	15	29 $\frac{3}{16}$	155	20.1	W\$ 3790
	65-1554TWD Three (3) Doors	54	15	29 $\frac{3}{16}$	140	18.1	W\$ 3496
	65-1548TWD Three (3) Doors	48	15	29 $\frac{3}{16}$	124	16.2	W\$ 3270
	65-1542TWD Two (2) Doors	42	15	29 $\frac{3}{16}$	109	12.3	W\$ 2653
	65-1536TWD Two (2) Doors	36	15	29 $\frac{3}{16}$	93	12.3	W\$ 2502
	65-1530TWD Two (2) Doors	30	15	29 $\frac{3}{16}$	77	9.1	W\$ 2343

Description

- One Fixed Shelf Behind Doors
- Component Hutch Tops with Profiles are Available; [See Top Sizes](#)
- If Applicable, Door Front Grain Direction Vertical Standard; Optional Horizontal Grain Direction
- Safely Write on Dry Erase, White and Black Tempered Glass Doors with Our Dry Erase Marker Set; [See Sets](#)
- Indiana Furniture Will Not be Liable for Wall Mount Hutches that are not Properly Installed
- Additional Options: Locking Doors ([See Locking Door Options](#)), Marker Boards, Work Wall, Tackboards, and Tasklights ([See Units](#)), Marker and Eraser Sets ([See Sets](#))

Options: Specify & Add		Per Door
	1-AD Aluminum Framed Satin Frosted Tempered Glass Doors (Non-Locking)	\$ 621
	1-DEB Dry Erase Board Doors	\$ 60
	WHGLS Aluminum Framed Doors with White Tempered Glass (Non-locking)	\$ 917
	BLGLS Black Matte Framed Doors with Black Tempered Glass (Non-locking)	\$ 1210
	1-HGA High Gloss Acrylic Doors; Must Specify Color	
	(GPA) Graphite Acrylic	\$ 602
	(BLA) Black, (WMA) Wired Mercury, or (WHA) White Acrylic	\$ 546

Pricing Codes:

W= Wood Top

P= HPL Top



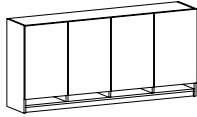

[See Gesso Intro Section for Ordering Options](#)

Item	Model No.	Width	Depth	Height	Ship Wt	Cubic Ft	List Price
 <p>TALL WALL MOUNT HUTCH HINGED DOOR WITH PAPER SLOTS</p> <p><i>Must Specify (in this order):</i> Model # Finish Door Style/Color Grain Direction (if applicable) Locking Doors Paperslot Divider Material/Color</p> <p>Also available as 21 1/4" H Standard Wall Mount</p>	65-15108TWDS Six (6) Doors / Six (6) Paper Slots	108	15	33 3/8	350	62.7	W\$ 8171
	65-15102TWDS Six (6) Doors / Six (6) Paper Slots	102	15	33 3/8	335	60.7	W\$ 7941
	65-1596TWDS Six (6) Doors / Six (6) Paper Slots	96	15	33 3/8	320	57.2	W\$ 7628
	65-1590TWDS Five (5) Doors / Five (5) Paper Slots	90	15	33 3/8	290	53.7	W\$ 7033
	65-1584TWDS Five (5) Doors / Five (5) Paper Slots	84	15	33 3/8	217	50.2	W\$ 6618
	65-1578TWDS Four (4) Doors / Four (4) Paper Slots	78	15	33 3/8	201	46.0	W\$ 6419
	65-1572TWDS Four (4) Doors / Four (4) Paper Slots	72	15	33 3/8	185	43.2	W\$ 5750
	65-1566TWDS Four (4) Doors / Four (4) Paper Slots	66	15	33 3/8	170	22.0	W\$ 5481
	65-1560TWDS Four (4) Doors / Four (4) Paper Slots	60	15	33 3/8	155	20.1	W\$ 5191
	65-1554TWDS Three (3) Doors / Three (3) Paper Slots	54	15	33 3/8	140	18.1	W\$ 4801
	65-1548TWDS Three (3) Doors / Three (3) Paper Slots	48	15	33 3/8	124	16.2	W\$ 4477
	65-1542TWDS Two (2) Doors / Two Paper Slots	42	15	33 3/8	109	14.2	W\$ 3780
	65-1536TWDS Two (2) Doors / Two Paper Slots	36	15	33 3/8	93	12.3	W\$ 3535
	65-1530TWDS Two (2) Doors / Two Paper Slots	30	15	33 3/8	81	12.3	W\$ 3286

Description

- One Fixed Shelf Behind Doors
- Paper Slot Divider Material and Color Must Specify: Chrome (CHRM) or Veneer (W) and Finish Color
- Component Hutch Tops with Profiles are Available; [See Top Sizes](#)
- If Applicable, Door Front Grain Direction Vertical Standard; Optional Horizontal Grain Direction
- Safely Write on Dry Erase, White and Black Tempered Glass Doors with Our Dry Erase Marker Set; [See Sets](#)
- Indiana Furniture Will Not be Liable for Wall Mount Hutches that are not Properly Installed
- Additional Options: Locking Doors ([See Locking Door Options](#)), Work Wall, Tackboards, and Tasklights ([See Units](#)), Marker and Eraser Sets ([See Sets](#))

Options: Specify & Add

		Per Door
	1-AD Aluminum Framed Satin Frosted Tempered Glass Doors (Non-Locking)	\$ 621
	1-DEB Dry Erase Board Doors	\$ 60
	WHGLS Aluminum Framed Doors with White Tempered Glass (Non-locking)	\$ 917
	BLGLS Black Matte Framed Doors with Black Tempered Glass (Non-locking)	\$ 1210
	1-HGA High Gloss Acrylic Doors; Must Specify Color	
	(GPA) Graphite Acrylic	\$ 602
	(BLA) Black, (WMA) Wired Mercury, or (WHA) White Acrylic	\$ 546

Pricing Codes:
 W= Wood Top
 P= HPL Top

[See Gesso Intro Section for Ordering Options](#)

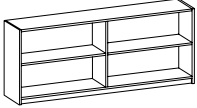
Item	Model No.	Width	Depth	Height	Ship Wt	Cubic Ft	List Price
TALL WALL MOUNT HUTCH OPEN  Must Specify (in this order): Model # Finish Also available as 17 3/16" H Standard Wall Mount	65-15108TOW Six Compartments	108	14 1/4	29 3/16	225	34.6	W\$ 4809
	65-15102TOW Six Compartments	102	14 1/4	29 3/16	212	32.7	W\$ 4697
	65-1596TOW Six Compartments	96	14 1/4	29 3/16	200	30.8	W\$ 4511
	65-1590TOW Six Compartments	90	14 1/4	29 3/16	186	29.0	W\$ 4103
	65-1584TOW Six Compartments	84	14 1/4	29 3/16	173	27.1	W\$ 3864
	65-1578TOW Four Compartments	78	14 1/4	29 3/16	161	25.2	W\$ 3790
	65-1572TOW Four Compartments	72	14 1/4	29 3/16	147	23.3	W\$ 3336
	65-1566TOW Four Compartments	66	14 1/4	29 3/16	135	21.4	W\$ 3191
	65-1560TOW Four Compartments	60	14 1/4	29 3/16	122	20.1	W\$ 3030

Description

- Component Hutch Tops with Profiles are Available; [See Top Sizes](#)
- Indiana Furniture Will Not be Liable for Wall Mount Hutches that are not Properly Installed
- Additional Options: Marker Boards, Work Wall, Tackboards, and Tasklights ([See Units](#)), Marker and Eraser Sets ([See Sets](#))

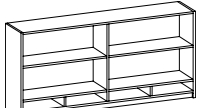
TALL WALL MOUNT HUTCH OPEN WITH PAPER SLOTS  Must Specify (in this order): Model # Finish Paperslot Divider Material/Color Also available as 17 3/16" H Standard Wall Mount	65-15108TOWS Six Compartments / Six (6) Paper Slots	108	14 1/4	33 3/8	245	34.6	W\$ 6969
	65-15102TOWS Six Compartments / Six (6) Paper Slots	102	14 1/4	33 3/8	232	32.7	W\$ 6772
	65-1596TOWS Six Compartments / Six (6) Paper Slots	96	14 1/4	33 3/8	220	30.8	W\$ 6500
	65-1590TOWS Six Compartments / Six (6) Paper Slots	90	14 1/4	33 3/8	206	29.0	W\$ 6006
	65-1584TOWS Six Compartments / Six (6) Paper Slots	84	14 1/4	33 3/8	193	27.1	W\$ 5652
	65-1578TOWS Four Compartments / Four (4) Paper Slots	78	14 1/4	33 3/8	181	25.2	W\$ 5476
	65-1572TOWS Four Compartments / Four (4) Paper Slots	72	14 1/4	33 3/8	167	23.2	W\$ 4916
	65-1566TOWS Four Compartments / Four (4) Paper Slots	66	14 1/4	33 3/8	155	21.4	W\$ 4684
	65-1560TOWS Four Compartments / Four (4) Paper Slots	60	14 1/4	33 3/8	142	20.1	W\$ 4432

Description

- Paper Slot Divider Material and Color Must Specify: Chrome (CHRM) or Veneer (W) and Finish Color
- Component Hutch Tops with Profiles are Available; [See Top Sizes](#)
- Indiana Furniture Will Not be Liable for Wall Mount Hutches that are not Properly Installed
- Additional Options: Work Wall, Tackboards, and Tasklights ([See Units](#)), Marker and Eraser Sets ([See Sets](#))

Pricing Codes:

W= Wood Top
P= HPL Top

[See Gesso Intro Section for Ordering Options](#)

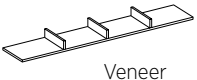
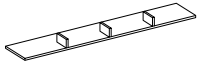
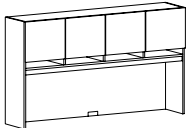
Item	Model No.	For Use With	Width	Depth	Height	Ship Wt	Cubic Ft	List Price
OPTIONAL PAPER SLOTS FOR SURFACE MOUNT HUTCH  Veneer  Chrome 	01-PAPERSLOT 108	For Use with 108" Unit Six (6) Slots	106½	11⅞	5¼	-	-	\$ 2107
	01-PAPERSLOT 102	For Use with 102" Unit Six (6) Slots	100½	11⅞	5¼	-	-	\$ 2022
	01-PAPERSLOT 96	For Use with 96" Unit Six (6) Slots	94½	11⅞	5¼	-	-	\$ 1940
	01-PAPERSLOT 90	For Use with 90" Unit Five (5) Slots	88½	11⅞	5¼	-	-	\$ 1854
	01-PAPERSLOT 84	For Use with 84" Unit Five (5) Slots	82½	11⅞	5¼	-	-	\$ 1746
	01-PAPERSLOT 78	For Use with 78" Unit Four (4) Slots	76½	11⅞	5¼	-	-	\$ 1644
	01-PAPERSLOT 72	For Use with 72" Unit Four (4) Slots	70½	11⅞	5¼	-	-	\$ 1540
	01-PAPERSLOT 66	For Use with 66" Unit Four (4) Slots	64½	11⅞	5¼	-	-	\$ 1454
	01-PAPERSLOT 60	For Use with 60" Unit Four (4) Slots	58½	11⅞	5¼	-	-	\$ 1361
	01-PAPERSLOT 54	For Use with 54" Unit Three (3) Slots	52½	11⅞	5¼	-	-	\$ 1274
	01-PAPERSLOT 48	For Use with 48" Unit Three (3) Slots	46½	11⅞	5¼	-	-	\$ 1181
	01-PAPERSLOT 42	For Use with 42" Unit Two (2) Slots	40½	11⅞	5¼	-	-	\$ 1095
	01-PAPERSLOT 36	For Use with 36" Unit Two (2) Slots	34½	11⅞	5¼	-	-	\$ 1008
01-PAPERSLOT 30	For Use with 30" Unit Two (2) Slots	28½	11⅞	5¼	-	-	\$ 923	

Must Specify (in this order):
 Model #
 Paperslot Divider Material/Color

Description

- Ships Factory Installed
- Paper Slot Divider Material and Color Must Specify: Chrome (CHRM) or Veneer (W) and Finish

Item	Model No.	Width	Depth	Height	Ship Wt	Cubic Ft	List Price
MODULAR TOP FOR 15" DEEP HUTCHES & BOOKCASES 	65-15108HT	108	15	1	67	5.7	W\$ 1075
	65-15102HT	102	15	1	63	5.4	W\$ 1056
	65-1596HT	96	15	1	61	5.1	W\$ 1018
	65-1590HT	90	15	1	57	4.8	W\$ 974
	65-1584HT	84	15	1	53	4.5	W\$ 932
	65-1578HT	78	15	1	50	4.2	W\$ 910
	65-1572HT	72	15	1	48	3.9	W\$ 846
	65-1566HT	66	15	1	42	3.5	W\$ 810
	65-1560HT	60	15	1	38	3.2	W\$ 790
	65-1554HT	54	15	1	34	2.9	W\$ 774
	65-1548HT	48	15	1	30	2.6	W\$ 755
	65-1542HT	42	15	1	27	2.3	W\$ 731
	65-1536HT	36	15	1	23	2.0	W\$ 702
	65-1530HT	30	15	1	11	1.0	W\$ 679

Must Specify (in this order):

Model #
Finish
Edge Profile

Description

- Provides an Edge Profile on Overhead Units While Giving Multiple Overhead Units a Cohesive Appearance
- Profiled on Front Edge Only

SURFACE MOUNT PAPER SLOT TOWER	65-1218HH	18	12	21	45	4.4	W\$ 1470
---------------------------------------	-----------	----	----	----	----	-----	----------

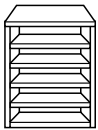

Description

- Four Adjustable Shelves

Must Specify (in this order):

Model #
Finish

Pricing Codes:

W= Wood Top
P= HPL Top

[See Gesso Intro Section for Ordering Options](#)

Item	Model No.	Width	Depth	Height	Ship Wt	Cubic Ft	List Price
SURFACE MOUNT STORAGE TOWER WITH DOOR AND OPEN SHELVING	Hinged Left	Hinged Right					
	65-1518HL1	65-1518HR1	18	15	40 $\frac{1}{8}$	78	8.6

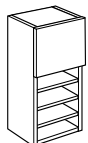

Shown as Right

Must Specify (in this order):

- Model #
- Finish
- Door
 - Style/Color
 - Grain Direction (if applicable)
 - Locking Doors

Description

- Storage Behind Door in Upper Section
- Three Adjustable Shelves
- If Applicable, Door Front Grain Direction Vertical Standard; Optional Horizontal Grain Direction
- Safely Write on Dry Erase, White and Black Tempered Glass Doors with Our Dry Erase Marker Set; [See Sets](#)
- Additional Options: Locking Door ([See Locking Options](#))

Options: Specify & Add

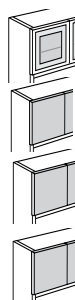

		Per Door
1-AD	Aluminum Framed Satin Frosted Tempered Glass Doors (Non-Locking)	\$ 438
1-DEB	Dry Erase Board Doors	\$ 28
WHGLS	Aluminum Framed Doors with White Tempered Glass (Non-locking)	\$ 652
BLGLS	Black Matte Framed Doors with Black Tempered Glass (Non-locking)	\$ 868
1-HGA	High Gloss Acrylic Doors; Must Specify Color	
	(GPA) Graphite Acrylic	\$ 269
	(BLA) Black, (WMA) Wired Mercury, or (WHA) White Acrylic	\$ 247

SURFACE MOUNT TALL STORAGE TOWER WITH DOOR AND OPEN SHELVING	Hinged Left	Hinged Right	Width	Depth	Height	Ship Wt	Cubic Ft	List Price
	65-1518THL1	65-1518THR1						

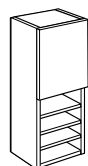

Shown as Right

Must Specify (in this order):

- Model #
- Finish
- Door
 - Style/Color
 - Grain Direction (if applicable)
 - Locking Doors

Description

- Storage Behind Door in Upper Section with One Adjustable Shelf
- Three Adjustable Shelves
- If Applicable, Door Front Grain Direction Vertical Standard; Optional Horizontal Grain Direction
- Safely Write on Dry Erase, White and Black Tempered Glass Doors with Our Dry Erase Marker Set; [See Sets](#)
- Additional Options: Locking Door ([See Locking Options](#))

Options: Specify & Add

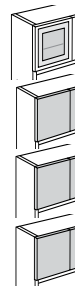

		Per Door
1-AD	Aluminum Framed Satin Frosted Tempered Glass Doors (Non-Locking)	\$ 621
1-DEB	Dry Erase Board Doors	\$ 60
WHGLS	Aluminum Framed Doors with White Tempered Glass (Non-locking)	\$ 917
BLGLS	Black Matte Framed Doors with Black Tempered Glass (Non-locking)	\$ 1210
1-HGA	High Gloss Acrylic Doors; Must Specify Color	
	(GPA) Graphite Acrylic	\$ 602
	(BLA) Black, (WMA) Wired Mercury, or (WHA) White Acrylic	\$ 546

Pricing Codes:
W= Wood Top
P= HPL Top

[See Gesso Intro Section for Ordering Options](#)

Item	Model No.	Width	Depth	Height	Ship Wt	Cubic Ft	List Price
SURFACE MOUNT STORAGE TOWER OPEN BOOKCASE	65-1518HB	18	14¼	40⅞	62	8.6	W\$ 1436

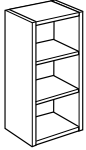

Description

- Two Adjustable Shelves

Must Specify (in this order):

Model #
Finish

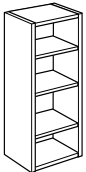
SURFACE MOUNT TALL STORAGE TOWER OPEN BOOKCASE	65-1518THB	18	14½	52⅞	68	11.0	W\$ 1709
--	------------	----	-----	-----	----	------	----------

Description

- Three Adjustable Shelves

Must Specify (in this order):

Model #
Finish

Pricing Codes:

W= Wood Top
P= HPL Top

[See Gesso Intro Section for Ordering Options](#)

Item	Model No.	Width	Depth	Height	Ship Wt	Cubic Ft	List Price
SURFACE MOUNT STORAGE TOWER WITH FULL DOOR	Hinged Left	Hinged Right					
	65-1518HL3	65-1518HR3	18	15	40 $\frac{7}{8}$	78	8.6 W\$ 1891

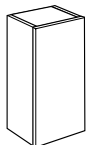

Shown as Right



Must Specify (in this order):

- Model #
- Finish
- Door
- Style/Color
- Grain Direction (if applicable)
- Locking Doors

Description

- Touch Latch Door with One Fixed Shelf/Two Adjustable Shelves Behind Door
- If Applicable, Door Front Grain Direction Vertical Standard; Optional Horizontal Grain Direction
- Safely Write on Dry Erase, White and Black Tempered Glass Doors with Our Dry Erase Marker Set; [See Sets](#)
- Additional Options: Locking Door ([See Locking Options](#))

Options: Specify & Add

		Per Unit
	1-AD Aluminum Framed Satin Frosted Tempered Glass Door (Non-Locking)	\$ 710
	1-DEB Dry Erase Board Door	\$ 77
	WHGLS Aluminum Framed Door with White Tempered Glass (Non-locking)	\$ 1113
	BLGLS Black Matte Framed Door with Black Tempered Glass (Non-locking)	\$ 1486
	1-HGA High Gloss Acrylic Door; Must Specify Color	
	(GPA) Graphite Acrylic	\$ 733
	(BLA) Black, (WMA) Wired Mercury, or (WHA) White Acrylic	\$ 668

Item	Model No.	Width	Depth	Height	Ship Wt	Cubic Ft	List Price
SURFACE MOUNT TALL STORAGE TOWER WITH FULL DOOR	Hinged Left	Hinged Right					
	65-1518THL3	65-1518THR3	18	15	52 $\frac{7}{8}$	95	11.0 W\$ 2241



Shown as Right



Must Specify (in this order):

- Model #
- Finish
- Door
- Style/Color
- Grain Direction (if applicable)
- Locking Doors

Description

- Touch Latch Door with One Fixed Shelf/Three Adjustable Shelves Behind Door
- If Applicable, Door Front Grain Direction Vertical Standard; Optional Horizontal Grain Direction
- Safely Write on Dry Erase, White and Black Tempered Glass Doors with Our Dry Erase Marker Set; [See Sets](#)
- Additional Options: Locking Door ([See Locking Options](#))

Options: Specify & Add

		Per Unit
	1-AD Aluminum Framed Satin Frosted Tempered Glass Door (Non-Locking)	\$ 849
	1-DEB Dry Erase Board Door	\$ 96
	WHGLS Aluminum Framed Door with White Tempered Glass (Non-locking)	\$ 1347
	BLGLS Black Matte Framed Door with Black Tempered Glass (Non-locking)	\$ 1796
	1-HGA High Gloss Acrylic; Must Specify Color	
	(GPA) Graphite Acrylic	\$ 960
	(BLA) Black, (WMA) Wired Mercury, or (WHA) White Acrylic	\$ 876

Pricing Codes:
W= Wood Top
P= HPL Top

[See Gesso Intro Section for Ordering Options](#)

Item	Model No.	Width	Depth	Height	Ship Wt	Cubic Ft	List Price
SURFACE MOUNT DOOR BOOKCASE	65-1536TUDB	36	15	40 $\frac{7}{8}$	168	16.1	W\$ 2708
	65-1530TUDB	30	15	40 $\frac{7}{8}$	140	13.4	W\$ 2514

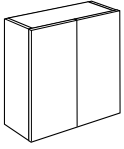





Must Specify (in this order):

Model #
Finish
Door
Style/Color
Grain Direction
(if applicable)
Locking Doors

Description

- Touch Latch Door with One Fixed Shelf/Two Adjustable Shelves Behind Door
- If Applicable, Door Front Grain Direction Vertical Standard; Optional Horizontal Grain Direction
- Safely Write on Dry Erase, White and Black Tempered Glass Doors with Our Dry Erase Marker Set; [See Sets](#)
- Additional Options: Locking Doors ([See Locking Options](#))

Options: Specify & Add

		Per Unit
	1-AD Aluminum Framed Satin Frosted Tempered Glass Doors (Non-Locking)	\$ 1420
	1-DEB Dry Erase Board Doors	\$ 148
	WHGLS Aluminum Framed Doors with White Tempered Glass (Non-locking)	\$ 2228
	BLGLS Black Matte Framed Doors with Black Tempered Glass (Non-locking)	\$ 2975
	1-HGA High Gloss Acrylic; Must Specify Color	
	(GPA) Graphite Acrylic	\$ 1462
	(BLA) Black, (WMA) Wired Mercury, or (WHA) White Acrylic	\$ 1334



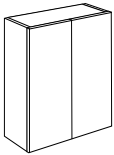

SURFACE MOUNT TALL DOOR BOOKCASE	65-1536TTUDB	36	15	52 $\frac{7}{8}$	216	20.5	W\$ 3183
	65-1530TTUDB	30	15	52 $\frac{7}{8}$	180	17.3	W\$ 2888



Must Specify (in this order):

Model #
Finish
Door
Style/Color
Grain Direction
(if applicable)
Locking Doors

Options: Specify & Add

		Per Unit
	1-AD Aluminum Framed Satin Frosted Tempered Glass Doors (Non-Locking)	\$ 1697
	1-DEB Dry Erase Board Doors	\$ 193
	WHGLS Aluminum Framed Doors with White Tempered Glass (Non-locking)	\$ 2692
	BLGLS Black Matte Framed Doors with Black Tempered Glass (Non-locking)	\$ 3589
	1-HGA High Gloss Acrylic; Must Specify Color	
	(GPA) Graphite Acrylic	\$ 1914
	(BLA) Black, (WMA) Wired Mercury, or (WHA) White Acrylic	\$ 1747

Pricing Codes:

W= Wood Top
P= HPL Top

[See Gesso Intro Section for Ordering Options](#)

Item	Model No.	Width	Depth	Height	Ship Wt	Cubic Ft	List Price	
SURFACE MOUNT DOOR BOOKCASE WITH SIDE SHELVING	Shelves Left	Shelves Right						
	65-3615TUDBL	65-3615TUDBR	36	15	40 $\frac{1}{2}$	157	13.8	W\$ 3689
	65-3015TUDBL	65-3015TUDBR	30	15	40 $\frac{1}{2}$	140	13.4	W\$ 3559

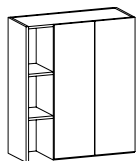

Shown as Left





Must Specify (in this order):

- Model #
- Finish
- Door
 - Style/Color
 - Grain Direction (if applicable)
- Locking Doors

Description

- Touch Latch Door with Two Adjustable Shelves Behind Doors
- Side Fixed Shelves; Top Shelf with 15" Clearance, Two Remaining Shelves with 11 $\frac{1}{2}$ " Clearance
- If Applicable, Door Front Grain Direction Vertical Standard; Optional Horizontal Grain Direction
- Safely Write on Dry Erase, White and Black Tempered Glass Doors with Our Dry Erase Marker Set; [See Sets](#)
- Additional Options: Locking Doors ([See Locking Options](#))

Options: Specify & Add

		Per Unit
	1-AD Aluminum Framed Satin Frosted Tempered Glass Doors (Non-Locking)	\$ 1420
	1-DEB Dry Erase Board Doors	\$ 148
	WHGLS Aluminum Framed Doors with White Tempered Glass (Non-locking)	\$ 2228
	BLGLS Black Matte Framed Doors with Black Tempered Glass (Non-locking)	\$ 2975
	1-HGA High Gloss Acrylic; Must Specify Color	
	(GPA) Graphite Acrylic	\$ 1462
	(BLA) Black, (WMA) Wired Mercury, or (WHA) White Acrylic	\$ 1334

Item	Model No.	Width	Depth	Height	Ship Wt	Cubic Ft	List Price	
SURFACE MOUNT DOOR BOOKCASE WITH SIDE SHELVING	Shelves Left	Shelves Right						
	65-3615TTUDBL	65-3615TTUDBR	36	15	52	157	13.8	W\$ 4199
	65-3015TTUDBL	65-3015TTUDBR	30	15	52	140	13.4	W\$ 4053

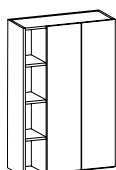

Shown as Left





Must Specify (in this order):

- Model #
- Finish
- Door
 - Style/Color
 - Grain Direction (if applicable)
- Locking Doors

Description

- Touch Latch Door with Three Adjustable Shelves Behind Doors
- Side Fixed Shelves; Top Shelf with 15" Clearance, Two Remaining Shelves with 12" Clearance
- If Applicable, Door Front Grain Direction Vertical Standard; Optional Horizontal Grain Direction
- Safely Write on Dry Erase, White and Black Tempered Glass Doors with Our Dry Erase Marker Set; [See Sets](#)
- Additional Options: Locking Doors ([See Locking Options](#))

Options: Specify & Add

		Per Unit
	1-AD Aluminum Framed Satin Frosted Tempered Glass Doors (Non-Locking)	\$ 1697
	1-DEB Dry Erase Board Doors	\$ 193
	WHGLS Aluminum Framed Doors with White Tempered Glass (Non-locking)	\$ 2692
	BLGLS Black Matte Framed Doors with Black Tempered Glass (Non-locking)	\$ 3589
	1-HGA High Gloss Acrylic; Must Specify Color	
	(GPA) Graphite Acrylic	\$ 1914
	(BLA) Black, (WMA) Wired Mercury, or (WHA) White Acrylic	\$ 1747

Pricing Codes:
W= Wood Top
P= HPL Top

[See Gesso Intro Section for Ordering Options](#)

Item	Model No.	Width	Depth	Height	Ship Wt	Cubic Ft	List Price
STORAGE CABINET WITH OPEN SHELVES AND FILE/FILE	Hinged Left	Hinged Right					
	65-1872DS2L	65-1872DS2R	18	24	70 $\frac{1}{8}$	145	22.0

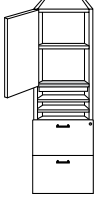

Shown as Left

Must Specify (in this order):

Model #
Finish
Door Style/Color
Door/Drawer Grain Direction
(if applicable)
Locking Doors
Drawer
Construction
Track
Pull

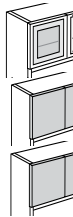

Description

- One Adjustable Shelf Behind Touch Latch Door; Two Adjustable Shelves in Center
- Locking File Drawers Provide Legal or Letter Filing
- If Applicable, Drawer/Door Front Grain Direction Vertical Standard; Optional Horizontal Grain Direction
- Safely Write on Dry Erase Doors with Our Dry Erase Marker Set; [See Sets](#)
- Additional Options: Dove Tail Drawer Construction and Soft Close Drawers ([See Drawer Options](#)), Locking Door ([See Locking Options](#))

Options: Specify & Add

	Per Door
1-AD Aluminum Framed Satin Frosted Tempered Glass Doors (Non-Locking)	\$ 621
1-DEB Dry Erase Board Doors	\$ 60
1-HGA High Gloss Acrylic Doors; Must Specify Color	
(GPA) Graphite Acrylic	\$ 602
(BLA) Black, (WMA) Wired Mercury, or (WHA) White Acrylic	\$ 546

Item	Model No.	Width	Depth	Height	Ship Wt	Cubic Ft	List Price
TALL STORAGE CABINET WITH OPEN SHELVES AND FILE/FILE	Hinged Left	Hinged Right					
	65-1884DS2L	65-1884DS2R	18	24	82 $\frac{1}{8}$	196	25.8

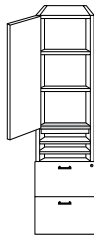

Shown as Left

Must Specify (in this order):

Model #
Finish
Door Style/Color
Door/Drawer Grain Direction
(if applicable)
Locking Doors
Drawer
Construction
Track
Pull

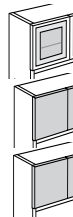

Description

- Two Adjustable Shelf Behind Touch Latch Door; Two Adjustable Shelves in Center
- Locking File Drawers Provide Legal or Letter Filing
- If Applicable, Drawer/Door Front Grain Direction Vertical Standard; Optional Horizontal Grain Direction
- Safely Write on Dry Erase Doors with Our Dry Erase Marker Set; [See Sets](#)
- Additional Options: Dove Tail Drawer Construction and Soft Close Drawers ([See Drawer Options](#)), Locking Door ([See Locking Options](#))

Options: Specify & Add

	Per Unit
1-AD Aluminum Framed Satin Frosted Tempered Glass Door (Non-Locking)	\$ 710
1-DEB Dry Erase Board Door	\$ 77
1-HGA High Gloss Acrylic Door; Must Specify Color	
(GPA) Graphite Acrylic	\$ 733
(BLA) Black, (WMA) Wired Mercury, or (WHA) White Acrylic	\$ 668

Pricing Codes:

W= Wood Top

P= HPL Top

[See Gesso Intro Section for Ordering Options](#)

Item	Model No.	Width	Depth	Height	Ship Wt	Cubic Ft	List Price
STORAGE CABINET WITH OPEN SHELVES AND BOX/BOX/FILE	Hinged Left	Hinged Right					
	65-1872DSIL	65-1872DSIR	18	24	70 ⁷ / ₈	145	22.0

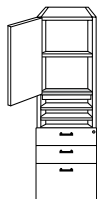

Shown as Left

Description

- One Adjustable Shelf Behind Touch Latch Door; Two Adjustable Shelves in Center
- Locking Drawers; File Drawer Provides Legal or Letter Filing
- If Applicable, Drawer/Door Front Grain Direction Vertical Standard; Optional Horizontal Grain Direction
- Safely Write on Dry Erase Doors with Our Dry Erase Marker Set; [See Sets](#)
- Additional Options: Dove Tail Drawer Construction and Soft Close Drawers ([See Drawer Options](#)), Locking Door ([See Locking Options](#))

Must Specify (in this order):

- Model #
- Finish
- Door Style/Color
- Door/Drawer Grain Direction (if applicable)
- Locking Doors
- Drawer Construction
- Track
- Pull

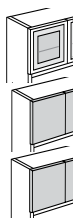

Options: Specify & Add

	Per Door
1-AD Aluminum Framed Satin Frosted Tempered Glass Doors (Non-Locking)	\$ 621
1-DEB Dry Erase Board Doors	\$ 60
1-HGA High Gloss Acrylic Doors; Must Specify Color	
(GPA) Graphite Acrylic	\$ 602
(BLA) Black, (WMA) Wired Mercury, or (WHA) White Acrylic	\$ 546

TALL STORAGE CABINET WITH OPEN SHELVES AND BOX/BOX/FILE	Hinged Left	Hinged Right						
	65-1884DSIL	65-1884DSIR	18	24	82 ⁷ / ₈	196	25.8	W\$ 4519

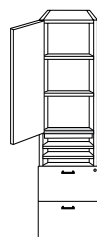

Shown as Left

Description

- Two Adjustable Shelf Behind Touch Latch Door; Two Adjustable Shelves in Center
- Locking Drawers; File Provide Legal or Letter Filing
- If Applicable, Drawer/Door Front Grain Direction Vertical Standard; Optional Horizontal Grain Direction
- Safely Write on Dry Erase Doors with Our Dry Erase Marker Set; [See Sets](#)
- Additional Options: Dove Tail Drawer Construction and Soft Close Drawers ([See Drawer Options](#)), Locking Door ([See Locking Options](#))

Must Specify (in this order):

- Model #
- Finish
- Door Style/Color
- Door/Drawer Grain Direction (if applicable)
- Locking Doors
- Drawer Construction
- Track
- Pull

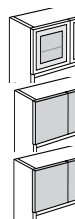

Options: Specify & Add

	Per Unit
1-AD Aluminum Framed Satin Frosted Tempered Glass Door (Non-Locking)	\$ 710
1-DEB Dry Erase Board Door	\$ 77
1-HGA High Gloss Acrylic Door; Must Specify Color	
(GPA) Graphite Acrylic	\$ 733
(BLA) Black, (WMA) Wired Mercury, or (WHA) White Acrylic	\$ 668

Pricing Codes:
W= Wood Top
P= HPL Top

[See Gesso Intro Section for Ordering Options](#)

Item	Model No.	Width	Depth	Height	Ship Wt	Cubic Ft	List Price	
STORAGE CABINET FILE/FILE	Hinged Left	Hinged Right						
	65-1884WFL	65-1884WFR	18	24	82 $\frac{1}{2}$ "	166	25.7	W\$ 4201
	Three Adjustable Shelves Behind Door							
	65-1872WFL	65-1872WFR	18	24	70 $\frac{1}{2}$ "	145	22.0	W\$ 4025
	Two Adjustable Shelves Behind Door							

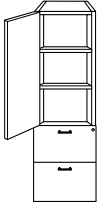

Shown as Left

Description

- Touch Latch Door
- Locking File Drawers Provide Legal or Letter Filing
- If Applicable, Drawer/Door Front Grain Direction Vertical Standard; Optional Horizontal Grain Direction
- Additional Options: Dove Tail Drawer Construction and Soft Close Drawers ([See Drawer Options](#)), Locking Door ([See Locking Options](#))

Must Specify (in this order):

Model #
 Finish
 Drawer Front/Door Grain Direction
 (if applicable)
 Locking Doors
 Drawer
 Construction
 Track
 Pull

OPEN STORAGE CABINET FILE/FILE	65-1884WFO	18	24	82 $\frac{1}{2}$ "	166	25.7	W\$ 3866
	Three Adjustable Shelves						
	65-1872WFO	18	24	70 $\frac{1}{2}$ "	145	22.0	W\$ 3701
	Two Adjustable Shelves						

**Description**

- Locking File Drawers Provide Legal or Letter Filing
- If Applicable, Drawer/Door Front Grain Direction Vertical Standard; Optional Horizontal Grain Direction
- Additional Options: Dove Tail Drawer Construction and Soft Close Drawers ([See Drawer Options](#))

Must Specify (in this order):

Model #
 Finish
 Drawer Front Grain Direction
 Drawer
 Construction
 Track
 Pull

Pricing Codes:

W= Wood Top
 P= HPL Top

[See Gesso Intro Section for Ordering Options](#)

Item	Model No.	Width	Depth	Height	Ship Wt	Cubic Ft	List Price	
STORAGE CABINET BOX/BOX/FILE	Hinged Left	Hinged Right						
	65-1884WBL	65-1884WBR	18	24	82 $\frac{7}{8}$	166	25.7	W\$ 4201
	Three Adjustable Shelves Behind Door							
	65-1872WBL	65-1872WBR	18	24	70 $\frac{7}{8}$	145	22.0	W\$ 4025
	Two Adjustable Shelves Behind Door							

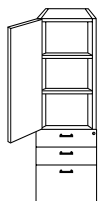

Shown as Left

Description

- Touch Latch Door
- Locking File Drawers Provide Legal or Letter Filing
- If Applicable, Drawer/Door Front Grain Direction Vertical Standard; Optional Horizontal Grain Direction
- Additional Options: Dove Tail Drawer Construction and Soft Close Drawers ([See Drawer Options](#)), Locking Door ([See Locking Options](#))

Must Specify (in this order):

- Model #
- Finish
- Door/Drawer Grain Direction (if applicable)
- Locking Door
- Drawer
- Construction
- Track
- Pull

OPEN STORAGE CABINET BOX/BOX/FILE	65-1884WBO	18	24	82 $\frac{7}{8}$	166	25.7	W\$ 3866
	Three Adjustable Shelves						
	65-1872WBO	18	24	70 $\frac{7}{8}$	145	22.0	W\$ 3701
	Two Adjustable Shelves						



Description

- Locking File Drawers Provide Legal or Letter Filing
- If Applicable, Drawer/Door Front Grain Direction Vertical Standard; Optional Horizontal Grain Direction
- Additional Options: Dove Tail Drawer Construction and Soft Close Drawers ([See Drawer Options](#))

Must Specify (in this order):

- Model #
- Finish
- Drawer Front Grain Direction
- Drawer
- Construction
- Track
- Pull

Pricing Codes:
W= Wood Top
P= HPL Top

[See Gesso Intro Section for Ordering Options](#)

Item	Model No.	Width	Depth	Height	Ship Wt	Cubic Ft	List Price
NARROW TOWER	Hinged Left	Hinged Right					
	65-1251WD1L	65-1251WD1R	12	24	51½	85	11.2

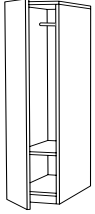

Shown as Left

Description

- 10" Coat Rod; One Adjustable Shelf
- Touch Latch Door
- Safely Write on Dry Erase Doors with Our Dry Erase Marker Set; [See Sets](#)
- If Applicable, Door Front Grain Direction Vertical Standard; Optional Horizontal Grain Direction
- Additional Options: Locking Door ([See Locking Options](#))

Must Specify (in this order):

- Model #
- Finish
- Door Style/Color
- Door Grain Direction (if applicable)
- Locking Doors

Options: Specify & Add

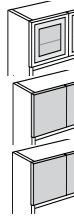

1-AD	Aluminum Framed Satin Frosted Tempered Glass Door (Non-Locking)	\$ 678
1-DEB	Dry Erase Board Door	\$ 60
1-HGA	High Gloss Acrylic Door; Must Specify Color	
	(GPA) Graphite Acrylic	\$ 614
	(BLA) Black, Wired Mercury (WMA), or White (WHA) Acrylic	\$ 560

WARDROBE/STORAGE CABINET	Hinged Left	Hinged Right	Width	Depth	Height	Ship Wt	Cubic Ft	List Price
	65-1884WL	65-1884WR	18	24	82⅞	162	25.7	W\$ 3804
	Four Adjustable Shelves Behind Door							
	65-1872WL	65-1872WR	18	24	70⅞	153	19.2	W\$ 3645
	Three Adjustable Shelves Behind Door							

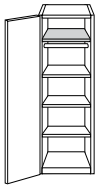

Must Specify (in this order):

- Model #
- Finish
- Door Style/Color
- Locking Doors

Description

- Coat Rod Under Top Fixed Shelf
- Adjustable Shelves can be Removed for Wardrobe Application
- Touch Latch Door
- Safely Write on Dry Erase Doors with Our Dry Erase Marker Set; [See Sets](#)
- Additional Options: Locking Door ([See Locking Options](#))

Options: Specify & Add

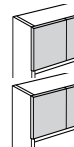

1-DEB	Dry Erase Board Door	\$ 129
1-HGA	High Gloss Acrylic Door; Must Specify Color	
	(GPA) Graphite Acrylic	\$ 1275
	(BLA) Black, Wired Mercury (WMA), or White (WHA) Acrylic	\$ 1162

Pricing Codes:

- W= Wood Top
- P= HPL Top

[See Gesso Intro Section for Ordering Options](#)

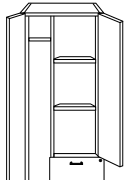
Item	Model No.	Width	Depth	Height	Ship Wt	Cubic Ft	List Price	
TOWER WARDROBE FILE/FILE 	Wardrobe Left	Wardrobe Right						
	65-2484WD2L	65-2484WD2R	24	24	82 $\frac{1}{2}$	252	22.7	W\$ 5720
	Three Adjustable Shelves Behind Door							
	65-2472WD2L	65-2472WD2R	24	24	70 $\frac{1}{2}$	242	20.7	W\$ 5316
Two Adjustable Shelves Behind Door								
	65-2451WD2L	65-2451WD2R	24	24	51 $\frac{1}{2}$	172	20.7	W\$ 4716
One Adjustable Shelf Behind Door								

Shown as Left

Must Specify (in this order):

- Model #
- Finish
- Drawer Construction Track
- Locking Doors Pull

Description

- Wardrobe Door Features Coat Rod and Knob Pull; Knob Color will Coordinate with Drawer Pull
- If Black or Gold Pull is Selected, Knob will be Black; If Chrome or Aluminum Pull is Selected, Knob will be Aluminum
- Cabinet Door Features Touch Latch Door
- Locking File Drawers Provides Legal or Letter Filing
- Additional Options: Dove Tail Drawer Construction and Soft Close Drawers ([See Drawer Options](#)), Locking Doors ([See Locking Options](#))

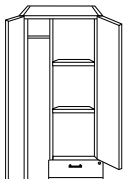
Item	Model No.	Width	Depth	Height	Ship Wt	Cubic Ft	List Price	
TOWER WARDROBE BOX/BOX/FILE 	Wardrobe Left	Wardrobe Right						
	65-2484WD1L	65-2484WD1R	24	24	82 $\frac{1}{2}$	252	22.7	W\$ 5720
	Three Adjustable Shelves Behind Door							
	65-2472WD1L	65-2472WD1R	24	24	70 $\frac{1}{2}$	242	20.7	W\$ 5316
Two Adjustable Shelves Behind Door								
	65-2451WD1L	65-2451WD1R	24	24	51 $\frac{1}{2}$	172	20.7	W\$ 4716
One Adjustable Shelf Behind Door								

Shown as Left

Must Specify (in this order):

- Model #
- Finish
- Drawer Construction Track
- Locking Doors Pull

Description

- Wardrobe Door Features Coat Rod and Knob Pull; Knob Color will Coordinate with Drawer Pull
- If Black or Gold Pull is Selected, Knob will be Black; If Chrome or Aluminum Pull is Selected, Knob will be Aluminum
- Cabinet Door Features Touch Latch Door
- Locking File Drawer Provides Legal or Letter Filing
- Additional Options: Dove Tail Drawer Construction and Soft Close Drawers ([See Drawer Options](#)), Locking Doors ([See Locking Options](#))

Pricing Codes:
W= Wood Top
P= HPL Top

[See Gesso Intro Section for Ordering Options](#)

Item	Model No.	Width	Depth	Height	Ship Wt	Cubic Ft	List Price
TALL WARDROBE/STORAGE CABINET	Wardrobe Left	Wardrobe Right					
	65-3684WDS2L	65-3684WDS2R	36	24	82 $\frac{7}{8}$	368	49.2

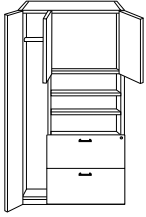

Shown as Left

Must Specify (in this order):

- Model #
- Finish
- Drawer Construction
- Locking Doors
- Pull

Description

- Veneer Wardrobe Door Features Coat Rod and Knob Pull; Knob Color will Coordinate with Drawer Pull
- If Black or Gold Pull is Selected, Knob will be Black; If Chrome or Aluminum Pull is Selected, Knob will be Aluminum
- Hutch Doors Standard with Touch Latch; See Door Options Below
- Safely Write on Dry Erase Doors with Our Dry Erase Marker Set; [See Sets](#)
- Two Adjustable Shelves
- Locking Lateral Drawers Provides Legal or Letter Filing
- Additional Options: Dove Tail Drawer Construction ([See Drawer Options](#)), Locking Doors ([See Locking Options](#))

Hutch Door Options: Specify & Add

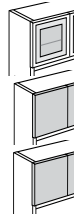

1-AD	Aluminum Framed Satin Frosted Tempered Glass Doors (Non-Locking)	\$ 1243
1-DEB	Dry Erase Board Doors	\$ 121
1-HGA	High Gloss Acrylic Doors; Must Specify Color (Non-Locking)	
	(GPA) Graphite Acrylic	\$ 1200
	(BLA) Black, (WMA), Wired Mercury or (WHA) White Acrylic	\$ 1095

WARDROBE/STORAGE CABINET	Wardrobe Left	Wardrobe Right	Width	Depth	Height	Ship Wt	Cubic Ft	List Price
	65-3672WDS2L	65-3672WDS2R	36	24	70 $\frac{7}{8}$	368	42.0	W\$ 5974

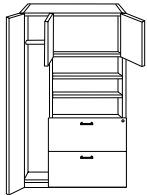

Shown as Left

Must Specify (in this order):

- Model #
- Finish
- Drawer Construction
- Locking Doors
- Pull

Description

- Veneer Wardrobe Door Features Coat Rod and Knob Pull; Knob Color will Coordinate with Drawer Pull
- If Black or Gold Pull is Selected, Knob will be Black; If Chrome or Aluminum Pull is Selected, Knob will be Aluminum
- Hutch Doors Standard with Touch Latch; See Door Options Below
- Safely Write on Dry Erase Doors with Our Dry Erase Marker Set; [See Sets](#)
- Two Adjustable Shelves
- Locking Lateral Drawers Provides Legal or Letter Filing
- Additional Options: Dove Tail Drawer Construction ([See Drawer Options](#)), Locking Doors ([See Locking Options](#))

Hutch Door Options: Specify & Add

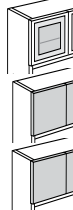

1-AD	Aluminum Framed Satin Frosted Tempered Glass Doors (Non-Locking)	\$ 877
1-DEB	Dry Erase Board Doors	\$ 54
1-HGA	High Gloss Acrylic Doors; Must Specify Color (Non-Locking)	
	(GPA) Graphite Acrylic	\$ 535
	(BLA) Black, (WMA), Wired Mercury or (WHA) White Acrylic	\$ 487

Pricing Codes:

- W= Wood Top
- P= HPL Top

[See Gesso Intro Section for Ordering Options](#)

Item	Model No.	Width	Depth	Height	Ship Wt	Cubic Ft	List Price
STORAGE CABINET WITH LATERAL FILES 	65-3684SU2 Three Adjustable Shelves	36	24	82 $\frac{7}{8}$	318	49.2	W\$ 6480
	65-3084SU2 Three Adjustable Shelves	30	24	82 $\frac{7}{8}$	271	42.9	W\$ 6329
	65-3672SU2 Two Adjustable Shelves	36	24	70 $\frac{7}{8}$	298	42.0	W\$ 6132
	65-3072SU2 Two Adjustable Shelves	30	24	70 $\frac{7}{8}$	251	35.7	W\$ 5990

Description

- Top - Two (2) Doors with Adjustable Shelves
- Bottom - File/File Locking Drawers Provide Legal or Letter Filing
- Touch Latch Doors
- Additional Options: Dove Tail Drawer Construction ([See Drawer Options](#)), Locking Doors ([See Locking Options](#))

Must Specify (in this order):

- Model #
- Finish
- Drawer Construction
- Locking Doors

WARDROBE/STORAGE CABINET 	65-3672WC	36	24	70 $\frac{7}{8}$	320	42.0	W\$ 5050
	65-3072WC	30	24	70 $\frac{7}{8}$	240	35.7	W\$ 4916

Description

- Left Side: One (1) Fixed Shelf at Top and Three (3) Adjustable Shelves below
- Right Side: One (1) Fixed Shelf at Top and Coat Rod below
- Touch Latch Door
- Safely Write on Dry Erase Doors with Our Dry Erase Marker Set; [See Sets](#)
- Additional Options: Locking Doors ([See Locking Options](#))

Must Specify (in this order):

- Model #
- Finish
- Door Style/Color
- Locking Doors

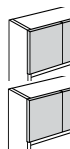

Options: Specify & Add

1-DEB	Dry Erase Board Doors	\$ 257
1-HGA	High Gloss Acrylic Doors; Must Specify Color	
	(GPA) Graphite Acrylic	\$ 2551
	(BLA) Black, (WMA), Wired Mercury or (WHA) White Acrylic	\$ 2329

Pricing Codes:

- W= Wood Top
- P= HPL Top

[See Gesso Intro Section for Ordering Options](#)

Item	Model No.	Width	Depth	Height	Ship Wt	Cubic Ft	List Price
TALL WARDROBE/STORAGE CABINET	65-3684WC	36	24	82 $\frac{7}{8}$	340	49.2	W\$ 5277
	65-3084WC	30	24	82 $\frac{7}{8}$	320	41.4	W\$ 5134

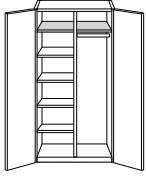



Must Specify (in this order):

- Model #
- Finish
- Door Style/Color
- Locking Doors

Description

- Left Side: One (1) Fixed Shelf at Top and Four (4) Adjustable Shelves below
- Right Side: One (1) Fixed Shelf at Top and Coat Rod below
- Touch Latch Doors
- Safely Write on Dry Erase Doors with Our Dry Erase Marker Set; [See Sets](#)
- Additional Options: Locking Doors ([See Locking Options](#))

Options: Specify & Add

	1-DEB	Dry Erase Board Doors	\$ 257
	1-HGA	High Gloss Acrylic Doors; Must Specify Color	
		(GPA) Graphite Acrylic	\$ 2551
		(BLA) Black, (WMA), Wired Mercury or (WHA) White Acrylic	\$ 2329

END BOOKCASE

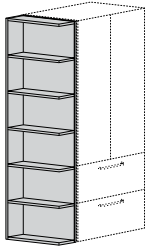

Shown as Left

Mounts Left	Mounts Right	Width	Depth	Height	Ship Wt	Cubic Ft	List Price
65-0984BEL	65-0984BER	9	23 $\frac{1}{2}$	82 $\frac{7}{8}$	90	13.6	W\$ 2626
Five Fixed 8" Shelves							
65-0972BEL	65-0972BER	9	23 $\frac{1}{2}$	70 $\frac{7}{8}$	75	11.7	W\$ 2318
Four Fixed 8" Shelves							

Description

- Top Shelf Clearance 15"
- Remaining Shelves 12 $\frac{1}{2}$ " Clearance Between Shelves
- Not for Freestanding, Must Mount to Other Storage Component

Must Specify (in this order):

- Model #
- Finish

Pricing Codes:

- W= Wood Top
- P= HPL Top

[See Gesso Intro Section for Ordering Options](#)

Item	Model No.	Width	Depth	Height	Ship Wt	Cubic Ft	List Price
	65-3684BC Four Adjustable Shelves - One Fixed Shelf	36	14¼	82⅞	200	30.3	W\$ 3747
	65-3672BC Three Adjustable Shelves - One Fixed Shelf	36	14¼	70⅞	176	26.9	W\$ 3227
	65-3660BC Three Adjustable Shelves	36	14¼	58⅞	147	23.2	W\$ 2783
	65-3648BC Two Adjustable Shelves	36	14¼	46⅞	120	18.7	W\$ 2568
	65-3630BC One Adjustable Shelf - Top Front Edge Profiled	36	14¼	30	75	11.9	W/P\$ 1950
	65-3084BC Four Adjustable Shelves - One Fixed Shelf	30	14¼	82⅞	175	25.5	W\$ 3070
	65-3072BC Three Adjustable Shelves - One Fixed Shelf	30	14¼	70⅞	146	23.3	W\$ 2642
	65-3060BC Three Adjustable Shelves	30	14¼	58⅞	122	19.5	W\$ 2320
	65-3048BC Two Adjustable Shelves	30	14¼	46⅞	100	15.7	W\$ 1999
	65-3030BC One Adjustable Shelf - Top Front Edge Profiled	30	14¼	30	62	10.1	W/P\$ 1639

Must Specify (in this order):

Model #
Material
Finish/Color
Edge

Description

- 1" Thick Shelf

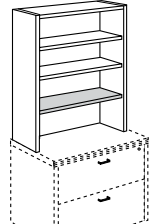
Item	Model No.	Width	Depth	Height	Ship Wt	Cubic Ft	List Price
	65-1536TTU Two Adjustable and One Fixed Shelf	36	14¼	52⅞	169	22.2	W\$ 2248
	65-1530TTU Two Adjustable and One Fixed Shelf	30	14¼	52⅞	141	17.3	W\$ 2048
	65-1536TU One Adjustable and One Fixed Shelf	36	14¼	40⅞	127	16.4	W\$ 1780
	65-1530TU One Adjustable and One Fixed Shelf	30	14¼	40⅞	98	15.9	W\$ 1639

Description

- For Use on Two Drawer Lateral Files
- 1" Thick Shelves

Must Specify (in this order):

Model #
Finish

Pricing Codes:
W= Wood Top
P= HPL Top

[See Gesso Intro Section for Ordering Options](#)

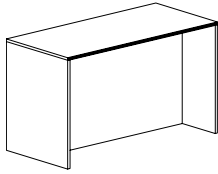
Item	Model No.	Width	Depth	Height	Ship Wt	Cubic Ft	List Price
WORK TABLES STANDING HEIGHT	65-4896TWT	96	48	42	402	14.2	W/P\$ 4256
	WMC_G4896TWT						Wire Management Upcharge \$ 836
	65-4884TWT	84	48	42	368	12.4	W/P\$ 3976
	WMC_G4884TWT						Wire Management Upcharge \$ 757
	65-4872TWT	72	48	42	332	10.7	W/P\$ 3695
	WMC_G4872TWT						Wire Management Upcharge \$ 672
	65-4860TWT	60	48	42	300	9.0	W/P\$ 3414
	WMC_G4860TWT						Wire Management Upcharge \$ 591
	65-4296TWT	96	42	42	374	12.5	W/P\$ 3841
	WMC_G4896TWT						Wire Management Upcharge \$ 836
	65-4284TWT	84	42	42	342	10.9	W/P\$ 3602
	WMC_G4884TWT						Wire Management Upcharge \$ 757
	65-4272TWT	72	42	42	308	9.4	W/P\$ 3363
	WMC_G4872TWT						Wire Management Upcharge \$ 672
	65-4260TWT	60	42	42	278	7.9	W/P\$ 3125
	WMC_G4860TWT						Wire Management Upcharge \$ 591
	65-3696TWT	96	36	42	346	10.8	W/P\$ 3624
	WMC_G4896TWT						Wire Management Upcharge \$ 836
	65-3684TWT	84	36	42	315	9.5	W/P\$ 3405
	WMC_G4884TWT						Wire Management Upcharge \$ 757
	65-3672TWT	72	36	42	283	8.1	W/P\$ 3184
	WMC_G4872TWT						Wire Management Upcharge \$ 672
	65-3660TWT	60	36	42	255	6.8	W/P\$ 2962
	WMC_G4860TWT						Wire Management Upcharge \$ 591
	65-2496TWT	96	24	42	211	64.9	W/P\$ 3244
	Modesty Recessed 5¼"						
	65-2484TWT	84	24	42	193	57.0	W/P\$ 3053
	Modesty Recessed 5¼"						
	65-2472TWT	72	24	42	176	49.0	W/P\$ 2864
	Modesty Recessed 5¼"						
	65-2460TWT	60	24	42	158	41.1	W/P\$ 2673
	Modesty Recessed 5¼"						

Must Specify (in this order):

- Model #
- Top Material
- Finish/Color
- Edge Profile
- Chassis Finish
- Modesty Finish/Color
- Grommet Location
- Wire Management
- Grommet Style/Color
- Power/Data Options

Description

- Available with Veneer (W) or HPL (P) Top; Must Specify
- Centered Modesty Available in Contrasting Colors
- Double Modesty/Wire Management Upcharge Included when Grommet, Dock 950, Dock 150 or other Power Units are Ordered
- Add a Purse Hook to Hold Personal Items; [See Hook Details](#)
- Duo/Trio and Power Data Port Units ([01-DPORT4A/B](#)); [See PDC Locations](#)
- 24"D Units Ship Assembled; Other Sizes Require Some Assembly
- 24"D Units Are Meant to be Used Against a Wall; Modesty Panel is Recessed 5¼"
- Additional Options: Power and Grommet Options ([See Options and Locations](#))

Pricing Codes:

W= Wood Top
P= HPL Top

[See Gesso Intro Section for Ordering Options](#)

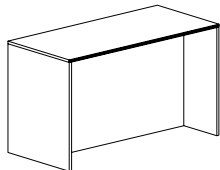
Item	Model No.	Width	Depth	Height	Ship Wt	Cubic Ft	List Price
WORK TABLES COUNTER HEIGHT	65-4896CWT	96	48	36	326	14.2	W/P\$ 4063
	WMC_G4896CWT					Wire Management Upcharge	\$ 773
	65-4884CWT	84	48	36	298	12.4	W/P\$ 3797
	WMC_G4884CWT					Wire Management Upcharge	\$ 698
	65-4872CWT	72	48	36	268	10.7	W/P\$ 3526
	WMC_G4872CWT					Wire Management Upcharge	\$ 620
	65-4860CWT	60	48	36	242	9.0	W/P\$ 3259
	WMC_G4860CWT					Wire Management Upcharge	\$ 545
	65-4296CWT	96	42	36	338	12.5	W/P\$ 3664
	WMC_G4896CWT					Wire Management Upcharge	\$ 773
	65-4284CWT	84	42	36	309	10.9	W/P\$ 3438
	WMC_G4884CWT					Wire Management Upcharge	\$ 698
	65-4272CWT	72	42	36	278	9.4	W/P\$ 3207
	WMC_G4872CWT					Wire Management Upcharge	\$ 620
	65-4260CWT	60	42	36	251	7.9	W/P\$ 2980
	WMC_G4860CWT					Wire Management Upcharge	\$ 545
	65-3696CWT	96	36	36	312	10.8	W/P\$ 3431
	WMC_G4896CWT					Wire Management Upcharge	\$ 773
	65-3684CWT	84	36	36	285	9.5	W/P\$ 3222
	WMC_G4884CWT					Wire Management Upcharge	\$ 698
	65-3672CWT	72	36	36	256	8.1	W/P\$ 3014
	WMC_G4872CWT					Wire Management Upcharge	\$ 620
	65-3660CWT	60	36	36	231	6.8	W/P\$ 2805
	WMC_G4860CWT					Wire Management Upcharge	\$ 545
	65-2496CWT	96	24	36	192	56.0	W/P\$ 2970
	Modesty Recessed 5¼"						
	65-2484CWT	84	24	36	176	49.2	W/P\$ 2797
	Modesty Recessed 5¼"						
	65-2472CWT	72	24	36	160	42.3	W/P\$ 2622
	Modesty Recessed 5¼"						
	65-2460CWT	60	24	36	143	35.5	W/P\$ 2448
	Modesty Recessed 5¼"						

Must Specify (in this order):

- Model #
- Top Material
- Finish/Color
- Edge Profile
- Chassis Finish
- Modesty Finish/Color
- Grommet Location
- Wire Management
- Grommet Style/Color
- Power/Data Options

Description

- Available with Veneer (W) or HPL (P) Top; Must Specify
- Centered Modesty Available in Contrasting Colors
- Double Modesty/Wire Management Upcharge Included when Grommet, Dock 950, Dock 150 or other Power Units are Ordered
- Add a Purse Hook to Hold Personal Items; [See Hook Details](#)
- Duo/Trio and Power Data Port Units ([01-DPORT4A/B](#)); [See PDC Locations](#)
- 24"D Units Ship Assembled; Other Sizes Require Some Assembly
- 24"D Units Are Meant to be Used Against a Wall; Modesty Panel is Recessed 5¼"
- Additional Options: Power and Grommet Options ([See Options and Locations](#))

Pricing Codes:
W= Wood Top
P= HPL Top

[See Gesso Intro Section for Ordering Options](#)

Item	Model No.	Width	Depth	Height	Ship Wt	Cubic Ft	List Price
WORK TABLES SEATED HEIGHT	65-4896WT	96	48	30	326	14.2	W/P\$ 3926
	WMC_G4896WT					Wire Management Upcharge	\$ 698
	65-4884WT	84	48	30	298	12.4	W/P\$ 3667
	WMC_G4884WT					Wire Management Upcharge	\$ 633
	65-4872WT	72	48	30	268	10.7	W/P\$ 3409
	WMC_G4872WT					Wire Management Upcharge	\$ 563
	65-4860WT	60	48	30	242	9.0	W/P\$ 3150
	WMC_G4860WT					Wire Management Upcharge	\$ 496
	65-4296WT	96	42	30	374	12.5	W/P\$ 3480
	WMC_G4896WT					Wire Management Upcharge	\$ 698
	65-4284WT	84	42	30	342	10.9	W/P\$ 3265
	WMC_G4884WT					Wire Management Upcharge	\$ 633
	65-4272WT	72	42	30	308	9.4	W/P\$ 3045
	WMC_G4872WT					Wire Management Upcharge	\$ 563
	65-4260WT	60	42	30	278	7.9	W/P\$ 2831
	WMC_G4860WT					Wire Management Upcharge	\$ 496
65-2496WT	96	24	30	173	47.2	W/P\$ 2738	
Modesty Recessed 5¼"							
65-2484WT	84	24	30	158	41.4	W/P\$ 2583	
Modesty Recessed 5¼"							
65-2472WT	72	24	30	143	35.6	W/P\$ 2419	
Modesty Recessed 5¼"							
65-2460WT	60	24	30	129	29.8	W/P\$ 2260	
Modesty Recessed 5¼"							

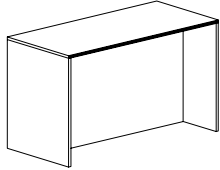

Must Specify (in this order):

- Model #
- Top Material
- Finish/Color
- Edge Profile
- Chassis Finish
- Modesty Finish/Color
- Grommet Location
- Wire Management
- Grommet Style/Color
- Power/Data Options

Description

- Available with Veneer (W) or HPL (P) Top; Must Specify
- Centered Modesty Available in Contrasting Colors
- Double Modesty/Wire Management Upcharge Included when Grommet, Dock 950, Dock 150 or other Power Units are Ordered
- Add a Purse Hook to Hold Personal Items; [See Hook Details](#)
- Duo/Trio and Power Data Port Units ([01-DPORT4A/B](#)); [See PDC Locations](#)
- 24"D Units Ship Assembled; Other Sizes Require Some Assembly
- 24"D Units Are Meant to be Used Against a Wall; Modesty Panel is Recessed 5¼"
- Additional Options: Power and Grommet Options ([See Options and Locations](#))

COMPUTER WORK TABLE	65-2442CW	42	24	27	115	19.2	W/P\$ 2071
	65-2436CW	36	24	27	99	16.6	W/P\$ 2030

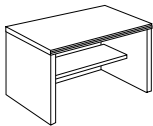

Must Specify (in this order):

- Model #
- Top Material
- Finish/Color
- Edge Profile
- Grommet Color
- Casters

Description

- Available with Veneer (W) or HPL (P) Top; Must Specify
- Fixed Shelf
- Grommet Standard; Must Specify: Black (BLK), Silver (SLV)

Options: Specify & Add

CS-66BL	Optional Black Casters (Increases Height to 29")	\$ 239
---------	--	--------



Braking Casters on User Side/Non-Braking Casters on Approach

Pricing Codes:

- W= Wood Top
- P= HPL Top

[See Gesso Intro Section for Ordering Options](#)

Item	Model No.	Width	Depth	Height	Ship Wt	Cubic Ft	List Price
MAGAZINE TABLE	65-2442MT	42	24	16	70	11.9	W/P\$ 1718

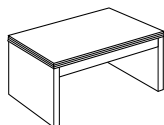

Description

- Available with Veneer (W) or HPL (P) Top; Must Specify
- Apron Rails and Panel Legs Feature Multi-Step, Hand-Finished Catalyzed Finish

Must Specify (in this order):

- Model #
- Top Material
- Finish/Color
- Edge Profile

END TABLE	65-2424ET	24	24	22	65	9.4	W/P\$ 1632
-----------	-----------	----	----	----	----	-----	------------

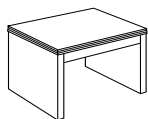

Description

- Available with Veneer (W) or HPL (P) Top; Must Specify
- Apron Rails and Panel Legs Feature Multi-Step, Hand-Finished Catalyzed Finish

Must Specify (in this order):

- Model #
- Top Material
- Finish/Color
- Edge Profile

Item	Model No.	Width	Depth	Height	Ship Wt	Cubic Ft	List Price
ROUND TOP	65-4848CT	48	48	1	95	4.3	W/P\$ 1295
	<i>Accommodates Five (5) Chairs</i>						
	65-4242CT	42	42	1	70	3.4	W/P\$ 1251
<i>Accommodates Four (4) Chairs</i>							
	65-3636CT	36	36	1	37	2.5	W/P\$ 1100
<i>Accommodates Three (3) Chairs</i>							



Must Specify (in this order):

- Model #
- Top Material
- Finish
- Edge Profile

Description

- Single Base or Four (4) Strut Legs (on 48" Top Only) Required; Ordered Separately, See Next Page
- Power Options not Available

Pricing Codes:

- W= Wood Top
- P= HPL Top

[See Gesso Intro Section for Ordering Options](#)

Item	Model No.		Width	Depth	Height	Ship Wt	Cubic Ft	List Price	
DISC BASE 	For 48" Round Tops								
	01-3230DBB	Black	30	30	27¾	42	4.1	\$ 1842	
	01-3230DBA	Aluminum							
	For 36" and 42" Round Tops								
	01-2430DBB	Black	24	24	27¾	32	3.2	\$ 1535	
	01-2430DBA	Aluminum							
Description									
<ul style="list-style-type: none"> • 4" Diameter 14 Gauge Steel Column with 12"x12" Mounting Plate at Top of Column • ¼" Thick Disc Plate with 5 Levelers • Stiffener Bar Not Included; Must Order Separately (See Stiffener Bars) • Some Assembly Required 									
Table Widths						Round	72"	84"	96"
Number of Bases Required						1	2	2	2

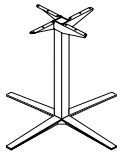
METAL X-BASE

For Use With									
Round Tops: 42" + 48"									
Top Surfaces: 42"x96"									
08-2642LXBB	For 42"H Tables	Black	35½	35½	40	33	20.0	\$ 1322	
08-2642LXBA		Aluminum							
08-2636LXBB	For 36"H Tables	Black	35½	35½	34	30	17.2	\$ 1275	
08-2636LXBA		Aluminum							
08-2630LXBB	For 30"H Tables	Black	35½	35½	28	27	14.5	\$ 1219	
08-2630LXBA		Aluminum							
For Use With									
Round Tops: 30" + 36"									
Top Surfaces: 36"x84", 36"x72"									
08-2042SXBB	For 42"H Tables	Black	29	29	40	27	15.9	\$ 1235	
08-2042SXBA		Aluminum							
08-2036SXBB	For 36"H Tables	Black	29	29	34	24	13.7	\$ 1185	
08-2036SXBA		Aluminum							
08-2030SXBB	For 30"H Tables	Black	29	29	28	21	11.6	\$ 1139	
08-2030SXBA		Aluminum							
Description									
<ul style="list-style-type: none"> • See Number of Bases Required Per Top Width Below • Power Units Available On Center When Using Two or More Metal X-Bases • Not Available to be Sold Separately • Ships Assembled 									
Table Widths						Round	72"	84"	96"
Number of Bases Required						1	2	2	2

Pricing Codes:

W= Wood Top

P= HPL Top

[See Gesso Intro Section for Ordering Options](#)

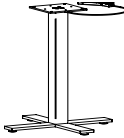
Item	Model No.		Width	Depth	Height	Ship Wt	Cubic Ft	List Price	
HEIGHT ADJUSTABLE PNEUMATIC X-BASE 	Maximum Round 42", Maximum Square 36"								
	01-3232HAXBB	Black	32	32	26	1	0.2	\$ 1721	
	01-3232HAXBA	Aluminum							
	Maximum Round 36", Maximum Square 30"								
	01-2626HAXBB	Black	22	22	26	1	0.2	\$ 1687	
	01-2626HAXBA	Aluminum							

Description

- Pre-Drilled Boring Pattern May Not Match Underside of Table Top
- Steel Mounting Plate: 8"x 8"x ¼"
- Eight (8) Bolts Included for Assembly
- Some Assembly Required; Hardware Included

TUBULAR X-BASE

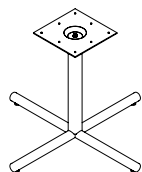

For Use With								
Round Tops: 48"								
Square Tops: 42"								
01-3830TXB	Black	38	38	27¾	40	4.2	\$ 699	
01-3830TXA	Aluminum							
For Use With								
Round Tops: 36", 42"								
Square Tops: 36"								
Top Surfaces: 36"x84", 36"x72"								
01-3230TXB	Black	32	32	27¾	32	3.2	\$ 633	
01-3230TXA	Aluminum							

Description

- 3" Diameter Column
- See Number of Bases Required Per Top Width Below
- Power Units Available On Center When Using Two or More Tubular X-Bases
- Some Assembly Required

Table Widths	Round	72"	84"	96"
Number of Bases Required	1	2	2	2

STRUT TABLE LEGS

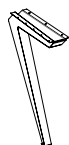

Must Specify (in this order):

Model # and Quantity

Color

Optional Stiffener Bar and Quantity

01-2228STR2	1 Pair (2 Legs)	1½	22½	28¾	32	4.5	\$ 1278
01-2228STR4	2 Pair (4 Legs)	1½	22½	28¾	64	9.0	\$ 2556

Description

- Available in Aluminum (ALUM) or Black (BLK); Must Specify Color
- Built-In Wire Management Cover on Inside of Legs
- Each Leg has Adjustable Glides
- Legs not Available To Be Sold Separately
- For Use with Indiana Furniture 48" Round Tops Only

Options: Specify & Add

01-00048SB	Stiffener Bar						\$ 121
------------	---------------	--	--	--	--	--	--------

See Individual Tops for Recommended Number of Stiffener Bars

Table Widths	48" CT	72"	96"
Number of Bases Required	4	4	4

Pricing Codes:

W= Wood Top

P= HPL Top

[See Gesso Intro Section for Ordering Options](#)

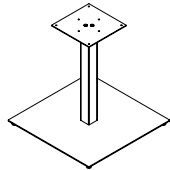
Item	Model No.		Width	Depth	Height	Ship Wt	Cubic Ft	List Price
SQUARE BASE 	For Use With Round Tops: 48" Square Tops: 42"							
	01-2630SBB	Black	26	26	27¾	32	3.2	\$ 1163
	01-2630SBA	Aluminum						
	For Use With Round Tops: 42" Square Tops: 36" Top Surfaces: 36"x84", 36"x72"							
	01-2030SBB	Black	20	20	27¾	32	3.2	\$ 956
	01-2030SBA	Aluminum						
	For Use With Round Tops: 36" Square Tops: 30"							
	01-1630SBB	Black	16	16	27¾	32	3.2	\$ 898
	01-1630SBA	Aluminum						

Description

- 2¾" Diameter Column
- 12"x12" Mounting Plate at Top of Column
- Stiffener Bar Not Included; Must Order Separately (See Stiffener Bars)
- See Number of Bases Required Per Top Width Below
- Power Units Available On Center When Using Two or More Square Bases
- Some Assembly Required

Table Widths	Round	72"	84"	96"
Number of Bases Required	1	2	2	2

CYLINDER BASE

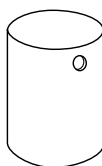

For Tables 42"D to 48"D								
01-2020CB			20	20	28½	136	10.9	W\$ 1553
For Tables 36"D								
01-1616CB			16	16	28½	101	7.2	W\$ 1419

Description

- Veneer Cylinder Base Features Multi-Step, Hand-Finished Catalyzed Finish
- Weighted for Stability
- Two (2) Wire Management Black Grommets Standard at Top Edge; 8" Opening Standard at Bottom
- See Number of Bases Required Per Table Width Below

Additional Grommet Options: Specify & Add

GCBIS	Only One (1) Grommet At Top Edge	\$	N/C
NOGC	No Grommets At Top Edge	\$	N/C

Table Widths	Round	72"	96"
Number of Bases Required	1	2	2

Must Specify (in this order):

- Model # and Quantity
- Finish
- Grommet Options

Pricing Codes:

- W= Wood Top
- P= HPL Top

[See Gesso Intro Section for Ordering Options](#)

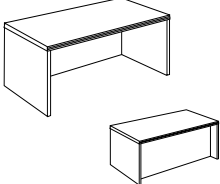
Item	Model No.	Width	Depth	Height	Ship Wt	Cubic Ft	List Price
 Recessed Front	65-3672SH	72	36	30	154	50.0	W/P\$ 3047
	65-3666SH	66	36	30	148	48.0	W/P\$ 2960
	65-3660SH	60	36	30	139	43.7	W/P\$ 2878
	65-3072SH	72	30	30	145	43.8	W/P\$ 2918
	65-3066SH	66	30	30	141	39.0	W/P\$ 2847
	65-3060SH	60	30	30	136	35.3	W/P\$ 2731

Must Specify (in this order):

- Model #
- Top Material
- Finish/Color
- Edge Profile
- Grommet Location
- Grommet Color

Kneespace 58"; No Additional Support Needed

Description

- Available with Veneer (W) or HPL (P) Top; Must Specify
- For Use With or Without Modular Pedestals
- Support Panel Required (See [65-2812SP](#)), Stiffener Bar ([See Sizes](#)) Recommended in Kneespaces 60" or Greater When Unsupported by a Pedestal
- 10" Recessed Front on 36" Deep Units; 4" Recessed Front on 30" Deep Units
- If Using with Pedestal, Surface Grommet Only Available Opposite Pedestal
- [Height Adjustable Units Available](#)
- Additional Options: Power and Grommet Options ([See Options and Locations](#))

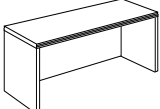
	65-2472SH	72	24	30	125	34.6	W/P\$ 2640
	65-2466SH	66	24	30	118	32.7	W/P\$ 2568
	65-2460SH	60	24	30	111	29.8	W/P\$ 2503

Must Specify (in this order):

- Model #
- Top Material
- Finish/Color
- Edge Profile
- Grommet Location
- Grommet Color

Description

- Available with Veneer (W) or HPL (P) Top; Must Specify
- For Use With or Without Modular Pedestals
- Support Panel Required (See [65-2812SP](#)), Stiffener Bar ([See Sizes](#)) Recommended in Kneespaces 60" or Greater When Unsupported by a Pedestal
- [Height Adjustable Units Available](#)
- If Using with Pedestal, Surface Grommet Only Available Opposite Pedestal
- Modesty Panel Grommet Standard; Must Specify: Black (BLK), Silver (SLV) or No Modesty Panel Grommet (NONE)
- Additional Options: Power and Grommet Options ([See Options and Locations](#))

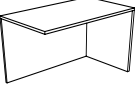
RETURN SHELL	Left Shell	Right Shell	Width	Depth	Height	Ship Wt	Cubic Ft	List Price
	65-2448RSHL	65-2448RSHR	48	24	30	70	24.2	W/P\$ 1780
	65-2442RSHL	65-2442RSHR	42	24	30	60	20.4	W/P\$ 1667

Must Specify (in this order):

- Model #
- Top Material
- Finish/Color
- Edge Profile
- Grommet Location
- Grommet Color

Description

- Available with Veneer (W) or HPL (P) Top; Must Specify
- Optional Surface Grommet; Must Specify Black or Silver
- For Use With or Without Modular Pedestals Modesty Panel Grommet is Standard; Must Specify: Black (BLK), Silver (SLV) or No Modesty Panel Grommet (NONE)
- Additional Options: Power and Grommet Options ([See Options and Locations](#))

Pricing Codes:

W= Wood Top
P= HPL Top

[See Gesso Intro Section for Ordering Options](#)

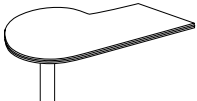
Item	Model No.	Width	Depth	Height	Ship Wt	Cubic Ft	List Price
P-TOP PENINSULA WITH CYLINDER BASE 	Left Top	Right Top					
	65-4284TL	65-4284TR	84	42-36	30	120	13.2 W/P\$ 3628
	65-4272TL	65-4272TR	72	42-36	30	115	11.3 W/P\$ 2975

Description

- Metal Cylinder Base Standard - 4" Diameter; Must Specify: Black or Aluminum
- 48" Stiffener Bar Required on 84" Units if Used as Runoff; [See Stiffener Bars](#)
- Some Assembly Required

Must Specify (in this order):

- Model #
- Top Material
- Top Finish/Color
- Edge Profile
- Leg Color
- Grommet
- Grommet Color

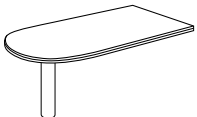
D-TOP PENINSULA WITH CYLINDER BASE 	65-3684DR	84	36	30	134	13.2	W/P\$ 3559
	65-3672DR	72	36	30	115	9.8	W/P\$ 2997
	65-3066DR	66	30	30	120	7.5	W/P\$ 2886

Description

- Metal Cylinder Base Standard - 4" Diameter; Must Specify: Black or Aluminum
- 48" Stiffener Bar Required on 84" Units if Used as Runoff; [See Stiffener Bars](#)
- Some Assembly Required

Must Specify (in this order):

- Model #
- Material
- Top Finish/Color
- Edge Profile
- Leg Color
- Grommet
- Grommet Color

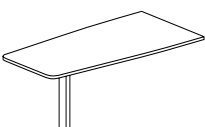
MEDIA PENINSULA WITH RECTANGLE LEG 	65-3672MP	36	72	30	90	52.1	W/P\$ 3841
	65-3066MP	30	66	30	77	40.3	W/P\$ 3543
	65-3060MP	30	60	30	70	36.7	W/P\$ 3387

Description

- Aluminum Rectangular Post Standard
- Standard with Aluminum Rectangle Leg to be Installed 17¾" from Front to Allow for Kneespace Area
- Wire Management Trough Included; 4¼" W x 46¾" L x 3½" H
- Some Assembly Required

Must Specify (in this order):

- Model #
- Material
- Top Finish/Color
- Edge Profile
- Leg Option
- Power Option
- Grommet Color

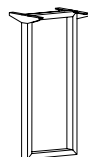

Leg Options: Specify & Add

OLEGA	12" Aluminum Tube Leg	\$ 112
OLEGB	12" Black Tube Leg	\$ 112

Pricing Codes:

W= Wood Top
P= HPL Top

[See Gesso Intro Section for Ordering Options](#)

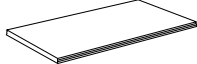
Item	Model No.	Width	Depth	Height	Ship Wt	Cubic Ft	List Price
 <p>MODULAR DESK TOPS</p> <p><u>Must Specify (in this order):</u> Model # Material Finish/Color Edge Profile Grommet Location Grommet Color</p>	65-6072TP For Use as a Desk Top With Benching Units	72	60	1 $\frac{3}{16}$	120	10.6	W/P\$ 1967
	65-6066TP For Use as a Desk Top With Benching Units	66	60	1 $\frac{3}{16}$	110	9.8	W/P\$ 1873
	65-6060TP For Use as a Desk Top With Benching Units	60	60	1 $\frac{3}{16}$	100	9.0	W/P\$ 1791
	65-4872TP For Use as a Desk Top With Benching Units	72	48	1 $\frac{3}{16}$	102	8.6	W/P\$ 1606
	65-4866TP For Use as a Desk Top With Benching Units	66	48	1 $\frac{3}{16}$	94	7.8	W/P\$ 1537
	65-4860TP For Use as a Desk Top With Benching Units	60	48	1 $\frac{3}{16}$	86	7.0	W/P\$ 1466
	65-3684TP	84	36	1 $\frac{3}{16}$	85	6.6	W/P\$ 1351
	65-3678TP	78	36	1 $\frac{3}{16}$	80	6.2	W/P\$ 1319
	65-3672TP	72	36	1 $\frac{3}{16}$	74	5.7	W/P\$ 1281
	65-3666TP	66	36	1 $\frac{3}{16}$	68	5.2	W/P\$ 1228
	65-3660TP	60	36	1 $\frac{3}{16}$	63	4.8	W/P\$ 1170
	65-3654TP	54	36	1 $\frac{3}{16}$	57	4.3	W/P\$ 1075
	65-3648TP	48	36	1 $\frac{3}{16}$	51	3.8	W/P\$ 997
	65-3642TP	42	36	1 $\frac{3}{16}$	45	3.4	W/P\$ 910
	65-3084TP	84	30	1 $\frac{3}{16}$	72	5.6	W/P\$ 1266
	65-3078TP	78	30	1 $\frac{3}{16}$	67	5.2	W/P\$ 1239
	65-3072TP	72	30	1 $\frac{3}{16}$	62	4.8	W/P\$ 1197
	65-3066TP	66	30	1 $\frac{3}{16}$	58	4.4	W/P\$ 1156
	65-3060TP	60	30	1 $\frac{3}{16}$	75	3.8	W/P\$ 1066
	65-3054TP	54	30	1 $\frac{3}{16}$	48	3.6	W/P\$ 1007
65-3048TP	48	30	1 $\frac{3}{16}$	43	3.2	W/P\$ 932	
65-3042TP	42	30	1 $\frac{3}{16}$	38	2.9	W/P\$ 848	

Description

- Left to Right Grain Direction on Top; For Front to Back Grain Direction See Next Page
- Optional Surface Grommet; Must Specify: Black (BLK) or Silver (SLV)
- Profiled on Approach and User Side
- Support Panel Required ([See 65-2812SP](#)), Stiffener Bar ([See Sizes](#)) Recommended in Kneespaces 60" or Greater and With Peninsula Application When Surface is Not Supported by a Pedestal
- For Power and Grommet Options ([See Options and Locations](#))

Pricing Codes:
 W= Wood Top
 P= HPL Top

[See Gesso Intro Section for Ordering Options](#)

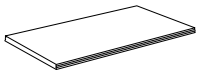
Item	Model No.	Width	Depth	Height	Ship Wt	Cubic Ft	List Price
 <p>MODULAR DESK TOPS</p>	65-6036TP	60	36	1 $\frac{1}{16}$	63	4.8	W/P\$ 1170
	65-5436TP	54	36	1 $\frac{1}{16}$	57	4.3	W/P\$ 1075
	65-4836TP	48	36	1 $\frac{1}{16}$	51	3.8	W/P\$ 997
	65-4236TP	42	36	1 $\frac{1}{16}$	45	3.4	W/P\$ 910
	65-6030TP	60	30	1 $\frac{1}{16}$	75	3.8	W/P\$ 1066
	65-5430TP	54	30	1 $\frac{1}{16}$	48	3.6	W/P\$ 1007
	65-4830TP	48	30	1 $\frac{1}{16}$	43	3.2	W/P\$ 932
	65-4230TP	42	30	1 $\frac{1}{16}$	38	2.9	W/P\$ 848

Must Specify (in this order):

Model #
Material
Finish/ Color
Edge Profile
Grommet Location
Grommet Color

Description

- Front to Back Grain Direction on Top
- Optional Surface Grommet; Must Specify: Black (BLK) or Silver (SLV)
- Profiled on Approach and User Side
- Support Panel Required ([See 65-2812SP](#)), Stiffener Bar ([See Sizes](#)) Recommended in Kneespaces 60" or Greater and With Peninsula Application When Surface is Not Supported by a Pedestal
- For Power and Grommet Options ([See Options and Locations](#))

Pricing Codes:

W= Wood Top
P= HPL Top

[See Gesso Intro Section for Ordering Options](#)

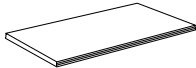
Item	Model No.	Width	Depth	Height	Ship Wt	Cubic Ft	List Price
24"D MODULAR BRIDGE, RETURN AND CREENZA TOPS	65-24108TP	108	24	1 $\frac{3}{16}$	110	5.5	W/P\$ 1295
LEFT TO RIGHT GRAIN DIRECTION	65-24102TP	102	24	1 $\frac{3}{16}$	105	5.2	W/P\$ 1269
	65-2496TP	96	24	1 $\frac{3}{16}$	100	4.9	W/P\$ 1242
	65-2490TP	90	24	1 $\frac{3}{16}$	95	4.6	W/P\$ 1210
	65-2484TP	84	24	1 $\frac{3}{16}$	90	4.3	W/P\$ 1107
	65-2478TP	78	24	1 $\frac{3}{16}$	85	4.0	W/P\$ 1085
	65-2472TP	72	24	1 $\frac{3}{16}$	80	3.7	W/P\$ 1054
	65-2466TP	66	24	1 $\frac{3}{16}$	75	3.4	W/P\$ 1007
	65-2460TP	60	24	1 $\frac{3}{16}$	70	3.0	W/P\$ 963
	65-2454TP	54	24	1 $\frac{3}{16}$	65	2.8	W/P\$ 881
	65-2448TP	48	24	1 $\frac{3}{16}$	44	2.5	W/P\$ 817
	65-2442TP	42	24	1 $\frac{3}{16}$	50	2.2	W/P\$ 743
	65-2436TP	36	24	1 $\frac{3}{16}$	45	2.0	W/P\$ 655
	65-2430TP	30	24	1 $\frac{3}{16}$	36	1.6	W/P\$ 634
	65-2418TP	18	24	1 $\frac{3}{16}$	28	1.0	W/P\$ 583

Must Specify (in this order):

Model #
Material
Finish/Color
Edge Profile
Grommet Location
Grommet Color

Description

- Left to Right Grain Direction on Top; [See Tops with Front-to-Back Grain Direction](#)
- For Use as 24" Bridge, Return and Credenza Modular Tops
- Optional Surface Grommet; Must Specify: Black (BLK) or Silver (SLV)
- Profiled on User Side
- Support Panel Required ([See 65-2812SP](#)), Stiffener Bar ([See Sizes](#)) Recommended in Kneespaces 60" or Greater and With Peninsula Application When Surface is Not Supported by a Pedestal
- For Power and Grommet Options ([See Options and Locations](#))

Pricing Codes:

W= Wood Top
P= HPL Top

[See Gesso Intro Section for Ordering Options](#)

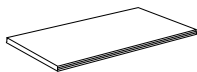
Item	Model No.	Width	Depth	Height	Ship Wt	Cubic Ft	List Price
20"D MODULAR BRIDGE, RETURN AND CREDENZA TOPS	65-20108TP	108	20	1 $\frac{3}{16}$	74	4.9	W/P\$ 1154
LEFT TO RIGHT GRAIN DIRECTION	65-20102TP	102	20	1 $\frac{3}{16}$	70	4.6	W/P\$ 1130
	65-2096TP	96	20	1 $\frac{3}{16}$	65	4.3	W/P\$ 1101
	65-2090TP	90	20	1 $\frac{3}{16}$	61	4.1	W/P\$ 1076
	65-2084TP	84	20	1 $\frac{3}{16}$	57	3.8	W/P\$ 988
	65-2078TP	78	20	1 $\frac{3}{16}$	53	3.6	W/P\$ 964
	65-2072TP	72	20	1 $\frac{3}{16}$	49	3.3	W/P\$ 936
	65-2066TP	66	20	1 $\frac{3}{16}$	45	2.7	W/P\$ 895
	65-2060TP	60	20	1 $\frac{3}{16}$	41	2.7	W/P\$ 851
	65-2054TP	54	20	1 $\frac{3}{16}$	37	2.5	W/P\$ 782
	65-2048TP	48	20	1 $\frac{3}{16}$	33	2.3	W/P\$ 730
	65-2042TP	42	20	1 $\frac{3}{16}$	29	1.9	W/P\$ 661
	65-2036TP	36	20	1 $\frac{3}{16}$	25	1.7	W/P\$ 581
	65-2030TP	30	20	1 $\frac{3}{16}$	21	1.4	W/P\$ 563
	65-2018TP	18	20	1 $\frac{3}{16}$	15	0.9	W/P\$ 522

Must Specify (in this order):

Model #
Material
Finish/Color
Edge Profile
Grommet Location
Grommet Color

Description

- Left to Right Grain Direction on Top; [See Tops with Front-to-Back Grain Direction](#)
- For use as 20" Bridge, Return and Credenza Modular Tops
- Optional Surface Grommet; Must Specify: Black (BLK) or Silver (SLV)
- Profiled on User Side
- Support Panel Required ([See 65-2812SP](#)), Stiffener Bar ([See Sizes](#)) Recommended in Kneespaces 60" or Greater and With Peninsula Application When Surface is Not Supported by a Pedestal
- For Power and Grommet Options ([See Options and Locations](#))

Pricing Codes:

W= Wood Top

P= HPL Top

[See Gesso Intro Section for Ordering Options](#)

Item	Model No.	Width	Depth	Height	Ship Wt	Cubic Ft	List Price
24"D AND 20"D MODULAR BRIDGE, RETURN AND CREDENZA TOPS	65-6024TP	60	24	1 $\frac{3}{16}$	70	3.0	W/P\$ 963
FRONT AND BACK GRAIN DIRECTION	65-5424TP	54	24	1 $\frac{3}{16}$	65	2.8	W/P\$ 881
	65-4824TP	48	24	1 $\frac{3}{16}$	44	2.5	W/P\$ 817
	65-4224TP	42	24	1 $\frac{3}{16}$	50	2.2	W/P\$ 743
	65-3624TP	36	24	1 $\frac{3}{16}$	45	2.0	W/P\$ 655
	65-3024TP	30	24	1 $\frac{3}{16}$	36	1.6	W/P\$ 634
	65-6020TP	60	20	1 $\frac{3}{16}$	41	2.7	W/P\$ 851
	65-5420TP	54	20	1 $\frac{3}{16}$	37	2.5	W/P\$ 782
	65-4820TP	48	20	1 $\frac{3}{16}$	33	2.3	W/P\$ 730
	65-4220TP	42	20	1 $\frac{3}{16}$	29	1.9	W/P\$ 661
	65-3620TP	36	20	1 $\frac{3}{16}$	25	1.7	W/P\$ 581
	65-3020TP	30	20	1 $\frac{3}{16}$	21	1.4	W/P\$ 563

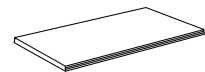

Must Specify (in this order):

Model #
Material
Finish/Color
Edge Profile
Grommet Location
Grommet Color

Description

- Front to Back Grain Direction on Top
- For use as 24" and 20" Bridge, Return and Credenza Modular Tops
- Optional Surface Grommet; Must Specify: Black (BLK) or Silver (SLV)
- Profiled on User Side
- Support Panel Required ([See 65-2812SP](#)), Stiffener Bar ([See Sizes](#)) Recommended in Kneespaces 60" or Greater and With Peninsula Application When Surface is is Not Supported by a Pedestal
- For Power and Grommet Options ([See Options and Locations](#))

Item	Model No.	Width	Depth	Height	Ship Wt	Cubic Ft	List Price
STIFFENER BAR	01-00060SB	60	1 $\frac{3}{4}$	$\frac{3}{4}$	8	0.3	\$ 129
	01-00048SB	48	1 $\frac{3}{4}$	$\frac{3}{4}$	5	0.3	\$ 121

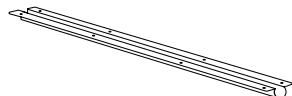

Description

- Reinforces Worksurfaces with Large Kneespace Widths
- Includes End Caps to Cover Sharp Edges
- Recommended in Kneespaces 60" or Greater
- Field Installed

Pricing Codes:

W= Wood Top
P= HPL Top

[See Gesso Intro Section for Ordering Options](#)

Item	Model No.	Width	Depth	Height	Ship Wt	Cubic Ft	List Price
------	-----------	-------	-------	--------	---------	----------	------------

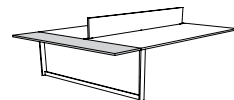

Must Specify (in this order):

Model #
Material
Finish/Color
Edge Profile

EXTENDED DESK TOPS	65-1560DTP	60	15	1	21	1.7	W\$ 686
	65-1548DTP	48	15	1	21	1.7	W\$ 639

Description

- Use as Extension of Top
- Profiled on Three Sides

ABOVE WORKSURFACE OPEN BOOKCASE END

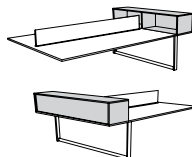

Must Specify (in this order):

Model #
Material
Finish/Color
Edge Profile

65-1560OBEA Two Compartments	60	15	15	75	9.8	W/P\$ 2079
65-1548OBEA Two Compartments	48	15	15	63	7.9	W/P\$ 1852
65-1530OBEA One Compartments	30	15	15	40	4.8	W/P\$ 1509
65-1524OBEA One Compartments	24	15	15	35	4.1	W/P\$ 1396

Description

- Profiled on Two Short Sides Edges
- Attached with 11 Gauge Undermount Brackets
- Only Compatible with the O Modular Peninsula Support Seated Height; [See Supports](#)

BELOW WORKSURFACE OPEN BOOKCASE END

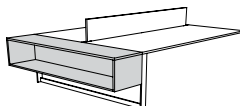

Must Specify (in this order):

Model #
Material
Finish/Color
Edge Profile

65-1560OBEB Two Compartments	60	15	15	75	9.8	W/P\$ 2079
65-1548OBEB Two Compartments	48	15	15	63	7.9	W/P\$ 1852
65-1530OBEB One Compartments	30	15	15	40	4.8	W/P\$ 1509
65-1524OBEB One Compartments	24	15	15	35	4.1	W/P\$ 1396

Description

- Profiled on Three Edges
- Only Compatible with the O Modular Peninsula Support Seated Height; [See Supports](#)

DESK END BOOKCASE

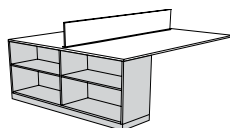

Must Specify (in this order):

Model #
Finish/Color

65-1560OBE	60	15	28¼	115	19.5	W\$ 2444
65-1548OBE	48	15	28¼	95	15.7	W\$ 2191
65-1530OBE	30	15	28¼	60	10.1	W\$ 1805
65-1524OBE	24	15	28¼	55	8.2	W\$ 1677

Description

- Adjustable Shelf
- To Be Used with Modular Benching Desk Top ([See Desk Tops](#)) or Can Be Used as Freestanding Unit with or without Hutch or Bookcase Modular Top ([See Bookcase Tops](#))

Pricing Codes:

W= Wood Top
P= HPL Top

[See Gesso Intro Section for Ordering Options](#)

Item	Model No.	Width	Depth	Height	Ship Wt	Cubic Ft	List Price
MODULAR PEDESTAL BOX/BOX/FILE 	65-3618PD1 Use with 36"D Modular Desk Tops	18	35¼	28¼	125	13.6	W\$ 2561
	65-3018PD1 Use with 30"D Modular Desk Tops	18	29¼	28¼	105	11.6	W\$ 2373
	65-2418PD1 Use with 24"D Modular Cabinet Tops and Shells	18	23¼	28¼	98	8.9	W\$ 2210
	65-2515SHPD1 Use with Desk Shells Only	15¾	25	28¼	96	8.4	W\$ 2022
	65-2415PD1 Use with 24"D Modular Cabinet Tops and Shells	15¾	23¼	28¼	93	7.8	W\$ 2094

Must Specify (in this order):

- Model #
- Finish
- Drawer
- Grain Direction
- Construction
- Track
- Pull
- Wire Management

Description

- Open Back; [See Back Panel Options](#)
- Top is Required; [See Top Sizes](#)
- Letter Width Locking Pedestal
- Drawer Front Grain Direction Vertical Standard; Optional Horizontal Grain Direction
- Additional Options: Dove Tail Drawer Construction and Soft Close Drawers ([See Drawer Options](#)), Power and Grommet Options ([See Option Details](#))

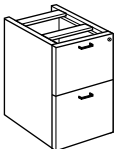
MODULAR PEDESTAL FILE/FILE 	65-3618PD2 Use with 36"D Modular Desk Tops	18	35¼	28¼	125	13.6	W\$ 2561
	65-3018PD2 Use with 30"D Modular Desk Tops	18	29¼	28¼	105	11.6	W\$ 2373
	65-2418PD2 Use with 24"D Modular Cabinet Tops and Shells	18	23¼	28¼	98	8.9	W\$ 2210
	65-2515SHPD2 Use with Desk Shells Only	15¾	25	28¼	96	8.4	W\$ 2022
	65-2415PD2 Use with 24"D Modular Cabinet Tops and Shells	15¾	23¼	28¼	93	7.8	W\$ 2094

Must Specify (in this order):

- Model #
- Finish
- Drawer
- Grain Direction
- Construction
- Track
- Pull
- Wire Management

Description

- Open Back; [See Back Panel Options](#)
- Top is Required; [See Top Sizes](#)
- Letter Width Locking Pedestal
- Drawer Front Grain Direction Vertical Standard; Optional Horizontal Grain Direction
- Additional Options: Dove Tail Drawer Construction and Soft Close Drawers ([See Drawer Options](#)), Power and Grommet Options ([See Option Details](#))

MODULAR PEDESTAL DOOR BOOKCASE	Left Shell	Right Shell	Width	Depth	Height	Ship Wt	Cubic Ft	List Price
	65-2418PD4L	65-2418PD4R						

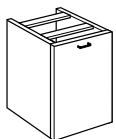

Must Specify (in this order):

- Model #
- Finish
- Door Grain Direction
- Pull
- Wire Management
- Locking Door

Description

- Open Back; [See Back Panel Options](#)
- Top is Required; [See Top Sizes](#)
- Adjustable Shelf
- Door Front Grain Direction Vertical Standard; Optional Horizontal Grain Direction
- Additional Options: Locking Door ([See Locking Options](#)) and Wire Management ([See Option Details](#))

Pricing Codes:
W= Wood Top
P= HPL Top

[See Gesso Intro Section for Ordering Options](#)

Item	Model No.	Width	Depth	Height	Ship Wt	Cubic Ft	List Price
MODULAR PEDESTAL MULTI-FILE	65-2436LF2	36	23¼	28¼	153	18.5	W\$ 3030
	65-2430LF2	30	23¼	28¼	128	14.9	W\$ 2918

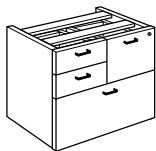

Must Specify (in this order):

Model #
Finish
Drawer
Grain Direction
Construction
Box and File Drawer Track
Pull
Wire Management

Description

- Open Back; [See Back Panel Options](#)
- For Use with 24" Deep Tops; Top is Required; [See 24"/Left-to-Right Grain Direction Tops](#) and [See 24"/Front-to-Back Grain Direction Tops](#)
- Locking File Drawers; File and Lateral Drawer Provides Legal or Letter Filing Front to Back or Side to Side
- Drawer Front Grain Direction Vertical Standard; Optional Horizontal Grain Direction
- Additional Options: Dove Tail Drawer Construction ([See Drawer Construction Options](#)), Soft Close Box and File Drawers ([See Soft Close Options](#)), Power and Grommet Options ([See Option Details](#))

MODULAR PEDESTAL OPEN MULTI-FILE	65-2436OMF	36	23¼	28¼	118	14.9	W\$ 2916
	65-2430OMF	30	23¼	28¼	128	18.5	W\$ 2799

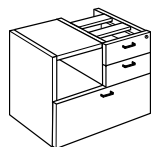

Must Specify (in this order):

Model #
Finish
Drawer
Grain Direction
Construction
Box Drawer Track
Pull
Wire Management

Description

- Open Back; [See Back Panel Options](#)
- For Use with 24" Deep Tops; Top is Required; [See 24"/Left-to-Right Grain Direction Tops](#) and [See 24"/Front-to-Back Grain Direction Tops](#)
- Upper Section Provides Open Storage and Two Locking Box Drawers
- 13½" Open Storage Clearance for 65-2430OMF and 12¾" Open Storage Clearance for 65-2436OMF
- Locking Lateral Drawers Provide Legal or Letter Filing Front to Back or Side to Side
- Drawer Front Grain Direction Vertical Standard; Optional Horizontal Grain Direction
- Additional Options: Dove Tail Drawer Construction ([See Drawer Construction Options](#)), Soft Close Box and File Drawers ([See Soft Close Options](#)), Power and Grommet Options ([See Option Details](#))

MODULAR PEDESTAL DOOR BOOKCASE	65-2436DB	36	23¼	28¼	105	18.5	W\$ 2509
	65-2430DB	30	23¼	28¼	87	14.9	W\$ 1983

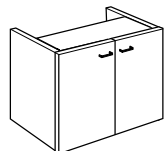

Must Specify (in this order):

Model #
Finish
Drawer Front Grain Direction
Pull
Locking Doors
Wire Management

Description

- Open Back; [See Back Panel Options](#)
- For Use with 24" Deep Tops; Top is Required; [See 24"/Left-to-Right Grain Direction Tops](#) and [See 24"/Front-to-Back Grain Direction Tops](#)
- 12" Deep Adjustable Shelf Behind Doors
- Door Front Grain Direction Vertical Standard; Optional Horizontal Grain Direction
- Additional Options: Locking Door ([See Locking Options](#)) and Wire Management ([See Option Details](#))

Pricing Codes:

W= Wood Top
P= HPL Top

[See Gesso Intro Section for Ordering Options](#)

Item	Model No.	Width	Depth	Height	Ship Wt	Cubic Ft	List Price
MODULAR PEDESTAL DOOR BOOKCASE W/OPEN COMPARTMENT	65-2436ODB	36	23¼	28¼	118	18.5	W\$ 2367
	65-2430ODB	30	23¼	28¼	108	14.9	W\$ 1829

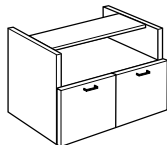

Must Specify (in this order):

Model #
Finish
Door Front Grain Direction
Pull
Locking Doors
Wire Management

Description

- Open Back; [See Back Panel Options](#)
- For Use with 24" Deep Tops; Top is Required; [See 24"/Left-to-Right Grain Direction Tops](#) and [See 24"/Front-to-Back Grain Direction Tops](#)
- Upper Section Provides 12¾" Clearance for Open Storage
- Lower Section Provides Storage Behind Two (2) Doors
- Door Front Grain Direction Vertical Standard; Optional Horizontal Grain Direction
- Additional Options: Locking Door ([See Locking Options](#)) and Wire Management ([See Option Details](#))

MODULAR PEDESTAL OPEN STORAGE	65-2436MBC	36	22½ ₃₂	28¼	118	18.5	W\$ 2045
	65-2430MBC	30	22½ ₃₂	28¼	108	14.9	W\$ 1735

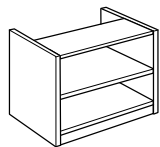

Must Specify (in this order):

Model #
Finish
Wire Management

Description

- Open Back; [See Back Panel Options](#)
- For Use with 24" Deep Tops; Top is Required; [See 24"/Left-to-Right Grain Direction Tops](#) and [See 24"/Front-to-Back Grain Direction Tops](#)
- One Adjustable Shelf
- Optional Wire Management ([See Option Details](#))

MODULAR PEDESTAL LATERAL FILE	65-2436LF1	36	23¼	28¼	154	18.5	W\$ 2640
	65-2430LF1	30	23¼	28¼	128	14.9	W\$ 2456

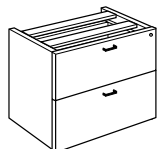

Must Specify (in this order):

Model #
Finish
Drawer
Grain Direction
Construction
Pull
Wire Management

Description

- Open Back; [See Back Panel Options](#)
- For Use with 24" Deep Tops; Top is Required; [See 24"/Left-to-Right Grain Direction Tops](#) and [See 24"/Front-to-Back Grain Direction Tops](#)
- Locking Lateral Drawers Provide Legal or Letter Filing Front to Back or Side to Side
- Drawer Front Grain Direction Vertical Standard; Optional Horizontal Grain Direction
- Additional Options: Dove Tail Drawer Construction ([See Drawer Construction Options](#)), Wire Management ([See Option Details](#))

Pricing Codes:

W= Wood Top
P= HPL Top

[See Gesso Intro Section for Ordering Options](#)

Item	Model No.	Width	Depth	Height	Ship Wt	Cubic Ft	List Price
MODULAR THREE DRAWER LATERAL FILE	65-2436LF3	36	24	42¾	130	24.2	W\$ 4004
	65-2430LF3	30	24	42¾	120	20.4	W\$ 3797

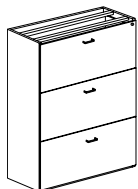

Must Specify (in this order):

Model #
 Finish
 Drawer
 Grain Direction
 Construction
 Pull
 Wire Management

Description

- Finished Back Panel Included
- For Use with 24" Deep Tops; Top is Required; [See 24"/Left-to-Right Grain Direction Tops](#) and [See 24"/Front-to-Back Grain Direction Tops](#)
- Locking Lateral Drawers Provide Legal or Letter Filing Front to Back or Side to Side
- Drawer Front Grain Direction Vertical Standard; Optional Horizontal Grain Direction
- Additional Options: Dove Tail Drawer Construction ([See Drawer Construction Options](#))

21" LOW MODULAR BOX/FILE	65-2436L21BF	36	23¼	20¾	84	13.2	W\$ 2386
	65-2430L21BF	30	23¼	20¾	76	11.1	W\$ 2288
	65-2418L21BF	18	23¼	20¾	42	6.6	W\$ 1942
	65-2036L21BF	36	19¼	20¾	80	11.2	W\$ 2267
	65-2030L21BF	30	19¼	20¾	72	9.4	W\$ 2174
	65-2018L21BF	18	19¼	20¾	40	5.6	W\$ 1842

Must Specify (in this order):

Model #
 Finish
 Drawer
 Grain Direction
 Construction
 Box Drawer Track
 Pull
 Wire Management

Description

- Open Back; [See Back Panel Options](#)
- For Low Height Credenzas or Benching Applications
- Locking Tray/File Drawers; File Provides Legal or Letter Filing
- Drawer Front Grain Direction Vertical Standard; Optional Horizontal Grain Direction
- Additional Options: Dove Tail Drawer Construction ([See Drawer Construction Options](#)), Soft Close Box Drawer ([See Soft Close Options](#)), Power and Grommet Options ([See Option Details](#))

Pricing Codes:

W= Wood Top
 P= HPL Top

[See Gesso Intro Section for Ordering Options](#)

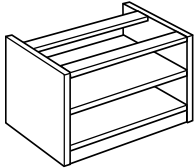
Item	Model No.	Width	Depth	Height	Ship Wt	Cubic Ft	List Price
21" LOW MODULAR OPEN STORAGE 	65-2436L21BC	36	22½	20¾	78	13.2	W\$ 1955
	65-2430L21BC	30	22½	20¾	74	11.1	W\$ 1889
	65-2418L21BC	18	22½	20¾	54	6.9	W\$ 1721
	65-2036L21BC	36	18½	20¾	74	11.2	W\$ 1857
	65-2030L21BC	30	18½	20¾	70	9.4	W\$ 1794
	65-2018L21BC	18	18½	20¾	50	5.9	W\$ 1633

Must Specify (in this order):

Model #
Finish
Wire Management

Description

- Open Back; [See Back Panel Options](#)
- For Low Height Credenzas or Benching Applications
- Removable Wire Management Panel
- One Adjustable Shelf
- Optional Wire Management ([See Option Details](#))

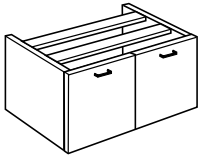
21" LOW MODULAR DOOR BOOKCASE 	65-2436L21DB	36	23¼	20¾	93	13.2	W\$ 2230
	65-2430L21DB	30	23¼	20¾	86	11.1	W\$ 1989
	65-2036L21DB	36	19¼	20¾	89	11.2	W\$ 2123
	65-2030L21DB	30	19¼	20¾	82	9.4	W\$ 1891

Must Specify (in this order):

Model #
Finish
Door Front Grain Direction
Pull
Locking Doors
Wire Management

Description

- Open Back; [See Back Panel Options](#)
- For Low Height Credenzas or Benching Applications
- Removable Wire Management Panel
- One Adjustable Shelf Behind Doors
- Door Front Grain Direction Vertical Standard; Optional Horizontal Grain Direction
- Additional Options: Locking Door ([See Locking Options](#)) and Wire Management ([See Option Details](#))

Pricing Codes:

W= Wood Top
P= HPL Top

[See Gesso Intro Section for Ordering Options](#)

Item	Model No.	Width	Depth	Height	Ship Wt	Cubic Ft	List Price
21" LOW MODULAR SLIDING DOOR BOOKCASE	65-2436L21SD	36	23¼	20¾	93	13.2	W\$ 2551
	65-2430L21SD	30	23¼	20¾	86	11.1	W\$ 2241
	65-2036L21SD	36	19¼	20¾	89	11.2	W\$ 2426
	65-2030L21SD	30	19¼	20¾	82	9.4	W\$ 2129

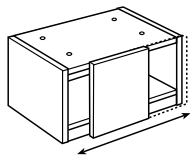

Must Specify (in this order):

Model #
Finish
Door Front Grain Direction
Wire Management

Description

- One Non-Locking Sliding Door
- Open Back; [See Back Panel Options](#)
- For Low Height Credenzas or Benching Applications
- Removable Wire Management Panel
- Storage Behind Sliding Door
- Door Front Grain Direction Vertical Standard; Optional Horizontal Grain Direction
- Optional Wire Management ([See Option Details](#))

MODULAR PENINSULA SUPPORT SEATED HEIGHT	65-3630EP	36	1	28¾	40	2.0	W\$ 706
	65-3030EP	30	1	28¾	34	1.6	W\$ 669
	65-2812SP	12	1	28¾	12	0.8	W\$ 436

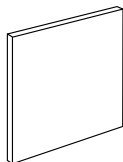

Must Specify (in this order):

Model #
Finish

Description

- To Be Used with Modular Desk Tops at 30" High
- Required to Be Used with T Support or the Support Panel Perpendicular to 36" and 30" Unit

H MODULAR PENINSULA SUPPORT SEATED HEIGHT	01-3628HLV	36	1	28¾	30	2.0	\$ 1145
	Single Mounted Plate						
	01-3028HLV	30	1	28¾	25	1.7	\$ 1126
	Single Mounted Plate						
	01-2428HLV	24	1	28¾	20	1.4	\$ 847
	Single Mounted Plate						
	01-3628TLV	36	1	28¾	30	2.0	\$ 1182
Double Mounted Plate							
01-3028TLV	30	1	28¾	25	1.7	\$ 1163	
Double Mounted Plate							
01-2428TLV	24	1	28¾	20	1.4	\$ 876	
Double Mounted Plate							

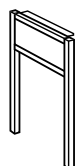

Must Specify (in this order):

Model #
Veneer Insert
Support Finish

Description

- Available in Aluminum (ALUM) or Black (BLK), Must Specify
- Constructed of Tubular Steel
- Metal End Support to Be Used with Modular Desk Tops at 30" High - Not Available to be Sold Separately
- Double Mount Plate Required for Freestanding Table/Desk

Leg Options: Specify & Add

HIW	Veneer Insert	\$ 117
-----	---------------	--------

Pricing Codes:

W= Wood Top
P= HPL Top

[See Gesso Intro Section for Ordering Options](#)

Item	Model No.	Width	Depth	Height	Ship Wt	Cubic Ft	List Price
O MODULAR PENINSULA SUPPORT SEATED HEIGHT 	01-6028OL	60	2	28¼	60	6.0	\$ 917
	01-4828OL	48	2	28¼	55	4.7	\$ 790
	01-3628OL	36	2	28¼	30	2.7	\$ 661
	01-3028OL	30	2	28¼	25	2.3	\$ 552
	01-2428OL	24	2	28¼	20	1.8	\$ 486

Must Specify (in this order):

Model #
Support Color

Description

- Available in Aluminum (ALUM) or Black (BLK), Must Specify
- Constructed of Tubular Steel
- Metal End Support to Be Used with Modular Desk Tops at 30" High - Not Available to be Sold Separately

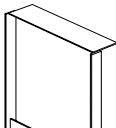
BAR MODULAR PENINSULA SUPPORT SEATED HEIGHT 	01-3628BL	36	2 ½	28¼	30	2.7	ALUM/BLK\$ 715 CHRM\$ 1239
	01-3028BL	30	2 ½	28¼	25	2.3	ALUM/BLK\$ 644 CHRM\$ 1039
	01-2428BL	24	2 ½	28¼	20	1.8	ALUM/BLK\$ 601 CHRM\$ 998

Must Specify (in this order):

Model #
Support Color

Description

- Available in Aluminum (ALUM), Black (BLK) or Chrome (CHRM)
- Constructed of Tubular Steel
- Metal End Support to Be Used with Modular Desk Tops at 30" High - Not Available to be Sold Separately

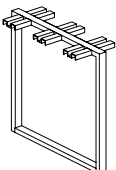
O SHARED METAL LEG SEATED HEIGHT 	01-3028OLS	30	2	28¼	50	3.1	\$ 629
	01-2428OLS	24	2	28¼	45	2.5	\$ 554

Must Specify (in this order):

Model #
Support Color

Description

- Available in Aluminum (ALUM) or Black (BLK), Must Specify
- Constructed of Tubular Steel
- Metal End Support to Be Used with Modular Desk Tops at 30" High - Not Available to be Sold Separately

Pricing Codes:
W= Wood Top
P= HPL Top

[See Gesso Intro Section for Ordering Options](#)

Item	Model No.		Width	Depth	Height	Ship Wt	Cubic Ft	List Price
28"D ELECTRIC HEIGHT ADJUSTABLE TABLE LIFT	01-2854ELB	Black	54-78	28	22-48	30	2.4	\$ 1832
	01-2854ELA	Silver						
22"D ELECTRIC HEIGHT ADJUSTABLE TABLE LIFT	01-2254ELB	Black	54-78	22	22-48	58	2.4	\$ 1832
	01-2254ELA	Silver						
22"D ELECTRIC HEIGHT ADJUSTABLE TABLE LIFT	01-2242ELB	Black	42-48	22	22-48	55	2.4	\$ 1832
	01-2242ELA	Silver						
ELECTRIC HEIGHT ADJUSTABLE ADVANCED SWITCH WITH MEMORY	01-MSWCH		3%	4%	1%	½	0.8	\$ 223

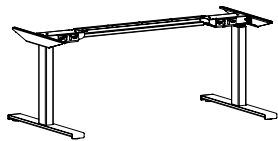
Description

- Standard with Up/Down Control Switch, 10' Power Cord, Integrated Anti-Collision Feature, Leveling Glides
- Standard Up/Down Control Switch can be Mounted for Left or Right Users; Upgrade to Advanced Memory Switch (01-MSWCH with Memory, Reminders, and Bluetooth), Must Specify and See Below for Details
- Adjusts to Accommodate Tops 54-78"W and 30"-36"D; Tops Sold Separately
- Lifting Capacity (Including Worksurface): 363 lbs
- Some Assembly Required; Installation Instructions Included

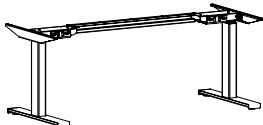
Description

- Standard with Up/Down Control Switch, 10' Power Cord, Anti-Collision Safety Feature, Leveling Glides
- Standard Up/Down Control Switch can be Mounted for Left or Right Users; Upgrade to Advanced Memory Switch (01-MSWCH with Memory, Reminders, and Bluetooth), Must Specify and See Below for Details
- Adjusts to Accommodate Tops 54-78"W and 24"D; Tops Sold Separately
- Lifting Capacity (Including Worksurface): 363 lbs
- Some Assembly Required; Installation Instructions Included

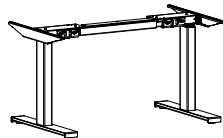
Description

- Standard with Up/Down Control Switch, 10' Power Cord, Anti-Collision Safety Feature, Leveling Glides
- Standard Up/Down Control Switch can be Mounted for Left or Right Users; Upgrade to Advanced Memory Switch (01-MSWCH with Memory, Reminders, and Bluetooth), Must Specify and See Below for Details
- Adjusts to Accommodate Tops 42-48"W and 24"-30"D; Tops Sold Separately
- Lifting Capacity (Including Worksurface): 363 lbs
- Some Assembly Required; Installation Instructions Included

Description

- Black Unit with Black Cord
- Bluetooth Capabilities
- Three Stand-Up Reminders
- Four Height Memory Positions

OPEN MARKET ONLY

Pricing Codes:

W= Wood Top

P= HPL Top

[See Gesso Intro Section for Ordering Options](#)

Item	Model No.	Width	Depth	Height	Ship Wt	Cubic Ft	List Price
LAYER SUPPORT FOR 21" LOW CREDENZA 	01-3607OL	36	2	7	25	1.1	\$ 576
	01-3007OL	30	2	7	20	0.9	\$ 557
	01-2407OL	24	2	7	15	0.7	\$ 523

Description

- Available in Aluminum (ALUM) or Black (BLK), Must Specify
- Supports 30" High Worksurfaces Over Low Height Components - Not Available to be Sold Separately

Must Specify (in this order):

Model #

Support Color

LAYER SUPPORT OVER LOW HEIGHT CABINETS	65-1807USP21	18	5¾	7	20	1.2	W\$ 455
---	--------------	----	----	---	----	-----	---------

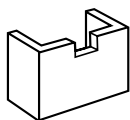
**Description**

- Supports 30" High Worksurfaces Over Low Height Components - Not Available to be Sold Separately
- Open Throughout and On Back Side to Manage Cables
- Rectangle Grommet Cover Included; Must Specify: Black (BLK) or Silver (SLV)

Must Specify (in this order):

Model #

Color

Grommet Color

FILLER PANEL 	65-2803FP	3	¾	28¾	6	0.5	W\$ 350
	For Standard Height Modular Pedestals and Credenzas						
	65-2003FP	3	¾	20¾	4	0.9	W\$ 326
For Low Height Credenzas or Benching Applications							

Description

- Used to Fill Gap Behind Modular Pedestals with a Modular Top

Must Specify (in this order):

Model #

Finish

Pricing Codes:

W= Wood Top

P= HPL Top

[See Gesso Intro Section for Ordering Options](#)

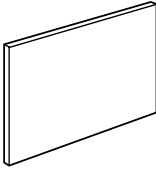
Item	Model No.	Width	Depth	Height	Ship Wt	Cubic Ft	List Price
 <p>MODULAR MODESTY/BACK PANEL</p>	65-10828BP	108	¾	28¼	130	5.7	W\$ 1073
	65-10228BP	102	¾	28¼	122	5.4	W\$ 1024
	65-9628BP	96	¾	28¼	115	5.0	W\$ 979
	65-9028BP	90	¾	28¼	108	4.6	W\$ 960
	65-8428BP	84	¾	28¼	101	4.3	W\$ 923
	65-7828BP	78	¾	28¼	94	4.0	W\$ 899
	65-7228BP	72	¾	28¼	86	3.7	W\$ 878
	65-6628BP	66	¾	28¼	79	3.4	W\$ 846
	65-6028BP	60	¾	28¼	65	3.7	W\$ 832
	65-5428BP	54	¾	28¼	60	2.8	W\$ 794
	65-4828BP	48	¾	28¼	55	2.5	W\$ 756
	65-4228BP	42	¾	28¼	50	2.2	W\$ 658
	65-3628BP	36	¾	28¼	45	2.0	W\$ 566
	65-3028BP	30	¾	28¼	30	1.6	W\$ 520
	65-1828BP	18	¾	28¼	19	1.0	W\$ 446
65-1528BP	15¾	¾	28¼	18	1.0	W\$ 413	

Must Specify (in this order):

Model #
Finish
Grommet
Grommet Color

Description

- For Use as a Modesty Panel to Create Bridges, Returns, or Credenzas, or as a Back Panel on Modular Units

Leg Options: Specify & Add

1-GRMT	Optional Top-Center Grommet, Must Specify: Black (BLK) or Silver (SLV)	\$ 52
--------	--	-------

 <p>FLIPDOWN MODESTY PANEL</p>	65-2836FDM	36	3½	28¼	35	3.3	W\$ 1605
	65-2830FDM	30	3½	28¼	30	2.7	W\$ 1421

Description

- Modesty Panel with 3" Deep Case Allows Room for Plugs
- Does Not Feature Soft Close Hinges
- Upper Panel: Open at Top, Hinged and Opens Fully for Easy Access to Ports and Cord Management

Must Specify (in this order):

Model #
Finish

Pricing Codes:

W= Wood Top
P= HPL Top

[See Gesso Intro Section for Ordering Options](#)

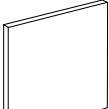
Item	Model No.	Width	Depth	Height	Ship Wt	Cubic Ft	List Price
	65-3530EP	35¼	1	28¼	41	2.6	W\$ 700
	65-2930EP	29¼	1	28¼	34	2.2	W\$ 662
	65-2330EP	23¼	1	28¼	27	1.6	W\$ 623

Description

- Must Be Used with a Back Panel

Must Specify (in this order):

Model #
Finish

SUPPORT PANEL	65-2812SP	12	1	28¼	12	0.8	W\$ 436
----------------------	-----------	----	---	-----	----	-----	---------

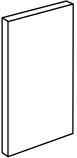

Description

- Required to be Used Perpendicular to Full Back Panels to Support Kneespace Areas of 60" or Longer

Must Specify (in this order):

Model #
Finish

SUPPORT T	65-1010SP	10	10	28¼	20	0.8	W\$ 634
	65-1010SPW	10	10	28¼	20	0.8	W\$ 634

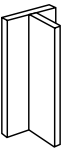

Support T with Wire Management

Description

- Supports Worksurfaces
- Required on Kneespace Areas of 60" or More Where Back Panels are Not Used

Must Specify (in this order):

Model #
Finish

O LEG SUPPORT	01-1228OL	12	2	28¼	20	1.2	\$ 442
----------------------	-----------	----	---	-----	----	-----	--------

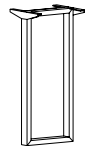

Description

- Available in Aluminum or Black; Must Specify Color
- Provides Additional Support Under Tops Greater Than 60" - Not Available to be Sold Separately

Must Specify (in this order):

Model #
Color
Wire Management Cover

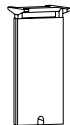

Leg Options: Specify & Add

01-1228OLWM	Wire Management Cover - Available in Aluminum or Black; Must Specify Color	\$ 291
-------------	--	--------

Pricing Codes:

W= Wood Top
P= HPL Top

[See Gesso Intro Section for Ordering Options](#)

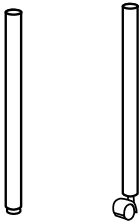
Item	Model No.	Width	Depth	Height	Ship Wt	Cubic Ft	List Price
	MODULAR TABLE DESK LEG						
	01-0401MLA Aluminum Leg with Leveler	2	2	28¾	10	0.5	\$ 320
	01-0401MLB Black Leg with Leveler	2	2	28¾	10	0.5	\$ 320
	01-0400MLA Aluminum Leg with Caster	2	2	28¾	10	0.5	\$ 272
	01-0400MLB Black Leg with Caster	2	2	28¾	10	0.5	\$ 272

Description

- Available in Adjustable Black Leveler or Locking Black Caster

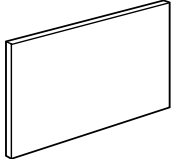
Item	Model No.	Width	Depth	Height	Ship Wt	Cubic Ft	List Price
	LOW HEIGHT BACK PANEL						
	65-10820BP	108	¾	20¾	45	3.6	W\$ 957
	65-10220BP	102	¾	20¾	43	3.5	W\$ 914
	65-9620BP	96	¾	20¾	40	3.4	W\$ 866
	65-9020BP	90	¾	20¾	38	3.3	W\$ 846
	65-8420BP	84	¾	20¾	36	3.2	W\$ 821
	65-7820BP	78	¾	20¾	34	3.1	W\$ 783
	65-7220BP	72	¾	20¾	31	3.0	W\$ 759
	65-6620BP	66	¾	20¾	29	2.9	W\$ 739
	65-6020BP	60	¾	20¾	27	2.8	W\$ 655
	65-5420BP	54	¾	20¾	24	2.7	W\$ 618
	65-4820BP	48	¾	20¾	22	2.6	W\$ 601
	65-4220BP	42	¾	20¾	20	2.5	W\$ 548
	65-3620BP	36	¾	20¾	17	2.4	W\$ 503
	65-3020BP	30	¾	20¾	15	2.3	W\$ 473
65-2420BP	24	¾	20¾	15	2.3	W\$ 431	
65-1820BP	18	¾	20¾	15	2.3	W\$ 416	

Must Specify (in this order):

Model #
Finish
Grommet
Grommet Color

Description

- For Use as a Back Panels to Create Low Height Returns, Credenzas, or Benches
- Grain Runs Vertically Up to 60" - All Larger Sizes are Horizontal Grain Patterns

Leg Options: Specify & Add



1-GRMT Optional Top-Center Grommet, Must Specify: Black (BLK) or Silver (SLV) \$ 52

Pricing Codes:

W= Wood Top
P= HPL Top

[See Gesso Intro Section for Ordering Options](#)

Item	Model No.	Width	Depth	Height	Ship Wt	Cubic Ft	List Price
LOW HEIGHT END PANEL	65-2420EP	23¾	1	20¾	15	0.8	W\$ 554
	65-2020EP	19¾	1	20¾	15	0.8	W\$ 451

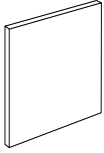

Must Specify (in this order):

Model #
Finish

Description

- Must Be Used with a Back Panel

LOW HEIGHT SUPPORT PANEL	65-2012SP	12	1	20¾	7	0.4	W\$ 396
--------------------------	-----------	----	---	-----	---	-----	---------

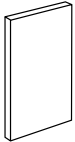

Must Specify (in this order):

Model #
Finish

Description

- Required to be Used Perpendicular to Full Back Panels to Support Kneespace Areas of 60" or Longer

LOW HEIGHT SUPPORT T	65-2010SP	10	10	20¾	11	2.3	W\$ 560
	65-2010SPW Support T with Wire Management	10	10	20¾	11	2.3	W\$ 564

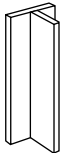

Must Specify (in this order):

Model #
Finish

Description

- Supports Worksurfaces
- Required on Kneespace Areas of 60" or More Where Back Panels are Not Used

Pricing Codes:

W= Wood Top
P= HPL Top

[See Gesso Intro Section for Ordering Options](#)

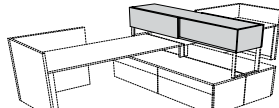
Item	Model No.	Width	Depth	Height	Ship Wt	Cubic Ft	List Price
 DUAL ACCESS SLIDING DOOR HUTCH	65-1572DAHS	72	16½	15	117	14.5	W\$ 4221
	65-1566DAHS	66	16½	15	111	13.4	W\$ 4053
	65-1560DAHS	60	16½	15	104	12.2	W\$ 3909

Description

- One Non-Locking Sliding Door
- Used with Shared Office Application
- Safely Write on Dry Erase Door and Dry Erase Back Panel with Our Dry Erase Marker Set; [See Sets](#)
- Metal Stanchion Leg Sold Separately; [See Stanchion Sizes](#)
- If Applicable, Door Front Grain Direction Vertical Standard; Optional Horizontal Grain Direction

Must Specify (in this order):

Model #
 Finish
 Door Style
 Door Finish (if applicable)
 Door Grain Direction (if applicable)
 Dry Erase Back Panel

Options: Specify & Add

1-AD	Aluminum Framed Satin Frosted Tempered Glass Doors (Non-Locking)	\$ 1490
1-DEB	Dry Erase Board Door (Non-Locking)	\$ 154
1-HGA	High Gloss Acrylic Door (Non-Locking); Must Specify Color	
	(GPA) Graphite Acrylic	\$ 1542
	(BLA) Black, (WMA) Wired Mercury, or (WHA) White Acrylic	\$ 1411
DEF	Dry Erase Fixed Back Panel	\$ 646

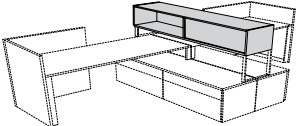
 DUAL ACCESS OPEN HUTCH	65-1572DAOH	72	15	15	95	14.5	W\$ 2350
	65-1566DAOH	66	15	15	90	13.4	W\$ 2270
	65-1560DAOH	60	15	15	85	12.2	W\$ 2237

Description

- Right Side - Fixed/Left Side - Open
- Used with Shared Office Application
- Safely Write on Dry Erase Back Panel with Our Dry Erase Marker Set; [See Sets](#)
- Metal Stanchion Leg Sold Separately; [See Stanchion Sizes](#)
- Optional Dry Erase Fixed Backs, See Below or Tackboard Fixed Backs; [See Tackboards](#)

Must Specify (in this order):

Model #
 Finish
 Dry Erase Back Panel
 Tackboard
 Tackboard Fabric

Options: Specify & Add

DEF	Dry Erase Fixed Back Panel	\$ 646
-----	----------------------------	--------

Pricing Codes:

W= Wood Top
 P= HPL Top

[See Gesso Intro Section for Ordering Options](#)

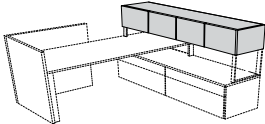
Item	Model No.	Width	Depth	Height	Ship Wt	Cubic Ft	List Price
 <p>SINGLE SIDED FOUR DOOR HUTCH</p>	65-1572SSHU	72	15¾	15	98	12.4	W\$ 2892
	65-1566SSHU	66	15¾	15	93	11.4	W\$ 2792
	65-1560SSHU	60	15¾	15	88	10.4	W\$ 2737





Must Specify (in this order):

- Model #
- Finish
- Door Style
- Door Finish (if applicable)
- Locking Doors

Description

- Storage Behind Doors
- Safely Write on Dry Erase, White and Black Tempered Glass Doors with Our Dry Erase Marker Set; [See Sets](#)
- Single or Shared Stanchions Must be Ordered Separately; See Next Page
- Optional Locking Door Available; [See Locking Door Options](#) and Specify Lock Color

Options: Specify & Add

		Per Door
	1-AD Aluminum Framed Satin Frosted Tempered Glass Doors (Non-Locking)	\$ 438
	1-DEB Dry Erase Board Doors	\$ 28
	WHGLS Aluminum Framed Doors with White Tempered Glass (Non-locking)	\$ 652
	BLGLS Black Matte Framed Doors with Black Tempered Glass (Non-locking)	\$ 868
	1-HGA High Gloss Acrylic Doors; Must Specify Color	
	(GPA) Graphite Acrylic	\$ 269
	(BLA) Black, (WMA) Wired Mercury, or (WHA) White Acrylic	\$ 247

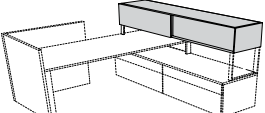
Item	Model No.	Width	Depth	Height	Ship Wt	Cubic Ft	List Price
 <p>SINGLE SIDED SLIDING DOOR HUTCH</p>	65-1572SSHS	72	15¾	15	89	12.4	W\$ 3132
	65-1566SSHS	66	15¾	15	84	11.4	W\$ 3048
	65-1560SSHS	60	15¾	15	79	10.4	W\$ 2936



Must Specify (in this order):

- Model #
- Finish
- Door Style
- Door Finish (if applicable)

Description

- One Non-Locking Sliding Door
- Safely Write on Dry Erase Doors =with Our Dry Erase Marker Set; [See Sets](#)
- Storage Behind Sliding Door
- Single or Shared Stanchions Must be Ordered Separately; See Next Page

Options: Specify & Add

		Per Door
	1-AD Aluminum Framed Satin Frosted Tempered Glass Doors (Non-Locking)	\$ 745
	1-DEB Dry Erase Board Door (Non-Locking)	\$ 77
	1-HGA High Gloss Acrylic Door (Non-Locking); Must Specify Color	
	(GPA) Graphite Acrylic	\$ 773
	(BLA) Black, (WMA) Wired Mercury, or (WHA) White Acrylic	\$ 705

Pricing Codes:

- W= Wood Top
- P= HPL Top

[See Gesso Intro Section for Ordering Options](#)

Item	Model No.	Width	Depth	Height	Ship Wt	Cubic Ft	List Price
METAL STANCHION FOR USE WITH LOW STORAGE AND SINGLE OR DUAL HUTCHES	01-1515OS For Use Over 21" Low Modular Ped	15	2	15	25	0.5	\$ 331
	01-1507OS For Use Over 30" Low Modular Ped	15	2	7	15	0.3	\$ 305

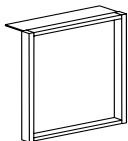

Must Specify (in this order):

Model #

Support Color

Description

- Available in Aluminum (ALUM) or Black (BLK), Must Specify
- For Use With Single Sided and Dual Access Hutches - Not Available to be Sold Separately

SHARED METAL STANCHION FOR USE WITH LOW STORAGE AND SINGLE OR DUAL HUTCHES	01-1515OSS For Use Over 21" Low Modular Ped	15	2	15	25	0.5	\$ 339
	01-1507OSS For Use Over 30" Low Modular Ped	15	2	7	15	0.3	\$ 327

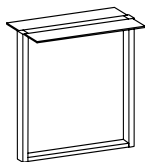

Must Specify (in this order):

Model #

Support Color

Description

- Available in Aluminum (ALUM) or Black (BLK), Must Specify
- For Use With Single Sided and Dual Access Hutches - Not Available to be Sold Separately
- Connects Two Dual Access Hutches

21" ABOVE AND BELOW SCREEN VENEER	65-6821AB	68	¾	21	41	3.3	W\$ 840
	65-6221AB	62	¾	21	39	3.0	W\$ 814
	65-5621AB	56	¾	21	36	2.7	W\$ 782
	65-5021AB	50	¾	21	34	2.4	W\$ 755
	65-4421AB	44	¾	21	31	2.2	W\$ 723

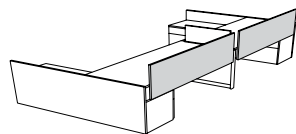

Must Specify (in this order):

Model #

Finish

Description

- Mounts to Worksurface
- Provides Privacy 12" Above and 10¾" Modesty Below

Pricing Codes:

W= Wood Top

P= HPL Top

[See Gesso Intro Section for Ordering Options](#)

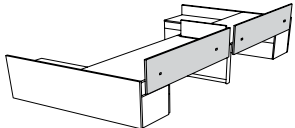
Item	Model No.	Width	Depth	Height	Ship Wt	Cubic Ft	List Price
21" ABOVE AND BELOW SCREEN FROSTED ACRYLIC 	65-6821ABA	68	¼	21	14	3.3	\$ 1352
	65-6221ABA	62	¼	21	12	2.8	\$ 1265
	65-5621ABA	56	¼	21	10	2.8	\$ 1177
	65-5021ABA	50	¼	21	9	2.2	\$ 1088
	65-4421ABA	44	¼	21	8	1.2	\$ 998

Must Specify (in this order):
Model #
Decorative Hardware Color

Description

- Mounts to Worksurface
- Provides Privacy 12" Above and 10¾" Modesty Below
- Decorative Hardware; Must Specify: Aluminum (ALUM) or Chrome (CHRM)

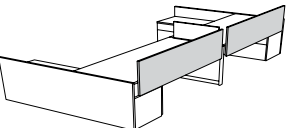
21" ABOVE AND BELOW SCREEN HIGH GLOSS ACRYLIC 	66-6821ABGA	68	¾	21	44	3.3	\$ 1447 GPA\$ 1886
	66-6221ABGA	62	¾	21	41	3.0	\$ 1344 GPA\$ 1747
	66-5621ABGA	56	¾	21	38	2.7	\$ 1246 GPA\$ 1606
	66-5021ABGA	50	¾	21	36	2.4	\$ 1147 GPA\$ 1470
	66-4421ABGA	44	¾	21	33	2.2	\$ 1051 GPA\$ 1333

Must Specify (in this order):
Model #
Color

Description

- Mounts to Worksurface
- Provides Privacy 12" Above and 10¾" Modesty Below
- Available in Black (BLA), White (WHA) or Graphite Acrylic (GPA); Graphite Acrylic Pricing (GPA\$)

12" PRIVACY PANEL VENEER  	65-2812PP	28	¾	12	12	0.9	W\$ 626
	65-2212PP	22	¾	12	10	0.7	W\$ 612

Must Specify (in this order):
Model #
Finish
Decorative Hardware Color

Description

- Mounts to Surface to Create Division Between Workstations
- Decorative Hardware; Must Specify: Aluminum (ALUM) or Chrome (CHRM)

Pricing Codes:
W= Wood Top
P= HPL Top

[See Gesso Intro Section for Ordering Options](#)

Item	Model No.	Width	Depth	Height	Ship Wt	Cubic Ft	List Price
12" PRIVACY PANEL FROSTED ACRYLIC	65-2812PPA	28	¼	12	8	0.7	\$ 580
	65-2212PPA	22	¼	12	7	0.6	\$ 523

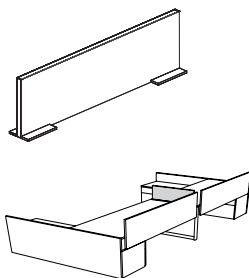

Must Specify (in this order):

Model #

Decorative Hardware Color

Description

- Mounts to Surface to Create Division Between Workstations
- Decorative Hardware; Must Specify: Aluminum (ALUM) or Chrome (CHRM)

12" PRIVACY PANEL HIGH GLOSS ACRYLIC	66-2812PPGA	68	¾	12	13	0.9	\$ 609 GPA\$ 686
	66-2212PPGA	62	¾	12	11	0.7	\$ 546 GPA\$ 605

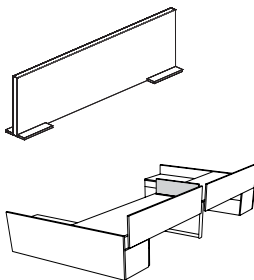

Must Specify (in this order):

Model #

Color

Decorative Hardware Color

Description

- Mounts to Surface to Create Division Between Workstations
- Decorative Hardware; Must Specify: Aluminum (ALUM) or Chrome (CHRM)
- Available in Black (BLA), White (WHA) or Graphite Acrylic (GPA); Graphite Acrylic Pricing (GPA\$)

12" FREESTANDING PRIVACY PANEL VENEER	65-6812PP	68	¾	12	26	2.2	W\$ 761
	65-6212PP	62	¾	12	25	2.0	W\$ 745
	65-5612PP	56	¾	12	23	1.8	W\$ 723

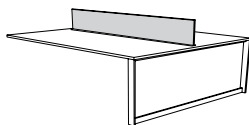

Must Specify (in this order):

Model #

Finish

Decorative Hardware Color

Description

- Freestanding on Surface to Create Division Between Workstations
- Decorative Hardware; Must Specify: Aluminum (ALUM) or Chrome (CHRM)

Pricing Codes:

W= Wood Top

P= HPL Top

[See Gesso Intro Section for Ordering Options](#)

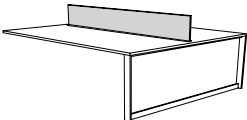
Item	Model No.	Width	Depth	Height	Ship Wt	Cubic Ft	List Price
12" FREESTANDING PRIVACY PANEL FROSTED ACRYLIC 	65-6812PPA	68	¼	12	8	2.2	\$ 982
	65-6212PPA	62	¼	12	7	2.0	\$ 925
	65-5612PPA	56	¼	12	6	1.8	\$ 854

Must Specify (in this order):
Model #
Decorative Hardware Color

Description

- Freestanding on Surface to Create Division Between Workstations
- Decorative Hardware; Must Specify: Aluminum (ALUM) or Chrome (CHRM)

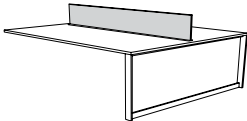
12" FREESTANDING PRIVACY PANEL HIGH GLOSS ACRYLIC 	66-6812PPGA	68	¾	12	25	3.3	\$ 1051 GPA\$ 1233
	66-6212PPGA	62	¾	12	23	3.0	\$ 979 GPA\$ 1154
	66-5612PPGA	56	¾	12	22	2.7	\$ 886 GPA\$ 1073

Must Specify (in this order):
Model #
Color
Decorative Hardware Color

Description

- Freestanding on Surface to Create Division Between Workstations
- Decorative Hardware; Must Specify: Aluminum (ALUM) or Chrome (CHRM)
- Available in Black (BLA), White (WHA) or Graphite Acrylic (GPA); Graphite Acrylic Pricing (GPA\$)

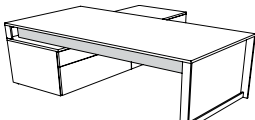
7" MODESTY PANEL VENEER 	65-6807MOD	68	¾	7	17	1.3	W\$ 720
	65-6207MOD	62	¾	7	16	1.2	W\$ 707
	65-5607MOD	56	¾	7	16	1.1	W\$ 694

Must Specify (in this order):
Model #
Finish

Description

- Works With Low Storage; [See Low Credenzas](#) and Modular Units; [See Modular Units](#)
- Attaches with Aluminum Mounting Brackets

Pricing Codes:
W= Wood Top
P= HPL Top

[See Gesso Intro Section for Ordering Options](#)

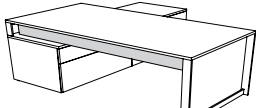
Item	Model No.	Width	Depth	Height	Ship Wt	Cubic Ft	List Price
7" MODESTY PANEL FROSTED ACRYLIC 	65-6807MODA	68	¼	7	12	1.3	\$ 705
	65-6207MODA	62	¼	7	11	1.2	\$ 652
	65-5607MODA	56	¼	7	10	1.1	\$ 620

Description

- Works With Low Storage; [See Low Credenzas](#) and Modular Units; [See Modular Units](#)
- Exposed Decorative Hardware; Must Specify: Aluminum (ALUM) or Chrome (CHRM)

Must Specify (in this order):

Model #

Decorative Hardware Color

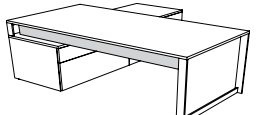
7" MODESTY PANEL HIGH GLOSS ACRYLIC 	65-6807MODGA	68	¾	7	17	1.3	\$ 725 GPA\$ 826
	65-6207MODGA	62	¾	7	16	1.2	\$ 707 GPA\$ 780
	65-5607MODGA	56	¾	7	16	1.1	\$ 690 GPA\$ 738

Description

- Works With Low Storage; [See Low Credenzas](#) and Modular Units; [See Modular Units](#)
- Attaches with Aluminum Mounting Brackets
- Available in Black (BLA), Wired Mercury (WMA), White (WHA) or Graphite Acrylic (GPA); Graphite Acrylic Pricing (GPA\$)

Must Specify (in this order):

Model #

Color

Pricing Codes:

W= Wood Top

P= HPL Top

[See Gesso Intro Section for Ordering Options](#)

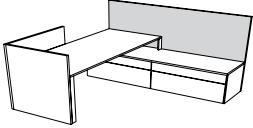
Item	Model No.	Width	Depth	Height	Ship Wt	Cubic Ft	List Price
51" GALLERY SCREEN STRAIGHT FLOORSTANDING  Must Specify (in this order): Model # Finish Grommet Grommet Color	65-5173GS	73	1	51¼	110	7.9	W\$ 2036
	65-5172GS	72	1	51¼	110	7.9	W\$ 2021
	65-5167GS	67	1	51¼	104	7.3	W\$ 1955
	65-5166GS	66	1	51¼	104	7.3	W\$ 1943
	65-5161GS	61	1	51¼	98	6.7	W\$ 1874
	65-5160GS	60	1	51¼	98	6.7	W\$ 1861
	65-5155GS	55	1	51¼	92	6.1	W\$ 1792
	65-5154GS	54	1	51¼	92	6.1	W\$ 1778
	65-5149GS	49	1	51¼	86	5.4	W\$ 1711
	65-5148GS	48	1	51¼	86	5.4	W\$ 1695
	65-5143GS	43	1	51¼	80	4.7	W\$ 1632
	65-5142GS	42	1	51¼	80	4.7	W\$ 1620
	65-5137GS	37	1	51¼	60	4.1	W\$ 1413
	65-5136GS	36	1	51¼	60	4.1	W\$ 1369
	65-5131GS	31	1	51¼	54	3.5	W\$ 1283
	65-5130GS	30	1	51¼	54	3.5	W\$ 1266
	65-5125GS	25	1	51¼	48	2.8	W\$ 1173
	65-5124GS	24	1	51¼	48	2.8	W\$ 1154
	65-5119GS	19	1	51¼	42	2.2	W\$ 1085
	65-5118GS	18	1	51¼	42	2.2	W\$ 1070

Description

- Vertical Woodgrain
- Mounts to Back of Modular Credenza for Space Division
- Extend up to 24" Beyond Workstation without Additional Support
- Gallery Screens 49" and Wider Feature Multi-Step, Hand-Finished Catalyzed Finish
- Six (6) Wire Management Grommet Location Options: [See Locations](#) and Specify Location Selections

Pricing Codes:

W= Wood Top
P= HPL Top

[See Gesso Intro Section for Ordering Options](#)

Studio Components

Boutique-inspired options to give all your working environments a fresh look with a subtle touch of home. Integrated into our ever-popular Canvas and Gesso Casegood lines, Studio models build upon simplicity and flexibility while allowing you to create eye-catching spaces. Whether you're looking to outfit an executive's office, team space, collaborative area, or anything in between, our Studio desk and storage components have the look and feel you desire.

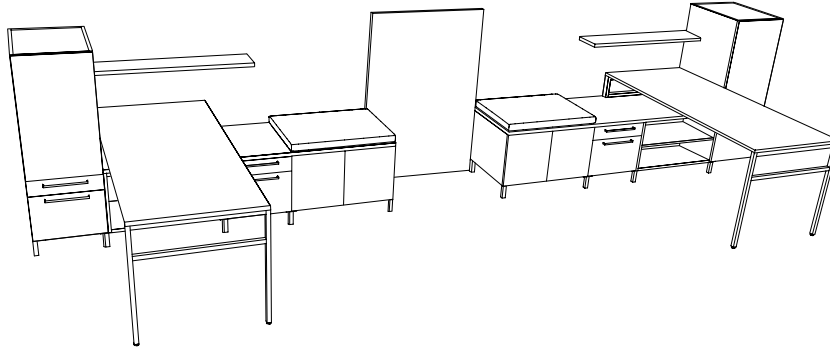

Studio components work with existing Canvas Tops, Peninsula Tops, and accessories such as Tackboards, Work Walls, Marker Boards, and Cushions to build the perfect workspace. The slim leg design provides an upscale feel for all of the Studio components. Storage units such as standard height pedestals offer the flexibility to build single or double pedestal desks or credenzas and low height pedestals allow you to create bench style credenzas.

The Studio pull features a clean application.



How to Use Studio

Start with a Modular Top to build a Desk, Peninsula Desk, Benching or Credenza ([See Modular Tops](#))



Next, choose from a number of Studio Pedestals options in Standard or Low Height. ([See Studio Peds](#))



Kneespace Modesty Panels are available in standard height in TFL or High Gloss Acrylic or low height in TFL ([See Modesty Panels](#))

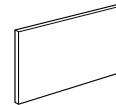

Add additional storage with Studio Storage Cabinets and the full door storage cabinet features high gloss acrylic and dry erase door options ([See Storage Cabinets](#))

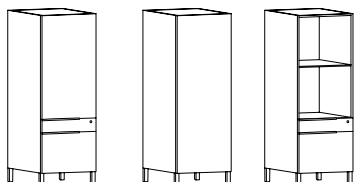

Single and Shared Stanchions offer a layer of support for workstations and single or dual sided hutches ([See Stanchions](#))

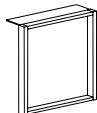

Studio Single and Shared Legs images below provide a simple and clean aesthetic. See below for a guide to the aesthetics of single, double, and shared legs ([See Leg Options](#))

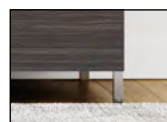

Single Standard Leg



Shared Leg (used between two models)

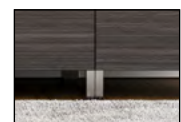

Double Standard Leg (standard legs used on each model)

Item	Model No.	Width	Depth	Height	Ship Wt	Cubic Ft	List Price
STUDIO COMPONENT, MODULAR PEDESTAL BOX/BOX/FILE 	65-3618SPD1	18	36	24¼	68	11.4	W\$ 2646
	65-3018SPD1	18	30	24¼	61	10.4	W\$ 2430
	65-2418SPD1	18	24	24¼	54	8.4	W\$ 2240

Description

- For Use With Other Studio Components
- Standard Locking Pedestal; File Drawer Provides Legal or Letter Filing
- Studio Pulls Are Installed on Left Aligned Position; Drawers Feature a ¾ Extension
- Drawer Front Grain Direction Vertical Standard; Optional Horizontal Grain Direction
- Finished Back Panel Included
- Height of Unit with Legs: 28¾; **Legs Must be Ordered Separately;** [See Leg Options](#)
- Worksurface Required; [See Worksurface Sizes](#)
- Additional Options: Dove Tail Drawer Construction and Soft Close Drawers ([See Drawer Options](#)), Wire Management ([See Option Details](#))

Must Specify (in this order):

Model #
 Finish
 Drawer Front Grain Direction
 Pull
 Drawer Construction
 Drawer Track
 Wire Management

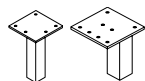

Legs Must be Ordered Separately; [See Leg Options](#)

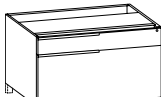
STUDIO COMPONENT, MODULAR PEDESTAL TRAY/FILE 	65-2436STF	36	24	16¾	59	10.6	W\$ 2228
	65-2430STF	30	24	16¾	51	8.9	W\$ 2155
	65-2418STF	18	24	16¾	37	5.6	W\$ 1798

Description

- For Use With Other Studio Components
- Standard Locking Pedestal; File Drawer Provides Legal or Letter Filing
- Studio Pulls Are Installed on Left Aligned Position; Drawers Feature a ¾ Extension
- Drawer Front Grain Direction Vertical Standard; Optional Horizontal Grain Direction
- Finished Back Panel Included
- Height of Unit with Legs: 20¾; **Legs Must be Ordered Separately;** [See Leg Options](#)
- Worksurface Required; [See Worksurface Sizes](#)
- Additional Options: Dove Tail Drawer Construction and Soft Close Drawers ([See Drawer Options](#)), Wire Management ([See Option Details](#))

Must Specify (in this order):

Model #
 Finish
 Drawer Front Grain Direction
 Pull
 Drawer Construction
 Drawer Track
 Wire Management

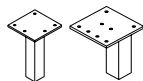

Legs Must be Ordered Separately; [See Leg Options](#)

Pricing Codes:

W= Wood Top
 P= HPL Top

[See Gesso Intro Section for Ordering Options](#)

Item	Model No.	Width	Depth	Height	Ship Wt	Cubic Ft	List Price
STUDIO COMPONENT, LOW MODULAR PEDESTAL OPEN BOOKCASE	65-2436SBC	36	24	16¾	67	10.6	W\$ 1941
	65-2430SBC	30	24	16¾	59	8.9	W\$ 1857
	65-2418SBC	18	24	16¾	45	5.6	W\$ 1705

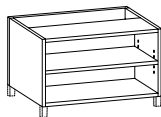

Must Specify (in this order):

Model #
Finish
Wire Management

Description

- For Use With Other Studio Components
- One Adjustable Shelf
- Finished Back Panel Included
- Removable Wire Management Panel
- Height of Unit with Legs: 20¾; **Legs Must be Ordered Separately;** [See Leg Options](#)
- Worksurface Required; [See Worksurface Sizes](#)
- Additional Options: Wire Management ([See Option Details](#))

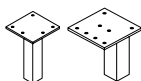

Legs Must be Ordered Separately; [See Leg Options](#)

STUDIO COMPONENT, LOW MODULAR PEDESTAL DOUBLE DOOR BOOKCASE	65-2436SDB	36	24	16¾	77	10.6	W\$ 1856
	65-2430SDB	30	24	16¾	67	8.9	W\$ 1626

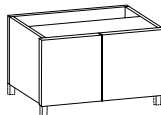

Must Specify (in this order):

Model #
Finish
Door Front Grain Direction
Pull
Locking Doors
Wire Management

Description

- For Use With Other Studio Components
- 16" Deep Adjustable Shelf Behind Doors
- Finished Back Panel Included
- Removable Wire Management Panel
- Drawer Front Grain Direction Vertical Standard; Optional Horizontal Grain Direction
- Height of Unit with Legs: 20¾; **Legs Must be Ordered Separately;** [See Leg Options](#)
- Worksurface Required; [See Worksurface Sizes](#)
- Optional Locking Doors ([See Locking Door Options](#)) and Specify Lock Color
- Optional Wire Management ([See Optional Details](#))

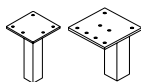

Legs Must be Ordered Separately; [See Leg Options](#)

Pricing Codes:

W= Wood Top
P= HPL Top

[See Gesso Intro Section for Ordering Options](#)

Item	Model No.	Width	Depth	Height	Ship Wt	Cubic Ft	List Price
STUDIO COMPONENT, LOW MODULAR PEDESTAL SINGLE DOOR BOOKCASE	Left	Right					
	65-2418SDBL	65-2418SDBR	18	24	16¾	51	5.6

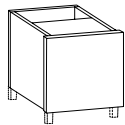

Must Specify (in this order):

Model #
Finish
Door Front Grain Direction
Pull
Wire Management

Description

- For Use With Other Studio Components
- 16" Deep Adjustable Shelf Behind Doors
- Finished Back Panel Included
- Removable Wire Management Panel
- Door Front Grain Direction Vertical Standard; Optional Horizontal Grain Direction
- Height of Unit with Legs: 20¾; **Legs Must be Ordered Separately; See Leg Options**
- Worksurface Required; [See Worksurface Sizes](#)
- Optional Locking Door ([See Locking Door Options](#)) and Specify Lock Color
- Optional Wire Management ([See Optional Details](#))

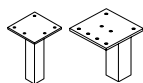

Legs Must be Ordered Separately; [See Leg Options](#)

Item	Model No.	Width	Depth	Height	Ship Wt	Cubic Ft	List Price
STUDIO COMPONENT, STORAGE CABINET DOOR/TRAY/FILE	Left	Right					
	65-1851SWBL	65-1851SWBR	18	24	47½	120	15.9

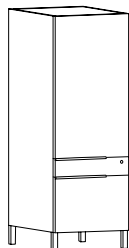

Must Specify (in this order):

Model #
Finish
Door/Drawer Front Grain Direction
Door Locking
Pull

Description

- For Use With Other Studio Components
- One Adjustable Shelf Behind Door
- Locking File Drawer Provides Legal or Letter Filing
- Studio Pulls Are Installed on Left Aligned Position; Drawers Feature a ¾ Extension
- Door/Drawer Front Grain Direction Vertical Standard; Optional Horizontal Grain Direction
- Height of Unit with Legs: 51½; **Legs Must be Ordered Separately; See Leg Options**
- Additional Options: Dove Tail Drawer Construction and Soft Close Drawers ([See Drawer Options](#)), Locking Doors ([See Locking Door Options](#))

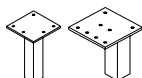

Legs Must be Ordered Separately; [See Leg Options](#)

Pricing Codes:

W= Wood Top
P= HPL Top

[See Gesso Intro Section for Ordering Options](#)

Item	Model No.	Width	Depth	Height	Ship Wt	Cubic Ft	List Price
STUDIO COMPONENT, OPEN STORAGE CABINET TRAY/FILE	65-1851SWBO	18	24	47½	109	15.9	W\$ 2692

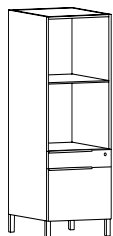

Description

- For Use With Other Studio Components
- One Adjustable Shelf
- Locking File Drawer Provides Legal or Letter Filing
- Studio Pulls Are Installed on Left Aligned Position; Drawers Feature a ¾ Extension
- Drawer Front Grain Direction Vertical Standard; Optional Horizontal Grain Direction
- Height of Unit with Legs: 51½; **Legs Must be Ordered Separately**; [See Leg Options](#)
- Additional Options: Dove Tail Drawer Construction and Soft Close Drawers ([See Drawer Options](#))

Must Specify (in this order):

- Model #
- Finish
- Drawer Front Grain Direction
- Pull

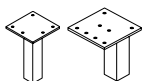

Legs Must be Ordered Separately; [See Leg Options](#)

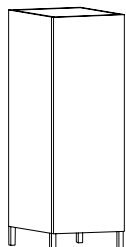

STUDIO COMPONENT, WARDROBE	Left	Right	Width	Depth	Height	Ship Wt	Cubic Ft	List Price
	65-1851SWL	65-1851SWR						
			18	24	47½	108	15.9	W\$ 2460



Description

- For Use With Other Studio Components
- Includes Coat Rod and (2) Adjustable Shelves
- Door Front Grain Direction Vertical Standard; Optional Horizontal Grain Direction
- Height of Unit with Legs: 51½; **Legs Must be Ordered Separately**; [See Leg Options](#)
- Additional Options: Locking Door ([See Locking Door Options](#))

Options: Specify & Add

	1-DEB	Dry Erase Board	\$ 96
	1-HGA	High Gloss Acrylic; Must Specify Color	
		(GPA) Graphite Acrylic	\$ 960
		(BLA) Black, (WMA) Wired Mercury, or (WHA) White Acrylic	\$ 876

Must Specify (in this order):

- Model #
- Finish
- Door Front Grain Direction
- Door Locking Pull

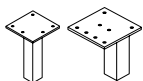

Legs Must be Ordered Separately; [See Leg Options](#)

Pricing Codes:

- W= Wood Top
- P= HPL Top

[See Gesso Intro Section for Ordering Options](#)

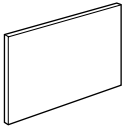
Item	Model No.	Width	Depth	Height	Ship Wt	Cubic Ft	List Price
STUDIO COMPONENT, KNEESPACE MODESTY PANEL, VENEER 	65-6024MD	60	¾	24½	37	2.9	W\$ 745
	65-5424MD	54	¾	24½	33	2.6	W\$ 706
	65-4824MD	48	¾	24½	30	2.3	W\$ 676
	65-4224MD	42	¾	24½	26	2.0	W\$ 604
	65-3624MD	36	¾	24½	22	1.7	W\$ 535
	65-3024MD	30	¾	24½	19	1.4	W\$ 498

Must Specify (in this order):

Model #
Finish
Grommet

Description

- For Use Between Two Studio Pedestals
- Attaches with L Bracket (Included)
- Optional Center Panel Grommet; Must Specify

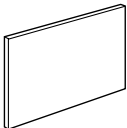
STUDIO COMPONENT, KNEESPACE MODESTY PANEL, HIGH GLOSS ACRYLIC 	65-4824MDHGA	48	¾	24½	30	2.3	\$ 774 GPA\$ 893
	65-4224MDHGA	42	¾	24½	30	2.1	\$ 700 GPA\$ 805
	65-3624MDHGA	36	¾	24½	26	2.0	\$ 589 GPA\$ 676
	65-3024MDHGA	30	¾	24½	19	1.4	\$ 513 GPA\$ 589

Must Specify (in this order):

Model #
Color
Grommet

Description

- For Use Between Two Studio Pedestals
- Attaches with L Bracket (Included)
- Available in Black (BLA), Wired Mercury (WMA), White (WHA) or Graphite Acrylic (GPA); Graphite Acrylic Pricing (GPA\$)

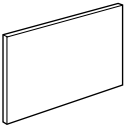
STUDIO COMPONENT, KNEESPACE MODESTY PANEL, FOR LOW STORAGE, VENEER 	65-6016MD	60	¾	16¼	25	2.0	W\$ 563
	65-5416MD	54	¾	16¼	23	1.8	W\$ 532
	65-4816MD	48	¾	16¼	20	1.6	W\$ 520
	65-4216MD	42	¾	16¼	18	1.4	W\$ 490
	65-3616MD	36	¾	16¼	15	1.2	W\$ 471
	65-3016MD	30	¾	16¼	13	1.0	W\$ 450

Must Specify (in this order):

Model #
Finish
Grommet

Description

- For Use Between Two Studio Pedestals
- Attaches with L Bracket (Included)
- Optional Center Panel Grommet; Must Specify

Pricing Codes:
W= Wood Top
P= HPL Top

[See Gesso Intro Section for Ordering Options](#)

Item	Model No.	Width	Depth	Height	Ship Wt	Cubic Ft	List Price
METAL STANCHION SINGLE	01-1515SOS	15	1	15	25	0.5	ALUM \$ 219
							BLK \$ 219
							CHRM \$ 271

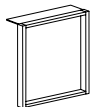

Must Specify (in this order):

Model #
Color

Description

- For Use With Single Sided Hutches ([See Hutches](#)) on Low Studio Components
- Available in Aluminum (ALUM), Black (BLK) or Chrome (CHRM); Must Specify

METAL STANCHION SHARED	01-1515SOSS	35¼	1	28¼	41	2.6	ALUM \$ 273
							BLK \$ 273
							CHRM \$ 338

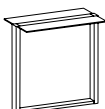

Must Specify (in this order):

Model #
Color

Description

- Connects Two Single Sided Hutches ([See Hutches](#)) on Low Studio Components
- Available in Aluminum (ALUM), Black (BLK) or Chrome (CHRM); Must Specify

STUDIO COMPONENT, SINGLE LEG	01-0404SL4	4-pack	1	1	4	10	1	ALUM \$ 273
								BLK \$ 273
								CHRM \$ 338
	01-0404SL2	2-pack	1	1	4	5	0.5	ALUM \$ 143
								BLK \$ 143
								CHRM \$ 176

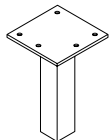

Must Specify (in this order):

Model #
Color

Description

- For Use With Studio Components
- Available in Aluminum (ALUM), Black (BLK) or Chrome (CHRM); Must Specify

STUDIO COMPONENT, SHARED LEG	01-0404SSL4	4-pack	1	1	4	10	1	ALUM \$ 247
								BLK \$ 247
								CHRM \$ 303
	01-0404SSL2	2-pack	1	1	4	5	0.5	ALUM \$ 143
								BLK \$ 143
								CHRM \$ 176

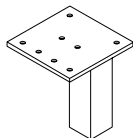

Must Specify (in this order):

Model #
Color

Description

- For Use With Studio Components
- Available in Aluminum (ALUM), Black (BLK) or Chrome (CHRM); Must Specify
- Connects Two Storage or Pedestal Units Together

Pricing Codes:

W= Wood Top
P= HPL Top

[See Gesso Intro Section for Ordering Options](#)

Height Adjustable Components

We've enhanced our height adjustable options to include a better integrated and easier to specify solution. These new models coupled with our existing modular height adjustable, and all of our standard models and storage options, provide you with the ultimate flexibility to meet the needs of your space and, more importantly, the needs of the user. And, we've made these new models more cost effective for you and more functional and spacious for the user.

Some Highlights of Our Integrated Solutions:

- Adjustable from 30"H to 45"H, with a load capacity up to 180lbs
- Gently adjust one worksurface or multiple worksurfaces with a 1 second stop at each memory position
- Two leg configuration options include the standard 2-channel for Desks, Desk Shells, D-top and P-Top units for one height adjustable worksurface or a 3-channel option for two height adjustable worksurfaces to raise simultaneously
- Two height adjustable control switches available. Standard up/down switch (SWCH) and advanced switch features Bluetooth capabilities, three stand-up reminder intervals and four height memory positions (MSWCH)
- Moving Modesty (MOVMOD) option creates a clean aesthetic when seated or standing
- Height adjust control switch is factory installed on all units except Desk Shells, Bridges or 3-Channel units
- Bridges, returns, and credenzas have an optional grommet on the back panel
- New black wire management mesh wrap included when worksurface grommet is selected
- Grommets and one Latch Duct wire management channel provided within kneespace to manage wires from switch and control box. Two Latch Duct wire management channels will be shipped with Desk Shells



Black wire management mesh sleeve included with worksurface grommet

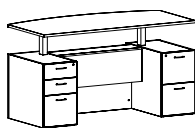

Standard 2-Channel Height Adjustable

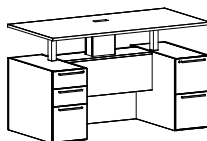

2-Channel Height Adjustable with Box



Bring the Open Plan and Shared Spaces to Life!

Modular Height Adjustable components make it easy to create the perfect work environment for any space. Select from an array of sizes of worksurfaces, pedestals, filing units and more to connect teams together so collaborating can be easy and productive.

If you prefer our original solution or have specified it previously, and would like to do so again, simply contact our Customer Service team for assistance. We can make that happen for you!

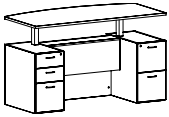
Item	Model No.	Width	Depth	Height	K	R	Ship Wt	Cubic Ft	List Price
HEIGHT ADJUSTABLE DOUBLE PED BOW TOP DESK 	67-3672BDPSSTS Stepped Front	72	36-42	30-45	40½	-	510	50.0 W/P\$	11086
	67-3672BDPSTS Recessed Front	72	36-42	30-45	40½	10	510	50.0 W/P\$	10855
	67-3666BDPSTS Recessed Front	66	36-42	30-45	34½	4	480	48.0 W/P\$	10650

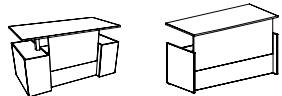

Shown with Rectangle Top, Stepped Front, Moving Modesty and Top Up

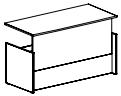

Shown with Rectangle Top, Recessed Front, Moving Modesty and Top Up

Must Specify (in this order):

- Model #
- Top Material
- Finish/Color
- Edge Profile
- Drawer Front Grain Direction
- Drawer Pull
- Drawer Construction
- Drawer Track
- Moving Modesty
- Height Adjust Switch
- Grommet Location
- Power/Data/Wire Management

Description

- Standard with: 2-Channel Leg Configuration for Single Surface Height Adjustment, Includes Controls, Top Profiled on Approach and User Side, Left to Right Grain Direction on Worksurface, Wire Management from Pedestal to Kneespace
- Optional Moving Modesty; Must Specify; Some Assembly Required; [See Below and Options](#)
- Control Switch Standard (SWCH-Up/Down) or Upgrade to Advanced Switch (MSWCH-Up/Down/Memory); [See Switch Options](#)
- Optional Dove Tail Drawer Construction and Soft Close Drawers ([See Drawer Options](#))
- For Additional Information Including Worksurface Grommets and Wire Management Boxes, Power Locations, and More can be Found in the [Intro Section](#)

High Gloss Acrylic Modesty Options for Stepped Front Desks: Specify & Add

65-HGAF	High Gloss Acrylic Full Modesty Panel; Must Specify Color (<i>Not Available as Moving Modesty</i>)	
	(GPA) Graphite Acrylic	\$ 1846
	(BLA) Black, (WMA) Wired Mercury, or (WHA) White Acrylic	\$ 1687

Moving Modesty Options: Specify & Add

MOVMOD	Moving Modesty	\$ 219
--------	----------------	--------

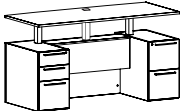
HEIGHT ADJUSTABLE DOUBLE PED DESK 	67-3672DPSSTS Stepped Front	72	36	30-45	40½	-	525	50.0 W/P\$	11557
	67-3672DPSTS Recessed Front	72	36	30-45	40½	10	525	50.0 W/P\$	10136
	67-3072DPSTS Recessed Front	72	30	30-45	40½	4	510	43.9 W/P\$	9963
	67-3066DPSTS Recessed Front	66	30	30-45	34½	4	490	38.7 W/P\$	9793
	67-3060DPSTS Recessed Front	60	30	30-45	28½	4	458	35.3 W/P\$	9593

Must Specify (in this order):

- Model #
- Top Material
- Finish/Color
- Edge Profile
- Drawer Front Grain Direction
- Drawer Pull
- Drawer Construction
- Drawer Track
- Moving Modesty
- Height Adjust Switch
- Grommet Location
- Power/Data/Wire Management

Description

- Standard with: 2-Channel Leg Configuration for Single Surface Height Adjustment, Includes Controls, Top Profiled on Approach and User Side, Wire Management from Pedestal to Kneespace
- Optional Moving Modesty; Must Specify; Some Assembly Required; [See Below and Options](#)
- Control Switch Standard (SWCH-Up/Down) or Upgrade to Advanced Switch (MSWCH-Up/Down/Memory); [See Switch Options](#)
- Optional Dove Tail Drawer Construction and Soft Close Drawers ([See Drawer Options](#))
- For Additional Information Including Worksurface Grommets and Wire Management Boxes, Power Locations, and More can be Found in the [Intro Section](#)

High Gloss Acrylic Modesty Options for Stepped Front Desks: Specify & Add

65-HGAF	High Gloss Acrylic Full Modesty Panel; Must Specify Color (<i>Not Available as Moving Modesty</i>)	
	(GPA) Graphite Acrylic	\$ 1846
	(BLA) Black, (WMA) Wired Mercury, or (WHA) White Acrylic	\$ 1687



Moving Modesty Options: Specify & Add

MOVMOD	Moving Modesty	\$ 219
--------	----------------	--------

Pricing Codes:

W= Wood Top
P= HPL Top

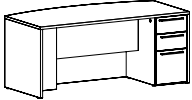
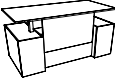
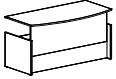
[See Gesso Intro Section for Ordering Options](#)

Item	Model No.	Width	Depth	Height	K	R	Ship Wt	Cubic Ft	List Price
HEIGHT ADJUSTABLE SINGLE PED, BOW TOP DESK WITH BOX/BOX/FILE	Left	Right							
	67-3672BLPSSTS	67-3672BRPSSTS	72	36-42	30-45	32¼	10	420	50.0 W/P\$ 10485
									
	67-3672BLPSTS	67-3672BRPSTS	72	36-42	30-45	32¼	10	420	50.0 W/P\$ 10184
 									
Shown with Rectangle Top, Stepped Front, Moving Modesty and Top Up	Shown with Bow Top, Recessed Front, Moving Modesty and Top Up								
 Support Panel (65-2812RSP) Needed When Connecting to Standard Return or Bridge									
Must Specify (in this order): Model # Top Material Finish/Color Edge Profile Drawer Front Grain Direction Drawer Pull Drawer Construction Drawer Track Moving Modesty Height Adjust Switch Grommet Location Power/Data/Wire Management									
	Description								
	<ul style="list-style-type: none"> Standard with: 2-Channel Leg Configuration for Single Surface Height Adjustment, Includes Controls, Top Profiled on Approach and User Side, Left to Right Grain Direction on Worksurface, Wire Management from Pedestal to Kneespace Support Panel (65-2812RSP) Needed When Connecting to Stationary Return or Bridge Control Switch Standard (SWCH-Up/Down) or Upgrade to Advanced Switch (MSWCH-Up/Down/Memory); See Switch Options Optional Moving Modesty (MOVMOD); Must Specify; Some Assembly Required; See Below and Options Optional 3-Channel Leg Configuration (STS3) for Use with 3-Channel Returns and Bridges; See Option Details and See 3-Channel Units Optional Dove Tail Drawer Construction and Soft Close Drawers (See Drawer Options) For Additional Information Including Worksurface Grommets and Wire Management Boxes, Power Locations, and More can be Found in the Intro Section 								
	High Gloss Acrylic Modesty Options for Stepped Front Desks: Specify & Add								
	65-HGAF High Gloss Acrylic Full Modesty Panel; Must Specify Color (<i>Not Available as Moving Modesty</i>)								
	(GPA) Graphite Acrylic								\$ 1846
	(BLA) Black, (WMA) Wired Mercury, or (WHA) White Acrylic								\$ 1687
	Moving Modesty Options: Specify & Add								
	MOVMOD Moving Modesty								\$ 219

Pricing Codes:
W= Wood Top
P= HPL Top

[See Gesso Intro Section for Ordering Options](#)

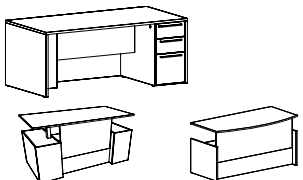
Item	Model No.	Width	Depth	Height	K	R	Ship Wt	Cubic Ft	List Price	
HEIGHT ADJUSTABLE SINGLE PED DESK WITH BOX/BOX/FILE  <p>Shown with Rectangle Top, Stepped Front, Moving Modesty and Top Up</p> <p>Shown with Bow Top, Recessed Front, Moving Modesty and Top Up</p>	Left	Right								
	67-3672LPSSTS	67-3672RPSSTS	72	36	30-45	32¼	10	420	50.0	W/P\$ 9784
	Stepped Front									
	67-3672LPSTS	67-3672RPSTS	72	36	30-45	32¼	10	430	50.0	W/P\$ 9398
	Recessed Front									
67-3072LPSTS	67-3072RPSTS	72	30	30-45	32¼	4	310	43.0	W/P\$ 9336	
Recessed Front										
67-3066LPSTS	67-3066RPSTS	66	30	30-45	26¼	4	280	38.7	W/P\$ 9170	
Recessed Front										
67-3060LPSTS	67-3060RPSTS	60	30	30-45	20¼	4	250	35.0	W/P\$ 9013	
Recessed Front										

Support Panel (65-2812RSP) Needed When Connecting to Standard Return or Bridge

Must Specify (in this order):

- Model #
- Top Material
- Finish/Color
- Edge Profile
- Drawer Front Grain Direction
- Drawer Pull
- Drawer Construction
- Drawer Track
- Moving Modesty
- Height Adjust Switch
- Grommet Location
- Power/Data/Wire Management

Description

- Standard with: 2-Channel Leg Configuration for Single Surface Height Adjustment, Includes Controls, Left to Right Grain Direction on Worksurface, Wire Management from Pedestal to Kneespace
- Control Switch Standard (SWCH-Up/Down) or Upgrade to Advanced Switch (MSWCH-Up/Down/Memory); [See Switch Options](#)
- Support Panel (65-2812RSP) Needed When Connecting to Stationary Return or Bridge
- Optional Moving Modesty (MOVMOD); Some Assembly Required; [See Below and Options](#)
- Optional 3-Channel Leg Configuration (STS3) for Use with 3-Channel Returns and Bridges; [See Option Details](#) and [See 3-Channel Units](#)
- Optional Dove Tail Drawer Construction and Soft Close Drawers ([See Drawer Options](#))
- For Additional Information Including Worksurface Grommets and Wire Management Boxes, Power Locations, and More can be Found in the [Intro Section](#)

High Gloss Acrylic Modesty Options for Stepped Front Desks: Specify & Add

65-HGAF	High Gloss Acrylic Full Modesty Panel; Must Specify Color (<i>Not Available as Moving Modesty</i>)	
	(GPA) Graphite Acrylic	\$ 1846
	(BLA) Black, (WMA) Wired Mercury, or (WHA) White Acrylic	\$ 1687

Moving Modesty Options: Specify & Add

MOVMOD	Moving Modesty	\$ 219
--------	----------------	--------

Pricing Codes:
W= Wood Top
P= HPL Top

[See Gesso Intro Section for Ordering Options](#)

HEIGHT ADJUSTABLE UNITS (6500/6700 SERIES)

Item	Model No.	Width	Depth	Height	Ship Wt	Cubic Ft	List Price
HEIGHT ADJUSTABLE DESK SHELL  <p>Shown with Recessed Front, Moving Modesty and Top Up</p>	65-3672SHSTS	72	36	30-45	274	50.0	W/P\$ 8269
	65-3666SHSTS	66	36	30-45	268	48.0	W/P\$ 8179
	65-3660SHSTS	60	36	30-45	259	43.7	W/P\$ 8098
	65-3072SHSTS	72	30	30-45	265	43.0	W/P\$ 8134
	65-3066SHSTS	66	30	30-45	261	39.0	W/P\$ 8068
	65-3060SHSTS	60	30	30-45	256	35.3	W/P\$ 7951

Must Specify (in this order):

- Model #
- Top Material
- Finish/Color
- Edge Profile
- Drawer Front Grain Direction
- Moving Modesty
- Leg Configuration
- Height Adjust Switch
- Grommet Color
- Power/Data/Wire Management



Support Panel (65-2812RSP) Needed When Connecting to Standard Return or Bridge

Description

- Standard with: 2-Channel Leg Configuration for Single Surface Height Adjustment, Includes Controls, Left to Right Grain Direction on Worksurface, Profiled on Approach and User Side
- Modular Pedestals not Applicable
- Optional 3-Channel Leg Configuration (STS3) for Use with 3-Channel Returns; [See Option Details](#) and [See 3-Channel Units](#)
- Optional Moving Modesty (MOVMOD); Must Specify; Some Assembly Required; [See Below and Options](#)
- Control Switch Standard (Up/Down) or Upgrade to Advanced Switch (MSWCH-Up/Down/Memory); Switch is Field Installed; [See Switch Options](#)
- For Additional Information Including Worksurface Grommets and Wire Management Boxes, Power Locations, and More can be Found in the [Intro Section](#)

Moving Modesty Options: Specify & Add

MOVMOD	Moving Modesty	\$ 219
--------	----------------	--------

HEIGHT ADJUSTABLE D-TOP

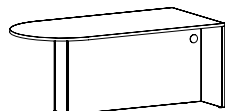

Shown as Left

	Left	Right	Width	Depth	Height	Ship Wt	Cubic Ft	List Price
	65-3684DULSTS	65-3684DURSTS	84	36	30-45	287	60.5	W/P\$ 9459
	65-3672DULSTS	65-3672DURSTS	72	36	30-45	260	50.0	W/P\$ 8828
	65-3084DULSTS	65-3084DURSTS	84	30	30-45	290	51.0	W/P\$ 9323
	65-3072DULSTS	65-3072DURSTS	72	30	30-45	260	50.0	W/P\$ 8715
	65-3066DULSTS	65-3066DURSTS	66	30	30-45	246	40.0	W/P\$ 8559

Must Specify (in this order):

- Model #
- Top Material
- Finish/Color
- Edge Profile
- Moving Modesty
- Leg Configuration
- Height Adjust Switch
- Grommet Location
- Power/Data/Wire Management



Support Panel (65-2812RSP) Needed When Connecting to Standard Return or Bridge

Description

- Standard with: 2-Channel Leg Configuration for Single Surface Height Adjustment, Includes Controls, Left to Right Grain Direction on Worksurface
- Must be Used with Stationary or Height Adjustable Return or Bridge with Credenza
- Support Panel (65-2812RSP) Needed When Connecting to Stationary Return or Bridge
- Optional Worksurface Center Grommet Only; Must Specify: Black (BLK), Silver (SLV) or None (NONE)
- Control Switch Standard (Up/Down) or Upgrade to Advanced Switch (MSWCH-Up/Down/Memory); Switch is Field Installed; [See Switch Options](#)
- Optional Moving Modesty (MOVMOD); Some Assembly Required; [See Below and Options](#)
- Optional 3-Channel Leg Configuration (STS3) for Use with 3-Channel Returns and Bridges; [See Option Details](#) and [See 3-Channel Units](#)
- For Additional Information Including Worksurface Materials and Wire Management Boxes, and More can be Found in the [Intro Section](#)

Moving Modesty Options for Recessed Front Desks: Specify & Add

MOVMOD	Moving Modesty	\$ 219
--------	----------------	--------

Pricing Codes:

W= Wood Top
P= HPL Top

[See Gesso Intro Section for Ordering Options](#)

Item	Model No.	Width	Depth	Height	Ship Wt	Cubic Ft	List Price
HEIGHT ADJUSTABLE P-TOP	Left	Right					
	65-4284PLSTS	65-4284PRSTS	84	36-42	30-45	270	70.0 W/P\$ 9936
	65-4272PLSTS	65-4272PRSTS	72	36-42	30-45	261	60.3 W/P\$ 9548

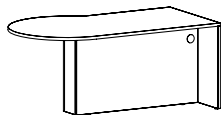

Shown as Left

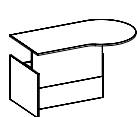

Shown as Left with Moving Modesty

Support Panel (65-2812RSP) Needed When Connecting to Standard Return or Bridge

Must Specify (in this order):

- Model #
- Top Material
- Finish/Color
- Edge Profile
- Moving Modesty
- Leg Configuration
- Height Adjust Switch
- Grommet Location
- Power/Data/Wire Management

Description

- Standard with: 2-Channel Leg Configuration for Single Surface Height Adjustment, Includes Controls, Left to Right Grain Direction on Worksurface
- Must be Used with Stationary or Height Adjustable Return or Bridge with Credenza
- Support Panel (65-2812RSP) Needed When Connecting to Stationary Return or Bridge
- Optional Worksurface Center Grommet Only; Must Specify: Black (BLK), Silver (SLV) or None (NONE)
- Control Switch Standard (Up/Down) or Upgrade to Advanced Switch (MSWCH-Up/Down/Memory); Switch is Field Installed; [See Switch Options](#)
- Optional Moving Modesty (MOVMOD); Some Assembly Required; [See Below and Options](#)
- Optional 3-Channel Leg Configuration (STS3) for Use with 3-Channel Returns and Bridges; [See Option Details](#) and [See 3-Channel Units](#)
- For Additional Information Including Worksurface Materials and Wire Management Boxes, and More can be Found in the [Intro Section](#)

Moving Modesty Options: Specify & Add

MOVMOD	Moving Modesty	\$ 219
--------	----------------	--------

Item	Model No.	Width	Depth	Height	Ship Wt	Cubic Ft	List Price
HEIGHT ADJUSTABLE RETURN WITH FILE/FILE 2-CHANNEL, FOR ONE WORKSURFACE	Left	Right					
	67-2448LF2STS	67-2448RF2STS	48	24	30-45	251	23.1 W/P\$ 7935
	Front to Back Grain Direction on Worksurface						
	67-2442LF2STS	67-2442RF2STS	42	24	30-45	233	20.4 W/P\$ 7823
Front to Back Grain Direction on Worksurface							
	67-4824LF2STS	67-4824RF2STS	48	24	30-45	251	23.1 W/P\$ 7935
Left to Right Grain Direction on Worksurface							
	67-4224LF2STS	67-4224RF2STS	42	24	30-45	233	20.4 W/P\$ 7823
Left to Right Grain Direction on Worksurface							

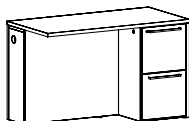

Shown as Right

Must Specify (in this order):

- Model #
- Top Material
- Finish/Color
- Edge Profile
- Drawer Front Grain Direction
- Drawer Pull
- Drawer Construction
- Drawer Track
- Moving Modesty
- Height Adjust Switch
- Grommet Location
- Power/Data/Wire Management
- Modesty Grommet
- Grommet Color

Description

- Standard with: 2-Channel Leg Configuration for Single Surface Height Adjustment, Includes Controls, Top Profiled on User Side, Wire Management from Pedestal to Kneespace
- Control Switch Standard (SWCH-Up/Down) or Upgrade to Advanced Switch (MSWCH-Up/Down/Memory); [See Switch Options](#)
- Optional Modesty Grommet for Wire Management to Wall; Must Specify: Black (GMBBL), Silver (GMBSV) or None (NONE); [See Wire Management Option](#)
- Optional Worksurface Grommet with Mesh Wire Management Sleeve or Wire Management Boxes Available Centered Between Height Adjustable Legs (CKS) and Over Peds and 6" from End (GL or GR); Must Specify Location and Color: GL or GL-MESH for Left or GR or GR-MESH for Right; Color Options: Black (BLK) or Silver (SLV); [See Wire Management Options](#)
- Optional Dove Tail Drawer Construction and Soft Close Drawers ([See Drawer Options](#))
- For Additional Information Including Worksurface Materials, Pulls, Power Availability, and More can be Found in the [Intro Section](#)

Pricing Codes:

W= Wood Top
P= HPL Top

[See Gesso Intro Section for Ordering Options](#)

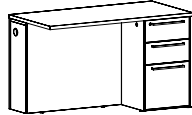
Item	Model No.	Width	Depth	Height	Ship Wt	Cubic Ft	List Price
HEIGHT ADJUSTABLE RETURN WITH BOX/BOX/FILE	Left						
	Right						
2-CHANNEL, FOR ONE WORKSURFACE	67-2448LF1STS	67-2448RF1STS	48	24	30-45	251	W/P\$ 7935
	Front to Back Grain Direction on Worksurface						
	67-2442LF1STS	67-2442RF1STS	42	24	30-45	233	W/P\$ 7823
	Front to Back Grain Direction on Worksurface						
	67-4824LF1STS	67-4824RF1STS	48	24	30-45	251	W/P\$ 7935
	Left to Right Grain Direction on Worksurface						
Shown as Right	67-4224LF1STS	67-4224RF1STS	42	24	30-45	233	W/P\$ 7823
	Left to Right Grain Direction on Worksurface						

Must Specify (in this order):

- Model #
- Top Material
- Finish/Color
- Edge Profile
- Drawer Front Grain Direction
- Drawer Pull
- Drawer Construction
- Drawer Track
- Height Adjust Switch
- Grommet Location
- Power/Data/Wire Management
- Modesty Grommet
- Grommet Color

Description

- Standard with: 2-Channel Leg Configuration for Single Surface Height Adjustment, Includes Controls, Top Profiled on User Side, Wire Management from Pedestal to Kneespace
- Control Switch Standard (SWCH-Up/Down) or Upgrade to Advanced Switch (MSWCH-Up/Down/Memory); [See Switch Options](#)
- Optional Modesty Grommet for Wire Management to Wall; Must Specify: Black (GMBBL), Silver (GMBSV) or None (NONE); [See Wire Management Option](#)
- Optional Worksurface Grommet with Mesh Wire Management Sleeve or Wire Management Boxes Available Centered Between Height Adjustable Legs (CKS) and Over Peds and 6" from End (GL or GR); Must Specify Location and Color: GL or GL-MESH for Left or GR or GR-MESH for Right; Color Options: Black (BLK) or Silver (SLV); [See Wire Management Options](#)
- Optional Dove Tail Drawer Construction and Soft Close Drawers ([See Drawer Options](#))
- For Additional Information Including Worksurface Materials, Pulls, Power Availability, and More can be Found in the [Intro Section](#)

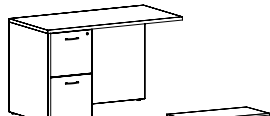
Item	Model No.	Width	Depth	Height	Ship Wt	Cubic Ft	List Price
HEIGHT ADJUSTABLE RETURN WITH FILE/FILE	Left						
	Right						
3-CHANNEL, FOR TWO SIMULTANEOUS WORKSURFACES	67-2448LF2STS3	67-2448RF2STS3	48	24	30-45	201	W/P\$ 5570
	Front to Back Grain Direction on Worksurface						
	67-2442LF2STS3	67-2442RF2STS3	42	24	30-45	183	W/P\$ 5458
	Front to Back Grain Direction on Worksurface						

Shown as Left

Shown as Left
Top Up

Must Specify (in this order):

- Model #
- Top Material
- Finish/Color
- Edge Profile
- Drawer Front Grain Direction
- Drawer Pull
- Drawer Construction
- Drawer Track
- Height Adjust Switch
- Grommet
- Power/Data/Wire Management
- Modesty Grommet
- Grommet Color

Description

- Standard with: 3-Channel Leg Configuration for Multiple Worksurface Height Adjustment, Top Profiled on User Side, Wire Management from Pedestal to Kneespace
- Must be Used with Height Adjustable Single Ped Desk, Height Adjustable D-Top or P-Top
- Control Switch Not Included; Control Switch will be on Adjoining Worksurface
- Optional Modesty Grommet for Wire Management to Wall; Must Specify: Black (GMBBL), Silver (GMBSV) or None (NONE); [See Wire Management Option](#)
- Optional Worksurface Grommet with or without Mesh Wire Management Sleeve Available Over Ped Only; 6" from Ends and 20" from User; Must Specify Location and Color: GL or GL-MESH for Left or GR or GR-MESH for Right; Color Options: Black (BLK) or Silver (SLV); [See Wire Management Options](#)
- Monitor Arms not Available on this Unit
- Optional Dove Tail Drawer Construction and Soft Close Drawers ([See Drawer Options](#))
- For Additional Information Including Worksurface Materials, Pulls, Power Availability, and More can be Found in the [Intro Section](#)

Pricing Codes:

- W= Wood Top
- P= HPL Top

[See Gesso Intro Section for Ordering Options](#)

Item	Model No.	Width	Depth	Height	Ship Wt	Cubic Ft	List Price
HEIGHT ADJUSTABLE RETURN WITH BOX/BOX/FILE	Left	Right					
	67-2448LF1STS3	67-2448RF1STS3	48	24	30-45	201	W/P\$ 5570
3-CHANNEL, FOR TWO SIMULTANEOUS WORKSURFACES							
	67-2442LF1STS3	67-2442RF1STS3	42	24	30-45	183	W/P\$ 5458

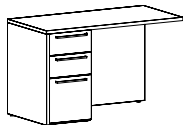

Shown as Left

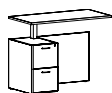
Shown as Left
Top UpMust Specify (in this order):

Model #
Top Material
Finish/Color
Edge Profile
Drawer Front Grain Direction
Drawer Pull
Drawer Construction
Drawer Track
Height Adjust Switch
Grommet
Power/Data/Wire Management
Modesty Grommet
Grommet Colors.

Description

- Standard with: 3-Channel Leg Configuration for Multiple Worksurface Height Adjustment, Top Profiled on User Side, Wire Management from Pedestal to Kneespace
- Must be Used with Height Adjustable Single Ped Desk, Height Adjustable D-Top or P-Top
- Control Switch Not Included; Control Switch will be on Adjoining Worksurface
- Optional Modesty Grommet for Wire Management to Wall; Must Specify: Black (GMBBL), Silver (GMBSV) or None (NONE); [See Wire Management Option](#)
- Optional Worksurface Grommet with or without Mesh Wire Management Sleeve Available Over Ped Only; 6" from Ends and 20" from User; Must Specify Location and Color: GL or GL-MESH for Left or GR or GR-MESH for Right; Color Options: Black (BLK) or Silver (SLV); [See Wire Management Options](#)
- Monitor Arms not Available on this Unit
- Optional Dove Tail Drawer Construction and Soft Close Drawers ([See Drawer Options](#))
- For Additional Information Including Worksurface Materials, Pulls, Power Availability, and More can be Found in the [Intro Section](#)

HEIGHT ADJUSTABLE RETURN SHELL

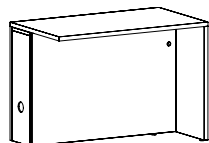
Must Specify (in this order):

Model #
Top Material
Finish/Color
Edge Profile
Height Adjust Switch
Grommet
Power/Data/Wire Management
Modesty Grommet
Grommet Color

End Panel Left	End Panel Right	Width	Depth	Height	Ship Wt	Cubic Ft	List Price
65-2448RSHLSTS	65-2448RSHRSTS	48	24	30-45	280	24.0	W/P\$ 7001
65-2442RSHLSTS	65-2442RSHRSTS	42	24	30-45	250	24.0	W/P\$ 6891

Description

- Standard with: 2-Channel Leg Configuration for Single Surface Height Adjustment, Includes Controls, Top Profiled on User Side, Front to Back Grain Direction on Worksurface
- Optional Worksurface Grommet with Mesh Wire Management Sleeve or Wire Management Box on Center Only; Must Specify: Black (BLK), Silver (SLV) or None (NONE); [See Grommet Option](#)
- Control Switch Standard (SWCH-Up/Down) or Upgrade to Advanced Switch (MSWCH-Up/Down/Memory); [See Switch Options](#)
- Optional Modesty Grommet on Approach for Wire Management to Wall; Must Specify: Black (GMBBL), Silver (GMBSV) or None (NONE); [See Wire Management Option](#)
- For Additional Information Including Worksurface Materials, Pulls, Power Availability, and More can be Found in the [Intro Section](#)

Pricing Codes:

W= Wood Top
P= HPL Top

[See Gesso Intro Section for Ordering Options](#)

Item	Model No.	Width	Depth	Height	Ship Wt	Cubic Ft	List Price
HEIGHT ADJUSTABLE BRIDGE 2-CHANNEL, FOR ONE WORKSURFACE	65-2448UFSTS	48	24	30-45	182	24.0	W/P\$ 6462
	65-2442UFSTS	42	24	30-45	168	21.0	W/P\$ 6415
	65-2436UFSTS	36	24	30-45	146	18.0	W/P\$ 6356
	65-2048UFSTS	48	20	30-45	177	20.0	W/P\$ 6372
	65-2042UFSTS	42	20	30-45	167	18.0	W/P\$ 6333
	65-2036UFSTS	36	20	30-45	143	15.0	W/P\$ 6279

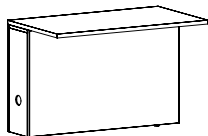

SIN PENDING

Must Specify (in this order):

- Model #
- Top Material
- Finish/Color
- Edge Profile
- Height Adjust Switch
- Grommet
- Power/Data/Wire Management
- Modesty Grommet
- Grommet Color

Description

- Standard with: 2-Channel Leg Configuration for Single Surface Height Adjustment, Includes Controls, Top Profiled on User Side, Front to Back Grain Direction on Worksurface
- Optional Worksurface Grommet with or without Mesh Wire Management Sleeve or Wire Management Box Available On Center Only [See Grommet Option](#)
- Control Switch Standard (Up/Down) or Upgrade to Advanced Switch (MSWCH-Up/Down/Memory); Switch is Field Installed; [See Switch Options](#)
- Optional Modesty Grommet on Approach for Wire Management to Wall; Must Specify: Black (GMBBL), Silver (GMBSV) or None (NONE); [See Wire Management Option](#)
- For Additional Information Including Worksurface Materials, Grommet and Power/Data Options, and More can be Found in the [Intro Section](#)

HEIGHT ADJUSTABLE BRIDGE FOR MULTIPLE SURFACES									
	Left	Right	Width	Depth	Height	Ship Wt	Cubic Ft	List Price	
3-CHANNEL, FOR TWO SIMULTANEOUS WORKSURFACES	65-2448UFSTSL3	65-2448UFSTSR3	48	24	30-45	172	24.0	W/P\$ 5271	
	65-2442UFSTSL3	65-2442UFSTSR3	42	24	30-45	158	21.0	W/P\$ 5225	
	65-2436UFSTSL3	65-2436UFSTSR3	36	24	30-45	136	18.0	W/P\$ 5166	
	65-2048UFSTSL3	65-2048UFSTSR3	48	20	30-45	167	20.0	W/P\$ 5182	
	65-2042UFSTSL3	65-2042UFSTSR3	42	20	30-45	154	18.0	W/P\$ 5143	
	65-2036UFSTSL3	65-2036UFSTSR3	36	20	30-45	133	15.0	W/P\$ 5089	

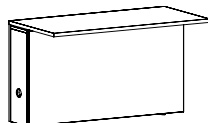

SIN PENDING

Must Specify (in this order):

- Model #
- Top Material
- Top Color
- Edge Profile
- Chassis Color
- Grommet
- Power/Data/Wire Management
- Modesty Grommet
- Grommet Color

Description

- Standard with: 3-Channel Leg Configuration for Multiple Surface Height Adjustment, Top Profiled on User Side, Front to Back Grain Direction on Worksurface
- Optional Worksurface Grommet with Mesh Wire Management Sleeve or Wire Management Box Available On Center Only [See Grommet Option](#)
- Control Switch Not Included; Control Switch will be on Adjoining Worksurface
- Optional Modesty Grommet on Approach for Wire Management to Wall; Must Specify: Black (GMBBL), Silver (GMBSV) or None (NONE); [See Wire Management Option](#)
- For Additional Information Including Worksurface Materials, Grommet and Power/Data Options, and More can be Found in the [Intro Section](#)

Pricing Codes:

- W= Wood Top
- P= HPL Top

[See Gesso Intro Section for Ordering Options](#)

Item	Model No.	Width	Depth	Height	Ship Wt	Cubic Ft	List Price
HEIGHT ADJUSTABLE SINGLE PED CREDENZA WITH FILE/FILE	End Panel Left	End Panel Right					
	67-2472LC2STS	67-2472RC2STS	72	24	30-45	300	W/P\$ 8639
	67-2466LC2STS	67-2466RC2STS	66	24	30-45	282	W/P\$ 8606

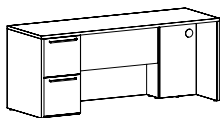

Shown as Left

Must Specify (in this order):

- Model #
- Top Material
- Finish/Color
- Edge Profile
- Drawer Front Grain Direction
- Drawer Pull
- Drawer Construction
- Drawer Track
- Height Adjust Switch
- Grommet Color
- Power/Data/Wire Management

Description

- Standard with: 2-Channel Leg Configuration for Single Surface Height Adjustment, Includes Controls; Top Profiled on Approach and User Side, Left to Right Grain Direction on Worksurface
- Support Panel ([65-2812RSP](#)) Needed When Connecting to Standard Return or Bridge
- Control Switch Standard (SWCH-Up/Down) or Upgrade to Advanced Switch (MSWCH-Up/Down/Memory); [See Switch Options](#)
- Optional 3-Channel Leg Configuration (STS3) for Use with 3-Channel Returns; [See Option Details](#) and [See 3-Channel Units](#)
- Optional Modesty Grommet on Approach for Wire Management to Wall; Must Specify: Black (GMBBL), Silver (GMBSV); [See Wire Management Option](#)
- Optional Dove Tail Drawer Construction and Soft Close Drawers ([See Drawer Options](#))
- For Additional Information Including Worksurface Grommet and Wire Management Box Locations, Pulls, Power Availability, and More can be Found in the [Intro Section](#)



Support Panel ([65-2812RSP](#)) Needed When Connecting to Standard Return or Bridge

HEIGHT ADJUSTABLE SINGLE PED CREDENZA WITH BOX/BOX/FILE	End Panel Left	End Panel Right					
	67-2472LC1STS	67-2472RC1STS	72	24	30-45	300	W/P\$ 8639
	67-2466LC1STS	67-2466RC1STS	66	24	30-45	282	W/P\$ 8606

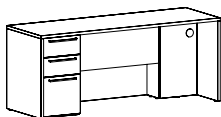

Shown as Left

Must Specify (in this order):

- Model #
- Top Material
- Finish/Color
- Edge Profile
- Drawer Front Grain Direction
- Drawer Pull
- Drawer Construction
- Drawer Track
- Height Adjust Switch
- Grommet Color
- Power/Data/Wire Management

Description

- Standard with: 2-Channel Leg Configuration for Single Surface Height Adjustment, Includes Controls; Top Profiled on Approach and User Side, Left to Right Grain Direction on Worksurface
- Support Panel ([65-2812RSP](#)) Needed When Connecting to Standard Return or Bridge
- Control Switch Standard (SWCH-Up/Down) or Upgrade to Advanced Switch (MSWCH-Up/Down/Memory); [See Switch Options](#)
- Optional 3-Channel Leg Configuration (STS3) for Use with 3-Channel Returns; [See Option Details](#) and [See 3-Channel Units](#)
- Optional Modesty Grommet on Approach for Wire Management to Wall; Must Specify: Black (GMBBL), Silver (GMBSV); [See Wire Management Option](#)
- Optional Dove Tail Drawer Construction and Soft Close Drawers ([See Drawer Options](#))
- For Additional Information Including Worksurface Grommet and Wire Management Box Locations, Pulls, Power Availability, and More can be Found in the [Intro Section](#)



Support Panel ([65-2812RSP](#)) Needed When Connecting to Standard Return or Bridge

Pricing Codes:

W= Wood Top
P= HPL Top

[See Gesso Intro Section for Ordering Options](#)

Item	Model No.	Width	Depth	Height	Ship Wt	Cubic Ft	List Price
HEIGHT ADJUSTABLE KNEESPACE CREDENZA WITH FILE/FILE PEDS	67-2472KCSTS	72	24	30-45	340	35.6	W/P\$ 9999
	67-2466KCSTS	66	24	30-45	320	32.7	W/P\$ 9666

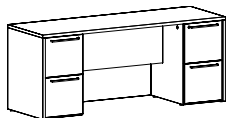

Must Specify (in this order):

- Model #
- Top Material
- Finish/Color
- Edge Profile
- Drawer Front Grain Direction
- Drawer Pull
- Drawer Construction
- Drawer Track
- Height Adjust Switch
- Grommet Color
- Power/Data/Wire Management

Description

- Standard with: 2-Channel Leg Configuration for Single Surface Height Adjustment, Includes Controls; Top Profiled on Approach and User Side, Left to Right Grain Direction on Worksurface
- Control Switch Standard (SWCH-Up/Down) or Upgrade to Advanced Switch (MSWCH-Up/Down/Memory); [See Switch Options](#)
- Optional Modesty Grommet on Approach for Wire Management to Wall; Must Specify: Black (GMBBL), Silver (GMBSV); [See Wire Management Option](#)
- Optional Dove Tail Drawer Construction and Soft Close Drawers ([See Drawer Options](#))
- For Additional Information Including Worksurface Grommet and Wire Management Box Locations, Pulls, Power Availability, and More can be Found in the [Intro Section](#)

HEIGHT ADJUSTABLE CREDENZA SHELL	65-2472SHSTS	72	24	30-45	294	36.0	W/P\$ 7861
	65-2466SHSTS	66	24	30-45	287	33.0	W/P\$ 7786
	65-2460SHSTS	60	24	30-45	280	30.0	W/P\$ 7722

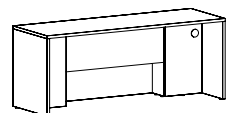

Must Specify (in this order):

- Model #
- Top Material
- Finish/Color
- Edge Profile
- Leg Configuration
- Height Adjust Switch
- Grommet Color
- Power/Data/Wire Management

Description

- Standard with: 2-Channel Leg Configuration for Single Surface Height Adjustment, Includes Controls; Profiled on User Side, Modesty Grommet, and Left to Right Grain Direction on Worksurface
- Optional 3-Channel Leg Configuration (STS3) for Use with 3-Channel Returns; [See Option Details](#) and [See 3-Channel Units](#)
- Modular Pedestals not Applicable
- Support Panel ([65-2812RSP](#)) Needed When Connecting to Standard Return or Bridge
- Control Switch Standard (Up/Down) or Upgrade to Advanced Switch (MSWCH-Up/Down/Memory); Switch is Field Installed; [See Switch Options](#)
- For Additional Information Including Worksurface Grommet and Wire Management Box Locations, Power Availability, and More can be Found in the [Intro Section](#)



Support Panel
[\(65-2812RSP\)](#)
Needed When
Connecting to
Standard Return
or Bridge

SUPPORT PANEL	65-2812RSP	12	1	28¼	12	0.8	W\$ 436
---------------	------------	----	---	-----	----	-----	---------



Description

- To be Used to Support Stationary Returns and Bridges Worksurfaces with Height Adjustable Units
- Required to be Used Perpendicular to Full Back Panels for Support of Kneespace Areas 60" or Longer

Must Specify (in this order):

- Model #
- Finish

Pricing Codes:
W= Wood Top
P= HPL Top

[See Gesso Intro Section for Ordering Options](#)

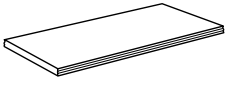
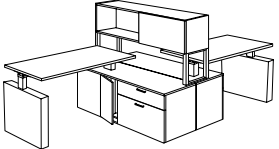
Item	Model No.	Width	Depth	Height	Ship Wt	Cubic Ft	List Price
 	65-3462HTP For 72" Footprint	62	34	1 $\frac{1}{16}$ "	84	5.3	W/P\$ 1141
	65-3456HTP For 66" Footprint	56	34	1 $\frac{1}{16}$ "	78	4.8	W/P\$ 1092
	65-2862HTP For 72" Footprint	62	28	1 $\frac{1}{16}$ "	79	4.2	W/P\$ 1076
	65-2856HTP For 66" Footprint	56	28	1 $\frac{1}{16}$ "	75	3.8	W/P\$ 990
	65-2850HTP For 60" Footprint	50	28	1 $\frac{1}{16}$ "	71	3.4	W/P\$ 936
	65-2262HTP For 72" Footprint	62	22	1 $\frac{1}{16}$ "	42	3.3	W/P\$ 935
	65-2256HTP For 66" Footprint	56	22	1 $\frac{1}{16}$ "	36	3.0	W/P\$ 892
	65-2250HTP For 60" Footprint	50	22	1 $\frac{1}{16}$ "	33	2.7	W/P\$ 818

Must Specify (in this order):

Model #
Top Material
Finish/Color
Edge Profile
Grommet Location
Grommet Color
Power/Data/Wire Management

Description

- Profiled on Approach and User Side
- 10" Width Offset to Provide Clearance for Overhead Storage and Access to Optional Power in Credenza
- Depth Allows for Use With Gallery Screens
- Not Available for Use with Height Adjustable Open Bookcase with Controls
- Optional Height Adjustable Legs and Cabinets; Starting on Next Page
- Additional Options: Power, Monitor Arm and Grommet Options ([See Options](#))

	65-3470HTP Stiffener Bar Included	70	34	1 $\frac{1}{16}$ "	115	6.2	W/P\$ 1588
	65-3464HTP	64	34	1 $\frac{1}{16}$ "	68	5.2	W/P\$ 1215
	65-3458HTP	58	34	1 $\frac{1}{16}$ "	62	4.8	W/P\$ 1159
	65-2870HTP Stiffener Bar Included	70	28	1 $\frac{1}{16}$ "	85	4.6	W/P\$ 1370
	65-2864HTP	64	28	1 $\frac{1}{16}$ "	81	4.3	W/P\$ 1052
	65-2858HTP	58	28	1 $\frac{1}{16}$ "	77	3.9	W/P\$ 999
	65-2852HTP	52	28	1 $\frac{1}{16}$ "	73	3.5	W/P\$ 918
	65-2846HTP	46	28	1 $\frac{1}{16}$ "	69	3.1	W/P\$ 853

Description

- Profiled on Approach and User Side
- Optional Height Adjustable Legs and Cabinets; Starting on Next Page
- Additional Options: Power, Monitor Arm and Grommet Options ([See Options](#))

Pricing Codes:

W= Wood Top
P= HPL Top

[See Gesso Intro Section for Ordering Options](#)

Item	Model No.	Width	Depth	Height	Ship Wt	Cubic Ft	List Price
HEIGHT ADJUSTABLE WORK SURFACE FOR MULTIPLE AND INDIVIDUAL WORKSTATIONS 	65-2270HTP Stiffener Bar Included	70	22	1	50	3.8	W/P\$ 1237
	65-2264HTP	64	22	1	44	3.4	W/P\$ 946
	65-2258HTP	58	22	1	38	3.1	W/P\$ 901
	65-2252HTP	52	22	1	35	2.8	W/P\$ 827
	65-2246HTP	46	22	1	31	2.5	W/P\$ 768

Must Specify (in this order):

Model #
Top Material
Finish/Color
Edge Profile
Grommet Location
Grommet Color
Power/Data/Wire Management

Description

- Profiled on Approach and User Side
- Can Also be Used in Individual Workstations Applications
- Optional Height Adjustable Legs and Cabinets; Starting below
- Additional Options: Power, Monitor Arm and Grommet Options ([See Options](#))

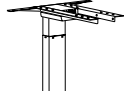
HEIGHT ADJUSTABLE T-LEG 	01-2245HTLC Includes Control, Motor Cable and Keypad	22	2	28¼	40	0.5	\$ 2077
	01-2245HTL Does Not Include Control, Requires a Unit with Control	22	2	28¼	40	0.5	\$ 1442

Must Specify (in this order):

Model #
Color

Description

- Available in Black or Silver; Must Specify
- 16" Adjustable Range

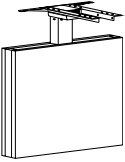
HEIGHT ADJUSTABLE PANEL LEG 	65-0536HPC For Use With 34"D Top Includes Control, Motor Cable and Keypad	36	5½	28¼	50	4.5	W/P\$ 3257
	65-0530HPC For Use With 28"D Top Includes Control, Motor Cable and Keypad	30	5½	28¼	49	4.5	W/P\$ 3191
	65-0524HPC For Use With 22"D Top Includes Control, Motor Cable and Keypad	24	5½	28¼	48	4.5	W/P\$ 3010
	65-0536HP For Use With 34"D Top Does Not Include Control, Requires a Unit with Control	36	5½	28¼	50	4.5	W/P\$ 2664
	65-0530HP For Use With 28"D Top Does Not Include Control, Requires a Unit with Control	30	5½	28¼	49	4.5	W/P\$ 2597
	65-0524HP For Use With 22"D Top Does Not Include Control, Requires a Unit with Control	24	5½	28¼	48	4.5	W/P\$ 2418

Must Specify (in this order):

Model #
Finish/Color

Description

- Available in Black or Silver; Must Specify
- 16" Adjustable Range

Pricing Codes:

W= Wood Top
P= HPL Top

[See Gesso Intro Section for Ordering Options](#)

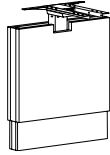
Item	Model No.	Width	Depth	Height	Ship Wt	Cubic Ft	List Price
HEIGHT ADJUSTABLE PANEL LEG WITH SLEEVE 	65-0536HPSC For Use With 34"D Top Includes Control, Motor Cable and Keypad	34	5 $\frac{5}{8}$	28 $\frac{1}{4}$	50	4.5	W/P\$ 4198
	65-0530HPSC For Use With 28"D Top Includes Control, Motor Cable and Keypad	28	5 $\frac{5}{8}$	28 $\frac{1}{4}$	49	4.5	W/P\$ 4076
	65-0524HPSC For Use With 22"D Top Includes Control, Motor Cable and Keypad	22	5 $\frac{5}{8}$	28 $\frac{1}{4}$	48	4.5	W/P\$ 3827
	65-0536HPS For Use With 34"D Top Does Not Include Control, Requires a Unit with Control	34	5 $\frac{5}{8}$	28 $\frac{1}{4}$	50	4.5	W/P\$ 3603
	65-0530HPS For Use With 28"D Top Does Not Include Control, Requires a Unit with Control	28	5 $\frac{5}{8}$	28 $\frac{1}{4}$	49	4.5	W/P\$ 3483
	65-0524HPS For Use With 22"D Top Does Not Include Control, Requires a Unit with Control	22	5 $\frac{5}{8}$	28 $\frac{1}{4}$	48	4.5	W/P\$ 3232

Must Specify (in this order):

Model #
Finish/Color

Description

- For Use in Place of Cabinet
- 16" Adjustable Range
- Not Compatible with 4" Modesty Panels

HEIGHT ADJUSTABLE PANEL LEG FOR SHARED WORKSTATION	65-1124HP	24	10 $\frac{1}{4}$	28 $\frac{1}{4}$	50	4.5	W/P\$ 3547
---	-----------	----	------------------	------------------	----	-----	------------

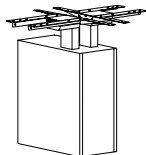

Description

- Available in Black or Silver; Must Specify
- 16" Adjustable Range
- Shared Cabinet with Dual Legs For Multi-Workstation Footprints
- Required to be Used with a Unit Including Controls
- For Use with 24" Deep Worksurfaces

Must Specify (in this order):

Model #
Finish/Color

Pricing Codes:

W= Wood Top
P= HPL Top

[See Gesso Intro Section for Ordering Options](#)

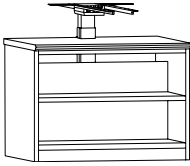
Item	Model No.	Width	Depth	Height	Ship Wt	Cubic Ft	List Price
HEIGHT ADJUSTABLE OPEN BOOKCASE WITH CONTROL 	65-2436HBM	36	24	21¾	99	18.3	W/P\$ 4721
	65-2430HBM	30	24	21¾	89	15.4	W/P\$ 4634
	65-2424HBM	24	24	21¾	79	12.5	W/P\$ 4537
	65-2036HBM	36	20	21¾	89	15.5	W/P\$ 4616
	65-2030HBM	30	20	21¾	79	13.1	W/P\$ 4543
	65-2024HBM	24	20	21¾	69	10.6	W/P\$ 4444

Must Specify (in this order):

Model #
 Top Material
 Finish/Color
 Edge Profile
 Leg Color
 Wire Management Sleeve
 Wire Management Kneespace Access

Description

- Open Back; [See Back Panel Options](#)
- Open Book Case with Controls; Profiled on User Side
- One Adjustable Shelf; 13" Deep Shelf on 24" Units/9" Deep Shelf on 20" Units
- Not Available for Use with Overhead Storage
- When Used as Peninsula Desk, Additional Panel Leg Must be Used on Opposite Side for Support ([See Panel Legs](#) 01-2245HTL, 65-0536HPS, 65-0530HPS, 65-0524HPS, 65-0536HP, 65-0530HPS, or 65-0524HPS)
- Leg Available in Black or Silver; Must Specify
- Worksurface Grommet Standard; Must Specify: Black (BLK), Silver (SLV)
- Optional Wire Management Sleeve Available (See Below); Wire Management Sleeve Replaces Standard Work Surface Grommet
- Wire Management Access from Pedestal to Kneespace; Specify Left (WML), Right (WMR) or Left and Right (WMLR)



Options: Specify & Add

WM Sleeve	Wire Management Sleeve	W\$ 715
-----------	------------------------	---------

Pricing Codes:

W= Wood Top
 P= HPL Top

[See Gesso Intro Section for Ordering Options](#)

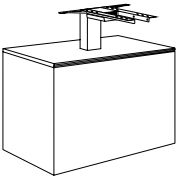
Item	Model No.	Width	Depth	Height	Ship Wt	Cubic Ft	List Price
HEIGHT ADJUSTABLE CABINET WITH CONTROL 	65-2436HM	36	24	21¾	99	18.3	W/P\$ 4190
	65-2430HM	30	24	21¾	89	15.4	W/P\$ 4112
	65-2424HM	24	24	21¾	79	12.5	W/P\$ 4025
	65-2036HM	36	20	21¾	89	15.5	W/P\$ 4095
	65-2030HM	30	20	21¾	79	13.1	W/P\$ 4028
	65-2024HM	24	20	21¾	69	10.6	W/P\$ 3940

Must Specify (in this order):

- Model #
- Top Material
- Finish/Color
- Edge Profile
- Access Front Panel Grain Direction
- Leg Color
- Wire Management Sleeve
- Wire Management Kneespace Access

Description

- Open Back; [See Back Panel Options](#)
- Cabinet with Controls; Profiled on User Side
- Open Bottom Allows for Wire Management
- Removable Access Front Panel Available in Vertical Grain Direction Standard; Optional Horizontal Grain Direction; Must Specify
- When Used as Peninsula Desk, Additional Panel Leg Must be Used on Opposite Side for Support ([See Panel Legs](#) 01-2245HTL, 65-0536HPS, 65-0530HPS, 65-0524HPS, 65-0536HP, 65-0530HP, or 65-0524HP)
- Leg Available in Black or Silver; Must Specify
- Worksurface Grommet Standard; Must Specify: Black (BLK), Silver (SLV)
- Optional Wire Management Sleeve Available (See Below); Wire Management Sleeve Replaces Standard Work Surface Grommet
- Wire Management Access from Pedestal to Kneespace; Specify Left (WML), Right (WMR) or Left and Right (WMLR)

Options: Specify & Add

WM Sleeve	Wire Management Sleeve	W\$ 715
-----------	------------------------	---------

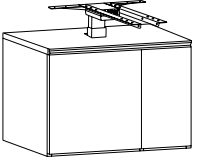

HEIGHT ADJUSTABLE CABINET WITH DOOR AND CONTROL 	Leg Left of Door	Leg Right of Door	Width	Depth	Height	Ship Wt	Cubic Ft	List Price
	65-2436HDL	65-2436HDR	30	24	21¾	95	18.3	W/P\$ 4770
	65-2430HDL	65-2430HDR	24	24	21¾	75	15.4	W/P\$ 4680
	65-2036HDL	65-2036HDR	36	20	21¾	85	15.5	W/P\$ 4669
	65-2030HDL	65-2030HDR	30	20	21¾	65	13.1	W/P\$ 4585

Shown as Left
(Leg is Left of Door)

Must Specify (in this order):

- Model #
- Top Material
- Finish/Color
- Edge Profile
- Door/Front Panel Grain Direction
- Leg Color
- Wire Management Sleeve
- Wire Management Kneespace Access

Description

- Open Back; [See Back Panel Options](#)
- Handed Based on Facing the Unit
- Cabinet with Controls; Profiled on User Side
- Open Bottom Allows for Wire Management
- 9" Door Opening With Touch Latch and Includes Bottom Panel, Storage Behind Door
- When Used as Peninsula Desk, Additional Panel Leg Must be Used on Opposite Side for Support ([See Panel Legs](#) 01-2245HTL, 65-0536HPS, 65-0530HPS, 65-0524HPS, 65-0536HP, 65-0530HP, or 65-0524HP)
- Door and Removable Access Front Panel Available in Vertical Grain Direction Standard; Optional Horizontal Grain Direction; Must Specify
- Leg Available in Black or Silver; Must Specify
- Worksurface Grommet Standard; Must Specify: Black (BLK), Silver (SLV)
- Wire Management Access from Pedestal to Kneespace; Specify Left (WML), Right (WMR) or Left and Right (WMLR)

Pricing Codes:

- W= Wood Top
- P= HPL Top

[See Gesso Intro Section for Ordering Options](#)

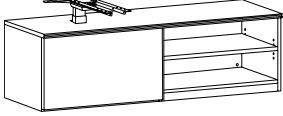
Item	Model No.	Width	Depth	Height	Ship Wt	Cubic Ft	List Price
HEIGHT ADJUSTABLE CREDENZA WITH OPEN BOOKCASE AND CONTROL  Shown as Left	Leg in Left Cabinet	Leg in Right Cabinet					
	65-2472HMOL	65-2472HMOR	72	24	21¾	240	W/P\$ 5871
	65-2466HMOL	65-2466HMOR	66	24	21¾	220	W/P\$ 5746
	65-2460HMOL	65-2460HMOR	60	24	21¾	220	W/P\$ 5621
	65-2072HMOL	65-2072HMOR	72	20	21¾	220	W/P\$ 5658
	65-2066HMOL	65-2066HMOR	66	20	21¾	210	W/P\$ 5539
	65-2060HMOL	65-2060HMOR	60	20	21¾	210	W/P\$ 5416
	Must Specify (in this order): Model # Top Material Finish/Color Edge Profile Wire Management Sleeve Front Panel Grain Direction Leg Color Worksurface Grommet Grommet Color Power/Data/Wire Management Back Panel Grommet						
Description <ul style="list-style-type: none"> • Standard with: Controls, Back Panel, One Adjustable Shelf in Bookcase End, Profiled on User Side • Bottom Panel Not Included Behind Removable Access Front Panel for Wire Management • Designed for 28" Deep Worksurfaces Only (See Worksurfaces) • Handed Based on Height Adjust Cabinet and Facing the Unit • Removable Access Front Panel Available in Vertical Grain Direction Standard; Optional Horizontal Grain Direction; Must Specify • When Used as Peninsula Desk, Additional Panel Leg Must be Used on Opposite Side for Support (See Panel Legs 01-2245HTL, 65-0536HPS, or 65-0530HPS) • Leg Available in Black or Silver; Must Specify • Worksurface Grommet Standard; Must Specify: Black (BLK), Silver (SLV) • Optional Back Panel Grommet, Must Specify • Optional Wire Management Sleeve Available (See Below); Wire Management Sleeve Replaces Standard Work Surface Grommet • Optional Power Locations; See Power Options 							
Options: Specify & Add							
	WM Sleeve	Wire Management Sleeve					W\$ 715



Pricing Codes:
 W= Wood Top
 P= HPL Top

[See Gesso Intro Section for Ordering Options](#)

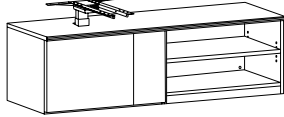
Item	Model No.	Width	Depth	Height	Ship Wt	Cubic Ft	List Price
HEIGHT ADJUSTABLE CREDENZA WITH DOOR, OPEN BOOKCASE AND CONTROL  Shown as Left	Leg in Left Cabinet	Leg in Right Cabinet					
	65-2472HDOL	65-2472HDOR	72	24	21¾	240	35.6 W/P\$ 6528
	65-2466HDOL	65-2466HDOR	66	24	21¾	230	32.6 W/P\$ 6391
	65-2460HDOL	65-2460HDOR	60	24	21¾	220	29.8 W/P\$ 6256
	65-2072HDOL	65-2072HDOR	72	20	21¾	240	30.2 W/P\$ 6296
	65-2066HDOL	65-2066HDOR	66	20	21¾	230	27.7 W/P\$ 6162
	65-2060HDOL	65-2060HDOR	60	20	21¾	220	25.2 W/P\$ 6033

Must Specify (in this order):

Model #
 Top Material
 Finish/Color
 Edge Profile
 Wire Management Sleeve
 Door/Front Panel Grain Direction
 Leg Color
 Worksurface Grommet
 Grommet Color
 Power/Data/Wire Management
 Back Panel Grommet

Description

- Credenza with Controls; Profiled on User Side; Back Panel Included, One Adjustable Shelf in Bookcase End
- Bottom Panel Not Included Behind Removable Access Front Panel for Wire Management
- 9" Door Opening With Touch Latch and Includes Bottom Panel, Storage Behind Door
- Designed for 28" Deep Worksurfaces Only ([See Worksurfaces](#))
- Handed Based on Height Adjust Cabinet and Facing the Unit
- Door and Removable Access Front Panel Available in Vertical Grain Direction Standard; Optional Horizontal Grain Direction; Must Specify
- When Used as Peninsula Desk, Additional Panel Leg Must be Used on Opposite Side for Support ([See Panel Legs](#) 01-2245HTL, 65-0536HPS, or 65-0530HPS)
- Leg Available in Black or Silver; Must Specify
- Worksurface Grommet Standard; Must Specify: Black (BLK), Silver (SLV)
- Optional Back Panel Grommet, Must Specify
- Optional Power Locations; [See Power Options](#)

Pricing Codes:

W= Wood Top
 P= HPL Top

[See Gesso Intro Section for Ordering Options](#)

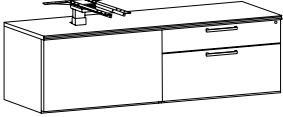
Item	Model No.	Width	Depth	Height	Ship Wt	Cubic Ft	List Price	
HEIGHT ADJUSTABLE CREDENZA WITH BOX/FILE AND CONTROL  Shown as Left	Leg in Left Cabinet	Leg in Right Cabinet						
	65-2472HMFL	65-2472HMFR	72	24	21¾	260	W/P\$ 6494	
	65-2466HMFL	65-2466HMFR	66	24	21¾	240	W/P\$ 6356	
	65-2460HMFL	65-2460HMFR	60	24	21¾	240	W/P\$ 6222	
	65-2072HMFL	65-2072HMFR	72	20	21¾	220	W/P\$ 6260	
	65-2066HMFL	65-2066HMFR	66	20	21¾	210	W/P\$ 6132	
	65-2060HMFL	65-2060HMFR	60	20	21¾	210	W/P\$ 6000	
	Description							
	<ul style="list-style-type: none"> • Cabinet with Controls; Profiled on User Side; Back Panel Included • Bottom Panel Not Included Behind Removable Access Front Panel for Wire Management • Locking Box/File; File Drawers Provide Legal or Letter Filing • Designed for 28" Deep Worksurfaces Only (See Worksurfaces) • Handed Based on Height Adjust Cabinet and Facing the Unit • When Used as Peninsula Desk, Additional Panel Leg Must be Used on Opposite Side for Support (See Panel Legs 01-2245HTL, 65-0536HPS, or 65-0530HPS) • Drawer Fronts and Removable Access Front Panel Available in Vertical Grain Direction Standard; Optional Horizontal Grain Direction; Must Specify • If Black or Gold Pull is Selected, Leg and Lock Core will be Black; If Chrome or Aluminum Pull is Selected, Leg and Lock Core will be Silver • Worksurface Grommet Standard; Must Specify: Black (BLK), Silver (SLV) • Optional Back Panel Grommet, Must Specify • Optional Wire Management Sleeve Available (See Below); Wire Management Sleeve Replaces Standard Work Surface Grommet • Additional Options: Dove Tail Drawer Construction and Soft Close Box Drawer (See Drawer Options), Power Locations (See Power Options) 							
	Options: Specify & Add							
WM Sleeve	Wire Management Sleeve						W\$ 715	

Must Specify (in this order):

- Model #
- Top Material
- Finish/Color
- Edge Profile
- Wire Management Sleeve
- Front Panel Grain Direction
- Leg Color
- Worksurface Grommet
- Grommet Color
- Power/Data/Wire Management
- Back Panel Grommet



Pricing Codes:
W= Wood Top
P= HPL Top

[See Gesso Intro Section for Ordering Options](#)

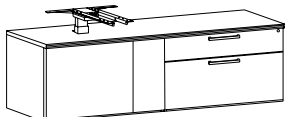
Item	Model No.	Width	Depth	Height	Ship Wt	Cubic Ft	List Price
HEIGHT ADJUSTABLE CREDENZA WITH DOOR, WITH BOX/FILE AND CONTROL  Shown as Left	Leg in Left Cabinet	Leg in Right Cabinet					
	65-2472HDFL	65-2472HDFR	72	24	21¾	260	W/P\$ 6992
	65-2466HDFL	65-2466HDFR	66	24	21¾	250	W/P\$ 6845
	65-2460HDFL	65-2460HDFR	60	24	21¾	240	W/P\$ 6705
	65-2072HDFL	65-2072HDFR	72	20	21¾	240	W/P\$ 6744
	65-2066HDFL	65-2066HDFR	66	20	21¾	230	W/P\$ 6605
	65-2060HDFL	65-2060HDFR	60	20	21¾	220	W/P\$ 6465

Must Specify (in this order):

Model #
 Top Material
 Finish/Color
 Edge Profile
 Wire Management Sleeve
 Door/Front Panel Grain Direction
 Leg Color
 Worksurface Grommet
 Grommet Color
 Power/Data/Wire Management
 Back Panel Grommet

Description

- Credenza with Controls; Profiled on User Side; Back Panel Included
- Bottom Panel Not Included Behind Removable Access Front Panel for Wire Management
- 9" Door Opening With Touch Latch and Includes Bottom Panel, Storage Behind Door
- Locking Box/File; File Drawers Provide Legal or Letter Filing
- Designed for 28" Deep Worksurfaces Only ([See Worksurfaces](#))
- Handed Based on Height Adjust Cabinet and Facing the Unit
- When Used as Peninsula Desk, Additional Panel Leg Must be Used on Opposite Side for Support ([See Panel Legs](#) 01-2245HTL, 65-0536HPS, or 65-0530HPS)
- Door, Drawers and Removable Access Front Panel Available in Vertical Grain Direction Standard; Optional Horizontal Grain Direction; Must Specify
- If Black or Gold Pull is Selected, Leg and Lock Core will be Black; If Chrome or Aluminum Pull is Selected, Leg and Lock Core will be Silver
- Worksurface Grommet Standard; Must Specify: Black (BLK), Silver (SLV)
- Optional Back Panel Grommet, Must Specify
- Additional Options: Dove Tail Drawer Construction and Soft Close Box Drawer ([See Drawer Options](#)), Power Locations ([See Power Options](#))

Pricing Codes:

W= Wood Top
 P= HPL Top

[See Gesso Intro Section for Ordering Options](#)

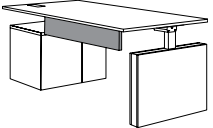
Item	Model No.	Width	Depth	Height	Ship Wt	Cubic Ft	List Price
7" MODESTY PANEL, VENEER 	65-5707MOD For Use with 70" Surface with Panel Leg	57	¾	7	16	1.1	W/P\$ 696
	65-5107MOD For Use with 64" Surface with Panel Leg	51	¾	7	16	1.1	W/P\$ 684
	65-4507MOD For Use with 70" Surface with 20" Credenza	45	¾	7	15	1	W/P\$ 670
	65-4107MOD For Use with 70" Surface with 24" Credenza	41	¾	7	15	1	W/P\$ 666
	65-3907MOD For Use with 64" Surface with 20" Credenza	39	¾	7	15	0.9	W/P\$ 658
	65-3507MOD For Use with 64" Surface with 24" Credenza	35	¾	7	15	0.9	W/P\$ 647
	65-3307MOD For Use with 58" Surface with 20" Credenza	33	¾	7	15	0.8	W/P\$ 639
	65-2907MOD For Use with 58" Surface with 24" Credenza	29	¾	7	15	0.8	W/P\$ 629

Must Specify (in this order):
Model #
Modesty Finish/Color

Description

- Works With Low Storage; [See Low Credenzas](#) and Modular Units; [See Modular Units](#)
- Attaches with Aluminum Mounting Brackets

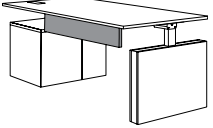
7" MODESTY PANEL, FROSTED ACRYLIC 	MD-5707FA For Use with 70" Surface with Panel Leg	57	¾	7	10	1.1	\$ 623
	MD-5107FA For Use with 64" Surface with Panel Leg	51	¾	7	9	1	\$ 612
	MD-4507FA For Use with 70" Surface with 20" Credenza	45	¾	7	9	1	\$ 602
	MD-4107FA For Use with 70" Surface with 24" Credenza	41	¾	7	8	0.9	\$ 597
	MD-3907FA For Use with 64" Surface with 20" Credenza	39	¾	7	8	0.8	\$ 590
	MD-3507FA For Use with 64" Surface with 24" Credenza	35	¾	7	7	0.7	\$ 581
	MD-3307FA For Use with 58" Surface with 20" Credenza	33	¾	7	7	0.6	\$ 574
	MD-2907FA For Use with 58" Surface with 24" Credenza	29	¾	7	6	0.5	\$ 564

Must Specify (in this order):
Model #
Decorative Hardware Color

Description

- Works With Low Storage; [See Low Credenzas](#) and Modular Units; [See Modular Units](#)
- Exposed Decorative Hardware; Must Specify: Aluminum (ALUM) or Chrome (CHRM)

Pricing Codes:
W= Wood Top
P= HPL Top

[See Gesso Intro Section for Ordering Options](#)

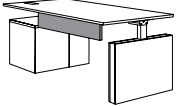
Item	Model No.	Width	Depth	Height	Ship Wt	Cubic Ft	List Price	
7" MODESTY PANEL, HIGH GLOSS ACRYLIC 	MD-5707HGA	For Use with 70" Surface with Panel Leg	57	¾	7	16	1.1	\$ 693
								GPA\$ 741
	MD-5107HGA	For Use with 64" Surface with Panel Leg	51	¾	7	15	1	\$ 680
								GPA\$ 730
	MD-4507HGA	For Use with 70" Surface with 20" Credenza	45	¾	7	15	1	\$ 668
								GPA\$ 714
	MD-4107HGA	For Use with 70" Surface with 24" Credenza	41	¾	7	14	0.9	\$ 661
								GPA\$ 707
	MD-3907HGA	For Use with 64" Surface with 20" Credenza	39	¾	7	14	0.8	\$ 655
							GPA\$ 702	
	MD-3507HGA	For Use with 64" Surface with 24" Credenza	35	¾	7	13	0.7	\$ 644
							GPA\$ 690	
	MD-3307HGA	For Use with 58" Surface with 20" Credenza	33	¾	7	13	0.6	\$ 637
							GPA\$ 680	
	MD-2907HGA	For Use with 58" Surface with 24" Credenza	29	¾	7	12	0.5	\$ 627
							GPA\$ 670	

Must Specify (in this order):
 Model #
 Modesty Color
 Decorative Hardware Color

Description

- Works With Low Storage; [See Low Storage](#) and Modular Units; [See Modular Units](#)
- Attaches with Aluminum Mounting Brackets
- Available in Black (BLA), Wired Mercury (WMA), White (WHA) or Graphite (GPA); Graphite Acrylic Pricing (GPA\$)

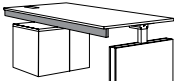
4" MODESTY PANEL, VENEER 	65-6804MOD	68	¾	4	17	1.3	W/P\$ 684
	65-6204MOD	62	¾	4	16	1.2	W/P\$ 668
	65-5604MOD	56	¾	4	16	1.1	W/P\$ 658

Must Specify (in this order):
 Model #
 Modesty Finish/Color

Description

- Attaches with Aluminum Mounting Brackets
- Not Compatible with Height Adjustable Panel Leg with Sleeve

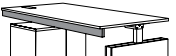
4" MODESTY PANEL, FROSTED ACRYLIC 	MD-6804FA	68	¾	4	12	1.3	\$ 669
	MD-6204FA	62	¾	4	11	1.2	\$ 619
	MD-5604FA	56	¾	4	10	1.1	\$ 589

Must Specify (in this order):
 Model #
 Modesty Color
 Decorative Hardware Color

Description

- Attaches with Aluminum Mounting Brackets
- Exposed Decorative Hardware; Must Specify (ALUM) Aluminum or (CHRM) Chrome
- Not Compatible with Height Adjustable Panel Leg with Sleeve

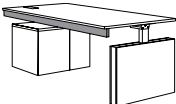
4" MODESTY PANEL, HIGH GLOSS ACRYLIC 	MD-6804HGA	68	¾	4	17	1.3	\$ 730
							GPA\$ 781
	MD-6204HGA	62	¾	4	16	1.2	\$ 693
							GPA\$ 742
	MD-5604HGA	56	¾	4	16	1.1	\$ 654
							GPA\$ 699

Must Specify (in this order):
 Model #
 Modesty Color

Description

- Attaches with Aluminum Mounting Brackets
- Available in Black (BLA), Wired Mercury (WMA), White (WHA) or Graphite (GPA); Graphite Acrylic Pricing (GPA\$)
- Not Compatible with Height Adjustable Panel Leg with Sleeve

Pricing Codes:

W= Wood Top
 P= HPL Top

[See Gesso Intro Section for Ordering Options](#)

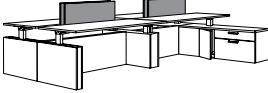
Item	Model No.	Width	Depth	Height	Ship Wt	Cubic Ft	List Price
20"H ABOVE/BELOW PRIVACY SCREEN, VENEER 	65-5720PS For Use with 70" Surface with Panel Leg	57	¾	20	36	2.7	W/P\$ 768
	65-5120PS For Use with 64" Surface with Panel Leg	51	¾	20	34	2.5	W/P\$ 742
	65-4520PS For Use with 70" Surface with 20" Credenza	45	¾	20	32	2.3	W/P\$ 714
	65-4120PS For Use with 70" Surface with 24" Credenza	41	¾	20	30	2.2	W/P\$ 687
	65-3920PS For Use with 64" Surface with 20" Credenza	39	¾	20	29	2.2	W/P\$ 662
	65-3520PS For Use with 64" Surface with 24" Credenza	35	¾	20	28	2.1	W/P\$ 638
	65-3320PS For Use with 58" Surface with 20" Credenza	33	¾	20	27	2.1	W/P\$ 614
	65-2920PS For Use with 58" Surface with 24" Credenza	29	¾	20	26	1.9	W/P\$ 589

Must Specify (in this order):
Model #
Modesty Finish/Color

Description

- Mounts to Worksurface
- Provides Privacy 12" Above and 7" Modesty Below

Item	Model No.	Width	Depth	Height	Ship Wt	Cubic Ft	List Price
20"H ABOVE/BELOW PRIVACY SCREEN, TACKBOARD 	PS-5720TB For Use with 70" Surface with Panel Leg	57	¾	20	14	2.2	\$ See Below
	PS-5120TB For Use with 64" Surface with Panel Leg	51	¾	20	13	2.2	\$ See Below
	PS-4520TB For Use with 70" Surface with 20" Credenza	45	¾	20	12	2	\$ See Below
	PS-4120TB For Use with 70" Surface with 24" Credenza	41	¾	20	12	1.8	\$ See Below
	PS-3920TB For Use with 64" Surface with 20" Credenza	39	¾	20	11	1.8	\$ See Below
	PS-3520TB For Use with 64" Surface with 24" Credenza	35	¾	20	11	1.5	\$ See Below
	PS-3320TB For Use with 58" Surface with 20" Credenza	33	¾	20	10	1.5	\$ See Below
	PS-2920TB For Use with 58" Surface with 24" Credenza	29	¾	20	10	1.5	\$ See Below

Must Specify (in this order):
Model #
Fabric Vendor
Fabric Pattern
Fabric Color

Description

- Mounts to Worksurface
- Provides Privacy 12" Above and 7" Modesty Below

Model	Ydg	Grades 1,2,3	Grade 4	Grade 5	Grade 6	Grade 7	Grade 8	Grade 9	Grade 10
PS-5720TB	2.00	\$ 623	901	1031	1163	1351	1547	1775	2039
PS-5120TB	2.00	\$ 578	856	986	1118	1306	1502	1730	1994
PS-4520TB	1.75	\$ 513	756	870	986	1150	1322	1521	1752
PS-4120TB	1.50	\$ 473	682	779	878	1019	1166	1337	1535
PS-3920TB	1.50	\$ 459	668	765	864	1005	1152	1323	1521
PS-3520TB	1.50	\$ 443	652	749	848	989	1136	1307	1505
PS-3320TB	1.25	\$ 404	578	659	742	859	982	1124	1289
PS-2920TB	1.25	\$ 383	557	638	721	838	961	1103	1268

Pricing Codes:
W= Wood Top
P= HPL Top

[See Gesso Intro Section for Ordering Options](#)

Item	Model No.	Width	Depth	Height	Ship Wt	Cubic Ft	List Price
 <p>20"H ABOVE/BELOW PRIVACY SCREEN, FROSTED ACRYLIC</p> <p>Must Specify (in this order): Model #</p>	PS-5720FA For Use with 70" Surface with Panel Leg	57	¼	20	20	2.2	\$ 1163
	PS-5120FA For Use with 64" Surface with Panel Leg	51	¼	20	19	2.1	\$ 1075
	PS-4520FA For Use with 70" Surface with 20" Credenza	45	¼	20	19	2	\$ 988
	PS-4120FA For Use with 70" Surface with 24" Credenza	41	¼	20	18	1.9	\$ 951
	PS-3920FA For Use with 64" Surface with 20" Credenza	39	¼	20	18	1.8	\$ 918
	PS-3520FA For Use with 64" Surface with 24" Credenza	35	¼	20	17	1.7	\$ 881
	PS-3320FA For Use with 58" Surface with 20" Credenza	33	¼	20	17	1.6	\$ 849
	PS-2920FA For Use with 58" Surface with 24" Credenza	29	¼	20	16	1.5	\$ 814

Description

- Mounts to Worksurface
- Provides Privacy 12" Above and 7" Modesty Below

 <p>20"H ABOVE/BELOW PRIVACY SCREEN, HIGH GLOSS ACRYLIC</p> <p>Must Specify (in this order): Model # Modesty Color</p>	PS-5720HGA For Use with 70" Surface with Panel Leg	57	⅝	20	36	2.7	\$ 1230 GPA\$ 1586
	PS-5120HGA For Use with 64" Surface with Panel Leg	51	⅝	20	34	2.5	\$ 1131 GPA\$ 1451
	PS-4520HGA For Use with 70" Surface with 20" Credenza	45	⅝	20	32	2.3	\$ 1032 GPA\$ 1313
	PS-4120HGA For Use with 70" Surface with 24" Credenza	41	⅝	20	30	2.2	\$ 990 GPA\$ 1261
	PS-3920HGA For Use with 64" Surface with 20" Credenza	39	⅝	20	29	2.2	\$ 960 GPA\$ 1219
	PS-3520HGA For Use with 64" Surface with 24" Credenza	35	⅝	20	29	2.2	\$ 922 GPA\$ 1174
	PS-3320HGA For Use with 58" Surface with 20" Credenza	33	⅝	20	27	2.1	\$ 889 GPA\$ 1133
	PS-2920HGA For Use with 58" Surface with 24" Credenza	29	⅝	20	26	1.9	\$ 851 GPA\$ 1087

Description

- Mounts to Worksurface
- Provides Privacy 12" Above and 7" Modesty Below
- Available in Available in Black (BLA), White (WHA) or Graphite (GPA); Graphite Acrylic Pricing (GPA\$)

Pricing Codes:

W= Wood Top

P= HPL Top

[See Gesso Intro Section for Ordering Options](#)

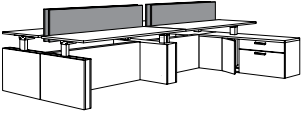
Item	Model No.	Width	Depth	Height	Ship Wt	Cubic Ft	List Price
17"H ABOVE/BELOW PRIVACY SCREEN, VENEER 	65-6817PS	68	¾	17	24	3.3	W/P\$ 791
	65-6217PS	62	¾	17	22	3.1	W/P\$ 767
	65-5617PS	56	¾	17	20	2.7	W/P\$ 741
	65-5017PS	50	¾	17	18	2.5	W/P\$ 714
	65-4417PS	44	¾	17	16	2.3	W/P\$ 690

Must Specify (in this order):
Model #
Modesty Finish/Color

Description

- Aluminum Hardware Used to Mount Screen to Worksurface
- Provides Privacy 12" Above and 4" Modesty Below

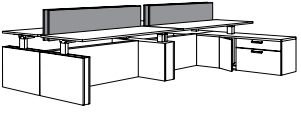
17"H ABOVE/BELOW PRIVACY SCREEN, TACKBOARD 	PS-6817TB	68	⅝	17	15	2.5	\$ See Below
	PS-6217TB	62	⅝	17	14	2.5	\$ See Below
	PS-5617TB	56	⅝	17	13	2.2	\$ See Below
	PS-5017TB	50	⅝	17	12	2	\$ See Below
	PS-4417TB	44	⅝	17	11	1.8	\$ See Below

Must Specify (in this order):
Model #
Fabric Vendor
Fabric Pattern
Fabric Color

Description

- Mounts to Worksurface
- Provides Privacy 12" Above and 4" Modesty Below
- Decorative Hardware; Must Specify: Aluminum (ALUM) or Chrome (CHRM)

Model	Ydg	Grades 1,2,3	Grade 4	Grade 5	Grade 6	Grade 7	Grade 8	Grade 9	Grade 10
PS-6817TB	2.00 \$	642	920	1050	1182	1370	1566	1794	2058
PS-6217TB	2.00 \$	602	880	1010	1142	1330	1526	1754	2018
PS-5617TB	2.00 \$	549	827	957	1089	1277	1473	1701	1965
PS-5017TB	2.00 \$	520	798	928	1060	1248	1444	1672	1936
PS-4417TB	1.75 \$	468	711	825	941	1105	1277	1476	1707

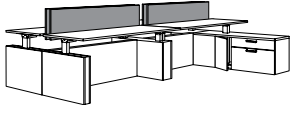
17"H ABOVE/BELOW PRIVACY SCREEN, FROSTED ACRYLIC 	PS-6817FA	68	¼	17	14	3.3	\$ 1196
	PS-6217FA	62	¼	17	14	3.1	\$ 1160
	PS-5617FA	56	¼	17	13	2.9	\$ 1121
	PS-5017FA	50	¼	17	13	2.7	\$ 1036
	PS-4417FA	44	¼	17	12	2.5	\$ 954

Must Specify (in this order):
Model #

Description

- Mounts to Worksurface
- Provides Privacy 12" Above and 4" Modesty Below
- Decorative Hardware; Must Specify: Aluminum (ALUM) or Chrome (CHRM)

Pricing Codes:
W= Wood Top
P= HPL Top

[See Gesso Intro Section for Ordering Options](#)

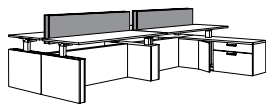
Item	Model No.	Width	Depth	Height	Ship Wt	Cubic Ft	List Price
 <p>17"H ABOVE/BELOW PRIVACY SCREEN, HIGH GLOSS ACRYLIC</p> <p>Must Specify (in this order): Model # Modesty Color</p>	PS-6817HGA	68	¾	17	24	3.3	\$ 1260 GPA\$ 1627
	PS-6217HGA	62	¾	17	22	3.1	\$ 1223 GPA\$ 1579
	PS-5617HGA	56	¾	17	20	2.7	\$ 1180 GPA\$ 1521
	PS-5017HGA	50	¾	17	18	2.5	\$ 1088 GPA\$ 1395
	PS-4417HGA	44	¾	17	16	2.3	\$ 995 GPA\$ 1267

Description

- Mounts to Worksurface
- Provides Privacy 12" Above and 4" Modesty Below
- Available in Available in Black (BLA), White (WHA) or Graphite Acrylic (GPA); Graphite Acrylic Pricing (GPA\$)

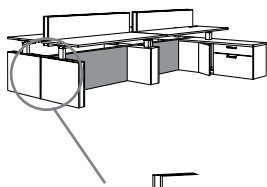
Item	Model No.	Width	Depth	Height	Ship Wt	Cubic Ft	List Price
 <p>GALLERY SCREEN, VENEER</p> <p>Gallery Screen is Positioned Between Height Adjustable Legs</p>	65-2272GS	72	1	22	31	3	W/P\$ 859
	65-2266GS	66	1	22	29	2.9	W/P\$ 827
	65-2260GS	60	1	22	27	2.8	W/P\$ 791
	65-2254GS	54	1	22	24	2.7	W/P\$ 757

Description

- Not Compatible with Optional Wire Management Sleeve
- Gallery Screens are Visible and Can Provide an Accent Between Users in Multi-Station Settings by Selecting a Contrasting Color
- Gallery Screen Positioned Between Height Adjustable Legs

Must Specify (in this order):
Model #
Modesty Finish/Color

Pricing Codes:

W= Wood Top
P= HPL Top

[See Gesso Intro Section for Ordering Options](#)

Item	Model No.	Width	Depth	Height	Ship Wt	Cubic Ft	List Price
MAGNETIC GLASS MARKER BOARD	GMB-23108H	106½	½	23	83	14.3	\$ 3834
FOR USE WITH 30"H DESKS AND CREDENZA AND SURFACE MOUNT HUTCHES WITHOUT PAPERSLOTS	GMB-23102H	100½	½	23	78	13.6	\$ 3558
	GMB-2396H	94½	½	23	74	12.9	\$ 3351
	GMB-2390H	88½	½	23	69	12.2	\$ 3145
	GMB-2384H	82½	½	23	64	11.4	\$ 3009
	GMB-2378H	76½	½	23	59	10.7	\$ 2802
	GMB-2372H	70½	½	23	55	10.0	\$ 2526
	GMB-2366H	64½	½	23	50	9.2	\$ 2318
	GMB-2360H	58½	½	23	45	8.5	\$ 2182
	GMB-2354H	52½	½	23	41	7.8	\$ 1908
	GMB-2348H	46½	½	23	36	7.0	\$ 1770
	GMB-2342H	40½	½	23	31	6.3	\$ 1494
	GMB-2336H	34½	½	23	27	5.6	\$ 1287
GMB-2330H	28½	½	23	22	4.9	\$ 1151	

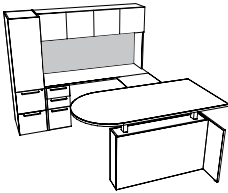
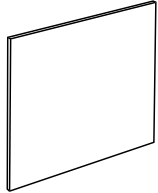

Must Specify (in this order):
Model #
Color



Rare Earth Magnets, Marker and Eraser set available; [See Set Options](#)

Description

- Available in Black (BLMKR) or White (WHMKR), Must Specify
- Tempered Glass Magnetic Marker Boards Are One (1) Piece with No Seams
- Mounting Brackets Included
- For Use with 30"H Desks and Credenzas with Surface Mount Hutches Without Paperslots
- For Rare Earth Magnets, Marker and Eraser Sets; [See Set Options](#)

Item	Model No.	Width	Depth	Height	Ship Wt	Cubic Ft	List Price
MAGNETIC GLASS MARKER BOARD	GMB-23108W	108	½	23	85	14.6	\$ 3834
FOR USE WITH 30"H DESKS AND CREDENZA AND WALL MOUNT HUTCHES WITHOUT PAPERSLOTS	GMB-23102W	102	½	23	80	13.9	\$ 3696
	GMB-2396W	96	½	23	75	13.1	\$ 3489
	GMB-2390W	90	½	23	70	12.4	\$ 3215
	GMB-2384W	84	½	23	66	11.7	\$ 3009
	GMB-2378W	78	½	23	61	10.9	\$ 2802
	GMB-2372W	72	½	23	56	10.2	\$ 2595
	GMB-2366W	66	½	23	52	9.5	\$ 2458
	GMB-2360W	60	½	23	47	8.8	\$ 2182
	GMB-2354W	54	½	23	42	8.0	\$ 1976
	GMB-2348W	48	½	23	38	7.3	\$ 1838
	GMB-2342W	42	½	23	33	6.6	\$ 1563
	GMB-2336W	36	½	23	28	5.8	\$ 1357
GMB-2330W	30	½	23	23	5.1	\$ 1151	

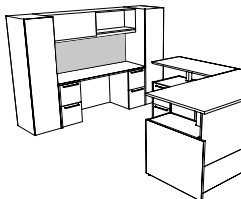
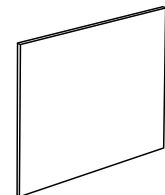

Must Specify (in this order):
Model #
Color



Rare Earth Magnets, Marker and Eraser set available; [See Set Options](#)

Description

- Available in Black (BLMKR) or White (WHMKR), Must Specify
- Tempered Glass Magnetic Marker Boards Are One (1) Piece with No Seams
- Mounting Brackets Included
- For Use over 30"H Desks and Credenzas with Wall Mount Hutches Without Paperslots
- For Rare Earth Magnets, Marker and Eraser Sets; [See Set Options](#)

[See Gesso Intro Section for Ordering Options](#)

Item	Model No.	Width	Depth	Height	Ship Wt	Cubic Ft	List Price
MAGNETIC GLASS MARKER BOARD	GMB-31108W	108	½	31	114	17.9	\$ 5073
FOR USE WITH 21" LOW CREDENZA AND WALL MOUNT HUTCHES	GMB-31102W	102	½	31	108	17.0	\$ 4889
	GMB-3196W	96	½	31	101	16.1	\$ 4613
	GMB-3190W	90	½	31	95	15.2	\$ 4246
	GMB-3184W	84	½	31	89	14.3	\$ 3972
	GMB-3178W	78	½	31	82	13.4	\$ 3696
	GMB-3172W	72	½	31	76	12.5	\$ 3421
	GMB-3166W	66	½	31	70	11.6	\$ 3235
	GMB-3160W	60	½	31	63	10.8	\$ 2870
	GMB-3154W	54	½	31	57	9.9	\$ 2595
	GMB-3148W	48	½	31	51	9.0	\$ 2414
	GMB-3142W	42	½	31	44	8.1	\$ 2045
	GMB-3136W	36	½	31	38	7.2	\$ 1770
	GMB-3130W	30	½	31	32	6.3	\$ 1494

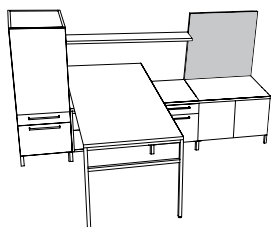
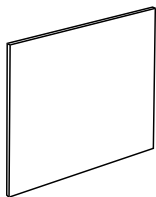

Must Specify (in this order):

Model #
Color



Rare Earth Magnets, Marker and Eraser set available; [See Set Options](#)

Description

- Available in Black (BLMKR) or White (WHMKR), Must Specify
- Tempered Glass Magnetic Marker Boards Are One (1) Piece with No Seams
- Mounting Brackets Included
- For Use over 21"H Desks and Credenzas with Wall Mount Hutches
- For Rare Earth Magnets, Marker and Eraser Sets; [See Set Options](#)

MAGNETIC GLASS MARKER BOARD	GMB-4048W	48	½	40%	67	11.0	\$ 3128
FOR USE WITH 30" H DESKS AND CREDENZA AND WALL MOUNT HUTCHES OR SHELVING	GMB-4042W	42	½	40%	58	9.9	\$ 2644
	GMB-4036W	36	½	40%	50	8.8	\$ 2285
	GMB-4030W	30	½	40%	42	7.7	\$ 1924

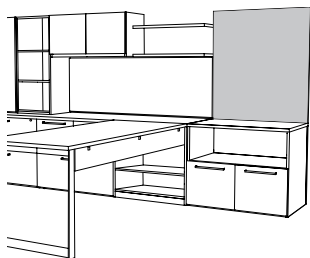

Must Specify (in this order):

Model #
Color



Rare Earth Magnets, Marker and Eraser set available; [See Set Options](#)

Description

- Available in Black (BLMKR) or White (WHMKR), Must Specify
- Tempered Glass Magnetic Marker Boards Include Mounting Brackets
- For Use over 30"H Desks and Credenzas with Wall Mount Hutches or Shelving
- For Rare Earth Magnets, Marker and Eraser Sets; [See Set Options](#)

[See Gesso Intro Section for Ordering Options](#)

Item	Model No.	Width	Depth	Height	Ship Wt	Cubic Ft	List Price
MAGNETIC GLASS MARKER BOARD	GMB-5248W	48	½	52⅞	86	13.5	\$ 3988
FOR USE WITH 30"H DESKS AND CREDENZA AND TALL WALL MOUNT HUTCHES OR SHELVING	GMB-5242W	42	½	52⅞	76	12.2	\$ 3369
	GMB-5236W	36	½	52⅞	65	10.8	\$ 2904
	GMB-5230W	30	½	52⅞	54	9.5	\$ 2441

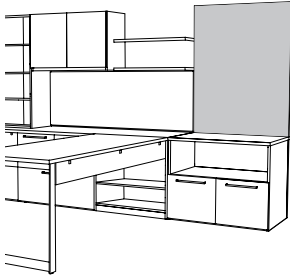

Description

- Available in Black (BLMKR) or White (WHMKR), Must Specify
- Tempered Glass Magnetic Marker Boards Include Mounting Brackets
- For Use Next to Tall Surface or Wall Mount Hutches
- For Rare Earth Magnets, Marker and Eraser Sets; [See Set Options](#)

Must Specify (in this order):

Model #
Color



Rare Earth Magnets, Marker and Eraser set available; [See Set Options](#)

MAGNETIC GLASS MARKER BOARD	GMB-8236W	36	½	82⅞	102	15.8	\$ 4453
FOR USE FROM FLOOR TO TOP OF UNIT	GMB-7036W	36	½	70⅞	87	13.8	\$ 3834
	GMB-5136W	36	½	51⅞	63	10.6	\$ 2802
	GMB-8230W	30	½	82⅞	85	13.8	\$ 3730
	GMB-7030W	30	½	70⅞	72	12.1	\$ 3215
	GMB-5130W	30	½	51⅞	53	9.3	\$ 2354

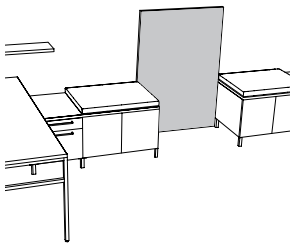

Description

- Available in Black (BLMKR) or White (WHMKR), Must Specify
- Tempered Glass Magnetic Marker Boards Are One (1) Piece with No Seams
- Mounting Brackets Included
- For Use From Floor to Top of Unit
- For Rare Earth Magnets, Marker and Eraser Sets; [See Set Options](#)

Must Specify (in this order):

Model #
Color



Rare Earth Magnets, Marker and Eraser set available; [See Set Options](#)

[See Gesso Intro Section for Ordering Options](#)

TALL TOOL RAIL WORK WALL FOR SURFACE MOUNT HUTCHES

USE OVER 30" H CREDENZA
23" TALL

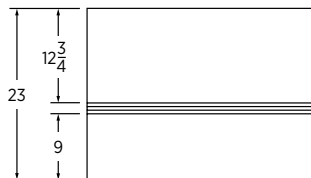

Must Specify (in this order):

- Model #
- Tackboard on Top or Bottom
- Dry Erase on Top or Bottom
- Tackboard Fabric Vendor, Pattern, and Color

Tackboard/Dry Erase Locations

- TB-TB: Tackboard Over Tackboard (Use Grade Prices)
- DEB-TB: Dry Erase Over Tackboard (Use Grade Prices)
- DEB-DEB: Dry Erase Over Dry Erase (Use Grade 1 Prices)

Model #	Size	COM ydg	COM, 1, 2 or 3	Grades							
				4	5	6	7	8	9	10	
WW-23108TRH	108"	3.50	\$ 1715	2202	2429	2660	2989	3332	3731	4193	
WW-23102TRH	102"	3.25	\$ 1635	2087	2298	2513	2818	3137	3507	3936	
WW-2396TRH	96"	3.00	\$ 1565	1982	2177	2375	2657	2951	3293	3689	
WW-2390TRH	90"	2.75	\$ 1471	1853	2032	2214	2472	2742	3055	3418	
WW-2384TRH	84"	2.50	\$ 1334	1682	1844	2009	2244	2489	2774	3104	
WW-2378TRH	78"	2.50	\$ 1285	1633	1795	1960	2195	2440	2725	3055	
WW-2372TRH	72"	2.25	\$ 1023	1336	1482	1631	1842	2063	2319	2616	
WW-2366TRH	66"	2.00	\$ 967	1245	1375	1507	1695	1891	2119	2383	
WW-2360TRH	60"	2.00	\$ 910	1188	1318	1450	1638	1834	2062	2326	
WW-2354TRH	54"	1.75	\$ 887	1130	1244	1360	1524	1696	1895	2126	
WW-2348TRH	48"	1.50	\$ 806	1015	1112	1211	1352	1499	1670	1868	
WW-2342TRH	42"	1.25	\$ 745	919	1000	1083	1200	1323	1465	1630	
WW-2336TRH	36"	1.25	\$ 727	901	982	1065	1182	1305	1447	1612	
WW-2330TRH	30"	1.00	\$ 671	810	875	941	1035	1133	1247	1379	

Description

- Aluminum Tool Rail
- Work Walls 78" and Larger will Ship in 4 Pieces
- [See Work Wall Accessories](#)

TALL TOOL RAIL WORK WALL FOR SURFACE MOUNT HUTCHES WITH PAPER SLOTS

USE OVER 30" H CREDENZA
19" TALL



Must Specify (in this order):

- Model #
- Tackboard on Top or Bottom
- Dry Erase on Top or Bottom
- Tackboard Fabric Vendor, Pattern, and Color

Tackboard/Dry Erase Locations

- TB-TB: Tackboard Over Tackboard (Use Grade Prices)
- DEB-TB: Dry Erase Over Tackboard (Use Grade Prices)
- DEB-DEB: Dry Erase Over Dry Erase (Use Grade 1 Prices)

Model #	Size	COM ydg	COM, 1, 2 or 3	Grades							
				4	5	6	7	8	9	10	
WW-19108TRHPS	108"	3.50	\$ 1579	2066	2293	2524	2853	3196	3595	4057	
WW-19102TRHPS	102"	3.25	\$ 1505	1957	2168	2383	2688	3007	3377	3806	
WW-1996TRHPS	96"	3.00	\$ 1440	1857	2052	2250	2532	2826	3168	3564	
WW-1990TRHPS	90"	2.75	\$ 1349	1731	1910	2092	2350	2620	2933	3296	
WW-1984TRHPS	84"	2.50	\$ 1215	1563	1725	1890	2125	2370	2655	2985	
WW-1978TRHPS	78"	2.50	\$ 1173	1521	1683	1848	2083	2328	2613	2943	
WW-1972TRHPS	72"	2.25	\$ 935	1248	1394	1543	1754	1975	2231	2528	
WW-1966TRHPS	66"	2.00	\$ 887	1165	1295	1427	1615	1811	2039	2303	
WW-1960TRHPS	60"	2.00	\$ 845	1123	1253	1385	1573	1769	1997	2261	
WW-1954TRHPS	54"	1.75	\$ 830	1073	1187	1303	1467	1639	1838	2069	
WW-1948TRHPS	48"	1.50	\$ 771	980	1077	1176	1317	1464	1635	1833	
WW-1942TRHPS	42"	1.25	\$ 709	883	964	1047	1164	1287	1429	1594	
WW-1936TRHPS	36"	1.25	\$ 698	872	953	1036	1153	1276	1418	1583	
WW-1930TRHPS	30"	1.00	\$ 643	782	847	913	1007	1105	1219	1351	

Description

- Aluminum Tool Rail
- Work Walls 78" and Larger will Ship in 4 Pieces
- [See Work Wall Accessories](#)

[See Gesso Intro Section for Ordering Options](#)

**TALL TOOL RAIL WORK WALL
FOR WALL MOUNT HUTCHES**

**USE OVER 21" H CREDENZA
31" TALL**

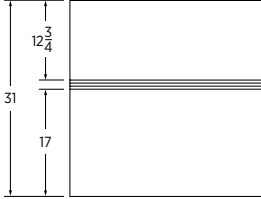

Must Specify (in this order):
 Model #
 Tackboard on Top or Bottom
 Dry Erase on Top or Bottom
 Tackboard Fabric Vendor, Pattern,
 and Color

- Tackboard/Dry Erase Locations**
- TB-TB: Tackboard Over Tackboard (Use Grade Prices)
 - DEB-TB: Dry Erase Over Tackboard (Use Grade Prices)
 - DEB-DEB: Dry Erase Over Dry Erase (Use Grade 1 Prices)

Model #	Size	COM ydg	COM, 1, 2 or 3	Grades						
				4	5	6	7	8	9	10
WW-31108TTRW	108"	3.50	\$ 2159	2646	2873	3104	3433	3776	4175	4637
WW-31102TTRW	102"	3.25	\$ 2044	2496	2707	2922	3227	3546	3916	4345
WW-3196TTRW	96"	3.00	\$ 1969	2386	2581	2779	3061	3355	3697	4093
WW-3190TTRW	90"	2.75	\$ 1854	2236	2415	2597	2855	3125	3438	3801
WW-3184TTRW	84"	2.50	\$ 1658	2006	2168	2333	2568	2813	3098	3428
WW-3178TTRW	78"	2.50	\$ 1585	1933	2095	2260	2495	2740	3025	3355
WW-3172TTRW	72"	2.25	\$ 1318	1631	1777	1926	2137	2358	2614	2911
WW-3166TTRW	66"	2.00	\$ 1265	1543	1673	1805	1993	2189	2417	2681
WW-3160TTRW	60"	2.00	\$ 1191	1469	1599	1731	1919	2115	2343	2607
WW-3154TTRW	54"	1.75	\$ 1137	1380	1494	1610	1774	1946	2145	2376
WW-3148TTRW	48"	1.50	\$ 1044	1253	1350	1449	1590	1737	1908	2106
WW-3142TTRW	42"	1.25	\$ 960	1134	1215	1298	1415	1538	1680	1845
WW-3136TTRW	36"	1.25	\$ 940	1114	1195	1278	1395	1518	1660	1825
WW-3130TTRW	30"	1.00	\$ 865	1004	1069	1135	1229	1327	1441	1573

- Description**
- Aluminum Tool Rail
 - Work Walls 78" and Larger will Ship in 4 Pieces
 - [See Work Wall Accessories](#)

**TALL TOOL RAIL WORK WALL
FOR WALL MOUNT HUTCHES
WITH PAPER SLOTS**

**USE OVER 21" H CREDENZA
27" TALL**

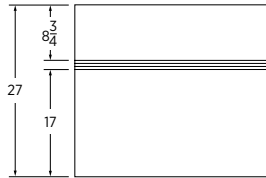

Must Specify (in this order):
 Model #
 Tackboard on Top or Bottom
 Dry Erase on Top or Bottom
 Tackboard Fabric Vendor, Pattern,
 and Color

- Tackboard/Dry Erase Locations**
- TB-TB: Tackboard Over Tackboard (Use Grade Prices)
 - DEB-TB: Dry Erase Over Tackboard (Use Grade Prices)
 - DEB-DEB: Dry Erase Over Dry Erase (Use Grade 1 Prices)

Model #	Size	COM ydg	COM, 1, 2 or 3	Grades						
				4	5	6	7	8	9	10
WW-27108TTRWPS	108"	3.50	\$ 1978	2465	2692	2923	3252	3595	3994	4456
WW-27102TTRWPS	102"	3.25	\$ 1867	2319	2530	2745	3050	3369	3739	4168
WW-2796TTRWPS	96"	3.00	\$ 1805	2222	2417	2615	2897	3191	3533	3929
WW-2790TTRWPS	90"	2.75	\$ 1699	2081	2260	2442	2700	2970	3283	3646
WW-2784TTRWPS	84"	2.50	\$ 1518	1866	2028	2193	2428	2673	2958	3288
WW-2778TTRWPS	78"	2.50	\$ 1454	1802	1964	2129	2364	2609	2894	3224
WW-2772TTRWPS	72"	2.25	\$ 1204	1517	1663	1812	2023	2244	2500	2797
WW-2766TTRWPS	66"	2.00	\$ 1153	1431	1561	1693	1881	2077	2305	2569
WW-2760TTRWPS	60"	2.00	\$ 1085	1363	1493	1625	1813	2009	2237	2501
WW-2754TTRWPS	54"	1.75	\$ 1035	1278	1392	1508	1672	1844	2043	2274
WW-2748TTRWPS	48"	1.50	\$ 954	1163	1260	1359	1500	1647	1818	2016
WW-2742TTRWPS	42"	1.25	\$ 879	1053	1134	1217	1334	1457	1599	1764
WW-2736TTRWPS	36"	1.25	\$ 859	1033	1114	1197	1314	1437	1579	1744
WW-2730TTRWPS	30"	1.00	\$ 791	930	995	1061	1155	1253	1367	1499

- Description**
- Aluminum Tool Rail
 - Work Walls 78" and Larger will Ship in 4 Pieces
 - [See Work Wall Accessories](#)

[See Gesso Intro Section for Ordering Options](#)

TOOL RAIL WORK WALL FOR WALL MOUNT HUTCHES

USE OVER 30”H CREDENZA 23” TALL

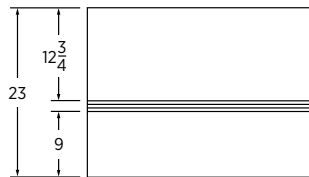

Must Specify (in this order):
 Model #
 Tackboard on Top or Bottom
 Dry Erase on Top or Bottom
 Tackboard Fabric Vendor, Pattern,
 and Color

Tackboard/Dry Erase Locations

- TB-TB: Tackboard Over Tackboard (Use Grade Prices)
- DEB-TB: Dry Erase Over Tackboard (Use Grade Prices)
- DEB-DEB: Dry Erase Over Dry Erase (Use Grade 1 Prices)

Model #	Size	COM ydg	COM, 1, 2 or 3	Grades						
				4	5	6	7	8	9	10
WW-23108TRW	108"	3.50	\$ 1797	2284	2511	2742	3071	3414	3813	4275
WW-23102TRW	102"	3.25	\$ 1693	2145	2356	2571	2876	3195	3565	3994
WW-2396TRW	96"	3.00	\$ 1643	2060	2255	2453	2735	3029	3371	3767
WW-2390TRW	90"	2.75	\$ 1548	1930	2109	2291	2549	2819	3132	3495
WW-2384TRW	84"	2.50	\$ 1379	1727	1889	2054	2289	2534	2819	3149
WW-2378TRW	78"	2.50	\$ 1319	1667	1829	1994	2229	2474	2759	3089
WW-2372TRW	72"	2.25	\$ 1099	1412	1558	1707	1918	2139	2395	2692
WW-2366TRW	66"	2.00	\$ 1040	1318	1448	1580	1768	1964	2192	2456
WW-2360TRW	60"	2.00	\$ 976	1254	1384	1516	1704	1900	2128	2392
WW-2354TRW	54"	1.75	\$ 934	1177	1291	1407	1571	1743	1942	2173
WW-2348TRW	48"	1.50	\$ 863	1072	1169	1268	1409	1556	1727	1925
WW-2342TRW	42"	1.25	\$ 795	969	1050	1133	1250	1373	1515	1680
WW-2336TRW	36"	1.25	\$ 780	954	1035	1118	1235	1358	1500	1665
WW-2330TRW	30"	1.00	\$ 716	855	920	986	1080	1178	1292	1424

Description

- Aluminum Tool Rail
- Work Walls 78" and Larger will Ship in 4 Pieces
- [See Work Wall Accessories](#)

TALL TOOL RAIL WORK WALL FOR WALL MOUNT HUTCHES WITH PAPER SLOTS

USE OVER 30”H CREDENZA 19” TALL



Must Specify (in this order):
 Model #
 Tackboard on Top or Bottom
 Dry Erase on Top or Bottom
 Tackboard Fabric Vendor, Pattern,
 and Color

Tackboard/Dry Erase Locations

- TB-TB: Tackboard Over Tackboard (Use Grade Prices)
- DEB-TB: Dry Erase Over Tackboard (Use Grade Prices)
- DEB-DEB: Dry Erase Over Dry Erase (Use Grade 1 Prices)

Model #	Size	COM ydg	COM, 1, 2 or 3	Grades						
				4	5	6	7	8	9	10
WW-19108TRWPS	108"	3.50	\$ 1654	2141	2368	2599	2928	3271	3670	4132
WW-19102TRWPS	102"	3.25	\$ 1555	2007	2218	2433	2738	3057	3427	3856
WW-1996TRWPS	96"	3.00	\$ 1507	1924	2119	2317	2599	2893	3235	3631
WW-1990TRWPS	90"	2.75	\$ 1419	1801	1980	2162	2420	2690	3003	3366
WW-1984TRWPS	84"	2.50	\$ 1258	1606	1768	1933	2168	2413	2698	3028
WW-1978TRWPS	78"	2.50	\$ 1203	1551	1713	1878	2113	2358	2643	2973
WW-1972TRWPS	72"	2.25	\$ 1004	1317	1463	1612	1823	2044	2300	2597
WW-1966TRWPS	66"	2.00	\$ 953	1231	1361	1493	1681	1877	2105	2369
WW-1960TRWPS	60"	2.00	\$ 901	1179	1309	1441	1629	1825	2053	2317
WW-1954TRWPS	54"	1.75	\$ 871	1114	1228	1344	1508	1680	1879	2110
WW-1948TRWPS	48"	1.50	\$ 818	1027	1124	1223	1364	1511	1682	1880
WW-1942TRWPS	42"	1.25	\$ 756	930	1011	1094	1211	1334	1476	1641
WW-1936TRWPS	36"	1.25	\$ 741	915	996	1079	1196	1319	1461	1626
WW-1930TRWPS	30"	1.00	\$ 684	823	888	954	1048	1146	1260	1392

Description

- Aluminum Tool Rail
- Work Walls 78" and Larger will Ship in 4 Pieces
- [See Work Wall Accessories](#)

[See Gesso Intro Section for Ordering Options](#)

Item	Model No.		Width	Depth	Height	Ship Wt	Cubic Ft	List Price
LEGAL TRAY	01-LGLTRAYC	Clear	14 ⁷ / ₈	10 ¹ / ₂	1 ¹ / ₈			\$ 115

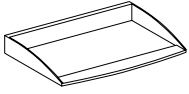

FOLDER SORTER	01-FLDRSRTRC	Clear	7 ¹ / ₄	12 ³ / ₈	7 ¹ / ₈			\$ 129
---------------	--------------	-------	-------------------------------	--------------------------------	-------------------------------	--	--	--------

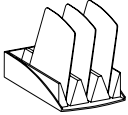

ACCESSORIES TRAY	01-ACCTRAYC	Clear	9 ¹ / ₄	10 ¹ / ₈	1 ¹ / ₈			\$ 125
------------------	-------------	-------	-------------------------------	--------------------------------	-------------------------------	--	--	--------

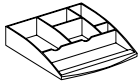

[See Gesso Intro Section for Ordering Options](#)

**TACKBOARDS
FOR SURFACE MOUNT HUTCHES**

23" TALL

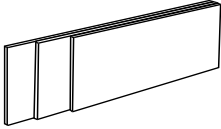

Must Specify (in this order):
Model #
Fabric Vendor, Pattern, and Color

Model #	Size	COM ydg	COM, 1, 2 or 3	Grades						
				4	5	6	7	8	9	10
TB-66108H	108"	3.50	\$ 758	1245	1472	1703	2032	2375	2774	3236
TB-66102H	102"	3.25	\$ 731	1183	1394	1609	1914	2233	2603	3032
TB-6696H	96"	3.00	\$ 707	1124	1319	1517	1799	2093	2435	2831
TB-6690H	90"	2.75	\$ 673	1055	1234	1416	1674	1944	2257	2620
TB-6684H	84"	2.50	\$ 639	987	1149	1314	1549	1794	2079	2409
TB-6678H	78"	2.50	\$ 628	976	1138	1303	1538	1783	2068	2398
TB-6672H	72"	2.25	\$ 566	879	1025	1174	1385	1606	1862	2159
TB-6666H	66"	2.00	\$ 533	811	941	1073	1261	1457	1685	1949
TB-6660H	60"	2.00	\$ 498	776	906	1038	1226	1422	1650	1914
TB-6654H	54"	1.75	\$ 485	728	842	958	1122	1294	1493	1724
TB-6648H	48"	1.50	\$ 436	645	742	841	982	1129	1300	1498
TB-6642H	42"	1.25	\$ 396	570	651	734	851	974	1116	1281
TB-6636H	36"	1.25	\$ 385	559	640	723	840	963	1105	1270
TB-6630H	30"	1.00	\$ 346	485	550	616	710	808	922	1054

Description

- All Tackboards 78" and Longer will Ship in 2 Pieces

**TACKBOARDS
FOR SURFACE MOUNT HUTCHES
WITH PAPER SLOTS**

19" TALL

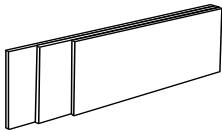

Must Specify (in this order):
Model #
Fabric Vendor, Pattern, and Color

Model #	Size	COM ydg	COM, 1, 2 or 3	Grades						
				4	5	6	7	8	9	10
TB-19108HPS	108"	3.50	\$ 680	1167	1394	1625	1954	2297	2696	3158
TB-19102HPS	102"	3.25	\$ 658	1110	1321	1536	1841	2160	2530	2959
TB-1996HPS	96"	3.00	\$ 635	1052	1247	1445	1727	2021	2363	2759
TB-1990HPS	90"	2.75	\$ 609	991	1170	1352	1610	1880	2193	2556
TB-1984HPS	84"	2.50	\$ 575	923	1085	1250	1485	1730	2015	2345
TB-1978HPS	78"	2.50	\$ 566	914	1076	1241	1476	1721	2006	2336
TB-1972HPS	72"	2.25	\$ 510	823	969	1118	1329	1550	1806	2103
TB-1966HPS	66"	2.00	\$ 476	754	884	1016	1204	1400	1628	1892
TB-1960HPS	60"	2.00	\$ 445	723	853	985	1173	1369	1597	1861
TB-1954HPS	54"	1.75	\$ 433	676	790	906	1070	1242	1441	1672
TB-1948HPS	48"	1.50	\$ 390	599	696	795	936	1083	1254	1452
TB-1942HPS	42"	1.25	\$ 352	526	607	690	807	930	1072	1237
TB-1936HPS	36"	1.25	\$ 343	517	598	681	798	921	1063	1228
TB-1930HPS	30"	1.00	\$ 311	450	515	581	675	773	887	1019

Description

- All Tackboards 78" and Longer will Ship in 2 Pieces

[See Gesso Intro Section for Ordering Options](#)

TACKBOARDS FOR WALL MOUNT HUTCHES

USE OVER 21"H CREDENZA
31" TALL

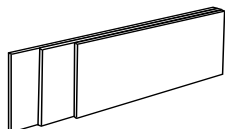

Must Specify (in this order):
Model #
Fabric Vendor, Pattern, and Color

Model #	Size	COM ydg	COM, 1, 2 or 3	Grades						
				4	5	6	7	8	9	10
TB-31108W	108"	3.50	\$ 1014	1501	1728	1959	2288	2631	3030	3492
TB-31102W	102"	3.25	\$ 969	1421	1632	1847	2152	2471	2841	3270
TB-3196W	96"	3.00	\$ 943	1360	1555	1753	2035	2329	2671	3067
TB-3190W	90"	2.75	\$ 899	1281	1460	1642	1900	2170	2483	2846
TB-3184W	84"	2.50	\$ 851	1199	1361	1526	1761	2006	2291	2621
TB-3178W	78"	2.50	\$ 836	1184	1346	1511	1746	1991	2276	2606
TB-3172W	72"	2.25	\$ 772	1085	1231	1380	1591	1812	2068	2365
TB-3166W	66"	2.00	\$ 738	1016	1146	1278	1466	1662	1890	2154
TB-3160W	60"	2.00	\$ 691	969	1099	1231	1419	1615	1843	2107
TB-3154W	54"	1.75	\$ 656	899	1013	1129	1293	1465	1664	1895
TB-3148W	48"	1.50	\$ 598	807	904	1003	1144	1291	1462	1660
TB-3142W	42"	1.25	\$ 539	713	794	877	994	1117	1259	1424
TB-3136W	36"	1.25	\$ 525	699	780	863	980	1103	1245	1410
TB-3130W	30"	1.00	\$ 473	612	677	743	837	935	1049	1181

Description

- All Tackboards 78" and Longer will Ship in 2 Pieces

TACKBOARDS FOR WALL MOUNT HUTCHES WITH PAPER SLOTS

USE OVER 21"H CREDENZA
27" TALL

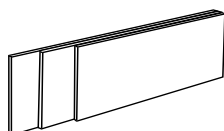

Must Specify (in this order):
Model #
Fabric Vendor, Pattern, and Color

Model #	Size	COM ydg	COM, 1, 2 or 3	Grades						
				4	5	6	7	8	9	10
TB-27108WPS	108"	3.50	\$ 929	1416	1643	1874	2203	2546	2945	3407
TB-27102WPS	102"	3.25	\$ 887	1339	1550	1765	2070	2389	2759	3188
TB-2796WPS	96"	3.00	\$ 864	1281	1476	1674	1956	2250	2592	2988
TB-2790WPS	90"	2.75	\$ 829	1211	1390	1572	1830	2100	2413	2776
TB-2784WPS	84"	2.50	\$ 783	1131	1293	1458	1693	1938	2223	2553
TB-2778WPS	78"	2.50	\$ 767	1115	1277	1442	1677	1922	2207	2537
TB-2772WPS	72"	2.25	\$ 707	1020	1166	1315	1526	1747	2003	2300
TB-2766WPS	66"	2.00	\$ 671	949	1079	1211	1399	1595	1823	2087
TB-2760WPS	60"	2.00	\$ 627	905	1035	1167	1355	1551	1779	2043
TB-2754WPS	54"	1.75	\$ 598	841	955	1071	1235	1407	1606	1837
TB-2748WPS	48"	1.50	\$ 545	754	851	950	1091	1238	1409	1607
TB-2742WPS	42"	1.25	\$ 492	666	747	830	947	1070	1212	1377
TB-2736WPS	36"	1.25	\$ 481	655	736	819	936	1059	1201	1366
TB-2730WPS	30"	1.00	\$ 433	572	637	703	797	895	1009	1141

Description

- All Tackboards 78" and Longer will Ship in 2 Pieces

[See Gesso Intro Section for Ordering Options](#)

TACKBOARDS FOR WALL MOUNT HUTCHES

23" TALL

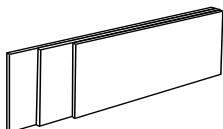

Must Specify (in this order):

Model #
Fabric Vendor, Pattern, and Color

Model #	Size	COM ydg	COM, 1, 2 or 3	Grades												
				4	5	6	7	8	9	10						
TB-66108W	108"	3.50	\$ 845	1332	1559	1790	2119	2462	2861	3323						
TB-66102W	102"	3.25	\$ 805	1257	1468	1683	1988	2307	2677	3106						
TB-6696W	96"	3.00	\$ 788	1205	1400	1598	1880	2174	2516	2912						
TB-6690W	90"	2.75	\$ 751	1133	1312	1494	1752	2022	2335	2698						
TB-6684W	84"	2.50	\$ 711	1059	1221	1386	1621	1866	2151	2481						
TB-6678W	78"	2.50	\$ 698	1046	1208	1373	1608	1853	2138	2468						
TB-6672W	72"	2.25	\$ 642	955	1101	1250	1461	1682	1938	2235						
TB-6666W	66"	2.00	\$ 609	887	1017	1149	1337	1533	1761	2025						
TB-6660W	60"	2.00	\$ 566	844	974	1106	1294	1490	1718	1982						
TB-6654W	54"	1.75	\$ 539	782	896	1012	1176	1348	1547	1778						
TB-6648W	48"	1.50	\$ 492	701	798	897	1038	1185	1356	1554						
TB-6642W	42"	1.25	\$ 446	620	701	784	901	1024	1166	1331						
TB-6636W	36"	1.25	\$ 434	608	689	772	889	1012	1154	1319						
TB-6630W	30"	1.00	\$ 394	533	598	664	758	856	970	1102						

Description

- All Tackboards 78" and Longer will Ship in 2 Pieces
- Not Compatible with Gallery Screens; Consider Work Wall Applications

TACKBOARDS FOR WALL MOUNT HUTCHES WITH PAPER SLOTS

19" TALL

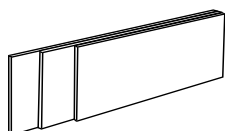

Must Specify (in this order):

Model #
Fabric Vendor, Pattern, and Color

Model #	Size	COM ydg	COM, 1, 2 or 3	Grades												
				4	5	6	7	8	9	10						
TB-19108WPS	108"	3.50	\$ 758	1245	1472	1703	2032	2375	2774	3236						
TB-19102WPS	102"	3.25	\$ 723	1175	1386	1601	1906	2225	2595	3024						
TB-1996WPS	96"	3.00	\$ 708	1125	1320	1518	1800	2094	2436	2832						
TB-1990WPS	90"	2.75	\$ 676	1058	1237	1419	1677	1947	2260	2623						
TB-1984WPS	84"	2.50	\$ 638	986	1148	1313	1548	1793	2078	2408						
TB-1978WPS	78"	2.50	\$ 626	974	1136	1301	1536	1781	2066	2396						
TB-1972WPS	72"	2.25	\$ 578	891	1037	1186	1397	1618	1874	2171						
TB-1966WPS	66"	2.00	\$ 542	820	950	1082	1270	1466	1694	1958						
TB-1960WPS	60"	2.00	\$ 502	780	910	1042	1230	1426	1654	1918						
TB-1954WPS	54"	1.75	\$ 481	724	838	954	1118	1290	1489	1720						
TB-1948WPS	48"	1.50	\$ 442	651	748	847	988	1135	1306	1504						
TB-1942WPS	42"	1.25	\$ 398	572	653	736	853	976	1118	1283						
TB-1936WPS	36"	1.25	\$ 388	562	643	726	843	966	1108	1273						
TB-1930WPS	30"	1.00	\$ 351	490	555	621	715	813	927	1059						

Description

- All Tackboards 78" and Longer will Ship in 2 Pieces
- Not Compatible with Gallery Screens; Consider Work Wall Applications

[See Gesso Intro Section for Ordering Options](#)

TACKBOARDS
FOR DUAL ACCESS OPEN HUTCHES

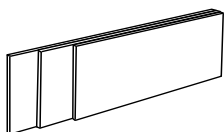

Model #	Coordinating Unit	COM ydg	COM, 1, 2 or 3	Grades						
				4	5	6	7	8	9	10
TB-1334	65-1572DAOH	1.25	\$ 446	620	446	784	901	1024	1166	1331
TB-1331	65-1566DAOH	1.00	\$ 377	516	377	647	741	839	953	1085
TB-1328	65-1560DAOH	1.00	\$ 351	490	351	621	715	813	927	1059

- Description**
- Includes 2 Tackboards

Must Specify (in this order):
Model #
Fabric Vendor, Pattern, and Color

Item	Model No.	Width	Depth	Height	Ship Wt	Cubic Ft	List Price
LED TASKLIGHTS	TL-0848	47½	¾	1⅝	-	-	\$ 445
	<i>240-LED, 18 Watts</i>						
LED TASKLIGHTS	TL-0824	22½	¾	1⅝	-	-	\$ 368
	<i>84-LED, 7 Watts</i>						

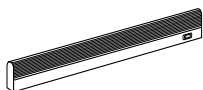

- Description**
- Includes the Power Supply and Three Upper Wire Management Grommets
 - Rocker Style On/Off Switch with a 10' Power Cord
 - Grommet Color will Match Lower Grommet Color

LED TASKLIGHTS	01-188LED58	57¾	2	¾	-	-	\$ 1648
	<i>96-LED, 33.7 Watts</i>						
	01-94LED31	30¾	2	¾	-	-	\$ 1195
LED TASKLIGHTS	<i>48-LED, 17.6 Watts</i>						
	01-47LED17	16¾	2	¾	-	-	\$ 690
<i>24-LED, 9.1 Watts</i>							

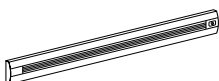

- Description**
- Includes the Power Supply and Three Upper Wire Management Grommets
 - 12' Power Cord
 - Grommet Color will Match Lower Grommet Color
 - Optional Occupancy Sensor Shuts Off After 30 Minutes of Inactivity and Turns On Immediately When Reentering the Detection Area

Options: Specify & Add

01-OSRP	Occupancy Sensor	\$ 366
---------	------------------	--------

[See Gesso Intro Section for Ordering Options](#)

Item	Model No.		Width	Depth	Height	Ship Wt	Cubic Ft	List Price
L SHELF 	65-15108LS	192 lbs Weight Limit	108	15	17	95	20.6	W\$ 2235
	65-15102LS	192 lbs Weight Limit	102	15	17	90	19.4	W\$ 2135
	65-1596LS	192 lbs Weight Limit	96	15	17	85	18.3	W\$ 2033
	65-1590LS	192 lbs Weight Limit	90	15	17	80	17.2	W\$ 1938
	65-1584LS	154 lbs Weight Limit	84	15	17	75	16.0	W\$ 1836
	65-1578LS	154 lbs Weight Limit	78	15	17	70	14.9	W\$ 1736
	65-1572LS	154 lbs Weight Limit	72	15	17	65	13.8	W\$ 1635
	65-1566LS	128 lbs Weight Limit	66	15	17	60	12.7	W\$ 1539
	65-1560LS	128 lbs Weight Limit	60	15	17	55	11.6	W\$ 1448
	65-1554LS	90 lbs Weight Limit	54	15	17	50	10.5	W\$ 1351
	65-1548LS	90 lbs Weight Limit	48	15	17	45	9.3	W\$ 1255
	65-1542LS	90 lbs Weight Limit	42	15	17	40	8.2	W\$ 1162
	65-1536LS	64 lbs Weight Limit	36	15	17	35	7.1	W\$ 1067
	65-1530LS	64 lbs Weight Limit	30	15	17	30	6.0	W\$ 969

Must Specify (in this order):
Model #
Color

Description

- Weight Capacity is a Distributed Load
- Not Liable for Wall Mount Units that are not Properly Installed

Item	Model No.		Width	Depth	Height	Ship Wt	Cubic Ft	List Price
FLOATING SHELF 	65-09108FS	123 lbs Weight Limit	108	9	1	23	2.5	W\$ 1508
	65-09102FS	123 lbs Weight Limit	102	9	1	22	2.3	W\$ 1452
	65-0996FS	123 lbs Weight Limit	96	9	1	20	2.2	W\$ 1394
	65-0990FS	123 lbs Weight Limit	90	9	1	19	2.1	W\$ 1335
	65-0984FS	99 lbs Weight Limit	84	9	1	18	1.9	W\$ 1275
	65-0978FS	99 lbs Weight Limit	78	9	1	16	1.8	W\$ 1216
	65-0972FS	99 lbs Weight Limit	72	9	1	16	1.6	W\$ 1159
	65-0966FS	82 lbs Weight Limit	66	9	1	14	1.5	W\$ 1091
	65-0960FS	82 lbs Weight Limit	60	9	1	13	1.4	W\$ 1018
	65-0954FS	57 lbs Weight Limit	54	9	1	12	1.3	W\$ 946
	65-0948FS	57 lbs Weight Limit	48	9	1	10	1.1	W\$ 876
	65-0942FS	57 lbs Weight Limit	42	9	1	9	0.9	W\$ 805
	65-0936FS	40 lbs Weight Limit	36	9	1	8	0.8	W\$ 731
	65-0930FS	40 lbs Weight Limit	30	9	1	6	0.7	W\$ 659

Must Specify (in this order):
Model #
Color

Description

- Weight Capacity is a Distributed Load
- Not Liable for Wall Mount Units that are not Properly Installed

[See Gesso Intro Section for Ordering Options](#)

Item	Model No.	Width	Depth	Height	Ship Wt	Cubic Ft	List Price
VISUAL BOARD	65-4848VB	48	5	48	150	11.0	W\$ 4908

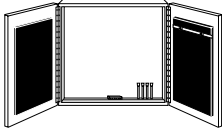

Description

- Standard with: Flipchart, Set of Four Dry Erase Markers, Eraser, Mounting Hardware, Tackboard on Each Door in Black Fabric, Display Rail with Adjustable Hooks for Flipchart
- Price Valid for Fabric Grades 1, 2, and 3
- Does Not Feature Soft Close Hinges
- Magnetic Porcelain Non-Glare Writing Surface

Must Specify (in this order):

- Model #
- Color
- Door Grain Direction
- Tackboard Fabric Vendor, Pattern, and Color
- Pull
- Projection Screen Installation

Options: Specify & Add

	GRADE	4	5	6	7	8	9	10
TB-4214 Tackboard		\$ 278	408	540	728	924	1152	1416
1-PS Optional Factory Installed Projection Screen								\$ 1062

CUSHIONS

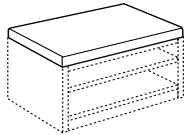

Model #	Size	COM Ydg	COM, 1, 2 or 3	Grades									
				4	5	6	7	8	9	10	L1	L2	
65-24108CUSHION	108"	3.25	\$ 790	1242	1453	1668	1973	2292	2662	3091	1863	2321	
65-2490CUSHION	90"	2.75	\$ 715	1097	1276	1458	1716	1986	2299	2662	1623	2010	
65-2472CUSHION	72"	2.25	\$ 604	917	1063	1212	1423	1644	1900	2197	1347	1664	
65-2460CUSHION	60"	2.00	\$ 523	801	931	1063	1251	1447	1675	1939	1183	1465	
65-2436CUSHION	36"	1.25	\$ 445	619	700	783	900	1023	1165	1330	858	1034	
65-2430CUSHION	30"	1.25	\$ 385	559	640	723	840	963	1105	1270	798	974	
65-20108CUSHION	108"	3.25	\$ 746	1198	1409	1624	1929	2248	2618	3047	1819	2277	
65-2090CUSHION	90"	2.75	\$ 675	1057	1236	1418	1676	1946	2259	2622	1583	1970	
65-2072CUSHION	72"	2.25	\$ 569	882	1028	1177	1388	1609	1865	2162	1312	1629	
65-2060CUSHION	60"	2.00	\$ 495	773	903	1035	1223	1419	1647	1911	1155	1437	
65-2036CUSHION	36"	1.25	\$ 416	590	671	754	871	994	1136	1301	829	1005	
65-2030CUSHION	30"	1.25	\$ 361	535	616	699	816	939	1081	1246	774	950	
65-1519CUSHION	15"	0.75	\$ 331	435	484	534	604	678	763	862	579	684	

Description

- For Use with Mobile Pedestals; [See Mobile Peds](#)
- Increases Height of Mobile Pedestal 2 1/4"

CENTER DRAWER

65-1622CD	22	16	2	7	1.4	W\$ 495
-----------	----	----	---	---	-----	---------

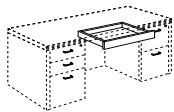

Description

- Fits Desks, P-Top Units, and D-Top Units
- Center Drawer Features Multi-Step, Hand-Finished Catalyzed Finish
- Will Not Work in Conjunction with Height Adjustable Mechanisms or Modesty Panels on 30" D-Top Units

Must Specify (in this order):

- Model #
- Color
- Drawer Front Grain
- Factory Installed

Options: Specify & Add

CD16	Factory Installed	\$ 208
------	-------------------	--------

[See Gesso Intro Section for Ordering Options](#)

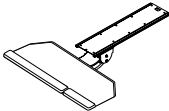
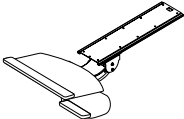
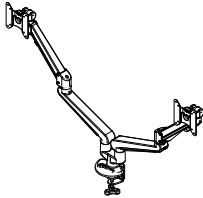
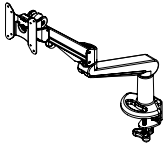
Item	Model No.		Width	Depth	Height	Ship Wt	Cubic Ft	List Price								
ARTICULATING KEYBOARD CORNER PLATFORM	01-KB2CC		25	10½	4½	16	1.4	\$ 832								
	 <p>Description</p> <ul style="list-style-type: none"> • Standard With: +/- 15° Tilt Adjustment , 360° Rotation, Independent Tilt Adjustment, 7" Lift and Lock Height Adjustment, 25" Cut Corner Platform • Keyboard and Mouse on same level; Single Palm Rest for both Left & Right Hands • Works with 17"+ Diagonal Work Surface • Cannot Be Used on 20" or 21" Deep Unit • Not Available with Optional Center Grommet • Track Measures 21" <p>Options: Specify & Add</p> <table border="1"> <tr> <td>KB2CC</td> <td>Factory Installed</td> <td></td> <td></td> <td></td> <td></td> <td></td> <td></td> <td>\$ 208</td> </tr> </table>								KB2CC	Factory Installed						
KB2CC	Factory Installed							\$ 208								
KEYBOARD MECHANISM WITH KEYBOARD CLAMP	01-KB3		26½	14	4.5	16	1.4	\$ 914								
	 <p>Description</p> <ul style="list-style-type: none"> • Standard With: 18.75" Platform with Swivel-Below Mouse Platform,+/- 15° Tilt Adjustment, 360° Rotation, 7" Lift and Lock Height Adjustment, Independent Tilt Adjustment, Palm Rest for Mousing Surface • Left or Right Handed Mouse Platform • Cannot Be Used on 20" or 21" Deep Unit • Not Available with Optional Center Grommet • Track Measures 21" <p>Options: Specify & Add</p> <table border="1"> <tr> <td>KB3</td> <td>Factory Installed</td> <td></td> <td></td> <td></td> <td></td> <td></td> <td></td> <td>\$ 208</td> </tr> </table>								KB3	Factory Installed						
KB3	Factory Installed							\$ 208								
DUAL ARTICULATING MONITOR ARM	01-MLEDGE2A	Aluminum	-	-	6½-19½	15	1.4	\$ 1313								
	01-MLEDGE2B	Black														
 <p>Description</p> <ul style="list-style-type: none"> • Dual Mount with Independent Adjustment Includes Desk Clamp, Grommet Mount, and Enclosed Cable Management • 180° Lockout Feature • 21" Monitor Extension; 3.5" Monitor Retraction • +30/-25° Monitor Tilt; 360° Swivel at Two Points • 17.6lb Weight Capacity per Arm • VESA 75mm and VESA 100mm Compatible with Quick Monitor Release 																
SINGLE MONITOR ARM	01-MLEDGE1A	Aluminum	-	-	6½-19½	13	2.2	\$ 773								
	01-MLEDGE1B	Black														
 <p>Description</p> <ul style="list-style-type: none"> • Includes Desk Clamp, Grommet Mount, and Enclosed Cable Management • 180° Lockout Feature • 21" Monitor Extension; 3.5" Monitor Retraction • +30/-25° Monitor Tilt; 17.6lb Weight Capacity • VESA 75mm and VESA 100mm Compatible with Quick Monitor Release 																

[See Gesso Intro Section for Ordering Options](#)

Item	Model No.	Width	Depth	Height	Ship Wt	Cubic Ft	List Price
PURSE HOOK FOR WORK TABLE	01-HOOK	2	1¼	2½ ₂₅			\$ 79



Description

- Black Hook Includes Mounting Hardware
- For Use with Work Tables, [See Work Tables](#)
- Field Installed

MARKER AND ERASER SET	01-MRKRSETBL	For Use with Black Marker Boards and Black Glass Doors					\$ 123
-----------------------	--------------	--	--	--	--	--	--------

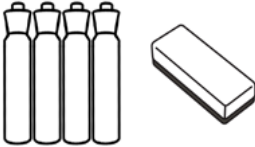

01-MRKRSETWH For Use with White Marker Boards and White Glass Doors

Description

- 01-MRKRSETWH May Also be Used with Standard Dry Erase Doors and Boards
- Includes Four (4) Markers and an Eraser

MAGNET SET	01-MAGBL	For Use with White Marker Boards					\$ 114
------------	----------	----------------------------------	--	--	--	--	--------



01-MAGWH For Use with Black Marker Boards

Description

- Includes Set of Five (5) Magnets

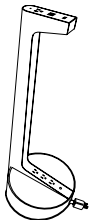

VESTA POWER CENTER	01-PDCTR	10¾	12	28¼	14	2.5	\$ 1776
--------------------	----------	-----	----	-----	----	-----	---------



Description

- Top Includes One (1) Power Outlet, Two (2) USB Ports and One (1) USBC Port; Base Includes Three (3) Outlet
- Available in White
- 120" Power Cord
- Built with Weight Distribution for Optimal Stability
- Base is 5" Tall

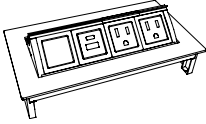
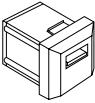
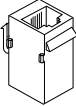
[See Gesso Intro Section for Ordering Options](#)

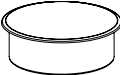
Item	Model No.		Width	Depth	Height	Ship Wt	Cubic Ft	List Price
	01-DPORT4A	Aluminum	8	4	-	7	0.2	\$ 1093
	01-DPORT4B	Black						
<p>Description</p> <ul style="list-style-type: none"> • Retracts into Worksurface to Regain Productive Space • One-Touch Access to Power and Data • Two Power Outlets and Two Open Ports for Data • Water-Proof Simplex (Outlets) • Includes a Voice/Data Adapter Kit to Accept Couplers and Jacks When Required 6' Power Cord • Only Available on 65-4872TP, 65-4866TP, 65-4860TP, 66-3672TP, 65-3072TP, 65-3066TP and 65-3060TP Modular Desktops (See Desk Tops) Centered, One End 								
USB PORT	01-USBPORT		-	-	-	-	-	\$ 161
	<p>Description</p> <ul style="list-style-type: none"> • Passive USB-A Port with Increased Transfer Speed Up to 5 gbs/sec • Simultaneous Read/Write Capability • Idle Device Power Saving State • 6' Cord 							
VOICE COUPLER	01-VOICE1		-	-	-	-	-	\$ 73
	<p>Description</p> <ul style="list-style-type: none"> • For Use with 01-DPORT4A and 01-DPORT4B • 6-Pin Modular Plug • Molded Black • Cord Not included 							
DATA PORT	01-RJ4DATA		-	-	-	-	-	\$ 167
	<p>Description</p> <ul style="list-style-type: none"> • For Use with 01-DPORT4A and 01-DPORT4B • 8-Pin Modular Plug, Cat6 Ethernet Cable, Pre-terminated Cable • 10' Cord 							
OPEN MARKET ONLY								
DOCK 950 WIRELESS CHARGER	01-DOCK950W	White	3¾"	3¾"	-	1	0.2	\$ 265
	01-DOCK950B	Black						
	<p>Description</p> <ul style="list-style-type: none"> • For Use with Wireless Charging Enabled Devices • 5 Watts Maximum Output with a Direct Current of 5V 2A and 10 Watts Maximum with Quick Charge 2.0 • Mounts in 76mm Round Cut-Out • LED will Confirm Pairing with Device and Begin Wireless Charging 							
OPEN MARKET ONLY								

[See Gesso Intro Section for Ordering Options](#)

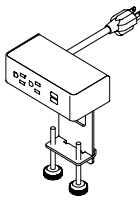
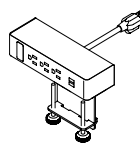
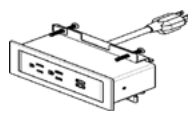
Item	Model No.		Width	Depth	Height	Ship Wt	Cubic Ft	List Price	
DOCK 150 WIRELESS AND USB CHARGER	01-DOCK150W	White		3	3	¾"	1	0.2	\$ 405
	01-DOCK150B	Black							
 <p>OPEN MARKET ONLY</p> <p>Description</p> <ul style="list-style-type: none"> • For Use with Wireless Charging Enabled Devices and USB Charging Devices • 5 Watt Maximum Output with a Direct Current Input of 5V 6A (Wireless Fast Charge) • Mounts in 76mm Round Cut-Out • Pop-Up is ¾"H and Includes Three (3) USB Ports; One (1) 12 Watt Maximum with 2.4A (USB Fast Charge) and Two (2) 5 Watt with 1A (USB Standard Charge) • LED Light will Confirm Pairing with Device and Begin Wireless Charging • UL and cUL Certified 									
DUO CLAMP NEMA PLUG	01-DUOCLAMPW	White	5½	3	7	1	0.2	\$ 572	
	01-DUOCLAMPB	Black							
	01-DUOCLAMPS	Silver							
 <p>Description</p> <ul style="list-style-type: none"> • Clamps to Top; All Mounting Hardware Included • Silver Metal Trim • Two (2) Power/Two (2) USB Power • Independent USB Circuit Controllers Deliver up to 2.1 Amps to Each Post • FCC Part 15A and UL Approved for Horizontal and Vertical Applications • 10' Cord 									
TRIO CLAMP NEMA PLUG	01-TRIOCLAMPW	White	8	3	7	1	0.2	\$ 671	
	01-TRIOCLAMPB	Black							
	01-TRIOCLAMPS	Silver							
 <p>Description</p> <ul style="list-style-type: none"> • Clamps to Top; All Mounting Hardware Included • Silver Metal Trim • Three (3) Power/Two (2) USB Power/One (1) Open Data • Independent USB Circuit Controllers Deliver up to 2.1 Amps to Each Post • HDMI, VGA, or RJ45 Accessories Sold Separately • FCC Part 15A and UL Approved for Horizontal and Vertical Applications • 10' Cord 									
DUO BEZEL NEMA PLUG	01-DUOBEZELW	White	9	2½	3	1	0.2	\$ 675	
	01-DUOBEZELB	Black							
	01-DUOBEZELS	Silver							
 <p>Description</p> <ul style="list-style-type: none"> • Sits On Top of the Worksurface; All Mounting Hardware Included • Two (2) Power/Two (2) USB Power • Independent USB Circuit Controllers Deliver up to 2.1 Amps to Each Post • FCC Part 15A and UL Approved for Horizontal and Vertical Applications • 10' Cord 									

[See Gesso Intro Section for Ordering Options](#)

Item	Model No.		Width	Depth	Height	Ship Wt	Cubic Ft	List Price
	01-TRIOBEZELW	White	6½	2½	3	1	0.2	\$ 725
	01-TRIOBEZELB	Black						
	01-TRIOBEZELS	Silver						

Description

- Sits On Top of the Worksurface
- Three (3) Power/Two (2) USB Power/One (1) Open Data
- Independent USB Circuit Controllers Deliver up to 2.1 Amps to Each Post
- HDMI, VGA, or RJ45 Accessories Sold Separately
- All Mounting Hardware Included
- FCC Part 15A and UL Approved for Horizontal and Vertical Applications
- 10' Cord

DUO BEZEL HARD WIRE

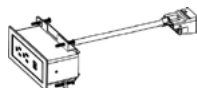

Circuit 1			Width	Depth	Height	Ship Wt	Cubic Ft	List Price
01-HWDUOBEZELW1	White	6½	2½	3	1	0.2	\$ 730	
01-HWDUOBEZELB1	Black							
01-HWDUOBEZELS1	Silver							
Circuit 2			Width	Depth	Height	Ship Wt	Cubic Ft	List Price
01-HWDUOBEZELW2	White	6½	2½	3	1	0.2	\$ 730	
01-HWDUOBEZELB2	Black							
01-HWDUOBEZELS2	Silver							
Circuit 3			Width	Depth	Height	Ship Wt	Cubic Ft	List Price
01-HWDUOBEZELW3	White	6½	2½	3	1	0.2	\$ 730	
01-HWDUOBEZELB3	Black							
01-HWDUOBEZELS3	Silver							
Circuit 4			Width	Depth	Height	Ship Wt	Cubic Ft	List Price
01-HWDUOBEZELW4	White	6½	2½	3	1	0.2	\$ 730	
01-HWDUOBEZELB4	Black							
01-HWDUOBEZELS4	Silver							

Description

- Must Specify Color and Circuit
- Sits on worksurface and includes: Two (2) Power, Two (2) USB Power, and all mounting hardware
- Independent USB Circuit Controllers Deliver up to 2.1 Amps to Each Post
- FCC Part 15A and UL Approved for Horizontal and Vertical Applications
- Maximum 10 Duo Units per Circuit
- Eight (8) Wire/Four (4) Circuit Hard Wire Power Unit

[See Gesso Intro Section for Ordering Options](#)

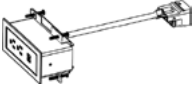
Item	Model No.		Width	Depth	Height	Ship Wt	Cubic Ft	List Price	
TRIO BEZEL HARD WIRE 	Circuit 1								
	01-HWTRIOBEZELW1	White	9	2½	3	1	0.2	\$ 749	
	01-HWTRIOBEZELB1	Black							
	01-HWTRIOBEZELS1	Silver							
	Circuit 2								
	01-HWTRIOBEZELW2	White	9	2½	3	1	0.2	\$ 749	
	01-HWTRIOBEZELB2	Black							
	01-HWTRIOBEZELS2	Silver							
	Circuit 3								
	01-HWTRIOBEZELW3	White	9	2½	3	1	0.2	\$ 749	
	01-HWTRIOBEZELB3	Black							
	01-HWTRIOBEZELS3	Silver							
	Circuit 4								
01-HWTRIOBEZELW4	White	9	2½	3	1	0.2	\$ 749		
01-HWTRIOBEZELB4	Black								
01-HWTRIOBEZELS4	Silver								

Description

- Must Specify Color and Circuit
- Sits on worksurface and includes: Three (3) Power, Two (2) USB Power, and all mounting hardware
- Independent USB Circuit Controllers Deliver up to 2.1 Amps to Each Post
- FCC Part 15A and UL Approved for Horizontal and Vertical Applications
- Maximum 6 Trio Units per Circuit
- Eight (8) Wire/Four (4) Circuit Hard Wire Power Unit

QUAD BLOCK HARD WIRED	01-HWQUADBLOCK		-	-	-	1	0.2	\$ 62
------------------------------	----------------	--	---	---	---	---	-----	-------

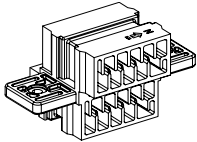
**Description**

- Eight (8) Wire/Four (4) Circuit Hard Wire Connector
- UL183 Compliant
- For Connecting Jumpers and Power Units
- Quantity of Four (4) Female Inputs

POWER ENTRY HARD WIRED	01-HWPOWERENTRY		72	-	-	1	0.2	\$ 322
-------------------------------	-----------------	--	----	---	---	---	-----	--------

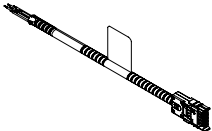
**Description**

- Eight (8) Wire/Four (4) Circuit Hard Wire Infeed
- UL183 Compliant

[See Gesso Intro Section for Ordering Options](#)

Item	Model No.	Width	Depth	Height	Ship Wt	Cubic Ft	List Price
	01-HW2JUMP	24	-	-	1	0.2	\$ 193
	01-HW3JUMP	36	-	-	1	0.2	\$ 206
	01-HW4JUMP	48	-	-	1	0.2	\$ 212
	01-HW5JUMP	60	-	-	1	0.2	\$ 255
	01-HW6JUMP	72	-	-	1	0.2	\$ 270

Description

- Eight (8) Wire/Four (4) Circuit Hard Wire Jumper
- UL183 Compliant

Item	Model No.	Color	Width	Depth	Height	Ship Wt	Cubic Ft	List Price
	01-PDUOBEZELW	White	6½	2½	3	1	0.2	\$ 668
	01-PDUOBEZELB	Black						
	01-PDUOBEZELS	Silver						

Description

- Sits On Top of the Worksurface
- Unit Includes Two (2) Power/Two (2) USB Power with a 12" Cord
- Independent USB Circuit Controllers Deliver up to 2.1 Amps to Each Post
- All Mounting Hardware Included
- FCC Part 15A, RU Listed and UL Recognized for Horizontal and Vertical Applications
- Non Sequential System Allows Up to Eight (8) Modules To Be Connected With Jumper Cord
- Requires Power Box

Item	Model No.	Color	Width	Depth	Height	Ship Wt	Cubic Ft	List Price
	01-PTRIOBEZELW	White	9	2½	3	1	0.2	\$ 715
	01-PTRIOBEZELB	Black						
	01-PTRIOBEZELS	Silver						

Description



- Sits On Top of the Worksurface
- Unit Includes Three (3) Power/Two (2) USB Power/One (1) Open Data with a 12" Cord
- HDMI, VGA, or RJ45 Accessories Sold Separately
- All Mounting Hardware Included
- FCC Part 15A, RU Listed and UL Recognized for Horizontal and Vertical Applications
- Non Sequential System Allows Up to Eight (8) Modules To Be Connected With Jumper Cord
- Requires Power Box

Item	Model No.	Width	Depth	Height	Ship Wt	Cubic Ft	List Price
	01-PPOWER 76" Perimeter, 36" Power Cord	-	-	-	1	0.2	\$ 775
	01-PPOWER2 24" Perimeter, 144" Power Cord	-	-	-	1	0.2	\$ 796

Description

- Powers up to Eight (8) Duo and Trio Daisy Chain Units
- One (1) Nema Plug and One (1) Daisy Chain Plug
- 12 Amp System Rating
- 15 Amp Over-Current Protection

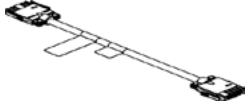
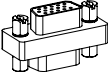
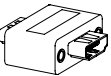
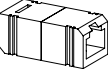
[See Gesso Intro Section for Ordering Options](#)

Item	Model No.		Width	Depth	Height	Ship Wt	Cubic Ft	List Price
DAISY CHAIN JUMPER CORD 	01-6JUMP	72" Long	-	-	-	1	0.2	\$ 299
	01-5JUMP	60" Long	-	-	-	1	0.2	\$ 284
	01-4JUMP	48" Long	-	-	-	1	0.2	\$ 240
	01-2JUMP	24" Long	-	-	-	1	0.2	\$ 220
	Description <ul style="list-style-type: none"> Connects Duo and Trio Daisy Chain Units Non Sequential System Allows up to Eight (8) Modules to be Connected 							
TRIO VGA DATA PORT ACCESSORY 	01-LCOMVGA		-	-	-	1	0.2	\$ 121
	Description <ul style="list-style-type: none"> VGA Port for Trio Bezel Units 							
TRIO HDMI DATA PORT ACCESSORY 	01-LCOMHDMI		-	-	-	1	0.2	\$ 166
	Description <ul style="list-style-type: none"> HDMI Port for Trio Bezel Units 							
OPEN MARKET ONLY								
TRIO RJ45 DATA PORT ACCESSORY 	01-LCOMRJ45		-	-	-	1	0.2	\$ 79
	Description <ul style="list-style-type: none"> RJ45 Port for Trio Bezel Units 							
SINGLE POWER SAND DOLLAR 	01-SAND60PW	White	3	3	4	1	0.2	\$ 98
	01-SAND60PB	Black						
	01-SAND60PS	Silver						
	Description <ul style="list-style-type: none"> Available on Height Adjustable Desks, Returns and Bridge Units with Wire Management Box in Center Grommet Only (GC-BOX) Unit is 2" Diameter; Mounts in 60mm Round Grommet 6' Cord Single Power Outlet 							

[See Gesso Intro Section for Ordering Options](#)

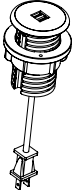
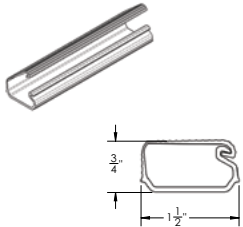
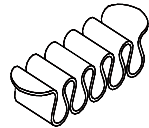
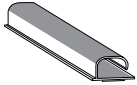
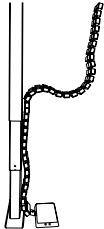
Item	Model No.		Width	Depth	Height	Ship Wt	Cubic Ft	List Price
	01-SAND60UW	White	3	3	4	1	0.2	\$ 277
	01-SAND60UB	Black						
	01-SAND60US	Silver						
Description <ul style="list-style-type: none"> • Available on Height Adjustable Desks, Returns and Bridge Units with Wire Management Box in Center Grommet Only (GC-BOX) • Unit is 2" Diameter; Mounts in 60mm Round Grommet • 6' Cord • Dual USB Outlets 								
	01-WMGR4		16	1½	¾	1	-	\$ 116
Description <ul style="list-style-type: none"> • Set of Four (4) Black Plastic Wire Management Channels • Snap Lock Channel • Attaches with Adhesive Strips • Ships via UPS Only 								
	01-WMGRCB		5 ⅜	2 ⅝		-	-	\$ 117
Description <ul style="list-style-type: none"> • Under Surface Wire Management • Black 								
	01-32125		24	1⅞	1	.25	0.3	\$ 106
Description <ul style="list-style-type: none"> • Available in Black • Channels Attach with 2 Double-Sided Installation Tape • Open J Channel for Easy Storage of Cables 								
	01-0251LINKSLV	Silver	5⅜	3⅜	30-51	4	3.0	\$ 390
	01-0251LINKBLK	Black	5⅜	3⅜	30-51	4	3.0	\$ 353
Description <ul style="list-style-type: none"> • Kit Includes: 50 Link 360™ elements, One (1) Quad Connector, One (1) Dumbbell Connector, One (1) Foot Assembly with Two (2) Magnetic Clips • Can Be Used For Height-Adjustable Mechanisms Up To 51" or Free-Standing Use 								

[See Gesso Intro Section for Ordering Options](#)

With a nod to the '50s and '60s, Iconic's clean lines, tapered legs, and unexpected details present a timeless, approachable quality while being suited to outfit a multitude of areas, including private office, open plan/benching, small meeting areas, and ancillary spaces.

CONSTRUCTION

Iconic features a Veneer chassis with your choice of a Veneer, HPL or 3D Laminate top. Units ship assembled unless otherwise noted.

veneer

- Exposed surfaces feature select-grade, plain-sliced hardwood Cherry, Maple, American Black Walnut, White Oak, and composite veneers; Veneers are carefully selected and matched to assure proper balance and consistency
- Veneer features UVAdvantage, an ultra-violet finish, on all exposed surfaces by utilizing roll-coat UV technology

LAMINATE

- TFL and HPL are made of woodgrain and solid color laminates fused to particleboard core; Each laminate offers lasting beauty, superior resistance to normal wear, and easy maintenance
- 3D laminate surfaces eliminate the need for edge banding, visible seams, and special edge treatments; elimination of seams helps mitigate the accumulation of potential contaminants and simplifies cleaning

TOPS

- Tops are 1 $\frac{3}{16}$ " thick
- Square (Y) Edge Profile is 3-ply balanced construction with 3mm wood edge-banded rims
- Square edge tops are shaped on all four sides
- Knife (KB) and Illusion (I) Edge Profile are 5-ply balanced construction with hardwood rims. Knife (KB) and Illusion (I) Edge Profile are profiled on three sides of Double Ped and Single Ped Desks with user side featuring Square Edge (Y)
- Grain direction runs left-to-right unless noted

CHASSIS

- Chassis are fastened by using high quality European fastening systems and heavy-duty, 16-gauge joining brackets to assure maximum strength
- All units ship with heavy-duty, adjustable glides to ensure proper leveling and compensate for uneven floors
- Horizontal grain direction unless otherwise noted

DRAWERS

- Box and file drawers are tested for 100lb capacity
- 5-sided drawer construction for easy removal of drawer fronts
- Fronts are 3-ply construction, $\frac{3}{4}$ " thick with matched grain
- Sides, back, and front are $\frac{1}{2}$ " thick woodgrain vinyl-wrapped miter fold construction; box and file drawers have $\frac{1}{8}$ " thick hardboard bottoms, lateral file drawers feature $\frac{1}{4}$ " thick bottoms
- Optional Dovetail construction with $\frac{7}{16}$ " thick hardwood sides and backs and $\frac{5}{32}$ " thick hardboard bottoms
- Box and file drawers feature full extension, progressive action slides with precision steel ball bearings allowing side-to-side and front-to-back
- Optional soft close on box and file drawers allows front-to-back filing in file drawers
- Lateral files $\frac{3}{4}$ extension, progressive action slides with precision steel ball bearings
- All suspensions have a limited lifetime warranty

FILING

- All file drawers are standard with filing systems designed to accommodate a variety of filing requirements
- Optional soft close on box and file drawers allows front-to-back filing in file drawer
- Legal width file drawers provide legal filing front to back, and letter or legal filing side to side

STORAGE

- All hinged doors include soft close hinges
- Soft close hinges reduce stress placed on the cabinet when the door is closed and offers a quiet closure

LOCKING

- All units with drawers feature standard locking; optional locking available on models with doors where noted ([see locking option](#))
- Lock core available in black or silver, please specify color
- Removable lock cylinders allow for units to be re-keyed at a later date if required
- Units are shipped randomly keyed as standard
- Keyed alike units available upon request at no additional charge

CORD MANAGEMENT

- Grommets are available in the tops of desks, returns, bridge tops, kneespace credenzas, and credenzas
- An exit grommet is standard on the bottom of pedestals for wires to escape
- Hutch units have standard grommets in back panels
- On units, where noted, a removable back panel for wire access/wire management, as well as an exit grommet, come standard
- Grommets are 2 $\frac{3}{8}$ " in diameter and available in black or silver
- [See all optional grommet locations](#)
- Wire channel ([01-WMGRCB](#)) available for additional undersurface cord management

INTERIOR DRAWER DIMENSIONS

Models

50-3672DP	50-3072DP	50-2472LKC	50-2472RKC
50-3666DP	50-3066DP	50-2466LKC	50-2466RKC
50-3660DP	50-3060DP	50-2460LKC	50-2460RKC
50-3672LP	50-3672RP	50-3072LP	50-3072RP
50-3666LP	50-3666RP	50-3066LP	50-3066RP
50-3660LP	50-3660RP	50-3060LP	50-3060RP
50-4824LPDR	50-4824RPDR	50-4224LPDR	50-4224RPDR
50-1872SWBL	50-1872SWBR		

Drawers

	W	L	D
Box	15 $\frac{3}{8}$ "	16 $\frac{3}{16}$ "	3 $\frac{1}{2}$ "
File	15 $\frac{3}{8}$ "	16 $\frac{3}{16}$ "	9 $\frac{5}{16}$ "

Models

50-2472LOBL	50-2472LOBR	50-2472DBF	50-2472LDF
50-2472OBFL	50-2472OBFR		

Drawers

	W	L	D
Lat File	32 $\frac{5}{32}$ "	15 $\frac{1}{16}$ "	9 $\frac{1}{4}$ "

Models

50-2460LOBL	50-2466LOBL	50-2460OBFL	50-2466OBFL
50-2460LOBR	50-2466LOBR	50-2460OBFR	50-2466OBFR
50-2460DBF	50-2460LDF	50-6024LLR	50-6024RLR

Drawers

	W	L	D
Box	15 $\frac{3}{8}$ "	12 $\frac{1}{8}$ "	3 $\frac{1}{2}$ "
Lat File	26 $\frac{5}{32}$ "	15 $\frac{1}{16}$ "	9 $\frac{1}{4}$ "

FILING CAPABILITIES

Drawers with Dimensions: 15³/₈"W x 16¹/₈"L

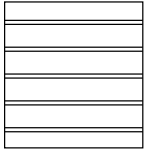

Letter Font to Back

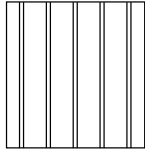

Legal Side to Side

Drawers with Dimensions: 26³/₂"W x 15¹/₈"L

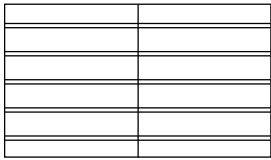

2 Rows Letter Font to Back

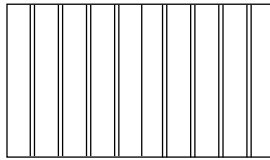

1 Row Legal Side to Side

Drawers with Dimensions: 32³/₂"W x 15¹/₈"L

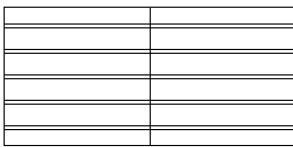

2 Rows Letter Font to Back

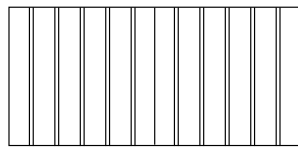

1 Row Legal Side to Side

HOW TO ORDER EXAMPLES

Model No.	Description	Example
50-3672DP	Top Material	3D
	Edge Profile	KB
	Top Finish/Color	CR3
	Chassis Finish	PNW
	Finger Pull Accent Material/Color	FPPFHG
	Leg Finish	PNW
	Modesty Accent Material	50-APFMD
	Modesty Accent Color	MAPFHG
	Drawer Construction	DOVE
	Drawer Track	SFTCL
	Lock Color	BLK
	Power/Data	GC, SLV
	Kneespace Options	01-1622CD
	50-2472OBFL	Top Material
Top Finish/Color		SKC
Chassis Finish		SKC
Cabinet Accent Color		CABSH
Finger Pull Accent Material/Color		FPPBSH
Leg Finish		SKC
Drawer Construction		-
Drawer Track		SFTCL
Lock Color		BLK
Power/Data		GC, BLK

Model No.	Description	Example
50-24600SD72	Chassis Finish	WTA
	Cabinet Accent Color	CAENL
	Round Pull/Metal Accent Color	CRD
	Leg Finish	BL

VENEER (W) OPTIONS

Veneer features UVAdvantage, an ultra-violet finish, on all exposed surfaces by utilizing roll-coat UV technology

AW	Artisan Walnut	MW	Mahogany Walnut
AS	Asian Night	MAS	Mesa Sunset*
CO	Columbian Walnut	MTS	Metropolis Sky
DC	Dark Cherry	ORW	Oak Riftwood*
DFW	Dark Forest Walnut	PNW	Pinnacle Walnut
EW	Espresso	SCH	Select Cherry
FO	Fawn Oak*	SKC	Shaker Cherry
GC	Golden Cherry	SM	Sugar Maple
HW	Harvest Walnut	WTA	Weathered Ash*
HNW	Henna Walnut	WC	Williamsburg Cherry
LW	Legacy Walnut		

* Finish is Low Sheen

HPL (P) OPTIONS

AS	Asian Night	PNW	Pinnacle Walnut
CO	Columbian Walnut	SCH	Select Cherry
EW	Espresso	SKC	Shaker Cherry
GC	Golden Cherry	SM	Sugar Maple
MW	Mahogany Walnut	WTA	Weathered Ash
ORW	Oak Riftwood	WC	Williamsburg Cherry

3D LAMINATE (3D) OPTIONS

3D laminate surfaces eliminate the need for edge banding, visible seams, and special edge treatments. The elimination of seams helps to mitigate the accumulation of potential contaminants and simplifies cleaning. See cleaning instructions on our website under Resources.

Our Matte White and Matte Black options are not only durable, they leave no fingerprints. The matte, soft touch finish will add a sense of luxury, beauty, and style to any interior space.

Our Concrete option features a city-inspired, grey concrete surface with an embossed texture that is real to the touch and feel.

See individual select products for availability.

CR3	Concrete	WH3	Matte White
BL3	Matte Black		



Concrete (CR3)



Matte Black (BL3)



Matte White (WH3)

WOOD FINISH LEG OPTIONS

AW	Artisan Walnut	LW	Legacy Walnut
AS	Asian Night	MW	Mahogany Walnut
CO	Columbian Walnut	MAS	Mesa Sunset*
DC	Dark Cherry	MTS	Metropolis Sky
DFW	Dark Forest Walnut	ORW	Oak Riftwood*
EW	Espresso	PNW	Pinnacle Walnut
FO	Fawn Oak*	SCH	Select Cherry
GC	Golden Cherry	SKC	Shaker Cherry
HW	Harvest Walnut	SM	Sugar Maple
HNW	Henna Walnut	WTA	Weathered Ash*
		WC	Williamsburg Cherry

* Finish is Low Sheen

SOLID COLORS

BL	Black	WH	Designer White
----	-------	----	----------------

EDGE PROFILE

Select units feature multiple profile options. See specific units for details. Double Ped and Single Ped Desks are profiled on three sides with user side featuring Square Edge (Y).

I	Illusion	Y	Square
KB	Knife		



PULL OPTIONS

STD	Finger Pull, Veneer*	BRD	Round Door Pull, Black
FPF	Finger Pull, Fabric	CRD	Round Door Pull, Chrome
FPP	Finger Pull, HPL		



Finger Pull



Round Door Pull

*Veneer Finger Pull Finish will match Chassis Finish

FINGER PULL HPL ACCENT (FPP) OPTIONS

FPPBL	Black	FPPFK	First Kiss
FPPBSH	Blush	FPPSG	Slate Grey
FPPWH	Designer White	FPPSV	Summer Vacation
FPPFHG	Fashion Grey	FPPSUS	Surfin USA

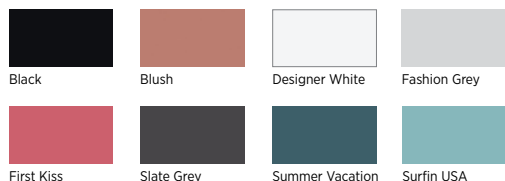

MODESTY ACCENT HPL (P) OPTIONS

MAPBL	Black	MAPFK	First Kiss
MAPBSH	Blush	MAPSG	Slate Grey
MAPWH	Designer White	MAPSV	Summer Vacation
MAPFHG	Fashion Grey	MAPSUS	Surfin USA



Modesty Panel is available in veneer only, while the Modesty Accent is available in veneer, HPL, or fabric.

UPHOLSTERY OPTIONS

For units available with a Fabric Finger Pull or Modesty Accent, as well as tackboards, we offer a wide variety of graded-in or contract options. Due to the minimal, 1/2 yard requirement for Accent Features, all leather options for these units will be COL.

All graded-in fabrics, contract partners, and our COM/COL Form may be found online at: www.indianafurniture.com/resources/textiles

INTERIOR CABINET ACCENT HPL (P) OPTIONS

Select units feature an optional interior HPL accent color. See specific units for details.

CABL	Black	CAFK	First Kiss
CABSH	Blush	CASG	Slate Grey
CAWH	Designer White	CASV	Summer Vacation
CAFHG	Fashion Grey	CASUS	Surfin USA

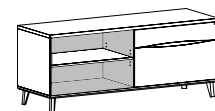

For example, Shaded Area Denotes Cabinet Accent Location

DRAWER OPTIONS

Units with drawers come standard with woodgrain vinyl-wrapped drawers. Optional dove tail construction for all box, file, and lateral file drawers is available. Soft close is also available for all box and file drawers. **File drawers with the soft close option feature front-to-back filing.** Must specify when ordering.

Pricing is per Drawer, not per Model/Unit.

DOVE	Wood Dove Tail Construction	\$	45
SFTCL	Soft Close Drawer Track (Box & File Drawers Only)	\$	34

LOCK CORE COLOR OPTIONS

BLK	Black	SLV	Silver
-----	-------	-----	--------



LOCKING DOORS

Locking doors are available on specific units, where noted. Must specify WITH LOCKING when ordering, denote color, and add upcharge. Color Options: Black (BLK) or Silver (SLV)

LKT_HU	78"W to 48"W Units	\$	115
LKT_HU	42"W to 30"W Units	\$	91
LKT_HU	18"W Units	\$	69

GROMMET OPTIONS & POWER UNIT LOCATIONS

Grommets are available in tops of returns, bridges, and credenzas, and may be ordered without grommets at no additional charge. Please specify NO GROMMET on order.

Grommets are available on hutches in standard locations for task light management at no additional charge. Please specify WMHUBL (Black) or WMHUSV (Silver).

Power/Data, Dock 950 and Dock 150 units must be specified separately with surface mount location. Dock 950 and Dock 150 units are available on Table Desks and Credenza Tops, and where otherwise noted.

Grommets are available in standard locations. Please specify using info below. Multiple locations may be selected. Only one unit per location.

GROMMET LOCATIONS (Black = BLK and Silver = SLV)

GC	Grommet, Center - Specify BLK or SLV	\$	52
GL	Grommet, Left - Specify BLK or SLV	\$	52
GR	Grommet, Right - Specify BLK or SLV	\$	52

DUO/TRIO BEZEL LOCATIONS

PDC-C	Bezel, Center
PDC-L	Bezel, Left
PDC-R	Bezel, Right

DOCK 950 and DOCK 150 LOCATIONS (See Dock Units)

DOCK950-L	D950 Wireless Charger, Left	\$	265
DOCK950-C	D950 Wireless Charger, Center	\$	265
DOCK950-R	D950 Wireless Charger, Right	\$	265
DOCK150-L	D150 Wireless and USB Charger, Left	\$	405
DOCK150-C	D150 Wireless and USB Charger, Center	\$	405
DOCK150-R	D150 Wireless and USB Charger, Right	\$	405

Verify Grommet Option is available on the model(s) you are specifying using the following location information. Grommets, Power Units, Dock 950 and Dock 150 may be ordered in non-standard locations. Call Customer Service to assist with specification and/or please attach a drawing to the PO showing the location of the grommet. Note additional charges and lead times may apply.

Models

50-3672DP	50-3072DP	50-3072LP	50-3072RP
50-3666DP	50-3066DP	50-3066LP	50-3066RP
50-3660DP	50-3060DP	50-3060LP	50-3060RP
50-3672LP	50-3672RP	50-3672TD	50-3072TD
50-3666LP	50-3666RP	50-3666TD	50-3066TD
50-3660LP	50-3660RP	50-3660TD	50-3060TD
50-3672ROTD	50-3072ROTD	50-3666ROTD	50-3066ROTD
50-3660ROTD	50-3060ROTD		

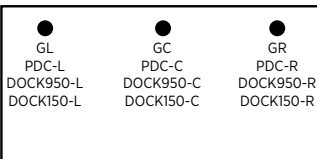

GL/GR/PDC-L/PDC-R/DOCK950-L/
DOCK950-R/DOCK150-L/DOCK150-R:
6" from ends; 21" from user side

GC/PDC-C/DOCK950-C/DOCK150-C:
21" from user side

Models

50-2472LOB	50-4224RPDR	50-6024RLR*	50-2472OBFL
50-2466LOB	50-2472DBF	50-4824TP	50-2472OBFR
50-2460LOB	50-2460DBF	50-4224TP	50-2466OBFL
50-4824LPDR	50-2472LDF	50-3624TP	50-2466OBFR
50-4224LPDR	50-2460LDF	50-2472SDB	50-2460OBFL
50-4824RPDR	50-6024LLR*	50-2466SDB	50-2460OBFR
50-2472LOBR	50-2460LOBR	50-2460SDB	50-2466LOBL
50-2466LOBR	50-2460LOBL	50-2472LOBL	

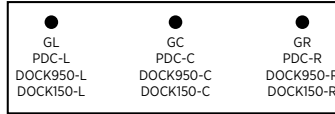

* Center grommet not available

PDC-L/PDC-R: 11" from ends; 21 1/2" from user side
PDC-C: 21 1/2" from user side

GL/GR/DOCK950-L/DOCK950-R/
DOCK150-L/DOCK150-R: 6" from ends; 20" from user side

GC/DOCK950-C/DOCK150-C: 20" from user side

Models

50-2472LKC	50-2472RKC	50-2466LKC	50-2466RKC
50-2460LKC	50-2460RKC		

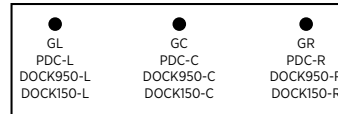

PDC-L/PDC-R: 6" from ends; 20" from user side
PDC-C: 20" from user side

GL/GR/DOCK950-L/DOCK950-R/
DOCK150-L/DOCK150-R:
4" from ends; 20" from user side

GC/DOCK950-C/DOCK150-C
20" from user side

Models

50-4824TDR	50-2472ROTD	50-2466ROTD	50-2460ROTD
50-4224TDR			

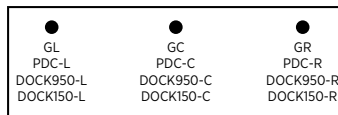

PDC-L/PDC-R: 11" from ends; 15" from user side
PDC-C: 15" from user side

GL/GR/DOCK950-L/DOCK950-R/
DOCK150-L/DOCK150-R: 6" from ends; 15" from user side

GC/DOCK950-C/DOCK150-C 15" from user side

Models

50-2436BF	50-2436LL	50-2430BF	50-2430LL
-----------	-----------	-----------	-----------

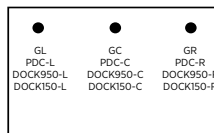

GL/GR/PDC-L/PDC-R/DOCK950-L/
DOCK950-R/DOCK150-L/DOCK150-R: 6" from ends; 20" from user side

GC/PDC-C/DOCK950-C/DOCK150-C: 20" from user side

CERTIFICATIONS & COMPLIANCE

- Intertek Sustainability Certified
- BIFMA level® Certified
- BIFMA Compliant® Certified
- TSCA Title VI (formerly CARB) Compliance
- US Green Building's LEED® Contribution

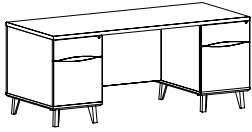

Double Ped Desks
[\(See Details\)](#)

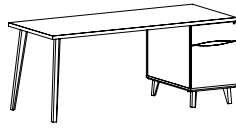

Single Ped Desks
[\(See Details\)](#)



Table Desks
[\(See Details\)](#)

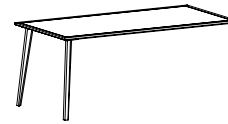

Run Off Table Desks
[\(See Multiple Unit Details\)](#)

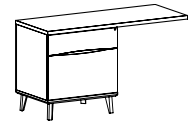

Returns
[\(See Details\)](#)



Bridge Surfaces
[\(See Details\)](#)

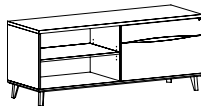

Standard & Low Height Credenzas
[\(See Multiple Unit Details\)](#)

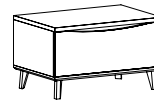
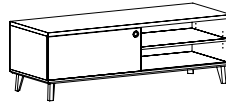

Low Height Lateral
[\(See Details\)](#)

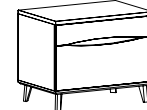

Box/Lateral File
[\(See Details\)](#)

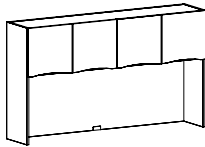

Wall Mount and Surface Mount Hutches
[\(See Multiple Unit Details\)](#)

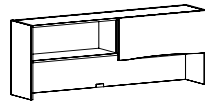

Low Surface Mount Hutches
[\(See Multiple Unit Details\)](#)

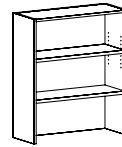

Surface Mount Bookcase
[\(See Details\)](#)

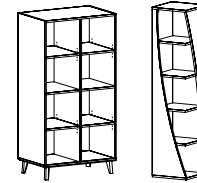

Bookcases and Twisted Bookcases
[\(See Multiple Unit Details\)](#)



Freestanding [\(See Details\)](#), Surface Mount Open Storage/Dividers [\(See Multiple Unit Details\)](#)

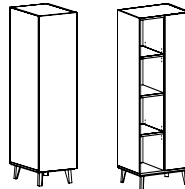
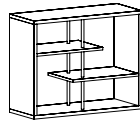

Storage/Wardrobes
[\(See Multiple Unit Details\)](#)



L-Shelves
[\(See Details\)](#)

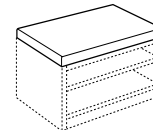

Component Cushions
[\(See Details\)](#)

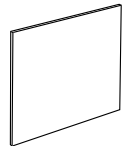

Marker Boards
[\(See Multiple Unit Details\)](#)

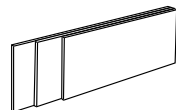

Tackboards
[\(See Multiple Unit Details\)](#)

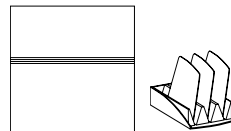

WorkWalls & Accessories
[\(See Multiple Unit Details\)](#)

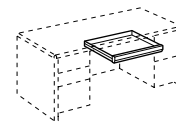

Kneespace Options
[\(See Multiple Unit Details\)](#)



Task Lighting
[\(See Multiple Unit Details\)](#)

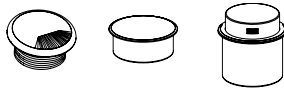

Power/Data and Accessories
[\(See Multiple Unit Details\)](#)

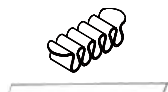
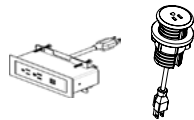

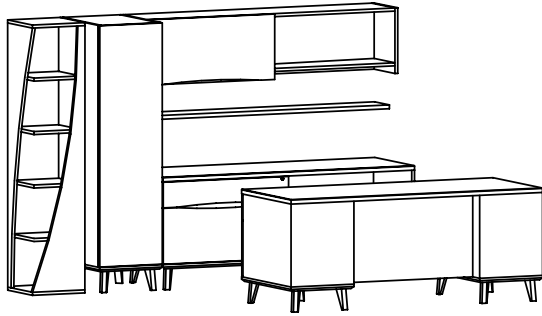

The floating shelf shown is part of the Gesso Casegoods line and can be used with Iconic.

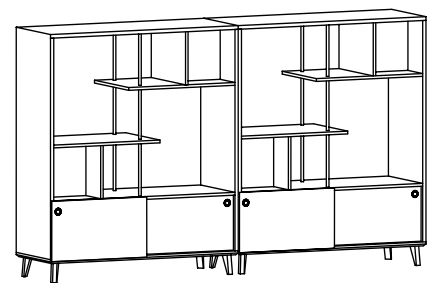
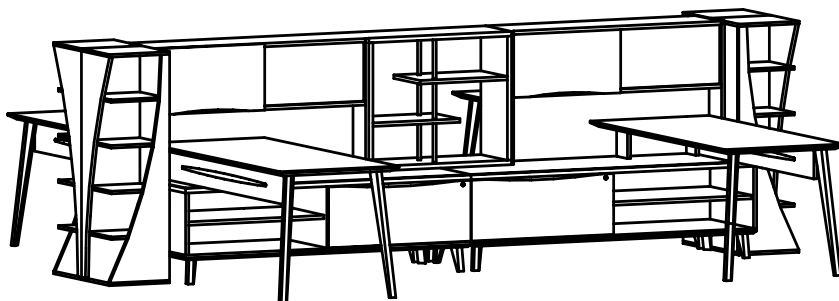
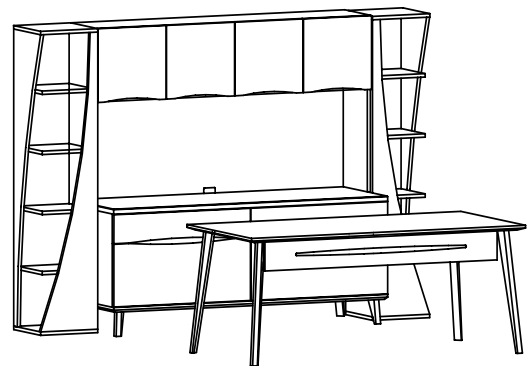
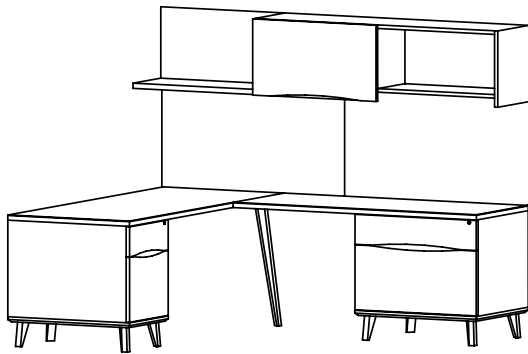
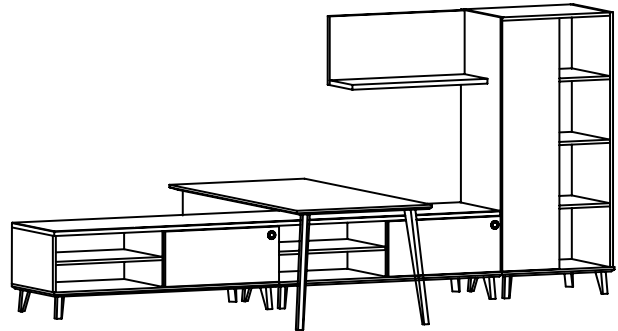

Item	Model No.	Width	Depth	Height	Ship Wt	Cubic Ft	List Price
L-UNIT OFFICE	50-1	96	72	78	527	100.8	P/W\$ 11583 3D\$ 14026

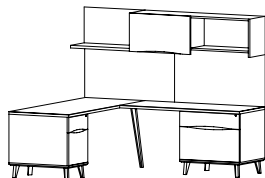
CONSISTS OF: QTY

50-3672LP	1	Single Ped Desk, Left with Square Edge and Finger Pull Accent in Veneer	P/W\$ 3990 3D\$ 6433
50-6024RLR	1	Box/Lateral Return, Right with Finger Pull Accent in Veneer	\$ 3647
50-1560SWD	1	Wall Mount Hutch with Sliding Door with Finger Pull Accent in Veneer	\$ 2314
50-1536LS	1	Open Wall Mounted L-Shelf	\$ 844
TB-6696W	1	96" Tackboard	GR1\$ 788

Products are available as left or right and with other features, where applicable
List does not include seating or accessories

EXECUTIVE OFFICE	50-2	105	102	70%	1089	125.7	P/W\$ 22102 3D\$ 24546
------------------	------	-----	-----	-----	------	-------	---------------------------

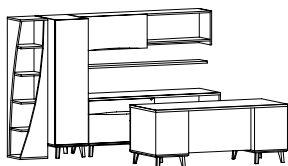
CONSISTS OF: QTY

50-3672DP	1	Double Ped Desk with Square Edge and Finger Pull Accent in Veneer	P/W\$ 5798 3D\$ 8242
50-2472OBFL	1	Credenza, Open Bookcase and Box/Lateral File, Left and Finger Pull Accent in Veneer	\$ 5423
50-1572SWD	1	Wall Mount Hutch with Sliding Door and Finger Pull Accent in Veneer	\$ 2419
50-2472WL	1	Storage Wardrobe, Left	\$ 4281
50-1572TBL	1	Twisted Bookcase, Left	\$ 3022
65-0972FS	1	Gesso Floating Display Shelf	\$ 1159

Products are available as left or right and with other features, where applicable
Depth includes 42" between Double Ped Desk and Credenza
List does not include seating or accessories

The floating shelf shown is part of the Gesso Casegoods line and can be used with Iconic.

Item	Model No.	Width	Depth	Height	Ship Wt	Cubic Ft	List Price
RUN-OFF TABLE DESK OFFICE	50-3	180	72	70 $\frac{1}{8}$	971	111.3	P/W\$ 17957 3D\$ 20398



CONSISTS OF:		QTY			
50-3672ROTD	1	Run Off Table Desk with Square Edge + Optional 7" Veneer Modesty	P/W\$ 1468 3D\$ 3909		
50-1807US	1	Layer Support for Low Storage	\$ 561		
50-2472SDB	2	Low Credenza with Open Bookcase and Sliding Door	\$ 4517		
50-1542LS	1	Open Wall Mounted L-Shelf	\$ 958		
50-2436OBD72L	1	Open Bookcase with Side Door, Left	\$ 5713		

Products are available as left or right and with other features, where applicable
List price does not include optional 7" veneer modesty, seating, or accessories

TABLE DESK OFFICE	50-4	102	102	70 $\frac{1}{8}$	916	100.9	P/W\$ 19848 3D\$ 22291
-------------------	------	-----	-----	------------------	-----	-------	---------------------------

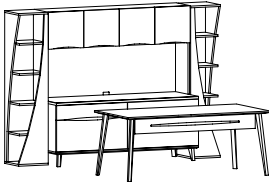

CONSISTS OF:		QTY			
50-3672TD	1	Table Desk with Square Edge + Optional 7" Veneer Modesty with Modesty Accent in Veneer	P/W\$ 1991 3D\$ 4434		
50-2472DBF	1	Credenza, Double Box/Lateral File with Finger Pull Accent in Veneer	\$ 6274		
50-1572HU	1	Surface Mount Hutch with Finger Pull Accent in Veneer	\$ 5316		
50-1572TBL	1	Twisted Bookcase, Left	\$ 3022		
50-1572TBR	1	Twisted Bookcase, Right	\$ 3022		

Products are available as left or right and with other features, where applicable
Depth includes 42" between Table Desk and Credenza
List price does not include optional 7" veneer modesty, modesty accent, seating, or accessories

[See Iconic Intro For Ordering Options and Grommet Locations](#)

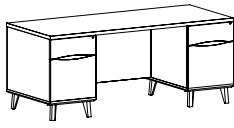
Item	Model No.		Width	Depth	Height	K	Ship Wt	Cubic Ft	List Price		
 <p>Shown with Square Edge</p> <p><u>Must Specify (in this order):</u> Model # Top Material Edge Profile Top Finish/Color Chassis Finish Finger Pull Accent Material/Color Leg Finish Modesty Accent Material Modesty Accent Color Drawer Construction Drawer Track Lock Color Power/Data Kneespace Options</p>	SQUARE (Y) EDGE PROFILE										
	50-3672DP <i>Square</i>	HPL/Veneer 3D Laminate	72	36	30	36	320	52.1	P/W\$ 3D\$	5798 8242	
	50-3666DP <i>Square</i>	HPL/Veneer 3D Laminate	66	36	30	30	310	47.9	P/W\$ 3D\$	5742 7619	
	50-3660DP <i>Square</i>	HPL/Veneer 3D Laminate	60	36	30	24	300	43.6	P/W\$ 3D\$	5683 7274	
	50-3072DP <i>Square</i>	HPL/Veneer 3D Laminate	72	30	30	36	285	43.9	P/W\$ 3D\$	5648 7610	
	50-3066DP <i>Square</i>	HPL/Veneer 3D Laminate	66	30	30	30	275	40.3	P/W\$ 3D\$	5569 7147	
	50-3060DP <i>Square</i>	HPL/Veneer 3D Laminate	60	30	30	24	265	36.7	P/W\$ 3D\$	5500 6958	
	KNIFE (KB) OR ILLUSION (I) EDGE PROFILE										
	50-3672DP <i>Knife/Illusion</i>	HPL/Veneer 3D Laminate	72	36	30	36	320	52.1	P/W\$ 3D\$	6157 8400	
	50-3666DP <i>Knife/Illusion</i>	HPL/Veneer 3D Laminate	66	36	30	30	310	47.9	P/W\$ 3D\$	6069 7689	
	50-3660DP <i>Knife/Illusion</i>	HPL/Veneer 3D Laminate	60	36	30	24	300	43.6	P/W\$ 3D\$	5982 7328	
	50-3072DP <i>Knife/Illusion</i>	HPL/Veneer 3D Laminate	72	30	30	36	285	43.9	P/W\$ 3D\$	5948 7901	
	50-3066DP <i>Knife/Illusion</i>	HPL/Veneer 3D Laminate	66	30	30	30	275	40.3	P/W\$ 3D\$	5843 7206	
	50-3060DP <i>Knife/Illusion</i>	HPL/Veneer 3D Laminate	60	30	30	24	265	36.7	P/W\$ 3D\$	5750 7058	

Description

- Standard With: Box/File Legal Width Locking Pedestals, Left to Right Grain Direction on Worksurface, Horizontal Grain on Chassis
- Available with Contrasting Top, Chassis, and Leg Color
- Top Available in Veneer (W), HPL (P), or 3D Laminate (3D)
- Three (3) Edge Profiles Available; Square (Y) Edge Profiled on All Four (4) Sides; Knife (KB) and Illusion Edge (I) Profiled on Approach and Sides with Square (Y) Edge Profile on User Side
- Finger Pull Accents Available in Veneer (FPV), HPL (FPP), or Fabric (FPF); See Below
- Locking Pedestals; Available with Black (BLK) or Silver (SLV) Lock Cores
- Exit Grommet on the Bottom of Both Pedestals for Wires to Escape
- Additional Options: Modesty Accent (See Below), Dove Tail Drawer Construction and Soft Close Drawers ([See Drawer Options](#)), Power and Grommet Options ([See Option Details](#)), Kneespace Options ([See Multiple Unit Detail](#)), Glass Marker Boards, Work Wall, Tackboards and Other Accessories ([See Multiple Unit Details](#))

Finger Pull Options: Must Specify & Add

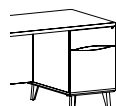

FPV	Finger Pull, Veneer Accent (Finish Will Match Chassis Selection)	\$	NC
FPP	Finger Pull, HPL Accent; Must Specify Color, See Color Options	\$	108
FPF	Finger Pull, Fabric Accent; Must Specify Fabric	\$	See Below

List Price/Grade	Yards	GR 1/ COM/COL	2	3	4	5	6	7	8	9	10	
FPF	Finger Pull, Fabric	0.5 \$	153	179	201	223	255	288	335	384	441	507

Optional Modesty Accent: Specify & Add

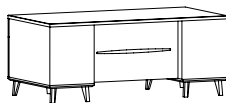

50-AVFMD	Modesty Accent, Veneer (Finish Will Match Chassis Selection)	\$	NC
50-APFMD	Modesty Accent, HPL; Must Specify Color, See Color Options	\$	54
50-AFFMD	Modesty Accent, Fabric; Must Specify Fabric	\$	See Below

List Price/Grade	Yards	GR 1/ COM/COL	2	3	4	5	6	7	8	9	10	
50-AFFMD	Modesty Accent, Fabric	0.5 \$	77	103	125	147	179	212	259	308	365	431

[See Iconic Intro For Ordering Options and Grommet Locations](#)

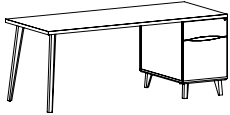
Item	Model No.		Width	Depth	Height	Ship Wt	Cubic Ft	List Price	
 <p>Shown as Right with Square Edge</p> <p><u>Must Specify (in this order):</u> Model # Top Material Edge Profile Top Finish/Color Chassis Finish Finger Pull Accent Material/Color Leg Finish Modesty Panel Finish Drawer Construction Drawer Track Lock Color Power/Data Kneespace Options</p>	SQUARE (Y) EDGE PROFILE								
		Left Ped	Right Ped						
	50-3672LP	50-3672RP	HPL/Veneer 3D Laminate	72	36	30	230	52.1	P/W\$ 3990 3D\$ 6433
	50-3666LP	50-3666RP	HPL/Veneer 3D Laminate	66	36	30	220	47.9	P/W\$ 3944 3D\$ 5823
	50-3660LP	50-3660RP	HPL/Veneer 3D Laminate	60	36	30	210	43.6	P/W\$ 3866 3D\$ 5457
	50-3072LP	50-3072RP	HPL/Veneer 3D Laminate	72	30	30	206	43.9	P/W\$ 3842 3D\$ 5807
	50-3066LP	50-3066RP	HPL/Veneer 3D Laminate	66	30	30	196	40.3	P/W\$ 3774 3D\$ 5353
	50-3060LP	50-3060RP	HPL/Veneer 3D Laminate	60	30	30	186	36.7	P/W\$ 3720 3D\$ 5176
	KNIFE (KB) OR ILLUSION (I) EDGE PROFILE								
		Left Ped	Right Ped						
	50-3672LP	50-3672RP	HPL/Veneer 3D Laminate	72	36	30	230	52.1	P/W\$ 4351 3D\$ 6591
	50-3666LP	50-3666RP	HPL/Veneer 3D Laminate	66	36	30	220	47.9	P/W\$ 4272 3D\$ 5893
	50-3660LP	50-3660RP	HPL/Veneer 3D Laminate	60	36	30	210	43.6	P/W\$ 4164 3D\$ 5511
	50-3072LP	50-3072RP	HPL/Veneer 3D Laminate	72	30	30	206	43.9	P/W\$ 4144 3D\$ 6097
	50-3066LP	50-3066RP	HPL/Veneer 3D Laminate	66	30	30	196	40.3	P/W\$ 4048 3D\$ 5410
	50-3060LP	50-3060RP	HPL/Veneer 3D Laminate	60	30	30	186	36.7	P/W\$ 3970 3D\$ 5277

Description

- Standard With: Box/File Legal-Width Locking Pedestal, Left to Right Grain Direction on Worksurface, Horizontal Grain on Chassis
- Available with Contrasting Top, Modesty, Chassis, and Leg Color
- Top Available in Veneer (W), HPL (P), or 3D Laminate (3D)
- Three (3) Edge Profiles Available; Square (Y) Edge Profiled on All Four (4) Sides; Knife (KB) and Illusion Edge (I) Profiled on Approach and Sides with Square (Y) Edge Profile on User Side
- Square (Y) Edge Profile Required on Top if Attaching to Another Unit
- Finger Pull Accents Available in Veneer (FPV), HPL (FPP), or Fabric (FPF)
- Locking Pedestal; Available with Black (BLK) or Silver (SLV) Lock Cores
- Exit Grommet on the Bottom of Pedestal for Wires to Escape
- Additional Options: Modesty Accent (See Below), Dove Tail Drawer Construction and Soft Close Drawers ([See Drawer Options](#)), Power and Grommet Options ([See Option Details](#)), Kneespace Options ([See Multiple Unit Detail](#)), Glass Marker Boards, Work Wall, Tackboards and Other Accessories ([See Multiple Unit Details](#))

Finger Pull Options: Must Specify & Add



FPV	Finger Pull, Veneer Accent (Finish Will Match Chassis Selection)	\$	NC
FPP _{,3672LP}	Finger Pull, HPL Accent; Must Specify Color, See Color Options	\$	54
FPF	Finger Pull, Fabric Accent; Must Specify Fabric	\$	See Below

List Price/Grade	Yards	GR 1/ COM/COL	2	3	4	5	6	7	8	9	10	
FPF	Finger Pull, Fabric	0.5 \$	77	103	125	147	179	212	259	308	365	431

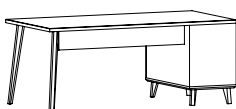

Optional Modesty: Specify & Add

50-HMD _{,3672LP}	7" Veneer Modesty; Must Specify Color, See Color Options	\$	195
---------------------------	--	----	-----

Modesty Accent Not Available On This Unit.

[See Iconic Intro For Ordering Options and Grommet Locations](#)

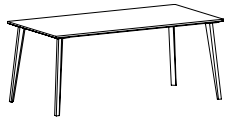
Item	Model No.		Width	Depth	Height	Ship Wt	Cubic Ft	List Price		
 <p>Shown with Knife Edge</p> <p><u>Must Specify (in this order):</u> Model # Top Material Edge Profile Top Finish/Color Leg Finish Modesty Panel Finish Modesty Accent Material Modesty Accent Color Power/Data</p>	SQUARE (Y) EDGE PROFILE									
	50-3672TD	HPL/Veneer	72	36	30	137	9.8	P/W\$	1991	
		Square						3D\$	4434	
	50-3666TD	HPL/Veneer	66	36	30	129	9.0	P/W\$	1944	
		Square						3D\$	3823	
	50-3660TD	HPL/Veneer	60	36	30	121	8.2	P/W\$	1895	
		Square						3D\$	3486	
	50-3072TD	HPL/Veneer	72	30	30	103	10.2	P/W\$	1894	
		Square						3D\$	3857	
	50-3066TD	HPL/Veneer	66	30	30	95	9.6	P/W\$	1837	
		Square						3D\$	3419	
	50-3060TD	HPL/Veneer	60	30	30	87	8.9	P/W\$	1787	
		Square						3D\$	3246	
	KNIFE (KB) OR ILLUSION (I) EDGE PROFILE									
50-3672TD	HPL/Veneer	72	36	30	137	9.8	P/W\$	2352		
	Knife/Illusion						3D\$	4592		
50-3666TD	HPL/Veneer	66	36	30	129	9.0	P/W\$	2272		
	Knife/Illusion						3D\$	3893		
50-3660TD	HPL/Veneer	60	36	30	121	8.2	P/W\$	2195		
	Knife/Illusion						3D\$	3542		
50-3072TD	HPL/Veneer	72	30	30	103	10.2	P/W\$	2194		
	Knife/Illusion						3D\$	4147		
50-3066TD	HPL/Veneer	66	30	30	95	9.6	P/W\$	2111		
	Knife/Illusion						3D\$	3474		
50-3060TD	HPL/Veneer	60	30	30	87	8.9	P/W\$	2036		
	Knife/Illusion						3D\$	3343		

Description

- Standard With: Left to Right Grain Direction on Worksurface and Stiffener Bar
- Available with Contrasting Top, Modesty (optional), and Leg Color
- Top Available in Veneer (W), HPL (P), or 3D Laminate (3D)
- Three (3) Edge Profiles Available; Square (Y), Knife (KB), and Illusion (I)
- Some Assembly Required
- Additional Options: Modesty Panel and Accent Feature (See Below), Power and Grommet Options ([See Option Details](#)), Kneespace Options ([See Multiple Unit Detail](#)), Glass Marker Boards, Work Wall, Tackboards and Other Accessories ([See Multiple Unit Details](#))

Optional Modesty: Specify & Add

50-HMD	7" Veneer Modesty	\$	223
--------	-------------------	----	-----

Optional Modesty Accent: Specify & Add

50-AVHMD	Modesty Accent, Veneer (Finish Will Match Modesty Selection)	\$	NC
50-APHMD	Modesty Accent, HPL; Must Specify Color, See Color Options	\$	54
50-AFHMD	Modesty Accent, Fabric; Must Specify Fabric	\$	See Below



List Price/Grade	Yards	GR 1/ COM/COL	2	3	4	5	6	7	8	9	10	
50-AFFMD	Modesty Accent, Fabric	0.5 \$	77	103	125	147	179	212	259	308	365	431

[See Iconic Intro For Ordering Options and Grommet Locations](#)

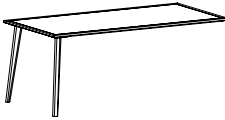
Item	Model No.		Width	Depth	Height	Ship Wt	Cubic Ft	List Price		
 <p>Shown with Knife Edge</p> <p>Must Specify (in this order): Model # Top Material Edge Profile Top Finish/Color Leg Finish Modesty Panel Finish Modesty Accent Material Modesty Accent Color Power/Data</p>	SQUARE (Y) EDGE PROFILE									
	50-3672ROTD	HPL/Veneer	72	36	30	117	9.8	P/W\$	1468	
	<i>Square</i>	3D Laminate						3D\$	3909	
	50-3666ROTD	HPL/Veneer	66	36	30	109	9.0	P/W\$	1417	
	<i>Square</i>	3D Laminate						3D\$	3293	
	50-3660ROTD	HPL/Veneer	60	36	30	101	8.2	P/W\$	1379	
	<i>Square</i>	3D Laminate						3D\$	2968	
	50-3072ROTD	HPL/Veneer	72	30	30	101	8.2	P/W\$	1378	
	<i>Square</i>	3D Laminate						3D\$	3340	
	50-3066ROTD	HPL/Veneer	66	30	30	94	7.6	P/W\$	1325	
	<i>Square</i>	3D Laminate						3D\$	2904	
	50-3060ROTD	HPL/Veneer	60	30	30	87	6.9	P/W\$	1275	
	<i>Square</i>	3D Laminate						3D\$	2732	
	50-2472ROTD	HPL/Veneer	72	24	30	85	6.7	P/W\$	1269	
	<i>Square</i>	3D Laminate						3D\$	3223	
	50-2466ROTD	HPL/Veneer	66	24	30	79	6.1	P/W\$	1232	
	<i>Square</i>	3D Laminate						3D\$	2806	
	50-2460ROTD	HPL/Veneer	60	24	30	74	5.6	P/W\$	1186	
<i>Square</i>	3D Laminate						3D\$	2639		
KNIFE (KB) OR ILLUSION (I) EDGE PROFILE										
50-3672ROTD	HPL/Veneer	72	36	30	117	9.8	P/W\$	1826		
<i>Knife/Illusion</i>	3D Laminate						3D\$	4065		
50-3666ROTD	HPL/Veneer	66	36	30	109	9.0	P/W\$	1745		
<i>Knife/Illusion</i>	3D Laminate						3D\$	3365		
50-3660ROTD	HPL/Veneer	60	36	30	101	8.2	P/W\$	1678		
<i>Knife/Illusion</i>	3D Laminate						3D\$	3024		
50-3072ROTD	HPL/Veneer	72	30	30	101	8.2	P/W\$	1677		
<i>Knife/Illusion</i>	3D Laminate						3D\$	3630		
50-3066ROTD	HPL/Veneer	66	30	30	94	7.6	P/W\$	1599		
<i>Knife/Illusion</i>	3D Laminate						3D\$	2961		
50-3060ROTD	HPL/Veneer	60	30	30	87	6.9	P/W\$	1524		
<i>Knife/Illusion</i>	3D Laminate						3D\$	2831		
50-2472ROTD	HPL/Veneer	72	24	30	85	6.7	P/W\$	1507		
<i>Knife/Illusion</i>	3D Laminate						3D\$	3515		
50-2466ROTD	HPL/Veneer	66	24	30	79	6.1	P/W\$	1452		
<i>Knife/Illusion</i>	3D Laminate						3D\$	2864		
50-2460ROTD	HPL/Veneer	60	24	30	74	5.6	P/W\$	1387		
<i>Knife/Illusion</i>	3D Laminate						3D\$	2738		

Description

- Standard With: Left to Right Grain Direction on Worksurface and Stiffener Bar
- To Be Used With 50-1807US Layer Support for Low Storage
- Available with Contrasting Top, Modesty (optional), and Leg Color
- Top Available in Veneer (W), HPL (P), or 3D Laminate (3D)
- Three (3) Edge Profiles Available; Square (Y), Knife (KB), and Illusion (I)
- Non-Handed; Some Assembly Required
- Additional Options: Modesty Panel and Accent Feature (See Next Page), Power and Grommet Options ([See Option Details](#)), Kneespace Options ([See Multiple Unit Detail](#)), Glass Marker Boards, Work Wall, Tackboards and Other Accessories ([See Multiple Unit Details](#))

CONTINUED ONTO NEXT PAGE

[See Iconic Intro For Ordering Options and Grommet Locations](#)

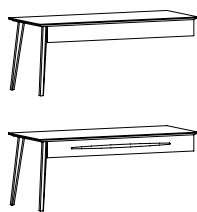
Item	Model No.	Width	Depth	Height	Ship Wt	Cubic Ft	List Price						
RUN OFF TABLE DESK (CONTINUED) 	Optional Modesty: Specify & Add												
	50-HMD	7" Veneer Modesty					\$	223					
	Optional Modesty Accent: Specify & Add												
	50-AVHMD	Modesty Accent, Veneer (Finish Will Match Modesty Selection)					\$	NC					
	50-APHMD	Modesty Accent, HPL; Must Specify Color, See Color Options					\$	54					
	50-AFHMD	Modesty Accent, Fabric; Must Specify Fabric					\$	See Below					
	List Price/Grade	Yards	GR 1/ COM/COL	2	3	4	5	6	7	8	9	10	
	50-AFFMD	Modesty Accent, Fabric	0.5	\$ 77	103	125	147	179	212	259	308	365	431

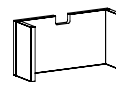
LAYER SUPPORT FOR LOW STORAGE	50-1807US	18	5¾	7	4	0.6	\$	561
 Must Specify (in this order): Model # Finish Grommet Color	Description <ul style="list-style-type: none"> • Supports Run-Off Table Desks Over Low Height Components • Available in Veneer (W) • Grommet Included; Available in Black (BLK) or Silver (SLV) • Open Throughout and On Back Side to Manage Cables 							

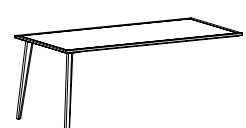
RETURN TABLE DESK	50-4824TDR	48	24	30	63	4.5	\$	974
 Shown with Knife Edge	50-4224TDR	42	24	30	57	4.0	\$	948
	Description <ul style="list-style-type: none"> • Standard With: Front to Back Grain Direction on Worksurface and Square (Y) Edge Profile • Available with Contrasting Top and Leg Color • Top Available in Veneer (W) or HPL (P) • Non-Handed; Some Assembly Required • Optional Power and Grommet Options (See Option Details) 							
Must Specify (in this order): Model # Top Material Top Finish/Color Leg Finish Power/Data								

[See Iconic Intro For Ordering Options and Grommet Locations](#)

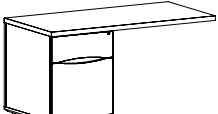
Item	Model No.	Width	Depth	Height	Ship Wt	Cubic Ft	List Price
	Left Ped	Right Ped					
	50-4824LPDR	50-4824RPDR	48	24	30	129	24.1 \$ 3256
	50-4224LPDR	50-4224RPDR	42	24	30	119	21.2 \$ 3175

Shown as Left with Square Edge

Must Specify (in this order):

- Model #
- Top Material
- Top Finish/Color
- Chassis Finish
- Finger Pull Accent Material/Color
- Leg Finish
- Drawer Construction
- Drawer Track
- Lock Color
- Power/Data

Description

- Standard With: Box/File Legal Width Locking Ped, Front to Back Grain Direction on Worksurface, Horizontal Grain on Chassis, and Square (Y) Edge Profile
- Available with Contrasting Top, Chassis, and Leg Color
- Top Available in Veneer (W) or HPL (P)
- Finger Pull Accents Available in Veneer (FPV), HPL (FPP), or Fabric (FPF)
- Locking Pedestal; Available with Black (BLK) or Silver (SLV) Lock Cores
- Exit Grommet on the Bottom of Pedestal for Wires to Escape
- Additional Options: Dove Tail Drawer Construction and Soft Close Drawers ([See Drawer Options](#)), Power and Grommet Options ([See Option Details](#)), Kneespace Options ([See Multiple Unit Detail](#)), Glass Marker Boards, Work Wall, Tackboards and Other Accessories ([See Multiple Unit Details](#))

Finger Pull Options: Must Specify & Add

FPV	Finger Pull, Veneer Accent (Finish Will Match Chassis Selection)	\$	NC
FPP	Finger Pull, HPL Accent; Must Specify Color, See Color Options	\$	54
FPF	Finger Pull, Fabric Accent; Must Specify Fabric	\$	See Below

List Price/Grade	Yards	GR 1/COM/COL	2	3	4	5	6	7	8	9	10
FPF Finger Pull, Fabric	0.5 \$	77	103	125	147	179	212	259	308	365	431

Item	Model No.	Width	Depth	Height	Ship Wt	Cubic Ft	List Price
	Left Ped	Right Ped					
	50-6024LLR	50-6024RLR	60	24	30	170	30.0 \$ 3647

Shown as Left with Square Edge

Must Specify (in this order):

- Model #
- Top Material
- Top Finish/Color
- Chassis Finish
- Finger Pull Accent Material/Color
- Leg Finish
- Drawer Construction
- Box Drawer Track
- Lock Color
- Power/Data

Description

- Standard With: 30" Wide Box/Lateral File Legal Width Locking Ped, Front to Back Grain Direction on Worksurface, Horizontal Grain on Chassis, and Square (Y) Edge Profile
- Available with Contrasting Top, Chassis, and Leg Color
- Top Available in Veneer (W) or HPL (P)
- Finger Pull Accents Available in Veneer (FPV), HPL (FPP), or Fabric (FPF)
- Locking Pedestal; Available with Black (BLK) or Silver (SLV) Lock Cores
- Exit Grommet on the Bottom of Pedestal for Wires to Escape
- Additional Options: Dove Tail Drawer Construction and Soft Close Box Drawer ([See Drawer Options](#)), Power and Grommet Options ([See Option Details](#)), Kneespace Options ([See Multiple Unit Detail](#)), Glass Marker Boards, Work Wall, Tackboards and Other Accessories ([See Multiple Unit Details](#))

Finger Pull Options: Must Specify & Add

FPV	Finger Pull, Veneer Accent (Finish Will Match Chassis Selection)	\$	NC
FPP	Finger Pull, HPL Accent; Must Specify Color, See Color Options	\$	54
FPF	Finger Pull, Fabric Accent; Must Specify Fabric	\$	See Below

List Price/Grade	Yards	GR 1/COM/COL	2	3	4	5	6	7	8	9	10
FPF Finger Pull, Fabric	0.5 \$	77	103	125	147	179	212	259	308	365	431

[See Iconic Intro For Ordering Options and Grommet Locations](#)

Item	Model No.	Width	Depth	Height	K	Ship Wt	Cubic Ft	List Price
	50-4824TP	48	24	1 $\frac{3}{16}$	-	48	4.5	\$ 570
	50-4224TP	42	24	1 $\frac{3}{16}$	-	42	4.0	\$ 538
	50-3624TP	36	24	1 $\frac{3}{16}$	-	36	3.5	\$ 505

Must Specify (in this order):

- Model #
- Top Material
- Top Finish/Color
- Power/Data

Description

- Standard With: Front to Back Grain Direction and Square (Y) Edge Profile
- Available in Veneer (W) or HPL (P)
- For Bridge Application Only
- Optional Power and Grommet Options ([See Option Details](#))

KNEESPACE CREENZA WITH OPEN BOOKCASE AND BOX/FILE

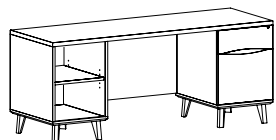

Shown as Right with Square Edge

Left Ped	Right Ped	Width	Depth	Height	K	Ship Wt	Cubic Ft	List Price
50-2472LKC	50-2472RKC	72	24	30	36	265	35.4	\$ 5114
50-2466LKC	50-2466RKC	66	24	30	30	255	32.7	\$ 4928
50-2460LKC	50-2460RKC	60	24	30	24	245	30.0	\$ 4724

Description

- Standard With: Legal Width Locking Box/File Ped with Open Bookcase Ped, One (1) Adjustable Shelf in Open Bookcase, Left to Right Grain Direction on Worksurface, Horizontal Grain on Chassis, and Square (Y) Edge Profile
- For Use in U-Shaped Workstation or Freestanding Applications
- 16" Opening in Open Bookcase Pedestal
- Open Bookcase Features Removable Back Panel for Wire Management; Exit Grommet on the Bottom of Both Pedestals for Wires to Escape
- Available with Contrasting Top, Chassis, and Leg Color
- Tops Available in Veneer (W) or HPL (P)
- Finger Pull Accents Available in Veneer (FPV), HPL (FPP), or Fabric (FPF)
- Locking Pedestal; Available with Black (BLK) or Silver (SLV) Lock Cores
- Additional Options: HPL Cabinet Accent on Bookcase Interior ([See Below](#) and [See Color Options](#)), Dove Tail Drawer Construction and Soft Close Drawers ([See Drawer Options](#)), Power and Grommet Options ([See Option Details](#)), Kneespace Options ([See Multiple Unit Detail](#)), Glass Marker Boards, Work Wall, Tackboards and Other Accessories ([See Multiple Unit Details](#))

Finger Pull Options: Must Specify & Add

FPV	Finger Pull, Veneer Accent (Finish Will Match Chassis Selection)	\$	NC
FPP	Finger Pull, HPL Accent; Must Specify Color, See Color Options	\$	54
FPF	Finger Pull, Fabric Accent; Must Specify Fabric	\$	See Below

List Price/Grade	Yards	GR 1/COM/COL	2	3	4	5	6	7	8	9	10	
FPF	Finger Pull, Fabric	0.5 \$	77	103	125	147	179	212	259	308	365	431

Cabinet Accent Option: Specify & Add

HPL	Cabinet Accent on Bookcase Interior; Must Specify Color, See Color Options	\$	102
-----	--	----	-----

[See Iconic Intro For Ordering Options and Grommet Locations](#)

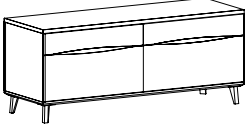
Item	Model No.	Width	Depth	Height	Ship Wt	Cubic Ft	List Price
CREDENZA WITH DOUBLE BOX/LATERAL FILE 	50-2472DBF <i>Includes (2) 36" Wide Box/Lateral Files</i>	72	24	30	316	35.4	\$ 6274
	50-2460DBF <i>Includes (2) 30" Wide Box/Lateral Files</i>	60	24	30	276	30.0	\$ 5847

Shown with Square Edge

Must Specify (in this order):

- Model #
- Top Material
- Top Finish/Color
- Chassis Finish
- Finger Pull Accent Material/Color
- Leg Finish
- Drawer Construction
- Drawer Track
- Lock Color
- Power/Data

Description

- Standard With: Dual Locking Box/Lateral Pedestals, Legal or Letter Filing, Left to Right Grain Direction on Top, Horizontal Grain on Chassis, Square (Y) Edge Profile, and Two (2) Stiffener Bars for Added Support
- Available with Contrasting Top, Chassis, and Leg Color
- Top Available in Veneer (W) or HPL (P)
- Finger Pull Accents Available in Veneer (FPV), HPL (FPP), or Fabric (FPF)
- Locking Pedestals; Available with Black (BLK) or Silver (SLV) Lock Cores
- Additional Options: Dove Tail Drawer Construction and Soft Close Box Drawers ([See Drawer Options](#)), Power and Grommet Options ([See Option Details](#)), Glass Marker Boards, Work Wall, Tackboards and Other Accessories ([See Multiple Unit Details](#))

Finger Pull Options: Must Specify & Add

FPV	Finger Pull, Veneer Accent (Finish Will Match Chassis Selection)	\$	NC
FPP	Finger Pull, HPL Accent; Must Specify Color, See Color Options	\$	108
FPF	Finger Pull, Fabric Accent; Must Specify Fabric	\$	See Below

List Price/Grade	Yards	1/COM/COL	2	3	4	5	6	7	8	9	10
FPF Finger Pull, Fabric	0.5	\$ 153	179	201	223	255	288	335	384	441	507

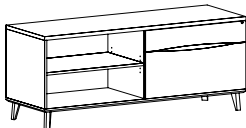
CREDENZA WITH OPEN BOOKCASE AND BOX/LATERAL 	Left Ped	Right Ped	Width	Depth	Height	Ship Wt	Cubic Ft	List Price
		50-2472OBFL <i>36" Wide Box/Lateral File</i>	50-2472OBFR	72	24	30	296	35.4
	50-2466OBFL <i>30" Wide Box/Lateral File</i>	50-2466OBFR	66	24	30	276	32.7	\$ 5208
	50-2460OBFL <i>30" Wide Box/Lateral File</i>	50-2460OBFR	60	24	30	256	30.0	\$ 4911

Shown as Right with Square Edge

Must Specify (in this order):

- Model #
- Top Material
- Top Finish/Color
- Chassis Finish
- Cabinet Accent Color
- Finger Pull Accent Material/Color
- Leg Finish
- Drawer Construction
- Drawer Track
- Lock Color
- Power/Data

Description

- Standard With: Box/Lateral File Locking Ped and Open Bookcase, One (1) Adjustable Shelf in Bookcase Ped, Legal or Letter Filing in Lateral File, Left to Right Grain Direction on Top, Horizontal Grain on Chassis, Square (Y) Edge Profile, and Two (2) Stiffener Bars for Added Support
- Open Bookcase Features Removable Back Panel for Wire Management; Exit Grommet on the Bottom of Both Sides for Wires to Escape
- Available with Contrasting Top, Chassis, and Leg Color
- Top Available in Veneer (W) or HPL (P)
- Finger Pull Accents Available in Veneer (FPV), HPL (FPP), or Fabric (FPF)
- Locking Pedestal; Available with Black (BLK) or Silver (SLV) Lock Cores
- Additional Options: HPL Cabinet Accent on Bookcase Interior (See Below and [See Color Options](#)), Dove Tail Drawer Construction and Soft Close Box Drawer ([See Drawer Options](#)), Power and Grommet Options ([See Option Details](#)), Glass Marker Boards, Work Wall, Tackboards and Other Accessories ([See Multiple Unit Details](#))

Finger Pull Options: Must Specify & Add

FPV	Finger Pull, Veneer Accent (Finish Will Match Chassis Selection)	\$	NC
FPP	Finger Pull, HPL Accent; Must Specify Color, See Color Options	\$	54
FPF	Finger Pull, Fabric Accent; Must Specify Fabric	\$	See Below

List Price/Grade	Yards	1/COM/COL	2	3	4	5	6	7	8	9	10
FPF Finger Pull, Fabric	0.5	\$ 77	103	125	147	179	212	259	308	365	431

Cabinet Accent Option: Specify & Add

HPL	Cabinet Accent on Bookcase Interior; Must Specify Color, See Color Options	\$	162
-----	--	----	-----

[See Iconic Intro For Ordering Options and Grommet Locations](#)

Item	Model No.	Width	Depth	Height	Ship Wt	Cubic Ft	List Price
LOW CREDENZA WITH OPEN BOOKCASE AND SLIDING DOOR	50-2472SDB	72	24	21 $\frac{1}{8}$	250	25.5	\$ 4517
	50-2466SDB	66	24	21 $\frac{1}{8}$	230	23.5	\$ 4254
	50-2460SDB	60	24	21 $\frac{1}{8}$	210	21.5	\$ 4082

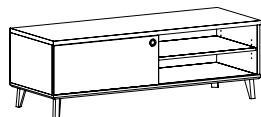

Must Specify (in this order):

- Model #
- Top Material
- Top Finish/Color
- Chassis Finish
- Cabinet Accent Color
- Round Pull Color
- Leg Finish
- Power/Data

Description

- Standard With: Open Bookcase with One (1) Non-Locking Sliding Door, One (1) Adjustable Shelf on Each Side, Left to Right Grain Direction on Top, Horizontal Grain on Chassis, and Square (Y) Edge Profile
- Open Bookcase Features Removable Back Panel for Wire Management; Exit Grommet on the Bottom of Both Sides for Wires to Escape
- Available with Contrasting Top, Chassis, and Leg Color
- Top Available in Veneer (W) or HPL (P)
- Optional Cushion Provides Additional Seating, [See Cushion Details](#)
- Sliding Door; Available with Round Door Pull in Black (BRD) or Chrome (CRD)
- Additional Options: HPL Cabinet Accent on Bookcase Interior (See Below and [See Color Options](#)), Power and Grommet Options ([See Option Details](#)), Glass Marker Boards, Work Wall, Tackboards and Other Accessories ([See Multiple Unit Details](#))

Cabinet Accent Option: Specify & Add

HPL Cabinet Accent on Bookcase Interior; Must Specify Color, See Color Options	\$ 271
--	--------

LOW CREDENZA WITH OPEN BOOKCASE AND LATERAL FILE

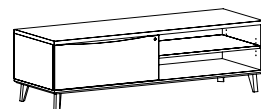

Shown as Left with Square Edge

Must Specify (in this order):

- Model #
- Top Material
- Top Finish/Color
- Chassis Finish
- Cabinet Accent Color
- Finger Pull Accent Material/Color
- Leg Finish
- Drawer Construction
- Lock Color
- Power/Data

Left Ped	Right Ped	Width	Depth	Height	Ship Wt	Cubic Ft	List Price
50-2472LOBL	50-2472LOBR	72	24	21 $\frac{1}{8}$	255	25.5	\$ 4903
<i>36" Wide Lateral File</i>							
50-2466LOBL	50-2466LOBR	66	24	21 $\frac{1}{8}$	235	23.5	\$ 4711
<i>30" Wide Lateral File</i>							
50-2460LOBL	50-2460LOBR	60	24	21 $\frac{1}{8}$	215	21.5	\$ 4532
<i>30" Wide Lateral File</i>							

Description

- Standard With: Locking Lateral File Ped with Open Bookcase, Legal or Letter Filing in Lateral File Drawer, One (1) Adjustable Shelf in Bookcase, Left to Right Grain Direction on Top, Horizontal Grain on Chassis, and Square (Y) Edge Profile
- Open Bookcase Features Removable Back Panel for Wire Management; Exit Grommet on the Bottom of Both Sides for Wires to Escape
- Available with Contrasting Top, Chassis, and Leg Color
- Top Available in Veneer (W) or HPL (P)
- Finger Pull Accents Available in Veneer (FPV), HPL (FPP), or Fabric (FPF)
- Optional Cushion Provides Additional Seating, [See Cushion Details](#)
- Locking Pedestal; Available with Black (BLK) or Silver (SLV) Lock Cores
- Additional Options: HPL Cabinet Accent on Bookcase Interior (See Below and [See Color Options](#)), Dove Tail Drawer Construction ([See Drawer Options](#)), Power and Grommet Options ([See Option Details](#)); Glass Marker Boards, Work Wall, Tackboards and Other Accessories ([See Multiple Unit Details](#))

Finger Pull Options: Must Specify & Add

FPV	Finger Pull, Veneer Accent (Finish Will Match Chassis Selection)	\$ NC
FPP	Finger Pull, HPL Accent; Must Specify Color, See Color Options	\$ 54
FPF	Finger Pull, Fabric Accent; Must Specify Fabric	\$ See Below

List Price/Grade	Yards	GR 1/COM/COL	2	3	4	5	6	7	8	9	10
FPF Finger Pull, Fabric	0.5 \$	77	103	125	147	179	212	259	308	365	431

Cabinet Accent Option: Specify & Add

HPL Cabinet Accent on Bookcase Interior; Must Specify Color, See Color Options	\$ 146
--	--------

[See Iconic Intro For Ordering Options and Grommet Locations](#)

Item	Model No.	Width	Depth	Height	Ship Wt	Cubic Ft	List Price
LOW CREDENZA WITH DOUBLE LATERAL FILE 	50-2472LDF <i>Includes (2) 36" Wide Lateral File</i>	72	24	21 $\frac{7}{8}$	265	25.5	\$ 5631
	50-2460LDF <i>Includes (2) 30" Wide Lateral File</i>	60	24	21 $\frac{7}{8}$	225	21.5	\$ 5114

Shown with Square Edge

Must Specify (in this order):

- Model #
- Top Material
- Top Finish/Color
- Chassis Finish
- Finger Pull Accent Material/Color
- Leg Finish
- Drawer Construction
- Lock Color
- Power/Data

Description

- Standard With: Legal or Letter Filing in Lateral File Drawers, Left to Right Grain Direction on Top, Horizontal Grain Direction on Chassis, Square (Y) Edge Profile, and Two (2) Stiffener Bars for Added Support
- Available with Contrasting Top, Chassis, and Leg Color
- Top Available in Veneer (W) or HPL (P)
- Finger Pull Accents Available in Veneer (FPV), HPL (FPP), or Fabric (FPF)
- Optional Cushion Provides Additional Seating, [See Cushion Details](#)
- Locking Pedestals; Available with Black (BLK) or Silver (SLV) Lock Cores
- Additional Options: Dove Tail Drawer Construction ([See Drawer Options](#)), Power and Grommet Options ([See Option Details](#)), Glass Marker Boards, Work Wall, Tackboards and Other Accessories ([See Multiple Unit Details](#))

Finger Pull Options: Must Specify & Add

FPV	Finger Pull, Veneer Accent (Finish Will Match Chassis Selection)	\$	NC
FPP	Finger Pull, HPL Accent; Must Specify Color, See Color Options	\$	108
FPF	Finger Pull, Fabric Accent; Must Specify Fabric	\$	See Below

List Price/Grade	Yards	1/COM/COL	2	3	4	5	6	7	8	9	10
FPF Finger Pull, Fabric	0.5	\$ 153	179	201	223	255	288	335	384	441	507

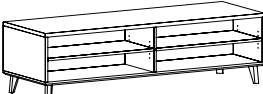
LOW CREDENZA WITH DOUBLE OPEN BOOKCASE 	50-2472LOB	72	24	21 $\frac{7}{8}$	245	25.5	\$ 4369
	50-2466LOB	66	24	21 $\frac{7}{8}$	225	23.5	\$ 4151
	50-2460LOB	60	24	21 $\frac{7}{8}$	205	21.5	\$ 4001

Shown with Square Edge

Must Specify (in this order):

- Model #
- Top Material
- Top Finish/Color
- Chassis Finish
- Cabinet Accent Color
- Leg Finish
- Power/Data

Description

- Standard With: One (1) Adjustable Shelf on Each Side, Left to Right Grain Direction on Top, Horizontal Grain Direction on Chassis, and Square (Y) Edge Profile
- Both Sides Feature Removable Back Panel for Wire Management and Exit Grommet on the Bottom for Wires to Escape
- Available with Contrasting Top, Chassis, and Leg Color
- Tops Available in Veneer (W) or HPL (P)
- Optional Cushion Provides Additional Seating, [See Cushion Details](#)
- Additional Options: HPL Cabinet Accent on Bookcase Interior (See Below and [See Color Options](#)), Power and Grommet Options ([See Option Details](#)), Glass Marker Boards, Work Wall, Tackboards and Other Accessories ([See Multiple Unit Details](#))

Cabinet Accent Option: Specify & Add

HPL	Cabinet Accent on Bookcase Interior; Must Specify Color, See Color Options	\$	261
-----	--	----	-----

[See Iconic Intro For Ordering Options and Grommet Locations](#)

Item	Model No.	Width	Depth	Height	Ship Wt	Cubic Ft	List Price
BOX/LATERAL FILE	50-2436BF	36	24	30	158	18.3	\$ 3240
	50-2430BF	30	24	30	138	15.4	\$ 3069

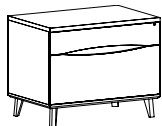

Shown with Square Edge

Must Specify (in this order):

- Model #
- Top Material
- Top Finish/Color
- Chassis Finish
- Finger Pull Accent Material/Color
- Leg Finish
- Drawer Construction
- Box Drawer Track
- Lock Color
- Power/Data

Description

- Standard With: Locking Box/Lateral Pedestal and Legal or Letter Filing in Lateral File Drawer, Left to Right Grain Direction on Top, Horizontal Grain on Chassis, Square (Y) Edge Profile
- Available with Contrasting Top, Chassis, and Leg Color
- Top Available in Veneer (W) or HPL (P)
- Finger Pull Accents Available in Veneer (FPV), HPL (FPP), or Fabric (FPF)
- Locking Pedestal; Available with Black (BLK) or Silver (SLV) Lock Cores
- Additional Options: Dove Tail Drawer Construction ([See Drawer Construction Details](#)), Soft Close Box Drawers ([See Soft Close Options](#)), Power and Grommet Options ([See Option Details](#)), Glass Marker Boards, Work Wall, Tackboards and Other Accessories ([See Multiple Unit Details](#))

Finger Pull Options: Must Specify & Add

FPV	Finger Pull, Veneer Accent (Finish Will Match Chassis Selection)	\$	NC
FPP	Finger Pull, HPL Accent; Must Specify Color, See Color Options	\$	54
FPF	Finger Pull, Fabric Accent; Must Specify Fabric	\$	See Below

List Price/Grade	Yards	GR 1/ COM/COL	2	3	4	5	6	7	8	9	10
FPF Finger Pull, Fabric	0.5 \$	77	103	125	147	179	212	259	308	365	431

Item	Model No.	Width	Depth	Height	Ship Wt	Cubic Ft	List Price
LOW LATERAL FILE	50-2436LL	36	24	21 $\frac{7}{8}$	132	13.2	\$ 2740
	50-2430LL	30	24	21 $\frac{7}{8}$	113	11.1	\$ 2592

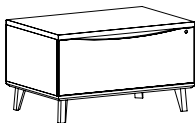

Shown with Square Edge

Must Specify (in this order):

- Model #
- Top Material
- Top Finish/Color
- Chassis Finish
- Finger Pull Accent Material/Color
- Leg Finish
- Drawer Construction
- Lock Color
- Power/Data

Description

- Standard With: One (1) Lateral File, Legal or Letter Filing, Left to Right Grain Direction on Top, Horizontal Grain Direction on Chassis, and Square (Y) Edge Profile
- Available with Contrasting Top, Chassis, and Leg Color
- Tops Available in Veneer (W) or HPL (P)
- Finger Pull Accents Available in Veneer (FPV), HPL (FPP), or Fabric (FPF)
- Optional Cushion Provides Additional Seating, [See Cushion Details](#)
- Locking Drawer; Available with Black (BLK) or Silver (SLV) Lock Cores
- Additional Options: Dove Tail Drawer Construction ([See Drawer Options](#)), Power and Grommet Options ([See Option Details](#)), Glass Marker Boards, Work Wall, Tackboards and Other Accessories ([See Multiple Unit Details](#))

Finger Pull Options: Must Specify & Add

FPV	Finger Pull, Veneer Accent (Finish Will Match Chassis Selection)	\$	NC
FPP	Finger Pull, HPL Accent; Must Specify Color, See Color Options	\$	54
FPF	Finger Pull, Fabric Accent; Must Specify Fabric	\$	See Below

List Price/Grade	Yards	GR 1/ COM/COL	2	3	4	5	6	7	8	9	10
FPF Finger Pull, Fabric	0.5 \$	77	103	125	147	179	212	259	308	365	431

[See Iconic Intro For Ordering Options and Grommet Locations](#)

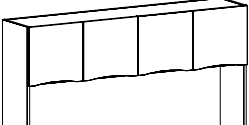
Item	Model No.	Width	Depth	Height	Ship Wt	Cubic Ft	List Price
	SURFACE MOUNT HUTCH 50-1572HU	72	15	40 7/8	203	34.1	\$ 5316
	50-1566HU	66	15	40 7/8	166	32.1	\$ 5132
	50-1560HU	60	15	40 7/8	129	28.4	\$ 5011

Description

- Standard With: Veneer Finish, Four (4) Soft-Close Hinged Doors, Horizontal Grain Direction, and Grommet
- 23 3/4" Clearance Below Doors
- Finger Pull Accents Available in Veneer (FPV), HPL (FPP), or Fabric (FPF); Fabric Patterns May Not Align From Door-to-Door, Use Caution with Patterned/Striped Fabrics
- Grommet Included; Available in Black (BLK) or Silver (SLV)
- Additional Options: HPL Cabinet Accent on Hutch Interior (See Below and [See Color Options](#)), Locking Doors ([See Locking Options](#)), Glass Marker Boards, Work Wall, Tackboards ([See Multiple Unit Details](#)), and Tasklights ([See Multiple Unit Details](#))

Must Specify (in this order):
 Model #
 Chassis Finish
 Cabinet Accent Color
 Finger Pull Accent Material/Color
 Lock Color
 Tackboard Fabric
 Tasklight
 Grommet Color

Finger Pull Options: Must Specify & Add

FPV	Finger Pull, Veneer Accent (Finish Will Match Chassis Selection)	\$	NC
FPP	Finger Pull, HPL Accent; Must Specify Color, See Color Options	\$	156
FPF	Finger Pull, Fabric Accent; Must Specify Fabric	\$	See Below

List Price/Grade	Yards	GR 1/ COM/COL	2	3	4	5	6	7	8	9	10
FPF Finger Pull, Fabric	0.5 \$	191	217	239	261	293	326	373	422	479	545

Cabinet Accent Option: Specify & Add

HPL	Cabinet Accent on Hutch Interior; Must Specify Color, See Color Options	\$	346
-----	---	----	-----

SURFACE MOUNT HUTCH WITH SLIDING DOOR

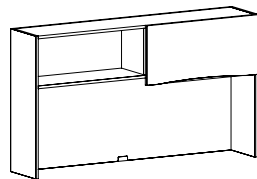

SURFACE MOUNT HUTCH WITH SLIDING DOOR 50-1572SHU	72	15	40 7/8	203	34.1	\$ 3690
50-1566SHU	66	15	40 7/8	166	32.1	\$ 3577
50-1560SHU	60	15	40 7/8	129	28.4	\$ 3455

Description

- Standard With: Veneer Finish, One (1) Non-Locking Sliding Door, Horizontal Grain Direction, Grommet
- 23 3/4" Clearance Below Door
- Sliding Door; Available with Round Door Pull in Black (BRD) or Chrome (CRD) or Finger Pull with Accents Available in Veneer (FPV), HPL (FPP), or Fabric (FPF)
- Grommet Included; Available in Black (BLK) or Silver (SLV)
- Additional Options: HPL Cabinet Accent on Hutch Interior (See Below and [See Color Options](#)), Glass Marker Boards, Work Wall, Tackboards ([See Multiple Unit Details](#)), and Tasklights ([See Multiple Unit Details](#))

Must Specify (in this order):
 Model #
 Chassis Finish
 Cabinet Accent Color
 Select Round Pull or Finger Pull:
 Round Pull Color
 Finger Pull Accent Material/Color
 Tackboard Fabric
 Tasklight
 Grommet Color

Finger Pull Options: Must Specify & Add

FPV	Finger Pull, Veneer Accent (Finish Will Match Chassis Selection)	\$	NC
FPP	Finger Pull, HPL Accent; Must Specify Color, See Color Options	\$	38
FPF	Finger Pull, Fabric Accent; Must Specify Fabric	\$	See Below

List Price/Grade	Yards	GR 1/ COM/COL	2	3	4	5	6	7	8	9	10
FPF Finger Pull, Fabric	0.5 \$	48	74	96	118	150	183	230	279	336	402

Cabinet Accent Option: Specify & Add

HPL	Cabinet Accent on Hutch Interior; Must Specify Color, See Color Options	\$	331
-----	---	----	-----

[See Iconic Intro For Ordering Options and Grommet Locations](#)

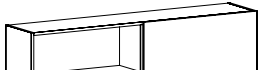
Item	Model No.	Width	Depth	Height	Ship Wt	Cubic Ft	List Price
WALL MOUNT HUTCH WITH SLIDING DOOR 	50-1572SWD	72	15	17	114	13.8	\$ 2419
	50-1566SWD	66	15	17	101	12.7	\$ 2384
	50-1560SWD	60	15	17	92	11.6	\$ 2314

Description

- Standard With: Veneer Finish, One (1) Non-Locking Sliding Door, Installation Hardware, and Horizontal Grain Direction
- Sliding Door; Available with Round Door Pull in Black (BRD) or Chrome (CRD) or Finger Pull with Accents Available in Veneer (FPV), HPL (FPP), or Fabric (FPF)
- Indiana Furniture Will Not Be Liable for Wall Mount Hutches That are Not Properly Installed
- Additional Option: HPL Cabinet Accent on Hutch Interior (See Below and [See Color Options](#)), Glass Marker Boards, Work Wall, Tackboards ([See Multiple Unit Details](#)), and Tasklights ([See Multiple Unit Details](#))

Must Specify (in this order):

- Model #
- Chassis Finish
- Cabinet Accent Color
- Select Round Pull or Finger Pull:
 - Round Pull Color
 - Finger Pull Accent Material/Color

Finger Pull Options: Must Specify & Add

FPV	Finger Pull, Veneer Accent (Finish Will Match Chassis Selection)	\$	NC
FPP	Finger Pull, HPL Accent; Must Specify Color, See Color Options	\$	38
FPF	Finger Pull, Fabric Accent; Must Specify Fabric	\$	See Below

List Price/Grade	Yards	GR 1/COM/COL	2	3	4	5	6	7	8	9	10	
FPF	Finger Pull, Fabric	0.5 \$	48	74	96	118	150	183	230	279	336	402

Cabinet Accent Option: Specify & Add

HPL	Cabinet Accent on Hutch Interior; Must Specify Color, See Color Options	\$	219
-----	---	----	-----

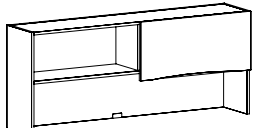
LOW SURFACE MOUNT HUTCH WITH SLIDING DOOR 	50-1572SSHS	72	15	30	124	23.3	\$ 3576
	50-1566SSHS	66	15	30	116	21.4	\$ 3466
	50-1560SSHS	60	15	30	109	21.4	\$ 3373
	50-1554SSHS	54	15	30	101	17.6	\$ 3262
	50-1548SSHS	48	15	30	101	15.7	\$ 3024

Description

- Standard With: Veneer Finish, One (1) Non-Locking Sliding Door, Horizontal Grain Direction, and Grommet
- For Use with Low Storage Units; 12⁷/₈" Clearance Below Door
- Sliding Door; Available with Round Door Pull in Black (BRD) or Chrome (CRD) or Finger Pull with Accents Available in Veneer (FPV), HPL (FPP), or Fabric (FPF)
- Grommet Included; Available in Black (BLK) or Silver (SLV)
- Additional Option: HPL Cabinet Accent on Hutch Interior (See Below and [See Color Options](#)), Glass Marker Boards, Work Wall, Tackboards ([See Multiple Unit Details](#)), and Tasklights ([See Multiple Unit Details](#))

Must Specify (in this order):

- Model #
- Chassis Finish
- Cabinet Accent Color
- Select Round Pull or Finger Pull:
 - Round Pull Color
 - Finger Pull Accent Material/Color
- Grommet Color

Finger Pull Options: Must Specify & Add

FPV	Finger Pull, Veneer Accent (Finish Will Match Chassis Selection)	\$	NC
FPP	Finger Pull, HPL Accent; Must Specify Color, See Color Options	\$	38
FPF	Finger Pull, Fabric Accent; Must Specify Fabric	\$	See Below

List Price/Grade	Yards	GR 1/COM/COL	2	3	4	5	6	7	8	9	10	
FPF	Finger Pull, Fabric	0.5 \$	48	74	96	118	150	183	230	279	336	402

Cabinet Accent Option: Specify & Add

HPL	Cabinet Accent on Hutch Interior; Must Specify Color, See Color Options	\$	323
-----	---	----	-----

[See Iconic Intro For Ordering Options and Grommet Locations](#)

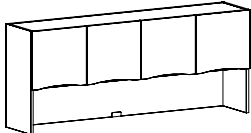
Item	Model No.	Width	Depth	Height	Ship Wt	Cubic Ft	List Price	
	50-1572SSHU	Four (4) Doors	72	15	30	141	23.3	\$ 4968
	50-1566SSHU	Four (4) Doors	66	15	30	132	21.4	\$ 4755
	50-1560SSHU	Four (4) Doors	60	15	30	123	19.5	\$ 4620
	50-1554SSHU	Three (3) Doors	54	15	30	111	17.6	\$ 4171
	50-1548SSHU	Three (3) Doors	48	15	30	102	15.7	\$ 3959

Description

- Standard With: Veneer Finish, Soft-Close Hinged Doors, Horizontal Grain Direction, and Grommet
- For Use with Low Storage Units; 12 $\frac{7}{8}$ " Clearance Below Doors
- Finger Pull Accents Available in Veneer (FPV), HPL (FPP), or Fabric (FPF); Fabric Patterns May Not Align From Door-to-Door, Use Caution with Patterned/Striped Fabrics
- Grommet Included; Available in Black (BLK) or Silver (SLV)
- Additional Options: HPL Cabinet Accent on Hutch Interior (See Below and [See Color Options](#)), Locking Doors ([See Locking Options](#)), Glass Marker Boards, Work Wall, Tackboards ([See Multiple Unit Details](#)), and Tasklights ([See Multiple Unit Details](#))

Must Specify (in this order):

Model #
Chassis Finish
Cabinet Accent Color
Finger Pull Accent Material/Color
Lock Color
Grommet Color

Finger Pull Options: Must Specify & Add

FPV	Finger Pull, Veneer Accent (Finish Will Match Chassis Selection)	\$	NC
FPP	Finger Pull, HPL Accent; Must Specify Color, See Color Options	\$	See Below
FPF	Finger Pull, Fabric Accent; Must Specify Fabric	\$	See Below

HPL Accent: Specify & Add

FPP	Finger Pull, HPL, See Color Options	3 Doors	\$	117
		4 Doors	\$	156

Fabric Accent:

List Price/Grade	Yards	GR 1/ COM/COL	2	3	4	5	6	7	8	9	10
FPF Pull, Fabric 3 Doors	0.5 \$	144	170	192	214	246	279	326	375	432	498
FPF Pull, Fabric 4 Doors	0.5 \$	191	217	239	261	293	326	373	422	479	545

Cabinet Accent Option: Specify & Add

HPL	Cabinet Accent on Hutch Interior; Must Specify Color, See Color Options	3 Doors	\$	271
		4 Doors	\$	323

Item	Model No.	Width	Depth	Height	Ship Wt	Cubic Ft	List Price
LOW DUAL SIDED SURFACE MOUNT HUTCH WITH SLIDING DOOR 	50-1572DSHS	72	15	30	135	23.3	\$ 4230
	50-1566DSHS	66	15	30	127	21.4	\$ 4114
	50-1560DSHS	60	15	30	119	19.5	\$ 4021
	50-1554DSHS	54	15	30	108	17.6	\$ 3922
	50-1548DSHS	48	15	30	100	15.7	\$ 3614

Must Specify (in this order):

- Model #
- Chassis Finish
- Cabinet Accent Color
- Select Round Pull or Finger Pull:
 - Round Pull Color
 - Finger Pull Accent Material/Color
- Dry Erase Fixed Back

Description

- Standard With: Veneer Finish, One (1) Non-Locking Sliding Door on Each Side, Horizontal Grain Direction
- For Use with Low Storage Units in Shared Office Applications; 12 7/8" Clearance Below Door
- Sliding Door; Available with Round Door Pull in Black (BRD) or Chrome (CRD) or Finger Pull with Accents Available in Veneer (FPV), HPL (FPP), or Fabric (FPF)
- Additional Options: HPL Cabinet Accent on Hutch Interior (See Below and [See Color Options](#)), Glass Marker Boards, Work Wall, Tackboards ([See Multiple Unit Details](#)), and Tasklights ([See Multiple Unit Details](#))

Finger Pull Options: Must Specify & Add

FPV	Finger Pull, Veneer Accent (Finish Will Match Chassis Selection)	\$	NC
FPP	Finger Pull, HPL Accent; Must Specify Color, See Color Options	\$	79
FPF	Finger Pull, Fabric Accent; Must Specify Fabric	\$	See Below

List Price/Grade	Yards	GR 1/COM/COL	2	3	4	5	6	7	8	9	10
FPF Finger Pull, Fabric	0.5	\$ 96	122	144	166	198	231	278	327	384	450

Cabinet Accent Option: Specify & Add

HPL	Cabinet Accent on Bookcase Interior; Must Specify Color, See Color Option	\$	381
-----	---	----	-----

Dry Erase Fixed Back Option: Specify & Add

DEF	Dry Erase Fixed Back Panel	\$	646
-----	----------------------------	----	-----

Dry Erase Panel always located on right, when facing the unit.

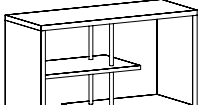
LOW SURFACE MOUNT OPEN STORAGE/DIVIDER 	50-1536SOSD	36	15	30	99	11.9	\$ 1822
	50-1530SOSD	30	15	30	71	10.1	\$ 1782
	50-1524SOSD	24	15	30	49	8.2	\$ 1744

Description

- Standard With: Veneer Finish, Horizontal Grain Direction, Two (2) Shelves, and Metal Rods
- Open Fixed Shelving; 9" Clearance Between Shelves
- Recommended For Use with Low Storage Units
- Set On Application Only
- Accent Metal Rod; Available in Black (BLK) or Chrome (CHRM)
- Additional Option: HPL Cabinet Accent on Interior (See Below and [See Color Options](#))

Cabinet Accent Option: Specify & Add

HPL	Cabinet Accent on Bookcase Interior; Must Specify Color, See Color Option	\$	109
-----	---	----	-----

[See Iconic Intro For Ordering Options and Grommet Locations](#)

Item	Model No.	Width	Depth	Height	Ship Wt	Cubic Ft	List Price
SURFACE MOUNT OPEN STORAGE/DIVIDER	50-153640SOSD	36	15	40 $\frac{3}{8}$	96	14.5	\$ 1894
	50-153040SOSD	30	15	40 $\frac{3}{8}$	81	13.5	\$ 1856

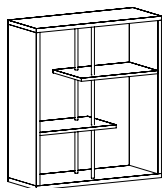

Must Specify (in this order):

Model #
Chassis Finish
Cabinet Accent Color
Metal Accent

Description

- Standard With: Veneer Finish, Horizontal Grain Direction, Two (2) Fixed Shelves, and Metal Rods
- Open Fixed Shelving; 12" Clearance Between Shelves
- Set On Application Only
- Accent Metal Rod; Available in Black (BLK) or Chrome (CHRM)
- Additional Option: HPL Cabinet Accent on Interior (See Below and [See Color Options](#))

Cabinet Accent Option: Specify & Add

HPL	Cabinet Accent on Bookcase Interior; Must Specify Color, See Color Option	\$ 109
-----	---	--------

SURFACE MOUNT BOOKCASE	50-1536TU	36	15	40 $\frac{3}{8}$	127	16.1	\$ 1930
	50-1530TU	30	15	40 $\frac{3}{8}$	98	15.9	\$ 1844

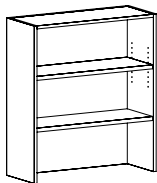

Must Specify (in this order):

Model #
HPL Cabinet Finish
Cabinet Accent Color

Description

- Standard With: Veneer Finish, One (1) Adjustable Shelf, One (1) Fixed Shelf, and Horizontal Grain
- Set On Application Only
- Additional Option: HPL Cabinet Accent on Bookcase Interior (See Below and [See Color Options](#))

Cabinet Accent Option: Specify & Add

HPL	Cabinet Accent on Bookcase Interior; Must Specify Color, See Color Option	\$ 193
-----	---	--------

SURFACE MOUNT BOOKCASE WITH DOORS	50-1536TUDB	36	15	40 $\frac{3}{8}$	168	16.1	\$ 3343
	50-1530TUDB	30	15	40 $\frac{3}{8}$	140	13.4	\$ 3231

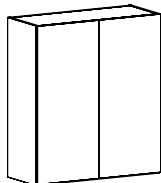

Must Specify (in this order):

Model #
Chassis Finish
Lock Color

Description

- Standard With: Veneer Finish, Soft-Close Touch Latch Doors, Two (2) Adjustable Shelves Inside, and Horizontal Grain Direction
- Set On Application Only
- Additional Option: Locking Doors ([See Locking Options](#))

[See Iconic Intro For Ordering Options and Grommet Locations](#)

Item	Model No.		Width	Depth	Height	Ship Wt	Cubic Ft	List Price
STORAGE CABINET WITH BOX/FILE	Door Hinged Left	Door Hinged Right						
	50-1872SWBL	50-1872SWBR	18	24	70 $\frac{7}{8}$	230	22.0	\$ 4774

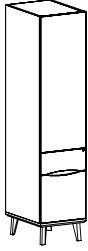

Description

- Standard With: Veneer Finish, Locking Box/File Drawers (Legal or Letter Filling), Soft-Close Touch Latch Door, Two (2) Adjustable Shelves Inside, and Horizontal Grain Direction
- Available with Contrasting Chassis and Leg Color
- Finger Pull Accents Available in Veneer (FPV), HPL (FPP), or Fabric (FPF)
- Locking Box/File Drawers; Available with Black (BLK) or Silver (SLV) Lock Cores
- Additional Options: Dove Tail Drawer Construction and Soft Close Drawers ([See Drawer Options](#)); Locking Door ([See Locking Options](#))

Must Specify (in this order):

- Model #
- Chassis Finish
- Finger Pull Accent Material/Color
- Leg Finish
- Drawer Construction
- Drawer Track
- Lock Color

Finger Pull Options: Must Specify & Add

FPV	Finger Pull, Veneer Accent (Finish Will Match Chassis Selection)	\$	NC
FPP	Finger Pull, HPL Accent; Must Specify Color, See Color Options	\$	108
FPF	Finger Pull, Fabric Accent; Must Specify Fabric	\$	See Below

List Price/Grade	Yards	GR 1/COM/COL	2	3	4	5	6	7	8	9	10	
FPF	Finger Pull, Fabric	0.5 \$	153	179	201	223	255	288	335	384	441	507

FPF_SWBL

Item	Model No.		Width	Depth	Height	Ship Wt	Cubic Ft	List Price
STORAGE WARDROBE	Door Hinged Left	Door Hinged Right						
	50-2472WL	50-2472WR	18	24	70 $\frac{7}{8}$	213	22.0	\$ 4281
	50-2451WL	50-2451WR	18	24	51 $\frac{1}{2}$	154	15.9	\$ 3712

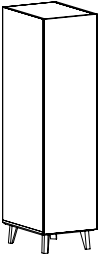

Description

- Standard With: Veneer Finish, Soft-Close Touch Latch Door, One (1) Fixed Shelf, Coat Rod Under Fixed Shelf, Three (3) Adjustable Shelves, and Horizontal Grain Direction
- Available with Contrasting Chassis and Leg Color
- Additional Option: Locking Door ([See Locking Options](#))

Must Specify (in this order):

- Model #
- Chassis Finish
- Leg Finish
- Lock Color

[See Iconic Intro For Ordering Options and Grommet Locations](#)

Item	Model No.	Width	Depth	Height	Ship Wt	Cubic Ft	List Price
DOUBLE WARDROBE	50-3672WC	36	24	70 $\frac{3}{8}$	321	41.7	\$ 6711
	50-3072WC	30	24	70 $\frac{3}{8}$	283	35.1	\$ 6538

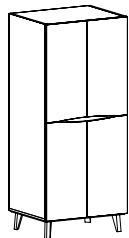

Description

- Standard With: Veneer Finish, Four (4) Soft-Close Touch Latch Doors, Both Sides Feature One (1) Fixed Shelf at Center and Two (2) Adjustable Shelves Inside, and Horizontal Grain Direction
- Available with Contrasting Chassis and Leg Color
- Finger Pull Accents Available in Veneer (FPV), HPL (FPP), or Fabric (FPF)
- Additional Option: Locking Door ([See Locking Options](#))

Finger Pull Options: Must Specify & Add

FPV	Finger Pull, Veneer Accent (Finish Will Match Chassis Selection)	\$	NC
FPP	Finger Pull, HPL Accent; Must Specify Color, See Color Options	\$	108
FPF	Finger Pull, Fabric Accent; Must Specify Fabric	\$	See Below

List Price/Grade	Yards	GR 1/COM/COL	2	3	4	5	6	7	8	9	10
FPF Finger Pull, Fabric	0.5	\$ 153	179	201	223	255	288	335	384	441	507

Must Specify (in this order):

- Model #
- Chassis Finish
- Finger Pull Accent Material/Color
- Leg Finish
- Lock Color

OPEN STORAGE/DIVIDER WITH SLIDING DOORS

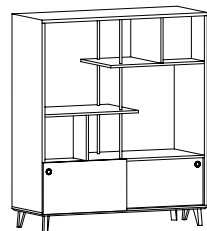

50-2460OSD72		60	24	70 $\frac{3}{8}$	328	68.1	\$ 7223
	<i>15" Clearance Between Shelves</i>						
50-2460OSD51		60	24	51 $\frac{1}{2}$	308	49.4	\$ 6853
	<i>8$\frac{3}{8}$" Clearance Between Shelves</i>						

Description

- Standard With: Veneer Finish, Dual Access Open Bookcase with Fixed Shelves, Two (2) Adjustable Shelves Behind Two (2) Non-Locking Sliding Doors, Metal Rods, and Horizontal Grain Direction
- Dual Access Cubbies are 10" Deep on each side
- Available with Contrasting Chassis and Leg Color
- Round Door Pull Available in Black (BRD) or Chrome (CRD)
- Accent Metal Rod Color Will Match Round Door Pull
- Additional Option: HPL Cabinet Accent on Interior ([See Below](#) and [See Color Options](#))

Cabinet Accent Option: Specify & Add

HPL	72"H Unit, HPL Cabinet Accent on Interior; Must Specify Color, See Color Options	\$	290
HPL	51"H Unit, HPL Cabinet Accent on Interior; Must Specify Color, See Color Options	\$	273

Must Specify (in this order):

- Model #
- Chassis Finish
- Cabinet Accent Color
- Round Pull/Metal Accent Color
- Leg Finish

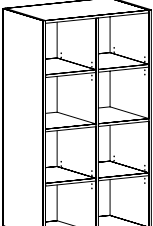
Item	Model No.	Width	Depth	Height	Ship Wt	Cubic Ft	List Price
	50-2436OB72 <i>Two (2) Adjustable Shelves and Fixed Middle Shelf</i>	36	24	70 $\frac{7}{8}$	291	42.0	\$ 5124
	50-2436OB51 <i>Two (2) Adjustable Shelves</i>	36	24	51 $\frac{1}{2}$	216	30.3	\$ 4161
	50-2430OB72 <i>Two (2) Adjustable Shelves and Fixed Middle Shelf</i>	30	24	70 $\frac{7}{8}$	267	35.6	\$ 5024
	50-2430OB51 <i>Two (2) Adjustable Shelves</i>	30	24	51 $\frac{1}{2}$	202	25.5	\$ 4065

Description

- Standard With: Veneer Finish, Fixed Vertical Divider, and Horizontal Grain Direction
- Available with Contrasting Chassis and Leg Color
- Additional Option: HPL Cabinet Accent on Bookcase Interior (See Below and [See Color Options](#))

Cabinet Accent Option: Specify & Add

HPL 72"H Units, HPL Cabinet Accent on Bookcase Interior; Must Specify Color, See Color Options	\$ 513
HPL 51"H Units, HPL Cabinet Accent on Bookcase Interior; Must Specify Color, See Color Options	\$ 415

Must Specify (in this order):

Model #
Chassis Finish
Cabinet Accent Color
Leg Finish

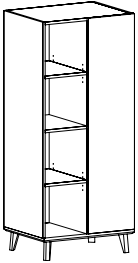
WARDROBE WITH OPEN BOOKCASE	Left Door	Right Door	Width	Depth	Height	Ship Wt	Cubic Ft	List Price
	50-2436OBD72L <i>Bookcase Features Two (2) Adjustable Shelves and Fixed Middle Shelf</i>	50-2436OBD72R	36	24	70 $\frac{7}{8}$	310	41.7	\$ 5713
	50-2436OBD51L <i>Bookcase Features Two (2) Adjustable Shelves</i>	50-2436OBD51R	36	24	51 $\frac{1}{2}$	236	30.3	\$ 4749
	50-2430OBD72L <i>Bookcase Features Two (2) Adjustable Shelves and Fixed Middle Shelf</i>	50-2430OBD72R	30	24	70 $\frac{7}{8}$	287	35.6	\$ 5598
	50-2430OBD51L <i>Bookcase Features Two (2) Adjustable Shelves</i>	50-2430OBD51R	30	24	51 $\frac{1}{2}$	220	25.5	\$ 4645

Shown as Right

Description

- Standard With: Veneer Finish, Soft-Close Touch Latch Hinged Door, Hanging Storage and Coat Rod Behind Door, and Horizontal Grain Direction
- Available with Contrasting Chassis and Leg Color
- Additional Options: HPL Cabinet Accent on Bookcase Interior (See Below and [See Color Options](#)), Locking Door ([See Locking Options](#))

Cabinet Accent Option: Specify & Add

HPL 72"H Units, HPL Cabinet Accent on Bookcase Interior; Must Specify Color, See Color Options	\$ 287
HPL 51"H Units, HPL Cabinet Accent on Bookcase Interior; Must Specify Color, See Color Options	\$ 237

Must Specify (in this order):

Model #
Chassis Finish
Cabinet Accent Color
Leg Finish
Lock Color

[See Iconic Intro For Ordering Options and Grommet Locations](#)

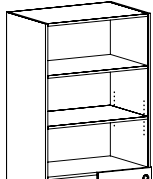
Item	Model No.	Width	Depth	Height	Ship Wt	Cubic Ft	List Price
OPEN BOOKCASE WITH LOWER SLIDING DOORS 	50-2436OBS72 <i>One (1) Adjustable Shelf and One (1) Fixed Shelf</i>	36	24	70 ⁷ / ₈	310	41.7	\$ 4927
	50-2436OBS51 <i>One (1) Adjustable Shelf</i>	36	24	51 ¹ / ₂	236	30.3	\$ 4309
	50-2430OBS72 <i>One (1) Adjustable Shelf and One (1) Fixed Shelf</i>	30	24	70 ⁷ / ₈	287	35.6	\$ 4682
	50-2430OBS51 <i>One (1) Adjustable Shelf</i>	30	24	51 ¹ / ₂	220	25.5	\$ 4023

Description

- Standard With: Veneer Finish, Two (2) Non-Locking Sliding Doors, and Horizontal Grain Direction
- Available with Contrasting Chassis and Leg Color
- Round Door Pull Available in Black (BRD) or Chrome (CRD)
- Additional Option: HPL Cabinet Accent on Bookcase Interior (See Below and [See Color Options](#))

Cabinet Accent Option: Specify & Add

HPL	72"H Units, HPL Cabinet Accent on Bookcase Interior; Must Specify Color, See Color Options	\$ 247
HPL	51"H Units, HPL Cabinet Accent on Bookcase Interior; Must Specify Color, See Color Options	\$ 213

Must Specify (in this order):

- Model #
- Chassis Finish
- Cabinet Accent Color
- Round Pull Color
- Leg Finish

TWISTED BOOKCASE

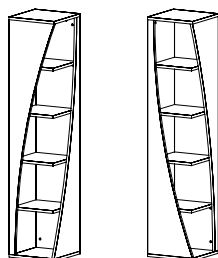

Left

Right

Left Twist	Right Twist	Width	Depth	Height	Ship Wt	Cubic Ft	List Price
50-1572TBL <i>Four (4) 3/4" Fixed Shelves</i>	50-1572TBR	15	15	70 ⁷ / ₈	130	10.8	\$ 3022
50-1551TBL <i>Three (3) 3/4" Fixed Shelves</i>	50-1551TBR	15	15	51 ¹ / ₂	100	8.9	\$ 2835

Description

- Standard With: Veneer Finish, Adjustable Glides, and Horizontal Grain Direction
- Must Attach to Wall or Another Unit; Not Freestanding; Attachment Hardware Included
- Additional Option: HPL Cabinet Accent on Bookcase Interior (See Below and [See Color Options](#))

Cabinet Accent Option: Specify & Add

HPL	72"H Units, HPL Cabinet Accent on Bookcase Interior; Must Specify Color, See Color Options	\$ 150
HPL	51"H Units, HPL Cabinet Accent on Bookcase Interior; Must Specify Color, See Color Options	\$ 143

Must Specify (in this order):

- Model #
- Chassis Finish
- Cabinet Accent Color

Item	Model No.		Width	Depth	Height	Ship Wt	Cubic Ft	List Price
	50-1572LS	154lb Weight Limit	72	15	17	65	13.8	\$ 1341
	50-1566LS	128lb Weight Limit	66	15	17	60	12.7	\$ 1317
	50-1560LS	128lb Weight Limit	60	15	17	55	11.6	\$ 1232
	50-1554LS	90lb Weight Limit	54	15	17	50	10.5	\$ 1180
	50-1548LS	90lb Weight Limit	48	15	17	45	9.3	\$ 1068
	50-1542LS	90lb Weight Limit	42	15	17	40	8.2	\$ 958
	50-1536LS	64lb Weight Limit	36	15	17	35	7.1	\$ 844
	50-1530LS	64lb Weight Limit	30	15	17	30	6.0	\$ 788

Must Specify (in this order):
Model #
Finish

Description

- Standard With: Veneer Finish, Installation Hardware, and Horizontal Grain Direction
- Weight Capacity is a Distributed Load

CUSHIONS

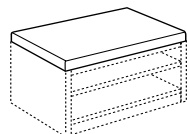

Model #	Size	COM Ydg	COM, 1, 2 or 3	Grades									
				4	5	6	7	8	9	10	L1	L2	
65-24108CUSHION	108"	3.25	\$ 790	1242	1453	1668	1973	2292	2662	3091	1863	2321	
65-2490CUSHION	90"	2.75	\$ 715	1097	1276	1458	1716	1986	2299	2662	1623	2010	
65-2472CUSHION	72"	2.25	\$ 604	917	1063	1212	1423	1644	1900	2197	1347	1664	
65-2460CUSHION	60"	2.00	\$ 523	801	931	1063	1251	1447	1675	1939	1183	1465	
65-2436CUSHION	36"	1.25	\$ 445	619	700	783	900	1023	1165	1330	858	1034	
65-2430CUSHION	30"	1.25	\$ 385	559	640	723	840	963	1105	1270	798	974	

Must Specify (in this order):
Model #
Fabric Vendor, Pattern and Color

Description

- Create Bench-Style Seating Over Low Height Storage Units
- Cushions are Shipped with Installation Hardware for Both Fixed and Movable Applications
- Increases Height of Pedestal 2¼"

PLANTER BOX

01-1909PL	19 ¼	9 ½	6	16	2.0	\$ 572
-----------	------	-----	---	----	-----	--------

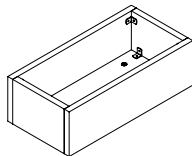

SIN NEW

Description

- Standard With: TFL, Installation Hardware (2-Black and 2-Nickel Bolts), and Horizontal Grain Direction
- Must Specify TFL (T) Color; Available in all Indiana Furniture TFL options
- Can Be Freestanding or Secured with Included Hardware
- Not Intended to Hold Water; Optional Planter Box Insert Sold Separately (See Below)

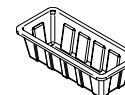

Options: Specify & Add

PBI	Planter Box Insert, Black Plastic	\$ 52
-----	-----------------------------------	-------

Must Specify (in this order):
Model #
TFL Color
Planter Insert

[See Iconic Intro For Ordering Options and Grommet Locations](#)

Item	Model No.	Width	Depth	Height	Ship Wt	Cubic Ft	List Price
MAGNETIC GLASS MARKER BOARD FOR USE WITH 30"H DESKS, CREDENZA AND SURFACE MOUNT HUTCHES	GMB-23108H	106½	½	23	83	14.3	\$ 3834
	GMB-23102H	100½	½	23	78	13.6	\$ 3558
	GMB-2396H	94½	½	23	74	12.9	\$ 3351
	GMB-2390H	88½	½	23	69	12.2	\$ 3145
	GMB-2384H	82½	½	23	64	11.4	\$ 3009
	GMB-2378H	76½	½	23	59	10.7	\$ 2802
	GMB-2372H	70½	½	23	55	10.0	\$ 2526
	GMB-2366H	64½	½	23	50	9.2	\$ 2318
	GMB-2360H	58½	½	23	45	8.5	\$ 2182
	GMB-2354H	52½	½	23	41	7.8	\$ 1908
	GMB-2348H	46½	½	23	36	7.0	\$ 1770
	GMB-2342H	40½	½	23	31	6.3	\$ 1494
	GMB-2336H	34½	½	23	27	5.6	\$ 1287
	GMB-2330H	28½	½	23	22	4.9	\$ 1151

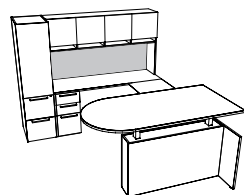
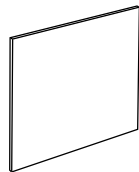

Must Specify (in this order):

Model #
Color



Rare Earth Magnet, Marker and Eraser Sets Available, [See Set Options](#)

Description

- Available in Black (BLMKR) or White (WHMKR), Must Specify
- Marker Boards Are One (1) Piece with No Seams
- Mounting Brackets Included
- For Use with 30"H Desks and Credenzas with Surface Mount Hutches
- For Rare Earth Magnets, Marker and Eraser Sets; [See Set Options](#)

Item	Model No.	Width	Depth	Height	Ship Wt	Cubic Ft	List Price
MAGNETIC GLASS MARKER BOARD FOR USE WITH 30"H DESKS, CREDENZA AND WALL MOUNT HUTCHES	GMB-23108W	108	½	23	85	14.6	\$ 3834
	GMB-23102W	102	½	23	80	13.9	\$ 3696
	GMB-2396W	96	½	23	75	13.1	\$ 3489
	GMB-2390W	90	½	23	70	12.4	\$ 3215
	GMB-2384W	84	½	23	66	11.7	\$ 3009
	GMB-2378W	78	½	23	61	10.9	\$ 2802
	GMB-2372W	72	½	23	56	10.2	\$ 2595
	GMB-2366W	66	½	23	52	9.5	\$ 2458
	GMB-2360W	60	½	23	47	8.8	\$ 2182
	GMB-2354W	54	½	23	42	8.0	\$ 1976
	GMB-2348W	48	½	23	38	7.3	\$ 1838
	GMB-2342W	42	½	23	33	6.6	\$ 1563
	GMB-2336W	36	½	23	28	5.8	\$ 1357
	GMB-2330W	30	½	23	23	5.1	\$ 1151

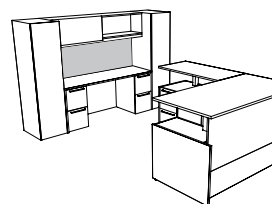
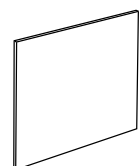

Must Specify (in this order):

Model #
Color



Rare Earth Magnet, Marker and Eraser Sets Available, [See Set Options](#)

Description

- Available in Black (BLMKR) or White (WHMKR), Must Specify
- Marker Boards Are One (1) Piece with No Seams
- Mounting Brackets Included
- For Use over 30"H Desks and Credenzas with Wall Mount Hutches
- For Rare Earth Magnets, Marker and Eraser Sets; [See Set Options](#)

Item	Model No.	Width	Depth	Height	Ship Wt	Cubic Ft	List Price
MAGNETIC GLASS MARKER BOARD	GMB-31108W	108	½	31	114	17.9	\$ 5073
FOR USE WITH 21" LOW CREDENZA AND WALL MOUNT HUTCHES	GMB-31102W	102	½	31	108	17.0	\$ 4889
	GMB-3196W	96	½	31	101	16.1	\$ 4613
	GMB-3190W	90	½	31	95	15.2	\$ 4246
	GMB-3184W	84	½	31	89	14.3	\$ 3972
	GMB-3178W	78	½	31	82	13.4	\$ 3696
	GMB-3172W	72	½	31	76	12.5	\$ 3421
	GMB-3166W	66	½	31	70	11.6	\$ 3235
	GMB-3160W	60	½	31	63	10.8	\$ 2870
	GMB-3154W	54	½	31	57	9.9	\$ 2595
	GMB-3148W	48	½	31	51	9.0	\$ 2414
	GMB-3142W	42	½	31	44	8.1	\$ 2045
	GMB-3136W	36	½	31	38	7.2	\$ 1770
	GMB-3130W	30	½	31	32	6.3	\$ 1494

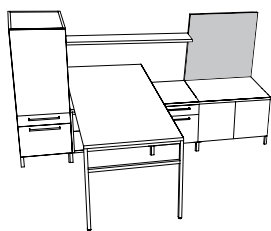
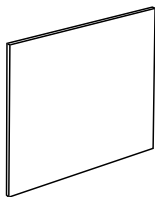

Must Specify (in this order):

Model #
Color



Rare Earth Magnet, Marker and Eraser Sets Available, [See Set Options](#)

Description

- Available in Black (BLMKR) or White (WHMKR), Must Specify
- Marker Boards Are One (1) Piece with No Seams
- Mounting Brackets Included
- For Use over 21"H Desks and Credenzas with Wall Mount Hutches
- For Rare Earth Magnets, Marker and Eraser Sets; [See Set Options](#)

MAGNETIC GLASS MARKER BOARD	GMB-4048W	48	½	40%	67	11.0	\$ 3128
FOR USE WITH 30"H DESKS, CREDENZA AND WALL MOUNT HUTCHES OR SHELVING	GMB-4042W	42	½	40%	58	9.9	\$ 2644
	GMB-4036W	36	½	40%	50	8.8	\$ 2285
	GMB-4030W	30	½	40%	42	7.7	\$ 1924

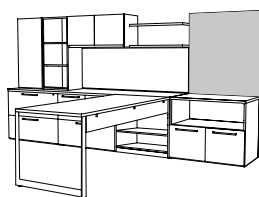

Must Specify (in this order):

Model #
Color



Rare Earth Magnet, Marker and Eraser Sets Available, [See Set Options](#)

Description

- Available in Black (BLMKR) or White (WHMKR), Must Specify
- Mounting Brackets Included
- For Use over 30"H Desks and Credenzas with Wall Mount Hutches or Shelving
- For Rare Earth Magnets, Marker and Eraser Sets; [See Set Options](#)

Item	Model No.	Width	Depth	Height	Ship Wt	Cubic Ft	List Price
MAGNETIC GLASS MARKER BOARD	GMB-7036W	36	½	70¾	87	13.8	\$ 3834
FOR USE FROM FLOOR TO TOP OF UNIT	GMB-5136W	36	½	51¾	63	10.6	\$ 2802
	GMB-7030W	30	½	70¾	72	12.1	\$ 3215
	GMB-5130W	30	½	51¾	53	9.3	\$ 2354

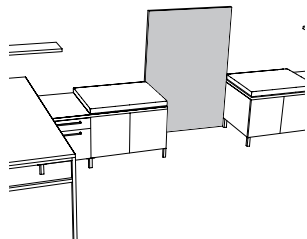

Description

- Available in Black (BLMKR) or White (WHMKR), Must Specify
- Marker Boards Are One (1) Piece with No Seams
- Mounting Brackets Included
- For Use From Floor to Top of Unit
- For Rare Earth Magnets, Marker and Eraser Sets; [See Set Options](#)

Must Specify (in this order):

Model #
Color



Rare Earth Magnet, Marker and Eraser Sets Available, [See Set Options](#)

TALL TOOL RAIL WORK WALL FOR WALL MOUNT HUTCHES

USE OVER 21" H CREDENZA 31" TALL

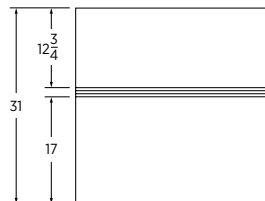

Must Specify (in this order):

Model #
Tackboard on Top or Bottom
Dry Erase on Top or Bottom
Tackboard Fabric Vendor, Pattern, and Color

Must Specify:

- TB-TB: Tackboard Over Tackboard (Use Grade Prices)
- DEB-TB: Dry Erase Over Tackboard (Use Grade Prices)
- DEB-DEB: Dry Erase Over Dry Erase (Use Grade 1 Prices)

Model #	Size	COM ydg	COM, 1, 2 or 3	Grades						
				4	5	6	7	8	9	10
WW-31108TTRW	108"	3.50	\$ 2159	2646	2873	3104	3433	3776	4175	4637
WW-31102TTRW	102"	3.25	\$ 2044	2496	2707	2922	3227	3546	3916	4345
WW-3196TTRW	96"	3.00	\$ 1969	2386	2581	2779	3061	3355	3697	4093
WW-3190TTRW	90"	2.75	\$ 1854	2236	2415	2597	2855	3125	3438	3801
WW-3184TTRW	84"	2.50	\$ 1658	2006	2168	2333	2568	2813	3098	3428
WW-3178TTRW	78"	2.50	\$ 1585	1933	2095	2260	2495	2740	3025	3355
WW-3172TTRW	72"	2.25	\$ 1318	1631	1777	1926	2137	2358	2614	2911
WW-3166TTRW	66"	2.00	\$ 1265	1543	1673	1805	1993	2189	2417	2681
WW-3160TTRW	60"	2.00	\$ 1191	1469	1599	1731	1919	2115	2343	2607
WW-3154TTRW	54"	1.75	\$ 1137	1380	1494	1610	1774	1946	2145	2376
WW-3148TTRW	48"	1.50	\$ 1044	1253	1350	1449	1590	1737	1908	2106
WW-3142TTRW	42"	1.25	\$ 960	1134	1215	1298	1415	1538	1680	1845
WW-3136TTRW	36"	1.25	\$ 940	1114	1195	1278	1395	1518	1660	1825
WW-3130TTRW	30"	1.00	\$ 865	1004	1069	1135	1229	1327	1441	1573

Description

- Aluminum Tool Rail
- Work Walls 78" and Larger will Ship in 4 Pieces
- [See Work Wall Accessories](#)

**TOOL RAIL WORK WALL
FOR WALL MOUNT HUTCHES**

**USE OVER 30"H CREDENZA
23" TALL**

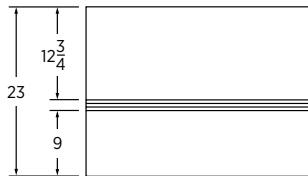

Must Specify (in this order):

- Model #
- Tackboard on Top or Bottom
- Dry Erase on Top or Bottom
- Tackboard Fabric Vendor, Pattern, and Color

Must Specify:

- TB-TB: Tackboard Over Tackboard (Use Grade Prices)
- DEB-TB: Dry Erase Over Tackboard (Use Grade Prices)
- DEB-DEB: Dry Erase Over Dry Erase (Use Grade 1 Prices)

Model #	Size	COM ydg	COM, 1, 2 or 3	Grades							
				4	5	6	7	8	9	10	
WW-23108TRW	108"	3.50	\$ 1797	2284	2511	2742	3071	3414	3813	4275	
WW-23102TRW	102"	3.25	\$ 1693	2145	2356	2571	2876	3195	3565	3994	
WW-2396TRW	96"	3.00	\$ 1643	2060	2255	2453	2735	3029	3371	3767	
WW-2390TRW	90"	2.75	\$ 1548	1930	2109	2291	2549	2819	3132	3495	
WW-2384TRW	84"	2.50	\$ 1379	1727	1889	2054	2289	2534	2819	3149	
WW-2378TRW	78"	2.50	\$ 1319	1667	1829	1994	2229	2474	2759	3089	
WW-2372TRW	72"	2.25	\$ 1099	1412	1558	1707	1918	2139	2395	2692	
WW-2366TRW	66"	2.00	\$ 1040	1318	1448	1580	1768	1964	2192	2456	
WW-2360TRW	60"	2.00	\$ 976	1254	1384	1516	1704	1900	2128	2392	
WW-2354TRW	54"	1.75	\$ 934	1177	1291	1407	1571	1743	1942	2173	
WW-2348TRW	48"	1.50	\$ 863	1072	1169	1268	1409	1556	1727	1925	
WW-2342TRW	42"	1.25	\$ 795	969	1050	1133	1250	1373	1515	1680	
WW-2336TRW	36"	1.25	\$ 780	954	1035	1118	1235	1358	1500	1665	
WW-2330TRW	30"	1.00	\$ 716	855	920	986	1080	1178	1292	1424	

Description

- Aluminum Tool Rail
- Work Walls 78" and Larger will Ship in 4 Pieces
- [See Work Wall Accessories](#)

**TALL TOOL RAIL WORK WALL
FOR SURFACE MOUNT HUTCHES**

**USE OVER 30"H CREDENZA
23" TALL**

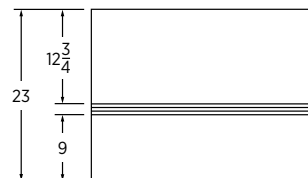

Must Specify (in this order):

- Model #
- Tackboard on Top or Bottom
- Dry Erase on Top or Bottom
- Tackboard Fabric Vendor, Pattern, and Color

Must Specify:

- TB-TB: Tackboard Over Tackboard (Use Grade Prices)
- DEB-TB: Dry Erase Over Tackboard (Use Grade Prices)
- DEB-DEB: Dry Erase Over Dry Erase (Use Grade 1 Prices)

Model #	Size	COM ydg	COM, 1, 2 or 3	Grades							
				4	5	6	7	8	9	10	
WW-2372TRH	72"	2.25	\$ 1023	1336	1482	1631	1842	2063	2319	2616	
WW-2366TRH	66"	2.00	\$ 967	1245	1375	1507	1695	1891	2119	2383	
WW-2360TRH	60"	2.00	\$ 910	1188	1318	1450	1638	1834	2062	2326	

Description

- Aluminum Tool Rail
- Work Walls 78" and Larger will Ship in 4 Pieces
- [See Work Wall Accessories](#)

[See Iconic Intro For Ordering Options and Grommet Locations](#)

Item	Model No.		Width	Depth	Height	Ship Wt	Cubic Ft	List Price
LEGAL TRAY	01-LGLTRAYC	Clear	14 $\frac{7}{8}$	10 $\frac{1}{2}$	1 $\frac{7}{8}$	1	0.2	\$ 1115

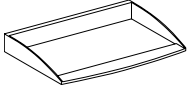

FOLDER SORTER	01-FLDRSRTRC	Clear	7 $\frac{1}{4}$	12 $\frac{3}{8}$	7 $\frac{1}{8}$	1	0.2	\$ 1129
---------------	--------------	-------	-----------------	------------------	-----------------	---	-----	---------

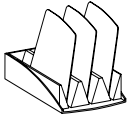

ACCESSORIES TRAY	01-ACCTRAYC	Clear	9 $\frac{1}{4}$	10 $\frac{1}{2}$	1 $\frac{1}{8}$	1	0.2	\$ 1125
------------------	-------------	-------	-----------------	------------------	-----------------	---	-----	---------

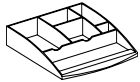

[See Iconic Intro For Ordering Options and Grommet Locations](#)

TACKBOARDS FOR WALL MOUNT HUTCHES

USE OVER 21" H CRENZENZA
31" TALL

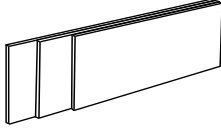

Must Specify (in this order):

Model #
Fabric Vendor, Pattern, and Color

Model #	Size	COM ydg	COM, 1, 2 or 3	Grades									
				4	5	6	7	8	9	10			
TB-31108W	108"	3.50	\$ 1014	1501	1728	1959	2288	2631	3030	3492			
TB-31102W	102"	3.25	\$ 969	1421	1632	1847	2152	2471	2841	3270			
TB-3196W	96"	3.00	\$ 943	1360	1555	1753	2035	2329	2671	3067			
TB-3190W	90"	2.75	\$ 899	1281	1460	1642	1900	2170	2483	2846			
TB-3184W	84"	2.50	\$ 851	1199	1361	1526	1761	2006	2291	2621			
TB-3178W	78"	2.50	\$ 836	1184	1346	1511	1746	1991	2276	2606			
TB-3172W	72"	2.25	\$ 772	1085	1231	1380	1591	1812	2068	2365			
TB-3166W	66"	2.00	\$ 738	1016	1146	1278	1466	1662	1890	2154			
TB-3160W	60"	2.00	\$ 691	969	1099	1231	1419	1615	1843	2107			
TB-3154W	54"	1.75	\$ 656	899	1013	1129	1293	1465	1664	1895			
TB-3148W	48"	1.50	\$ 598	807	904	1003	1144	1291	1462	1660			
TB-3142W	42"	1.25	\$ 539	713	794	877	994	1117	1259	1424			
TB-3136W	36"	1.25	\$ 525	699	780	863	980	1103	1245	1410			
TB-3130W	30"	1.00	\$ 473	612	677	743	837	935	1049	1181			

Description

- All Tackboards 78" and Longer will Ship in 2 Pieces

TACKBOARDS FOR SURFACE MOUNT HUTCHES

23" TALL

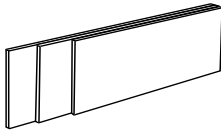

Must Specify (in this order):

Model #
Fabric Vendor, Pattern, and Color

Model #	Size	COM ydg	COM, 1, 2 or 3	Grades									
				4	5	6	7	8	9	10			
TB-65108H	108"	3.50	\$ 758	1245	1472	1703	2032	2375	2774	3236			
TB-65102H	102"	3.25	\$ 731	1183	1394	1609	1914	2233	2603	3032			
TB-6596H	96"	3.00	\$ 707	1124	1319	1517	1799	2093	2435	2831			
TB-6590H	90"	2.75	\$ 673	1055	1234	1416	1674	1944	2257	2620			
TB-6584H	84"	2.50	\$ 639	987	1149	1314	1549	1794	2079	2409			
TB-6578H	78"	2.50	\$ 628	976	1138	1303	1538	1783	2068	2398			
TB-6572H	72"	2.25	\$ 566	879	1025	1174	1385	1606	1862	2159			
TB-6566H	66"	2.00	\$ 533	811	941	1073	1261	1457	1685	1949			
TB-6560H	60"	2.00	\$ 498	776	906	1038	1226	1422	1650	1914			
TB-6554H	54"	1.75	\$ 485	728	842	958	1122	1294	1493	1724			
TB-6548H	48"	1.50	\$ 436	645	742	841	982	1129	1300	1498			
TB-6542H	42"	1.25	\$ 396	570	651	734	851	974	1116	1281			
TB-6536H	36"	1.25	\$ 385	559	640	723	840	963	1105	1270			
TB-6530H	30"	1.00	\$ 346	485	550	616	710	808	922	1054			

Description

- All Tackboards 78" and Longer will Ship in 2 Pieces

[See Iconic Intro For Ordering Options and Grommet Locations](#)

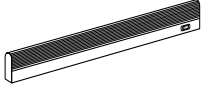
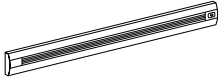
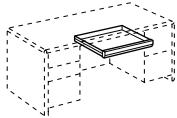
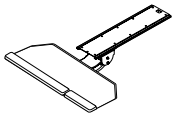
Item	Model No.	Width	Depth	Height	Ship Wt	Cubic Ft	List Price
LED TASKLIGHTS 	TL-0848	47½	7⁄8	1⅝	-	-	\$ 445
	<i>240-LED, 18 Watts</i>						
	TL-0824	22½	7⁄8	1⅝	-	-	\$ 368
	<i>84-LED, 7 Watts</i>						
Description							
<ul style="list-style-type: none"> • Includes the Power Supply and Three (3) Upper Wire Management Grommets • Rocker Style On/Off Switch with a 10' Power Cord • Three (3) Upper Wire Management Grommets; Must Specify Color: Black (BLK), Silver (SLV) 							
LED TASKLIGHTS 	01-188LED58	57¾	2	¾	-	-	\$ 1648
	<i>96-LED, 33.7 Watts</i>						
	01-94LED31	30¾	2	¾	-	-	\$ 1195
	<i>48-LED, 17.6 Watts</i>						
	01-47LED17	16¾	2	¾	-	-	\$ 690
	<i>24-LED, 9.1 Watts</i>						
Description							
<ul style="list-style-type: none"> • Includes the Power Supply and Three (3) Upper Wire Management Grommets • 12' Power Cord • Three (3) Upper Wire Management Grommets; Must Specify Color: Black (BLK), Silver (SLV) • Optional Occupancy Sensor Shuts Off After 30 Minutes of Inactivity and Turns On Immediately When Reentering the Detection Area 							
Options: Specify & Add							
	01-OSRP	Occupancy Sensor					\$ 366
CENTER DRAWER 	01-1622CD	22	16¾	2¾	7	1.4	\$ 495
	Description						
<ul style="list-style-type: none"> • Standard With: Beveled Drawer Front, ¾ Extension, and Wood Drawer Interiors with Built-in Pen Tray 							
Options: Specify & Add							
	CD16	Factory Installed					\$ 208
ARTICULATING KEYBOARD CORNER PLATFORM 	01-KB2CC	25	10½	4½	16	1.4	\$ 832
	Description						
<ul style="list-style-type: none"> • Standard With: +/- 15° Tilt Adjustment , 360° Rotation, Independent Tilt Adjustment, 7" Lift and Lock Height Adjustment, 25" Cut Corner Platform • Keyboard and Mouse on same level; Single Palm Rest for both Left & Right Hands • Works with 17"+ Diagonal Work Surface • Cannot Be Used on 20" or 21" Deep Unit • Not Available with Optional Center Grommet • Track Measures 21" 							
Options: Specify & Add							
	KB2CC	Factory Installed					\$ 208

[See Iconic Intro For Ordering Options and Grommet Locations](#)

Item	Model No.	Width	Depth	Height	Ship Wt	Cubic Ft	List Price
KEYBOARD MECHANISM WITH KEYBOARD PLATFORM, MOUSE TRAY, AND PALM REST	01-KB3	26½	14	4.5	16	1.4	\$ 914

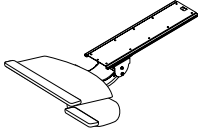

Description

- Standard With: 18¾" Platform & Swivel-Below Mouse Platform, Palm Rest for Mousing Surface, Life & Lock 7" Height Adjustment, +/- 15° Tilt Adjustment, 360° Rotation, and Independent Tilt Adjustment
- Cannot be Used on 20"D or 21"D Unit
- Track Measures 21"
- Not Available with Optional Center Grommet

Options: Specify & Add

KB3	Factory Installed	\$ 208
-----	-------------------	--------

MARKER AND ERASER SET	01-MRKRSETBL	For Use with Black Marker Boards and Black Glass Doors	\$ 123
	01-MRKRSETWH	For Use with White Marker Boards and White Glass Doors	

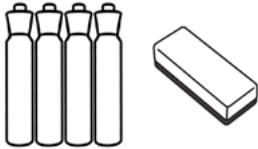

Description

- 01-MRKRSETWH May Also be Used with Standard Dry Erase Doors and Boards
- Includes Four (4) Markers and an Eraser

MAGNET SET	01-MAGBL	For Use with White Marker Boards	\$ 114
	01-MAGWH	For Use with Black Marker Boards	



Description

- Includes Set of Five (5) Magnets

LINK 360 CABLE MANAGER	01-0251LINKSLV	<i>Silver</i>	5¾	3¾	30-51	4	3.0	\$ 390
	01-0251LINKBLK	<i>Black</i>	5¾	3¾	30-51	4	3.0	\$ 353

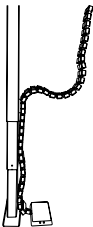

Description

- Kit Includes: 50 Link 360™ elements, One (1) Quad Connector, One (1) Dumbbell Connector, and One (1) Foot Assembly with Two (2) Magnetic Clips
- Can Be Used For Height-Adjustable Mechanisms Up To 51" or Free-Standing Use

[See Iconic Intro For Ordering Options and Grommet Locations](#)

Item	Model No.	Width	Depth	Height	Ship Wt	Cubic Ft	List Price
WIRE CHANNEL	01-32125	24	1 $\frac{1}{8}$	1	.25	0.3	\$ 106

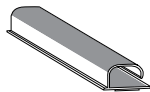

Description

- Available in Black
- Channels Attach with Two (2) Double-Sided Installation Tape
- Easily Attach to an Iconic Leg to Route Wires/Cords from the Top to the Floor
- Open J Channel for Easy Storage of Cables

CABLE GRIP	01-WMGRCB	5 $\frac{3}{8}$	2 $\frac{5}{8}$	-	-	\$ 17
------------	-----------	-----------------	-----------------	---	---	-------

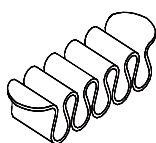

Description

- Under Surface Wire Management
- Black

DOCK 950 WIRELESS CHARGER	01-DOCK950W	White	3 $\frac{3}{16}$	3 $\frac{3}{16}$	-	1	0.2	\$ 265
	01-DOCK950B	Black						



OPEN MARKET ONLY

Description

- For Use with Wireless Charging Enabled Devices
- Mounts in 76mm Round Cut-Out
- 5 Watts Maximum Output with a Direct Current of 5V 2A and 10 Watts Maximum with Quick Charge 2.0
- LED will Confirm Pairing with Device and Begin Wireless Charging

DOCK 150 WIRELESS AND USB CHARGER	01-DOCK150W	White	3	3	$\frac{3}{4}$	1	0.2	\$ 405
	01-DOCK150B	Black						



OPEN MARKET ONLY

Description

- For Use with Wireless Charging Enabled Devices and USB Charging Devices
- 5 Watt Maximum Output with a Direct Current Input of 5V 6A (Wireless Fast Charge)
- Mounts in 76mm Round Cut-Out
- Pop-Up is $\frac{3}{4}$ "H and Includes Three (3) USB Ports; One (1) 12 Watt Maximum with 2.4A (USB Fast Charge) and Two (2) 5 Watt with 1A (USB Standard Charge)
- LED Light will Confirm Pairing with Device and Begin Wireless Charging
- UL and cUL Certified

[See Iconic Intro For Ordering Options and Grommet Locations](#)

Item	Model No.		Width	Depth	Height	Ship Wt	Cubic Ft	List Price
SINGLE POWER SAND DOLLAR	01-SAND60PW	White	3	3	4	1	0.2	\$ 98
	01-SAND60PB	Black						
	01-SAND60PS	Silver						

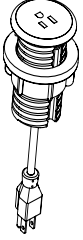
Description

- Unit is 2" Diameter; Mounts in 60mm Round Grommet
- 6' Cord
- Single Power Outlet

DOUBLE USB SAND DOLLAR	01-SAND60UW	White	3	3	4	1	0.2	\$ 277
	01-SAND60UB	Black						
	01-SAND60US	Silver						

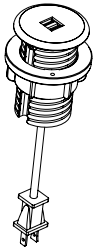
Description

- Unit is 2" Diameter; Mounts in 60mm Round Grommet
- 6' Cord
- Dual USB Outlets

DUO CLAMP NEMA PLUG	01-DUOCLAMPW	White	5½	3	7	1	0.2	\$ 572
	01-DUOCLAMPB	Black						
	01-DUOCLAMPS	Silver						

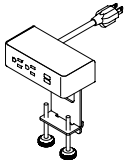
Description

- Clamps to Worksurface and Includes: Two (2) Power, Two (2) USB, 10' Cord, and All Mounting Hardware
- Silver Metal Trim on All Color Options
- Independent USB Circuit Controllers Deliver up to 2.1 Amps to Each Post
- FCC Part 15A, UL Approved for Horizontal and Vertical Applications

TRIO CLAMP NEMA PLUG	01-TRIOCLAMPW	White	8	3	7	1	0.2	\$ 671
	01-TRIOCLAMPB	Black						
	01-TRIOCLAMPS	Silver						

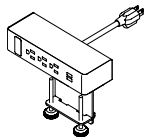
Description

- Clamps to Worksurface and Includes: Three (3) Power, Two (2) USB, One (1) Open Data, 10' Cord, and All Mounting Hardware
- HDMI, VGA, or RJ45 Accessory for Open Data Port Specified Separately, [See Accessories](#)
- Silver Metal Trim on All Color Options
- Independent USB Circuit Controllers Deliver up to 2.1 Amps to Each Post
- FCC Part 15A, UL Approved for Horizontal and Vertical Applications

[See Iconic Intro For Ordering Options and Grommet Locations](#)

Item	Model No.		Width	Depth	Height	Ship Wt	Cubic Ft	List Price
	01-DUOBEZELW	White	6½	2½	3¼	1	0.2	\$ 675
	01-DUOBEZELB	Black						
	01-DUOBEZELS	Silver						

Description

- Sits on Worksurface and Includes: Two (2) Power, Two (2) USB, 10' Cord, and All Mounting Hardware
- Independent USB Circuit Controllers Deliver up to 2.1 Amps to Each Post
- FCC Part 15A, UL Approved for Horizontal and Vertical Applications

	01-TRIOBEZELW	White	9	2½	3	1	0.2	\$ 725
	01-TRIOBEZELB	Black						
	01-TRIOBEZELS	Silver						

Description

- Sits on Worksurface and Includes: Three (3) Power, Two (2) USB, One (1) Open Data, 10' Cord, and All Mounting Hardware
- HDMI, VGA, or RJ45 Accessory for Open Data Port Specified Separately, [See Accessories](#)
- Independent USB Circuit Controllers Deliver up to 2.1 Amps to Each Post
- FCC Part 15A, UL Approved for Horizontal and Vertical Applications

	01-DUOUNDERW	White	6½	2½	3	1	0.2	\$ 546
	01-DUOUNDERB	Black						
	01-DUOUNDERS	Silver						

Description

- Sits Under Worksurface and Includes: Two (2) Power, Two (2) USB, 10' Cord, and All Mounting Hardware
- Independent USB Circuit Controllers Deliver up to 2.1 Amps to Each Post
- FCC Part 15A, UL Approved for Horizontal and Vertical Applications

	01-TRIOUNDERW	White	9	2½	3	1	0.2	\$ 655
	01-TRIOUNDERB	Black						
	01-TRIOUNDERS	Silver						

Description

- Sits Under Worksurfaces and Includes: Three (3) Power, Two (2) USB, One (1) Open Data, 10' Cord, and All Mounting Hardware
- HDMI, VGA, or RJ45 Accessory for Open Data Port Specified Separately, [See Accessories](#)
- Independent USB Circuit Controllers Deliver up to 2.1 Amps to Each Post
- FCC Part 15A, UL Approved for Horizontal and Vertical Applications

[See Iconic Intro For Ordering Options and Grommet Locations](#)

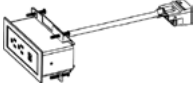
Item	Model No.		Width	Depth	Height	Ship Wt	Cubic Ft	List Price
DUO BEZEL HARD WIRE 	Circuit 1							
	01-HWDUOBEZELW1	White	6½	2½	3	1	0.2	\$ 730
	01-HWDUOBEZELB1	Black						
	01-HWDUOBEZELS1	Silver						
	Circuit 2							
	01-HWDUOBEZELW2	White	6½	2½	3	1	0.2	\$ 730
	01-HWDUOBEZELB2	Black						
	01-HWDUOBEZELS2	Silver						
	Circuit 3							
	01-HWDUOBEZELW3	White	6½	2½	3	1	0.2	\$ 730
	01-HWDUOBEZELB3	Black						
	01-HWDUOBEZELS3	Silver						
Circuit 4								
01-HWDUOBEZELW4	White	6½	2½	3	1	0.2	\$ 730	
01-HWDUOBEZELB4	Black							
01-HWDUOBEZELS4	Silver							

Description

- Must Specify Color and Circuit
- Sits on worksurface and includes: Two (2) Power, Two (2) USB Power, and all mounting hardware
- Independent USB Circuit Controllers Deliver up to 2.1 Amps to Each Post
- FCC Part 15A and UL Approved for Horizontal and Vertical Applications
- Maximum 10 Duo Units per Circuit
- Eight (8) Wire/Four (4) Circuit Hard Wire Power Unit

[See Iconic Intro For Ordering Options and Grommet Locations](#)

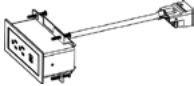
Item	Model No.		Width	Depth	Height	Ship Wt	Cubic Ft	List Price
 <p>TRIO BEZEL HARD WIRE</p>	Circuit 1							
	01-HWTRIOBEZELW1	White	9	2½	3	1	0.2	\$ 749
	01-HWTRIOBEZELB1	Black						
	01-HWTRIOBEZELS1	Silver						
	Circuit 2							
	01-HWTRIOBEZELW2	White	9	2½	3	1	0.2	\$ 749
	01-HWTRIOBEZELB2	Black						
	01-HWTRIOBEZELS2	Silver						
	Circuit 3							
	01-HWTRIOBEZELW3	White	9	2½	3	1	0.2	\$ 749
	01-HWTRIOBEZELB3	Black						
	01-HWTRIOBEZELS3	Silver						
	Circuit 4							
01-HWTRIOBEZELW4	White	9	2½	3	1	0.2	\$ 749	
01-HWTRIOBEZELB4	Black							
01-HWTRIOBEZELS4	Silver							

Description

- Must Specify Color and Circuit
- Sits on worksurface and includes: Three (3) Power, Two (2) USB Power, and all mounting hardware
- Independent USB Circuit Controllers Deliver up to 2.1 Amps to Each Post
- FCC Part 15A and UL Approved for Horizontal and Vertical Applications
- Maximum 6 Trio Units per Circuit
- Eight (8) Wire/Four (4) Circuit Hard Wire Power Unit

QUAD BLOCK HARD WIRED

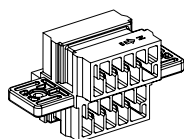

01-HWQUADBLOCK			-	-	-	1	0.2	\$ 62
----------------	--	--	---	---	---	---	-----	-------

Description

- Eight (8) Wire/Four (4) Circuit Hard Wire Connector
- UL183 Compliant
- For Connecting Jumpers and Power Units
- Quantity of Four (4) Female Inputs

Item	Model No.	Width	Depth	Height	Ship Wt	Cubic Ft	List Price
 <p>JUMPER HARD WIRE CABLE</p>	01-HW2JUMP	24	-	-	1	0.2	\$ 193
	01-HW3JUMP	36	-	-	1	0.2	\$ 206
	01-HW4JUMP	48	-	-	1	0.2	\$ 212
	01-HW5JUMP	60	-	-	1	0.2	\$ 255
	01-HW6JUMP	72	-	-	1	0.2	\$ 270

Description

- Eight (8) Wire/Four (4) Circuit Hard Wire Jumper
- UL183 Compliant

 <p>POWER ENTRY HARD WIRED</p>	01-HWPOWERENTRY	72	-	-	1	0.2	\$ 322
---	-----------------	----	---	---	---	-----	--------

Description

- Eight (8) Wire/Four (4) Circuit Hard Wire Infeed
- UL183 Compliant

 <p>DUO BEZEL DAISY CHAIN PLUG</p>	01-PDUOBEZELW	White	6½	2½	3	1	0.2	\$ 668
	01-PDUOBEZELB	Black						\$ 668
	01-PDUOBEZELS	Silver						\$ 668

Description

- Sits on Worksurface and Includes: Two (2) Power, Two (2) USB, 12" Cord, and All Mounting Hardware
- Requires Daisy Chain Power Box, Specified Separately, See Below
- Non-Sequential System Allows up to Eight (8) Modules to be Connected with Jumper Cord, Next See Page
- Independent USB Circuit Controllers Deliver up to 2.1 Amps to Each Post
- FCC Part 15A, RU Listed and UL Recognized for Horizontal and Vertical Applications

[See Iconic Intro For Ordering Options and Grommet Locations](#)

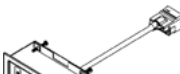
Item	Model No.		Width	Depth	Height	Ship Wt	Cubic Ft	List Price
TRIO BEZEL DAISY CHAIN PLUG 	01-PTRIOBEZELW	White	9	2½	3	1	0.2	\$ 715
	01-PTRIOBEZELB	Black						\$ 715
	01-PTRIOBEZELS	Silver						\$ 715

Description

- Sits on Worksurface and Includes: Three (3) Power, Two (2) USB, 1 Open Data, 12" Cord, and All Mounting Hardware
- HDMI, VGA, or RJ45 Accessory for Open Data Port Specified Separately, [See Accessories](#)
- Requires Daisy Chain Power Box, Specified Separately, See Below
- Non-Sequential System Allows up to Eight (8) Modules to be Connected with Jumper Cord, See Below
- FCC Part 15A, RU Listed and UL Recognized for Horizontal and Vertical Applications

DAISY CHAIN POWER BOX 	01-PPOWER	-	-	-	1	0.2	\$ 775
		<i>76" Perimeter, 36" Power Cord</i>					
	01-PPOWER2	-	-	-	1	0.2	\$ 796
		<i>24" Perimeter, 144" Power Cord</i>					

Description

- Powers up to Eight (8) Duo and Trio Daisy Chain Units
- One (1) Nema Plug and One (1) Daisy Chain Plug
- 12 Amp System Rating
- 15 Amp Over-Current Protection

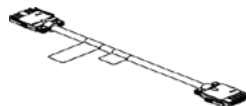
DAISY CHAIN JUMPER CORD 	01-6JUMP	-	-	-	1	0.2	\$ 299
		<i>72" Long</i>					
	01-5JUMP	-	-	-	1	0.2	\$ 284
		<i>60" Long</i>					
	01-4JUMP	-	-	-	1	0.2	\$ 240
		<i>48" Long</i>					
	01-2JUMP	-	-	-	1	0.2	\$ 220
		<i>24" Long</i>					

Description

- Connects Duo and Trio Daisy Chain Units
- Non Sequential System Allows up to Eight (8) Modules to be Connected

Item	Model No.	Width	Depth	Height	Ship Wt	Cubic Ft	List Price
HDMI DATA PORT ACCESSORY FOR TRIO UNITS	01-LCOMHDMI	-	-	-	1	0.2	\$ 166

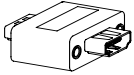

OPEN MARKET ONLY

VGA DATA PORT ACCESSORY FOR TRIO UNITS	01-LCOMVGA	-	-	-	1	0.2	\$ 121
--	------------	---	---	---	---	-----	--------

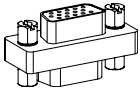

RJ45 DATA PORT ACCESSORY FOR TRIO UNITS	01-LCOMRJ45	-	-	-	1	0.2	\$ 79
---	-------------	---	---	---	---	-----	-------

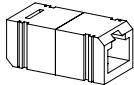

VESTA POWER CENTER	01-PDCTR	10¾	12	28¼	14	2.5	\$ 1776
--------------------	----------	-----	----	-----	----	-----	---------

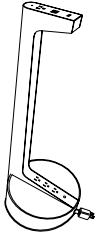

Description

- Available in White
- 120" Power Cord
- Four (4) Power Outlets, Three (3) on the Base and One (1) on the Top
- Two (2) USB Ports and One (1) USBC Port, All on Top
- Built with Weight Distribution for Optimal Stability
- Base is 5" Tall

[See Iconic Intro For Ordering Options and Grommet Locations](#)

Jefferson echoes history and creates a timeless foundation for today's sophisticated work place. Finely crafted in select solids with Walnut and Cherry veneers, the tailored details of this collection accentuate our expert craftsmanship and perfect attention to detail.

Jefferson forges traditional styling with modern sensibility with new Height Adjustable options and coordinating reception models, allowing the premium feel and flexibility of Jefferson to easily function throughout entire facilities.

CONSTRUCTION

Jefferson features a Veneer chassis with your choice of a Veneer or HPL top. Units ship assembled unless otherwise noted.

VENEER

- Choose from premium or select veneer on exposed surfaces in American Black Walnut or Cherry species in bookmatched veneer faces
- Veneers are carefully selected and matched to assure proper balance and consistency

TOPS

- Veneer tops offer a 5-ply balanced construction, 1 3/16" thick with solid hardwood mitered rims
- High Pressure Laminate (HPL) tops offer a 3-ply balanced construction, 1 3/16" thick with solid hardwood mitered rims
- Grain direction runs left-to-right unless otherwise noted
- All Jefferson tops are standard with the Jefferson edge profile (C2), unless otherwise noted.



CHASSIS

- Chassis is securely fastened using high quality European fastening systems, heavy-duty, 16-gauge joining brackets and wood dowels to assure maximum strength
- Bases are solid hardwood with mitered corners
- All units have finished veneer backs
- Construction offers tight tolerances and long term durability
- All units equipped with heavy-duty, adjustable glides to ensure proper leveling and compensate for uneven floors
- Vertical grain direction on chassis

DRAWERS

- Drawer fronts standard with bookmatched veneer faces
- Fronts are 3-ply construction and 3/4" thick
- Drawer interiors are dovetail, wood constructed with 7/16" hardwood sides and backs and 5/32" thick hardboard bottoms
- All drawers feature full extension, progressive action slides with precision steel ball bearings
- Box and file drawers are tested for 100lb capacity
- Lateral files feature 1/4" thick bottoms. Drawers are tested for 200lb of equally distributed weight (ex: hanging file folders) and 65lbs of bottom load weight (ex: stacked catalogs)
- All suspensions have a limited lifetime warranty
- Optional soft close ([see soft close options](#)) is available on center, tray, box, and file drawers, unless otherwise noted; **File drawers with the soft close option feature front-to-back filing.**

FILING

- All file drawers are standard with filing systems designed to accommodate a variety of filing requirements
- **Optional soft close on box and file drawers allows front-to-back filing in file drawer**

FILING (CONT.)

- Legal width file drawers provide legal filing front to back, and letter or legal filing side to side
- Letter width file drawers provide letter filing front to back, and letter or legal filing side to side

STORAGE

- All hinged doors include soft close hinges, unless noted
- Soft close hinges reduce stress placed on the cabinet when the door is closed and offers a quiet closure

LOCKING

- Central locking is standard on all desks and optional for credenzas and returns; one key in the lock cylinder locks all drawers in the desk
- Lock core color will coordinate with pull selection (brass pulls will have black cores, while aluminum pulls will have silver cores)
- Removable lock cylinders allow for units to be re-keyed at a later date if required
- Units are shipped randomly keyed as standard. Keyed alike units available upon request at no additional charge.

CORD MANAGEMENT

- Grommets are standard in back panels of returns, bridges, kneespace credenzas, and hutch units (does not apply to height adjustable or reception units)
- Grommets may be ordered in the tops of desks, returns, bridges, credenzas, and component worksurfaces
- [See all optional grommet locations](#)
- Undersurface Wire Managers are available for additional cord management; [See Multiple Units](#)

HEIGHT ADJUSTABILITY

- Electric-powered height adjustable mechanisms are offered in 2-channel for single surface height adjustment and 3-channel for simultaneous, two surface height adjustment
- Height adjustable legs available in black finish only
- Height adjustment range 30"H to 45"H
- 5-year warranty
- Recommended load capacity of 180lbs
- Two control switches are available, including an up/down switch (standard with product, unless noted) and an advanced switch with Bluetooth capabilities, position memory, three stand up reminder intervals, and more; gently adjust worksurface with a one second stop at each memory position
- The standard control switch is factory installed on all units except bridges and 3-channel units
- Bridges, returns, and credenzas will not have a standard grommet on the back panel
- New wire management mesh wrap included when worksurface grommet is selected
- Grommets and one wire management channel provided within kneespace to manage wires from switch and control box; two wire management channels will be shipped with desk shells

INTERIOR DRAWER DIMENSIONS

Models

46-4284DPS 46-4278DPS 46-3672CHS

Drawers	W	L	D
Tray	15 ³ / ₈ "	19 ³ / ₈ "	12 ⁷ / ₃₂ "
Box	15 ³ / ₈ "	19 ³ / ₈ "	3 ²¹ / ₃₂ "
File	15 ³ / ₈ "	25 ³ / ₄ "	8 ²⁹ / ₃₂ "
Center	30 ⁵ / ₈ "	19 ¹¹ / ₃₂ "	12 ⁷ / ₃₂ "

Models

46-3672LPS 46-3672RPS

Drawers	W	L	D
Tray	15 ³ / ₈ "	19 ³ / ₈ "	12 ⁷ / ₃₂ "
Box	15 ³ / ₈ "	19 ³ / ₈ "	3 ²¹ / ₃₂ "
File	15 ³ / ₈ "	25 ³ / ₄ "	8 ²⁹ / ₃₂ "
Center	25 ³ / ₄ "	19 ¹¹ / ₃₂ "	12 ⁷ / ₃₂ "

Models

46-3672DPS 46-3066DPS

Drawers	W	L	D
Tray	12 ³ / ₈ "	19 ³ / ₈ "	12 ⁷ / ₃₂ "
Box	12 ³ / ₈ "	19 ³ / ₈ "	3 ²¹ / ₃₂ "
File	12 ³ / ₈ "	25 ³ / ₄ "	8 ²⁹ / ₃₂ "
Center	30 ⁵ / ₈ "	19 ¹¹ / ₃₂ "	12 ⁷ / ₃₂ "

Models

46-3066LPS 46-3066RPS

Drawers	W	L	D
Tray	12 ³ / ₈ "	19 ³ / ₈ "	12 ⁷ / ₃₂ "
Box	12 ³ / ₈ "	19 ³ / ₈ "	3 ²¹ / ₃₂ "
File	12 ³ / ₈ "	25 ³ / ₄ "	8 ²⁹ / ₃₂ "
Center	22 ⁷ / ₈ "	19 ¹¹ / ₃₂ "	12 ⁷ / ₃₂ "

Models

46-4284DP 46-4278DP 46-3672CH

Drawers	W	L	D
Box	15 ³ / ₈ "	19 ³ / ₈ "	3 ²¹ / ₃₂ "
File	15 ³ / ₈ "	25 ³ / ₄ "	11 ¹³ / ₃₂ "
Center	30 ⁵ / ₈ "	19 ¹¹ / ₃₂ "	12 ⁷ / ₃₂ "

Models

46-3672LP 46-3672RP

Drawers	W	L	D
Box	15 ³ / ₈ "	19 ³ / ₈ "	3 ²¹ / ₃₂ "
File	15 ³ / ₈ "	25 ³ / ₄ "	11 ¹³ / ₃₂ "
Center	25 ³ / ₄ "	19 ³ / ₈ "	12 ⁷ / ₃₂ "

Models

46-3672DP 46-3066DP

Drawers	W	L	D
Box	12 ³ / ₈ "	19 ³ / ₈ "	3 ²¹ / ₃₂ "
File	12 ³ / ₈ "	25 ³ / ₄ "	11 ¹³ / ₃₂ "
Center	30 ⁵ / ₈ "	19 ³ / ₈ "	12 ⁷ / ₃₂ "

Models

46-3066LP 46-3066RP

Drawers	W	L	D
Box	12 ³ / ₈ "	19 ³ / ₈ "	3 ²¹ / ₃₂ "
File	12 ³ / ₈ "	25 ³ / ₄ "	11 ¹³ / ₃₂ "
Center	22 ⁷ / ₈ "	19 ³ / ₈ "	12 ⁷ / ₃₂ "

Models

46-2448LF 46-2448RF 46-2442LF 46-2442RF
46-2066KC 46-2066LC 46-2066RC

Drawers	W	L	D
Box	12 ³ / ₈ "	16 ⁷ / ₃₂ "	3 ²¹ / ₃₂ "
File	12 ³ / ₈ "	16 ⁷ / ₃₂ "	11 ¹³ / ₃₂ "

Models

46-2072SC1 46-2072KC 46-2072LC 46-2072RC

Drawers	W	L	D
Box	15 ³ / ₈ "	16 ⁷ / ₃₂ "	3 ²¹ / ₃₂ "
File	15 ³ / ₈ "	16 ⁷ / ₃₂ "	11 ¹³ / ₃₂ "

Models

46-2072KC1

Drawers	W	L	D
Box	15 ³ / ₈ "	16 ⁷ / ₃₂ "	3 ²¹ / ₃₂ "
File	15 ³ / ₈ "	16 ⁷ / ₃₂ "	11 ¹³ / ₃₂ "
Center	30 ⁵ / ₈ "	14 ³ / ₁₆ "	12 ⁷ / ₃₂ "

Models

46-2066KC1

Drawers	W	L	D
Box	12 ³ / ₈ "	16 ⁷ / ₃₂ "	3 ²¹ / ₃₂ "
File	12 ³ / ₈ "	16 ⁷ / ₃₂ "	11 ¹³ / ₃₂ "
Center	30 ⁵ / ₈ "	14 ³ / ₁₆ "	12 ⁷ / ₃₂ "

Models

46-2036L2 46-2036L4 46-2034L2FE 46-2034L4FE
46-2072LL 46-2072RL 46-2072DL 46-2066LL
46-2066RL

Drawers	W	L	D
File	12 ³ / ₈ "	25 ³ / ₄ "	8 ¹³ / ₃₂ "

Models

46-1829MU

Drawers	W	L	D
Box	25 ¹ / ₂ "	16 ⁷ / ₃₂ "	3 ²¹ / ₃₂ "
File	25 ¹ / ₂ "	16 ⁷ / ₃₂ "	8 ¹³ / ₃₂ "

Models

46-1829MF

Drawers	W	L	D
File	25 ¹ / ₂ "	16 ⁷ / ₃₂ "	8 ¹³ / ₃₂ "

INTERIOR DRAWER DIMENSIONS

Models			
46-3672TD	43-3066TD	46-3672TDQ	43-3066TDQ
Drawers	W	L	D
Center	30 ⁵ / ₈ "	19 ³ / ₈ "	12 ⁷ / ₃₂ "

Models			
46-1818MU			
Drawers	W	L	D
Box	15 ³ / ₈ "	19 ³ / ₈ "	3 ²¹ / ₃₂ "
File	15 ³ / ₈ "	16 ⁷ / ₃₂ "	8 ²⁹ / ₃₂ "

Models			
46-1818MF	46-2072KC2	46-2072LC2	46-2072RC2
Drawers	W	L	D
File	15 ³ / ₈ "	16 ⁷ / ₃₂ "	8 ²⁹ / ₃₂ "

Models			
46-2448LF2	46-2448RF2	46-2442LF2	46-2442RF2
46-2066KC2	46-2066LC2	46-2066RC2	46-2448LF2STS
46-2448RF2STS	46-2442LF2STS	46-2442RF2STS	46-2448LF2SR
46-2448RF2SR	46-2442LF2SR	46-2442RF2SR	46-2472RCL
46-2472RCR	46-2466RCL	46-2466RCR	46-2448RPD2L
46-2448RPD2R			
Drawers	W	L	D
File	12 ³ / ₈ "	16 ⁷ / ₃₂ "	8 ²⁹ / ₃₂ "

Models			
46-3672DPSTS	46-3066DPSTS	46-3066LPSTS	46-3066RPSTS
46-2066SC1			
Drawers	W	L	D
Box	12 ³ / ₈ "	16 ⁷ / ₃₂ "	3 ²¹ / ₃₂ "
File	12 ³ / ₈ "	16 ⁷ / ₃₂ "	8 ²⁹ / ₃₂ "

Models			
46-3672LPSTS	46-3672RPSTS		
Drawers	W	L	D
Box	15 ³ / ₈ "	16 ⁷ / ₃₂ "	3 ²¹ / ₃₂ "
File	15 ³ / ₈ "	16 ⁷ / ₃₂ "	8 ²⁹ / ₃₂ "

Models			
46-3672DPSSTS	46-3066DPSSTS	46-3066LPSSTS	46-3066RPSSTS
Drawers	W	L	D
Tray	12 ³ / ₈ "	16 ⁷ / ₃₂ "	12 ⁷ / ₃₂ "
Box	12 ³ / ₈ "	16 ⁷ / ₃₂ "	3 ²¹ / ₃₂ "
File	12 ³ / ₈ "	16 ⁷ / ₃₂ "	8 ²⁹ / ₃₂ "

Models			
46-3672LPSSTS	46-3672RPSSTS		
Drawers	W	L	D
Tray	15 ³ / ₈ "	16 ⁷ / ₃₂ "	12 ⁷ / ₃₂ "
Box	15 ³ / ₈ "	16 ⁷ / ₃₂ "	3 ²¹ / ₃₂ "
File	15 ³ / ₈ "	16 ⁷ / ₃₂ "	8 ²⁹ / ₃₂ "

Models			
46-2448LF2STS3	46-2448RF2STS3		
46-2442LF2STS3	46-2442RF2STS3		
Drawers	W	L	D
File	12 ³ / ₈ "	12 ⁷ / ₈ "	8 ²⁹ / ₃₂ "

Models			
46-3672RPD1L	46-3672RPD1R		
Drawers	W	L	D
Box	15 ³ / ₈ "	19 ³ / ₈ "	3 ²¹ / ₃₂ "
File	15 ³ / ₈ "	25 ³ / ₄ "	8 ²⁹ / ₃₂ "
Center	25 ³ / ₄ "	19 ³ / ₈ "	12 ⁷ / ₃₂ "

Models			
46-3066RPD1L	46-3066RPD1R		
Drawers	W	L	D
Box	12 ³ / ₈ "	19 ³ / ₈ "	3 ²¹ / ₃₂ "
File	12 ³ / ₈ "	25 ³ / ₄ "	8 ²⁹ / ₃₂ "
Center	22 ⁷ / ₈ "	19 ³ / ₈ "	12 ⁷ / ₃₂ "

FILING CAPABILITIES

Drawers with Dimensions:

15³/₈"W x 25³/₄"L

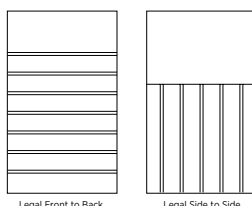

12³/₈"W x 25³/₄"L

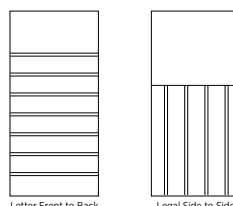

12³/₈"W x 12⁷/₈"L

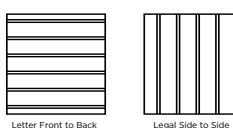

15³/₈"W x 16⁷/₃₂"L

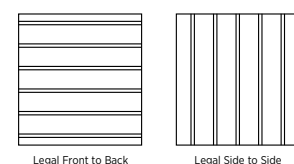

12³/₈"W x 16⁷/₃₂"L

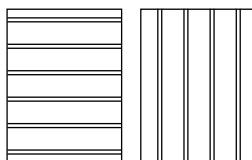

25³/₂"W x 16⁷/₃₂"L

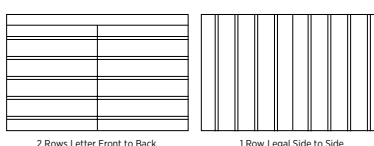

HOW TO ORDER EXAMPLES

DESKS, RETURNS, AND CREDENZAS

MODEL #	QTY	DESCRIPTION	EXAMPLE
46-4284DPS	1	Premium or Standard Veneer	PV
		Top Material	P
		Finish/Color	MW
		Pull	JEF
		No Molding	-
		Dictation Slide	DSL
		Drawer Track	SOFT
		Top Grommet Loc./Color	GC/BLK
		Flip Down Center Drawer	LFD

HEIGHT ADJUSTABLE 3-COLUMN L-UNIT

46-3672LPSTS	1	Premium or Standard Veneer	W
		Top Material	W
		Finish/Color	SKC
		Pull	ALB
		No Molding	NO MOLDING
		Drawer Track	STD
		Leg Configuration	STS3
		Top Grommet Loc./Color	GC-BOX/SLV
		Control Switch	MSWCH

46-2448RF2STS3	1	Premium or Standard Veneer	W
		Top Material	W
		Finish/Color	SKC
		Pull	ALB
		No Molding	NO MOLDING
		Locking Pedestal	LKI-46L
		Drawer Track	STD
		Top Grommet Loc./Color	GC-BOX/SLV

RECEPTION L-UNIT

46-3672RPD1L	1	Premium or Standard Veneer	W
		Top Material	P
		Finish/Color	GC
		Pull	ARA
		No Molding	-
		Drawer Track	SOFT
		Top Grommet Loc./Color	GC/BLK
		Flip Down Center Drawer	LFD
		Tackboard/Fabric	CF Stinson Nikko Beach

46-2448RPD2R	1	Premium or Standard Veneer	W
		Top Material	P
		Finish/Color	GC
		Pull	ARA
		No Molding	-
		Drawer Track	SOFT
		Top Grommet Loc./Color	GC/BLK

PREMIUM AND STANDARD VENEER (W) OPTIONS

Veneer features UVAdvantage, an ultra-violet finish, on all exposed surfaces by utilizing roll-coat UV technology.

AW	Artisan Walnut	LW	Legacy Walnut
CO	Columbian Walnut	MW	Mahogany Walnut
DC	Dark Cherry	MTS	Metropolis Sky**
DFW	Dark Forest Walnut	PNW	Pinnacle Walnut**
EW	Espresso	SCH	Select Cherry
GC	Golden Cherry	SKC	Shaker Cherry
HW	Harvest Walnut	WC	Williamsburg Cherry
HNW	Henna Walnut**		

** Available in Standard Veneer Only

HPL (P) TOP OPTIONS

WOODGRAIN

CO	Columbian Walnut	PNW	Pinnacle Walnut
EF	Espresso	SCH	Select Cherry
GC	Golden Cherry	SKC	Shaker Cherry
MW	Mahogany Walnut	WC	Williamsburg Cherry

DRAWER AND DOOR PULL OPTIONS

Units with doors and drawers will feature coordinating pulls however door and drawer pulls cannot be intermixed.

ARA	Arlington A, Antique Brass	JEF	Jefferson, Antique Brass
ARB	Arlington B, Antique Brass	ALB	Liberty, Aluminum
WLM	Wilmington, Antique Brass		



Arlington A (ARA)
Antique Brass - 5/4"



Arlington B (ARB)
Antique Brass - 5/4"



Jefferson (JEF)
Antique Brass - 5/4"



Wilmington (WLM)
Antique Brass - 5/4"



Liberty (ALB)
Aluminum - 4/4"

DRAWER TRACK OPTIONS

Soft close tracks are available on center, tray, box, and file drawers in Jefferson. Soft close drawer tracks have many benefits including reduced stress on the unit, extends the life of the drawer, and ensures a gentle close so fingers don't accidentally get hurt. **File drawers with the soft close option feature front-to-back filing.** Must specify when ordering.

Pricing is per Drawer, not per Model/Unit

SFTCL	Soft Close Drawer Track	\$	34
-------	-------------------------	----	----

LOCKING FLIP DOWN CENTER DRAWER

Single and double pedestal desks and kneespace credenzas standard with a center drawer have an optional central locking, keyboard flip down drawer. Drawer front is wood veneer with laminate drawer interior.

LFD	Locking Flip Down Front Center Drawer	\$	82
-----	---------------------------------------	----	----

APPROACH SIDE DICTATION SLIDES

Some desk models offer an approach side pull-out dictation slide. Specify DSLD when placing your order and add upcharge. If adding the dictation slide, the center grommet will not be available.

NONE	No Approach Dictation Slide	\$	STD
DSL	Approach Side Dictation Slide	\$	611

MOLDING OPTIONS

All standard, height adjustable, and reception units ship with decorative pencil molding. If you do not want molding, please specify "NO MOLDING" when ordering each model.

Modular components come standard with no molding. To accommodate for flush ends, molding is offered as an option. Specify one of the following codes when ordering.

STD	No Molding	\$	STD
M46R1	Molding on Right Side Only	\$	85
M46L1	Molding on Left Side Only	\$	85
M46LR	Molding on Both Right and Left Sides	\$	170

Note: Left or right is determined when facing the front of the unit. Molding features multi-step, hand-finished catalyzed finish

GLASS SHELVES OPTION

Units with beveled glass and mesh grille inserts offer the option of glass shelving.

GLSSH	Units with Two Doors	\$	104
GLSSH	Units with Four Doors	\$	208

DOWN LIGHTING OPTION

Select units with beveled glass and mesh grille inserts offer the option of down lighting. See individual models for availability.

DNLGT	Units with Two Doors	\$	410
DNLGT	Units with Four Doors	\$	820

LOCKING PEDESTALS ON RETURNS/CREDENZAS

Locking drawers are available on returns and credenzas. Please specify LKI-46L on order and add upcharge. Lock core will coordinate with pull selection.

Returns and single pedestal credenzas will have the lock positioned in the upper right corner of the top pedestal drawer.

LKI-46L	Return or Single Pedestal Credenza Locking	\$	205
---------	--	----	-----

Double pedestal credenzas will have locks positioned in the upper right corner of both of the top drawers.

LKI-46L	Double Pedestal Credenza Locking	\$	410
---------	----------------------------------	----	-----

LOCKING DOORS

Locking doors are available on specific units, where noted. Specify WITH LOCKING when ordering and add upcharge. Lock core will coordinate with pull selection.

LKT_HU	Two & Four Door Vertical Hutches	\$	135
LKT_HU	72"W to 48"W Units	\$	115
LKT_HU	42"W to 30"W Units	\$	91
LKT_HU	18"W Units	\$	69

HEIGHT ADJUST LEG CONFIGURATION

The 2-channel leg configuration is standard on height adjustable Desks, Returns, Bridges, and Credenza for one height adjustable worksurface. Desk models offer an optional 3-channel leg configuration for use with 3-channel Returns to allow two worksurfaces to raise and lower simultaneously.

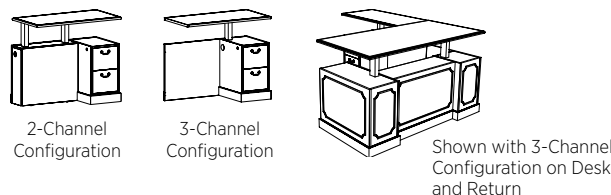

STS2	2-Channel Configuration (For one height adjustable worksurface)	STD
STS3	3-Channel Configuration (For two height adjustable worksurfaces)	\$ N/C

HEIGHT ADJUST CONTROL OPTIONS

Height adjustable units offer two switch options. The standard switch is a simple up and down switch to move your worksurface from seated to standing height. This comes standard with height adjustable units, unless otherwise noted. The advanced switch features Bluetooth capabilities to connect to smart devices, three stand-up reminder intervals, and height adjustment memory positions, and more.

Please specify desired Control Switch when ordering applicable Height Adjustable units.

SWCH	Standard Up/Down Switch	\$	STD
MSWCH	Advanced Up/Down with Memory Switch	\$	135



SWCH (standard) MSWCH

WORKSURFACE GROMMETS FOR STANDARD UNITS & RECEPTION

GC	Grommet, Center; Must Specify Black (BLK) or Silver (SLV)	\$	52
GL	Grommet, Left; Must Specify Black (BLK) or Silver (SLV)	\$	52
GR	Grommet, Right; Must Specify Black (BLK) or Silver (SLV)	\$	52

Verify Grommet Option is available on the model(s) you are specifying using the location information on Pages 430-431.

Grommets may be ordered in non-standard locations. Call Customer Service to assist with specification. Note additional charges and lead times may apply.

Multiple locations may be selected.

See Grommet Locations on Next Page.

WORKSURFACE GROMMETS FOR STANDARD UNITS & RECEPTION (CONT.)

Models

46-4284DPS 46-4284DP

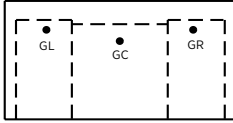

GL/GR: Located 17" from ends and 32" from user side

GC: Located 28" from user side

Models

46-4278DPS 46-4278DP

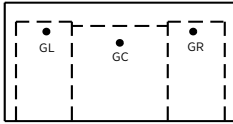

GL/GR: Located 14" from ends and 32" from user side

GC: Located 28" from user side

Models

46-3672CHS 46-3672CH 46-3672LP 46-3672RP
46-3672LPS 46-3672RPS

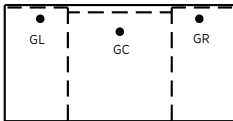

GL/GR: Located 11" from ends and 32" from user side

GC: Located 28" from user side

Models

46-3672DPS 46-3672DP

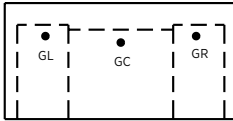

GL/GR: Located 13" from ends and 26" from user side

GC: Located 24" from user side

Models

46-3066DPS 46-3066DP 46-3066LP 46-3066RP
46-3066LPS 46-3066RPS

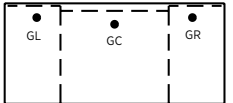

GL/GR: Located 10" from ends and 26" from user side

GC: Located 24" from user side

Models

46-2448UF 46-2448UFH 46-2442UF 46-2442UFH
46-2448LF 46-2448RF 46-2442LF 46-2442RF
46-2448LF2 46-2448RF2 46-2442LF2 46-2442RF2
46-2436CW

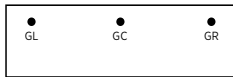

GL/GR: Located 4" from ends and 20" from user side

GC: Located 20" from user side

Models

46-2072KC 46-2072LC 46-2072RC 46-2072LL*
46-2072RL*

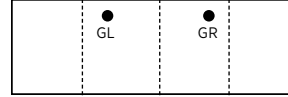

GL/GR: Located 22½" from ends and 17" from user side

* Grommets are only available opposite the pedestal

Models

46-2066KC 46-2066LC 46-2066RC 46-2066LL*
46-2066RL*

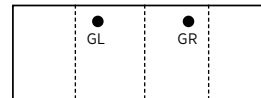

GL/GR: Located 19½" from ends and 17" from user side

* Grommets are only available opposite the pedestal

Models

46-2072KC1 46-2072KC2 46-2066KC2 46-2072LC2
46-2072RC2

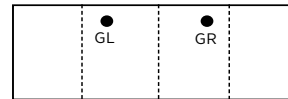

GL/GR: Located 22½" from ends and 17" from user side

Models

46-2066KC1 46-2066LC2 46-2066RC2

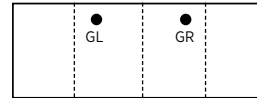

GL/GR: Located 19½" from ends and 17" from user side

Models

46-3672RPD1L 46-3672RPD1R

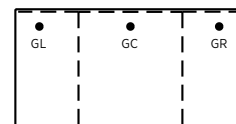

GL/GR: Located 6" from sides and 31¼" from user side

GC: 31¼" from user side

Models

46-3066RPD1L 46-3066RPD1R

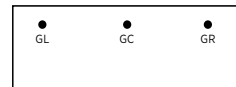

GL/GR: Located 6" from sides and 26%" from user side

GC: 26%" from user side

Models

46-2448RPD2L 46-2448RPD2R 46-2448RUF 46-2442RUF

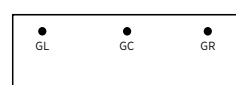

GL/GR: Located 6" from ends and 20" from user side

GC: Located 19" from user side

Models

46-2472RCL 46-2472RCR 46-2466RCL 46-2466RCR

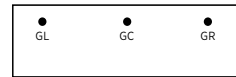

GL/GR: Located 6" from sides and 19" from user

GC: 19" from user side

WORKSURFACE GROMMETS FOR HEIGHT ADJUSTABILITY UNITS

When you select a grommet for use with Height Adjustable worksurfaces, it will automatically come with a wire management sleeve. One grommet per worksurface. Must specify Left, Right, or Center. See below for specific location availability by model. You may also choose to add the Wire Management Box, which will automatically come with a center grommet.

Grommet with Mesh Sleeve \$ 142
Must Specify Grommet Color: Black (BLK) or Silver (SLV)

HA Desks/Returns/Credenzas Choose Left, Right, or Center (See Below)
 HA Bridges Center Only

- GC-MESH Grommet, Center
- GL-MESH Grommet, Left
- GR-MESH Grommet, Right
- GCKS-MESH Grommet, Centered Between Legs



Wire Management Box with Center Grommet \$ 485
Must Specify Black (BLK) or Silver (SLV)

Available on All HA Desks, Returns and Bridges

GC-BOX Grommet, Center

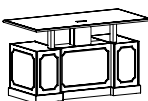

Verify Grommet Option is available on the model(s) you are specifying using the following location information.

Grommets may be ordered in non-standard locations. Call Customer Service to assist with specification. Note additional charges and lead times may apply.

Models

46-3672DPSTS 46-3672DPSSTS

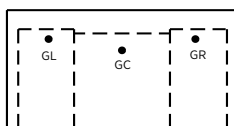

GL or GR: Located 9" from ends and 22½" from user side
 GC: Located 20" from user side

Models

46-3066DPSTS 46-3066DPSSTS 46-3672LPSTS 46-3672RPSTS
 46-3672LPSSTS 46-3672RPSSTS 46-3066LPSTS 46-3672RPSTS
 46-3066LPSSTS 46-3066RPSSTS

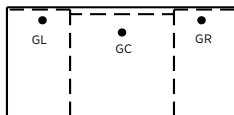

GL or GR: Located 6" from ends and 22½" from user side
 GC: Located 20" from user side

Models

46-2448LF2STS 46-2448RF2STS 46-2442LF2STS 46-2442RF2STS

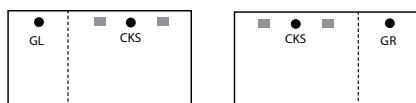

GL or GR: Located 6" from ends and 20" from user side
 CKS: Located 20" from user side

Models

46-2448LF2STS3 46-2448RF2STS3 46-2442LF2STS3 46-2442RF2STS3

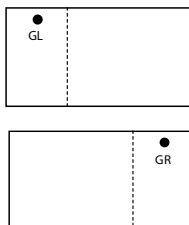

Grommet with Mesh Wire Management Sleeve only available in ped space
 GL-MESH or GR-MESH: Located 6" from ends and 20" from user side

Models

46-2448UFSTS 46-2442UFSTS 46-2448UFSTSL3
 46-2442UFSTSL3 46-2448UFSTSR3 46-2442UFSTSR3

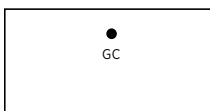

GC: Located 18" from user side

Models

46-2448LF2SR 46-2448RF2SR 46-2442LF2SR 46-2442RF2SR
 46-2448SUFL 46-2448SUFR 46-2442SUFL 46-2442SUFR

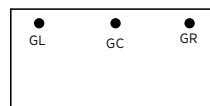

GL/GR: Located 4" from ends and 20" from user side
 GC: Located 20" from user side

HUTCH GROMMET OPTIONS

Select Surface Mount and Vertical Hutches come standard with a lower, center grommet in the back panel. Please specify color: Black (BLK) or Silver (SLV).

Three upper wire management grommets are also available, and are great for use with tasklights. Must specify color option.

WMHUBL Black Lower + 3 Upper Grommets \$ N/C
 WMHUSV Silver Lower + 3 Upper Grommets \$ N/C

CERTIFICATIONS & COMPLIANCE

- Intertek Sustainability Certified
- BIFMA level® Certified
- BIFMA Compliant® Certified
- TSCA Title VI (formerly CARB) Compliance
- US Green Building's LEED® Contribution

Standard Units + Tables



Double Ped Desks
(See Details)

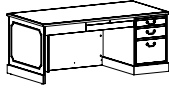

Single Ped Desks
(See Details)

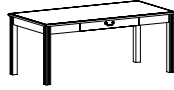
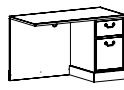
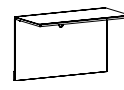

Table Desks
(See Details)



Returns
(See Multiple Unit Details)



Bridges
(See Multiple Unit Details)

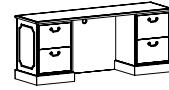

Single Ped, Storage, Kneespace,
and Double Lateral Credenzas
(See Multiple Unit Details)

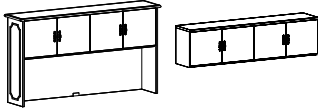

Standard and Tall Surface Mount Hutches
and Wall Mount Hutches
(See Multiple Unit Details)

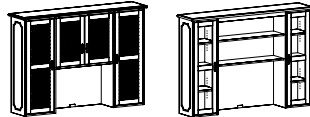

Two and Four Door Vertical Mount Hutches
(See Multiple Unit Details)



Lateral Filing
(See Multiple Unit Details)



Surface Mount Bookcases
with Molding or Flush Ends
(See Multiple Unit Details)

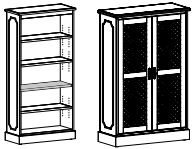

Bookcases with or
without Doors
(See Multiple Unit Details)

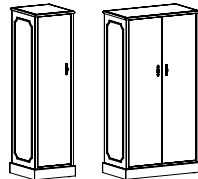

Single and Double Wardrobe/
Storage Cabinets
(See Multiple Unit Details)

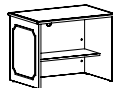

Computer Work Table
(See Details)



Round Tables and Bases
(See Details)

Modular Units

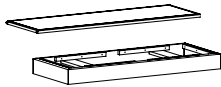

Modular Tops and Bases
(See Multiple Unit Details)
Modular Bookcase Tops and Bases
(See Multiple Unit Details)

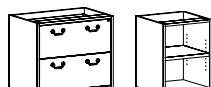

Modular Pedestals
(See Multiple Unit Details)

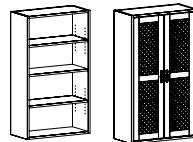

Modular Bookcases
(See Multiple Unit Details)

Occasional Tables



End Tables
(See Details) Lamp Tables
(See Details) Magazine Tables
(See Details)

Height Adjustable (HA) Units

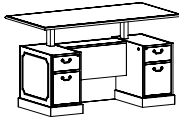

HA Double Ped Desks
(See Multiple Unit Details)

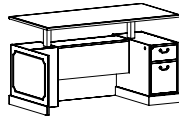

HA Single Ped Desks
(See Multiple Unit Details)



HA Returns
(See Multiple Unit Details)

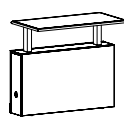

HA Bridges
(See Multiple Unit Details)

Tackboards + Tasklights

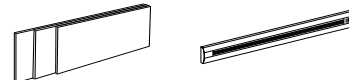

Tackboards
(See Multiple Unit Details)

Tasklights
(See Multiple Unit Details)

Reception Units



Reception Desks
(See Multiple Unit Details)



Reception Returns
(See Details)

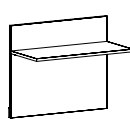

Reception Bridges
(See Multiple Unit Details)

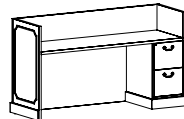

Reception Credenzas
(See Multiple Unit Details)

Kneespace Options + Accessories

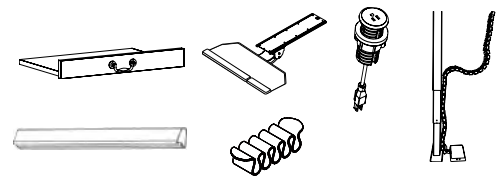

Item	Model No.	Width	Depth	Height	K	R	Ship Wt	Cubic Ft	List Price	
L UNIT	46-20	72	84	30	27¾	-	480	71.8	W/P\$	10661
									PV\$	11940

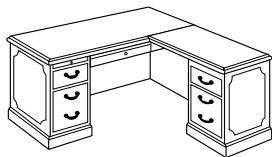

CONSISTS OF:		QTY			
46-3672LP	1	Left Pedestal Desk		W/P\$	6338
				PV\$	7099
46-2448RF	1	Right Return		W/P\$	4323
				PV\$	4841

Products are available as left or right, where applicable

U UNIT	46-21	72	104	30	-	-	658	84.5	W/P\$	13408
									PV\$	15019

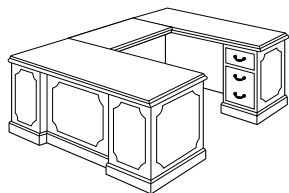

CONSISTS OF:		QTY			
46-3672LP	1	Left Pedestal Desk		W/P\$	6338
				PV\$	7099
46-2448UF	1	Bridge with Full Modesty		W/P\$	2213
				PV\$	2480
46-2072RC	1	Credenza, Right Pedestal		W/P\$	4857
				PV\$	5440

Products are available as left or right, where applicable

MODULAR STORAGE UNIT	46-4	88½	20	83	-	-	721	88.6	W/P\$	18760
									PV\$	20739



CONSISTS OF:		QTY			
46-1589FC	1	Modular Cornice Frame		W\$	1111
46-2952BC	2	Modular Bookcases		W\$	3600
				PV\$	4034
46-2952MB	1	Modular Bookcase with Mesh Doors		W\$	3141
				PV\$	3519
46-2089TP	1	Modular Top		W/P\$	1740
				PV\$	1948
46-1829MU	2	Modular Box/Box/File Cabinets		W\$	5848
				PV\$	6550
46-1829MS	1	Modular Storage Cabinet		W\$	2148
				PV\$	2405
46-2089BS	1	Modular Base		W\$	1172

Products are available as left or right, where applicable

Item	Model No.	Width	Depth	Height	K	R	Ship Wt	Cubic Ft	List Price
MODULAR STORAGE UNIT	46-17	88½	20	83	-	-	547	62.8	W/P\$ 16007 PV\$ 17673



CONSIST OF:	QTY			
46-1589FC	1	Modular Cornice Frame	W\$	1111
46-2952MB	2	Modular Bookcase with Mesh Doors	W\$ PV\$	6282 7038
46-2089TP	1	Modular Top	W/P\$ PV\$	1740 1948
46-1829MF	2	Modular File/File Cabinets	W\$ PV\$	5848 6550
46-2031BS	2	Modular Bases	W\$	1026

Products are available as left or right, where applicable

HEIGHT ADJUSTABLE L UNIT WITH CRENDENZA/HUTCH	46-22	72	140	83	-	-	1207	139.9	W/P\$ 31492 PV\$ 35270
---	-------	----	-----	----	---	---	------	-------	---------------------------

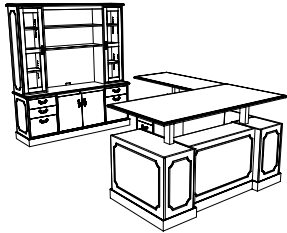

CONSISTS OF:	QTY			
46-3672RPSTS	1	Height Adjustable Right Pedestal Desk	W/P\$ PV\$	11552 12936
46-2448LF2STS3	1	Height Adjustable Left Return for Multiple Surfaces, 3-Channel	W/P\$ PV\$	7474 8372
46-2072SC1	1	Storage Credenza	W/P\$ PV\$	6915 7745
46-1572VHG	1	Vertical Open Hutch with Glass Doors	W/P\$ PV\$	5551 6217

Products are available as left or right, where applicable; Depth is figured with 36" between return and credenza

RECEPTION U-UNIT	46-23	72	108	42	-	-	677	104.5	W/P\$ 17386 PV\$ 19471
------------------	-------	----	-----	----	---	---	-----	-------	---------------------------

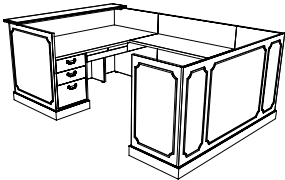

CONSISTS OF:	QTY			
46-3672RPD1L	1	Reception Desk, Left	W/P\$ PV\$	8254 9245
46-2448RUF	1	Reception Bridge	W/P\$ PV\$	2520 2821
46-2472RCR	1	Reception Credenza	W/P\$ PV\$	6612 7405

Products are available as left or right, where applicable

[See Jefferson Intro Section for Ordering Options](#)

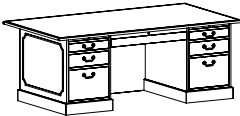
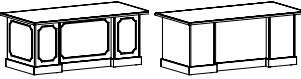
Item	Model No.	Width	Depth	Height	K	R	Ship Wt	Cubic Ft	List Price	
DOUBLE PED DESK TRAY/BOX/FILE   Approach Side Shown with Decorative Molding and Optional No Molding	TOP OVERHANG FEATURE									
	46-4284DPS	84	42	30	32½	3	458	67.4	W/P\$ 11864 PV\$ 13288	
	<i>Chassis 72W x 36D - Legal Ped; Approach Overhang 6", Side Overhang 7"</i>									
	46-4278DPS	78	42	30	32½	3	408	62.6	W/P\$ 10520 PV\$ 11785	
	<i>Chassis 72W x 36D - Legal Ped; Approach Overhang 6", Side Overhang 4"</i>									
	46-3672DPS	72	36	30	32½	3	358	50.0	W/P\$ 7118 PV\$ 7973	
<i>Chassis 66W x 30D - Letter Ped; Approach Overhang 6", Side Overhang 4"</i>										
STANDARD TOP										
46-3672CHS	72	36	30	32½	3	358	50.0	W/P\$ 9942 PV\$ 11132		
<i>Legal Ped</i>										
46-3066DPS	66	30	30	32½	3	300	38.7	W/P\$ 6873 PV\$ 7697		
<i>Letter Ped</i>										

Must Specify (in this order):

- Model #
- Premium or Standard Veneer
- Top Material
- Finish/Color
- Pull
- No Molding
- Dictation Slide
- Drawer Track
- Top Grommet Location/Color
- Flip Down Center Drawer

Description

- Standard with: Stepped Front, Rectangle Top Profiled on All Sides, Base Molding on All Sides, Decorative Molding on Approach and Both Sides, Central Locking in Center Drawer, Tray/Box/File Peds, Left-to-Right Grain Direction on Top, Pull Out Writing Shelf on Both Sides (Above Tray Drawer), and Dovetail Wood Drawer Construction
- Chassis Available with Premium Veneer (PV) or Standard Veneer (W); Must Specify
- Top Available with Premium/Standard Veneer (PV/W) or HPL (P); Must Specify
- [Height Adjustable Units Available](#)
- Lock Core Color will Coordinate with Pull Selection (Brass Pull with Black Lock, Silver Pull with Silver Lock)
- Additional Options: No Decorative Molding (Specify NO MOLDING); Keyboard Flip Down Center Drawer (Order Separately, [See Center Drawer](#)); Dictation Slide on Approach Side for 36"D and 30"D Units Only ([See Dictation Slide Options](#)); Soft Close Drawer Closure ([See Soft Close Drawer Option](#)); Top Grommet Options ([See Grommet Options](#)); Wire Management + Accessories (Order Separately; [See Multiple Unit Details](#))

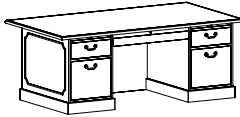
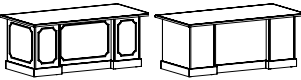
Item	Model No.	Width	Depth	Height	K	R	Ship Wt	Cubic Ft	List Price	
DOUBLE PED DESK BOX/FILE   Approach Side Shown with Decorative Molding and Optional No Molding	TOP OVERHANG FEATURE									
	46-4284DP	84	42	30	32½	3	458	67.4	W/P\$ 10728 PV\$ 12016	
	<i>Chassis 72W x 36D - Legal Ped; Approach Overhang 6", Side Overhang 7"</i>									
	46-4278DP	78	42	30	32½	3	408	62.6	W/P\$ 9514 PV\$ 10655	
	<i>Chassis 72W x 36D - Legal Ped; Approach Overhang 6", Side Overhang 4"</i>									
	46-3672DP	72	36	30	32½	3	358	50.0	W/P\$ 6743 PV\$ 7553	
<i>Chassis 66W x 30D - Letter Ped; Approach Overhang 6", Side Overhang 4"</i>										
STANDARD TOP										
46-3672CH	72	36	30	32½	3	358	50.0	W/P\$ 9167 PV\$ 10268		
<i>Legal Ped</i>										
46-3066DP	66	30	30	32½	3	300	38.7	W/P\$ 6468 PV\$ 7244		
<i>Letter Ped</i>										

Must Specify (in this order):

- Model #
- Premium or Standard Veneer
- Top Material
- Finish/Color
- Pull
- No Molding
- Dictation Slide
- Drawer Track
- Top Grommet Location/Color
- Flip Down Center Drawer

Description

- Standard with: Stepped Front, Rectangle Top Profiled on All Sides, Base Molding on All Sides, Decorative Molding on Approach and Both Sides, Central Locking in Center Drawer, Box/File Peds, Left-to-Right Grain Direction on Top, Pull Out Writing Shelf on Both Sides (Above Box Drawer), and Dovetail Wood Drawer Construction
- Chassis Available with Premium Veneer (PV) or Standard Veneer (W); Must Specify
- Top Available with Premium/Standard Veneer (PV/W) or HPL (P); Must Specify
- [Height Adjustable Units Available](#)
- Lock Core Color will Coordinate with Pull Selection (Brass Pull with Black Lock, Silver Pull with Silver Lock)
- Additional Options: No Decorative Molding (Specify NO MOLDING); Keyboard Flip Down Center Drawer (Order Separately, [See Center Drawer](#)); Dictation Slide on Approach Side for 36"D and 30"D Units Only ([See Dictation Slide Options](#)); Soft Close Drawer Closure ([See Soft Close Drawer Option](#)); Top Grommet Options ([See Grommet Options](#)); Wire Management + Accessories (Order Separately; [See Multiple Unit Details](#))

P = HPL W = Veneer PV = Premium Veneer

[See Jefferson Intro Section for Ordering Options](#)

Item	Model No.	Width	Depth	Height	K	R	Ship Wt	Cubic Ft	List Price	
SINGLE PED DESK TRAY/BOX/FILE	Left Ped	Right Ped								
	46-3672LPS <i>Legal Ped</i>	46-3672RPS	72	36	30	28¼	3	315	50.4	W/P\$ 6705 PV\$ 7509
	46-3066LPS <i>Letter Ped</i>	46-3066RPS	66	30	30	25¼	3	262	38.7	W/P\$ 6126 PV\$ 6864

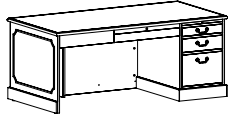

Shown as Right

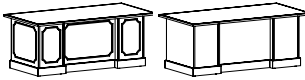

Approach Side Shown with Decorative Molding and Optional No Molding

Must Specify (in this order):

- Model #
- Premium or Standard Veneer
- Top Material
- Finish/Color
- Pull
- No Molding
- Dictation Slide
- Drawer Track
- Top Grommet Location/Color
- Flip Down Center Drawer

Description

- Standard with: Stepped Front, Rectangle Top Profiled on All Sides, Base Molding on All Sides, Decorative Molding on Approach and Both Sides, Central Locking in Center Drawer, Tray/Box/File Ped, Left-to-Right Grain Direction on Top, Pull Out Writing Shelf Above Tray Drawer, and Dovetail Wood Drawer Construction
- Chassis Available with Premium Veneer (PV) or Standard Veneer (W); Must Specify
- Top Available with Premium/Standard Veneer (PV/W) or HPL (P); Must Specify
- [Height Adjustable Units Available](#)
- Lock Core Color will Coordinate with Pull Selection (Brass Pull with Black Lock, Silver Pull with Silver Lock)
- Additional Options: No Decorative Molding (Specify NO MOLDING); Keyboard Flip Down Center Drawer (Order Separately, [See Center Drawer](#)); Dictation Slide on Approach Side for 36"D and 30"D Units Only ([See Dictation Slide Options](#)); Soft Close Drawer Closure ([See Soft Close Drawer Option](#)); Top Grommet Options ([See Grommet Options](#)); Wire Management + Accessories (Order Separately; [See Multiple Unit Details](#))

Item	Model No.	Width	Depth	Height	K	R	Ship Wt	Cubic Ft	List Price	
SINGLE PED DESK BOX/FILE	Left Ped	Right Ped								
	46-3672LP <i>Legal Ped</i>	46-3672RP	72	36	30	28¼	3	315	50.4	W/P\$ 6338 PV\$ 7099
	46-3066LP <i>Letter Ped</i>	46-3066RP	66	30	30	25¼	3	262	38.7	W/P\$ 5760 PV\$ 6451

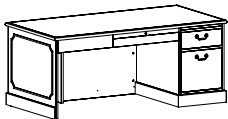

Shown as Right

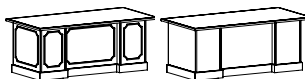

Approach Side Shown with Decorative Molding and Optional No Molding

Must Specify (in this order):

- Model #
- Premium or Standard Veneer
- Top Material
- Finish/Color
- Pull
- No Molding
- Dictation Slide
- Drawer Track
- Top Grommet Location/Color
- Flip Down Center Drawer

Description

- Standard with: Stepped Front, Rectangle Top Profiled on All Sides, Base Molding on All Sides, Decorative Molding on Approach and Both Sides, Central Locking in Center Drawer, Box/File Ped, Left-to-Right Grain Direction on Top, Pull Out Writing Shelf Above Box Drawer, and Dovetail Wood Drawer Construction
- Chassis Available with Premium Veneer (PV) or Standard Veneer (W); Must Specify
- Top Available with Premium/Standard Veneer (PV/W) or HPL (P); Must Specify
- [Height Adjustable Units Available](#)
- Lock Core Color will Coordinate with Pull Selection (Brass Pull with Black Lock, Silver Pull with Silver Lock)
- Additional Options: No Decorative Molding (Specify NO MOLDING); Keyboard Flip Down Center Drawer (Order Separately, [See Center Drawer](#)); Dictation Slide on Approach Side for 36"D and 30"D Units Only ([See Dictation Slide Options](#)); Soft Close Drawer Closure ([See Soft Close Drawer Option](#)); Top Grommet Options ([See Grommet Options](#)); Wire Management + Accessories (Order Separately; [See Multiple Unit Details](#))

P = HPL W = Veneer PV = Premium Veneer

[See Jefferson Intro Section for Ordering Options](#)

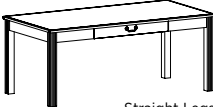
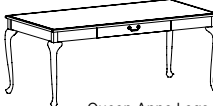
Item	Model No.	Width	Depth	Height	K	R	Ship Wt	Cubic Ft	List Price
TABLE DESK									
WITH STRAIGHT LEGS									
	46-3672TD	72	36	30	-	-	120	12.2	W/P\$ 3975 PV\$ 4453
	46-3066TD	66	30	30	-	-	110	9.7	W/P\$ 3326 PV\$ 3727
WITH QUEEN ANNE LEGS									
	46-3672TDQ	72	36	30	-	-	120	12.2	W/P\$ 6327 PV\$ 6804
	46-3066TDQ	66	30	30	-	-	110	9.7	W/P\$ 5678 PV\$ 6079

Must Specify (in this order):

Model #
Top Material
Finish/Color
Pull
Drawer Track

Description

- Standard with: Rectangle Top Profiled on All Sides, Center Drawer with Dovetail Wood Drawer Construction, and Left-to-Right Grain Direction on Top
- Top Available with Premium Veneer (PV), Veneer (W), or HPL (P); Must Specify
- Top and Legs Ship Separately; Some Assembly Required
- Additional Option: Soft Close Drawer Closure ([See Soft Close Drawer Option](#))

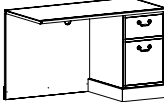
RETURN WITH BOX/FILE	Left Ped	Right Ped	Width	Depth	Height	K	R	Ship Wt	Cubic Ft	List Price
	46-2448LF	46-2448RF	48	24	30	30¾	-	165	21.8	W/P\$ 4323 PV\$ 4841
	46-2442LF	46-2442RF	42	24	30	27¾	-	165	21.8	W/P\$ 4271 PV\$ 4786

Shown as Right

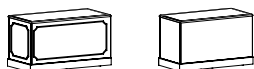

Approach Side Shown with Decorative Molding and Optional No Molding

Description

- Standard with: Rectangle Top Profiled on Three Sides with Reverse Profile on Connecting Side, Base Molding on All Sides, Decorative Molding on Approach and Side, Box/File Ped, Grommet in Back Panel, Front-to-Back Grain Direction on Top, and Dovetail Wood Drawer Construction
- Chassis Available with Premium Veneer (PV) or Standard Veneer (W); Must Specify
- Top Available with Premium/Standard Veneer (PV/W) or HPL (P); Must Specify
- [Height Adjustable Units Available](#)
- Grommet in Back Panel; Must Specify: Black (BLK), Silver (SLV), or None (NONE)
- Additional Options: No Decorative Molding (Specify NO MOLDING); Locking Pedestal ([See Locking Options](#)); Kneespace Options (Order Separately, [See Multiple Units](#)); Soft Close Drawer Closure ([See Soft Close Drawer Option](#)); Top Grommet Options ([See Grommet Options](#)); Wire Management + Accessories (Order Separately; [See Multiple Unit Details](#))

Must Specify (in this order):

Model #
Premium or Standard Veneer
Top Material
Finish/Color
Pull
No Molding
Drawer Track
Locking Pedestal
Back Panel Grommet Color
Top Grommet Location/Color
Kneespace Options

P = HPL W = Veneer PV = Premium Veneer

See [Jefferson Intro Section for Ordering Options](#)

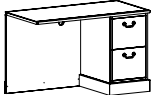
Item	Model No.	Width	Depth	Height	K	R	Ship Wt	Cubic Ft	List Price	
 Shown as Right	Left Ped	Right Ped								
	46-2448LF2	46-2448RF2	48	24	30	30¾	-	165	21.8	W/P\$ 4680 PV\$ 5240
	46-2442LF2	46-2442RF2	42	24	30	27¾	-	165	21.8	W/P\$ 4627 PV\$ 5185

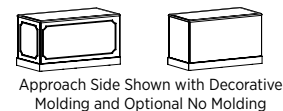

Must Specify (in this order):
 Model #
 Premium or Standard Veneer
 Top Material
 Finish/Color
 Pull
 No Molding
 Drawer Track
 Locking Pedestal
 Back Panel Grommet Color
 Top Grommet Location/Color
 Kneespace Options

Description

- Standard with: Rectangle Top Profiled on Three Sides with Reverse Profile on Connecting Side, Base Molding on All Sides, Decorative Molding on Approach and Side, File/File Ped, Grommet in Back Panel, Front-to-Back Grain Direction on Top, and Dovetail Wood Drawer Construction
- Chassis Available with Premium Veneer (PV) or Standard Veneer (W); Must Specify
- Top Available with Premium/Standard Veneer (PV/W) or HPL (P); Must Specify
- [Height Adjustable Units Available](#)
- Grommet in Back Panel; Must Specify: Black (BLK), Silver (SLV), or None (NONE)
- Additional Options: No Decorative Molding (Specify NO MOLDING); Locking Pedestal ([See Locking Options](#)); Kneespace Options (Order Separately, [See Multiple Units](#)); Soft Close Drawer Closure ([See Soft Close Drawer Option](#)); Top Grommet Options ([See Grommet Options](#)); Wire Management + Accessories (Order Separately; [See Multiple Unit Details](#))

 Approach Side Shown with Decorative Molding and Optional No Molding	BRIDGE WITH FULL MODESTY	46-2448UF	48	24	30	50	-	89	5.4	W/P\$ 2213 PV\$ 2480
		46-2442UF	42	24	30	42	-	85	4.6	W/P\$ 2088 PV\$ 2338

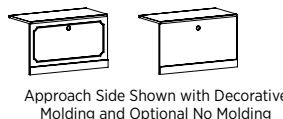

Must Specify (in this order):
 Model #
 Premium or Standard Veneer
 Top Material
 Finish/Color
 No Molding
 Top Grommet Location/Color

Description

- Standard With: Rectangle Top Profiled on Approach and User Side with Reverse Profile on Connecting Sides, Base and Decorative Molding on Approach Side, Grommet in Back Panel, Front-to-Back Grain Direction on Top, and Hinged Back Panel
- Chassis Available with Premium Veneer (PV) or Standard Veneer (W); Must Specify
- Top Available with Premium/Standard Veneer (PV/W) or HPL (P); Must Specify
- [Height Adjustable Units Available](#)
- Grommet in Back Panel; Must Specify: Black (BLK) or Silver (SLV) or None (NONE)
- Additional Options: No Decorative Molding (Specify No Molding); Kneespace Options (Order Separately, Available for Field Installation Only [See Multiple Units](#)); Soft Close Drawer Closure ([See Soft Close Drawer Option](#)); Top Grommet Options ([See Grommet Options](#)); Wire Management + Accessories (Order Separately; [See Multiple Unit Details](#))

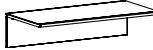
	BRIDGE WITH HALF MODESTY	46-2448UFH	48	24	11½	50	-	89	5.4	W/P\$ 1939 PV\$ 2170
		46-2442UFH	42	24	11½	42	-	85	4.6	W/P\$ 1822 PV\$ 2040

Must Specify (in this order):
 Model #
 Premium or Standard Veneer
 Top Material
 Finish/Color
 Top Grommet Location/Color

Description

- Standard With: Rectangle Top Profiled on Approach and User Side with Reverse Profile on Connecting Sides, Front-to-Back Grain Direction on Top, and Hinged Back Panel
- Chassis Available with Premium Veneer (PV) or Standard Veneer (W); Must Specify
- Top Available with Premium/Standard Veneer (PV/W) or HPL (P); Must Specify
- No Base or Decorative Molding
- Additional Options: Top Grommet Options (Starting on Page 429); Kneespace Options (Order Separately, Available for Field Installation Only [See Multiple Units](#)); Soft Close Drawer Closure ([See Soft Close Drawer Option](#)); Top Grommet Options ([See Grommet Options](#)); Wire Management + Accessories (Order Separately; [See Multiple Unit Details](#))

P = HPL W = Veneer PV = Premium Veneer

[See Jefferson Intro Section for Ordering Options](#)

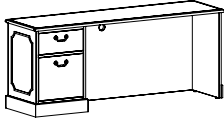
Item	Model No.	Width	Depth	Height	K	R	Ship Wt	Cubic Ft	List Price	
 <p>Shown as Left</p>	Left Ped	Right Ped								
	46-2072LC <i>Legal Ped</i>	46-2072RC	72	20	30	28¼	-	254	29.0	W/P\$ 4857 PV\$ 5440
	46-2066LC <i>Letter Ped</i>	46-2066RC	66	20	30	25¼	-	195	26.6	W/P\$ 4787 PV\$ 5360

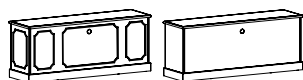

Back Side Shown with Decorative Molding and Optional No Molding

Must Specify (in this order):

Model #
Premium or Standard Veneer
Top Material
Finish/Color
Pull
No Molding
Drawer Track
Locking Pedestal
Back Panel Grommet Color
Top Grommet Location/Color

Description

- Standard With: Rectangle Top Profiled on All Sides, Base Molding on All Sides, Decorative Molding on Back and Both Sides, Box/File Ped, Grommet in Back Panel, Left-to-Right Grain Direction on Top, and Dovetail Wood Drawer Construction
- Chassis Available with Premium Veneer (PV) or Standard Veneer (W); Must Specify
- Top Available with Premium/Standard Veneer (PV/W) or HPL (P); Must Specify
- Grommet in Back Panel; Must Specify: Black (BLK), Silver (SLV), or None (NONE)
- Additional Options: No Decorative Molding (Specify NO MOLDING); Locking Pedestal ([See Locking Options](#)); Soft Close Drawer Closure ([See Soft Close Drawer Option](#)); Top Grommet Options ([See Grommet Options](#)); Wire Management + Accessories (Order Separately; [See Multiple Unit Details](#))

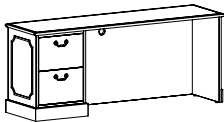
Item	Model No.	Width	Depth	Height	K	R	Ship Wt	Cubic Ft	List Price	
 <p>Shown as Left</p>	Left Ped	Right Ped								
	46-2072LC2 <i>Legal Ped</i>	46-2072RC2	72	20	30	28¼	-	254	29.0	W/P\$ 4955 PV\$ 5550
	46-2066LC2 <i>Letter Ped</i>	46-2066RC2	66	20	30	25¼	-	195	26.6	W/P\$ 4866 PV\$ 5449



Back Side Shown with Decorative Molding and Optional No Molding

Must Specify (in this order):

Model #
Premium or Standard Veneer
Top Material
Finish/Color
Pull
No Molding
Drawer Track
Locking Pedestal
Back Panel Grommet Color
Top Grommet Location/Color

Description

- Standard With: Rectangle Top Profiled on All Sides, Base Molding on All Sides, Decorative Molding on Back and Both Sides, File/File Ped, Grommet in Back Panel, Left-to-Right Grain Direction on Top, and Dovetail Wood Drawer Construction
- Chassis Available with Premium Veneer (PV) or Standard Veneer (W); Must Specify
- Top Available with Premium/Standard Veneer (PV/W) or HPL (P); Must Specify
- Grommet in Back Panel; Must Specify: Black (BLK), Silver (SLV), or None (NONE)
- Additional Options: No Decorative Molding (Specify NO MOLDING); Locking Pedestal ([See Locking Options](#)); Soft Close Drawer Closure ([See Soft Close Drawer Option](#)); Top Grommet Options ([See Grommet Options](#)); Wire Management + Accessories (Order Separately; [See Multiple Unit Details](#))

P = HPL W = Veneer PV = Premium Veneer

[See Jefferson Intro Section for Ordering Options](#)

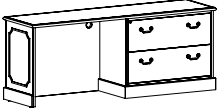
Item	Model No.	Width	Depth	Height	K	R	Ship Wt	Cubic Ft	List Price	
CREDENZA WITH LATERAL/LATERAL FILE 	Left Ped	Right Ped								
	46-2072LL	46-2072RL	72	20	30	28¼	-	315	50.4	W/P\$ 5053 PV\$ 5658
	46-2066LL	46-2066RL	66	20	30	25¼	-	262	38.7	W/P\$ 4946 PV\$ 5539

Shown as Right

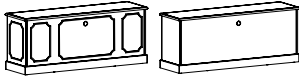

Back Side Shown with Decorative Molding and Optional No Molding

Must Specify (in this order):

- Model #
- Premium or Standard Veneer
- Top Material
- Finish/Color
- Pull
- No Molding
- Back Panel Grommet Color
- Top Grommet Location/Color

Description

- Standard With: Rectangle Top Profiled on All Sides, Base Molding on All Sides, Decorative Molding on Back and Both Sides, Locking Lateral/Lateral File Ped with Legal or Letter Filing, Grommet in Back Panel, Left-to-Right Grain Direction on Top, and Dovetail Wood Drawer Construction
- Chassis Available with Premium Veneer (PV) or Standard Veneer (W); Must Specify
- Top Available with Premium/Standard Veneer (PV/W) or HPL (P); Must Specify
- Grommet in Back Panel; Must Specify: Black (BLK), Silver (SLV), or None (NONE)
- Additional Options: No Decorative Molding (Specify NO MOLDING); Top Grommet Options ([See Grommet Options](#)); Wire Management + Accessories (Order Separately; [See Multiple Unit Details](#))

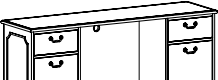
KNEESPACE CREDENZA WITH BOX/FILE 	46-2072KC	72	20	30	32½	-	275	29.0	W/P\$ 5794 PV\$ 6489
	<i>Legal Ped</i>								
	46-2066KC	66	20	30	32½	-	216	26.6	W/P\$ 5262 PV\$ 5893

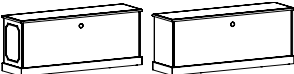

Side Shown with Decorative Molding and Optional No Molding

Must Specify (in this order):

- Model #
- Premium or Standard Veneer
- Top Material
- Finish/Color
- Pull
- No Molding
- Drawer Track
- Locking Pedestal
- Back Panel Grommet Color
- Top Grommet Location/Color

Description

- Standard With: Rectangle Top Profiled on All Sides, Base Molding on All Sides, Decorative Molding on Both Sides, Box/File Peds, Grommet in Back Panel, Left-to-Right Grain Direction on Top, and Dovetail Wood Drawer Construction
- Chassis Available with Premium Veneer (PV) or Standard Veneer (W); Must Specify
- Top Available with Premium/Standard Veneer (PV/W) or HPL (P); Must Specify
- Grommet in Back Panel; Must Specify: Black (BLK), Silver (SLV), or None (NONE)
- Additional Options: No Decorative Molding (Specify NO MOLDING); Locking Pedestal ([See Locking Options](#)); Soft Close Drawer Closure ([See Soft Close Drawer Option](#)); Top Grommet Options ([See Grommet Options](#)); Wire Management + Accessories (Order Separately; [See Multiple Unit Details](#))

P = HPL W = Veneer PV = Premium Veneer

[See Jefferson Intro Section for Ordering Options](#)

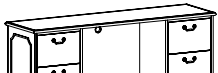
Item	Model No.	Width	Depth	Height	K	R	Ship Wt	Cubic Ft	List Price	
KNEESPACE CREDENZA WITH FILE/FILE 	46-2072KC2 <i>Legal Ped</i>	72	20	30	32½	-	275	29.0	W/P\$ 6177 PV\$ 6918	
	46-2066KC2 <i>Letter Ped</i>	66	20	30	32½	-	216	26.6	W/P\$ 5645 PV\$ 6324	

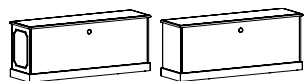

Side Shown with Decorative Molding and Optional No Molding

Must Specify (in this order):

Model #
 Premium or Standard Veneer
 Top Material
 Finish/Color
 Pull
 No Molding
 Drawer Track
 Locking Pedestal
 Back Panel Grommet Color
 Top Grommet Location/Color

Description

- Standard With: Rectangle Top Profiled on All Sides, Base Molding on All Sides, Decorative Molding on Both Sides, File/File Peds, Grommet in Back Panel, Left-to-Right Grain Direction on Top, and Dovetail Wood Drawer Construction
- Chassis Available with Premium Veneer (PV) or Standard Veneer (W); Must Specify
- Top Available with Premium/Standard Veneer (PV/W) or HPL (P); Must Specify
- Grommet in Back Panel; Must Specify: Black (BLK), Silver (SLV), or None (NONE)
- Additional Options: No Decorative Molding (Specify NO MOLDING); Locking Pedestal ([See Locking Options](#)); Soft Close Drawer Closure ([See Soft Close Drawer Option](#)); Top Grommet Options ([See Grommet Options](#)); Wire Management + Accessories (Order Separately; [See Multiple Unit Details](#))

KNEESPACE CREDENZA WITH BOX/BOX/FILE 	46-2072KC1 <i>Legal Ped</i>	72	20	30	32½	-	275	29.0	W/P\$ 6558 PV\$ 7346
	46-2066KC1 <i>Letter Ped</i>	66	20	30	32½	-	216	26.6	W/P\$ 6028 PV\$ 6749

With Decorative Molding

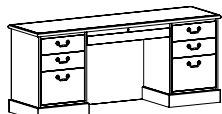

Without Decorative Molding

Must Specify (in this order):

Model #
 Premium or Standard Veneer
 Top Material
 Finish/Color
 Pull
 No Molding
 Drawer Track
 Back Panel Grommet Color
 Top Grommet Location/Color
 Flip Down Center Drawer

Description

- Standard With: Rectangle Top Profiled on All Sides, Central Locking in Center Drawer, Base Molding on All Sides, Decorative Molding on Both Sides, Box/Box/File Peds, Grommet in Back Panel, Left-to-Right Grain Direction on Top, and Dovetail Wood Drawer Construction
- Chassis Available with Premium Veneer (PV) or Standard Veneer (W); Must Specify
- Top Available with Premium/Standard Veneer (PV/W) or HPL (P); Must Specify
- Grommet in Back Panel; Must Specify: Black (BLK), Silver (SLV), or None (NONE)
- Additional Options: No Decorative Molding (Specify NO MOLDING); Soft Close Drawer Closure ([See Soft Close Drawer Option](#)); Top Grommet Options ([See Grommet Options](#)); Wire Management + Accessories (Order Separately; [See Multiple Unit Details](#))

P = HPL W = Veneer PV = Premium Veneer

See [Jefferson Intro Section](#) for Ordering Options

Item	Model No.	Width	Depth	Height	Ship Wt	Cubic Ft	List Price
DOUBLE LATERAL CREDENZA	46-2072DL	72	20	30	304	29.0	W/P\$ 7531 PV\$ 8433

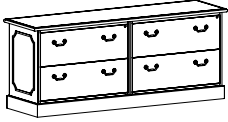

With Decorative Molding

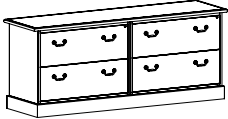

Without Decorative Molding

Description

- Standard With: Rectangle Top Profiled on All Sides, Base Molding on All Sides, Decorative Molding on Both Sides, Dual Locking Double Lateral/Lateral Peds with Legal or Letter Filing, Side-to-Side Grain Direction on Top, Dovetail Wood Drawer Construction, and Anti-Tilt System
- Chassis Available with Premium Veneer (PV) or Standard Veneer (W); Must Specify
- Top Available with Premium/Standard Veneer (PV/W) or HPL (P); Must Specify
- Lock Core Color will Coordinate with Pull Selection (Brass Pull with Black Lock, Silver Pull with Silver Lock)
- Additional Options: No Decorative Molding (Specify NO MOLDING)

Must Specify (in this order):

- Model #
- Premium or Standard Veneer
- Top Material
- Finish/Color
- Pull
- No Molding

STORAGE CREDENZA WITH BOX/BOX/FILE	46-2072SC1	72	20	30	296	29.0	W/P\$ 6915 PV\$ 7745
	<i>Legal Ped</i>						
	46-2066SC1	66	20	30	296	29.0	W/P\$ 6222 PV\$ 6968
	<i>Letter Ped</i>						

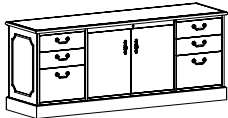

With Decorative Molding

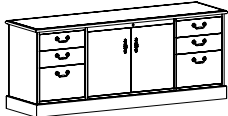

Without Decorative Molding

Description

- Standard With: Rectangle Top Profiled on All Sides, Central Locking, Base Molding on All Sides, Decorative Molding on Both Sides, Box/Box/File Peds with Legal or Letter Filing, One Fixed Shelf Behind Doors, Side-to-Side Grain Direction on Top, and Dovetail Wood Drawer Construction
- Chassis Available with Premium Veneer (PV) or Standard Veneer (W); Must Specify
- Top Available with Premium/Standard Veneer (PV/W) or HPL (P); Must Specify
- Lock Core Color will Coordinate with Pull Selection (Brass Pull with Black Lock, Silver Pull with Silver Lock)
- Additional Options: No Decorative Molding (Specify NO MOLDING); Soft Close Drawer Closure ([See Soft Close Drawer Option](#))

Must Specify (in this order):

- Model #
- Premium or Standard Veneer
- Top Material
- Finish/Color
- Pull
- No Molding
- Drawer Track

P = HPL W = Veneer PV = Premium Veneer

[See Jefferson Intro Section for Ordering Options](#)

Item	Model No.	Width	Depth	Height	Ship Wt	Cubic Ft	List Price
SURFACE MOUNTED HUTCH WITH WOOD DOORS	46-1572HU <i>Four (4) Doors</i>	72	15	39¾	200	30.2	W\$ 6824 PV\$ 7643
	46-1566HU <i>Four (4) Doors</i>	66	15	39¾	192	26.9	W\$ 6443 PV\$ 7216

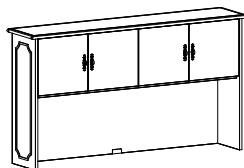

Must Specify (in this order):

Model #
Premium or Standard Veneer
Finish
Pull
No Molding
Tasklights
Upper Grommets
Grommet Color
Locking Door
Tackboard/Fabric

Description

- Standard With: Top Profiled on All Sides, Decorative Molding on Both Sides, Four (4) Soft-Close Doors, and Grommet in Back Panel
- Available in Premium Veneer (PV) or Standard Veneer (W); Must Specify
- Lower, Center Grommet in Back Panel; Must Specify: Black (BLK) or Silver (SLV)
- 20⅞" Clearance Below Doors
- Additional Options: No Decorative Molding (Specify NO MOLDING); Locking Doors ([See Locking Door Options](#)); Factory-Installed Tackboard ([See Sizes](#)); Tasklights ([See Sizes](#)); Upper Wire Management Grommets ([See Grommet Options](#))

WALL MOUNT HUTCH WITH WOOD DOORS	46-1584WD <i>Five (5) Doors</i>	84	15	18	138	15.2	W\$ 5380 PV\$ 6028
	46-1578WD <i>Four (4) Doors</i>	78	15	18	128	14.1	W\$ 4672 PV\$ 5233
	46-1572WD <i>Four (4) Doors</i>	72	15	18	118	13.1	W\$ 4600 PV\$ 5153
	46-1566WD <i>Four (4) Doors</i>	66	15	18	105	12.0	W\$ 4498 PV\$ 5038
	46-1560WD <i>Four (4) Doors</i>	60	15	18	96	11.0	W\$ 4304 PV\$ 4820
	46-1554WD <i>Three (3) Doors</i>	54	15	18	87	9.9	W\$ 4029 PV\$ 4513
	46-1548WD <i>Three (3) Doors</i>	48	15	18	77	8.9	W\$ 3751 PV\$ 4200
	46-1542WD <i>Two (2) Doors</i>	42	15	18	67	7.8	W\$ 3454 PV\$ 3870
	46-1536WD <i>Two (2) Doors</i>	36	15	18	55	5.9	W\$ 3081 PV\$ 3452

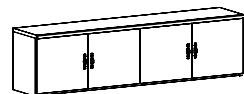

Must Specify (in this order):

Model #
Premium or Standard Veneer
Finish
Pull
Locking Door

Description

- Standard With: Top Profiled on Front Only for Multiple Unit Application, No Molding, Onset Doors with Soft-Close Hinges, and Wall Mounting Brackets
- Available in Premium Veneer (PV) or Standard Veneer (W); Must Specify
- Additional Options: Locking Doors ([See Locking Door Options](#)); Tackboards ([See Sizes](#)); Tasklights ([See Sizes](#))
- Indiana Furniture will not be held liable for wall mount hutches that are not properly installed

W = Veneer PV = Premium Veneer

[See Jefferson Intro Section for Ordering Options](#)

Item	Model No.	Width	Depth	Height	Ship Wt	Cubic Ft	List Price
TALL SURFACE MOUNTED HUTCH WITH FOUR WOOD DOORS	46-1572THU <i>4 Doors</i>	72	15	51	231	38.7	W\$ 8699 PV\$ 9743
	46-1566THU <i>4 Doors</i>	66	15	51	226	36.0	W\$ 8218 PV\$ 9204

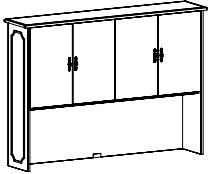

Must Specify (in this order):

Model #
Premium or Standard Veneer
Finish
Pull
No Molding
Tasklights
Upper Grommets
Grommet Color
Locking Door
Tackboard/Fabric

Description

- Standard With: Top Profiled on All Sides, Decorative Molding on Both Sides, Four (4) Soft-Close Doors, One (1) Adjustable Shelf Behind Doors, and Grommet in Back Panel
- Available in Premium Veneer (PV) or Standard Veneer (W); Must Specify
- Lower, Center Grommet in Back Panel; Must Specify: Black (BLK) or Silver (SLV)
- 21½" Clearance Below Doors
- Additional Options: No Decorative Molding (Specify NO MOLDING); Locking Doors ([See Locking Door Options](#)); Factory-Installed Tackboard ([See Sizes](#)); Tasklights ([See Sizes](#)); Upper Wire Management Grommets ([See Grommet Options](#))

VERTICAL HUTCH WITH OPEN STORAGE	46-1572VH4O	72	15	51	231	38.7	W\$ 4621 PV\$ 5175
	46-1566VH4O	66	15	51	185	36.0	W\$ 4394 PV\$ 4920

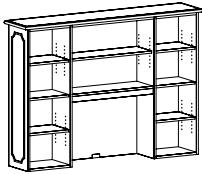

Must Specify (in this order):

Model #
Premium or Standard Veneer
Finish
No Molding
Tasklights
Upper Grommets
Grommet Color
Tackboard/Fabric

Description

- Standard With: Top Profiled on All Sides, Decorative Molding on Both Sides, One (1) Adjustable Shelf and One (1) Fixed Shelf In Center Cabinet, Two (2) Adjustable Shelves and One (1) Fixed Middle Shelf in Each End Cabinet, and Grommet in Back Panel
- Available in Premium Veneer (PV) or Standard Veneer (W); Must Specify
- Lower, Center Grommet in Back Panel; Must Specify: Black (BLK) or Silver (SLV)
- 24½" Clearance Below Center Shelves
- Additional Options: No Decorative Molding (Specify NO MOLDING); Factory-Installed Tackboard ([See Sizes](#)); Tasklights ([See Sizes](#)); Upper Wire Management Grommets ([See Grommet Options](#))

W = Veneer PV = Premium Veneer

[See Jefferson Intro Section for Ordering Options](#)

Item	Model No.	Width	Depth	Height	Ship Wt	Cubic Ft	List Price
VERTICAL HUTCH WITH FOUR DOORS AND WOOD DOOR INSERTS	46-1572VH4W <i>4 Doors</i>	72	15	51	231	38.7	W\$ 6674 PV\$ 7474
	46-1566VH4W <i>4 Doors</i>	66	15	51	226	36.0	W\$ 6445 PV\$ 7217

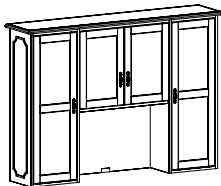

Must Specify (in this order):
 Model #
 Premium or Standard Veneer Finish
 Pull
 No Molding
 Locking Doors
 Tasklights
 Upper Grommets
 Grommet Color
 Tackboard/Fabric

Description

- Standard With: Top Profiled on All Sides, Decorative Molding on Both Sides, Four (4) Wood-Framed Soft-Close Doors with Wood Inserts, One (1) Adjustable Shelf and One (1) Fixed Shelf Behind Center Doors, Two (2) Adjustable Shelves and One (1) Fixed Middle Shelf Behind Each End Door, and Grommet in Back Panel
- Available in Premium Veneer (PV) or Standard Veneer (W); Must Specify
- Lower, Center Grommet in Back Panel; Must Specify: Black (BLK) or Silver (SLV)
- 24 1/8" Clearance Below Center Doors
- Additional Options: No Decorative Molding (Specify NO MOLDING); Locking Doors ([See Locking Door Options](#)); Factory-Installed Tackboard ([See Sizes](#)); Tasklights ([See Sizes](#)); Upper Wire Management Grommets ([See Grommet Options](#))

VERTICAL HUTCH WITH FOUR DOORS AND GLASS DOOR INSERTS	46-1572VH4G <i>4 Doors</i>	72	15	51	244	38.7	W\$ 7382 PV\$ 8267
	46-1566VH4G <i>4 Doors</i>	66	15	51	231	36.0	W\$ 7145 PV\$ 8004

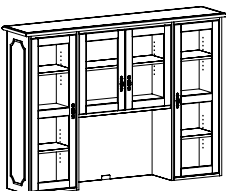

Must Specify (in this order):
 Model #
 Premium or Standard Veneer Finish
 Pull
 Beveled Glass Design
 No Molding
 Locking Doors
 Glass Shelves
 Down Lighting
 Tasklights
 Upper Grommets
 Grommet Color
 Tackboard/Fabric

Description

- Standard With: Top Profiled on All Sides, Decorative Molding on Both Sides, Four (4) Wood-Framed Soft-Close Doors with Glass Inserts, One (1) Adjustable Shelf and One (1) Fixed Shelf Behind Center Doors, Two (2) Adjustable Shelves and One (1) Fixed Middle Shelf Behind Each End Door, and Grommet in Back Panel
- Available in Premium Veneer (PV) or Standard Veneer (W); Must Specify
- Beveled Glass Inserts Available in Clear and Cracked Ice; Must Specify (See Below)
- Lower, Center Grommet in Back Panel; Must Specify: Black (BLK) or Silver (SLV)
- 24 1/8" Clearance Below Center Doors
- Additional Options: No Decorative Molding (Specify NO MOLDING); Locking Doors ([See Locking Door Options](#)); Factory-Installed Tackboard ([See Sizes](#)); Tasklights ([See Sizes](#)); Upper Wire Management Grommets ([See Grommet Options](#))

Beveled Glass Options: Specify & Add

1-CL	Beveled Clear Glass Insert	N/C
1-CR	Beveled Cracked Ice Glass Insert	\$ 1565

W = Veneer PV = Premium Veneer

[See Jefferson Intro Section for Ordering Options](#)

Item	Model No.	Width	Depth	Height	Ship Wt	Cubic Ft	List Price
VERTICAL HUTCH WITH FOUR DOORS AND MESH DOOR INSERTS	46-1572VH4M <i>4 Doors</i>	72	15	51	231	38.7	W\$ 8281 PV\$ 9274
	46-1566VH4M <i>4 Doors</i>	66	15	51	226	36.0	W\$ 8050 PV\$ 9014

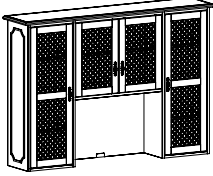

Must Specify (in this order):

- Model #
- Premium or Standard Veneer Finish
- Pull/Mesh Grille Color
- No Molding
- Locking Doors
- Glass Shelves
- Down Lighting
- Tasklights
- Upper Grommets
- Grommet Color
- Tackboard/Fabric

Description

- Standard With: Top Profiled on All Sides, Decorative Molding on Both Sides, Four (4) Wood-Framed Soft-Close Doors with Mesh Inserts, One (1) Adjustable Shelf and One (1) Fixed Shelf Behind Center Doors, Two (2) Adjustable Shelves and One (1) Fixed Middle Shelf Behind Each End Door, and Grommet in Back Panel
- Available in Premium Veneer (PV) or Standard Veneer (W); Must Specify
- Mesh Grille Inserts Available in Antique Brass and Silver; Must Specify (See Below)
- Lower, Center Grommet in Back Panel; Must Specify: Black (BLK) or Silver (SLV)
- 24 $\frac{3}{8}$ " Clearance Below Center Doors
- Additional Options: No Decorative Molding (Specify NO MOLDING); Glass Shelves ([See Glass Shelf Options](#)); Down Lighting ([See Down Lighting Options](#)); Locking Doors ([See Locking Door Options](#)); Factory-Installed Tackboard ([See Sizes](#)); Tasklights ([See Sizes](#)); Upper Wire Management Grommets ([See Grommet Options](#))

Mesh Grille Options: Specify & Add

1-BM	Antique Brass Mesh Grille Insert <i>Only available when a Brass Pull is specified</i>	N/C
1-AM	Silver Mesh Grille Insert <i>Only available when Liberty Pull (ALB) is specified</i>	\$ 1173

VERTICAL OPEN HUTCH WITH TWO DOORS AND WOOD DOOR INSERTS	46-1572VHW <i>2 Doors</i>	72	15	51	231	38.7	W\$ 5314 PV\$ 5953
	46-1566VHW <i>2 Doors</i>	66	15	51	226	36.0	W\$ 5086 PV\$ 5696

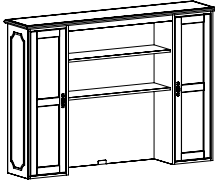

Must Specify (in this order):

- Model #
- Premium or Standard Veneer Finish
- Pull
- No Molding
- Locking Doors
- Grommet Color

Description

- Standard With: Top Profiled on All Sides, Decorative Molding on Both Sides, Two (2) Wood-Framed Soft-Close Doors with Wood Inserts, One (1) Adjustable Shelf and One (1) Fixed Shelf in Center Cabinet, Two (2) Adjustable Shelves and One (1) Fixed Middle Shelf Behind Each End Door, and Grommet in Back Panel
- Available in Premium Veneer (PV) or Standard Veneer (W); Must Specify
- Lower, Center Grommet in Back Panel; Must Specify: Black (BLK) or Silver (SLV)
- 24 $\frac{3}{8}$ " Clearance Below Center
- Additional Options: No Decorative Molding (Specify NO MOLDING); Locking Doors ([See Locking Door Options](#))

W = Veneer PV = Premium Veneer

[See Jefferson Intro Section for Ordering Options](#)

Item	Model No.	Width	Depth	Height	Ship Wt	Cubic Ft	List Price
VERTICAL OPEN HUTCH WITH TWO DOORS AND GLASS DOOR INSERTS	46-1572VHG <i>2 Doors</i>	72	15	51	244	38.7	W\$ 5551 PV\$ 6217
	46-1566VHG <i>2 Doors</i>	66	15	51	231	36.0	W\$ 5314 PV\$ 5953

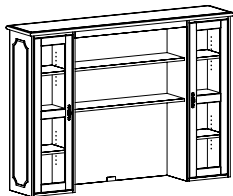

Must Specify (in this order):

Model #
Premium or Standard Veneer
Finish
Pull
Beveled Glass Design
No Molding
Glass Shelves
Down Lighting
Grommet Color

Description

- Standard With: Top Profiled on All Sides, Decorative Molding on Both Sides, Two (2) Wood-Framed Soft-Close Doors with Glass Inserts, One (1) Adjustable Shelf and One (1) Fixed Shelf in Center Cabinet, Two (2) Adjustable Shelves and One (1) Fixed Middle Shelf Behind Each End Door, and Grommet in Back Panel
- Available in Premium Veneer (PV) or Standard Veneer (W); Must Specify
- Beveled Glass Inserts Available in Clear and Cracked Ice; Must Specify (See Below)
- Lower, Center Grommet in Back Panel; Must Specify: Black (BLK) or Silver (SLV)
- 24 $\frac{3}{8}$ " Clearance Below Center
- Additional Options: No Decorative Molding (Specify NO MOLDING); Glass Shelves ([See Glass Shelf Options](#)); Down Lighting ([See Down Lighting Options](#))

Beveled Glass Options: Specify & Add

1-CL	Clear Glass Inserts	N/C
1-CR	Cracked Ice Glass Inserts	\$ 1040

VERTICAL OPEN HUTCH WITH TWO DOORS AND MESH DOOR INSERTS	46-1572VHM <i>2 Doors</i>	72	15	51	231	38.7	W\$ 5782 PV\$ 6477
	46-1566VHM <i>2 Doors</i>	66	15	51	226	36.0	W\$ 5551 PV\$ 6217

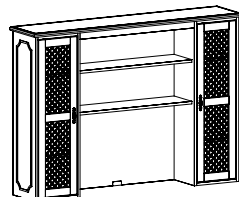

Must Specify (in this order):

Model #
Premium or Standard Veneer
Finish
Pull/Mesh Grille Color
No Molding
Glass Shelves
Down Lighting
Grommet Color

Description

- Standard With: Top Profiled on All Sides, Decorative Molding on Both Sides, Two (2) Wood-Framed Soft-Close Doors with Mesh Inserts, One (1) Adjustable Shelf and One (1) Fixed Shelf in Center Cabinet, Two (2) Adjustable Shelves and One (1) Fixed Middle Shelf Behind Each End Door, and Grommet in Back Panel
- Available in Premium Veneer (PV) or Standard Veneer (W); Must Specify
- Mesh Grille Inserts Available in Antique Brass and Silver; Must Specify (See Below)
- Lower, Center Grommet in Back Panel; Must Specify: Black (BLK) or Silver (SLV)
- 24 $\frac{3}{8}$ " Clearance Below Center
- Additional Options: No Decorative Molding (Specify NO MOLDING); Glass Shelves ([See Glass Shelf Options](#)); Down Lighting ([See Down Lighting Options](#))

Mesh Grille Options: Specify & Add

1-BM	Antique Brass Mesh Grille Insert <i>Only available when a Brass Pull is specified</i>	N/C
1-AM	Silver Mesh Grille Insert <i>Only available when Liberty Pull (ALB) is specified</i>	\$ 782

W = Veneer PV = Premium Veneer

[See Jefferson Intro Section for Ordering Options](#)

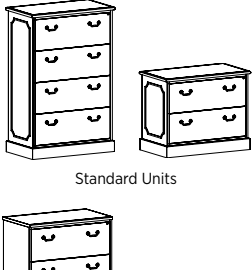
Item	Model No.	Width	Depth	Height	Ship Wt	Cubic Ft	List Price	
LATERAL FILES								
STANDARD: PROFILED ALL SIDES + DECORATIVE MOLDING								
	46-2036L4 <i>4 Drawers</i>	36	20	55½ ₂	290	27.5	W/P\$ 6407 PV\$ 7176	
	46-2036L2 <i>2 Drawers</i>	36	20	30	152	14.9	W/P\$ 3915 PV\$ 4386	
	FLUSH ENDS: PROFILED FRONT SIDE + NO DECORATIVE MOLDING							
	46-2034L4FE <i>4 Drawers</i>	34¼	20	55½ ₂	290	27.5	W/P\$ 6152 PV\$ 6891	
	46-2034L2FE <i>2 Drawers</i>	34¼	20	30	152	14.9	W/P\$ 3762 PV\$ 4212	

Description

- Standard With: Central Locking Drawers with Legal or Letter Filing Side-to-Side or Front-to-Back, Dovetail Wood Drawer Construction, and Anti-Tilt System
- For Standard Units, Top Profiled on All Sides, Base Molding on All Sides, Decorative Molding on Both Sides
- For Flush Units, Top Profiled on Front Side, Base Molding on Front Side, No Decorative Molding
- Chassis Available with Premium Veneer (PV) or Standard Veneer (W); Must Specify
- Top Available with Premium/Standard Veneer (PV/W) or HPL (P); Must Specify
- Additional Options: No Decorative Molding (Specify NO MOLDING) on Standard Units

Must Specify (in this order):

- Model #
- Premium or Standard Veneer
- Top Material
- Finish/Color
- Pull
- No Molding (if applicable)

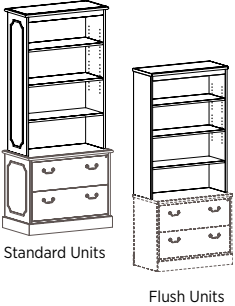
SURFACE MOUNT BOOKCASES								
STANDARD: PROFILED ALL SIDES + DECORATIVE MOLDING								
	46-1534TU <i>For Use with 46-2036L2</i>	36	15	51	125	19.0	W\$ 2921 PV\$ 3271	
	FLUSH ENDS: PROFILED FRONT SIDE + NO DECORATIVE MOLDING							
	46-1534TUFE <i>For Use with 46-2034L2FE</i>	34¼	15	51	125	19.0	W\$ 2847 PV\$ 3188	

Description

- Standard With: One (1) Fixed Bottom Shelf with 12" Clearance and Two (2) Adjustable Shelves
- For Standard Units, Top Profiled on All Sides and Decorative Molding on Both Sides
- For Flush Units, Top Profiled on Front Side and No Decorative Molding
- Available in Premium Veneer (PV) or Standard Veneer (W); Must Specify
- Additional Options: No Decorative Molding (Specify NO MOLDING) on Standard Units

Must Specify (in this order):

- Model #
- Premium or Standard Veneer
- Finish/Color
- No Molding (if applicable)

P = HPL W = Veneer PV = Premium Veneer

[See Jefferson Intro Section for Ordering Options](#)

Item	Model No.	Width	Depth	Height	Ship Wt	Cubic Ft	List Price
SURFACE MOUNT BOOKCASES WITH DOORS AND WOOD INSERTS	STANDARD: PROFILED ALL SIDES + DECORATIVE MOLDING						
	46-1534TUW	36	15	51	125	19.0	W\$ 4334 PV\$ 4854
	<i>For Use with 46-2036L2</i>						
	FLUSH ENDS: PROFILED FRONT SIDE + NO DECORATIVE MOLDING						
	46-1534TUWFE	34¼	15	51	125	19.0	W\$ 4258 PV\$ 4769
<i>For Use with 46-2034L2FE</i>							

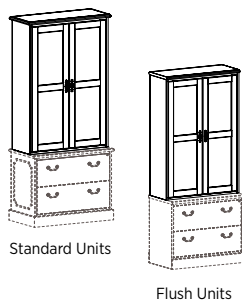

Description

- Standard With: Two (2) Wood-Framed Soft-Close Doors with Wood Inserts, One (1) Fixed Bottom Shelf with 12" Clearance, and Two (2) Adjustable Shelves
- For Standard Units, Top Profiled on All Sides and Decorative Molding on Both Sides
- For Flush Units, Top Profiled on Front Side and No Decorative Molding
- Available in Premium Veneer (PV) or Standard Veneer (W); Must Specify
- Additional Options: No Decorative Molding (Specify NO MOLDING) on Standard Units

Must Specify (in this order):

- Model #
- Premium or Standard Veneer Finish
- No Molding (if applicable)

SURFACE MOUNT BOOKCASES WITH DOORS AND GLASS INSERTS	STANDARD: PROFILED ALL SIDES + DECORATIVE MOLDING						
	46-1534TUG	36	15	51	125	19.0	W\$ 4563 PV\$ 5112
	<i>For Use with 46-2036L2</i>						
	FLUSH ENDS: PROFILED FRONT SIDE + NO DECORATIVE MOLDING						
	46-1534TUGFE	34¼	15	51	125	19.0	W\$ 4525 PV\$ 5068
<i>For Use with 46-2034L2FE</i>							

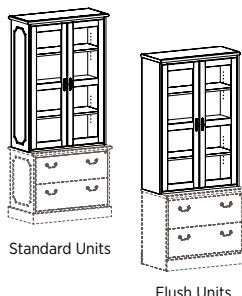

Description

- Standard With: Two (2) Wood-Framed Soft-Close Doors with Glass Inserts, One (1) Fixed Bottom Shelf with 12" Clearance, and Two (2) Adjustable Shelves
- For Standard Units, Top Profiled on All Sides and Decorative Molding on Both Sides
- For Flush Units, Top Profiled on Front Side and No Decorative Molding
- Available in Premium Veneer (PV) or Standard Veneer (W); Must Specify
- Beveled Glass Inserts Available in Clear and Cracked Ice; Must Specify (See Below)
- Additional Options: No Decorative Molding (Specify NO MOLDING) on Standard Units; Glass Shelves ([See Glass Shelf Options](#)); Down Lighting ([See Down Lighting Options](#))

Must Specify (in this order):

- Model #
- Premium or Standard Veneer Finish
- Pull
- Beveled Glass Design
- No Molding (if applicable)
- Glass Shelves
- Down Lighting

Beveled Glass Options: Specify & Add

1-CL	Clear Glass Inserts	N/C
1-CR	Cracked Ice Glass Inserts	\$ 1040

W = Veneer PV = Premium Veneer

[See Jefferson Intro Section for Ordering Options](#)

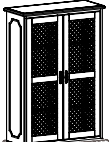
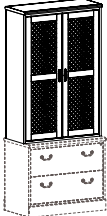
Item	Model No.	Width	Depth	Height	Ship Wt	Cubic Ft	List Price
SURFACE MOUNT BOOKCASES WITH DOORS AND MESH INSERTS							
STANDARD: PROFILED ALL SIDES + DECORATIVE MOLDING							
	46-1534TUM	36	15	51	125	19.0	W\$ 4791 PV\$ 5366
	<i>For Use with 46-2036L2</i>						
	FLUSH ENDS: PROFILED FRONT SIDE + NO DECORATIVE MOLDING						
	46-1534TUMFE	34¼	15	51	125	19.0	W\$ 4718 PV\$ 5283
<i>For Use with 46-2034L2FE</i>							

Standard Units

Flush Units

Must Specify (in this order):
 Model #
 Premium or Standard Veneer
 Finish
 Pull/Mesh Grille Color
 No Molding (if applicable)
 Glass Shelves
 Down Lighting

Description

- Standard With: Two (2) Wood-Framed Soft-Close Doors with Mesh Inserts, One (1) Fixed Bottom Shelf with 12" Clearance, and Two (2) Adjustable Shelves
- For Standard Units, Top Profiled on All Sides and Decorative Molding on Both Sides
- For Flush Units, Top Profiled on Front Side and No Decorative Molding
- Available in Premium Veneer (PV) or Standard Veneer (W); Must Specify
- Mesh Grille Inserts Available in Antique Brass and Silver; Must Specify (See Below)
- Additional Options: No Decorative Molding (Specify NO MOLDING) on Standard Units; Glass Shelves ([See Glass Shelf Options](#)); Down Lighting ([See Down Lighting Options](#))

Mesh Grille Options: Specify & Add

1-BM	Antique Brass Mesh Grille Insert <i>Only available when a Brass Pull is specified</i>	N/C
1-AM	Silver Mesh Grille Insert <i>Only available when Liberty Pull (ALB) is specified</i>	\$ 782

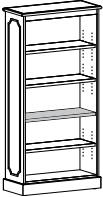
	BOOKCASE	46-3470BC	34	15	69½	152	26.1	W\$ 3954 PV\$ 4429
	<i>Three Adjustable Shelves</i>							
		46-3456BC	34	15	55½	140	20.1	W/P\$ 3374 PV\$ 3779
<i>Two Adjustable Shelves</i>								

Description

- Standard With: Top Profiled on All Sides, Decorative Molding on Both Sides, Two (2) or Three (3) 1" Thick Adjustable Shelves (Depending Upon Model, See Above), and One (1) 1" Thick Fixed Shelf (Shaded in Art)
- Available with Premium Veneer (PV) or Standard Veneer (W); 56"H Bookcases Also Available with HPL (P) Tops; Must Specify
- Additional Options: No Decorative Molding (Specify NO MOLDING)

Must Specify (in this order):
 Model #
 Premium or Standard Veneer
 Top Material (for 56"H Only)
 Finish/Color
 No Molding

P = HPL W = Veneer PV = Premium Veneer

[See Jefferson Intro Section for Ordering Options](#)

Item	Model No.	Width	Depth	Height	Ship Wt	Cubic Ft	List Price
BOOKCASE WITH DOORS AND WOOD INSERTS	46-3656BCW	36	15	55¼	140	20.1	W/P\$ 5217 PV\$ 5843

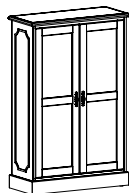

Must Specify (in this order):

Model #
Premium or Standard Veneer
Top Material
Finish/Color
Pull
No Molding
Locking Door

Description

- Standard With: Top Profiled on All Sides, Base Molding on All Sides, Decorative Molding on Both Sides, Two (2) Wood-Framed Soft-Close Doors with Wood Inserts, One (1) 1" Thick Fixed Middle Shelf, and Two (2) 1" Thick Adjustable Shelves
- Chassis Available with Premium Veneer (PV) or Standard Veneer (W); Must Specify
- Top Available with Premium/Standard Veneer (PV/W) or HPL (P); Must Specify
- Additional Options: No Decorative Molding (Specify NO MOLDING); Locking Doors ([See Locking Door Options](#))

BOOKCASE WITH DOORS AND GLASS INSERTS	46-3656BCG	36	15	55¼	140	20.1	W/P\$ 5305 PV\$ 5942
---------------------------------------	------------	----	----	-----	-----	------	-------------------------

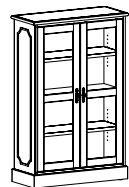

Must Specify (in this order):

Model #
Premium or Standard Veneer
Top Material
Finish/Color
Pull
Beveled Glass Design
No Molding
Locking Door

Description

- Standard With: Top Profiled on All Sides, Base Molding on All Sides, Decorative Molding on Both Sides, Two (2) Wood-Framed Soft-Close Doors with Glass Inserts, One (1) 1" Thick Fixed Middle Shelf, and Two (2) 1" Thick Adjustable Shelves
- Chassis Available with Premium Veneer (PV) or Standard Veneer (W); Must Specify
- Top Available with Premium/Standard Veneer (PV/W) or HPL (P); Must Specify
- Beveled Glass Inserts Available in Clear and Cracked Ice; Must Specify (See Below)
- Additional Options: No Decorative Molding (Specify NO MOLDING); Locking Doors ([See Locking Door Options](#))

Beveled Glass Options: Specify & Add

1-CL	Clear Glass Inserts	N/C
1-CR	Cracked Ice Glass Inserts	\$ 1040

BOOKCASE WITH DOORS AND MESH INSERTS	46-3656BCM	36	15	55¼	140	20.1	W/P\$ 5534 PV\$ 6197
--------------------------------------	------------	----	----	-----	-----	------	-------------------------

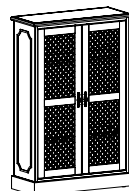

Must Specify (in this order):

Model #
Premium or Standard Veneer
Top Material
Finish
Pull/Mesh Grille Color
No Molding
Locking Door

Description

- Standard With: Top Profiled on All Sides, Base Molding on All Sides, Decorative Molding on Both Sides, Two (2) Wood-Framed Soft-Close Doors with Mesh Grille Inserts, One (1) 1" Thick Fixed Middle Shelf, and Two (2) 1" Thick Adjustable Shelves
- Chassis Available with Premium Veneer (PV) or Standard Veneer (W); Must Specify
- Top Available with Premium/Standard Veneer (PV/W) or HPL (P); Must Specify
- Mesh Grille Inserts Available in Antique Brass and Silver; Must Specify (See Below)
- Additional Options: No Decorative Molding (Specify NO MOLDING); Locking Doors ([See Locking Door Options](#))

Mesh Grille Options: Specify & Add

1-BM	Antique Brass Mesh Grille Insert <i>Only available when a Brass Pull is specified</i>	N/C
1-AM	Silver Mesh Grille Insert <i>Only available when Liberty Pull (ALB) is specified</i>	\$ 782

P = HPL W = Veneer PV = Premium Veneer

[See Jefferson Intro Section for Ordering Options](#)

Item	Model No.	Width	Depth	Height	Ship Wt	Cubic Ft	List Price
SINGLE WARDROBE/ STORAGE CABINET	Left Hinged						
	Right Hinged						
	46-1870WL	18	20	69½"	155	17.2	W\$ 5390 PV\$ 6036

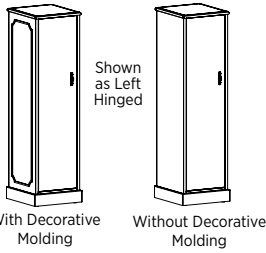

Description

- Standard With: Top Profiled on All Sides, Base Molding on All Sides, Decorative Molding on Both Sides, Fixed Top Shelf Behind Door, Coat Rod Under Fixed Shelf, Three (3) Adjustable Shelves Behind Door
- Available in Premium Veneer (PV) or Standard Veneer (W); Must Specify
- Adjustable Shelves Can Be Easily Removed for Wardrobe Application
- Additional Options: No Decorative Molding (Specify NO MOLDING); Locking Doors ([See Locking Door Options](#))

Must Specify (in this order):

- Model #
- Premium or Standard Veneer
- Finish
- Pull
- No Molding
- Locking Door

DOUBLE WARDROBE/ STORAGE CABINET	46-3670WD	36	20	69½"	310	34.2	W\$ 9514 PV\$ 10655
	46-3270WD	32	24	69½"	310	34.2	W\$ 9769 PV\$ 10943

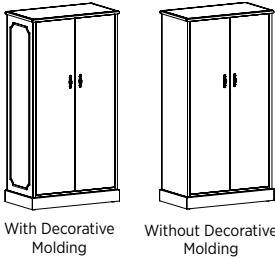

Description

- Standard With: Non-Locking, Top Profiled on All Sides, Base Molding on All Sides, Decorative Molding on Both Sides, Fixed Top Shelf Behind Each Door, Coat Rod Under Each Fixed Shelf, Three (3) Adjustable Shelves Behind Each Door
- Available in Premium Veneer (PV) or Standard Veneer (W); Must Specify
- Adjustable Shelves Can Be Easily Removed for Wardrobe Application
- Additional Options: No Decorative Molding (Specify NO MOLDING); Locking Doors ([See Locking Door Options](#))

Must Specify (in this order):

- Model #
- Premium or Standard Veneer
- Finish
- Pull
- No Molding
- Locking Door

COMPUTER WORK TABLE	46-2436CW <i>Kneespace 32½"</i>	36	24	26½"	115	17.6	W/P\$ 2767 PV\$ 3097
----------------------------	------------------------------------	----	----	------	-----	------	-------------------------

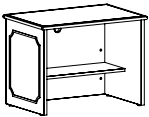

Description

- Standard With: Rectangle Top Profiled on All Sides, Decorative Molding on Both Sides, Grommet in Back Panel, Front-to-Back Grain Direction on Top, and Fixed Shelf with 15 7/8" Clearance
- Chassis Available with Premium Veneer (PV) or Standard Veneer (W); Must Specify
- Top Available with Premium/Standard Veneer (PV/W) or HPL (P); Must Specify
- Grommet in Back Panel; Must Specify: Black (BLK), Silver (SLV), or None (NONE)
- Additional Options: Kneespace Options (Order Separately, [See Multiple Units](#)); Casters (See Below); Top Grommet Options ([See Grommet Options](#)); Wire Management + Accessories (Order Separately; [See Multiple Unit Details](#))

Options: Specify & Add

CAST	Optional Black Caster (Increases Height to 30")	\$ 239
------	---	--------



Braking Casters on User Side/Non-Braking Casters on Approach

Must Specify (in this order):

- Model #
- Premium or Standard Veneer
- Top Material
- Finish/Color
- No Molding
- Top Grommet Location
- Back Panel Grommet
- Grommet Color
- Kneespace Options
- Casters

P = HPL W = Veneer PV = Premium Veneer

[See Jefferson Intro Section for Ordering Options](#)

Item	Model No.	Width	Depth	Height	Ship Wt	Cubic Ft	List Price
	ROUND TOP & BASES 46-4848CT <i>Accommodates Five (5) Chairs</i>	48	48	13 1/16	58	5.9	W/P\$ 4287 PV\$ 4801
	46-4242CT <i>Accommodates Four (4) Chairs</i>	42	42	13 1/16	51	4.5	W/P\$ 3730 PV\$ 4178
	46-3636CT <i>Accommodates Three (3) Chairs</i>	36	36	13 1/16	43	3.3	W/P\$ 3361 PV\$ 3763

Top Must Specify (in this order):

- Model #
- Top Material
- Finish/Color

Base Must Specify (in this order):

- Model #
- Premium or Standard Veneer (if applicable)
- Finish

Description

- Top Available with Premium/Standard Veneer (PV/W) or HPL (P); Must Specify
- See Below for Base Options, Order Separately; One (1) Required
- Power Options not Available

Base Options: Must Order & Add



Queen Anne Base

01-0606QB	Must Specify Finish	24	24	28 3/4	136	11.1	\$ 1406
-----------	---------------------	----	----	--------	-----	------	---------

Description

- Classic Design Detail on Column
- Queen Anne Base Features Multi-Step, Hand-Finished Catalyzed Finish
- Four Legs with Adjustable Glides

Cylinder Bases



01-2020CB	For Use with 48" and 42" Tops	20	20	28 1/4	136	11.1	W\$ 1553 PV\$ 1813
01-1616CB	For Use with 36" Tops	16	16	28 1/4	101	7.2	W\$ 1419 PV\$ 1660

Description

- Premium Veneer (PV) or Standard Veneer (W) Cylinder Base; Weighted for Stability
- Base Features Multi-Step, Hand-Finished Catalyzed Finish
- Two (2) Black Wire Management Grommets at Top and One (1) 8" Wire Management Opening in Bottom

Options: Specify & Add

GCB1S	Single Grommet at Top Edge (Factory Installed)	N/C
NOGC	No Grommet at Top Edge	N/C

Height Adjustable Pneumatic X-Bases



Maximum Round 42", Maximum Square 36"							
01-3232HAXBB	Black	32	32	26	1	0.2	\$ 1721
01-3232HAXBA	Aluminum						
Maximum Round 36", Maximum Square 30"							
01-2626HAXBB	Black	22	22	26	1	0.2	\$ 1687
01-2626HAXBA	Aluminum						

Description

- Pre-Drilled Boring Pattern May Not Match Underside of Table Top
- Steel Mounting Plate: 8"x 8"x 1/4"
- Eight (8) Bolts Included for Assembly
- Some Assembly Required

P = HPL W = Veneer PV = Premium Veneer

[See Jefferson Intro Section for Ordering Options](#)

Item	Model No.	Width	Depth	Height	Ship Wt	Cubic Ft	List Price
END TABLE	46-1824ET	24	18	21 ¹³ / ₁₆	25	2.0	W/P\$ 1357 PV\$ 1521

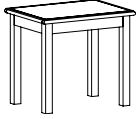

Must Specify (in this order):

Model #
Top Material
Finish/Color

Description

- Available with Premium/Standard Veneer (PV/W) or HPL (P) Top; Must Specify
- Hardwood Legs
- Apron Rails and Panel Legs Feature Multi-Step, Hand-Finished Catalyzed Finish
- Some Assembly Required

LAMP TABLE	46-2424LT	24	24	21 ¹³ / ₁₆	37	3.3	W/P\$ 1728 PV\$ 1935
------------	-----------	----	----	----------------------------------	----	-----	-------------------------

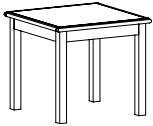

Must Specify (in this order):

Model #
Top Material
Finish/Color

Description

- Available with Premium/Standard Veneer (PV/W) or HPL (P) Top; Must Specify
- Hardwood Legs
- Apron Rails and Panel Legs Feature Multi-Step, Hand-Finished Catalyzed Finish
- Some Assembly Required

MAGAZINE TABLE	46-1847MT	47	18	16	42	3.4	W/P\$ 1632 PV\$ 1828
----------------	-----------	----	----	----	----	-----	-------------------------

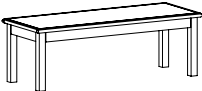

Must Specify (in this order):

Model #
Top Material
Finish/Color
Optional 30"H Leg

Description

- Available with Premium/Standard Veneer (PV/W) or HPL (P) Top; Must Specify
- Hardwood Legs
- Apron Rails and Panel Legs Feature Multi-Step, Hand-Finished Catalyzed Finish
- Optional 30"H Legs, See Below
- Some Assembly Required

Options: Specify & Add

SH-46	Optional 30"H Legs	\$ 223
-------	--------------------	--------

P = HPL W = Veneer PV = Premium Veneer

[See Jefferson Intro Section for Ordering Options](#)

Item	Model No.	Width	Depth	Height	Ship Wt	Cubic Ft	List Price
MODULAR CABINET/ CREDENZA TOPS  Must Specify (in this order): Model # Top Material Finish/Color	FOR 29"W MODULAR UNITS						
	46-2089TP <i>Top for Three 29"W Modular Units</i>	88½	20	1¾	43	5.8	W/P\$ 1740 PV\$ 1948
	46-2060TP <i>Top for Two 29"W Modular Units</i>	59½	20	1¾	30	4.0	W/P\$ 1145 PV\$ 1281
	46-2031TP <i>Top for One 29" Modular Units</i>	30½	20	1¾	18	2.1	W/P\$ 650 PV\$ 726
	FOR 18"W MODULAR UNITS						
	46-2038TP <i>Top for Two 18"W Modular Units</i>	39¾	20	1¾	21	1.7	W/P\$ 769 PV\$ 862
	46-2020TP <i>Top for One 18" W Modular Units</i>	19½	20	1¾	13	1.1	W/P\$ 462 PV\$ 516
	FOR COMBO OF 18"W and 29"W MODULAR UNITS						
	46-2067TP <i>Top for Two 18" and One 29" Unit</i>	68¾	20	1¾	37	4.7	W/P\$ 1290 PV\$ 1444
	46-2049TP <i>Top for One 18" and One 29" Unit</i>	48½	20	1¾	24	2.3	W/P\$ 957 PV\$ 1071

Description

- Standard With: Rectangle Top Profiled on All Sides
- Available with Premium/Standard Veneer (PV/W) or HPL (P) Top; Must Specify
- **For Use with 18"W and 29"W Modular Storage Units (See Multiple Units)**
- Not For Use on Freestanding Bookcases

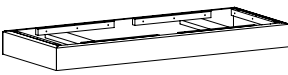
Item	Model No.	Width	Depth	Height	Ship Wt	Cubic Ft	List Price
MODULAR CABINET/ CREDENZA BASES  Must Specify (in this order): Model # Finish	FOR 29"W MODULAR UNITS						
	46-2089BS <i>Base for Three 29" Units</i>	88½	19½	4¼	53	5.8	W\$ 1172
	46-2060BS <i>Base for Two 29" Units</i>	59½	19½	4¼	38	4.0	W\$ 795
	46-2031BS <i>Base for One 29" Units</i>	30½	19½	4¼	18	2.1	W\$ 513
	FOR 18"W MODULAR UNITS						
	46-2038BS <i>Base for Two 18" Units</i>	38¾	19½	4¼	25	2.7	W\$ 581
	46-2020BS <i>Base for One 18" Units</i>	19½	19½	4¼	16	1.5	W\$ 406
	FOR COMBO OF 18"W and 29"W MODULAR UNITS						
	46-2067BS <i>Base for Two 18" and One 29" Units</i>	66½	19½	4¼	45	4.7	W\$ 885
	46-2049BS <i>Base for One 18" and One 29" Units</i>	48½	19½	4¼	33	3.0	W\$ 687

Description

- **For Use with 18"W and 29"W Modular Storage Units (See Multiple Units)**
- Bases Feature Multi-Step, Hand-Finished Catalyzed Finish
- Not For Use with Freestanding Bookcases

P = HPL W = Veneer PV = Premium Veneer

See Jefferson Intro Section for Ordering Options

Item	Model No.	Width	Depth	Height	Ship Wt	Cubic Ft	List Price
MODULAR STORAGE FILE/FILE	46-1829MF	29	18½	24	119	9.8	W\$ 2924 PV\$ 3275

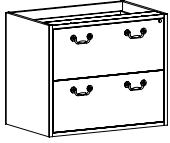

Must Specify (in this order):

- Model #
- Premium or Standard Veneer
- Finish
- Pull
- Molding

Description

- Standard With: No Molding, Central Locking File/File Ped, Legal-or-Letter Filing Side-to-Side or Letter Filing Front to Back, and Finished Back Panel
- Available with Premium Veneer (PV) or Standard Veneer (W); Must Specify
- **Must Specify Top and Base for Freestanding Applications; Order Separately (See Tops and Bases)**

Molding Options: Specify & Add

M46L1	Molding on Left Side Only	\$ 85
M46R1	Molding on Right Side Only	\$ 85
M46LR	Molding on Left and Right Side	\$ 170

MODULAR STORAGE BOX/BOX/FILE	46-1829MU	29	18½	24	119	9.8	W\$ 2924 PV\$ 3275
------------------------------	-----------	----	-----	----	-----	-----	-----------------------



Must Specify (in this order):

- Model #
- Premium or Standard Veneer
- Finish
- Pull
- Molding

Description

- Standard With: No Molding, Central Locking Box/Box/File Ped, Legal-or-Letter Filing Side-to-Side or Letter Filing Front to Back, and Finished Back Panel
- Available with Premium Veneer (PV) or Standard Veneer (W); Must Specify
- **Must Specify Top and Base for Freestanding Applications; Order Separately (See Tops and Bases)**

Molding Options: Specify & Add

M46L1	Molding on Left Side Only	\$ 85
M46R1	Molding on Right Side Only	\$ 85
M46LR	Molding on Left and Right Side	\$ 170

MODULAR STORAGE TWO DOOR	46-1829MS	29	18½	24	92	9.8	W\$ 2148 PV\$ 2405
--------------------------	-----------	----	-----	----	----	-----	-----------------------

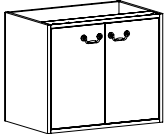

Must Specify (in this order):

- Model #
- Premium or Standard Veneer
- Finish
- Pull
- Molding

Description

- Standard With: No Molding, Two (2) Soft-Close Doors, One (1) Adjustable Shelf, and Finished Back Panel
- Available with Premium Veneer (PV) or Standard Veneer (W); Must Specify
- **Must Specify Top and Base for Freestanding Applications; Order Separately (See Tops and Bases)**

Molding Options: Specify & Add

M46L1	Molding on Left Side Only	\$ 85
M46R1	Molding on Right Side Only	\$ 85
M46LR	Molding on Left and Right Side	\$ 170

MODULAR STORAGE OPEN STORAGE	46-1829MBC	29	18½	24	92	9.8	W\$ 1882 PV\$ 2107
------------------------------	------------	----	-----	----	----	-----	-----------------------

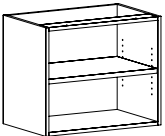

Must Specify (in this order):

- Model #
- Premium or Standard Veneer
- Finish
- Molding

Description

- Standard With: No Molding, One (1) Adjustable 1" Thick Shelf, and Finished Back Panel
- Available with Premium Veneer (PV) or Standard Veneer (W); Must Specify
- **Must Specify Top and Base for Freestanding Applications; Order Separately (See Tops and Bases)**

Molding Options: Specify & Add

M46L1	Molding on Left Side Only	\$ 85
M46R1	Molding on Right Side Only	\$ 85
M46LR	Molding on Left and Right Side	\$ 170

W = Veneer PV = Premium Veneer

[See Jefferson Intro Section for Ordering Options](#)

Item	Model No.	Width	Depth	Height	Ship Wt	Cubic Ft	List Price
MODULAR STORAGE FILE/FILE	46-1818MF	18 ²⁷ / ₃₂	18½	24	98	4.9	W\$ 2632 PV\$ 2948

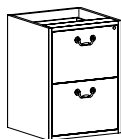

Must Specify (in this order):

Model #
Premium or Standard Veneer
Finish
Pull
Molding

Description

- Standard With: No Molding, Central Locking File/File Ped, Legal-or-Letter Filing Side-to-Side or Letter Filing Front to Back, and Finished Back Panel
- Available with Premium Veneer (PV) or Standard Veneer (W); Must Specify
- **Must Specify Top and Base for Freestanding Applications; Order Separately (See Tops and Bases)**

Molding Options: Specify & Add

M46L1	Molding on Left Side Only	\$ 85
M46R1	Molding on Right Side Only	\$ 85
M46LR	Molding on Left and Right Side	\$ 170

MODULAR STORAGE BOX/BOX/FILE	46-1818MU	18 ²⁷ / ₃₂	18½	24	98	4.9	W\$ 2632 PV\$ 2948
---------------------------------	-----------	----------------------------------	-----	----	----	-----	-----------------------



Must Specify (in this order):

Model #
Premium or Standard Veneer
Finish
Pull
Molding

Description

- Standard With: No Molding, Central Locking Box/Box/File Ped, Legal-or-Letter Filing Side-to-Side or Letter Filing Front to Back, and Finished Back Panel
- Available with Premium Veneer (PV) or Standard Veneer (W); Must Specify
- **Must Specify Top and Base for Freestanding Applications; Order Separately (See Tops and Bases)**

Molding Options: Specify & Add

M46L1	Molding on Left Side Only	\$ 85
M46R1	Molding on Right Side Only	\$ 85
M46LR	Molding on Left and Right Side	\$ 170

MODULAR STORAGE SINGLE DOOR	Left Hinged	Right Hinged	Width	Depth	Height	Ship Wt	Cubic Ft	List Price
	46-1818MSL	46-1818MSR	18 ²⁷ / ₃₂	18½	24	80	9.2	W\$ 1933 PV\$ 2165

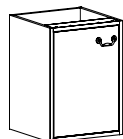

Shown as Left Hinged

Must Specify (in this order):

Model #
Premium or Standard Veneer
Finish
Pull
Molding

Description

- Standard With: No Molding, One (1) Soft-Close Door, One (1) Adjustable Shelf, and Finished Back Panel
- Available with Premium Veneer (PV) or Standard Veneer (W); Must Specify
- **Must Specify Top and Base for Freestanding Applications; Order Separately (See Tops and Bases)**

Molding Options: Specify & Add

M46L1	Molding on Left Side Only	\$ 85
M46R1	Molding on Right Side Only	\$ 85
M46LR	Molding on Left and Right Side	\$ 170

MODULAR OPEN STORAGE	46-1818MBC	18 ²⁷ / ₃₂	18½	24	45	4.6	W\$ 1693 PV\$ 1896
----------------------	------------	----------------------------------	-----	----	----	-----	-----------------------

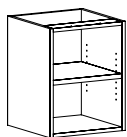

Must Specify (in this order):

Model #
Premium or Standard Veneer
Finish
Molding

Description

- Standard With: No Molding and Finished Back Panel
- Available with Premium Veneer (PV) or Standard Veneer (W); Must Specify
- **Must Specify Top and Base for Freestanding Applications; Order Separately (See Tops and Bases)**

Molding Options: Specify & Add

M46L1	Molding on Left Side Only	\$ 85
M46R1	Molding on Right Side Only	\$ 85
M46LR	Molding on Left and Right Side	\$ 170

P = HPL W = Veneer PV = Premium Veneer

See Jefferson Intro Section for Ordering Options

Item	Model No.	Width	Depth	Height	Ship Wt	Cubic Ft	List Price
MODULAR OVERHEAD CORNICE BOOKCASE TOP 	46-1589FC <i>Cornice for 3 Modular Bookcases</i>	89	15	3½	30	4.5	W\$ 1111
	46-1560FC <i>Cornice for 2 Modular Bookcases</i>	60	15	3½	18	3.1	W\$ 637
	46-1531FC <i>Cornice for 1 Modular Bookcase</i>	31	15	3½	10	3.1	W\$ 468

Must Specify (in this order):

Model #
Finish

Description

- 46-1589FC Features Insert for Additional Stability
- Recommended for Use Above Line of Sight; Unfinished Open Top
- **For Use with Modular Bookcases (See Multiple Bookcase Units); Not For Use on Standard Bookcases**

MODULAR BOOKCASE TOP 	46-1560TP <i>Top for 2 Modular Bookcases</i>	59½	15	1½ ₂	30	3.1	W/P\$ 1040 PV\$ 1166
	46-1531TP <i>Top for 1 Modular Bookcase</i>	30½	15	1½ ₂	16	1.6	W/P\$ 633 PV\$ 708

Must Specify (in this order):

Model #
Top Material
Finish/Color

Description

- Top Available with Premium/Standard Veneer (W) or HPL (P), Must Specify
- **For Use with Modular Bookcases (See Multiple Bookcase Units); Not For Use on Standard Bookcases**

MODULAR BOOKCASE BASE 	46-1560BS Base for 2 Bookcases	59⅙	14⅝	4¼	15	3.1	W\$ 591
	46-1531BS Base for 1 Bookcase	30⅙	14⅝	4¼	10	1.6	W\$ 432

Must Specify (in this order):

Model #
Finish

Description

- **For Use with Modular Bookcases (See Multiple Bookcase Units); Not For Use on Standard Bookcases**
- Bases Feature Multi-Step, Hand-Finished Catalyzed Finish

P = HPL W = Veneer PV = Premium Veneer

[See Jefferson Intro Section for Ordering Options](#)

Item	Model No.	Width	Depth	Height	Ship Wt	Cubic Ft	List Price
MODULAR BOOKCASE	46-2952BC	29	13½	50	84	14.6	W\$ 1800 PV\$ 2017

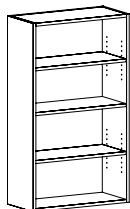

Description

- Standard With: No Molding, One (1) Fixed Shelf, and Two (2) Adjustable Shelves
- Available with Premium Veneer (PV) or Standard Veneer (W); Must Specify
- **Must Specify Top and Base for Freestanding Applications; Order Separately (See Tops and Bases)**
- Additional Options: Molding on One or Both Sides (See Below)
- Recommended for Applications Against a Wall

Molding Options: Specify & Add

M46L1	Molding on Left Side Only	\$ 85
M46R1	Molding on Right Side Only	\$ 85
M46LR	Molding on Left and Right Side	\$ 170

Must Specify (in this order):

Model #
Premium or Standard Veneer
Finish
Molding

MODULAR BOOKCASE WITH DOORS AND WOOD INSERTS	46-2952WB	29	13½	50	114	14.6	W\$ 3687 PV\$ 4130
--	-----------	----	-----	----	-----	------	-----------------------

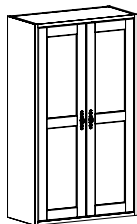

Description

- Standard With: No Molding, Two (2) Wood-Framed Soft-Close Doors with Wood Inserts, One (1) Fixed Shelf, and Two (2) Adjustable Shelves
- Available with Premium Veneer (PV) or Standard Veneer (W); Must Specify
- **Must Specify Top and Base for Freestanding Applications; Order Separately (See Tops and Bases)**
- Additional Options: Molding on One or Both Sides (See Below)
- Recommended for Applications Against a Wall

Molding Options: Specify & Add

M46L1	Molding on Left Side Only	\$ 85
M46R1	Molding on Right Side Only	\$ 85
M46LR	Molding on Left and Right Side	\$ 170

Must Specify (in this order):

Model #
Premium or Standard Veneer
Finish
Pull
Molding

Item	Model No.	Width	Depth	Height	Ship Wt	Cubic Ft	List Price
MODULAR BOOKCASE WITH DOORS AND GLASS INSERTS	46-2952GB	29	13½	50	123	14.6	W\$ 3687 PV\$ 4130

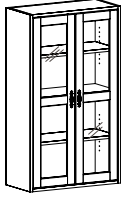

Description

- Standard With: No Molding, Two (2) Wood-Framed Soft-Close Doors with Glass Inserts, One (1) Fixed Shelf, and Two (2) Adjustable Shelves
- Available with Premium Veneer (PV) or Standard Veneer (W); Must Specify
- Beveled Glass Inserts Available in Clear and Cracked Ice; Must Specify (See Below)
- **Must Specify Top and Base for Freestanding Applications; Order Separately (See Tops and Bases)**
- Additional Options: Molding on One or Both Sides (See Below); Glass Shelves (See Glass Shelf Options)
- Recommended for Applications Against a Wall

Beveled Glass Options: Specify & Add

1-CL	Clear Glass Inserts	N/C
1-CR	Cracked Ice Glass Inserts	\$ 1040

Molding Options: Specify & Add

M46L1	Molding on Left Side Only	\$ 85
M46R1	Molding on Right Side Only	\$ 85
M46LR	Molding on Left and Right Side	\$ 170

Must Specify (in this order):

- Model #
- Premium or Standard Veneer Finish
- Pull
- Beveled Glass Design
- Molding
- Glass Shelves

MODULAR BOOKCASE WITH DOORS AND MESH INSERTS	46-2952MB	29	13½	50	97	14.6	W\$ 3141 PV\$ 3519
--	-----------	----	-----	----	----	------	-----------------------

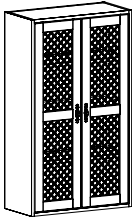

Description

- Standard With: No Molding, Two (2) Wood-Framed Soft-Close Doors with Mesh Inserts, One (1) Fixed Shelf, and Two (2) Adjustable Shelves
- Available in Premium Veneer (PV) or Standard Veneer (W); Must Specify
- Mesh Grille Inserts Available in Antique Brass and Silver; Must Specify (See Below)
- **Must Specify Top and Base for Freestanding Applications; Order Separately (See Tops and Bases)**
- Additional Options: Molding on One or Both Sides (See Below); Glass Shelves (See Glass Shelf Options)
- Recommended for Applications Against a Wall

Mesh Grille Options: Specify & Add

1-BM	Antique Brass Mesh Grille Insert <i>Only available when a Brass Pull is specified</i>	N/C
1-AM	Silver Mesh Grille Insert <i>Only available when Liberty Pull (ALB) is specified</i>	\$ 782

Molding Options: Specify & Add

M46L1	Molding on Left Side Only	\$ 85
M46R1	Molding on Right Side Only	\$ 85
M46LR	Molding on Left and Right Side	\$ 170

Must Specify (in this order):

- Model #
- Premium or Standard Veneer Finish
- Pull/Mesh Grille Color
- Molding
- Glass Shelves

[See Jefferson Intro Section for Ordering Options](#)

Item	Model No.	Width	Depth	Height	K	R	Ship Wt	Cubic Ft	List Price
HEIGHT ADJUSTABLE DOUBLE PED DESK TRAY/BOX/FILE	TOP OVERHANG FEATURE								
	46-3672DPSSTS	72	36	30-45	16	3	530	50.4	W/P\$ 12331 PV\$ 13812
	<i>Chassis 66W x 30D - Letter Ped; Approach Overhang 6"; Side Overhang 4"</i>								
	STANDARD TOP								
	46-3066DPSSTS	66	30	30-45	16	3	495	38.7	W/P\$ 12086 PV\$ 13538
	<i>Letter Ped</i>								

Description

- Standard with: Stepped Front, Rectangle Top Profiled on All Sides, Base Molding on All Sides, Decorative Molding on Approach and Both Sides, Locking Tray/Box/File Peds, Left-to-Right Grain Direction on Top, 2-Channel Leg Configuration for Single Surface Height Adjustment, Standard Up/Down Control Switch, and Dovetail Wood Drawer Construction
- Chassis Available with Premium Veneer (PV) or Standard Veneer (W); Must Specify
- Top Available with Premium/Standard Veneer (PV/W) or HPL (P); Must Specify
- Lock Core Color will Coordinate with Pull Selection (Brass Pull with Black Lock, Silver Pull with Silver Lock)
- Wire Management Box Available; Attaches to Bottom Side of Worksurface and Moves Up/Down with Worksurface to Hide Cords/Wires from Top to Chassis ([See Top Grommet Options](#))
- Additional Options: No Decorative Molding (Specify NO MOLDING); Advanced (Memory/Up/Down) Control Switch ([See Switch Options](#)); Soft Close Drawer Closure ([See Soft Close Options](#)); Wire Management + Accessories (Order Separately; [See Multiple Unit Details](#))

Approach Side Shown with Decorative Molding and Optional No Molding

Left Shown with Wire Management Box and Center Grommet

Must Specify (in this order):

- Model #
- Premium or Standard Veneer
- Top Material
- Finish/Color
- Pull
- No Molding
- Drawer Track
- Control Switch
- Top Grommet Location/Color

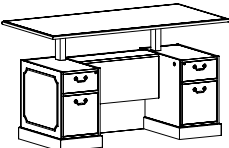
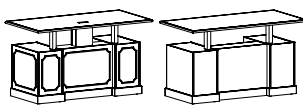
HEIGHT ADJUSTABLE DOUBLE PED DESK BOX/FILE	RECESSED MODESTY WITH TOP OVERHANG FEATURE								
	46-3672DPSTS	72	36	30-45	16	3	525	50.4	W/P\$ 11958 PV\$ 13390
	<i>Chassis 66W x 30D - Letter Ped; Approach Overhang 6"; Side Overhang 4"</i>								
	STANDARD TOP + MODESTY								
	46-3672CHSTS	72	36	30-45	16	3	557	50.4	W/P\$ 14381 PV\$ 16108
	<i>Legal Ped</i>								
	46-3066DPSTS	66	30	30-45	16	3	490	38.7	W/P\$ 11682 PV\$ 13082
	<i>Letter Ped</i>								

Description

- Standard with: Stepped Front, Rectangle Top Profiled on All Sides, Base Molding on All Sides, Decorative Molding on Approach and Both Sides, Locking Box/File Peds, Left-to-Right Grain Direction on Top, 2-Channel Leg Configuration for Single Surface Height Adjustment, Standard Up/Down Control Switch, and Dovetail Wood Drawer Construction
- Chassis Available with Premium Veneer (PV) or Standard Veneer (W); Must Specify
- Top Available with Premium/Standard Veneer (PV/W) or HPL (P); Must Specify
- Lock Core Color will Coordinate with Pull Selection (Brass Pull with Black Lock, Silver Pull with Silver Lock)
- Wire Management Box Available; Attaches to Bottom Side of Worksurface and Moves Up/Down with Worksurface to Hide Cords/Wires from Top to Chassis ([See Top Grommet Options](#))
- Additional Options: No Decorative Molding (Specify NO MOLDING); Advanced (Memory/Up/Down) Control Switch ([See Switch Options](#)); Soft Close Drawer Closure ([See Soft Close Options](#)); Wire Management + Accessories (Order Separately; [See Multiple Unit Details](#))

Approach Side Shown with Decorative Molding and Optional No Molding

Left Shown with Wire Management Box and Center Grommet

Must Specify (in this order):

- Model #
- Premium or Standard Veneer
- Top Material
- Finish/Color
- Pull
- No Molding
- Drawer Track
- Control Switch
- Top Grommet Location/Color

Item	Model No.	Width	Depth	Height	K	R	Ship Wt	Cubic Ft	List Price	
HEIGHT ADJUSTABLE SINGLE PED DESK TRAY/BOX/FILE	Left Ped	Right Ped								
	46-3672LPSSTS <i>Legal Ped</i>	46-3672RPSSTS	72	36	30-45	16	3	435	50.4	W/P\$ 11917 PV\$ 13348
	46-3066LPSSTS <i>Letter Ped</i>	46-3066RPSSTS	66	30	30-45	16	3	285	38.7	W/P\$ 11340 PV\$ 12702

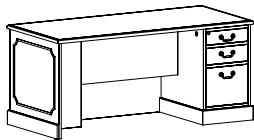

Shown as Right

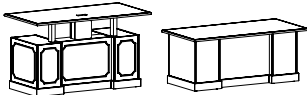

Approach Side Shown with Decorative Molding and Optional No Molding

Left Shown with Wire Management Box and Center Grommet

Must Specify (in this order):

- Model #
- Premium or Standard Veneer
- Top Material
- Finish/Color
- Pull
- No Molding
- Drawer Track
- Leg Configuration
- Control Switch
- Top Grommet Location/Color

Description

- Standard with: Stepped Front, Rectangle Top Profiled on All Sides, Base Molding on All Sides, Decorative Molding on Approach and Both Sides, Locking Tray/Box/File Ped, Left-to-Right Grain Direction on Top, 2-Channel Leg Configuration for Single Surface Height Adjustment, Standard Up/Down Control Switch, and Dovetail Wood Drawer Construction
- Chassis Available with Premium Veneer (PV) or Standard Veneer (W); Must Specify
- Top Available with Premium/Standard Veneer (PV/W) or HPL (P); Must Specify
- Lock Core Color will Coordinate with Pull Selection (Brass Pull with Black Lock, Silver Pull with Silver Lock)
- Stationary Returns and Bridges Available for Use with Single Ped Desks, [See Stationary Return](#) and [Stationary Bridge](#)
- Optional 3-Channel Leg Configuration (STS3) for Use with 3-Channel Returns; [See Option Details](#) and [See 3-Channel Units](#)
- Wire Management Box Available; Attaches to Bottom Side of Worksurface and Moves Up/Down with Worksurface to Hide Cords/Wires from Top to Chassis ([See Top Grommet Options](#))
- Additional Options: No Decorative Molding (Specify NO MOLDING); Advanced (Memory/Up/Down) Control Switch ([See Switch Options](#)); Soft Close Drawer Closure ([See Soft Close Options](#)); Wire Management + Accessories (Order Separately; [See Multiple Unit Details](#))

Item	Model No.	Width	Depth	Height	K	R	Ship Wt	Cubic Ft	List Price	
HEIGHT ADJUSTABLE SINGLE PED DESK BOX/FILE	Left Ped	Right Ped								
	46-3672LPSTS <i>Legal Ped</i>	46-3672RPSTS	72	36	30-45	16	3	430	50.4	W/P\$ 11552 PV\$ 12936
	46-3066LPSTS <i>Letter Ped</i>	46-3066RPSTS	66	30	30-45	16	3	280	38.7	W/P\$ 10973 PV\$ 12291

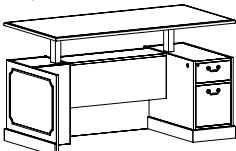

Shown as Right

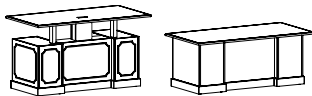

Approach Side Shown with Decorative Molding and Optional No Molding

Left Shown with Wire Management Box and Center Grommet

Must Specify (in this order):

- Model #
- Premium or Standard Veneer
- Top Material
- Finish/Color
- Pull
- No Molding
- Drawer Track
- Leg Configuration
- Control Switch
- Top Grommet Location/Color

Description

- Standard with: Stepped Front, Rectangle Top Profiled on All Sides, Base Molding on All Sides, Decorative Molding on Approach and Both Sides, Locking Box/File Ped, Left-to-Right Grain Direction on Top, 2-Channel Leg Configuration for Single Surface Height Adjustment, Standard Up/Down Control Switch, and Dovetail Wood Drawer Construction
- Chassis Available with Premium Veneer (PV) or Standard Veneer (W); Must Specify
- Top Available with Premium/Standard Veneer (PV/W) or HPL (P); Must Specify
- Lock Core Color will Coordinate with Pull Selection (Brass Pull with Black Lock, Silver Pull with Silver Lock)
- Stationary Returns and Bridges Available for Use with Single Ped Desks, [See Stationary Return](#) and [Stationary Bridge](#)
- Optional 3-Channel Leg Configuration (STS3) for Use with 3-Channel Returns; [See Option Details](#) and [See 3-Channel Units](#)
- Wire Management Box Available; Attaches to Bottom Side of Worksurface and Moves Up/Down with Worksurface to Hide Cords/Wires from Top to Chassis ([See Top Grommet Options](#))
- Additional Options: No Decorative Molding (Specify NO MOLDING); Advanced (Memory/Up/Down) Control Switch ([See Switch Options](#)); Soft Close Drawer Closure ([See Soft Close Options](#)); Wire Management + Accessories (Order Separately; [See Multiple Unit Details](#))

[See Jefferson Intro Section for Ordering Options](#)

Item	Model No.	Width	Depth	Height	K	R	Ship Wt	Cubic Ft	List Price	
HEIGHT ADJUSTABLE RETURN WITH FILE/FILE	Left Ped	Right Ped								
	46-2448LF2STS	46-2448RF2STS	48	24	30-45	13	-	237	21.8	W/P\$ 9891 PV\$ 11080
2-CHANNEL, FOR ONE WORKSURFACE	46-2442LF2STS	46-2442RF2STS	42	24	30-45	13	-	237	20.4	W/P\$ 9842 PV\$ 11024

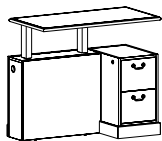

Shown as Right

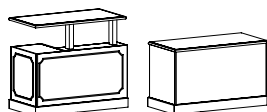

Approach Shown with and without Decorative Molding

Must Specify (in this order):

- Model #
- Premium or Standard Veneer
- Top Material
- Finish/Color
- Pull
- No Molding
- Locking
- Drawer Track
- Control Switch
- Top Grommet Location/Color
- Modesty Grommet

Description

- Standard with: Rectangle Top Profiled on All Sides, Base Molding on All Sides, Decorative Molding on Approach and Side, File/File Ped, Worksurface Grommet, Front-To-Back Grain Direction on Top, 2-Channel Leg Configuration for Single Surface Height Adjustment, Standard Up/Down Control Switch, Wire Management from Pedestal to Kneespace, and Dovetail Wood Drawer Construction
- Note: Surface is 1/8" Short on Connecting Side
- Chassis Available with Premium Veneer (PV) or Standard Veneer (W); Must Specify
- Top Available with Premium/Standard Veneer (PV/W) or HPL (P); Must Specify
- Optional Modesty Grommet for Wire Management to Wall; Must Specify: Black (GMBBL), Silver (GMBSV) or None (NONE)
- Wire Management Box Available; Attaches to Bottom Side of Worksurface and Moves Up/Down with Worksurface to Hide Cords/Wires from Top to Chassis ([See Top Grommet Options](#))
- Additional Options: No Decorative Molding (Specify NO MOLDING); Locking Pedestal ([See Locking Options](#)); Advanced (Memory/Up/Down) Control Switch ([See Switch Options](#)); Soft Close Drawer Closure ([See Soft Close Options](#)); Wire Management + Accessories (Order Separately; [See Multiple Unit Details](#))

HEIGHT ADJUSTABLE RETURN WITH FILE/FILE FOR MULTIPLE SURFACES	Left Ped	Right Ped								
	46-2448LF2STS3	46-2448RF2STS3	48	24	30-45	22	-	237	21.8	W/P\$ 7474 PV\$ 8372
3-CHANNEL, FOR TWO SIMULTANEOUS WORKSURFACES	46-2442LF2STS3	46-2442RF2STS3	42	24	30-45	22	-	237	20.4	W/P\$ 7424 PV\$ 8314

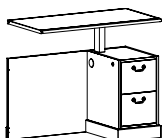

Shown as Right

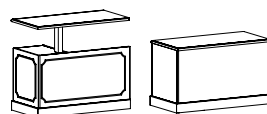

Approach Shown with and without Decorative Molding

Must Specify (in this order):

- Model #
- Premium or Standard Veneer
- Top Material
- Finish/Color
- Pull
- No Molding
- Locking
- Drawer Track
- Top Grommet Location/Color
- Modesty Grommet

Description

- Standard with: Rectangle Top Profiled on Approach and User Sides with Reverse Profile on Connecting Side, Base Molding on All Sides, Decorative Molding on Approach and Side, File/File Ped, Front-To-Back Grain Direction on Top, 3-Channel Leg Configuration for Simultaneous Surface Height Adjustment Across Two Units, Wire Management from Pedestal to Kneespace, and Dovetail Wood Drawer Construction
- Chassis Available with Premium Veneer (PV) or Standard Veneer (W); Must Specify
- Top Available with Premium/Standard Veneer (PV/W) or HPL (P); Must Specify
- **Must Be Used with Height Adjustable Single Pedestal Desk (Order Separately, [See Single Ped Desks](#))**
- Control Switch Not Included, Will Be On Adjoining Unit
- Optional Modesty Grommet for Wire Management to Wall; Must Specify: Black (GMBBL), Silver (GMBSV) or None (NONE)
- Optional Worksurface Grommet with or without Mesh Wire Management Sleeve Available Over Ped Only; 6" from Ends and 20" from User; Must Specify Location and Color: GL or GL-MESH for Left or GR or GR-MESH for Right; Color Options: Black (BLK) or Silver (SLV); [See Grommet Options](#)
- Monitor Arms not Available on this Unit
- Additional Options: No Decorative Molding (Specify NO MOLDING); Locking Pedestal ([See Locking Options](#)); Soft Close Drawer Closure ([See Soft Close Options](#)); Wire Management + Accessories (Order Separately; [See Multiple Unit Details](#))

Item	Model No.	Width	Depth	Height	K	R	Ship Wt	Cubic Ft	List Price	
STATIONARY RETURN WITH FILE/FILE	Left Ped	Right Ped								
	46-2448LF2SR	46-2448RF2SR	48	24	30-45	22	-	165	21.8	W/P\$ 4888 PV\$ 5474
	46-2442LF2SR	46-2442RF2SR	42	24	30-45	22	-	110	20.4	W/P\$ 4836 PV\$ 5415

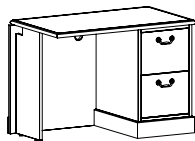

Shown as Right

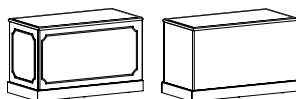

Approach Side Shown with Decorative Molding and Optional No Molding

Must Specify (in this order):

- Model #
- Premium or Standard Veneer
- Top Material
- Finish/Color
- Pull
- No Molding
- Locking
- Drawer Track
- Locking Pedestal
- Top Grommet Location/Color
- Modesty Grommet
- Kneespace Options

Description

- Standard with: Rectangle Top Profiled on All Sides, Base Molding on All Sides, Decorative Molding on Approach and Side, File/File Ped, Front-To-Back Grain Direction on Top, Wire Management from Pedestal to Kneespace, and Dovetail Wood Drawer Construction
- Note: Surface is 1/8" Short on Connecting Side
- Chassis Available with Premium Veneer (PV) or Standard Veneer (W); Must Specify
- Top Available with Premium/Standard Veneer (PV/W) or HPL (P); Must Specify
- **Must Be Used with Height Adjustable Single Pedestal Desk (Order Separately, See Single Ped Desks)**
- Additional Options: No Decorative Molding (Specify NO MOLDING); Kneespace Options (See Multiple Unit Details); Locking Pedestal (See Locking Options); Soft Close Drawer Closure (See Soft Close Options); Top Grommet Options (See Top Grommet Options); Wire Management + Accessories (Order Separately; See Multiple Unit Details)

HEIGHT ADJUSTABLE BRIDGE	46-2448UFSTS	48	24	30-45	13	-	250	24.0	W/P\$ 7428 PV\$ 8318
2-CHANNEL, FOR ONE WORKSURFACE	46-2442UFSTS	42	24	30-45	13	-	230	21.8	W/P\$ 7299 PV\$ 8177

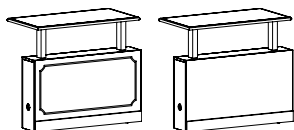
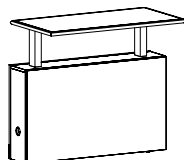

Approach Shown with and without Decorative Molding

Must Specify (in this order):

- Model #
- Premium or Standard Veneer
- Top Material
- Finish/Color
- No Molding
- Top Grommet Location/Color
- Modesty Grommet
- Control Switch
- Kneespace Options

Description

- Standard with: Rectangle Top Profiled on All Sides, Base Molding on Back Side, Decorative Molding on Approach, Front-To-Back Grain Direction on Top, 2-Channel Leg Configuration for Single Surface Height Adjustment, and Standard Up/Down Control Switch (Field Installed)
- Note: Surface is 1/8" Short on Both Connecting Sides to Prevent Contact Between Tops
- Chassis Available with Premium Veneer (PV) or Standard Veneer (W); Must Specify
- Top Available with Premium/Standard Veneer (PV/W) or HPL (P); Must Specify
- Control Switch Standard (Up/Down) or Upgrade to Advanced Switch (MSWCH-Up/Down/Memory); Switch is Field Installed; See Switch Options
- Optional Modesty Grommet for Wire Management to Wall; Must Specify: Black (GMBBL), Silver (GMBSV) or None (NONE)
- Optional Worksurface Grommet with or without Mesh Wire Management Sleeve or Wire Management Box Available On Center Only (See Top Grommet Options)
- Additional Options: No Decorative Molding (Specify NO MOLDING); Kneespace Options (See Multiple Unit Details); Advanced (Memory/Up/Down) Control Switch (See Switch Options); Soft Close Drawer Closure (See Soft Close Options); Wire Management + Accessories (Order Separately; See Multiple Unit Details)

See Jefferson Intro Section for Ordering Options

Item	Model No.	Width	Depth	Height	K	R	Ship Wt	Cubic Ft	List Price	
HEIGHT ADJUSTABLE BRIDGE FOR MULTIPLE SURFACES	Left	Right								
	46-2448UFSTSL3	46-2448UFSTSR3	48	24	30-45	13	-	250	24.0	W/P\$ 6238 PV\$ 7128
3-CHANNEL, FOR TWO SIMULTANEOUS WORKSURFACES	46-2442UFSTSL3	46-2442UFSTSR3	42	24	30-45	13	-	230	21.8	W/P\$ 6109 PV\$ 6986

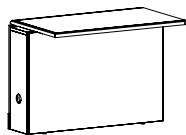

SIN PENDING

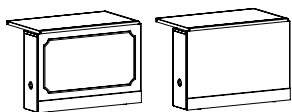

Approach Shown with and without Decorative Molding

Must Specify (in this order):

- Model #
- Premium or Standard Veneer
- Top Material
- Finish/Color
- No Molding
- Top Grommet Location/Color
- Modesty Grommet
- Control Switch
- Kneespace Options

Description

- Standard with: Rectangle Top Profiled on All Sides, Base Molding on Back Side, Decorative Molding on Approach, Front-To-Back Grain Direction on Top, 3-Channel Leg Configuration for Multiple Surface Height Adjustment
- Note: Surface is 1/8" Short on Both Connecting Sides to Prevent Contact Between Tops
- Chassis Available with Premium Veneer (PV) or Standard Veneer (W); Must Specify
- Top Available with Premium/Standard Veneer (PV/W) or HPL (P); Must Specify
- Control Switch Not Included; Control Switch will be on Adjoining Unit
- Optional Modesty Grommet for Wire Management to Wall; Must Specify: Black (GMBBL), Silver (GMBSV) or None (NONE)
- Optional Worksurface Grommet with Mesh Wire Management Sleeve or Wire Management Box Available On Center Only ([See Options](#))
- Additional Options: No Decorative Molding (Specify NO MOLDING); Wire Management + Accessories (Order Separately; [See Multiple Unit Details](#))

STATIONARY BRIDGE FULL MODESTY	Left Attachment	Right Attachment	Width	Depth	Height	K	R	Ship Wt	Cubic Ft	List Price
	46-2448SUFL	46-2448SUFR	48	24	30	22	-	89	5.5	W/P\$ 2421 PV\$ 2712
	46-2442SUFL	46-2442SUFR	42	24	30	22	-	89	5.5	W/P\$ 2296 PV\$ 2570

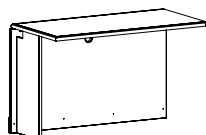

Shown as Right

Must Specify (in this order):

- Model #
- Premium or Standard Veneer
- Top Material
- Finish/Color
- No Molding
- Top Grommet Location/Color

Description

- Standard with: Rectangle Top Profiled on Approach and User Sides with Reverse Profile on Connecting Side (To Credenza), Base Molding on Back Side, Decorative Molding on Approach, and Front-To-Back Grain Direction on Top
- Note: Surface is 1/8" Short on Connecting Side to Prevent Contact Between Tops
- Chassis Available with Premium Veneer (PV) or Standard Veneer (W); Must Specify
- Top Available with Premium/Standard Veneer (PV/W) or HPL (P); Must Specify
- **Must Be Used with Height Adjustable Single Pedestal Desk (Order Separately, [See Single Ped Desks](#))**
- Additional Options: No Decorative Molding (Specify NO MOLDING); Top Grommet Options ([See Top Grommet Options](#)); Kneespace Options (Order Separately; Available for Field Installation Only; [See Multiple Unit Details](#)); Wire Management + Accessories (Order Separately; [See Multiple Unit Details](#))

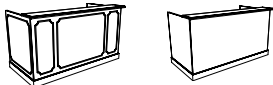
Item	Model No.	Width	Depth	Height	K	R	Ship Wt	Cubic Ft	List Price	
SINGLE PED RECEPTION DESK BOX/BOX/FILE  <p>Shown as Left</p>  <p>Approach Side Shown with Decorative Molding and Optional No Molding</p>	Left Ped	Right Ped								
	46-3672RPD1L	46-3672RPD1R	74	39	42	28¼	-	374	76.3	W/P\$ 8254 PV\$ 9245
	<i>Worksurface 70W x 34½D; Legal Ped</i>									
	46-3066RPD1L	46-3066RPD1R	68	33	42	25¼	-	327	59.9	W/P\$ 7545 PV\$ 8453
<i>Worksurface 64W x 28½D; Letter Ped</i>										

Description

- Standard with: Transaction Surface Profiled on All Sides, Rectangle User Surface with Square Profile, Base Molding on All Sides, Decorative Molding on Approach and Both Sides, Central Locking Center Drawer, Box/Box/File Ped, Left-to-Right Grain Direction on Top, and Dovetail Wood Drawer Construction
- Chassis Available with Premium Veneer (PV) or Standard Veneer (W); Must Specify
- Top/Transaction Available with Premium/Standard Veneer (PV/W) or HPL (P); Must Specify
- Lock Core Color will Coordinate with Pull Selection (Brass Pull with Black Lock, Silver Pull with Silver Lock)
- Additional Options: No Decorative Molding (Specify NO MOLDING); Keyboard Flip Down Center Drawer (Order Separately, [See Center Drawer](#)); Factory-Installed Tackboard ([See Tackboards](#)); Soft Close Drawer Closure ([See Soft Close Drawer Option](#)); Top Grommet Options ([See Grommet Options](#)); Wire Management + Accessories (Order Separately; [See Multiple Unit Details](#))

Must Specify (in this order):

- Model #
- Premium or Standard Veneer
- Top Material
- Finish/Color
- Pull
- No Molding
- Drawer Track
- Top Grommet Location/Color
- Flip Down Center Drawer
- Tackboard/Fabric

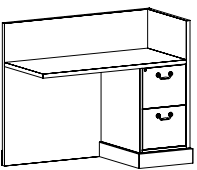
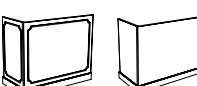
Item	Model No.	Width	Depth	Height	K	R	Ship Wt	Cubic Ft	List Price	
RECEPTION RETURN FILE/FILE  <p>Shown as Right</p>  <p>Approach Side Shown with Decorative Molding and Optional No Molding</p>	Left Ped	Right Ped								
	46-2448RPD2L	46-2448RPD2R	48	24	40⅞	28¼	-	195	33.3	W/P\$ 5520 PV\$ 6183
	<i>Worksurface 46¼W x 21½D</i>									

Description

- Standard with: Rectangle Top with Square Profile, Base Molding on All Sides, Decorative Molding on Approach and Side, Locking File/File Ped, Front-To-Back Grain Direction on Top, and Dovetail Wood Drawer Construction
- Chassis Available with Premium Veneer (PV) or Standard Veneer (W); Must Specify
- Top Available with Premium/Standard Veneer (PV/W) or HPL (P); Must Specify
- Additional Options: No Decorative Molding (Specify NO MOLDING); Soft Close Drawer Closure ([See Soft Close Drawer Option](#)); Keyboard Flip Down Center Drawer (Order Separately, [See Center Drawer](#)); Top Grommet Options ([See Grommet Options](#)); Wire Management + Accessories (Order Separately; [See Multiple Unit Details](#))

Must Specify (in this order):

- Model #
- Premium or Standard Veneer
- Top Material
- Finish/Color
- Pull
- No Molding
- Drawer Track
- Top Grommet Location/Color

[See Jefferson Intro Section for Ordering Options](#)

Item	Model No.	Width	Depth	Height	K	R	Ship Wt	Cubic Ft	List Price
RECEPTION BRIDGE	46-2448RUF <i>Worksurface 48W x 22¼D</i>	48	24	40⅞	48	-	116	7.3	W/P\$ 2520 PV\$ 2821
	46-2442RUF <i>Worksurface 42W x 22¼D</i>	42	24	40⅞	42	-	104	6.3	W/P\$ 2373 PV\$ 2659

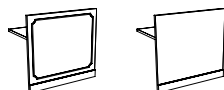
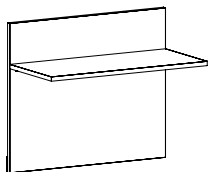

Approach Side Shown with Decorative Molding and Optional No Molding

Must Specify (in this order):

- Model #
- Premium or Standard Veneer
- Top Material
- Finish/Color
- No Molding
- Top Grommet Location/Color

Description

- Standard With: Rectangle Top with Square Profile, Front-to-Back Grain Direction on Top, and Hinged Back Panel
- Chassis Available with Premium Veneer (PV) or Standard Veneer (W); Must Specify
- Top Available with Premium/Standard Veneer (PV/W) or HPL (P); Must Specify
- Additional Options: No Decorative Molding (Specify No Molding); Kneespace Options ([See Multiple Unit Details](#); Available for Field Installation Only); Top Grommet Options ([See Grommet Options](#)); Wire Management + Accessories (Order Separately; [See Multiple Unit Details](#))

SINGLE PED RECEPTION CREDENZA FILE/FILE	Left Ped	Right Ped	Width	Depth	Height	K	R	Ship Wt	Cubic Ft	List Price
	Model No.	Model No.								
	46-2472RCL <i>Worksurface 70W x 22D; Legal Ped</i>	46-2472RCR	72	24	40⅞	32¼	-	264	46.8	W/P\$ 6612 PV\$ 7405
	46-2466RCL <i>Worksurface 64W x 22D; Letter Ped</i>	46-2466RCR	66	24	40⅞	26¼	-	249	43.0	W/P\$ 6509 PV\$ 7291

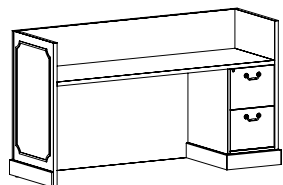

Shown as Right

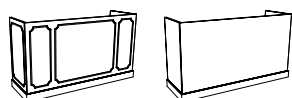

Approach Side Shown with Decorative Molding and Optional No Molding

Must Specify (in this order):

- Model #
- Premium or Standard Veneer
- Top Material
- Finish/Color
- Pull
- Back Panel Grommet Color
- No Molding
- Drawer Track
- Top Grommet Location/Color

Description

- Standard with: Rectangle Top with Square Profile, Base Molding on All Sides, Decorative Molding on Approach and Both Sides, Locking File/File Ped, Left-to-Right Grain Direction on Top, and Dovetail Wood Drawer Construction
- Chassis Available with Premium Veneer (PV) or Standard Veneer (W); Must Specify
- Top Available with Premium/Standard Veneer (PV/W) or HPL (P); Must Specify
- Lock Core Color will Coordinate with Pull Selection (Brass Pull with Black Lock, Silver Pull with Silver Lock)
- Additional Options: No Decorative Molding (Specify NO MOLDING); Soft Close Drawer Closure ([See Soft Close Drawer Option](#)); Kneespace Options ([See Multiple Unit Details](#); Available for Field Installation Only); Top Grommet Options ([See Grommet Options](#)); Wire Management + Accessories (Order Separately; [See Multiple Unit Details](#))

SURFACE MOUNT HUTCH TACKBOARDS
20 1/8" H

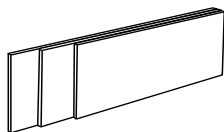

Model #	For Units:	COM YDG	COM, 1, 2, or 3	GRADES						
				4	5	6	7	8	9	10
TB-4672H	72"W	2.25	\$ 566	879	1025	1174	1385	1606	1862	2159
TB-4666H	66"W	2.00	\$ 533	811	941	1073	1261	1457	1685	1949

Description

- Coordinates with Standard and Tall Height Surface Mount Hutches
- Factory Installed

Must Specify (in this order):

- Model #
- Fabric Vendor, Pattern, and Color

VERTICAL HUTCH TACKBOARDS
21 1/8" H

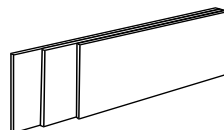

Model #	For Units:	COM YDG	COM, 1, 2, or 3	GRADES						
				4	5	6	7	8	9	10
TB-4672VH	72"W	1.25	\$ 385	559	640	723	840	963	1105	1270
TB-4666VH	66"W	1.25	\$ 377	551	632	715	832	955	1097	1262

Description

- Coordinates with Vertical Hutches: TB-4672VH is compatible with 46-1572VH4G, 46-1572VH4O, 46-1572VH4W, and 46-1572VH4M; TB-4666VH is compatible with 46-1566VH4G, 46-1566VH4O, 46-1566VH4W, and 46-1566VH4M
- Factory Installed

Must Specify (in this order):

- Model #
- Fabric Vendor, Pattern, and Color

WALL MOUNT HUTCH TACKBOARDS
21 1/8" H

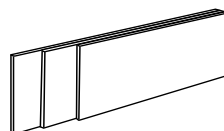

Model #	For Units:	COM YDG	COM, 1, 2, or 3	GRADES						
				4	5	6	7	8	9	10
TB-0184W	84"W	2.50	\$ 711	1059	1221	1386	1621	1866	2151	2481
TB-0178W	78"W	2.50	\$ 698	1046	1208	1373	1608	1853	2138	2468
TB-0172W	72"W	2.25	\$ 642	955	1101	1250	1461	1682	1938	2235
TB-0166W	66"W	2.00	\$ 609	887	1017	1149	1337	1533	1761	2025
TB-0160W	60"W	2.00	\$ 566	844	974	1106	1294	1490	1718	1982
TB-0154W	54"W	1.75	\$ 539	782	896	1012	1176	1348	1547	1778
TB-0148W	48"W	1.50	\$ 492	701	798	897	1038	1185	1356	1554
TB-0142W	42"W	1.25	\$ 446	620	701	784	901	1024	1166	1331
TB-0136W	36"W	1.25	\$ 434	608	689	772	889	1012	1154	1319

Description

- Coordinates with Wall Mount Hutches
- Factory Installed

Must Specify (in this order):

- Model #
- Fabric Vendor, Pattern, and Color

RECEPTION DESK TACKBOARDS
9" H



Model #	For Units:	COM YDG	COM, 1, 2, or 3	GRADES						
				4	5	6	7	8	9	10
TB-6172	72"W	2.25	\$ 256	569	715	864	1075	1296	1552	1849
TB-6166	66"W	2.00	\$ 232	510	640	772	960	1156	1384	1648

Description

- Coordinates with Reception Desks
- Factory Installed

Must Specify (in this order):

- Model #
- Fabric Vendor, Pattern, and Color

[See Jefferson Intro Section for Ordering Options](#)

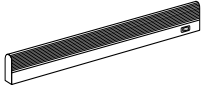
Item	Model No.	Width	Depth	Height	Ship Wt	Cubic Ft	List Price
LED TASKLIGHTS 	TL-0848 <i>240-LED, 18 Watts</i>	47½	7⁄8	1½	-	-	\$ 445
	TL-0824 <i>84-LED, 7 Watts</i>	22½	7⁄8	1½	-	-	\$ 368

Description

- Includes the Power Supply and Three (3) Upper Wire Management Grommets
- Rocker Style On/Off Switch with a 10' Power Cord
- Three (3) Upper Wire Management Grommets; Must Specify Color: Black (BLK), Silver (SLV)

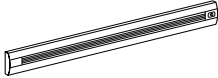
LED TASKLIGHTS 	01-188LED58 <i>96-LED, 33.7 Watts</i>	57¾	2	¾	-	-	\$ 1648
	01-94LED31 <i>48-LED, 17.6 Watts</i>	30¾	2	¾	-	-	\$ 1195
	01-47LED17 <i>24-LED, 9.1 Watts</i>	16¾	2	¾	-	-	\$ 690

Description

- Includes the Power Supply and Three (3) Upper Wire Management Grommets
- 12' Power Cord
- Three (3) Upper Wire Management Grommets; Must Specify Color: Black (BLK), Silver (SLV)
- Optional Occupancy Sensor Shuts Off After 30 Minutes of Inactivity and Turns On Immediately When Reentering the Detection Area

Options: Specify & Add

01-OSRP	Occupancy Sensor						\$ 366
---------	------------------	--	--	--	--	--	--------

Item	Model No.	Width	Depth	Height	Ship Wt	Cubic Ft	List Price
KEYBOARD FLIP DOWN CENTER DRAWER	46-2410FD	24	15 ¾	3 ⅙	12	2.0	W\$ 988 PV\$ 1106

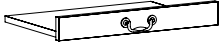

Must Specify (in this order):
 Model #
 Premium or Standard Veneer
 Finish
 Pull
 Factory Installed

Description

- Flip Down Front
- Available with Premium Veneer (PV) or Standard Veneer (W); Must Specify
- Does Not Feature Soft Close Hinges
- Use on Any Open Kneespace 24" or Larger
- Field Installed

ARTICULATING KEYBOARD CORNER PLATFORM	01-KB2CC	25	10½	4½	16	1.4	\$ 832
---------------------------------------	----------	----	-----	----	----	-----	--------

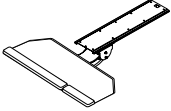

Description

- Standard With: +/- 15° Tilt Adjustment , 360° Rotation, Independent Tilt Adjustment, 7" Lift and Lock Height Adjustment, 25" Cut Corner Platform
- Keyboard and Mouse on same level; Single Palm Rest for both Left & Right Hands
- Works with 17"+ Diagonal Work Surface
- Cannot Be Used on 20" or 21" Deep Unit
- Not Available with Optional Center Grommet
- Track Measures 21"

Options: Specify & Add

KB2CC	Factory Installed	\$ 208
-------	-------------------	--------

KEYBOARD MECHANISM WITH KEYBOARD CLAMP	01-KB3	26½	14	4.5	16	1.4	\$ 914
--	--------	-----	----	-----	----	-----	--------

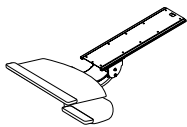

Description

- Standard With: 18.75" Platform with Swivel-Below Mouse Platform,+/- 15° Tilt Adjustment, 360° Rotation, 7" Lift and Lock Height Adjustment, Independent Tilt Adjustment, Palm Rest for Mousing Surface
- Left or Right Handed Mouse Platform
- Cannot Be Used on 20" or 21" Deep Unit
- Not Available with Optional Center Grommet
- Track Measures 21"

Options: Specify & Add

KB3	Factory Installed	\$ 208
-----	-------------------	--------

Kneespace Options Continued on Next Page

W = Veneer PV = Premium Veneer

[See Jefferson Intro Section for Ordering Options](#)

Item	Model No.		Width	Depth	Height	Ship Wt	Cubic Ft	List Price
ROUND GROMMET COVER	01-GRMTBK	Black	2 $\frac{1}{2}$ s	2 $\frac{1}{2}$ s	-	1	0.1	\$ 11
	01-GRMTSL	Silver						



OPEN MARKET ONLY
(SILVER)

Must Specify (in this order):

Model #
Factory Installed

Description

- 2 $\frac{1}{2}$ " (60mm) Round Grommet Cover
- Field Installed

SINGLE POWER SAND DOLLAR	01-SAND60PW	White	3	3	4	1	0.2	\$ 98
	01-SAND60PB	Black						
	01-SAND60PS	Silver						



Description

- Available on Height Adjustable Desks, Returns and Bridge Units with Wire Management Box in Center Grommet Only (GC-BOX)
- Unit is 2" Diameter; Mounts in 60mm Round Grommet
- 6' Cord
- Single Power Outlet

DOUBLE USB SAND DOLLAR	01-SAND60UW	White	3	3	4	1	0.2	\$ 277
	01-SAND60UB	Black						
	01-SAND60US	Silver						



Description

- Available on Height Adjustable Desks, Returns and Bridge Units with Wire Management Box in Center Grommet Only (GC-BOX)
- Unit is 2" Diameter; Mounts in 60mm Round Grommet
- 6' Cord
- Dual USB Outlets

DUO CLAMP NEMA PLUG	01-DUOCLAMPW	White	5 $\frac{1}{2}$	3	7	1	0.2	\$ 572
	01-DUOCLAMPB	Black						
	01-DUOCLAMPS	Silver						

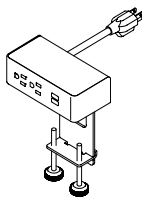

Description

- Standard with: Two (2) Power Outlet, Two (2) USB Ports, 10' Cord
- Clamps to Top and Features Silver Metal Trim
- Independent USB Circuit Controllers Deliver up to 2.1 Amps to Each Post
- All Mounting Hardware Included
- FCC Part 15A and UL Approved for Horizontal and Vertical Applications

Item	Model No.		Width	Depth	Height	Ship Wt	Cubic Ft	List Price
TRIO CLAMP NEMA PLUG	01-TRIOCLAMPW	White	8	3	7	1	0.2	\$ 671
	01-TRIOCLAMPB	Black						
	01-TRIOCLAMP S	Silver						

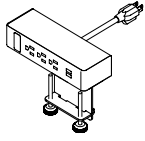

Description

- Standard with: Three (3) Power Outlets, Two (2) USB Ports, One (1) Open Data, 10' Cord
- Clamps to Top and Features Silver Metal Trim
- Independent USB Circuit Controllers Deliver up to 2.1 Amps to Each Post
- HDMI, VGA, or RJ45 Accessories Sold Separately (See Below)
- All Mounting Hardware Included
- FCC Part 15A and UL Approved for Horizontal and Vertical Applications

TRIO VGA DATA PORT ACCESSORY	01-LCOMVGA		-	-	-	1	0.2	\$ 121
---------------------------------	------------	--	---	---	---	---	-----	--------

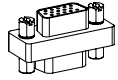

Description

- VGA Port for Trio Bezel Units

TRIO HDMI DATA PORT ACCESSORY	01-LCOMHDMI		-	-	-	1	0.2	\$ 166
----------------------------------	-------------	--	---	---	---	---	-----	--------

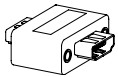

Description

- HDMI Port for Trio Bezel Units

TRIO RJ45 DATA PORT ACCESSORY	01-LCOMRJ45		-	-	-	1	0.2	\$ 79
----------------------------------	-------------	--	---	---	---	---	-----	-------

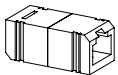

Description

- RJ45 Port for Trio Bezel Units

[See Jefferson Intro Section for Ordering Options](#)

Item	Model No.	Width	Depth	Height	Ship Wt	Cubic Ft	List Price
VESTA POWER CENTER	01-PDCTR	10¾	12	28¾	14	2.5	\$ 1776



Description

- Top Includes One (1) Power Outlet, Two (2) USB Ports and One (1) USBC Port; Base Includes Three (3) Outlet
- Available in White
- 120" Power Cord
- Built with Weight Distribution for Optimal Stability
- Base is 5" Tall

POWER STRIP	01-PRSP	9	2	2	1	-	\$ 205
-------------	---------	---	---	---	---	---	--------

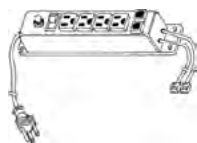

Description

- Four (4) Outlets
- Two (2) Phone Jacks
- Rocker Switch
- Black Plastic
- Suitable for Surface or Recessed Mounting
- 13 Amp Circuit Breaker
- 10' Power Cord
- Two (2) 14 ft. Phone Hook Up Cords
- UL and CSA Recognized
- Item will ship via UPS only

HEIGHT ADJUSTABLE WORKSTATION	01-S2SBLK Black	35½	25	6-22	49	6.5	\$ 1503
-------------------------------	--------------------	-----	----	------	----	-----	---------

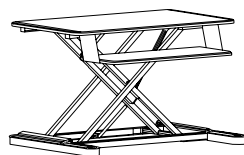

Description

- Height Adjustable
- Weight Capacity: 35lbs
- One-Handed Operation; Platforms Move Simultaneously
- Keyboard Platform: 10½"D x 26⅝"W
- Worksurface: 21"D x 35½"W
- Can be Used on Worksurface 24"D x 35"W

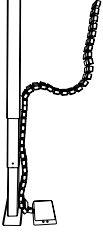
Item	Model No.		Width	Depth	Height	Ship Wt	Cubic Ft	List Price
LINK 360 CABLE MANAGER 	01-0251LINKSLV	Silver	5 $\frac{3}{16}$	3 $\frac{3}{16}$	30-51	4	3.0	\$ 390
	01-0251LINKBLK	Black	5 $\frac{3}{16}$	3 $\frac{3}{16}$	30-51	4	3.0	\$ 353

Description

- Kit Includes: 50 Link 360™ elements, One (1) Quad Connector, One (1) Dumbbell Connector, One (1) Foot Assembly with Two (2) Magnetic Clips
- Can Be Used For Height-Adjustable Mechanisms Up To 51" or Free-Standing Use

WIRE MANAGEMENT CHANNEL 	01-WMGR4		16	1 $\frac{1}{2}$	1	1	-	\$ 116
--	----------	--	----	-----------------	---	---	---	--------

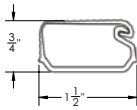
**Description**

- Set of Four (4) Black Plastic Wire Management Channels
- Snap Lock Channel
- Attaches with Adhesive Strips
- Ships via UPS Only

WIRE CHANNEL 	01-32125		24	1 $\frac{1}{8}$	1	.25	0.3	\$ 106
---	----------	--	----	-----------------	---	-----	-----	--------

Description

- Available in Black
- Channels Attach with Two (2) Double-Sided Installation Tape
- Open J Channel for Easy Storage of Cables

CABLE GRIP 	01-WMGRCB		5 $\frac{3}{16}$	2 $\frac{3}{16}$	-	-	-	\$ 17
---	-----------	--	------------------	------------------	---	---	---	-------

Description

- Under Surface Wire Management
- Black

[See Jefferson Intro Section for Ordering Options](#)

Madera creates a variety of looks from rich, refined transitional to fresh, modern contemporary by offering an abundance of options, including premium veneer. Finely crafted in select Cherry, Maple, Walnut, and Oak veneers, Madera features a UV topcoat on all exposed surfaces adding unsurpassed hardness and extreme durability for long lasting office applications.

CONSTRUCTION

Madera features a Veneer chassis with your choice of either a Veneer or HPL top. Units ship assembled unless otherwise noted.

VENEER

- Choose from premium veneer or select veneer on exposed surfaces in American Black Walnut, White Oak, Cherry, or Maple species
- The American Black Walnut, White Oak, and Cherry veneers are book matched veneer faces, while the Maple is a slip-matched veneer face
- These veneers are carefully selected and matched to assure proper balance and consistency

TOPS

- Tops are 1 3/16" thick
- Wood Veneer tops have a 5-ply balanced construction with hardwood rims
- High Pressure Laminate (HPL) tops have a 3-ply balanced construction with hardwood rims
- Tops featuring the Bullnose (D), Tri-Round (E), Fluted (X), and Square (Y) edge profiles have vertical profiles
- Tops featuring the Radius (A) and Bevel (B) edge profiles have the same construction, but provide a matching reverse profile on connecting edge
- Grain direction runs left to right unless otherwise noted

CHASSIS

- Chassis are securely fastened using high quality European style fastening systems and heavy-duty, 16-gauge joining brackets to assure maximum strength
- All units are equipped with heavy-duty, adjustable glides to ensure proper leveling and compensation for uneven floors
- Vertical grain direction unless otherwise noted

DRAWERS

- All drawers feature 5-sided construction allowing for easy removal of drawer fronts
- Fronts are 3-ply construction and are 3/4" thick with matched grain
- Drawer interiors are dovetail wood construction with 7/16" thick hardwood sides and backs and 5/32" thick hardboard bottoms
- The drawer interiors are sanded, sealed, and finished to provide a smooth, quality feel and appearance
- All drawers feature full extension, progressive action slides with precision steel ball bearings
- Box and file drawers are tested for 100lb capacity
- Lateral files feature 1/4" thick bottoms. Drawers are tested for 200lb of equally distributed weight (ex: hanging file folders) and 65lbs of bottom load weight (ex: stacked catalogs)
- All suspensions have a limited lifetime warranty

FILING

- All file drawers are standard with filing systems designed to accommodate a variety of filing requirements
- Letter width file drawers provide letter filing front to back and legal filing side to side
- Lateral file drawers provide legal or letter filing front to back or side to side

STORAGE

- All hinged doors include soft close hinges, unless otherwise noted
- One piece hinge and base plate combination
- Soft close hinges reduce stress placed on the cabinet when the door is closed and offers a quiet closure

LOCKING

- All units feature locking file drawers
- Removable lock cylinders allow for units to be re-keyed at a later date, if required
- Units are shipped randomly keyed as standard
- Keyed alike units available upon request at no additional charge
- Lock core color will match pull color

CORD MANAGEMENT

- Grommets are available in the tops of all units, unless noted
- Optional grommets are standard in back panels of assembled returns, bridge units, and kneespace credenzas,
- Hutch units have a rectangle grommet in bottom center of back panel
- A grommet is standard in tops of corner units
- Grommets are available in black or silver, please specify color
- [See all optional grommet locations](#)
- [Wire Manager units available for additional cord management](#)

INTERIOR DRAWER DIMENSIONS

Models

14-4272DP	14-3672DP	14-3672LP	14-3672RP
14-3072DP	14-3072LP	14-3072RP	16-4272LPS
16-4272DP	16-4272DPS	16-4272DPSO	16-4272RPSO
16-4272LPSO	16-4272RP	16-4272RPS	16-3672LP
16-3672DP	16-3672DPS	16-3672DPSO	16-3672RPS
16-3672LPS	16-3672LPSO	16-3672RP	16-3072LPS
16-3672RPSO	16-3072DP	16-3072LP	16-3072RPSO
16-3072LPSO	16-3072RP	16-3072RPS	

Drawers

	W	L	D
Box	15 1/32"	19 3/8"	3 5/8"
File	15 1/32"	19 3/8"	8 7/8"

Models

14-3066DP	14-3060DP	14-3066LP	14-3066RP
16-3066DP	16-3066LP	16-3066LPS	16-3066LPSO
16-3060DP	16-3066RP	16-3066RPS	16-3066RPSO

Drawers

	W	L	D
Box	12 1/32"	19 3/8"	3 5/8"
File	12 1/32"	19 3/8"	8 7/8"

INTERIOR DRAWER DIMENSIONS (CONTINUED)
Models

14-1619MP1	14-2448LF	14-2448RF	14-2442LF
14-2442RF	16-2448LF	16-2448LF2	16-2448LFH
16-2448LF2H	16-2448RF	16-2448RF2	16-2448RFH
16-2448RF2H	16-2442LF	16-2442LF2	16-2442LFH
16-2442LF2H	16-2442RF	16-2442RF2	16-2442RFH
16-2442RF2H			

Drawers

	W	L	D
Box	12 ¹¹ / ₃₂ "	16 ¹ / ₄ "	3 ²⁹ / ₃₂ "
File	12 ¹¹ / ₃₂ "	16 ¹ / ₄ "	8 ²⁹ / ₃₂ "

Models

16-2466SC

Drawers

	W	L	D
File	12 ¹¹ / ₃₂ "	16 ¹ / ₄ "	8 ²⁹ / ₃₂ "

Models

16-2472KC 16-2472KCH 16-2472SC 16-2072KC
16-2072SC

Drawers

	W	L	D
File	15 ¹¹ / ₃₂ "	16 ¹ / ₄ "	8 ²⁹ / ₃₂ "

Models

14-2072SC 14-2072KC 14-2072LC 14-2072RC
16-2472LC 16-2472LC2 16-2472LCH 16-2472LC2H
16-2472RC 16-2472RC2 16-2472RCH 16-2472RC2H
16-2072LC 16-2072LC2 16-2072RC 16-2072RC2

Drawers

	W	L	D
Box	15 ¹¹ / ₃₂ "	16 ¹ / ₄ "	3 ²¹ / ₃₂ "
File	15 ¹¹ / ₃₂ "	16 ¹ / ₄ "	8 ²⁹ / ₃₂ "

Models

14-2066KC 14-2066LC 14-2066RC 16-2466KC
16-2466KCH 16-2466LC 16-2466LC2 16-2466LCH
16-2466LC2H 16-2466RC 16-2466RC2 16-2466RCH
16-2466RC2H 16-2066KC 16-2066LC 16-2066LC2
16-2066RC 16-2066RC2

Drawers

	W	L	D
Box	12 ¹¹ / ₃₂ "	16 ¹ / ₄ "	3 ²¹ / ₃₂ "
File	12 ¹¹ / ₃₂ "	16 ¹ / ₄ "	8 ²⁹ / ₃₂ "

Models

14-2472LL3 14-2472LL3H 14-2472RL3 14-2472RL3H
14-2466LL3 14-2466LL3H 14-2466RL3 14-2466RL3H
14-2430L2 14-2430L3 14-2430L4

Drawers

	W	L	D
Lateral	25 ³ / ₄ "	16 ¹ / ₄ "	8 ²⁹ / ₃₂ "

Models

14-2472LL 14-2472LLH 14-2472RL 14-2472RLH
14-2472DL 14-2466LL 14-2466LLH 14-2466RL
14-2466RLH 14-2436L2 14-2436L3 14-2436L4
14-2036L2 14-2036L4 14-2072LL 14-2072LL4
14-2072RL 14-2072RL4 14-2072DL

Drawers

	W	L	D
Lateral	31 ³ / ₄ "	16 ¹ / ₄ "	8 ²⁹ / ₃₂ "

Models

14-2418PD1 14-3670WDIL 14-3670WD1R

Drawers

	W	L	D
Box	14 ⁹ / ₃₂ "	16 ¹ / ₄ "	3 ²¹ / ₃₂ "
File	14 ⁹ / ₃₂ "	16 ¹ / ₄ "	8 ²⁹ / ₃₂ "

Models

14-3618PD1 14-3018PD1

Drawers

	W	L	D
Box	14 ⁹ / ₃₂ "	19 ³ / ₈ "	3 ²¹ / ₃₂ "
File	14 ⁹ / ₃₂ "	19 ³ / ₈ "	8 ²⁹ / ₃₂ "

Models
14-2418PD2 14-3618PD2 14-3018PD2 14-3670WD2L
14-3670WD2R
Drawers

	W	L	D
File	14 ⁹ / ₃₂ "	16 ¹ / ₄ "	8 ²⁹ / ₃₂ "

Models

14-2436LF2

Drawers

	W	L	D
Box	15 ⁵ / ₁₆ "	16 ¹ / ₄ "	3 ²¹ / ₃₂ "
File	14 ¹ / ₂ "	16 ¹ / ₄ "	8 ²⁹ / ₃₂ "
Lateral	32 ⁹ / ₁₆ "	16 ¹ / ₄ "	8 ²⁹ / ₃₂ "

Models

14-2430LF2

Drawers

	W	L	D
Box	11 ¹ / ₂ "	16 ¹ / ₄ "	3 ²¹ / ₃₂ "
File	12 ¹¹ / ₃₂ "	16 ¹ / ₄ "	8 ²⁹ / ₃₂ "
Lateral	26 ⁹ / ₁₆ "	16 ¹ / ₄ "	8 ²⁹ / ₃₂ "

Models

14-2036MF

Drawers

	W	L	D
Box	13 ²³ / ₃₂ "	16 ¹ / ₄ "	3 ²¹ / ₃₂ "
File	15 ¹¹ / ₃₂ "	16 ¹ / ₄ "	8 ²⁹ / ₃₂ "
Lateral	3 ³ / ₄ "	16 ¹ / ₄ "	8 ²⁹ / ₃₂ "

Models

14-2436LF1 14-3670SU2

Drawers

	W	L	D
Lateral	32 ⁹ / ₁₆ "	16 ¹ / ₄ "	8 ²⁹ / ₃₂ "

INTERIOR DRAWER DIMENSIONS (CONTINUED)

Models

14-2436LF1

Drawers	W	L	D
Lateral	26 ¹ / ₆ "	16 ¹ / ₄ "	8 ⁷ / ₈ "

FILING CAPABILITIES

Drawers with Dimensions: 15¹/₂"W x 19³/₈"L and 14³/₂" x 19³/₈"

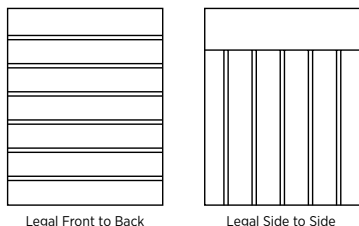

Drawers with Dimensions: 32³/₁₆" x 16¹/₄", 31³/₄" x 16¹/₄", and 26³/₁₆" x 16¹/₄"

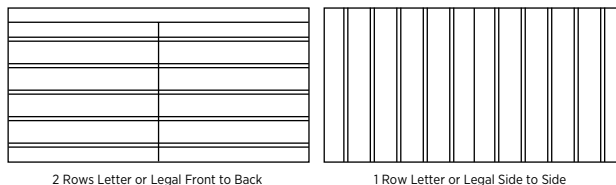

Drawers with Dimensions: 12¹/₂"W x 19³/₈"L

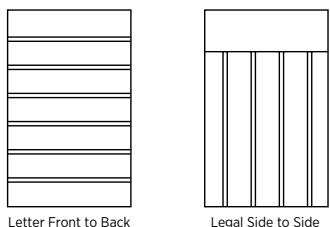

Drawers with Dimensions: 14¹/₂" x 16¹/₄", 14³/₂" x 16¹/₄", and 12¹/₂" x 16¹/₄"

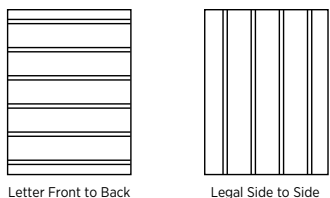

Drawers with Dimensions: 15¹/₂" x 16¹/₄"

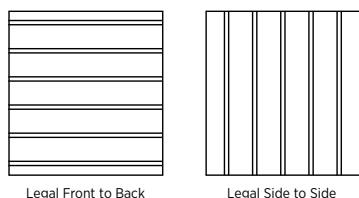

Drawers with Dimensions: 25³/₄" x 19³/₈"

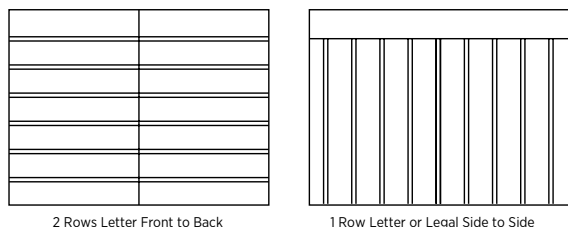

HOW TO ORDER EXAMPLES

Model No.	Description	Example
16-3672DP	Premium or Standard Veneer	Standard
	Top Material	W
	Finish/Color	AW
	Edge Profile	D
	Pull/Pull & Lock Color	BBT
	Writing Shelf	AS
	Grommet Location & Color	GR, BLK
	Center Drawer/Keyboard Selection	01-2122CD

PREMIUM VENEER (PV) AND VENEER (W) OPTIONS

Veneer features UVAdvantage, an ultra-violet finish, on all exposed surfaces by utilizing roll-coat UV technology

AW	Artisan Walnut**	MW	Mahogany Walnut**
AS	Asian Night	MAS	Mesa Sunset*
CO	Columbian Walnut**	MTS	Metropolis Sky
DC	Dark Cherry**	ORW	Oak Riftwood*
DFW	Dark Forest Walnut**	PNW	Pinnacle Walnut
EW	Espresso**	SCH	Select Cherry**
FO	Fawn Oak**,**	SKC	Shaker Cherry**
GC	Golden Cherry**	SM	Sugar Maple
HW	Harvest Walnut**	WTA	Weathered Ash*
HNW	Henna Walnut	WC	Williamsburg Cherry**
LW	Legacy Walnut**		

* Finish is Low Sheen ** Available in Premium Veneer (PV)

HPL (P) LAMINATE WORKSURFACE OPTIONS

WOODGRAIN

AS	Asian Night	PNW	Pinnacle Walnut
CO	Columbian Walnut	SCH	Select Cherry
EF	Espresso	SKC	Shaker Cherry
GC	Golden Cherry	SM	Sugar Maple
MW	Mahogany Walnut	WTA	Weathered Ash
ORW	Oak Riftwood	WC	Williamsburg Cherry

EDGE PROFILES

B	Bevel	A	Radius
D	Bullnose	Y	Square
X	Flute	E	Tri-Round

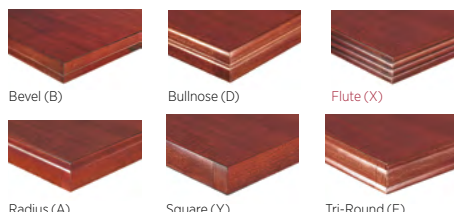

PULL OPTIONS

Note: Lock Core will match Pull Color

AAC Arc, Aluminum	AEL Elite, Aluminum
BAC Arc, Black	BEL Elite, Black
ABM Beam, Aluminum	FPL Finger
BBM Beam, Black	AFL Flair, Aluminum
BBT Bow Tie, Black	CFL Flair, Chrome
NBT Bow Tie, Nickel	AFC Focus, Aluminum
ABU Buckle, Aluminum	BFC Focus, Black
BBU Buckle, Black	AQD Quadra, Aluminum
	BQD Quadra, Black

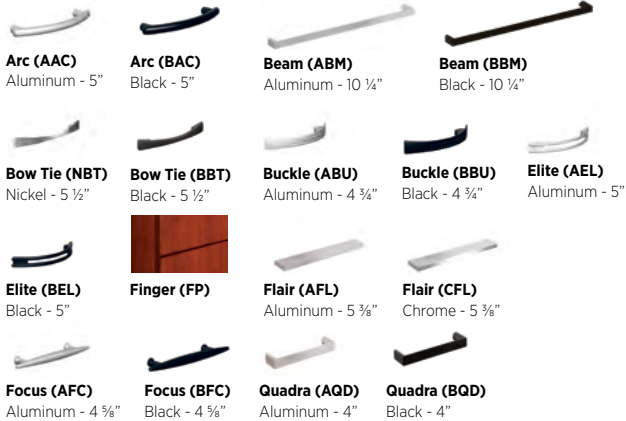

PULL-OUT WRITING SHELVES

Pull-out writing shelves are available on desks. Please specify AS on order and add upcharge.

AS	Single Pedestal Desks	\$ 120
AS	Double Pedestal Desks	\$ 240

GROMMET OPTIONS & LOCATIONS

Grommets are standard in the back panels of returns, bridges, and credenzas, and may be ordered without grommets at no additional charge. Please specify NO GROMMET on order.

Desk grommets are available in standard locations. Please specify using table below. Multiple unit locations may be selected. Only one unit per location.

GC	Grommet, Center - Specify BLK or SLV	\$ 52
GL	Grommet, Left - Specify BLK or SLV	\$ 52
GR	Grommet, Right - Specify BLK or SLV	\$ 52
GAL	Grommet, Approach Left - P-Tops Only - Specify BLK or SLV	\$ 52
GAR	Grommet, Approach Right - P-Tops Only - Specify BLK or SLV	\$ 52
GSL	Grommet, Seat Side Left - P-Tops Only - Specify BLK or SLV	\$ 52
GSR	Grommet, Seat Side Right - P-Tops Only - Specify BLK or SLV	\$ 52

Verify Grommet Option is available on the model(s) you are specifying using the following location information. Grommets may be ordered in non-standard locations. Call Customer Service to assist with specification. Note additional charges and lead times may apply.

Models

16-4272DPS	16-4272DPSO	16-4272LPS	16-4272LPSO
16-4272RPS	16-4272RPSO	16-3672DPS	16-3672LPS
16-3672RP	And All 42"D Modular Tops		

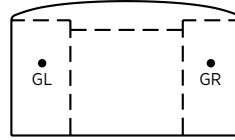

GL/GR: Located 6" from ends and 22 1/2" from user side

Models

14-4272DP	14-4272LP	14-4272RP	16-4272DP
16-4272LP	16-4272RP	And All 42"D Modular Tops	

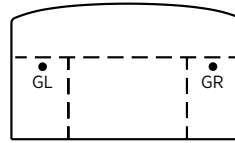

GL/GR: Located 6" from ends and 22 1/2" from user side

Models

16-3672DPSO	16-3672LPSO	16-3672RPSO
And All 36"D Modular Tops		

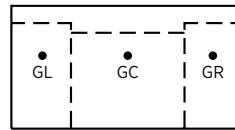

GL/GR: Located 6" from ends and 22 1/2" from user side
 GC: Located 22 1/2" from user side

Models

14-3672DP	14-3672LP	14-3672RP
16-3672DP	16-3672LP	16-3672RP
And All 36"D Modular Tops		

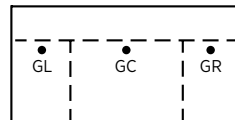

GL/GR: Located 6" from ends and 22 1/2" from user side
 GC: Located 22 1/2" from user side

Models

16-3072LPSO	16-3072RPSO	16-3066LPSO	16-3066RPSO
And All 30"D Modular Tops			

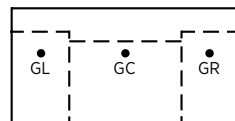

GL/GR: Located 6" from ends and 17" from user side
 GC: Located 17" from user side

Models

14-3060DP	16-3060DP	And All 30"D Modular Tops
-----------	-----------	---------------------------

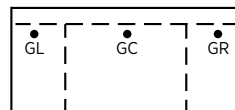

GL/GR: Located 6" from ends and 22 1/2" from user side
 GC: Located 22 1/2" from user side

GROMMET OPTIONS & LOCATIONS (CONTINUED)

Models

14-3072DP 14-3072LP 14-3072RP 14-3066DP
 14-3066LP 14-3066RP 16-3072DP 16-3072LP
 16-3072RP 16-3066DP 16-3066LP 16-3066RP

And All 30"D Modular Tops

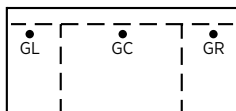

GL/GR: Located 6" from ends and 22 1/2" from user side
 GC: Located 22 1/2" from user side

Models

16-3072LPS 16-3072RPS 16-3066LPS 16-3066RPS

And All 30"D Modular Tops

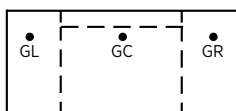

GL/GR: Located 6" from ends and 22 1/2" from user side
 GC: Located 22 1/2" from user side

Models

14-2448UF 14-2448UFH 14-2442UF 14-2442UFH
 14-2436UF 14-2436UFH And All 24"D Modular Bridge
 Tops

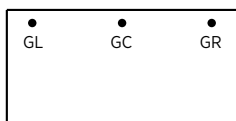

GL/GR: Located 6" from ends and 20" from user side
 GC: Located 20" from user side

Models

14-2448LF 14-2448RF 14-2472LMR* 14-2472RMR*
 14-2442LF 14-2442RF 16-2448LF 16-2448LF2
 16-2448LFH 16-2448LF2H 16-2448RF 16-2448RF2
 16-2448RFH 16-2448RF2H 16-2442LF 16-2442LF2
 16-2442LFH 16-2442LF2H 16-2442RF 16-2442RF2
 16-2442RFH 16-2442RF2H And All 24"D Modular Return
 Tops

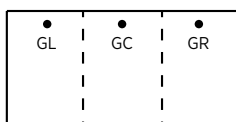

GL/GR: Located 6" from ends and 20" from user side
 GC: Located 20" from user side
 *Grommets are only available on opposite side of pedestal

Models

14-2072KC 14-2072LC 14-2072RC 14-2072RL
 14-2072RL4* 14-2072LL 14-2072LL4* 16-2072KC
 16-2072LC 16-2072LC2 16-2072RC 16-2072RC2

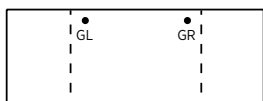

GL/GR: Located 22 1/2" from ends and 17" from user side
 *Grommets are only available on opposite side of pedestal

Models

16-2472KC 16-2472KCH 16-2472LC 16-2472LC2
 16-2472RC 16-2472RC2 16-2472LCH 16-2472LC2H
 16-2472RCH 16-2472RC2H And All 24"D Modular Credenza
 Tops

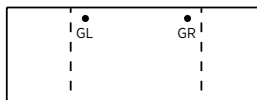

GL/GR: Located 22 1/2" from ends and 20" from user side

Models

14-2066KC 14-2066LC 14-2066RC 16-2066KC
 16-2066LC 16-2066LC2 16-2066RC 16-2066RC2

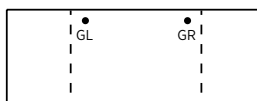

GL/GR: Located 19 1/2" from ends and 17" from user side

Models

16-2466KC 16-2466KCH 16-2466LC 16-2466LC2
 16-2466RC 16-2466RC2 16-2466LCH 16-2466LC2H
 16-2466RCH 16-2466RC2H And All 24"D Modular Credenza
 Tops

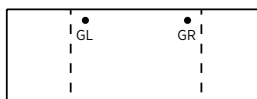

GL/GR: Located 19 1/2" from ends and 20" from user side

Models

14-2472LL 14-2472LL3 14-2472RL 14-2472RL3
 14-2472LLH 14-2472LL3H 14-2472RLH 14-2472RL3H
 14-2466LL 14-2466LL3 14-2466RL 14-2466RL3
 14-2466LLH 14-2466LL3H 14-2466RLH 14-2466RL3H
 14-2066LL4 14-2066RL4 And All 24"D Modular Credenza
 Top

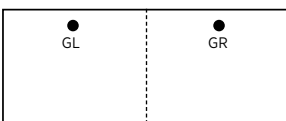

GL/GR: Located 22 1/2" from ends and 20" from user side
 *Grommets are only available on opposite side of pedestal

Models

14-4272PR

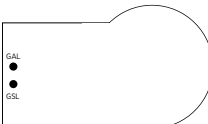

GAL/GSL: Located 12" from approach or seated side, 6" from end

14-4272PR



GAR/GSR: Located 12" from approach or seated side, 6" from end

GROMMET OPTIONS & LOCATIONS (CONTINUED)

Models

14-3672DUR 14-3072DUR



GAL/GSL: Located 12" from approach or seated side, 6" from end

14-3672DUL 14-3072DUL



GAR/GSR: Located 12" from approach or seated side, 6" from end

TABLE GROMMET & POWER UNIT OPTIONS

Power units and grommets are sold separately and must be specified separately with surface mount location. Multiple locations may be selected. Only one unit per location.

Power units and Grommets Available in Table Surfaces (See Units)

Grommet Specify Color: Black = BLK and Silver = SLV

DUO/TRIO BEZEL

01-DUOBEZEL Available in Black (B), Silver (S), or White (W)

01-TRIOBEZEL Available in Black (B), Silver (S), or White (W)

DOCK 950, DOCK 800 and DOCK 150

DOCK950 Available in Black or White

DOCK150 Available in Black or White

DOCK800 Available in Black or Silver

Other Power Units

DPORT4 Available in Aluminum or Black

INTERACTG Available in Aluminum or Black

OASISM Available in Aluminum or Black

Power/Data Location Information:

- Designate unit and location when specifying the top model. Power/Data Module need to be ordered separately.
- Power/Data Modules specified at the time of order will be routed for field installation.

E1 Unit on One End

E2 Unit on Each End

OC Unit on Center

- All power units available **On Center (OC) only** when paired with two (2) or more of the following bases:

Cylinder Base Square Base

X-Base Disc

Tubular X-Base

Grommets and Power Units may be ordered in non-standard locations. Call Customer Service to assist with specification and/or please attach a drawing to the PO showing the location of the grommet. Note additional charges and lead times may apply.

Top Locations

Power units available on Each End (E1 and E2) and On Center (OC) unless otherwise noted, when paired with any Rectangle Panel Base, Rectangle Box Base or Rectangle Accent Box Base. ([See Unit Details](#))

Power units centered at locations below:

36" Tops centered 18"D 48" Tops centered 24"D
42" Tops centered 21"D

72: OC 36" from end (**available with OC Only**)

96: OC 48" from end; E1/E2 29" from end

120: OC 60" from end; E1/E2 29" from end

144: OC 72" from end; E1/E2 29" from end

HUTCH GROMMET OPTIONS

Surface Mount Hutches come standard with one center grommet at workstation level on back panel. Three upper wire management grommets also available. One grommet located on right, center and left. Must specify.

WMHUBL Black Lower Grommet + Three (3) Upper Grommets N/C

WMHUSV Silver Lower Grommet + Three (3) Upper Grommets N/C

LOCKING DOORS

Locking doors are available on select units. You must specify WITH LOCKING when ordering and add upcharge.

LKT_HU	94"W - 84"W Units	\$ 135
LKT_HU	78"W - 48"W Units	\$ 115
LKT_HU	42"W - 24"W Units	\$ 91
LKT_HU	18"W Unit	\$ 69

CERTIFICATIONS & COMPLIANCE

- Intertek Sustainability Certified
- BIFMA level® Certified
- BIFMA Compliant Certified
- TSCA Title VI (formerly CARB) Compliance
- US Green Building's LEED Contribution

Standard Components

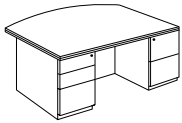

Double Ped Desks with or without Bow Tops and Overhangs
(See Multiple Unit Details)

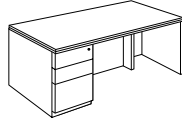

Single Ped Desks with or without Bow Tops
(See Multiple Unit Details)

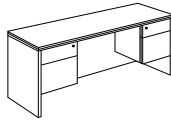

3/4 Double and Single Ped Desks with or without Bow Tops
(See Multiple Double Ped and Single Ped Details)

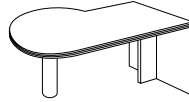

P-Tops and D-Tops
(See Multiple Unit Details)

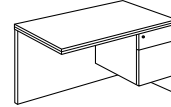

Returns
(See Multiple Unit Details)

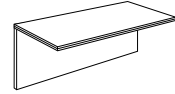

Bridges
(See Multiple Unit Details)



Corner Units
(See Multiple Unit Details)

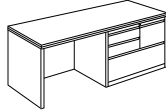

Kneespace, Storage, and Single Ped Credenzas
(See Multiple Unit Details)

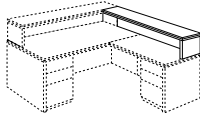

Transaction Risers
(See Multiple Unit Details)

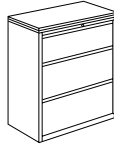

Filing
(See Multiple Unit Details)



Mobile Pedestals
(See Multiple Unit Details)

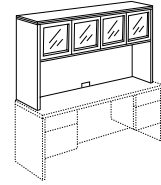

Surface Mount and Wall Mount Hutches
(See Multiple Unit Details)

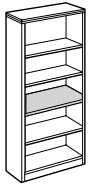

Bookcases
(See Multiple Unit Details)



Wardrobes & Storage Cabinets
(See Multiple Unit Details)

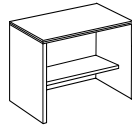

Computer and Work Tables
(See Multiple Unit Details)

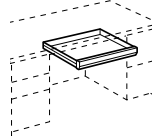

Center Drawer
(See Multiple Unit Details)

Modular Components *(See Multiple Units)*

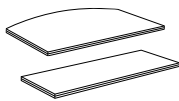

Tables + Bases *(See Multiple Units)*



Occasional Tables

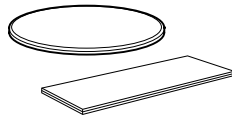
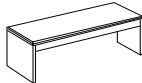

Tables and Tops



Cylinder Bases



Metal Bases

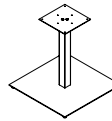

Square Bases

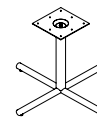

Tubular X- Bases

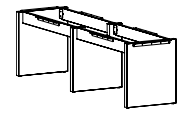

Rectangular Panel Bases with Trough

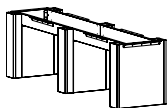

6" Rectangular Bases with Trough

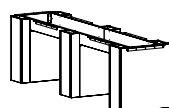

6" Rectangular Accent Bases with Trough

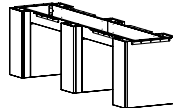

10" Rectangular Bases with Trough

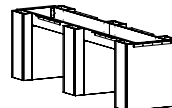

10" Rectangular Accent Bases with Trough

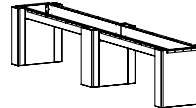

6" + 10" Combo Rectangular Bases with Trough

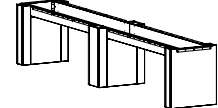

6" + 10" Combo Rectangular Accent Bases with Trough

Keyboard, Tackboard, Tasklights, and Other Accessories *(See Multiple Units)*

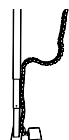
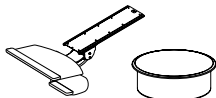
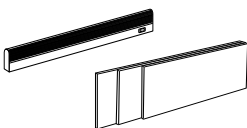

Item	Model No.	Width	Depth	Height	K	R	Ship Wt	Cubic Ft	List Price
L UNIT WITH FULL PEDS AND STEPPED FRONT	16-1	72	84	30	-	-	402	74.9	W/P\$ 9225 PV\$ 10792

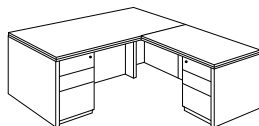

CONSIST OF:	QTY			
16-3672LPS	1	Left Pedestal Desk	W/P\$ 5585 PV\$ 6532	
16-2448RF	1	Right Return	W/P\$ 3640 PV\$ 4260	

Products are available as left or right, where applicable

U UNIT WITH BOW TOP DESK, FULL PED AND STEPPED FRONT	16-2	72	110	70	-	-	756	127.2	W/P\$ 16715 PV\$ 19555
--	------	----	-----	----	---	---	-----	-------	---------------------------

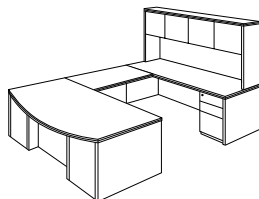

CONSIST OF:	QTY			
16-4272LPS	1	Bow Top Desk, Left Pedestal	W/P\$ 6646 PV\$ 7779	
14-2448UF	1	Bridge	W/P\$ 1703 PV\$ 1991	
16-2072RC	1	Credenza, Right Pedestal	W/P\$ 4015 PV\$ 4696	
14-1572HU	1	Surface Mount Hutch	W/P\$ 4351 PV\$ 5089	

Products are available as left or right, where applicable

Pricing Codes:

W = Wood Top

P = Laminate Top

PV = Premium Veneer

[See Madera Intro Section for Ordering Options](#)

Item	Model No.	Width	Depth	Height	K	R	Ship Wt	Cubic Ft	List Price	
U UNIT WITH P-TOP	16-3	72	110	70	-	-	625	128.2	W/P\$ 15914	PV\$ 18619

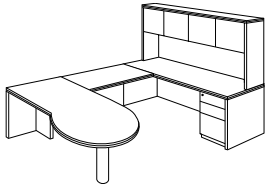

CONSIST OF:		QTY			
14-4272PL	1	P-Top Desk, Left		W/P\$ 5845	PV\$ 6843
14-2448UF	1	Bridge		W/P\$ 1703	PV\$ 1991
16-2072RC	1	Single Ped Credenza, Right		W/P\$ 4015	PV\$ 4696
14-1572HU	1	Hutch		W/P\$ 4351	PV\$ 5089

Products are available as left or right, where applicable

U UNIT WITH D-TOP	16-4	72	104	30	-	-	231	88.8	W/P\$ 9994	PV\$ 11688
-------------------	------	----	-----	----	---	---	-----	------	------------	------------

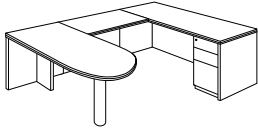

CONSIST OF:		QTY			
14-3672DUL	1	D-Top Desk		W/P\$ 4276	PV\$ 5001
14-2448UF	1	Bridge		W/P\$ 1703	PV\$ 1991
16-2072RC	1	Single Ped Credenza, Right		W/P\$ 4015	PV\$ 4696

Products are available as left or right, where applicable

[See Madera Intro Section for Ordering Options](#)

Item	Model No.	Width	Depth	Height	K	R	Ship Wt	Cubic Ft	List Price
DOUBLE PED DESK WITH BOW TOP	16-4272DPS Stepped Front	72	42-36	30	34 $\frac{5}{16}$	-	326	58.4	W/P\$ 7620 PV\$ 8914
	16-4272DP Recessed Front	72	42-36	30	33 $\frac{1}{2}$	15 $\frac{7}{8}$ -9 $\frac{7}{8}$	326	58.4	W/P\$ 6969 PV\$ 8154

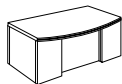
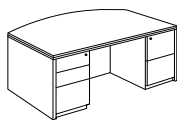

Stepped Front

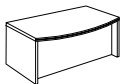

Recessed Front

Description

- Standard With: Bow Top, Letter Width Locking Box/Box/File on Left Pedestal and File/File on Right, Left to Right Grain Direction on Worksurface, Black Utility Tray for Box Drawer
- Available with Premium Veneer (PV) or Standard Veneer (W) Chassis, Must Specify
- Available with Veneer (PV/W) or HPL (P) Top, Must Specify
- Lock Core Color will Coordinate with Pull Selection
- Additional Options: Pull-Out Writing Shelf ([See Shelf Options](#)), Grommet Options ([See Grommet Options](#)), Kneespace Options (Sold Separately, [See Multiple Unit Details](#)), Wire Management + Accessories (Sold Separately, [See Multiple Unit Details](#))

Must Specify (in this order):

Model
Premium or Standard Veneer Chassis
Top Material
Finish/Color
Edge Profile
Drawer Pull
Pull Out Writing Shelf
Worksurface Grommet Location
Grommet Color
Kneespace Options

DOUBLE PED DESK WITH RECTANGLE TOP	16-3672DPS Stepped Front - Legal Ped	72	36	30	34 $\frac{5}{16}$	4 $\frac{13}{16}$	400	51.9	W/P\$ 6575 PV\$ 7691
	16-3672DP Recessed Front - Legal Ped	72	36	30	33 $\frac{3}{16}$	9 $\frac{7}{8}$	425	51.9	W/P\$ 5968 PV\$ 6983
DOUBLE PED DESK WITH RECTANGLE TOP	16-3072DP Recessed Front - Legal Ped	72	30	30	33 $\frac{3}{16}$	3 $\frac{7}{8}$	410	43.9	W/P\$ 5902 PV\$ 6906
	16-3066DP Recessed Front - Letter Ped	66	30	30	33 $\frac{3}{16}$	3 $\frac{7}{8}$	277	40.4	W/P\$ 5567 PV\$ 6512
	16-3060DP Recessed Front - Letter Ped	60	30	30	27 $\frac{1}{16}$	3 $\frac{7}{8}$	259	36.9	W/P\$ 5288 PV\$ 6185

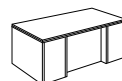

Stepped Front

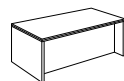

Recessed Front

Description

- Standard With: Rectangle Top, Locking Box/Box/File on Left Pedestal and File/File on Right, Left to Right Grain Direction on Worksurface, Black Utility Tray for Box Drawer
- Available with Premium Veneer (PV) or Standard Veneer (W) Chassis, Must Specify
- Available with Veneer (PV/W) or HPL (P) Top, Must Specify
- Lock Core Color will Coordinate with Pull Selection
- Additional Options: Pull-Out Writing Shelf ([See Shelf Options](#)), Grommet Options ([See Grommet Options](#)), Kneespace Options (Sold Separately, [See Multiple Unit Details](#)), Wire Management + Accessories (Sold Separately, [See Multiple Unit Details](#))

Must Specify (in this order):

Model
Premium or Standard Veneer Chassis
Top Material
Finish/Color
Edge Profile
Drawer Pull
Pull Out Writing Shelf
Worksurface Grommet Location
Grommet Color
Kneespace Options

Pricing Codes:

W = Wood Top

P = Laminate Top

PV = Premium Veneer

[See Madera Intro Section for Ordering Options](#)

Item	Model No.	Width	Depth	Height	K	R	Ship Wt	Cubic Ft	List Price
DOUBLE PED DESK WITH BOW TOP AND STEPPED FRONT	16-4272DPSO	72	42-36	30	34 $\frac{5}{16}$	12-6	310	58.4	W/P\$ 7473 PV\$ 8745

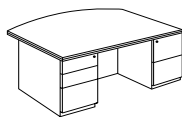

Stepped Front

Description

- Standard With: Bow Top, Stepped Front Modesty, Legal Width Locking Box/Box/File on Left Pedestal and File/File on Right, Left to Right Grain Direction on Worksurface, Black Utility Tray for Box Drawer
- Available with Premium Veneer (PV) or Standard Veneer (W) Chassis, Must Specify
- Available with Veneer (PV/W) or HPL (P) Top, Must Specify
- 16 $\frac{13}{16}$ " Overhang on Approach From Center of Arc to Center of Modesty Panel
- Lock Core Color will Coordinate with Pull Selection
- Additional Options: Pull-Out Writing Shelf ([See Shelf Options](#)), Grommet Options ([See Grommet Options](#)), Kneespace Options (Sold Separately, [See Multiple Unit Details](#)), Wire Management + Accessories (Sold Separately, [See Multiple Unit Details](#))

Must Specify (in this order):

Model
 Premium or Standard Veneer Chassis
 Top Material
 Finish/Color
 Edge Profile
 Drawer Pull
 Pull Out Writing Shelf
 Worksurface Grommet Location
 Grommet Color
 Kneespace Options

DOUBLE PED DESK WITH RECTANGLE TOP AND STEPPED FRONT	16-3672DPSO	72	36	30	34 $\frac{5}{16}$	6	385	51.9	W/P\$ 6438 PV\$ 7532
--	-------------	----	----	----	-------------------	---	-----	------	-------------------------

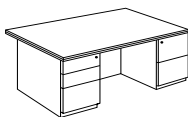

Stepped Front

Description

- Standard With: Rectangle Top, Stepped Front Modesty, Left to Right Grain Direction on Worksurface, Legal Width Locking Ped, Box/Box/File on Left Pedestal and File/File on Right, Black Utility Tray for Box Drawer
- Available with Premium Veneer (PV) or Standard Veneer (W) Chassis, Must Specify
- Available with Veneer (PV/W) or HPL (P) Top, Must Specify
- 10 $\frac{13}{16}$ " Overhang on Approach From Center of Arc to Center of Modesty Panel
- Lock Core Color will Coordinate with Pull Selection
- Additional Options: Pull-Out Writing Shelf ([See Shelf Options](#)), Grommet Options ([See Grommet Options](#)), Kneespace Options (Sold Separately, [See Multiple Unit Details](#)), Wire Management + Accessories (Sold Separately, [See Multiple Unit Details](#))

Must Specify (in this order):

Model
 Premium or Standard Veneer Chassis
 Top Material
 Finish/Color
 Edge Profile
 Drawer Pull
 Pull Out Writing Shelf
 Worksurface Grommet Location
 Grommet Color
 Kneespace Options

[See Madera Intro Section for Ordering Options](#)

Item	Model No.	Width	Depth	Height	K	R	Ship Wt	Cubic Ft	List Price
DOUBLE DESK WITH ¾ PED AND BOW TOP	14-4272DP	72	42-36	33½	34⅝	15⅞ - 9⅞	318	60.1	W/P\$ 6525 PV\$ 7635

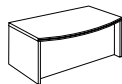
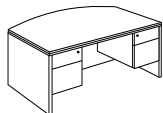

Recessed Front

Description

- Standard With: Bow Top, Recessed Front Modesty, Two (2) Legal Width Locking Box/File ¾ Pedestals, Left to Right Grain Direction on Worksurface, Black Utility Tray for Box Drawer
- Available with Premium Veneer (PV) or Standard Veneer (W) Chassis, Must Specify
- Available with Veneer (PV/W) or HPL (P) Top, Must Specify
- Lock Core Color will Coordinate with Pull Selection
- Additional Options: Pull-Out Writing Shelf ([See Shelf Options](#)), Grommet Options ([See Grommet Options](#)), Kneespace Options (Sold Separately, [See Multiple Unit Details](#)), Wire Management + Accessories (Sold Separately, [See Multiple Unit Details](#))

Must Specify (in this order):

Model
 Premium or Standard Veneer Chassis
 Top Material
 Finish/Color
 Edge Profile
 Drawer Pull
 Pull Out Writing Shelf
 Worksurface Grommet Location
 Grommet Color
 Kneespace Options

DOUBLE DESK WITH ¾ PED AND RECTANGLE TOP	14-3672DP <i>Legal Ped</i>	72	36	30	33⅞	9⅞	295	51.9	W/P\$ 5212 PV\$ 6101
	14-3072DP <i>Legal Ped</i>	72	30	30	33⅞	3⅞	264	43.9	W/P\$ 5062 PV\$ 5925
	14-3066DP <i>Legal Ped</i>	66	30	30	33⅞	3⅞	251	40.0	W/P\$ 4732 PV\$ 5535
	14-3060DP <i>Letter Ped</i>	60	30	30	27⅞	3⅞	228	35.3	W/P\$ 4454 PV\$ 5209

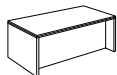
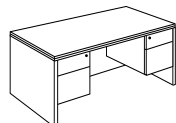

Recessed Front

Description

- Standard With: Rectangle Top, Recessed Front Modesty, Two (2) Locking Box/File ¾ Peds, Left to Right Grain Direction on Worksurface, Black Utility Tray for Box Drawer
- Available with Premium Veneer (PV) or Standard Veneer (W) Chassis, Must Specify
- Available with Veneer (PV/W) or HPL (P) Top, Must Specify
- Lock Core Color will Coordinate with Pull Selection
- Additional Options: Pull-Out Writing Shelf ([See Shelf Options](#)), Grommet Options ([See Grommet Options](#)), Kneespace Options (Sold Separately, [See Multiple Unit Details](#)), Wire Management + Accessories (Sold Separately, [See Multiple Unit Details](#))

Must Specify (in this order):

Model
 Premium or Standard Veneer Chassis
 Top Material
 Finish/Color
 Edge Profile
 Drawer Pull
 Pull Out Writing Shelf
 Worksurface Grommet Location
 Grommet Color
 Kneespace Options

Pricing Codes:

W = Wood Top

P = Laminate Top

PV = Premium Veneer

[See Madera Intro Section for Ordering Options](#)

Item	Model No.	Width	Depth	Height	K	R	Ship Wt	Cubic Ft	List Price	
SINGLE PED DESK WITH BOW TOP 	Left Ped	Right Ped								
	16-4272LPS	16-4272RPS	72	42-36	30	34 ⁵ / ₁₆	10 ¹³ / ₁₆	286	60.1	W/P\$ 6646 PV\$ 7779
	16-4272LP	16-4272RP	66	42-36	30	51 ⁵ / ₈	15 ⁵ / ₈	286	60.1	W/P\$ 5856 PV\$ 6850

Shown as Left

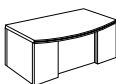

Stepped Front

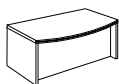

Recessed Front

Must Specify (in this order):

- Model
- Premium or Standard Veneer Chassis
- Top Material
- Finish/Color
- Edge Profile
- Drawer Pull
- Pull Out Writing Shelf
- Worksurface Grommet Location
- Grommet Color
- Kneespace Options

Description

- Standard with: Bow Top, Legal Width Locking Box/Box/File, Left to Right Grain Direction on Worksurface, Black Utility Tray for Box Drawer
- Available with Premium Veneer (PV) or Standard Veneer (W) Chassis, Must Specify
- Available with Veneer (PV/W) or HPL (P) Top, Must Specify
- Lock Core Color will Coordinate with Pull Selection
- Additional Options: Pull-Out Writing Shelf ([See Shelf Options](#)), Grommet Options ([See Grommet Options](#)), Kneespace Options (Sold Separately, [See Multiple Unit Details](#)), Wire Management + Accessories (Sold Separately, [See Multiple Unit Details](#))

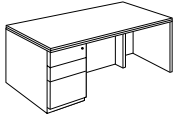
Item	Model No.	Width	Depth	Height	K	R	Ship Wt	Cubic Ft	List Price	
SINGLE PED DESK WITH RECTANGLE TOP 	Left Ped	Right Ped								
	16-3672LPS	16-3672RPS	72	36	30	34 ⁵ / ₁₆	4 ¹³ / ₁₆	267	51.9	W/P\$ 5585 PV\$ 6532
	16-3672LP	16-3672RP	72	36	30	51 ⁵ / ₈	9 ⁵ / ₈	267	51.9	W/P\$ 4974 PV\$ 5816
	16-3072LPS	16-3072RPS	72	30	30	34 ⁵ / ₁₆	4 ¹³ / ₁₆	236	43.9	W/P\$ 5431 PV\$ 6357
	16-3072LP	16-3072RP	72	30	30	51 ⁵ / ₈	3 ⁵ / ₈	236	43.9	W/P\$ 4834 PV\$ 5658
	16-3066LPS	16-3066RPS	66	30	30	28 ⁵ / ₁₆	4 ¹³ / ₁₆	223	40.0	W/P\$ 5031 PV\$ 5887
	16-3066LP	16-3066RP	66	30	30	48 ⁵ / ₁₆	3 ⁵ / ₈	223	40.0	W/P\$ 4478 PV\$ 5244

Shown as Left

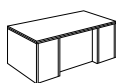

Stepped Front

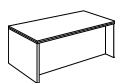

Recessed Front

Must Specify (in this order):

- Model
- Premium or Standard Veneer Chassis
- Top Material
- Finish/Color
- Edge Profile
- Drawer Pull
- Pull Out Writing Shelf
- Worksurface Grommet Location
- Grommet Color
- Kneespace Options

Description

- Standard With: Rectangle Top, Left to Right Grain Direction on Worksurface, Full Modesty, Locking Box/Box/File Pedestal, Black Utility Tray for Box Drawer
- Available with Premium Veneer (PV) or Standard Veneer (W) Chassis, Must Specify
- Available with Veneer (PV/W) or HPL (P) Top, Must Specify
- Lock Core Color will Coordinate with Pull Selection
- Additional Options: Pull-Out Writing Shelf ([See Shelf Options](#)), Grommet Options ([See Grommet Options](#)), Kneespace Options (Sold Separately, [See Multiple Unit Details](#)), Wire Management + Accessories (Sold Separately, [See Multiple Unit Details](#))

[See Madera Intro Section for Ordering Options](#)

Item	Model No.	Width	Depth	Height	K	R	Ship Wt	Cubic Ft	List Price
SINGLE PED DESK WITH BOW TOP AND STEPPED FRONT	Left Ped	Right Ped							
	16-4272LPSO	16-4272RPSO	72	42-36	30	-	12-6	270	58.4

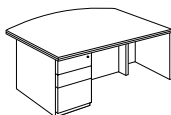

Shown as Left

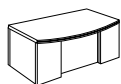

Stepped Front

Description

- Standard with: Bow Top, Stepped Front Modesty, Legal Width Locking Box/Box/File Pedestal, Left to Right Grain Direction on Worksurface, Black Utility Tray for Box Drawer
- Available with Premium Veneer (PV) or Standard Veneer (W) Chassis, Must Specify
- Available with Veneer (PV/W) or HPL (P) Top, Must Specify
- 16¹³/₁₆" Overhang on Approach From Center of Arc to Center of Modesty Panel
- Lock Core Color will Coordinate with Pull Selection
- Additional Options: Pull-Out Writing Shelf ([See Shelf Options](#)), Grommet Options ([See Grommet Options](#)), Kneespace Options (Sold Separately, [See Multiple Unit Details](#)), Wire Management + Accessories (Sold Separately, [See Multiple Unit Details](#))

Must Specify (in this order):

- Model
- Premium or Standard Veneer Chassis
- Top Material
- Finish/Color
- Edge Profile
- Drawer Pull
- Pull Out Writing Shelf
- Worksurface Grommet Location
- Grommet Color
- Kneespace Options

SINGLE PED DESK WITH RECTANGLE TOP AND STEPPED FRONT	Left Ped	Right Ped								
	16-3672LPSO	16-3672RPSO	72	36	30	-	6	251	51.9	W/P\$ 5444 PV\$ 6372
	Legal Ped									
	16-3072LPSO	16-3072RPSO	72	30	30	-	6	220	43.9	W/P\$ 5261 PV\$ 6156
	Legal Ped									
	16-3066LPSO	16-3066RPSO	66	30	30	-	6	207	40.0	W/P\$ 4868 PV\$ 5696
	Letter Ped									

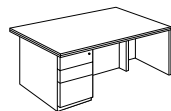

Shown as Left

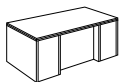

Stepped Front

Description

- Standard With: Rectangle Top, Stepped Front Modesty, Locking Box/Box/File Pedestal, Left to Right Grain Direction on Worksurface, Black Utility Tray for Box Drawer
- Available with Premium Veneer (PV) or Standard Veneer (W) Chassis, Must Specify
- Available with Veneer (PV/W) or HPL (P) Top, Must Specify
- 10¹³/₁₆" Overhang on Approach From Center of Arc to Center of Modesty Panel
- Lock Core Color will Coordinate with Pull Selection
- Additional Options: Pull-Out Writing Shelf ([See Shelf Options](#)), Grommet Options ([See Grommet Options](#)), Kneespace Options (Sold Separately, [See Multiple Unit Details](#)), Wire Management + Accessories (Sold Separately, [See Multiple Unit Details](#))

Must Specify (in this order):

- Model
- Premium or Standard Veneer Chassis
- Top Material
- Finish/Color
- Edge Profile
- Drawer Pull
- Pull Out Writing Shelf
- Worksurface Grommet Location
- Grommet Color
- Kneespace Options

Pricing Codes:

- W = Wood Top
- P = Laminate Top
- PV = Premium Veneer

[See Madera Intro Section for Ordering Options](#)

Item	Model No.	Width	Depth	Height	K	R	Ship Wt	Cubic Ft	List Price
SINGLE DESK WITH ¾ PED AND BOW TOP	Left Ped	Right Ped							
	14-4272LP	14-4272RP	72	42-36	30	51⅝	15⅞	268	60.1

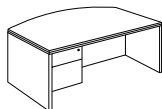

Shown as Left

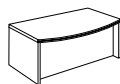

Recessed Front

Description

- Standard With: Bow Top, Recessed Front Modesty, Legal Width Locking Box/File ¾ Pedestal, Left to Right Grain Direction on Worksurface, Black Utility Tray for Box Drawer
- Available with Premium Veneer (PV) or Standard Veneer (W) Chassis, Must Specify
- Available with Veneer (PV/W) or HPL (P) Top, Must Specify
- Lock Core Color will Coordinate with Pull Selection
- Additional Options: Pull-Out Writing Shelf ([See Shelf Options](#)), Grommet Options ([See Grommet Options](#)), Kneespace Options (Sold Separately, [See Multiple Unit Details](#)), Wire Management + Accessories (Sold Separately, [See Multiple Unit Details](#))

Must Specify (in this order):

- Model
- Premium or Standard Veneer Chassis
- Top Material
- Finish/Color
- Edge Profile
- Drawer Pull
- Pull Out Writing Shelf
- Worksurface Grommet Location
- Grommet Color
- Kneespace Options

SINGLE DESK WITH ¾ PED AND RECTANGLE TOP	Left Ped	Right Ped	Width	Depth	Height	K	R	Ship Wt	Cubic Ft	List Price	
	Model No.	Model No.									
SINGLE DESK WITH ¾ PED AND RECTANGLE TOP	14-3672LP	14-3672RP	72	36	30	51⅝	9 7/8	245	51.9	W/P\$ 4427 PV\$ 5176	
	Legal Ped										
	14-3072LP	14-3072RP	72	30	30	51⅝	3 7/8	214	43.9	W/P\$ 4301 PV\$ 5034	
Legal Ped											
SINGLE DESK WITH ¾ PED AND RECTANGLE TOP	14-3066LP	14-3066RP	66	30	30	48⅝	3 7/8	201	40.4	W/P\$ 3958 PV\$ 4631	
	Letter Ped										

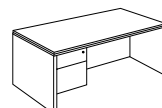

Shown as Left

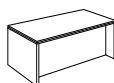

Recessed Front

Description

- Standard With: Rectangle Top, Recessed Front Modesty, Locking Box/File ¾ Pedestal, Left to Right Grain Direction on Worksurface, Black Utility Tray for Box Drawer
- Available with Premium Veneer (PV) or Standard Veneer (W) Chassis, Must Specify
- Available with Veneer (PV/W) or HPL (P) Top, Must Specify
- Lock Core Color will Coordinate with Pull Selection
- Additional Options: Pull-Out Writing Shelf ([See Shelf Options](#)), Grommet Options ([See Grommet Options](#)), Kneespace Options (Sold Separately, [See Multiple Unit Details](#)), Wire Management + Accessories (Sold Separately, [See Multiple Unit Details](#))

Must Specify (in this order):

- Model
- Premium or Standard Veneer Chassis
- Top Material
- Finish/Color
- Edge Profile
- Drawer Pull
- Pull Out Writing Shelf
- Worksurface Grommet Location
- Grommet Color
- Kneespace Options

[See Madera Intro Section for Ordering Options](#)

Item	Model No.	Width	Depth	Height	Ship Wt	Cubic Ft	List Price
	Left Ped	Right Ped					
	14-4272PL	14-4272PR	72	42-36	30	155	58.4

Shown as Left

Must Specify (in this order):

Model
 Premium or Standard Veneer Chassis
 Top Material
 Finish/Color
 Edge Profile
 Worksurface Grommet Location
 Grommet Color
 Leg Color
 Kneespace Options

Description

- 4½" Diameter Metal Base; Must Specify: Black or Aluminum
- Not Recommended for Freestanding Applications
- Available with Premium Veneer (PV) or Standard Veneer (W) Chassis, Must Specify
- Available with Veneer (PV/W) or HPL (P) Top, Must Specify
- For Optional Center Drawer Used with Modesty Panel, [Use 01-1622CD](#)
- Additional Options: Grommet Options ([See Grommet Options](#)), Wire Management + Accessories (Sold Separately, [See Multiple Unit Details](#))

Options: Specify & Add

14-HMD	Optional 10" Modesty Panel; Must specify Color	W\$ 335 PV\$ 390
14-FMD	Optional Full Modesty Panel; Must specify Color	W\$ 554 PV\$ 650

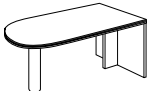
Item	Model No.	Width	Depth	Height	Ship Wt	Cubic Ft	List Price	
	Left Ped	Right Ped						
	14-3672DUL	14-3672DUR	72	36	30	160	50.1	W/P\$ 4276 PV\$ 5001
	14-3072DUL	14-3072DUR	72	30	30	160	44.0	W/P\$ 4041 PV\$ 4731

Shown as Left

Must Specify (in this order):

Model
 Premium or Standard Veneer Chassis
 Top Material
 Finish/Color
 Edge Profile
 Worksurface Grommet Location
 Grommet Color
 Leg Color
 Kneespace Options (14-3672DUL and 14-3672DUR only)

Description

- 4½" Diameter Metal Base; Must Specify: Black or Aluminum
- Not Recommended for Freestanding Applications
- Available with Premium Veneer (PV) or Standard Veneer (W) Chassis, Must Specify
- Available with Veneer (PV/W) or HPL (P) Top, Must Specify
- For Optional Center Drawer Used with Modesty Panel, [Use 01-1622CD](#)
- Keyboard Options and Center Drawer Only Available on 14-3672DUL or 14-3672DUR
- Additional Options: Grommet Options ([See Grommet Options](#)), Kneespace Options (Sold Separately, [See Multiple Unit Details](#)), Wire Management + Accessories (Sold Separately, [See Multiple Unit Details](#))

Options: Specify & Add

14-HMD	Optional 10" Modesty Panel; Must specify Color	W\$ 335 PV\$ 390
14-FMD	Optional Full Modesty Panel; Must specify Color	W\$ 554 PV\$ 650

Pricing Codes:

W = Wood Top

P = Laminate Top

PV = Premium Veneer

[See Madera Intro Section for Ordering Options](#)

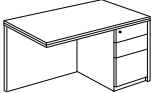
Item	Model No.	Width	Depth	Height	K	R	Ship Wt	Cubic Ft	List Price	
RETURN WITH FULL MODESTY BOX/BOX/FILE 	Left Ped	Right Ped								
	16-2448LF	16-2448RF	48	24	30	31¾	-	140	22.9	W/P\$ 3640 PV\$ 4260
	16-2442LF	16-2442RF	42	24	30	25¾	-	130	19.9	W/P\$ 3556 PV\$ 4161

Shown as Right

Must Specify (in this order):

- Model
- Premium or Standard Veneer Chassis
- Top Material
- Finish/Color
- Edge Profile
- Drawer Pull
- Worksurface Grommet Location
- Grommet Color
- Kneespace Options

Description

- Standard With: Full Modesty, Letter Width Locking Box/Box/File Pedestal, Front to Back Grain Direction on Worksurface
- Available with Premium Veneer (PV) or Standard Veneer (W) Chassis, Must Specify
- Available with Veneer (PV/W) or HPL (P) Top, Must Specify
- Grommet in Back Panel; Must Specify: Black (BLK) or Silver (SLV) or No Back Panel Grommet (NONE)
- Lock Core Color will Coordinate with Pull Selection
- Additional Options: Grommet Options ([See Grommet Options](#)), Kneespace Options (Sold Separately, [See Multiple Unit Details](#)), Wire Management + Accessories (Sold Separately, [See Multiple Unit Details](#))

Item	Model No.	Width	Depth	Height	K	R	Ship Wt	Cubic Ft	List Price	
RETURN WITH FULL MODESTY FILE/FILE 	Left Ped	Right Ped								
	16-2448LF2	16-2448RF2	48	24	30	31¾	-	140	22.9	W/P\$ 3640 PV\$ 4260
	16-2442LF2	16-2442RF2	42	24	30	25¾	-	130	19.9	W/P\$ 3556 PV\$ 4161

Shown as Right

Must Specify (in this order):

- Model
- Premium or Standard Veneer Chassis
- Top Material
- Finish/Color
- Edge Profile
- Drawer Pull
- Worksurface Grommet Location
- Grommet Color
- Kneespace Options

Description

- Standard With: Full Modesty, Letter Width Locking File/File Pedestal, Front to Back Grain Direction on Worksurface
- Available with Premium Veneer (PV) or Standard Veneer (W) Chassis, Must Specify
- Available with Veneer (PV/W) or HPL (P) Top, Must Specify
- Grommet in Back Panel; Must Specify: Black (BLK) or Silver (SLV) or No Back Panel Grommet (NONE)
- Lock Core Color will Coordinate with Pull Selection
- Additional Options: Grommet Options ([See Grommet Options](#)), Kneespace Options (Sold Separately, [See Multiple Unit Details](#)), Wire Management + Accessories (Sold Separately, [See Multiple Unit Details](#))

[See Madera Intro Section for Ordering Options](#)

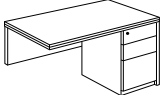
Item	Model No.	Width	Depth	Height	K	R	Ship Wt	Cubic Ft	List Price	
RETURN WITH HALF MODESTY BOX/BOX/FILE 	Left Ped	Right Ped								
	16-2448LFH	16-2448RFH	48	24	30	31¾	-	133	22.9	W/P\$ 3544 PV\$ 4146
	16-2442LFH	16-2442RFH	42	24	30	25¾	-	122	19.9	W/P\$ 3474 PV\$ 4062

Shown as Right

Must Specify (in this order):

- Model
- Premium or Standard Veneer Chassis
- Top Material
- Finish/Color
- Edge Profile
- Drawer Pull
- Worksurface Grommet Location
- Grommet Color
- Kneespace Options

Description

- Standard With: 10" Half Modesty, Letter Width Locking Box/Box/File Pedestal, Front to Back Grain Direction on Worksurface
- Available with Premium Veneer (PV) or Standard Veneer (W) Chassis, Must Specify
- Available with Veneer (PV/W) or HPL (P) Top, Must Specify
- Lock Core Color will Coordinate with Pull Selection
- Additional Options: Grommet Options ([See Grommet Options](#)), Kneespace Options (Sold Separately, [See Multiple Unit Details](#)), Wire Management + Accessories (Sold Separately, [See Multiple Unit Details](#))

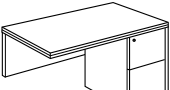
Item	Model No.	Width	Depth	Height	K	R	Ship Wt	Cubic Ft	List Price	
RETURN WITH HALF MODESTY FILE/FILE 	Left Ped	Right Ped								
	16-2448LF2H	16-2448RF2H	48	24	30	31¾	-	132	22.9	W/P\$ 3544 PV\$ 4146
	16-2442LF2H	16-2442RF2H	42	24	30	25¾	-	122	19.9	W/P\$ 3474 PV\$ 4062

Shown as Right

Must Specify (in this order):

- Model
- Premium or Standard Veneer Chassis
- Top Material
- Finish/Color
- Edge Profile
- Drawer Pull
- Worksurface Grommet Location
- Grommet Color
- Kneespace Options

Description

- Standard With: 10" Half Modesty, Letter Width Locking File/File Pedestal, Front to Back Grain Direction on Worksurface
- Available with Premium Veneer (PV) or Standard Veneer (W) Chassis, Must Specify
- Available with Veneer (PV/W) or HPL (P) Top, Must Specify
- Lock Core Color will Coordinate with Pull Selection
- Additional Options: Grommet Options ([See Grommet Options](#)), Kneespace Options (Sold Separately, [See Multiple Unit Details](#)), Wire Management + Accessories (Sold Separately, [See Multiple Unit Details](#))

Pricing Codes:
W = Wood Top
P = Laminate Top
PV = Premium Veneer

[See Madera Intro Section for Ordering Options](#)

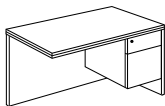
Item	Model No.	Width	Depth	Height	K	R	Ship Wt	Cubic Ft	List Price	
RETURN WITH ¾ BOX/FILE PED 	Left Ped	Right Ped								
	14-2448LF	14-2448RF	48	24	30	3¼	-	132	22.9	W/P\$ 3344 PV\$ 3912
	14-2442LF	14-2442RF	42	24	30	25¾	-	122	19.9	W/P\$ 3270 PV\$ 3826

Shown as Right

Must Specify (in this order):

- Model
- Premium or Standard Veneer Chassis
- Top Material
- Finish/Color
- Edge Profile
- Drawer Pull
- Worksurface Grommet Location
- Modesty Grommet
- Grommet Color
- Kneespace Options

Description

- Standard With: Full Modesty, Letter Width Locking Box/File ¾ Pedestal, Front to Back Grain Direction on Worksurface
- Available with Premium Veneer (PV) or Standard Veneer (W) Chassis, Must Specify
- Available with Veneer (PV/W) or HPL (P) Top, Must Specify
- Grommet in Back Panel; Must Specify: Black (BLK) or Silver (SLV) or No Back Panel Grommet (NONE)
- Lock Core Color will Coordinate with Pull Selection
- Additional Options: Grommet Options ([See Grommet Options](#)), Kneespace Options (Sold Separately, [See Multiple Unit Details](#)), Wire Management + Accessories (Sold Separately, [See Multiple Unit Details](#))

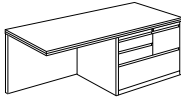
Item	Model No.	Width	Depth	Height	K	R	Ship Wt	Cubic Ft	List Price
MULTI-FILE RETURN WITH FULL MODESTY 	Left Ped	Right Ped							
	14-2472LMR	14-2472RMR	72	24	30	36	-	227	29.0

Shown as Right

Must Specify (in this order):

- Model
- Premium or Standard Veneer Chassis
- Top Material
- Finish/Color
- Edge Profile
- Drawer Pull
- Worksurface Grommet Location
- Modesty Grommet
- Grommet Color
- Kneespace Options

Description

- Standard With: Full Modesty, Box/Box/File/Lateral Pedestal, Locking File Drawer
- Front to Back Grain Direction on Veneer Worksurface; Left to Right Grain Direction on Laminate Worksurface
- Available with Premium Veneer (PV) or Standard Veneer (W) Chassis, Must Specify
- Available with Veneer (PV/W) or HPL (P) Top, Must Specify
- Grommet in Back Panel; Must Specify: Black (BLK) or Silver (SLV) or No Back Panel Grommet (NONE)
- Lateral File Provides Legal or Letter filing Side to Side or Front to Back
- File Drawer Lock Core Color will Coordinate with Pull Selection
- Optional Left or Right Worksurface Grommet Location Only ([See Details](#))
- Additional Options: Kneespace Options (Sold Separately, [See Multiple Unit Details](#)), Wire Management + Accessories (Sold Separately, [See Multiple Unit Details](#))

[See Madera Intro Section for Ordering Options](#)

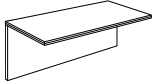
Item	Model No.	Width	Depth	Height	K	R	Ship Wt	Cubic Ft	List Price	
	BRIDGE WITH FULL MODESTY	14-2448UF	48	24	30	23	-	82	6.2	W/P\$ 1703 PV\$ 1991
		14-2442UF	42	24	30	23	-	68	5.5	W/P\$ 1579 PV\$ 1852
		14-2436UF	36	24	30	23	-	68	4.0	W/P\$ 1498 PV\$ 1749

Must Specify (in this order):

Model
 Premium or Standard Veneer Chassis
 Top Material
 Finish/Color
 Edge Profile
 Worksurface Grommet Location
 Modesty Grommet
 Grommet Color

Description

- Standard With: Hinged Full Modesty, Grain Direction Runs Front to Back on Worksurface
- Available with Premium Veneer (PV) or Standard Veneer (W) Chassis, Must Specify
- Available with Veneer (PV/W) or HPL (P) Top, Must Specify
- Grommet in Back Panel; Must Specify: Black (BLK) or Silver (SLV) or No Back Panel Grommet (NONE)
- Some Assembly Required
- Keyboard Accessories Cannot be Factory Installed but are Available for Field Installation
- Additional Options: Grommet Options ([See Grommet Options](#)), Kneespace Options (Sold Separately, [See Multiple Unit Details](#)), Wire Management + Accessories (Sold Separately, [See Multiple Unit Details](#))

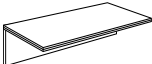
	BRIDGE WITH HALF MODESTY	14-2448UFH	48	24	11 $\frac{5}{16}$	23	-	62	6.2	W/P\$ 1560 PV\$ 1825
		14-2442UFH	42	24	11 $\frac{5}{16}$	23	-	48	5.5	W/P\$ 1429 PV\$ 1678
		14-2436UFH	36	24	11 $\frac{5}{16}$	23	-	48	4.0	W/P\$ 1382 PV\$ 1619

Must Specify (in this order):

Model
 Premium or Standard Veneer Chassis
 Top Material
 Finish/Color
 Edge Profile
 Worksurface Grommet Location
 Grommet Color

Description

- Standard With: Hinged 10" Half Modesty, Grain Direction Runs Front to Back on Worksurface
- Available with Premium Veneer (PV) or Standard Veneer (W) Chassis, Must Specify
- Available with Veneer (PV/W) or HPL (P) Top, Must Specify
- Some Assembly Required
- Keyboard Accessories Cannot be Factory Installed but are Available for Field Installation
- Additional Options: Grommet Options ([See Grommet Options](#)), Kneespace Options (Sold Separately, [See Multiple Unit Details](#)), Wire Management + Accessories (Sold Separately, [See Multiple Unit Details](#))

	CORNER UNIT	14-4242CU	42	42	30	25 $\frac{7}{16}$	-	145	34.5	W/P\$ 3618 PV\$ 4234
		14-3636CU	36	36	30	17	-	135	25.7	W/P\$ 3470 PV\$ 4057

Description

- Connects to 24" Deep Bridge and Return Units
- Available with Veneer (PV/W) or HPL (P) Top, Must Specify
- Available with Premium Veneer (PV) or Standard Veneer (W) Chassis, Must Specify
- Grain Direction Runs Front to Back on Worksurface
- Surface Grommet Standard in Top; Must Specify: Black (BLK) or Silver (SLV)
- Keyboards Accessories for 14-4242CU: 01-KB3 or 01-KB2CC (Sold Separately, [See Multiple Unit Details](#))
- Additional Options: Wire Management + Accessories (Sold Separately, [See Multiple Unit Details](#))

Must Specify (in this order):

Model
 Premium or Standard Veneer Chassis
 Top Material
 Finish/Color
 Edge Profile
 Worksurface Grommet Color

Pricing Codes:

W = Wood Top

P = Laminate Top

PV = Premium Veneer

[See Madera Intro Section for Ordering Options](#)

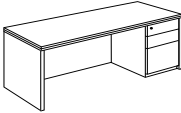
Item	Model No.	Width	Depth	Height	K	R	Ship Wt	Cubic Ft	List Price	
CREDENZA WITH FULL MODESTY BOX/BOX/FILE  Shown as Right	Left Ped	Right Ped								
	16-2472LC	16-2472RC	72	24	30	28¾	-	199	35.6	W/P\$ 4360
		Legal Pedestal								PV\$ 5105
	16-2466LC	16-2466RC	66	24	30	25¾	-	182	32.7	W/P\$ 4087
		Letter Pedestal								PV\$ 4781
	16-2072LC	16-2072RC	72	20	30	28¾	-	183	30.5	W/P\$ 4015
		Legal Pedestal								PV\$ 4696
	16-2066LC	16-2066RC	66	20	30	25¾	-	167	27.8	W/P\$ 3759
	Letter Pedestal								PV\$ 4399	

Must Specify (in this order):

- Model
- Premium or Standard Veneer Chassis
- Top Material
- Finish/Color
- Edge Profile
- Drawer Pull
- Worksurface Grommet Location
- Back Panel Grommet
- Grommet Color
- Kneespace Options

Description

- Standard With: Full Modesty, Left to Right Grain Direction on Worksurface, Locking Box/Box/File Pedestal
- Available with Premium Veneer (PV) or Standard Veneer (W) Chassis, Must Specify
- Available with Veneer (PV/W) or HPL (P) Top, Must Specify
- Grommet in Back Panel; Must Specify: Black (BLK) or Silver (SLV) or No Back Panel Grommet (NONE)
- Lock Core Color will Coordinate with Pull Selection
- Additional Options: Grommet Options ([See Grommet Options](#)), Kneespace Options (Sold Separately, [See Multiple Unit Details](#)), Wire Management + Accessories (Sold Separately, [See Multiple Unit Details](#))

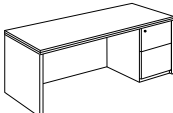
Item	Model No.	Width	Depth	Height	K	R	Ship Wt	Cubic Ft	List Price	
CREDENZA WITH FULL MODESTY FILE/FILE  Shown as Right	Left Ped	Right Ped								
	16-2472LC2	16-2472RC2	72	24	30	28¾	-	199	35.6	W/P\$ 4360
		Legal Pedestal								PV\$ 5105
	16-2466LC2	16-2466RC2	66	24	30	25¾	-	182	32.7	W/P\$ 4087
		Letter Pedestal								PV\$ 4781
	16-2072LC2	16-2072RC2	72	20	30	28¾	-	183	30.5	W/P\$ 4015
		Legal Pedestal								PV\$ 4696
	16-2066LC2	16-2066RC2	66	20	30	25¾	-	167	27.8	W/P\$ 3759
	Letter Pedestal								PV\$ 4399	

Must Specify (in this order):

- Model
- Premium or Standard Veneer Chassis
- Top Material
- Finish/Color
- Edge Profile
- Drawer Pull
- Worksurface Grommet Location
- Back Panel Grommet
- Grommet Color
- Kneespace Options

Description

- Standard With: Full Modesty, Left to Right Grain Direction on Worksurface, Locking File/File Pedestal
- Available with Premium Veneer (PV) or Standard Veneer (W) Chassis, Must Specify
- Available with Veneer (PV/W) or HPL (P) Top, Must Specify
- Grommet in Back Panel; Must Specify: Black (BLK) or Silver (SLV) or No Back Panel Grommet (NONE)
- Lock Core Color will Coordinate with Pull Selection
- Additional Options: Grommet Options ([See Grommet Options](#)), Kneespace Options (Sold Separately, [See Multiple Unit Details](#)), Wire Management + Accessories (Sold Separately, [See Multiple Unit Details](#))

[See Madera Intro Section for Ordering Options](#)

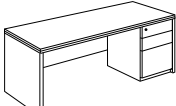
Item	Model No.	Width	Depth	Height	K	R	Ship Wt	Cubic Ft	List Price	
CREENZA WITH HALF MODESTY BOX/BOX/FILE 	Left Ped	Right Ped								
	16-2472LCH	16-2472RCH	72	24	30	28¾	-	242	35.6	W/P\$ 4198
		Legal Pedestal								PV\$ 4911
	16-2466LCH	16-2466RCH	66	24	30	28¾	-	170	32.7	W/P\$ 3928
	Letter Pedestal								PV\$ 4597	

Shown as Right

Must Specify (in this order):

Model
 Premium or Standard Veneer Chassis
 Top Material
 Finish/Color
 Edge Profile
 Drawer Pull
 Worksurface Grommet Location
 Grommet Color
 Kneespace Options

Description

- Standard With: 10" Half Modesty, Left to Right Grain Direction on Worksurface, Locking Box/Box/File Pedestal
- Available with Premium Veneer (PV) or Standard Veneer (W) Chassis, Must Specify
- Available with Veneer (PV/W) or HPL (P) Top, Must Specify
- Lock Core Color will Coordinate with Pull Selection
- Additional Options: Grommet Options ([See Grommet Options](#)), Kneespace Options (Sold Separately, [See Multiple Unit Details](#)), Wire Management + Accessories (Sold Separately, [See Multiple Unit Details](#))

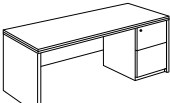
Item	Model No.	Width	Depth	Height	K	R	Ship Wt	Cubic Ft	List Price	
CREENZA WITH HALF MODESTY FILE/FILE 	Left Ped	Right Ped								
	16-2472LC2H	16-2472RC2H	72	24	30	28¾	-	242	35.6	W/P\$ 4198
		Legal Pedestal								PV\$ 4911
	16-2466LC2H	16-2466RC2H	66	24	30	28¾	-	170	32.7	W/P\$ 3928
	Letter Pedestal								PV\$ 4597	

Shown as Right

Must Specify (in this order):

Model
 Premium or Standard Veneer Chassis
 Top Material
 Finish/Color
 Edge Profile
 Drawer Pull
 Worksurface Grommet Location
 Grommet Color
 Kneespace Options

Description

- Standard With: 10" Half Modesty, Left to Right Grain Direction on Worksurface, Locking File/File Pedestal
- Available with Premium Veneer (PV) or Standard Veneer (W) Chassis, Must Specify
- Available with Veneer (PV/W) or HPL (P) Top, Must Specify
- Lock Core Color will Coordinate with Pull Selection
- Additional Options: Grommet Options ([See Grommet Options](#)), Kneespace Options (Sold Separately, [See Multiple Unit Details](#)), Wire Management + Accessories (Sold Separately, [See Multiple Unit Details](#))

Pricing Codes:

W = Wood Top

P = Laminate Top

PV = Premium Veneer

[See Madera Intro Section for Ordering Options](#)

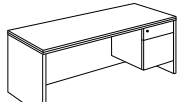
Item	Model No.	Width	Depth	Height	K	R	Ship Wt	Cubic Ft	List Price	
CREDENZA WITH FULL MODESTY BOX/FILE 3/4 PED 	Left Ped	Right Ped								
	14-2072LC	14-2072RC	72	20	30	28¾	-	172	30.5	W/P\$ 3670
		Legal Pedestal								PV\$ 4294
	14-2066LC	14-2066RC	66	20	30	25¾	-	158	27.8	W/P\$ 3365
	Letter Pedestal								PV\$ 3938	

Shown as Right

Must Specify (in this order):

- Model
- Premium or Standard Veneer Chassis
- Top Material
- Finish/Color
- Edge Profile
- Drawer Pull
- Worksurface Grommet Location
- Back Panel Grommet
- Grommet Color
- Kneespace Options

Description

- Standard With: Full Modesty, Left to Right Grain Direction on Worksurface, Locking Box/File ¾ Pedestal
- Available with Premium Veneer (PV) or Standard Veneer (W) Chassis, Must Specify
- Available with Veneer (PV/W) or HPL (P) Top, Must Specify
- Grommet in Back Panel; Must Specify: Black (BLK) or Silver (SLV) or No Back Panel Grommet (NONE)
- Lock Core Color will Coordinate with Pull Selection
- Additional Options: Grommet Options ([See Grommet Options](#)), Kneespace Options (Sold Separately, [See Multiple Unit Details](#)), Wire Management + Accessories (Sold Separately, [See Multiple Unit Details](#))

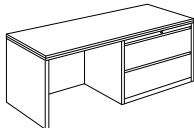
Item	Model No.	Width	Depth	Height	K	R	Ship Wt	Cubic Ft	List Price	
CREDENZA WITH FULL MODESTY LATERAL FILE 	Left Ped	Right Ped								
	14-2472LL	14-2472RL	72	24	30	12	-	277	35.6	W/P\$ 4751
		36" Pedestal								PV\$ 5555
	14-2466LL	14-2466RL	66	24	30	6	-	264	32.7	W/P\$ 4670
		36" Pedestal								PV\$ 5465
	14-2472LL3	14-2472RL3	72	24	30	12	-	267	35.6	W/P\$ 4533
		30" Pedestal								PV\$ 5304
	14-2466LL3	14-2466RL3	66	24	30	6	-	254	32.7	W/P\$ 4456
	30" Pedestal								PV\$ 5212	
14-2072LL	14-2072RL	72	20	30	12	-	224	30.2	W/P\$ 4404	
	36" Pedestal								PV\$ 5154	
14-2066LL	14-2066RL	66	20	30	6	-	215	27.8	W/P\$ 4333	
	36" Pedestal								PV\$ 5070	

Shown as Right

Must Specify (in this order):

- Model
- Premium or Standard Veneer Chassis
- Top Material
- Finish/Color
- Edge Profile
- Drawer Pull
- Worksurface Grommet Location
- Back Panel Grommet
- Grommet Color
- Kneespace Options

Description

- Standard With: Full Modesty, Left to Right Grain Direction on Worksurface, Two (2) Central Locking Lateral Drawers
- Available with Premium Veneer (PV) or Standard Veneer (W) Chassis, Must Specify
- Available with Veneer (PV/W) or HPL (P) Top, Must Specify
- Grommet in Back Panel; Must Specify: Black (BLK) or Silver (SLV) or No Back Panel Grommet (NONE)
- Lock Core Color will Coordinate with Pull Selection
- Lateral File Provides Legal or Letter filing Side to Side or Front to Back
- Additional Options: Grommet Options ([See Grommet Options](#)), Kneespace Options (Sold Separately, [See Multiple Unit Details](#)), Wire Management + Accessories (Sold Separately, [See Multiple Unit Details](#))

[See Madera Intro Section for Ordering Options](#)

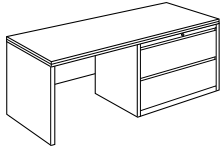
Item	Model No.	Width	Depth	Height	K	R	Ship Wt	Cubic Ft	List Price	
CREDENZA WITH HALF MODESTY LATERAL FILE 	Left Ped	Right Ped								
	14-2472LLH	14-2472RLH	72	24	30	12	-	273	35.6	W/P\$ 4634 PV\$ 5423
	14-2466LLH	14-2466RLH	66	24	30	6	-	260	32.7	W/P\$ 4577 PV\$ 5353
	14-2472LL3H	14-2472RL3H	72	24	30	12	-	263	35.6	W/P\$ 4402 PV\$ 5152
	14-2466LL3H	14-2466RL3H	66	24	30	6	-	250	32.7	W/P\$ 4343 PV\$ 5080

Shown as Right

Must Specify (in this order):

Model
 Premium or Standard Veneer Chassis
 Top Material
 Finish/Color
 Edge Profile
 Drawer Pull
 Worksurface Grommet Location
 Grommet Color
 Kneespace Options

Description

- Standard With: 10" Half Modesty, Left to Right Grain Direction on Worksurface, Two (2) Central Locking Lateral Drawers
- Available with Premium Veneer (PV) or Standard Veneer (W) Chassis, Must Specify
- Available with Veneer (PV/W) or HPL (P) Top, Must Specify
- Lock Core Color will Coordinate with Pull Selection
- Lateral File Provides Legal or Letter filing Side to Side or Front to Back
- Additional Options: Grommet Options ([See Grommet Options](#)), Kneespace Options (Sold Separately, [See Multiple Unit Details](#)), Wire Management + Accessories (Sold Separately, [See Multiple Unit Details](#))

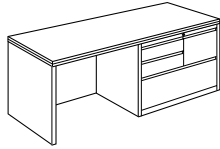
Item	Model No.	Width	Depth	Height	K	R	Ship Wt	Cubic Ft	List Price	
MULTI-FILE CREDENZA WITH FULL MODESTY BOX/BOX/FILE/LATERAL FILE 	Left Ped	Right Ped								
	14-2072LL4	14-2072RL4	72	20	30	12	-	231	29.0	W/P\$ 4995 PV\$ 5845
	14-2066LL4	14-2066RL4	66	20	30	6	-	219	27.8	W/P\$ 4929 PV\$ 5768

Shown as Right

Must Specify (in this order):

Model
 Premium or Standard Veneer Chassis
 Top Material
 Finish/Color
 Edge Profile
 Drawer Pull
 Worksurface Grommet Location
 Grommet Color
 Kneespace Options

Description

- Standard With: Full Modesty, Left to Right Grain Direction on Worksurface, Box/Box/File/Lateral Pedestal, Locking File Drawer
- Available with Premium Veneer (PV) or Standard Veneer (W) Chassis, Must Specify
- Available with Veneer (PV/W) or HPL (P) Top, Must Specify
- Lock Core Color will Coordinate with Pull Selection
- Lateral File Provides Legal or Letter filing Side to Side or Front to Back
- Additional Options: Grommet Options ([See Grommet Options](#)), Kneespace Options (Sold Separately, [See Multiple Unit Details](#)), Wire Management + Accessories (Sold Separately, [See Multiple Unit Details](#))

Pricing Codes:

W = Wood Top

P = Laminate Top

PV = Premium Veneer

[See Madera Intro Section for Ordering Options](#)

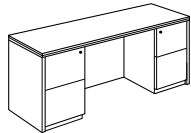
Item	Model No.	Width	Depth	Height	K	R	Ship Wt	Cubic Ft	List Price
 KNEESPACE CREDENZA FULL MODESTY WITH FILE/FILE	16-2472KC Legal Ped	72	24	30	33½	-	240	35.6	W/P\$ 5568 PV\$ 6516
	16-2466KC Letter Ped	66	24	30	33½	-	220	32.7	W/P\$ 5090 PV\$ 5955
	16-2072KC Legal Ped	72	20	30	33½	-	223	30.5	W/P\$ 5188 PV\$ 6069
	16-2066KC Letter Ped	66	20	30	33½	-	221	27.8	W/P\$ 4741 PV\$ 5549

Must Specify (in this order):

Model
 Premium or Standard Veneer Chassis
 Top Material
 Finish/Color
 Edge
 Drawer Pull
 Worksurface Grommet Location
 Back Panel Grommet
 Grommet Color
 Kneespace Options

Description

- Standard With: Full Modesty, Left to Right Grain Direction on Worksurface, Locking File/File Pedestals
- Available with Premium Veneer (PV) or Standard Veneer (W) Chassis, Must Specify
- Available with Veneer (PV/W) or HPL (P) Top, Must Specify
- Grommet in Back Panel; Must Specify: Black (BLK) or Silver (SLV) or No Back Panel Grommet (NONE)
- Lock Core Color will Coordinate with Pull Selection
- Additional Options: Grommet Options ([See Grommet Options](#)), Kneespace Options (Sold Separately, [See Multiple Unit Details](#)), Wire Management + Accessories (Sold Separately, [See Multiple Unit Details](#))

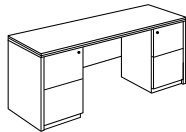
 KNEESPACE CREDENZA HALF MODESTY WITH FILE/FILE	16-2472KCH Legal Ped	72	24	30	33½	-	236	35.6	W/P\$ 5461 PV\$ 6391
	16-2466KCH Letter Ped	66	24	30	33½	-	216	32.7	W/P\$ 4982 PV\$ 5829

Must Specify (in this order):

Model
 Premium or Standard Veneer Chassis
 Top Material
 Finish/Color
 Edge
 Drawer Pull
 Worksurface Grommet Location
 Grommet Color
 Kneespace Options

Description

- Standard With: 10" Half Modesty, Left to Right Grain Direction on Worksurface, Locking File/File Pedestals
- Available with Premium Veneer (PV) or Standard Veneer (W) Chassis, Must Specify
- Available with Veneer (PV/W) or HPL (P) Top, Must Specify
- Lock Core Color will Coordinate with Pull Selection
- Additional Options: Grommet Options ([See Grommet Options](#)), Kneespace Options (Sold Separately, [See Multiple Unit Details](#)), Wire Management + Accessories (Sold Separately, [See Multiple Unit Details](#))

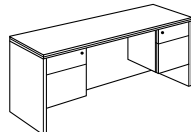
 KNEESPACE CREDENZA FULL MODESTY WITH 3/4 PED BOX/FILE	14-2072KC Legal Ped	72	20	30	33½	-	295	51.9	W/P\$ 4416 PV\$ 5168
	14-2066KC Letter Ped	66	20	30	33½	-	264	43.9	W/P\$ 4111 PV\$ 4807

Must Specify (in this order):

Model
 Premium or Standard Veneer Chassis
 Top Material
 Finish/Color
 Edge
 Drawer Pull
 Worksurface Grommet Location
 Back Panel Grommet
 Grommet Color

Description

- Standard With: Full Modesty, Left to Right Grain Direction on Worksurface, Locking Box/File Pedestals
- Available with Premium Veneer (PV) or Standard Veneer (W) Chassis, Must Specify
- Available with Veneer (PV/W) or HPL (P) Top, Must Specify
- Grommet in Back Panel; Must Specify: Black (BLK) or Silver (SLV) or No Back Panel Grommet (NONE)
- Lock Core Color will Coordinate with Pull Selection
- Additional Options: Grommet Options ([See Grommet Options](#)), Kneespace Options (Sold Separately, [See Multiple Unit Details](#)), Wire Management + Accessories (Sold Separately, [See Multiple Unit Details](#))

[See Madera Intro Section for Ordering Options](#)

Item	Model No.	Width	Depth	Height	Ship Wt	Cubic Ft	List Price
TRANSACTION RISER FOR DESKS AND CREDENZAS	14-1270TR	70 $\frac{5}{8}$	12	13 $\frac{3}{16}$	62	9.7	W/P\$ 2696 PV\$ 3153
	14-1264TR	64 $\frac{5}{8}$	12	13 $\frac{3}{16}$	56	8.9	W/P\$ 2416 PV\$ 2826

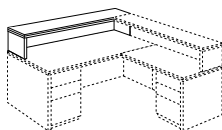

Must Specify (in this order):

Model
Premium or Standard Veneer Chassis
Top Material
Finish/Color
Edge Profile

Description

- Left to Right Grain Direction
- Freestanding Riser; May Be Used in Conjunction with Return Riser or Bridge Risers
- Available with Premium Veneer (PV) or Standard Veneer (W) Chassis, Must Specify
- Available with Veneer (PV/W) or HPL (P) Top, Must Specify

TRANSACTION RISER FOR RETURNS	Left Ped	Right Ped	Width	Depth	Height	Ship Wt	Cubic Ft	List Price
	14-0971LU	14-0971RU	71	9	13 $\frac{3}{16}$	45	6.8	W/P\$ 2674 PV\$ 3131
	14-0959LU	14-0959RU	59	9	13 $\frac{3}{16}$	40	6.1	W/P\$ 2207 PV\$ 2579

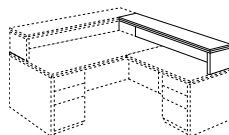

Shown as Right

Must Specify (in this order):

Model
Premium or Standard Veneer Chassis
Top Material
Finish/Color
Edge Profile

Description

- Left to Right Grain Direction
- Must Be Used in Conjunction with Desk Risers
- Available with Premium Veneer (PV) or Standard Veneer (W) Chassis, Must Specify
- Available with Veneer (PV/W) or HPL (P) Top, Must Specify

TRANSACTION RISER FOR BRIDGES	14-0978BU	78	9	13 $\frac{3}{16}$	48	7.9	W/P\$ 2472 PV\$ 2887
	14-0966BU	66	9	13 $\frac{3}{16}$	43	6.5	W/P\$ 2225 PV\$ 2605

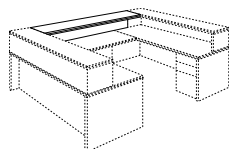

Must Specify (in this order):

Model
Premium or Standard Veneer Chassis
Top Material
Finish/Color
Edge Profile

Description

- Left to Right Grain Direction
- Must Be Used in Conjunction with Two (2) Desk/Credenza Risers
- Available with Premium Veneer (PV) or Standard Veneer (W) Chassis, Must Specify
- Available with Veneer (PV/W) or HPL (P) Top, Must Specify

Pricing Codes:

W = Wood Top

P = Laminate Top

PV = Premium Veneer

[See Madera Intro Section for Ordering Options](#)

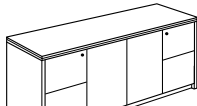
Item	Model No.	Width	Depth	Height	Ship Wt	Cubic Ft	List Price
STORAGE CREDENZA FULL PEDESTAL 	16-2472SC Legal Width Ped	72	24	30	285	35.6	W/P\$ 6020 PV\$ 7047
	16-2466SC Letter Width Ped	66	24	30	261	32.7	W/P\$ 5509 PV\$ 6443
	16-2072SC Legal Width Ped	72	20	30	270	30.5	W/P\$ 5682 PV\$ 6650

Description

- Locking File/File Pedestals
- Fixed Storage Shelf Behind Doors
- Available with Premium Veneer (PV) or Standard Veneer (W) Chassis, Must Specify
- Available with Veneer (PV/W) or HPL (P) Top, Must Specify
- Lock Core Color for Drawers will Coordinate with Pull Selection

Must Specify (in this order):

Model
 Premium or Standard Veneer Chassis
 Top Material
 Finish/Color
 Edge Profile
 Drawer Pull

STORAGE CREDENZA 3/4 PEDESTAL 	14-2072SC	72	20	30	227	30.5	W/P\$ 4919 PV\$ 5758
---	-----------	----	----	----	-----	------	-------------------------

Description

- Legal Width, Locking Box/File Pedestals
- Available with Premium Veneer (PV) or Standard Veneer (W) Chassis, Must Specify
- Available with Veneer (PV/W) or HPL (P) Top, Must Specify
- Lock Core Color for Drawers will Coordinate with Pull Selection

Must Specify (in this order):

Model
 Premium or Standard Veneer Chassis
 Top Material
 Finish/Color
 Edge Profile
 Drawer Pull

DOUBLE LATERAL CREDENZA 	14-2072DL	72	20	30	303	30.2	W/P\$ 6625 PV\$ 7753
--	-----------	----	----	----	-----	------	-------------------------

Description

- Dual Locking Lateral File Drawers Provide Legal or Letter Filing
- Available with Premium Veneer (PV) or Standard Veneer (W) Chassis, Must Specify
- Available with Veneer (PV/W) or HPL (P) Top, Must Specify
- Lock Core Color will Coordinate with Pull Selection

Must Specify (in this order):

Model
 Premium or Standard Veneer Chassis
 Top Material
 Finish/Color
 Edge Profile
 Drawer Pull

[See Madera Intro Section for Ordering Options](#)

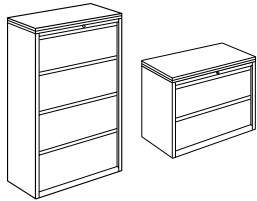
Item	Model No.	Width	Depth	Height	Ship Wt	Cubic Ft	List Price
	LATERAL FILE						
	14-2436L4	36	24	55½	312	30.2	W/P\$ 6815 PV\$ 7980
	Four (4) Drawers						
	14-2430L4	30	24	55½	260	27.5	W/P\$ 6413 PV\$ 7504
	Four (4) Drawers						
	14-2036L4	36	20	55½	276	28.3	W/P\$ 6377 PV\$ 7461
	Four (4) Drawers						
	14-2436L3	36	24	42	235	24.9	W/P\$ 5442 PV\$ 6367
	Three (3) Drawers						
	14-2430L3	30	24	42	204	21.9	W/P\$ 5118 PV\$ 5990
Three (3) Drawers							
14-2436L2	36	24	30	184	18.3	W/P\$ 3614 PV\$ 4229	
Two (2) Drawers							
14-2430L2	30	24	30	153	15.6	W/P\$ 3400 PV\$ 3976	
Two (2) Drawers							
14-2036L2	36	20	30	153	15.5	W/P\$ 3378 PV\$ 3955	
Two (2) Drawers							

Must Specify (in this order):

Model
 Premium or Standard Veneer Chassis
 Top Material
 Finish/Color
 Edge Profile
 Drawer Pull

Description

- Standard with: Central Locking, Anti-Tilt System
- Available with Premium Veneer (PV) or Standard Veneer (W) Chassis, Must Specify
- Available with Veneer (PV/W) or HPL (P) Top, Must Specify
- Lock Core Color will Coordinate with Pull Selection
- File Drawers Provide Legal or Letter Filing

MULTI-FILE	14-2036MF	36	20	30	185	14.9	W/P\$ 4060 PV\$ 4754
------------	-----------	----	----	----	-----	------	-------------------------

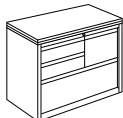

Must Specify (in this order):

Model
 Premium or Standard Veneer Chassis
 Top Material
 Finish/Color
 Edge Profile
 Drawer Pull

Description

- Standard: Box/Box/File/Lateral Pedestal, Locking File Drawer
- Available with Premium Veneer (PV) or Standard Veneer (W) Chassis, Must Specify
- Available with Veneer (PV/W) or HPL (P) Top, Must Specify
- Lock Core Color will Coordinate with Pull Selection
- File Drawers Provide Legal or Letter Filing

Pricing Codes:

W = Wood Top

P = Laminate Top

PV = Premium Veneer

[See Madera Intro Section for Ordering Options](#)

Item	Model No.	Width	Depth	Height	Ship Wt	Cubic Ft	List Price
MOBILE PEDESTAL	14-1619MP1	16	19	28½	90	9.0	W\$ 2924 PV\$ 3420



Description

- Standard with: Locking Box/Box/File Pedestal, Letter Width Pedestal, and Five Casters
- Available with Premium Veneer (PV) or Standard Veneer (W) Chassis, Must Specify
- Lock Core Color will Coordinate with Pull Selection
- Fits Underneath 30"H Worksurfaces
- Finger Pull Option Not Available

Must Specify (in this order):

Model
Premium or Standard Veneer Chassis
Finish/Color
Drawer Pull

SURFACE MOUNT HUTCH WITH WOOD DOORS

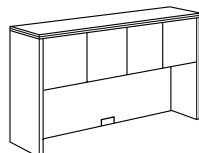

14-1596HU Six Doors	96-93	15¼	40	305	41.0	W\$ 6333 PV\$ 7413
14-1590HU Five Doors	90-87	15¼	40	285	38.9	W\$ 5769 PV\$ 6746
14-1584HU Five Doors	84-81	15¼	40	270	36.8	W\$ 5370 PV\$ 6279
14-1578HU Four Doors	78-75	15¼	40	260	33.8	W\$ 4786 PV\$ 5599
14-1572HU Four Doors	72-69	15¼	40	205	33.1	W\$ 4351 PV\$ 5089
14-1566HU Four Doors	66-63	15¼	40	193	32.9	W\$ 4142 PV\$ 4844

Must Specify (in this order):

Model
Premium or Standard Veneer Chassis
Finish/Color
Edge Profile
Door Pull
Locking Doors
Tackboard
Tackboard Fabric
Task Light
Grommet Color

Description

- Standard with: Soft-Close Hinged Doors, Vertical Grain Direction
- 22¾" Clearance Below Apron Rail
- Lower, Center Grommet on Back Panel Standard; Must Specify: Black (BLK) or Silver (SLV)
- Available in Premium Veneer (PV) or Standard Veneer (W), Must Specify
- Overall Width of Unit will be Determined by Edge Detail Selected
- Additional Options: Locking Doors ([See Locking Options](#)), Factory Installed Tackboard ([See Tackboard](#)), Tasklights ([See Tasklights](#)), Three (3) Upper Wire Management Grommets ([See Grommet Options](#))

[See Madera Intro Section for Ordering Options](#)

Item	Model No.	Width	Depth	Height	Ship Wt	Cubic Ft	List Price
SURFACE MOUNT HUTCH WITH ACRYLIC DOORS	14-1572AH	72-69	15¼	40	258	33.1	W\$ 4781 PV\$ 5597
	14-1566AH	66-63	15¼	40	235	24.3	W\$ 4564 PV\$ 5340

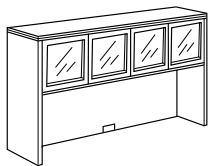

Must Specify (in this order):

Model
Premium or Standard Veneer Chassis
Finish/Color
Edge Profile
Acrylic Insert Style
Door Pull
Locking Doors
Tackboard
Tackboard Fabric
Task Light
Grommet Color

Description

- Standard with: Four (4) Wood Frame Doors with Acrylic Inserts, Soft-Close Hinges, Vertical Grain Direction
- 22 ¾" Clearance Below Apron Rail
- Lower, Center Grommet on Back Panel Standard; Must Specify: Black (BLK) or Silver (SLV)
- Available in Premium Veneer (PV) or Standard Veneer (W), Must Specify
- Overall Width of Unit will be Determined by Edge Detail Selected
- Additional Options: Locking Doors ([See Locking Options](#)), Factory Installed Tackboard ([See Tackboard](#)), Tasklights ([See Tasklights](#)), Three (3) Upper Wire Management Grommets ([See Grommet Options](#))

Options: Specify & Add

CA	Clear Acrylic Door Inserts	Included
FA	Frosted Acrylic Door Inserts	Included

Item	Model No.	Width	Depth	Height	Ship Wt	Cubic Ft	List Price
OPTIONAL PAPER SLOTS FOR SURFACE MOUNT HUTCHES	14-1194PS Six Slots	93½-90½	11½	5¼	55	4.2	W\$ 2952 PV\$ 3453
	14-1188PS Five Slots	87½-84½	11½	5¼	52	3.9	W\$ 2737 PV\$ 3200
	14-1182PS Five Slots	81½-78½	11½	5¼	49	3.7	W\$ 2526 PV\$ 2956
	14-1176PS Four Slots	75 ½-72½	11½	5¼	45	3.4	W\$ 2307 PV\$ 2701
	14-1170PS Four Slots	69½-66½	11½	5¼	42	3.1	W\$ 2095 PV\$ 2452
	14-1164PS Four Slots	63½-60½	11½	5¼	38	2.9	W\$ 1884 PV\$ 2207

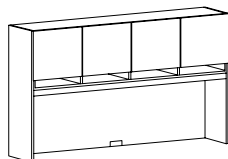
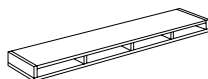

Must Specify (in this order):

Model
Premium or Standard Veneer Chassis
Finish/Color

Description

- For Use with Surface Mount Hutches
- Available in Premium Veneer (PV) or Standard Veneer (W), Must Specify
- Overall Width of Units will be Determined by Edge Detail Selected
- Ships Factory Installed

Pricing Codes:

W = Wood Top

P = Laminate Top

PV = Premium Veneer

[See Madera Intro Section for Ordering Options](#)

Item	Model No.	Width	Depth	Height	Ship Wt	Cubic Ft	List Price
WALL MOUNT HUTCH WITH WOOD DOORS	14-1536WD	36	15¼	17½	70	7.6	W\$ 2412 PV\$ 2818

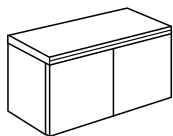

Description

- Standard with: Two (2) Soft-Close Hinge Doors, Vertical Grain Direction
- Mounts to Wall with Mounting Bracket Included
- Available in Premium Veneer (PV) or Standard Veneer (W), Must Specify
- Top Profiled on Front Only for Multiple Unit Application
- Indiana Furniture Will Not Be Liable for Wall Mount Hutch Units That are not Properly Installed
- Additional Options: Locking Doors ([See Locking Options](#))

Must Specify (in this order):

- Model
- Premium or Standard Veneer Chassis
- Finish/Color
- Edge Profile
- Door Pull
- Locking Doors

WALL MOUNT HUTCH WITH ACRYLIC DOORS	14-1536AW	36	15¼	17½	70	7.6	W\$ 2594 PV\$ 3033
-------------------------------------	-----------	----	-----	-----	----	-----	-----------------------

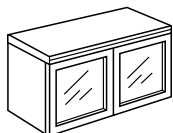

Description

- Standard with: Two (2) **Wood Frame Doors with Acrylic Inserts**, Soft-Close Hinges, and Vertical Grain Direction
- Mounts to Wall with Mounting Bracket Included
- Available in Premium Veneer (PV) or Standard Veneer (W), Must Specify
- Top Profiled on Front Only for Multiple Unit Application
- Indiana Furniture Will Not Be Liable for Wall Mount Hutch Units That are not Properly Installed
- Additional Options: Locking Doors ([See Locking Options](#))

Must Specify (in this order):

- Model
- Premium or Standard Veneer Chassis
- Finish/Color
- Edge Profile
- Glass Style
- Door Pull
- Locking Doors

Options: Specify & Add

CA	Clear Acrylic Door Inserts	Included
FA	Frosted Acrylic Door Inserts	Included

[See Madera Intro Section for Ordering Options](#)

Item	Model No.	Width	Depth	Height	Ship Wt	Cubic Ft	List Price
SURFACE MOUNT BOOKCASE	14-1534TU	34	15¼	40	107	15.1	W\$ 2160 PV\$ 2526
	14-1528TU	28	15¼	40	96	12.6	W\$ 1835 PV\$ 2148

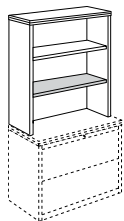

Description

- 1" Thick Shelves
- Shaded Shelf on Bottom Fixed with 12" Clearance
- One Adjustable Shelf
- Available in Premium Veneer (PV) or Standard Veneer (W), Must Specify
- For Surface Mount Use on Two (2) Drawer Lateral Files or Credenza Against a Wall

Must Specify (in this order):

Model
Premium or Standard Veneer Chassis
Finish/Color
Edge Profile

Item	Model No.	Width	Depth	Height	Ship Wt	Cubic Ft	List Price
BOOKCASE	14-3684BC	36	15¼	84	205	31.3	W\$ 4532 PV\$ 5303
	4 Adjustable Shelves and 1 Fixed Shelf						
	14-3670BC	36	15¼	69¾	176	26.9	W\$ 3763 PV\$ 4403
	3 Adjustable Shelves and 1 Fixed Shelf						
	14-3660BC	36	15¼	60	147	23.2	W/P\$ 3124 PV\$ 3656
	3 Adjustable Shelves						
	14-3648BC	36	15¼	48¾	120	18.7	W/P\$ 2821 PV\$ 3302
	2 Adjustable Shelves						
	14-3630BC	36	15¼	30	75	11.9	W/P\$ 2728 PV\$ 3191
	1 Adjustable Shelves						
Must Specify (in this order):	14-1570BC	34	15¼	69¾	198	26.9	W\$ 3554 PV\$ 4158
	3 Adjustable Shelves						
	14-1548BC	34	15¼	48¾	135	18.6	W/P\$ 2665 PV\$ 3117
	2 Adjustable Shelves						
Must Specify (in this order):	14-1530BC	34	15¼	30	85	11.1	W/P\$ 2577 PV\$ 3013
	1 Adjustable Shelves						

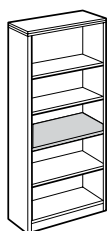

Description

- 1" Thick Shelves
- Shaded Indicates Fixed Shelf
- 84"H and 69¾"H Available in Premium Veneer (PV) or Standard Veneer (W); Must Specify
- 60"H, 48¾"H and 30"H Available in Premium Veneer (PV) or Standard Veneer (W), and HPL (P); Must Specify

Pricing Codes:

W = Wood Top

P = Laminate Top

PV = Premium Veneer

[See Madera Intro Section for Ordering Options](#)

Item	Model No.	Width	Depth	Height	Ship Wt	Cubic Ft	List Price	
WARDROBE/STORAGE CABINET SINGLE DOOR	Left Hinged	Right Hinged						
	14-1870WL	14-1870WR	18	24	69¾	153	19.2	W\$ 5263 PV\$ 6159
	14-1870CL	14-1870CR	18	20	69¾	150	18.6	W\$ 4454 PV\$ 5209

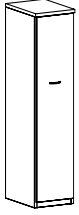

Shown as Right

Description

- Standard with: Fixed Top Shelf, Coat Rod, Three (3) Adjustable/Removable Shelves, Soft-Close Hinges, Vertical Grain Direction
- Available in Premium Veneer (PV) or Standard Veneer (W); Must Specify
- Finger Pull Not Available; Knob Pull will be Substituted
- Additional Options: Locking Doors ([See Locking Options](#))

Must Specify (in this order):

- Model
- Premium or Standard Veneer Chassis
- Finish/Color
- Edge Profile
- Pull
- Locking Door

WARDROBE/STORAGE CABINET DOUBLE DOOR	14-3670WD	36	24	69¾	290	42.0	W\$ 9291 PV\$ 10875
---	-----------	----	----	-----	-----	------	------------------------

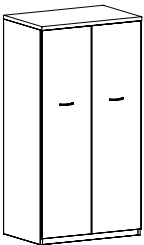

Description

- Standard with: Fixed Top Shelf Behind Each Door, Coat Rod, Three (3) Adjustable/Removable Shelves on Each Side, Soft-Close Hinges
- Available in Premium Veneer (PV) or Standard Veneer (W); Must Specify
- Finger Pull Not Available; Knob Pull will be Substituted
- Additional Options: Locking Doors ([See Locking Options](#))

Must Specify (in this order):

- Model
- Premium or Standard Veneer Chassis
- Finish/Color
- Edge Profile
- Pull
- Locking Door

[See Madera Intro Section for Ordering Options](#)

Item	Model No.	Width	Depth	Height	Ship Wt	Cubic Ft	List Price
WARDROBE/STORAGE CABINET WITH FILE/FILE	Left Drawers	Right Drawers					
	14-3670WD2L	14-3670WD2R	36	24	69¾	315	42.0
							W\$ 10629 PV\$ 12438

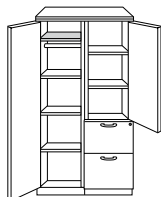

Shown as Right

Must Specify (in this order):

Model
Premium or Standard Veneer Chassis
Finish/Color
Edge Profile
Pull
Locking Door

Description

- Standard with: Vertical Grain Direction, Soft-Close Hinged Doors, Locking File/File Drawers
- Wardrobe Side - Shaded Fixed Top Shelf, Coat Rod, and Three (3) Adjustable Shelves
- Storage Side - Top Storage with Two (2) Adjustable Shelves, Bottom Locking File/File
- Available in Premium Veneer (PV) or Standard Veneer (W); Must Specify
- Pedestal Determines Left or Right Handed Unit
- Lock Core Color will Coordinate with Pull Selection
- Finger Pull Not Available
- Additional Options: Locking Doors ([See Locking Options](#))

WARDROBE/STORAGE CABINET WITH BOX/BOX/FILE	Left Drawers	Right Drawers					
	14-3670WD1L	14-3670WD1R	36	24	69¾	315	42.0
							W\$ 10629 PV\$ 12438



Shown as Right

Must Specify (in this order):

Model
Premium or Standard Veneer Chassis
Finish/Color
Edge Profile
Pull
Locking Door

Description

- Standard with: Vertical Grain Direction, Soft-Close Hinged Doors, Locking Box/Box/File Drawers
- Wardrobe Side - Shaded Fixed Top Shelf, Coat Rod, and Three (3) Adjustable Shelves
- Storage Side - Top Storage with Two (2) Adjustable Shelves, Bottom Locking Box/Box/File
- Available in Premium Veneer (PV) or Standard Veneer (W); Must Specify
- Pedestal Determines Left or Right Handed Unit
- Lock Core Color will Coordinate with Pull Selection
- Finger Pull Not Available
- Additional Options: Locking Doors ([See Locking Options](#))

STORAGE CABINET WITH LATERAL FILE DRAWERS	14-3670SU2	36	24	69¾	298	42.0	W\$ 10170 PV\$ 11899
---	------------	----	----	-----	-----	------	-------------------------

**Must Specify (in this order):**

Model
Premium or Standard Veneer Chassis
Finish/Color
Edge Profile
Pull
Locking Doors

Description

- Standard with: Two (2) 170° Hinged Doors, Two (2) Adjustable Shelves on Top, Two (2) Locking Lateral File Drawers on Bottom, Vertical Grain Direction
- Lateral Drawers Provide Letter or Legal Filing Capabilities
- Available in Premium Veneer (PV) or Standard Veneer (W); Must Specify
- Lock Core Color will Coordinate with Pull Selection
- Finger Pull Not Available
- Additional Options: Locking Doors ([See Locking Options](#))

Pricing Codes:

W = Wood Top

P = Laminate Top

PV = Premium Veneer

[See Madera Intro Section for Ordering Options](#)

Item	Model No.	Width	Depth	Height	Ship Wt	Cubic Ft	List Price
MODULAR BOW TOP 	14-4272BWT	72	42-36	1 $\frac{3}{16}$	125	7.1	W/P\$ 2638 PV\$ 3083
	14-3672BWT	72	36-30	1 $\frac{3}{16}$	110	6.2	W/P\$ 2509 PV\$ 2935

Description

- Profiled on All Four (4) Sides
- Available with Premium Veneer (PV), Veneer (W) or HPL (P) Top, Must Specify
- Not Recommended for Use With Center Grommet
- Additional Options: Grommet Options ([See Grommet Options](#)), Kneespace Options (Sold Separately, [See Multiple Unit Details](#)), Wire Management + Accessories (Sold Separately, [See Multiple Unit Details](#))

Must Specify (in this order):

Model
Top Material
Finish/Color
Edge Profile
Surface Grommet
Grommet Color

MODULAR DESK TOP 36"D AND 30"D 	14-3678TP	78	36	1 $\frac{3}{16}$	125	7.0	W/P\$ 2027 PV\$ 2370
	14-3672TP	72	36	1 $\frac{3}{16}$	115	6.5	W/P\$ 1935 PV\$ 2264
	14-3666TP	66	36	1 $\frac{3}{16}$	105	6.0	W/P\$ 1861 PV\$ 2175
	14-3084TP	84	30	1 $\frac{3}{16}$	95	5.3	W/P\$ 1887 PV\$ 2210
	14-3078TP	78	30	1 $\frac{3}{16}$	90	4.9	W/P\$ 1806 PV\$ 2111
	14-3072TP	72	30	1 $\frac{3}{16}$	85	4.6	W/P\$ 1725 PV\$ 2019
	14-3066TP	66	30	1 $\frac{3}{16}$	80	4.2	W/P\$ 1659 PV\$ 1940
	14-3060TP	60	30	1 $\frac{3}{16}$	75	3.8	W/P\$ 1587 PV\$ 1856
	14-3054TP	54	30	1 $\frac{3}{16}$	70	3.4	W/P\$ 1528 PV\$ 1788
	14-3048TP	48	30	1 $\frac{3}{16}$	60	3.1	W/P\$ 1471 PV\$ 1724
	14-3042TP	42	30	1 $\frac{3}{16}$	55	2.7	W/P\$ 1414 PV\$ 1654

Description

- Profiled on All Four (4) Sides
- Available with Premium Veneer (PV), Veneer (W) or HPL (P) Top, Must Specify
- Support Panel Required and Stiffener Bar Recommended in Kneespaces 60" or Greater and With Peninsula Application When Surface is Not Supported by a Pedestal, [See Support Options](#)
- For Table Lift Options, [See Table Lift Bases](#)
- Table Lifts to be used with Vertical Profiles - Bullnose (D), Tri-Round (E), Fluted (X), Square (Y)
- Additional Options: Grommet Options ([See Grommet Options](#)), Kneespace Options (Sold Separately, [See Multiple Unit Details](#)), Wire Management + Accessories (Sold Separately, [See Multiple Unit Details](#))

[See Madera Intro Section for Ordering Options](#)

Item	Model No.	Width	Depth	Height	Ship Wt	Cubic Ft	List Price
MODULAR CREDENZA TOP 24"D 	14-24108TP	108	24	1 $\frac{3}{16}$	110	6.6	W/P\$ 2729 PV\$ 3196
	14-24102TP	102	24	1 $\frac{3}{16}$	105	6.3	W/P\$ 2614 PV\$ 3059
	14-2496TP	96	24	1 $\frac{3}{16}$	100	5.0	W/P\$ 1909 PV\$ 2232
	14-2490TP	90	24	1 $\frac{3}{16}$	95	4.6	W/P\$ 1796 PV\$ 2096
	14-2484TP	84	24	1 $\frac{3}{16}$	90	4.3	W/P\$ 1672 PV\$ 1953
	14-2478TP	78	24	1 $\frac{3}{16}$	85	4.0	W/P\$ 1599 PV\$ 1870
	14-2472TP	72	24	1 $\frac{3}{16}$	80	3.7	W/P\$ 1541 PV\$ 1805
	14-2466TP	66	24	1 $\frac{3}{16}$	75	3.4	W/P\$ 1484 PV\$ 1735
	14-2460TP	60	24	1 $\frac{3}{16}$	70	3.0	W/P\$ 1433 PV\$ 1680
	14-2454TP	54	24	1 $\frac{3}{16}$	65	2.8	W/P\$ 1352 PV\$ 1586
	14-2448TP	48	24	1 $\frac{3}{16}$	55	2.5	W/P\$ 1299 PV\$ 1518
	14-2442TP	42	24	1 $\frac{3}{16}$	50	2.2	W/P\$ 1239 PV\$ 1451
	14-2436TP	36	24	1 $\frac{3}{16}$	45	2.0	W/P\$ 1204 PV\$ 1412
	14-2430TP	30	24	1 $\frac{3}{16}$	36	1.6	W/P\$ 1156 PV\$ 1352
	14-2418TP	18	24	1 $\frac{3}{16}$	28	1.0	W/P\$ 1067 PV\$ 1247

Must Specify (in this order):

Model
 Top Material
 Finish/Color
 Edge Profile
 Surface Grommet
 Grommet Color

Description

- Profiled on All Four (4) Sides
- Available with Premium Veneer (PV), Veneer (W) or HPL (P) Top, Must Specify
- Support Panel Required and Stiffener Bar Recommended in Kneespaces 60" or Greater and With Peninsula Application When Surface is Not Supported by a Pedestal, [See Support Options](#)
- For Table Lift Options, [See Table Lift Bases](#)
- Table Lifts to be used with Vertical Profiles - Bullnose (D), Tri-Round (E), **Fluted (X)**, Square (Y)
- Additional Options: Grommet Options ([See Grommet Options](#)), Kneespace Options (Sold Separately, [See Multiple Unit Details](#)), Wire Management + Accessories (Sold Separately, [See Multiple Unit Details](#))

Pricing Codes:

W = Wood Top

P = Laminate Top

PV = Premium Veneer

[See Madera Intro Section for Ordering Options](#)

Item	Model No.	Width	Depth	Height	Ship Wt	Cubic Ft	List Price	
MODULAR RETURN TOP 24"D  Must Specify (in this order): Model Top Material Finish/Color Edge Profile Surface Grommet Grommet Color	Left Ped	Right Ped						
	14-7224TPL	14-7224TPR	72	24	1⅜	80	3.7	W/P\$ 1541 PV\$ 1805
	14-6624TPL	14-6624TPR	66	24	1⅜	75	3.4	W/P\$ 1484 PV\$ 1735
	14-6024TPL	14-6024TPR	60	24	1⅜	70	3.1	W/P\$ 1433 PV\$ 1680
	14-5424TPL	14-5424TPR	54	24	1⅜	65	2.8	W/P\$ 1352 PV\$ 1586
	14-4824TPL	14-4824TPR	48	24	1⅜	55	2.5	W/P\$ 1299 PV\$ 1518
	14-4224TPL	14-4224TPR	42	24	1⅜	50	2.2	W/P\$ 1239 PV\$ 1451
	14-3624TPL	14-3624TPR	36	24	1⅜	45	1.9	W/P\$ 1204 PV\$ 1412

Description

- Profiled on All Four (4) Sides With Reverse Profile on Connecting Edge
- Available with Premium Veneer (PV), Veneer (W) or HPL (P) Top, Must Specify
- For Use on 24" Deep Pedestals/Files
- Front to Back Grain Direction on Worksurface Unless Noted Above
- Support Panel Required and Stiffener Bar Recommended in Kneespaces 60" or Greater and With Peninsula Application When Surface is Not Supported by a Pedestal, [See Support Options](#)
- For Table Lift Options, [See Table Lift Bases](#)
- Table Lifts to be used with Vertical Profiles - Bullnose (D), Tri-Round (E), Fluted (X), Square (Y)
- Additional Options: Grommet Options ([See Grommet Options](#)), Kneespace Options (Sold Separately, [See Multiple Unit Details](#)), Wire Management + Accessories (Sold Separately, [See Multiple Unit Details](#))

MODULAR BRIDGE TOP 24"D  Must Specify (in this order): Model Top Material Finish/Color Edge Profile Surface Grommet Grommet Color	14-6024TPB	60	24	1⅜	70	3.1	W/P\$ 1433 PV\$ 1680
	14-5424TPB	54	24	1⅜	65	2.8	W/P\$ 1352 PV\$ 1586
	14-4824TPB	48	24	1⅜	55	2.5	W/P\$ 1299 PV\$ 1518
	14-4224TPB	42	24	1⅜	50	2.2	W/P\$ 1239 PV\$ 1451
	14-3624TPB	36	24	1⅜	45	1.9	W/P\$ 1204 PV\$ 1412

Description

- Profiled on All Four (4) Sides With Reverse Profile on Connecting Edge
- Available with Premium Veneer (PV), Veneer (W) or HPL (P) Top, Must Specify
- Front to Back Grain Direction on Worksurface Unless Noted Above
- Support Panel Required and Stiffener Bar Recommended in Kneespaces 60" or Greater and With Peninsula Application When Surface is Not Supported by a Pedestal, [See Support Options](#)
- For Table Lift Options, [See Table Lift Bases](#)
- Table Lifts to be used with Vertical Profiles - Bullnose (D), Tri-Round (E), Fluted (X), Square (Y)
- Additional Options: Grommet Options ([See Grommet Options](#)), Kneespace Options (Sold Separately, [See Multiple Unit Details](#)), Wire Management + Accessories (Sold Separately, [See Multiple Unit Details](#))

[See Madera Intro Section for Ordering Options](#)

Item	Model No.	Width	Depth	Height	Ship Wt	Cubic Ft	List Price
MODULAR PEDESTAL BOX/BOX/FILE 	14-3618PD1	18	35¼	28¼	125	13.6	W\$ 2846 PV\$ 3333
	14-3018PD1	18	29¼	28¼	105	11.6	W\$ 2702 PV\$ 3163
	14-2418PD1	18	23¼	28¼	85	9.5	W\$ 2581 PV\$ 3021

Must Specify (in this order):

Model
 Premium or Standard Veneer Chassis
 Finish/Color
 Pull

Description

- Available with Premium Veneer (PV) or Standard Veneer (W) Chassis, Must Specify
- Locking Box/Box/File
- Legal Width Pedestal
- Lock Core Color will Coordinate with Pull Selection
- Open Back; Optional Back Panel Sold Separately, [See Moldular Back Panels](#)
- Modular Top Required, [See Multiple Modular Tops](#)

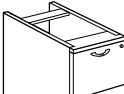
MODULAR PEDESTAL FILE/FILE 	14-3618PD2	18	35¼	28¼	125	13.6	W\$ 2846 PV\$ 3333
	14-3018PD2	18	29¼	28¼	105	11.6	W\$ 2702 PV\$ 3163
	14-2418PD2	18	23¼	28¼	85	9.5	W\$ 2581 PV\$ 3021

Must Specify (in this order):

Model
 Premium or Standard Veneer Chassis
 Finish/Color
 Pull

Description

- Locking File/File
- Legal Width Pedestal
- Lock Core Color will Coordinate with Pull Selection
- Open Back; Optional Back Panel Sold Separately, [See Moldular Back Panels](#)
- Modular Top Required, [See Multiple Modular Tops](#)

MODULAR PEDESTAL LATERAL FILE 	14-2436LF1	36	23 ¼	28¼	154	17.5	W\$ 3195 PV\$ 3739
	14-2430LF1	30	23 ¼	28¼	128	14.9	W\$ 3110 PV\$ 3635

Must Specify (in this order):

Model
 Premium or Standard Veneer Chassis
 Finish/Color
 Pull

Description

- Locking Lateral File/Lateral File
- Anti-Tilt System
- Lock Core Color will Coordinate with Pull Selection
- Open Back; Optional Back Panel Sold Separately, [See Moldular Back Panels](#)
- Modular Top Required, [See Multiple Modular Tops](#)

Pricing Codes:

W = Wood Top

P = Laminate Top

PV = Premium Veneer

[See Madera Intro Section for Ordering Options](#)

Item	Model No.	Width	Depth	Height	Ship Wt	Cubic Ft	List Price
MODULAR PEDESTAL MULTI-FILE	14-2436LF2	36	23¼	28¼	154	17.5	W\$ 3579 PV\$ 4189
	14-2430LF2	30	23¼	28¼	128	14.9	W\$ 3483 PV\$ 4076

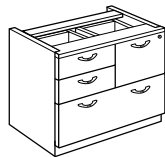

Must Specify (in this order):

Model
Premium or Standard Veneer Chassis
Finish/Color
Pull

Description

- Box/Box/File Over Lateral File
- Locking File Drawers Only
- Lock Core Color will Coordinate with Pull Selection
- Open Back; Optional Back Panel Sold Separately, [See Moldular Back Panels](#)
- Modular Top Required, [See Multiple Modular Tops](#)

MODULAR PEDESTAL SINGLE DOOR BOOKCASE	Hinged Left	Hinged Right	Width	Depth	Height	Ship Wt	Cubic Ft	List Price
	14-2418PD4L	14-2418PD4R						

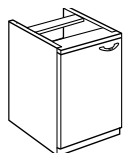

Shown as Left

Must Specify (in this order):

Model
Premium or Standard Veneer Chassis
Finish/Color
Pull

Description

- (1) Adjustable Shelf Behind Doors
- Open Back; Optional Back Panel Sold Separately, [See Moldular Back Panels](#)
- Modular Top Required, [See Multiple Modular Tops](#)
- Additional Options: Locking Door ([See Locking Options](#))

MODULAR PEDESTAL DOUBLE DOOR BOOKCASE	14-2436DB	36	23¼	28¼	105	17.5	W\$ 2782 PV\$ 3253
	14-2430DB	30	23¼	28¼	87	14.9	W\$ 2704 PV\$ 3167

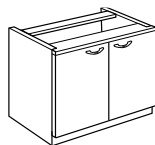

Must Specify (in this order):

Model
Premium or Standard Veneer Chassis
Finish/Color
Pull

Description

- 13" Adjustable Shelf Behind Doors
- Finger Pull Not Available
- Open Back; Optional Back Panel Sold Separately, [See Moldular Back Panels](#)
- Modular Top Required, [See Multiple Modular Tops](#)
- Additional Options: Locking Door ([See Locking Options](#))

[See Madera Intro Section for Ordering Options](#)

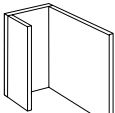
Item	Model No.	Width	Depth	Height	Ship Wt	Cubic Ft	List Price	
	Left Ped	Right Ped						
	14-3618PD3L	14-3618PD3R	18	36	28¼	50	13.6	W\$ 1265 PV\$ 1479
	14-3018PD3L	14-3018PD3R	18	30	28¼	42	11.6	W\$ 1158 PV\$ 1359

Shown as Right

Must Specify (in this order):

Model
Premium or Standard Veneer Chassis
Finish/Color

Description

- Used to Complete Single Pedestal Configuration
- Finished Back

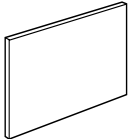
Item	Model No.	Width	Depth	Height	Ship Wt	Cubic Ft	List Price	
	MODULAR BACK PANEL	14-9628BP	96	¾	28¼	115	5.0	W\$ 1233 PV\$ 1442
	14-9028BP	90	¾	28¼	108	4.6	W\$ 1201 PV\$ 1406	
	14-8428BP	84	¾	28¼	101	4.3	W\$ 1174 PV\$ 1374	
	14-7828BP	78	¾	28¼	94	4.0	W\$ 1127 PV\$ 1318	
	14-7228BP	72	¾	28¼	86	3.7	W\$ 960 PV\$ 1124	
	14-6628BP	66	¾	28¼	79	3.4	W\$ 928 PV\$ 1087	
	14-6028BP	60	¾	28¼	72	3.0	W\$ 887 PV\$ 1036	
	14-5428BP	54	¾	28¼	65	2.8	W\$ 831 PV\$ 969	
	14-4828BP	48	¾	28¼	55	2.5	W\$ 791 PV\$ 925	
	14-4228BP	42	¾	28¼	50	2.2	W\$ 747 PV\$ 878	
	14-3628BP	36	¾	28¼	45	2.0	W\$ 626 PV\$ 735	
	14-3028BP	30	¾	28¼	30	1.6	W\$ 587 PV\$ 684	
	14-2428BP	24	¾	28¼	24	1.4	W\$ 563 PV\$ 661	
	14-1828BP	18	¾	28¼	18	1.0	W\$ 545 PV\$ 637	

Must Specify (in this order):

Model
Premium or Standard Veneer Chassis
Finish/Color
Top Center Grommet
Grommet Color

Description

- For Use as a Modesty Panel to Create Bridges, Returns, or Credenzas

Options: Specify & Add

1-GRMT	Optional Top Centered Grommet; Must Specify: Black (BLK) or Silver (SLV)	\$ 52
--------	--	-------

Pricing Codes:

W = Wood Top

P = Laminate Top

PV = Premium Veneer

[See Madera Intro Section for Ordering Options](#)

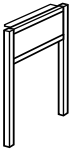
Item	Model No.	Width	Depth	Height	Ship Wt	Cubic Ft	List Price
H MODULAR PENINSULA SUPPORT SEATED HEIGHT 	01-3628TLV Double Mount Plate	36	1	28¼	30	2.0	\$ 1182
	01-3028TLV Double Mount Plate	30	1	28¼	25	1.7	\$ 1163
	01-2428TLV Double Mount Plate	24	1	28¼	25	1.4	\$ 876
	01-3628HLV Single Mount Plate	36	1	28¼	30	2.0	\$ 1145
	01-3028HLV Single Mount Plate	30	1	28¼	25	1.7	\$ 1126
	01-2428HLV Single Mount Plate	24	1	28¼	25	1.4	\$ 847

Must Specify (in this order):

Model
Wood Insert
Insert Color

Description

- Metal End Support to Be Used with Modular Desk Tops at 30"H ([See Multiple Modular Tops](#))
- Aluminum Only
- Double Mount Plate Required for Freestanding Table/Desk
- Recommended to Be Used with Vertical Profiles - Bullnose (D), Tri-Round (E), **Fluted (X)**, Square (Y)

Options: Specify & Add

HIW	Veneer Insert	W\$	117
		PV\$	135

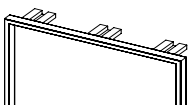
O MODULAR PENINSULA SUPPORT SEATED HEIGHT 	01-3628OL	36	2	28¼	30	2.7	\$ 661
	01-3028OL	30	2	28¼	25	2.3	\$ 552
	01-2428OL	24	2	28¼	20	1.8	\$ 486

Description

- Metal End Support to Be Used with Modular Desk Tops at 30"H ([See Multiple Modular Tops](#))
- Aluminum Only

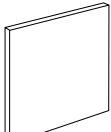
MODULAR END PANEL 	14-3628EP	35¼	1½	28¼	41	2.0	W\$ 690 PV\$ 806
	14-3028EP	29¼	1½	28¼	34	1.6	W\$ 646 PV\$ 755
	14-2428EP	23¼	1½	28¼	27	1.6	W\$ 605 PV\$ 705

Must Specify (in this order):

Model
Panel Material

Description

- End Panel for Worksurfaces to Create Desks, Returns, or Credenzas
- Required to be Used with a Back Panel, [See Multiple Unit Details](#)

[See Madera Intro Section for Ordering Options](#)

Item	Model No.	Width	Depth	Height	Ship Wt	Cubic Ft	List Price
MODULAR SUPPORT PANEL	14-2812SP	12	1 5/32	28 1/4	12	0.8	W\$ 390 PV\$ 455

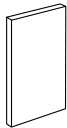
**Description**

- Used to Support Worksurfaces
- Required to be Used Perpendicular to Full Back Panels to Support Kneespace Areas Greater Than 60"

Must Specify (in this order):

Model
Panel Material

MODULAR T SUPPORT	14-1010SP	10	10	28 1/4	12	0.9	W\$ 534 PV\$ 625
-------------------	-----------	----	----	--------	----	-----	---------------------

**Description**

- Used to Support Worksurfaces
- Required to be Used Perpendicular to Full Back Panels to Support Kneespace Areas Greater Than 60"

Must Specify (in this order):

Model
Panel Material

MODULAR FILLER SUPPORT	14-2803FP	3	3/4	28 1/4	6	0.5	W\$ 324 PV\$ 382
------------------------	-----------	---	-----	--------	---	-----	---------------------

**Description**

- Used to Fill Gap Behind Modular Pedestals When Back Panels are Not Used

Must Specify (in this order):

Model
Panel Material

STIFFENER BAR	01-00060SB	60	1 1/4	3/4	8	0.3	\$ 129
	01-00048SB	48	1 1/4	3/4	5	0.3	\$ 121

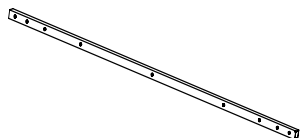
**Description**

- Reinforces Worksurfaces with Large Kneespace Widths
- Includes End Caps to Cover Sharp Edges
- Field Installed
- Recommended in Kneespaces 60" or Greater

Pricing Codes:

W = Wood Top

P = Laminate Top

PV = Premium Veneer

[See Madera Intro Section for Ordering Options](#)

Item	Model No.	Width	Depth	Height	Ship Wt	Cubic Ft	List Price
END TABLE	14-1824ET	24	18	21 ⁷ / ₁₆	48	7.6	W/P\$ 1365 PV\$ 1599

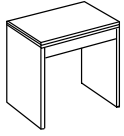

Must Specify (in this order):

- Model
- Premium or Standard Veneer Chassis
- Top Material
- Finish/Color
- Edge Profile

Description

- Standard with: Left to Right Grain Direction on Worksurface, Vertical Grain Direction on Solid End Panels
- Available in Premium Veneer (PV) or Standard Veneer (W); Must Specify
- Available with Veneer (PV/W) or HPL (P) Top; Must Specify
- Apron Rails and Panel Legs Feature Multi-Step, Hand-Finished Catalyzed Finish
- Ships Assembled

LAMP TABLE	14-2828LT	28	28	21 ⁷ / ₁₆	56	12.3	W/P\$ 1768 PV\$ 2072
------------	-----------	----	----	---------------------------------	----	------	-------------------------

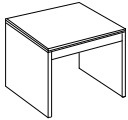

Must Specify (in this order):

- Model
- Premium or Standard Veneer Chassis
- Top Material
- Finish/Color
- Edge Profile

Description

- Standard with: Left to Right Grain Direction on Worksurface, Vertical Grain Direction on Solid End Panels
- Available in Premium Veneer (PV) or Standard Veneer (W); Must Specify
- Available with Veneer (PV/W) or HPL (P) Top; Must Specify
- Apron Rails and Panel Legs Feature Multi-Step, Hand-Finished Catalyzed Finish
- Ships Assembled

MAGAZINE TABLE	14-1847MT	47	18	15 ⁷ / ₁₆	75	9.9	W/P\$ 1492 PV\$ 1747
----------------	-----------	----	----	---------------------------------	----	-----	-------------------------

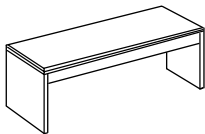

Must Specify (in this order):

- Model
- Premium or Standard Veneer Chassis
- Top Material
- Finish/Color
- Edge Profile

Description

- Standard with: Left to Right Grain Direction on Worksurface, Vertical Grain Direction on Solid End Panels
- Available in Premium Veneer (PV) or Standard Veneer (W); Must Specify
- Available with Veneer (PV/W) or HPL (P) Top; Must Specify
- Apron Rails and Panel Legs Feature Multi-Step, Hand-Finished Catalyzed Finish
- Ships Assembled

[See Madera Intro Section for Ordering Options](#)

Item	Model No.	Width	Depth	Height	Ship Wt	Cubic Ft	List Price
COMPUTER WORK TABLE	14-2445CW	45	24	26 $\frac{3}{8}$	120	21.8	W/P\$ 2591 PV\$ 3029
	14-2436CW	36	24	26 $\frac{3}{8}$	110	17.6	W/P\$ 2479 PV\$ 2900

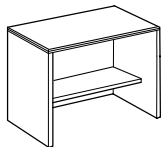

Must Specify (in this order):

Model
Premium or Standard Veneer Chassis
Top Material
Finish/Color
Edge Profile
Casters
Back Panel Grommet

Description

- Standard with: Left to Right Grain Direction on Worksurface, Vertical Grain Direction on End and Modesty Panels
- Fixed Shelf is 12" Deep with a 16" Clearance
- Available with Premium Veneer (PV) or Standard Veneer (W) Chassis; Must Specify
- Available with Veneer (PV/W) or HPL (P) Top; Must Specify
- Grommet in Back Panel; Must Specify: Black (BLK) or Silver (SLV)

Options: Specify & Add

CS-14BL Optional Black Casters (Increases Height to 28 $\frac{3}{8}$ ") \$ 239

**WORK TABLE
SEATED HEIGHT**

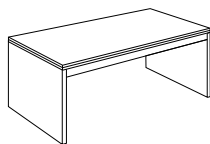

Must Specify (in this order):

Model
Premium or Standard Veneer Chassis
Top Material
Finish/Color
Edge Profile

14-3672WT	72	36	30	195	50.0	W/P\$ 3199 PV\$ 3742
14-3060WT	60	30	30	134	35.5	W/P\$ 2503 PV\$ 2932

Description

- Standard with: Left to Right Grain Direction on Worksurface, Vertical Grain Direction on Solid End Panels with Apron Rail
- Add a Purse Hook to Hold Personal Items; [See Hook Details](#)
- Available with Premium Veneer (PV) or Standard Veneer (W) Chassis; Must Specify
- Available with Veneer (PV/W) or HPL (P) Top; Must Specify
- Some Assembly Required

ROUND TABLE TOP

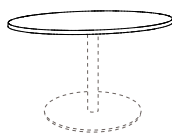

14-4242CT shown with
01-2430DBA
(Disc Base)
BASES SOLD SEPARATELY

14-4848CT	48	48	30	60	5.7	W/P\$ 2876 PV\$ 3363
14-4242CT	42	42	30	40	4.4	W/P\$ 2608 PV\$ 3053
14-3636CT	36	36	30	35	3.4	W/P\$ 2289 PV\$ 2678

Description

- Available with Premium/Standard Veneer (PV/W) or HPL (P) Top, Must Specify
- Single Base Required; Ordered Separately, [See Details](#)
- Bases Sold Separately
- Power Options not Available

Must Specify (in this order):

Model #
Top Material
Finish/Color
Edge Profile

Pricing Codes:

W = Wood Top

P = Laminate Top

PV = Premium Veneer

[See Madera Intro Section for Ordering Options](#)

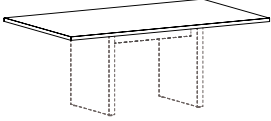
Item	Model No.	Width	Depth	Height	Ship Wt	Cubic Ft	List Price	
 <p>14-3672RT shown with 88-2034RPB (Rectangle Panel Base) BASES SOLD SEPARATELY</p> <p>Must Specify (in this order): Model # Top Material Finish/Color Edge Profile</p>	RECTANGULAR TOP							
	144" or 12' - 2 Piece Tops							
	14-48144RT	144	48	1 $\frac{3}{16}$	275	12.3	W/P\$ 2323 PV\$ 2717	
	120" or 10' - 2 Piece Tops							
	14-48120RT	120	48	1 $\frac{3}{16}$	225	10.3	W/P\$ 2134 PV\$ 2497	
	96" or 8' - 1 Piece Top							
	14-4896RT	96	48	1 $\frac{3}{16}$	180	9.4	W/P\$ 2039 PV\$ 2386	
	72" or 6' - 1 Piece Top							
	14-3672RT	72	36	1 $\frac{3}{16}$	100	6.2	W/P\$ 1282 PV\$ 1501	

Description

- Grain Runs the Width of the Table
- Available with Veneer (PV/W) or HPL (P) Top; Must Specify
- Heavy-Duty Ganging Mechanisms Connect Two (2) Piece Tops
- See Bases/Legs and Number Required For Each Top Size, Must Order Bases Separately
- Optional Grommets and Power/Data Units; [See Location Options](#), [See Power Units Available](#)

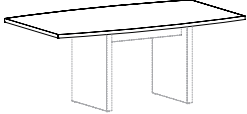
 <p>14-3672BT shown with 88-2034RPB (Rectangle Panel Base) BASES SOLD SEPARATELY</p> <p>Must Specify (in this order): Model # Top Material Finish/Color Edge Profile</p>	BOAT TOP							
	144" or 12' - 2 Piece Tops							
	14-48144BT	144	48	1 $\frac{3}{16}$	275	12.3	W/P\$ 4380 PV\$ 5124	
	120" or 10' - 2 Piece Tops							
	14-48120BT	120	48	1 $\frac{3}{16}$	225	10.3	W/P\$ 3980 PV\$ 4656	
	96" or 8' - 1 Piece Top							
	14-4896BT	96	48	1 $\frac{3}{16}$	180	9.4	W/P\$ 3228 PV\$ 3777	
	72" or 6' - 1 Piece Top							
	14-3672BT	72	36	1 $\frac{3}{16}$	100	6.2	W/P\$ 1865 PV\$ 2182	

Description

- Grain Runs the Width of the Table
- Available with Veneer (PV/W) or HPL (P) Top; Must Specify
- Heavy-Duty Ganging Mechanisms Connect Two (2) Piece Tops
- See Bases/Legs and Number Required For Each Top Size, Must Order Bases Separately
- Optional Grommets and Power/Data Units; [See Location Options](#), [See Power Units Available](#)

[See Madera Intro Section for Ordering Options](#)

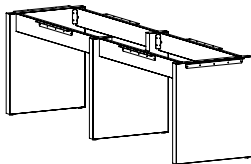
Item	Model No.		Width	Depth	Height	Ship Wt	Cubic Ft	List Price
RECTANGLE PANEL BASES WITH TROUGH 	Three (3) Panel Bases - For Use With 48" x 144" Surfaces							
	88-24106RPB	Laminate	24	106	28¾	116	13.8	T\$ 3000
		Veneer						W\$ 3059
	Two (2) Panel Bases - For Use With 48" x 120" Surfaces							
	88-2482RPB	Laminate	24	82	28¾	90	6.9	T\$ 2150
		Veneer						W\$ 2201
	Two (2) Panel Bases - For Use With 48" x 96" Surfaces							
	88-2458RPB	Laminate	24	58	28¾	84	6.9	T\$ 1880
		Veneer						W\$ 1954
	Two (2) Panel Bases - For Use With 36" x 72" Surfaces							
	88-2034RPB	Laminate	20	34	28¾	66	6.7	T\$ 1575
		Veneer						W\$ 1742

Must Specify (in this order):

Model #
Material
Finish / Color

Description

- 2" Panel Bases with Trough, Stretcher Rails, and L-Bracket Hardware Included
- Available with TFL (T) or Veneer (W)
- Vertical Grain Direction on Bases
- Bases Require Some Assembly; Attachment Hardware Included
- Tops Sold Separately

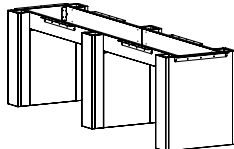
6" RECTANGLE BASES WITH TROUGH AND REMOVABLE PANEL 	Three (3) 6" Rectangle Bases - For Use With 48" x 144" Surfaces							
	88-2410606RB	Laminate	24	106	28¾	106	19.6	T\$ 4720
		Veneer						W\$ 6457
	Two (2) 6" Rectangle Bases - For Use With 48" x 120" Surfaces							
	88-248206RB	Laminate	24	82	28¾	99	12.9	T\$ 3219
		Veneer						W\$ 4449
	Two (2) 6" Rectangle Bases - For Use With 48" x 96" Surfaces							
	88-245806RB	Laminate	24	58	28¾	93	12.9	T\$ 3023
		Veneer						W\$ 4128
	Two (2) 6" Rectangle Bases - For Use With 36" x 72" Surfaces							
	88-203406RB	Laminate	20	34	28¾	76	12.9	T\$ 2777
		Veneer						W\$ 3820

Must Specify (in this order):

Model #
Material
Finish / Color

Description

- 6" Rectangle Bases with Trough and Stretcher Rails
- Available with TFL (T) or Veneer (W)
- Vertical Grain Direction on Bases
- Bases Include Interior Removable Panel for Wire Management Access; Removable Panel is 15⅞"W for 24" Bases and 11⅞"W for 20" Bases
- Removable Panels Attached with Z Brackets
- Bases Require Some Assembly; Attachment Hardware Included
- Tops Sold Separately

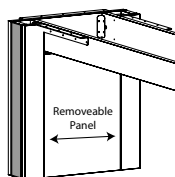

Pricing Codes:

W = Wood Top

P = Laminate Top

PV = Premium Veneer

[See Madera Intro Section for Ordering Options](#)

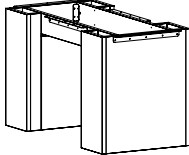
Item	Model No.		Width	Depth	Height	Ship Wt	Cubic Ft	List Price
10" RECTANGLE BASES WITH TROUGH AND REMOVABLE PANEL 	Three (3) 10" Rectangle Bases - For Use With 48" x 144" Surfaces							
	88-241061ORB	Laminate	24	106	28¾	141	18.2	T\$ 4841
		Veneer						W\$ 6551
	Two (2) 10" Rectangle Bases - For Use With 48" x 120" Surfaces							
	88-24821ORB	Laminate	24	82	28¾	96	12.0	T\$ 3300
		Veneer						W\$ 4512
	Two (2) 10" Rectangle Bases - For Use With 48" x 96" Surfaces							
	88-24581ORB	Laminate	24	58	28¾	89	12.0	T\$ 3104
		Veneer						W\$ 4190
	Two (2) 10" Rectangle Bases - For Use With 36" x 72" Surfaces							
	88-20341ORB	Laminate	20	34	28¾	72	10.0	T\$ 2857
		Veneer						W\$ 3882

Must Specify (in this order):

- Model #
- Material
- Finish / Color

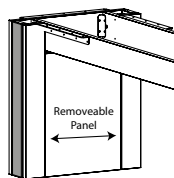

Description

- 10" Rectangle Bases with Trough and Stretcher Rails
- Available with TFL (T) or Veneer (W)
- Vertical Grain Direction on Bases
- Bases Include Interior Removable Panel for Wire Management Access; Removable Panel is 15⅞"W for 24" Bases and 11⅞"W for 20" Bases
- Removable Panels Attached with Z Brackets
- Bases Require Some Assembly Attachment Hardware Included
- Tops Sold Separately

6" + 10" COMBO RECTANGLE BASES WITH TROUGH AND REMOVABLE PANEL

Three (3) Bases Total: Two (2) 6" and One (1) 10" Rectangle Bases - For Use With 60" / 54" / 48" x 144" Surfaces								
88-24106C61ORB	Laminate	24	106	28¾	141	18.2	T\$ 4760	
	Veneer						W\$ 6488	

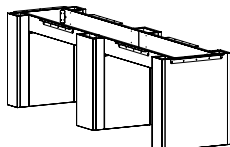

Must Specify (in this order):

- Model #
- Material
- Finish / Color

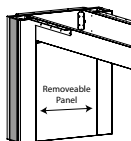

Description

- 6" + 10" Rectangle Bases with Trough and Stretcher Rails; 6" Bases on Exterior and 10" Base on Interior
- Available with TFL (T) or Veneer (W)
- Vertical Grain Direction on Bases
- Bases Include Interior Removable Panel for Wire Management; Removable Panel is 15⅞"W and Attaches with Z Brackets.
- Bases Require Some Assembly; Attachment Hardware Included
- Tops Sold Separately

[See Madera Intro Section for Ordering Options](#)

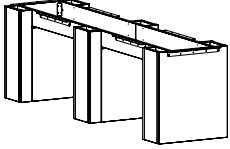
Item	Model No.		Width	Depth	Height	Ship Wt	Cubic Ft	List Price	
6" RECTANGLE ACCENT BASES WITH TROUGH AND REMOVABLE PANEL 	Three (3) 6" Rectangle Bases - For Use With 48" x 144" Surfaces								
	88-2410606RAB	Laminate	24	106	28¾	106	19.6	T\$ 5394	
		Veneer						W\$ 7174	
	Two (2) 6" Rectangle Bases - For Use With 48" x 120" Surfaces								
	88-248206RAB	Laminate	24	82	28¾	99	12.9	T\$ 4745	
		Veneer						W\$ 6436	
	Two (2) 6" Rectangle Bases - For Use With 48" x 96" Surfaces								
	88-245806RAB	Laminate	24	58	28¾	93	12.9	T\$ 3480	
		Veneer						W\$ 4610	
	Two (2) 6" Rectangle Bases - For Use With 36" x 72" Surfaces								
	88-203406RAB	Laminate	20	34	28¾	76	12.9	T\$ 3232	
		Veneer						W\$ 4302	

Must Specify (in this order):

- Model #
- Base Finish/Color
- Metal Accent Color
- Accent Panel Finish/Color

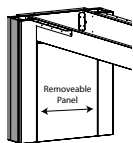

Description

- 6" Rectangle Bases with Trough and Stretcher Rails
- Available with TFL (T) or Veneer (W)
- 5/16" Metal Accent Available in Four (4) Colors: Aluminum, Black, Gold, and Platinum; Must Specify Color
- Vertical Grain Direction on Bases
- Bases Include Interior Removable Panel for Wire Management Access; Removable Panel is 15 7/8"W for 24" Bases and 11 7/8"W for 20" Bases
- Removable Panels Attached with Z Brackets
- Bases Require Some Assembly; Attachment Hardware Included
- Tops Sold Separately

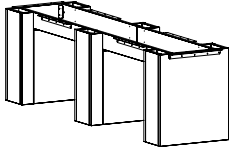
10" RECTANGLE ACCENT BASES WITH TROUGH AND REMOVABLE PANEL 	Three (3) 10" Rectangle Bases - For Use With 48" x 144" Surfaces								
	88-2410610RAB	Laminate	24	106	28¾	141	18.2	T\$ 5462	
		Veneer						W\$ 7258	
	Two (2) 10" Rectangle Bases - For Use With 48" x 120" Surfaces								
	88-248210RAB	Laminate	24	82	28¾	96	12.0	T\$ 3717	
		Veneer						W\$ 4986	
	Two (2) 10" Rectangle Bases - For Use With 48" x 96" Surfaces								
	88-245810RAB	Laminate	24	58	28¾	89	12.0	T\$ 3521	
		Veneer						W\$ 4664	
	Two (2) 10" Rectangle Bases - For Use With 36" x 72" Surfaces								
	88-203410RAB	Laminate	20	34	28¾	72	10.0	T\$ 3209	
		Veneer						W\$ 4276	

Must Specify (in this order):

- Model #
- Base Finish/Color
- Metal Accent Color
- Accent Panel Finish/Color

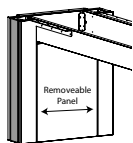

Description

- 10" Rectangle Bases with Trough and Stretcher Rails
- Available with TFL (T) or Veneer (W)
- 5/16" Metal Accent Available in Four (4) Colors: Aluminum, Black, Gold, and Platinum; Must Specify Color
- Vertical Grain Direction on Bases
- Bases Include Interior Removable Panel for Wire Management Access; Removable Panel is 15 7/8"W for 24" Bases and 11 7/8"W for 20" Bases
- Removable Panels Attached with Z Brackets
- Bases Require Some Assembly; Attachment Hardware Included
- Tops Sold Separately

Pricing Codes:

- W = Wood Top
- P = Laminate Top
- PV = Premium Veneer

[See Madera Intro Section for Ordering Options](#)

Item	Model No.		Width	Depth	Height	Ship Wt	Cubic Ft	List Price
6" + 10" COMBO RECTANGLE ACCENT BASES WITH TROUGH AND REMOVABLE PANEL	Three (3) Bases Total: Two (2) 6" and One (1) 10" Rectangle Bases - For Use With 60" / 54" / 48" x 144" Surfaces							
	88-24106C610RAB	Laminate	24	106	28¾	141	18.2	T\$ 5420
		Veneer						W\$ 7205

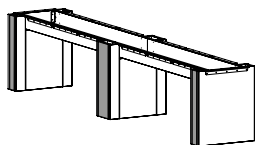

Must Specify (in this order):

- Model #
- Base Finish/Color
- Metal Accent Color
- Accent Panel Finish/Color

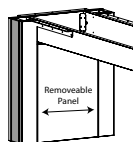

Description

- 6" + 10" Rectangle Accent Bases with Trough and Stretcher Rails; 6" Bases on Exterior and 10" Bases on Interior
- Available with TFL (T) or Veneer (W)
- 5/16" Metal Accent Available in Four (4) Colors: Aluminum, Black, Gold, and Platinum; Must Specify Color
- Vertical Grain Direction on Bases
- Bases Include Interior Removable Panel for Wire Management; Removable Panel is 15 7/8"W and Attaches with Z Brackets
- Bases Require Some Assembly; Attachment Hardware Included
- Tops Sold Separately

SQUARE BASE

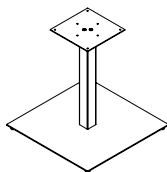

For Use With								
Round Tops: 48"								
Top Surfaces: 48"x96"								
01-2630SBB	Black	26	26	27¾	32	3.2	\$	1163
01-2630SBA	Aluminum							
For Use With								
Round Tops: 42"								
Top Surfaces: 36"x72"								
01-2030SBB	Black	20	20	27¾	32	3.2	\$	956
01-2030SBA	Aluminum							
For Use With								
Round Tops: 36"								
01-1630SBB	Black	16	16	27¾	32	3.2	\$	898
01-1630SBA	Aluminum							

Description

- 2¾" Diameter Column
- 12"x12" Mounting Plate at Top of Column
- Stiffener Bar Not Included; Must Order Separately (See Stiffener Bars)
- See Number of Bases Required Per Top Width Below
- Power Units Available On Center When Using Two or More Square Bases
- Some Assembly Required

Table Widths	Round	72"	96"
Number of Bases Required	1	2	2

[See Madera Intro Section for Ordering Options](#)

Item	Model No.		Width	Depth	Height	Ship Wt	Cubic Ft	List Price	
DISC BASE 	For 48" Round Tops								
	01-3230DBB	Black	30	30	27¾	42	4.1	\$ 1842	
	01-3230DBA	Aluminum	30	30	27¾	42	4.1		
	For 36" and 42" Round Tops								
	01-2430DBB	Black	24	24	27¾	32	3.2	\$ 1535	
	01-2430DBA	Aluminum	24	24	27¾	32	3.2		

Description

- 4" Diameter 14 Gauge Steel Column
- 12"x12" Mounting Plate at Top of Column
- ¼" Thick Disc Plate with 5 Levelers
- Some Assembly Required

Table Widths**Number of Bases Required**

Round	72"	96"
1	2	2

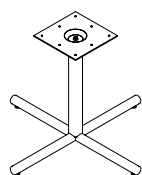
TUBULAR X-BASE

OPEN MARKET ONLY

For Use With: 48" Round Tops and 48"x96" Top Surfaces								
01-3830TXB	Black	38	38	27¾	40	4.2	\$ 699	
01-3830TXA	Aluminum							
For Use With: 36" + 42" Round Tops and 36"x72" Top Surfaces								
01-3230TXB	Black	32	32	27¾	32	3.2	\$ 633	
01-3230TXA	Aluminum							

Description

- 3" Diameter Column
- See Number of Bases Required Per Top Width Below
- Power Units Available On Center When Using Two or More Tubular X-Bases
- Some Assembly Required

Table Widths**Number of Bases Required**

Round	72"	96"
1	2	2

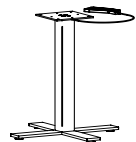
HEIGHT ADJUSTABLE PNEUMATIC X-BASE

Maximum Round 42"								
01-3232HAXBB	Black	32	32	26-45¾	1	0.2	\$ 1721	
01-3232HAXBA	Aluminum							
Maximum Round 36"								
01-2626HAXBB	Black	22	22	26-45¾	1	0.2	\$ 1687	
01-2626HAXBA	Aluminum							

Description

- Pre-Drilled Boring Pattern May Not Match Underside of Table Top
- Steel Mounting Plate: 8"x 8"x ¼"
- Eight (8) Bolts Included for Assembly
- Some Assembly Required

Pricing Codes:

W = Wood Top

P = Laminate Top

PV = Premium Veneer

[See Madera Intro Section for Ordering Options](#)

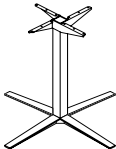
Item	Model No.		Width	Depth	Height	Ship Wt	Cubic Ft	List Price	
	For Use With: 42" + 48" Round Tops and 48"x96" Top Surfaces								
	08-2642LXBB	For 42"H Tables	Black	35½	35½	40	33	20.0	\$ 1322
	08-2642LXBA		Aluminum						
	08-2636LXBB	For 36"H Tables	Black	35½	35½	34	30	17.2	\$ 1275
	08-2636LXBA		Aluminum						
	08-2630LXBB	For 30"H Tables	Black	35½	35½	28	27	14.5	\$ 1219
	08-2630LXBA		Aluminum						
	For Use With: 36" Round Tops and 36"x72" Top Surfaces								
	08-2042SXBB	For 42"H Tables	Black	29	29	40	27	15.9	\$ 1235
	08-2042SXBA		Aluminum						
	08-2036SXBB	For 36"H Tables	Black	29	29	34	24	13.7	\$ 1185
	08-2036SXBA		Aluminum						
	08-2030SXBB	For 30"H Tables	Black	29	29	28	21	11.6	\$ 1139
	08-2030SXBA		Aluminum						

Description

- See Number of Bases Required Per Top Width Below
- Power Units Available On Center When Using Two or More Metal X-Bases
- Ships Assembled

Table Widths	Round	72"	96"
Number of Bases Required	1	2	2

CYLINDER BASE

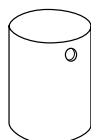

01-2020CB		20	20	28½	136	11.1	W\$ 1553
	<i>For Use With 42" or 48" Round Top</i>						PV\$ 1813
01-1616CB		16	16	28½	101	7.2	W\$ 1419
	<i>For Use With 36" Round Top</i>						PV\$ 1660

Description

- Veneer Cylinder Base Features Multi-Step, Hand-Finished Catalyzed Finish
- Weighted for Stability
- Two (2) Wire Management Black Grommets Standard at Top with 8" Opening Standard in Bottom

Options: Specify & Add

GCBIS	Single Grommet at Top Edge	N/C
NOGC	No Grommets	N/C

Must Specify (in this order):

- Model
- Finish/Color
- Grommet
- Grommet Color

[See Madera Intro Section for Ordering Options](#)

SURFACE MOUNT TACKBOARDS
21" H

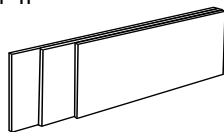

Model #	Size	COM ydg	COM, 1, 2 or 3	Grades									
				4	5	6	7	8	9	10			
TB-1496H	96"	3.00	\$ 707	1124	1319	1517	1799	2093	2435	2831			
TB-1490H	90"	2.75	\$ 673	1055	1234	1416	1674	1944	2257	2620			
TB-1484H	84"	2.50	\$ 639	987	1149	1314	1549	1794	2079	2409			
TB-1478H	78"	2.50	\$ 628	976	1138	1303	1538	1783	2068	2398			
TB-1472H	72"	2.25	\$ 566	879	1025	1174	1385	1606	1862	2159			
TB-1466H	66"	2.00	\$ 533	811	941	1073	1261	1457	1685	1949			

Must Specify (in this order):
Model #
Fabric Vendor, Pattern, and Color

Description

- Coordinates with Surface Mount Hitches
- Factory Installed

WALL MOUNT TACKBOARDS
21½" H

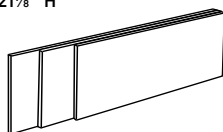

Model #	Size	COM ydg	COM, 1, 2 or 3	Grades									
				4	5	6	7	8	9	10			
TB-0136W	36"	1.25	\$ 434	608	689	772	889	1012	1154	1319			

Must Specify (in this order):
Model #
Fabric Vendor, Pattern, and Color

Description

- Coordinates with Wall Mount Hitches
- Factory Installed

Item	Model No.	Width	Depth	Height	Ship Wt	Cubic Ft	List Price
LED TASKLIGHTS	TL-0848 <i>240-LED, 18 Watts</i>	47½	7/8	1½	-	-	\$ 445
	TL-0824 <i>84-LED, 7 Watts</i>	22½	7/8	1½	-	-	\$ 368

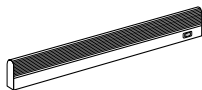

Description

- Includes the Power Supply and Three (3) Upper Wire Management Grommets
- Rocker Style On/Off Switch with a 10' Power Cord
- Three (3) Upper Wire Management Grommets; Must Specify Color: Black (BLK), Silver (SLV)

LED TASKLIGHTS	01-188LED58 <i>96-LED, 33.7 Watts</i>	57¾	2	¾	-	-	\$ 1648
	01-94LED31 <i>48-LED, 17.6 Watts</i>	30¾	2	¾	-	-	\$ 1195
	01-47LED17 <i>24-LED, 9.1 Watts</i>	16¾	2	¾	-	-	\$ 690

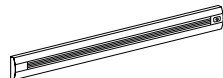

Description

- Includes the Power Supply and Three (3) Upper Wire Management Grommets
- 12' Power Cord
- Three (3) Upper Wire Management Grommets; Must Specify Color: Black (BLK), Silver (SLV)
- Optional Occupancy Sensor Shuts Off After 30 Minutes of Inactivity and Turns On Immediately When Reentering the Detection Area

Options: Specify & Add

01-OSRP	Occupancy Sensor	\$ 366
---------	------------------	--------

[See Madera Intro Section for Ordering Options](#)

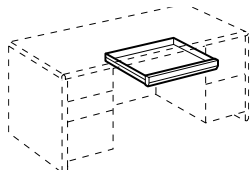
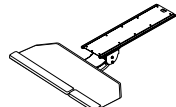
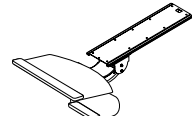
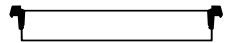
Item	Model No.	Width	Depth	Height	Ship Wt	Cubic Ft	List Price
CENTER DRAWER 	01-2122CD	22	20 $\frac{5}{8}$	2 $\frac{3}{4}$	13	1.7	\$ 529
	01-1622CD	22	16 $\frac{5}{8}$	2 $\frac{3}{4}$	7	1.4	\$ 495
Description <ul style="list-style-type: none"> • Beveled Drawer Front • $\frac{3}{4}$ Extension • Center Drawer Features Multi-Step, Hand-Finished Catalyzed Finish • Wood Drawer Interiors with Built in Pen Tray 							
Options: Specify & Add							
CD16 Factory Installed 01-1622CD							\$ 208
<hr/>							
ARTICULATING KEYBOARD CORNER PLATFORM 	01-KB2CC	25	10 $\frac{1}{2}$	4 $\frac{1}{2}$	16	1.4	\$ 832
Description <ul style="list-style-type: none"> • Standard With: +/- 15° Tilt Adjustment , 360° Rotation, Independent Tilt Adjustment, 7" Lift and Lock Height Adjustment, 25" Cut Corner Platform • Keyboard and Mouse on same level; Single Palm Rest for both Left & Right Hands • Works with 17"+ Diagonal Work Surface • Cannot Be Used on 20" or 21" Deep Unit • Not Available with Optional Center Grommet • Track Measures 21" 							
Options: Specify & Add							
KB2CC Factory Installed							\$ 208
<hr/>							
KEYBOARD MECHANISM WITH KEYBOARD CLAMP 	01-KB3	26 $\frac{1}{2}$	14	4.5	16	1.4	\$ 914
Description <ul style="list-style-type: none"> • Standard With: 18.75" Platform with Swivel-Below Mouse Platform,+/- 15° Tilt Adjustment, 360° Rotation, 7" Lift and Lock Height Adjustment, Independent Tilt Adjustment, Palm Rest for Mousing Surface • Left or Right Handed Mouse Platform • Cannot Be Used on 20" or 21" Deep Unit • Not Available with Optional Center Grommet • Track Measures 21" 							
Options: Specify & Add							
KB3 Factory Installed							\$ 208
<hr/>							
BOX DRAWER DIVIDER 	14-0316DV	15 $\frac{7}{32}$	$\frac{1}{4}$	3 $\frac{1}{2}$	1	0.5	\$ 116
	For Use in Legal Width Box Drawer						
	14-0315DV	14 $\frac{5}{32}$	$\frac{1}{4}$	3 $\frac{1}{2}$	1	0.5	\$ 107
	For Use in Modular Ped Box Drawer						
14-0313DV	14 $\frac{5}{32}$	$\frac{1}{4}$	3 $\frac{1}{2}$	1	0.5	\$ 93	
For Use in Letter Width Box Drawer							
Description <ul style="list-style-type: none"> • Clear Acrylic • Plastic Clips Mount Over Drawer Sides • Frosted Divider 							

[See Madera Intro Section for Ordering Options](#)

Item	Model No.		Width	Depth	Height	Ship Wt	Cubic Ft	List Price
28"D ELECTRIC HEIGHT ADJUSTABLE TABLE LIFT	01-2854ELB	Black	54-78	28	22-48	30	2.4	\$ 1832
	01-2854ELA	Silver						

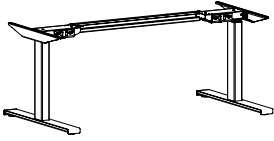

Description

- Standard with Up/Down Control Switch, 10' Power Cord, Integrated Anti-Collision Feature, Leveling Glides
- Standard Up/Down Control Switch can be Mounted for Left or Right Users; Upgrade to Advanced Memory Switch (01-MSWCH with Memory, Reminders, and Bluetooth), Must Specify and See Below for Details
- Adjusts to Accommodate Tops 54-78"W and 30"-36"D; Tops Sold Separately
- Lifting Capacity (Including Worksurface): 363 lbs
- Some Assembly Required; Installation Instructions Included

22"D ELECTRIC HEIGHT ADJUSTABLE TABLE LIFT	01-2254ELB	Black	54-78	22	22-48	58	2.4	\$ 1832
	01-2254ELA	Silver						

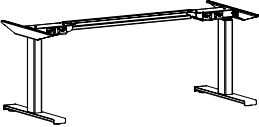

Description

- Standard with Up/Down Control Switch, 10' Power Cord, Anti-Collision Safety Feature, Leveling Glides
- Standard Up/Down Control Switch can be Mounted for Left or Right Users; Upgrade to Advanced Memory Switch (01-MSWCH with Memory, Reminders, and Bluetooth), Must Specify and See Below for Details
- Adjusts to Accommodate Tops 54-78"W and 24"D; Tops Sold Separately
- Lifting Capacity (Including Worksurface): 363 lbs
- Some Assembly Required; Installation Instructions Included

22"D ELECTRIC HEIGHT ADJUSTABLE TABLE LIFT	01-2242ELB	Black	42-48	22	22-48	55	2.4	\$ 1832
	01-2242ELA	Silver						

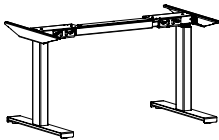

Description

- Standard with Up/Down Control Switch, 10' Power Cord, Anti-Collision Safety Feature, Leveling Glides
- Standard Up/Down Control Switch can be Mounted for Left or Right Users; Upgrade to Advanced Memory Switch (01-MSWCH with Memory, Reminders, and Bluetooth), Must Specify and See Below for Details
- Adjusts to Accommodate Tops 42-48"W and 24"D; Tops Sold Separately
- Lifting Capacity (Including Worksurface): 363 lbs
- Some Assembly Required; Installation Instructions Included

ELECTRIC HEIGHT ADJUSTABLE ADVANCED SWITCH WITH MEMORY	01-MSWCH		3⅝	4⅜	1⅝	½	0.8	\$ 223
--	----------	--	----	----	----	---	-----	--------



Description

- Black Unit with Black Cord
- Bluetooth Capabilities
- Three Stand-Up Reminders
- Four Height Memory Positions

OPEN MARKET ONLY

[See Madera Intro Section for Ordering Options](#)

Item	Model No.		Width	Depth	Height	Ship Wt	Cubic Ft	List Price
	01-SAND60PW	White	3	3	4	1	0.2	\$ 98
	01-SAND60PB	Black						
	01-SAND60PS	Silver						

Description

- Unit is 2" Diameter; Mounts in 60mm Round Grommet
- 6' Cord
- Single Power Outlet

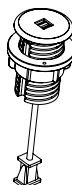
	01-SAND60UW	White	3	3	4	1	0.2	\$ 277
	01-SAND60UB	Black						
	01-SAND60US	Silver						

Description

- Unit is 2" Diameter; Mounts in 60mm Round Grommet
- 6' Cord
- Dual USB Outlets

	01-DOCK950W	White	3 $\frac{3}{10}$	3 $\frac{3}{10}$	-	1	0.2	\$ 265
	01-DOCK950B	Black						

Description

- For Use with Wireless Charging Enabled Devices
- 5 Watts Maximum Output with a Direct Current of 5V 2A and 10 Watts Maximum with Quick Charge 2.0
- LED will Confirm Pairing with Device and Begin Wireless Charging

OPEN MARKET ONLY

	01-DOCK150W	White	3	3	$\frac{3}{4}$ "	1	0.2	\$ 405
	01-DOCK150B	Black						

Description

- For Use with Wireless Charging Enabled Devices and USB Charging Devices
- 5 Watt Maximum Output with a Direct Current Input of 5V 6A (Wireless Fast Charge)
- Pop-Up is $\frac{3}{4}$ "H and Includes Three (3) USB Ports; One (1) 12 Watt Maximum with 2.4A (USB Fast Charge) and Two (2) 5 Watt with 1A (USB Standard Charge)
- LED Light will Confirm Pairing with Device and Begin Wireless Charging
- UL and cUL Certified

OPEN MARKET ONLY

[See Madera Intro Section for Ordering Options](#)

Item	Model No.		Width	Depth	Height	Ship Wt	Cubic Ft	List Price
------	-----------	--	-------	-------	--------	---------	----------	------------

DUO BEZEL NEMA PLUG

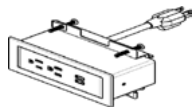

01-DUOBEZELW

White

6½

2½

3¼

1

0.2

\$ 675

01-DUOBEZELB

Black

01-DUOBEZELS

Silver

Description

- Sits on Table Top and Includes: Two (2) Power, Two (2) USB, 10' Cord, and All Mounting Hardware
- Independent USB Circuit Controllers Deliver up to 2.1 Amps to Each Post
- FCC Part 15A, UL Recognized for Horizontal and Vertical Applications

TRIO BEZEL NEMA PLUG



01-TRIOBEZELW

White

9

2½

3

1

0.2

\$ 725

01-TRIOBEZELB

Black

01-TRIOBEZELS

Silver

Description

- Sits on Table Top and Includes: Three (3) Power Outlets, Two (2) USB Ports, One (1) Open Data Port, 10' Cord, and All Mounting Hardware
- HDMI, VGA, and RJ45 Accessories for Open Data Port; Sold Separately, [See Accessories](#)
- Independent USB Circuit Controllers Deliver up to 2.1 Amps to Each Post
- FCC Part 15A, UL Recognized for Horizontal and Vertical Applications

DUO BEZEL DAISY CHAIN PLUG

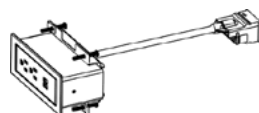

01-PDUOBEZELW

White

6½

2½

3

1

0.2

\$ 668

01-PDUOBEZELB

Black

01-PDUOBEZELS

Silver

Description

- Sits on Table Top and Includes: Two (2) Power, Two (2) USB, 12" Cord, and All Mounting Hardware
- Requires Daisy Chain Power Box; Sold Separately, [See Power Box Details](#)
- Non-Sequential System Allows up to Eight (8) Modules to be Connected with Jumper Cord, [See Jumper Cord Details](#)
- Independent USB Circuit Controllers Deliver up to 2.1 Amps to Each Post
- FCC Part 15A, RU Listed and UL Recognized for Horizontal and Vertical Applications

TRIO BEZEL DAISY CHAIN PLUG

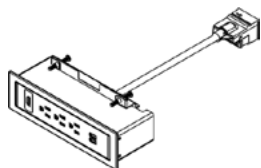

01-PTRIOBEZELW

White

9

2½

3

1

0.2

\$ 715

01-PTRIOBEZELB

Black

01-PTRIOBEZELS

Silver

Description

- Sits on Table Top and Includes: Three (3) Power Outlets, Two (2) USB Ports, One (1) Open Data Port, 12" Cord, and All Mounting Hardware
- HDMI, VGA, or RJ45 Accessory for Open Data Port; Sold Separately, [See Accessories](#)
- Requires Daisy Chain Power Box, Specified Separately, See Next Page
- Non-Sequential System Allows up to Eight (8) Modules to be Connected with Jumper Cord, [See Jumper Cord Details](#)
- Independent USB Circuit Controllers Deliver up to 2.1 Amps to Each Post
- FCC Part 15A, RU Listed and UL Recognized for Horizontal and Vertical Applications

[See Madera Intro Section for Ordering Options](#)

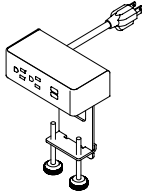
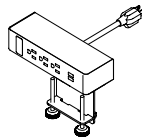
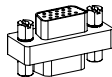
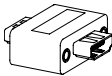
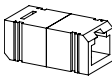
Item	Model No.		Width	Depth	Height	Ship Wt	Cubic Ft	List Price
DUO CLAMP NEMA PLUG 	01-DUOCLAMPW	White	5½	3	7	1	0.2	\$ 572
	01-DUOCLAMPB	Black						
	01-DUOCLAMP S	Silver						
	Description <ul style="list-style-type: none"> Standard with: Two (2) Power Outlet, Two (2) USB Ports, 10' Cord Clamps to Top and Features Silver Metal Trim Independent USB Circuit Controllers Deliver up to 2.1 Amps to Each Post All Mounting Hardware Included FCC Part 15A and UL Approved for Horizontal and Vertical Applications 							
TRIO CLAMP NEMA PLUG 	01-TRIOCLAMPW	White	8	3	7	1	0.2	\$ 671
	01-TRIOCLAMPB	Black						
	01-TRIOCLAMP S	Silver						
	Description <ul style="list-style-type: none"> Standard with: Three (3) Power Outlets, Two (2) USB Ports, One (1) Open Data, 10' Cord Clamps to Top and Features Silver Metal Trim Independent USB Circuit Controllers Deliver up to 2.1 Amps to Each Post HDMI, VGA, or RJ45 Accessories Sold Separately All Mounting Hardware Included FCC Part 15A and UL Approved for Horizontal and Vertical Applications 							
TRIO VGA DATA PORT ACCESSORY 	01-LCOMVGA		-	-	-	1	0.2	\$ 121
Description <ul style="list-style-type: none"> VGA Port for Trio Bezel Units 								
TRIO HDMI DATA PORT ACCESSORY 	01-LCOMHDMI		-	-	-	1	0.2	\$ 166
Description <ul style="list-style-type: none"> HDMI Port for Trio Bezel Units 								
OPEN MARKET ONLY								
TRIO RJ45 DATA PORT ACCESSORY 	01-LCOMRJ45		-	-	-	1	0.2	\$ 79
Description <ul style="list-style-type: none"> RJ45 Port for Trio Bezel Units 								

[See Madera Intro Section for Ordering Options](#)

Item	Model No.	Width	Depth	Height	Ship Wt	Cubic Ft	List Price
DAISY CHAIN POWER BOX 	01-PPOWER <i>76" Perimeter, 36" Power Cord</i>	-	-	-	1	0.2	\$ 775
	01-PPOWER2 <i>24" Perimeter, 144" Power Cord</i>	-	-	-	1	0.2	\$ 796

Description

- Powers up to Eight (8) Duo and Trio Daisy Chain Units
- One Nema Plug and One Daisy Chain Plug
- 12-Amp System Rating
- 15-Amp Over-Current Protection

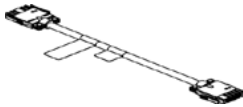
DAISY CHAIN JUMPER CORD 	01-6JUMP <i>72" Long</i>	-	-	-	1	0.2	\$ 299
	01-5JUMP <i>60" Long</i>	-	-	-	1	0.2	\$ 284
	01-4JUMP <i>48" Long</i>	-	-	-	1	0.2	\$ 240
	01-2JUMP <i>24" Long</i>	-	-	-	1	0.2	\$ 220

Description

- Connects Duo and Trio Daisy Chain Units
- Non-Sequential System Allows up to Eight (8) Modules to be Connected

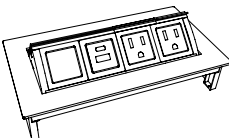
DPORT 	01-DPORT4A Aluminum	8	4	-	7	0.2	\$ 1093
	01-DPORT4B Black						

Description



- Retracts into Work Surface to Regain Productive Space; One-Touch Access to Power and Data
- Two (2) Power Outlets, One (1) USB A+C, and One (1) Open Port
- See Optional Telecom Plates in the Table and Space Division Price List
- Water-Proof Simplex (Outlets)
- Includes a Voice/Data Adapter Kit to Accept Couplers and Jacks When Required and a 10' Power Cord
- UL Recognized
- For Use with Rectangle and Boat Table Tops

USB PORT 	01-USBPORT	-	-	-	-	-	\$ 161
---	------------	---	---	---	---	---	--------

Description

- Passive USB-A Port with Increased Transfer Speed Up to 5 gbs/sec
- Simultaneous Read/Write Capability; Idle Device Power Saving State
- 6' Cord
- Compatible with 01-DPORT4A and 01-DPORT4B

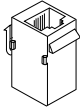
[See Madera Intro Section for Ordering Options](#)

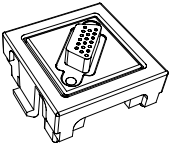
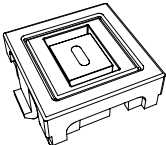
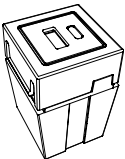
Item	Model No.	Width	Depth	Height	Ship Wt	Cubic Ft	List Price
VOICE COUPLER 	01-VOICE1	-	-	-	-	-	\$ 73
Description <ul style="list-style-type: none"> • 6-Pin Modular Plug • Molded Black; Cord Not included • Compatible with 01-DPORT4A and 01-DPORT4B 							
DATA PORT 	01-RJ4DATA	-	-	-	-	-	\$ 167
Description <ul style="list-style-type: none"> • 8-Pin Modular Plug; Cat6 Ethernet Cable; Pre-terminated Cable • 10' Cord • Compatible with 01-DPORT4A and 01-DPORT4B 							
VGA CONNECTOR ACCESSORY 	01-VGACON	-	-	-	1	0.2	\$ 149
Description <ul style="list-style-type: none"> • VGA Port for 01-DPORT4A and 01-DPORT4B • Enables Devices to Remote Display on Monitors • 10' Cord • Male/Female Connector 							
PASSIVE USB-C ACCESSORY 	01-PUSBC	-	-	-	1	0.2	\$ 95
Description <ul style="list-style-type: none"> • Passive USB-C Port ; Unit Provides Data Connection to Transfer Data Only, No Charging Capabilities • Compatible with 01-DPORT4A and 01-DPORT4B • Male/Female Connector 							
CHARGING USB-A+C ACCESSORY 	01-USBAC	-	-	-	1	0.2	\$ 283
Description <ul style="list-style-type: none"> • For Charging Devices • 20 Watt Power Supply • USB+C Charging Port for 01-DPORT4A and 01-DPORT4B 							

[See Madera Intro Section for Ordering Options](#)

Item	Model No.	Width	Depth	Height	Ship Wt	Cubic Ft	List Price
HDMI CONNECTOR ACCESSORY	01-HDMICON	-	-	-	1	0.2	\$ 124

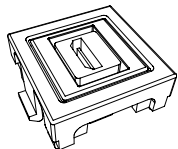
Description

- HDMI Port for 01-DPORT4A and 01-DPORT4B
- Connects to High Definition Displays
- Female/Female Connector
- 18" Cord

INTERACT POWER & DATA	01-INTERACTG2A	Aluminum	9	5 $\frac{3}{8}$	2 $\frac{3}{4}$	5	0.2	\$ 891
	01-INTERACTG2B	Black						



Description

- Includes: Two (2) Power Outlets, Two (2) USB-A Charging Ports, One (1) Telecom Plate Opening; Two (2) Keystone Openings for Voice/Data Jacks
- One (1) Telecom Plates Included with the Unit: One (1) 01-ABLAB Plate (Consists of One (1) RJ45 Cat 6, One (1) RJ11 Cat 3 Phone Jack)
- Convenience Plug on Bottom with 6' Power Cord
- UL and CSA Recognized
- See Optional Telecom Plates in the Table and Space Division Price List
- For Use with Rectangle and Boat Table Tops

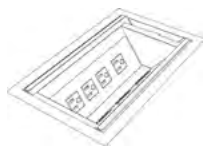
OASIS MINI POWER & DATA	01-OASISMA	Aluminum	15	9	5	11	0.3	\$ 3191
	01-OASISMB	Black						

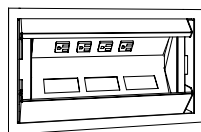

Top View

Description

- Soft Touch Hinged Lid
- Plate Includes: Two (2) Data, One (1) Voice Telecom Plates, Four (4) Power Outlets, 9' Power Cord
- Two (2) Telecom Plates Included with the Unit: One (1) 01-ABLAB Plate (Consists of One (1) RJ45 Cat 6, One (1) RJ11 Cat 3 Phone Jack); One (1) 01-ABLB Plate (Consists of One (1) RJ45 Cat 6)
- 9' Cord with Nema Plug; Fits 15A/120V AC Receptacles
- UL Listed
- See Optional Telecom Plates in the Table and Space Division Price List
- For Use with Rectangle and Boat Table Tops

DOCK800	01-DOCK800S	Silver	14	9	-			\$ 2047
	01-DOCK800B	Black						

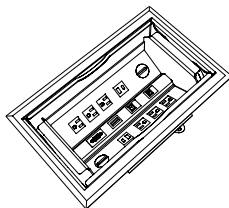

OPEN MARKET ONLY

Description

- Stylish Aluminum Housing with Beveled Edges; Soft Touch Access and Closure
- Includes: Six (6) Power Outlets, Two (2) USB-A 5V Ports, Two (2) USB-C Charging Ports, One (1) RJ45 Ethernet Port, One (1) RJ11 Port, One (1) HDMI Port, and One (1) VGA Port
- 10' Power Cord
- UL and cUL Certified
- See Optional Telecom Plates in the Table and Space Division Price List
- For Use with Rectangle and Boat Table Tops

[See Madera Intro Section for Ordering Options](#)

Item	Model No.	Width	Depth	Height	Ship Wt	Cubic Ft	List Price
POWER ENTRY HARD WIRED	01-HWPOWERENTRY	72	-	-	1	0.2	\$ 322

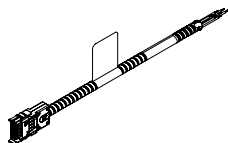

Description

- Eight (8) Wire/Four (4) Circuit Hard Wire In-feed
- UL183 Compliant

JUMPER HARD WIRE CABLE	01-HW2JUMP	24	-	-	1	0.2	\$ 193
------------------------	------------	----	---	---	---	-----	--------

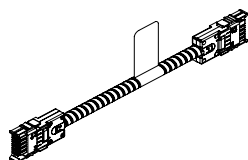

01-HW3JUMP	36	-	-	1	0.2	\$ 206
01-HW4JUMP	48	-	-	1	0.2	\$ 212
01-HW5JUMP	60	-	-	1	0.2	\$ 255
01-HW6JUMP	72	-	-	1	0.2	\$ 270

Description

- Eight (8) Wire/Four (4) Circuit Hard Wire Jumper
- UL183 Compliant

QUAD BLOCK HARD WIRED	01-HWQUADBLOCK	-	-	-	1	0.2	\$ 62
-----------------------	----------------	---	---	---	---	-----	-------

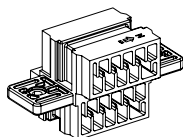

Description

- Eight (8) Wire/Four (4) Circuit Hard Wire Connector
- UL183 Compliant
- For Connecting Jumpers and Power Units
- Quantity of Four (4) Female Inputs

PURSE HOOK FOR WORK TABLE	01-HOOK	2	1¼	2½ ₂₅			\$ 79
---------------------------	---------	---	----	------------------	--	--	-------



Description

- Black Hook Includes Mounting Hardware
- For Use with Work Tables, [See Work Tables](#)
- Field Installed

HEIGHT ADJUSTABLE WORKSTATION	01-S2SBLK	Black	35½	25	6-22	49	6.5	\$ 1503
-------------------------------	-----------	-------	-----	----	------	----	-----	---------

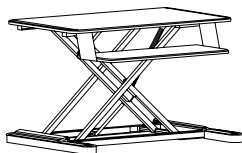

Description

- Height Adjustable
- Weight Capacity: 35lbs
- One-Handed Operation; Platforms Move Simultaneously
- Keyboard Platform: 10½"D x 26½"W
- Worksurface: 21"D x 35½"W
- Can be Used on Worksurface 24"D x 35"W

[See Madera Intro Section for Ordering Options](#)

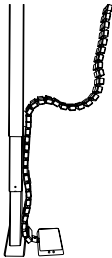
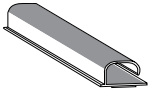
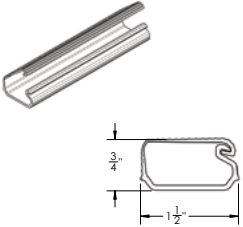
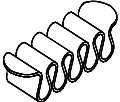
Item	Model No.		Width	Depth	Height	Ship Wt	Cubic Ft	List Price
VESTA POWER CENTER 	01-PDCTR		10¾	12	28¼	14	2.5	\$ 1776
	Description <ul style="list-style-type: none"> • Top Includes One (1) Power Outlet, Two (2) USB Ports and One (1) USBC Port; Base Includes Three (3) Outlet • Available in White • 120" Power Cord • Built with Weight Distribution for Optimal Stability • Base is 5" Tall 							
LINK 360 CABLE MANAGER 	01-0251LINKSLV	Silver	5¾	3 ⅞	30-51	4	3.0	\$ 390
	01-0251LINKBLK	Black	5¾	3 ⅞	30-51	4	3.0	\$ 353
Description <ul style="list-style-type: none"> • Kit Includes: 50 Link 360™ elements, One (1) Quad Connector, One (1) Dumbbell Connector, and One (1) Foot Assembly with Two (2) Magnetic Clips • Can Be Used For Height-Adjustable Mechanisms Up To 51" or Free-Standing Use 								
WIRE CHANNEL 	01-32125		24	1⅞	1	.25	0.3	\$ 106
	Description <ul style="list-style-type: none"> • Available in Black • Channels Attach with Two (2) Double-Sided Installation Tape • Easily Attach to an Iconic Leg to Route Wires/Cords from the Top to the Floor • Open J Channel for Easy Storage of Cables 							
WIRE MANAGEMENT CHANNEL 	01-WMGR4		16	1½	1	1	-	\$ 116
	Description <ul style="list-style-type: none"> • Set of Four (4) Black Plastic Wire Management Channels • Snap Lock Channel • Attaches with Adhesive Strips • Ships via UPS Only 							
CABLE GRIP 	01-WMGRCB		5¾	2¾		-	-	\$ 17
	Description <ul style="list-style-type: none"> • Under Surface Wire Management • Black 							

[See Madera Intro Section for Ordering Options](#)

Crafted in select solids and American veneers, Phoenix's clean, transitional styling is at ease in both contemporary and traditional settings. It is a perfect choice for value-minded companies who want a sophisticated, yet uncomplicated, furniture solution.

CONSTRUCTION

Phoenix features a Veneer chassis with your choice of a Veneer or HPL top. Units ship assembled unless otherwise noted.

VENEER

- Exposed surfaces feature select grade sliced American Black Walnut or Cherry veneer carefully selected and matched to assure proper balance and consistency

TOPS

- Veneer tops are 5-ply balanced construction and 1 5/32" thick with solid hardwood rims
- High Pressure Laminate (HPL) tops are 3-ply balanced construction and 1 1/32" thick with solid hardwood rims
- Grain direction runs left to right unless noted

CHASSIS

- Chassis is securely fastened using high quality European fastening systems and heavy-duty, 16-gauge joining brackets to assure maximum strength
- Units feature finished backs unless otherwise noted
- All units equipped with heavy-duty, adjustable glides to ensure proper leveling and compensate for uneven floors

DRAWERS

- Drawer fronts standard with matched veneer faces
- Drawer sides, back and front are woodgrain vinyl-wrapped, and are 1/2" thick
- 5-sided drawer construction for easy removal of drawer fronts
- Box and file drawers have 1/8" thick hardboard bottoms and tested for 100lb capacity
- Lateral files feature 1/4" thick bottoms. Drawers are tested for 200lb of equally distributed weight (ex: hanging file folders) and 65lbs of bottom load weight (ex: stacked catalogs)
- All drawers feature full extension, progressive action slides with precision steel ball bearings
- All suspensions have a limited lifetime warranty

FILING

- All file drawers are standard with filing systems designed to accommodate a variety of filing requirements
- Legal width file drawers provide legal filing front to back, and letter or legal filing side to side
- Letter width file drawers provide letter filing front to back, and letter or legal filing side to side

STORAGE

- All hinged doors include soft close hinges, unless noted
- One piece hinge and base plate combination
- Soft close hinges reduce stress placed on the cabinet when the door is closed and offers a quiet closure

LOCKING

- All desks, credenzas, returns, and files feature standard locking
- Lock core will coordinate with pull selection unless otherwise noted
- Removable lock cylinders allow for units to be re-keyed at a later date if required
- Units are shipped randomly keyed as standard. Keyed alike units available upon request at no additional charge.

CORD MANAGEMENT

- Grommets are standard in back panels of assembled returns, bridge units, kneespace credenzas, and hutch units
- A grommet is standard in tops of corner units
- Grommets may be ordered in the tops of desks, returns, bridge units, and credenzas worksurfaces
- Grommets are 2 3/8" in diameter and available in black or silver, please specify color
- [See grommet options and locations.](#)
- Wire Manager available for additional cord management; [See Accessories](#)

INTERIOR DRAWER DIMENSIONS

Models

21-3672BDP	21-3072LP	21-2448LF1	21-2066LC2
21-3672BLP	21-3072RP	21-2448RF1	21-2066RC2
21-3672BRP	21-3066LP	21-2442LF2	21-2072LC1
21-3672DP	21-3066RP	21-2442RF2	21-2072RC1
21-3072DP	21-3060LP	21-2442LF1	21-2066LC1
21-3066DP	21-3060RP	21-2442RF1	21-2066RC1
21-3060DP	21-2448LF2	21-2072LC2	21-2072SC
21-3672LP	21-2448RF2	21-2072RC2	21-2066SC
21-3672RP	21-2072KC	21-2066KC	

Drawers	W	L	D
Box	12 1/8"	16 3/16"	3 1/2"
File	12 1/8"	16 3/16"	9 5/16"

Models

21-2036L4	21-2030L4	21-2036L2	21-2030L2
21-2072RL	21-2072LL	21-2066RL	21-2066LL

Drawers	W	L	D
Lat File	30 1/2"	15 1/16"	9 7/32"

Models

21-2472RMR	21-2472LMR	21-2072RMF	21-2072LMF
21-2066RMF	21-2066LMF		

Drawers	W	L	D
Box	16 3/16"	12 1/8"	3 1/2"
Upper File	12 1/8"	16 3/16"	9 1/4"
Lat File	31 1/2"	15 1/16"	9 7/32"

Models

21-3672TD	21-3066TD
-----------	-----------

Drawers	W	L	D
Tray	30 11/16"	15 3/16"	1 3/4"

Models

21-1622CD

Drawers	W	L	D
Center	18 15/16"	14 15/16"	1 3/4"

FILING CAPABILITIES

Drawers with Dimensions: 12 $\frac{1}{8}$ "W x 15 $\frac{3}{16}$ "L

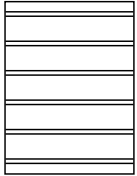

Letter Front to Back

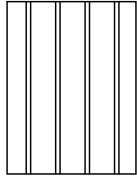

Legal Side to Side

Drawers with Dimensions: 30 $\frac{1}{2}$ "W x 15 $\frac{1}{16}$ "L

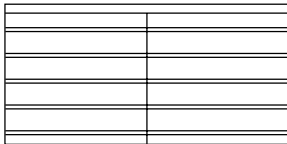

2 Rows Letter Front to Back

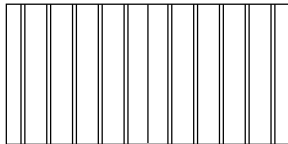

1 Row Letter or Legal Side to Side

Drawers with Dimensions: 31 $\frac{1}{2}$ "W x 15 $\frac{1}{16}$ "L

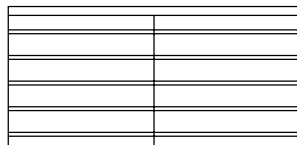

2 Rows Letter or Legal Front to Back

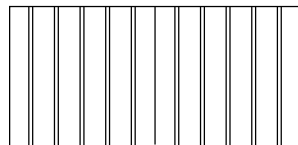

1 Row Letter or Legal Side to Side

HOW TO ORDER EXAMPLES

Model No.	Description	Example
21-3672BDP	Top Material	W
	Finish	AW
	Pull/Color	AFL
	Grommet Location & Color	GC, SLV
	Center Drawer/Keyboard	21-1622CD

VENEER (W) OPTIONS

Veneer features UVAdvantage, an ultra-violet finish, on all exposed surfaces by utilizing roll-coat UV technology. Molding features multi-step, hand-finished catalyzed finish.

AW	Artisan Walnut	LW	Legacy Walnut
CO	Columbian Walnut	MW	Mahogany Walnut
DC	Dark Cherry	MTS	Metropolis Sky
DFW	Dark Forest Walnut	PNW	Pinnacle Walnut
EW	Espresso	SCH	Select Cherry
GC	Golden Cherry	SKC	Shaker Cherry
HW	Harvest Walnut	WC	Williamsburg Cherry
HNW	Henna Walnut		

HPL (P) TOP OPTIONS

WOODGRAIN

CO	Columbian Walnut	PNW	Pinnacle Walnut
EF	Espresso	SCH	Select Cherry
GC	Golden Cherry	SKC	Shaker Cherry
MW	Mahogany Walnut	WC	Williamsburg Cherry

EDGE PROFILE

Select units feature multiple flush options allowing units to be placed next to each other. See specific units for details.

- FL Flush Left
- FR Flush Right
- FLR Flush Left and Right



(FL) Flush Left Shown

O Phoenix



Phoenix (O)

PULL OPTIONS

Note: Lock Core will match Pull Color

AAC	Arc, Aluminum	AEL	Elite, Aluminum
BAC	Arc, Black	BEL	Elite, Black
ABM	Beam, Aluminum	AFL	Flair, Aluminum
BBM	Beam, Black	CFL	Flair, Chrome
BBT	Bow Tie, Black	AFC	Focus, Aluminum
NBT	Bow Tie, Nickel	BFC	Focus, Black
ABU	Buckle, Aluminum	AQD	Quadra, Aluminum
BBU	Buckle, Black	BQD	Quadra, Black



Arc (AAC)
Aluminum - 5"



Arc (BAC)
Black - 5"



Beam (ABM)
Aluminum - 10 $\frac{1}{4}$ "



Beam (BBM)
Black - 10 $\frac{1}{4}$ "



Bow Tie (NBT)
Nickel - 5 $\frac{1}{2}$ "



Bow Tie (BBT)
Black - 5 $\frac{1}{2}$ "



Buckle (ABU)
Aluminum - 4 $\frac{3}{4}$ "



Buckle (BBU)
Black - 4 $\frac{3}{4}$ "



Elite (AEL)
Aluminum - 5"



Elite (BEL)
Black - 5"



Flair (AFL)
Aluminum - 5 $\frac{3}{8}$ "



Flair (CFL)
Chrome - 5 $\frac{3}{8}$ "



Focus (AFC)
Aluminum - 4 $\frac{3}{8}$ "



Focus (BFC)
Black - 4 $\frac{3}{8}$ "



Quadra (AQD)
Aluminum - 4"



Quadra (BQD)
Black - 4"

GROMMET OPTIONS & LOCATIONS

Select Location, then specify Black (BLK) or Silver (SLV)

GC	Grommet, Center	\$	52
GL	Grommet, Left	\$	52
GR	Grommet, Right	\$	52
GSL	Grommet, Seat Side Left - P/D-Tops Only	\$	52
GSR	Grommet, Seat Side Right - P/D-Tops Only	\$	52

Verify Grommet Option is available on the model(s) you are specifying using the following location information. Grommets may be ordered in non-standard locations. Call Customer Service to assist with specification. Note additional charges and lead times may apply.

Multiple unit locations may be selected. Only one unit per location.

[See locations](#)

GROMMET OPTIONS & LOCATIONS (CONTINUED)

Grommets are standard in the back panels of returns, bridges, and credenzas, and may be ordered without grommets at no additional charge. Please specify NO GROMMET on order.

Models

21-3672BDP 21-3672BLP 21-3672BRP

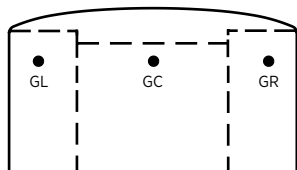

GL/GR: Located 6" from ends and 23" from user side
GC: Located 23" from user side

Models

21-3672DP 21-3672LP 21-3672RP 21-3672TD

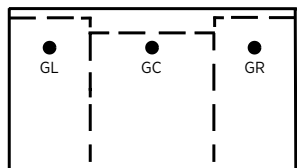

GL/GR: Located 6" from ends and 23" from user side
GC: Located 23" from user side

Models

21-3072DP 21-3072LP 21-3066LP 21-3060LP
21-3066DP 21-3072RP 21-3066RP 21-3060RP
21-3060DP 21-3066TD

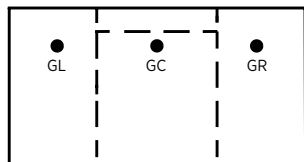

GL/GR: Located 6" from ends and 23" from user side
GC: Located 23" from user side

Models

21-2448UF 21-2448UFH 21-2442UF 21-2442UFH

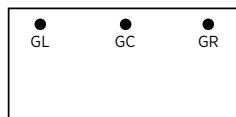

GL/GR: Located 6" from ends and 20" from user side
GC: Located 20" from user side

Models

21-2448LF1 21-2448LF2 21-2442LF1 21-2442LF2
21-2448RF1 21-2448RF2 21-2442RF1 21-2442RF2

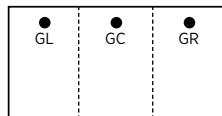

GL/GR: Located 6" from ends and 20" from user side
GC: Located 20" from user side

Models

21-2072KC 21-2072LC1 21-2072LC2 21-2072LL*
21-2066KC 21-2072RC1 21-2072RC2 21-2072RL*
21-2472LMR* 21-2072LMF* 21-2066LC1 21-2066LC2
21-2472RMR* 21-2072RMF* 21-2066RC1 21-2066RC2
21-2066LL* 21-2066RL* 21-2066LMF* 21-2066RMF*

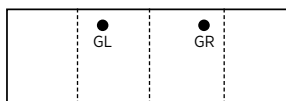

GL/GR: Located 19½" from ends and 17¾" from user side
* Grommets are only available opposite the pedestal

Models

21-4272PR 21-4272PL

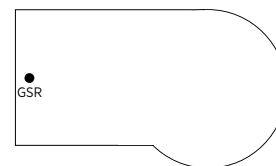
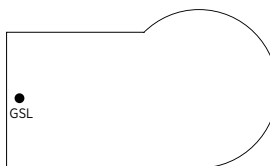

GSL/GSR: Located 18" from approach or seated side, 6" from end

Models

21-3672DL 21-3672DR 21-3072DL 21-3072DR

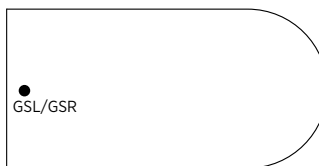

GSL/GSR: Located 18" from approach or seated side, 6" from end

Models

21-4242CU 21-3636CU

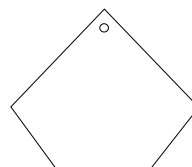

GC: Located 4" from corner edge

HUTCH GROMMET OPTIONS

Surface Mount Hutches come standard with one center grommet at workstation level on back panel. Three upper wire management grommets also are available. One grommet located on right, center and left. Must specify with color selection.

WMHUBL Black Lower Grommet + Three (3) Upper Grommets N/C
WMHUSV Silver Lower Grommet + Three (3) Upper Grommets N/C

TABLE GROMMET & POWER UNIT OPTIONS

Power units and grommets are sold separately and must be specified separately with surface mount location. Multiple locations may be selected. Only one unit per location.

Power units and Grommets Available in Table Surfaces (See Units)

Grommet Specify Color: Black = BLK and Silver = SLV

See Next Page for Additional Grommet and Power Information.

TABLE GROMMET & POWER UNIT OPTIONS CONTINUED

DUO/TRIO BEZEL

- 01-DUOBEZEL Available in Black (B), Silver (S), or White (W)
- 01-TRIOBEZEL Available in Black (B), Silver (S), or White (W)

DOCK 950, DOCK 800 and DOCK 150

- DOCK950 Available in Black or White
- DOCK150 Available in Black or White
- DOCK800 Available in Black or Silver

Other Power Units

- DPORT4 Available in Aluminum or Black
- INTERACTG Available in Aluminum or Black
- OASISM Available in Aluminum or Black

Power/Data Location Information:

- Designate unit and location when specifying the top model. Power/Data Module need to be ordered separately.
- Power/Data Modules specified at the time of order will be routed for field installation.
 - E1 Unit on One End
 - E2 Unit on Each End
 - OC Unit on Center
- All power units available **On Center (OC) only** when paired with two (2) or more of the following bases:
 - Cylinder Base Square Base
 - X-Base Disc
 - Tubular X-Base

Grommets and Power Units may be ordered in non-standard locations. Call Customer Service to assist with specification and/or please attach a drawing to the PO showing the location of the grommet. Note additional charges and lead times may apply.

Top Locations

Power units available on Each End (E1 and E2) and On Center (OC) unless otherwise noted, when paired with any Rectangle Panel Base, Rectangle Box Base or Rectangle Accent Box Base. ([See Unit Details](#))

Power units centered at locations below:

- 36" Tops centered 18"D 48" Tops centered 24"D
- 42" Tops centered 21"D

- 72: OC 36" from end (**available with OC Only**)
- 96: OC 48" from end; E1/E2 29" from end
- 120: OC 60" from end; E1/E2 29" from end
- 144: OC 72" from end; E1/E2 29" from end

LOCKING DOORS

Locking doors are available.. You must specify WITH LOCKING when ordering and add upcharge. See color Information below.

LKT_HU	82"W Units	\$	135
LKT_HU	78"W - 46"W Units	\$	115
LKT_HU	42"W - 24"W Units	\$	91
LKT_HU	18"W - 12"W Units	\$	69

LOCK CORE OPTIONS

Lock core will coordinate with pull color unless otherwise noted.

- BLK Black
- SLV Silver



CERTIFICATIONS & COMPLIANCE

- Intertek Sustainability Certified
- BIFMA level® Certified
- BIFMA Compliant® Certified
- TSCA Title VI (formerly CARB) Compliance
- US Green Building's LEED® Contribution

Standard Components

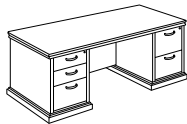

Double Ped Desks with or without Bow Tops
[\(See Multiple Unit Details\)](#)

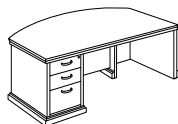

Single Ped Desks with or without Bow Tops
[\(See Multiple Unit Details\)](#)

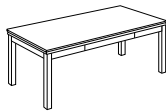
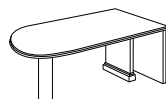
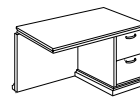

Table Desks
[\(See Details\)](#)



P-Tops and D-Tops
[\(See Multiple Unit Details\)](#)



Returns
[\(See Multiple Unit Details\)](#)

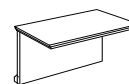

Bridges
[\(See Details\)](#)

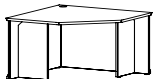

Corner Units
[\(See Details\)](#)

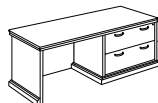

Single Ped, Storage, and Kneespace Credenzas
[\(See Multiple Unit Details\)](#)

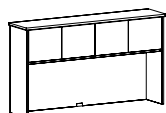

Wall Mount and Surface Mount Hutches
[\(See Multiple Unit Details\)](#)



Lateral Filing
[\(See Details\)](#)

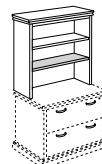

Bookcases
[\(See Multiple Unit Details\)](#)

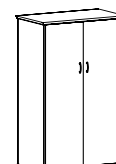

Wardrobes/Storage
[\(See Multiple Unit Details\)](#)

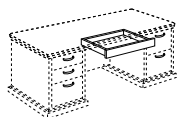

Center Drawer
[\(See Details\)](#)

Tables + Bases [\(See Multiple Units\)](#)

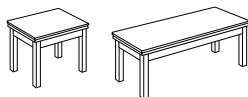

Occasional Tables



Rectangle Tops



Boat Tops



Round Tops

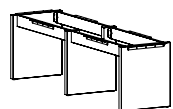

Rectangular Panel Bases with Trough

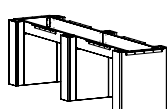

6" Rectangular Bases with Trough

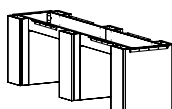

10" Rectangular Bases with Trough

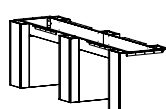

6" Rectangular Accent Bases with Trough

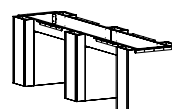

10" Rectangular Accent Bases with Trough

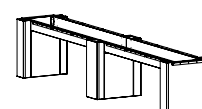

6" + 10" Combo Rectangular Bases with Trough

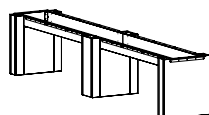

6" + 10" Combo Rectangular Accent Bases with Trough



Disc Bases

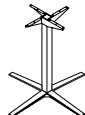

Small and Large X-Bases



HA Pneumatic X-Base



Metal Bases

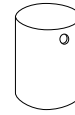

Cylinder

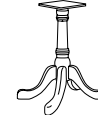

Queen Anne

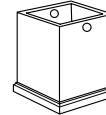

Square

Tackboard, Tasklights, Wire Management & Power/Data Accessories [\(See Multiple Units\)](#)

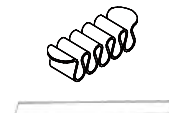
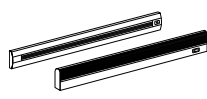
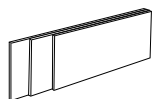

Item	Model No.	Width	Depth	Height	K	R	Ship Wt	Cubic Ft	List Price
EXECUTIVE L UNIT	21-1	72	84	30	31 $\frac{3}{8}$	10 $\frac{3}{4}$	372	73.1	P\$ 6232 W\$ 6780

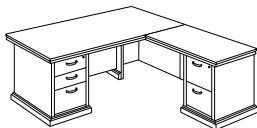

CONSIST OF:	QTY			
21-3672LP	1	Pedestal Desk, Left		P\$ 3624 W\$ 3959
21-2448RF2	1	Return, Right		P\$ 2608 W\$ 2821

Products are available as left or right, where applicable

EXECUTIVE U UNIT BOW TOP DESK STEPPED FRONT	21-2	72	104 $\frac{7}{16}$	30	31 $\frac{3}{8}$	10 $\frac{3}{4}$	568	85.5	P\$ 8532 W\$ 9316
---	------	----	--------------------	----	------------------	------------------	-----	------	----------------------

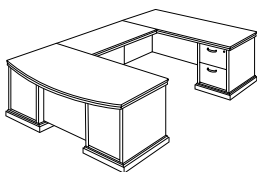

CONSIST OF:	QTY			
21-3672BLP	1	Bow Desk, Left		P\$ 4001 W\$ 4310
21-2448UF	1	Bridge		P\$ 1538 W\$ 1628
21-2072RC2	1	Single Pedestal Credenza, Right		P\$ 2993 W\$ 3378

Products are available as left or right, where applicable

EXECUTIVE U UNIT P-TOP	21-3	72	110 $\frac{7}{16}$	30	-	-	409	95.3	P\$ 7762 W\$ 8306
---------------------------	------	----	--------------------	----	---	---	-----	------	----------------------

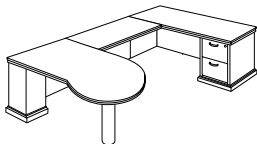

CONSIST OF:	QTY			
21-4272PL	1	P-Top Unit, Left		P\$ 3231 W\$ 3300
21-2448UF	1	Bridge		P\$ 1538 W\$ 1628
21-2072RC2	1	Single Pedestal Credenza, Right		P\$ 2993 W\$ 3378

Products are available as left or right, where applicable

EXECUTIVE U UNIT D-TOP	21-4	72	104 $\frac{7}{16}$	30	-	-	408	85.5	P\$ 7241 W\$ 8048
---------------------------	------	----	--------------------	----	---	---	-----	------	----------------------

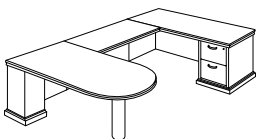

CONSIST OF:	QTY			
21-3672DL	1	D-Top Unit, Left		P\$ 2710 W\$ 3042
21-2448UF	1	Bridge		P\$ 1538 W\$ 1628
21-2072RC2	1	Single Pedestal Credenza, Right		P\$ 2993 W\$ 3378

Products are available as left or right, where applicable

Pricing Codes:
P = Laminate Top
W = Wood Top

[See Phoenix Intro Section for Ordering Options](#)

Item	Model No.	Width	Depth	Height	K	R	Ship Wt	Cubic Ft	List Price
DOUBLE PED DESK WITH BOW TOP	21-3672BDP	72	36-30	30	38¾	10¾	360	50.0	P\$ 4760 W\$ 5077

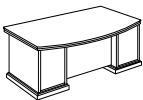
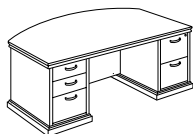

Approach

Description

- Standard with: Bow Top, Stepped Front, Locking Letter Width Box/Box/File on Left and File/File on Right, Black Utility Tray Included in Box Drawer, Wire Management from Pedestal to Kneespace
- Available with Veneer (W) or HPL (P) Top, Must Specify
- Additional Options: Grommet Options ([See Options and Locations](#)), Kneespace Options (Sold Separately, [See Unit Details](#))

Must Specify (in this order):

- Model #
- Top Material
- Finish/Color
- Drawer Pull
- Worksurface Grommet Location
- Grommet Color
- Kneespace Options

DOUBLE PED DESK	21-3672DP	72	36	30	38¾	10¾	360	50.0	P\$ 4387
	6¾" Approach Overhang								W\$ 4723
	21-3072DP	72	30	30	38¾	4¾	330	43.8	P\$ 4311
	¾" Approach Overhang								W\$ 4697
DOUBLE PED DESK	21-3066DP	66	30	30	32¾	4¾	249	38.7	P\$ 4224
	¾" Approach Overhang								W\$ 4601
DOUBLE PED DESK	21-3060DP	60	30	30	26¾	4¾	241	35.3	P\$ 4136
	¾" Approach Overhang								W\$ 4519

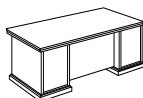
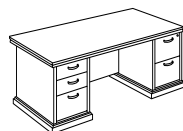

Approach

Description

- Standard with: Rectangle Top, Stepped Front, Locking Letter Width Box/Box/File on Left; File/File on Right, Black Utility Tray Included in Box Drawer, Wire Management from Pedestal to Kneespace
- ¾" Overhang on Left, Right and User Sides
- Available with Veneer (W) or HPL (P) Top, Must Specify
- Additional Options: Additional Options: Grommet Options ([See Options and Locations](#)), Kneespace Options (Sold Separately, [See Unit Details](#))

Must Specify (in this order):

- Model #
- Top Material
- Finish/Color
- Drawer Pull
- Worksurface Grommet Location
- Grommet Color
- Kneespace Options

[See Phoenix Intro Section for Ordering Options](#)

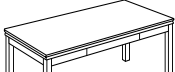
Item	Model No.	Width	Depth	Height	K	R	Ship Wt	Cubic Ft	List Price
	21-3672TD	72	36	30	38¾	10¾	274	50.0	P\$ 2719 W\$ 3058
	21-3066TD	66	30	30	32¾	4¾	249	38.7	P\$ 2555 W\$ 2938

Description

- Includes Center Drawer
- Available with Veneer (W) or HPL (P) Top, Must Specify
- Top and Legs Ship Separately; Legs Must Be Specified, See Below
- Additional Options: Grommet Options ([See Options and Locations](#)),

Must Specify:

21-0202TL	Table Legs - Must Specify	20	0.1	N/C
-----------	---------------------------	----	-----	-----

Legs Feature Multi-Step, Hand-Finished Catalyzed Finish

Must Specify (in this order):

Model #
Top Material
Finish/Color
Table Legs
Grommet

SINGLE PED DESK WITH BOW TOP

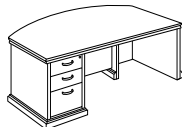

Shown as Left

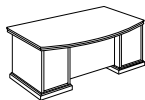

Approach

Left	Right	Width	Depth	Height	K	R	Ship Wt	Cubic Ft	List Price
21-3672BLP	21-3672BRP	72	36-30	30	31¾	10¾	320	50.0	P\$ 4001 W\$ 4310

Description

- Standard with: Bow Top, Stepped Front, Locking Letter Width Box/Box/File Pedestal, Black Utility Tray Included in Box Drawer, Wire Management from Pedestal to Kneespace
- Available with Veneer (W) or HPL (P) Top, Must Specify
- Additional Options: Grommet Options ([See Options and Locations](#)), Kneespace Options (Sold Separately, [See Unit Details](#))

Must Specify (in this order):

Model #
Top Material
Finish/Color
Drawer Pull
Worksurface Grommet Location
Grommet Color
Kneespace Options

Pricing Codes:
P = Laminate Top
W = Wood Top

[See Phoenix Intro Section for Ordering Options](#)

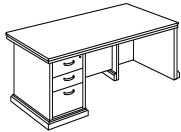
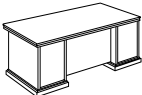
Item	Model No.	Width	Depth	Height	K	R	Ship Wt	Cubic Ft	List Price	
 <p>Shown as Left</p>  <p>Approach</p>	Left	Right								
	21-3672LP	21-3672RP	72	36	30	3 1/8"	10 3/4"	320	50.0	P\$ 3624 W\$ 3959
	21-3072LP	21-3072RP	72	30	30	3 1/8"	4 3/4"	305	43.8	P\$ 3539 W\$ 3897
	21-3066LP	21-3066RP	66	30	30	2 5/8"	4 3/4"	300	38.7	P\$ 3454 W\$ 3836
	21-3060LP	21-3060RP	60	30	30	1 9/8"	4 3/4"	275	35.3	P\$ 3393 W\$ 3751

Description

- Standard with: Rectangle Top, Stepped Front, Locking Letter Width Box/Box/File in Pedestal, Black Utility Tray Included in Box Drawer, Wire Management from Pedestal to Kneespace
- Available with Veneer (W) or HPL (P) Top, Must Specify
- 3/4" Overhang on Left, Right and User Sides
- Additional Options: Grommet Options ([See Options and Locations](#)), Kneespace Options (Sold Separately, [See Unit Details](#))

Must Specify (in this order):

- Model #
- Top Material
- Finish/Color
- Drawer Pull
- Worksurface Grommet Location
- Grommet Color
- Kneespace Options

P-TOP	Left	Right	Width	Depth	Height	K	R	Ship Wt	Cubic Ft	List Price
 <p>Shown as Left</p>	21-4272PL	21-4272PR	72	42-36	30	-	-	221	50.0	P\$ 3231 W\$ 3300

Description

- Available with Veneer (W) or HPL (P) Top, Must Specify
- False Ped on Wing End
- Metal 4 1/2" Cylinder Base; Must Specify: Black or Aluminum
- Not Recommended for Freestanding Applications
- Additional Options: Modesty Panel (See Below), Grommet Options ([See Options and Locations](#)), Kneespace Options (Sold Separately, [See Unit Details](#))

Options: Specify & Add

21-FMD	Optional Full Modesty Panel	\$	352
--------	-----------------------------	----	-----

Must Specify (in this order):

- Model #
- Top Material
- Finish/Color
- Modesty Panel
- Base Color
- Worksurface Grommet Location
- Grommet Color
- Kneespace Options

[See Phoenix Intro Section for Ordering Options](#)

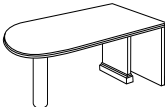
Item	Model No.	Width	Depth	Height	K	R	Ship Wt	Cubic Ft	List Price	
	Left		Right							
	21-3672DL	21-3672DR	72	36	30	-	-	221	50.0	P\$ 2710 W\$ 3042
	21-3072DL	21-3072DR	72	30	30	-	-	160	44.0	P\$ 2575 W\$ 2888

Shown as Left

Must Specify (in this order):

- Model #
- Top Material
- Finish/Color
- Modesty Panel
- Leg Color
- Worksurface Grommet Location
- Grommet Color
- Kneespace Options

Description

- Available with Veneer (W) or HPL (P) Top, Must Specify
- False Ped on Wing End
- Metal 4 1/2" Cylinder Base; Must Specify: Black or Aluminum
- Not Recommended for Freestanding Applications
- Additional Options: Modesty Panel (See Below), Grommet Options ([See Options and Locations](#)), Kneespace Options (Sold Separately, [See Unit Details](#))

Options: Specify & Add

21-FMD	Optional Full Modesty Panel	\$ 352
--------	-----------------------------	--------

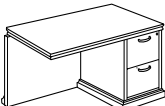
RETURN WITH FILE/FILE	Left	Right	Width	Depth	Height	K	R	Ship Wt	Cubic Ft	List Price
	21-2448LF2	21-2448RF2	48	24	30	31%	-	151	23.1	P\$ 2608 W\$ 2821
	21-2442LF2	21-2442RF2	42	24	30	25%	-	133	20.4	P\$ 2562 W\$ 2742

Shown as Right

Must Specify (in this order):

- Model #
- Top Material
- Finish/Color
- Drawer Pull
- Worksurface Grommet Location
- Back Panel Grommet
- Grommet Color
- Flush Edge
- Kneespace Options

Description

- Standard with: Letter Width Locking File/File Pedestal, Wire Management from Pedestal to Kneespace, Front to Back Grain Direction on Worksurface
- Available with Veneer (W) or HPL (P) Top, Must Specify
- Grommet in Back Panel; Must Specify: Black (BLK), Silver (SLV) or No Back Panel Grommet (NONE)
- Profiled on All Sides Standard; See Below for Optional Flush Feature
- Flush Feature Available; Must Specify: Flush Left (FL) or Flush Right (FR)
- Flush Option Reduces Unit by 3/4"
- Additional Options: Grommet Options ([See Options and Locations](#)), Kneespace Options (Sold Separately, [See Unit Details](#))

Pricing Codes:
P = Laminate Top
W = Wood Top

[See Phoenix Intro Section for Ordering Options](#)

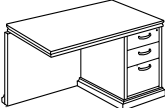
Item	Model No.	Width	Depth	Height	K	R	Ship Wt	Cubic Ft	List Price	
	RETURN WITH BOX/BOX/FILE									
		Left	Right							
	21-2448LF1	21-2448RF1	48	24	30	31 $\frac{3}{8}$	-	140	23.1	P\$ 2608 W\$ 2821
	21-2442LF1	21-2442RF1	42	24	30	25 $\frac{3}{8}$	-	133	20.4	P\$ 2562 W\$ 2742

Shown as Right

Must Specify (in this order):

- Model #
- Top Material
- Finish/Color
- Drawer Pull
- Worksurface Grommet Location
- Back Panel Grommet
- Grommet Color
- Flush Edge
- Kneespace Options

Description

- Standard with: Letter Width Locking Box/Box/File Pedestal, Wire Management from Pedestal to Kneespace, Front to Back Grain Direction on Worksurface
- Available with Veneer (W) or HPL (P) Top, Must Specify
- Grommet in Back Panel; Must Specify: Black (BLK), Silver (SLV) or No Back Panel Grommet (NONE)
- Profiled on All Sides Standard; See Below for Optional Flush Feature
- Flush Feature Available; Must Specify: Flush Left (FL) or Flush Right (FR)
- Flush Option Reduces Unit by $\frac{3}{4}$ "
- Additional Options: Grommet Options ([See Options and Locations](#)), Kneespace Options (Sold Separately, [See Unit Details](#))

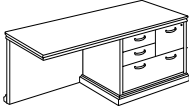
Item	Model No.	Width	Depth	Height	K	R	Ship Wt	Cubic Ft	List Price	
	MULTI-RETURN PED WITH BOX/BOX/FILE/LATERAL									
		Left	Right							
	21-2472LMR	21-2472RMR	72	24	30	36	-	280	33.6	P\$ 3671 W\$ 4065

Shown as Right

Must Specify (in this order):

- Model #
- Top Material
- Finish/Color
- Drawer Pull
- Worksurface Grommet Location
- Back Panel Grommet
- Grommet Color
- Flush Edge
- Kneespace Options

Description

- Standard with: Box/Box/File/Lateral, Front to Back Grain Direction on Worksurface
- Available with Veneer (W) or HPL (P) Top, Must Specify
- Lateral File Provides Legal or Letter Filing Side to Side or Front to Back
- Single Lock Secures File and Lateral Drawers
- Grommet in Back Panel; Must Specify: Black (BLK), Silver (SLV) or No Back Panel Grommet (NONE)
- Profiled on All Sides Standard; See Below for Optional Flush Feature
- Flush Feature Available; Must Specify: Flush Left (FL) or Flush Right (FR)
- Flush Option Reduces Unit by $\frac{3}{4}$ "
- Additional Options: Grommet Options ([See Options and Locations](#)), Kneespace Options (Sold Separately, [See Unit Details](#))

[See Phoenix Intro Section for Ordering Options](#)

Item	Model No.	Width	Depth	Height	K	R	Ship Wt	Cubic Ft	List Price
BRIDGE WITH FULL MODESTY	21-2448UF	48	24	30	48	-	78	5.3	P\$ 1538 W\$ 1628
	21-2442UF	42	24	30	42	-	68	4.7	P\$ 1479 W\$ 1562

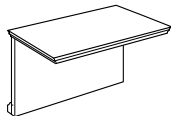

Must Specify (in this order):

Model #
Top Material
Finish/Color
Worksurface Grommet Location
Back Panel Grommet
Grommet Color

Description

- Standard with: Hinged Back Panel, Front to Back Grain Direction on Worksurface
- Available with Veneer (W) or HPL (P) Top, Must Specify
- Grommet in Back Panel; Must Specify: Black (BLK), Silver (SLV) or No Back Panel Grommet (NONE)
- Some Assembly Required
- Keyboard Accessories Cannot be Factory Installed but are Available for Field Installation (Sold Separately, [See Unit Details](#))
- Additional Options: Grommet Options ([See Options and Locations](#))

BRIDGE WITH HALF MODESTY	21-2448UFH	48	24	11½ ²	48	-	82	5.3	P\$ 1424 W\$ 1517
	21-2442UFH	42	24	11½ ²	42	-	62	4.7	P\$ 1378 W\$ 1456

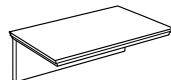

Must Specify (in this order):

Model #
Top Material
Finish/Color
Worksurface Grommet Location
Grommet Color

Description

- Standard with: 10" Hinged Back Panel, Front to Back Grain Direction on Worksurface
- Available with Veneer (W) or HPL (P) Top, Must Specify
- Some Assembly Required
- Keyboard Accessories Cannot be Factory Installed but are Available for Field Installation (Sold Separately, [See Unit Details](#))
- Additional Options: Grommet Options ([See Options and Locations](#))

CORNER UNIT	21-4242CU	42	42	30	25 ⁷ / ₁₆	-	145	34.5	P\$ 2387 W\$ 2562
	21-3636CU	36	36	30	17	-	135	25.7	P\$ 2131 W\$ 2268

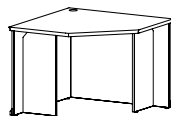

Must Specify (in this order):

Model #
Top Material
Finish/Color
Worksurface Grommet Color
Kneespace Options

Description

- Available with Veneer (W) or HPL (P) Top, Must Specify
- Freestanding Support Unit or Connects to 24" Deep Bridge and Return Units
- Surface Grommet in Top: Must Specify: Must Specify: Black (BLK) or Silver (SLV)
- Grain Direction Runs Front to Back on Veneer Worksurfaces
- Grain Direction Runs with the Long Edge on HPL Worksurface
- Keyboard Accessories for 21-4242CU Only: 01-KB2CC and 01-KB3 (Sold Separately, [See Unit Details](#))

Pricing Codes:
P = Laminate Top
W = Wood Top

[See Phoenix Intro Section for Ordering Options](#)

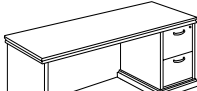
Item	Model No.	Width	Depth	Height	K	R	Ship Wt	Cubic Ft	List Price	
CREDENZA WITH FILE/FILE 	Left Ped	Right Ped								
	21-2072LC2	21-2072RC2	72	20 ⁷ / ₁₆	30	31 ³ / ₈	-	235	29.0	P\$ 2993 W\$ 3378
	21-2066LC2	21-2066RC2	66	20 ⁷ / ₁₆	30	25 ³ / ₈	-	225	26.6	P\$ 2880 W\$ 3267

Shown as Right

Must Specify (in this order):

- Model #
- Top Material
- Finish/Color
- Drawer Pull
- Worksurface Grommet Location
- Back Panel Grommet
- Grommet Color
- Flush Edge

Description

- Standard with: Letter Width Locking File/File Pedestal, Left to Right Grain Direction on Worksurface
- Available with Veneer (W) or HPL (P) Top, Must Specify
- Grommet in Back Panel; Must Specify: Black (BLK), Silver (SLV) or No Back Panel Grommet (NONE)
- Profiles on Three (3) Sides for Flush Wall Application Standard
- Flush Feature Available; Must Specify: Flush Left (FL), Flush Right (FR) or Flush Left and Right (FLR)
- Flush Option Reduces Unit by 3/4" Per Side and 1 1/2" for Both Flush Sides
- Additional Options: Grommet Options ([See Options and Locations](#)), Kneespace Options (Sold Separately, [See Unit Details](#))

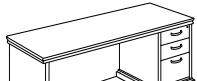
Item	Model No.	Width	Depth	Height	K	R	Ship Wt	Cubic Ft	List Price	
CREDENZA WITH BOX/BOX/FILE 	Left Ped	Right Ped								
	21-2072LC1	21-2072RC1	72	20 ⁷ / ₁₆	30	31 ³ / ₈	-	235	29.0	P\$ 2993 W\$ 3378
	21-2066LC1	21-2066RC1	66	20 ⁷ / ₁₆	30	25 ³ / ₈	-	225	26.6	P\$ 2880 W\$ 3267

Shown as Right

Must Specify (in this order):

- Model #
- Top Material
- Finish/Color
- Drawer Pull
- Worksurface Grommet Location
- Back Panel Grommet
- Grommet Color
- Flush Edge

Description

- Standard with: Letter Width Locking Box/Box/File Pedestal, Left to Right Grain Direction on Worksurface
- Available with Veneer (W) or HPL (P) Top, Must Specify
- Grommet in Back Panel; Must Specify: Black (BLK), Silver (SLV) or No Back Panel Grommet (NONE)
- Profiles on Three (3) Sides for Flush Wall Application Standard
- Flush Feature Available; Must Specify: Flush Left (FL), Flush Right (FR) or Flush Left and Right (FLR)
- Flush Option Reduces Unit by 3/4" Per Side and 1 1/2" for Both Flush Sides
- Additional Options: Grommet Options ([See Options and Locations](#)), Kneespace Options (Sold Separately, [See Unit Details](#))

[See Phoenix Intro Section for Ordering Options](#)

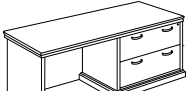
Item	Model No.	Width	Depth	Height	K	R	Ship Wt	Cubic Ft	List Price	
CREDENZA WITH LATERAL/LATERAL 	Left Ped	Right Ped								
	21-2072LL	21-2072RL	72	20 $\frac{1}{16}$	30	31 $\frac{3}{8}$	-	255	29.0	P\$ 3262 W\$ 3650
	21-2066LL	21-2066RL	66	20 $\frac{1}{16}$	30	25 $\frac{3}{8}$	-	220	26.6	P\$ 3063 W\$ 3452

Shown as Right

Must Specify (in this order):

Model #
 Top Material
 Finish/Color
 Drawer Pull
 Worksurface Grommet Location
 Back Panel Grommet
 Grommet Color
 Flush Edge

Description

- Standard with: Two (2) Locking Lateral File Drawers, Left to Right Grain Direction on Worksurface
- Available with Veneer (W) or HPL (P) Top, Must Specify
- Grommet in Back Panel; Must Specify: Black (BLK), Silver (SLV) or No Back Panel Grommet (NONE)
- Profiles on Three (3) Sides for Flush Wall Application Standard
- Flush Feature Available; Must Specify: Flush Left (FL), Flush Right (FR) or Flush Left and Right (FLR)
- Flush Option Reduces Unit by $\frac{3}{4}$ " Per Side and $1\frac{1}{2}$ " for Both Flush Sides
- Additional Options: Grommet Options ([See Options and Locations](#)), Kneespace Options (Sold Separately, [See Unit Details](#))

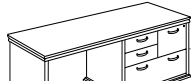
Item	Model No.	Width	Depth	Height	K	R	Ship Wt	Cubic Ft	List Price	
CREDENZA WITH BOX/BOX/FILE/LATERAL 	Left	Right								
	21-2072LMF	21-2072RMF	72	20 $\frac{1}{16}$	30	12	-	255	29.0	P\$ 3633 W\$ 4019
	21-2066LMF	21-2066RMF	66	20 $\frac{1}{16}$	30	6	-	220	26.6	P\$ 3526 W\$ 3915

Shown as Right

Must Specify (in this order):

Model #
 Top Material
 Finish/Color
 Drawer Pull
 Worksurface Grommet Location
 Back Panel Grommet
 Grommet Color
 Flush Edge

Description

- Standard with: Box/Box/File/Lateral, Lateral File Provides Legal or Letter Filing Side to Side or Front to Back, Left to Right Grain Direction on Worksurface
- Locking File Drawer
- Available with Veneer (W) or HPL (P) Top, Must Specify
- Grommet in Back Panel; Must Specify: Black (BLK), Silver (SLV) or No Back Panel Grommet (NONE)
- Flush Feature Available; Must Specify: Flush Left (FL), Flush Right (FR) or Flush Left and Right (FLR)
- Flush Option Reduces Unit by $\frac{3}{4}$ " Per Side and $1\frac{1}{2}$ " for Both Flush Sides
- Additional Options: Grommet Options ([See Options and Locations](#)), Kneespace Options (Sold Separately, [See Unit Details](#))

Pricing Codes:
 P = Laminate Top
 W = Wood Top

[See Phoenix Intro Section for Ordering Options](#)

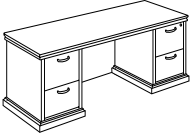
Item	Model No.	Width	Depth	Height	K	R	Ship Wt	Cubic Ft	List Price
	21-2072KC	72	20 ⁷ / ₁₆	30	38 ³ / ₄	-	300	29.0	P\$ 3763 W\$ 4147
	21-2066KC	66	20 ⁷ / ₁₆	30	32 ³ / ₄	-	285	26.6	P\$ 3637 W\$ 4023

Description

- Letter Width Locking File/File Pedestal
- Available with Veneer (W) or HPL (P) Top, Must Specify
- Grommet in Back Panel; Must Specify: Black (BLK), Silver (SLV) or No Back Panel Grommet (NONE)
- Profiles on Three (3) Sides for Flush Wall Application Standard
- Flush Feature Available; Must Specify: Flush Left (FL), Flush Right (FR) or Flush Left and Right (FLR)
- Flush Option Reduces Unit by ³/₄" Per Side and 1¹/₂" for Both Flush Sides
- Additional Options: Grommet Options ([See Options and Locations](#)), Kneespace Options (Sold Separately, [See Unit Details](#))

Must Specify (in this order):

Model #
Top Material
Finish/Color
Drawer Pull
Worksurface Grommet Location
Back Panel Grommet
Grommet Color
Flush Edge

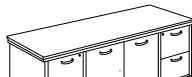
	21-2072SC	72	20 ⁷ / ₁₆	30	-	-	349	29.0	P\$ 4360 W\$ 4754
	21-2066SC	66	20 ⁷ / ₁₆	30	-	-	320	26.6	P\$ 4206 W\$ 4589

Description

- Letter Width Locking File/File Pedestals
- Available with Veneer (W) or HPL (P) Top, Must Specify
- Fixed Storage Shelf Behind Doors
- Profiles on Three (3) Sides for Flush Wall Application Standard
- Flush Feature Available; Must Specify: Flush Left (FL), Flush Right (FR) or Flush Left and Right (FLR)
- Flush Option Reduces Unit by ³/₄" Per Side and 1¹/₂" for Both Flush Sides

Must Specify (in this order):

Model #
Top Material
Finish/Color
Drawer Pull
Flush Edge

[See Phoenix Intro Section for Ordering Options](#)

Item	Model No.	Width	Depth	Height	Ship Wt	Cubic Ft	List Price
	21-2036L4 Four (4) Drawers	36	20 ⁷ / ₁₆	55	260	27.5	P\$ 4178 W\$ 4397
	21-2030L4 Four (4) Drawers	30	20 ⁷ / ₁₆	55	230	24.5	P\$ 3864 W\$ 4065
	21-2036L2 Two (2) Drawers	36	20 ⁷ / ₁₆	30	185	14.9	P\$ 2802 W\$ 3015
	21-2030L2 Two (2) Drawers	30	20 ⁷ / ₁₆	30	175	13.1	P\$ 2592 W\$ 2788

Description

- Central Locking Drawers Provide Legal or Letter Filing Front to Back or Side to Side
- Available with Veneer (W) or HPL (P) Top, Must Specify
- Anti-Tilt Mechanism
- ¼" Thick Drawer Bottoms for Added Support
- Profiles on Three (3) Sides for Flush Wall Application Standard
- Flush Feature Available; Must Specify: Flush Left (FL), Flush Right (FR) or Flush on Both Sides (FLR)
- Flush Option Reduces Unit by ¾" Per Side and 1½" if Both Sides Are Selected to be Flush

Must Specify (in this order):

Model #
Top Material
Finish/Color
Drawer Pull
Flush Edge

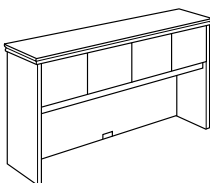
Item	Model No.	Doors	Width	Depth	Height	Ship Wt	Cubic Ft	List Price
	21-1684HU	Five (5) Doors	84	15 ³ / ₄	40 ⁷ / ₈	268	40.0	\$ 3801
	21-1678HU	Four (4) Doors	78	15 ³ / ₄	40 ⁷ / ₈	258	36.7	\$ 3451
	21-1672HU	Four (4) Doors	72	15 ³ / ₄	40 ⁷ / ₈	258	30.7	\$ 3060
	21-1666HU	Four (4) Doors	66	15 ³ / ₄	40 ⁷ / ₈	235	28.1	\$ 3020

Description

- Standard with: Soft-Close Hinged Doors, Vertical Grain Direction
- 23¾" Clearance Below Doors
- Top Profiled on Three (3) Sides for Flush Wall Application Standard
- Lower, Center Grommet on Back Panel Standard; Must Specify: Black (BLK) or Silver (SLV)
- Flush Feature Available; Must Specify: Flush Left (FL), Flush Right (FR) or Flush on Both Sides (FLR)
- Flush Option Reduces Unit by ¾" Per Side and 1½" if Both Sides Are Selected to be Flush
- Additional Options: Locking Doors ([See Locking Options](#)), Factory-Installed Tackboard ([See Tackboards](#)), Tasklights ([See Tasklights](#)), Glass Marker Boards ([See Marker Board Sizes](#)), Three (3) Upper Wire Management Grommets ([See Grommet Options](#))

Must Specify (in this order):

Model #
Finish
Tackboard
Tackboard Fabric
Tasklight
Grommet Color
Locking Doors
Lock Core Color
Flush Edge

Pricing Codes:
P = Laminate Top
W = Wood Top

[See Phoenix Intro Section for Ordering Options](#)

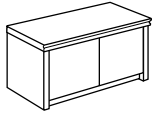
Item	Model No.		Width	Depth	Height	Ship Wt	Cubic Ft	List Price
	21-1682WD	Five (5) Doors	82	15¾	17½ ₃₂	138	15.5	\$ 3486
	21-1676WD	Four (4) Doors	76	15¾	17½ ₃₂	128	14.1	\$ 3026
	21-1670WD	Four (4) Doors	70	15¾	17½ ₃₂	118	13.1	\$ 2980
	21-1664WD	Four (4) Doors	66	15¾	17½ ₃₂	105	12.0	\$ 2887
	21-1658WD	Four (4) Doors	58	15¾	17½ ₃₂	96	11.0	\$ 2835
	21-1652WD	Three (3) Doors	52	15¾	17½ ₃₂	87	9.9	\$ 2640
	21-1646WD	Three (3) Doors	46	15¾	17½ ₃₂	77	8.9	\$ 2525
	21-1640WD	Two (2) Doors	40	15¾	17½ ₃₂	67	7.8	\$ 2401
	21-1634WD	Two (2) Doors	34	15¾	17½ ₃₂	58	6.7	\$ 2263
	21-1628WD	Two (2) Doors	28	15¾	17½ ₃₂	48	5.6	\$ 2098

Must Specify (in this order):

Model #
Finish
Locking Doors
Lock Core Color

Description

- Standard with: Soft-Close Hinged Doors, Vertical Grain Direction
- Top Profiled on Front Standard for Flush Side and Wall Applications
- Mounts to Wall with Mounting Bracket Included
- Indiana Furniture Will Not Be Liable for Wall Mounted Hutches That Are Not Properly Installed
- Additional Options: Locking Doors ([See Locking Options](#)), Tackboards ([See Tackboards](#)), Tasklights ([See Tasklights](#)), Glass Marker Boards ([See Marker Board Sizes](#))

SURFACE MOUNT BOOKCASE

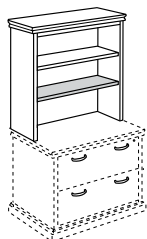

21-1636TU	36	15 ¾	40 7/8	125	15.8	\$ 1798
21-1630TU	30	15 ¾	40 7/8	98	15.8	\$ 1619

Description

- 1" Thick Shelves; One (1) Adjustable and One (1) Fixed Shaded
- 12" Clearance Below Fixed Shelf
- For Surface Mount Use on Two (2) Drawer Lateral File or Credenza Against a Wall
- Top Profiled on Three (3) Sides for Flush Wall Application Standard
- Flush Feature Available; Must Specify: Flush Left (FL), Flush Right (FR) or Flush on Both Sides (FLR)
- Flush Option Reduces Unit by ¾" Per Side and 1 ½" if Both Sides Are Selected to be Flush

Must Specify (in this order):

Model #
Finish
Flush Edge

[See Phoenix Intro Section for Ordering Options](#)

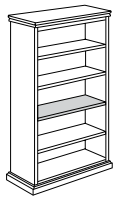
Item	Model No.	Width	Depth	Height	Ship Wt	Cubic Ft	List Price
	21-3672BC Three (3) Adjustable and One (1) Fixed Shelf	36	15¾	70⅞	205	36.5	W\$ 2759
	21-3648BC Two (2) Adjustable Shelves, No Fixed Shelf	36	15¾	48⅜½	104	19.9	P\$ 2071 W\$ 2176
	21-3630BC One (1) Adjustable Shelf, No Fixed Shelf	36	15¾	30	85	11.1	P\$ 1862 W\$ 1970
	21-3072BC Three (3) Adjustable and One (1) Fixed Shelf	30	15¾	70⅞	190	30.0	W\$ 2237
	21-3048BC Two (2) Adjustable Shelves, No Fixed Shelf	30	15¾	48⅜½	94	19.9	P\$ 1679 W\$ 1764
	21-3030BC One (1) Adjustable Shelf, No Fixed Shelf	30	15¾	30	85	11.1	P\$ 1508 W\$ 1597

Must Specify (in this order):

Model #
Top Material (48"H & 30"H Only)
Edge Profile (48"H & 30"H Only)
Finish/Color
Flush Edge

Description

- Fixed Shelf Shaded
- 48"H and 30"H Available with Veneer (W) or HPL (P) Top, Must Specify Material and Edge Profile
- Profiled on Three (3) Sides for Flush Wall Application Standard
- Flush Feature Available; Must Specify: Flush Left (FL), Flush Right (FR) or Flush on Both Sides (FLR)
- Flush Option Reduces Unit by ¾" Per Side and 1 ½" if Both Sides Are Selected to be Flush

DOUBLE WARDROBE/STORAGE 	21-3672WC	36	20⅞	70⅞	290	42.0	\$ 4139
	21-3072WC	30	20⅞	70⅞	240	35.7	\$ 4030

Must Specify (in this order):

Model #
Finish
Pull
Locking Doors
Flush Edge

Description

- Fixed Top Shelf Behind Each Door
- Three (3) Adjustable Shelves on Left Side; Coat Rod Under Fixed Shelf on Right Side
- Profiled on Three (3) Sides for Flush Wall Applications Standard
- Flush Feature Available; Must Specify: Flush Left (FL), Flush Right (FR) or Flush on Both Sides (FLR)
- Flush Option Reduces Unit by ¾" Per Side and 1 ½" if Both Sides Are Selected to be Flush
- Optional Locking Doors ([See Locking Options](#)), Lock Core will Coordinate with Pull Color

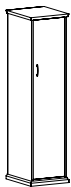
WARDROBE/STORAGE CABINET	Left	Right	Width	Depth	Height	Ship Wt	Cubic Ft	List Price
	21-1872WL	21-1872WR	18	20⅞	70⅞	152	19.2	\$ 2981

Shown as Right

Must Specify (in this order):

Model #
Finish
Pull
Locking Doors
Flush Edge

Description

- Coat Rod Under Top Fixed Shelf
- Three (3) Adjustable Shelves; Adjustable Shelves can be Removed for Wardrobe Application
- Profiles on Three (3) Sides for Flush Wall Application Standard
- Pull Installed Vertically; Capsule Pull will be Substituted for Elite, Buckle, and Flair Pulls
- Flush Feature Available; Must Specify: Flush Left (FL), Flush Right (FR) or Flush on Both Sides (FLR)
- Flush Option Reduces Unit by ¾" Per Side and 1 ½" if Both Sides Are Selected to be Flush
- Optional Locking Doors ([See Locking Options](#)), Lock Core will Coordinate with Pull Color

Pricing Codes:
P = Laminate Top
W = Wood Top

[See Phoenix Intro Section for Ordering Options](#)

Item	Model No.	Width	Depth	Height	Ship Wt	Cubic Ft	List Price
END TABLE	21-1824ET	18	24	22	25	2.0	P\$ 928 W\$ 980

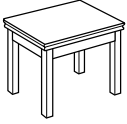

Must Specify (in this order):

Model #
Top Material
Finish/Color

Description

- Available with Veneer (W) or HPL (P) Top, Must Specify
- Apron Rails and Panel Legs Feature Multi-Step, Hand-Finished Catalyzed Finish
- Some Assembly Required

MAGAZINE TABLE	21-1847MT	47	18	16	42	3.4	P\$ 1210 W\$ 1322
----------------	-----------	----	----	----	----	-----	----------------------

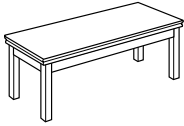

Must Specify (in this order):

Model #
Top Material
Finish/Color
Leg Option

Description

- Available with Veneer (W) or HPL (P) Top, Must Specify
- Apron Rails and Panel Legs Feature Multi-Step, Hand-Finished Catalyzed Finish
- Some Assembly Required
- Optional 30" Leg; See Below

Options: Specify & Add

30H-2SQ	Optional 30"H Legs	20	0.9	\$ 223
---------	--------------------	----	-----	--------

[See Phoenix Intro Section for Ordering Options](#)

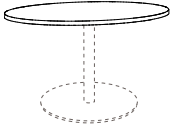
Item	Model No.		Width	Depth	Height	Ship Wt	Cubic Ft	List Price
	21-4848CT	<i>Accommodates Five (5) Chairs</i>	48	48	30	60	5.7	P\$ 1587 W\$ 2048
	21-4242CT	<i>Accommodates Four (4) Chairs</i>	42	42	30	40	4.4	P\$ 1471 W\$ 1891
	21-3636CT	<i>Accommodates Three (3) to Four (4) Chairs</i>	36	36	30	35	3.4	P\$ 1363 W\$ 1735

21-4242CT shown with 01-2430DBA
(Disc Base)
BASES SOLD SEPARATELY

Must Specify (in this order):

Model #
Top Material
Finish/Color
Edge Profile

Description

- Available with Premium/Standard Veneer (PV/W) or HPL (P) Top, Must Specify
- Single Base Required; Ordered Separately, [See Details](#)
- Power Options not Available

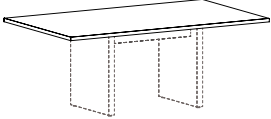
RECTANGULAR TOP	144" or 12' - 2 Piece Tops							
	21-48144RT		144	48	1 $\frac{1}{16}$	275	12.3	P\$ 4423 W\$ 4724
	120" or 10' - 2 Piece Tops							
	21-48120RT		120	48	1 $\frac{1}{16}$	225	10.3	P\$ 4043 W\$ 4270
	96" or 8' - 1 Piece Top							
	21-4896RT		96	48	1 $\frac{1}{16}$	180	9.4	P\$ 2564 W\$ 2805
	72" or 6' - 1 Piece Top							
	21-3672RT		72	36	1 $\frac{1}{16}$	100	6.2	P\$ 1679 W\$ 1778

Description

- Grain Runs the Width of the Table
- Available with Veneer (PV/W) or HPL (P) Top; Must Specify
- Heavy-Duty Ganging Mechanisms Connect Two (2) Piece Tops
- See Bases/Legs and Number Required For Each Top Size, [See Multiple Base Options](#); Must Order Separately
- Optional Grommets and Power/Data Units; [See Location Options](#), [See Power Units Available](#)

Pricing Codes:
P = Laminate Top
W = Wood Top

[See Phoenix Intro Section for Ordering Options](#)

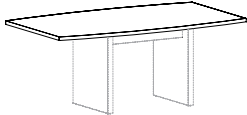
Item	Model No.	Width	Depth	Height	Ship Wt	Cubic Ft	List Price
 <p>21-3672BT shown with 88-2034RPB (Rectangle Panel Base) BASES SOLD SEPARATELY</p>	144" or 12' - 2 Piece Tops						
	21-48144BT	144	48	1 $\frac{3}{16}$	275	12.3	P\$ 5141 W\$ 5533
	120" or 10' - 2 Piece Tops						
	21-48120BT	120	48	1 $\frac{3}{16}$	225	10.3	P\$ 4680 W\$ 4986
	96" or 8' - 1 Piece Top						
	21-4896BT	96	48	1 $\frac{3}{16}$	180	9.4	P\$ 3737 W\$ 4041
	72" or 6' - 1 Piece Top						
	21-3672BT	72	36	1 $\frac{3}{16}$	100	6.2	P\$ 2279 W\$ 2357

Description

- Grain Runs the Width of the Table
- Available with Veneer (PV/W) or HPL (P) Top; Must Specify
- Heavy-Duty Ganging Mechanisms Connect Two (2) Piece Tops
- See Bases/Legs and Number Required For Each Top Size, See Below for Multiple Base Options; Must Order Separately
- Optional Grommets and Power/Data Units; [See Location Options](#), [See Power Units Available](#)

RECTANGLE PANEL BASES WITH TROUGH

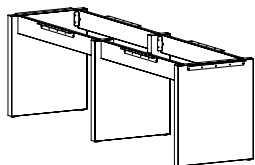

Three (3) Panel Bases - For Use With 48" x 144" Surfaces							
88-24106RPB	Laminate	24	106	28 $\frac{3}{4}$	116	13.8	T\$ 3000 W\$ 3059
	Veneer						
Two (2) Panel Bases - For Use With 48" x 120" Surfaces							
88-2482RPB	Laminate	24	82	28 $\frac{3}{4}$	90	6.9	T\$ 2150 W\$ 2201
	Veneer						
Two (2) Panel Bases - For Use With 48" x 96" Surfaces							
88-2458RPB	Laminate	24	58	28 $\frac{3}{4}$	84	6.9	T\$ 1880 W\$ 1954
	Veneer						
Two (2) Panel Bases - For Use With 36" x 72" Surfaces							
88-2034RPB	Laminate	20	34	28 $\frac{3}{4}$	66	6.7	T\$ 1575 W\$ 1742
	Veneer						

Must Specify (in this order):

- Model #
- Material
- Finish / Color

Description

- 2" Panel Bases with Trough, Stretcher Rails, and L-Bracket Hardware Included
- Available with TFL (T) or Veneer (W)
- Vertical Grain Direction on Bases
- Bases Require Some Assembly; Attachment Hardware Included
- Tops Sold Separately

[See Phoenix Intro Section for Ordering Options](#)

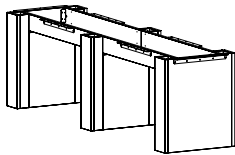
Item	Model No.		Width	Depth	Height	Ship Wt	Cubic Ft	List Price
6" RECTANGLE BASES WITH TROUGH AND REMOVABLE PANEL 	Three (3) 6" Rectangle Bases - For Use With 48" x 144" Surfaces							
	88-2410606RB	Laminate	24	106	28¾	106	19.6	T\$ 4720
		Veneer						W\$ 6457
	Two (2) 6" Rectangle Bases - For Use With 48" x 120" Surfaces							
	88-248206RB	Laminate	24	82	28¾	99	12.9	T\$ 3219
		Veneer						W\$ 4449
	Two (2) 6" Rectangle Bases - For Use With 48" x 96" Surfaces							
	88-245806RB	Laminate	24	58	28¾	93	12.9	T\$ 3023
		Veneer						W\$ 4128
	Two (2) 6" Rectangle Bases - For Use With 36" x 72" Surfaces							
	88-203406RB	Laminate	20	34	28¾	76	12.9	T\$ 2777
		Veneer						W\$ 3820

Must Specify (in this order):

Model #
Material
Finish / Color

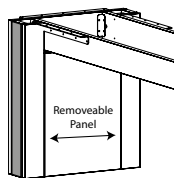

Description

- 6" Rectangle Bases with Trough and Stretcher Rails
- Available with TFL (T) or Veneer (W)
- 5/16" Metal Accent Available in Four (4) Colors: Aluminum, Black, Gold, and Platinum; Must Specify Color
- Vertical Grain Direction on Bases
- Bases Include Interior Removable Panel for Wire Management Access. Removable Panel is 15 7/8"W for 24" Bases and 11 7/8"W for 20" Bases
- Removable Panels Attached with Z Brackets
- Bases Require Some Assembly; Attachment Hardware Included
- Tops Sold Separately

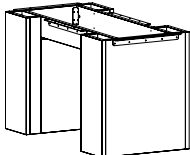
10" RECTANGLE BASES WITH TROUGH AND REMOVABLE PANEL 	Three (3) 10" Rectangle Bases - For Use With 48" x 144" Surfaces							
	88-2410610RB	Laminate	24	106	28¾	141	18.2	T\$ 4841
		Veneer						W\$ 6551
	Two (2) 10" Rectangle Bases - For Use With 48" x 120" Surfaces							
	88-248210RB	Laminate	24	82	28¾	96	12.0	T\$ 3300
		Veneer						W\$ 4512
	Two (2) 10" Rectangle Bases - For Use With 48" x 96" Surfaces							
	88-245810RB	Laminate	24	58	28¾	89	12.0	T\$ 3104
		Veneer						W\$ 4190
	Two (2) 10" Rectangle Bases - For Use With 36" x 72" Surfaces							
	88-203410RB	Laminate	20	34	28¾	72	10.0	T\$ 2857
		Veneer						W\$ 3882

Must Specify (in this order):

Model #
Material
Finish / Color

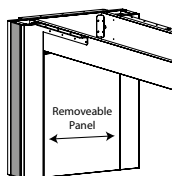

Description

- 6" Rectangle Bases with Trough and Stretcher Rails
- Available with TFL (T) or Veneer (W)
- 5/16" Metal Accent Available in Four (4) Colors: Aluminum, Black, Gold, and Platinum; Must Specify Color
- Vertical Grain Direction on Bases
- Bases Include Interior Removable Panel for Wire Management Access. Removable Panel is 15 7/8"W for 24" Bases and 11 7/8"W for 20" Bases
- Removable Panels Attached with Z Brackets
- Bases Require Some Assembly; Attachment Hardware Included
- Tops Sold Separately

Pricing Codes:
P = Laminate Top
W = Wood Top

[See Phoenix Intro Section for Ordering Options](#)

Item	Model No.		Width	Depth	Height	Ship Wt	Cubic Ft	List Price
6" + 10" COMBO RECTANGLE BASES WITH TROUGH AND REMOVABLE PANEL	Three (3) Bases Total: Two (2) 6" and One (1) 10" Rectangle Bases - For Use With 60" / 54" / 48" x 144" Surfaces							
	88-24106C610RB	Laminate	24	106	28¾	141	18.2	T\$ 4760
		Veneer						W\$ 6488

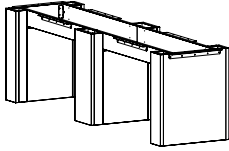

Must Specify (in this order):

- Model #
- Material
- Finish / Color

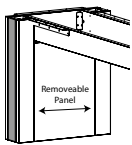

Description

- 6" + 10" Rectangle Bases with Trough and Stretcher Rails; 6" Bases on Exterior and 10" Bases on Interior
- Available with TFL (T) or Veneer (W)
- Vertical Grain Direction on Bases
- Bases Include Interior Removable Panel for Wire Management. Removable Panel is 15⅞"W and Attaches with Z Brackets.
- Bases Require Some Assembly; Attachment Hardware Included
- Tops Sold Separately

6" RECTANGLE ACCENT BASES WITH TROUGH AND REMOVABLE PANEL

6" RECTANGLE ACCENT BASES WITH TROUGH AND REMOVABLE PANEL	Three (3) 6" Rectangle Bases - For Use With 48" x 144" Surfaces							
	88-2410606RAB	Laminate	24	106	28¾	106	19.6	T\$ 5394
		Veneer						W\$ 7174
	Two (2) 6" Rectangle Bases - For Use With 48" x 120" Surfaces							
	88-248206RAB	Laminate	24	82	28¾	99	12.9	T\$ 4745
		Veneer						W\$ 6436
	Two (2) 6" Rectangle Bases - For Use With 48" x 96" Surfaces							
	88-245806RAB	Laminate	24	58	28¾	93	12.9	T\$ 3480
		Veneer						W\$ 4610
	Two (2) 6" Rectangle Bases - For Use With 36" x 72" Surfaces							
	88-203406RAB	Laminate	20	34	28¾	76	12.9	T\$ 3232
		Veneer						W\$ 4302

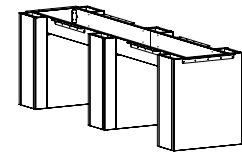

Must Specify (in this order):

- Model #
- Base Finish/Color
- Metal Accent Color
- Accent Panel Finish/Color

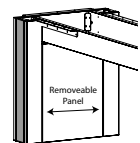

Description

- 6" Rectangle Bases with Trough and Stretcher Rails
- Available with TFL (T) or Veneer (W)
- ⅝" Metal Accent Available in Four (4) Colors: Aluminum, Black, Gold, and Platinum; Must Specify Color
- Vertical Grain Direction on Bases
- Bases Include Interior Removable Panel for Wire Management Access. Removable Panel is 15⅞"W for 24" Bases and 11⅞"W for 20" Bases
- Removable Panels Attached with Z Brackets
- Bases Require Some Assembly; Attachment Hardware Included
- Tops Sold Separately

[See Phoenix Intro Section for Ordering Options](#)

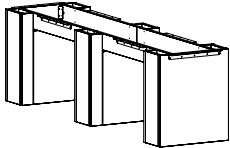
Item	Model No.		Width	Depth	Height	Ship Wt	Cubic Ft	List Price	
10" RECTANGLE ACCENT BASES WITH TROUGH AND REMOVABLE PANEL 	Three (3) 10" Rectangle Bases - For Use With 48" x 144" Surfaces								
	88-241061ORAB	Laminate	24	106	28¾	141	18.2	T\$	5462
		Veneer						W\$	7258
	Two (2) 10" Rectangle Bases - For Use With 48" x 120" Surfaces								
	88-248210RAB	Laminate	24	82	28¾	96	12.0	T\$	3717
		Veneer						W\$	4986
	Two (2) 10" Rectangle Bases - For Use With 48" x 96" Surfaces								
	88-245810RAB	Laminate	24	58	28¾	89	12.0	T\$	3521
		Veneer						W\$	4664
	Two (2) 10" Rectangle Bases - For Use With 36" x 72" Surfaces								
	88-203410RAB	Laminate	20	34	28¾	72	10.0	T\$	3209
		Veneer						W\$	4276

Must Specify (in this order):

- Model #
- Base Finish/Color
- Metal Accent Color
- Accent Panel Finish/Color

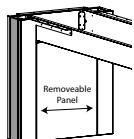

Description

- 10" Rectangle Bases with Trough and Stretcher Rails
- Available with TFL (T) or Veneer (W)
- 5/16" Metal Accent Available in Four (4) Colors: Aluminum, Black, Gold, and Platinum; Must Specify Color
- Vertical Grain Direction on Bases
- Bases Include Interior Removable Panel for Wire Management Access. Removable Panel is 15 7/8"W for 24" Bases and 11 7/8"W for 20" Bases
- Removable Panels Attached with Z Brackets
- Bases Require Some Assembly; Attachment Hardware Included
- Tops Sold Separately

6" + 10" COMBO RECTANGLE ACCENT BASES WITH TROUGH AND REMOVABLE PANEL

Three (3) Bases Total: Two (2) 6" and One (1) 10" Rectangle Bases - For Use With 60" / 54" / 48" x 144" Surfaces									
88-24106C610RAB	Laminate	24	106	28¾	141	18.2	T\$	5420	
	Veneer						W\$	7205	

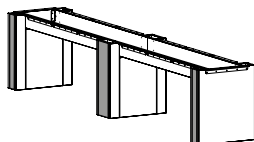

Must Specify (in this order):

- Model #
- Base Finish/Color
- Metal Accent Color
- Accent Panel Finish/Color

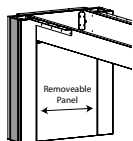

Description

- 6" + 10" Rectangle Accent Bases with Trough and Stretcher Rails; 6" Bases on Exterior and 10" Bases on Interior
- Available with TFL (T) or Veneer (W)
- 5/16" Metal Accent Available in Four (4) Colors: Aluminum, Black, Gold, and Platinum; Must Specify Color
- Vertical Grain Direction on Bases
- Bases Include Interior Removable Panel for Wire Management. Removable Panel is 15 7/8"W and Attaches with Z Brackets
- Bases Require Some Assembly; Attachment Hardware Included
- Tops Sold Separately

Pricing Codes:
P = Laminate Top
W = Wood Top

[See Phoenix Intro Section for Ordering Options](#)

Item	Model No.		Width	Depth	Height	Ship Wt	Cubic Ft	List Price
DISC BASE 	For 48" Round Tops							
	01-3230DBB	Black	30	30	27¾	42	4.1	\$ 1842
	01-3230DBA	Aluminum	30	30	27¾	42	4.1	
	For 36" and 42" Round Tops							
	01-2430DBB	Black	24	24	27¾	32	3.2	\$ 1535
	01-2430DBA	Aluminum	24	24	27¾	32	3.2	

Description

- 4" Diameter 14 Gauge Steel Column
- 12"x12" Mounting Plate at Top of Column
- ¼" Thick Disc Plate with 5 Levelers
- Some Assembly Required

Table Widths	Round+Square	72"	96"
Number of Bases Required	1	2	2

METAL X-BASE

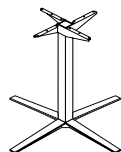

For Use With Round Tops: 42" + 48" Top Surfaces: 48"x96"								
08-2642LXBB	For 42"H Tables	Black	35½	35½	40	33	20.0	\$ 1322
08-2642LXBA		Aluminum						
08-2636LXBB	For 36"H Tables	Black	35½	35½	34	30	17.2	\$ 1275
08-2636LXBA		Aluminum						
08-2630LXBB	For 30"H Tables	Black	35½	35½	28	27	14.5	\$ 1219
08-2630LXBA		Aluminum						
For Use With Round: 36" Top Surfaces: 36"x72"								
08-2042SXBB	For 42"H Tables	Black	29	29	40	27	15.9	\$ 1235
08-2042SXBA		Aluminum						
08-2036SXBB	For 36"H Tables	Black	29	29	34	24	13.7	\$ 1185
08-2036SXBA		Aluminum						
08-2030SXBB	For 30"H Tables	Black	29	29	28	21	11.6	\$ 1139
08-2030SXBA		Aluminum						

Description

- See Number of Bases Required Per Top Width Below
- Power Units Available On Center When Using Two or More Metal X-Bases
- Ships Assembled

Table Widths	Round	72"	96"
Number of Bases Required	1	2	2

[See Phoenix Intro Section for Ordering Options](#)

Item	Model No.		Width	Depth	Height	Ship Wt	Cubic Ft	List Price	
HEIGHT ADJUSTABLE PNEUMATIC X-BASE 	Maximum Round 42"								
	01-3232HAXBB	Black	32	32	26-45¾	1	0.2	\$ 1721	
	01-3232HAXBA	Aluminum	32	32	26-45¾	1	0.2		
	Maximum Round 36"								
	01-2626HAXBB	Black	22	22	26-45¾	1	0.2	\$ 1687	
	01-2626HAXBA	Aluminum	22	22	26-45¾	1	0.2		

Description

- Pre-Drilled Boring Pattern May Not Match Underside of Table Top
- Steel Mounting Plate: 8"x 8"x ¼"
- Eight (8) Bolts Included for Assembly
- Some Assembly Required

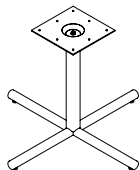
TUBULAR X-BASE

For Use With								
Round Tops: 48"								
Top Surfaces: 48"x96"								
01-3830TXB	Black	38	38	27¾	40	4.2	\$ 699	
01-3830TXA	Aluminum							
For Use With								
Round Tops: 36", 42"								
Top Surfaces: 36"x72"								
01-3230TXB	Black	32	32	27¾	32	3.2	\$ 633	
01-3230TXA	Aluminum							

Description

- 3" Diameter Column
- See Number of Bases Required Per Top Width Below
- Power Units Available On Center When Using Two or More Tubular X-Bases
- Some Assembly Required

Table Widths	Round	72"	96"
Number of Bases Required	1	2	2

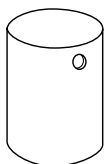
CYLINDER BASE

For Tables 42"D to 48"D								
01-2020CB		20	20	28½	136	10.9	W\$ 1553	
For Tables 36"D								
01-1616CB		16	16	28½	101	7.2	W\$ 1419	

Description

- Veneer Base Features Multi-Step, Hand-Finished Catalyzed Finish
- Weighted for Stability
- Two (2) Wire Management Black Grommets Standard at Top Edge; 8" Opening Standard at Bottom

Additional Grommet Options: Specify & Add

GCB1S	Only One (1) Grommet At Top Edge	\$	N/C
NOGC	No Grommets At Top Edge	\$	N/C

Must Specify (in this order):

Model #

Finish

Grommet Options

Pricing Codes:
 P = Laminate Top
 W = Wood Top

[See Phoenix Intro Section for Ordering Options](#)

Item	Model No.	Width	Depth	Height	Ship Wt	Cubic Ft	List Price
QUEEN ANNE BASE	01-0606QB	24	24	28¾	136	11.1	W\$ 1406

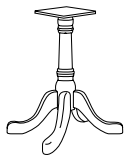

Description

- Classic Design Detail on Column
- Base Features Multi-Step, Hand-Finished Catalyzed Finish
- Four (4) Legs with Adjustable Glides

Must Specify (in this order):

Model #
Finish

SQUARE BASE	21-2020SB	20	20	28¾	57	8.4	W\$ 1183
	<i>For Use with 48" or 42" Tops</i>						
	21-1616SB	16	16	28¾	41	6.0	W\$ 1100
	<i>For Use with 36" Top</i>						

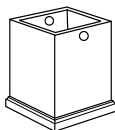

Description

- Veneer Base
- Two (2) Wire Management Black Grommets Standard at Top and 8" Wire Management Opening in Bottom

Must Specify (in this order):

Model #
Finish
Grommet Options



Options: Specify & Add

NOGC	No Grommet at Top Edge	\$	N/C
------	------------------------	----	-----

[See Phoenix Intro Section for Ordering Options](#)

Item	Model No.	Width	Depth	Height	Ship Wt	Cubic Ft	List Price
MAGNETIC GLASS MARKER BOARD FOR USE WITH 30"H DESKS, CREDENZA AND WALL MOUNT HUTCHES OR SHELVING	GMB-4048W	48	½	40⅞	67	11.0	\$ 3128
	GMB-4042W	42	½	40⅞	58	9.9	\$ 2644
	GMB-4036W	36	½	40⅞	50	8.8	\$ 2285
	GMB-4030W	30	½	40⅞	42	7.7	\$ 1924

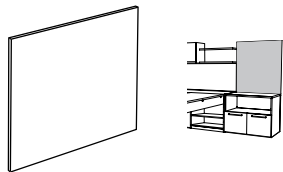

Must Specify (in this order):

Model #
Color



Rare Earth Magnet, Marker and Eraser sets available, [See Set Options](#)

Description

- Available in Black (BLMKR) or White (WHMKR), Must Specify
- Mounting Brackets Included
- For Use over 30"H Desks and Credenzas with Wall Mount Hutches or Shelving
- For Rare Earth Magnets, Marker and Eraser Sets; [See Set Options](#)

MAGNETIC GLASS MARKER BOARD FOR USE WITH 30"H DESKS, CREDENZA AND TALL WALL MOUNT HUTCHES OR SHELVING	GMB-5248W	48	½	52⅞	86	13.5	\$ 3988
	GMB-5242W	42	½	52⅞	76	12.2	\$ 3369
	GMB-5236W	36	½	52⅞	65	10.8	\$ 2904
	GMB-5230W	30	½	52⅞	54	9.5	\$ 2441

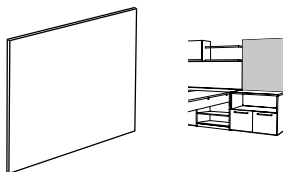

Must Specify (in this order):

Model #
Color



Rare Earth Magnet, Marker and Eraser sets available, [See Set Options](#)

Description

- Available in Black (BLMKR) or White (WHMKR), Must Specify
- Mounting Brackets Included
- For Use Next to Tall Surface or Wall Mount Hutches
- For Rare Earth Magnets, Marker and Eraser Sets; [See Set Options](#)

MAGNETIC GLASS MARKER BOARD FOR USE FROM FLOOR TO TOP OF UNIT	GMB-8236W	36	½	82⅞	102	15.8	\$ 4453
	GMB-7036W	36	½	70⅞	87	13.8	\$ 3834
	GMB-5136W	36	½	51⅞	63	10.6	\$ 2802
	GMB-8230W	30	½	82⅞	85	13.8	\$ 3730
	GMB-7030W	30	½	70⅞	72	12.1	\$ 3215
	GMB-5130W	30	½	51⅞	53	9.3	\$ 2354

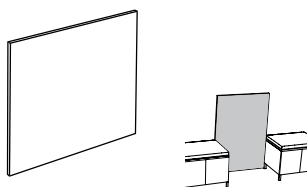

Must Specify (in this order):

Model #
Color



Rare Earth Magnet, Marker and Eraser sets available, [See Set Options](#)

Description

- Available in Black (BLMKR) or White (WHMKR), Must Specify
- Marker Boards Are One (1) Piece with No Seams
- Mounting Brackets Included
- For Use From Floor to Top of Unit
- For Rare Earth Magnets, Marker and Eraser Sets; [See Set Options](#)

[See Phoenix Intro Section for Ordering Options](#)

SURFACE MOUNT TACKBOARDS
20 1/8" H

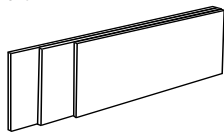

Must Specify (in this order):
Model #
Tackboard Fabric Vendor, Pattern,
and Color

Model #	Size	COM ydg	COM, 1, 2 or 3	Grades						
				4	5	6	7	8	9	10
TB-2184H	84"	2.50	\$ 639	987	1149	1314	1549	1794	2079	2409
TB-2178H	78"	2.50	\$ 628	976	1138	1303	1538	1783	2068	2398
TB-2172H	72"	2.25	\$ 566	879	1025	1174	1385	1606	1862	2159
TB-2166H	66"	2.00	\$ 533	811	941	1073	1261	1457	1685	1949

- Description**
- Coordinates with Surface Mount Hitches
 - Factory Installed

WALL MOUNT TACKBOARDS
21 1/8" H

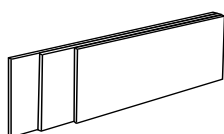

Must Specify (in this order):
Model #
Tackboard Fabric Vendor, Pattern,
and Color

Model #	Size	COM ydg	COM, 1, 2 or 3	Grades						
				4	5	6	7	8	9	10
TB-2182W	82"	2.50	\$ 711	1059	1221	1386	1621	1866	2151	2481
TB-2176W	76"	2.50	\$ 698	1046	1208	1373	1608	1853	2138	2468
TB-2170W	70"	2.25	\$ 642	955	1101	1250	1461	1682	1938	2235
TB-2164W	64"	2.00	\$ 609	887	1017	1149	1337	1533	1761	2025
TB-2158W	58"	2.00	\$ 566	844	974	1106	1294	1490	1718	1982
TB-2152W	52"	1.75	\$ 539	782	896	1012	1176	1348	1547	1778
TB-2146W	46"	1.50	\$ 492	701	798	897	1038	1185	1356	1554
TB-2140W	40"	1.25	\$ 446	620	701	784	901	1024	1166	1331
TB-2134W	34"	1.25	\$ 434	608	689	772	889	1012	1154	1319
TB-2128W	28"	1.00	\$ 394	533	598	664	758	856	970	1102

- Description**
- Coordinates with Wall Mount Hitches
 - Field Installed

Item	Model No.	Width	Depth	Height	Ship Wt	Cubic Ft	List Price
LED TASKLIGHT	TL-0848 <i>240-LED, 18 Watts</i>	47 1/2	7/8	1 5/8	-	-	\$ 445
	TL-0824 <i>84-LED, 7 Watts</i>	22 1/2	7/8	1 5/8	-	-	\$ 368

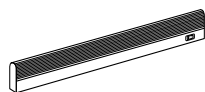

- Description**
- Includes the Power Supply and Three Upper Wire Management Grommets
 - Rocker Style On/Off Switch with a 10' Power Cord
 - Grommet Color will Match Lower Grommet Color

[See Phoenix Intro Section for Ordering Options](#)

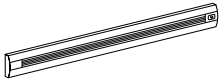
Item	Model No.	Width	Depth	Height	Ship Wt	Cubic Ft	List Price
LED TASKLIGHT 	01-188LED58	96-LED, 33.7 Watts	57 $\frac{3}{8}$	2	$\frac{3}{4}$	-	\$ 1648
	01-94LED31	48-LED, 17.6 Watts	30 $\frac{1}{8}$	2	$\frac{3}{4}$	-	\$ 1195
	01-47LED17	24-LED, 9.1 Watts	16 $\frac{3}{8}$	2	$\frac{3}{4}$	-	\$ 690

Description

- Includes the Power Supply and Three Upper Wire Management Grommets
- 12' Power Cord
- Grommet Color will Match Lower Grommet Color
- Optional Occupancy Sensor Shuts Off After 30 Minutes of Inactivity and Turns On Immediately When Reentering the Detection Area

Options: Specify & Add

01-OSRP	Occupancy Sensor	\$ 366
---------	------------------	--------

CENTER DRAWER	21-1622CD	22	16 $\frac{1}{4}$	2 $\frac{3}{4}$	7	1.4	\$ 495
---------------	-----------	----	------------------	-----------------	---	-----	--------

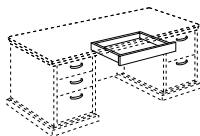
**Description**

- Drawer Features Multi-Step, Hand-Finished Catalyzed Finish
- Built in Pen Tray

Options: Specify & Add

CD16	Factory Installed 01-1622CD	\$ 208
------	-----------------------------	--------

Must Specify (in this order):

Model #
Finish
Factory Installation

ARTICULATING KEYBOARD CORNER PLATFORM	01-KB2CC	25	10 $\frac{1}{2}$	4 $\frac{1}{2}$	16	1.4	\$ 832
---------------------------------------	----------	----	------------------	-----------------	----	-----	--------

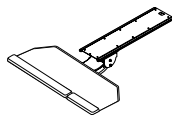
**Description**

- Standard With: +/- 15° Tilt Adjustment , 360° Rotation, Independent Tilt Adjustment, 7" Lift and Lock Height Adjustment, 25" Cut Corner Platform
- Keyboard and Mouse on same level; Single Palm Rest for both Left & Right Hands
- Works with 17"+ Diagonal Work Surface
- Cannot Be Used on 20" or 21" Deep Unit
- Not Available with Optional Center Grommet
- Track Measures 21"

Options: Specify & Add

KB2CC	Factory Installed	\$ 208
-------	-------------------	--------

Pricing Codes:
P = Laminate Top
W = Wood Top

[See Phoenix Intro Section for Ordering Options](#)

Item	Model No.	Width	Depth	Height	Ship Wt	Cubic Ft	List Price
KEYBOARD MECHANISM WITH KEYBOARD CLAMP	01-KB3	26½	14	4.5	16	1.4	\$ 914

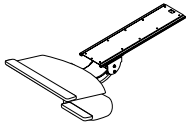

Description

- Standard With: 18.75" Platform with Swivel-Below Mouse Platform,+/- 15° Tilt Adjustment, 360° Rotation, 7" Lift and Lock Height Adjustment, Independent Tilt Adjustment, Palm Rest for Mousing Surface
- Left or Right Handed Mouse Platform
- Cannot Be Used on 20" or 21" Deep Unit
- Not Available with Optional Center Grommet
- Track Measures 21"

Options: Specify & Add

KB3	Factory Installed						\$ 208
-----	-------------------	--	--	--	--	--	--------

DOCK 950 WIRELESS CHARGER	01-DOCK950W	White	3¾	3¾	-	1	0.2	\$ 265
---------------------------	-------------	-------	----	----	---	---	-----	--------

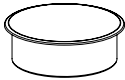

OPEN MARKET ONLY

	01-DOCK950B	Black						
--	-------------	-------	--	--	--	--	--	--

Description

- For Use with Wireless Charging Enabled Devices
- 5 Watts Maximum Output with a Direct Current of 5V 2A and 10 Watts Maximum with Quick Charge 2.0
- LED will Confirm Pairing with Device and Begin Wireless Charging

WIRELESS AND USB CHARGER	01-DOCK150W	White	3	3	¾"	1	0.2	\$ 405
--------------------------	-------------	-------	---	---	----	---	-----	--------



OPEN MARKET ONLY

	01-DOCK150B	Black						
--	-------------	-------	--	--	--	--	--	--

Description

- For Use with Wireless Charging Enabled Devices and USB Charging Devices
- 5 Watt Maximum Output with a Direct Current Input of 5V 6A (Wireless Fast Charge)
- Pop-Up is ¾"H and Includes Three (3) USB Ports; One (1) 12 Watt Maximum with 2.4A (USB Fast Charge) and Two (2) 5 Watt with 1A (USB Standard Charge)
- LED Light will Confirm Pairing with Device and Begin Wireless Charging
- UL and cUL Certified

[See Phoenix Intro Section for Ordering Options](#)

Item	Model No.		Width	Depth	Height	Ship Wt	Cubic Ft	List Price
------	-----------	--	-------	-------	--------	---------	----------	------------

SINGLE POWER SAND DOLLAR



01-SAND60PW	White	3	3	4	1	0.2	\$ 98
01-SAND60PB	Black						
01-SAND60PS	Silver						

Description

- Unit is 2" Diameter; Mounts in 60mm Round Grommet
- 6' Cord
- Single Power Outlet

DOUBLE USB SAND DOLLAR



01-SAND60UW	White	3	3	4	1	0.2	\$ 277
01-SAND60UB	Black						
01-SAND60US	Silver						

Description

- Unit is 2" Diameter; Mounts in 60mm Round Grommet
- 6' Cord
- Dual USB Outlets

DUO BEZEL NEMA PLUG

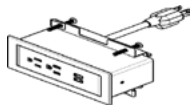

01-DUOBEZELW	White	6½	2½	3¼	1	0.2	\$ 675
01-DUOBEZELB	Black						
01-DUOBEZELS	Silver						

Description

- Sits on Table Top and Includes: Two (2) Power, Two (2) USB, 10' Cord, and All Mounting Hardware
- Independent USB Circuit Controllers Deliver up to 2.1 Amps to Each Post
- FCC Part 15A, UL Recognized for Horizontal and Vertical Applications

TRIO BEZEL NEMA PLUG

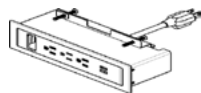

01-TRIOBEZELW	White	9	2½	3	1	0.2	\$ 725
01-TRIOBEZELB	Black						
01-TRIOBEZELS	Silver						

Description

- Sits on Table Top and Includes: Three (3) Power Outlets, Two (2) USB Ports, One (1) Open Data Port, 10' Cord, and All Mounting Hardware
- HDMI, VGA, and RJ45 Accessories for Open Data Port; Sold Separately, [See Accessories](#)
- Independent USB Circuit Controllers Deliver up to 2.1 Amps to Each Post
- FCC Part 15A, UL Recognized for Horizontal and Vertical Applications

Pricing Codes:
P = Laminate Top
W = Wood Top

[See Phoenix Intro Section for Ordering Options](#)

Item	Model No.		Width	Depth	Height	Ship Wt	Cubic Ft	List Price
	01-PDUOBEZELW	White	6½	2½	3	1	0.2	\$ 668
	01-PDUOBEZELB	Black						
	01-PDUOBEZELS	Silver						

Description

- Sits on Table Top and Includes: Two (2) Power, Two (2) USB, 12" Cord, and All Mounting Hardware
- Requires Daisy Chain Power Box; Sold Separately, [See Power Box Details](#)
- Non-Sequential System Allows up to Eight (8) Modules to be Connected with Jumper Cord, [See Jumper Cord Details](#)
- Independent USB Circuit Controllers Deliver up to 2.1 Amps to Each Post
- FCC Part 15A, RU Listed and UL Recognized for Horizontal and Vertical Applications

	01-PTRIOBEZELW	White	9	2½	3	1	0.2	\$ 715
	01-PTRIOBEZELB	Black						
	01-PTRIOBEZELS	Silver						

Description

- Sits on Table Top and Includes: Three (3) Power Outlets, Two (2) USB Ports, One (1) Open Data Port, 12" Cord, and All Mounting Hardware
- HDMI, VGA, or RJ45 Accessory for Open Data Port; Sold Separately, [See Accessories](#)
- Requires Daisy Chain Power Box, Specified Separately, See Next Page
- Non-Sequential System Allows up to Eight (8) Modules to be Connected with Jumper Cord, [See Jumper Cord Details](#)
- Independent USB Circuit Controllers Deliver up to 2.1 Amps to Each Post
- FCC Part 15A, RU Listed and UL Recognized for Horizontal and Vertical Applications

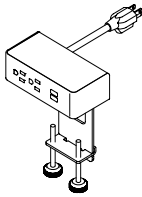
	01-DUOCLAMPW	White	5½	3	7	1	0.2	\$ 572
	01-DUOCLAMPB	Black						
	01-DUOCLAMP S	Silver						

Description

- Standard with: Two (2) Power Outlet, Two (2) USB Ports, 10' Cord
- Clamps to Top and Features Silver Metal Trim
- Independent USB Circuit Controllers Deliver up to 2.1 Amps to Each Post
- All Mounting Hardware Included
- FCC Part 15A and UL Approved for Horizontal and Vertical Applications

[See Phoenix Intro Section for Ordering Options](#)

Item	Model No.		Width	Depth	Height	Ship Wt	Cubic Ft	List Price
TRIO CLAMP NEMA PLUG	01-TRIOCLAMPW	White	8	3	7	1	0.2	\$ 671
	01-TRIOCLAMPB	Black						
	01-TRIOCLAMPS	Silver						

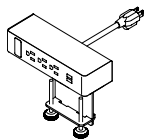

Description

- Standard with: Three (3) Power Outlets, Two (2) USB Ports, One (1) Open Data, 10' Cord
- Clamps to Top and Features Silver Metal Trim
- Independent USB Circuit Controllers Deliver up to 2.1 Amps to Each Post
- HDMI, VGA, or RJ45 Accessories Sold Separately
- All Mounting Hardware Included
- FCC Part 15A and UL Approved for Horizontal and Vertical Applications

TRIO VGA DATA PORT ACCESSORY	01-LCOMVGA		-	-	-	1	0.2	\$ 121
---------------------------------	------------	--	---	---	---	---	-----	--------

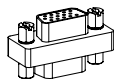

Description

- VGA Port for Trio Bezel Units

TRIO HDMI DATA PORT ACCESSORY	01-LCOMHDMI		-	-	-	1	0.2	\$ 166
----------------------------------	-------------	--	---	---	---	---	-----	--------

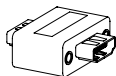

OPEN MARKET ONLY

Description

- HDMI Port for Trio Bezel Units

TRIO RJ45 DATA PORT ACCESSORY	01-LCOMRJ45		-	-	-	1	0.2	\$ 79
----------------------------------	-------------	--	---	---	---	---	-----	-------

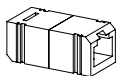

Description

- RJ45 Port for Trio Bezel Units

Pricing Codes:
P = Laminate Top
W = Wood Top

[See Phoenix Intro Section for Ordering Options](#)

Item	Model No.	Width	Depth	Height	Ship Wt	Cubic Ft	List Price
 DAISY CHAIN POWER BOX	01-PPOWER <i>76" Perimeter, 36" Power Cord</i>	-	-	-	1	0.2	\$ 775
	01-PPOWER2 <i>24" Perimeter, 144" Power Cord</i>	-	-	-	1	0.2	\$ 796

Description

- Powers up to Eight (8) Duo and Trio Daisy Chain Units
- One Nema Plug and One Daisy Chain Plug
- 12-Amp System Rating
- 15-Amp Over-Current Protection

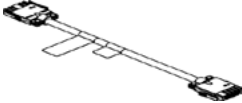
 DAISY CHAIN JUMPER CORD	01-6JUMP <i>72" Long</i>	-	-	-	1	0.2	\$ 299
	01-5JUMP <i>60" Long</i>	-	-	-	1	0.2	\$ 284
	01-4JUMP <i>48" Long</i>	-	-	-	1	0.2	\$ 240
	01-2JUMP <i>24" Long</i>	-	-	-	1	0.2	\$ 220

Description

- Connects Duo and Trio Daisy Chain Units
- Non-Sequential System Allows up to Eight (8) Modules to be Connected

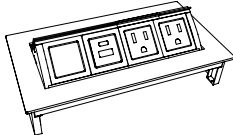
 DPORT	01-DPORT4A Aluminum	8	4	-	7	0.2	\$ 1093
	01-DPORT4B Black						

Description



- Retracts into Work Surface to Regain Productive Space; One-Touch Access to Power and Data
- Two (2) Power Outlets, One (1) USB A+C, and One (1) Open Port
- See Optional Telecom Plates in the Table and Space Division Price List
- Water-Proof Simplex (Outlets)
- Includes a Voice/Data Adapter Kit to Accept Couplers and Jacks When Required and a 10' Power Cord
- UL Recognized
- For Use with Rectangle and Boat Table Tops

 USB PORT	01-USBPORT	-	-	-	-	-	\$ 161
--	------------	---	---	---	---	---	--------

Description

- Passive USB-A Port with Increased Transfer Speed Up to 5 gbs/sec
- Simultaneous Read/Write Capability; Idle Device Power Saving State
- 6' Cord
- Compatible with 01-DPORT4A and 01-DPORT4B

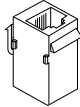
[See Phoenix Intro Section for Ordering Options](#)

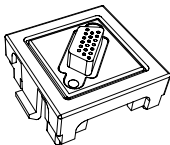
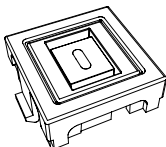
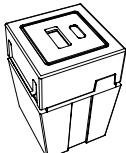
Item	Model No.	Width	Depth	Height	Ship Wt	Cubic Ft	List Price
VOICE COUPLER 	01-VOICE1	-	-	-	-	-	\$ 73
Description <ul style="list-style-type: none"> • 6-Pin Modular Plug • Molded Black; Cord Not included • Compatible with 01-DPORT4A and 01-DPORT4B 							
DATA PORT 	01-RJ4DATA	-	-	-	-	-	\$ 167
Description <ul style="list-style-type: none"> • 8-Pin Modular Plug; Cat6 Ethernet Cable; Pre-terminated Cable • 9' Cord • Compatible with 01-DPORT4A and 01-DPORT4B 							
VGA CONNECTOR ACCESSORY 	01-VGACON	-	-	-	1	0.2	\$ 149
Description <ul style="list-style-type: none"> • VGA Port for 01-DPORT4A and 01-DPORT4B • Enables Devices to Remote Display on Monitors • 10' Cord • Male/Female Connector 							
PASSIVE USB-C ACCESSORY 	01-PUSBC	-	-	-	1	0.2	\$ 95
Description <ul style="list-style-type: none"> • Passive USB-C Port ; Unit Provides Data Connection to Transfer Data Only, No Charging Capabilities • Compatible with 01-DPORT4A and 01-DPORT4B • Male/Female Connector 							
CHARGING USB-A+C ACCESSORY 	01-USBAC	-	-	-	1	0.2	\$ 283
Description <ul style="list-style-type: none"> • For Charging Devices • 20 Watt Power Supply • USB+C Charging Port for 01-DPORT4A and 01-DPORT4B 							

Pricing Codes:
P = Laminate Top
W = Wood Top

[See Phoenix Intro Section for Ordering Options](#)

Item	Model No.	Width	Depth	Height	Ship Wt	Cubic Ft	List Price
HDMI CONNECTOR ACCESSORY	01-HDMICON	-	-	-	1	0.2	\$ 124

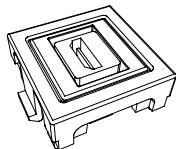

Description

- HDMI Port for 01-DPORT4A and 01-DPORT4B
- Connects to High Definition Displays
- Female/Female Connector
- 18" Cord

INTERACT POWER & DATA	01-INTERACTG2A	Aluminum	9	5¾	2¾	5	0.2	\$ 891
	01-INTERACTG2B	Black						



Description

- Includes: Two (2) Power Outlets, Two (2) USB-A Charging Ports, One (1) Telecom Plate Opening; Two (2) Keystone Openings for Voice/Data Jacks
- One (1) Telecom Plates Included with the Unit: One (1) 01-ABLAB Plate (Consists of One (1) RJ45 Cat 6, One (1) RJ11 Cat 3 Phone Jack)
- Convenience Plug on Bottom
- 6' Power Cord
- UL and CSA Recognized
- See Optional Telecom Plates in the Table and Space Division Price List

OASIS MINI POWER & DATA	01-OASISMA	Aluminum	15	9	5	11	0.3	\$ 3191
	01-OASISMB	Black						



Top View

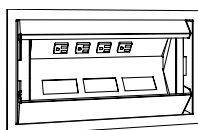

Description

- Soft Touch Hinged Lid
- Four (4) Power Outlets, Three (3) Telecom Plate Openings
- Two (2) Telecom Plates Included with the Unit: One (1) 01-ABLAB Plate (Consists of One (1) RJ45 Cat 6, One (1) RJ11 Cat 3 Phone Jack); One (1) 01-ABLB Plate (Consists of One (1) RJ45 Cat 6)
- 9' Cord with Nema Plug; Fits 15A/120V AC Receptacles
- UL Listed
- See Optional Telecom Plates in the Table and Space Division Price List
- For Use with Rectangle and Boat Table Tops

DOCK800	01-DOCK800S	Silver	14	9	-			\$ 2047
	01-DOCK800B	Black						

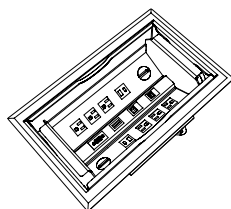

OPEN MARKET ONLY

Description

- Stylish Aluminum Housing with Beveled Edges; Soft Touch Access and Closure
- Includes: Six (6) Power Outlets, Two (2) USB-A 5V Ports, Two (2) USB-C Charging Ports, One (1) RJ45 Ethernet Port, One (1) RJ11 Port, One (1) HDMI Port, and One (1) VGA Port
- 10' Power Cord
- UL and cUL Certified
- See Optional Telecom Plates in the Table and Space Division Price List

[See Phoenix Intro Section for Ordering Options](#)

Item	Model No.	Width	Depth	Height	Ship Wt	Cubic Ft	List Price
POWER ENTRY HARD WIRED	01-HWPOWERENTRY	72	-	-	1	0.2	\$ 322

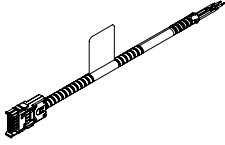

Description

- Eight (8) Wire/Four (4) Circuit Hard Wire In-feed
- UL183 Compliant

Item	Model No.	Width	Depth	Height	Ship Wt	Cubic Ft	List Price
JUMPER HARD WIRE CABLE	01-HW2JUMP	24	-	-	1	0.2	\$ 193
	01-HW3JUMP	36	-	-	1	0.2	\$ 206
	01-HW4JUMP	48	-	-	1	0.2	\$ 212
	01-HW5JUMP	60	-	-	1	0.2	\$ 255
	01-HW6JUMP	72	-	-	1	0.2	\$ 270

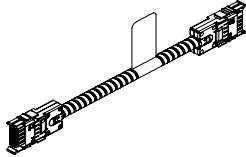

Description

- Eight (8) Wire/Four (4) Circuit Hard Wire Jumper
- UL183 Compliant

Item	Model No.	Width	Depth	Height	Ship Wt	Cubic Ft	List Price
QUAD BLOCK HARD WIRED	01-HWQUADBLOCK	-	-	-	1	0.2	\$ 62

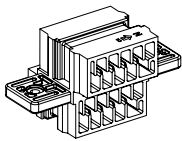

Description

- Eight (8) Wire/Four (4) Circuit Hard Wire Connector
- UL183 Compliant
- For Connecting Jumpers and Power Units
- Quantity of Four (4) Female Inputs

Pricing Codes:
P = Laminate Top
W = Wood Top

[See Phoenix Intro Section for Ordering Options](#)

Item	Model No.	Width	Depth	Height	Ship Wt	Cubic Ft	List Price
VESTA POWER CENTER	01-PDCTR	10 $\frac{3}{4}$	12	28 $\frac{1}{4}$	14	2.5	\$ 1776



Description

- Top Includes One (1) Power Outlet, Two (2) USB Ports and One (1) USBC Port; Base Includes Three (3) Outlet
- Available in White
- 120" Power Cord
- Built with Weight Distribution for Optimal Stability
- Base is 5" Tall

HEIGHT ADJUSTABLE WORKSTATION	01-S2SBLK	Black	35 $\frac{1}{2}$	25	6-22	49	6.5	\$ 1503
-------------------------------	-----------	-------	------------------	----	------	----	-----	---------

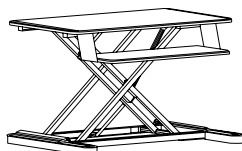

Description

- Height Adjustable
- Weight Capacity: 35lbs
- One-Handed Operation; Platforms Move Simultaneously
- Keyboard Platform: 10 $\frac{1}{2}$ "D x 26 $\frac{1}{2}$ "W
- Worksurface: 21"D x 35 $\frac{1}{2}$ "W
- Can be Used on Worksurface 24"D x 35"W

LINK 360 CABLE MANAGER	01-0251LINKSLV	Silver	5 $\frac{3}{16}$	3 $\frac{9}{16}$	30-51	4	3.0	\$ 390
	01-0251LINKBLK	Black	5 $\frac{3}{16}$	3 $\frac{9}{16}$	30-51	4	3.0	\$ 353

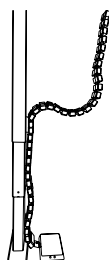

Description

- Kit Includes: 50 Link 360™ elements, One (1) Quad Connector, One (1) Dumbbell Connector, and One (1) Foot Assembly with Two (2) Magnetic Clips
- Can Be Used For Height-Adjustable Mechanisms Up To 51" or Free-Standing Use

[See Phoenix Intro Section for Ordering Options](#)

Item	Model No.	Width	Depth	Height	Ship Wt	Cubic Ft	List Price
WIRE CHANNEL	01-32125	24	1½	1	.25	0.3	\$ 106

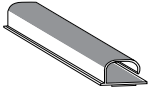

Description

- Available in Black
- Channels Attach with Two (2) Double-Sided Installation Tape
- Easily Attach to an Iconic Leg to Route Wires/Cords from the Top to the Floor
- Open J Channel for Easy Storage of Cables

WIRE MANAGEMENT CHANNEL	01-WMGR4	16	1½	1	1	-	\$ 116
-------------------------	----------	----	----	---	---	---	--------

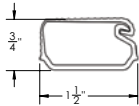

Description

- Set of Four (4) Black Plastic Wire Management Channels
- Snap Lock Channel
- Attaches with Adhesive Strips
- Ships via UPS Only

CABLE GRIP	01-WMGRCB	5 ¾	2 ¾	-	-	-	\$ 17
------------	-----------	-----	-----	---	---	---	-------

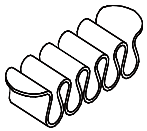

Description

- Under Surface Wire Management
- Black

MARKER AND ERASER SET	01-MRKRSETBL	For Use with Black Marker Boards and Black Glass Doors	\$ 123
	01-MRKRSETWH	For Use with White Marker Boards and White Glass Doors	

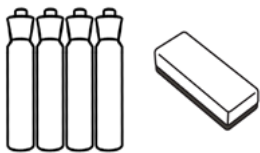

Description

- 01-MRKRSETWH May Also be Used with Standard Dry Erase Doors and Boards
- Includes Four (4) Markers and an Eraser

MAGNET SET	01-MAGBL	For Use with White Marker Boards	\$ 114
	01-MAGWH	For Use with Black Marker Boards	



Description

- Includes Set of Five (5) Magnets

Pricing Codes:
P = Laminate Top
W = Wood Top

[See Phoenix Intro Section for Ordering Options](#)

Reception



Welcoming environments start with furniture that’s warm and inviting. Create a customized work environment through flexible combinations of shells, components, and work surfaces that address multiple configuration options. Subtle details, including multiple pull styles, edge options, overlay panels and molding options allow for a personalized look or seamless blending with any of our standard casegood offerings.

CONSTRUCTION

Aura Reception features a Veneer chassis with your choice of either a Veneer, HPL, or Solid Surface transaction counter. Units ship assembled unless otherwise noted.

VENEER

- Exposed surfaces feature select grade plain sliced hardwood Cherry, Maple, American Black Walnut, or composite veneers
- Veneers are carefully selected and matched to assure proper balance and consistency

TOPS

- Veneer worksurface tops are 3-ply balanced construction and 1 5/32" thick with a self-edge
- Transaction tops are 1 1/2" thick with a 5-ply balanced construction in Veneer, 3-ply balanced construction in High Pressure Laminate
- Transaction tops in Cherry, Maple, and American Black Walnut have solid hardwood rims and are profiled on all sides with mitered corners.
- Optional 3/8" thick glass accent top with 1 1/4" silver standoffs
- Transaction tops in solid surface materials are 1 1/2" thick and available in 6 standard colors
- Grain runs left to right unless otherwise stated

CHASSIS

- Tops and end panels are securely fastened using high quality European fastening systems to ensure maximum strength
- All units have finished backs unless noted
- All pedestals offer optional wire management access from pedestal to kneespace
- All units ship with heavy-duty, adjustable leveling glides to ensure proper leveling and compensation for uneven floors

DRAWERS

- Drawer fronts are 3-ply construction, 3/4" thick with matched grain
- Drawer sides, back, and front are 1/2" thick, woodgrain vinyl wrapped construction with mitered corners
- Box and file drawers have 1/8" thick hardboard bottoms and tested for 100lb capacity
- Lateral files feature 1/4" thick bottoms. Drawers are tested for 200lb of equally distributed weight (ex: hanging file folders) and 65lbs of bottom load weight (ex: stacked catalogs)
- 5-Sided drawer construction for easy removal of drawer fronts
- All drawers feature full extension, progressive action slides with precision steel ball bearings
- All suspensions have a limited lifetime warranty

FILING

- All file drawers are standard with filing systems designed to accommodate a variety of filing requirements
- Modular component pedestals provide letter filing front to back and legal filing side to side
- Lateral file drawers provide legal or letter filing front to back or side to side

STORAGE

- All hinged doors include soft close hinges, unless noted
- One piece hinge and base plate combination
- Soft close hinges reduce stress placed on the cabinet when the door is closed and offers a quiet closure

LOCKING

- All units with file drawers feature locking
- Removable lock cylinders allow for units to be re-keyed at a later date, if required
- Units are shipped randomly keyed as standard
- Keyed alike units available upon request at no additional charge
- Lock core will match pull color

CORD MANAGEMENT

- Grommets may be ordered in the tops
- [See grommet options and locations](#)
- Wire Managers available for additional cord management; [See Accessories](#)

INTERIOR DRAWER DIMENSIONS

Model			
62-2418PD1			
Drawers	W	L	D
Box	14 9/32"	15 1/8"	3 1/2"
File	14 9/32"	15 1/8"	9 1/4"

Model			
62-2418PD2			
Drawers	W	L	D
File	14 9/32"	15 1/8"	9 1/4"

Model			
62-2436LF1			
Drawers	W	L	D
Lat File	32 9/32"	15 1/16"	9 1/4"

Model			
62-2430LF1			
Drawers	W	L	D
Lat File	26 9/32"	15 1/16"	9 1/4"

Model			
62-2436MF1			
Drawers	W	L	D
Box	14 9/32"	15 1/8"	3 1/2"
File	14 9/32"	15 1/8"	9 1/4"
Lat File	32 9/32"	15 1/16"	9 1/4"

Model			
62-2430MF1			
Drawers	W	L	D
Box	11 5/16"	16 3/16"	3 1/2"
File	12 1/8"	16 3/16"	9 1/4"
Lat File	26 9/32"	15 1/16"	9 1/4"

62-1622CD	Center	19	15	1 1/8"
-----------	--------	----	----	--------

Aura Reception

FILING CAPABILITIES

Drawers with Dimensions: 11⁵/₁₆" W x 16³/₁₆" L

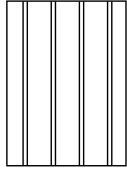

Letter or Legal Side to Side

Drawers with Dimensions: 12¹/₈" W x 16⁵/₃₂" L



Letter Front to Back

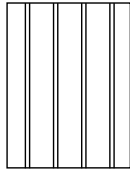

Letter or Legal Side to Side

Drawers with Dimensions: 14³/₃₂" W x 15¹/₈" L

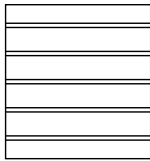

Letter Front to Back

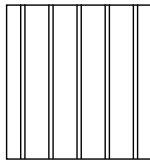

Legal Side to Side

Drawers with Dimensions: 32³/₃₂" W x 15¹/₈" L

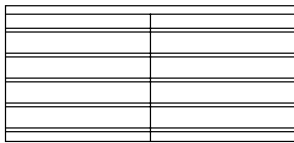

2 Rows Letter Front to Back

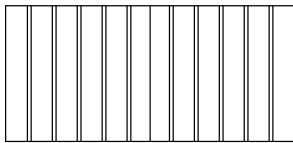

1 Row Legal Side to Side

Drawers with Dimensions: 26³/₃₂" W x 15¹/₈" L

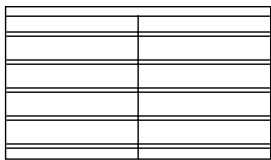

2 Rows Letter Front to Back

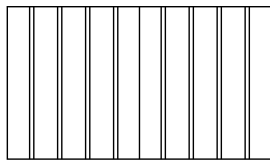

1 Row Legal Side to Side

HOW TO ORDER EXAMPLES

	QTY	MODEL NO.	DESCRIPTION	EXAMPLE
DESK SHELL	1	62-3696RS	Top Material	W
			Finish/Color	AW
			Edge Profile	E
			Tackboard	YES
			Upholstery	Momentum Grid Chrome
			Grommet	GLR
			Grommet Color	SLV
			Glass Top	YES
			Overlay	YES
			Overlay Color	SC
PEDESTAL	2	62-2418PD1	Finish	AW
			Pull/Color	AAC
			Wire	WMENDS
			Management	

VENEER (W) OPTIONS AVAILABLE

Veneer features UV Advantage, an ultra-violet finish, on all exposed surfaces by utilizing roll-coat UV technology

AW	Artisan Walnut	MW	Mahogany Walnut
AS	Asian Night*	MAS	Mesa Sunset*,**
CO	Columbian Walnut	MTS	Metropolis Sky*
DC	Dark Cherry	ORW	Oak Riftwood*,**
DFW	Dark Forest Walnut	PNW	Pinnacle Walnut*
EW	Espresso	SCH	Select Cherry
FO	Fawn Oak**	SKC	Shaker Cherry
GC	Golden Cherry	SM	Sugar Maple*
HW	Harvest Walnut	WTA	Weathered Ash*,**
HNW	Henna Walnut*	WC	Williamsburg Cherry
LW	Legacy Walnut		

* Composite Veneer/ ** Finish is Low Sheen

ADDITIONAL OVERLAY COLOR OPTIONS

SC	Sugar Cookie	WH	White
----	--------------	----	-------

HPL (P) LAMINATE TRANSACTION TOP OPTIONS

WOODGRAIN

AS	Asian Night	PNW	Pinnacle Walnut
CO	Columbian Walnut	SCH	Select Cherry
EF	Espresso	SKC	Shaker Cherry
GC	Golden Cherry	SM	Sugar Maple
MW	Mahogany Walnut	WTA	Weathered Ash
ORW	Oak Riftwood	WC	Williamsburg Cherry

SOLID SURFACE (S) TRANSACTION TOP OPTIONS

AR	Arroyo	SNW	Snow White
PE	Pebble Beach	SN	Starry Night
SE	Sedona	TN	Tundra

EDGE PROFILES

CHASSIS/WORKSURFACES
Y Square

TRANSACTION TOPS

B Bevel	Y Square*
D Bullnose	Z Tail
X Flute*	E Tri-Round
O Phoenix	N Waterfall
A Radius	

** Composite Veneers available only in Square (Y) profile*

SOLID SURFACE TRANSACTION TOPS

S1 Straight	S2 Roman
-------------	----------

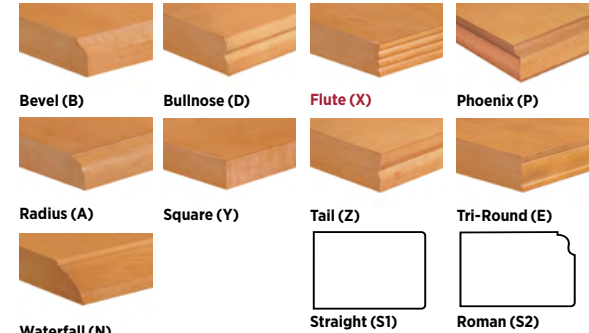

Bevel (B) Bullnose (D) Flute (X) Phoenix (P)
Radius (A) Square (Y) Tail (Z) Tri-Round (E)
Waterfall (N) Straight (S1) Roman (S2)

PULL OPTIONS

Note: Lock Core will match Pull Color

AAV Alcove, Aluminum	AEL Elite, Aluminum
CAV Alcove, Chrome	BEL Elite, Black
AAC Arc, Aluminum	AFL Flair, Aluminum
BAC Arc, Black	CFL Flair, Chrome
ABM Beam, Aluminum	AFC Focus, Aluminum
BBM Beam, Black	BFC Focus, Black
BBT Bow Tie, Black	AQD Quadra, Aluminum
NBT Bow Tie, Nickel	BQD Quadra, Black
ABU Buckle, Aluminum	
BBU Buckle, Black	



GROMMET OPTIONS & LOCATIONS

Multiple locations may be selected. Black = BLK and Silver = SLV

GC	Grommet, Center - Specify BLK or SLV	\$	52
GL	Grommet, Left - Specify BLK or SLV	\$	52
GR	Grommet, Right - Specify BLK or SLV	\$	52

Verify Grommet Option is available on the model(s) you are specifying using the following location information. Grommets may be ordered in non-standard locations. Call Customer Service to assist with specification and/or please attach a drawing to the PO showing the location of the grommet. Note additional charges and lead times may apply.

Models

62-3696RSS	62-3690RSS	62-3684RSS	62-3678RSS
62-3672RSS	62-3666RSS	62-3660RSS	62-3696RS
62-3690RS	62-3684RS	62-3678RS	62-3672RS
62-3666RS	62-3660RS		

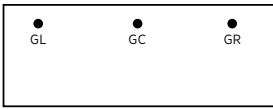

GL/GR: Located 6" from ends and 32¾" from user side
GC: Located 32¾" from user side

Models

62-3096RSS	62-3090RSS	62-3084RSS	62-3078RSS
62-3072RSS	62-3066RSS	62-3060RSS	62-3096RS
62-3090RS	62-3084RS	62-3078RS	62-3072RS
62-3066RS	62-3060RS		

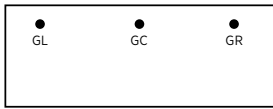

GL/GR: Located 6" from ends and 26¾" from user side
GC: Located 26¾" from user side

Models

62-2560RSLF	62-2560RSRF	62-2554RSLF	62-2554RSRF
62-2548RSLF	62-2548RSRF	62-2542RSLF	62-2542RSRF
62-2536RSLF	62-2536RSRF		

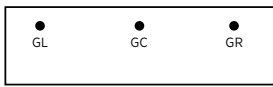

GL/GR: Located 6" from ends and 20" from user side
GC: Located 20" from user side

CERTIFICATIONS & COMPLIANCE

- Intertek Sustainability Certified
- BIFMA level® Certified
- BIFMA Compliant Certified
- TSCA Title VI (formerly CARB) Compliance
- US Green Building's LEED Contribution

Aura Reception

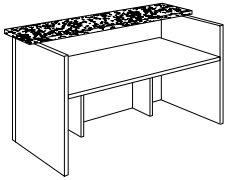

Reception Desk Shells with Solid Surface Transaction Counters
[\(See Details\)](#)

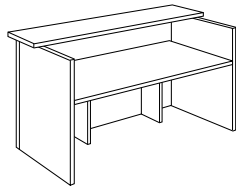

Reception Desk Shells with Veneer/HPL Transaction Counters
[\(See Details\)](#)

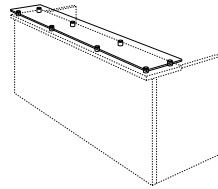

Optional Glass Transaction Top for Desk Shells with Wood Transaction Counters
[\(See Details\)](#)

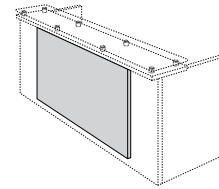

Optional Modesty Panel Overlay for Desk Shells
[\(See Details\)](#)

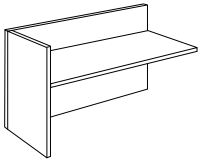

Reception Station Return Shell
[\(See Details\)](#)

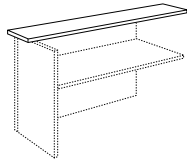

Return Transaction Counter
[\(See Details\)](#)

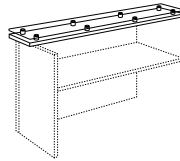

Optional Glass Transaction Top for Return Shells with Wood Transaction Counters
[\(See Details\)](#)

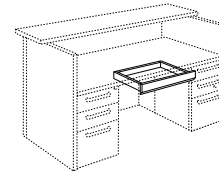

Optional Center Drawer
[\(See Details\)](#)

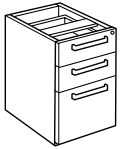

Component Ped Box/Box/File
[\(See Details\)](#)

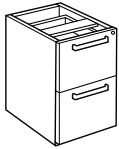

Component Ped File/File
[\(See Details\)](#)

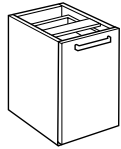

Component Ped Door Bookcase
[\(See Details\)](#)

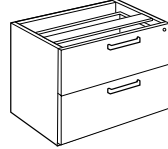

Component Ped Lateral File
[\(See Details\)](#)

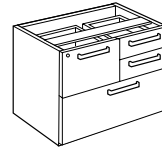

Component Ped Multi-File
[\(See Details\)](#)

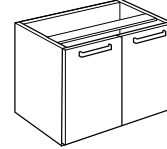

Component Ped Double Door Bookcase
[\(See Details\)](#)

[Reception Desk Shell Tackboards](#)



[Power + Wire Management Accessories](#)

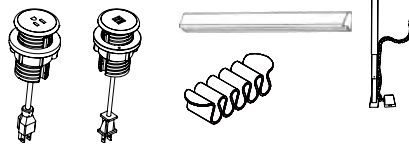

Item	Model No.	Width	Depth	Height	Ship Wt	Cubic Ft	List Price
RECEPTION DESK DOUBLE PED WITH GLASS TOP	62-1	74	39	42	472	97.2	P\$ 13748 W\$ 13822

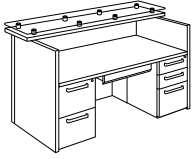

CONSIST OF:	QTY		
62-3672RS	1	Reception Station Shell	P\$ 5319 W\$ 5393
62-72SOG	1	Optional Glass Top	\$ 2604
62-2418PD1	1	Modular Pedestal with Box/Box/File	\$ 2665
62-2418PD2	1	Modular Pedestal with File/File	\$ 2665
62-1622CD	1	Center Drawer	\$ 495

Products are available as left or right, where applicable

RECEPTION STATION L-UNIT	62-2	80	82	42	587	141.3	P\$ 14288 W\$ 14458
--------------------------	------	----	----	----	-----	-------	------------------------

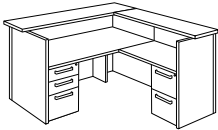

CONSIST OF:	QTY		
62-3678RS	1	Reception Station Shell	P\$ 5586 W\$ 5661
62-2418PD1	1	Modular Pedestal with Box/Box/File	\$ 2665
62-2542RSRF	1	Reception Station Return Shell - Right	\$ 2137
62-1270RTP	1	Return Shell Transaction Top	P\$ 1235 W\$ 1330
62-2418PD2	1	Modular Pedestal with File/File	\$ 2665

Products are available as left or right, where applicable

RECEPTION STATION L-UNIT WITH SOLID SURFACE	62-3	96¾	96¾	42	664	161.9	\$ 16821
---	------	-----	-----	----	-----	-------	----------

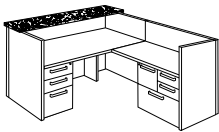

CONSIST OF:	QTY		
62-3672RSS	1	Reception Station Shell with Solid Surface Top	\$ 7428
62-2418PD1	1	Modular Pedestal with Box/Box/File	\$ 2665
62-2560RSRF	1	Reception Station Return Shell - Right	\$ 2564
62-2436MF1	1	Modular Pedestal with Multi-File	\$ 4164

Products are available as left or right, where applicable

Pricing Codes:
P= Laminate Top
W= Wood Top

[See Aura Reception Intro Section for Ordering Options](#)

Item	Model No.	Width	Depth	Height	Ship Wt	Cubic Ft	List Price
RECEPTION STATION U-UNIT	62-4	86	88	42	755	187.2	P\$ 18185 W\$ 18468

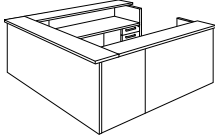

CONSIST OF:	QTY		
62-3084RS	1	Reception Station Shell	P\$ 5393 W\$ 5478
62-2554RSLF	1	Reception Station Return Shell - Left	\$ 2437
62-2554RSRF	1	Reception Station Return Shell - Right	\$ 2437
62-1276RTP_62-4	2	Transaction Riser for Return Shell	P\$ 2588
62-1276RTP_62-4			W\$ 2786
62-2418PD1	1	Modular Pedestal with Box/Box/File	\$ 2665
62-2418PD2	1	Modular Pedestal with File/File	\$ 2665

Products are available as left or right, where applicable

RECEPTION STATION U-UNIT WITH GLASS TOPS	62-5	86	94	42	804	19.8	P\$ 28967 W\$ 29191
--	------	----	----	----	-----	------	------------------------

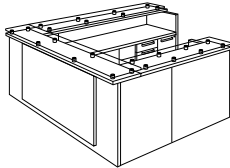

CONSIST OF:	QTY		
62-3084RS	1	Reception Station Shell	P\$ 5393 W\$ 5478
62-84SOG	1	Optional Glass Top	\$ 3092
62-2542RSLF	1	Reception Station Return Shell - Left	\$ 2137
62-2560RSRF	1	Reception Station Return Shell - Right	\$ 2564
62-2418PD1	1	Modular Pedestal with Box/Box/File	\$ 2665
62-2436MF1	1	Modular Pedestal with Multi-File	\$ 4164
62-1264RTP	1	Transaction Riser for Return Shell	P\$ 1185 W\$ 1250
62-64SOG	1	Optional Glass Top	\$ 2511
62-1282RTP	1	Transaction Riser for Return Shell	P\$ 1364 W\$ 1438
62-82SOG	1	Optional Glass Top	\$ 3033
62-OV84	1	Modesty Panel Overlay	\$ 859

Products are available as left or right, where applicable

Pricing Codes:

P= Laminate Top

W= Wood Top

[See Aura Reception Intro Section for Ordering Options](#)

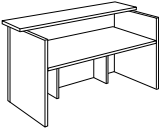
Item	Model No.	Width	Depth	Height	K	R	Ship Wt	Cubic Ft	List Price
RECEPTION DESK SHELL WITH TRANSACTION TOP 	62-3696RS 94" Worksurface	96	39	42	93¾	3	359	108.0	P\$ 6325 W\$ 6378
	62-3690RS 88" Worksurface	90	39	42	87¾	3	377	101.0	P\$ 5990 W\$ 6056
	62-3684RS 82" Worksurface	84	39	42	81¾	3	315	93.0	P\$ 5816 W\$ 5894
	62-3678RS 76" Worksurface	78	39	42	75¾	3	285	90.0	P\$ 5586 W\$ 5661
	62-3672RS 70" Worksurface	72	39	42	69¾	3	271	77.0	P\$ 5319 W\$ 5393
	62-3666RS 64" Worksurface	66	39	42	63¾	3	249	72.0	P\$ 5073 W\$ 5175
	62-3660RS 58" Worksurface	60	39	42	57¾	3	220	65.0	P\$ 4962 W\$ 5054
	62-3096RS 94" Worksurface	96	33	42	93¾	3	299	108.0	P\$ 5864 W\$ 5934
	62-3090RS 88" Worksurface	90	33	42	87¾	3	281	101.0	P\$ 5540 W\$ 5616
	62-3084RS 82" Worksurface	84	33	42	81¾	3	263	93.0	P\$ 5393 W\$ 5478
	62-3078RS 76" Worksurface	78	33	42	75¾	3	238	90.0	P\$ 5182 W\$ 5287
	62-3072RS 70" Worksurface	72	33	42	69¾	3	226	77.0	P\$ 4982 W\$ 5053
	62-3066RS 64" Worksurface	66	33	42	63¾	3	207	72.0	P\$ 4741 W\$ 4856
	62-3060RS 58" Worksurface	60	33	42	57¾	3	183	65.0	P\$ 4626 W\$ 4725

Must Specify (in this order):

- Model #
- Transaction Top Material
- Finish/Color
- Edge Profile
- Tackboard
- Tackboard Fabric
- Grommet Location
- Grommet Color
- Overlay
- Overlay Color

Description

- Vertical Woodgrain on Chassis; Side-to-Side Woodgrain on Worksurface
- Available with Veneer (W) or HPL (P) Transaction Top, Must Specify
- Veneer Worksurface and Shell Desk with 12"D Veneer or HPL Transaction Top
- Worksurface Features Square Profiled Edge
- Transaction Top Profiled on All 4 Sides
- Stiffener Bar ([See Sizes](#)) Recommended Surfaces Not Supported by a Pedestal
- Optional Contrasting Modesty Panel Overlay ([See Overlay Options](#))
- Additional Options: Worksurface Grommet ([See Options and Locations](#)), Glass Transaction Top ([See Glass Sizes](#)), Center Drawer ([See Center Drawer](#)), Tackboard ([See Tackboards](#)), Wire Management, Sand Dollar Power and USB (Sold Separately, [See Accessories](#))

Pricing Codes:
P= Laminate Top
W= Wood Top

[See Aura Reception Intro Section for Ordering Options](#)

Item	Model No.	Width	Depth	Height	K	R	Ship Wt	Cubic Ft	List Price
 <p>RECEPTION DESK SHELL WITH SOLID SURFACE TRANSACTION TOP</p> <p>Must Specify (in this order): Model # Finish Solid Surface Color Solid Surface Edge Tackboard Tackboard Fabric Grommet Location Grommet Color Overlay Overlay Color</p>	62-3696RSS 94" Worksurface	96	39	42	93¾	3	389	108.0	\$ 9201
	62-3690RSS 88" Worksurface	90	39	42	87¾	3	367	101.0	\$ 8651
	62-3684RSS 82" Worksurface	84	39	42	81¾	3	345	93.0	\$ 8304
	62-3678RSS 76" Worksurface	78	39	42	75¾	3	315	90.0	\$ 7948
	62-3672RSS 70" Worksurface	72	39	42	69¾	3	301	77.0	\$ 7428
	62-3666RSS 64" Worksurface	66	39	42	63¾	3	279	72.0	\$ 7104
	62-3660RSS 58" Worksurface	60	39	42	57¾	3	250	65.0	\$ 6833
	62-3096RSS 94" Worksurface	96	33	42	93¾	3	329	108.0	\$ 8835
	62-3090RSS 88" Worksurface	90	33	42	87¾	3	311	101.0	\$ 8294
	62-3084RSS 82" Worksurface	84	33	42	81¾	3	293	93.0	\$ 7966
	62-3078RSS 76" Worksurface	78	33	42	75¾	3	267	90.0	\$ 7620
	62-3072RSS 70" Worksurface	72	33	42	69¾	3	256	77.0	\$ 7136
	62-3066RSS 64" Worksurface	66	33	42	63¾	3	237	72.0	\$ 6820
	62-3060RSS 58" Worksurface	60	33	42	57¾	3	213	65.0	\$ 6541

Description

- Vertical Woodgrain on Chassis; Side-to-Side Woodgrain on Worksurface
- Veneer Shell Desk with 12"D Solid Surface Transaction Top
- Worksurface Features Square Profiled Edge
- Transaction Top Profiled on All 4 Sides
- Optional Contrasting Modesty Panel Overlay ([See Overlay Options](#))
- Additional Options: Worksurface Grommet ([See Options and Locations](#)), Glass Transaction Top ([See Glass Sizes](#)), Center Drawer ([See Center Drawer](#)), Tackboard ([See Tackboards](#)), Wire Management, Sand Dollar Power and USB (Sold Separately, [See Accessories](#))

Pricing Codes:

P= Laminate Top
W= Wood Top

[See Aura Reception Intro Section for Ordering Options](#)

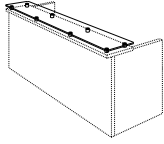
Item	Model No.	Width	Depth	Height	Ship Wt	Cubic Ft	List Price
GLASS TRANSACTION TOP FOR DESK SHELLS 	62-96SOG For Use With 96"W Reception Desk Shells	98	12	3/8	-	-	\$ 3200
	62-90SOG For Use With 90"W Reception Desk Shells	92	12	3/8	-	-	\$ 3148
	62-84SOG For Use With 84"W Reception Desk Shells	86	12	3/8	-	-	\$ 3092
	62-78SOG For Use With 78"W Reception Desk Shells	80	12	3/8	-	-	\$ 2660
	62-72SOG For Use With 72"W Reception Desk Shells	74	12	3/8	-	-	\$ 2604
	62-66SOG For Use With 66"W Reception Desk Shells	68	12	3/8	-	-	\$ 2549
	62-60SOG For Use With 60"W Reception Desk Shells	62	12	3/8	-	-	\$ 2496

Description

- For Desks with Veneer (W) or HPL (P) Transaction Tops
- Glass Top Featured a Self-Edge on All 4 Sides with 1/4" Silver Standoff
- Must be Field Installed
- Only Available on Bullnose, Tri-Round, Fluted, Square, or Tail Edge Tops ([See Edge Profiles](#))

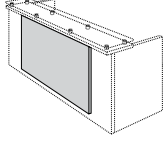
Item	Model No.	Width	Depth	Height	Ship Wt	Cubic Ft	List Price
MODESTY PANEL OVERLAY FOR DESK SHELLS 	62-OV96 For Use With 96"W Reception Desk Shells	72	1	37 1/2	-	-	\$ 976
	62-OV90 For Use With 90"W Reception Desk Shells	66	1	37 1/2	-	-	\$ 922
	62-OV84 For Use With 84"W Reception Desk Shells	60	1	37 1/2	-	-	\$ 859
	62-OV78 For Use With 78"W Reception Desk Shells	54	1	37 1/2	-	-	\$ 783
	62-OV72 For Use With 72"W Reception Desk Shells	48	1	37 1/2	-	-	\$ 705
	62-OV66 For Use With 66"W Reception Desk Shells	42	1	37 1/2	-	-	\$ 643
	62-OV60 For Use With 60"W Reception Desk Shells	36	1	37 1/2	-	-	\$ 559

Must Specify (in this order):
Model #
Color

Description

- Veneer (W) Finish Color, Sugar Cookie (SC) or White (WH) Painted Accent Panel Creates Contemporary Modern Style
- Ships Factory Installed on Corresponding Width Reception Station Desk Shells

Pricing Codes:
P= Laminate Top
W= Wood Top

[See Aura Reception Intro Section for Ordering Options](#)

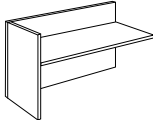
Item	Model No.	Width	Depth	Height	K	Ship Wt	Cubic Ft	List Price	
RECEPTION STATION RETURN SHELL 	Left	Right							
	62-2560RSLF	62-2560RSRF	60	25 ³ / ₈	40 ¹ / ₂	58 ¹³ / ₁₆	139	39.0	\$ 2564
	62-2554RSLF	62-2554RSRF	54	25 ³ / ₈	40 ¹ / ₂	52 ¹³ / ₁₆	125	35.0	\$ 2437
	62-2548RSLF	62-2548RSRF	48	25 ³ / ₈	40 ¹ / ₂	46 ¹³ / ₁₆	116	32.0	\$ 2243
	62-2542RSLF	62-2542RSRF	42	25 ³ / ₈	40 ¹ / ₂	40 ¹³ / ₁₆	102	30.0	\$ 2137
	62-2536RSLF	62-2536RSRF	36	25 ³ / ₈	40 ¹ / ₂	34 ¹³ / ₁₆	87	26.0	\$ 1999

Shown as Left

Must Specify (in this order):

Model #

Finish

Grommet Location

Grommet Color

Description

- Vertical Woodgrain on Chassis; Front to Back on Worksurface
- Worksurface Features Square Edge
- See Below for Coordinating Optional Transaction Top and Glass Top (See Below and Page 565)
- Stiffener Bar ([See Sizes](#)) Recommended Surfaces Not Supported by a Pedestal
- Additional Options: Worksurface Grommet ([See Options and Locations](#)), Transaction Top (See Below), Wire Management, Sand Dollar Power and USB (Sold Separately, [See Accessories](#))

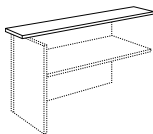
WOOD TRANSACTION TOP FOR RETURN SHELL 	62-1288RTP	88	12	1 ¹ / ₂	-	45	3.5	P\$ 1396
	For Use with 36"D Desks and 60"W Returns							W\$ 1484
	62-1282RTP	82	12	1 ¹ / ₂	-	42	2.9	P\$ 1364
	For Use with 36"D Desks and 54"W Returns or 33"D Desks and 60"W Returns							W\$ 1438
	62-1276RTP	76	12	1 ¹ / ₂	-	39	2.7	P\$ 1294
	For Use with 36"D Desks and 48"W Returns or 33"D Desks and 54"W Returns							W\$ 1393
62-1270RTP	70	12	1 ¹ / ₂	-	36	2.5	P\$ 1235	
For Use with 36"D Desks and 42"W Returns or 33"D Desks and 48"W Returns							W\$ 1330	
62-1264RTP	64	12	1 ¹ / ₂	-	33	2.3	P\$ 1185	
For Use with 36"D Desks and 36"W Returns or 33"D Desks and 42"W Returns							W\$ 1250	
62-1258RTP	58	12	1 ¹ / ₂	-	30	2.1	P\$ 1153	
For Use with 30"D Desks and 36"W Returns							W\$ 1213	

Must Specify (in this order):

Model #

Material

Finish/Color

Edge Profile

Description

- Transaction Top for Use on the Return Shell (See Above)
- Profiled on All 4 Sides with Reverse Shape on Joining End
- Grain Runs Front to Back on Veneer Top; Side to Side on HPL (P) Top
- Optional Glass Transaction Top ([See Glass Sizes](#))

Pricing Codes:

P= Laminate Top

W= Wood Top

[See Aura Reception Intro Section for Ordering Options](#)

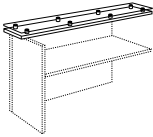
Item	Model No.	Width	Depth	Height	Ship Wt	Cubic Ft	List Price
GLASS TOP FOR WOOD TRANSACTION TOPS FOR RETURN SHELL 	62-88SOG For Use with 88"W Wood Transaction Top	88	12	3/8	-	-	\$ 3117
	62-82SOG For Use with 82"W Wood Transaction Top	82	12	3/8	-	-	\$ 3033
	62-76SOG For Use with 76"W Wood Transaction Top	76	12	3/8	-	-	\$ 2626
	62-70SOG For Use with 70"W Wood Transaction Top	70	12	3/8	-	-	\$ 2566
	62-64SOG For Use with 64"W Wood Transaction Top	64	12	3/8	-	-	\$ 2511
	62-58SOG For Use with 58"W Wood Transaction Top	58	12	3/8	-	-	\$ 2455

Must Specify (in this order):
 Model #
 Edge Profile

Description

- Glass Top Featured a Self-Edge on All 4 Sides with 1 1/4" Silver Standoff
- Field Installed on Corresponding Width Return Risers
- Only Available on Bullnose, Tri-Round, **Fluted**, Square, or Tail Edge Tops ([See Edge Profiles](#))

MODULAR PEDESTAL WITH BOX/BOX/FILE	62-2418PD1	18	24	28 1/4	82	9.4	\$ 2665
---	------------	----	----	--------	----	-----	---------



Description

- Box/Box/File Locking Modular Pedestal; Legal Width Provides Legal or Letter Filing
- Lock Core Color will Coordinate with Pull Selection
- Vertical Grain on Chassis and Drawer Fronts

Options: Specify & Add

WMENDS	Wire Management on Both Side Panels	\$ 161
--------	-------------------------------------	--------

Must Specify (in this order):
 Model #
 Finish
 Pull
 Wire Management

MODULAR PEDESTAL WITH FILE/FILE	62-2418PD2	18	24	28 1/4	82	9.4	\$ 2665
--	------------	----	----	--------	----	-----	---------

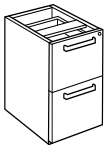

Description

- File/File Locking Modular Pedestal; Legal Width Provides Legal or Letter Filing
- Lock Core Color will Coordinate with Pull Selection
- Vertical Grain on Chassis and Drawer Fronts

Options: Specify & Add

WMENDS	Wire Management on Both Side Panels	\$ 161
--------	-------------------------------------	--------

Must Specify (in this order):
 Model #
 Finish
 Pull
 Wire Management

Pricing Codes:
 P= Laminate Top
 W= Wood Top

[See Aura Reception Intro Section for Ordering Options](#)

Item	Model No.	Width	Depth	Height	Ship Wt	Cubic Ft	List Price
MODULAR PEDESTAL SINGLE DOOR BOOKCASE	Left	Right					
	62-2418PD4L	62-2418PD4R	18	24	28¼	82	9.4

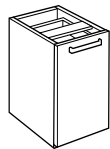

Must Specify (in this order):

Model #
Finish
Pull
Wire Management

Description

- One Door with a 12"D Adjustable Shelf Inside Cabinet
- Vertical Grain on Chassis and Drawer Fronts

Options: Specify & Add

LKT	Optional Locking Doors (Lock Core Color will Coordinate with Pull)	\$ 69
WMENDS	Wire Management on Both Side Panels	\$ 161

MODULAR PEDESTAL LATERAL FILE	62-2436LF1	36	24	28¼	143	17.2	\$ 3381
-------------------------------	------------	----	----	-----	-----	------	---------

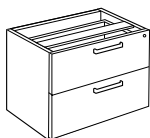

Must Specify (in this order):

Model #
Finish
Pull
Wire Management

Description

- Double Lateral File Locking Modular Pedestal; Drawers Provides Legal or Letter Filing
- Lock Core Color will Coordinate with Pull Selection
- Vertical Grain on Chassis and Drawer Fronts

Options: Specify & Add

WMENDS	Wire Management on Both Side Panels	\$ 161
--------	-------------------------------------	--------

MODULAR PEDESTAL MULTI-FILE	62-2436MF1	36	24	28¼	143	17.2	\$ 4164
-----------------------------	------------	----	----	-----	-----	------	---------

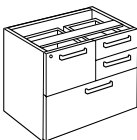

Must Specify (in this order):

Model #
Finish
Pull
Wire Management

Description

- Box/Box/File Over Lateral File
- Locking File Drawer Provides Legal or Letter Filing
- Lock Core Color will Coordinate with Pull Selection
- Vertical Grain on Chassis and Drawer Fronts

Options: Specify & Add

WMENDS	Wire Management on Both Side Panels	\$ 161
--------	-------------------------------------	--------

MODULAR PEDESTAL DOUBLE DOOR BOOKCASE	62-2436DB	36	24	28¼	145	17.2	\$ 3081
---------------------------------------	-----------	----	----	-----	-----	------	---------

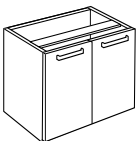

Must Specify (in this order):

Model #
Finish
Pull
Locking Door
Wire Management

Description

- Adjustable 12"D Shelf Inside Cabinet
- Vertical Grain on Chassis and Drawer Fronts
- Optional Locking Doors (See Below)

Options: Specify & Add

LKT	Optional Locking Doors (Lock Core Color will Coordinate with Pull)	\$ 91
WMENDS	Wire Management on Both Side Panels	\$ 161

Pricing Codes:

P= Laminate Top
W= Wood Top

[See Aura Reception Intro Section for Ordering Options](#)

Item	Model No.	Width	Depth	Height	Ship Wt	Cubic Ft	List Price
STIFFENER BAR	01-00060SB	60	1¾	¾	8	0.3	\$ 129
	01-00048SB	48	1¾	¾	5	0.3	\$ 121

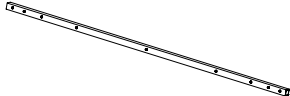

- Description**
- Reinforces Worksurfaces with Large Kneespace Widths
 - Includes End Caps to Cover Sharp Edges
 - Recommended in Kneespaces 60" or Greater
 - Field Installed

CENTER DRAWER	62-1622CD	22	16	2¾	7	1.4	\$ 495
---------------	-----------	----	----	----	---	-----	--------

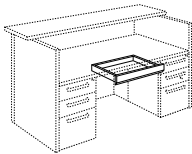

- Description**
- Fits Desks and Returns
 - Built in Pen Tray
 - Field Installed Only

Must Specify (in this order):
Model #
Finish

RECEPTION DESK SHELL TACKBOARDS				Grades						
Model #	Size	COM ydg	COM, 1, 2 or 3	4	5	6	7	8	9	10
TB-6296	96"	3.00	\$ 351	768	963	1161	1443	1737	2079	2475
TB-6290	90"	2.75	\$ 335	717	896	1078	1336	1606	1919	2282
TB-6284	84"	2.50	\$ 317	665	827	992	1227	1472	1757	2087
TB-6278	78"	2.50	\$ 311	659	821	986	1221	1466	1751	2081
TB-6272	72"	2.25	\$ 256	569	715	864	1075	1296	1552	1849
TB-6266	66"	2.00	\$ 232	510	640	772	960	1156	1384	1648
TB-6260	60"	1.75	\$ 219	462	576	692	856	1028	1227	1458



Must Specify (in this order):
Model #
Tackboard Fabric Vendor, Pattern, and Color

- Description**
- Coordinates with Reception Desk Shells
 - Factory Installed

SINGLE POWER SAND DOLLAR	01-SAND60PW	White	3	3	4	1	0.2	\$ 98
	01-SAND60PB	Black						
	01-SAND60PS	Silver						

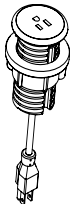

- Description**
- Unit is 2" Diameter; Mounts in 60mm Round Grommet Cutout
 - 6' Cord
 - Single Power Outlet

Pricing Codes:
P= Laminate Top
W= Wood Top

[See Aura Reception Intro Section for Ordering Options](#)

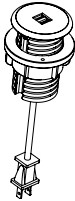
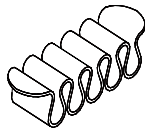
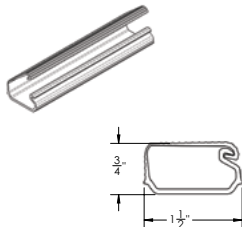
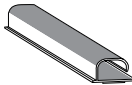
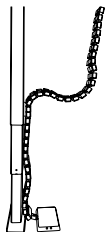
Item	Model No.		Width	Depth	Height	Ship Wt	Cubic Ft	List Price	
	DOUBLE USB SAND DOLLAR	01-SAND60UW	White	3	3	4	1	0.2	\$ 277
		01-SAND60UB	Black						
		01-SAND60US	Silver						
		Description <ul style="list-style-type: none"> • Unit is 2" Diameter; Mounts in 60mm Round Grommet Cutout • 6' Cord • Dual USB Outlets 							
	CABLE GRIP	01-WMGRCB		5 3/8	2 5/8		-	-	\$ 17
		Description <ul style="list-style-type: none"> • Under Surface Wire Management • Black 							
	WIRE MANAGEMENT CHANNEL	01-WMGR4		16	1 1/2	3/4	1	-	\$ 116
		Description <ul style="list-style-type: none"> • Set of Four (4) Black Plastic Wire Management Channels • Snap Lock Channel • Attaches with Adhesive Strips • Ships via UPS Only 							
	WIRE CHANNEL	01-32125		24	1 5/8	1	.25	0.3	\$ 106
		Description <ul style="list-style-type: none"> • Available in Black • Channels Attach with 2 Double-Sided Installation Tape • Open J Channel for Easy Storage of Cables 							
	LINK 360 CABLE MANAGER	01-0251LINKSLV	Silver	5 3/16	3 3/16	30-51	4	3.0	\$ 390
		01-0251LINKBLK	Black	5 3/16	3 3/16	30-51	4	3.0	\$ 353
		Description <ul style="list-style-type: none"> • Kit Includes: 50 Link 360™ elements, 1 Quad Connector, 1 Dumbbell Connector, 1 Foot Assembly with Two (2) Magnetic Clips • Can Be Used For Height-Adjustable Mechanisms Up To 51" or Free-Standing Use 							

Pricing Codes:

P= Laminate Top

W= Wood Top

[See Aura Reception Intro Section for Ordering Options](#)

The traditional stylings of Cameo echo history and create a timeless foundation for welcoming environments that complement our Jefferson, Wilmington, and Arlington casegoods collections, as well as Cameo Conferencing. Create a customized work environment through combinations of shells, components, and work surfaces that address multiple configuration options.

CONSTRUCTION

Cameo Reception features a veneer chassis with your choice of either a Veneer or HPL transaction counter.

veneer

- Veneers on exposed surfaces are select grade sliced American Black Walnut and are carefully selected and matched to assure proper balance and consistency

TOPS

- Work surface tops are 3-ply balanced construction and 1½” thick with a self-edge
- Transaction tops are 1½” thick and have a 5-ply balanced construction in Veneer or 3-ply balanced construction in High Pressure Laminate
- Transaction tops have solid hardwood rims and are profiled on all sides with mitered corners
- Grain runs left to right unless otherwise stated

CHASSIS

- Tops and end panels are securely fastened using high quality European fastening systems to assure maximum strength
- All units have finished backs unless noted
- All pedestals have wire management access from pedestal to kneespace
- Decorative moldings are hand applied
- All units are equipped with heavy-duty, adjustable leveling glides to ensure proper leveling and compensation for uneven floors

DRAWERS

- Drawer fronts are 3-ply construction, ¾” thick with matched grain
- Drawer sides, back, and front are ½” thick, woodgrain vinyl wrapped construction with mitered corners
- Box and file drawers have ½” thick hardboard bottoms and tested for 100lb capacity
- Lateral files feature ¼” thick bottoms. Drawers are tested for 200lb of equally distributed weight (ex: hanging file folders) and 65lbs of bottom load weight (ex: stacked catalogs)
- 5-Sided drawer construction for easy removal of drawer fronts
- All drawers feature full extension, progressive action slides with precision steel ball bearings
- All suspensions have a limited lifetime warranty

FILING

- All file drawers are standard with filing systems designed to accommodate a variety of filing requirements
- Modular component pedestals provide letter filing front to back and legal filing side to side
- Lateral file drawers provide legal or letter filing front to back or side to side

STORAGE

- All hinged doors include soft close hinges, unless otherwise noted
- One piece hinge and base plate combination
- Soft close hinges reduce stress placed on the cabinet when the door is closed and offers a quiet closure

LOCKING

- All units with file drawers feature locking
- Removable black lock cylinders allow for units to be re-keyed at a later date if required
- Units are shipped randomly keyed as standard. Keyed alike units available upon request at no additional charge
- Keyed alike units available upon request at no additional charge

CORD MANAGEMENT

- Grommets may be ordered in the tops
- [See all grommet options and locations](#)
- Wire Managers available for additional cord management; [See Accessories](#)

INTERIOR DRAWER DIMENSIONS

Models

61-2418PDI

Drawers	W	L	D
Box	14½”	15½”	3½”
File	14½”	15½”	9¼”

Models

61-2418PD2

Drawers	W	L	D
File	14½”	15½”	9¼”

Models

61-2436LFI

Drawers	W	L	D
Lat File	32½”	15½”	9¼”

Models

61-2430LFI

Drawers	W	L	D
Lat File	26½”	15½”	9¼”

Models

61-2436MF1

Drawers	W	L	D
Box	14½”	15½”	3½”
File	14½”	15½”	9¼”
Lat File	32½”	15½”	9¼”

Models

61-2430MF1

Drawers	W	L	D
Box	11½”	16¾”	3½”
File	12½”	16¾”	9¼”
Lat File	26½”	15½”	9¼”

Models

61-1622CD

Drawers	W	L	D
Box	1	15	1½”

FILING CAPABILITIES

Drawers with Dimensions: 11¹/₁₆"W x 16³/₁₆"L

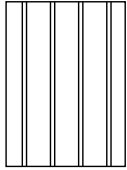

Letter or Legal Side to Side

Drawers with Dimensions: 12¹/₈"W x 16⁵/₃₂"L

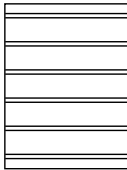

Letter Front to Back

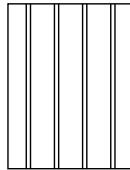

Letter or Legal Side to Side

Drawers with Dimensions: 14⁹/₃₂"W x 15¹/₁₆"L

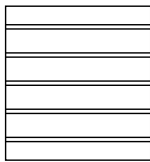

Letter Front to Back

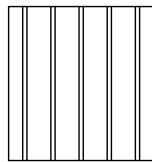

Legal Side to Side

Drawers with Dimensions: 32⁹/₃₂"W x 15¹/₁₆"L

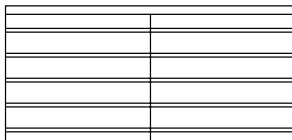

2 Rows Letter Front to Back

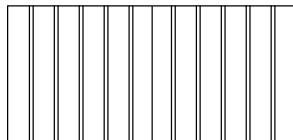

1 Row Legal Side to Side

Drawers with Dimensions: 26⁹/₃₂"W x 15¹/₁₆"L

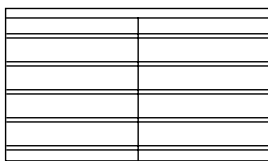

2 Rows Letter Front to Back

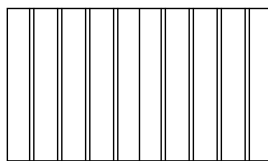

1 Row Legal Side to Side

HOW TO ORDER EXAMPLES

	QTY	MODEL NO.	DESCRIPTION	EXAMPLE
DESK SHELL	1	61-3684RS	Top Material	P
			Finish/Color	CO
			Grommet/Location	GR
			Grommet Color	SLV
			Tackboard	YES
			Upholstery	Momentum Graph Alloy

HOW TO ORDER EXAMPLES CONTINUED

RETURN SHELL	1	61-2554RSRF	Finish	GO
			Grommet/Location	GR
			Grommet Color	SLV
PEDESTAL	1	61-2418PD2	Finish	CO
			Pull	ALB
			Wire Management	WMENDS

VENEER (W) OPTIONS

Veneer tops feature UVAdvantage, an ultra-violet finish, on all exposed surfaces by utilizing roll-coat UV technology

AW	Artisan Walnut	LW	Legacy Walnut
CO	Columbian Walnut	MW	Mahogany Walnut
DC	Dark Cherry	MTS	Metropolis Sky
DFW	Dark Forest Walnut	PNW	Pinnacle Walnut
EW	Espresso	SCH	Select Cherry
GC	Golden Cherry	SKC	Shaker Cherry
HW	Harvest Walnut	WC	Williamsburg Cherry
HNW	Henna Walnut		

HPL (P) LAMINATE WORKSURFACE OPTIONS

WOODGRAIN

CO	Columbian Walnut	PNW	Pinnacle Walnut
EF	Espresso	SCH	Select Cherry
GC	Golden Cherry	SKC	Shaker Cherry
MW	Mahogany Walnut	WC	Williamsburg Cherry

EDGE PROFILES

CHASSIS/WORKSURFACES

Y Square

WOOD TRANSACTION COUNTERS

C2 Jefferson



Jefferson (C2)

PULL OPTIONS

ARA	Arlington A, Antique Brass	ALB	Liberty, Aluminum
ARB	Arlington B, Antique Brass	WLM	Wilmington, Antique Brass
JEF	Jefferson, Antique Brass		



Arlington A
Antique Brass - 5/4"



Arlington B
Antique Brass - 5/4"



Jefferson
Antique Brass - 5/4"



Liberty
Aluminum - 5/4"



Wilmington
Antique Brass - 5/4"

RECEPTION SHELLS + COMPONENTS (6100 SERIES)

GROMMET OPTIONS & LOCATIONS

Multiple locations may be selected. Black = BLK and Silver = SLV

GC	Grommet, Center - Specify BLK or SLV	\$	52
GL	Grommet, Left - Specify BLK or SLV	\$	52
GR	Grommet, Right - Specify BLK or SLV	\$	52

Verify Grommet Option is available on the model(s) you are specifying using the following location information. Grommets may be ordered in non-standard locations. Call Customer Service to assist with specification and/or please attach a drawing to the PO showing the location of the grommet. Note additional charges and lead times may apply.

Models

61-3696RS	61-3690RS	61-3684RS	61-3678RS
61-3672RS	61-3666RS	61-3660RS	

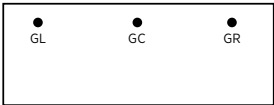

GL/GR: Located 6" from ends and 32 $\frac{3}{8}$ " from user side
GC: Located 32 $\frac{3}{8}$ " from user side

Models

61-3096RS	61-3090RS	61-3084RS	61-3078RS
61-3072RS	61-3066RS	61-3060RS	



GL/GR: Located 6" from ends and 26 $\frac{3}{8}$ " from user side
GC: Located 26 $\frac{3}{8}$ " from user side

Models

61-2560RSLF	61-2560RSRF	61-2554RSLF	61-2554RSRF
61-2548RSLF	61-2548RSRF	61-2542RSLF	61-2542RSRF
61-2536RSLF	61-2536RSRF		

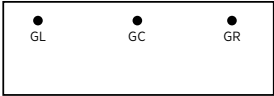

GL/GR: Located 6" from ends and 21 $\frac{3}{8}$ " from user side
GC: Located 21 $\frac{3}{8}$ " from user side

CERTIFICATIONS & COMPLIANCE

- Intertek Sustainability Certified
- BIFMA level® Certified
- BIFMA Compliant Certified
- TSCA Title VI (formerly CARB) Compliance
- US Green Building's LEED Contribution

STATEMENT OF LINE

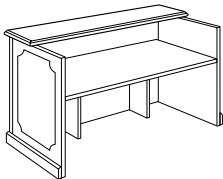

Reception Desk Shells with Transaction Counters
[\(See Details\)](#)

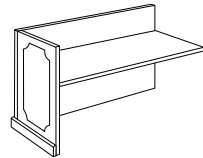

Reception Station Return Shell
[\(See Details\)](#)

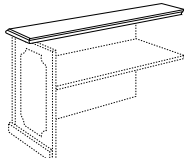

Return Transaction Counter
[\(See Details\)](#)

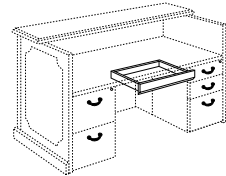

Optional Center Drawer
[\(See Details\)](#)

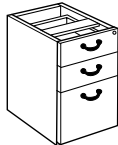

Component Ped Box/Box/File
[\(See Details\)](#)



Component Ped File/File
[\(See Details\)](#)

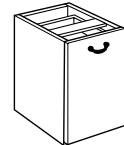

Component Ped Door Bookcase
[\(See Details\)](#)

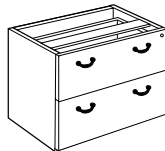

Component Ped Lateral File
[\(See Details\)](#)

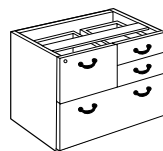

Component Ped Multi-File
[\(See Details\)](#)

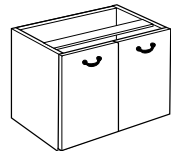

Component Ped Double Door Bookcase
[\(See Details\)](#)

Reception Desk Shell Tackboards



Sand Dollar Power/Data + Wire Management Accessories

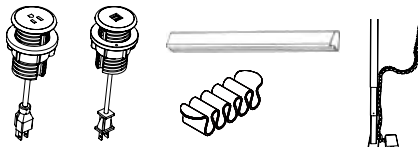

Item	Model No.	Width	Depth	Height	Ship Wt	Cubic Ft	List Price
RECEPTION DESK DOUBLE PED	61-1	74	39	42	442	97.2	P\$ 11625 W\$ 11847

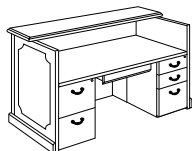

CONSIST OF:	QTY		
61-3672RS	1	Reception Station Shell	P\$ 5842 W\$ 6064
61-1622CD	1	Center Drawer	\$ 495
61-2418PD1	1	Modular Pedestal with Box/Box/File	\$ 2644
61-2418PD2	1	Modular Pedestal with File/File	\$ 2644

Products are available as left or right, where applicable

Item	Model No.	Width	Depth	Height	Ship Wt	Cubic Ft	List Price
RECEPTION STATION L-UNIT	61-2	74	82	42	590	130.5	P\$ 14903 W\$ 15303

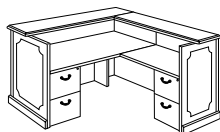

CONSIST OF:	QTY		
61-3672RS	1	Reception Station Shell	P\$ 5842 W\$ 6064
61-2548RSRF	1	Reception Station Return Shell - Right	\$ 2524
61-1276RTP	1	Return Shell Transaction Riser	P\$ 1249 W\$ 1427
61-2418PD2	2	Modular Pedestal with File/File	\$ 5288

Products are available as left or right, where applicable

Item	Model No.	Width	Depth	Height	Ship Wt	Cubic Ft	List Price
RECEPTION STATION U-UNIT	61-3	86	88	42	796	182.6	P\$ 19766 W\$ 20203

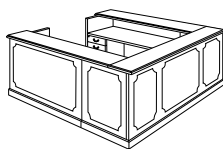

CONSIST OF:	QTY		
61-3684RS	1	Reception Station Shell	P\$ 6437 W\$ 6518
61-2548RSLF	1	Reception Station Return Shell - Left	\$ 2524
61-2548RSRF	1	Reception Station Return Shell - Right	\$ 2524
61-1276RTP_613	2	Transaction Riser for Return Shell	P\$ 2498 W\$ 2854
61-2418PD1	1	Modular Pedestal with Box/Box/File	\$ 2644
61-2418PD2	1	Modular Pedestal with File/File	\$ 2644
61-1622CD	1	Center Drawer	\$ 495

Products are available as left or right, where applicable

Pricing Codes:

P= Laminate Top
W= Wood Top

[See Cameo Reception Intro Section for Ordering Options](#)

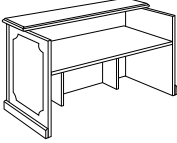
Item	Model No.	Width	Depth	Height	K	R	Ship Wt	Cubic Ft	List Price
RECEPTION DESK SHELL WITH TRANSACTION TOP 	61-3696RS 94" Worksurface	96	39	42	93¾	3	359	108.0	P\$ 6980 W\$ 7162
	61-3690RS 88" Worksurface	90	39	42	87¾	3	377	101.0	P\$ 6720 W\$ 6806
	61-3684RS 82" Worksurface	84	39	42	81¾	3	315	93.0	P\$ 6437 W\$ 6518
	61-3678RS 76" Worksurface	78	39	42	75¾	3	285	90.0	P\$ 6221 W\$ 6228
	61-3672RS 70" Worksurface	72	39	42	69¾	3	271	77.0	P\$ 5842 W\$ 6064
	61-3666RS 64" Worksurface	66	39	42	63¾	3	249	72.0	P\$ 5645 W\$ 5782
	61-3660RS 58" Worksurface	60	39	42	57¾	3	220	65.0	P\$ 5474 W\$ 5621
	61-3096RS 94" Worksurface	96	33	42	93¾	3	299	108.0	P\$ 6322 W\$ 6469
	61-3090RS 88" Worksurface	90	33	42	87¾	3	281	101.0	P\$ 6196 W\$ 6296
	61-3084RS 82" Worksurface	84	33	42	81¾	3	263	93.0	P\$ 5949 W\$ 6037
	61-3078RS 76" Worksurface	78	33	42	75¾	3	238	90.0	P\$ 5747 W\$ 5850
	61-3072RS 70" Worksurface	72	33	42	69¾	3	226	77.0	P\$ 5432 W\$ 5665
	61-3066RS 64" Worksurface	66	33	42	63¾	3	207	72.0	P\$ 5236 W\$ 5381
	61-3060RS 58" Worksurface	60	33	42	57¾	3	183	65.0	P\$ 5074 W\$ 5232

Must Specify (in this order):

Model #
Transaction Top Material
Finish/Color
Transaction Top Edge
Grommet Location
Grommet Color
Tackboard
Tackboard Fabric

Description

- Vertical Woodgrain on Chassis; Side-to-Side Woodgrain on Worksurface
- Available with Veneer (W) or HPL (P) Transaction Top, Must Specify
- Veneer Worksurface and Shell Desk with 12"D Veneer or HPL Transaction Top
- Worksurface Features Square Profiled Edge
- Transaction Top Profiled on All 4 Sides
- Stiffener Bar ([See Sizes](#)) Recommended for Surfaces Not Supported by a Pedestal
- Additional Options: Center Drawer ([See Center Drawer](#)), Tackboard ([See Tackboards](#)), Sand Dollar Power and USB + Wire Management (Sold Separately, [See Accessories](#))

Pricing Codes:
P= Laminate Top
W= Wood Top

[See Cameo Reception Intro Section for Ordering Options](#)

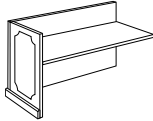
Item	Model No.	Width	Depth	Height	K	R	Ship Wt	Cubic Ft	List Price	
RECEPTION STATION RETURN SHELL 	Left	Right								
	61-2560RSLF	61-2560RSRF	60½	25 ¹⁵ / ₁₆	40½	58 ¹³ / ₁₆	-	139	39.0	\$ 2831
	61-2554RSLF	61-2554RSRF	54½	25 ¹⁵ / ₁₆	40½	52 ¹³ / ₁₆	-	125	35.0	\$ 2694
	61-2548RSLF	61-2548RSRF	48½	25 ¹⁵ / ₁₆	40½	46 ¹³ / ₁₆	-	116	32.0	\$ 2524
	61-2542RSLF	61-2542RSRF	42½	25 ¹⁵ / ₁₆	40½	40 ¹³ / ₁₆	-	102	30.0	\$ 2428
	61-2536RSLF	61-2536RSRF	36½	25 ¹⁵ / ₁₆	40½	34 ¹³ / ₁₆	-	87	26.0	\$ 2276

Shown as Left

Must Specify (in this order):

Model #
 Finish/Color
 Grommet Location
 Grommet Color

Description

- Vertical Woodgrain on Chassis; Front-to-Back Woodgrain on Worksurface
- Worksurface Features Square Profiled Edge
- Stiffener Bar ([See Sizes](#)) Recommended for Surfaces Not Supported by a Pedestal
- See Below for Coordinating Optional Transaction Top
- Additional Options: Tackboard ([See Tackboards](#)), Sand Dollar Power and USB + Wire Management (Sold Separately, [See Accessories](#))

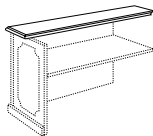
WOOD TRANSACTION TOP FOR RETURN SHELL 	61-1288RTP	88	12	1½ ₃₂	-	-	45	3.5	P\$ 1335 W\$ 1499	
	For Use with 39" Desks and 60" Returns									
	61-1282RTP	82	12	1½ ₃₂	-	-	42	2.9	P\$ 1308 W\$ 1473	
	For Use with 39" Desks and 54" Returns or 33" Desks and 60" Returns									
	61-1276RTP	76	12	1½ ₃₂	-	-	39	2.7	P\$ 1249 W\$ 1427	
	For Use with 39" Desks and 48" Returns or 33" Desks and 54" Returns									
61-1270RTP	70	12	1½ ₃₂	-	-	36	2.5	P\$ 1199 W\$ 1402		
For Use with 39" Desks and 42" Returns or 33" Desks and 48" Returns										
61-1264RTP	64	12	1½ ₃₂	-	-	33	2.3	P\$ 1159 W\$ 1341		
For Use with 39" Desks and 36" Returns or 33" Desks and 42" Returns										
61-1258RTP	58	12	1½ ₃₂	-	-	30	2.1	P\$ 1125 W\$ 1318		
For Use with 39" Desks and 36" Returns or 33" Desks and 42" Returns										

Description

- For Use with Return Shell, See Above
- Profiled on All 4 Sides with Reverse Shape on Joining End
- Grain Runs Front to Back on Veneer Top; Side to Side on HPL Top

Pricing Codes:

P= Laminate Top
 W= Wood Top

[See Cameo Reception Intro Section for Ordering Options](#)

Item	Model No.	Width	Depth	Height	Ship Wt	Cubic Ft	List Price
MODULAR PEDESTAL WITH BOX/BOX/FILE	61-2418PD1	18	24	28¾	82	9.4	\$ 2644

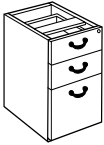

Description

- Box/Box/File Locking Modular Pedestal
- Black Lock Core
- File Drawer Provides Legal or Letter Filing
- Vertical Grain on Chassis and Drawer Fronts

Must Specify (in this order):

- Model #
- Finish
- Pull/Pull Color
- Wire Management

Options: Specify & Add

WMENDS	Wire Management on Both Side Panels	\$ 161
--------	-------------------------------------	--------

MODULAR PEDESTAL WITH FILE/FILE	61-2418PD2	18	24	28¾	82	9.4	\$ 2644
--	------------	----	----	-----	----	-----	---------

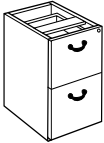

Description

- File/File Locking Modular Pedestal
- Black Lock Core
- File Drawer Provides Legal or Letter Filing
- Vertical Grain on Chassis and Drawer Fronts

Must Specify (in this order):

- Model #
- Finish
- Pull/Pull Color
- Wire Management

Options: Specify & Add

WMENDS	Wire Management on Both Side Panels	\$ 161
--------	-------------------------------------	--------

MODULAR PEDESTAL SINGLE DOOR BOOKCASE	Left	Right	Width	Depth	Height	Ship Wt	Cubic Ft	List Price
	61-2418PD4L	61-2418PD4R						

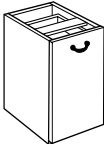

Description

- One Door with 12"D Adjustable Shelf Inside Cabinet
- Vertical Grain on Chassis and Door Front

Options: Specify & Add

LKT	Optional Locking	\$ 69
WMENDS	Wire Management on Both Side Panels	\$ 161

Must Specify (in this order):

- Model #
- Finish
- Pull/Pull Color
- Locking Door
- Wire Management

Pricing Codes:
P= Laminate Top
W= Wood Top

[See Cameo Reception Intro Section for Ordering Options](#)

Cameo Reception

Item	Model No.	Width	Depth	Height	Ship Wt	Cubic Ft	List Price
MODULAR PEDESTAL WITH LATERAL FILE	61-2436LF1	36	24	28¼	143	17.2	\$ 3346
	61-2430LF1	30	24	28¼	119	14.4	\$ 3295
Description							
<ul style="list-style-type: none"> • Double Lateral File Locking Modular Pedestal • Black Lock Core • Lateral File Drawers Provides Legal or Letter Filing • Vertical Grain on Chassis and Drawer Fronts 							
Options: Specify & Add							
WMENDS Wire Management on Both Side Panels							\$ 161

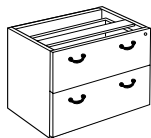
Must Specify (in this order):

Model #
Finish
Pull
Wire Management

MODULAR PEDESTAL WITH MULTI-FILE	61-2436MF1	36	24	28¼	143	17.2	\$ 4147
	61-2430MF1	30	24	28¼	119	14.4	\$ 4074
Description							
<ul style="list-style-type: none"> • Box/Box/File Over Lateral File • Black Lock Core • Locking File Drawer Provides Legal or Letter Filing • Vertical Grain on Chassis and Drawer Fronts 							
Options: Specify & Add							
WMENDS Wire Management on Both Side Panels							\$ 161

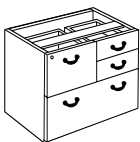
Must Specify (in this order):

Model #
Finish
Pull
Wire Management

MODULAR PEDESTAL DOUBLE DOOR BOOKCASE	61-2436DB	36	24	28¼	145	17.2	\$ 3045
	61-2430DB	30	24	28¼	105	14.4	\$ 2920
Description							
<ul style="list-style-type: none"> • Adjustable 12"D Shelf Inside Cabinet • Vertical Grain on Chassis and Door Fronts • Optional Locking Door (See Below) 							
Options: Specify & Add							
LKT Optional Locking							\$ 91
WMENDS Wire Management on Both Side Panels							\$ 161

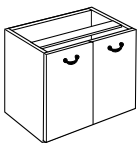
Must Specify (in this order):

Model #
Finish
Pull
Locking Door
Wire Management

Pricing Codes:

P= Laminate Top
W= Wood Top

[See Cameo Reception Intro Section for Ordering Options](#)

Item	Model No.	Width	Depth	Height	Ship Wt	Cubic Ft	List Price
STIFFENER BAR 	01-00060SB	60	1¾	¾	8	0.3	\$ 129
	01-00048SB	48	1¾	¾	5	0.3	\$ 121

Description

- Reinforces Worksurfaces with Large Kneespace Widths
- Includes End Caps to Cover Sharp Edges
- Recommended in Kneespaces 60" or Greater
- Field Installed

CENTER DRAWER	61-1622CD	22	16	2¾	7	1.4	\$ 495
---------------	-----------	----	----	----	---	-----	--------

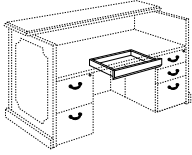

Description

- Attaches to Under Side of Worksurface
- Built in Pen Tray
- Field Installed Only

Must Specify (in this order):
Model #
Finish

RECEPTION DESK SHELL TACKBOARDS
9" H

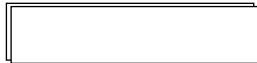

Model #	Size	COM ydg	COM, 1, 2 or 3	Grades									
				4	5	6	7	8	9	10			
TB-6196	96"	3.00	\$	351	768	963	1161	1443	1737	2079	2475		
TB-6190	90"	2.75	\$	335	717	896	1078	1336	1606	1919	2282		
TB-6184	84"	2.50	\$	317	665	827	992	1227	1472	1757	2087		
TB-6178	78"	2.50	\$	311	659	821	986	1221	1466	1751	2081		
TB-6172	72"	2.25	\$	256	569	715	864	1075	1296	1552	1849		
TB-6166	66"	2.00	\$	232	510	640	772	960	1156	1384	1648		
TB-6160	60"	1.75	\$	219	462	576	692	856	1028	1227	1458		

Must Specify (in this order):
Model #
Tackboard Fabric Vendor, Pattern,
and Color

Description

- Coordinates with Reception Desk Shells
- Factory Installed

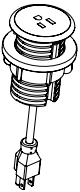
SINGLE POWER SAND DOLLAR 	01-SAND60PW	White	3	3	4	1	0.2	\$ 98
	01-SAND60PB	Black						
	01-SAND60PS	Silver						

Description

- Unit is 2" Diameter; Mounts in 60mm Round Grommet
- 6' Cord
- Single Power Outlet

Pricing Codes:
P= Laminate Top
W= Wood Top

[See Cameo Reception Intro Section for Ordering Options](#)

Item	Model No.		Width	Depth	Height	Ship Wt	Cubic Ft	List Price
	01-SAND60UW	White	3	3	4	1	0.2	\$ 277
	01-SAND60UB	Black						
	01-SAND60US	Silver						

Description

- Unit is 2" Diameter; Mounts in 60mm Round Grommet
- 6' Cord
- Dual USB Outlets

WIRE MANAGEMENT CHANNEL	01-WMGR4		16	1½	¾	1	-	\$ 116
-------------------------	----------	--	----	----	---	---	---	--------

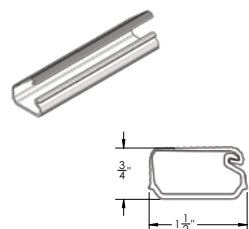

Description

- Set of Four (4) Black Plastic Wire Management Channels
- Snap Lock Channel
- Attaches with Adhesive Strips
- Ships via UPS Only

CABLE GRIP	01-WMGRCB		5 ⅜	2 ⅝		-	-	\$ 117
------------	-----------	--	-----	-----	--	---	---	--------

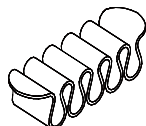

Description

- Under Surface Wire Management
- Black

WIRE CHANNEL	01-32125		24	1 ⅝	1	.25	0.3	\$ 106
--------------	----------	--	----	-----	---	-----	-----	--------

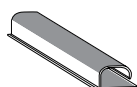

Description

- Available in Black
- Channels Attach with 2 Double-Sided Installation Tape
- Open J Channel for Easy Storage of Cables

LINK 360 CABLE MANAGER	01-0251LINKSLV	Silver	5 ⅝	3 ⅝	30-51	4	3.0	\$ 390
	01-0251LINKBLK	Black	5 ⅝	3 ⅝	30-51	4	3.0	\$ 353

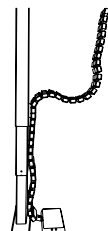

Description

- Kit Includes: 50 Link 360™ elements, 1 Quad Connector, 1 Dumbbell Connector, 1 Foot Assembly with Two (2) Magnetic Clips
- Can Be Used For Height-Adjustable Mechanisms Up To 51" or Free-Standing Use

Pricing Codes:

P= Laminate Top
W= Wood Top

[See Cameo Reception Intro Section for Ordering Options](#)

Explore Canvas Reception models, sizes, and premium details to heighten function and luxury for the user, the environment, and all of your visitors. Choose from waterfall transaction counters with paper slots, conventional transaction counters available in a variety of materials, matching or contrasting overlays, backlighting, extended gallery returns with storage, ADA returns, and more!

CONSTRUCTION

Canvas Reception features a TFL chassis with your choice of TFL or HPL Top and TFL, HPL, or Solid Surface transaction counters. Units ship assembled unless otherwise noted.

LAMINATES

- Exposed surfaces are woodgrain and solid color laminates
- Worksurfaces are bonded to the core with a PVA adhesive in a cold press to prevent separation of the laminate from the core
- Each laminate offers lasting beauty, superior resistance to normal wear, and easy maintenance

TOPS

- Worksurfaces are 1" thick thermally-fused laminate (TFL) or High Pressure Laminate (HPL) with 1mm matching PVC rims in a square profile; Designer White, Sugar Maple, Williamsburg Cherry feature ABS edge bands
- Worksurfaces are shaped on all four sides and fit flush with adjoining worksurfaces for a clean aesthetic
- Transaction tops in TFL or HPL are edge-banded and have a self-edge on all sides
- Accent tops of 3/8" glass with 1/4" silver standoffs are available
- Transaction tops in Solid Surface materials are 1/2" thick and available in 6 standard colors

CHASSIS/COMPONENTS

- TFL chassis and storage components
- Worksurfaces, storage components and end panels are securely fastened using high quality European fastening systems, 16-gauge joining brackets and wooden dowels to assure maximum strength
- Exposed edges have matching PVC edge band
- All units are equipped with heavy-duty glides featuring 1 1/4" adjustment to ensure proper leveling and compensation for uneven floors
- All modular components have standard wire openings from inside the pedestal to the kneespace allowing quick access to technology below

DRAWERS

- Drawers feature 5-sided construction allowing for easy removal of drawer fronts
- Drawer fronts are 3-ply, 3/4" thick thermally fused laminate on both faces with matching PVC banded edges
- All drawer sides are 1/2" thick woodgrain vinyl-wrapped construction with mitered corners
- Box and file drawers have 1/8" thick hardboard bottoms and tested for 100lb capacity
- Lateral files feature 1/4" thick bottoms. Drawers are tested for 200lb of equally distributed weight (ex: hanging file folders) and 65lbs of bottom load weight (ex: stacked catalogs)
- All drawers feature full extension, progressive action slides with precision steel ball bearings
- All suspensions have a limited lifetime warranty

FILING

- All file drawers are standard with filing systems designed to accommodate a variety of filing requirements
- Letter width file drawers provide letter filing front to back and legal filing side to side
- Lateral file drawers provide legal or letter filing front to back or side to side

LOCKING

- All units with file drawers feature locking
- Removable lock cylinders allow for units to be re-keyed at a later date, if required
- Units are shipped randomly keyed as standard
- Keyed alike units available upon request at no additional charge
- Lock core will match pull color (if applicable, otherwise specify)

INTERIOR DRAWER DIMENSIONS

Model

66-2415PD1

Drawers

	W	L	D
Box	12 1/8"	16 3/16"	3 1/2"
File	12 1/8"	16 3/16"	9 5/16"

Model

66-2418PD1

Drawers

	W	L	D
Box	14 9/32"	15 1/8"	3 1/2"
File	14 9/32"	15 1/8"	9 5/16"

Model

66-2436LF1

Drawers

	W	L	D
Lat File	32 7/32"	15 1/16"	9 7/32"

Model

66-2430LF1

Drawers

	W	L	D
Lat File	26 7/32"	15 1/16"	9 7/32"

Model

66-2430LF2

Drawers

	W	L	D
Box	11 5/16"	16 3/16"	3 1/2"
File	12 1/8"	16 3/16"	9 5/16"
Lat File	26 7/32"	15 1/16"	9 1/4"

Model

66-2436LF2

Drawers

	W	L	D
Box	14 9/32"	15 1/8"	3 1/2"
File	14 9/32"	15 1/8"	9 5/16"
Lat File	32 7/32"	15 1/16"	9 7/32"

Model

66-2415PD2

Drawers

	W	L	D
File	12 1/8"	16 3/16"	9 5/16"

Model

66-2418PD2

Drawers

	W	L	D
File	14 9/32"	15 1/8"	9 5/16"

INTERIOR DRAWER DIMENSIONS (CONTINUED)

Model

66-2436OMF

Drawers	W	L	D
File	14 ⁹ / ₃₂ "	15 ¹ / ₈ "	3 ¹ / ₂ "
Lat File	32 ⁹ / ₃₂ "	15 ¹ / ₁₆ "	9 ⁷ / ₃₂ "

Model

66-2430OMF

Drawers	W	L	D
Box	11 ⁵ / ₁₆ "	16 ³ / ₁₆ "	3 ¹ / ₂ "
Lat File	26 ⁹ / ₃₂ "	15 ¹ / ₁₆ "	9 ¹ / ₄ "

Model

64-2595ERSWD2L46 64-2595ERSWD2L41 64-2583ERSWD2L23

64-2595ERSWD2L35 64-2583ERSWD2L34 64-2583ERSWD2L29

Drawers	W	L	D
Box	14 ⁹ / ₃₂ "	15 ¹ / ₈ "	3 ¹ / ₂ "
File	14 ⁹ / ₃₂ "	15 ¹ / ₈ "	9 ⁵ / ₁₆ "

FILING CAPABILITIES

Drawers with Dimensions: 11⁵/₁₆"W x 16³/₁₆"L

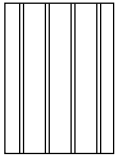

Letter or Legal Side to Side

Drawers with Dimensions: 12¹/₈"W x 16⁵/₃₂"L



Letter Front to Back

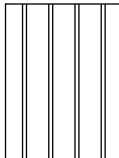

Letter or Legal Side to Side

Drawers with Dimensions: 12¹/₈"W x 16³/₁₆"L



Letter Front to Back

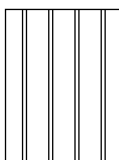

Legal Side to Side

Drawers with Dimensions: 14⁹/₃₂"W x 15¹/₈"L

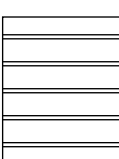

Letter Front to Back

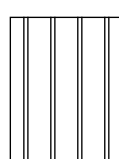

Legal Side to Side

Drawers with Dimensions: 26⁹/₃₂"W x 15¹/₁₆"L

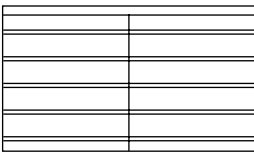

2 Rows Letter Front to Back

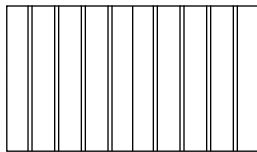

1 Row Legal Side to Side

Drawers with Dimensions: 32⁹/₃₂"W x 15¹/₁₆"L

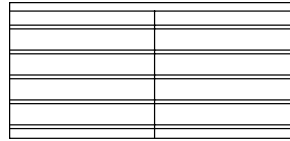

2 Rows Letter Front to Back

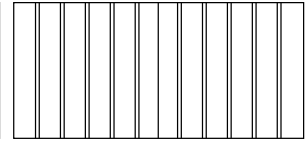

1 Row Legal Side to Side

HOW TO ORDER EXAMPLES

	QTY	MODEL NO.	DESCRIPTION	EXAMPLE
DESK SHELL	1	64-3066RSRL	Color	AS
			Overlay	HGA
			Overlay Color	WHA
			Back Lighting	YES
			Grommet	GL
			Grommet Color	BLK
			PDC Type	CHGSP
			PDC Location	C
			PDC Color	N/A
	RETURN SHELL	1	64-2583ERSWD1R41	Color
			Overlay	NO
			Grommet	GL
			Grommet Color	BLK
			PDC Type	HWDUO-BEZEL
			PDC Location	C
			PDC Color/Circuits	S3
			Door Style	DEB
			Grain Direction	N/A
			Door Lock	YES
		Lock Color	BLK	
PED	2	66-2418PD2	Color	AS
			Drawer Color	AS
			Grain Direction	VERTICAL
			Pull/Color	AAV
			Wire Management	WMLR

TFL (T) AND HPL (P) LAMINATE OPTIONS

WOODGRAIN

AS	Asian Night	PNW	Pinnacle Walnut
BW	Beigewood	PTK	Portico Teak
CO	Columbian Walnut	RC	River Cherry
EF	Espresso	SCH	Select Cherry
FLW	Florence Walnut	SPW	Sepia Walnut
GC	Golden Cherry	SKC	Shaker Cherry
HVM	Harvest Maple	SBP	Smoky Brown Pear
KHE	Kirsche	TK	Studio Teak
MW	Mahogany Walnut	SM	Sugar Maple
MNR	Midnight Run	WTA	Weathered Ash
NTM	Natural Marrone	WNB	White Nebbia
ORW	Oak Riftwood	WC	Williamsburg Cherry
SOLID			
BL	Black	FHG	Fashion Grey
WH	Designer White	SG	Slate Grey

SOLID SURFACE (S) TRANSACTION COUNTER OPTIONS

AR	Arroyo	SNW	Snow White
PE	Pebble Beach	SN	Starry Night
SE	Sedona	TN	Tundra

ACRYLIC OVERLAY OPTIONS

FST	Frosted	WHA	White
BLA	Black	WMA	Wired Mercury
GPA	Graphite		

EDGE PROFILES

CHASSIS/WORKSURFACES/TRANSACTION COUNTERS

H Square

SOLID SURFACE TRANSACTION COUNTERS

S1 Straight



Square



Straight

PULL OPTIONS

Note: Lock Core will match Pull Color

AAV	Alcove, Aluminum	AEL	Elite, Aluminum
CAV	Alcove, Chrome	BEL	Elite, Black
AAC	Arc, Aluminum	AFL	Flair, Aluminum
BAC	Arc, Black	CFL	Flair, Chrome
ABM	Beam, Aluminum	AFC	Focus, Aluminum
BBM	Beam, Black	BFC	Focus, Black
BBT	Bow Tie, Black	AQD	Quadra, Aluminum
NBT	Bow Tie, Nickel	BQD	Quadra, Black
ABU	Buckle, Aluminum	AST	Studio, Aluminum
BBU	Buckle, Black	BST	Studio, Black
		CST	Studio, Chrome



GROMMET OPTIONS & POWER UNIT LOCATIONS

Desk grommets are available in standard locations. Please specify using table below. Multiple unit locations may be selected. Only one unit per location.

Grommets are available on hutches in standard locations for task light management at no additional charge. Please specify HUGRMT.

Multiple locations may be selected. Only one unit per location.

GROMMET LOCATIONS (Black = BLK and Silver = SLV)

GC	Grommet, Center - Specify BLK or SLV	\$	52
GL	Grommet, Left - Specify BLK or SLV	\$	52
GR	Grommet, Right - Specify BLK or SLV	\$	52

DUO/TRIO BEZEL LOCATIONS

PDC-C	Bezel, Center
PDC-L	Bezel, Left
PDC-R	Bezel, Right

DOCK 950 and DOCK 150 LOCATIONS (See Dock Units)

DOCK950-L	D950 Wireless Charger, Left	\$	265
DOCK950-C	D950 Wireless Charger, Center	\$	265
DOCK950-R	D950 Wireless Charger, Right	\$	265
DOCK150-L	D150 Wireless and USB Charger, Left	\$	405
DOCK150-C	D150 Wireless and USB Charger, Center	\$	405
DOCK150-R	D150 Wireless and USB Charger, Right	\$	405

Verify Grommet Option is available on the model(s) you are specifying using the following location information. Grommets, Power Units, Dock 950 and Dock 150 may be ordered in non-standard locations. Call Customer Service to assist with specification and/or please attach a drawing to the PO showing the location of the grommet. Note additional charges and lead times may apply.

Power Units, Dock 950 and Dock 150 must be specified separately with surface mount location.

Models

64-3696RSRL	64-3672RSRL	64-3660ARSRR
64-3696RSRR	64-3672RSRR	64-3654ARSRL
64-3696RS	64-3672RS	64-3654ARSRR
64-3694B46	64-3672ARSRL	64-3648ARSRL
64-3690RSRL	64-3672ARSRR	64-3648ARSRR
64-3690RSRR	64-3666RSRL	64-3642ARSRL
64-3690RS	64-3666RSRR	64-3642ARSRR
64-3688B40	64-3666RS	64-3636ARSRL
64-3684RSRL	64-3666ARSRL	64-3636ARSRR
64-3684RSRR	64-3666ARSRR	64-3630ARSRL
64-3684RS	64-3660RSRL	64-3630ARSRR
64-3678RSRL	64-3660RSRR	
64-3678RSRR	64-3660RS	
64-3678RS	64-3660ARSRL	

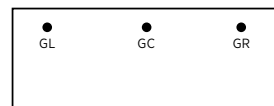

GL/GR/PDC-L/PDC-R/DOCK950-L/DOCK950-R/DOCK150-L/DOCK150-R: Located 6" from ends and 32" from user side

GC/PDC-C/DOCK950-C/DOCK150-C: Located 32" from user side

See additional units and locations on the next page.

GROMMET OPTIONS & POWER UNIT LOCATIONS (CONTINUED)

Models

64-3096RSRL	64-3084RSRL	64-3066RSRL
64-3096RSRR	64-3084RSRR	64-3066RSRR
64-3096RS	64-3084RS	64-3066RS
64-3094B46	64-3078RSRL	64-3060RSRL
64-3090RSRL	64-3078RSRR	64-3060RSRR
64-3090RSRR	64-3078RS	64-3060RSPDC
64-3090RS	64-3072RSRL	64-3060RS
64-3090RS	64-3072RSRR	
64-3088B40	64-3072RS	



GL/GR/PDC-L/PDC-R/CHGSP-L/
CHGSP-R: Located 6" from ends
and 26" from user side

GC/PDC-C/CHGSP-C: Located 26"
from user side

Models

64-2596RSRL	64-2584RSRR	64-2566RS
64-2596RSRR	64-2583ERSL58	64-2560RSRL
64-2596RS	64-2583ERSR58	64-2560RSRR
64-2595ERSWD2L46	64-2583ERSL53	64-2560RS
64-2595ERSWD2R46	64-2583ERSR53	64-2559ERSL34
64-2595ERSWD2L41	64-2583ERSL47	64-2559ERSR34
64-2595ERSWD2R41	64-2583ERSR47	64-2559ERSL29
64-2595ERSWD2L35	64-2578RSRL	64-2559ERSR29
64-2595ERSWD2R35	64-2578RSRR	64-2559ERSL23
64-2595ERSWD1L58	64-2578RS	64-2559ERSR23
64-2595ERSWD1R58	64-2572RSRL	64-3072ARSRL
64-2595ERSWD1L53	64-2572RSRR	64-3072ARSRR
64-2595ERSWD1R53	64-2572RS	64-3066ARSRL
64-2595ERSWD1L47	64-2571ERSWD1L34	64-3066ARSRR
64-2595ERSWD1R47	64-2571ERSWD1R34	64-3060ARSRL
64-2595ERSL70	64-2571ERSWD1L29	64-3060ARSRR
64-2595ERSR70	64-2571ERSWD1R29	64-3054ARSRL
64-2595ERSL65	64-2571ERSWD1L23	64-3054ARSRR
64-2595ERSR65	64-2571ERSWD1R23	64-3048ARSRL
64-2595ERSL59	64-2571ERSL46	64-3048ARSRR
64-2595ERSR59	64-2571ERSR46	64-3042ARSRL
64-2594B46	64-2571ERSL41	64-3042ARSRR
64-2590RSRL	64-2571ERSR41	64-3036ARSRL
64-2590RSRR	64-2571ERSL35	64-3036ARSRR
64-2590RS	64-2571ERSR35	64-3030ARSRL
64-2588B40	64-2566RSRL	64-3030ARSRR
64-2584RSRL	64-2566RSRR	



GL/GR/PDC-L/PDC-R/CHGSP-L/
CHGSP-R: Located 6" from ends
and 20" from user side

GC/PDC-C/CHGSP-C: Located 20"
from user side

LOCKING DOORS

Locking doors are available. You must specify WITH LOCKING when ordering and add upcharge.

LKT	42"W to 24"W Units	\$	91
LKT	18"W to 12"W Units	\$	69

CERTIFICATIONS & COMPLIANCE

- Intertek Sustainability Certified
- BIFMA Level® Certified
- BIFMA Compliant Certified
- TSCA Title VI (formerly CARB) Compliance
- US Green Building's LEED Contribution

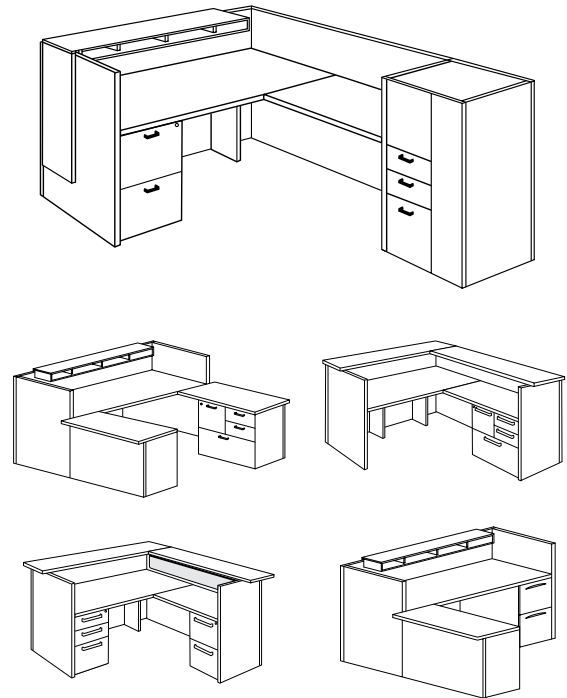

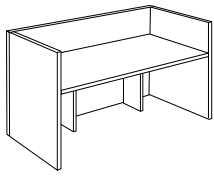

Reception Desk Shell with Gallery Screen
[\(See Details\)](#)

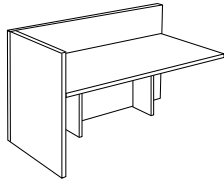

Single Reception Desk Shell with Gallery Screen
[\(See Details\)](#)

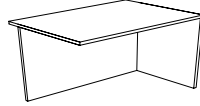

ADA Reception Return Shell
[\(See Details\)](#)

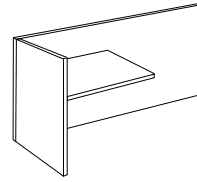

Return Shell with Extended Gallery Screen
[\(See Details\)](#)

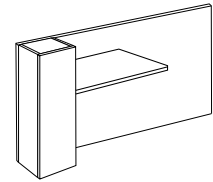

Narrow Tower Storage Return with Extended Gallery Screen
[\(See Details\)](#)

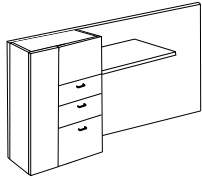

Tower Storage Return with Gallery Screen
[\(See Details\)](#)

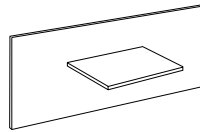

Reception Bridge with Gallery Screen
[\(See Details\)](#)

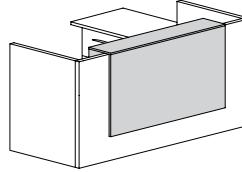

Waterfall Transaction Kits with Paper Slots
[\(See Details\)](#)

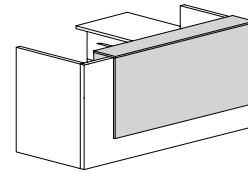

Corner Waterfall Transaction Kits with Paper Slots
[\(See Details\)](#)

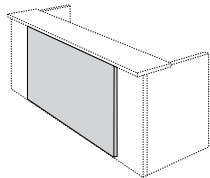

Overlay Panels
TFL [\(See Details\)](#)
High Gloss Acrylic [\(See Details\)](#)
Frosted Acrylic [\(See Details\)](#)

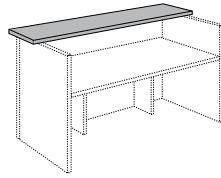

Transaction Top
[\(See Multiple Unit Details\)](#)

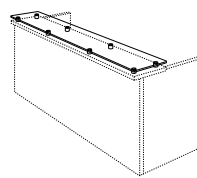

Optional Glass Transaction Top
[\(See Multiple Unit Details\)](#)

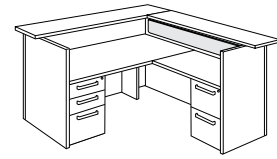

Tackboards for use under Transaction Counters
[\(See Details\)](#)

Modular Component Pedestals



Box/Box/File Pedestal
[\(See Details\)](#)



File/File Pedestal
[\(See Details\)](#)

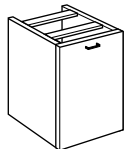

Door Bookcase Pedestal
[\(See Details\)](#)

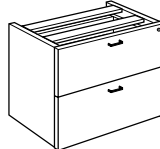

Lateral File Pedestal
[\(See Details\)](#)

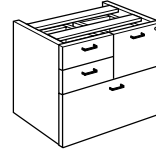

Multi-File Pedestal
[\(See Details\)](#)

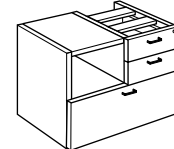

Open Multi-File Pedestal
[\(See Details\)](#)

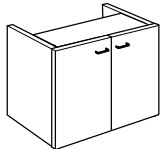

Pedestal with Doors
[\(See Details\)](#)

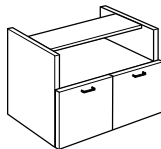

Pedestal with Doors and Open Compartment
[\(See Details\)](#)

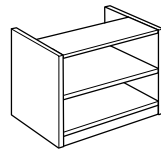

Pedestal Open Storage
[\(See Details\)](#)

Accessories + Power Options

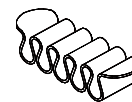
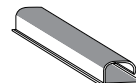
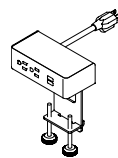
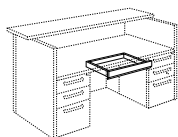

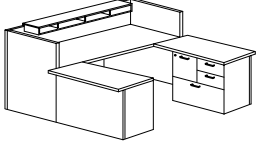
Item	Model No.	Width	Depth	Height	Ship Wt	Cubic Ft	List Price
	64-1	106	97	42	813	199.2	T\$ 9291 P\$ 10091
	CONSIST OF:		QTY				
	64-3096RS	1	Reception Desk Shell with Gallery Screen		T\$ 2262 P\$ 2580		
	64-1284TKS	1	Waterfall Transaction Kit with Paper Slots		T\$ 1952		
	64-3060ARSRL	1	ADA Reception Return Shell - Left		T\$ 1025 P\$ 1266		
	66-2430LF1	1	Modular Pedestal with Lateral File		T\$ 1384		
	64-3060ARSRR	1	ADA Reception Return Shell - Right		T\$ 1025 P\$ 1266		
	66-2430LF2	1	Modular Pedestal with Multi-File		T\$ 1643		

Products are available as left or right, where applicable

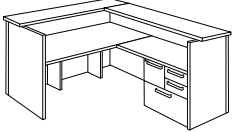
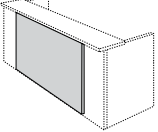
  Optional Overlay	64-2	102	87	42	596	154.6	T\$ 6500 P\$ 7424	
								<i>Add Optional Glass Top to TFL or HPL Pricing +Glass \$ 3401</i>
	CONSIST OF:		QTY					
	64-3090RSRL	1	Single Reception Desk Shell with Gallery Screen		T\$ 1961 P\$ 2273			
	64-2583ERSR53	1	Return Shell with Extended Gallery Screen		T\$ 1228 P\$ 1426			
	66-2430LF2	1	Modular Pedestal with Multi-File		T\$ 1643			
	64-1296TP	1	Transaction Top - 99" Wide		T\$ 545 P\$ 763			
								<i>Add Optional Glass Top to TFL or HPL Pricing +Glass \$ 1905</i>
	64-1275TP	1	Transaction Top - 75" Wide		T\$ 491 P\$ 687			
								<i>Add Optional Glass Top to TFL or HPL Pricing +Glass \$ 1496</i>
64-OT90	1	Overlay Panel - For Use With 90" Desks		\$ 632				
							<i>Optional Back Lighting Not Included</i>	

Products are available as left or right, where applicable

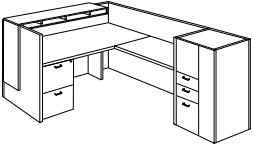
	64-3	96¾	96¾	42	664	161.9	T\$ 8261 P\$ 8748
	CONSIST OF:		QTY				
	64-3096RSRL	1	Single Reception Desk Shell with Gallery Screen		T\$ 2013 P\$ 2332		
	64-1284CTKSL	1	Corner Waterfall Transaction Kit with Paper Slots		T\$ 2073		
	64-2595ERSWD2R41	1	Tower Storage Return with Gallery Screen		T\$ 2928 P\$ 3096		
	66-2418PD2	1	Modular Pedestal with File/File		T\$ 1247		

Products are available as left or right, where applicable

Pricing Codes:

T= TFL
P= HPL

[See Canvas Reception Overview for Ordering Options](#)

CANVAS™

LAMINATE RECEPTION + COMPONENTS (6400 SERIES)

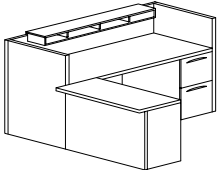
Item	Model No.	Width	Depth	Height	Ship Wt	Cubic Ft	List Price
	64-4	89	96	42	604	139.6	T\$ 7679 P\$ 8207

CONSIST OF:**QTY**

64-3084RS	1	Single Reception Desk Shell with Gallery Screen	T\$ 2151 P\$ 2438
64-3060ARSRL	1	ADA Reception Return Shell - Left	T\$ 1025 P\$ 1266
64-1272TKS	1	Waterfall Transaction Kit with Paper Slots	T\$ 1613
66-2430LF2	1	Modular Pedestal with Multi-File	T\$ 1643
66-2418PD2	1	Modular Pedestal with File/File	T\$ 1247

Products are available as left or right, where applicable

	64-5	78	87	42	559	135.9	T\$ 6501 P\$ 7362
							<i>Add Optional Glass Top to TFL or HPL Pricing</i> Glass \$ 2992

CONSIST OF:**QTY**

64-3072RSRL	1	Single Reception Desk Shell with Gallery Screen	T\$ 1480 P\$ 1751
64-2583ERSR53	1	Return Shell with Extended Gallery Screen	T\$ 1228 P\$ 1426
64-1275TP	2	Transaction Top - 75" Wide	T\$ 982 P\$ 1374
		<i>Add Optional Glass Top to TFL or HPL Pricing</i>	+Glass \$ 2992
66-2418PD1	1	Modular Pedestal with Box/Box/File	T\$ 1247
66-2418PD2	1	Modular Pedestal with File/File	T\$ 1247
TB-6284	1	Tackboard (Optional)	G1\$ 317

Products are available as left or right, where applicable

Pricing Codes:

T= TFL
P= HPL

[See Canvas Reception Overview for Ordering Options](#)

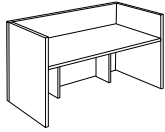
Item	Model No.		Width	Depth	Height	Ship Wt	Cubic Ft	List Price
RECEPTION DESK SHELL WITH GALLERY SCREEN	64-3696RS	94" Worksurface	96	36	41	272	90.3	T\$ 2464 P\$ 2802
	64-3690RS	88" Worksurface	90	36	41	261	84.8	T\$ 2394 P\$ 2726
	64-3684RS	82" Worksurface	84	36	41	249	79.3	T\$ 2338 P\$ 2642
	64-3678RS	76" Worksurface	78	36	41	237	73.8	T\$ 2269 P\$ 2564
Must Specify (in this order): Model # Top Material Top Color Chassis Color Overlay Overlay Color Back Lighting Grommet Location Grommet Color PDC Type PDC Location PDC Color	64-3672RS	70" Worksurface	72	36	41	226	68.3	T\$ 1933 P\$ 2223
	64-3666RS	64" Worksurface	66	36	41	214	62.8	T\$ 1861 P\$ 2137
	64-3660RS	58" Worksurface	60	36	41	203	57.3	T\$ 1792 P\$ 2056
	64-3096RS	94" Worksurface	96	30	41	245	80.3	T\$ 2262 P\$ 2580
	64-3090RS	88" Worksurface	90	30	41	234	75.8	T\$ 2205 P\$ 2517
	64-3084RS	82" Worksurface	84	30	41	223	71.3	T\$ 2151 P\$ 2438
	64-3078RS	76" Worksurface	78	30	41	213	66.7	T\$ 2076 P\$ 2355
	64-3072RS	70" Worksurface	72	30	41	202	62.1	T\$ 1727 P\$ 1996
	64-3066RS	64" Worksurface	66	30	41	192	57.5	T\$ 1663 P\$ 1921
	64-3060RS	58" Worksurface	60	30	41	181	48.2	T\$ 1596 P\$ 1836
	64-2596RS	94" Worksurface	96	25	41	245	80.3	T\$ 1685 P\$ 1965
	64-2590RS	88" Worksurface	90	25	41	234	75.8	T\$ 1625 P\$ 1899
	64-2584RS	82" Worksurface	84	25	41	198	58.4	T\$ 1567 P\$ 1820
	64-2578RS	76" Worksurface	78	25	41	188	53.8	T\$ 1502 P\$ 1745
	64-2572RS	70" Worksurface	72	25	41	177	49.2	T\$ 1439 P\$ 1675
	64-2566RS	64" Worksurface	66	25	41	167	44.6	T\$ 1383 P\$ 1606
	64-2560RS	58" Worksurface	60	25	41	156	40.0	T\$ 1280 P\$ 1501

Kneespace 58"; No Additional Support Needed

Description

- Horizontal Woodgrain on Chassis; Side-to-Side Woodgrain on Top
- Available with TFL (T) or HPL (P) Top; Must Specify
- Top and Chassis Available in Contrasting Colors; Must Specify Color of Each Component
- Stiffener Bar Recommended in Kneespaces 60" or Greater When Unsupported by Pedestal, [See Stiffener Bar](#)
- Optional Overlay Panel for Approach Side of Gallery Screen, [See Overlay Options](#)
- Additional Options: Waterfall Transaction Kit ([See Kit Options](#)), TFL, HPL, or Solid Surface Transaction Tops ([See Multiple Unit Details](#)), Power Options (Sold Separately, [See Accessories](#))

Pricing Codes:

T= TFL
P= HPL

[See Canvas Reception Overview for Ordering Options](#)

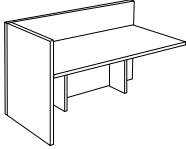
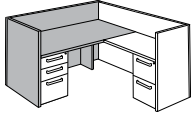
Item	Model No.	Width	Depth	Height	Ship Wt	Cubic Ft	List Price	
SINGLE RECEPTION DESK SHELL WITH GALLERY SCREEN	Left	Right						
	64-3696RSRL 94" Worksurface	64-3696RSRR	96	36	41	326	91.6	T\$ 2171 P\$ 2509
	64-3690RSRL 88" Worksurface	64-3690RSRR	90	36	41	315	86.0	T\$ 2120 P\$ 2452
	64-3684RSRL 82" Worksurface	64-3684RSRR	84	36	41	303	80.4	T\$ 2067 P\$ 2372
	64-3678RSRL 76" Worksurface	64-3678RSRR	78	36	41	291	74.7	T\$ 1997 P\$ 2292
	64-3672RSRL 70" Worksurface	64-3672RSRR	72	36	41	201	69.2	T\$ 1665 P\$ 1955
Desk Shell Shaded (Shown as Left)	64-3666RSRL 64" Worksurface	64-3666RSRR	66	36	41	190	63.5	T\$ 1590 P\$ 1865
	64-3660RSRL 58" Worksurface	64-3660RSRR	60	36	41	179	57.9	T\$ 1524 P\$ 1789
Must Specify (in this order):	64-3096RSRL 94" Worksurface	64-3096RSRR	96	30	41	206	73.2	T\$ 2013 P\$ 2332
Model #	64-3090RSRL 88" Worksurface	64-3090RSRR	90	30	41	196	69.3	T\$ 1961 P\$ 2273
Top Material	64-3084RSRL 82" Worksurface	64-3084RSRR	84	30	41	186	65.4	T\$ 1902 P\$ 2189
Top Color	64-3078RSRL 76" Worksurface	64-3078RSRR	78	30	41	176	61.5	T\$ 1830 P\$ 2109
Chassis Color	64-3072RSRL 70" Worksurface	64-3072RSRR	72	30	41	165	57.6	T\$ 1480 P\$ 1751
Overlay	64-3066RSRL 64" Worksurface	64-3066RSRR	66	30	41	155	53.0	T\$ 1419 P\$ 1676
Overlay Color	64-3060RSRL 58" Worksurface	64-3060RSRR	60	30	41	144	48.2	T\$ 1353 P\$ 1594
Back Lighting	64-2596RSRL 94" Worksurface	64-2596RSRR	96	25	41	184	64.1	T\$ 1461 P\$ 1741
Grommet Location	64-2590RSRL 88" Worksurface	64-2590RSRR	90	25	41	174	60.2	T\$ 1400 P\$ 1674
Grommet Color	64-2584RSRL 82" Worksurface	64-2584RSRR	84	25	41	163	56.3	T\$ 1338 P\$ 1591
PDC Type	64-2578RSRL 76" Worksurface	64-2578RSRR	78	25	41	153	52.4	T\$ 1277 P\$ 1521
PDC Location	64-2572RSRL 70" Worksurface	64-2572RSRR	72	25	41	143	48.5	T\$ 1216 P\$ 1452
PDC Color	64-2566RSRL 64" Worksurface	64-2566RSRR	66	25	41	133	44.6	T\$ 1162 P\$ 1386
	64-2560RSRL 58" Worksurface	64-2560RSRR	60	25	41	123	40.7	T\$ 1062 P\$ 1281

Kneespace 58"; No Additional Support Needed

Description

- Horizontal Woodgrain on Chassis; Side-to-Side Woodgrain on Top
- Available with TFL (T) or HPL (P) Top; Must Specify
- Top and Chassis Available in Contrasting Colors; Must Specify Color of Each Component
- Stiffener Bar Recommended in Kneespaces 60" or Greater When Surface is Not Supported By Pedestal, [See Stiffener Bar](#)
- Not for Freestanding, Must Attach to Return or Bridge Components
- Optional Overlay Panel for Approach Side of Gallery Screen, [See Overlay Options](#)
- Additional Options: Waterfall Transaction Kit ([See Kit Options](#)), TFL, HPL, or Solid Surface Transaction Tops ([See Multiple Unit Details](#)), Power Options (Sold Separately, [See Accessories](#))

Pricing Codes:

T= TFL
P= HPL

[See Canvas Reception Overview for Ordering Options](#)

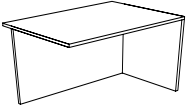
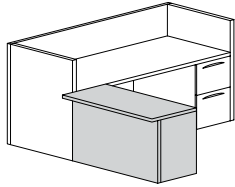
Item	Model No.	Width	Depth	Height	Ship Wt	Cubic Ft	List Price
ADA RECEPTION RETURN SHELL	Left	Right					
	64-3672ARSRL	64-3672ARSRR	72	36	30	144	T\$ 1228 P\$ 1518
	64-3666ARSRL	64-3666ARSRR	66	36	30	134	T\$ 1176 P\$ 1452
Shown as Right	64-3660ARSRL	64-3660ARSRR	60	36	30	123	T\$ 1124 P\$ 1389
	64-3654ARSRL	64-3654ARSRR	54	36	30	113	T\$ 1056 P\$ 1300
	64-3648ARSRL	64-3648ARSRR	48	36	30	102	T\$ 999 P\$ 1222
Return Shell Shaded (Shown as Left)	64-3642ARSRL	64-3642ARSRR	42	36	30	92	T\$ 935 P\$ 1140
Must Specify (in this order): Model # Top Material Top Color Chassis Color Grommet Location Grommet Color PDC Type PDC Location PDC Color	64-3636ARSRL	64-3636ARSRR	36	36	30	81	T\$ 876 P\$ 1063
	64-3630ARSRL	64-3630ARSRR	30	36	30	71	T\$ 817 P\$ 986
	64-3072ARSRL	64-3072ARSRR	72	30	30	125	T\$ 1181 P\$ 1452
	64-3066ARSRL	64-3066ARSRR	66	30	30	116	T\$ 1086 P\$ 1343
	64-3060ARSRL	64-3060ARSRR	60	30	30	107	T\$ 1025 P\$ 1266
	64-3054ARSRL	64-3054ARSRR	54	30	30	98	T\$ 969 P\$ 1195
	64-3048ARSRL	64-3048ARSRR	48	30	30	89	T\$ 913 P\$ 1123
	64-3042ARSRL	64-3042ARSRR	42	30	30	80	T\$ 857 P\$ 1048
	64-3036ARSRL	64-3036ARSRR	36	30	30	71	T\$ 797 P\$ 966
	64-3030ARSRL	64-3030ARSRR	30	30	30	62	T\$ 755 P\$ 918

Description

- Horizontal Woodgrain on Chassis; Side-to-Side Woodgrain on Top
- Available with TFL (T) or HPL (P) Top; Must Specify
- Top and Chassis Available in Contrasting Colors; Must Specify Color of Each Component
- Stiffener Bar Recommended in Kneespaces 60" or Greater When Unsupported By Pedestal, [See Stiffener Bar](#)
- 5" Overhang on Approach Side
- Must Attach to Reception Desk Shell or Panel End of Single Reception Desk Shell

Pricing Codes:

T= TFL
P= HPL

[See Canvas Reception Overview for Ordering Options](#)

Item	Model No.	Width	Depth	Height	Ship Wt	Cubic Ft	List Price
RETURN SHELL WITH EXTENDED GALLERY SCREEN	Left	Right					
	64-2595ERSL70	64-2595ERSR70	95	25	41	176	T\$ 1332 P\$ 1568
	70" Worksurface; To Connect to 25" Deep Single Desk Shell						
	64-2595ERSL65	64-2595ERSR65	95	25	41	174	T\$ 1316 P\$ 1539
	65" Worksurface; To Connect to 30" Deep Single Desk Shell						
	64-2595ERSL59	64-2595ERSR59	95	25	41	172	T\$ 1301 P\$ 1521
	59" Worksurface; To Connect to 36" Deep Single Desk Shell						
	64-2583ERSL58	64-2583ERSR58	83	25	41	154	T\$ 1245 P\$ 1465
	58" Worksurface; To Connect to 25" Deep Single Desk Shell						
	64-2583ERSL53	64-2583ERSR53	83	25	41	151	T\$ 1228 P\$ 1426
	53" Worksurface; To Connect to 30" Deep Single Desk Shell						
	64-2583ERSL47	64-2583ERSR47	83	25	41	148	T\$ 1209 P\$ 1395
	47" Worksurface; To Connect to 36" Deep Single Desk Shell						
	64-2571ERSL46	64-2571ERSR46	71	25	41	131	T\$ 1154 P\$ 1340
	46" Worksurface; To Connect to 25" Deep Single Desk Shell						
	64-2571ERSL41	64-2571ERSR41	71	25	41	129	T\$ 1138 P\$ 1306
	41" Worksurface; To Connect to 30" Deep Single Desk Shell						
	64-2571ERSL35	64-2571ERSR35	71	25	41	127	T\$ 1117 P\$ 1265
	35" Worksurface; To Connect to 36" Deep Single Desk Shell						
	64-2559ERSL34	64-2559ERSR34	59	25	41	112	T\$ 1019 P\$ 1167
	34" Worksurface; To Connect to 25" Deep Single Desk Shell						
	64-2559ERSL29	64-2559ERSR29	59	25	41	109	T\$ 1003 P\$ 1146
	29" Worksurface; To Connect to 30" Deep Single Desk Shell						
	64-2559ERSL23	64-2559ERSR23	59	25	41	107	T\$ 985 P\$ 1122
	23" Worksurface; To Connect to 36" Deep Single Desk Shell						

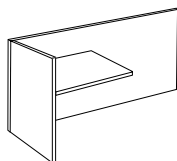

Shown as Left

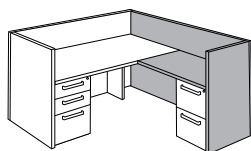
Return Shell Shaded
(Shown as Right)**Must Specify (in this order):**

- Model #
- Top Material
- Top Color
- Chassis Color
- Overlay
- Overlay Color
- Overlay Back Lighting
- Grommet Location
- Grommet Color
- PDC Type
- PDC Location
- PDC Color

Description

- Horizontal Woodgrain on Chassis; Front to Back Woodgrain on Top
- Top and Chassis Available in Contrasting Colors; Must Specify Color of Each Component
- Available with TFL (T) or HPL (P) Top; Must Specify
- 24" Deep Worksurfaces
- Side-to-Side Woodgrain on Top over 60"
- Stiffener Bar Recommended in Kneespaces 60" or Greater When Unsupported By Pedestal, [See Stiffener Bar](#)
- Optional Overlay Panel for Approach Side of Gallery Screen, [See Overlay Options](#)
- Additional Options: Waterfall Transaction Kit ([See Kit Options](#)), TFL, HPL, or Solid Surface Transaction Tops ([See Multiple Unit Details](#)), Power Options (Sold Separately, [See Accessories](#))

Pricing Codes:

- T= TFL
- P= HPL

[See Canvas Reception Overview for Ordering Options](#)

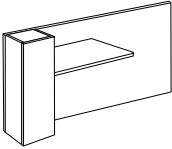
Item	Model No.	Width	Depth	Height	Ship Wt	Cubic Ft	List Price	
NARROW TOWER STORAGE RETURN WITH EXTENDED GALLERY SCREEN  Shown as Left Must Specify (in this order): Model # Top Material Top Color Chassis Color Overlay Overlay Color Overlay Back Lighting Grommet Location Grommet Color PDC Type PDC Location PDC Color Door Style/Color Door Grain Direction Locking Door Lock Core Color	Left	Right						
	64-2595ERSWD1L58	64-2595ERSWD1R58	95	25	41	208	T\$ 1942 P\$ 2162	
	58" Worksurface; To Connect to 25" Deep Single Desk Shell							
	64-2595ERSWD1L53	64-2595ERSWD1R53	95	25	41	204	T\$ 1926 P\$ 2124	
	53" Worksurface; To Connect to 30" Deep Single Desk Shell							
	64-2595ERSWD1L47	64-2595ERSWD1R47	95	25	41	201	T\$ 1906 P\$ 2092	
	47" Worksurface; To Connect to 36" Deep Single Desk Shell							
	64-2583ERSWD1L46	64-2583ERSWD1R46	83	25	41	188	T\$ 1850 P\$ 2035	
	46" Worksurface; To Connect to 25" Deep Single Desk Shell							
	64-2583ERSWD1L41	64-2583ERSWD1R41	83	25	41	184	T\$ 1832 P\$ 2000	
	41" Worksurface; To Connect to 30" Deep Single Desk Shell							
	64-2583ERSWD1L35	64-2583ERSWD1R35	83	25	41	181	T\$ 1814 P\$ 1962	
35" Worksurface; To Connect to 36" Deep Single Desk Shell								
64-2571ERSWD1L34	64-2571ERSWD1R34	71	25	41	167	T\$ 1757 P\$ 1904		
34" Worksurface; To Connect to 25" Deep Single Desk Shell								
64-2571ERSWD1L29	64-2571ERSWD1R29	71	25	41	164	T\$ 1739 P\$ 1883		
29" Worksurface; To Connect to 30" Deep Single Desk Shell								
64-2571ERSWD1L23	64-2571ERSWD1R23	71	25	41	161	T\$ 1720 P\$ 1858		
23" Worksurface; To Connect to 36" Deep Single Desk Shell								

Description

- Standard with Horizontal Woodgrain on Chassis; Front to Back Woodgrain on Worksurface Top; Vertical Woodgrain on Door Fronts
- Worksurface Top and Chassis Available in Contrasting Colors; Must Specify Color of Each Component
- Available with TFL (T) or HPL (P) Worksurface Top; Must Specify
- Worksurface Top Flush with Storage Cabinet Door Front
- 12" Wide Tower Features Touch Latch Door, Coat Rod, and Two (2) Adjustable Shelves Behind Door
- For Use with Single Reception Desk Shell
- Door Options: Dry Erase (See below), High Gloss Acrylic (See Below), Panel Door with Horizontal Grain Direction on Door Front ([See Color Options](#)); Must Specify
- Optional Locking Door ([See Options](#)); Must Specify and Add
- Optional Overlay Panel for Approach Side of Gallery Screen, [See Overlay Options](#)
- Additional Options: Waterfall Transaction Kit ([See Kit Options](#)), TFL, HPL, or Solid Surface Transaction Tops ([See Multiple Unit Details](#)), Power Options (Sold Separately, [See Accessories](#))

Door Options: Specify & Add

1-DEB	Dry Erase Board	\$ 122
1-HGA	High Gloss Acrylic; Must Specify Color	
	GPA Graphite Acrylic	\$ 462
	BLA Black, Wired Mercury or White Acrylic	\$ 418

Pricing Codes:

T= TFL
P= HPL

[See Canvas Reception Overview for Ordering Options](#)

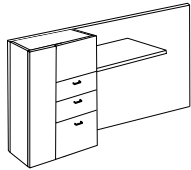
Item	Model No.	Width	Depth	Height	Ship Wt	Cubic Ft	List Price	
TOWER STORAGE RETURN WITH GALLERY SCREEN  Shown as Left <u>Must Specify (in this order):</u> Model # Top Material Top Color Chassis Color Overlay Overlay Color Overlay Back Lighting Drawer Pull Door/Drawer Color Door/Drawer Grain Direction Locking Door Lock Core Color Grommet Location Grommet Color PDC Type PDC Location PDC Color	Left	Right						
	64-2595ERSWD2L46	64-2595ERSWD2R46	95	25	41	258	63.7	T\$ 2944 P\$ 3130
	46" Worksurface; To Connect to 25" Deep Single Desk Shell							
	64-2595ERSWD2L41	64-2595ERSWD2R41	95	25	41	254	63.7	T\$ 2928 P\$ 3096
	41" Worksurface; To Connect to 30" Deep Single Desk Shell							
	64-2595ERSWD2L35	64-2595ERSWD2R35	95	25	41	251	63.7	T\$ 2907 P\$ 3056
	35" Worksurface; To Connect to 36" Deep Single Desk Shell							
	64-2583ERSWD2L34	64-2583ERSWD2R34	83	25	41	238	55.8	T\$ 2854 P\$ 3001
34" Worksurface; To Connect to 25" Deep Single Desk Shell								
64-2583ERSWD2L29	64-2583ERSWD2R29	83	25	41	234	55.8	T\$ 2837 P\$ 2980	
29" Worksurface; To Connect to 30" Deep Single Desk Shell								
64-2583ERSWD2L23	64-2583ERSWD2R23	83	25	41	230	55.8	T\$ 2819 P\$ 2957	
23" Worksurface; To Connect to 36" Deep Single Desk Shell								

Description

- Standard with Horizontal Woodgrain on Chassis; Front to Back Woodgrain on Worksurface Top; Vertical Woodgrain on Door Fronts
- Worksurface Top and Chassis Available in Contrasting Colors; Must Specify Color of Each Component
- Must Select Drawer Pull Options, [See Pull Options](#)
- Worksurface Top Flush with Storage Cabinet Door Front
- Tower Features Touch Latch Door and 6 $\frac{7}{8}$ " Coat Rod
- Box/Box/File Locking Pedestal Provides Legal or Letter Filing
- For Use With Single Reception Desk Shell
- Optional Horizontal Grain Direction on Door and Drawer Fronts; Must Specify
- Optional Locking Doors ([See Options](#)); Must Specify and Add
- Optional Overlay Panel for Approach Side of Gallery Screen, [See Overlay Options](#)
- Additional Options: Waterfall Transaction Kit ([See Kit Options](#)), TFL, HPL, or Solid Surface Transaction Tops ([See Multiple Unit Details](#)), Power Options (Sold Separately, [See Accessories](#))

Pricing Codes:

T= TFL
P= HPL

[See Canvas Reception Overview for Ordering Options](#)

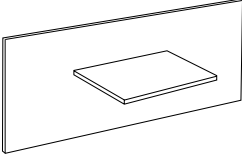
Item	Model No.		Width	Depth	Height	Ship Wt	Cubic Ft	List Price
RECEPTION BRIDGE WITH GALLERY SCREEN 	64-3694B46	46" Worksurface	96	36	41	139	11.7	T\$ 1109 P\$ 1332
	64-3688B40	40" Worksurface	90	36	41	127	10.9	T\$ 1062 P\$ 1267
	64-3094B46	46" Worksurface	96	30	41	132	11.7	T\$ 1081 P\$ 1291
	64-3088B40	40" Worksurface	90	30	41	121	10.9	T\$ 1036 P\$ 1228
	64-2594B46	46" Worksurface	96	25	41	126	11.7	T\$ 1055 P\$ 1241
	64-2588B40	40" Worksurface	90	25	41	116	10.9	T\$ 1015 P\$ 1183

Must Specify (in this order):

Model #
 Top Material
 Top Color
 Chassis Color
 Overlay
 Overlay Color
 Overlay Back Lighting
 Grommet Location
 Grommet Color
 PDC Type
 PDC Location
 PDC Color

Description

- For Use With Two 25" Deep Single Reception Desk Shells; Must Attach to Open End of Shells
- Cannot Be Used with 30" or 36" Reception Desk Shells
- Available with TFL (T) or HPL (P) Worksurface Top; Must Specify
- Worksurface Top and Chassis Available in Contrasting Colors; Must Specify Color of Each Component
- Optional Overlay Panel for Approach Side of Gallery Screen, [See Overlay Options](#)
- Some Assembly Required
- Additional Options: Waterfall Transaction Kit ([See Kit Options](#)), TFL, HPL, or Solid Surface Transaction Tops ([See Multiple Unit Details](#)), Power Options (Sold Separately, [See Accessories](#))

Pricing Codes:

T= TFL
P= HPL

[See Canvas Reception Overview for Ordering Options](#)

Item	Model No.	Width	Depth	Height	Ship Wt	Cubic Ft	List Price
MODULAR PEDESTAL WITH BOX/BOX/FILE	66-2418PD1	18	23¼	28¼	93	7.8	T\$ 1247
	66-2415PD1	15¾	23¼	28¼	98	8.9	T\$ 1181

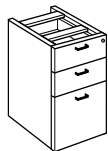

Must Specify (in this order):

- Model #
- Chassis Color
- Drawer Front Color
- Drawer Front Grain Direction
- Pull
- Wire Management

Description

- Box/Box/File Locking Modular Pedestal; Letter Width
- For Use With Desk and Return Shells
- Open Back
- Grain Runs Vertical on Drawer Fronts. Optional Horizontal Grain Direction on Drawer Fronts; Must Specify

Options: Specify & Add

WML	Wire Management - Left Panel	\$ 80
WMR	Wire Management - Right Panel	\$ 80
WMLR	Wire Management - Left and Right Panel	\$ 160

MODULAR PEDESTAL WITH FILE/FILE	66-2418PD2	18	23¼	28¼	93	7.8	T\$ 1247
	66-2415PD2	15¾	23¼	28¼	98	8.9	T\$ 1181

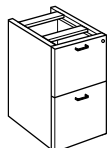

Must Specify (in this order):

- Model #
- Chassis Color
- Drawer Front Color
- Drawer Front Grain Direction
- Pull
- Wire Management

Description

- File/File Locking Modular Pedestal; Letter Width
- For Use With Desk and Return Shells
- Open Back
- Grain Runs Vertical on Drawer Fronts. Optional Horizontal Grain Direction on Drawer Fronts; Must Specify

Options: Specify & Add

WML	Wire Management - Left Panel	\$ 80
WMR	Wire Management - Right Panel	\$ 80
WMLR	Wire Management - Left and Right Panel	\$ 160

MODULAR PEDESTAL WITH DOOR BOOKCASE	Left	Right	Width	Depth	Height	Ship Wt	Cubic Ft	List Price
	66-2418PD4L	66-2418PD4R						

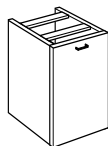

Must Specify (in this order):

- Model #
- Chassis Color
- Drawer Front Color
- Drawer Front Grain Direction
- Pull
- Wire Management

Description

- Adjustable Shelf Inside Cabinet
- For Use With Desk and Return Shells
- Open Back
- Grain Runs Vertical on Door Front. Optional Horizontal Grain Direction on Door Fronts; Must Specify
- Optional Locking Doors ([See Options](#)); [Must Specify](#) and Add

Options: Specify & Add

WML	Wire Management - Left Panel	\$ 80
WMR	Wire Management - Right Panel	\$ 80
WMLR	Wire Management - Left and Right Panel	\$ 160

Pricing Codes:

- T= TFL
- P= HPL

[See Canvas Reception Overview for Ordering Options](#)

Item	Model No.	Width	Depth	Height	Ship Wt	Cubic Ft	List Price
MODULAR PEDESTAL WITH LATERAL FILE	66-2436LF1	36	23¼	28¼	154	18.5	T\$ 1489
	66-2430LF1	30	23¼	28¼	128	14.9	T\$ 1384

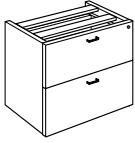

Must Specify (in this order):
 Model #
 Chassis Color
 Drawer Front Color
 Drawer Front Grain Direction
 Pull
 Wire Management

Description

- Lateral/Lateral Locking Modular Pedestal
- For Use With Desk and Return Shells
- Open Back
- Legal or Letter Filing Front to Back or Side to Side
- Grain Runs Vertical on Drawer Fronts. Optional Horizontal Grain Direction on Drawer Fronts; Must Specify

Options: Specify & Add

WML	Wire Management - Left Panel	\$ 80
WMR	Wire Management - Right Panel	\$ 80
WMLR	Wire Management - Left and Right Panel	\$ 160

MODULAR PEDESTAL WITH MULTI-FILE	66-2436LF2	36	23¼	28¼	153	18.5	T\$ 1710
	66-2430LF2	30	23¼	28¼	128	14.9	T\$ 1643

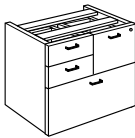

Must Specify (in this order):
 Model #
 Chassis Color
 Drawer Front Color
 Drawer Front Grain Direction
 Pull
 Wire Management

Description

- Box/Box/File/Lateral Locking Modular Pedestal
- For Use With Desk and Return Shells
- Open Back
- Lateral File Drawer Provides Legal or Letter Filing Front to Back or Side to Side
- Grain Runs Vertical on Drawer Fronts. Optional Horizontal Grain Direction on Drawer Fronts; Must Specify

Options: Specify & Add

WML	Wire Management - Left Panel	\$ 80
WMR	Wire Management - Right Panel	\$ 80
WMLR	Wire Management - Left and Right Panel	\$ 160

MODULAR PEDESTAL WITH OPEN MULTI-FILE	66-2436OMF	36	23¼	28¼	128	18.5	T\$ 1641
	66-2430OMF	30	23¼	28¼	118	14.9	T\$ 1575

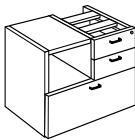

Must Specify (in this order):
 Model #
 Chassis Color
 Drawer Front Color
 Drawer Front Grain Direction
 Pull
 Wire Management

Description

- Box/Box/Lateral Locking Modular Pedestal
- Upper Section Provides 12¾" Clearance for Open Storage
- For Use With Desk and Return Shells
- Open Back
- Lateral File Drawer Provides Legal or Letter Filing Front to Back or Side to Side
- Grain Runs Vertical on Drawer Fronts. Optional Horizontal Grain Direction on Drawer Fronts; Must Specify

Options: Specify & Add

WML	Wire Management - Left Panel	\$ 80
WMR	Wire Management - Right Panel	\$ 80
WMLR	Wire Management - Left and Right Panel	\$ 160

Pricing Codes:

T= TFL
 P= HPL

[See Canvas Reception Overview for Ordering Options](#)

Item	Model No.	Width	Depth	Height	Ship Wt	Cubic Ft	List Price
MODULAR PEDESTAL WITH DOORS	66-2436DB	36	23¼	28¼	105	18.5	T\$ 1412
	66-2430DB	30	23¼	28¼	87	14.9	T\$ 1116

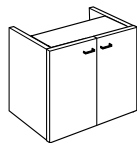

Must Specify (in this order):

- Model #
- Chassis Color
- Drawer Front Color
- Drawer Front Grain Direction
- Pull
- Wire Management

Description

- 12" Deep Adjustable Shelf Behind Doors
- For Use With Desk and Return Shells
- Open Back
- Grain Runs Vertical on Door Fronts. Optional Horizontal Grain Direction on Door Fronts; Must Specify
- Optional Locking Doors ([See Options](#)); Must Specify and Add

Options: Specify & Add

WML	Wire Management - Left Panel	\$ 80
WMR	Wire Management - Right Panel	\$ 80
WMLR	Wire Management - Left and Right Panel	\$ 160

MODULAR PEDESTAL WITH DOORS AND OPEN COMPARTMENT	66-2436ODB	36	23¼	28¼	118	18.5	T\$ 1334
	66-2430ODB	30	23¼	28¼	108	14.9	T\$ 1032

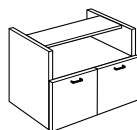

Must Specify (in this order):

- Model #
- Chassis Color
- Drawer Front Color
- Drawer Front Grain Direction
- Pull
- Wire Management

Description

- Upper Section Provides 12¾" Clearance for Open Storage
- Lower Section Provides Storage Behind Two (2) Doors
- For Use With Desk and Return Shells
- Open Back
- Grain Runs Vertical on Door Fronts. Optional Horizontal Grain Direction on Door Fronts; Must Specify
- Optional Locking Doors ([See Options](#)); Must Specify and Add

Options: Specify & Add

WML	Wire Management - Left Panel	\$ 80
WMR	Wire Management - Right Panel	\$ 80
WMLR	Wire Management - Left and Right Panel	\$ 160

MODULAR PEDESTAL WITH OPEN STORAGE	66-2436MBC	36	22 ¹ / ₂	28¼	118	18.5	T\$ 1154
	66-2430MBC	30	22 ¹ / ₂	28¼	108	14.9	T\$ 979

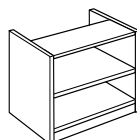

Must Specify (in this order):

- Model #
- Chassis Color
- Wire Management

Description

- For Use With Desk and Return Shells
- Open Back
- One (1) Adjustable Shelf

Options: Specify & Add

WML	Wire Management - Left Panel	\$ 80
WMR	Wire Management - Right Panel	\$ 80
WMLR	Wire Management - Left and Right Panel	\$ 160

Pricing Codes:

- T= TFL
- P= HPL

[See Canvas Reception Overview for Ordering Options](#)

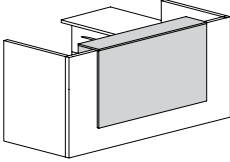
Item	Model No.	Width	Depth	Height	Ship Wt	Cubic Ft	List Price
WATERFALL TRANSACTION KIT WITH PAPER SLOTS 	64-1284TKS Five Slots; For Use With 96" Gallery	84	12	38	98	16.1	T\$ 1952
	64-1278TKS Four Slots; For Use With 90" Gallery	78	12	38	91	15.0	T\$ 1899
	64-1272TKS Four Slots; For Use With 84" Gallery	72	12	38	85	13.9	T\$ 1613
	64-1266TKS Four Slots; For Use With 78" Gallery	66	12	38	78	12.8	T\$ 1563
	64-1260TKS Four Slots; For Use With 72" Gallery	60	12	38	71	11.7	T\$ 1517
	64-1254TKS Three Slots; For Use With 66" Gallery	54	12	38	64	10.6	T\$ 1462
	64-1248TKS Three Slots; For Use With 60" Gallery	48	12	38	57	9.5	T\$ 1412
	64-1242TKS Two Slots	42	12	38	50	8.4	T\$ 1361
	64-1236TKS Two Slots	36	12	38	43	7.3	T\$ 1260
	64-1230TKS Two Slots	30	12	38	36	6.2	T\$ 1212
	64-1224TKS Two Slots	24	12	38	29	5.1	T\$ 1164

Must Specify (in this order):

Model #
Color
Paper Slot Divider Color
Support Bracket Color

Description

- Two (2) Support Brackets Included; Must Specify: Black (BLK) or Silver (SLV)
- Paper Slot Divider; Must Specify Color: Chrome or Laminate in Matching or Contrasting Color
- Some Assembly Required

Pricing Codes:

T= TFL
P= HPL

[See Canvas Reception Overview for Ordering Options](#)

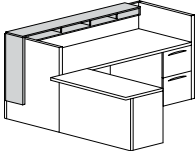
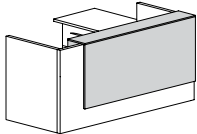
Item	Model No.	Width	Depth	Height	Ship Wt	Cubic Ft	List Price	
CORNER WATERFALL TRANSACTION KIT WITH PAPER SLOTS  Shown as Left 	Left	Right						
	64-1290CTKSL	64-1290CTKSR	90	12	38	113	17.2	T\$ 2124
	Five Slots; For Use With 96" Gallery							
	64-1284CTKSL	64-1284CTKSR	84	12	38	106	16.1	T\$ 2073
	Five Slots; For Use With 90" Gallery							
	64-1278CTKSL	64-1278CTKSR	78	12	38	99	15.0	T\$ 2021
	Four Slots; For Use With 84" Gallery							
	64-1272CTKSL	64-1272CTKSR	72	12	38	92	13.9	T\$ 1734
	Four Slots; For Use With 78" Gallery							
	64-1266CTKSL	64-1266CTKSR	66	12	38	85	12.8	T\$ 1684
	Four Slots; For Use With 72" Gallery							
	64-1260CTKSL	64-1260CTKSR	60	12	38	78	11.7	T\$ 1635
	Four Slots; For Use With 66" Gallery							
	64-1254CTKSL	64-1254CTKSR	54	12	38	71	10.6	T\$ 1578
	Three Slots; For Use With 60" Gallery							
64-1248CTKSL	64-1248CTKSR	48	12	38	65	9.5	T\$ 1531	
Three Slots								
64-1242CTKSL	64-1242CTKSR	42	12	38	58	8.4	T\$ 1475	
Two Slots								
64-1236CTKSL	64-1236CTKSR	36	12	38	51	7.3	T\$ 1376	
Two Slots								
64-1230CTKSL	64-1230CTKSR	30	12	38	44	6.2	T\$ 1328	
Two Slots								
64-1224CTKSL	64-1224CTKSR	24	12	38	37	5.1	T\$ 1277	
Two Slots								

Must Specify (in this order):

Model #
 Color
 Paper Slot Divider Color
 Support Bracket Color



Description

- One (1) Support Brackets Included; Must Specify: Black (BLK) or Silver (SLV)
- Paper Slot Divider; Must Specify Color: Chrome or Laminate in Matching or Contrasting Color
- Some Assembly Required

Pricing Codes:

T= TFL
 P= HPL

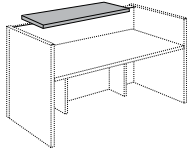
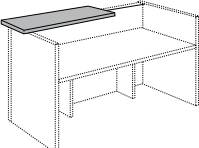
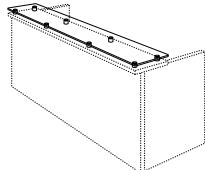
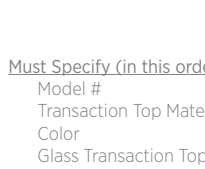
[See Canvas Reception Overview for Ordering Options](#)

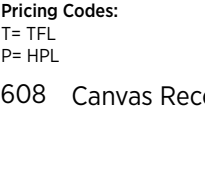
Item	Model No.	Width	Depth	Height	Ship Wt	Cubic Ft	List Price
	64-6012TP	60	12	1	18	1.8	T\$ 425
	Front to Back Grain						P\$ 597
							Optional Glass Top Add \$ 1362
	64-5712TP	57	12	1	17	1.7	T\$ 418
	Front to Back Grain						P\$ 587
							Optional Glass Top Add \$ 1323
	64-5412TP	54	12	1	16	1.6	T\$ 414
	Front to Back Grain						P\$ 579
							Optional Glass Top Add \$ 1304
	64-5112TP	51	12	1	16	1.5	T\$ 407
	Front to Back Grain						P\$ 571
							Optional Glass Top Add \$ 1099
	64-4812TP	48	12	1	15	1.4	T\$ 403
	Front to Back Grain						P\$ 564
							Optional Glass Top Add \$ 1082
	64-4512TP	45	12	1	14	1.3	T\$ 384
	Front to Back Grain						P\$ 536
							Optional Glass Top Add \$ 1043
	64-4212TP	42	12	1	13	1.2	T\$ 376
	Front to Back Grain						P\$ 528
							Optional Glass Top Add \$ 1023
	64-3912TP	39	12	1	12	1.1	T\$ 372
	Front to Back Grain						P\$ 520
							Optional Glass Top Add \$ 986
	64-3612TP	36	12	1	11	1.0	T\$ 366
	Front to Back Grain						P\$ 513
							Optional Glass Top Add \$ 967
	64-3312TP	33	12	1	10	0.9	T\$ 361
	Front to Back Grain						P\$ 505
							Optional Glass Top Add \$ 927
	64-3012TP	30	12	1	9	0.8	T\$ 357
	Front to Back Grain						P\$ 500
							Optional Glass Top Add \$ 906
	64-2712TP	27	12	1	8	0.7	T\$ 348
	Front to Back Grain						P\$ 489
							Optional Glass Top Add \$ 702
	64-2412TP	24	12	1	7	0.6	T\$ 341
	Front to Back Grain						P\$ 474
							Optional Glass Top Add \$ 684

Two (2) Support Bracket Required

One (1) Support Bracket Required

Optional Glass Transaction Top for TFL or HPL Transaction Tops

Must Specify (in this order):
Model #
Transaction Top Material Color
Glass Transaction Top
Support Bracket Color

Additional Transaction Tops on next page.

Description

- Square (H) Edge Profile On All Sides
- 1½" Overhang on Approach and Side Depending on Placement
- If Top is Not Supported By An End Panel, Support Bracket is Required (Not Included)
- Support Brackets Required; See Below and Must Specify: Black (BLK) or Silver (SLV)
- Optional Glass Transaction Top with ¼" Silver Standoff, See "Optional Glass Top Add" Pricing and Specify (SOG)
- Optional Glass Transaction Top Field Installed

Support Brackets Required for Non-Supported End: Specify & Add

01-0607SSB	Black	\$ 49
01-0607SSS	Silver	\$ 49



Pricing Codes:
T= TFL
P= HPL

[See Canvas Reception Overview for Ordering Options](#)

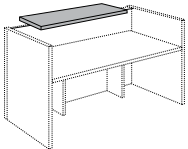
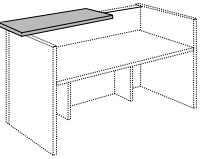
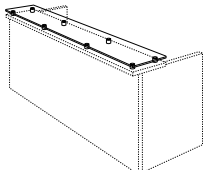
Item	Model No.	Width	Depth	Height	Ship Wt	Cubic Ft	List Price
 Two (2) Support Bracket Required	64-1296TP Side to Side Grain	96	12	1	29	3.0	T\$ 545 P\$ 763 Optional Glass Top Add \$ 1905
	64-1293TP Side to Side Grain	93	12	1	28	2.9	T\$ 524 P\$ 733 Optional Glass Top Add \$ 1832
	64-1290TP Side to Side Grain	90	12	1	27	2.8	T\$ 519 P\$ 726 Optional Glass Top Add \$ 1816
 One (1) Support Bracket Required	64-1287TP Side to Side Grain	87	12	1	26	2.7	T\$ 513 P\$ 719 Optional Glass Top Add \$ 1776
	64-1284TP Side to Side Grain	84	12	1	26	2.6	T\$ 508 P\$ 710 Optional Glass Top Add \$ 1757
	64-1281TP Side to Side Grain	81	12	1	25	2.5	T\$ 501 P\$ 704 Optional Glass Top Add \$ 1720
 Optional Glass Transaction Top for TFL or HPL Transaction Tops	64-1278TP Side to Side Grain	78	12	1	24	2.4	T\$ 497 P\$ 695 Optional Glass Top Add \$ 1534
	64-1275TP Side to Side Grain	75	12	1	23	2.3	T\$ 491 P\$ 687 Optional Glass Top Add \$ 1496
	64-1272TP Side to Side Grain	72	12	1	22	2.2	T\$ 486 P\$ 679 Optional Glass Top Add \$ 1457
Must Specify (in this order): Model # Transaction Top Material Color Glass Transaction Top Support Bracket Color Additional Transaction Tops on next page.	64-1269TP Side to Side Grain	69	12	1	21	2.1	T\$ 441 P\$ 618 Optional Glass Top Add \$ 1439
	64-1266TP Side to Side Grain	66	12	1	21	2.1	T\$ 437 P\$ 611 Optional Glass Top Add \$ 1419

Description

- Square (H) Edge Profile On All Sides
- 1½" Overhang on Approach and Side Depending on Placement
- If Top is Not Supported By An End Panel, Support Bracket is Required (Not Included)
- Support Brackets Required; See Below and Must Specify: Black (BLK) or Silver (SLV)
- Optional Glass Transaction Top with 1¼" Silver Standoff, See "Optional Glass Top Add" Pricing and Specify (SOG)
- Optional Glass Transaction Top Field Installed

Support Brackets Required for Non-Supported End: Specify & Add

01-0607SSB	Black	\$ 49
01-0607SSS	Silver	\$ 49



Pricing Codes:

T= TFL
P= HPL

[See Canvas Reception Overview for Ordering Options](#)

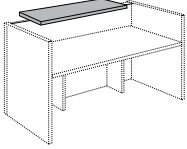
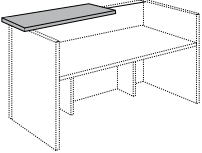
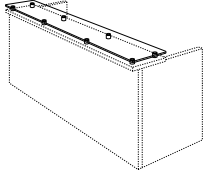
Item	Model No.	Width	Depth	Height	Ship Wt	Cubic Ft	List Price
 Two (2) Support Bracket Required	64-1263TP Side to Side Grain	63	12	1	19	1.9	T\$ 432 P\$ 602 Optional Glass Top Add \$ 1379
	64-1260TP Side to Side Grain	60	12	1	18	1.8	T\$ 425 P\$ 597 Optional Glass Top Add \$ 1362
	64-1257TP Side to Side Grain	57	12	1	17	1.7	T\$ 419 P\$ 588 Optional Glass Top Add \$ 1323
 One (1) Support Bracket Required	64-1254TP Side to Side Grain	54	12	1	16	1.6	T\$ 414 P\$ 579 Optional Glass Top Add \$ 1304
	64-1251TP Side to Side Grain	51	12	1	16	1.5	T\$ 407 P\$ 571 Optional Glass Top Add \$ 1099
 Optional Glass Transaction Top for TFL or HPL Transaction Tops	64-1248TP Side to Side Grain	48	12	1	15	1.4	T\$ 403 P\$ 564 Optional Glass Top Add \$ 1082
	64-1245TP Side to Side Grain	45	12	1	14	1.3	T\$ 384 P\$ 536 Optional Glass Top Add \$ 1043
	64-1242TP Side to Side Grain	42	12	1	13	1.2	T\$ 376 P\$ 528 Optional Glass Top Add \$ 1023
Must Specify (in this order): Model # Transaction Top Material Color Glass Transaction Top Support Bracket Color	64-1239TP Side to Side Grain	39	12	1	12	1.1	T\$ 372 P\$ 520 Optional Glass Top Add \$ 986
	64-1236TP Side to Side Grain	36	12	1	11	1.0	T\$ 366 P\$ 513 Optional Glass Top Add \$ 967
Additional Transaction Tops on next page.	64-1233TP Side to Side Grain	33	12	1	10	0.9	T\$ 361 P\$ 505 Optional Glass Top Add \$ 927
	64-1230TP Side to Side Grain	30	12	1	9	0.8	T\$ 357 P\$ 500 Optional Glass Top Add \$ 906
	64-1227TP Side to Side Grain	27	12	1	8	0.7	T\$ 348 P\$ 489 Optional Glass Top Add \$ 702
	64-1224TP Side to Side Grain	24	12	1	7	0.6	T\$ 341 P\$ 474 Optional Glass Top Add \$ 684

Description

- Square (H) Edge Profile On All Sides
- 1½" Overhang on Approach and Side Depending on Placement
- If Top is Not Supported By An End Panel, Support Bracket is Required (Not Included)
- Support Brackets Required; See Below and Must Specify: Black (BLK) or Silver (SLV)
- Optional Glass Transaction Top with 1 ¼" Silver Standoff, See "Optional Glass Top Add" Pricing and Specify (SOG)
- Optional Glass Transaction Top Field Installed

Support Brackets Required for Non-Supported End: Specify & Add

01-0607SSB	Black	\$ 49
01-0607SSS	Silver	\$ 49



Pricing Codes:

T= TFL
P= HPL

[See Canvas Reception Overview for Ordering Options](#)

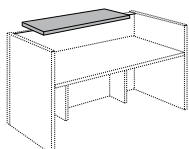
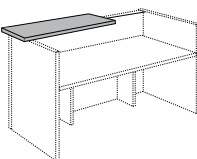
Item	Model No.	Width	Depth	Height	Ship Wt	Cubic Ft	List Price
TRANSACTION TOP WITH SOLID SURFACE  Two (2) Support Bracket Required  One (1) Support Bracket Required Must Specify (in this order): Model # Color Support Bracket Color	64-1296SSTP	96	12	1½	102	3.0	\$ 2884
	64-1293SSTP	93	12	1½	99	2.9	\$ 2824
	64-1290SSTP	90	12	1½	96	2.8	\$ 2770
	64-1287SSTP	87	12	1½	92	2.7	\$ 2724
	64-1284SSTP	84	12	1½	89	2.5	\$ 2561
	64-1281SSTP	81	12	1½	86	2.5	\$ 2506
	64-1278SSTP	78	12	1½	83	2.4	\$ 2460
	64-1275SSTP	75	12	1½	80	2.3	\$ 2419
	64-1272SSTP	72	12	1½	76	2.2	\$ 2203
	64-1269SSTP	69	12	1½	73	2.1	\$ 2155
	64-1266SSTP	66	12	1½	70	2.0	\$ 2114
	64-1263SSTP	63	12	1½	67	1.9	\$ 2076
	64-1260SSTP	60	12	1½	64	1.8	\$ 1891
	64-1257SSTP	57	12	1½	60	1.7	\$ 1846
	64-1254SSTP	54	12	1½	57	1.6	\$ 1807
	64-1251SSTP	51	12	1½	54	1.5	\$ 1773
	64-1248SSTP	48	12	1½	51	1.4	\$ 1563
	64-1245SSTP	45	12	1½	48	1.3	\$ 1522
	64-1242SSTP	42	12	1½	44	1.2	\$ 1486
	64-1239SSTP	39	12	1½	41	1.1	\$ 1455
64-1236SSTP	36	12	1½	38	1.0	\$ 1247	
64-1233SSTP	33	12	1½	35	0.9	\$ 1212	
64-1230SSTP	30	12	1½	32	0.8	\$ 1177	
64-1227SSTP	27	12	1½	28	0.7	\$ 1151	
64-1224SSTP	24	12	1½	25	0.6	\$ 845	

Description

- Straight (S1) Edge Profile On All Sides
- 1½" Overhang on Approach and Side Depending on Placement
- If Top is Not Supported By An End Panel, Support Bracket is Required (Not Included)
- Support Brackets Available in Black or Silver: See Below and Must Specify



Support Brackets Required for Non-Supported End: Specify & Add

01-0607SSB	Black	\$ 49
01-0607SSS	Silver	\$ 49

Pricing Codes:

T= TFL
P= HPL

[See Canvas Reception Overview for Ordering Options](#)

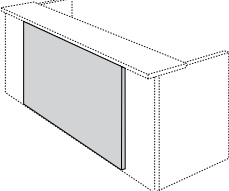
Item	Model No.	Width	Depth	Height	Ship Wt	Cubic Ft	List Price	
 <p>Shaded Overlay Panel (Shown with Optional Transactional Top)</p>	OVERLAY PANEL							
	64-OT96	72	¾	41	57	5.2	T\$ 666	
	For Use With 96" Desk or 95" Return							
	64-OT90	66	¾	41	52	4.8	T\$ 632	
	For Use With 90" Desk							
	64-OT84	60	¾	41	47	4.4	T\$ 599	
	For Use With 84" Desk or 83" Return							
	64-OT78	54	¾	41	42	4.0	T\$ 564	
	For Use With 78" Desk							
	64-OT72	48	¾	41	38	3.6	T\$ 526	
For Use With 72" Desk or 71" Return								
64-OT66	42	¾	41	33	3.2	T\$ 486		
For Use With 66" Desk								
64-OT60	36	¾	41	28	2.8	T\$ 443		
For Use With 60" Desk or 58" Return								
Description								
<ul style="list-style-type: none"> • Horizontal Woodgrain • Designed to be Used with a Transaction Top • Not Compatible with Waterfall Transaction Kit • Optional Back Lighting 								
Options: Specify & Add								
BKLIT	Back Lighting						\$ 1568	

Must Specify (in this order):

Model #
Color
Overlay Back Lighting

Pricing Codes:

T= TFL
P= HPL

[See Canvas Reception Overview for Ordering Options](#)

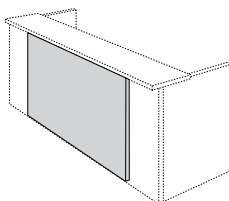
Item	Model No.	Width	Depth	Height	Ship Wt	Cubic Ft	List Price	
 <p>Shaded Overlay Panel (Shown with Optional Transactional Top)</p> <p>Must Specify (in this order): Model # Color Overlay Back Lighting</p>	64-OHGA96 For Use With 96" Desk or 95" Return	72	¼	41	57	5.2	\$ 2511 GPA\$ 3370	
	64-OHGA90 For Use With 90" Desk	66	¼	41	52	4.8	\$ 2329 GPA\$ 3111	
	64-OHGA84 For Use With 84" Desk or 83" Return	60	¼	41	47	4.4	\$ 2141 GPA\$ 2854	
	64-OHGA78 For Use With 78" Desk	54	¼	41	42	4.0	\$ 1951 GPA\$ 2595	
	64-OHGA72 For Use With 72" Desk or 71" Return	48	¼	41	38	3.6	\$ 1765 GPA\$ 2336	
	64-OHGA66 For Use With 66" Desk	42	¼	41	33	3.2	\$ 1571 GPA\$ 2071	
	64-OHGA60 For Use With 60" Desk or 58" Return	36	¼	41	28	2.8	\$ 1376 GPA\$ 1803	
	Description							
	<ul style="list-style-type: none"> • Must Specify Color: Black (BLA), Wired Mercury (WMA), White (WHA) or Graphite Acrylic (GPA); Graphite Acrylic Pricing (GPA\$) • Optional Back Lighting 							
	Options: Specify & Add							
BKLIT	Back Lighting						\$ 1568	

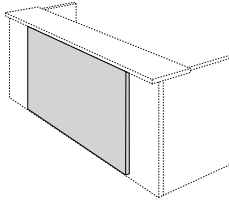
 <p>Shaded Overlay Panel (Shown with Optional Transactional Top)</p>	64-OFA96 For Use With 96" Desk or 95" Return	72	¼	41	21	5.2	\$ 2218	
	64-OFA90 For Use With 90" Desk	66	¼	41	19	4.8	\$ 2120	
	64-OFA84 For Use With 84" Desk or 83" Return	60	¼	41	17	4.4	\$ 1947	
	64-OFA78 For Use With 78" Desk	54	¼	41	15	4.0	\$ 1796	
	64-OFA72 For Use With 72" Desk or 71" Return	48	¼	41	13	3.6	\$ 1652	
	64-OFA66 For Use With 66" Desk	42	¼	41	11	3.2	\$ 1498	
	64-OFA60 For Use With 60" Desk or 58" Return	36	¼	41	9	2.8	\$ 1304	
	Description							
	<ul style="list-style-type: none"> • Features Decorative Hardware, 1¼" Silver Standoffs • Optional Custom Engraving Available; Call Customer Service For Lead Times and Pricing 							

Pricing Codes:

T= TFL
P= HPL

[See Canvas Reception Overview for Ordering Options](#)

Item	Model No.	Width	Depth	Height	Ship Wt	Cubic Ft	List Price
CENTER DRAWER	66-1622CD	22	16	2	7	1.4	T\$ 401

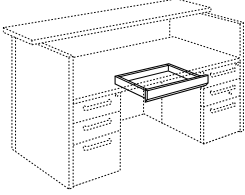

Description

- Attaches Under Worksurfaces
- Built in Pen Tray
- Field Installed Only
- Grain Runs Vertical on Drawer Fronts. Optional Horizontal Grain Direction on Drawer Fronts; Must Specify

Must Specify (in this order):

Model #
Color
Grain Direction

STIFFENER BAR	01-00060SB	60	1¼	¾	8	0.3	\$ 129
	01-00048SB	48	1¼	¾	5	0.3	\$ 121

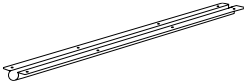

Description

- Reinforces Worksurfaces with Large Kneespace Widths
- Includes End Caps to Cover Sharp Edges
- Field Installed
- Recommended in Kneespaces 60" or Greater

TRANSACTION SUPPORT BRACKET	01-0607SSB	Black	6	-	-	1	1.0	\$ 49
	01-0607SSS	Silver						



Description

- For Use With Unsupported Transaction Tops and Waterfall Transaction Kits

Pricing Codes:

T= TFL
P= HPL

[See Canvas Reception Overview for Ordering Options](#)

DESK SHELL TACKBOARDS
9" H

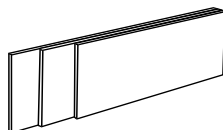

Must Specify (in this order):
Model #
Tackboard Fabric Vendor, Pattern,
and Color

Model #	Size	COM ydg	COM, 1, 2 or 3	Grades							
				4	5	6	7	8	9	10	
TB-6296	96"	3.00	\$ 351	768	963	1161	1443	1737	2079	2475	
TB-6290	90"	2.75	\$ 335	717	896	1078	1336	1606	1919	2282	
TB-6284	84"	2.50	\$ 317	665	827	992	1227	1472	1757	2087	
TB-6278	78"	2.50	\$ 311	659	821	986	1221	1466	1751	2081	
TB-6272	72"	2.25	\$ 256	569	715	864	1075	1296	1552	1849	
TB-6266	66"	2.00	\$ 232	510	640	772	960	1156	1384	1648	
TB-6260	60"	1.75	\$ 219	462	576	692	856	1028	1227	1458	

Description

- All tackboards 78" and longer are Two (2) pieces
- Field Installed
- For Use with Transaction Tops
- Not Compatible with Waterfall Transaction Kit

Item	Model No.		Width	Depth	Height	Ship Wt	Cubic Ft	List Price
DOCK 950 WIRELESS CHARGER	01-DOCK950W	White	3 $\frac{3}{16}$ "	3 $\frac{3}{16}$ "	-	1	0.2	\$ 265
	01-DOCK950B	Black						



OPEN MARKET ONLY

Description

- For Use with Wireless Charging Enabled Devices
- 5 Watts Maximum Output with a Direct Current of 5V 2A and 10 Watts Maximum with Quick Charge 2.0
- Mounts in 76mm Round Cut-Out
- LED will Confirm Pairing with Device and Begin Wireless Charging

DOCK 150 WIRELESS AND USB CHARGER	01-DOCK150W	White	3	3	$\frac{3}{4}$ "	1	0.2	\$ 405
	01-DOCK150B	Black						



OPEN MARKET ONLY

Description

- For Use with Wireless Charging Enabled Devices and USB Charging Devices
- 5 Watt Maximum Output with a Direct Current Input of 5V 6A (Wireless Fast Charge)
- Mounts in 76mm Round Cut-Out
- Pop-Up is $\frac{3}{4}$ "H and Includes Three (3) USB Ports; One (1) 12 Watt Maximum with 2.4A (USB Fast Charge) and Two (2) 5 Watt with 1A (USB Standard Charge)
- LED Light will Confirm Pairing with Device and Begin Wireless Charging
- UL and cUL Certified

Item	Model No.		Width	Depth	Height	Ship Wt	Cubic Ft	List Price
POWER DATA PORT	01-DPORT4A	Aluminum	8	4	-	7	0.2	\$ 1093
	01-DPORT4B	Black	8	4	-	7	0.2	\$ 1093

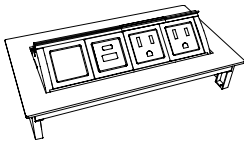

Description

- Retracts into Work Surface to Regain Productive Space
- One-Touch Access to Power and Data
- Two Power Outlets and Two Open Ports for Data
- Water-Proof Simplex (Outlets)
- Includes a Voice/Data Adapter Kit to Accept Couplers and Jacks When Required
- 6' Power Cord

USB PORT	01-USBPORT		-	-	-	-	-	\$ 161
----------	------------	--	---	---	---	---	---	--------

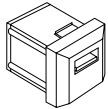

Description

- Passive USB-A Port with Increased Transfer Speed Up to 5 gbs/sec
- Simultaneous Read/Write Capability
- Idle Device Power Saving State
- 6' Cord

VOICE COUPLER	01-VOICE1		-	-	-	-	-	\$ 73
---------------	-----------	--	---	---	---	---	---	-------

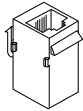

Description

- 6-Pin Modular Plug
- Molded Black
- Cord Not included

DATA PORT	01-RJ4DATA		-	-	-	-	-	\$ 167
-----------	------------	--	---	---	---	---	---	--------



Description

- 8-Pin Modular Plug
- Cat6 Ethernet Cable
- Pre-terminated Cable
- 10' Cord

Item	Model No.		Width	Depth	Height	Ship Wt	Cubic Ft	List Price
DUO CLAMP NEMA PLUG	01-DUOCLAMPW	White	5 ½	3	7	1	0.2	\$ 572
	01-DUOCLAMPB	Black						
	01-DUOCLAMPS	Silver						

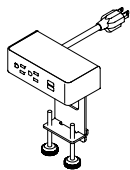

Description

- Silver Metal Trim
- Clamps to Top
- Two (2) Power/Two (2) USB Power
- Independent USB Circuit Controllers Deliver up to 2.1 Amps to Each Post
- All Mounting Hardware Included
- FCC Part 15A and UL Approved for Horizontal and Vertical Applications
- 10 Cord

TRIO CLAMP NEMA PLUG	01-TRIOCLAMPW	White	8	3	7	1	0.2	\$ 671
	01-TRIOCLAMPB	Black						
	01-TRIOCLAMPS	Silver						

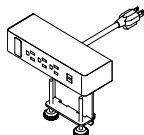

Description

- Silver Metal Trim
- Clamps to Top
- Three (3) Power/Two (2) USB Power/One (1) Open Data
- Independent USB Circuit Controllers Deliver up to 2.1 Amps to Each Post
- HDMI, VGA, or RJ45 Sold Separately; [See Accessories](#)
- All Mounting Hardware Included
- FCC Part 15A and UL Approved for Horizontal and Vertical Applications
- 10 Cord

DUO BEZEL NEMA PLUG	01-DUOBEZELW	White	9	2½	3	1	0.2	\$ 675
	01-DUOBEZELB	Black						
	01-DUOBEZELS	Silver						

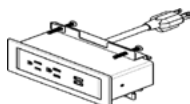

Description

- Sits On Top of the Worksurface
- Two (2) Power/Two (2) USB Power
- Independent USB Circuit Controllers Deliver up to 2.1 Amps to Each Post
- All Mounting Hardware Included
- FCC Part 15A and UL Approved for Horizontal and Vertical Applications
- 10' Cord

Item	Model No.		Width	Depth	Height	Ship Wt	Cubic Ft	List Price
------	-----------	--	-------	-------	--------	---------	----------	------------

TRIO BEZEL NEMA PLUG

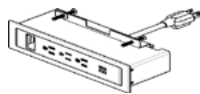

01-TRIOBEZELW	White
01-TRIOBEZELB	Black
01-TRIOBEZELS	Silver

Description

- Sits On Top of the Worksurface
- Three (3) Power/Two (2) USB Power/One (1) Open Data
- Independent USB Circuit Controllers Deliver up to 2.1 Amps to Each Post
- HDMI, VGA, or RJ45 Sold Separately; [See Accessories](#)
- All Mounting Hardware Included
- FCC Part 15A and UL Approved for Horizontal and Vertical Applications
- 10' Cord

UNDERMOUNT DUO NEMA PLUG



01-DUOUNDERW	White	6½	2½	3	1	0.2	\$ 546
01-DUOUNDERB	Black						
01-DUOUNDEERS	Silver						

Description

- Sits Under the Worksurface
- Two (2) Power/Two (2) USB Power
- Independent USB Circuit Controllers Deliver up to 2.1 Amps to Each Post
- All Mounting Hardware Included
- FCC Part 15A and UL Approved for Horizontal and Vertical Applications
- 10' Cord

UNDERMOUNT TRIO NEMA PLUG



01-TRIOUNDERW	White	6½	2½	3	1	0.2	\$ 655
01-TRIOUNDERB	Black						
01-TRIOUNDERS	Silver						

Description

- Sits On Top of the Worksurface
- Three (3) Power/Two (2) USB Power/One (1) Open Data
- Independent USB Circuit Controllers Deliver up to 2.1 Amps to Each Post
- HDMI, VGA, or RJ45 Sold Separately; [See Accessories](#)
- All Mounting Hardware Included
- FCC Part 15A and UL Approved for Horizontal and Vertical Applications
- 10' Cord

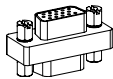
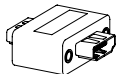
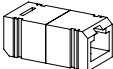
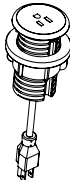
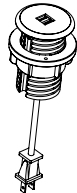
Item	Model No.		Width	Depth	Height	Ship Wt	Cubic Ft	List Price
TRIO VGA DATA PORT ACCESSORY	01-LCOMVGA		-	-	-	1	0.2	\$ 121
	Description							
	<ul style="list-style-type: none"> VGA Port for Trio Bezel Units 							
TRIO HDMI DATA PORT ACCESSORY	01-LCOMHDMI		-	-	-	1	0.2	\$ 166
	Description							
	<ul style="list-style-type: none"> HDMI Port for Trio Bezel Units 							
	OPEN MARKET ONLY							
TRIO RJ45 DATA PORT ACCESSORY	01-LCOMRJ45		-	-	-	1	0.2	\$ 79
	Description							
	<ul style="list-style-type: none"> RJ45 Port for Trio Bezel Units 							
SINGLE POWER SAND DOLLAR	01-SAND60PW	White	3	3	4	1	0.2	\$ 98
	01-SAND60PB	Black						
	01-SAND60PS	Silver						
	Description							
	<ul style="list-style-type: none"> Available on Height Adjustable Desks, Returns and Bridge Units with Wire Management Box in Center Grommet Only (GC-BOX) Unit is 2" Diameter; Mounts in 60mm Round Grommet 6' Cord Single Power Outlet 							
DOUBLE USB SAND DOLLAR	01-SAND60UW	White	3	3	4	1	0.2	\$ 277
	01-SAND60UB	Black						
	01-SAND60US	Silver						
	Description							
	<ul style="list-style-type: none"> Available on Height Adjustable Desks, Returns and Bridge Units with Wire Management Box in Center Grommet Only (GC-BOX) Unit is 2" Diameter; Mounts in 60mm Round Grommet 6' Cord Dual USB Outlets 							

Pricing Codes:

T= TFL

P= HPL

[See Canvas Reception Overview for Ordering Options](#)

Item	Model No.	Width	Depth	Height	Ship Wt	Cubic Ft	List Price
VESTA POWER CENTER	01-PDCTR	10 $\frac{3}{4}$	12	28 $\frac{1}{4}$	14	2.5	\$ 1776

**Description**

- Top Includes One (1) Power Outlet, Two (2) USB Ports and One (1) USBC Port; Base Includes Three (3) Outlet
- Available in White
- 120" Power Cord
- Built with Weight Distribution for Optimal Stability
- Base is 5" Tall

WIRE MANAGEMENT CHANNEL	01-WMGR4	16	1 $\frac{1}{2}$	$\frac{3}{4}$	1	-	\$ 116
-------------------------	----------	----	-----------------	---------------	---	---	--------

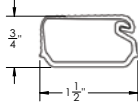
**Description**

- Set of Four (4) Black Plastic Wire Management Channels
- Snap Lock Channel
- Attaches with Adhesive Strips
- Ships via UPS Only

CABLE GRIP	01-WMGRCB	5 $\frac{3}{8}$	2 $\frac{5}{8}$		-	-	\$ 17
------------	-----------	-----------------	-----------------	--	---	---	-------

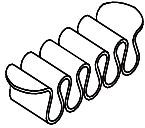
**Description**

- Under Surface Wire Management
- Black

WIRE CHANNEL	01-32125	24	1 $\frac{5}{8}$	1	.25	0.3	\$ 106
--------------	----------	----	-----------------	---	-----	-----	--------

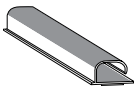
**Description**

- Available in Black
- Channels Attach with Two (2) Double-Sided Installation Tape
- Open J Channel for Easy Storage of Cables

LINK 360 CABLE MANAGER	01-0251LINKSLV	Silver	5 $\frac{3}{16}$	3 $\frac{3}{16}$	30-51	4	3.0	\$ 390
	01-0251LINKBLK	Black	5 $\frac{3}{16}$	3 $\frac{3}{16}$	30-51	4	3.0	\$ 353

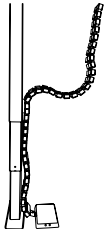
**Description**

- Kit Includes: 50 Link 360™ elements, One (1) Quad Connector, One (1) Dumbbell Connector, One (1) Foot Assembly with Two (2) Magnetic Clips
- Can Be Used For Height-Adjustable Mechanisms Up To 51" or Free-Standing Use

Pricing Codes:

T= TFL

P= HPL

[See Canvas Reception Overview for Ordering Options](#)

Jefferson echoes history and creates a timeless foundation for today's sophisticated work place. Finely crafted in select solids with Walnut and Cherry veneers, the tailored details of this collection accentuate our expert craftsmanship and perfect attention to detail.

Jefferson forges traditional styling with modern sensibility with new Height Adjustable options and coordinating reception models, allowing the premium feel and flexibility of Jefferson to easily function throughout entire facilities.

CONSTRUCTION

Jefferson features a Veneer chassis with your choice of a Veneer or HPL top. Units ship assembled unless otherwise noted.

VENEER

- Choose from premium or select veneer on exposed surfaces in American Black Walnut or Cherry species in bookmatched veneer faces
- Veneers are carefully selected and matched to assure proper balance and consistency

TOPS

- Veneer tops offer a 5-ply balanced construction, 1 $\frac{3}{16}$ " thick with solid hardwood mitered rims
- High Pressure Laminate (HPL) tops offer a 3-ply balanced construction, 1 $\frac{3}{16}$ " thick with solid hardwood mitered rims
- Grain direction runs left-to-right unless otherwise noted
- All Jefferson tops are standard with the Jefferson edge profile (C2), unless otherwise noted.



CHASSIS

- Chassis is securely fastened using high quality European fastening systems, heavy-duty, 16-gauge joining brackets and wood dowels to assure maximum strength
- Bases are solid hardwood with mitered corners
- All units have finished veneer backs
- Construction offers tight tolerances and long term durability
- All units equipped with heavy-duty, adjustable glides to ensure proper leveling and compensate for uneven floors
- Vertical grain direction on chassis

DRAWERS

- Drawer fronts standard with bookmatched veneer faces
- Fronts are 3-ply construction and $\frac{3}{4}$ " thick
- Drawer interiors are dovetail, wood constructed with $\frac{7}{16}$ " hardwood sides and backs and $\frac{5}{32}$ " thick hardboard bottoms
- All drawers feature full extension, progressive action slides with precision steel ball bearings
- Box and file drawers are tested for 100lb capacity
- All suspensions have a limited lifetime warranty
- Optional soft close is available on center, box, and file drawers, unless otherwise noted ([see option details](#)): **File drawers with the soft close option feature front-to-back filing.**

FILING

- All file drawers are standard with filing systems designed to accommodate a variety of filing requirements
- Optional soft close on box and file drawers allows front-to-back filing in file drawer**

FILING (CONT)

- Legal width file drawers provide legal filing front to back, and letter or legal filing side to side
- Letter width file drawers provide letter filing front to back, and letter or legal filing side to side

LOCKING

- Central locking is standard on all desks; one key in the lock cylinder locks all drawers in the desk
- Pedestal locking for credenzas and returns
- Lock core color will coordinate with pull selection (brass pulls will have black cores, while aluminum pulls will have silver cores)
- Removable lock cylinders allow for units to be re-keyed at a later date if required
- Units are shipped randomly keyed as standard. Keyed alike units available upon request at no additional charge.

CORD MANAGEMENT

- Grommets may be ordered in the tops of desks, returns, bridges, and credenzas
- [See all grommet options and locations](#)
- Wire Managers available for additional cord management; [See Accessories](#)

INTERIOR DRAWER DIMENSIONS

Models

46-2472RCR	46-2466RCL	46-2466RCR	46-2448RPD2L
46-2448RPD2R	46-2472RCL		

Drawers

	W	L	D
File	12 $\frac{3}{8}$ "	16 $\frac{7}{32}$ "	8 $\frac{29}{32}$ "

Models

46-3672RPD1L	46-3672RPD1R
--------------	--------------

Drawers

	W	L	D
Box	15 $\frac{3}{8}$ "	19 $\frac{3}{8}$ "	3 $\frac{21}{32}$ "
File	15 $\frac{3}{8}$ "	25 $\frac{3}{4}$ "	8 $\frac{29}{32}$ "
Center	25 $\frac{3}{4}$ "	19 $\frac{3}{8}$ "	1 $\frac{27}{32}$ "

Models

46-3066RPD1L	46-3066RPD1R
--------------	--------------

Drawers

	W	L	D
Box	12 $\frac{3}{8}$ "	19 $\frac{3}{8}$ "	3 $\frac{21}{32}$ "
File	12 $\frac{3}{8}$ "	25 $\frac{3}{4}$ "	8 $\frac{29}{32}$ "
Center	22 $\frac{7}{8}$ "	19 $\frac{3}{8}$ "	1 $\frac{27}{32}$ "

FILING CAPABILITIES

Drawers with Dimensions: 15³/₈"W x 25³/₄"L

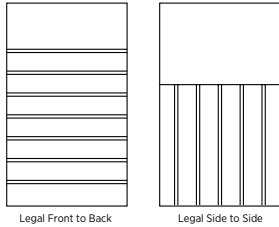

Drawers with Dimensions: 12³/₈"W x 25³/₄"L

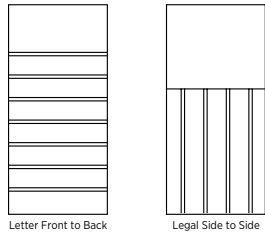

Drawers with Dimensions: 12³/₈"W x 16⁷/₃₂"L

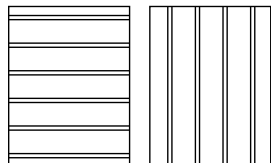

HOW TO ORDER EXAMPLES

RECEPTION L-UNIT

46-3672RPD1L	1	Premium or Standard Veneer	W
		Top Material	P
		Finish/Color	GC
		Pull	ARA
		No Molding	-
		Drawer Track	SOFT
		Top Grommet Loc./Color	GC/BLK
		Flip Down Center Drawer	LFD
		Tackboard/Fabric	CF Stinson Nikko Beach

46-2448RPD2R	1	Premium or Standard Veneer	W
		Top Material	P
		Finish/Color	GC
		Pull	ARA
		No Molding	-
		Drawer Track	SOFT
		Top Grommet Loc./Color	GC/BLK

PREMIUM AND STANDARD VENEER (W) OPTIONS

The multi-step, finish process used by Indiana Furniture provides years of lasting beauty. High quality finish materials offer distinctive grain clarity, superior resistance to normal wear, and easy maintenance. Wood veneer tops are shipped standard with satin sheen finish.

AW	Artisan Walnut	LW	Legacy Walnut
CO	Columbian Walnut	MW	Mahogany Walnut
DC	Dark Cherry	MTS	Metropolis Sky**
DFW	Dark Forest Walnut	PNW	Pinnacle Walnut**
EW	Espresso	SCH	Select Cherry
GC	Golden Cherry	SKC	Shaker Cherry
HW	Harvest Walnut	WC	Williamsburg Cherry
HNW	Henna Walnut**		

** Available in Standard Veneer Only

HPL (P) TOP OPTIONS

WOODGRAIN

CO	Columbian Walnut	PNW	Pinnacle Walnut
EF	Espresso	SCH	Select Cherry
GC	Golden Cherry	SKC	Shaker Cherry
MW	Mahogany Walnut	WC	Williamsburg Cherry

DRAWER AND DOOR PULL OPTIONS

Units with doors and drawers will feature coordinating pulls however door and drawer pulls cannot be intermixed.

ARA	Arlington A, Antique Brass	JEF	Jefferson, Antique Brass
ARB	Arlington B, Antique Brass	ALB	Liberty, Aluminum
WLM	Wilmington, Antique Brass		

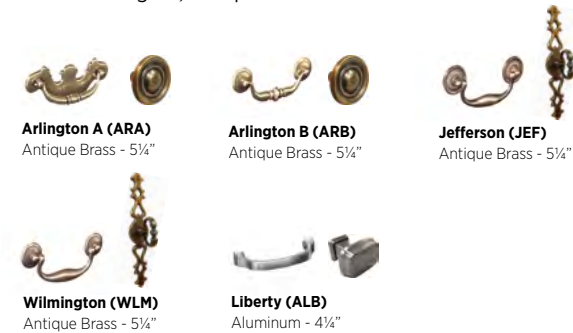

DRAWER TRACK OPTIONS

Soft close tracks are available on center, tray, box, and file drawers in Jefferson. Soft close drawer tracks have many benefits including reduced stress on the unit, extends the life of the drawer, and ensures a gentle close so fingers don't accidentally get hurt. File drawers with the soft close option feature front-to-back filing. Must specify when ordering.

Pricing is per Drawer, not per Model/Unit

SFTCL	Soft Close Drawer Track	\$	34
-------	-------------------------	----	----

LOCKING FLIP DOWN CENTER DRAWER

Single and double pedestal desks and kneespace credenzas standard with a center drawer have an optional central locking, keyboard flip down drawer. Drawer front is wood veneer with laminate drawer interior.

LFD Locking Flip Down Front Center Drawer \$ 82

MOLDING OPTIONS

All standard, height adjustable, and reception units ship with decorative pencil molding. If you do not want molding, please specify "NO MOLDING" when ordering each model.

Modular components come standard with no molding. To accommodate for flush ends, molding is offered as an option. Specify one of the following codes when ordering.

STD	No Molding	\$	Std
MR46R1	Molding on Right Side Only	\$	85
MR46L1	Molding on Left Side Only	\$	85
M46LR	Molding on Both Right and Left Sides	\$	170

Note: Left or right is determined when facing the front of the unit.

WORKSURFACE GROMMETS FOR RECEPTION

GC	Grommet, Center; Must Specify Black (BLK) or Silver (SLV)	\$	52
GL	Grommet, Left; Must Specify Black (BLK) or Silver (SLV)	\$	52
GR	Grommet, Right; Must Specify Black (BLK) or Silver (SLV)	\$	52

Verify Grommet Option is available on the model(s) you are specifying using the location.

Grommets may be ordered in non-standard locations. Call Customer Service to assist with specification. Note additional charges and lead times may apply.

Multiple locations may be selected.

Models

46-3672RPD1L 46-3672RPDIR

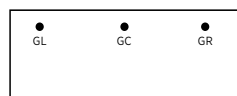

GL/GR: Located 6" from sides and 3 1/4" from user side

GC: 3 1/4" from user side

Models

46-3066RPD1L 46-3066RPDIR



GL/GR: Located 6" from sides and 26 5/8" from user side

GC: 26 5/8" from user side

Models

46-2448RPD2L 46-2448RPD2R 46-2448RUF 46-2442RUF
46-2472RCL 46-2472RCR 46-2466RCL 46-2466RCR

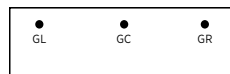

GL/GR: Located 6" from sides and 19" from user

GC: 19" from user side

CERTIFICATIONS & COMPLIANCE

- Intertek Sustainability Certified
- BIFMA level® Certified
- BIFMA Compliant Certified
- TSCA Title VI (formerly CARB) Compliance
- US Green Building's LEED Contribution

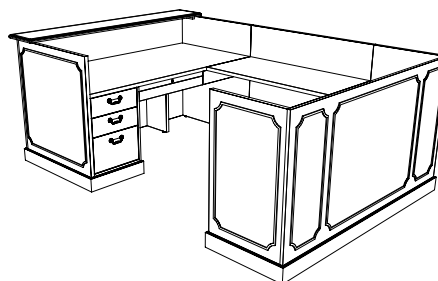
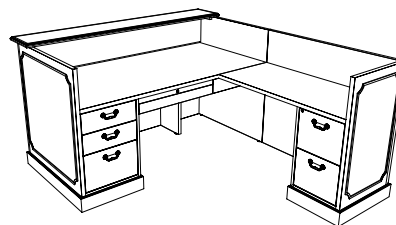

Reception Units

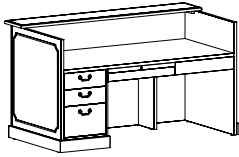

Reception Desks
(See Details)

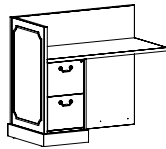

Reception Returns
(See Details)

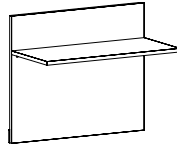

Reception Bridges
(See Details)

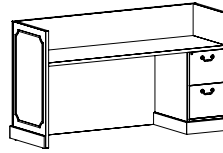

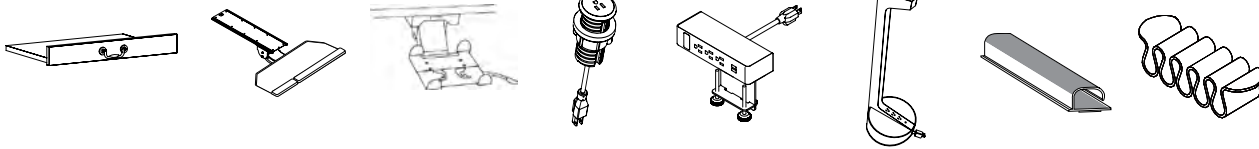

Reception Credenzas
(See Details)

Kneespace Options, Wire Management + Accessories

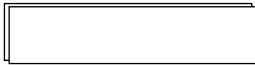

Tackboards



Item	Model No.	Width	Depth	Height	K	R	Ship Wt	Cubic Ft	List Price		
SINGLE PED RECEPTION DESK BOX/BOX/FILE  Shown as Left  Approach Side Shown with Decorative Molding and Optional No Molding	Left Ped	Right Ped									
	46-3672RPD1L	46-3672RPD1R	74	39	42	28¼	-	374	76.3	W/P\$ 8254 PV\$ 9245	
	<i>Worksurface 70W x 34¾D; Legal Ped</i>										
	46-3066RPD1L	46-3066RPD1R	68	33	42	25¼	-	327	59.9	W/P\$ 7545 PV\$ 8453	
<i>Worksurface 64W x 28¾D; Letter Ped</i>											

Description

- Standard with: Transaction Surface Profiled on All Sides, Rectangle User Surface with Square Profile, Base Molding on All Sides, Decorative Molding on Approach and Both Sides, Central Locking Center Drawer, Box/Box/File Ped, Left-to-Right Grain Direction on Top, and Dovetail Wood Drawer Construction
- Chassis Available with Premium Veneer (PV) or Standard Veneer (W); Must Specify
- Top/Transaction Available with Premium/Standard Veneer (PV/W) or HPL (P); Must Specify
- Lock Core Color will Coordinate with Pull Selection (Brass Pull with Black Lock, Silver Pull with Silver Lock)
- Additional Options: No Decorative Molding (Specify NO MOLDING); Keyboard Flip Down Center Drawer ([See Center Drawer Options](#)); Factory-Installed Tackboard ([See Tackboards](#)); Soft Close Drawer Closure ([See Soft Close Options](#)); Top Grommet Options ([See Grommet Options](#)); Wire Management + Accessories (Sold Separately; [See Accessories](#))

Must Specify (in this order):

- Model #
- Premium or Standard Veneer
- Top Material
- Finish/Color
- Pull
- No Molding
- Drawer Track
- Top Grommet Location/Color
- Flip Down Center Drawer
- Tackboard/Fabric

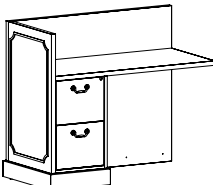
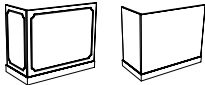
Item	Model No.	Width	Depth	Height	K	R	Ship Wt	Cubic Ft	List Price	
RECEPTION RETURN FILE/FILE  Shown as Left  Approach Side Shown with Decorative Molding and Optional No Molding	Left Ped	Right Ped								
	46-2448RPD2L	46-2448RPD2R	48	24	40⅞	28¼	-	195	33.3	W/P\$ 5520 PV\$ 6183
	<i>Worksurface 46¼W x 21¾D</i>									

Description

- Standard with: Rectangle Top with Square Profile, Base Molding on All Sides, Decorative Molding on Approach and Side, Locking File/File Ped, Front-To-Back Grain Direction on Top, and Dovetail Wood Drawer Construction
- Chassis Available with Premium Veneer (PV) or Standard Veneer (W); Must Specify
- Top Available with Premium/Standard Veneer (PV/W) or HPL (P); Must Specify
- Additional Options: No Decorative Molding (Specify NO MOLDING); Keyboard Flip Down Center Drawer ([See Center Drawer Options](#)); Keyboard Flip Down Center Drawer ([See Center Drawer Options](#)); Soft Close Drawer Closure ([See Soft Close Options](#)); Top Grommet Options ([See Grommet Options](#)); Kneespace Options (Sold Separately, [See Units](#)), Wire Management + Accessories (Sold Separately; [See Accessories](#))

Must Specify (in this order):

- Model #
- Premium or Standard Veneer
- Top Material
- Finish/Color
- Pull
- No Molding
- Drawer Track
- Top Grommet Location/Color
- Kneespace Options

Item	Model No.	Width	Depth	Height	K	R	Ship Wt	Cubic Ft	List Price
RECEPTION BRIDGE	46-2448RUF <i>Worksurface 48W x 22½D</i>	48	24	40⅞	48	-	116	7.3	W/P\$ 2520 PV\$ 2821
	46-2442RUF <i>Worksurface 42W x 22½D</i>	42	24	40⅞	42	-	104	6.3	W/P\$ 2373 PV\$ 2659

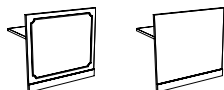
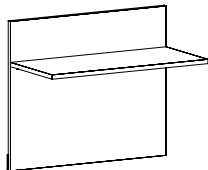

Approach Side Shown with Decorative Molding and Optional No Molding

Description

- Standard With: Rectangle Top with Square Profile, Front-to-Back Grain Direction on Top, and Hinged Back Panel
- Chassis Available with Premium Veneer (PV) or Standard Veneer (W); Must Specify
- Top Available with Premium/Standard Veneer (PV/W) or HPL (P); Must Specify
- Additional Options: No Decorative Molding (Specify NO MOLDING); Top Grommet Options ([See Grommet Options](#)); Wire Management + Accessories (Sold Separately; [See Accessories](#))

Must Specify (in this order):

- Model #
- Premium or Standard Veneer
- Top Material
- Finish/Color
- No Molding
- Top Grommet Location/Color

SINGLE PED RECEPTION CREENZA FILE/FILE

Left Ped	Right Ped	Width	Depth	Height	K	R	Ship Wt	Cubic Ft	List Price
46-2472RCL <i>Worksurface 70W x 22D; Legal Ped</i>	46-2472RCR	72	24	40⅞	32¼	-	264	46.8	W/P\$ 6612 PV\$ 7405
46-2466RCL <i>Worksurface 64W x 22D; Letter Ped</i>	46-2466RCR	66	24	40⅞	26¼	-	249	43.0	W/P\$ 6509 PV\$ 7291

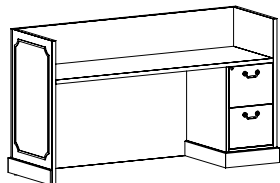

Shown as Right

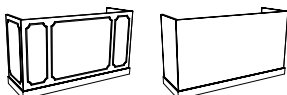

Approach Side Shown with Decorative Molding and Optional No Molding

Description

- Standard with: Rectangle Top with Square Profile, Base Molding on All Sides, Decorative Molding on Approach and Both Sides, Locking File/File Ped, Left-to-Right Grain Direction on Top, and Dovetail Wood Drawer Construction
- Chassis Available with Premium Veneer (PV) or Standard Veneer (W); Must Specify
- Top Available with Premium/Standard Veneer (PV/W) or HPL (P); Must Specify
- Lock Core Color will Coordinate with Pull Selection (Brass Pull with Black Lock, Silver Pull with Silver Lock)
- Additional Options: No Decorative Molding (Specify NO MOLDING); Soft Close Drawer Closure ([See Soft Close Options](#)); Top Grommet Options ([See Grommet Options](#)); Wire Management + Accessories (Sold Separately; [See Accessories](#))

Must Specify (in this order):

- Model #
- Premium or Standard Veneer
- Top Material
- Finish/Color
- Pull
- Back Panel Grommet Color
- No Molding
- Drawer Track
- Top Grommet Location/Color

[See Jefferson Reception Intro For Ordering Options](#)

RECEPTION DESK TACKBOARDS
9" H



Model #	For Units:	COM YDG	COM, 1, 2, or 3	GRADES						
				4	5	6	7	8	9	10
TB-6172	72"	2.25	\$ 256	569	715	864	1075	1296	1552	1849
TB-6166	66"	2.00	\$ 232	510	640	772	960	1156	1384	1648

Must Specify (in this order):
Model #
Fabric Vendor, Pattern, and Color

- Description**
- Coordinates with Reception Desks
 - Factory Installed

Item	Model No.	Width	Depth	Height	Ship Wt	Cubic Ft	List Price
KEYBOARD FLIP DOWN CENTER DRAWER	46-2410FD	24	15¾	3⅙	12	2.0	W\$ 988 PV\$ 1106



Must Specify (in this order):
Model #
Premium or Standard Veneer Finish
Pull
Factory Installed

- Description**
- Flip Down Front
 - Available with Premium Veneer (PV) or Standard Veneer (W); Must Specify
 - Does Not Feature Soft Close Hinges
 - Use on Any Open Kneespace 24" or Larger

Options: Specify & Add
Factory Installed - Must Specify \$ 208

ARTICULATING KEYBOARD CORNER PLATFORM	01-KB2CC	25	10½	4½	16	1.4	\$ 832
---------------------------------------	----------	----	-----	----	----	-----	--------

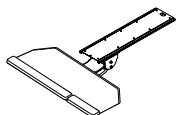

Must Specify (in this order):
Model #
Factory Installed

- Description**
- Standard With: 25" Cut Corner Platform, +/- 15° Tilt Adjustment, 360° Rotation, 21" Track, Independent Tilt Adjustment, 7" Locking Height Adjustment
 - Keyboard and Mouse on Same Level
 - Single Palm Rest for Both Left and Right Hands
 - Works with 17"+ Diagonal Work Surface
 - Cannot Be Used on 20" or 21" Deep Unit
 - Not Available with Optional Center Grommet

KEYBOARD MECHANISM WITH KEYBOARD CLAMP	01-KB3	9	17	6	13	1.0	\$ 914
--	--------	---	----	---	----	-----	--------

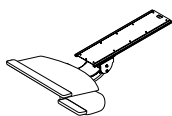

Must Specify (in this order):
Model #
Factory Installed

- Description**
- Standard With: 18.75" Platform, Left or Right Handed Swivel Mouse Platform, Palm Rest, 7" Locking Height Adjustment, +/- 15° Tilt Adjustment, 360° Rotation, Independent Tilt Adjustment, 21" Track
 - Cannot Be Used on 20" or 21" Deep Unit
 - Not Available with Optional Center Grommet

Item	Model No.		Width	Depth	Height	Ship Wt	Cubic Ft	List Price
ROUND GROMMET COVER	01-GRMTBK	Black	2 $\frac{9}{25}$ "	2 $\frac{9}{25}$ "	-	1	0.1	\$ 11
	01-GRMTSL	Silver						



OPEN MARKET ONLY
(SILVER)

Must Specify (in this order):
Model #
Factory Installed

Description

- 2 $\frac{9}{25}$ " (60mm) Round Grommet Cover
- Field Installed

SINGLE POWER SAND DOLLAR	01-SAND60PW	White	3	3	4	1	0.2	\$ 98
--------------------------	-------------	-------	---	---	---	---	-----	-------



01-SAND60PB	Black
01-SAND60PS	Silver

Description

- Unit is 2" Diameter; Mounts in 60mm Round Grommet
- 6' Cord
- Single Power Outlet

DOUBLE USB SAND DOLLAR	01-SAND60UW	White	3	3	4	1	0.2	\$ 277
------------------------	-------------	-------	---	---	---	---	-----	--------



01-SAND60UB	Black
01-SAND60US	Silver

Description

- Unit is 2" Diameter; Mounts in 60mm Round Grommet
- 6' Cord
- Dual USB Outlets

[See Jefferson Reception Intro For Ordering Options](#)

Item	Model No.		Width	Depth	Height	Ship Wt	Cubic Ft	List Price	
DUO BEZEL CLAMP NEMA PLUG	01-DUOCLAMPW	White	5½	3	7	1	0.2	\$ 572	
	01-DUOCLAMPB	Black							
	01-DUOCLAMPS	Silver							
		Description							
		<ul style="list-style-type: none"> Standard with: Two Power Outlet, Two USB Ports, 10' Cord Clamps to Top and Features Silver Metal Trim Independent USB Circuit Controllers Deliver up to 2.1 Amps to Each Post All Mounting Hardware Included FCC Part 15A and UL Approved for Horizontal and Vertical Applications 							
TRIO BEZEL CLAMP NEMA PLUG	01-TRIOCLAMPW	White	8	3	7	1	0.2	\$ 671	
	01-TRIOCLAMPB	Black							
	01-TRIOCLAMPS	Silver							
		Description							
		<ul style="list-style-type: none"> Standard with: Three (3) Power Outlets, Two (2) USB Ports, One (1) Open Data, 10' Cord Clamps to Top and Features Silver Metal Trim Independent USB Circuit Controllers Deliver up to 2.1 Amps to Each Post HDMI, VGA, or RJ45 Accessories Sold Separately (See Below) All Mounting Hardware Included FCC Part 15A and UL Approved for Horizontal and Vertical Applications 							
TRIO VGA DATA PORT ACCESSORY	01-LCOMVGA		-	-	-	1	0.2	\$ 121	
		Description							
		<ul style="list-style-type: none"> VGA Port for Trio Bezel Units 							
TRIO HDMI DATA PORT ACCESSORY	01-LCOMHDMI		-	-	-	1	0.2	\$ 166	
		Description							
		<ul style="list-style-type: none"> HDMI Port for Trio Bezel Units 							
OPEN MARKET ONLY									
TRIO RJ45 DATA PORT ACCESSORY	01-LCOMRJ45		-	-	-	1	0.2	\$ 79	
		Description							
		<ul style="list-style-type: none"> RJ45 Port for Trio Bezel Units 							

[See Jefferson Reception Intro For Ordering Options](#)

Item	Model No.	Width	Depth	Height	Ship Wt	Cubic Ft	List Price
VESTA POWER CENTER	01-PDCTR	10¾	12	28¼	14	2.5	\$ 1776

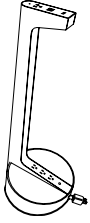

Description

- Top Includes One (1) Power Outlet, Two (2) USB Ports and One (1) USBC Port; Base Includes Three (3) Outlet
- Available in White
- 120" Power Cord
- Built with Weight Distribution for Optimal Stability
- Base is 5" Tall

POWER STRIP	01-PRSP	9	2	2	1	-	\$ 205
-------------	---------	---	---	---	---	---	--------

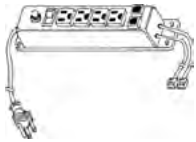

Description

- Four (4) Outlets
- Two (2) Phone Jacks
- Rocker Switch
- Black Plastic
- Suitable for Surface or Recessed Mounting
- 13 Amp Circuit Breaker
- 10' Power Cord
- Two (2) 14 ft. Phone Hook Up Cords
- UL and CSA Recognized
- Item will ship via UPS only

HEIGHT ADJUSTABLE WORKSTATION	01-S2SBLK Black	35½	25	6-22	49	6.5	\$ 1503
-------------------------------	--------------------	-----	----	------	----	-----	---------

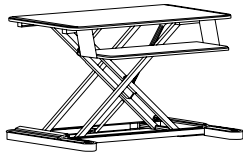

Description

- Height Adjustable
- Weight Capacity: 35lbs
- One-Handed Operation; Platforms Move Simultaneously
- Keyboard Platform: 10½"D x 26½"W
- Worksurface: 21"D x 35½"W
- Can be Used on Worksurface 24"D x 35"W

[See Jefferson Reception Intro For Ordering Options](#)

Item	Model No.		Width	Depth	Height	Ship Wt	Cubic Ft	List Price
LINK 360 CABLE MANAGER	01-0251LINKSLV	Silver	5 $\frac{3}{16}$	3 $\frac{3}{16}$	30-51	4	3.0	\$ 390
	01-0251LINKBLK	Black	5 $\frac{3}{16}$	3 $\frac{3}{16}$	30-51	4	3.0	\$ 353

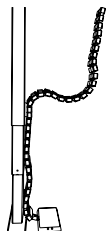

Description

- Kit Includes: 50 Link 360™ elements, One (1) Quad Connector, One (1) Dumbbell Connector, One (1) Foot Assembly with Two (2) Magnetic Clips
- Can Be Used For Height-Adjustable Mechanisms Up To 51" or Free-Standing Use

WIRE MANAGEMENT CHANNEL	01-WMGR4		16	1 $\frac{1}{2}$	1	1	-	\$ 116
-------------------------	----------	--	----	-----------------	---	---	---	--------

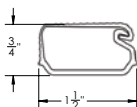

Description

- Set of Four (4) Black Plastic Wire Management Channels
- Snap Lock Channel
- Attaches with Adhesive Strips
- Ships via UPS Only

WIRE CHANNEL	01-32125		24	1 $\frac{5}{8}$	1	.25	0.3	\$ 106
--------------	----------	--	----	-----------------	---	-----	-----	--------

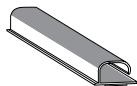

Description

- Available in Black
- Channels Attach with Two (2) Double-Sided Installation Tape
- Open J Channel for Easy Storage of Cables

CABLE GRIP	01-WMGRCB		5 $\frac{3}{8}$	2 $\frac{5}{8}$	-	-	-	\$ 17
------------	-----------	--	-----------------	-----------------	---	---	---	-------

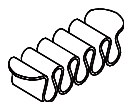

Description

- Under Surface Wire Management
- Black

Accessories

Item	Model No.		Width	Depth	Height	Ship Wt	Cubic Ft	List Price
CPU HOLDER	01-CPUMINIA	Aluminum	-	-	-	16	.4	\$ 387

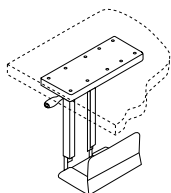

Description

- Vertically Mounts to Undersurface; No Tools Required for Adjustment
- 360° Swivel
- 13 $\frac{1}{2}$ " Ball Bearing Glide Track
- 3 $\frac{1}{4}$ "W-6"W and 16"H - 23"H Adjustment
- 55lb Load Capacity
- Fits CPU's 5"H - 20"H Overall Height

DUAL ARTICULATING MONITOR ARM	01-MLEDGE2A	Aluminum	-	-	-	15	1.4	\$ 1313
	01-MLEDGE2B	Black						

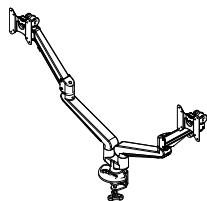

Description

- Dual Mount with Independent Adjustment
- 180° Lockout Feature
- 6.5"H to 19.5"H Adjustment
- 21" Monitor Extension
- 3.5" Monitor Retraction
- +30/-25° Monitor Tilt; 360° Swivel at Two Points
- 17.6lb Weight Capacity per Arm
- Enclosed Cable Management
- VESA 75mm and VESA 100mm Compatible with Quick Monitor Release
- Includes Desk Clamp and Grommet Mount

SINGLE MONITOR ARM	01-MLEDGE1A	Aluminum	-	-	-	13	2.2	\$ 773
	01-MLEDGE1B	Black						

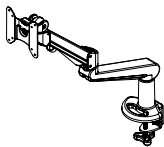

Description

- Includes Desk Clamp and Grommet Mount
- 180° Lockout Feature
- 6.5"H to 19.5"H Adjustment
- 21" Monitor Extension
- 3.5" Monitor Retraction
- +30/-25° Monitor Tilt
- 17.6lb Weight Capacity
- Enclosed Cable Management
- VESA 75mm and VESA 100mm Compatible with Quick Monitor Release

Item	Model No.	Width	Depth	Height	Ship Wt	Cubic Ft	List Price
ARTICULATING KEYBOARD CORNER PLATFORM	01-KB2CC	25	10½	4½	16	1.4	\$ 832

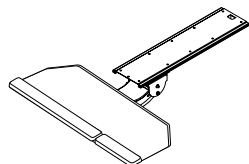
**Description**

- Works with 17"+ Diagonal Work Surface; 25" Cut Corner Platform
- Keyboard and Mouse on Same Level with Single Palm Rest on Both Sides
- +/- 15° Tilt Adjustment & 360° Rotation
- Independent Tilt Adjustment; Lift & Lock 7"H Adjustment
- Cannot Be Used on 20"D Unit
- Not Available with Optional Center Grommet
- Track Measures 21"

Options: Specify & Add

KB2CC	Factory Installed	\$ 208
-------	-------------------	--------

KEYBOARD MECHANISM WITH
 KEYBOARD PLATFORM AND
 MOUSE TRAY AND PALM REST

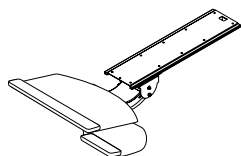

01-KB3	26½	14	4.5	16	1.4	\$ 914
--------	-----	----	-----	----	-----	--------

Description

- 18¾" Platform with Swivel-Below Mouse Platform
- Palm Rest for Mousing Surface
- +/- 15° Tilt Adjustment & 360° Rotation
- Independent Tilt Adjustment; Lift & Lock 7"H Adjustment
- Cannot Be Used on 20" Deep Unit
- Left or Right Handed Mouse Platform
- Not Available with Optional Center Grommet
- Track Measures 21"

Options: Specify & Add

KB3	Factory Installed	\$ 208
-----	-------------------	--------

LED TASKLIGHT

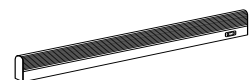

TL-0848	47½	7/8	1 5/8	-	-	\$ 445
<i>240-LED, 18 Watts</i>						
TL-0824	22½	7/8	1 5/8	-	-	\$ 368
<i>84-LED, 7 Watts</i>						

Description

- Includes the Power Supply and Three (3) Upper Wire Management Grommet
- Rocker Style On/Off Switch with 10' Power Cord
- Grommet Color will Match Lower Grommet Color

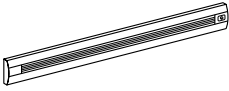
Item	Model No.	Width	Depth	Height	Ship Wt	Cubic Ft	List Price
	01-188LED58 <i>96-LED, 33.7 Watts</i>	57 $\frac{3}{8}$ "	2"	$\frac{3}{4}$ "	-	-	\$ 1648
	01-94LED31 <i>48-LED, 17.6 Watts</i>	30 $\frac{1}{8}$ "	2"	$\frac{3}{4}$ "	-	-	\$ 1195
	01-47LED17 <i>24-LED, 9.1 Watts</i>	16 $\frac{3}{8}$ "	2"	$\frac{3}{4}$ "	-	-	\$ 690

Description

- Includes the Power Supply and Three (3) Upper Wire Management Grommet
- 12' Power Cord
- Grommet Color will Match Lower Grommet Color
- Optional Occupancy Sensor Shuts Off After 30 Minutes of Inactivity and Turns On Immediately When Reentering the Detection Area

Options: Specify & Add

01-OSRP	Occupancy Sensor						\$ 366
---------	------------------	--	--	--	--	--	--------

RECTANGULAR GROMMET	01-HUGRMTSL	Silver	-	-	-	1	.1	\$ 11
---------------------	-------------	--------	---	---	---	---	----	-------

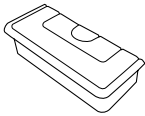

OPEN MARKET ONLY

Description

- For Use with Surface Mount Hatches Only
- 70mm x 30mm Silver Rectangular Grommet with Cover
- Field Installed

ROUND GROMMET COVER FIELD INSTALLED	01-GRMTBK	Black	-	-	-	-	-	\$ 11
	01-GRMTSL	Silver						

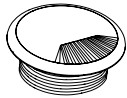

OPEN MARKET ONLY
(SILVER)

Description

- 60mm Round Grommet Cover
- Field Installed

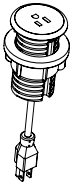
	01-SAND60PW	White	3	3	4	1	0.2	\$ 98
	01-SAND60PB	Black						
	01-SAND60PS	Silver						

Description

- Unit is 2" Diameter; Mounts in 60mm Round Grommet
- 6' Cord
- Single Power Outlet

Item	Model No.		Width	Depth	Height	Ship Wt	Cubic Ft	List Price
DOUBLE USB SAND DOLLAR	01-SAND60UW	White	3	3	4	1	0.2	\$ 277
	01-SAND60UB	Black						
	01-SAND60US	Silver						

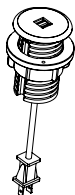

Description

- Unit is 2" Diameter; Mounts in 60mm Round Grommet
- 6' Cord
- Dual USB Outlets

DOCK 950 WIRELESS CHARGER	01-DOCK950W	White	3 $\frac{3}{16}$	3 $\frac{3}{16}$	-	1	0.2	\$ 265
	01-DOCK950B	Black						



OPEN MARKET ONLY

Description

- For Use with Wireless Charging Enabled Devices
- 5 Watts Maximum Output with a Direct Current of 5V 2A and 10 Watts Maximum with Quick Charge 2.0
- Mounts in 76mm Round Cut-Out
- LED will Confirm Pairing with Device and Begin Wireless Charging

DOCK 150 WIRELESS AND USB CHARGER	01-DOCK150W	White	3	3	$\frac{3}{4}$	1	0.2	\$ 405
	01-DOCK150B	Black						

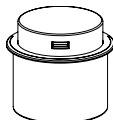

OPEN MARKET ONLY

Description

- For Use with Wireless Charging Enabled Devices and USB Charging Devices
- 5 Watt Maximum Output with a Direct Current Input of 5V 6A (Wireless Fast Charge)
- Mounts in 76mm Round Cut-Out
- Pop-Up is $\frac{3}{4}$ "H and Includes Three (3) USB Ports; One (1) 12 Watt Maximum with 2.4A (USB Fast Charge) and Two (2) 5 Watt with 1A (USB Standard Charge)
- LED Light will Confirm Pairing with Device and Begin Wireless Charging
- UL and cUL Certified

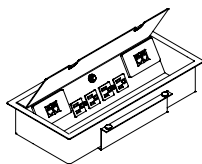

POWER CENTER	01-INTRFC1A	Aluminum	14 $\frac{1}{4}$	6 $\frac{3}{8}$	3 $\frac{3}{8}$	11	0.3	\$ 2064
	01-INTRFC1B	Black						



Description

- Four (4) Power Receptacles in Two (2) 15 Amp Duplexes
- One (1) 15 Amp Circuit Breaker
- One (1) Voice Port and Three (3) Data Ports
- One (1) Convenience Plug on Bottom
- 6' Foot Cord
- UL Listed/CSA Certified

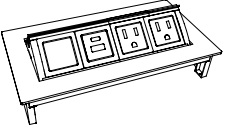
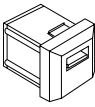
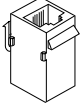
NOTE: To order voice/data modules for your specific requirements contact the local computer or telecommunications installation service in your area.

Item	Model No.		Width	Depth	Height	Ship Wt	Cubic Ft	List Price
INTERACT POWER AND DATA	01-INTERACTG2A	Aluminum	9	5 $\frac{3}{8}$	2 $\frac{3}{4}$	5	0.2	\$ 891
	01-INTERACTG2B	Black						
	Description <ul style="list-style-type: none"> • Two (2) Power Outlets, Two (2) USB Connections, One (1) Data, One (1) Voice Telecom Plate Included • Shown with Optional Telecom Plates; Sold Separately (See Telecom Plates) • Convenience Plug on Bottom • 6' Power Cord • UL and CSA Recognized 							
DATA PORT 4	01-DPORT4A	Aluminum	8	4	—	7	0.2	\$ 1093
	01-DPORT4B	Black						
	Description <ul style="list-style-type: none"> • Retracts into Work Surface to Regain Productive Space • One-Touch Access to Power and Data • Two (2) Water-Proof Simplex Power Outlets, One (1) USB A+C, and One (1) Open Port • Optional Telecom Port Components, See Below • Includes a Voice/Data Adapter Kit to Accept Couplers and Jacks When Required • 10' Power Cord 							
USB PORT	01-USBPORT		-	-	-	-	-	\$ 161
	Description <ul style="list-style-type: none"> • Passive USB-A Port with Increased Transfer Speed Up to 5 gbs/sec • For Use with 01-DPORT4A and 01-DPORT4B • Simultaneous Read/Write Capability • Idle Device Power Saving State 							
VOICE COUPLER	01-VOICE1		-	-	-	-	-	\$ 73
	Description <ul style="list-style-type: none"> • For Use with 01-DPORT4A and 01-DPORT4B • 6-Pin Modular Plug • Molded Black • Cord Not included 							
DATA PORT	01-RJ4DATA		-	-	-	-	-	\$ 167
	Description <ul style="list-style-type: none"> • For Use with 01-DPORT4A and 01-DPORT4B • 8-Pin Modular Plug, Cat6 Ethernet Cable, Pre-terminated Cable • 10' Cord 							

Item	Model No.		Width	Depth	Height	Ship Wt	Cubic Ft	List Price
POWER 440	01-DATA440A	Aluminum	5 ⁵ / ₁₆	4 ³ / ₈	—	5	0.2	\$ 964
	01-DATA440B	Black						

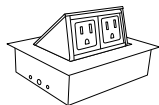

Description

- Two (2) Power Outlets
- Soft Touch Hinged Lid
- 6' Power Cord

POWER AND DATA VAULT	01-CVAULTG2A	Silver	4 ¹ / ₂	15 ⁷ / ₈	4 ¹ / ₁₆	10	0.4	\$ 1944
----------------------	--------------	--------	-------------------------------	--------------------------------	--------------------------------	----	-----	---------



OPEN MARKET ONLY

Description

- Electric Drive Motor Rotates the Surface Technology 180° to the Proper Position
- Photo-Electronic Eye Prevents Rotation When Obstructed
- Two (2) Data Ports, Three (3) Power Outlets, One (1) HDMI and Two (2) 5V USB
- 6' Power Cord

OASIS MINI POWER & DATA	01-OASISMA	Aluminum	15	9	4 ¹⁵ / ₁₆	7	0.7	\$ 3191
	01-OASISMB	Black						



Top View

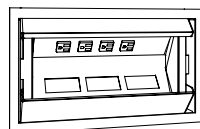

Description

- Includes Four (4) Power Outlets, Two (2) Data Ports, and One (1) Voice Telecom Plate
- Soft Touch Hinged Lid
- 9' Cord with Nema Plug; Fits 15A/120V AC Receptacles
- UL Listed
- Opening for One (1) Additional Telecom Plate; Sold Separately ([See Telecom Plates](#))

DUO BEZEL NEMA PLUG	01-DUOBEZELW	White	6 ¹ / ₂	2 ⁵ / ₈	3	1	0.2	\$ 675
	01-DUOBEZELB	Black						
	01-DUOBEZELS	Silver						

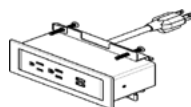

Description

- Sits On Top of the Worksurface
- Two (2) Power/Two (2) USB Power
- Independent USB Circuit Controllers Deliver up to 2.1 Amps to Each Post
- All Mounting Hardware Included
- FCC Part 15A and UL Approved for Horizontal and Vertical Applications
- 10' Cord

Item	Model No.		Width	Depth	Height	Ship Wt	Cubic Ft	List Price
	01-TRIOBEZELW	White	9	2½	3	1	0.2	\$ 725
	01-TRIOBEZELB	Black						
	01-TRIOBEZELS	Silver						

Description

- Sits On Top of the Worksurface
- Three (3) Power/Two (2) USB Power/One (1) Open Data
- Independent USB Circuit Controllers Deliver up to 2.1 Amps to Each Post
- HDMI, VGA, or RJ45 Sold Separately; [See Accessories](#)
- All Mounting Hardware Included
- FCC Part 15A and UL Approved for Horizontal and Vertical Applications
- 10' Cord

DUO BEZEL HARD WIRE

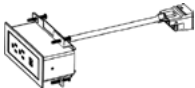

Circuit 1

01-HWDUOBEZELW1	White	6½	2½	3	1	0.2	\$ 730
01-HWDUOBEZELB1	Black						
01-HWDUOBEZELS1	Silver						

Circuit 2

01-HWDUOBEZELW2	White	6½	2½	3	1	0.2	\$ 730
01-HWDUOBEZELB2	Black						
01-HWDUOBEZELS2	Silver						

Circuit 3

01-HWDUOBEZELW3	White	6½	2½	3	1	0.2	\$ 730
01-HWDUOBEZELB3	Black						
01-HWDUOBEZELS3	Silver						

Circuit 4

01-HWDUOBEZELW4	White	6½	2½	3	1	0.2	\$ 730
01-HWDUOBEZELB4	Black						
01-HWDUOBEZELS4	Silver						

Description

- Must Specify Color and Circuit
- Sits on worksurface and includes: Two (2) Power, Two (2) USB Power, and all mounting hardware
- Independent USB Circuit Controllers Deliver up to 2.1 Amps to Each Post
- FCC Part 15A and UL Approved for Horizontal and Vertical Applications
- Maximum 10 Duo Units per Circuit
- Eight (8) Wire/Four (4) Circuit Hard Wire Power Unit

Item	Model No.		Width	Depth	Height	Ship Wt	Cubic Ft	List Price	
TRIO BEZEL HARD WIRE 	Circuit 1								
	01-HWTRIOBEZELW1	White	9	2½	3	1	0.2	\$ 749	
	01-HWTRIOBEZELB1	Black							
	01-HWTRIOBEZELS1	Silver							
	Circuit 2								
	01-HWTRIOBEZELW2	White	9	2½	3	1	0.2	\$ 749	
	01-HWTRIOBEZELB2	Black							
	01-HWTRIOBEZELS2	Silver							
	Circuit 3								
	01-HWTRIOBEZELW3	White	9	2½	3	1	0.2	\$ 749	
	01-HWTRIOBEZELB3	Black							
	01-HWTRIOBEZELS3	Silver							
Circuit 4									
01-HWTRIOBEZELW4	White	9	2½	3	1	0.2	\$ 749		
01-HWTRIOBEZELB4	Black								
01-HWTRIOBEZELS4	Silver								

Description

- Must Specify Color and Circuit
- Sits on worksurface and includes: Three (3) Power, Two (2) USB Power, and all mounting hardware
- Independent USB Circuit Controllers Deliver up to 2.1 Amps to Each Post
- FCC Part 15A and UL Approved for Horizontal and Vertical Applications
- Maximum 6 Trio Units per Circuit
- Eight (8) Wire/Four (4) Circuit Hard Wire Power Unit

QUAD BLOCK HARD WIRED	01-HWQUADBLOCK					1	0.2	\$ 62
------------------------------	----------------	--	--	--	--	---	-----	-------

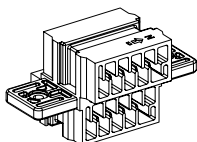

Description

- Eight (8) Wire/Four (4) Circuit Hard Wire Connector
- UL183 Compliant
- For Connecting Jumpers and Power Units
- Quantity of Four (4) Female Inputs

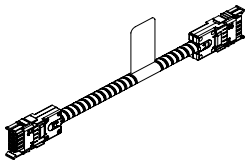
JUMPER HARD WIRE CABLE 	01-HW6JUMP		72	-	-	1	0.2	\$ 270
	01-HW5JUMP		60	-	-	1	0.2	\$ 255
	01-HW4JUMP		48	-	-	1	0.2	\$ 212
	01-HW3JUMP		36	-	-	1	0.2	\$ 206
	01-HW2JUMP		24	-	-	1	0.2	\$ 193

Description

- Eight (8) Wire/Four (4) Circuit Hard Wire Jumper
- UL183 Compliant

Item	Model No.	Width	Depth	Height	Ship Wt	Cubic Ft	List Price
POWER ENTRY HARD WIRED	01-HWPOWERENTRY	72	-	-	1	0.2	\$ 322

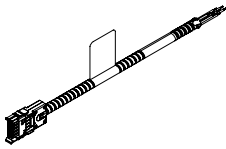

Description

- Eight (8) Wire/Four (4) Circuit Hard Wire Infeed
- UL183 Compliant

Item	Model No.	Color	Width	Depth	Height	Ship Wt	Cubic Ft	List Price
DUO BEZEL DAISY CHAIN PLUG	01-PDUOBEZELW	White	6½	2½	3	1	0.2	\$ 668
	01-PDUOBEZELB	Black						
	01-PDUOBEZELS	Silver						

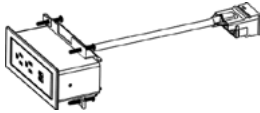

Description

- Sits On Top of the Worksurface
- Two (2) Power/Two (2) USB Power
- Independent USB Circuit Controllers Deliver up to 2.1 Amps to Each Post
- All Mounting Hardware Included
- FCC Part 15A, RU Listed and UL Recognized for Horizontal and Vertical Applications
- Non Sequential System Allows Up to Eight (8) Modules To Be Connected With Jumper Cord
- Requires Power Box
- 12" Cord

Item	Model No.	Color	Width	Depth	Height	Ship Wt	Cubic Ft	List Price
TRIO BEZEL DAISY CHAIN PLUG	01-PTRIOBEZELW	White	9	2½	3	1	0.2	\$ 715
	01-PTRIOBEZELB	Black						
	01-PTRIOBEZELS	Silver						

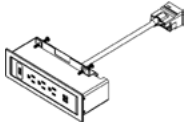

Description

- Sits On Top of the Worksurface
- Three (3) Power/Two (2) USB Power/One (1) Open Data
- HDMI, VGA, or RJ45 Sold Separately; [See Accessories](#)
- All Mounting Hardware Included
- FCC Part 15A, RU Listed and UL Recognized for Horizontal and Vertical Applications
- Non Sequential System Allows Up to Eight (8) Modules To Be Connected With Jumper Cord
- Requires Power Box
- 12" Cord

Item	Model No.	Width	Depth	Height	Ship Wt	Cubic Ft	List Price
DAISY CHAIN POWER BOX	01-PPOWER2 24" Perimeter, 144" Power Cord	-	-	-	1	0.2	\$ 796
	01-PPOWER 76" Perimeter, 36" Power Cord	-	-	-	1	0.2	\$ 775



Description

- Powers up to Eight (8) Duo and Trio Daisy Chain Units
- One (1) Nema Plug and One (1) Daisy Chain Plug
- 12 Amp System Rating
- 15 Amp Over-Current Protection

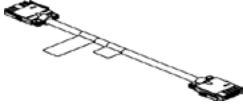
Item	Model No.		Width	Depth	Height	Ship Wt	Cubic Ft	List Price
 DAISY CHAIN JUMPER CORD	01-6JUMP	72" Long	-	-	-	1	0.2	\$ 299
	01-5JUMP	60" Long	-	-	-	1	0.2	\$ 284
	01-4JUMP	48" Long	-	-	-	1	0.2	\$ 240
	01-2JUMP	24" Long	-	-	-	1	0.2	\$ 220

Description

- Connects Duo and Trio Daisy Chain Units
- Non Sequential System Allows up to Eight (8) Modules to be Connected

 DUO CLAMP NEMA PLUG	01-DUOCLAMPW	White	6½	3	7	1	0.2	\$ 572
	01-DUOCLAMPB	Black						
	01-DUOCLAMPS	Silver						

Description

- Standard with: Two (2) Power Outlet, Two (2) USB Ports, 10' Cord
- Clamps to Top and Features Silver Metal Trim
- Independent USB Circuit Controllers Deliver up to 2.1 Amps to Each Post
- All Mounting Hardware Included
- FCC Part 15A and UL Approved for Horizontal and Vertical Applications

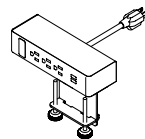
 TRIO CLAMP NEMA PLUG	01-TRIOCLAMPW	White	9	3	7	1	0.2	\$ 671
	01-TRIOCLAMPB	Black						
	01-TRIOCLAMPS	Silver						



Description

- Standard with: Three (3) Power Outlets, Two (2) USB Ports, One (1) Open Data, 10' Cord
- Clamps to Top and Features Silver Metal Trim
- Independent USB Circuit Controllers Deliver up to 2.1 Amps to Each Post
- HDMI, VGA, or RJ45 Sold Separately; See Below
- All Mounting Hardware Included
- FCC Part 15A and UL Approved for Horizontal and Vertical Applications

 TRIO VGA DATA PORT ACCESSORY	01-LCOMVGA		-	-	-	1	0.2	\$ 121
--	------------	--	---	---	---	---	-----	--------

Description

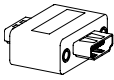
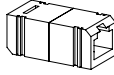
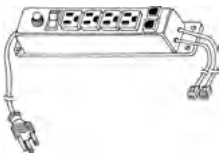
- VGA Port for Trio Bezel Units
- See HDMI and RJ45 Accessories on next page

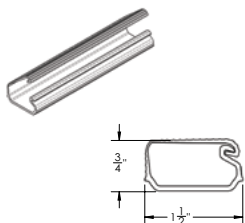
Item	Model No.	Width	Depth	Height	Ship Wt	Cubic Ft	List Price
TRIO HDMI DATA PORT ACCESSORY	01-LCOMHDMI	-	-	-	1	0.2	\$ 166
	Description						
	<ul style="list-style-type: none"> HDMI Port for Trio Bezel Units 						
OPEN MARKET ONLY							
TRIO RJ45 DATA PORT ACCESSORY	01-LCOMRJ45	-	-	-	1	0.2	\$ 79
	Description						
	<ul style="list-style-type: none"> RJ45 Port for Trio Bezel Units 						
POWER STRIP	01-PRSP	9	2	2	1	-	\$ 205
	Description						
	<ul style="list-style-type: none"> Includes Four (4) Outlets and Two (2) Phone Jacks Black Plastic with Rocker On/Off Switch 13 Amp Circuit Breaker 10' Power Cord and Two (2) 14' Phone Hook Up Cords UL Listed and CSA Certified Suitable for Surface or Recessed Mounting Ships via UPS Only 						
VESTA POWER CENTER	01-PDCTR	10 ³ / ₄	12	28 ¹ / ₄	14	2.5	\$ 1776
	Description						
	<ul style="list-style-type: none"> Top Includes One (1) Power Outlet, Two (2) USB Ports and One (1) USBC Port; Base Includes Three (3) Outlet Available in White 120" Power Cord Built with Weight Distribution for Optimal Stability Base is 5" Tall 						
WIRE MANAGEMENT CHANNEL	01-WMGR4	16	1 ¹ / ₂	1	1	-	\$ 116
	Description						
	<ul style="list-style-type: none"> Set of Four (4) Black Plastic Wire Management Channels Snap Lock Channel Attaches with Adhesive Strips Ships via UPS Only 						

Item	Model No.	Width	Depth	Height	Ship Wt	Cubic Ft	List Price
WIRE CHANNEL	01-32125	24	1 7/8	1	.25	0.3	\$ 106

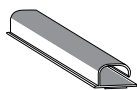

Description

- Available in Black
- Channels Attach with Two (2) Double-Sided Installation Tape
- Open J Channel for Easy Storage of Cables

LINK 360 CABLE MANAGER	Model No.	Color	Width	Depth	Height	Ship Wt	Cubic Ft	List Price
	01-0251LINKSLV	Silver	5 3/8	3 3/8	30-51	4	3.0	\$ 390
	01-0251LINKBLK	Black	5 3/8	3 3/8	30-51	4	3.0	\$ 353

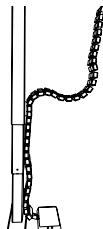

Description

- Kit Includes: 50 Link 360™ elements, One (1) Quad Connector, One (1) Dumbbell Connector, One (1) Foot Assembly with Two (2) Magnetic Clips
- Can Be Used For Height-Adjustable Mechanisms Up To 51" or Free-Standing Use

CABLE GRIP	Model No.	Width	Depth	Height	Ship Wt	Cubic Ft	List Price
	01-WMGRCB	5 3/8	2 5/8	-	-	-	\$ 17

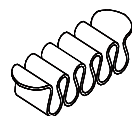

Description

- Under Surface Wire Management
- Black

HEIGHT ADJUSTABLE WORKSTATION	Model No.	Color	Width	Depth	Height	Ship Wt	Cubic Ft	List Price
	01-S2SBLK	Black	35 1/2	25	6-22	49	6.5	\$ 1503

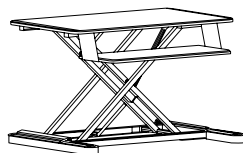

Description

- Height Adjustable
- Weight Capacity: 35lbs
- One-Handed Operation; Platforms Move Simultaneously
- Keyboard Platform: 10 1/2"D x 26 1/8"W
- Worksurface: 21"D x 35 1/2"W
- Can be Used on Worksurface 24"D x 35"W

HEIGHT ADJUSTABLE PNEUMATIC X-BASE	Model No.	Color	Width	Depth	Height	Ship Wt	Cubic Ft	List Price
Maximum Round 42", Maximum Square 36"								
	01-3232HAXBB	Black	32	32	26	1	0.2	\$ 1721
	01-3232HAXBA	Aluminum						
Maximum Round 36", Maximum Square 30"								
	01-2626HAXBB	Black	22	22	26	1	0.2	\$ 1687
	01-2626HAXBA	Aluminum						

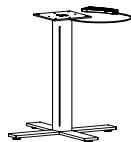

Description

- Pre-Drilled Boring Pattern May Not Match Underside of Table Top
- Steel Mounting Plate: 8"x 8"x 1/4"
- Some Assembly Required; Hardware Included

Item	Model No.		Width	Depth	Height	Ship Wt	Cubic Ft	List Price
28"D ELECTRIC HEIGHT ADJUSTABLE TABLE LIFT	01-2854ELB	Black	54-78	28	22-48	30	2.4	\$ 1832
	01-2854ELA	Silver						

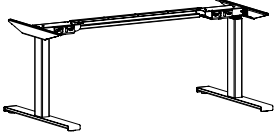
Description

- Standard with Up/Down Control Switch, 10' Power Cord, Integrated Anti-Collision Feature, Leveling Glides
- Standard Up/Down Control Switch can be Mounted for Left or Right Users; Upgrade to Advanced Memory Switch (01-MSWCH with Memory, Reminders, and Bluetooth), Must Specify and See Below for Details
- Adjusts to Accommodate Tops 54-78"W and 30"-36"D; Tops Sold Separately
- Lifting Capacity (Including Worksurface): 363 lbs
- Some Assembly Required; Installation Instructions Included

22"D ELECTRIC HEIGHT ADJUSTABLE TABLE LIFT	01-2254ELB	Black	54-78	22	22-48	58	2.4	\$ 1832
	01-2254ELA	Silver						

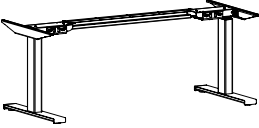
Description

- Standard with Up/Down Control Switch, 10' Power Cord, Anti-Collision Safety Feature, Leveling Glides
- Standard Up/Down Control Switch can be Mounted for Left or Right Users; Upgrade to Advanced Memory Switch (01-MSWCH with Memory, Reminders, and Bluetooth), Must Specify and See Below for Details
- Adjusts to Accommodate Tops 54-78"W and 24"D; Tops Sold Separately
- Lifting Capacity (Including Worksurface): 363 lbs
- Some Assembly Required; Installation Instructions Included

22"D ELECTRIC HEIGHT ADJUSTABLE TABLE LIFT	01-2242ELB	Black	42-48	22	22-48	55	2.4	\$ 1832
	01-2242ELA	Silver						

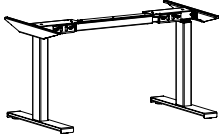
Description

- Standard with Up/Down Control Switch, 10' Power Cord, Anti-Collision Safety Feature, Leveling Glides
- Standard Up/Down Control Switch can be Mounted for Left or Right Users; Upgrade to Advanced Memory Switch (01-MSWCH with Memory, Reminders, and Bluetooth), Must Specify and See Below for Details
- Adjusts to Accommodate Tops 42-48"W and 24"-30"D; Tops Sold Separately
- Lifting Capacity (Including Worksurface): 363 lbs
- Some Assembly Required; Installation Instructions Included

ELECTRIC HEIGHT ADJUSTABLE ADVANCED SWITCH WITH MEMORY	01-MSWCH		3 1/8	4 3/8	1 1/8	1/2	0.8	\$ 223
---	----------	--	-------	-------	-------	-----	-----	--------

Description

- Black Unit with Black Cord
- Bluetooth Capabilities
- Three Stand-Up Reminders
- Four Height Memory Positions

OPEN MARKET ONLY

Item	Model No.		Width	Depth	Height	Ship Wt	Cubic Ft	List Price
L SHELF  Must Specify (in this order): Model # Color	66-1596LS	192 lbs Weight Limit	96	15	17	85	18.3	T\$ 1147
	66-1590LS	192 lbs Weight Limit	90	15	17	80	17.2	T\$ 1090
	66-1584LS	154 lbs Weight Limit	84	15	17	75	16.0	T\$ 1034
	66-1578LS	154 lbs Weight Limit	78	15	17	70	14.9	T\$ 979
	66-1572LS	154 lbs Weight Limit	72	15	17	65	13.8	T\$ 922
	66-1566LS	128lbs Weight Limit	66	15	17	60	12.7	T\$ 869
	66-1560LS	128 lbs Weight Limit	60	15	17	55	11.6	T\$ 815
	66-1554LS	90 lbs Weight Limit	54	15	17	50	10.5	T\$ 761
	66-1548LS	90 lbs Weight Limit	48	15	17	45	9.3	T\$ 709
	66-1542LS	90 lbs Weight Limit	42	15	17	40	8.2	T\$ 656
	66-1536LS	64 lbs Weight Limit	36	15	17	35	7.1	T\$ 601
	66-1530LS	64 lbs Weight Limit	30	15	17	30	6.0	T\$ 546

Description

- Weight Capacity is a Distributed Load
- Not Liable for Wall Mount Units that are not Properly Installed

FLOATING SHELF

Must Specify (in this order):
 Model #
 Color

66-0996FS	123 lbs Weight Limit	96	9	1	20	2.2	T\$ 785
66-0990FS	123 lbs Weight Limit	90	9	1	19	2.1	T\$ 753
66-0984FS	99 lbs Weight Limit	84	9	1	18	1.9	T\$ 719
66-0978FS	99 lbs Weight Limit	78	9	1	16	1.8	T\$ 687
66-0972FS	99 lbs Weight Limit	72	9	1	16	1.6	T\$ 655
66-0966FS	82 lbs Weight Limit	66	9	1	14	1.5	T\$ 614
66-0960FS	82 lbs Weight Limit	60	9	1	13	1.4	T\$ 572
66-0954FS	57 lbs Weight Limit	54	9	1	12	1.3	T\$ 534
66-0948FS	57 lbs Weight Limit	48	9	1	10	1.1	T\$ 494
66-0942FS	57 lbs Weight Limit	42	9	1	9	0.9	T\$ 454
66-0936FS	40 lbs Weight Limit	36	9	1	8	0.8	T\$ 411
66-0930FS	40 lbs Weight Limit	30	9	1	6	0.7	T\$ 372

Description

- Weight Capacity is a Distributed Load
- Not Liable for Wall Mount Units that are not Properly Installed

Item	Model No.	Width	Depth	Height	Ship Wt	Cubic Ft	List Price
PLANTER BOX	01-1909PL	19¼	9½	6	16	2.0	T\$ 572

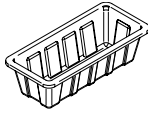
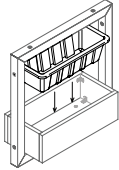
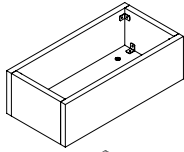

Description

- Material is TFL. Must Specify TFL (T) Color; [See Color Options](#)
- Planter Will Ship with Attachment Hardware: Two (2) Black and Two (2) Nickel Bolts
- Horizontal Grain
- Planter Boxes Cannot be Installed on Both Sides of a Corner
- Optional Planter Box Insert Sold Separately

Option: Specify & Add

PBI	Planter Box Insert, Black Plastic	\$	52
-----	-----------------------------------	----	----

Must Specify (in this order):

- Model #
- TFL Color
- Optional Planter Insert

Item	Model No.	Width	Depth	Height	Ship Wt	Cubic Ft	List Price
VISUAL BOARD	66-4848VB	48	5	48	150	11.0	T\$ 2770

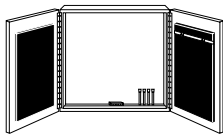

Description

- Standard with: Flipchart, Set of Four Dry Erase Markers, Eraser, Mounting Hardware, Tackboard on Each Door in Black Fabric, Display Rail with Adjustable Hooks for Flipchart
- Price Valid for Fabric Grades 1, 2, and 3, See Below For Higher Grade Fabric Pricing
- Does Not Feature Soft Close Hinges
- Magnetic Porcelain Non-Glare Writing Surface
- Find Textile Partners on Our Website; [Click Here](#)
- TFL Laminate Colors and Pulls can be Found Under Coordinating Casegoods Collections

Must Specify (in this order):

- Model #
- Color
- Tackboard Fabric Vendor, Pattern, and Color
- Pull
- Projection Screen Installation

Options: Specify & Add

		GRADE	4	5	6	7	8	9	10
TB-4214	Tackboard	\$	278	408	540	728	924	1152	1416
1-PS	Optional Factory Installed Projection Screen								\$ 1062

Item	Model No.	Material	Width	Depth	Height	Ship Wt	Options	List Price
LECTERN STAND	88-2650LS	TFL+HPL	24	23	49	130	21.9	F, G, Y / T+P\$ 1911
								H / T+P\$ 1921
		Veneer+HPL	F, G, Y / W+P\$ 3451					
			H / W+P\$ 3477					
Veneer	F, G, Y / W\$ 3587							
	H / W\$ 3601							

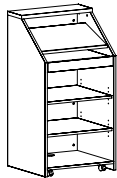

Description

- Top Edge Profiled on Approach Side Only (See Edge Options); Must Specify Edge Selection
- Fixed Shelf Angled for User Comfort, One (1) Pullout Shelf, and Two (2) Adjustable Shelves
- Two (2) Locking and Two (2) Non-Locking Casters
- Wire Management Grommet on Second and Bottom Shelf, Middle Shelf Features Wire Management Grommet Cut Out

Must Specify (in this order):

- Model #
- Color

ACCESSORIES

MAGNETIC GLASS MARKER BOARDS

Item	Model No.	Width	Depth	Height	Ship Wt	Cubic Ft	List Price
MAGNETIC GLASS MARKER BOARD	GMB-5248W	48	½	52⅞	86	13.5	\$ 3988
COORDINATES WITH 30"H DESKS AND CREDENZA AND TALL WALL MOUNT HUTCHES OR SHELVING	GMB-5242W	42	½	52⅞	76	12.2	\$ 3369
	GMB-5236W	36	½	52⅞	65	10.8	\$ 2904
	GMB-5230W	30	½	52⅞	54	9.5	\$ 2441

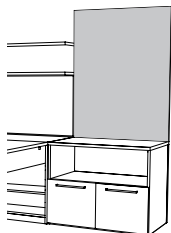

Description

- Available in Black (BLMKR) or White (WHMKR), Must Specify
- Mounting Brackets Included
- Coordinates With Tall Surface or Wall Mount Hutches
- See Rare Earth Magnets, Marker and Eraser Sets Below
- Find Additional Magnetic Glass Marker Boards in Casegoods Collections

Must Specify (in this order):

Model #
Color

MAGNETIC GLASS MARKER BOARD	GMB-8236W	36	½	82⅞	102	15.8	\$ 4453
FOR USE FROM FLOOR TO TOP OF UNIT	GMB-7036W	36	½	70⅞	87	13.8	\$ 3834
	GMB-5136W	36	½	51⅞	63	10.6	\$ 2802
	GMB-8230W	30	½	82⅞	85	13.8	\$ 3730
	GMB-7030W	30	½	70⅞	72	12.1	\$ 3215
	GMB-5130W	30	½	51⅞	53	9.3	\$ 2354

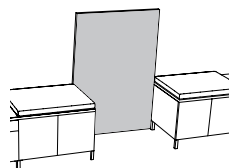

Description

- Available in Black (BLMKR) or White (WHMKR), Must Specify
- Marker Boards Are One (1) Piece with No Seams
- Mounting Brackets Included
- See Rare Earth Magnets, Marker and Eraser Sets Below
- Find Additional Magnetic Glass Marker Boards in Casegoods Collections

Must Specify (in this order):

Model #
Color

MARKER AND ERASER SET	01-MRKRSETBL	For Use with Black Marker Boards and Black Glass Doors	\$ 123
	01-MRKRSETWH	For Use with White Marker Boards and White Glass Doors	

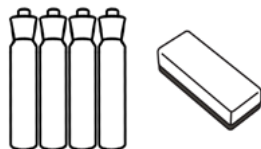

Description

- 01-MRKRSETWH May Also be Used with Standard Dry Erase Doors and Boards
- Includes Four (4) Markers and an Eraser

MAGNET SET	01-MAGBL	For Use with White Marker Boards	\$ 114
	01-MAGWH	For Use with Black Marker Boards	



Description

- Includes Set of Five (5) Magnets

23" TALL TOOL RAIL WORK WALL

FOR SURFACE OR WALL MOUNT HUTCHES AND 30"H CREENZA



Must Specify (in this order):

- Model #
- Tackboard on Top or Bottom
- Dry Erase on Top or Bottom
- Tackboard Fabric Vendor, Pattern, and Color

Tackboard/Dry Erase Locations

- TB-TB: Tackboard Over Tackboard (Use Grade Prices)
- DEB-TB: Dry Erase Over Tackboard (Use Grade Prices)
- DEB-DEB: Dry Erase Over Dry Erase (Use Grade 1 Prices)

Model #	Size	COM ydg	COM, 1, 2 or 3	Grades							
				4	5	6	7	8	9	10	
WW-23108TRH	108"	3.50	\$ 1715	2202	2429	2660	2989	3332	3731	4193	
WW-23102TRH	102"	3.25	\$ 1635	2087	2298	2513	2818	3137	3507	3936	
WW-2396TRH	96"	3.00	\$ 1565	1982	2177	2375	2657	2951	3293	3689	
WW-2390TRH	90"	2.75	\$ 1471	1853	2032	2214	2472	2742	3055	3418	
WW-2384TRH	84"	2.50	\$ 1334	1682	1844	2009	2244	2489	2774	3104	
WW-2378TRH	78"	2.50	\$ 1285	1633	1795	1960	2195	2440	2725	3055	
WW-2372TRH	72"	2.25	\$ 1023	1336	1482	1631	1842	2063	2319	2616	
WW-2366TRH	66"	2.00	\$ 967	1245	1375	1507	1695	1891	2119	2383	
WW-2360TRH	60"	2.00	\$ 910	1188	1318	1450	1638	1834	2062	2326	
WW-2354TRH	54"	1.75	\$ 887	1130	1244	1360	1524	1696	1895	2126	
WW-2348TRH	48"	1.50	\$ 806	1015	1112	1211	1352	1499	1670	1868	
WW-2342TRH	42"	1.25	\$ 745	919	1000	1083	1200	1323	1465	1630	
WW-2336TRH	36"	1.25	\$ 727	901	982	1065	1182	1305	1447	1612	
WW-2330TRH	30"	1.00	\$ 671	810	875	941	1035	1133	1247	1379	

Description

- Aluminum Tool Rail
- Work Walls 78" and Larger will Ship in 4 Pieces
- [See Work Wall Accessories](#)

31" TALL TOOL RAIL WORK WALL

FOR USE WITH WALL MOUNT HUTCHES AND 21"H CREENZA

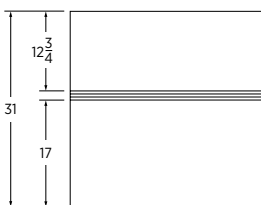

Must Specify (in this order):

- Model #
- Tackboard on Top or Bottom
- Dry Erase on Top or Bottom
- Tackboard Fabric Vendor, Pattern, and Color

Tackboard/Dry Erase Locations

- TB-TB: Tackboard Over Tackboard (Use Grade Prices)
- DEB-TB: Dry Erase Over Tackboard (Use Grade Prices)
- DEB-DEB: Dry Erase Over Dry Erase (Use Grade 1 Prices)

Model #	Size	COM ydg	COM, 1, 2 or 3	Grades							
				4	5	6	7	8	9	10	
WW-31108TTRW	108"	3.50	\$ 2159	2646	2873	3104	3433	3776	4175	4637	
WW-31102TTRW	102"	3.25	\$ 2044	2496	2707	2922	3227	3546	3916	4345	
WW-3196TTRW	96"	3.00	\$ 1969	2386	2581	2779	3061	3355	3697	4093	
WW-3190TTRW	90"	2.75	\$ 1854	2236	2415	2597	2855	3125	3438	3801	
WW-3184TTRW	84"	2.50	\$ 1658	2006	2168	2333	2568	2813	3098	3428	
WW-3178TTRW	78"	2.50	\$ 1585	1933	2095	2260	2495	2740	3025	3355	
WW-3172TTRW	72"	2.25	\$ 1318	1631	1777	1926	2137	2358	2614	2911	
WW-3166TTRW	66"	2.00	\$ 1265	1543	1673	1805	1993	2189	2417	2681	
WW-3160TTRW	60"	2.00	\$ 1191	1469	1599	1731	1919	2115	2343	2607	
WW-3154TTRW	54"	1.75	\$ 1137	1380	1494	1610	1774	1946	2145	2376	
WW-3148TTRW	48"	1.50	\$ 1044	1253	1350	1449	1590	1737	1908	2106	
WW-3142TTRW	42"	1.25	\$ 960	1134	1215	1298	1415	1538	1680	1845	
WW-3136TTRW	36"	1.25	\$ 940	1114	1195	1278	1395	1518	1660	1825	
WW-3130TTRW	30"	1.00	\$ 865	1004	1069	1135	1229	1327	1441	1573	

Description

- Aluminum Tool Rail
- Work Walls 78" and Larger will Ship in 4 Pieces
- [See Work Wall Accessories](#)

Item	Model No.		Width	Depth	Height	Ship Wt	Cubic Ft	List Price
LEGAL TRAY	01-LGLTRAYC	Clear	14 ⁷ / ₈	10 ½	1 ¹ / ₈			\$ 115

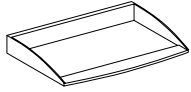

FOLDER SORTER	01-FLDRSRTRC	Clear	7 ¼	12 ¾	7 ½			\$ 129
---------------	--------------	-------	-----	------	-----	--	--	--------

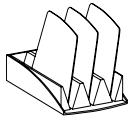

ACCESSORIES TRAY	01-ACCTRAYC	Clear	9 ¼	10 ½	1 ¹ / ₈			\$ 125
------------------	-------------	-------	-----	------	-------------------------------	--	--	--------

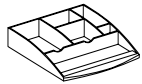

Item	Model No.	List Price
ECA TELECOM PLATES		
	01-ABL	Telecom Plate, Blank Plate \$ 41
	01-ABL737373	Telecom Plate, (3) RJ45 Cat 5e \$ 367
	01-ABLAB	Telecom Plate, (1) RJ45 Cat 6, (1) RJ11 Cat 3 Phone \$ 206
	01-ABLAB102	Telecom Plate, (1) RJ45 Cat 6, (1) RJ11 Cat 3, (1) USB W/72" Patch Cord \$ 320
	01-ABLABB	Telecom Plate, (2) RJ45 Cat 6, (1) RJ11 Cat 3 Phone \$ 320
	01-ABLB	Telecom Plate, (1) RJ45 Cat 6 \$ 149
	01-ABLBB	Telecom Plate, (2) RJ45 Cat 6 \$ 260
	01-ABLBBB	Telecom Plate, (3) RJ45 Cat 6 \$ 367
	01-ABLBBBB	Telecom Plate, (4) RJ45 Cat 6 \$ 476
	01-ABLBBBC51	Telecom Plate, (2) RJ45 Cat 6, (1) 15 Pin HD VGA w/72" Patch Cord \$ 446
	01-ABLBC51L	Telecom Plate, (1) RJ45 Cat 6, (1) Mini Stereo Inline, (1) 15 Pin HD VGA w/72" Patch Cord \$ 410
	01-ABLC3811	Telecom Plate, (1) RJ45 Cat 6 Data Inline, (1) RJ11 Cat 3 Phone Inline \$ 197
	01-ABLC45	Telecom Plate, (1) HDMI w/36" Patch Cord \$ 295
	01-ABLC45C51L	Telecom Plate, (1) Mini Stereo Inline, (1) HDMI w/36" Patch Cord, (1) 15 Pin HD VGA w/72" Patch Cord \$ 558
	01-ABLC51L	Telecom Plate, (1) 15 Pin HD VGA & (1) Mini Stereo Inline Jack \$ 298
	01-ABLCRDM	Telecom Plate, (3) Cord Bushings \$ 96



Oasis Mini Power & Data
01-OASISMA, 01-OASISMB



Interact Power & Data
01-INTERACTG2A, 01-INTERACTG2B

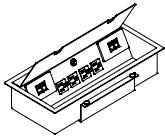

Worksurface Power Center
01-INTRFCIA, 01-INTRFCIB

Surface Materials

Wood Finishes and Woodgrain, Solid, and 3D Laminates

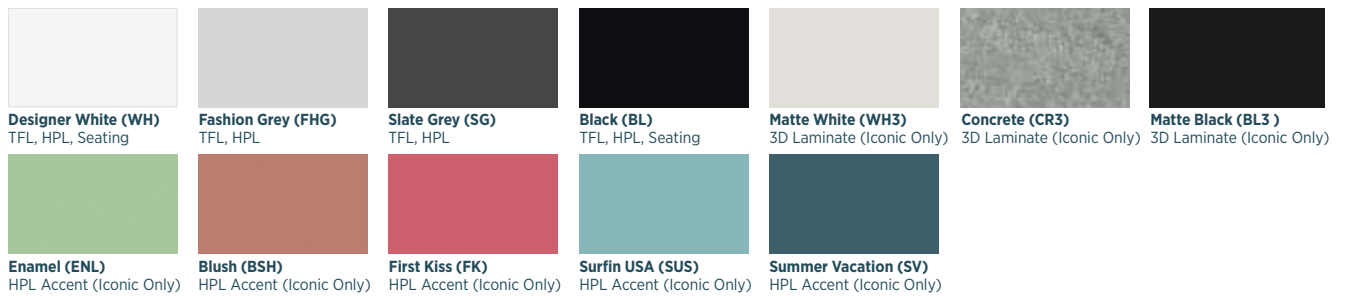
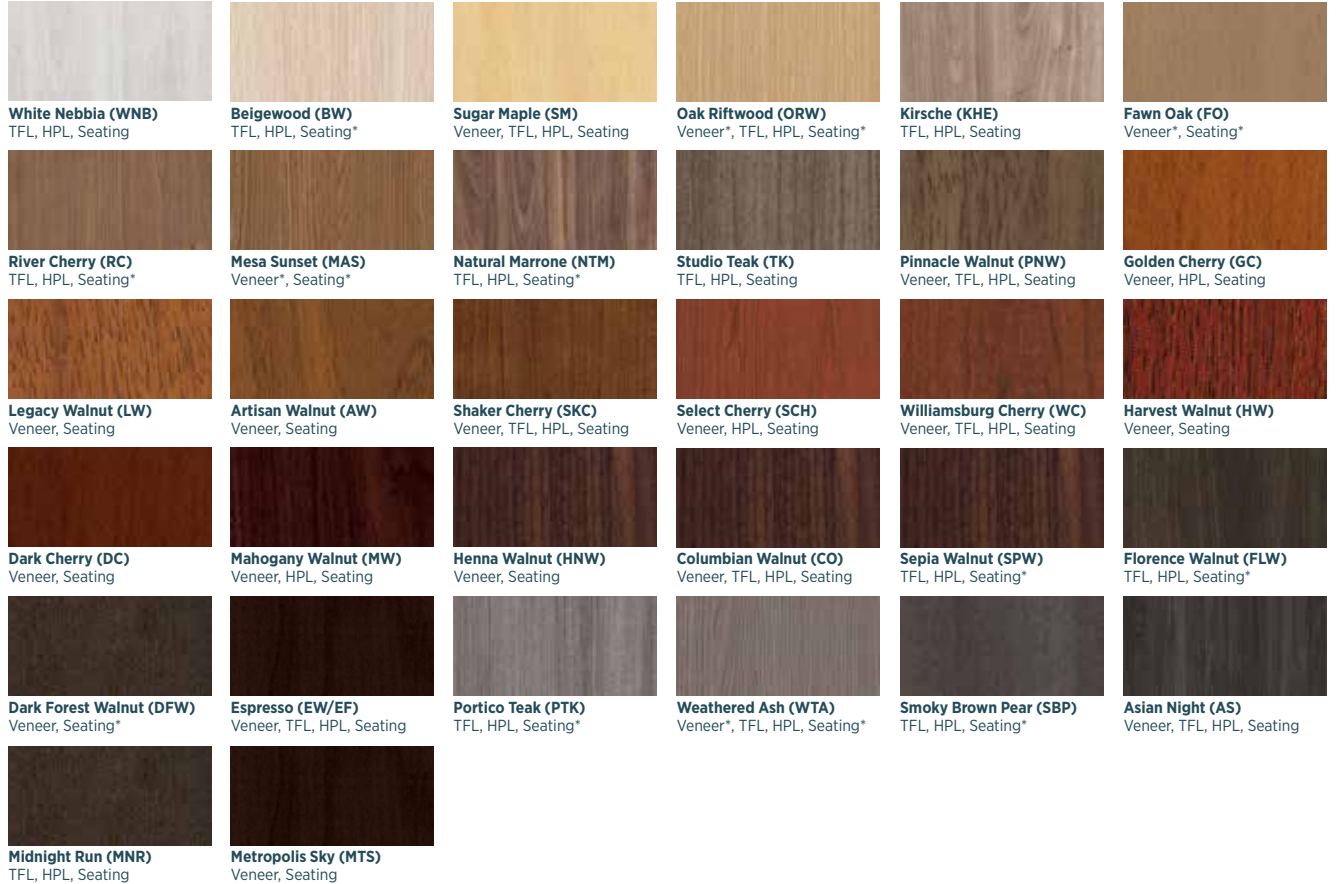

* Finish is Low Sheen

Frosted & High Gloss Acrylics

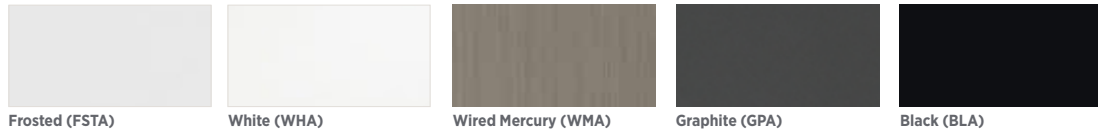

Solid Surfaces

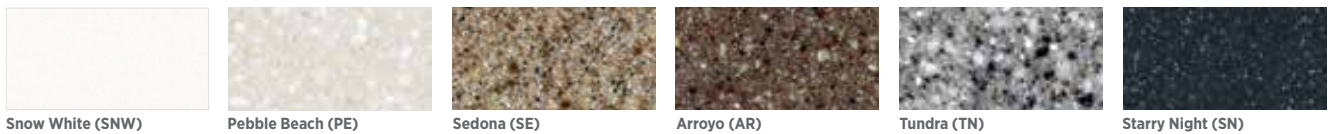

Metal Options

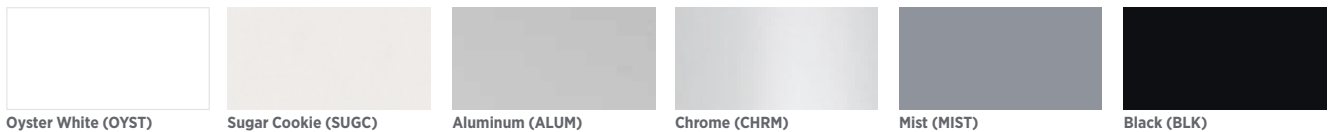

Colors represented are high-resolution reproductions and may vary slightly from the actual product. To order samples, please contact our Customer Service team or order online at www.indianafurniture.com. Graining and finish colors may vary yet will continue to complement, across Veneer, HPL, TFL, and Seating products due to the inherent differences of these materials.

Indiana[®]

FURNITURE

1919 Hospitality Drive, Suite A
PO Box 270
Jasper, Indiana 47547-0270

Tel 812.482.5727

Toll 800.422.5727

Fax 812.482.9035

sales@indianafurniture.com

www.indianafurniture.com

Federal Classification: Small Business

©2024 Indiana Furniture 5/24

