

# TABLES + SPACE DIVISION

PRICING EFFECTIVE MAY 13, 2024

Indiana  
FURNITURE

Being over a century old hasn't slowed us down! Sure, we are still the reliable, ethical company that was born in southern Indiana, steeped in quality, craftsmanship, and service. But have you seen our latest introductions? We are making a splash with design and challenging the concept of modern offices. Go ahead. Take a look. You know you want to.

## Our Pledge to People + Our Planet.

We've been making wood furniture longer than just about anyone...and we want to be doing so for a long time to come. That's a large part of why we take a stewardship approach to our resources. We believe that environmental sustainability and business profits need not be mutually exclusive. They can and should exist side by side in a mutually beneficial relationship. And for more than a century, we've been showing how it's done.

We've proven our commitment to a sustainable future by supporting the standards and programs that protect our home planet and human health. Whether it's local sourcing, reducing contaminants, implementing wellness and safety programs, or diverting waste from landfills, social responsibility is a part of every decision we make at Indiana Furniture.

One of the surest ways to reduce our impact on the planet is to make and buy things that last. And this one's a natural for us. Our products are made with craftsmanship and attention to detail that are a part of our more than a century-long legacy in wood manufacturing. And our products are backed by our 12-year warranty, which facilitates maintenance, servicing and reassembly.

All of our product lines:

- Are manufactured and assembled in the USA,
- Meet or exceed Indoor Air quality standards\*,
- Meet or exceed BIFMA level® Sustainability standards and certification\*,
- Conform to the BIFMA Compliance standards\*,
- Comply with TSCA Title VI (CARB) standards,
- and can contribute to U.S. Green Building's LEED Program.

To learn more, simply go to [www.IndianaFurniture.com/resources](http://www.IndianaFurniture.com/resources).



## Ease of Specification

Whether you're looking to specify your office spaces or simply to visualize them in the options and surface materials you are desiring, we make it easy. You can find the entire Indiana Furniture portfolio on the following third-party, space-planning platforms.



\* Recently launched or new products may still be in testing; Cush Pillows is currently not BIFMA Compliant due to no available compliance test.

<b><u>General Information + Conditions of Sale</u></b>	<b><u>2</u></b>
<b><u>Warranty</u></b>	<b><u>3</u></b>
<b><u>Tables+Storage</u></b>	<b><u>5</u></b>
<u>Arlington (2900 Series)</u>	<u>7</u>
<u>Cameo (9100 Series)</u>	<u>19</u>
<u>Catalyst (8800 Series)</u>	<u>41</u>
<u>Madera (1400/1600 Series)</u>	<u>123</u>
<u>Natta by Pledge (NAT Series)</u>	<u>147</u>
<u>One10 (9600 Series)</u>	<u>149</u>
<u>Phoenix (2100 Series)</u>	<u>179</u>
<u>Strut (8800 Series)</u>	<u>199</u>
<u>Tri-One (8500/8600 Series)</u>	<u>263</u>
<b><u>Occasional Tables</u></b>	<b><u>289</u></b>
General Occasional Tables Information	<u>298</u>
<u>Arlington End, Lamp + Magazine Tables (2900 Series)</u>	<u>299</u>
<u>Bailey End + Cocktail Tables (720 Series)</u>	<u>301</u>
<u>Britta End + Cocktail (230 Series)</u>	<u>305</u>
<u>Canvas End + Magazine Tables (6600 Series)</u>	<u>307</u>
<u>Cicero End, Lamp, Magazine + Console Tables (290 Series)</u>	<u>309</u>
<u>Gesso End + Magazine Tables (6500 Series)</u>	<u>311</u>
<u>Isla End, Lamp + Magazine Tables (370 Series)</u>	<u>313</u>
<u>Jefferson End, Lamp &amp; Magazine Tables (4600 Series)</u>	<u>317</u>
<u>Jot Auxiliary, End, Cocktail + Console Tables (410 Series)</u>	<u>319</u>
<u>Madera End, Lamp + Magazine Tables (1400 Series)</u>	<u>323</u>
<u>Natta Tables by Pledge (NAT Series)</u>	<u>325</u>
<u>Phoenix End + Magazine Tables (2100 Series)</u>	<u>327</u>
<u>Plush Cocktail Tables (620 Series)</u>	<u>329</u>
<u>Spirit Tables by Pledge (S Series)</u>	<u>333</u>
<b><u>Space Division</u></b>	<b><u>335</u></b>
<u>Screens+Dividers</u>	<u>357</u>
<u>Square One (1700 Series)</u>	<u>347</u>

## ORDERING INFORMATION

All orders should be emailed to [neworders@indianafurniture.com](mailto:neworders@indianafurniture.com). Orders can be faxed to 812-482-9035 or mailed to:

Indiana Furniture  
P.O. Box 270, 1919 Hospitality Dr., Ste A  
Jasper, IN 47547-0270

## ORDER PROCEDURE

All orders must include purchase order number, billing address, ship-to address and phone number, and any special instructions.

When ordering casegoods or tables, give complete quantity, model number, finish and any other options.

When ordering seating, give complete quantity, model number, finish, fabric and any other options.

Within each series, an example of "How to Order" is illustrated at the beginning of each series section. For further clarification of order procedure, contact Customer Service.

## PRICING

All prices shown are suggested retail prices F.O.B. Point of Origin, freight prepaid and allowed to one continental US destination. Prices, specifications and materials are subject to change without notice. Possession and/or distribution of this price list does not in itself constitute an offer to sell. Orders can be received only from authorized Indiana Furniture dealers. Orders will be billed at prices prevailing at time of shipment, unless acknowledged prior to the effective date of the price change, in which case billing will be at the price acknowledged.

## ACKNOWLEDGMENT

All orders will be acknowledged promptly, showing how the order was entered, its approximate shipping date and other pertinent information. This acknowledgment is the final agreement between the customer and Indiana Furniture and is the exclusive statement of the terms thereof. Please examine this acknowledgment carefully and advise Indiana Furniture immediately of any discrepancies. Note: Shipping fees will not be listed on the acknowledgment.

## BUYER'S OBLIGATION: RIGHTS OF SELLER

If Indiana Furniture shall at any time doubt Buyer's financial responsibility, Indiana Furniture may decline to make shipments hereunder except upon receipt of cash payment in advance or security or other proof of responsibility satisfactory to Indiana Furniture. If buyer fails in any way to fulfill the terms and conditions set forth herein, Indiana Furniture may defer shipments until such default is corrected. Remedies provided herein shall be in addition to, and not in lieu of other remedies. Buyer agrees to abide by payment terms as listed on invoice. Buyer shall pay all reasonable costs and expenses, including attorney and collection fees, and late fees, incurred by Seller in connection with any amounts due for goods ordered.

## CANCELLATIONS AND CHANGES

Due to immediate production on build-to-order items, all orders are considered firm and are not subject to cancellation or change without approval from Indiana Furniture. All approved changes are subject to additional charges and revised lead times.

## PRODUCT DESIGN AND SPECIFICATION CHANGES

Indiana Furniture reserves the right to make changes in design and construction or discontinue products without prior notice.

## REPAIR CHARGES

Indiana Furniture will only pay repair charges if Customer Service gives prior written authorization. No repair charge will be paid without advance approval at which time you will be issued a repair authorization number that will allow you to invoice Indiana Furniture for the completed work.

## WAREHOUSE STORAGE CHARGES

If a shipment is held beyond 14 calendar days at your request, a **.084% per calendar day** (2.52% per month) storage charge will be assessed. The effective date will be 14 calendar days after the acknowledged ship date. Further, the prices applied to the order will be those in effect at the time of shipment.

## DAMAGED MERCHANDISE

The consignee is responsible for filing claims with the carrier for damage and shortages. Claims for both obvious and concealed damage must be filed within 15 calendar days, and the damaged merchandise must not have been moved from the original receiving location. All damaged merchandise, including the cartons and packing materials, must be retained for inspection by either the carrier or by an Indiana Furniture Sales Representative. Indiana Furniture reserves the right to select the most cost effective way to repair or replace the damaged item. Once you have notified the carrier, please contact Customer Service for further assistance.

**Obvious Damage/Missing Cartons** — Do not refuse merchandise damaged in transit. Indiana Furniture recommends the consignee inspect all merchandise upon arrival. If a shipment is received damaged or short, note all information on carrier's copy and your copy of freight bill and delivery receipt. Notify the delivering carrier and file a claim immediately. Pending the results of your claim, either Indiana Furniture or the carrier will cover 100% of the cost to repair or replace the damaged or missing item.

**Concealed Damage** — If concealed damage is discovered, notify the delivering carrier at once and request an inspection. This must be done within 15 calendar days of delivery. If the carrier will not perform the inspection, you should prepare an affidavit that you contacted them, noting the time and date, and that they failed to comply with your request. This, along with the other papers in your possession, will support the claim. Pending the results of your claim, the cost to repair or replace the item will be covered 1/3 by the carrier and 2/3 by Indiana Furniture for shipments less than a full truckload and 100% by Indiana Furniture for shipments of full truck loads.

## RETURN MERCHANDISE

Merchandise will not be accepted for return without a RGA (Return Goods Authorization) issued by Indiana Furniture. We will consider issuing RGAs for the following reasons:

1. Manufacturing defect (inspected by Indiana Furniture representative)
2. Indiana Furniture order processing error
3. Shipping error
4. Mis-marked cartons
5. Duplicated shipments

If you have any questions as to whether your reason for return qualifies for consideration, please contact your Customer Service Representative. Merchandise must be returned within 60 days of the RGA issued date, or within 60 days upon receipt of replacement product to receive credit. Returns due to mis-marked cartons must also be returned in the original cartoning, with shipping labels intact, to receive credit.

**All merchandise being returned must be properly packed and protected to ensure no further damage is incurred during transportation back to an Indiana Furniture facility. Upon receipt, all returned merchandise will be thoroughly inspected and the results compared to the reason for return stated on the RGA. Any discrepancies, such as additional damage, signs of usage, missing parts, etc., will result in an adjustment to the amount of credit issued.**

## DELIVERY AND FREIGHT CHARGES

All shipments are F.O.B. Point of Origin, Jasper, IN, freight prepaid and allowed dock to dock on 53' trailer. Ownership and responsibility of the merchandise becomes that of the buyer upon delivery to the freight company. Shipments into Alaska, Hawaii, Canada, Mexico, Puerto Rico and other exports are freight prepaid and allowed to port of exit.

Indiana Furniture reserves the right to select the most appropriate carrier and routing on all shipments. Indiana Furniture will attempt to accommodate requests for favored carriers and delivery times. Deliveries requested Monday through Thursday, after 3pm, will be assessed a \$300 per truck after hours fee. Deliveries requested after 3pm on Friday or on weekends, will be assessed a \$600 per truck weekend delivery fee.

Inside delivery and installation services are not included in the pricing shown. Any deviation from dock-to-dock delivery, such as but not limited to, non-dock, residential, or inside delivery must be specified on the order. Should these services be requested or required, all charges incurred will be charged to the "Sold To" of the order.

Shipments totaling less than \$3000 (net value, product only) will be assessed a small order fee of \$300 net per shipment. This fee will be reduced for items shipped via small package carriers. For order shipments of \$100 or less, shipped by small package carrier, the fee is \$18. For order shipments over \$100, shipped by small package carrier, the fee is \$40. All shipping fees will be added at the time of invoicing.

## BIFMA AND ANSI TESTING

Indiana Furniture is a member of the Business and Institutional Furniture Manufacturer's Association (BIFMA). Tests developed by the BIFMA and approved by the American National Standards Institute (ANSI) determine the strength and durability of casegoods and seating in its everyday use. Although this testing does not serve as a warranty or guarantee, Indiana Furniture products within this price list have been tested by an independent verifying body and meet or exceed applicable BIFMA and ANSI standards.

Subject to the limitations set forth in this warranty, Indiana Furniture Industries, Inc. (“**Indiana Furniture**”) warrants to the original purchaser all product in this price list (“**Product**”) to be free from defects in material and workmanship given normal use for a 12-year period from the date of manufacture. During the applicable warranty period, Indiana Furniture, as its sole obligation, will repair or replace (in Indiana Furniture’s sole discretion) any Product, part, or component covered by this warranty and sold after May 13, 2024, which fails under normal use as a result of a defect in material or workmanship. Normal use is defined as the equivalent of a single shift, 40-hour work week. Indiana Furniture will repair or replace the defective Product, part, or component with a comparable Product, part, or component.

**Warranty periods are limited** for certain Products and parts as follows:

**12-year Warranty** (from the date of manufacture)

- Seating Mechanisms
- Veneers
- Laminates
- Casters and Glides

**7-year Warranty** (from the date of shipment)

- Pneumatic Table Lift
- Electric Table Lift

**5-year Warranty** (from the date of manufacture)

- Triple Play Series
- Electrical Components
- Pneumatic Cylinders
- Textiles, Foam, and Decorative Trim
- Swivel Arm Pads
- Keyboard Kits
- Lighting
- All Height Adjustable Mechanisms

**3-year Warranty** (from date of shipment)

- Dock 950 Wireless Charger
- Dock 150 Wireless and USB Charger

**THIS WARRANTY DOES NOT COVER:**

- Damage caused by a carrier or third party
- Normal or routine wear and tear
- Appearance, durability, quality, behavior, colorfastness, or any other attribute of customer’s own materials or any non-standard Indiana Furniture material (including CF Stinson, Maharam, Momentum, Mayer, UltraFabrics, Architex, and other alliance programs) specified by the customer and applied to a Product
- Color, grain or texture of wood, laminate and other covering materials
- Changes in wood or fabric color due to aging or exposure to light

As the manufacturer of the Product, Indiana Furniture stands behind its craftsmanship and pledges to do everything it can to reasonably resolve, as quickly as possible, any problems you may have with the Product within the terms and conditions of this warranty.

If you encounter a defect covered by the foregoing warranty, contact the dealer from whom you purchased the Product. If the dealer is unable to resolve your warranty issues, you should contact Indiana Furniture. Please ensure that you have all of the pertinent facts when contacting the dealer or Indiana Furniture, including the model number and factory order number from the inspection label attached to the Product.

INDIANA FURNITURE IS NOT PROVIDING, AND SPECIFICALLY DISCLAIMS, ANY OTHER WARRANTIES FOR THE PRODUCTS, EXPRESS OR IMPLIED, INCLUDING ANY IMPLIED WARRANTY OF MERCHANTABILITY OR FITNESS FOR A PARTICULAR PURPOSE. INDIANA FURNITURE SHALL NOT BE LIABLE TO THE PURCHASER OR ANY THIRD PARTY FOR CONSEQUENTIAL, INCIDENTAL, INDIRECT, OR SPECIAL DAMAGES, INCLUDING, WITHOUT LIMITATION, DAMAGES ARISING OUT OF OR RESULTING IN ANY MALFUNCTIONS, DELAYS, LOSS OF PROFIT, INTERRUPTION OF BUSINESS, PERSONAL INJURY, BODILY INJURY, DEATH, DISMEMBERMENT, OR PROPERTY DAMAGE.

Indiana Furniture Industries, Inc.  
Attn: Customer Service  
1919 Hospitality Dr., Ste A  
P.O. Box 270  
Jasper, Indiana 47547-0270  
800.422.5727  
Fax 812.482.9035  
custserv@indianafurniture.com



# Tables+Storage





Arlington offers all the grace and embellishments associated with traditional styling with an added emphasis on value. Finely crafted in select solids with walnut and cherry veneers and high pressure laminate worksurfaces, Arlington ensures quality and expert craftsmanship with a selection of configurations for today's functional workspaces.

**CONSTRUCTION**

*Arlington features a Veneer chassis with your choice of a Veneer or HPL top. Units ship assembled unless otherwise noted.*

**VENEER**

- Exposed surfaces feature select grade, plain sliced American Black Walnut or Cherry veneers, carefully selected and matched to assure proper balance and consistency

**TOPS**

- Veneer tops are 5-ply balanced construction and 1 3/16" thick with solid hardwood rims with butt corners
- High Pressure Laminate (HPL) tops are 3-ply balanced construction and 1 3/16" thick with solid hardwood rims with butt corners
- Grain direction runs left to right unless noted

**CHASSIS**

- Chassis is securely fastened using high quality European fastening systems and heavy-duty, 16-gauge joining brackets to assure maximum strength
- All units ship with heavy-duty, adjustable leveling glides to ensure proper leveling and compensation for uneven floors
- Bases are solid hardwood with mitered corners
- Construction offers tight tolerances and long term durability
- Vertical grain direction on chassis

**DRAWERS**

- Drawer fronts standard with matched veneer faces
- Drawer sides, back and front are woodgrain vinyl-wrapped, and are 1/2" thick
- 5-sided drawer construction for easy removal of drawer front
- Box and file drawers have 1/8" thick hardboard bottoms and tested for 100lb capacity
- Lateral file drawers feature 1/4" thick bottoms and tested for 200lb capacity
- All drawers feature full extension, progressive action slides with precision steel ball bearings
- All suspensions have a limited lifetime warranty

**FILING**

- All file drawers are standard with filing systems designed to accommodate a variety of filing requirements
- Letter width file drawers provide letter filing front to back and legal filing side to side
- Lateral file drawers provide legal or letter filing front to back or side to side

**STORAGE**

- All hinged doors include soft close hinges, unless noted
- One piece hinge and base plate combination
- Soft close hinges reduce stress placed on the cabinet when the door is closed and offers a quiet closure

**LOCKING**

- See [locking details](#) for locking door and drawer options
- Lock core available in black or silver and will coordinate with pull selection; See [locking details](#)
- Removable lock cylinders allow for units to be re-keyed at a later date if required
- Units are shipped randomly keyed as standard. Keyed alike units available upon request at no additional charge.

**CORD MANAGEMENT**

- Grommets are available in black or silver, please specify color
- See [optional grommet locations](#)
- Undersurface Wire Managers available for additional cord management; See [Accessories](#)

**INTERIOR DRAWER DIMENSIONS & FILING CAPABILITIES**

**Model**

29-2072SC      29-2066SC

**Drawers**

	<b>W</b>	<b>L</b>	<b>D</b>
Box	15 3/8"	16 1/2"	3 1/2"
File	15 3/8"	16 1/2"	8 29/32"

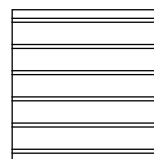

Legal Front to Back

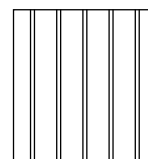

Legal Side to Side

**Model**

29-2072DL

**Drawers**

	<b>W</b>	<b>L</b>	<b>D</b>
Lateral File	24 7/8"	16 1/2"	9 7/32"

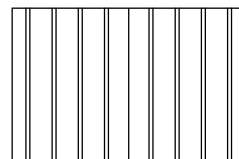

1 Row Letter or Legal Side to Side

**HOW TO ORDER EXAMPLES**

	<b>QTY</b>	<b>Model No.</b>	<b>Description</b>	<b>Example</b>
<b>TOP/BASE</b>	1	29-4296RT	Top Material	W
			Finish	CO
			Grommet/Power/ Data Location	OC
			Finish	CO
<b>BASES</b>	1	29-2828TB	Finish	CO
<b>PORT</b>	1	01-INTRFCIA		
<b>CREDENZA</b>	1	29-2072SC	Top Material	W
			Finish	CO
			Base Molding	BM3600
			Decorative Molding	M3600
			Pull	ARA
			Locking	LKT-HU
			Drawer Construction	STD

**VENEER (W) OPTIONS**

Veneer features UVAdvantage, an ultra-violet finish, on all exposed surfaces by utilizing roll-coat UV technology.

*Note: Base and decorative molding feature multi-step, hand-finished catalyzed finish.*

AW	Artisan Walnut	HW	Harvest Walnut
CO	Columbian Walnut	LW	Legacy Walnut
DC	Dark Cherry	MW	Mahogany Walnut
DFW	Dark Forest Walnut	PNW	Pinnacle Walnut
EW	Espresso	SCH	Select Cherry
GC	Golden Cherry	SKC	Shaker Cherry
HNW	Henna Walnut	WC	Williamsburg Cherry

**HPL (P) TOP OPTIONS**

**WOODGRAIN**

CO	Columbian Walnut	PNW	Pinnacle Walnut
EF	Espresso	SCH	Select Cherry
GC	Golden Cherry	SKC	Shaker Cherry
MW	Mahogany Walnut	WC	Williamsburg Cherry

**EDGE PROFILES**

R Arlington



**MOLDING LOCATIONS AND OPTIONS**

**Base Molding**

Arlington and Wilmington Base Molding are skillfully applied on Credenzas to front and both sides with no molding on back for flush wall applications.



Arlington Base Molding



Wilmington Base Molding

**Decorative Molding**

Optional Decorative Molding is available with the Wilmington Base Molding package. Credenzas will feature decorative molding on the left and right sides only.



Wilmington Decorative Molding



No Decorative Molding

Molding selection must be specified on order.

**Arlington Molding**

BM2900 Arlington Base Molding \$ N/C

**Wilmington Molding**

BM3600 Wilmington Base Molding \$ N/C

M3600 Optional Wilmington Decorative Molding \$ 139

*Note: Base and Decorative Molding features multi-step, hand-finished catalyzed finish*

**DRAWER AND DOOR PULL OPTIONS**

Units with doors and drawers will feature coordinating pulls however door and drawer pulls cannot be intermixed.

ARA	Arlington A, Antique Brass	JEF	Jefferson, Antique Brass
ARB	Arlington B, Antique Brass	ALB	Liberty, Aluminum
WLM	Wilmington, Antique Brass		



**Arlington A (ARA)**  
Antique Brass - 5¼"



**Arlington B (ARB)**  
Antique Brass - 5¼"



**Jefferson (JEF)**  
Antique Brass - 5¼"



**Wilmington (WLM)**  
Antique Brass - 5¼"



**Liberty (ALB)**  
Aluminum - 4¼"

**LOCK CORE OPTIONS**

Lock core will be black if Arlington, Wilmington or Jefferson pulls are selected. Lock core will be silver if Liberty Pulls are selected.

BLK	Black
SLV	Silver



Black (BLK)



Silver (SLV)

**CREDENZA LOCKING DOORS AND DRAWERS**

Locking doors and drawers are available on credenzas. Please specify applicable code on order with model/unit and add upcharge.

Storage credenzas offer locking pedestals and locking doors with the lock positioned in the face of the drawer nearest to doors. Door lock is positioned in top right corner of left door.

LKT_P	Double Pedestal Lock	\$ 410
LKT_HU	Double Pedestal and Double Door Locking	\$ 492

**LOCKING DOORS**

Locking doors are available on specific units, where noted. You must specify WITH LOCKING when ordering and add upcharge.

LKT_HU	36"W to 28"W Units	\$ 91
LKT_HU	18"W Units	\$ 69

**DRAWER OPTIONS**

Units with drawers come standard with woodgrain vinyl-wrapped drawers with mitered corners. Optional wood dove tail construction for all box, file, and lateral file drawers is available. Must specify when ordering.

**Pricing is per Drawer, not per Model/Unit.**

MITER	Mitered Fold Construction	STD
DOVE	Wood Dove Tail Construction	\$ 45

**CONFERENCE AND MEETING TABLE GROMMET OPTIONS**

Arlington Meeting and Conference Tables offer Power/Data and grommets at a variety of locations. Available Power/Data and Grommets may be found on Pages 21 to 23

**Must Specify Black (BLK) or Silver (SLV)**

**Grommet Locations**

OC	On Center	CL	5½" Left of Center
EL	24½" from Left End	CR	5½" Right of Center
ER	24½" from Right End	BB	Centered Between Bases

**Panel Base Location Availability by Top Size**

96"W Tops	OC, EL+ER	
120"W Tops	BB, CL, CR, CL+EL+ER, CR+EL+ER	
144"W Tops	BB, CL, CR, CL+CR, EL+ER, CL+EL+ER, CR+EL+ER	

Power and Grommet Units only available **On Center (OC)** when Queen Anne Bases are selected.



Arlington Work Tables offer grommets at left/right and on center locations.

**Must Specify Black (BLK) or Silver (SLV) Grommets**

		Per Grommet
<b>Locations Availability by Model</b>		\$ 52
29-3672WT	GL/GR: Grommet Left and Right; 12" from end and 23" from user (Requires 2 grommets)	
	GC: Grommet Center; 23" from user	
29-3060WT	GL/GR: Grommet Left and Right; 9" from end and 23" from user (Requires 2 grommets)	
	GC: Grommet Center; 9" from user	

**CERTIFICATIONS & COMPLIANCE**

- Intertek Sustainability Certified
- BIFMA level® Certified
- BIFMA Compliant® Certified
- TSCA Title VI (formerly CARB) Compliance
- US Green Building's LEED® Contribution

**Tops and Tables**



Round Tops  
[\(See Details\)](#)



1-Piece Rectangle Tops  
[\(See Details\)](#)



2-Piece Rectangle Tops  
[\(See Details\)](#)

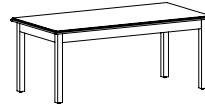

Work Tables  
[\(See Details\)](#)

**Bases**

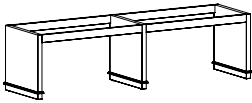

Rectangle Bases  
1-Pc Top [\(See Details\)](#)  
2-Pc Top [\(See Details\)](#)

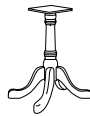

Queen Anne Bases  
Round Tops [\(See Details\)](#)  
1-Pc Top [\(See Details\)](#)  
2-Pc Top [\(See Details\)](#)

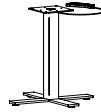

Height Adjustable Pneumatic  
X-Bases [\(See Details\)](#)

**Storage Components**

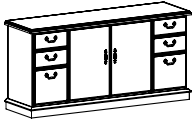

Storage Credenza  
[\(See Details\)](#)

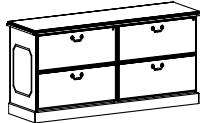

Credenza with Double Lateral  
[\(See Details\)](#)



Door Bookcases  
[\(See Details\)](#)



Wardrobe/Storage  
[\(See Details\)](#)

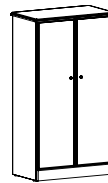

Double Wardrobe/Storage  
[\(See Details\)](#)

**Wire Management & Power/Data Accessories**

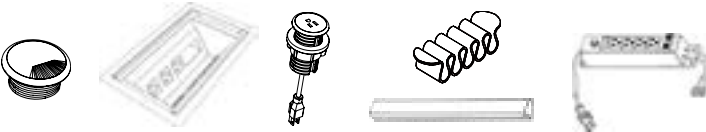

For additional solutions for desking, storage, and accessories, see the [Arlington Casegoods](#) and [Accessories](#) Price Lists.

Item	Model No.	Width	Depth	Height	Ship Wt	Cubic Ft	List Price
	29-4848CT <i>Accommodates Five (5) Chairs</i>	48	48	30	58	5.9	P\$ 2625 W\$ 3083
	29-4242CT <i>Accommodates Four (4) Chairs</i>	42	42	30	51	4.5	P\$ 1829 W\$ 2247
	29-3636CT <i>Accommodates Three (3) Chairs</i>	36	36	30	50	3.3	P\$ 1590 W\$ 1959

Top Must Specify (in this order):

- Model #
- Top Material
- Finish/Color

Base Must Specify (in this order):

- Model #
- Finish/Color

**Description**

- Available with Veneer (W) or HPL (P) Top, Must Specify
- See Below for Queen Anne Base and Height Adjustable Pneumatic X-Base; Order Separately
- Power Options not Available

**Base Options: Must Order Separately**

**Queen Anne Base**

01-0606QB	Optional Queen Anne Base (1 Required)	54	22.4	\$ 1406
-----------	---------------------------------------	----	------	---------



**Description**

- Queen Anne Base Features Multi-Step, Hand-Finished Catalyzed Finish
- Four Legs with Adjustable Glides

**Height Adjustable Pneumatic X-Bases**

**Maximum Round 42", Maximum Square 36"**

01-3232HAXBB	Black	32	32	26-45¾	1	0.2	\$ 1721
01-3232HAXBA	Aluminum						



**Maximum Round 36", Maximum Square 30"**

01-2626HAXBB	Black	22	22	26-45¾	1	0.2	\$ 1687
01-2626HAXBA	Aluminum						

**Description**

- Pre-Drilled Boring Pattern May Not Match Underside of Table Top
- Steel Mounting Plate: 8" x 8" x ¼"
- Eight (8) Bolts Included for Assembly
- Some Assembly Required

Item	Model No.	Width	Depth	Height	Ship Wt	Cubic Ft	List Price
	29-4296RT <i>Accommodates Eight (8) Chairs</i>	96	42	30	140	12.5	P\$ 3724 W\$ 4387
	29-3672RT <i>Accommodates Six (6) Chairs</i>	72	36	30	91	6.6	P\$ 3085 W\$ 3596

Must Specify (in this order):

- Model #
- Top Material
- Finish/Color
- Grommet/Power/Data Location
- Base Model #
- Base Finish

**Description**

- One (1) Piece Top
- Available with Veneer (W) or HPL (P) Top, Must Specify
- Top and Bases Shipped Separately
- Bases Must Specified. Top Price Includes Standard Two (2) Rectangle Bases with Two (2) Stretchers, Optional Queen Anne Bases Available (See Below)
- Queen Anne Base Features Multi-Step, Hand-Finished Catalyzed Finish
- Optional Power/Data/Grommets are Available ([See Details](#)), Must Order Separately

**Base Options: Must Specify and Add**

29-2828TB	Rectangular Bases (Includes Two (2) Bases and Two (2) Stretchers)	104	7.0	Included
01-0606QB	Queen Anne Base Upgrade (Includes Two (2) Bases)	54	22.4	\$ 943

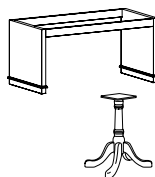

P = HPL W = Veneer

[See Arlington Overview For Ordering Options](#)

Item	Model No.	Width	Depth	Height	Ship Wt	Cubic Ft	List Price
	29-48144RT <i>Accommodates Twelve (12) Chairs</i>	144	48	30	315	22.0	P\$ 7711 W\$ 8820
	29-48120RT <i>Accommodates Ten (10) Chairs</i>	120	48	30	198	22.0	P\$ 4696 W\$ 5584

Must Specify (in this order):

- Model #
- Top Material
- Finish/Color
- Grommet/Power/Data Location
- Base Model #
- Base Finish

**Description**

- Two (2) Piece Top
- Available with Veneer (W) or HPL (P) Top, Must Specify
- Top and Bases Shipped Separately
- Bases Must Specified. Top Price Includes Standard Two (2) Rectangle Bases with Two (2) Stretchers, Optional Queen Anne Bases Available (See Below)
- Queen Anne Base Features Multi-Step, Hand-Finished Catalyzed Finish
- Optional Power/Data/Grommets are Available ([See Details](#)), Must Order Separately

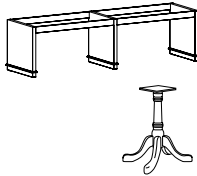

**Base Options: Must Specify and Add**

29-2828TB	Rectangular Bases (Includes Three (3) Bases and Four (4) Stretchers)	104	7.0	Included
01-0606QB	Queen Anne Base Upgrade (Includes Three (3) Bases)	80	33.6	\$ 1414

Item	Model No.	Width	Depth	Height	Ship Wt	Cubic Ft	List Price
	29-3672WT <i>64" Kneespace</i>	72	36	30	125	11.4	P\$ 2235 W\$ 2636
	29-3060WT <i>52" Kneespace</i>	60	30	30	89	8.0	P\$ 1839 W\$ 2151

Must Specify (in this order):

- Model #
- Top Material
- Finish/Color
- Grommet Location/Color

**Description**

- Available with Veneer (W) or HPL (P) Top, Must Specify
- Left to Right Grain Direction on Worksurface
- Optional Factory-Installed, Worksurface Grommets Available; See Locations Below, Must Specify Grommet Color: Black (BLK) or Silver (SLV)
- Some Assembly Required
- Optional Wire Management ([See Units](#)), Power/Data/Grommets are Available ([See Details](#)), Must Order Separately

P = HPL W = Veneer

[See Arlington Overview For Ordering Options](#)

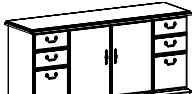
Item	Model No.	Width	Depth	Height	Ship Wt	Cubic Ft	List Price
	29-2072SC	72	20	30	237	30.5	P\$ 4245 W\$ 4607
	29-2066SC	66	20	30	217	30.5	P\$ 3687 W\$ 4032

Shown with Jefferson Drawer and Door Pulls (JEF)

Must Specify (in this order):

Model #  
Top Material  
Finish/Color  
Base Molding  
Decorative Molding  
Pull  
Locking  
Drawer Construction

**Description**

- Standard With: Letter Width Box/Box/File in Pedestals, Left to Right Grain Direction on Worksurface
- Available with Veneer (W) or HPL (P) Top, Must Specify
- Top Profiled on only Three (3) Sides for Flush Wall Application
- Door Pull will Coordinate with Drawer Pull, [See Pull Options](#)
- Base Molding on Sides and User Side, Must Specify: Arlington or Wilmington (See Below)
- Standard with No Decorative Molding; Optional Wilmington Decorative Molding; Must Specify (See Below and [Molding Details](#))
- Optional Locking Pedestals (LKT-P) or Locking Pedestals and Doors (LKT-HU), ([See Details](#))
- Additional Options: Wood Dove Tail Drawers ([See Details](#))

**Molding Options: Must Specify and Add**

**Arlington Molding Options**

BM2900	Arlington Base Molding	N/C
--------	------------------------	-----

**Wilmington Molding Options**

BM3600	Wilmington Base Molding	N/C
M3600	Optional Wilmington Decorative Molding	\$ 139

*Note: Wilmington Decorative Molding may only be used with Wilmington Base Molding*

<b>CREDENZA WITH DOUBLE LATERAL FILE</b> 	29-2072DL	72	20	30	270	30.5	P\$ 4880 W\$ <a href="#">5242</a>
---	-----------	----	----	----	-----	------	--------------------------------------

Shown with Jefferson Drawer and Door Pulls (JEF) and Optional Wilmington Decorative Molding

Must Specify (in this order):

Model #  
Top Material  
Finish/Color  
Base Molding  
Decorative Molding  
Pull  
Drawer Construction

**Description**

- Standard With: Four Locking Lateral File Drawers, Left to Right Grain Direction on Worksurface
- Available with Veneer (W) or HPL (P) Top, Must Specify
- Top Profiled on only Three (3) Sides for Flush Wall Application
- Base Molding on Sides and User Side, Must Specify: Arlington or Wilmington (See Below)
- Standard with No Decorative Molding; Optional Wilmington Decorative Molding; Must Specify (See Below and [Molding Details](#))
- Additional Options: Wood Dove Tail Drawers ([See Details](#))

**Molding Options: Must Specify and Add**

**Arlington Molding Options**

BM2900	Arlington Base Molding	N/C
--------	------------------------	-----

**Wilmington Molding Options**

BM3600	Wilmington Base Molding	N/C
M3600	Optional Wilmington Decorative Molding	\$ 139

*Note: Wilmington Decorative Molding may only be used with Wilmington Base Molding*

P = HPL W = Veneer

[See Arlington Overview For Ordering Options](#)

Item	Model No.	Width	Depth	Height	Ship Wt	Cubic Ft	List Price
DOOR BOOKCASE	29-2870DB	28	15	70 $\frac{1}{8}$	78	17.8	\$ 2592

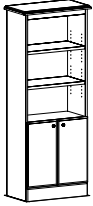

Shown with Arlington (ARB) Door Pull

**Description**

- Open Bookcase with Two (2) 1" Thick Adjustable Shelves
- Storage Behind Doors; One (1) Adjustable Shelf
- Top Profiled on only Three (3) Sides for Flush Wall Application
- Vertical Woodgrain
- Optional Locking Doors, [See Locking Options](#)

Must Specify (in this order):

- Model #
- Finish
- Pull
- Locking

WARDROBE/STORAGE CABINET	Hinged Left	Hinged Right	Width	Depth	Height	Ship Wt	Cubic Ft	List Price
	29-1870WL	29-1870WR	18	20	70 $\frac{1}{8}$	153	19.2	\$ 3053

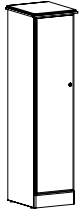

Shown as Left

**Description**

- Coat Rod Under Top Fixed Shelf and Three (3) Adjustable Shelves
- Adjustable Shelves can be Removed for Wardrobe Application
- Top Profiled on only Three (3) Sides for Flush Wall Application
- Must Specify Door Pull: Arlington B (ARB), Jefferson (JEF), and Liberty (ALB)
- Vertical Woodgrain
- Optional Locking Door, [See Locking Options](#)

Must Specify (in this order):

- Model #
- Finish
- Pull
- Locking

DOUBLE WARDROBE/STORAGE CABINET	29-3670WD	36	20	70 $\frac{1}{8}$	310	34.2	\$ 5391
---------------------------------	-----------	----	----	------------------	-----	------	---------

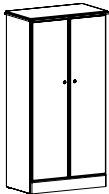

**Description**

- Three (3) Adjustable Shelves on Both Sides; Coat Rod Under Top Fixed Shelf on Right
- Recommended Against Wall
- Top Profiled on only Three (3) Sides for Flush Wall Application
- Must Specify Door Pull: Arlington B (ARB), Jefferson (JEF), and Liberty (ALB)
- Vertical Woodgrain
- Optional Locking Door, [See Locking Options](#)

Must Specify (in this order):

- Model #
- Finish
- Pull
- Locking

ROUND GROMMET COVER	01-GRMTBK	Black	2 $\frac{3}{8}$	2 $\frac{3}{8}$	-	1	0.1	\$ 11
	01-GRMTSL	Silver						



OPEN MARKET ONLY (SILVER)

**Description**

- 2 $\frac{3}{8}$ " (60mm) Round Grommet Cover
- Field Installed

[See Arlington Overview For Ordering Options](#)



Item	Model No.		Width	Depth	Height	Ship Wt	Cubic Ft	List Price
SINGLE POWER SAND DOLLAR	01-SAND60PS	Silver	3	3	4	1	0.2	\$ 98
	01-SAND60PW	White						
	01-SAND60PB	Black						

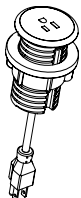

#### Description

- Mounts in 2 $\frac{3}{8}$ " (60mm) Round Grommet
- Single Power Outlet with 6' Cord

DOUBLE USB SAND DOLLAR	01-SAND60US	Silver	3	3	4	1	0.2	\$ 277
	01-SAND60UW	White						
	01-SAND60UB	Black						

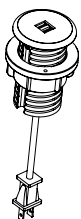

#### Description

- Mounts in 2 $\frac{3}{8}$ " (60mm) Round Grommet
- Dual USB Outlets with 6' Cord

DUO CLAMP NEMA PLUG	01-DUOCLAMPS	Silver	5 $\frac{1}{2}$	3	7	1	0.2	\$ 572
	01-DUOCLAMPW	White						
	01-DUOCLAMPB	Black						

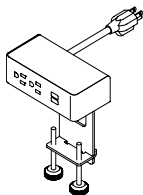

#### Description

- Standard with: Two (2) Power Outlet, Two (2) USB Ports, 10' Cord
- Clamps to Top and Features Silver Metal Trim
- Independent USB Circuit Controllers Deliver up to 2.1 Amps to Each Post
- All Mounting Hardware Included
- FCC Part 15A and UL Approved for Horizontal and Vertical Applications

OASIS MINI POWER & DATA	01-OASISMA	Aluminum	14 $\frac{1}{4}$	6 $\frac{3}{8}$	2 $\frac{7}{8}$	11	0.3	\$ 3191
	01-OASISMB	Black						



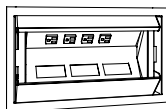

Top View



#### Description

- For Use with Conference Tables
- Plate Includes: Two (2) Data and Four (4) Power Outlets, 9' Power Cord
- Two (2) Telecom Plates Included with the Unit: One (1) 01-ABLAB Plate (Consists of One (1) RJ45 Cat 6, One (1) RJ11 Cat 3 Phone Jack); One (1) 01-ABLB Plate (Consists of One (1) RJ45 Cat 6)
- Soft Touch Hinged Lid
- UL Listed
- Additional Telecom Plates, [See Telecom Plate Options](#)

[See Arlington Overview For Ordering Options](#)

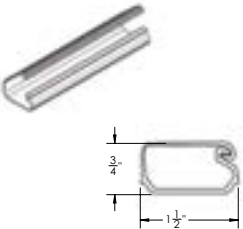
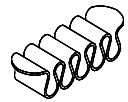
Item	Model No.		Width	Depth	Height	Ship Wt	Cubic Ft	List Price
INTERACT POWER & DATA	01-INTERACTG2A	Aluminum	9	5 $\frac{5}{8}$	2 $\frac{3}{4}$	5	0.2	\$ 891
	01-INTERACTG2B	Black						
	<b>Description</b>							
	<ul style="list-style-type: none"> <li>Includes: Two (2) Power Outlets, Two (2) USB-A Charging Ports, One (1) Telecom Plate Opening; Two (2) Keystone Openings for Voice/Data Jacks</li> <li>One (1) Telecom Plates Included with the Unit: One (1) 01-ABLAB Plate (Consists of One (1) RJ45 Cat 6, One (1) RJ11 Cat 3 Phone Jack)</li> <li>Convenience Plug on Bottom</li> <li>6' Power Cord</li> <li>UL and CSA Recognized</li> <li>Additional Telecom Plates, <a href="#">See Telecom Plate Options</a></li> </ul>							
WORKSURFACE POWER CENTER	01-INTRFC1A	Aluminum	14 $\frac{1}{4}$	6 $\frac{3}{8}$	2 $\frac{7}{8}$	11	0.3	\$ 2064
	01-INTRFC1B	Black						
	<b>Description</b>							
	<ul style="list-style-type: none"> <li>For Use with Conference Tables</li> <li>Four (4) Power Outlets, Three (3) Telecom Plate Openings</li> <li>Two (2) Telecom Plates Included with the Unit: One (1) 01-ABLAB Plate (Consists of One (1) RJ45 Cat 6, One (1) RJ11 Cat 3 Phone Jack); One (1) 01-ABLBB Plate (Consists of Two (2) RJ45 Cat 6)</li> <li>6' Power Cord</li> <li>Convenience Plug on Bottom</li> <li>UL Listed/CSA Certified</li> <li>Additional Telecom Plates, <a href="#">See Telecom Plate Options</a></li> </ul>							
WIRE MANAGEMENT CHANNEL	01-WMGR4		16	1 $\frac{1}{2}$	$\frac{3}{4}$	1	-	\$ 116
	<b>Description</b>							
	<ul style="list-style-type: none"> <li>Set of Four (4) Black Plastic Wire Management Channels</li> <li>Snap Lock Channel</li> <li>Attaches with Adhesive Strips</li> <li>Ships via UPS Only</li> </ul>							
	<b>Description</b>							
CABLE GRIP	01-WMGRCB		5 $\frac{3}{8}$	2 $\frac{5}{8}$	-	-	-	\$ 17
	<b>Description</b>							
	<ul style="list-style-type: none"> <li>Under Surface Wire Management</li> <li>Black</li> </ul>							

[See Arlington Overview For Ordering Options](#)

Item	Model No.	Description	List Price
ECA TELECOM PLATES	01-ABL	Telecom Plate, Blank Plate	\$ 41
	01-ABL737373	Telecom Plate, Three (3) RJ45 Cat 5e	\$ 367
	01-ABLAB	Telecom Plate, One (1) RJ45 Cat 6, One (1) RJ11 Cat 3 Phone	\$ 206
	01-ABLAB102	Telecom Plate, One (1) RJ45 Cat 6, One (1) RJ11 Cat 3, One (1) USB W/72" Patch Cord	\$ 320
	01-ABLABB	Telecom Plate, Two (2) RJ45 Cat 6, One (1) RJ11 Cat 3 Phone	\$ 320
	01-ABLB	Telecom Plate, One (1) RJ45 Cat 6	\$ 149
	01-ABLBB	Telecom Plate, Two (2) RJ45 Cat 6	\$ 260
	01-ABLBBB	Telecom Plate, Three (3) RJ45 Cat 6	\$ 367
	01-ABLBBBB	Telecom Plate, (4) RJ45 Cat 6	\$ 476
	01-ABLBBC51	Telecom Plate, Two (2) RJ45 Cat 6, One (1) 15 Pin HD VGA w/72" Patch Cord	\$ 446
	01-ABLBC51L	Telecom Plate, One (1) RJ45 Cat 6, One (1) Mini Stereo Inline, One (1) 15 Pin HD VGA w/72" Patch Cord	\$ 410
	01-ABL3811	Telecom Plate, One (1) RJ45 Cat 6 Data Inline, One (1) RJ11 Cat 3 Phone Inline	\$ 197
	01-ABLC45	Telecom Plate, One (1) HDMI w/36" Patch Cord	\$ 295
	01-ABLC45C51L	Telecom Plate, One (1) Mini Stereo Inline, One (1) HDMI w/36" Patch Cord, One (1) 15 Pin HD VGA w/72" Patch Cord	\$ 558
	01-ABLC51L	Telecom Plate, One (1) 15 Pin HD VGA & One (1) Mini Stereo Inline Jack	\$ 298
	01-ABLCRDM	Telecom Plate, Three (3) Cord Bushings	\$ 96

Compatible with:



Interact Power & Data  
01-INTERACTG2A, 01-INTERACTG2B



Power Center  
01-INTRFCIA, 01-INTRFCIB

# Indiana

FURNITURE

---

---

---

---

---

---

---

---

---

---

---

---

---

---

---

---

---

---

---

---

---

---

---

---

---

---

---

---

---

Traditional components echo history and create timeless foundations for meeting rooms that complement our Jefferson and Arlington casegoods collections, and Cameo and Jefferson Reception options. Facilitate presentations with lecterns and visual presentation boards. Mobile serving carts and buffet height credenzas provide additional in-room utility.

### CONSTRUCTION

*Cameo Tables and Components feature your choice of either a Veneer or HPL top, Veneer bases, and Veneer chassis (where applicable).*

### VENEERS

- Veneers on exposed surfaces are select grade sliced American Black Walnut and are carefully selected and matched to assure proper balance and consistency

### LAMINATES

- Exposed surfaces are produced from wood grained laminates fused to a particle-board core
- Each laminate offers lasting beauty, superior resistance to normal wear, and easy maintenance

### TOPS

- Wood Veneer tops are 5-ply balanced construction and High Pressure Laminate (HPL) tops are 3-ply balanced construction
- Tops are 1 $\frac{3}{16}$ " thick with solid hardwood rims
- All buffets, credenzas, serving carts, video cabinets, and storage/wardrobe cabinets are shaped on user side only
- Grain direction runs left to right unless otherwise noted
- All Veneer tops, as well as Laminate tops up to 144" (12 feet), will have matching woodgrain. Laminate tops sized 156" (13 feet) and longer will have non-matching woodgrain

### CHASSIS

- Tops and end panels are securely fastened using high quality European fastening systems to ensure maximum strength
- All units are equipped with heavy-duty, adjustable glides to ensure proper leveling and compensation for uneven floors

### DRAWERS

- All drawer fronts are standard with elegant vertically matched walnut veneer faces
- Drawers feature 5-sided construction with  $\frac{3}{4}$ " 3-ply fronts,  $\frac{7}{16}$ " thick hardwood sides and  $\frac{5}{32}$ " hardboard bottoms
- Units with 36" wide file drawers feature  $\frac{1}{4}$ " thick drawer bottoms for maximum storage strength
- Drawer interiors are sanded, sealed, and finished to provide for a smooth, quality feel and appearance
- All drawers feature full extension, progressive action slides with precision steel ball bearings
- Box and file drawers are tested for 100lb capacity
- Lateral files are tested for 200lb capacity
- All suspensions have a limited lifetime warranty

### STORAGE

- All hinged doors include soft close hinges, unless otherwise noted
- One piece hinge and base plate combination
- Soft close hinges reduce stress placed on the cabinet when the door is closed and offers a quiet closure

### LOCKING

- All units with file drawers feature locking
- Removable lock cylinders allow for units to be re-keyed at a later date if required
- Units are shipped randomly keyed as standard. Keyed alike units available upon request at no additional charge.
- Keyed alike units available upon request at no additional charge
- Lock cores match pull color

### INTERIOR DRAWER DIMENSIONS & FILING CAPABILITIES

#### Models

91-2472BFD 91-2436SV

#### Drawers

Box

W

14 $\frac{17}{32}$ "

L

19 $\frac{1}{4}$ "

D

3 $\frac{21}{32}$ "

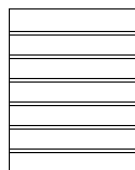

Legal Front to Back

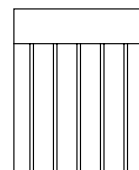

Legal Side to Side

#### Models

91-2436BF 91-2472BF

#### Drawers

Box

W

32 $\frac{9}{16}$ "

L

19 $\frac{1}{4}$ "

D

3 $\frac{21}{32}$ "

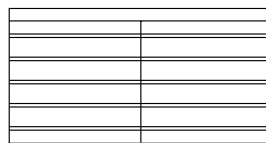

2 Rows Letter or Legal Front to Back

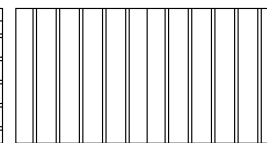

1 Row Letter or Legal Side to Side

#### Models

91-2472SBF

#### Drawers

Box

W

14 $\frac{17}{32}$ "

L

19 $\frac{1}{4}$ "

D

3 $\frac{21}{32}$ "

Box

32 $\frac{9}{16}$ "

19 $\frac{1}{4}$ "

3 $\frac{21}{32}$ "

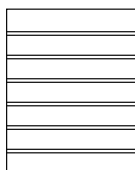

Legal Front to Back

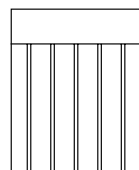

Legal Side to Side

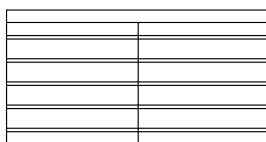

2 Rows Letter or Legal Front to Back

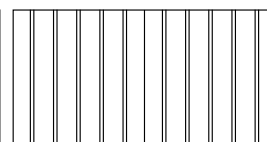

1 Row Letter or Legal Side to Side

### HOW TO ORDER EXAMPLES

	QTY	MODEL NO.	DESCRIPTION	EXAMPLE
<b>TOP</b>	1	91-4296RT	Top Material	W
			Finish/Color	EW
			Edge Profile	C2
			Grommet/Power/ Data Location	EL
<b>BASES</b>	2	01-2028TB	Finish	EW
<b>PORTS</b>	2	01-OASISMA		
<b>TELECOM PLATE</b>	1	01-ABLAB		
<b>MOBILE CART</b>	1	91-2436SV	Top Material	P
			Finish/Color	EW
			Edge Profile	C2
			Pull	ALB
			Back Panel	1-GRMT
			Grommet Grommet Color	Black

### VENEER (W) OPTIONS

Veneer features UVAdvantage, an ultra-violet finish, on all exposed surfaces by utilizing roll-coat UV technology

AW	Artisan Walnut	LW	Legacy Walnut
CO	Columbian Walnut	MW	Mahogany Walnut
DC	Dark Cherry	MTS	Metropolis Sky
DFW	Dark Forest Walnut	PNW	Pinnacle Walnut
EW	Espresso	SCH	Select Cherry
GC	Golden Cherry	SKC	Shaker Cherry
HW	Harvest Walnut	WC	Williamsburg Cherry
HNW	Henna Walnut		

### HPL (P) LAMINATE

#### WOODGRAIN

CO	Columbian Walnut	PNW	Pinnacle Walnut
EF	Espresso	SCH	Select Cherry
GC	Golden Cherry	SKC	Shaker Cherry
MW	Mahogany Walnut	WC	Williamsburg Cherry

### EDGE PROFILES

- C2 Jefferson
- R Arlington



Jefferson (C2)



Arlington (R)

### PULL OPTIONS

ARA	Arlington A, Brass	ALB	Liberty, Aluminum
ARB	Arlington B, Brass	WLM	Wilmington, Brass
JEF	Jefferson, Brass		



**Arlington A (ARA)**  
Antique Brass - 5¼"



**Arlington B (ARB)**  
Antique Brass - 5¼"



**Jefferson (JEF)**  
Antique Brass - 5¼"



**Wilmington (WLM)**  
Antique Brass - 5¼"



**Liberty (ALB)**  
Aluminum - 4¼"

### GROMMET/POWER/DATA OPTIONS & LOCATIONS

See units and options in [accessories section](#) and the [general power and locations information section](#)

### LOCKING DOORS

Locking doors are available on specific units, where noted. You must specify WITH LOCKING when ordering and add upcharge.

Lock core will be black if Arlington, Jefferson, and Wilmington brass pulls are selected and silver if Liberty Aluminum pulls are selected.

LKT_HU	72" W - 48" W Units	\$	115
LKT_HU	42" W - 24" W Units	\$	91
LKT_HU	18" W Units	\$	69

### CERTIFICATIONS & COMPLIANCE

- Intertek Sustainability Certified
- BIFMA level® Certified
- BIFMA Compliant® Certified
- TSCA Title VI (formerly CARB) Compliance
- US Green Building's LEED® Contribution

**Tops/Shapes**

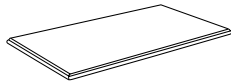

Rectangular [\(See Details\)](#)

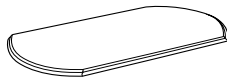

Arc Rectangular [\(See Details\)](#)



Racetrack [\(See Details\)](#)



Boat-Shaped [\(See Details\)](#)

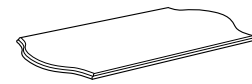

Wave-Rectangular [\(See Details\)](#)

**Bases**

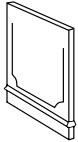

Rectangular [\(See Details\)](#)

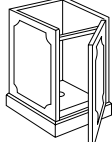

Square [\(See Details\)](#)

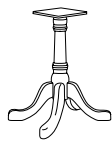

Queen Anne Base [\(See Details\)](#)

**Storage Components**

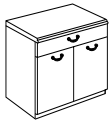

Two Door Buffet w/Drawer [\(See Details\)](#)

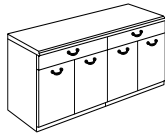

Four Door Buffet w/2 Drawers [\(See Details\)](#)

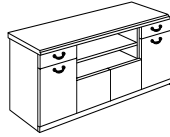

Four Door Buffet w/2 Drawers & Open Storage [\(See Details\)](#)

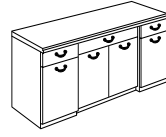

Four Door Buffet w/3 Drawers [\(See Details\)](#)

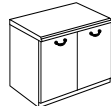

Two Door Credenza [\(See Details\)](#)

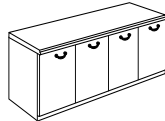

Four Door Credenza [\(See Details\)](#)

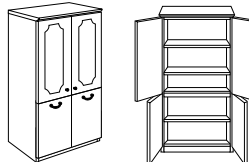

Storage Cabinet Double Doors [\(See Details\)](#)

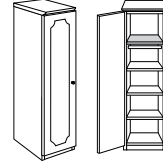

Wardrobe/Storage Cabinet [\(See Details\)](#)



Mobile Serving Cart [\(See Details\)](#)

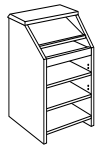

Lectern Stand [\(See Details\)](#)

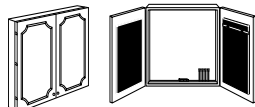

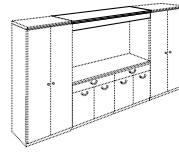

Visual Board [\(See Details\)](#)

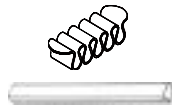

Visor Rail [\(See Details\)](#)

**Wire Management & Power/Data Accessories**



Item	Model No.	W	D	H	Ship Wt	Cubic Ft	List Price
	<b>192" or 16' - 2 Piece Tops</b>						
	91-48192RT	192	48	1 3/16	375	15.5	P\$ 7801 W\$ 9809
	<b>168" or 14' - 2 Piece Tops</b>						
	91-48168RT	168	48	1 3/16	325	13.6	P\$ 7690 W\$ 9140
	<b>144" or 12' - 2 Piece Tops</b>						
	91-48144RT	144	48	1 3/16	275	12.3	P\$ 6468 W\$ 7583
	<b>120" or 10' - 2 Piece Tops</b>						
	91-48120RT	120	48	1 3/16	225	10.3	P\$ 5796 W\$ 6687
	<b>96" or 8' - 1 Piece Top</b>						
	91-4296RT	96	42	1 3/16	180	9.4	P\$ 4349 W\$ 5015
<b>72" or 6' - 1 Piece Top</b>							
91-3672RT	72	36	1 3/16	100	6.2	P\$ 2831 W\$ 3341	

Must Specify (in this order):  
 Model #  
 Top Material  
 Finish/Color  
 Edge Profile  
 Grommet/Power/Data Location

**Description**

- Grain Runs the Width of the Table
- All Veneer Tops, as well as Laminate Tops up to 144" (12 feet), have Matching Woodgrain. Laminate Tops Sized 156" (13 feet) and Longer have Non-Matching Woodgrain
- Heavy-Duty Ganging Mechanisms Connect Two (2) Piece Tops
- See Bases and Number Required For Each Top Size, [See Multiple Base Options](#); Must Order Separately
- Optional Grommets and Power/Data; For Locations See [Power and Locations Information Section](#), See Units and Unit Options in [Accessories Section](#)

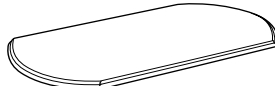
Item	Model No.	W	D	H	Ship Wt	Cubic Ft	List Price
	<b>192" or 16' - 2 Piece Tops</b>						
	91-48192AR	192	48	1 3/16	375	15.5	P\$ 8248 W\$ 10254
	<b>168" or 14' - 2 Piece Tops</b>						
	91-48168AR	168	48	1 3/16	325	13.6	P\$ 8137 W\$ 9586
	<b>144" or 12' - 2 Piece Tops</b>						
	91-48144AR	144	48	1 3/16	275	12.3	P\$ 6911 W\$ 8023
	<b>120" or 10' - 2 Piece Tops</b>						
	91-48120AR	120	48	1 3/16	225	10.3	P\$ 6243 W\$ 7135
	<b>96" or 8' - 1 Piece Top</b>						
	91-4296AR	96	42	1 3/16	180	9.4	P\$ 4904 W\$ 5571
<b>72" or 6' - 1 Piece Top</b>							
91-3672AR	72	36	1 3/16	100	6.2	P\$ 3124 W\$ 3633	

Must Specify (in this order):  
 Model #  
 Top Material  
 Finish/Color  
 Edge Profile  
 Grommet/Power/Data Location

**Description**

- Grain Runs the Width of the Table
- All Veneer Tops, as well as Laminate Tops up to 144" (12 feet), have Matching Woodgrain. Laminate Tops Sized 156" (13 feet) and Longer have Non-Matching Woodgrain
- Heavy-Duty Ganging Mechanisms Connect (2) Piece Tops
- See Bases and Number Required For Each Top Size, [See Multiple Base Options](#); Must Order Separately
- Optional Grommets and Power/Data; For Locations See [Power and Locations Information Section](#), See Units and Unit Options in [Accessories Section](#)

W = Veneer P = HPL

[See Cameo Overview For Ordering Options](#)



Item	Model No.	W	D	H	Ship Wt	Cubic Ft	List Price
<b>RACETRACK TOPS</b> 	<b>192" or 16' - 2 Piece Tops</b>						
	91-48192AT	192	48	1 $\frac{3}{16}$	375	15.5	P\$ 9586 W\$ 11590
	<b>168" or 14' - 2 Piece Tops</b>						
	91-48168AT	168	48	1 $\frac{3}{16}$	325	13.6	P\$ 9252 W\$ 10700
	<b>144" or 12' - 2 Piece Tops</b>						
	91-48144AT	144	48	1 $\frac{3}{16}$	275	12.3	P\$ 7914 W\$ 9029
	<b>120" or 10' - 2 Piece Tops</b>						
	91-48120AT	120	48	1 $\frac{3}{16}$	225	10.3	P\$ 7025 W\$ 7914
	<b>96" or 8' - 1 Piece Top</b>						
	91-4296AT	96	42	1 $\frac{3}{16}$	180	9.4	P\$ 5347 W\$ 6017
	<b>72" or 6' - 1 Piece Top</b>						
	91-3672AT	72	36	1 $\frac{3}{16}$	100	6.2	P\$ 3725 W\$ 4233

Must Specify (in this order):

Model #  
 Top Material  
 Finish/Color  
 Edge Profile  
 Grommet/Power/Data Location

**Description**

- Grain Runs the Width of the Table
- All Veneer Tops, as well as Laminate Tops up to 144" (12 feet), have Matching Woodgrain. Laminate Tops Sized 156" (13 feet) and Longer have Non-Matching Woodgrain
- Heavy-Duty Ganging Mechanisms Connect (2) Piece Tops
- See Bases and Number Required For Each Top Size, [See Multiple Base Options](#); Must Order Separately
- Optional Grommets and Power/Data; For Locations See [Power and Locations Information Section](#), See Units and Unit Options in [Accessories Section](#)

Item	Model No.	W	D	H	Ship Wt	Cubic Ft	List Price
<b>BOAT-SHAPED TOPS</b> 	<b>192" or 16' - 2 Piece Tops</b>						
	91-48192BT	192	48	1 $\frac{3}{16}$	375	15.5	P\$ 9586 W\$ 11590
	<b>168" or 14' - 2 Piece Tops</b>						
	91-48168BT	168	48	1 $\frac{3}{16}$	325	13.6	P\$ 9252 W\$ 10700
	<b>144" or 12' - 2 Piece Tops</b>						
	91-48144BT	144	48	1 $\frac{3}{16}$	275	12.3	P\$ 7914 W\$ 9029
	<b>120" or 10' - 2 Piece Tops</b>						
	91-48120BT	120	48	1 $\frac{3}{16}$	225	10.3	P\$ 7025 W\$ 7914
	<b>96" or 8' - 1 Piece Top</b>						
	91-4296BT	96	42	1 $\frac{3}{16}$	180	9.4	P\$ 5347 W\$ 6017
	<b>72" or 6' - 1 Piece Top</b>						
	91-3672BT	72	36	1 $\frac{3}{16}$	100	6.2	P\$ 3725 W\$ 4233

Must Specify (in this order):

Model #  
 Top Material  
 Finish/Color  
 Edge Profile  
 Grommet/Power/Data Location

**Description**

- Grain Runs the Width of the Table
- All Veneer Tops, as well as Laminate Tops up to 144" (12 feet), have Matching Woodgrain. Laminate Tops Sized 156" (13 feet) and Longer have Non-Matching Woodgrain
- Heavy-Duty Ganging Mechanisms Connect (2) Piece Tops
- See Bases and Number Required For Each Top Size, [See Multiple Base Options](#); Must Order Separately
- Optional Grommets and Power/Data; For Locations See [Power and Locations Information Section](#), See Units and Unit Options in [Accessories Section](#)

W = Veneer P = HPL

[See Cameo Overview For Ordering Options](#)

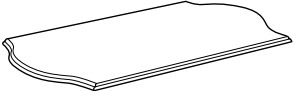
Item	Model No.	W	D	H	Ship Wt	Cubic Ft	List Price
<b>WAVE-RECTANGULAR TOPS</b> 	<b>192" or 16' - 2 Piece Tops</b>						
	91-48192WR	192	48	1¾"	375	15.5	P\$ 8248 W\$ 10254
	<b>168" or 14' - 2 Piece Tops</b>						
	91-48168WR	168	48	1¾"	325	13.6	P\$ 8137 W\$ 9586
	<b>144" or 12' - 2 Piece Tops</b>						
	91-48144WR	144	48	1¾"	275	12.3	P\$ 6911 W\$ 8023
	<b>120" or 10' - 2 Piece Tops</b>						
	91-48120WR	120	48	1¾"	225	10.3	P\$ 6243 W\$ 7135
	<b>96" or 8' - 1 Piece Top</b>						
	91-4296WR	96	42	1¾"	180	9.4	P\$ 4904 W\$ 5571
	<b>72" or 6' - 1 Piece Top</b>						
	91-3672WR	72	36	1¾"	100	6.2	P\$ 3124 W\$ 3633

Must Specify (in this order):

- Model #
- Top Material
- Finish/Color
- Edge Profile
- Grommet/Power/Data Location

**Description**

- Grain Runs the Width of the Table
- All Veneer Tops, as well as Laminate Tops up to 144" (12 feet), have Matching Woodgrain. Laminate Tops Sized 156" (13 feet) and Longer have Non-Matching Woodgrain
- Heavy-Duty Ganging Mechanisms Connect (2) Piece Tops
- See Bases and Number Required For Each Top Size, [See Multiple Base Options](#); Must Order Separately
- Optional Grommets and Power/Data; For Locations See [Power and Locations Information Section](#), See Units and Unit Options in [Accessories Section](#)

**RECTANGULAR BASE TRADITIONAL**

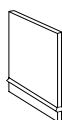
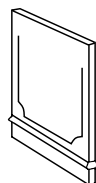

For Use with 48"D Tops							
01-2428TB	24	2	28½"	38	2.7	W\$	1489
For Use with 42"D or Less Tops							
01-2028TB	20	2	28½"	32	2.3	W\$	1397

**Description**

- Veneer Panel Base
- Traditional Molding on Outer Side Standard; For No Decorative Molding Option, Must Specify (See Below)
- Stretchers are Included in Pricing; Must Specify Model (See Below)

**Molding Option: Specify**

NONE	No Decorative Molding	\$	N/C
------	-----------------------	----	-----

Table Width	72"	96"	120"	144"	168"	192"
<b>Number of Bases Required</b>	2	2	3	3	3	5
<b>Stretcher Rail Needed</b>	01-72STR	01-96STR	01-120STR	01-144STR	01-168STR	01-192STR

Note: Molding is applied to one side of outer extreme bases. If 3 or more bases are required, center bases will not have molding on either side.

Must Specify (in this order):

- Model # and Quantity
- Finish
- No Molding
- Stretcher Rail

W = Veneer P = HPL

[See Cameo Overview For Ordering Options](#)

Item	Model No.	W	D	H	Ship Wt	Cubic Ft	List Price
SQUARE BASE TRADITIONAL	01-2020TSB	20	20	28½	57	8.4	W\$ 2033

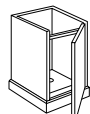
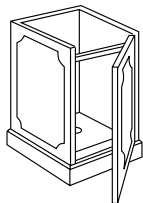
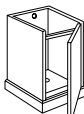
No Molding  
OptionGrommet  
Option**Description**

- Panel Access Door Features Soft Close Hinges
- Traditional Molding Standard on All Sides; For No Decorative Molding Option, Must Specify (See Below)
- 2" Wire Management Opening Above Door; 2¾" (60mm) Wire Management Opening in Bottom
- Optional Grommet at Top Edge, Must Specify (See Below)

**Options: Specify & Add**

NONE	No Decorative Molding	\$	N/C
GCB1S	Grommet at Top Edge One (1) - Factory Installed	\$	52

Table Width	72"	96"	120"	144"	168"	192"
<b>Number of Bases Required</b>	2	2	3	3	3	3

Note: Recommended on tables 72"W or Larger. If specified on smaller tables, a ballast must be ordered separately. Contact Customer Service for more information.

Must Specify (in this order):

- Model # and Quantity
- Finish
- No Molding
- Grommet Option

QUEEN ANNE BASE	01-0606QB	24	24	28¾	35	10.8	W\$ 1406
-----------------	-----------	----	----	-----	----	------	----------

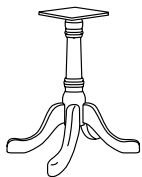
**Description**

- Classic Design Detail on Column
- Queen Anne Base Features Multi-Step, Hand-Finished Catalyzed Finish
- Four (4) Legs with Adjustable Glides

Table Width	72"	96"	120"	144"	168"	192"
<b>Number of Bases Required</b>	2	2	3	3	3	5

Must Specify (in this order):

- Model # and Quantity
- Finish

W = Veneer P = HPL

[See Cameo Overview For Ordering Options](#)

Item	Model No.	W	D	H	Ship Wt	Cubic Ft	List Price
<b>TWO DOOR BUFFET WITH DRAWER</b>	91-2436BF	36	24	36	189	21.7	P\$ 4213 W\$ 4290

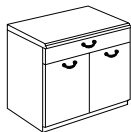
**Description**

- Top Edge Profiled on Approach Side Only ([See Edge Options](#)); Must Specify Edge Selection
- One (1) Drawer and Storage Behind Two (2) Doors with One (1) Adjustable Shelf

Must Specify (in this order):

Model #  
Top Material  
Finish/Color  
Edge Profile  
Pull

<b>FOUR DOOR BUFFET WITH TWO DRAWERS</b>	91-2472BF	72	24	36	342	45.6	P\$ 8005 W\$ 8137
--	-----------	----	----	----	-----	------	----------------------

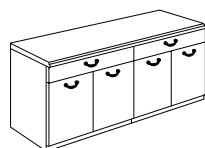
**Description**

- Top Edge Profiled on Approach Side Only ([See Edge Options](#)); Must Specify Edge Selection
- Two (2) Drawers and Storage Behind Four (4) Doors with Two (2) Adjustable Shelves

Must Specify (in this order):

Model #  
Top Material  
Finish/Color  
Edge Profile  
Pull

<b>FOUR DOOR BUFFET WITH TWO DRAWERS AND OPEN STORAGE</b>	91-2472BFD	72	24	36	337	45.6	P\$ 9231 W\$ 9366
---	------------	----	----	----	-----	------	----------------------

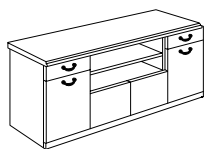
**Description**

- Top Edge Profiled on Approach Side Only ([See Edge Options](#)); Must Specify Edge Selection
- Two (2) Drawers with Open Storage with One (1) Adjustable Shelf
- Left and Right Storage Behind Doors with One (1) Adjustable Shelf
- Storage Behind Center Doors

Must Specify (in this order):

Model #  
Top Material  
Finish/Color  
Edge Profile  
Pull

<b>FOUR DOOR BUFFET WITH THREE DRAWERS</b>	91-2472SBF	72	24	36	362	45.6	P\$ 9231 W\$ 9366
--	------------	----	----	----	-----	------	----------------------

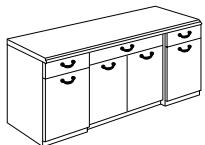
**Description**

- Top Edge Profiled on Approach Side Only ([See Edge Options](#)); Must Specify Edge Selection
- Three (3) Drawers and Storage Behind Four (4) Doors with Three (3) Adjustable Shelves
- Center Section is Stepped Back

Must Specify (in this order):

Model #  
Top Material  
Finish/Color  
Edge Profile  
Pull

W = Veneer P = HPL

[See Cameo Overview For Ordering Options](#)

Item	Model No.	W	D	H	Ship Wt	Cubic Ft	List Price
TWO DOOR CREDENZA	91-2436CC	36	24	30	150	17.6	P\$ 3264 W\$ 3341

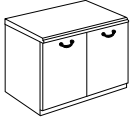

Must Specify (in this order):

- Model #
- Top Material
- Finish/Color
- Edge Profile
- Pull
- Locking Option

**Description**

- Top Edge Profiled on Approach Side Only ([See Edge Options](#)); Must Specify Edge Selection
- Two (2) Doors with One (1) Adjustable Shelf Behind Doors
- Additional Option: Locking Doors ([See Locking Options](#))

FOUR DOOR CREDENZA	91-2472CC	72	24	30	290	34.2	P\$ 6613 W\$ 6746
--------------------	-----------	----	----	----	-----	------	----------------------

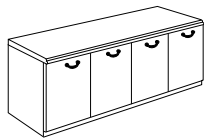

Must Specify (in this order):

- Model #
- Top Material
- Finish/Color
- Edge Profile
- Pull
- Locking Option

**Description**

- Top Edge Profiled on Approach Side Only ([See Edge Options](#)); Must Specify Edge Selection
- Four (4) Doors with Two (2) Adjustable Shelves Behind Doors
- Additional Option: Locking Doors ([See Locking Options](#))

DOUBLE DOOR STORAGE CABINET	91-3672SUD	36	24	72	285	42.0	W\$ 6784
-----------------------------	------------	----	----	----	-----	------	----------

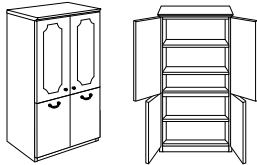

Must Specify (in this order):

- Model #
- Finish
- Edge Profile
- Knob
- Pull
- No Molding

**Description**

- Top Section has Two (2) Adjustable Shelves; Bottom Section has One (1) Adjustable Shelf
- Two (2) Knobs on Top Doors, Available with Antique Brass (TKN) Door Knob or Aluminum (ALK) Door Knob; Must Specify; Selection of Pulls on Bottom Doors

**Options: Specify**

NONE	No Decorative Molding	\$	N/C
------	-----------------------	----	-----

WARDROBE/STORAGE CABINET	HINGED LEFT	HINGED RIGHT	W	D	H	Ship Wt	Cubic Ft	List Price
	91-1872WL	91-1872WR	18	24	72	155	22.0	W\$ 5402

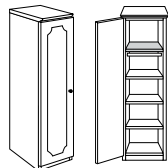

Must Specify (in this order):

- Model #
- Finish
- Edge Profile
- Knob
- No Molding

**Description**

- Available with Antique Brass (TKN) Door Knob or Aluminum (ALK) Door Knob; Must Specify
- Fixed Top Shelf; Coat Rod Under Fixed Shelf
- Three (3) Adjustable Shelves Behind Door
- Adjustable Shelves can be Removed for Wardrobe Application

**Options: Specify**

NONE	No Decorative Molding	\$	N/C
------	-----------------------	----	-----

W = Veneer P = HPL

[See Cameo Overview For Ordering Options](#)

Item	Model No.	W	D	H	Ship Wt	Cubic Ft	List Price
VISOR RAIL	91-2472VR	72	24	5 <sup>3</sup> / <sub>16</sub>	100	8.9	W\$ 1394

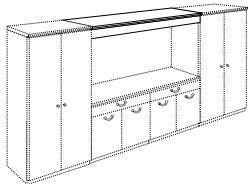

Must Specify (in this order):  
Model #  
Finish  
Projection Screen  
Task Light

**Description**

- Overhead Rail Creates Wall Unit
- For Use with 72" High Cabinets and Credenzas/Bufets (Ordered Separately)

**Options: Specify & Add**

1-PS	Projection Screen (Requires Field Installation)	\$ 1062
TL-0848	Task Light (Requires Field Installation)	\$ 445

SERVING CART	91-2436SV	36	24	36	149	24.0	P\$ 5052 W\$ 5132
--------------	-----------	----	----	----	-----	------	----------------------



Must Specify (in this order):  
Model #  
Top Material  
Finish/Color  
Edge Profile  
Pull  
Grommet Option

**Description**

- Top Edge Profiled on Approach Side Only; Must Specify Edge Selection
- Two (2) Box Drawers with Storage Behind Two (2) Doors
- Open Storage
- Locking Casters

**Grommet Option: Specify & Add**

1-GRMT	Grommet in Back Panel; Must Specify Black or Silver	\$ 52
--------	---	-------

LECTERN STAND	91-2650LS	26	24	50	130	21.9	W\$ 4017
---------------	-----------	----	----	----	-----	------	----------

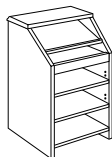

Must Specify (in this order):  
Model #  
Finish  
Edge Profile

**Description**

- Top Edge Profiled on Approach Side Only; Must Specify Edge Selection
- Fixed Reading Shelf
- Pullout Shelf
- Two (2) Adjustable Storage Shelves in Lower Compartment
- Two (2) Locking and Two (2) Non-Locking Casters
- Wire Management Grommet in Bottom Shelf

VISUAL BOARD	91-4848VB	48	5	48	150	11.0	W\$ 5796
--------------	-----------	----	---	----	-----	------	----------

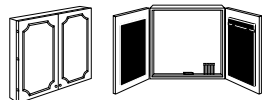

Must Specify (in this order):  
Model #  
Finish  
Project Screen  
Tackboard Fabric  
Pull

**Description**

- Tackboard on Each Door Standard in Black Fabric Unless Specified; Price Valid for Grades 1, 2, & 3 (See Other Pricing Below)
- Display Rail with Adjustable Hooks for Flipchart
- Magnetic Door Closure and Porcelain Non-Glare Writing Surface
- Includes Flipchart, Set of Four (4) Dry Erase Markers and Eraser, Mounting Hardware
- Does Not Feature Soft Close Hinges

**Options: Specify & Add**

	Grade 4	Grade 5	Grade 6	Grade 7	Grade 8	Grade 9	Grade 10
Tackboard Fabric Change	\$ Empty Field!	Empty Field!	Empty Field!	Empty Field!	Empty Field!	Empty Field!	Empty Field!
1-PS	Projection Screen (Requires Field Installation)						\$ 1062

W = Veneer P = HPL

[See Cameo Overview For Ordering Options](#)

Item	Model No.	W	D	H	Ship Wt	Cubic Ft	List Price
TABLE POWER & DATA VAULT	01-CVAULTG2A	4½	15⅞	4⅞	10	0.4	\$ 1944



OPEN MARKET ONLY

**Description**

- Electric Drive Motor Rotates the Surface Technology 180° to the Proper Position
- Photo-Electronic Eye Prevents Rotation When Obstructed
- Two (2) Data Ports, Three (3) Power Outlets, and One (1) HDMI and Two (2) 5V USB
- 6' Power Cord
- UL and CSA Recognized

Item	Model No.	Material	W	D	H	Ship Wt	Cubic Ft	List Price
WORKSURFACE POWER CENTER	01-INTRFC1A	Aluminum	14¼	6⅝	2⅞	11	0.3	\$ 2064
	01-INTRFC1B	Black						

**Description**

- For Use with Conference Tables
- Four (4) Power Outlets, Three (3) Telecom Plate Openings
- Two (2) Telecom Plates Included with the Unit: One (1) 01-ABLAB Plate (Consists of One (1) RJ45 Cat 6, One (1) RJ11 Cat 3 Phone Jack); One (1) 01-ABLBB Plate (Consists of Two (2) RJ45 Cat 6)
- 6' Power Cord
- Convenience Plug on Bottom
- UL Listed/CSA Certified
- Additional Telecom Plates, [See Telecom Plate Options](#)

Item	Model No.	Material	W	D	H	Ship Wt	Cubic Ft	List Price
OASIS MINI POWER & DATA	01-OASISMA	Aluminum	14¼	6⅝	2⅞	11	0.3	\$ 3191
	01-OASISMB	Black						

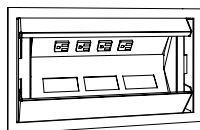

Top View

**Description**



- For Use with Conference Tables
- Soft Touch Hinged Lid
- Four (4) Power Outlets, Three (3) Telecom Plate Openings
- Two (2) Telecom Plates Included with the Unit: One (1) 01-ABLAB Plate (Consists of One (1) RJ45 Cat 6, One (1) RJ11 Cat 3 Phone Jack); One (1) 01-ABLB Plate (Consists of One (1) RJ45 Cat 6)
- 9' Power Cord
- UL Listed
- Additional Telecom Plates, [See Telecom Plate Options](#)

Item	Model No.	Material	W	D	H	Ship Wt	Cubic Ft	List Price
INTERACT POWER & DATA	01-INTERACTG2A	Aluminum	9	5⅝	2¾	5	0.2	\$ 891
	01-INTERACTG2B	Black						

**Description**

- Includes: Two (2) Power Outlets, Two (2) USB-A Charging Ports, One (1) Telecom Plate Opening; Two (2) Keystone Openings for Voice/Data Jacks
- One (1) Telecom Plates Included with the Unit: One (1) 01-ABLAB Plate (Consists of One (1) RJ45 Cat 6, One (1) RJ11 Cat 3 Phone Jack)
- Convenience Plug on Bottom
- 6' Power Cord
- UL and CSA Recognized
- Additional Telecom Plates, [See Telecom Plate Options](#)

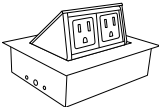
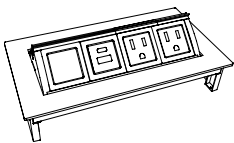
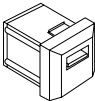
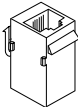
[See Cameo Overview For Ordering Options](#)

Item	Model No.		W	D	H	Ship Wt	Cubic Ft	List Price
POWER 440 	01-DATA440A	Aluminum	5 $\frac{5}{16}$	4 $\frac{3}{8}$	-	5	0.2	\$ 964
	01-DATA440B	Black						
<b>Description</b>								
<ul style="list-style-type: none"> <li>• Two (2) Power Outlets</li> <li>• Soft Touch Hinged Lid</li> <li>• 6' Power Cord</li> <li>• UL and CSA Recognized</li> </ul>								
POWER DATA PORT 	01-DPORT4A	Aluminum	8	4	-	7	0.2	\$ 1093
	01-DPORT4B	Black						
<b>Description</b>								
<ul style="list-style-type: none"> <li>• Retracts into Work Surface to Regain Productive Space; One-Touch Access to Power and Data</li> <li>• Two (2) Power Outlets and Two (2) Open Ports for Data</li> <li>• Additional Telecom Plates, <a href="#">See Telecom Plate Options</a></li> <li>• Water-Proof Simplex (Outlets)</li> <li>• Includes a Voice/Data Adapter Kit to Accept Couplers and Jacks When Required</li> <li>• 6' Power Cord</li> <li>• UL and CSA Recognized</li> </ul>								
USB PORT 	01-USBPORT		-	-	-	-	-	\$ 161
<b>Description</b>								
<ul style="list-style-type: none"> <li>• Passive USB-A Port with Increased Transfer Speed Up to 5 gbs/sec</li> <li>• Simultaneous Read/Write Capability; Idle Device Power Saving State</li> <li>• 6' Cord</li> <li>• Compatible with 01-DPORT4</li> </ul>								
VOICE COUPLER 	01-VOICE1		-	-	-	-	-	\$ 73
<b>Description</b>								
<ul style="list-style-type: none"> <li>• 6-Pin Modular Plug</li> <li>• Molded Black; Cord Not included</li> <li>• Compatible with 01-DPORT4</li> </ul>								
DATA PORT 	01-RJ4DATA		-	-	-	-	-	\$ 167
<b>Description</b>								
<ul style="list-style-type: none"> <li>• 8-Pin Modular Plug; Cat6 Ethernet Cable; Pre-terminated Cable</li> <li>• 10' Cord</li> <li>• Compatible with 01-DPORT4</li> </ul>								

[See Cameo Overview For Ordering Options](#)



Item	Model No.		W	D	H	Ship Wt	Cubic Ft	List Price
ROUND GROMMET COVER	01-GRMTBK	Black	2 $\frac{3}{8}$	2 $\frac{3}{8}$	-	1	0.1	\$ 11
	01-GRMTSL	Silver						



OPEN MARKET ONLY  
(SILVER)

#### Description

- 2 $\frac{3}{8}$ " (60mm) Round Grommet Cover
- Field Installed

SINGLE POWER SAND DOLLAR	01-SAND60PS	Silver	3	3	4	1	0.2	\$ 98
	01-SAND60PW	White						
	01-SAND60PB	Black						

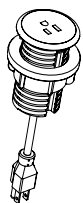

#### Description

- Mounts in 2 $\frac{3}{8}$ " (60mm) Round Grommet
- Single Power Outlet with 6' Cord

DOUBLE USB SAND DOLLAR	01-SAND60US	Silver	3	3	4	1	0.2	\$ 277
	01-SAND60UW	White						
	01-SAND60UB	Black						

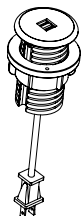

#### Description

- Mounts in 2 $\frac{3}{8}$ " (60mm) Round Grommet
- Dual USB Outlets with 6' Cord

DUO BEZEL CLAMP NEMA PLUG	01-DUOCLAMPS	Silver	5 $\frac{1}{2}$	3	7	1	0.2	\$ 572
	01-DUOCLAMPW	White						
	01-DUOCLAMPB	Black						

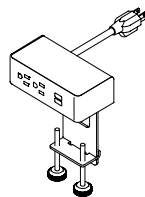

#### Description

- Silver Metal Trim
- Clamps to Top
- Two (2) Power/Two (2) USB; 10' Cord
- Independent USB Circuit Controllers Deliver up to 2.1 Amps to Each Post
- All Mounting Hardware Included
- FCC Part 15A and UL Approved for Horizontal and Vertical Applications

[See Cameo Overview For Ordering Options](#)

Item	Model No.		W	D	H	Ship Wt	Cubic Ft	List Price
TRIO BEZEL CLAMP NEMA PLUG	01-TRIOCLAMPS	Silver	8	3	7	1	0.2	\$ 671
	01-TRIOCLAMPW	White						
	01-TRIOCLAMPS	Black						

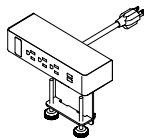
**Description**

- Silver Metal Trim
- Clamps to Top
- Three (3) Power/Two (2) USB Power/One (1) Open Data; 10' Cord
- Independent USB Circuit Controllers Deliver up to 2.1 Amps to Each Post
- HDMI, VGA, or RJ45 Accessories Sold Separately; See Below
- All Mounting Hardware Included
- FCC Part 15A and UL Approved for Horizontal and Vertical Applications

HDMI DATA PORT ACCESSORY FOR TRIO UNITS	01-LCOMHDMI		-	-	-	1	0.2	\$ 166
--	-------------	--	---	---	---	---	-----	--------

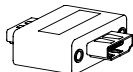

OPEN MARKET ONLY

**Description**

- HDMI Port for Trio Bezel Units

VGA DATA PORT ACCESSORY FOR TRIO UNITS	01-LCOMVGA		-	-	-	1	0.2	\$ 121
---	------------	--	---	---	---	---	-----	--------

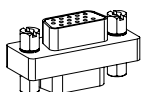
**Description**

- VGA Port for Trio Bezel Units

RJ45 DATA PORT ACCESSORY FOR TRIO UNITS	01-LCOMRJ45		-	-	-	1	0.2	\$ 79
--	-------------	--	---	---	---	---	-----	-------

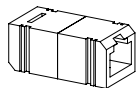
**Description**

- RJ45 Port for Trio Bezel Units

[See Cameo Overview For Ordering Options](#)

Item	Model No.	W	D	H	Ship Wt	Cubic Ft	List Price
VESTA POWER CENTER	01-PDCTR	10 $\frac{3}{4}$	12	28 $\frac{1}{4}$	14	2.5	\$ 1776

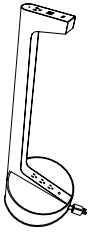

### Description

- Top Includes One (1) Power Outlet, Two (2) USB Ports and One (1) USBC Port; Base Includes Three (3) Outlets
- Available in White
- 120" Power Cord
- Built with Weight Distribution for Optimal Stability
- Base is 5" Tall

WIRE MANAGERS	01-WMGR4	16	1 $\frac{1}{2}$	$\frac{3}{4}$	1	-	\$ 116
---------------	----------	----	-----------------	---------------	---	---	--------

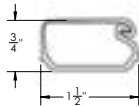

### Description

- Four (4) Wire Manager Strips
- Black Plastic
- Snap Lock Channel
- Attaches with Adhesive Strips
- Can be Placed on All Units to Route Wires

CABLE GRIP	01-WMGRCB	5 $\frac{3}{8}$	2 $\frac{5}{8}$	-	-	-	\$ 17
------------	-----------	-----------------	-----------------	---	---	---	-------

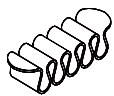

### Description

- Under Surface Wire Management
- Black

POWER STRIP	01-PRSP	9	2	2	1	-	\$ 205
-------------	---------	---	---	---	---	---	--------



### Description

- Includes Four (4) Outlets and Two (2) Phone Jacks
- Black Plastic with Rocker On/Off Switch
- 13 Amp Circuit Breaker
- 10' Power Cord and Two (2) 14' Phone Hook Up Cords
- UL Listed and CSA Certified
- Suitable for Surface or Recessed Mounting
- Ships via UPS Only

Item	Model No.	Description	List Price
ECA TELECOM PLATES	01-ABL	Telecom Plate, Blank Plate	\$ 41
	01-ABL737373	Telecom Plate, Three (3) RJ45 Cat 5e	\$ 367
	Compatible with:		
	01-ABLAB	Telecom Plate, One (1) RJ45 Cat 6, One (1) RJ11 Cat 3 Phone	\$ 206
	01-ABLAB102	Telecom Plate, One (1) RJ45 Cat 6, One (1) RJ11 Cat 3, One (1) USB W/72" Patch Cord	\$ 320
	01-ABLABB	Telecom Plate, Two (2) RJ45 Cat 6, One (1) RJ11 Cat 3 Phone	\$ 320
	01-ABLB	Telecom Plate, One (1) RJ45 Cat 6	\$ 149
	01-ABLB	Telecom Plate, Two (2) RJ45 Cat 6	\$ 260
	01-ABLB	Telecom Plate, Three (3) RJ45 Cat 6	\$ 367
	01-ABLB	Telecom Plate, Four (4) RJ45 Cat 6	\$ 476
	01-ABLBB	Telecom Plate, Two (2) RJ45 Cat 6, One (1) 15 Pin HD VGA w/72" Patch Cord	\$ 446
	01-ABLBBB	Telecom Plate, One (1) RJ45 Cat 6, One (1) Mini Stereo Inline, One (1) 15 Pin HD VGA w/72" Patch Cord	\$ 410
	01-ABLBBB	Telecom Plate, One (1) RJ45 Cat 6 Data Inline, One (1) RJ11 Cat 3 Phone Inline	\$ 197
	01-ABLBBB	Telecom Plate, One (1) HDMI w/36" Patch Cord	\$ 295
	01-ABLBBB	Telecom Plate, One (1) Mini Stereo Inline, One (1) HDMI w/36" Patch Cord, One (1) 15 Pin HD VGA w/72" Patch Cord	\$ 558
	01-ABLBBB	Telecom Plate, One (1) 15 Pin HD VGA & One (1) Mini Stereo Inline Jack	\$ 298
	01-ABLBBB	Telecom Plate, Three (3) Cord Bushings	\$ 96



Oasis Mini Power & Data  
01-OASISMA, 01-OASISMB



Interact Power & Data  
01-INTERACTG2A, 01-INTERACTG2B



Power Center  
01-INTRFCIA, 01-INTRFCIB

**Standard Cutout Types & General Location Information**

- Grommets can be specified, at an upcharge, add \$11 for a field installed grommet cover or add \$50 for a factory installed grommet (unless otherwise noted).
- Power/Data Modules can be specified in standard locations at no additional charge.
- The selection of both the Power/Data Module and Base will determine cutout locations for each table size, as well as placement over or between bases.
- [See exact measurements of Module locations.](#)
- For specific locations available by table size see series pages, [see Cameo locations.](#)

**Cutout Locations Available**

**OC** = On Center  
**BB** = Between Bases (*requires 2 modules*)  
**CL** = Left of Center  
**CR** = Right of Center  
**EL** = End Left  
**ER** = End Right  
**ML** = Middle Left  
**MR** = Middle Right

**General Location of Cutouts**

*For Tables with **Two (2) Bases** and **One (1) Location**:*

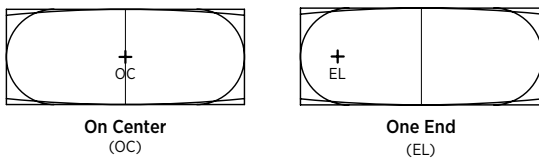

*For Tables with **Two (2) Bases** and **Two (2) Locations**:*

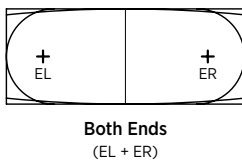

*For Tables with **Three (3) Bases** and **One (1) Location**:*

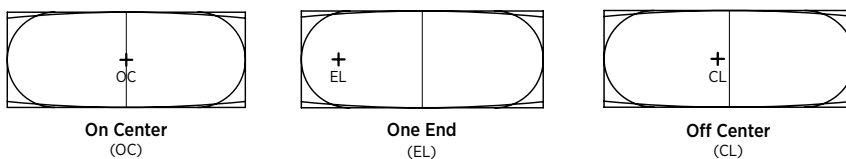

*For Tables with **Three (3) Bases** and **Two (2) Locations**:*

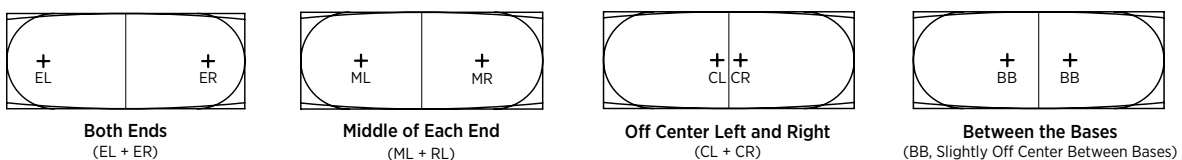

*For Tables with **Three (3) Bases** and **Three (3) Locations**:*

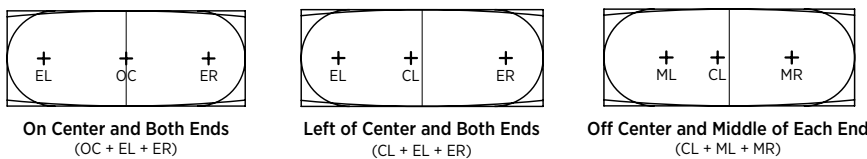

*Continued on Next Page.*

[See Cameo Overview For Ordering Options](#)

**Standard Cutout Types & General Location Information (Continued)**

- Grommets can be specified, at an upcharge, add \$11 for a field installed grommet cover or add \$50 for a factory installed grommet (unless otherwise noted).
- Power/Data Modules can be specified in standard locations at no additional charge.
- The selection of both the Power/Data Module and Base will determine cutout locations for each table size, as well as placement over or between bases.
- [See exact measurements of Module locations.](#)
- For specific locations available by table size see series pages, [see Cameo locations.](#)

**Cutout Locations Available**

**OC** = On Center  
**BB** = Between Bases (*requires 2 modules*)  
**CL** = Left of Center  
**CR** = Right of Center  
**EL** = End Left  
**ER** = End Right  
**ML** = Middle Left  
**MR** = Middle Right

**General Location of Cutouts**

*Continued from Previous Page*

*For Tables with **Three (3) Bases** and **Four (4) Locations**:*

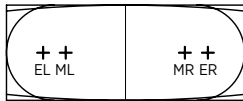

**Middle of Each End and Both Ends**  
(ML + MR + EL + ER)

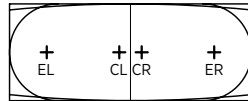

**Off Center and Both Ends**  
(CL + CR + EL + ER)

*For Tables with **Five (5) Bases** and **One (1) Location**:*

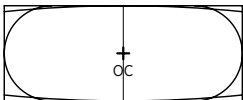

**On Center**  
(OC)



**One End**  
(EL)

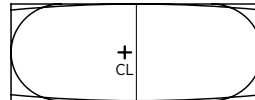

**Off Center**  
(CL)

*For Tables with **Five (5) Bases** and **Two (2) Locations**:*



**Both Ends**  
(EL + ER)



**Middle of Each End**  
(ML + MR)

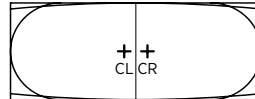

**Off Center Left and Right**  
(CL + CR)

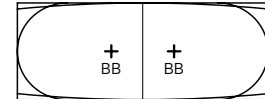

**Between the Bases**  
(BB, Slightly Off Center Between Bases)

*For Tables with **Five (5) Bases** and **Three (3) Locations**:*

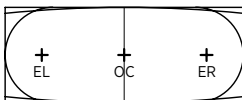

**On Center and Both Ends**  
(OC + EL + ER)

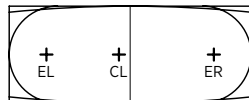

**Left of Center and Both Ends**  
(CL + EL + ER)

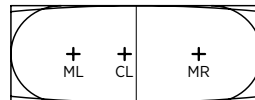

**Off Center and Middle of Each End**  
(CL + ML + MR)

*For Tables with **Five (5) Bases** and **Four (4) Locations**:*

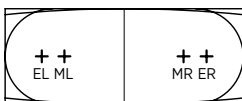

**Middle of Each End and Both Ends**  
(ML + MR + EL + ER)

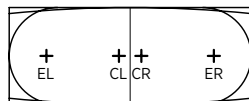







**Off Center and Both Ends**  
(CL + CR + EL + ER)

[See Cameo Overview For Ordering Options](#)

Location Measurements By Module



	72" Tops	96" Tops	120", 144" & 168" Tops	192" Tops
	<b>OC</b> On Center <b>BB</b> Between Bases (requires 2 modules)		<b>CL</b> Left of Center <b>CR</b> Right of Center	<b>EL</b> End Left <b>ER</b> End Right <b>ML</b> Middle Left <b>MR</b> Middle Right
<b>GROMMET</b> 	OC Center of Table	OC Center of Table EL, EL + ER 24½" from end	CL, CL + CR 5½" from center EL, EL + ER 24½" from end CL + EL + ER, 5½" from center and CL + CR + EL + ER 24½" from end BB Slightly off centered between bases	CL, CL + CR 5½" from center EL, EL + ER 24½" from end CL + EL + ER, 5½" from center and CL + CR + EL + ER 24½" from end BB Slightly off centered between bases ML + MR 48" from end CL + ML + MR, 5½" from center and CL + CR + ML + MR 48" from end
<b>POWER 440</b>  <b>INTERACT</b> 	OC Center of Table	OC Center of Table EL, EL + ER 25" from end	OC Splits seam in center of bases EL, EL + ER 25" from end CL, CL + CR 5" from center CL + EL + ER, 5" from center and CL + CR + EL + ER 25" from end BB Slightly off centered between bases	OC Splits seam in center of bases EL, EL + ER 25" from end CL, CL + CR 5" from center CL + EL + ER, 5" from center and CL + CR + EL + ER 25" from end BB Slightly off centered between bases ML + MR 48" from end CL + ML + MR, 5" from center and CL + CR + ML + MR 48" from end
<b>DPORT 4A</b>  <b>OASIS MINI,</b>  <b>INTRFC1</b>  <b>POWER &amp; DATA VAULT</b> 	OC Center of Table	OC Center of Table EL, EL + ER 29" from end	OC Splits seam in center of bases EL, EL + ER 29" from end CL + EL + ER, 9½" from center and CL + CR + EL + ER 29" from end CL, CL + CR 9½" from center BB Slightly off centered between bases	OC Splits seam in center of bases EL, EL + ER 29" from end CL + EL + ER, 9½" from center and CL + CR + EL + ER 29" from end CL, CL + CR 9½" from center BB Slightly off centered between bases ML + MR 48" from end OC+ EL + ER Splits center seam and 29" from end OC+ ML + MR Splits center seam and 48" from end CL + ML + MR, 9½" from center and CL + CR + ML + MR 48" from end

[See Cameo Overview For Ordering Options](#)



## 36"x72" & 42"x96" TOPS

For General Location Information, [See Cut Out Locations](#); For Exact Measurements of Locations, [See Details](#).

### TOP LOCATIONS AVAILABLE BY BASE & MODULE COMBINATION

OC On Center

BB Between Bases (requires 2 modules)

CL Left of Center















CR Right of Center

EL End Left

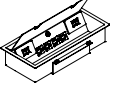
ER End Right

ML Middle Left

MR Middle Right

36x72				42x96			
	RECTANGLE	SQUARE	QUEEN ANNE		RECTANGLE	SQUARE	QUEEN ANNE
<b>GROMMET</b> 	OC	OC	OC	<b>GROMMET</b> 	OC EL EL + ER	OC EL EL + ER	OC
<b>POWER &amp; DATA VAULT</b> 	OC			<b>POWER &amp; DATA VAULT</b> 	OC EL EL + ER	OC EL EL + ER	OC
<b>OASIS MINI</b> 	OC			<b>OASIS MINI</b> 	OC EL EL + ER	OC EL EL + ER	OC
<b>INTERACT</b> 	OC			<b>INTERACT</b> 	OC EL EL + ER	OC EL EL + ER	OC
<b>INTRFC1</b> 	OC			<b>INTRFC1</b> 	OC EL EL + ER	OC EL EL + ER	OC
<b>POWER 440</b> 	OC	OC	OC	<b>POWER 440</b> 	OC EL EL + ER	OC EL EL + ER	OC
<b>DPORT4A</b> 	OC	OC	OC	<b>DPORT4A</b> 	OC EL EL + ER	OC EL EL + ER	OC

[See Cameo Overview For Ordering Options](#)

















**48"x120" & 48"x144" TOPS**

For General Location Information, [See Cut Out Locations](#); For Exact Measurements of Locations, [See Details](#).

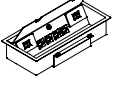
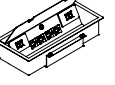
**TOP LOCATIONS AVAILABLE BY BASE & MODULE COMBINATION**

**OC** On Center      **CL** Left of Center      **EL** End Left      **ML** Middle Left  
**BB** Between Bases (requires 2 modules)      **CR** Right of Center      **ER** End Right      **MR** Middle Right

48x120				48x144			
	RECTANGLE	SQUARE	QUEEN ANNE		RECTANGLE	SQUARE	QUEEN ANNE
<b>GROMMET</b> 	BB, CL or EL CL + CR EL + ER CL + EL + ER CL + CR + EL + ER	BB, CL or EL CL + CR EL + ER CL + EL + ER CL + CR + EL + ER	BB	<b>GROMMET</b> 	BB, CL or EL CL + CR EL + ER CL + EL + ER CL + CR + EL + ER	BB, CL or EL CL + CR EL + ER CL + EL + ER CL + CR + EL + ER	BB
<b>POWER &amp; DATA VAULT</b> 	BB, CL or EL CL + CR EL + ER CL + EL + ER CL + CR + EL + ER	OC EL EL + ER OC + EL + ER		<b>POWER &amp; DATA VAULT</b> 	BB, CL or EL CL + CR EL + ER CL + EL + ER CL + CR + EL + ER	OC BB EL EL + ER OC + EL + ER	BB
<b>OASIS MINI</b> 	BB, CL or EL CL + CR EL + ER CL + EL + ER CL + CR + EL + ER	OC EL EL + ER OC + EL + ER		<b>OASIS MINI</b> 	BB, CL or EL CL + CR EL + ER CL + EL + ER CL + CR + EL + ER	OC BB EL EL + ER OC + EL + ER	BB
<b>INTERACT</b> 	BB, CL or EL CL + CR EL + ER CL + EL + ER CL + CR + EL + ER	OC EL EL + ER OC + EL + ER	BB	<b>INTERACT</b> 	BB, CL or EL CL + CR EL + ER CL + EL + ER CL + CR + EL + ER	OC BB EL EL + ER OC + EL + ER	BB
<b>INTRFC1</b> 	BB, CL or EL CL + CR EL + ER CL + EL + ER CL + CR + EL + ER	OC EL EL + ER OC + EL + ER	BB	<b>POWER CENTER</b> 	BB, CL or EL CL + CR EL + ER CL + EL + ER CL + CR + EL + ER	OC BB EL EL + ER OC + EL + ER	BB
<b>POWER 440</b> 	BB, CL or EL CL + CR EL + ER CL + EL + ER CL + CR + EL + ER	BB, CL or EL CL + CR EL + ER CL + EL + ER CL + CR + EL + ER	BB	<b>POWER 440</b> 	BB, CL or EL CL + CR EL + ER CL + EL + ER CL + CR + EL + ER	BB, CL or EL CL + CR EL + ER CL + EL + ER CL + CR + EL + ER	BB
<b>DPORT4A</b> 	BB, CL or EL CL + CR EL + ER CL + EL + ER CL + CR + EL + ER	OC EL EL + ER OC + EL + ER	BB	<b>DPORT4A</b> 	BB, CL or EL CL + CR EL + ER CL + EL + ER CL + CR + EL + ER	OC BB EL EL + ER OC + EL + ER	BB

[See Cameo Overview For Ordering Options](#)



**48"x168" & 48"x192" TOPS**

For General Location Information, [See Cut Out Locations](#); For Exact Measurements of Locations, [See Details](#).

**TOP LOCATIONS AVAILABLE BY BASE & MODULE COMBINATION**

OC On Center

BB Between Bases (requires 2 modules)

CL Left of Center

CR Right of Center

EL End Left

ER End Right

ML Middle Left

MR Middle Right

48x168			
	RECTANGLE	SQUARE	QUEEN ANNE
<b>GROMMET</b> 	BB, CL or EL CL + CR EL + ER CL + EL + ER CL + CR + EL + ER	BB, CL or EL CL + CR EL + ER CL + EL + ER CL + CR + EL + ER	BB
<b>POWER &amp; DATA VAULT</b> 	BB, CL or EL CL + CR EL + ER CL + EL + ER CL + CR + EL + ER	OC, BB or EL EL + ER OC + EL + ER	BB
<b>OASIS MINI</b> 	BB, CL or EL CL + CR EL + ER CL + EL + ER CL + CR + EL + ER	OC, BB or EL EL + ER OC + EL + ER	BB
<b>INTERACT</b> 	BB, CL or EL CL + CR EL + ER CL + EL + ER CL + CR + EL + ER	OC, BB or EL EL + ER OC + EL + ER	BB
<b>INTRFC1</b> 	BB, CL or EL CL + CR EL + ER CL + EL + ER CL + CR + EL + ER	OC, BB or EL EL + ER OC + EL + ER	BB
<b>POWER 440</b> 	BB, CL or EL CL + CR EL + ER CL + EL + ER CL + CR + EL + ER	BB, CL or EL CL + CR EL + ER CL + EL + ER CL + CR + EL + ER	BB
<b>DPORT4A</b> 	BB, CL or EL CL + CR EL + ER CL + EL + ER CL + CR + EL + ER	OC, BB or EL EL + ER OC + EL + ER	BB

48x192			
	RECTANGLE	SQUARE	QUEEN ANNE
<b>GROMMET</b> 	CL or EL CL + CR EL + ER ML + MR CL + EL + ER CL + ML + MR CL + CR + EL + ER CL + CR + ML + MR	BB, CL or EL CL + CR EL + ER ML + MR CL + EL + ER CL + ML + MR CL + CR + EL + ER CL + CR + ML + MR	BB ML + MR
<b>POWER &amp; DATA VAULT</b> 	CL or EL CL + CR EL + ER ML + MR CL + EL + ER CL + ML + MR CL + CR + EL + ER CL + CR + ML + MR	OC, BB or EL EL + ER ML + MR OC + EL + ER OC + ML + MR	BB ML + MR
<b>OASIS MINI</b> 	CL or EL CL + CR EL + ER ML + MR CL + EL + ER CL + ML + MR CL + CR + EL + ER CL + CR + ML + MR	OC, BB or EL EL + ER ML + MR OC + EL + ER OC + ML + MR	BB ML + MR
<b>INTERACT</b> 	CL or EL CL + CR EL + ER ML + MR CL + EL + ER CL + ML + MR CL + CR + EL + ER CL + CR + ML + MR	OC, BB or EL EL + ER ML + MR OC + EL + ER OC + ML + MR	BB ML + MR
<b>INTRFC1</b> 	CL or EL CL + CR EL + ER ML + MR CL + EL + ER CL + ML + MR CL + CR + EL + ER CL + CR + ML + MR	OC, BB or EL EL + ER ML + MR OC + EL + ER OC + ML + MR	BB ML + MR
<b>POWER 440</b> 	CL or EL CL + CR EL + ER ML + MR CL + EL + ER CL + ML + MR CL + CR + EL + ER CL + CR + ML + MR	BB, CL or EL CL + CR EL + ER ML + MR CL + EL + ER CL + ML + MR CL + CR + EL + ER CL + CR + ML + MR	BB ML + MR
<b>DPORT4A</b> 	CL or EL CL + CR EL + ER ML + MR CL + EL + ER CL + ML + MR CL + CR + EL + ER CL + CR + ML + MR	OC, BB or EL EL + ER ML + MR OC + EL + ER OC + ML + MR	BB ML + MR

[See Cameo Overview For Ordering Options](#)

Catalyst Tables blend desired aesthetics, functionality, and technology to deliver a comprehensive solution for all types of meeting needs and spaces. The line boasts a broad selection of veneers, laminates, and glass with a variety of top shapes, and a vast range of sizes spanning from 36”D to 60”D and 36”W to 240”W, integrated power/data, and a variety of heights, including work, counter, and bar. Buffets, Credenzas, Waste Bins, and more will help to complete your space.

## CONSTRUCTION

### veneer

- Exposed surfaces feature select grade plain-sliced hardwood veneers in Cherry, Maple, American Black Walnut, or composite veneers. Veneers are carefully selected and matched to assure proper balance and consistency
- Veneer features UVAdvantage, an ultra-violet finish, on all exposed surfaces by utilizing roll-coat UV technology

### laminate

- Thermally-Fused Laminate (TFL) and High-Pressure Laminate (HPL) are made of woodgrain and solid color laminates fused to particleboard core; each laminate offers lasting beauty, superior resistance to normal wear, and easy maintenance

### tops

- Veneer (W) or HPL (P) Tops available in five shapes: Rectangle, Boat, Modern Rectangle, Square and Round with woodgrain patterns following the depth (short) of Veneer (W) table tops while grain patterns follow the width (long) of HPL (P) table tops
- Tops are shaped on all four sides and are available in two thicknesses and five edge profiles
- Double Kerf (F), Duo (G) and Square (Y) available in Veneer (W) and HPL (P) tops with 3-ply balanced construction, 1 $\frac{3}{16}$ ” thick and matching 3mm wood or PVC edge bands on profiled edges; Designer White, Sugar Maple, and Williamsburg Cherry feature ABS edge bands
- Knife (K) edge profile tops are 1 $\frac{3}{16}$ ” thick with solid wood rims available on both Veneer (W) or HPL (P) tops
- Vertical Square (H) edge profile tops are 1 $\frac{1}{2}$ ” thick with 1.5mm wood edge band on Veneer (W) tops and 1mm PVC edge band on HPL (P) tops; Designer White, Sugar Maple, and Williamsburg Cherry feature ABS edge bands
- Credenzas, buffets, and other ancillary support models are available in Square (Y), Double Kerf (F), Duo (G), and Vertical Square (H) edge profiles and profiled on approach side only
- All Veneer tops, as well as Laminate tops up to 144” (12 feet), will have matching woodgrain. Laminate tops sized 156” (13 feet) and longer will have non-matching woodgrain
- All surfaces feature reverse slip matched pattern
- Back Painted, Tempered Glass Tops are 1/4” thick and are attached to a substrate topped with black paper covering
- Tempered glass top has a 1/8” overhang from the sub-top

### locking

- All box drawers feature locking
- Removable lock cylinders allow for units to be re-keyed at a later date, if required
- Units are shipped randomly keyed as standard
- Keyed alike units available upon request at no additional charge
- Lock core is predetermined by pull color. Black lock cores are used with black and gold pulls while silver lock cores are used with chrome and aluminum pulls
- Optional locking doors available on buffets and credenzas

### bases

- All rectangle bases are available in TFL (T) or Veneer (W), feature vertical grain direction and include L-bracket hardware for easy installation

### bases con't

- Rectangle box bases include removable access panel and wire management and support trough
- Rectangle Accent bases feature 5/16” metal accent available in four colors including Aluminum, Black, Gold, and Platinum
- All units ship with heavy-duty, adjustable leveling glides to ensure proper leveling and compensation for uneven floors

### chassis

- All credenzas are available in TFL (T) or Veneer (W) with vertical grain direction
- Chassis for storage units are securely fastened using high quality European fastening systems and heavy-duty 16-gauge joining brackets to assure maximum strength
- All units ship with heavy-duty, adjustable leveling glides to ensure proper leveling and compensation for uneven floors

### drawers

- Drawers feature 5-sided drawer construction allowing for easy removal of drawer fronts; All drawer fronts are standard with elegant vertically matched faces
- Drawer sides, back, and front are woodgrain vinyl-wrapped 1/2” thick with 1/8” thick hardboard bottoms
- Drawer interiors are dovetail construction with 7/16” thick hardwood sides and backs, and 5/32” thick hardboard bottoms
- All drawers feature full extension, progressive action slides with precision steel ball bearings
- Box drawers are tested for 100lb capacity
- All suspensions have a limited lifetime warranty

### storage

- All hinged doors are soft-close with one piece hinge and base plate combination
- Soft close hinges reduce stress placed on the cabinet when the door is closed and offers a quiet closure
- All Credenzas feature a 2”W wire management channel along back of the interior cabinet for easy accessibility to wall outlets

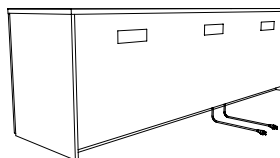

2”W wire management channel

## INTERIOR DRAWER DIMENSIONS

### Models

88-2496BF

	W	L	D
Box Drawers	15 $\frac{3}{4}$ "	16 $\frac{3}{8}$ "	3 $\frac{2}{32}$ "

### Models

88-2484BF

	W	L	D
Box Drawers	30"	16 $\frac{3}{8}$ "	3 $\frac{2}{32}$ "
	13 $\frac{3}{8}$ "	16 $\frac{3}{8}$ "	3 $\frac{2}{32}$ "

### Models

88-2472BF

88-2436BF

	W	L	D
Box Drawers	32 $\frac{3}{16}$ "	16 $\frac{3}{8}$ "	3 $\frac{2}{32}$ "

### Models

88-2460BF

	W	L	D
Box Drawers	16 $\frac{1}{2}$ "	16 $\frac{3}{8}$ "	3 $\frac{2}{32}$ "

### Models

88-2448BF

	W	L	D
Box Drawers	20 $\frac{15}{16}$ "	16 $\frac{3}{8}$ "	3 $\frac{2}{32}$ "

## INTERIOR CABINET DIMENSIONS

### Models

88-2496BF

	W	D	H
Double Door	36 $\frac{3}{4}$ "	22 $\frac{3}{8}$ "	23 $\frac{1}{2}$ "
Single Door with Waste Bin	18"	22 $\frac{3}{8}$ "	23 $\frac{1}{2}$ "

### Models

88-2484BF

	W	D	H
Double Door	32"	22 $\frac{3}{8}$ "	23 $\frac{1}{2}$ "
Single Door with Waste Bin	15 $\frac{1}{2}$ "	22 $\frac{3}{8}$ "	23 $\frac{1}{2}$ "

### Models

88-2472BF

88-2436BF

	W	D	H
Double Door	34 $\frac{3}{8}$ "	22 $\frac{3}{8}$ "	23 $\frac{1}{2}$ "
Single Door with Waste Bin	16 $\frac{3}{4}$ "	22 $\frac{3}{8}$ "	23 $\frac{1}{2}$ "

### Models

88-2460BF

	W	D	H
Single Door	18 $\frac{3}{8}$ "	22 $\frac{3}{8}$ "	23 $\frac{1}{2}$ "

### Models

88-2448BF

	W	D	H
Double Door	46 $\frac{3}{8}$ "	22 $\frac{3}{8}$ "	23 $\frac{1}{2}$ "
Single Door with Waste Bin	22 $\frac{3}{4}$ "	22 $\frac{3}{8}$ "	23 $\frac{1}{2}$ "

### Models

88-2496CC

	W	D	H
Double Door	36 $\frac{3}{4}$ "	22 $\frac{3}{8}$ "	24 $\frac{3}{8}$ "
Single Door with Waste Bin	18"	22 $\frac{3}{8}$ "	24 $\frac{3}{8}$ "

### Models

88-2484CC

	W	D	H
Double Door	32"	22 $\frac{3}{8}$ "	24 $\frac{3}{8}$ "
Single Door with Waste Bin	15 $\frac{1}{2}$ "	22 $\frac{3}{8}$ "	24 $\frac{3}{8}$ "

### Models

88-2472CC

88-2436BF

	W	D	H
Double Door	34 $\frac{3}{8}$ "	22 $\frac{3}{8}$ "	24 $\frac{3}{8}$ "
Single Door with Waste Bin	16 $\frac{3}{4}$ "	22 $\frac{3}{8}$ "	24 $\frac{3}{8}$ "

### Models

88-2460CC

	W	D	H
Single Door with Waste Bin	18 $\frac{3}{8}$ "	22 $\frac{3}{8}$ "	24 $\frac{3}{8}$ "

### Models

88-2448CC

	W	D	H
Double Door	46 $\frac{3}{8}$ "	22 $\frac{3}{8}$ "	24 $\frac{3}{8}$ "
Single Door with Waste Bin	22 $\frac{3}{4}$ "	22 $\frac{3}{8}$ "	24 $\frac{3}{8}$ "

### Models

88-2096CC

	W	D	H
Double Door	36 $\frac{3}{4}$ "	18 $\frac{3}{8}$ "	24 $\frac{3}{8}$ "
Single Door	17 $\frac{3}{8}$ "	18 $\frac{3}{8}$ "	24 $\frac{3}{8}$ "

### Models

88-2084CC

	W	D	H
Double Door	32"	18 $\frac{3}{8}$ "	24 $\frac{3}{8}$ "
Single Door	15 $\frac{1}{2}$ "	18 $\frac{3}{8}$ "	24 $\frac{3}{8}$ "

**INTERIOR CABINET DIMENSIONS CONTINUED**

**Models**

88-2072CC	88-2036CC		
	<b>W</b>	<b>D</b>	<b>H</b>
Single Door	34 <sup>3</sup> / <sub>8</sub> "	18 <sup>3</sup> / <sub>8</sub> "	24 <sup>3</sup> / <sub>8</sub> "

**Models**

88-2060CC			
	<b>W</b>	<b>D</b>	<b>H</b>
Single Door	18 <sup>3</sup> / <sub>8</sub> "	18 <sup>3</sup> / <sub>8</sub> "	24 <sup>3</sup> / <sub>8</sub> "

**Models**

88-2048CC			
	<b>W</b>	<b>D</b>	<b>H</b>
Double Door	46 <sup>3</sup> / <sub>8</sub> "	18 <sup>3</sup> / <sub>8</sub> "	24 <sup>3</sup> / <sub>8</sub> "

**HOW TO ORDER EXAMPLES**

**SQUARE MEETING TABLE**

	QTY	MODEL NO.		EXAMPLE
<b>TOP</b>	1	88-4848SQ	Top/Edge Material Finish/Color Edge Profile Glass Top Glass Color/Surface Finish Power/Data Location	P FO 3MMW/F Y GBLG OC
<b>BASE</b>	1	08-2642LXBAB		
<b>POWER</b>	1	01-DUOBEZELS		

**MODERN RECTANGLE MEETING TABLES**

	QTY	MODEL NO.		EXAMPLE
<b>TOP</b>	1	88-54192MR	Top/Edge Material Top/Edge Finish/Color Edge Profile Glass Top Glass Color/Surface Finish Grommet/Power/Data Type Grommet/Power/Data Location	W MAS 3MMW/F Y GBLG DPORTA OC
<b>BASES</b>	1	88-2415406RAB	Base Material Base Finish/Color Accent Finish/Color Metal Accent Color	W MAS BL GLD
<b>POWER</b>	1	DPORTA		

**STORAGE & ACCESSORIES**

Buffet Credenza			
QTY	MODEL NO.		EXAMPLE
1	88-2472BF	Top/Edge Material Finish/Color Edge Profile Chassis Finish/Color Glass Top Glass Color/Surface Finish Studio Pull Color Locking Drawer Construction Drawer Track Vent Waste Bin	W MAS 3MMW/F ORW Y GBLG GST LKT_BFD DOVE SFTCL VENT WBL

**VENEER (W) OPTIONS ON TOPS / EDGES, BASES, AND ACCENT PANELS**

Veneer features UVAdvantage, an ultra-violet finish, on all exposed surfaces or our Catalyzed finish (where noted), which is a multi-step, finish process that provides years of lasting beauty.

AW	Artisan Walnut	MW	Mahogany Walnut
AS	Asian Night	MAS	Mesa Sunset*
CO	Columbian Walnut	MTS	Metropolis Sky
DC	Dark Cherry	ORW	Oak Riftwood*
DFW	Dark Forest Walnut	PNW	Pinnacle Walnut
EW	Espresso	SCH	Select Cherry
FO	Fawn Oak*	SKC	Shaker Cherry
GC	Golden Cherry	SM	Sugar Maple
HW	Harvest Walnut	WTA	Weathered Ash*
HNW	Henna Walnut	WC	Williamsburg Cherry
LW	Legacy Walnut		

\* Finish is Low Sheen

**TFL (T) OPTIONS FOR BASES / ACCENT PANELS AND HPL (P) LAMINATE OPTIONS ON TOPS / EDGES**

**WOODGRAIN**

AS	Asian Night	PNW	Pinnacle Walnut
BW	Beigewood	PTK	Portico Teak
CO	Columbian Walnut	RC	River Cherry
EF	Espresso	SPW	Sepia Walnut
FLW	Florence Walnut	SKC	Shaker Cherry
GC	Golden Cherry	SCH	Select Cherry
HVM	Harvest Maple	SBP	Smoky Brown Pear
KHE	Kirsche	TK	Studio Teak
MW	Mahogany Walnut	SM	Sugar Maple
MNR	Midnight Run	WTA	Weathered Ash
NTM	Natural Marrone	WC	Williamsburg Cherry
ORW	Oak Riftwood	WNB	White Nebbia
<b>SOLID</b>			
BL	Black	FHG	Fashion Grey
WH	Designer White	SG	Slate Grey

### BASE METAL ACCENT COLOR OPTIONS

6" and 10" Rectangle Accent Bases feature 5/16" metal trim. Must specify color

ALUM	Aluminum	PLAT	Platinum
BLK	Black	GLD	Gold

### EDGE PROFILES

Double Kerf (F), Duo (G), Square (Y) and Knife (K) edge profiles are 1 3/16" thick and available in Veneer (W) and HPL (P) tops. Vertical Square (H) edge profile available is 1 1/2" thick and also available Veneer (W) and HPL (P) tops. Must specify edge profile.

Knife (K) edge not available on buffet and credenzas

#### Laminate (P) Top Edges

3MMP/F	Double Kerf (1 3/16" H)	3MMP/Y	Square (1 3/16" H)
3MMP/G	Duo (1 3/16" H)	RIMP/K	Knife (1 3/16" H)
3MMP/X	Fluted (1 3/16" H)	HP	Vertical Square (1 1/2" H)

#### Veneer (W) Top Edges

3MMW/F	Double Kerf (1 3/16" H)	3MMW/Y	Square (1 3/16" H)
3MMW/G	Duo (1 3/16" H)	RIMW/K	Knife (1 3/16" H)
3MMW/X	Fluted (1 3/16" H)	HW	Vertical Square (1 1/2" H)



Double Kerf (F) 1 3/16" H    Duo (G) 1 3/16" H    Fluted (X) 1 3/16" H    Square (Y) 1 3/16" H



Knife (K) 1 3/16" H    Vertical Square (H) 1 1/2" H

### PULL OPTIONS

Buffets and Credenzas available with pulls on doors. Must specify and select color.

Lock core color is predetermined by pull color.

AST	Studio, Aluminum	CST	Studio, Chrome
BST	Studio, Black	GST	Studio, Gold



Studio (AST) Aluminum - 13"    Studio (BST) Black - 13"    Studio (CST) Chrome - 13"



Studio (GST) Gold - 13"

### GLASS OPTIONS ON TOPS

Back painted tempered glass tops are 1/4" thick and available in Black or White with Gloss or Acid Etched finish. Glass top sits 1/16" on top of substrate top. Must specify color and finish.

GWHG	White Gloss	GBLG	Black Gloss
GWHA	White Acid Etched	GBLA	Black Acid Etched



White Gloss (GWHG)    White Acid Etched (GWHA)    Black Gloss (GBLG)    Black Acid Etched (GBLA)

### LOCK CORE COLOR OPTIONS

BLK	Black (Used with Black and Gold Pulls)
SLV	Silver (Used with Aluminum and Chrome Pulls)



Black (BLK)    Silver (SLV)

### GROMMET & POWER UNIT OPTIONS

Power units and grommets are available on Rectangle, Modern Rectangle, and Boat shaped tops. Each unit is sold separately and must be specified separately with surface mount location. Multiple locations may be selected. Only one unit per location.

#### Power units and Grommets Available in Table Surfaces (See Units)

Grommet	\$ 52
Specify Color: Black = BLK and Silver = SLV	

#### DUO/TRIO BEZEL

01-DUOBEZEL	Available in Black (B), Silver (S), or White (W)
01-TRIOBEZEL	Available in Black (B), Silver (S), or White (W)

#### DOCK 950, DOCK 800 and DOCK 150

DOCK950	Available in Black or White
DOCK150	Available in Black or White
DOCK800	Available in Black or Silver

#### Other Power Units

DPORT4	Available in Aluminum or Black
ELLORA	Available in Aluminum or Black
E2X	Available in Aluminum or Black
INTERACTG	Available in Aluminum or Black
OASISM	Available in Aluminum or Black

#### Power/Data Location Information:

- Designate unit and location when specifying the top model. Power/Data Module need to be ordered separately.
- Power/Data Modules specified at the time of order will be routed for field installation.
 

E1	Unit on One End
E2	Unit on Each End
OC	Unit on Center

- All power units available **On Center (OC) only** when paired with two (2) or more of the following bases:

Cylinder Base	Square Base
X-Base	Disc
Tubular X-Base	

Grommets and Power Units may be ordered in non-standard locations. Call Customer Service to assist with specification and/or please attach a drawing to the PO showing the location of the grommet. Note additional charges and lead times may apply.

#### Top Locations

Power units available on Each End (E1 and E2) and On Center (OC) unless otherwise noted, when paired with any Rectangle Panel Base, Rectangle Box Base or Rectangle Accent Box Base.

#### Power units centered at locations below:

36" Tops	Centered 18"D	54" Tops	Centered 27"D
42" Tops	Centered 21"D	60" Tops	Centered 30"D
48" Tops	Centered 24"D		

### GROMMET OPTIONS & POWER UNIT OPTIONS CONTINUED

#### Top Locations Continued

- 72: OC 36" from end (available with OC Only)
- 84: OC 42" from end (available with OC Only)
- 96: OC 48" from end; E1/E2 29" from end
- 108: OC 54" from end; E1/E2 29" from end
- 120: OC 60" from end; E1/E2 29" from end
- 132: OC 66" from end; E1/E2 29" from end
- 144: OC 72" from end; E1/E2 29" from end
- 156: OC 78" from end; E1/E2 29" from end
- 168: OC 84" from end; E1/E2 29" from end
- 180: OC 90" from end; E1/E2 36" from end
- 192: OC 96" from end; E1/E2 36" from end
- 204: OC 102" from end; E1/E2 36" from end
- 216: OC 108" from end; E1/E2 36" from end
- 228: OC 114" from end; E1/E2 36" from end
- 240: OC 120" from end; E1/E2 36" from end

Example: 60x204 Modern Rectangle

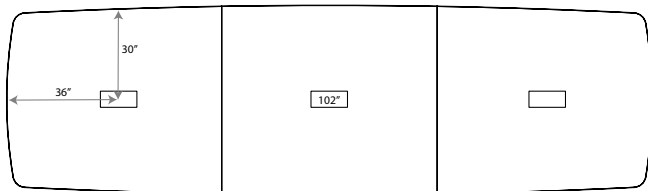

### DRAWER TRACK OPTIONS

Soft close tracks are available on box drawers. Soft close drawer tracks have many benefits including reduced stress on the unit, extends the life of the drawer, and ensures a gentle close so fingers don't accidentally get pinched. Must specify when ordering.

**Pricing is per Drawer, not per Model/Unit**

SFTCL	Soft Close Drawer Track	\$ 34
-------	-------------------------	-------

### VENT OPTION FOR CREDENZAS

Buffets and Credenzas feature optional ventilation grommets. Includes one vent per compartment.

Vents are 10" Down from top surface on Buffet Credenzas and 2 7/8" on Credenzas.

NONE	No Vent Grommet	
VENT	Vented back panel	\$ 68

Number of vents per unit:

36"	1 vent
72" / 48"	2 vents
96" / 84" / 60"	3 vents

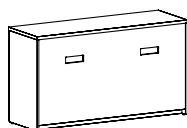

### WASTE BIN OPTIONS

Buffet and 24" Credenzas are available with two (2) 41-quart beige waste bins in a pull out cabinet with silver hardware and divider panel. Adjacent cabinet features one (1) adjustable shelf. Studio pulls applied centered on doors when waste bin is selected. Locking not available.

WBL	Waste Bin on Left	\$ 510
WBR	Waste Bin on Right	\$ 510

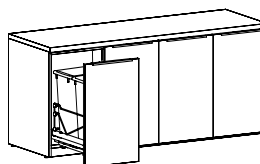

Shown as Left

### LOCKING DOORS

Locking doors are available on Buffets and Credenzas. You must specify WITH LOCKING when ordering and add upcharge.

Note: When locking is selected with optional waste bin, locking will not apply to waste bin door.

LKT_BFD	96"W to 84"W Units	\$ 135
LKT_BFD	72"W to 48"W Units	\$ 115
LKT_BFD	36"W Units	\$ 91

### CERTIFICATIONS & COMPLIANCE

- Intertek Sustainability Certified
- BIFMA level® Certified
- BIFMA Compliant® Certified
- TSCA Title VI (Formerly CARB) Compliance
- US Green Building's LEED® Contribution

**Tops/Shapes**



Square ([See Details](#))



Round ([See Details](#))



Rectangular ([See Details](#))



Modern Rectangular ([See Details](#))



Boat ([See Details](#))

**Bases**

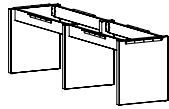

Rectangular Panel Bases with Trough ([See Details](#))

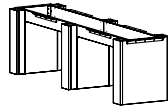

6" Rectangular Bases with Trough ([See Details](#))

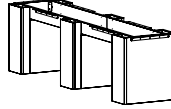

10" Rectangular Bases with Trough ([See Details](#))

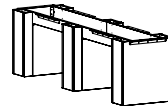

6" Rectangular Accent Bases with Trough ([See Details](#))

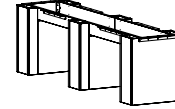

10" Rectangular Accent Bases with Trough ([See Details](#))

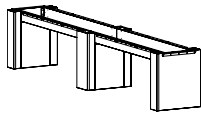

6" + 10" Combo Rectangular Bases with Trough ([See Details](#))

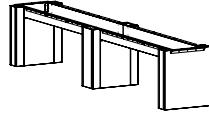

6" + 10" Combo Rectangular Accent Bases with Trough ([See Details](#))



Metal ([See Details](#))

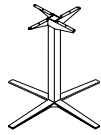

X-Base ([See Details](#))

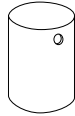

Cylinder ([See Details](#))



Disc Base ([See Details](#))

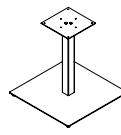

Square Base ([See Details](#))

**Storage Components + Accessories**

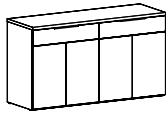

Buffet with Doors + Drawers ([See Details](#))

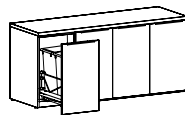

24" + 20" Credenzas with Doors ([See Details](#))

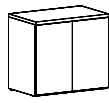

Mobile Serving Cart ([See Details](#))

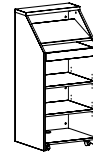

Lectern Stand ([See Details](#))

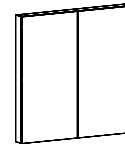

Visual Board ([See Details](#))

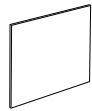
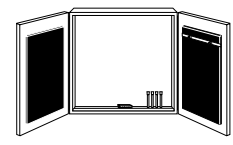

Marker Boards ([See Multiple Unit Details](#))



Marker, Eraser and Magnet Sets ([See Details](#))

**Wire Management + Power/Data Accessories ([See Details](#))**

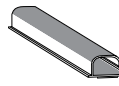
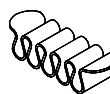
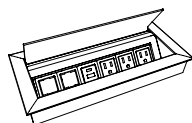



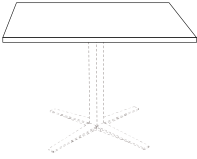

Item	Model No.		W	D	H	Ship Wt	Cubic Ft	Edge Profile + Material	List Price						
<b>SQUARE - 1 PIECE TOP</b>    88-3636SQ shown with 08-2036SXB (Metal X-Base) BASES SOLD SEPARATELY  Must Specify (in this order): Model # Top/Edge Material Top/Edge Finish/Color Edge Profile Glass (Y/N) Glass Color + Surface Finish	88-4848SQ	Laminate	48	48	1 <sup>3</sup> / <sub>16</sub>	82	7.2	F, G, X, Y / P\$	850						
					1 <sup>3</sup> / <sub>16</sub>			K / P\$	1398						
					1 <sup>1</sup> / <sub>2</sub>			H / P\$	948						
		Veneer	1 <sup>3</sup> / <sub>16</sub>						F, G, X, Y / W\$	967					
			1 <sup>3</sup> / <sub>16</sub>						K / W\$	1620					
			1 <sup>1</sup> / <sub>2</sub>						H / W\$	1146					
	Glass	1 <sup>1</sup> / <sub>4</sub>						Acid Etched Glass Top \$	5455						
		1 <sup>1</sup> / <sub>4</sub>						Gloss Glass Top \$	4541						
	88-4242SQ	Laminate	42	42	1 <sup>3</sup> / <sub>16</sub>	70	3.4	F, G, X, Y / P\$	757						
					1 <sup>3</sup> / <sub>16</sub>				K / P\$	1215					
					1 <sup>1</sup> / <sub>2</sub>				H / P\$	875					
					Veneer				1 <sup>3</sup> / <sub>16</sub>						F, G, X, Y / W\$
1 <sup>3</sup> / <sub>16</sub>									K / W\$						1468
1 <sup>1</sup> / <sub>2</sub>									H / W\$						962
Glass		1 <sup>1</sup> / <sub>4</sub>						Acid Etched Glass Top \$	4396						
		1 <sup>1</sup> / <sub>4</sub>						Gloss Glass Top \$	3695						
88-3636SQ		Laminate	36	36	1 <sup>3</sup> / <sub>16</sub>	37	2.5	F, G, X, Y / P\$	648						
					1 <sup>3</sup> / <sub>16</sub>				K / P\$	968					
					1 <sup>1</sup> / <sub>2</sub>				H / P\$	748					
					Veneer				1 <sup>3</sup> / <sub>16</sub>						F, G, X, Y / W\$
	1 <sup>3</sup> / <sub>16</sub>								K / W\$						1255
	1 <sup>1</sup> / <sub>2</sub>								H / W\$						885
	Glass	1 <sup>1</sup> / <sub>4</sub>						Acid Etched Glass Top \$	3394						
		1 <sup>1</sup> / <sub>4</sub>						Gloss Glass Top \$	2879						
	88-3030SQ	Laminate	30	30	1 <sup>3</sup> / <sub>16</sub>	30	2.3	F, G, X, Y / P\$	550						
					1 <sup>3</sup> / <sub>16</sub>				K / P\$	824					
					1 <sup>1</sup> / <sub>2</sub>				H / P\$	620					
					Veneer				1 <sup>3</sup> / <sub>16</sub>						F, G, X, Y / W\$
1 <sup>3</sup> / <sub>16</sub>									K / W\$						976
1 <sup>1</sup> / <sub>2</sub>									H / W\$						676
Glass		1 <sup>1</sup> / <sub>4</sub>						Acid Etched Glass Top \$	2597						
		1 <sup>1</sup> / <sub>4</sub>						Gloss Glass Top \$	2238						

**Description**

- Tops Feature a 1-piece, 1<sup>3</sup>/<sub>16</sub>" or 1<sup>1</sup>/<sub>2</sub>" Thick Top in Veneer (W) or HPL (P)
- Must Specify Edge Profile: 1<sup>3</sup>/<sub>16</sub>" Thick/Double Kerf (F), Duo (G), Fluted (X), Square (Y), and Knife (K) Edge Profiles or 1<sup>1</sup>/<sub>2</sub>" Thick/Vertical Square (H)
- Due to Top Sizes and Base Placement, Power is Not Available on Square Tops
- Available with Back Painted Tempered Glass Top; Must Specify Color and Finish; [See Options](#)
- Bases Sold Separately, See [Multiple Base Options](#)



Double Kerf (F) 1<sup>3</sup>/<sub>16</sub>"   Duo (G) 1<sup>3</sup>/<sub>16</sub>"   Fluted (X) 1<sup>3</sup>/<sub>16</sub>"   Square (Y) 1<sup>3</sup>/<sub>16</sub>"   Knife (K) 1<sup>3</sup>/<sub>16</sub>"   Vertical Square (H) 1<sup>1</sup>/<sub>2</sub>"

P = HPL   W = Veneer

[See Catalyst Overview For Ordering Options](#)

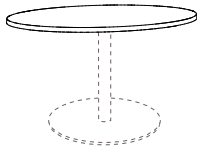
Item	Model No.		W	D	H	Ship Wt	Cubic Ft	Edge Profile + Material	List Price
 <p>88-4848CT shown with 01-3230DBB (Disc Base) BASES SOLD SEPARATELY</p> <p><u>Must Specify (in this order):</u> Model # Top/Edge Material Top/Edge Finish/Color Edge Profile Glass (Y/N) Glass Color + Surface Finish</p>	88-6060CT	Laminate	60	60	1 3/16	143	8.4	F, G, X, Y / P\$	1037
					1 3/16			K / P\$	2195
					1 1/2			H / P\$	1085
		Veneer	1 3/16	F, G, X, Y / W\$	1406				
			1 3/16	K / W\$	2461				
			1 1/2	H / W\$	1662				
	Glass	1/4	Acid Etched Glass Top \$	8681					
		1/4	Gloss Glass Top \$	7210					
	88-5454CT	Laminate	54	54	1 3/16	114	6.8	F, G, X, Y / P\$	997
					1 3/16			K / P\$	2003
					1 1/2			H / P\$	1033
			Veneer	1 3/16	F, G, X, Y / W\$	1248			
1 3/16				K / W\$	2190				
1 1/2				H / W\$	1460				
Glass		1/4	Acid Etched Glass Top \$	7267					
		1/4	Gloss Glass Top \$	6073					
88-4848CT		Laminate	48	48	1 3/16	90	5.5	F, G, X, Y / P\$	904
					1 3/16			K / P\$	1894
					1 1/2			H / P\$	930
			Veneer	1 3/16	F, G, X, Y / W\$	1024			
	1 3/16			K / W\$	2130				
	1 1/2			H / W\$	1195				
	Glass	1/4	Acid Etched Glass Top \$	6064					
		1/4	Gloss Glass Top \$	5122					
	88-4242CT	Laminate	42	42	1 3/16	70	3.4	F, G, X, Y / P\$	806
					1 3/16			K / P\$	1632
					1 1/2			H / P\$	870
			Veneer	1 3/16	F, G, X, Y / W\$	923			
1 3/16				K / W\$	1895				
1 1/2				H / W\$	1008				
Glass		1/4	Acid Etched Glass Top \$	4890					
		1/4	Gloss Glass Top \$	4174					

Additional Round Tops on Next Page.



Double Kerf (F) 1 3/16" Duo (G) 1 3/16" Fluted (X) 1 3/16" Square (Y) 1 3/16" Knife (K) 1 3/16" Vertical Square (H) 1 1/2"

P = HPL W = Veneer

[See Catalyst Overview For Ordering Options](#)

Item	Model No.		W	D	H	Ship Wt	Cubic Ft	Edge Profile + Material	List Price	
<i>CONTINUED FROM PREVIOUS PAGE</i>	88-3636CT	Laminate	36	36	1 3/16	37	2.5	F, G, X, Y / P\$	700	
					1 3/16			K / P\$	1439	
					1 1/2			H / P\$	794	
					Veneer			1 3/16	F, G, X, Y / W\$	881
								1 3/16	K / W\$	1720
								1 1/2	H / W\$	893
	Glass	1/4	Acid Etched Glass Top \$	3903						
		1/4	Gloss Glass Top \$	3373						
	88-3030CT	Laminate	30	30	1 3/16	30	2.3	F, G, X, Y / P\$	610	
					1 3/16			K / P\$	1196	
					1 1/2			H / P\$	638	
					Veneer			1 3/16	F, G, X, Y / W\$	684
1 3/16								K / W\$	1332	
1 1/2								H / W\$	736	
Glass	1/4	Acid Etched Glass Top \$	3463							
	1/4	Gloss Glass Top \$	3094							

Must Specify (in this order):

- Model #
- Top/Edge Material
- Top/Edge Finish/Color
- Edge Profile
- Glass (Y/N)
- Glass Color + Surface Finish

**Description**

- Tops Feature a 1-piece, 1 3/16" or 1 1/2" Thick Top in Veneer (W) or HPL (P)
- Must Specify Edge Profile: 1 3/16" Thick/Double Kerf (F), Duo (G), Fluted (X), Square (Y), and Knife (K) Edge Profiles or 1 1/2" Thick/Vertical Square (H)
- 60" and 54" Tops Feature Catalyzed Finish
- Due to Top Sizes and Base Placement, Power is Not Available on Round Tops
- Available with Back Painted Tempered Glass Top; Must Specify Color and Finish; [See Options](#)
- Bases Sold Separately, See [Multiple Base Options](#)



Double Kerf (F)  
1 3/16"



Duo (G)  
1 3/16"



Fluted (X)  
1 3/16"



Square (Y)  
1 3/16"



Knife (K)  
1 3/16"



Vertical Square (H)  
1 1/2"

P = HPL W = Veneer C = Combination of Wood/Laminate

[See Catalyst Overview For Ordering Options](#)

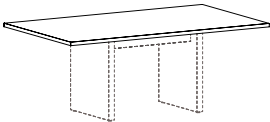
Item	Model No.		W	D	H	Ship Wt	Cubic Ft	Edge Profile + Material	List Price	
<b>RECTANGLE SHAPE MEETING TOP</b> <b>36"D</b>  88-3672RT shown with 88-2034RPB (Rectangle Panel Base) BASES SOLD SEPARATELY	<b>36"D x 96"W or 8' - 1 Piece Rectangle Top</b>									
	88-3696RT	Laminate	96	36	1 3/16"	142	12.9	F, G, X, Y / P\$	1364	
					1 3/16"			K / P\$	2150	
					1 1/2"			H / P\$	1547	
		Veneer			1 3/16"			F, G, X, Y / W\$	1544	
					1 3/16"			K / W\$	2556	
					1 1/2"			H / W\$	1858	
		Glass			1/4"			Acid Etched Glass Top \$	8134	
					1/4"			Gloss Glass Top \$	6806	
	<b>36"D x 84"W or 7' - 1 Piece Rectangle Top</b>									
	88-3684RT	Laminate	84	36	1 3/16"	126	11.3	F, G, X, Y / P\$	1299	
					1 3/16"			K / P\$	2006	
				1 1/2"			H / P\$	1489		
	Veneer			1 3/16"			F, G, X, Y / W\$	1462		
				1 3/16"			K / W\$	2437		
				1 1/2"			H / W\$	1707		
	Glass			1/4"			Acid Etched Glass Top \$	7313		
				1/4"			Gloss Glass Top \$	6151		
<b>36"D x 72"W or 6' - 1 Piece Rectangle Top</b>										
88-3672RT	Laminate	72	36	1 3/16"	109	10.3	F, G, X, Y / P\$	1052		
				1 3/16"			K / P\$	1695		
				1 1/2"			H / P\$	1188		
	Veneer			1 3/16"			F, G, X, Y / W\$	1238		
				1 3/16"			K / W\$	1957		
				1 1/2"			H / W\$	1478		
	Glass			1/4"			Acid Etched Glass Top \$	6321		
				1/4"			Gloss Glass Top \$	5324		

Must Specify (in this order):

- Model #
- Top/Edge Material
- Top/Edge Finish/Color
- Edge Profile
- Glass (Y/N)
- Glass Color + Surface Finish
- Power/Data Type
- Power/Data Location

**Description**

- Tops Available with Veneer (W) or HPL (P) Top in 1 3/16" and 1 1/2" Thicknesses
- Must Specify Edge Profile: 1 3/16" Thick/Double Kerf (F), Duo (G), **Fluted (X)**, Square (Y), and Knife (K) Edge Profiles or 1 1/2" Thick/Vertical Square (H)
- Veneer (W) Top Grain Runs Depth of Top and HPL (P) Top Grain Runs Width of Top
- Available with Back Painted Tempered Glass Top; Must Specify Color and Finish; [See Options](#)
- Power and Data Options Available; Sold Separately, [See Multiple Power Unit Details](#)
- Bases Sold Separately, See [Multiple Base Options](#)



Double Kerf (F)  
1 3/16"



Duo (G)  
1 3/16"



Fluted (X)  
1 3/16"



Square (Y)  
1 3/16"



Knife (K)  
1 3/16"



Vertical Square (H)  
1 1/2"

P = HPL W = Veneer

[See Catalyst Overview For Ordering Options](#)

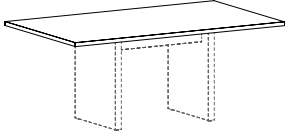
Item	Model No.		W	D	H	Ship Wt	Cubic Ft	Edge Profile + Material	List Price	
<b>RECTANGLE SHAPE MEETING TOP</b> <b>42"D</b>  <p>88-4272RT shown with 88-2034RPB (Rectangle Panel Base) BASES SOLD SEPARATELY</p> <p><i>Must Specify (in this order):</i>                      Model #                      Top/Edge Material                      Top/Edge Finish/Color                      Edge Profile                      Glass (Y/N)                      Glass Color + Surface Finish                      Power/Data Type                      Power/Data Location</p>	<b>42"D x 120"W or 10' - 2 Piece Rectangle Top</b>									
	88-42120RT	Laminate	120	42	1 3/16"	268	27.0	F, G, X, Y / P\$	1892	
					1 3/16"			K / P\$	3077	
					1 1/2"			H / P\$	2162	
		Veneer			1 3/16"			F, G, X, Y / W\$	2200	
					1 3/16"			K / W\$	3492	
					1 1/2"			H / W\$	2645	
		Glass			1/4"			Acid Etched Glass Top \$	11225	
					1/4"			Gloss Glass Top \$	9288	
	<b>42"D x 108"W or 9' - 2 Piece Rectangle Top</b>									
	88-42108RT	Laminate	108	42	1 3/16"	260	27.0	F, G, X, Y / P\$	1853	
					1 3/16"			K / P\$	2899	
				1 1/2"			H / P\$	2097		
	Veneer			1 3/16"			F, G, X, Y / W\$	2062		
				1 3/16"			K / W\$	3359		
				1 1/2"			H / W\$	2465		
	Glass			1/4"			Acid Etched Glass Top \$	10270		
				1/4"			Gloss Glass Top \$	8527		
<b>42"D x 96"W or 8' - 1 Piece Rectangle Top</b>										
88-4296RT	Laminate	96	42	1 3/16"	164	15.0	F, G, X, Y / P\$	1393		
				1 3/16"			K / P\$	2337		
				1 1/2"			H / P\$	1608		
	Veneer			1 3/16"			F, G, X, Y / W\$	1685		
				1 3/16"			K / W\$	2697		
				1 1/2"			H / W\$	2042		
	Glass			1/4"			Acid Etched Glass Top \$	8955		
				1/4"			Gloss Glass Top \$	7405		
<b>42"D x 84"W or 7' - 1 Piece Rectangle Top</b>										
88-4284RT	Laminate	84	42	1 3/16"	145	13.1	F, G, X, Y / P\$	1355		
				1 3/16"			K / P\$	2174		
				1 1/2"			H / P\$	1542		
	Veneer			1 3/16"			F, G, X, Y / W\$	1551		
				1 3/16"			K / W\$	2567		
				1 1/2"			H / W\$	1867		
	Glass			1/4"			Acid Etched Glass Top \$	8002		
				1/4"			Gloss Glass Top \$	6647		

*Additional 42" Rectangle Shaped Tops on Next Page*



Double Kerf (F) 1 3/16"   Duo (G) 1 3/16"   Fluted (X) 1 3/16"   Square (Y) 1 3/16"   Knife (K) 1 3/16"   Vertical Square (H) 1 1/2"

P = HPL   W = Veneer

[See Catalyst Overview For Ordering Options](#)

Item	Model No.		W	D	H	Ship Wt	Cubic Ft	Edge Profile + Material	List Price	
<i>CONTINUED FROM PREVIOUS PAGE</i>	<b>42"D x 72"W or 6' - 1 Piece Rectangle Top</b>									
	88-4272RT	Laminate	72	42	1 3/16	126	11.3	F, G, X, Y / P\$	1125	
					1 3/16			K / P\$	1906	
					1 1/2			H / P\$	1285	
		Veneer			1 3/16			F, G, X, Y / W\$	1408	
					1 3/16			K / W\$	2134	
					1 1/2			H / W\$	1681	
		Glass			1/4		Acid Etched Glass Top \$	7015		
					1/4		Gloss Glass Top \$	5853		

Must Specify (in this order):

- Model #
- Top/Edge Material
- Top/Edge Finish/Color
- Edge Profile
- Glass (Y/N)
- Glass Color + Surface Finish
- Power/Data Type
- Power/Data Location

**Description**

- Tops Available with Veneer (W) or HPL (P) Top in 1 3/16" and 1 1/2" Thicknesses
- Must Specify Edge Profile: 1 3/16" Thick/Double Kerf (F), Duo (G), Fluted (X), Square (Y), and Knife (K) Edge Profiles or 1 1/2" Thick/Vertical Square (H)
- Veneer (W) Top Grain Runs Depth of Top and HPL (P) Top Grain Runs Width of Top
- Available with Back Painted Tempered Glass Top; Must Specify Color and Finish; [See Options](#)
- Power and Data Options Available; Sold Separately, [See Multiple Power Unit Details](#)
- Bases Sold Separately, See [Multiple Base Options](#)



Double Kerf (F)  
1 3/16"



Duo (G)  
1 3/16"



Fluted (X)  
1 3/16"



Square (Y)  
1 3/16"



Knife (K)  
1 3/16"



Vertical Square (H)  
1 1/2"

P = HPL W = Veneer

[See Catalyst Overview For Ordering Options](#)

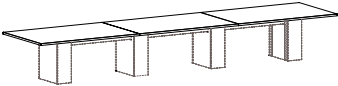
Item	Model No.		W	D	H	Ship Wt	Cubic Ft	Edge Profile + Material	List Price	
<b>RECTANGLE SHAPE MEETING TOP</b> <b>48" D</b>  <p>88-48216RT shown with 88-2417810RB (10" Rectangle Base) BASES SOLD SEPARATELY</p> <p>Must Specify (in this order):                      Model #                      Top/Edge Material                      Top/Edge Finish/Color                      Edge Profile                      Glass (Y/N)                      Glass Color + Surface Finish                      Power/Data Type                      Power/Data Location</p>	<b>48"D x 240"W or 20' - 3 Piece Rectangle Top</b>									
	88-48240RT	Laminate	240	48	1 3/16"	460	28.5	F, G, X, Y / P\$	4463	
					1 3/16"			K / P\$	7279	
					1 1/2"			H / P\$	5088	
		Veneer			1 3/16"			F, G, X, Y / W\$	6000	
					1 3/16"			K / W\$	8081	
					1 1/2"			H / W\$	6974	
		Glass			1/4"			Acid Etched Glass Top \$	24958	
					1/4"			Gloss Glass Top \$	20531	
	<b>48"D x 228"W or 19' - 3 Piece Rectangle Top</b>									
	88-48228RT	Laminate	228	48	1 3/16"	438	27.0	F, G, X, Y / P\$	4419	
					1 3/16"			K / P\$	7144	
					1 1/2"			H / P\$	5015	
		Veneer			1 3/16"			F, G, X, Y / W\$	5743	
					1 3/16"			K / W\$	7825	
				1 1/2"			H / W\$	6670		
	Glass			1/4"			Acid Etched Glass Top \$	23871		
				1/4"			Gloss Glass Top \$	19666		
<b>48"D x 216"W or 18' - 3 Piece Rectangle Top</b>										
88-48216RT	Laminate	216	48	1 3/16"	416	25.5	F, G, X, Y / P\$	3513		
				1 1/2"			K / P\$	5875		
				1 3/16"			H / P\$	4077		
	Veneer			1 3/16"			F, G, X, Y / W\$	5081		
				1 3/16"			K / W\$	6624		
				1 1/2"			H / W\$	5961		
	Glass			1/4"			Acid Etched Glass Top \$	22339		
				1/4"			Gloss Glass Top \$	18355		
<b>48"D x 204"W or 17' - 3 Piece Rectangle Top</b>										
88-48204RT	Laminate	204	48	1 3/16"	394	24.0	F, G, X, Y / P\$	3470		
				1 3/16"			K / P\$	5739		
				1 1/2"			H / P\$	4002		
	Veneer			1 3/16"			F, G, X, Y / P\$	4824		
				1 3/16"			K / W\$	6599		
				1 1/2"			H / W\$	5657		
	Glass			1/4"			Acid Etched Glass Top \$	21427		
				1/4"			Gloss Glass Top \$	17664		

*Additional 48" Rectangle Shaped Tops on Next Page*



Double Kerf (F) 1 3/16"    Duo (G) 1 3/16"    Fluted (X) 1 3/16"    Square (Y) 1 3/16"    Knife (K) 1 3/16"    Vertical Square (H) 1 1/2"

P = HPL    W = Veneer

[See Catalyst Overview For Ordering Options](#)



Item	Model No.		W	D	H	Ship Wt	Cubic Ft	Edge Profile + Material	List Price	
<b>48"D x 192"W or 16' - 2 Piece Rectangle Top</b>										
<i>CONTINUED FROM PREVIOUS PAGE</i>	88-48192RT	Laminate	192	48	1 <sup>3</sup> / <sub>16</sub>	372	31.2	F, G, X, Y / P\$	3002	
					1 <sup>3</sup> / <sub>16</sub>			K / P\$	5173	
					1 <sup>1</sup> / <sub>2</sub>			H / P\$	3500	
	Veneer	1 <sup>3</sup> / <sub>16</sub>	F, G, X, Y / W\$	4079						
		1 <sup>3</sup> / <sub>16</sub>	K / W\$	5673						
		1 <sup>1</sup> / <sub>2</sub>	H / W\$	4861						
	Glass		1 <sup>1</sup> / <sub>4</sub>	Acid Etched Glass Top \$	19497					
			1 <sup>1</sup> / <sub>4</sub>	Gloss Glass Top \$	15957					
	<b>48"D x 180"W or 15' - 2 Piece Rectangle Top</b>									
	Must Specify (in this order): Model # Top/Edge Material Top/Edge Finish/Color Edge Profile Glass (Y/N) Glass Color + Surface Finish Power/Data Power/Data Location	88-48180RT	Laminate	180	48	1 <sup>3</sup> / <sub>16</sub>	350	31.2	F, G, X, Y / P\$	2959
						1 <sup>3</sup> / <sub>16</sub>			K / P\$	4936
						1 <sup>1</sup> / <sub>2</sub>			H / P\$	3427
Veneer		1 <sup>3</sup> / <sub>16</sub>	F, G, X, Y / W\$	3910						
		1 <sup>3</sup> / <sub>16</sub>	K / W\$	5556						
		1 <sup>1</sup> / <sub>2</sub>	H / W\$	4646						
Glass			1 <sup>1</sup> / <sub>4</sub>	Acid Etched Glass Top \$	18411					
			1 <sup>1</sup> / <sub>4</sub>	Gloss Glass Top \$	15091					
<b>48"D x 168"W or 14' - 2 Piece Rectangle Top</b>										
		88-48168RT	Laminate	168	48	1 <sup>3</sup> / <sub>16</sub>	328	31.2	F, G, X, Y / P\$	2808
						1 <sup>3</sup> / <sub>16</sub>			K / P\$	4653
						1 <sup>1</sup> / <sub>2</sub>			H / P\$	3245
	Veneer	1 <sup>3</sup> / <sub>16</sub>	F, G, X, Y / W\$	3604						
		1 <sup>3</sup> / <sub>16</sub>	K / W\$	5242						
		1 <sup>1</sup> / <sub>2</sub>	H / W\$	4292						
	Glass		1 <sup>1</sup> / <sub>4</sub>	Acid Etched Glass Top \$	17213					
			1 <sup>1</sup> / <sub>4</sub>	Gloss Glass Top \$	14114					
	<b>48"D x 156"W or 13' - 2 Piece Rectangle Top</b>									
		88-48156RT	Laminate	156	48	1 <sup>3</sup> / <sub>16</sub>	306	31.2	F, G, X, Y / P\$	2766
						1 <sup>3</sup> / <sub>16</sub>			K / P\$	4505
						1 <sup>1</sup> / <sub>2</sub>			H / P\$	3171
Veneer		1 <sup>3</sup> / <sub>16</sub>	F, G, X, Y / W\$	3435						
		1 <sup>3</sup> / <sub>16</sub>	K / W\$	5043						
		1 <sup>1</sup> / <sub>2</sub>	H / W\$	4077						
Glass			1 <sup>1</sup> / <sub>4</sub>	Acid Etched Glass Top \$	16126					
			1 <sup>1</sup> / <sub>4</sub>	Gloss Glass Top \$	13249					

*Additional 48" Rectangle Shaped Tops on Next Page*



Double Kerf (F)  
1<sup>3</sup>/<sub>16</sub>"



Duo (G)  
1<sup>3</sup>/<sub>16</sub>"



Fluted (X)  
1<sup>3</sup>/<sub>16</sub>"



Square (Y)  
1<sup>3</sup>/<sub>16</sub>"



Knife (K)  
1<sup>3</sup>/<sub>16</sub>"



Vertical Square (H)  
1<sup>1</sup>/<sub>2</sub>"

P = HPL W = Veneer

[See Catalyst Overview For Ordering Options](#)

Item	Model No.		W	D	H	Ship Wt	Cubic Ft	Edge Profile + Material	List Price	
<i>CONTINUED FROM PREVIOUS PAGE</i>	<b>48"D x 144"W or 12' - 2 Piece Rectangle Top</b>									
	88-48144RT	Laminate	144	48	1 3/16	284	23.5	F, G, X, Y / P\$	2304	
					1 3/16			K / P\$	3924	
					1 1/2			H / P\$	2678	
		Veneer			1 3/16			F, G, X, Y / W\$	3197	
					1 3/16			K / W\$	4389	
					1 1/2			H / W\$	3792	
		Glass			1/4			Acid Etched Glass Top \$	15016	
					1/4			Gloss Glass Top \$	12360	
	<b>48"D x 132"W or 11' - 2 Piece Rectangle Top</b>									
	88-48132RT	Laminate	132	48	1 3/16	262	23.5	F, G, X, Y / P\$	2248	
					1 3/16			K / P\$	3775	
					1 1/2			H / P\$	2591	
		Veneer			1 3/16			F, G, X, Y / W\$	2975	
					1 3/16			K / W\$	4144	
					1 1/2			H / W\$	3522	
		Glass			1/4			Acid Etched Glass Top \$	13917	
					1/4			Gloss Glass Top \$	11481	
<b>48"D x 120"W or 10' - 2 Piece Rectangle Top</b>										
88-48120RT	Laminate	120	48	1 3/16	240	23.5	F, G, X, Y / P\$	2183		
				1 3/16			K / P\$	3529		
				1 1/2			H / P\$	2493		
	Veneer			1 3/16			F, G, X, Y / W\$	2741		
				1 3/16			K / W\$	3975		
				1 1/2			H / W\$	3241		
	Glass			1/4			Acid Etched Glass Top \$	12806		
				1/4			Gloss Glass Top \$	10593		
<b>48"D x 108"W or 9' - 2 Piece Rectangle Top</b>										
88-48108RT	Laminate	108	48	1 3/16	218	23.5	F, G, X, Y / P\$	2126		
				1 3/16			K / P\$	3361		
				1 1/2			H / P\$	2406		
	Veneer			1 3/16			F, G, X, Y / W\$	2518		
				1 3/16			K / W\$	3756		
				1 1/2			H / W\$	2970		
	Glass			1/4			Acid Etched Glass Top \$	11706		
				1/4			Gloss Glass Top \$	9715		

Must Specify (in this order):

- Model #
- Top/Edge Material
- Top/Edge Finish/Color
- Edge Profile
- Glass (Y/N)
- Glass Color + Surface Finish
- Power/Data Type
- Power/Data Location

*Additional 48" Rectangle Shaped Tops on Next Page*



Double Kerf (F)  
1 3/16"



Duo (G)  
1 3/16"



Fluted (X)  
1 3/16"



Square (Y)  
1 3/16"



Knife (K)  
1 3/16"



Vertical Square (H)  
1 1/2"

P = HPL W = Veneer

[See Catalyst Overview For Ordering Options](#)

Item	Model No.		W	D	H	Ship Wt	Cubic Ft	Edge Profile + Material	List Price	
<b>48"D x 96"W or 8' - 1 Piece Rectangle Top</b>										
CONTINUED FROM PREVIOUS PAGE	88-4896RT	Laminate	96	48	1 3/16"	196	11.3	F, G, X, Y / P\$	1469	
					1 3/16"			K / P\$	2549	
					1 1/2"			H / P\$	1715	
	Veneer	1 3/16"	F, G, X, Y / W\$	1883						
		1 3/16"	K / W\$	2867						
		1 1/2"	H / W\$	2284						
	Glass	1/4"	Acid Etched Glass Top \$	10062						
		1/4"	Gloss Glass Top \$	8291						
	<b>48"D x 84"W or 7' - 1 Piece Rectangle Top</b>									
		88-4884RT	Laminate	84	48	1 3/16"	174	10.0	F, G, X, Y / P\$	1426
1 3/16"						K / P\$			2299	
1 1/2"						H / P\$			1640	
Veneer		1 3/16"	F, G, X, Y / W\$	1658						
		1 3/16"	K / W\$	2650						
		1 1/2"	H / W\$	2013						
Glass		1/4"	Acid Etched Glass Top \$	8910						
		1/4"	Gloss Glass Top \$	7361						
<b>48"D x 72"W or 6' - 1 Piece Rectangle Top</b>										
		88-4872RT	Laminate	72	48	1 3/16"	152	8.6	F, G, X, Y / P\$	1192
	1 3/16"					K / P\$			2048	
	1 1/2"					H / P\$			1376	
	Veneer	1 3/16"	F, G, X, Y / W\$	1569						
		1 3/16"	K / W\$	2307						
		1 1/2"	H / W\$	1876						
	Glass	1/4"	Acid Etched Glass Top \$	7859						
		1/4"	Gloss Glass Top \$	6531						

Must Specify (in this order):

- Model #
- Top/Edge Material
- Top/Edge Finish/Color
- Edge Profile
- Glass (Y/N)
- Glass Color + Surface Finish
- Power/Data
- Power/Data Location

Description

- Tops Available with Veneer (W) or HPL (P) Top in 1 3/16" and 1 1/2" Thicknesses
- Must Specify Edge Profile: 1 3/16" Thick/Double Kerf (F), Duo (G), Fluted (X), Square (Y), and Knife (K) Edge Profiles or 1 1/2" Thick/Vertical Square (H)
- Veneer (W) Top Grain Runs Depth of Top and HPL (P) Top Grain Runs Width of Top
- All Veneer Tops, as well as Laminate Tops up to 144" (12 feet), have Matching Woodgrain. Laminate Tops Sized 156" (13 feet) and Longer have Non-Matching Woodgrain
- Available with Back Painted Tempered Glass Top; Must Specify Color and Finish; [See Options](#)
- Power and Data Options Available; Sold Separately, [See Multiple Power Unit Details](#)
- Dock800, Oasis, and E2X Power Units Available on Ends Only (E2 and E2) for 108"D - 156"D and 204"D-240"D Tops Bases Sold Separately, See [Multiple Base Options](#)



Double Kerf (F)  
1 3/16"



Duo (G)  
1 3/16"



Fluted (X)  
1 3/16"



Square (Y)  
1 3/16"



Knife (K)  
1 3/16"



Vertical Square (H)  
1 1/2"

P = HPL W = Veneer

[See Catalyst Overview For Ordering Options](#)

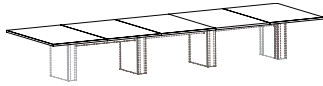
Item	Model No.		W	D	H	Ship Wt	Cubic Ft	Edge Profile + Material	List Price	
<b>RECTANGLE SHAPE MEETING TOP 54"D</b>    88-54204RT shown in Veneer with 88-2416606RAB (6" Rectangle Accent Base) BASES SOLD SEPARATELY	<b>54"D x 240"W or 20' - 5 Piece Veneer (W) and 3 Piece HPL (P) Rectangle Top</b>									
	88-54240RT	Laminate	240	54	1 3/16"	519	24.0	F, G, X, Y / P\$	4515	
					1 3/16"			K / P\$	7566	
					1 1/2"			H / P\$	5221	
		Veneer			1 3/16"			F, G, X, Y / W\$	7573	
					1 3/16"			K / W\$	9727	
					1 1/2"			H / W\$	8862	
		Glass			1/4"			Acid Etched Glass Top \$	27961	
					1/4"			Gloss Glass Top \$	22981	
	<b>54"D x 228"W or 19' - 5 Piece Veneer (W) and 3 Piece HPL (P) Rectangle Top</b>									
	88-54228RT	Laminate	228	54	1 3/16"	495	23.0	F, G, X, Y / P\$	4467	
					1 3/16"			K / P\$	7418	
					1 1/2"			H / P\$	5139	
		Veneer			1 3/16"			F, G, X, Y / W\$	7340	
					1 3/16"			K / W\$	9434	
				1 1/2"			H / W\$	8576		
	Glass			1/4"			Acid Etched Glass Top \$	26742		
				1/4"			Gloss Glass Top \$	22011		
<b>54"D x 216"W or 18' - 5 Piece Veneer (W) and 3 Piece HPL (P) Rectangle Top</b>										
88-54216RT	Laminate	216	54	1 3/16"	470	22.0	F, G, X, Y / P\$	3873		
				1 3/16"			K / P\$	6460		
				1 1/2"			H / P\$	4508		
	Veneer			1 3/16"			F, G, X, Y / W\$	7107		
				1 3/16"			K / W\$	9142		
				1 1/2"			H / W\$	8291		
	Glass			1/4"			Acid Etched Glass Top \$	25472		
				1/4"			Gloss Glass Top \$	20991		
<b>54"D x 204"W or 17' - 5 Piece Veneer (W) and 3 Piece HPL (P) Rectangle Top</b>										
88-54204RT	Laminate	204	54	1 3/16"	445	21.0	F, G, X, Y / P\$	3826		
				1 3/16"			K / P\$	6312		
				1 1/2"			H / P\$	4427		
	Veneer			1 3/16"			F, G, X, Y / W\$	6874		
				1 3/16"			K / W\$	8849		
				1 1/2"			H / W\$	8007		
	Glass			1/4"			Acid Etched Glass Top \$	24254		
				1/4"			Gloss Glass Top \$	20021		

*Additional 54" Rectangle Shaped Tops on Next Page*



Double Kerf (F) 1 3/16"    Duo (G) 1 3/16"    Fluted (X) 1 3/16"    Square (Y) 1 3/16"    Knife (K) 1 3/16"    Vertical Square (H) 1 1/2"

P = HPL    W = Veneer

[See Catalyst Overview For Ordering Options](#)

Item	Model No.		W	D	H	Ship Wt	Cubic Ft	Edge Profile + Material	List Price	
<b>54"D x 192"W or 16' - 4 Piece Veneer (W) and 2 Piece HPL (P) Rectangle Top</b>										
<i>CONTINUED FROM PREVIOUS PAGE</i>	88-54192RT	Laminate	192	54	1 3/16	408	19.0	F, G, X, Y / P\$	3168	
					1 3/16			K / P\$	5542	
					1 1/2			H / P\$	3732	
		Veneer			1 3/16			F, G, X, Y / W\$	5654	
					1 3/16			K / W\$	7438	
					1 1/2			H / W\$	6532	
		Glass			1/4			Acid Etched Glass Top \$	22145	
					1/4			Gloss Glass Top \$	18160	
	<b>54"D x 180"W or 15' - 4 Piece Veneer (W) and 2 Piece HPL (P) Rectangle Top</b>									
	<i>Must Specify (in this order):</i> Model # Top/Edge Material Top/Edge Finish/Color Edge Profile Glass (Y/N) Glass Color + Surface Finish Power/Data Type Power/Data Location	88-54180RT	Laminate	180	54	1 3/16	384	18.0	F, G, X, Y / P\$	3122
						1 3/16			K / P\$	5393
						1 1/2			H / P\$	3649
		Veneer			1 3/16			F, G, X, Y / W\$	5440	
					1 3/16			K / W\$	7163	
					1 1/2			H / W\$	6265	
		Glass			1/4			Acid Etched Glass Top \$	20926	
					1/4			Gloss Glass Top \$	17191	
<b>54"D x 168"W or 14' - 4 Piece Veneer (W) and 2 Piece HPL (P) Rectangle Top</b>										
		88-54168RT	Laminate	168	54	1 3/16	359	17.0	F, G, X, Y / P\$	3075
						1 3/16			K / P\$	5245
						1 1/2			H / P\$	3568
		Veneer			1 3/16			F, G, X, Y / W\$	5226	
					1 3/16			K / W\$	6889	
					1 1/2			H / W\$	5998	
		Glass			1/4			Acid Etched Glass Top \$	19707	
					1/4			Gloss Glass Top \$	16222	
	<b>54"D x 156"W or 13' - 4 Piece Veneer (W) and 2 Piece HPL (P) Rectangle Top</b>									
		88-54156RT	Laminate	156	54	1 3/16	334	16.0	F, G, X, Y / P\$	3028
						1 3/16			K / P\$	5096
						1 1/2			H / P\$	3485
		Veneer			1 3/16			F, G, X, Y / W\$	5011	
					1 3/16			K / W\$	6615	
					1 1/2			H / W\$	5732	
		Glass			1/4			Acid Etched Glass Top \$	18489	
					1/4			Gloss Glass Top \$	15253	

*Additional 54" Rectangle Shaped Tops on Next Page*



Double Kerf (F) 1 3/16"    Duo (G) 1 3/16"    Fluted (X) 1 3/16"    Square (Y) 1 3/16"    Knife (K) 1 3/16"    Vertical Square (H) 1 1/2"

P = HPL    W = Veneer

[See Catalyst Overview For Ordering Options](#)

Item	Model No.		W	D	H	Ship Wt	Cubic Ft	Edge Profile + Material	List Price	
<i>CONTINUED FROM PREVIOUS PAGE</i>	<b>54"D x 144"W or 12' - 3 Piece Veneer (W) and 2 Piece HPL (P) Rectangle Top</b>									
	88-54144RT	Laminate	144	54	1 3/16	309	15.0	F, G, X, Y / P\$	2557	
					1 3/16			K / P\$	4349	
					1 1/2			H / P\$	2980	
		Veneer			1 3/16			F, G, X, Y / W\$	4061	
					1 3/16			K / W\$	5474	
					1 1/2			H / W\$	4724	
		Glass			1/4			Acid Etched Glass Top \$	17401	
					1/4			Gloss Glass Top \$	14413	
		<b>54"D x 132"W or 11' - 3 Piece Veneer (W) and 2 Piece HPL (P) Rectangle Top</b>								
		88-54132RT	Laminate	132	54	1 3/16	285	13.2	F, G, X, Y / P\$	2497
						1 3/16			K / P\$	4188
					1 1/2			H / P\$	2884	
		Veneer			1 3/16			F, G, X, Y / W\$	3866	
					1 3/16			K / W\$	5218	
					1 1/2			H / W\$	4476	
		Glass			1/4			Acid Etched Glass Top \$	16170	
					1/4			Gloss Glass Top \$	13430	
	<b>54"D x 120"W or 10' - 3 Piece Veneer (W) and 2 Piece HPL (P) Rectangle Top</b>									
	88-54120RT	Laminate	120	54	1 3/16	260	12.1	F, G, X, Y / P\$	2436	
					1 3/16			K / P\$	4026	
					1 1/2			H / P\$	2788	
		Veneer			1 3/16			F, G, X, Y / W\$	3670	
					1 3/16			K / W\$	4963	
					1 1/2			H / W\$	4229	
		Glass			1/4			Acid Etched Glass Top \$	14938	
					1/4			Gloss Glass Top \$	12448	

Must Specify (in this order):

- Model #
- Top/Edge Material
- Top/Edge Finish/Color
- Edge Profile
- Glass (Y/N)
- Glass Color + Surface Finish
- Power/Data
- Power/Data Location

Description

- Tops Available with Veneer (W) or HPL (P) Top in 1 3/16" and 1 1/2" Thicknesses
- Must Specify Edge Profile: 1 3/16" Thick/Double Kerf (F), Duo (G), Fluted (X), Square (Y), and Knife (K) Edge Profiles or 1 1/2" Thick/Vertical Square (H)
- Veneer (W) Top Grain Runs Depth of Top and HPL (P) Top Grain Runs Width of Top
- All Veneer Tops, as well as Laminate Tops up to 144" (12 feet), have Matching Woodgrain. Laminate Tops Sized 156" (13 feet) and Longer have Non-Matching Woodgrain
- Available with Back Painted Tempered Glass Top; Must Specify Color and Finish; [See Options](#)
- Power and Data Options Available; Sold Separately, [See Multiple Power Unit Details](#)
- Bases Sold Separately, See [Multiple Base Options](#)



Double Kerf (F)  
1 3/16"



Duo (G)  
1 3/16"



Fluted (X)  
1 3/16"



Square (Y)  
1 3/16"



Knife (K)  
1 3/16"



Vertical Square (H)  
1 1/2"

P = HPL W = Veneer

[See Catalyst Overview For Ordering Options](#)

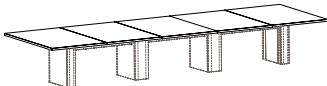
Item	Model No.		W	D	H	Ship Wt	Cubic Ft	Edge Profile + Material	List Price
<b>RECTANGLE SHAPE MEETING TOP 60"D</b>    88-60204RT Shown in Veneer with 88-24166C610RAB (6" + 10" Combo Rectangle Accent Base) BASES SOLD SEPARATELY	<b>60"D x 240"W or 20' - 5 Piece Veneer (W) and 3 Piece HPL (P) Rectangle Top</b>								
	88-60240RT	Laminate	240	60	1 3/16"	574	26.3	F, G, X, Y / P\$	4603
					1 3/16"			K / P\$	7839
					1 1/2"			H / P\$	5390
	Veneer				1 3/16"			F, G, X, Y / W\$	8087
					1 3/16"			K / W\$	10324
					1 1/2"			H / W\$	9485
	Glass				1/4"			Acid Etched Glass Top \$	30611
					1/4"			Gloss Glass Top \$	25078
	<b>60"D x 228"W or 19' - 5 Piece Veneer (W) and 3 Piece HPL (P) Rectangle Top</b>								
	88-60228RT	Laminate	228	60	1 3/16"	547	25.0	F, G, X, Y / P\$	4552
					1 3/16"			K / P\$	7678
				1 1/2"			H / P\$	5300	
Veneer				1 3/16"			F, G, X, Y / W\$	7830	
				1 3/16"			K / W\$	10003	
				1 1/2"			H / W\$	9168	
Glass				1/4"			Acid Etched Glass Top \$	29260	
				1/4"			Gloss Glass Top \$	24005	
<b>60"D x 216"W or 18' - 5 Piece Veneer (W) and 3 Piece HPL (P) Rectangle Top</b>									
88-60216RT	Laminate	216	60	1 3/16"	519	23.7	F, G, X, Y / P\$	3953	
				1 3/16"			K / P\$	6708	
				1 1/2"			H / P\$	4662	
Veneer				1 3/16"			F, G, X, Y / W\$	7571	
				1 3/16"			K / W\$	9681	
				1 1/2"			H / W\$	8852	
Glass				1/4"			Acid Etched Glass Top \$	27859	
				1/4"			Gloss Glass Top \$	22880	
<b>60"D x 204"W or 17' - 5 Piece Veneer (W) and 3 Piece HPL (P) Rectangle Top</b>									
88-60204RT	Laminate	204	60	1 3/16"	492	22.4	F, G, X, Y / P\$	3902	
				1 3/16"			K / P\$	6547	
				1 1/2"			H / P\$	4572	
Veneer				1 3/16"			F, G, X, Y / W\$	7313	
				1 3/16"			K / W\$	9361	
				1 1/2"			H / W\$	8537	
Glass				1/4"			Acid Etched Glass Top \$	26509	
				1/4"			Gloss Glass Top \$	21806	

Additional 60" Rectangle Shaped Tops on Next Page



Double Kerf (F) 1 3/16" Duo (G) 1 3/16" Fluted (X) 1 3/16" Square (Y) 1 3/16" Knife (K) 1 3/16" Vertical Square (H) 1 1/2"

P = HPL W = Veneer

[See Catalyst Overview For Ordering Options](#)

Item	Model No.		W	D	H	Ship Wt	Cubic Ft	Edge Profile + Material	List Price	
<i>CONTINUED FROM PREVIOUS PAGE</i>	<b>60"D x 192"W or 16' - 4 Piece Veneer (W) and 2 Piece HPL (P) Rectangle Top</b>									
	88-60192RT	Laminate	192	60	1 3/16"	458	21.1	F, G, X, Y / P\$	3241	
					1 3/16"			K / P\$	5763	
					1 1/2"			H / P\$	3868	
		Veneer			1 3/16"			F, G, X, Y / W\$	6033	
					1 3/16"			K / W\$	7886	
					1 1/2"			H / W\$	6997	
		Glass			1/4"			Acid Etched Glass Top \$	24267	
					1/4"			Gloss Glass Top \$	19841	
	<b>60"D x 180"W or 15' - 4 Piece Veneer (W) and 2 Piece HPL (P) Rectangle Top</b>									
	88-60180RT	Laminate	180	60	1 3/16"	430	19.8	F, G, X, Y / P\$	3190	
					1 3/16"			K / P\$	5602	
					1 1/2"			H / P\$	3778	
		Veneer			1 3/16"			F, G, X, Y / W\$	5796	
					1 3/16"			K / W\$	7584	
					1 1/2"			H / W\$	6702	
		Glass			1/4"			Acid Etched Glass Top \$	22917	
					1/4"			Gloss Glass Top \$	18768	
<b>60"D x 168"W or 14' - 4 Piece Veneer (W) and 2 Piece HPL (P) Rectangle Top</b>										
88-60168RT	Laminate	168	60	1 3/16"	403	18.5	F, G, X, Y / P\$	3138		
				1 3/16"			K / P\$	5441		
				1 1/2"			H / P\$	3688		
	Veneer			1 3/16"			F, G, X, Y / W\$	5558		
				1 3/16"			K / W\$	7283		
				1 1/2"			H / W\$	6407		
	Glass			1/4"			Acid Etched Glass Top \$	21567		
				1/4"			Gloss Glass Top \$	17694		
<b>60"D x 156"W or 13' - 4 Piece Veneer (W) and 2 Piece HPL (P) Rectangle Top</b>										
88-60156RT	Laminate	156	60	1 3/16"	376	17.2	F, G, X, Y / P\$	3087		
				1 3/16"			K / P\$	5280		
				1 1/2"			H / P\$	3597		
	Veneer			1 3/16"			F, G, X, Y / W\$	5320		
				1 3/16"			K / W\$	6982		
				1 1/2"			H / W\$	6112		
	Glass			1/4"			Acid Etched Glass Top \$	20218		
				1/4"			Gloss Glass Top \$	16621		

Must Specify (in this order):

- Model #
- Top/Edge Material
- Top/Edge Finish/Color
- Edge Profile
- Glass (Y/N)
- Glass Color + Surface Finish
- Power/Data Type
- Power/Data Location

*Additional 60" Rectangle Shaped Tops on Next Page*



Double Kerf (F)  
1 3/16"



Duo (G)  
1 3/16"



Fluted (X)  
1 3/16"



Square (Y)  
1 3/16"



Knife (K)  
1 3/16"



Vertical Square (H)  
1 1/2"

P = HPL W = Veneer

[See Catalyst Overview For Ordering Options](#)



Item	Model No.		W	D	H	Ship Wt	Cubic Ft	Edge Profile + Material	List Price	
<b>60"D x 144"W or 12' - 3 Piece Veneer (W) and 2 Piece HPL (P) Rectangle Top</b>										
<i>CONTINUED FROM PREVIOUS PAGE</i>	88-60144RT	Laminate	144	60	1 3/16	342	16.0	F, G, X, Y / P\$	2612	
					1 3/16			K / P\$	4520	
					1 1/2			H / P\$	3083	
		Veneer			1 3/16			F, G, X, Y / W\$	4320	
					1 3/16			K / W\$	5789	
					1 1/2			H / W\$	5050	
		Glass			1/4			Acid Etched Glass Top \$	18997	
					1/4			Gloss Glass Top \$	15678	
	<b>60"D x 132"W or 11' - 3 Piece Veneer (W) and 2 Piece HPL (P) Rectangle Top</b>									
		88-60132RT	Laminate	132	60	1 3/16	323	14.6	F, G, X, Y / P\$	2548
					1 3/16			K / P\$	4345	
					1 1/2			H / P\$	2979	
		Veneer			1 3/16			F, G, X, Y / W\$	4104	
					1 3/16			K / W\$	5508	
					1 1/2			H / W\$	4775	
		Glass			1/4			Acid Etched Glass Top \$	17634	
					1/4			Gloss Glass Top \$	14591	
<b>60"D x 120"W or 10' - 3 Piece Veneer (W) and 2 Piece HPL (P) Rectangle Top</b>										
	88-60120RT	Laminate	120	60	1 3/16	287	13.3	F, G, X, Y / P\$	2484	
					1 3/16			K / P\$	4170	
					1 1/2			H / P\$	2875	
		Veneer			1 3/16			F, G, X, Y / W\$	3886	
					1 3/16			K / W\$	5228	
					1 1/2			H / W\$	4500	
		Glass			1/4			Acid Etched Glass Top \$	16271	
					1/4			Gloss Glass Top \$	13505	

Must Specify (in this order):

- Model #
- Top/Edge Material
- Top/Edge Finish/Color
- Edge Profile
- Glass (Y/N)
- Glass Color + Surface Finish
- Power/Data Type
- Power/Data Location

**Description**

- Tops Available with Veneer (W) or HPL (P) Top in 1 3/16" and 1 1/2" Thicknesses
- Must Specify Edge Profile: 1 3/16" Thick/Double Kerf (F), Duo (G), Fluted (X), Square (Y), and Knife (K) Edge Profiles or 1 1/2" Thick/Vertical Square (H)
- Veneer (W) Top Grain Runs Depth of Top and HPL (P) Top Grain Runs Width of Top
- All Veneer Tops, as well as Laminate Tops up to 144" (12 feet), have Matching Woodgrain. Laminate Tops Sized 156" (13 feet) and Longer have Non-Matching Woodgrain
- Available with Back Painted Tempered Glass Top; Must Specify Color and Finish; [See Options](#)
- Power and Data Options Available; Sold Separately, [See Multiple Power Unit Details](#)
- Bases Sold Separately, See [Multiple Base Options](#)



Double Kerf (F)  
1 3/16"



Duo (G)  
1 3/16"



Fluted (X)  
1 3/16"



Square (Y)  
1 3/16"



Knife (K)  
1 3/16"



Vertical Square (H)  
1 1/2"

P = HPL W = Veneer

[See Catalyst Overview For Ordering Options](#)

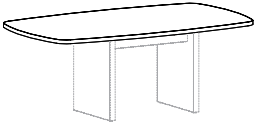
Item	Model No.		W	D	H	Ship Wt	Cubic Ft	Edge Profile + Material	List Price	
<b>MODERN RECTANGLE SHAPE MEETING TOP 36"D</b>    88-3672MR shown with 88-2034RPB (Rectangle Panel Base) BASES SOLD SEPARATELY	<b>36"D x 96"W or 8' - 1 Piece Modern Rectangle Top</b>									
	88-3696MR	Laminate	96	36	1 3/16"	142	12.9	F, G, X, Y / P\$	1424	
					1 3/16"			K / P\$	2821	
					1 1/2"			H / P\$	1606	
		Veneer			1 3/16"			F, G, X, Y / W\$	1613	
					1 3/16"			K / W\$	3163	
					1 1/2"			H / W\$	1921	
		Glass			1/4"			Acid Etched Glass Top \$	8724	
					1/4"			Gloss Glass Top \$	7396	
	<b>36"D x 84"W or 7' - 1 Piece Modern Rectangle Top</b>									
		88-3684MR	Laminate	84	36	1 3/16"	126	11.3	F, G, X, Y / P\$	1357
						1 3/16"			K / P\$	2583
					1 1/2"			H / P\$	1547	
		Veneer			1 3/16"			F, G, X, Y / W\$	1529	
					1 3/16"			K / W\$	2958	
					1 1/2"			H / W\$	1768	
		Glass			1/4"			Acid Etched Glass Top \$	7821	
					1/4"			Gloss Glass Top \$	6659	
<b>36"D x 72"W or 6' - 1 Piece Modern Rectangle Top</b>										
	88-3672MR	Laminate	72	36	1 3/16"	109	10.3	F, G, X, Y / P\$	1108	
					1 3/16"			K / P\$	2236	
					1 1/2"			H / P\$	1245	
		Veneer			1 3/16"			F, G, X, Y / W\$	1302	
					1 3/16"			K / W\$	2518	
					1 1/2"			H / W\$	1537	
		Glass			1/4"			Acid Etched Glass Top \$	6829	
					1/4"			Gloss Glass Top \$	5832	

Must Specify (in this order):

- Model #
- Top/Edge Material
- Top/Edge Finish/Color
- Edge Profile
- Glass (Y/N)
- Glass Color + Surface Finish
- Power/Data
- Power/Data Location

**Description**

- Tops Available with Veneer (W) or HPL (P) Top in 1 3/16" and 1 1/2" Thicknesses
- Must Specify Edge Profile: 1 3/16" Thick/Double Kerf (F), Duo (G), Fluted (X), Square (Y), and Knife (K) Edge Profiles or 1 1/2" Thick/Vertical Square (H)
- Veneer (W) Top Grain Runs Depth of Top and HPL (P) Top Grain Runs Width of Top
- Available with Back Painted Tempered Glass Top; Must Specify Color and Finish; [See Options](#)
- Power and Data Options Available; Sold Separately, [See Multiple Power Unit Details](#)
- Bases Sold Separately, See [Multiple Base Options](#)



Double Kerf (F)  
1 3/16"



Duo (G)  
1 3/16"



Fluted (X)  
1 3/16"



Square (Y)  
1 3/16"



Knife (K)  
1 3/16"



Vertical Square (H)  
1 1/2"

P = HPL W = Veneer

[See Catalyst Overview For Ordering Options](#)

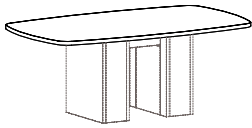
Item	Model No.		W	D	H	Ship Wt	Cubic Ft	Edge Profile + Material	List Price	
<b>MODERN RECTANGLE SHAPE MEETING TOP 42"D</b>    88-42108MR shown with 88-203406GRAB (Rectangle Panel Base) BASES SOLD SEPARATELY	<b>42"D x 120"W or 10' - 2 Piece Modern Rectangle Top</b>									
	88-42120MR	Laminate	120	42	1 3/16"	268	27.0	F, G, X, Y / P\$	2008	
					1 3/16"			K / P\$	3846	
					1 1/2"			H / P\$	2278	
		Veneer			1 3/16"			F, G, X, Y / W\$	2330	
					1 3/16"			K / W\$	4333	
					1 1/2"			H / W\$	2769	
		Glass			1/4"			Acid Etched Glass Top \$	12215	
					1/4"			Gloss Glass Top \$	10279	
	<b>42"D x 108"W or 9' - 2 Piece Modern Rectangle Top</b>									
	88-42108MR	Laminate	108	42	1 3/16"	260	27.0	F, G, X, Y / P\$	1970	
					1 3/16"			K / P\$	3630	
				1 1/2"			H / P\$	2213		
	Veneer			1 3/16"			F, G, X, Y / W\$	2192		
				1 3/16"			K / W\$	4063		
				1 1/2"			H / W\$	2590		
	Glass			1/4"			Acid Etched Glass Top \$	11182		
				1/4"			Gloss Glass Top \$	9439		
<b>42"D x 96"W or 8' - 1 Piece Modern Rectangle Top</b>										
88-4296MR	Laminate	96	42	1 3/16"	164	15.0	F, G, X, Y / P\$	1453		
				1 3/16"			K / P\$	2984		
				1 1/2"			H / P\$	1667		
	Veneer			1 3/16"			F, G, X, Y / W\$	1752		
				1 3/16"			K / W\$	3361		
				1 1/2"			H / W\$	2104		
	Glass			1/4"			Acid Etched Glass Top \$	9818		
				1/4"			Gloss Glass Top \$	8269		
<b>42"D x 84"W or 7' - 1 Piece Modern Rectangle Top</b>										
88-4284MR	Laminate	84	42	1 3/16"	145	13.1	F, G, X, Y / P\$	1414		
				1 3/16"			K / P\$	2769		
				1 1/2"			H / P\$	1600		
	Veneer			1 3/16"			F, G, X, Y / W\$	1618		
				1 3/16"			K / W\$	3102		
				1 1/2"			H / W\$	1928		
	Glass			1/4"			Acid Etched Glass Top \$	8786		
				1/4"			Gloss Glass Top \$	7430		

*Additional 42" Modern Rectangle Shaped Tops on Next Page*



Double Kerf (F)  
1 3/16"



Duo (G)  
1 3/16"



Fluted (X)  
1 3/16"



Square (Y)  
1 3/16"



Knife (K)  
1 3/16"



Vertical Square (H)  
1 1/2"

P = HPL W = Veneer

[See Catalyst Overview For Ordering Options](#)

Item	Model No.		W	D	H	Ship Wt	Cubic Ft	Edge Profile + Material	List Price
<i>CONTINUED FROM PREVIOUS PAGE</i>	<b>42"D x 72"W or 6' - 1 Piece Modern Rectangle Top</b>								
	88-4272MR	Laminate	72	42	1 3/16	126	11.3	F, G, X, Y / P\$	1182
					1 3/16			K / P\$	2467
					1 1/2			H / P\$	1341
		Veneer			1 3/16			F, G, X, Y / W\$	1473
					1 3/16			K / W\$	2710
					1 1/2			H / W\$	1741
		Glass			1/4			Acid Etched Glass Top \$	7725
					1/4			Gloss Glass Top \$	6563

Must Specify (in this order):

- Model #
- Top/Edge Material
- Top/Edge Finish/Color
- Edge Profile
- Glass (Y/N)
- Glass Color + Surface Finish
- Power/Data
- Power/Data Location

**Description**

- Tops Available with Veneer (W) or HPL (P) Top in 1 3/16" and 1 1/2" Thicknesses
- Must Specify Edge Profile: 1 3/16" Thick/Double Kerf (F), Duo (G), Fluted (X), Square (Y), and Knife (K) Edge Profiles or 1 1/2" Thick/Vertical Square (H)
- Veneer (W) Top Grain Runs Depth of Top and HPL (P) Top Grain Runs Width of Top
- Available with Back Painted Tempered Glass Top; Must Specify Color and Finish; [See Options](#)
- Power and Data Options Available; Sold Separately, [See Multiple Power Unit Details](#)
- Bases Sold Separately, See [Multiple Base Options](#)



Double Kerf (F)  
1 3/16"



Duo (G)  
1 3/16"



Fluted (X)  
1 3/16"



Square (Y)  
1 3/16"



Knife (K)  
1 3/16"



Vertical Square (H)  
1 1/2"

P = HPL W = Veneer

[See Catalyst Overview For Ordering Options](#)

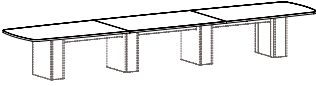
Item	Model No.		W	D	H	Ship Wt	Cubic Ft	Edge Profile + Material	List Price	
<b>MODERN RECTANGLE SHAPE MEETING TOP 48"D</b>    88-48216MR shown in HPL with 88-24178C610RAB (10" Rectangle Accent Base) BASES SOLD SEPARATELY	<b>48"D x 240"W or 20' - 3 Piece Modern Rectangle Top</b>									
	88-48240MR	Laminate	240	48	1 3/16	460	48.9	F, G, X, Y / P\$	4638	
					1 3/16			K / P\$	8499	
					1 1/2			H / P\$	5257	
		Veneer			1 3/16			F, G, X, Y / W\$	6301	
					1 3/16			K / W\$	9571	
					1 1/2			H / W\$	7153	
		Glass			1/4			Acid Etched Glass Top \$	26634	
					1/4			Gloss Glass Top \$	22207	
	<b>48"D x 228"W or 19' - 3 Piece Modern Rectangle Top</b>									
	88-48228MR	Laminate	228	48	1 3/16	438	48.9	F, G, X, Y / P\$	4594	
					1 3/16			K / P\$	8284	
				1 1/2			H / P\$	5182		
	Veneer			1 3/16			F, G, X, Y / W\$	6037		
				1 3/16			K / W\$	9216		
				1 1/2			H / W\$	6849		
	Glass			1/4			Acid Etched Glass Top \$	25468		
				1/4			Gloss Glass Top \$	21263		
<b>48"D x 216"W or 18' - 3 Piece Modern Rectangle Top</b>										
88-48216MR	Laminate	216	48	1 3/16	416	48.9	F, G, X, Y / P\$	3687		
				1 3/16			K / P\$	7182		
				1 1/2			H / P\$	4244		
	Veneer			1 3/16			F, G, X, Y / W\$	5369		
				1 3/16			K / W\$	8456		
				1 1/2			H / W\$	6139		
	Glass			1/4			Acid Etched Glass Top \$	23917		
				1/4			Gloss Glass Top \$	19933		
<b>48"D x 204"W or 17' - 3 Piece Modern Rectangle Top</b>										
88-48204MR	Laminate	204	48	1 3/16	394	48.9	F, G, X, Y / P\$	3643		
				1 3/16			K / P\$	6968		
				1 1/2			H / P\$	4169		
	Veneer			1 3/16			F, G, X, Y / W\$	5106		
				1 3/16			K / W\$	8101		
				1 1/2			H / W\$	5834		
	Glass			1/4			Acid Etched Glass Top \$	22751		
				1/4			Gloss Glass Top \$	18988		

Must Specify (in this order):

- Model #
- Top/Edge Material
- Top/Edge Finish/Color
- Edge Profile
- Glass (Y/N)
- Glass Color + Surface Finish
- Power/Data
- Power/Data Location

*Additional 48" Modern Rectangle Shaped Tops on Next Page*



Double Kerf (F)  
1 3/16"



Duo (G)  
1 3/16"



Fluted (X)  
1 3/16"



Square (Y)  
1 3/16"



Knife (K)  
1 3/16"



Vertical Square (H)  
1 1/2"

P = HPL W = Veneer

[See Catalyst Overview For Ordering Options](#)

Item	Model No.		W	D	H	Ship Wt	Cubic Ft	Edge Profile + Material	List Price		
<b>48"D x 192"W or 16' - 2 Piece Modern Rectangle Top</b>											
<i>CONTINUED FROM PREVIOUS PAGE</i>	88-48192MR	Laminate	192	48	1 3/16	372	31.2	F, G, X, Y / P\$	3125		
					1 3/16			K / P\$	6249		
					1 1/2			H / P\$	3621		
	Veneer								F, G, X, Y / W\$	4215	
									1 3/16	K / W\$	6996
									1 1/2	H / W\$	4991
	Glass								Acid Etched Glass Top \$	21073	
										Gloss Glass Top \$	17531
	<b>48"D x 180"W or 15' - 2 Piece Modern Rectangle Top</b>										
	<i>Must Specify (in this order):</i> Model # Top/Edge Material Top/Edge Finish/Color Edge Profile Glass (Y/N) Glass Color + Surface Finish Power/Data Power/Data Location	88-48180MR	Laminate	180	48	1 3/16	350	31.2	F, G, X, Y / P\$	3080	
1 3/16						K / P\$			6034		
1 1/2						H / P\$			3547		
Veneer									F, G, X, Y / W\$	4045	
									1 3/16	K / W\$	6679
									1 1/2	H / W\$	4773
Glass									Acid Etched Glass Top \$	19906	
										Gloss Glass Top \$	16586
<b>48"D x 168"W or 14' - 2 Piece Modern Rectangle Top</b>											
		88-48168MR	Laminate	168	48	1 3/16	328	31.2	F, G, X, Y / P\$	2928	
	1 3/16					K / P\$			5708		
	1 1/2					H / P\$			3363		
	Veneer								F, G, X, Y / W\$	3736	
									1 3/16	K / W\$	6223
									1 1/2	H / W\$	4418
	Glass								Acid Etched Glass Top \$	18629	
										Gloss Glass Top \$	15530
	<b>48"D x 156"W or 13' - 2 Piece Modern Rectangle Top</b>										
		88-48156MR	Laminate	156	48	1 3/16	306	31.2	F, G, X, Y / P\$	2885	
1 3/16						K / P\$			5363		
1 1/2						H / P\$			3288		
Veneer									F, G, X, Y / W\$	3567	
									1 3/16	K / W\$	6039
									1 1/2	H / W\$	4202
Glass									Acid Etched Glass Top \$	17463	
										Gloss Glass Top \$	14585

*Additional 48" Modern Rectangle Shaped Tops on Next Page*



Double Kerf (F)  
1 3/16"



Duo (G)  
1 3/16"



Fluted (X)  
1 3/16"



Square (Y)  
1 3/16"



Knife (K)  
1 3/16"



Vertical Square (H)  
1 1/2"

P = HPL W = Veneer

[See Catalyst Overview For Ordering Options](#)

Item	Model No.		W	D	H	Ship Wt	Cubic Ft	Edge Profile + Material	List Price		
<b>48"D x 144"W or 12' - 2 Piece Modern Rectangle Top</b>											
<i>CONTINUED FROM PREVIOUS PAGE</i>	88-48144MR	Laminate	144	48	1 <sup>3</sup> / <sub>16</sub>	284	23.5	F, G, X, Y / P\$	2421		
					1 <sup>3</sup> / <sub>16</sub>			K / P\$	4847		
					1 <sup>1</sup> / <sub>2</sub>			H / P\$	2793		
					Veneer			1 <sup>3</sup> / <sub>16</sub>	F, G, X, Y / W\$	3328	
								1 <sup>3</sup> / <sub>16</sub>	K / W\$	5521	
								1 <sup>1</sup> / <sub>2</sub>	H / W\$	3915	
		Glass	1 <sup>1</sup> / <sub>4</sub>	Acid Etched Glass Top \$	16201						
			1 <sup>1</sup> / <sub>4</sub>	Gloss Glass Top \$	13544						
		<b>48"D x 132"W or 11' - 2 Piece Modern Rectangle Top</b>									
			88-48132MR	Laminate	132	48	1 <sup>3</sup> / <sub>16</sub>	262	23.5	F, G, X, Y / P\$	2365
							1 <sup>3</sup> / <sub>16</sub>			K / P\$	4619
							1 <sup>1</sup> / <sub>2</sub>			H / P\$	2705
Veneer	1 <sup>3</sup> / <sub>16</sub>						F, G, X, Y / W\$			3105	
	1 <sup>3</sup> / <sub>16</sub>						K / W\$			5178	
	1 <sup>1</sup> / <sub>2</sub>						H / W\$			3645	
Glass	1 <sup>1</sup> / <sub>4</sub>			Acid Etched Glass Top \$	15022						
	1 <sup>1</sup> / <sub>4</sub>			Gloss Glass Top \$	12588						
<b>48"D x 120"W or 10' - 2 Piece Modern Rectangle Top</b>											
	88-48120MR			Laminate	120	48	1 <sup>3</sup> / <sub>16</sub>	240	23.5	F, G, X, Y / P\$	2299
							1 <sup>3</sup> / <sub>16</sub>			K / P\$	4383
							1 <sup>1</sup> / <sub>2</sub>			H / P\$	2609
		Veneer	1 <sup>3</sup> / <sub>16</sub>				F, G, X, Y / W\$			2870	
			1 <sup>3</sup> / <sub>16</sub>				K / W\$			4823	
			1 <sup>1</sup> / <sub>2</sub>				H / W\$			3364	
		Glass	1 <sup>1</sup> / <sub>4</sub>	Acid Etched Glass Top \$	13835						
			1 <sup>1</sup> / <sub>4</sub>	Gloss Glass Top \$	11622						
		<b>48"D x 108"W or 9' - 2 Piece Modern Rectangle Top</b>									
			88-48108MR	Laminate	108	48	1 <sup>3</sup> / <sub>16</sub>	218	23.5	F, G, X, Y / P\$	2243
							1 <sup>3</sup> / <sub>16</sub>			K / P\$	4063
							1 <sup>1</sup> / <sub>2</sub>			H / P\$	2522
Veneer	1 <sup>3</sup> / <sub>16</sub>						F, G, X, Y / W\$			2648	
	1 <sup>3</sup> / <sub>16</sub>						K / W\$			4575	
	1 <sup>1</sup> / <sub>2</sub>						H / W\$			3095	
Glass	1 <sup>1</sup> / <sub>4</sub>			Acid Etched Glass Top \$	12657						
	1 <sup>1</sup> / <sub>4</sub>			Gloss Glass Top \$	10665						

Must Specify (in this order):  
 Model #  
 Top/Edge Material  
 Top/Edge Finish/Color  
 Edge Profile  
 Glass (Y/N)  
 Glass Color + Surface Finish  
 Power/Data  
 Power/Data Location

*Additional 48" Modern Rectangle Shaped Tops on Next Page*



Double Kerf (F) 1<sup>3</sup>/<sub>16</sub>"    Duo (G) 1<sup>3</sup>/<sub>16</sub>"    Fluted (X) 1<sup>3</sup>/<sub>16</sub>"    Square (Y) 1<sup>3</sup>/<sub>16</sub>"    Knife (K) 1<sup>3</sup>/<sub>16</sub>"    Vertical Square (H) 1<sup>1</sup>/<sub>2</sub>"

P = HPL    W = Veneer

[See Catalyst Overview For Ordering Options](#)

Item	Model No.		W	D	H	Ship Wt	Cubic Ft	Edge Profile + Material	List Price	
<i>CONTINUED FROM PREVIOUS PAGE</i>	<b>48"D x 96"W or 8' - 1 Piece Modern Rectangle Top</b>									
	88-4896MR	Laminate	96	48	1 3/16	315	18.0	F, G, X, Y / P\$	1529	
					1 3/16			K / P\$	3258	
					1 1/2			H / P\$	1774	
		Veneer			1 3/16			F, G, X, Y / W\$	1951	
					1 3/16			K / W\$	3558	
					1 1/2			H / W\$	2347	
		Glass			1/4			Acid Etched Glass Top \$	10965	
					1/4			Gloss Glass Top \$	9194	
	<b>48"D x 84"W or 7' - 1 Piece Modern Rectangle Top</b>									
	88-4884MR	Laminate	84	48	1 3/16	164	15.0	F, G, X, Y / P\$	1484	
					1 3/16			K / P\$	2899	
					1 1/2			H / P\$	1698	
		Veneer			1 3/16			F, G, X, Y / W\$	1724	
					1 3/16			K / W\$	3266	
					1 1/2			H / W\$	2074	
		Glass			1/4			Acid Etched Glass Top \$	9732	
					1/4			Gloss Glass Top \$	8184	
<b>48"D x 72"W or 6' - 1 Piece Modern Rectangle Top</b>										
88-4872MR	Laminate	72	48	1 3/16	142	12.8	F, G, X, Y / P\$	1249		
				1 3/16			K / P\$	2637		
				1 1/2			H / P\$	1432		
	Veneer			1 3/16			F, G, X, Y / W\$	1633		
				1 3/16			K / W\$	2948		
				1 1/2			H / W\$	1935		
	Glass			1/4			Acid Etched Glass Top \$	8608		
				1/4			Gloss Glass Top \$	7280		

Must Specify (in this order):

- Model #
- Top/Edge Material
- Top/Edge Finish/Color
- Edge Profile
- Glass (Y/N)
- Glass Color + Surface Finish
- Power/Data
- Power/Data Location

**Description**

- Tops Available with Veneer (W) or HPL (P) Top in 1 3/16" and 1 1/2" Thicknesses
- Must Specify Edge Profile: 1 3/16" Thick/Double Kerf (F), Duo (G), **Fluted (X)**, Square (Y), and Knife (K) Edge Profiles or 1 1/2" Thick/Vertical Square (H)
- Veneer (W) Top Grain Runs Depth of Top and HPL (P) Top Grain Runs Width of Top
- **All Veneer Tops, as well as Laminate Tops up to 144" (12 feet), have Matching Woodgrain. Laminate Tops Sized 156" (13 feet) and Longer have Non-Matching Woodgrain**
- Available with Back Painted Tempered Glass Top; Must Specify Color and Finish; [See Options](#)
- Power and Data Options Available; Sold Separately, [See Multiple Power Unit Details](#)
- Bases Sold Separately, See [Multiple Base Options](#)



Double Kerf (F) 1 3/16"    Duo (G) 1 3/16"    **Fluted (X)** 1 3/16"    Square (Y) 1 3/16"    Knife (K) 1 3/16"    Vertical Square (H) 1 1/2"

P = HPL    W = Veneer

[See Catalyst Overview For Ordering Options](#)

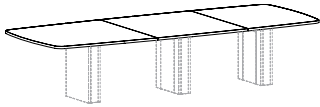

Item	Model No.		W	D	H	Ship Wt	Cubic Ft	Edge Profile + Material	List Price	
<b>MODERN RECTANGLE SHAPE MEETING TOP 54"D</b>    88-54156MR shown in HPL with 88-2411806RAB (6" Rectangle Accent Base) BASES SOLD SEPARATELY	<b>54"D x 240"W or 20' - 5 Piece Veneer (W) and 3 Piece HPL (P) Modern Rectangle Top</b>									
	88-54240MR	Laminate	240	54	1 3/16	519	24.0	F, G, X, Y / P\$	4690	
					1 3/16			K / P\$	8773	
					1 1/2			H / P\$	5389	
		Veneer			1 3/16			F, G, X, Y / W\$	7844	
					1 3/16			K / W\$	11557	
					1 1/2			H / W\$	8912	
		Glass			1/4			Acid Etched Glass Top \$	29666	
					1/4			Gloss Glass Top \$	24687	
	<b>54"D x 228"W or 19' - 5 Piece Veneer (W) and 3 Piece HPL (P) Modern Rectangle Top</b>									
	88-54228MR	Laminate	228	54	1 3/16	495	23.0	F, G, X, Y / P\$	4642	
					1 3/16			K / P\$	8545	
				1 1/2			H / P\$	5306		
	Veneer			1 3/16			F, G, X, Y / W\$	7602		
				1 3/16			K / W\$	11159		
				1 1/2			H / W\$	8619		
	Glass			1/4			Acid Etched Glass Top \$	28369		
				1/4			Gloss Glass Top \$	23639		
<b>54"D x 216"W or 18' - 5 Piece Veneer (W) and 3 Piece HPL (P) Modern Rectangle Top</b>										
88-54216MR	Laminate	216	54	1 3/16	470	22.0	F, G, X, Y / P\$	4047		
				1 3/16			K / P\$	7755		
				1 1/2			H / P\$	4676		
	Veneer			1 3/16			F, G, X, Y / W\$	7361		
				1 3/16			K / W\$	10761		
				1 1/2			H / W\$	8327		
	Glass			1/4			Acid Etched Glass Top \$	27037		
				1/4			Gloss Glass Top \$	22556		
<b>54"D x 204"W or 17' - 5 Piece Veneer (W) and 3 Piece HPL (P) Modern Rectangle Top</b>										
88-54204MR	Laminate	204	54	1 3/16	445	21.0	F, G, X, Y / P\$	3999		
				1 3/16			K / P\$	7528		
				1 1/2			H / P\$	4593		
	Veneer			1 3/16			F, G, X, Y / W\$	7119		
				1 3/16			K / W\$	10364		
				1 1/2			H / W\$	8034		
	Glass			1/4			Acid Etched Glass Top \$	25741		
				1/4			Gloss Glass Top \$	21509		

Must Specify (in this order):  
 Model #  
 Top/Edge Material  
 Top/Edge Finish/Color  
 Edge Profile  
 Glass (Y/N)  
 Glass Color + Surface Finish  
 Power/Data  
 Power/Data Location

*Additional 54" Modern Rectangle Shaped Tops on Next Page*



Double Kerf (F) 1 3/16" Duo (G) 1 3/16" Fluted (X) 1 3/16" Square (Y) 1 3/16" Knife (K) 1 3/16" Vertical Square (H) 1 1/2"

P = HPL W = Veneer

[See Catalyst Overview For Ordering Options](#)

Item	Model No.		W	D	H	Ship Wt	Cubic Ft	Edge Profile + Material	List Price	
<i>CONTINUED FROM PREVIOUS PAGE</i>	<b>54"D x 192"W or 16' - 4 Piece Veneer (W) and 2 Piece HPL (P) Modern Rectangle Top</b>									
	88-54192MR	Laminate	192	54	1 3/16	408	19.0	F, G, X, Y / P\$	3291	
					1 3/16			K / P\$	6606	
					1 1/2			H / P\$	3852	
		Veneer			1 3/16			F, G, X, Y / W\$	5874	
					1 3/16			K / W\$	8938	
					1 1/2			H / W\$	6734	
		Glass			1/4			Acid Etched Glass Top \$	23748	
					1/4			Gloss Glass Top \$	19764	
	<b>54"D x 180"W or 15' - 4 Piece Veneer (W) and 2 Piece HPL (P) Modern Rectangle Top</b>									
	88-54180MR	Laminate	180	54	1 3/16	384	18.0	F, G, X, Y / P\$	3244	
					1 3/16			K / P\$	6379	
					1 1/2			H / P\$	3769	
		Veneer			1 3/16			F, G, X, Y / W\$	5652	
					1 3/16			K / W\$	8560	
				1 1/2			H / W\$	6460		
	Glass			1/4			Acid Etched Glass Top \$	22451		
				1/4			Gloss Glass Top \$	18716		
<b>54"D x 168"W or 14' - 4 Piece Veneer (W) and 2 Piece HPL (P) Modern Rectangle Top</b>										
88-54168MR	Laminate	168	54	1 3/16	359	17.0	F, G, X, Y / P\$	3195		
				1 3/16			K / P\$	6151		
				1 1/2			H / P\$	3687		
	Veneer			1 3/16			F, G, X, Y / W\$	5431		
				1 3/16			K / W\$	8182		
				1 1/2			H / W\$	6188		
	Glass			1/4			Acid Etched Glass Top \$	21154		
				1/4			Gloss Glass Top \$	17668		
<b>54"D x 156"W or 13' - 4 Piece Veneer (W) and 2 Piece HPL (P) Modern Rectangle Top</b>										
88-54156MR	Laminate	156	54	1 3/16	334	16.0	F, G, X, Y / P\$	3147		
				1 3/16			K / P\$	5923		
				1 1/2			H / P\$	3603		
	Veneer			1 3/16			F, G, X, Y / W\$	5209		
				1 3/16			K / W\$	7802		
				1 1/2			H / W\$	5915		
	Glass			1/4			Acid Etched Glass Top \$	19856		
				1/4			Gloss Glass Top \$	16619		

Must Specify (in this order):  
 Model #  
 Top/Edge Material  
 Top/Edge Finish/Color  
 Edge Profile  
 Glass (Y/N)  
 Glass Color + Surface Finish  
 Power/Data  
 Power/Data Location

*Additional 54" Modern Rectangle Shaped Tops on Next Page*



Double Kerf (F) 1 3/16"    Duo (G) 1 3/16"    Fluted (X) 1 3/16"    Square (Y) 1 3/16"    Knife (K) 1 3/16"    Vertical Square (H) 1 1/2"

P = HPL    W = Veneer

[See Catalyst Overview For Ordering Options](#)

Item	Model No.		W	D	H	Ship Wt	Cubic Ft	Edge Profile + Material	List Price	
<b>54"D x 144"W or 12' - 3 Piece Veneer (W) and 2 Piece HPL (P) Modern Rectangle Top</b>										
CONTINUED FROM PREVIOUS PAGE	88-54144MR	Laminate	144	54	1 3/16	309	15.0	F, G, X, Y / P\$	2675	
					1 3/16			K / P\$	5261	
					1 1/2			H / P\$	3097	
		Veneer			1 3/16			F, G, X, Y / W\$	4300	
					1 3/16			K / W\$	6645	
					1 1/2			H / W\$	6645	
		Glass			1/4			Acid Etched Glass Top \$	18228	
					1/4			Gloss Glass Top \$	15240	
	<b>54"D x 132"W or 11' - 3 Piece Veneer (W) and 2 Piece HPL (P) Modern Rectangle Top</b>									
	Must Specify (in this order): Model # Top/Edge Material Top/Edge Finish/Color Edge Profile Glass (Y/N) Glass Color + Surface Finish Power/Data Power/Data Location	88-54132MR	Laminate	132	54	1 3/16	285	13.2	F, G, X, Y / P\$	2614
					1 3/16			K / P\$	5021	
					1 1/2			H / P\$	3000	
		Veneer			1 3/16			F, G, X, Y / W\$	4090	
					1 3/16			K / W\$	6285	
					1 1/2			H / W\$	4624	
		Glass			1/4			Acid Etched Glass Top \$	16918	
					1/4			Gloss Glass Top \$	14180	
<b>54"D x 120"W or 10' - 3 Piece Veneer (W) and 2 Piece HPL (P) Modern Rectangle Top</b>										
		88-54120MR	Laminate	120	54	1 3/16	260	12.1	F, G, X, Y / P\$	2553
					1 3/16			K / P\$	4780	
					1 1/2			H / P\$	2904	
		Veneer			1 3/16			F, G, X, Y / W\$	3880	
					1 3/16			K / W\$	5927	
					1 1/2			H / W\$	4370	
		Glass			1/4			Acid Etched Glass Top \$	15612	
					1/4			Gloss Glass Top \$	13122	

**Description**

- Tops Available with Veneer (W) or HPL (P) Top in 1 3/16" and 1 1/2" Thicknesses
- Must Specify Edge Profile: 1 3/16" Thick/Double Kerf (F), Duo (G), Fluted (X), Square (Y), and Knife (K) Edge Profiles or 1 1/2" Thick/Vertical Square (H)
- Veneer (W) Top Grain Runs Depth of Top and HPL (P) Top Grain Runs Width of Top
- All Veneer Tops, as well as Laminate Tops up to 144" (12 feet), have Matching Woodgrain. Laminate Tops Sized 156" (13 feet) and Longer have Non-Matching Woodgrain
- Available with Back Painted Tempered Glass Top; Must Specify Color and Finish; [See Options](#)
- Power and Data Options Available; Sold Separately, [See Multiple Power Unit Details](#)
- Bases Sold Separately, See [Multiple Base Options](#)



Double Kerf (F)  
1 3/16"



Duo (G)  
1 3/16"



Fluted (X)  
1 3/16"



Square (Y)  
1 3/16"



Knife (K)  
1 3/16"



Vertical Square (H)  
1 1/2"

P = HPL W = Veneer

[See Catalyst Overview For Ordering Options](#)

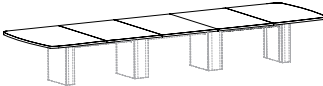
Item	Model No.		W	D	H	Ship Wt	Cubic Ft	Edge Profile + Material	List Price	
<b>MODERN RECTANGLE SHAPE MEETING TOP 60"D</b>    88-60204MR shown in Veneer with 88-24166C6I06RAB (6" + 10" Combo Rectangle Accent Base) BASES SOLD SEPARATELY	<b>60"D x 240"W or 20' - 5 Piece Veneer (W) and 3 Piece HPL (P) Modern Rectangle Top</b>									
	88-60240MR	Laminate	240	60	1 3/16"	574	26.3	F, G, X, Y / P\$	4779	
					1 3/16"			K / P\$	9084	
					1 1/2"			H / P\$	5559	
		Veneer			1 3/16"			F, G, X, Y / W\$	8359	
					1 3/16"			K / W\$	12204	
					1 1/2"			H / W\$	9534	
		Glass			1/4"			Acid Etched Glass Top \$	32356	
					1/4"			Gloss Glass Top \$	26823	
	<b>60"D x 228"W or 19' - 5 Piece Veneer (W) and 3 Piece HPL (P) Modern Rectangle Top</b>									
	88-60228MR	Laminate	228	60	1 3/16"	547	25.0	F, G, X, Y / P\$	4727	
					1 3/16"			K / P\$	8844	
					1 1/2"			H / P\$	5468	
		Veneer			1 3/16"			F, G, X, Y / W\$	8092	
					1 3/16"			K / W\$	11776	
				1 1/2"			H / W\$	9210		
	Glass			1/4"			Acid Etched Glass Top \$	30928		
				1/4"			Gloss Glass Top \$	25671		
<b>60"D x 216"W or 18' - 5 Piece Veneer (W) and 3 Piece HPL (P) Modern Rectangle Top</b>										
88-60216MR	Laminate	216	60	1 3/16"	519	23.7	F, G, X, Y / P\$	4127		
				1 3/16"			K / P\$	8042		
				1 1/2"			H / P\$	4829		
	Veneer			1 3/16"			F, G, X, Y / W\$	7825		
				1 3/16"			K / W\$	11350		
				1 1/2"			H / W\$	8888		
	Glass			1/4"			Acid Etched Glass Top \$	29463		
				1/4"			Gloss Glass Top \$	24483		
<b>60"D x 204"W or 17' - 5 Piece Veneer (W) and 3 Piece HPL (P) Modern Rectangle Top</b>										
88-60204MR	Laminate	204	60	1 3/16"	492	22.4	F, G, X, Y / P\$	4075		
				1 3/16"			K / P\$	7802		
				1 1/2"			H / P\$	4738		
	Veneer			1 3/16"			F, G, X, Y / W\$	7558		
				1 3/16"			K / W\$	10922		
				1 1/2"			H / W\$	8564		
	Glass			1/4"			Acid Etched Glass Top \$	28035		
				1/4"			Gloss Glass Top \$	23332		

Must Specify (in this order):  
 Model #  
 Top/Edge Material  
 Top/Edge Finish/Color  
 Edge Profile  
 Glass (Y/N)  
 Glass Color + Surface Finish  
 Power/Data Type  
 Power/Data Location

*Additional 60" Modern Rectangle Shaped Tops on Next Page*



Double Kerf (F) 1 3/16" Duo (G) 1 3/16" Fluted (X) 1 3/16" Square (Y) 1 3/16" Knife (K) 1 3/16" Vertical Square (H) 1 1/2"

P = HPL W = Veneer

[See Catalyst Overview For Ordering Options](#)

Item	Model No.		W	D	H	Ship Wt	Cubic Ft	Edge Profile + Material	List Price		
<b>60"D x 192"W or 16' - 4 Piece Veneer (W) and 2 Piece HPL (P) Modern Rectangle Top</b>											
<i>CONTINUED FROM PREVIOUS PAGE</i>	88-60192MR	Laminate	192	60	1 3/16	458	21.1	F, G, X, Y / P\$	3364		
					1 3/16			K / P\$	6866		
					1 1/2			H / P\$	3989		
	Veneer								F, G, X, Y / W\$	6252	
									1 3/16	K / W\$	9435
									1 1/2	H / W\$	7199
	Glass								Acid Etched Glass Top \$	25909	
										Gloss Glass Top \$	21482
	<b>60"D x 180"W or 15' - 4 Piece Veneer (W) and 2 Piece HPL (P) Modern Rectangle Top</b>										
	<i>Must Specify (in this order):</i> Model # Top/Edge Material Top/Edge Finish/Color Edge Profile Glass (Y/N) Glass Color + Surface Finish Power/Data Power/Data Location	88-60180MR	Laminate	180	60	1 3/16	431	19.8	F, G, X, Y / P\$	3311	
						1 3/16			K / P\$	6625	
						1 1/2			H / P\$	3898	
Veneer									F, G, X, Y / W\$	6007	
									1 3/16	K / W\$	9030
									1 1/2	H / W\$	6898
Glass									Acid Etched Glass Top \$	24481	
										Gloss Glass Top \$	20332
<b>60"D x 168"W or 14' - 4 Piece Veneer (W) and 2 Piece HPL (P) Modern Rectangle Top</b>											
		88-60168MR	Laminate	168	60	1 3/16	403	18.5	F, G, X, Y / P\$	3259	
						1 3/16			K / P\$	6385	
						1 1/2			H / P\$	3806	
	Veneer								F, G, X, Y / W\$	5762	
									1 3/16	K / W\$	8625
									1 1/2	H / W\$	6596
	Glass								Acid Etched Glass Top \$	23053	
										Gloss Glass Top \$	19180
	<b>60"D x 156"W or 13' - 4 Piece Veneer (W) and 2 Piece HPL (P) Modern Rectangle Top</b>										
		88-60156MR	Laminate	156	60	1 3/16	376	17.2	F, G, X, Y / P\$	3206	
						1 3/16			K / P\$	6145	
						1 1/2			H / P\$	3715	
Veneer									F, G, X, Y / W\$	5518	
									1 3/16	K / W\$	8220
									1 1/2	H / W\$	6295
Glass									Acid Etched Glass Top \$	21624	
										Gloss Glass Top \$	18028

*Additional 60" Modern Rectangle Shaped Tops on Next Page*



Double Kerf (F)  
1 3/16"



Duo (G)  
1 3/16"



Fluted (X)  
1 3/16"



Square (Y)  
1 3/16"



Knife (K)  
1 3/16"



Vertical Square (H)  
1 1/2"

P = HPL W = Veneer

[See Catalyst Overview For Ordering Options](#)

Item	Model No.		W	D	H	Ship Wt	Cubic Ft	Edge Profile + Material	List Price		
<i>CONTINUED FROM PREVIOUS PAGE</i>	<b>60"D x 144"W or 12' - 3 Piece Veneer (W) and 2 Piece HPL (P) Modern Rectangle Top</b>										
	88-60144MR	Laminate	144	60	1 3/16	342	16.0	F, G, X, Y / P\$	2731		
					1 3/16			K / P\$	5470		
					1 1/2			H / P\$	3200		
		Veneer			1 3/16			F, G, X, Y / W\$	4568		
					1 3/16			K / W\$	7008		
					1 1/2			H / W\$	5205		
		Glass			1/4			Acid Etched Glass Top \$	19864		
					1/4			Gloss Glass Top \$	16543		
		<b>60"D x 132"W or 11' - 3 Piece Veneer (W) and 2 Piece HPL (P) Modern Rectangle Top</b>									
	88-60132MR	Laminate	132	60	1 3/16	323	14.6	F, G, X, Y / P\$	2666		
					1 3/16			K / P\$	5216		
					1 1/2			H / P\$	3096		
		Veneer			1 3/16			F, G, X, Y / W\$	4336		
					1 3/16			K / W\$	6621		
				1 1/2			H / W\$	4922			
	Glass			1/4			Acid Etched Glass Top \$	18421			
				1/4			Gloss Glass Top \$	15378			
	<b>60"D x 120"W or 10' - 3 Piece Veneer (W) and 2 Piece HPL (P) Modern Rectangle Top</b>										
88-60120MR	Laminate	120	60	1 3/16	287	13.3	F, G, X, Y / P\$	2601			
				1 3/16			K / P\$	4964			
				1 1/2			H / P\$	2991			
	Veneer			1 3/16			F, G, X, Y / W\$	4104			
				1 3/16			K / W\$	6237			
				1 1/2			H / W\$	4641			
	Glass			1/4			Acid Etched Glass Top \$	16980			
				1/4			Gloss Glass Top \$	14214			

Must Specify (in this order):  
 Model #  
 Top/Edge Material  
 Top/Edge Finish/Color  
 Edge Profile  
 Glass (Y/N)  
 Glass Color + Surface Finish  
 Power/Data Type  
 Power/Data Location

**Description**

- Tops Available with Veneer (W) or HPL (P) Top in 1 3/16" and 1 1/2" Thicknesses
- Must Specify Edge Profile: 1 3/16" Thick/Double Kerf (F), Duo (G), Fluted (X), Square (Y), and Knife (K) Edge Profiles or 1 1/2" Thick/Vertical Square (H)
- Veneer (W) Top Grain Runs Depth of Top and HPL (P) Top Grain Runs Width of Top
- All Veneer Tops, as well as Laminate Tops up to 144" (12 feet), have Matching Woodgrain. Laminate Tops Sized 156" (13 feet) and Longer have Non-Matching Woodgrain
- Available with Back Painted Tempered Glass Top; Must Specify Color and Finish; [See Options](#)
- Power and Data Options Available; Sold Separately, [See Multiple Power Unit Details](#)
- Bases Sold Separately, See [Multiple Base Options](#)



Double Kerf (F)  
1 3/16"



Duo (G)  
1 3/16"



Fluted (X)  
1 3/16"



Square (Y)  
1 3/16"



Knife (K)  
1 3/16"



Vertical Square (H)  
1 1/2"

P = HPL W = Veneer

[See Catalyst Overview For Ordering Options](#)

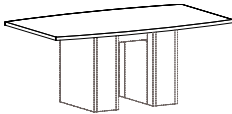
Item	Model No.		W	D	H	Ship Wt	Cubic Ft	Edge Profile + Material	List Price	
<b>BOAT SHAPE MEETING TOP</b> <b>36"D</b>  88-3696BT shown with 88-203406RAB (6" Rectangle Accent Base) BASES SOLD SEPARATELY	<b>36"D x 96"W or 8' - 1 Piece Boat Top</b>									
	88-3696BT	Laminate	96	36-30	1 3/16	142	12.9	F, G, X, Y / P\$	1424	
					1 3/16			K / P\$	2821	
					1 1/2			H / P\$	1606	
		Veneer			1 3/16			F, G, X, Y / W\$	1613	
					1 3/16			K / W\$	3163	
					1 1/2			H / W\$	1921	
		Glass			1/4			Acid Etched Glass Top \$	8724	
					1/4			Gloss Glass Top \$	7396	
	<b>36"D x 84"W or 7' - 1 Piece Boat Top</b>									
		88-3684BT	Laminate	84	36-30	1 3/16	126	11.3	F, G, X, Y / P\$	1357
					1 3/16			K / P\$	2583	
				1 1/2			H / P\$	1547		
		Veneer			1 3/16			F, G, X, Y / W\$	1529	
				1 3/16			K / W\$	2958		
				1 1/2			H / W\$	1768		
		Glass			1/4			Acid Etched Glass Top \$	7821	
				1/4			Gloss Glass Top \$	6659		
<b>36"D x 72"W or 6' - 1 Piece Boat Top</b>										
	88-3672BT	Laminate	72	36-30	1 3/16	109	10.3	F, G, X, Y / P\$	1108	
				1 3/16				K / P\$	2236	
				1 1/2				H / P\$	1245	
		Veneer			1 3/16			F, G, X, Y / W\$	1302	
				1 3/16				K / W\$	2518	
				1 1/2				H / W\$	1537	
		Glass			1/4			Acid Etched Glass Top \$	6829	
				1/4				Gloss Glass Top \$	5832	

Must Specify (in this order):

- Model #
- Top/Edge Material
- Top/Edge Finish/Color
- Edge Profile
- Glass (Y/N)
- Glass Color + Surface Finish
- Power/Data
- Power/Data Location

**Description**

- Tops Available with Veneer (W) or HPL (P) Top in 1 3/16" and 1 1/2" Thicknesses
- Must Specify Edge Profile: 1 3/16" Thick/Double Kerf (F), Duo (G), Fluted (X), Square (Y), and Knife (K) Edge Profiles or 1 1/2" Thick/Vertical Square (H)
- Veneer (W) Top Grain Runs Depth of Top and HPL (P) Top Grain Runs Width of Top
- Available with Back Painted Tempered Glass Top; Must Specify Color and Finish; [See Options](#)
- Power and Data Options Available; Sold Separately, [See Multiple Power Unit Details](#)
- Bases Sold Separately, See [Multiple Base Options](#)



Double Kerf (F)  
1 3/16"



Duo (G)  
1 3/16"



Fluted (X)  
1 3/16"



Square (Y)  
1 3/16"



Knife (K)  
1 3/16"



Vertical Square (H)  
1 1/2"

P = HPL W = Veneer

[See Catalyst Overview For Ordering Options](#)

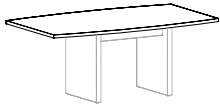
Item	Model No.		W	D	H	Ship Wt	Cubic Ft	Edge Profile + Material	List Price	
<b>BOAT SHAPE MEETING TOP</b> <b>42"D</b>  88-4272BT shown with 88-2034RPB (Rectangle Panel Base) BASES SOLD SEPARATELY	<b>42"D x 120"W or 10' - 2 Piece Boat Top</b>									
	88-42120BT	Laminate	120	42-36	1 3/16	268	27.0	F, G, X, Y / P\$	2008	
					1 3/16			K / P\$	3846	
					1 1/2			H / P\$	2278	
		Veneer			1 3/16			F, G, X, Y / W\$	2330	
					1 3/16			K / W\$	4333	
					1 1/2			H / W\$	2769	
		Glass			1/4			Acid Etched Glass Top \$	12215	
					1/4			Gloss Glass Top \$	10279	
	<b>42"D x 108"W or 9' - 2 Piece Boat Top</b>									
	88-42108BT	Laminate	108	42-36	1 3/16	260	27.0	F, G, X, Y / P\$	1970	
					1 3/16			K / P\$	3630	
					1 1/2			H / P\$	2213	
		Veneer			1 3/16			F, G, X, Y / W\$	2192	
					1 3/16			K / W\$	4063	
				1 1/2			H / W\$	2590		
	Glass			1/4			Acid Etched Glass Top \$	11182		
				1/4			Gloss Glass Top \$	9439		
<b>42"D x 96"W or 8' - 1 Piece Boat Top</b>										
88-4296BT	Laminate	96	42-36	1 3/16	164	15.0	F, G, X, Y / P\$	1453		
				1 3/16			K / P\$	2984		
				1 1/2			H / P\$	1667		
	Veneer			1 3/16			F, G, X, Y / W\$	1752		
				1 3/16			K / W\$	3361		
				1 1/2			H / W\$	2104		
	Glass			1/4			Acid Etched Glass Top \$	9818		
				1/4			Gloss Glass Top \$	8269		
<b>42"D x 84"W or 7' - 1 Piece Boat Top</b>										
88-4284BT	Laminate	84	42-36	1 3/16	145	13.1	F, G, X, Y / P\$	1414		
				1 3/16			K / P\$	2769		
				1 1/2			H / P\$	1600		
	Veneer			1 3/16			F, G, X, Y / W\$	1618		
				1 3/16			K / W\$	3102		
				1 1/2			H / W\$	1928		
	Glass			1/4			Acid Etched Glass Top \$	8786		
				1/4			Gloss Glass Top \$	7430		

Must Specify (in this order):  
 Model #  
 Top/Edge Material  
 Top/Edge Finish/Color  
 Edge Profile  
 Glass (Y/N)  
 Glass Color + Surface Finish  
 Power/Data  
 Power/Data Location

*Additional 42" Boat Shaped Tops on Next Page*



Double Kerf (F) 1 3/16"    Duo (G) 1 3/16"    Fluted (X) 1 3/16"    Square (Y) 1 3/16"    Knife (K) 1 3/16"    Vertical Square (H) 1 1/2"

P = HPL    W = Veneer

[See Catalyst Overview For Ordering Options](#)



Item	Model No.		W	D	H	Ship Wt	Cubic Ft	Edge Profile + Material	List Price	
<i>CONTINUED FROM PREVIOUS PAGE</i>	<b>42"D x 72"W or 6' - 1 Piece Boat Top</b>									
	88-4272BT	Laminate	72	42-36	1 3/16	164	15.0	F, G, X, Y / P\$	1182	
					1 3/16			K / P\$	2467	
					1 1/2			H / P\$	1341	
		Veneer			1 3/16			F, G, X, Y / W\$	1473	
					1 3/16			K / W\$	2710	
					1 1/2			H / W\$	1741	
		Glass			1/4			Acid Etched Glass Top \$	7725	
					1/4			Gloss Glass Top \$	6563	

Must Specify (in this order):

- Model #
- Top/Edge Material
- Top/Edge Finish/Color
- Edge Profile
- Glass (Y/N)
- Glass Color + Surface Finish
- Power/Data
- Power/Data Location

**Description**

- Tops Available with Veneer (W) or HPL (P) Top in 1 3/16" and 1 1/2" Thicknesses
- Must Specify Edge Profile: 1 3/16" Thick/Double Kerf (F), Duo (G), Fluted (X), Square (Y), and Knife (K) Edge Profiles or 1 1/2" Thick/Vertical Square (H)
- Veneer (W) Top Grain Runs Depth of Top and HPL (P) Top Grain Runs Width of Top
- Available with Back Painted Tempered Glass Top; Must Specify Color and Finish; [See Options](#)
- Power and Data Options Available; Sold Separately, [See Multiple Power Unit Details](#)
- Bases Sold Separately, See [Multiple Base Options](#)



Double Kerf (F)  
1 3/16"



Duo (G)  
1 3/16"



Fluted (X)  
1 3/16"



Square (Y)  
1 3/16"



Knife (K)  
1 3/16"



Vertical Square (H)  
1 1/2"

P = HPL W = Veneer

[See Catalyst Overview For Ordering Options](#)

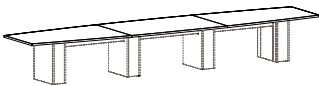
Item	Model No.		W	D	H	Ship Wt	Cubic Ft	Edge Profile + Material	List Price	
<b>BOAT SHAPE MEETING TOP</b> <b>48"D</b>  88-48216BT shown with 88-2417810RAB (10" Rectangle Accent Base) BASES SOLD SEPARATELY	<b>48"D x 240"W or 20' - 3 Piece Boat Top</b>									
	88-48240BT	Laminate	240	48-36	1 3/16	460	48.9	F, G, X, Y / P\$	4638	
					1 3/16			K / P\$	8499	
					1 1/2			H / P\$	5257	
		Veneer			1 3/16			F, G, X, Y / W\$	6301	
					1 3/16			K / W\$	9571	
					1 1/2			H / W\$	7153	
		Glass			1/4			Acid Etched Glass Top \$	26634	
					1/4			Gloss Glass Top \$	22207	
	<b>48"D x 228"W or 19' - 3 Piece Boat Top</b>									
	88-48228BT	Laminate	228	48-36	1 3/16	438	48.9	F, G, X, Y / P\$	4594	
					1 3/16			K / P\$	8284	
					1 1/2			H / P\$	5182	
		Veneer			1 3/16			F, G, X, Y / W\$	6037	
					1 3/16			K / W\$	9216	
				1 1/2			H / W\$	6849		
	Glass			1/4			Acid Etched Glass Top \$	25468		
				1/4			Gloss Glass Top \$	21263		
<b>48"D x 216"W or 18' - 3 Piece Boat Top</b>										
88-48216BT	Laminate	216	48-36	1 3/16	416	48.9	F, G, X, Y / P\$	3687		
				1 3/16			K / P\$	7182		
				1 1/2			H / P\$	4244		
	Veneer			1 3/16			F, G, X, Y / W\$	5369		
				1 3/16			K / W\$	8456		
				1 1/2			H / W\$	6139		
	Glass			1/4			Acid Etched Glass Top \$	23917		
				1/4			Gloss Glass Top \$	19933		
<b>48"D x 204"W or 17' - 3 Piece Boat Top</b>										
88-48204BT	Laminate	204	48-36	1 3/16	394	48.9	F, G, X, Y / P\$	3643		
				1 3/16			K / P\$	6968		
				1 1/2			H / P\$	4169		
	Veneer			1 3/16			F, G, X, Y / W\$	5106		
				1 3/16			K / W\$	8101		
				1 1/2			H / W\$	5834		
	Glass			1/4			Acid Etched Glass Top \$	22751		
				1/4			Gloss Glass Top \$	18988		

Must Specify (in this order):  
 Model #  
 Top/Edge Material  
 Top/Edge Finish/Color  
 Edge Profile  
 Glass (Y/N)  
 Glass Color + Surface Finish  
 Power/Data  
 Power/Data Location

*Additional 48" Boat Shaped Tops on Next Page*



Double Kerf (F) 1 3/16"    Duo (G) 1 3/16"    Fluted (X) 1 3/16"    Square (Y) 1 3/16"    Knife (K) 1 3/16"    Vertical Square (H) 1 1/2"

P = HPL    W = Veneer

[See Catalyst Overview For Ordering Options](#)

Item	Model No.		W	D	H	Ship Wt	Cubic Ft	Edge Profile + Material	List Price		
<i>CONTINUED FROM PREVIOUS PAGE</i>	<b>48"D x 192"W or 16' - 2 Piece Boat Top</b>										
	88-48192BT	Laminate	192	48-36	1 3/16	372	31.2	F, G, X, Y / P\$	3125		
					1 3/16			K / P\$	6249		
					1 1/2			H / P\$	3621		
		Veneer			1 3/16			F, G, X, Y / W\$	4215		
					1 3/16			K / W\$	6996		
					1 1/2			H / W\$	4991		
		Glass			1/4			Acid Etched Glass Top \$	21073		
					1/4			Gloss Glass Top \$	17531		
		<b>48"D x 180"W or 15' - 2 Piece Boat Top</b>									
	88-48180BT	Laminate	180	48-36	1 3/16	350	31.2	F, G, X, Y / P\$	3080		
					1 3/16			K / P\$	6034		
					1 1/2			H / P\$	3547		
		Veneer			1 3/16			F, G, X, Y / W\$	4045		
					1 3/16			K / W\$	6679		
					1 1/2			H / W\$	4773		
		Glass			1/4			Acid Etched Glass Top \$	19906		
					1/4			Gloss Glass Top \$	16586		
	<b>48"D x 168"W or 14' - 2 Piece Boat Top</b>										
88-48168BT	Laminate	168	48-36	1 3/16	328	31.2	F, G, X, Y / P\$	2928			
				1 3/16			K / P\$	5708			
				1 1/2			H / P\$	3363			
	Veneer			1 3/16			F, G, X, Y / W\$	3736			
				1 3/16			K / W\$	6223			
				1 1/2			H / W\$	4418			
	Glass			1/4			Acid Etched Glass Top \$	18629			
				1/4			Gloss Glass Top \$	15530			
	<b>48"D x 156"W or 13' - 2 Piece Boat Top</b>										
88-48156BT	Laminate	156	48-36	1 3/16	306	31.2	F, G, X, Y / P\$	2885			
				1 3/16			K / P\$	5363			
				1 1/2			H / P\$	3288			
	Veneer			1 3/16			F, G, X, Y / W\$	3567			
				1 3/16			K / W\$	6039			
				1 1/2			H / W\$	4202			
	Glass			1/4			Acid Etched Glass Top \$	17463			
				1/4			Gloss Glass Top \$	14585			

Must Specify (in this order):

- Model #
- Top/Edge Material
- Top/Edge Finish/Color
- Edge Profile
- Glass (Y/N)
- Glass Color + Surface Finish
- Power/Data
- Power/Data Location

*Additional 48" Boat Shaped Tops on Next Page*



Double Kerf (F)  
1 3/16"



Duo (G)  
1 3/16"



Fluted (X)  
1 3/16"



Square (Y)  
1 3/16"



Knife (K)  
1 3/16"



Vertical Square (H)  
1 1/2"

P = HPL W = Veneer

[See Catalyst Overview For Ordering Options](#)

Item	Model No.		W	D	H	Ship Wt	Cubic Ft	Edge Profile + Material	List Price		
<i>CONTINUED FROM PREVIOUS PAGE</i>	<b>48"D x 144"W or 12' - 2 Piece Boat Top</b>										
	88-48144BT	Laminate	144	48-36	1 3/16	284	23.5	F, G, X, Y / P\$	2421		
					1 3/16			K / P\$	4847		
					1 1/2			H / P\$	2793		
		Veneer			1 3/16			F, G, X, Y / W\$	3328		
					1 3/16			K / W\$	5521		
					1 1/2			H / W\$	3915		
		Glass			1/4			Acid Etched Glass Top \$	16201		
					1/4			Gloss Glass Top \$	13544		
		<b>48"D x 132"W or 11' - 2 Piece Boat Top</b>									
	88-48132BT	Laminate	132	48-36	1 3/16	262	23.5	F, G, X, Y / P\$	2365		
					1 3/16			K / P\$	4619		
					1 1/2			H / P\$	2705		
		Veneer			1 3/16			F, G, X, Y / W\$	3105		
					1 3/16			K / W\$	5178		
					1 1/2			H / W\$	3645		
		Glass			1/4			Acid Etched Glass Top \$	15022		
					1/4			Gloss Glass Top \$	12588		
	<b>48"D x 120"W or 10' - 2 Piece Boat Top</b>										
88-48120BT	Laminate	120	48-36	1 3/16	240	23.5	F, G, X, Y / P\$	2299			
				1 3/16			K / P\$	4383			
				1 1/2			H / P\$	2609			
	Veneer			1 3/16			F, G, X, Y / W\$	2870			
				1 3/16			K / W\$	4823			
				1 1/2			H / W\$	3364			
	Glass			1/4			Acid Etched Glass Top \$	13835			
				1/4			Gloss Glass Top \$	11622			
	<b>48"D x 108"W or 9' - 2 Piece Boat Top</b>										
88-48108BT	Laminate	108	48-36	1 3/16	218	23.5	F, G, X, Y / P\$	2243			
				1 3/16			K / P\$	4063			
				1 1/2			H / P\$	2522			
	Veneer			1 3/16			F, G, X, Y / W\$	2648			
				1 3/16			K / W\$	4575			
				1 1/2			H / W\$	3095			
	Glass			1/4			Acid Etched Glass Top \$	12657			
				1/4			Gloss Glass Top \$	10665			

Must Specify (in this order):  
 Model #  
 Top/Edge Material  
 Top/Edge Finish/Color  
 Edge Profile  
 Glass (Y/N)  
 Glass Color + Surface Finish  
 Power/Data  
 Power/Data Location

*Additional 48" Boat Shaped Tops on Next Page*



Double Kerf (F) 1 3/16"    Duo (G) 1 3/16"    Fluted (X) 1 3/16"    Square (Y) 1 3/16"    Knife (K) 1 3/16"    Vertical Square (H) 1 1/2"

P = HPL    W = Veneer

[See Catalyst Overview For Ordering Options](#)

Item	Model No.		W	D	H	Ship Wt	Cubic Ft	Edge Profile + Material	List Price	
<b>48"D x 96"W or 8' - 1 Piece Boat Top</b>										
<i>CONTINUED FROM PREVIOUS PAGE</i>	88-4896BT	Laminate	96	48-36	1 <sup>3</sup> / <sub>16</sub>	295	27.0	F, G, X, Y / P\$	1529	
					1 <sup>3</sup> / <sub>16</sub>			K / P\$	3258	
					1 <sup>1</sup> / <sub>2</sub>			H / P\$	1774	
	Veneer	1 <sup>3</sup> / <sub>16</sub>	F, G, X, Y / W\$	1951						
		1 <sup>3</sup> / <sub>16</sub>	K / W\$	3558						
		1 <sup>1</sup> / <sub>2</sub>	H / W\$	2347						
	Glass		1 <sup>4</sup> / <sub>4</sub>	Acid Etched Glass Top \$	10965					
			1 <sup>4</sup> / <sub>4</sub>	Gloss Glass Top \$	9194					
	<b>48"D x 84"W or 7' - 1 Piece Boat Top</b>									
	Must Specify (in this order): Model # Top/Edge Material Top/Edge Finish/Color Edge Profile Glass (Y/N) Glass Color + Surface Finish Power/Data Power/Data Location	88-4884BT	Laminate	84	48-36	1 <sup>3</sup> / <sub>16</sub>	164	15.0	F, G, X, Y / P\$	1484
1 <sup>3</sup> / <sub>16</sub>						K / P\$			2899	
1 <sup>1</sup> / <sub>2</sub>						H / P\$			1698	
Veneer		1 <sup>3</sup> / <sub>16</sub>	F, G, X, Y / W\$	1724						
		1 <sup>3</sup> / <sub>16</sub>	K / W\$	3266						
		1 <sup>1</sup> / <sub>2</sub>	H / W\$	2074						
Glass			1 <sup>4</sup> / <sub>4</sub>	Acid Etched Glass Top \$	9732					
			1 <sup>4</sup> / <sub>4</sub>	Gloss Glass Top \$	8184					
<b>48"D x 72"W or 6' - 1 Piece Boat Top</b>										
		88-4872BT	Laminate	72	48-36	1 <sup>3</sup> / <sub>16</sub>	142	12.8	F, G, X, Y / P\$	1249
	1 <sup>3</sup> / <sub>16</sub>					K / P\$			2637	
	1 <sup>1</sup> / <sub>2</sub>					H / P\$			1432	
	Veneer	1 <sup>3</sup> / <sub>16</sub>	F, G, X, Y / W\$	1633						
		1 <sup>3</sup> / <sub>16</sub>	K / W\$	2948						
		1 <sup>1</sup> / <sub>2</sub>	H / W\$	1935						
	Glass		1 <sup>4</sup> / <sub>4</sub>	Acid Etched Glass Top \$	8608					
			1 <sup>4</sup> / <sub>4</sub>	Gloss Glass Top \$	7280					

**Description**

- Tops Available with Veneer (W) or HPL (P) Top in 1<sup>3</sup>/<sub>16</sub>" and 1<sup>1</sup>/<sub>2</sub>" Thicknesses
- Must Specify Edge Profile: 1<sup>3</sup>/<sub>16</sub>" Thick/Double Kerf (F), Duo (G), Fluted (X), Square (Y), and Knife (K) Edge Profiles or 1<sup>1</sup>/<sub>2</sub>" Thick/Vertical Square (H)
- Veneer (W) Top Grain Runs Depth of Top and HPL (P) Top Grain Runs Width of Top
- All Veneer Tops, as well as Laminate Tops up to 144" (12 feet), have Matching Woodgrain. Laminate Tops Sized 156" (13 feet) and Longer have Non-Matching Woodgrain
- Available with Back Painted Tempered Glass Top; Must Specify Color and Finish; [See Options](#)
- Power and Data Options Available; Sold Separately, [See Multiple Power Unit Details](#)
- Bases Sold Separately, See [Multiple Base Options](#)



Double Kerf (F)  
1<sup>3</sup>/<sub>16</sub>"



Duo (G)  
1<sup>3</sup>/<sub>16</sub>"



Fluted (X)  
1<sup>3</sup>/<sub>16</sub>"



Square (Y)  
1<sup>3</sup>/<sub>16</sub>"



Knife (K)  
1<sup>3</sup>/<sub>16</sub>"



Vertical Square (H)  
1<sup>1</sup>/<sub>2</sub>"

P = HPL W = Veneer

[See Catalyst Overview For Ordering Options](#)

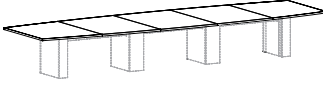
Item	Model No.		W	D	H	Ship Wt	Cubic Ft	Edge Profile + Material	List Price	
<b>BOAT SHAPE MEETING TOP</b> <b>54"D</b>  88-54204BT shown in Veneer with 88-241661ORB (10" Rectangle Base) BASES SOLD SEPARATELY	<b>54"D x 240"W or 20' - 5 Piece Veneer (W) and 3 Piece HPL (P) Boat Top</b>									
	88-54240BT	Laminate	240	54-42	1 3/16"	519	24.0	F, G, X, Y / P\$	4690	
					1 3/16"			K / P\$	8773	
					1 1/2"			H / P\$	5389	
		Veneer			1 3/16"			F, G, X, Y / W\$	7844	
					1 3/16"			K / W\$	11557	
					1 1/2"			H / W\$	8912	
		Glass			1/4"			Acid Etched Glass Top \$	29666	
					1/4"			Gloss Glass Top \$	24687	
	<b>54"D x 228"W or 19' - 5 Piece Veneer (W) and 3 Piece HPL (P) Boat Top</b>									
	88-54228BT	Laminate	228	54-42	1 3/16"	495	23.0	F, G, X, Y / P\$	4642	
					1 3/16"			K / P\$	8545	
					1 1/2"			H / P\$	5306	
		Veneer			1 3/16"			F, G, X, Y / W\$	7602	
					1 3/16"			K / W\$	11159	
				1 1/2"			H / W\$	8619		
	Glass			1/4"			Acid Etched Glass Top \$	28369		
				1/4"			Gloss Glass Top \$	23639		
<b>54"D x 216"W or 18' - 5 Piece Veneer (W) and 3 Piece HPL (P) Boat Top</b>										
88-54216BT	Laminate	216	54-42	1 3/16"	470	22.0	F, G, X, Y / P\$	4047		
				1 3/16"			K / P\$	7755		
				1 1/2"			H / P\$	4676		
	Veneer			1 3/16"			F, G, X, Y / W\$	7361		
				1 3/16"			K / W\$	10761		
				1 1/2"			H / W\$	8327		
	Glass			1/4"			Acid Etched Glass Top \$	27037		
				1/4"			Gloss Glass Top \$	22556		
<b>54"D x 204"W or 17' - 5 Piece Veneer (W) and 3 Piece HPL (P) Boat Top</b>										
88-54204BT	Laminate	204	54-42	1 3/16"	445	21.0	F, G, X, Y / P\$	3999		
				1 3/16"			K / P\$	7528		
				1 1/2"			H / P\$	4593		
	Veneer			1 3/16"			F, G, X, Y / W\$	7119		
				1 3/16"			K / W\$	10364		
				1 1/2"			H / W\$	8034		
	Glass			1/4"			Acid Etched Glass Top \$	25741		
				1/4"			Gloss Glass Top \$	21509		

Must Specify (in this order):

- Model #
- Top/Edge Material
- Top/Edge Finish/Color
- Edge Profile
- Glass (Y/N)
- Glass Color + Surface Finish
- Power/Data
- Power/Data Location

*Additional 54" Boat Shaped Tops on Next Page*



Double Kerf (F) 1 3/16"   Duo (G) 1 3/16"   Fluted (X) 1 3/16"   Square (Y) 1 3/16"   Knife (K) 1 3/16"   Vertical Square (H) 1 1/2"

P = HPL   W = Veneer

[See Catalyst Overview For Ordering Options](#)

Item	Model No.		W	D	H	Ship Wt	Cubic Ft	Edge Profile + Material	List Price	
<b>54"D x 192"W or 16' - 4 Piece Veneer (W) and 2 Piece HPL (P) Boat Top</b>										
<i>CONTINUED FROM PREVIOUS PAGE</i>	88-54192BT	Laminate	192	54-42	1 <sup>3</sup> / <sub>16</sub>	408	19.0	F, G, X, Y / P\$	3291	
					1 <sup>3</sup> / <sub>16</sub>			K / P\$	6606	
					1 <sup>1</sup> / <sub>2</sub>			H / P\$	3852	
		Veneer			1 <sup>3</sup> / <sub>16</sub>			F, G, X, Y / W\$	5874	
					1 <sup>3</sup> / <sub>16</sub>			K / W\$	8938	
					1 <sup>1</sup> / <sub>2</sub>			H / W\$	6734	
		Glass			1/4			Acid Etched Glass Top \$	23748	
					1/4			Gloss Glass Top \$	19764	
	<b>54"D x 180"W or 15' - 4 Piece Veneer (W) and 2 Piece HPL (P) Boat Top</b>									
	<u>Must Specify (in this order):</u> Model # Top/Edge Material Top/Edge Finish/Color Edge Profile Glass (Y/N) Glass Color + Surface Finish Power/Data Power/Data Location	88-54180BT	Laminate	180	54-42	1 <sup>3</sup> / <sub>16</sub>	384	18.0	F, G, X, Y / P\$	3244
					1 <sup>3</sup> / <sub>16</sub>			K / P\$	6379	
					1 <sup>1</sup> / <sub>2</sub>			H / P\$	3769	
		Veneer			1 <sup>3</sup> / <sub>16</sub>			F, G, X, Y / W\$	5652	
					1 <sup>3</sup> / <sub>16</sub>			K / W\$	8560	
					1 <sup>1</sup> / <sub>2</sub>			H / W\$	6460	
		Glass			1/4			Acid Etched Glass Top \$	22451	
					1/4			Gloss Glass Top \$	18716	
<b>54"D x 168"W or 14' - 4 Piece Veneer (W) and 2 Piece HPL (P) Boat Top</b>										
		88-54168BT	Laminate	168	54-42	1 <sup>3</sup> / <sub>16</sub>	359	17.0	F, G, X, Y / P\$	3195
					1 <sup>3</sup> / <sub>16</sub>			K / P\$	6151	
					1 <sup>1</sup> / <sub>2</sub>			H / P\$	3687	
		Veneer			1 <sup>3</sup> / <sub>16</sub>			F, G, X, Y / W\$	5431	
					1 <sup>3</sup> / <sub>16</sub>			K / W\$	8182	
					1 <sup>1</sup> / <sub>2</sub>			H / W\$	6188	
		Glass			1/4			Acid Etched Glass Top \$	21154	
					1/4			Gloss Glass Top \$	17668	
	<b>54"D x 156"W or 13' - 4 Piece Veneer (W) and 2 Piece HPL (P) Boat Top</b>									
		88-54156BT	Laminate	156	54-42	1 <sup>3</sup> / <sub>16</sub>	334	16.0	F, G, X, Y / P\$	3147
					1 <sup>3</sup> / <sub>16</sub>			K / P\$	5923	
					1 <sup>1</sup> / <sub>2</sub>			H / P\$	3603	
		Veneer			1 <sup>3</sup> / <sub>16</sub>			F, G, X, Y / W\$	5209	
					1 <sup>3</sup> / <sub>16</sub>			K / W\$	7802	
					1 <sup>1</sup> / <sub>2</sub>			H / W\$	5915	
		Glass			1/4			Acid Etched Glass Top \$	19856	
					1/4			Gloss Glass Top \$	16619	

*Additional 54" Boat Shaped Tops on Next Page*



Double Kerf (F)  
1<sup>3</sup>/<sub>16</sub>"



Duo (G)  
1<sup>3</sup>/<sub>16</sub>"



Fluted (X)  
1<sup>3</sup>/<sub>16</sub>"



Square (Y)  
1<sup>3</sup>/<sub>16</sub>"



Knife (K)  
1<sup>3</sup>/<sub>16</sub>"



Vertical Square (H)  
1<sup>1</sup>/<sub>2</sub>"

P = HPL W = Veneer

[See Catalyst Overview For Ordering Options](#)

Item	Model No.		W	D	H	Ship Wt	Cubic Ft	Edge Profile + Material	List Price	
<i>CONTINUED FROM PREVIOUS PAGE</i>	<b>54"D x 144"W or 12' - 3 Piece Veneer (W) and 2 Piece HPL (P) Boat Top</b>									
	88-54144BT	Laminate	144	54-42	1 3/16"	309	15.0	F, G, X, Y / P\$	2675	
					1 3/16"			K / P\$	5261	
					1 1/2"			H / P\$	3097	
		Veneer			1 3/16"			F, G, X, Y / W\$	4300	
					1 3/16"			K / W\$	6645	
					1 1/2"			H / W\$	4880	
		Glass			1/4"			Acid Etched Glass Top \$	18228	
					1/4"			Gloss Glass Top \$	15240	
		<b>54"D x 132"W or 11' - 3 Piece Veneer (W) and 2 Piece HPL (P) Boat Top</b>								
	88-54132BT	Laminate	132	54-42	1 3/16"	285	13.2	F, G, X, Y / P\$	2614	
					1 3/16"			K / P\$	5021	
					1 1/2"			H / P\$	3000	
		Veneer			1 3/16"			F, G, X, Y / W\$	4090	
					1 3/16"			K / W\$	6285	
				1 1/2"			H / W\$	4624		
	Glass			1/4"			Acid Etched Glass Top \$	16918		
				1/4"			Gloss Glass Top \$	14180		
	<b>54"D x 120"W or 10' - 3 Piece Veneer (W) and 2 Piece HPL (P) Boat Top</b>									
88-54120BT	Laminate	120	54-42	1 3/16"	260	12.1	F, G, X, Y / P\$	2553		
				1 3/16"			K / P\$	4780		
				1 1/2"			H / P\$	2904		
	Veneer			1 3/16"			F, G, X, Y / W\$	3880		
				1 3/16"			K / W\$	5927		
				1 1/2"			H / W\$	4370		
	Glass			1/4"			Acid Etched Glass Top \$	15612		
				1/4"			Gloss Glass Top \$	13122		

Must Specify (in this order):

- Model #
- Top/Edge Material
- Top/Edge Finish/Color
- Edge Profile
- Glass (Y/N)
- Glass Color + Surface Finish
- Power/Data
- Power/Data Location

**Description**

- Tops Available with Veneer (W) or HPL (P) Top in 1 3/16" and 1 1/2" Thicknesses
- Must Specify Edge Profile: 1 3/16" Thick/Double Kerf (F), Duo (G), Fluted (X), Square (Y), and Knife (K) Edge Profiles or 1 1/2" Thick/Vertical Square (H)
- Veneer (W) Top Grain Runs Depth of Top and HPL (P) Top Grain Runs Width of Top
- All Veneer Tops, as well as Laminate Tops up to 144" (12 feet), have Matching Woodgrain. Laminate Tops Sized 156" (13 feet) and Longer have Non-Matching Woodgrain
- Available with Back Painted Tempered Glass Top; Must Specify Color and Finish; [See Options](#)
- Power and Data Options Available; Sold Separately, [See Multiple Power Unit Details](#)
- Bases Sold Separately, See [Multiple Base Options](#)



Double Kerf (F)  
1 3/16"



Duo (G)  
1 3/16"



Fluted (X)  
1 3/16"



Square (Y)  
1 3/16"



Knife (K)  
1 3/16"



Vertical Square (H)  
1 1/2"

P = HPL W = Veneer

[See Catalyst Overview For Ordering Options](#)

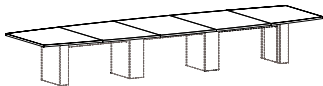

Item	Model No.		W	D	H	Ship Wt	Cubic Ft	Edge Profile + Material	List Price	
<b>BOAT SHAPE MEETING TOP</b> <b>60"D</b>  88-60204BT shown in Veneer with 88-24166C610RB (6" + 10" Combo Rectangle Base) BASES SOLD SEPARATELY	<b>60"D x 240"W or 20' - 5 Piece Veneer (W) and 3 Piece HPL (P) Boat Top</b>									
	88-60240BT	Laminate	240	60-48	1 3/16"	574	26.3	F, G, X, Y / P\$	4779	
					1 3/16"			K / P\$	9084	
					1 1/2"			H / P\$	5559	
	Veneer				1 3/16"			F, G, X, Y / W\$	8359	
					1 3/16"			K / W\$	12204	
					1 1/2"			H / W\$	9534	
	Glass				1/4"			Acid Etched Glass Top \$	32356	
					1/4"			Gloss Glass Top \$	26823	
	<b>60"D x 228"W or 19' - 5 Piece Veneer (W) and 3 Piece HPL (P) Boat Top</b>									
	88-60228BT	Laminate	228	60-48	1 3/16"	547	25.0	F, G, X, Y / P\$	4727	
					1 3/16"			K / P\$	8844	
				1 1/2"			H / P\$	5468		
Veneer				1 3/16"			F, G, X, Y / W\$	8092		
				1 3/16"			K / W\$	11776		
				1 1/2"			H / W\$	9210		
Glass				1/4"			Acid Etched Glass Top \$	30928		
				1/4"			Gloss Glass Top \$	25671		
<b>60"D x 216"W or 18' - 5 Piece Veneer (W) and 3 Piece HPL (P) Boat Top</b>										
88-60216BT	Laminate	216	60-48	1 3/16"	519	23.7	F, G, X, Y / P\$	4127		
				1 3/16"			K / P\$	8042		
				1 1/2"			H / P\$	4829		
Veneer				1 3/16"			F, G, X, Y / W\$	7825		
				1 3/16"			K / W\$	11350		
				1 1/2"			H / W\$	8888		
Glass				1/4"			Acid Etched Glass Top \$	29463		
				1/4"			Gloss Glass Top \$	24483		
<b>60"D x 204"W or 17' - 5 Piece Veneer (W) and 3 Piece HPL (P) Boat Top</b>										
88-60204BT	Laminate	204	60-48	1 3/16"	492	22.4	F, G, X, Y / P\$	4075		
				1 3/16"			K / P\$	7802		
				1 1/2"			H / P\$	4738		
Veneer				1 3/16"			F, G, X, Y / W\$	7558		
				1 3/16"			K / W\$	10922		
				1 1/2"			H / W\$	8564		
Glass				1/4"			Acid Etched Glass Top \$	28035		
				1/4"			Gloss Glass Top \$	23332		

Must Specify (in this order):

- Model #
- Top/Edge Material
- Top/Edge Finish/Color
- Edge Profile
- Glass (Y/N)
- Glass Color + Surface Finish
- Power/Data
- Power/Data Location

*Additional 60" Boat Shaped Tops on Next Page*



Double Kerf (F)  
1 3/16"



Duo (G)  
1 3/16"



Fluted (X)  
1 3/16"



Square (Y)  
1 3/16"



Knife (K)  
1 3/16"



Vertical Square (H)  
1 1/2"

P = HPL W = Veneer

[See Catalyst Overview For Ordering Options](#)

Item	Model No.		W	D	H	Ship Wt	Cubic Ft	Edge Profile + Material	List Price	
<i>CONTINUED FROM PREVIOUS PAGE</i>	<b>60"D x 192"W or 16' - 4 Piece Veneer (W) and 2 Piece HPL (P) Boat Top</b>									
	88-60192BT	Laminate	192	60-48	1 3/16"	458	21.1	F, G, X, Y / P\$	3364	
					1 3/16"			K / P\$	6866	
					1 1/2"			H / P\$	3989	
		Veneer			1 3/16"			F, G, X, Y / W\$	6252	
					1 3/16"			K / W\$	9435	
					1 1/2"			H / W\$	7199	
		Glass			1/4"			Acid Etched Glass Top \$	25909	
					1/4"			Gloss Glass Top \$	21482	
	<b>60"D x 180"W or 15' - 4 Piece Veneer (W) and 2 Piece HPL (P) Boat Top</b>									
	88-60180BT	Laminate	180	60-48	1 3/16"	431	19.8	F, G, X, Y / P\$	3311	
					1 3/16"			K / P\$	6625	
					1 1/2"			H / P\$	3898	
		Veneer			1 3/16"			F, G, X, Y / W\$	6007	
					1 3/16"			K / W\$	9030	
					1 1/2"			H / W\$	6898	
		Glass			1/4"			Acid Etched Glass Top \$	24481	
					1/4"			Gloss Glass Top \$	20332	
<b>60"D x 168"W or 14' - 4 Piece Veneer (W) and 2 Piece HPL (P) Boat Top</b>										
88-60168BT	Laminate	168	60-48	1 3/16"	403	18.5	F, G, X, Y / P\$	3259		
				1 3/16"			K / P\$	6385		
				1 1/2"			H / P\$	3806		
	Veneer			1 3/16"			F, G, X, Y / W\$	5762		
				1 3/16"			K / W\$	8625		
				1 1/2"			H / W\$	6596		
	Glass			1/4"			Acid Etched Glass Top \$	23053		
				1/4"			Gloss Glass Top \$	19180		
<b>60"D x 156"W or 13' - 4 Piece Veneer (W) and 2 Piece HPL (P) Boat Top</b>										
88-60156BT	Laminate	156	60-48	1 3/16"	376	17.2	F, G, X, Y / P\$	3206		
				1 3/16"			K / P\$	6145		
				1 1/2"			H / P\$	3715		
	Veneer			1 3/16"			F, G, X, Y / W\$	5518		
				1 3/16"			K / W\$	8220		
				1 1/2"			H / W\$	6295		
	Glass			1/4"			Acid Etched Glass Top \$	21624		
				1/4"			Gloss Glass Top \$	18028		

Must Specify (in this order):

- Model #
- Top/Edge Material
- Top/Edge Finish/Color
- Edge Profile
- Glass (Y/N)
- Glass Color + Surface Finish
- Power/Data
- Power/Data Location

*Additional 60" Boat Shaped Tops on Next Page*



Double Kerf (F)  
1 3/16"



Duo (G)  
1 3/16"



Fluted (X)  
1 3/16"



Square (Y)  
1 3/16"



Knife (K)  
1 3/16"



Vertical Square (H)  
1 1/2"

P = HPL W = Veneer

[See Catalyst Overview For Ordering Options](#)

Item	Model No.		W	D	H	Ship Wt	Cubic Ft	Edge Profile + Material	List Price	
<b>60"D x 144"W or 12' - 3 Piece Veneer (W) and 2 Piece HPL (P) Boat Top</b>										
<i>CONTINUED FROM PREVIOUS PAGE</i>	88-60144BT	Laminate	144	60-48	1 <sup>3</sup> / <sub>16</sub> "	342	16.0	F, G, X, Y / P\$	2731	
					1 <sup>3</sup> / <sub>16</sub> "			K / P\$	5470	
					1 <sup>1</sup> / <sub>2</sub> "			H / P\$	3200	
	Veneer	1 <sup>3</sup> / <sub>16</sub> "	F, G, X, Y / W\$	4568						
		1 <sup>3</sup> / <sub>16</sub> "	K / W\$	7008						
		1 <sup>1</sup> / <sub>2</sub> "	H / W\$	5205						
	Glass		1 <sup>1</sup> / <sub>4</sub> "	Acid Etched Glass Top \$	19864					
			1 <sup>1</sup> / <sub>4</sub> "	Gloss Glass Top \$	16543					
	<b>60"D x 132"W or 11' - 3 Piece Veneer (W) and 2 Piece HPL (P) Boat Top</b>									
	<u>Must Specify (in this order):</u> Model # Top/Edge Material Top/Edge Finish/Color Edge Profile Glass (Y/N) Glass Color + Surface Finish Power/Data Power/Data Location	88-60132BT	Laminate	132	60-48	1 <sup>3</sup> / <sub>16</sub> "	323	14.6	F, G, X, Y / P\$	2666
1 <sup>3</sup> / <sub>16</sub> "						K / P\$			5216	
1 <sup>1</sup> / <sub>2</sub> "						H / P\$			3096	
Veneer		1 <sup>3</sup> / <sub>16</sub> "	F, G, X, Y / W\$	4336						
		1 <sup>3</sup> / <sub>16</sub> "	K / W\$	6621						
		1 <sup>1</sup> / <sub>2</sub> "	H / W\$	4922						
Glass			1 <sup>1</sup> / <sub>4</sub> "	Acid Etched Glass Top \$	18421					
			1 <sup>1</sup> / <sub>4</sub> "	Gloss Glass Top \$	15378					
<b>60"D x 120"W or 10' - 3 Piece Veneer (W) and 2 Piece HPL (P) Boat Top</b>										
		88-60120BT	Laminate	120	60-48	1 <sup>3</sup> / <sub>16</sub> "	287	13.3	F, G, X, Y / P\$	2601
	1 <sup>3</sup> / <sub>16</sub> "					K / P\$			4964	
	1 <sup>1</sup> / <sub>2</sub> "					H / P\$			2991	
	Veneer	1 <sup>3</sup> / <sub>16</sub> "	F, G, X, Y / W\$	4104						
		1 <sup>3</sup> / <sub>16</sub> "	K / W\$	6237						
		1 <sup>1</sup> / <sub>2</sub> "	H / W\$	4641						
	Glass		1 <sup>1</sup> / <sub>4</sub> "	Acid Etched Glass Top \$	16980					
			1 <sup>1</sup> / <sub>4</sub> "	Gloss Glass Top \$	14214					

**Description**

- Tops Available with Veneer (W) or HPL (P) Top in 1<sup>3</sup>/<sub>16</sub>" and 1<sup>1</sup>/<sub>2</sub>" Thicknesses
- Must Specify Edge Profile: 1<sup>3</sup>/<sub>16</sub>" Thick/Double Kerf (F), Duo (G), **Fluted (X)**, Square (Y), and Knife (K) Edge Profiles or 1<sup>1</sup>/<sub>2</sub>" Thick/Vertical Square (H)
- Veneer (W) Top Grain Runs Depth of Top and HPL (P) Top Grain Runs Width of Top
- **All Veneer Tops, as well as Laminate Tops up to 144" (12 feet), have Matching Woodgrain. Laminate Tops Sized 156" (13 feet) and Longer have Non-Matching Woodgrain**
- Available with Back Painted Tempered Glass Top; Must Specify Color and Finish; [See Options](#)
- Power and Data Options Available; Sold Separately, [See Multiple Power Unit Details](#)
- Bases Sold Separately, See [Multiple Base Options](#)



Double Kerf (F) 1<sup>3</sup>/<sub>16</sub>" Duo (G) 1<sup>3</sup>/<sub>16</sub>" **Fluted (X)** 1<sup>3</sup>/<sub>16</sub>" Square (Y) 1<sup>3</sup>/<sub>16</sub>" Knife (K) 1<sup>3</sup>/<sub>16</sub>" Vertical Square (H) 1<sup>1</sup>/<sub>2</sub>"

P = HPL W = Veneer

[See Catalyst Overview For Ordering Options](#)

Item	Model No.		W	D	H	Ship Wt	Cubic Ft	List Price	
RECTANGLE PANEL BASES WITH TROUGH 24"W	<b>Four (4) Panel Bases - For Use With 60" / 54" / 48" x 240" Surfaces</b>								
	88-24202RPB	Laminate	24	202	28¾	159	14.3	T\$	4441
		Veneer						W\$	4500
	<b>Four (4) Panel Bases - For Use With 60" / 54" / 48" x 228" Surfaces</b>								
	88-24190RPB	Laminate	24	190	28¾	158	14.3	T\$	4395
		Veneer						W\$	4446
	<b>Four (4) Panel Bases - For Use With 60" / 54" / 48" x 216" Surfaces</b>								
	88-24178RPB	Laminate	24	178	28¾	156	14.3	T\$	4363
		Veneer						W\$	4414
	<b>Four (4) Panel Bases - For Use With 60" / 54" / 48" x 204" Surfaces</b>								
	88-24166RPB	Laminate	24	166	28¾	155	14.3	T\$	4315
		Veneer						W\$	4360
	<b>Three (3) Panel Bases - For Use With 60" / 54" / 48" x 192" Surfaces</b>								
	88-24154RPB	Laminate	24	154	28¾	122	13.8	T\$	3450
		Veneer						W\$	3675
	<b>Three (3) Panel Bases - For Use With 60" / 54" / 48" x 180" Surfaces</b>								
	88-24142RPB	Laminate	24	142	28¾	120	13.8	T\$	3135
		Veneer						W\$	3171
	<b>Three (3) Panel Bases - For Use With 60" / 54" / 48" x 168" Surfaces</b>								
	88-24130RPB	Laminate	24	130	28¾	119	13.8	T\$	3110
		Veneer						W\$	3134
	<b>Three (3) Panel Bases - For Use With 60" / 54" / 48" x 156" Surfaces</b>								
	88-24118RPB	Laminate	24	118	28¾	118	13.8	T\$	3071
		Veneer						W\$	3097
	<b>Three (3) Panel Bases - For Use With 60" / 54" / 48" x 144" Surfaces</b>								
	88-24106RPB	Laminate	24	106	28¾	116	13.8	T\$	3000
		Veneer						W\$	3059
	<b>Three (3) Panel Bases - For Use With 60" / 54" / 48" x 132" Surfaces</b>								
	88-2494RPB	Laminate	24	94	28¾	115	13.8	T\$	2666
		Veneer						W\$	2781
	<b>Two (2) Panel Bases - For Use With 60" / 54" / 48" x 120" Surfaces</b>								
	88-2482RPB	Laminate	24	82	28¾	90	6.9	T\$	2150
		Veneer						W\$	2201

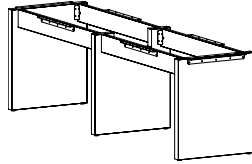

Shown: 88-2494RPB

TOPS SOLD SEPARATELY

Must Specify (in this order):

Model #  
Material  
Finish / Color

*Additional Rectangle Panel Bases on Next Page*

T = TFL W = Veneer

[See Catalyst Overview For Ordering Options](#)

Item	Model No.		W	D	H	Ship Wt	Cubic Ft	List Price	
<b>CONTINUED FROM PREVIOUS PAGE</b>  <b>RECTANGLE PANEL BASES WITH TROUGH 24" + 20"W</b>	<b>24"W Bases Continued</b>								
	<b>Two (2) Panel Bases - For Use With 48" x 108" Surfaces</b>								
	88-2470RPB	Laminate	24	70	28¾	87	6.9	T\$	1919
		Veneer						W\$	1991
	<b>Two (2) Panel Bases - For Use With 48" x 96" Surfaces</b>								
	88-2458RPB	Laminate	24	58	28¾	84	6.9	T\$	1880
		Veneer						W\$	1954
	<b>Two (2) Panel Bases - For Use With 48" x 84" Surfaces</b>								
	88-2446RPB	Laminate	24	46	28¾	81	6.9	T\$	1677
		Veneer						W\$	1797
	<b>Two (2) Panel Bases - For Use With 48" x 72" Surfaces</b>								
	88-2434RPB	Laminate	24	34	28¾	78	6.9	T\$	1602
		Veneer						W\$	1758
	<b>20"W Bases</b>								
	<b>Two (2) Panel Bases - For Use With 42" x 120" Surfaces</b>								
	88-2082RPB	Laminate	20	82	28¾	78	6.7	T\$	2132
		Veneer						W\$	2175
	<b>Two (2) Panel Bases - For Use With 42" x 108" Surfaces</b>								
88-2070RPB	Laminate	20	70	28¾	75	6.7	T\$	1892	
	Veneer						W\$	1975	
<b>Two (2) Panel Bases - For Use With 36" / 42" x 96" Surfaces</b>									
88-2058RPB	Laminate	20	58	28¾	72	6.7	T\$	1853	
	Veneer						W\$	1938	
<b>Two (2) Panel Bases - For Use With 36" / 42" x 84" Surfaces</b>									
88-2046RPB	Laminate	20	46	28¾	69	6.7	T\$	1651	
	Veneer						W\$	1779	
<b>Two (2) Panel Bases - For Use With 36" / 42" x 72" Surfaces</b>									
88-2034RPB	Laminate	20	34	28¾	66	6.7	T\$	1575	
	Veneer						W\$	1742	

Must Specify (in this order):

- Model #
- Material
- Finish / Color

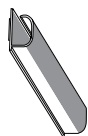

Wire Management Channel

**Description**

- 2" Panel Bases with Trough, Stretcher Rails, and L-Bracket Hardware Included
- Available with TFL (T) or Veneer (W)
- Vertical Grain Direction on Bases
- Wire Management Channel Included; Two (2) Base Units Include One (1) Wire Management Channel and Three (3) Base Units Includes Two (2) Wire Management Channel
- Bases Require Some Assembly; Attachment Hardware Included
- Tops Sold Separately, [See Multiple Unit Details](#)

T = TFL W = Veneer

[See Catalyst Overview For Ordering Options](#)

Item	Model No.		W	D	H	Ship Wt	Cubic Ft	List Price	
6" RECTANGLE BASES WITH TROUGH AND REMOVABLE PANEL 24"W	<b>Four (4) 6" Rectangle Bases - For Use With 60" / 54" / 48" x 240" Surfaces</b>								
	88-2420206RB	Laminate	24	202	28¾	158	26.3	T\$	6570
		Veneer						W\$	8938
	<b>Four (4) 6" Rectangle Bases - For Use With 60" / 54" / 48" x 228" Surfaces</b>								
	88-2419006RB	Laminate	24	190	28¾	156	26.3	T\$	6523
		Veneer						W\$	8899
	<b>Four (4) 6" Rectangle Bases - For Use With 60" / 54" / 48" x 216" Surfaces</b>								
	88-2417806RB	Laminate	24	178	28¾	154	26.3	T\$	6490
		Veneer						W\$	8867
	<b>Four (4) 6" Rectangle Bases - For Use With 60" / 54" / 48" x 204" Surfaces</b>								
	88-2416606RB	Laminate	24	166	28¾	152	26.3	T\$	6444
		Veneer						W\$	8813
	<b>Three (3) 6" Rectangle Bases - For Use With 60" / 54" / 48" x 192" Surfaces</b>								
	88-2415406RB	Laminate	24	154	28¾	114	19.6	T\$	5110
		Veneer						W\$	7101
	<b>Three (3) 6" Rectangle Bases - For Use With 60" / 54" / 48" x 180" Surfaces</b>								
	88-2414206RB	Laminate	24	142	28¾	112	19.6	T\$	5073
		Veneer						W\$	6856
	<b>Three (3) 6" Rectangle Bases - For Use With 60" / 54" / 48" x 168" Surfaces</b>								
	88-2413006RB	Laminate	24	130	28¾	110	19.6	T\$	4794
		Veneer						W\$	6536
	<b>Three (3) 6" Rectangle Bases - For Use With 60" / 54" / 48" x 156" Surfaces</b>								
	88-2411806RB	Laminate	24	118	28¾	108	19.6	T\$	4757
		Veneer						W\$	6497
	<b>Three (3) 6" Rectangle Bases - For Use With 60" / 54" / 48" x 144" Surfaces</b>								
	88-2410606RB	Laminate	24	106	28¾	106	19.6	T\$	4720
		Veneer						W\$	6457
	<b>Three (3) 6" Rectangle Bases - For Use With 60" / 54" / 48" x 132" Surfaces</b>								
	88-249406RB	Laminate	24	94	28¾	102	12.9	T\$	4442
		Veneer						W\$	6092
	<b>Two (2) 6" Rectangle Bases - For Use With 60" / 54" / 48" x 120" Surfaces</b>								
	88-248206RB	Laminate	24	82	28¾	99	12.9	T\$	3219
		Veneer						W\$	4449

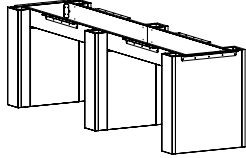

Shown: 88-249406RB

TOPS SOLD SEPARATELY

Must Specify (in this order):

Model #

Material

Finish / Color

*Additional 6" Rectangle Panel Bases on Next Page*

T = TFL W = Veneer

[See Catalyst Overview For Ordering Options](#)

Item	Model No.		W	D	H	Ship Wt	Cubic Ft	List Price	
CONTINUED FROM PREVIOUS PAGE -	<b>24"W Bases Continued</b>								
	<b>Two (2) 6" Rectangle Bases - For Use With 48" x 108" Surfaces</b>								
<b>6" RECTANGLE BASES WITH TROUGH AND REMOVABLE PANEL 24" + 20"W</b>	88-247006RB	Laminate	24	70	28¾	96	12.9	T\$	3062
		Veneer						W\$	4160
	<b>Two (2) 6" Rectangle Bases - For Use With 48" x 96" Surfaces</b>								
	88-245806RB	Laminate	24	58	28¾	93	12.9	T\$	3023
		Veneer						W\$	4128
	<b>Two (2) 6" Rectangle Bases - For Use With 48" x 84" Surfaces</b>								
	88-244606RB	Laminate	24	46	28¾	90	12.9	T\$	2866
		Veneer						W\$	3925
	<b>Two (2) 6" Rectangle Bases - For Use With 48" x 72" Surfaces</b>								
	88-243406RB	Laminate	24	34	28¾	87	12.9	T\$	2829
		Veneer						W\$	3850
<u>Must Specify (in this order):</u>	<b>20"W Bases</b>								
Model #	<b>Two (2) 6" Rectangle Bases - For Use With 42" x 120" Surfaces</b>								
Material	88-208206RB	Laminate	20	82	28¾	89	12.9	T\$	3167
Finish / Color		Veneer						W\$	4419
	<b>Two (2) 6" Rectangle Bases - For Use With 42" x 108" Surfaces</b>								
	88-207006RB	Laminate	20	70	28¾	86	12.9	T\$	3009
		Veneer						W\$	4130
	<b>Two (2) 6" Rectangle Bases - For Use With 36" / 42" x 96" Surfaces</b>								
	88-205806RB	Laminate	20	58	28¾	82	12.9	T\$	2971
		Veneer						W\$	4098
	<b>Two (2) 6" Rectangle Bases - For Use With 36" / 42" x 84" Surfaces</b>								
	88-204606RB	Laminate	20	46	28¾	79	12.9	T\$	2814
		Veneer						W\$	3895
	<b>Two (2) 6" Rectangle Bases - For Use With 36" / 42" x 72" Surfaces</b>								
	88-203406RB	Laminate	20	34	28¾	76	12.9	T\$	2777
		Veneer						W\$	3820

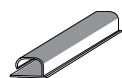
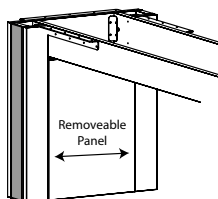

Wire Management Channel

**Description**

- 6" Rectangle Bases with Trough, Stretcher Rails, and L-Bracket Hardware Included
- Available with TFL (T) or Veneer (W)
- Vertical Grain Direction on Bases
- Bases Include Interior Removable Panel for Wire Management Access; Removable Panel is 15⅞"W for 24" Bases and 11⅞"W for 20" Bases
- Wire Management Channel Included; Two (2) Base Units Include One (1) Wire Management Channel and Three (3) Base Units Includes Two (2) Wire Management Channel
- Removable Panels Attached with Z Brackets.
- Bases Require Some Assembly; Attachment Hardware Included
- Tops Sold Separately, [See Multiple Unit Details](#)

T = TFL W = Veneer

[See Catalyst Overview For Ordering Options](#)

Item	Model No.		W	D	H	Ship Wt	Cubic Ft	List Price	
10" RECTANGLE BASES WITH TROUGH AND REMOVABLE PANEL 24"W	<b>Four (4) 10" Rectangle Bases - For Use With 60" / 54" / 48" x 240" Surfaces</b>								
	88-242021ORB	Laminate	24	202	28¾	205	24.6	T\$	6731
		Veneer						W\$	9062
	<b>Four (4) 10" Rectangle Bases - For Use With 60" / 54" / 48" x 228" Surfaces</b>								
	88-241901ORB	Laminate	24	190	28¾	202	24.6	T\$	6684
		Veneer						W\$	9023
	<b>Four (4) 10" Rectangle Bases - For Use With 60" / 54" / 48" x 216" Surfaces</b>								
	88-241781ORB	Laminate	24	178	28¾	198	24.6	T\$	6651
		Veneer						W\$	8991
	<b>Four (4) 10" Rectangle Bases - For Use With 60" / 54" / 48" x 204" Surfaces</b>								
	88-241661ORB	Laminate	24	166	28¾	195	24.6	T\$	6604
		Veneer						W\$	8937
	<b>Three (3) 10" Rectangle Bases - For Use With 60" / 54" / 48" x 192" Surfaces</b>								
	88-241541ORB	Laminate	24	154	28¾	155	18.2	T\$	5231
		Veneer						W\$	7194
	<b>Three (3) 10" Rectangle Bases - For Use With 60" / 54" / 48" x 180" Surfaces</b>								
	88-241421ORB	Laminate	24	142	28¾	151	18.2	T\$	5193
		Veneer						W\$	6949
	<b>Three (3) 10" Rectangle Bases - For Use With 60" / 54" / 48" x 168" Surfaces</b>								
	88-241301ORB	Laminate	24	130	28¾	148	18.2	T\$	4915
		Veneer						W\$	6629
	<b>Three (3) 10" Rectangle Bases - For Use With 60" / 54" / 48" x 156" Surfaces</b>								
	88-241181ORB	Laminate	24	118	28¾	144	18.2	T\$	4878
		Veneer						W\$	6590
	<b>Three (3) 10" Rectangle Bases - For Use With 60" / 54" / 48" x 144" Surfaces</b>								
	88-241061ORB	Laminate	24	106	28¾	141	18.2	T\$	4841
		Veneer						W\$	6551
	<b>Three (3) 10" Rectangle Bases - For Use With 60" / 54" / 48" x 132" Surfaces</b>								
	88-24941ORB	Laminate	24	94	28¾	137	18.2	T\$	4562
		Veneer						W\$	6185
	<b>Two (2) 10" Rectangle Bases - For Use With 60" / 54" / 48" x 120" Surfaces</b>								
	88-24821ORB	Laminate	24	82	28¾	96	12.0	T\$	3300
		Veneer						W\$	4512

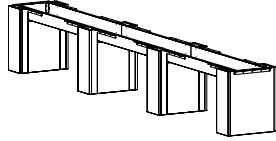

Shown: 88-241901ORB

TOPS SOLD SEPARATELY

Must Specify (in this order):

Model #

Material

Finish / Color

*Additional 10" Rectangle Panel Bases on Next Page*

T = TFL W = Veneer

[See Catalyst Overview For Ordering Options](#)



Item	Model No.		W	D	H	Ship Wt	Cubic Ft	List Price	
<i>CONTINUED FROM PREVIOUS PAGE</i>		<b>24"W Bases Continued</b>							
		<b>Two (2) 10" Rectangle Bases - For Use With 48" x 108" Surfaces</b>							
10" RECTANGLE BASES WITH TROUGH AND REMOVABLE PANEL 24" + 20"W	88-24701ORB	Laminate	24	70	28¾	93	12.0	T\$	3141
		Veneer						W\$	4222
		<b>Two (2) 10" Rectangle Bases - For Use With 48" x 96" Surfaces</b>							
	88-24581ORB	Laminate	24	58	28¾	89	12.0	T\$	3104
		Veneer						W\$	4190
		<b>Two (2) 10" Rectangle Bases - For Use With 48" x 84" Surfaces</b>							
	88-24461ORB	Laminate	24	46	28¾	86	12.0	T\$	2947
		Veneer						W\$	3987
		<b>Two (2) 10" Rectangle Bases - For Use With 48" x 72" Surfaces</b>							
	88-24341ORB	Laminate	24	34	28¾	82	12.0	T\$	2843
		Veneer						W\$	3832
		<b>20"W Bases</b>							
		<b>Two (2) 10" Rectangle Bases - For Use With 42" x 120" Surfaces</b>							
	88-20821ORB	Laminate	20	82	28¾	86	10.0	T\$	3247
		Veneer						W\$	4482
		<b>Two (2) 10" Rectangle Bases - For Use With 42" x 108" Surfaces</b>							
	88-20701ORB	Laminate	20	70	28¾	82	10.0	T\$	3089
		Veneer						W\$	4192
		<b>Two (2) 10" Rectangle Bases - For Use With 36" / 42" x 96" Surfaces</b>							
	88-20581ORB	Laminate	20	58	28¾	79	10.0	T\$	3052
		Veneer						W\$	4160
		<b>Two (2) 10" Rectangle Bases - For Use With 36" / 42" x 84" Surfaces</b>							
	88-20461ORB	Laminate	20	46	28¾	75	10.0	T\$	2894
		Veneer						W\$	3957
		<b>Two (2) 10" Rectangle Bases - For Use With 36" / 42" x 72" Surfaces</b>							
	88-20341ORB	Laminate	20	34	28¾	72	10.0	T\$	2857
		Veneer						W\$	3882

Must Specify (in this order):

- Model #
- Material
- Finish / Color

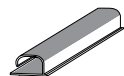
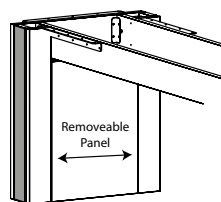

Wire Management Channel

**Description**

- 10" Rectangle Bases with Trough and Stretcher Rails
- Available with TFL (T) or Veneer (W)
- Vertical Grain Direction on Bases
- Bases Include Interior Removable Panel for Wire Management Access; Removable Panel is 15⅞"W for 24" Bases and 11⅞"W for 20" Bases
- Wire Management Channel Included; Two (2) Base Units Include One (1) Wire Management Channel and Three (3) Base Units Includes Two (2) Wire Management Channel
- Removable Panels Attached with Z Brackets.
- Bases Require Some Assembly; Attachment Hardware Included
- Tops Sold Separately, [See Multiple Unit Details](#)

T = TFL W = Veneer

[See Catalyst Overview For Ordering Options](#)

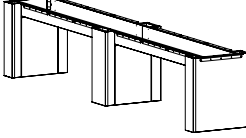
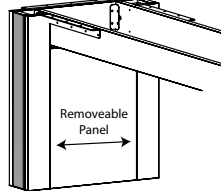
Item	Model No.		W	D	H	Ship Wt	Cubic Ft	List Price
<b>6" + 10" COMBO RECTANGLE BASES WITH TROUGH AND REMOVABLE PANEL</b> 24"W	<b>Four (4) Bases Total: Two (2) 6" and Two (2) 10" Rectangle Bases - For Use With 60" / 54" / 48" x 240" Surfaces</b>							
	88-24202C610RB	Laminate	24	202	28 $\frac{3}{4}$	205	24.6	T\$ 6650
		Veneer						W\$ 9015
	<b>Four (4) Bases Total: Two (2) 6" and Two (2) 10" Rectangle Bases - For Use With 60" / 54" / 48" x 228" Surfaces</b>							
	88-24190C610RB	Laminate	24	190	28 $\frac{3}{4}$	202	24.6	T\$ 6603
		Veneer						W\$ 8961
Shown: 88-24142C610RB TOPS SOLD SEPARATELY	<b>Four (4) Bases Total: Two (2) 6" and Two (2) 10" Rectangle Bases - For Use With 60" / 54" / 48" x 216" Surfaces</b>							
	88-24178C610RB	Laminate	24	178	28 $\frac{3}{4}$	198	24.6	T\$ 6570
		Veneer						W\$ 8929
	<b>Four (4) Bases Total: Two (2) 6" and Two (2) 10" Rectangle Bases - For Use With 60" / 54" / 48" x 204" Surfaces</b>							
	88-24166C610RB	Laminate	24	166	28 $\frac{3}{4}$	195	24.6	T\$ 6524
		Veneer						W\$ 8875
Must Specify (in this order): Model # Material Finish / Color	<b>Three (3) Bases Total: Two (2) 6" and One (1) 10" Rectangle Bases - For Use With 60" / 54" / 48" x 192" Surfaces</b>							
	88-24154C610RB	Laminate	24	154	28 $\frac{3}{4}$	155	18.2	T\$ 5544
		Veneer						W\$ 7616
	<b>Three (3) Bases Total: Two (2) 6" and One (1) 10" Rectangle Bases - For Use With 60" / 54" / 48" x 180" Surfaces</b>							
	88-24142C610RB	Laminate	24	142	28 $\frac{3}{4}$	151	18.2	T\$ 5113
		Veneer						W\$ 6887
	<b>Three (3) Bases Total: Two (2) 6" and One (1) 10" Rectangle Bases - For Use With 60" / 54" / 48" x 168" Surfaces</b>							
	88-24130C610RB	Laminate	24	130	28 $\frac{3}{4}$	148	18.2	T\$ 4834
		Veneer						W\$ 6567
	<b>Three (3) Bases Total: Two (2) 6" and One (1) 10" Rectangle Bases - For Use With 60" / 54" / 48" x 156" Surfaces</b>							
	88-24118C610RB	Laminate	24	118	28 $\frac{3}{4}$	144	18.2	T\$ 4797
		Veneer						W\$ 6528
	<b>Three (3) Bases Total: Two (2) 6" and One (1) 10" Rectangle Bases - For Use With 60" / 54" / 48" x 144" Surfaces</b>							
	88-24106C610RB	Laminate	24	106	28 $\frac{3}{4}$	141	18.2	T\$ 4760
		Veneer						W\$ 6488
	<b>Three (3) Bases Total: Two (2) 6" and One (1) 10" Rectangle Bases - For Use With 60" / 54" / 48" x 132" Surfaces</b>							
	88-2494C610RB	Laminate	24	94	28 $\frac{3}{4}$	137	18.2	T\$ 4482
		Veneer						W\$ 6123

### Description

- 6" + 10" Rectangle Bases with Trough and Stretcher Rails; 6" Bases on Exterior and 10" Bases on Interior
- Available with TFL (T) or Veneer (W)
- Vertical Grain Direction on Bases
- Wire Management Channel Included; Two (2) Base Units Include One (1) Wire Management Channel and Three (3) Base Units Includes Two (2) Wire Management Channel
- Bases Include Interior Removable Panel for Wire Management. Removable Panel is 15 $\frac{7}{8}$ "W and Attaches with Z Brackets.
- Bases Require Some Assembly; Attachment Hardware Included
- Tops Sold Separately, [See Multiple Unit Details](#)

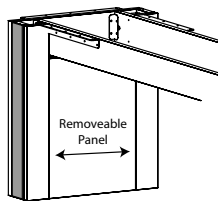

Removeable  
Panel

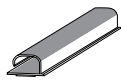

Wire Management  
Channel

T = TFL W = Veneer

[See Catalyst Overview For Ordering Options](#)

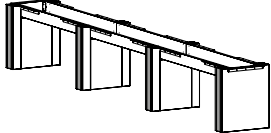
Item	Model No.		W	D	H	Ship Wt	Cubic Ft	List Price	
<b>6" RECTANGLE ACCENT BASES WITH TROUGH AND REMOVABLE PANEL 24"W</b>	<b>Four (4) 6" Rectangle Bases - For Use With 60" / 54" / 48" x 240" Surfaces</b>								
	88-2420206RAB	Laminate	24	202	28¾	158	26.3	T\$	7463
		Veneer						W\$	9887
	<b>Four (4) 6" Rectangle Bases - For Use With 60" / 54" / 48" x 228" Surfaces</b>								
	88-2419006RAB	Laminate	24	190	28¾	156	26.3	T\$	7417
		Veneer						W\$	9847
Shown: 88-2419006RAB	<b>Four (4) 6" Rectangle Bases - For Use With 60" / 54" / 48" x 216" Surfaces</b>								
	88-2417806RAB	Laminate	24	178	28¾	154	26.3	T\$	7384
TOPS SOLD SEPARATELY		Veneer						W\$	9815
Must Specify (in this order):	<b>Four (4) 6" Rectangle Bases - For Use With 60" / 54" / 48" x 204" Surfaces</b>								
	88-2416606RAB	Laminate	24	166	28¾	152	26.3	T\$	7337
Model #		Veneer						W\$	9762
Base Finish/Color	<b>Three (3) 6" Rectangle Bases - For Use With 60" / 54" / 48" x 192" Surfaces</b>								
Metal Accent Color	88-2415406RAB	Laminate	24	154	28¾	114	19.6	T\$	5785
Accent Panel Finish/Color		Veneer						W\$	7817
	<b>Three (3) 6" Rectangle Bases - For Use With 60" / 54" / 48" x 180" Surfaces</b>								
	88-2414206RAB	Laminate	24	142	28¾	112	19.6	T\$	5747
		Veneer						W\$	7571
	<b>Three (3) 6" Rectangle Bases - For Use With 60" / 54" / 48" x 168" Surfaces</b>								
	88-2413006RAB	Laminate	24	130	28¾	110	19.6	T\$	5469
		Veneer						W\$	7252
	<b>Three (3) 6" Rectangle Bases - For Use With 60" / 54" / 48" x 156" Surfaces</b>								
	88-2411806RAB	Laminate	24	118	28¾	108	19.6	T\$	5432
		Veneer						W\$	7213
	<b>Three (3) 6" Rectangle Bases - For Use With 60" / 54" / 48" x 144" Surfaces</b>								
	88-2410606RAB	Laminate	24	106	28¾	106	19.6	T\$	5394
		Veneer						W\$	7174
	<b>Three (3) 6" Rectangle Bases - For Use With 60" / 54" / 48" x 132" Surfaces</b>								
	88-249406RAB	Laminate	24	94	28¾	102	12.9	T\$	5117
		Veneer						W\$	6808
	<b>Two (2) 6" Rectangle Bases - For Use With 60" / 54" / 48" x 120" Surfaces</b>								
	88-248206RAB	Laminate	24	82	28¾	99	12.9	T\$	4745
		Veneer						W\$	6436

*Additional 6" Rectangle Accent Bases on Next Page.*

T = TFL W = Veneer

[See Catalyst Overview For Ordering Options](#)

Item	Model No.		W	D	H	Ship Wt	Cubic Ft	List Price
<b>CONTINUED FROM PREVIOUS PAGE</b>	<b>24"W Bases Continued</b>							
	<b>Two (2) 6" Rectangle Bases - For Use With 48" x 108" Surfaces</b>							
<b>6" RECTANGLE ACCENT BASES WITH TROUGH AND REMOVABLE PANEL 24" + 20"W</b>	88-247006RAB	Laminate	24	70	28 <sup>3</sup> / <sub>4</sub>	96	12.9	T\$ 3517
		Veneer						W\$ 4642
	<b>Two (2) 6" Rectangle Bases - For Use With 48" x 96" Surfaces</b>							
	88-245806RAB	Laminate	24	58	28 <sup>3</sup> / <sub>4</sub>	93	12.9	T\$ 3480
		Veneer						W\$ 4610
	<b>Two (2) 6" Rectangle Bases - For Use With 48" x 84" Surfaces</b>							
	88-244606RAB	Laminate	24	46	28 <sup>3</sup> / <sub>4</sub>	90	12.9	T\$ 3322
		Veneer						W\$ 4408
	<b>Two (2) 6" Rectangle Bases - For Use With 48" x 72" Surfaces</b>							
	88-243406RAB	Laminate	24	34	28 <sup>3</sup> / <sub>4</sub>	87	12.9	T\$ 3284
		Veneer						W\$ 4333
	<b>20"W Bases</b>							
	<b>Two (2) 6" Rectangle Bases - For Use With 42" x 120" Surfaces</b>							
	88-208206RAB	Laminate	20	82	28 <sup>3</sup> / <sub>4</sub>	89	12.9	T\$ 3623
		Veneer						W\$ 4902
	<b>Two (2) 6" Rectangle Bases - For Use With 42" x 108" Surfaces</b>							
	88-207006RAB	Laminate	20	70	28 <sup>3</sup> / <sub>4</sub>	86	12.9	T\$ 3465
		Veneer						W\$ 4612
	<b>Two (2) 6" Rectangle Bases - For Use With 36" / 42" x 96" Surfaces</b>							
	88-205806RAB	Laminate	20	58	28 <sup>3</sup> / <sub>4</sub>	82	12.9	T\$ 3428
		Veneer						W\$ 4580
	<b>Two (2) 6" Rectangle Bases - For Use With 36" / 42" x 84" Surfaces</b>							
	88-204606RAB	Laminate	20	46	28 <sup>3</sup> / <sub>4</sub>	79	12.9	T\$ 3270
		Veneer						W\$ 4378
	<b>Two (2) 6" Rectangle Bases - For Use With 36" / 42" x 72" Surfaces</b>							
	88-203406RAB	Laminate	20	34	28 <sup>3</sup> / <sub>4</sub>	76	12.9	T\$ 3232
		Veneer						W\$ 4302

**Must Specify (in this order):**

Model #  
 Base Finish/Color  
 Metal Accent Color  
 Accent Panel Finish/Color

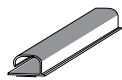
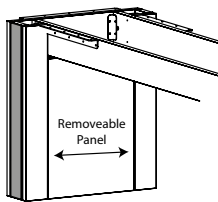

Wire Management Channel

**Description**

- 6" Rectangle Bases with Trough and Stretcher Rails
- Available with TFL (T) or Veneer (W)
- 5/8" Metal Accent Available in Four (4) Colors: Aluminum, Black, Gold, and Platinum; Must Specify Color
- Vertical Grain Direction on Bases
- Bases Include Interior Removable Panel for Wire Management Access; Removable Panel is 15 1/8"W for 24" Bases and 11 7/8"W for 20" Bases
- Wire Management Channel Included; Two (2) Base Units Include One (1) Wire Management Channel and Three (3) Base Units Includes Two (2) Wire Management Channel
- Removable Panels Attached with Z Brackets.
- Bases Require Some Assembly; Attachment Hardware Included
- Tops Sold Separately, [See Multiple Unit Details](#)

T = TFL W = Veneer

[See Catalyst Overview For Ordering Options](#)

Item	Model No.		W	D	H	Ship Wt	Cubic Ft	List Price	
<b>10" RECTANGLE ACCENT BASES WITH TROUGH AND REMOVABLE PANEL</b> 24"W	<b>Four (4) 10" Rectangle Bases - For Use With 60" / 54" / 48" x 240" Surfaces</b>								
	88-242021ORAB	Laminate	24	202	28¾	205	24.6	T\$	7556
		Veneer						W\$	10002
	<b>Four (4) 10" Rectangle Bases - For Use With 60" / 54" / 48" x 228" Surfaces</b>								
	88-241901ORAB	Laminate	24	190	28¾	202	24.6	T\$	7509
		Veneer						W\$	9963
	<b>Four (4) 10" Rectangle Bases - For Use With 60" / 54" / 48" x 216" Surfaces</b>								
	88-241781ORAB	Laminate	24	178	28¾	198	24.6	T\$	7477
		Veneer						W\$	9931
	<b>Four (4) 10" Rectangle Bases - For Use With 60" / 54" / 48" x 204" Surfaces</b>								
	88-241661ORAB	Laminate	24	166	28¾	195	24.6	T\$	7429
		Veneer						W\$	9877
	<b>Three (3) 10" Rectangle Bases - For Use With 60" / 54" / 48" x 192" Surfaces</b>								
	88-241541ORAB	Laminate	24	154	28¾	155	18.2	T\$	5852
		Veneer						W\$	7902
	<b>Three (3) 10" Rectangle Bases - For Use With 60" / 54" / 48" x 180" Surfaces</b>								
	88-241421ORAB	Laminate	24	142	28¾	151	18.2	T\$	5815
		Veneer						W\$	7656
	<b>Three (3) 10" Rectangle Bases - For Use With 60" / 54" / 48" x 168" Surfaces</b>								
	88-241301ORAB	Laminate	24	130	28¾	148	18.2	T\$	5536
		Veneer						W\$	7337
	<b>Three (3) 10" Rectangle Bases - For Use With 60" / 54" / 48" x 156" Surfaces</b>								
	88-241181ORAB	Laminate	24	118	28¾	144	18.2	T\$	5499
		Veneer						W\$	7298
	<b>Three (3) 10" Rectangle Bases - For Use With 60" / 54" / 48" x 144" Surfaces</b>								
	88-241061ORAB	Laminate	24	106	28¾	141	18.2	T\$	5462
		Veneer						W\$	7258
	<b>Three (3) 10" Rectangle Bases - For Use With 60" / 54" / 48" x 132" Surfaces</b>								
	88-24941ORAB	Laminate	24	94	28¾	137	18.2	T\$	5183
		Veneer						W\$	6892
	<b>Two (2) 10" Rectangle Bases - For Use With 60" / 54" / 48" x 120" Surfaces</b>								
	88-24821ORAB	Laminate	24	82	28¾	96	12.0	T\$	3717
		Veneer						W\$	4986

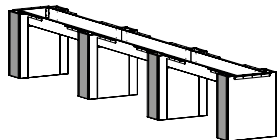

Shown: 88-241901ORAB  
Shown with Gray Accent Panel

TOPS SOLD SEPARATELY

Must Specify (in this order):

- Model #
- Base Finish/Color
- Metal Accent Color
- Accent Panel Finish/Color

*Additional 10" Rectangle Accent Bases on Next Page.*

T = TFL W = Veneer

[See Catalyst Overview For Ordering Options](#)

Item	Model No.		W	D	H	Ship Wt	Cubic Ft	List Price	
<b>CONTINUED FROM PREVIOUS PAGE</b>  <b>10" RECTANGLE ACCENT BASES WITH TROUGH AND REMOVABLE PANEL 24" + 20"W</b>	<b>24"W Bases Continued</b>								
	<b>Two (2) 10" Rectangle Bases - For Use With 48" x 108" Surfaces</b>								
	88-247010RAB	Laminate	24	70	28¾	93	12.0	T\$	3558
		Veneer						W\$	4696
	<b>Two (2) 10" Rectangle Bases - For Use With 48" x 96" Surfaces</b>								
	88-245810RAB	Laminate	24	58	28¾	89	12.0	T\$	3521
		Veneer						W\$	4664
	<b>Two (2) 10" Rectangle Bases - For Use With 48" x 84" Surfaces</b>								
	88-244610RAB	Laminate	24	46	28¾	86	12.0	T\$	3364
		Veneer						W\$	4461
	<b>Two (2) 10" Rectangle Bases - For Use With 48" x 72" Surfaces</b>								
	88-243410RAB	Laminate	24	34	28¾	82	12.0	T\$	3260
		Veneer						W\$	4306
	<b>20"W Bases</b>								
	<b>Two (2) 10" Rectangle Bases - For Use With 42" x 120" Surfaces</b>								
	88-208210RAB	Laminate	20	82	28¾	86	10.0	T\$	3664
		Veneer						W\$	4956
	<b>Two (2) 10" Rectangle Bases - For Use With 42" x 108" Surfaces</b>								
	88-207010RAB	Laminate	20	70	28¾	82	10.0	T\$	3507
		Veneer						W\$	4666
	<b>Two (2) 10" Rectangle Bases - For Use With 36" / 42" x 96" Surfaces</b>								
	88-205810RAB	Laminate	20	58	28¾	79	10.0	T\$	3469
		Veneer						W\$	4634
	<b>Two (2) 10" Rectangle Bases - For Use With 36" / 42" x 84" Surfaces</b>								
88-204610RAB	Laminate	20	46	28¾	75	10.0	T\$	3311	
	Veneer						W\$	4431	
<b>Two (2) 10" Rectangle Bases - For Use With 36" / 42" x 72" Surfaces</b>									
88-203410RAB	Laminate	20	34	28¾	72	10.0	T\$	3209	
	Veneer						W\$	4276	

Must Specify (in this order):

Model #  
Base Finish/Color  
Metal Accent Color  
Accent Panel Finish/Color

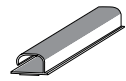
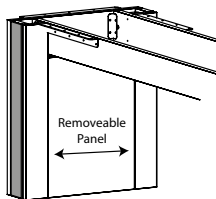

Wire Management Channel

**Description**

- 10" Rectangle Bases with Trough and Stretcher Rails
- Available with TFL (T) or Veneer (W)
- 5/16" Metal Accent Available in Four (4) Colors: Aluminum, Black, Gold, and Platinum; Must Specify Color
- Vertical Grain Direction on Bases
- Bases Include Interior Removable Panel for Wire Management Access; Removable Panel is 15 7/8"W for 24" Bases and 11 7/8"W for 20" Bases
- Wire Management Channel Included; Two (2) Base Units Include One (1) Wire Management Channel and Three (3) Base Units Includes Two (2) Wire Management Channel
- Removable Panels Attached with Z Brackets.
- Bases Require Some Assembly; Attachment Hardware Included
- Tops Sold Separately, [See Multiple Unit Details](#)

T = TFL W = Veneer

[See Catalyst Overview For Ordering Options](#)

Item	Model No.		W	D	H	Ship Wt	Cubic Ft	List Price
<b>6" + 10" COMBO RECTANGLE ACCENT BASES WITH TROUGH AND REMOVABLE PANEL 24"W</b>	<b>Four (4) Bases Total: Two (2) 6" and Two (2) 10" Rectangle Bases - For Use With 60" / 54" / 48" x 240" Surfaces</b>							
	88-24202C610RAB	Laminate	24	202	28¾	205	24.6	T\$ 7514
		Veneer					W\$ 9964	
	<b>Four (4) Bases Total: Two (2) 6" and Two (2) 10" Rectangle Bases - For Use With 60" / 54" / 48" x 228" Surfaces</b>							
	88-24190C610RAB	Laminate	24	190	28¾	202	24.6	T\$ 7468
		Veneer					W\$ 9909	
	<b>Four (4) Bases Total: Two (2) 6" and Two (2) 10" Rectangle Bases - For Use With 60" / 54" / 48" x 216" Surfaces</b>							
	88-24178C610RAB	Laminate	24	178	28¾	198	24.6	T\$ 7434
		Veneer					W\$ 9877	
	<b>Four (4) Bases Total: Two (2) 6" and Two (2) 10" Rectangle Bases - For Use With 60" / 54" / 48" x 204" Surfaces</b>							
	88-24166C610RAB	Laminate	24	166	28¾	195	24.6	T\$ 7388
		Veneer					W\$ 9824	
	<b>Three (3) Bases Total: Two (2) 6" and One (1) 10" Rectangle Bases - For Use With 60" / 54" / 48" x 192" Surfaces</b>							
	88-24154C610RAB	Laminate	24	154	28¾	155	18.2	T\$ 5810
		Veneer					W\$ 7848	
	<b>Three (3) Bases Total: Two (2) 6" and One (1) 10" Rectangle Bases - For Use With 60" / 54" / 48" x 180" Surfaces</b>							
	88-24142C610RAB	Laminate	24	142	28¾	151	18.2	T\$ 5773
		Veneer					W\$ 7602	
	<b>Three (3) Bases Total: Two (2) 6" and One (1) 10" Rectangle Bases - For Use With 60" / 54" / 48" x 168" Surfaces</b>							
	88-24130C610RAB	Laminate	24	130	28¾	148	18.2	T\$ 5495
		Veneer					W\$ 7283	
	<b>Three (3) Bases Total: Two (2) 6" and One (1) 10" Rectangle Bases - For Use With 60" / 54" / 48" x 156" Surfaces</b>							
	88-24118C610RAB	Laminate	24	118	28¾	144	18.2	T\$ 5458
		Veneer					W\$ 7244	
	<b>Three (3) Bases Total: Two (2) 6" and One (1) 10" Rectangle Bases - For Use With 60" / 54" / 48" x 144" Surfaces</b>							
	88-24106C610RAB	Laminate	24	106	28¾	141	18.2	T\$ 5420
		Veneer					W\$ 7205	
	<b>Three (3) Bases Total: Two (2) 6" and One (1) 10" Rectangle Bases - For Use With 60" / 54" / 48" x 132" Surfaces</b>							
	88-2494C610RAB	Laminate	24	94	28¾	137	18.2	T\$ 5142
		Veneer					W\$ 6839	

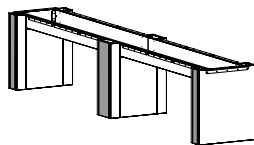

Shown: 88-24142C610RAB  
Shown with Gray Accent Panel

TOPS SOLD SEPARATELY

**Must Specify (in this order):**

- Model #
- Base Finish/Color
- Metal Accent Color
- Accent Panel Finish/Color

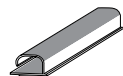
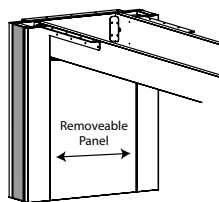

Wire Management Channel

**Description**

- 6" + 10" Rectangle Accent Bases with Trough and Stretcher Rails; 6" Bases on Exterior and 10" Bases on Interior
- Available with TFL (T) or Veneer (W)
- 5/16" Metal Accent Available in Four (4) Colors: Aluminum, Black, Gold, and Platinum; Must Specify Color
- Vertical Grain Direction on Bases
- Bases Include Interior Removable Panel for Wire Management. Removable Panel is 15 7/8" W and Attaches with Z Brackets.
- Wire Management Channel Included; Two (2) Base Units Include One (1) Wire Management Channel and Three (3) Base Units Includes Two (2) Wire Management Channel
- Bases Require Some Assembly; Attachment Hardware Included
- Tops Sold Separately, [See Multiple Unit Details](#)

T = TFL W = Veneer

[See Catalyst Overview For Ordering Options](#)

Item	Model No.		W	D	H	Ship Wt	Cubic Ft	List Price
<b>DISC BASE</b> 	<b>Heavy Duty For Use With</b> Round Tops: 54" + 60" Square Tops: 48"							
	01-2432HDBB	Black	32	32	27 $\frac{3}{4}$	42	4.1	\$ 2523
	01-2432HDBA	Aluminum						
	<b>For Use With</b> Round Tops: 48" Square Tops: 42" Top Surfaces: 48"x96", 48"x84", 48"x72", 42"x96", 42"x84", 42"x72"							
	01-3230DBB	Black	32	32	27 $\frac{3}{4}$	32	3.2	\$ 1842
	01-3230DBA	Aluminum						
	<b>For Use With</b> Round Tops: 30", 36", 42" Square Tops: 36" Top Surfaces: 36"x96", 36"x84", 36"x72"							
	01-2430DBB	Black	24	24	27 $\frac{3}{4}$	32	3.2	\$ 1535
	01-2430DBA	Aluminum						

#### Description

- 4" Diameter 14 Gauge Steel Column with 12"x12" Mounting Plate at Top of Column
- $\frac{1}{4}$ " Thick Disc Plate with 5 Levelers
- Stiffener Bar Not Included; Must Order Separately ([See Stiffener Bars](#))
- See Number of Bases Required Per Top Width Below
- Power Units Available On Center When Using Two or More Disc Bases
- Some Assembly Required

Table Widths	Round+Square	72"	84"	96"
<b>Number of Bases Required</b>	1	2	2	2

#### SQUARE BASE

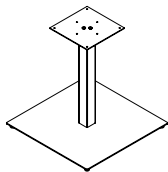

<b>For Use With</b> Round Tops: 48" Square Tops: 42" Top Surfaces: 48"x96", 48"x84", 48"x72", 42"x96", 42"x84", 42"x72"							
01-2630SBB	Black	26	26	27 $\frac{3}{4}$	32	3.2	\$ 1163
01-2630SBA	Aluminum						
<b>For Use With</b> Round Tops: 42" Square Tops: 36" Top Surfaces: 36"x96", 36"x84", 36"x72"							
01-2030SBB	Black	20	20	27 $\frac{3}{4}$	32	3.2	\$ 956
01-2030SBA	Aluminum						
<b>For Use With</b> Round Tops: 36" Square Tops: 30"							
01-1630SBB	Black	16	16	27 $\frac{3}{4}$	32	3.2	\$ 898
01-1630SBA	Aluminum						

#### Description

- 2 $\frac{3}{4}$ " Diameter Column with 12"x12" Mounting Plate at Top of Column
- Stiffener Bar Not Included; Must Order Separately ([See Stiffener Bars](#))
- See Number of Bases Required Per Top Width Below
- Power Units Available On Center When Using Two or More Square Bases
- Some Assembly Required

Table Widths	Round+Square	72"	84"	96"
<b>Number of Bases Required</b>	1	2	2	2

[See Catalyst Overview For Ordering Options](#)

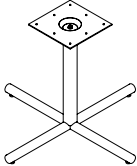

Item	Model No.		W	D	H	Ship Wt	Cubic Ft	List Price		
<b>TUBULAR X-BASE</b> 	<b>For Use With</b> Round Tops: 48" Square Tops: 42" Top Surfaces: 48"x96", 48"x84", 48"x72", 42"x96", 42"x84", 42"x72"									
	01-3830TXB	Black	38	38	27 $\frac{3}{4}$	40	4.2	\$ 699		
	01-3830TXA	Aluminum								
	<b>For Use With</b> Round Tops: 36" + 42" Square Tops: 36" Top Surfaces: 36"x96", 36"x84", 36"x72"									
	01-3230TXB	Black	32	32	27 $\frac{3}{4}$	32	3.2	\$ 633		
	01-3230TXA	Aluminum								
	<b>Description</b> <ul style="list-style-type: none"> <li>• 3" Diameter Column</li> <li>• See Number of Bases Required Per Top Width Below</li> <li>• Stiffener Bar Not Included; Must Order Separately (<a href="#">See Stiffener Bars</a>)</li> <li>• Power Units Available On Center When Using Two or More Tubular X-Bases</li> <li>• Some Assembly Required</li> </ul>									
	<b>Table Widths</b>						<b>Round+Square</b>	<b>72"</b>	<b>84"</b>	<b>96"</b>
	<b>Number of Bases Required</b>						1	2	2	2

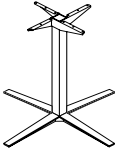
<b>METAL X-BASE</b> 	<b>For Use With</b> Round + Square Tops: 42" + 48" Top Surfaces: 48"x96", 48"x84", 48"x72", 42"x96", 42"x84", 42"x72"								
	08-2642LXBB	Black	35 $\frac{1}{2}$	35 $\frac{1}{2}$	40	33	20.0	\$ 1322	
	08-2642LXBA	Aluminum							
	<i>For 42"H Tables</i>								
	08-2636LXBB	Black	35 $\frac{1}{2}$	35 $\frac{1}{2}$	34	30	17.2	\$ 1275	
	08-2636LXBA	Aluminum							
	<i>For 36"H Tables</i>								
	08-2630LXBB	Black	35 $\frac{1}{2}$	35 $\frac{1}{2}$	28	27	14.5	\$ 1219	
	08-2630LXBA	Aluminum							
	<i>For 30"H Tables</i>								
	<b>For Use With</b> Round + Square Tops: 30" + 36" Top Surfaces: 36"x96", 36"x84", 36"x72"								
	08-2042SXBB	Black	29	29	40	27	15.9	\$ 1235	
	08-2042SXBA	Aluminum							
	<i>For 42"H Tables</i>								
	08-2036SXBB	Black	29	29	34	24	13.7	\$ 1185	
	08-2036SXBA	Aluminum							
<i>For 36"H Tables</i>									
08-2030SXBB	Black	29	29	28	21	11.6	\$ 1139		
08-2030SXBA	Aluminum								
<i>For 30"H Tables</i>									
<b>Description</b> <ul style="list-style-type: none"> <li>• See Number of Bases Required Per Top Width Below</li> <li>• Not Available to be Sold Separately</li> <li>• Stiffener Bar Not Included; Must Order Separately (<a href="#">See Stiffener Bars</a>)</li> <li>• Power Units Available On Center When Using Two or More Metal X-Bases</li> <li>• Ships Assembled</li> </ul>									
<b>Table Widths</b>						<b>Round+Square</b>	<b>72"</b>	<b>84"</b>	<b>96"</b>
<b>Number of Bases Required</b>						1	2	2	2

[See Catalyst Overview For Ordering Options](#)

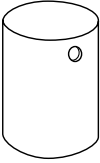
Item	Model No.	W	D	H	Ship Wt	Cubic Ft	List Price
<b>CYLINDER BASE</b> 	<b>For Use With</b> Round Tops: 54" + 60" Square Tops: 48"						
	01-3030CB	30	30	28½	136	10.9	W\$ 3924
	<b>For Use With</b> Round Tops: 42" + 48" Square Tops: 36" + 42" Top Surfaces: 48"x96", 48"x84", 48"x72", 42"x96", 42"x84", 42"x72"						
	01-2020CB	20	20	28½	136	10.9	W\$ 1553
	<b>For Use With</b> Round Tops: 36" Square Tops: 30" Top Surfaces: 36"x96", 36"x84", 36"x72"						
	01-1616CB	16	16	28½	101	7.2	W\$ 1419

Must Specify (in this order):

- Model # and Quantity
- Finish
- Grommet Options

**Description**

- Veneer Cylinder Base Features Multi-Step, Hand-Finished Catalyzed Finish
- Weighted for Stability
- Two (2) Wire Management Black Grommets Standard at Top Edge; 8"Wire Management Opening Standard at Bottom
- See Number of Bases Required Per Top Width Below
- Power Units Available On Center When Using Two or More Cylinder Bases

**Additional Grommet Options: Specify & Add**

GCB1S	Only One (1) Grommet At Top Edge	\$	N/C
NOGC	No Grommets At Top Edge	\$	N/C

Table Widths	Round+Square	72"	84"	96"
<b>Number of Bases Required</b>	1	2	2	2

<b>STIFFENER BAR</b> 	01-00060SB	60	1¾	¾	8	0.3	\$ 129
	01-00048SB	48	1¾	¾	5	0.3	\$ 121

**Description**

- Reinforce Worksurfaces with Large Kneespace Widths
- Includes End Caps to Cover Sharp Edges
- Recommended in Kneespaces 60" or Greater
- Field Installed

[See Catalyst Overview For Ordering Options](#)

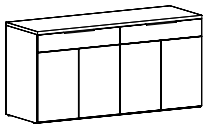
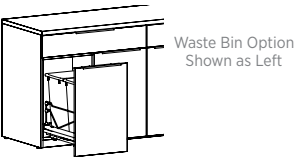
Item	Model No.		W	D	H	Ship Wt	Cubic Ft	Edge Profile + Material	List Price	
<b>BUFFET CREDENZA WITH DRAWERS</b>   Shown: 88-2472BF   Waste Bin Option Shown as Left  Must Specify (in this order): Model # Top/Edge Material Top/Edge Finish/Color Edge Profile Chassis Color Glass (Y/N) Glass Color + Surface Finish Pull Locking Drawer Track Vent Waste Bin	88-2496BF <i>Five Doors + Five Drawers</i>	TFL+HPL	96	24	36	466	56.0	F, G, X, Y / T+P\$	5839	
									H / T+P\$	5952
		Veneer+HPL							F, G, X, Y / W+P\$	8909
									H / W+P\$	9078
		Veneer							F, G, X, Y / W\$	9242
									H / W\$	9379
		88-2484BF <i>Five Doors + Three Drawers</i>	Glass+TFL						Acid Etched Glass Top +T\$	9417
									Gloss Glass Top +T\$	8532
	Glass+Veneer								Acid Etched Glass Top +W\$	12818
									Gloss Glass Top +W\$	11934
	TFL+HPL		84	24	36	404	49.2	F, G, X, Y / T+P\$	5109	
									H / T+P\$	5208
	88-2484BF <i>Five Doors + Three Drawers</i>	Veneer+HPL						F, G, X, Y / W+P\$	7679	
								H / W+P\$	7828	
Veneer								F, G, X, Y / W\$	8015	
								H / W\$	8136	
Glass+TFL								Acid Etched Glass Top +T\$	8204	
								Gloss Glass Top +T\$	7430	
	88-2472BF <i>Four Doors + Two Drawers</i>	Glass+Veneer						Acid Etched Glass Top +W\$	11111	
								Gloss Glass Top +W\$	10336	
TFL+HPL		72	24	36	342	42.3	F, G, X, Y / T+P\$	4098		
								H / T+P\$	4183	
Veneer+HPL								F, G, X, Y / W+P\$	6292	
								H / W+P\$	6420	
	88-2472BF <i>Four Doors + Two Drawers</i>	Veneer						F, G, X, Y / W\$	6450	
								H / W\$	6556	
Glass+TFL								Acid Etched Glass Top +T\$	6853	
								Gloss Glass Top +T\$	6189	
Glass+Veneer								Acid Etched Glass Top +W\$	9205	
								Gloss Glass Top +W\$	8541	
	88-2460BF <i>Three Doors + Three Drawers</i>	TFL+HPL	60	24	36	280	34.5	F, G, X, Y / T+P\$	3940	
								H / T+P\$	4012	
Veneer+HPL								F, G, X, Y / W+P\$	5833	
								H / W+P\$	5942	
Veneer								F, G, X, Y / W\$	5996	
								H / W\$	6084	
	88-2460BF <i>Three Doors + Three Drawers</i>	Glass+TFL						Acid Etched Glass Top +T\$	6213	
								Gloss Glass Top +T\$	5659	
Glass+Veneer								Acid Etched Glass Top +W\$	8269	
								Gloss Glass Top +W\$	7715	

T= TFL P = HPL W = Veneer

*Additional Buffet Credenzas on Next Page*

[See Catalyst Overview For Ordering Options](#)

Item	Model No.		W	D	H	Ship Wt	Cubic Ft	Edge Profile + Material	List Price
<i>CONTINUED FROM PREVIOUS PAGE</i>	88-2448BF <i>Two Doors + Two Drawers</i>	TFL+HPL	48	24	36	209	28.6	F, G, X, Y / T+P\$	2783
								H / T+P\$	2841
		Veneer+HPL						F, G, X, Y / W+P\$	4296
								H / W+P\$	4385
		Veneer						F, G, X, Y / W\$	4463
								H / W\$	4534
		Glass+TFL						Acid Etched Glass Top +T\$	4574
								Gloss Glass Top +T\$	4131
		Glass+Veneer						Acid Etched Glass Top +W\$	6253
								Gloss Glass Top +W\$	5812
<i>Must Specify (in this order):</i> Model # Top/Edge Material Top/Edge Finish/Color Edge Profile Chassis Color Glass (Y/N) Glass Color + Surface Finish Pull Drawer Track Vent Waste Bin	88-2436BF <i>Two Doors + One Drawer</i>	TFL+HPL	36	24	36	209	28.6	F, G, X, Y / T+P\$	2323
								H / T+P\$	2367
		Veneer+HPL						F, G, X, Y / W+P\$	3424
								H / W+P\$	3492
		Veneer						F, G, X, Y / W\$	3594
								H / W\$	3648
		Glass+TFL						Acid Etched Glass Top +T\$	3631
								Gloss Glass Top +T\$	3299
		Glass+Veneer						Acid Etched Glass Top +W\$	4903
								Gloss Glass Top +W\$	4571

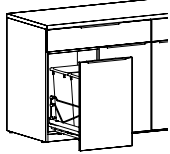

Waste Bin Option Shown as Left

**Description**

- Standard with: Touch Latch Doors with One (1) Adjustable Shelf Behind Doors, Top Profile on Approach Side, 2" Wire Management Channel Along Back of Interior Cabinet, Reverse Slip Matched Pattern on Top Surface, and Vertical Grain Direction on Chassis
- Available with Veneer (W), HPL (P), or Back Painted Tempered Glass (Black or White with Gloss or Acid Etched Finish) Top with Veneer (W) or HPL (P) Chassis
- When Selecting Back Painted Tempered Glass Top; Must Specify Glass Color, Gloss or Acid Etched Finish and Edge Profile; [See Options](#)
- Tops and Chassis Available in Contrasting Colors; Must Specific Color of Each Component
- Studio Pull Centered on Drawer Fronts Standard; Must Specify Pull Color ([See Color Options](#))
- Touch Latch Doors Standard Without Pulls, Optional Studio Pulls; Must Specify Pull Color ([See Color Options](#))
- Studio Pulls Will be Added and Centered on Top of Doors When Waste Bin is Selected; Must Specify Pull Color ([See Color Options](#)) and Optional Waste Bin ([See Options](#))
- Knife Edge not Available
- Additional Options: Locking Doors ([See Options Details](#)); Pull Out Waste Bin ([See Options Details](#)); Back Panel Vent ([See Options Details](#)); Soft Close Drawers ([See Soft Close Option](#))



Double Kerf (F)  
1 3/16"



Duo (G)  
1 3/16"



Fluted (X)  
1 3/16"



Square (Y)  
1 3/16"



Vertical Square (H)  
1 1/2"

T= TFL P= HPL W= Veneer

[See Catalyst Overview For Ordering Options](#)

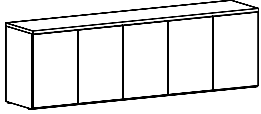
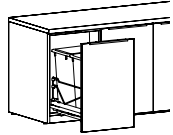
Item	Model No.		W	D	H	Ship Wt	Cubic Ft	Edge Profile + Material	List Price	
<b>24"D CREDENZA</b>   Shown: 88-2496CC   Waste Bin Option Shown as Left	88-2496CC <i>Five Doors</i>	TFL+HPL	96	24	30	415	47.2	F, G, X, Y / T+P\$	4591	
									H / T+P\$	4704
		Veneer+HPL							F, G, X, Y / W+P\$	7195
									H / W+P\$	7365
		Veneer							F, G, X, Y / W\$	7528
									H / W\$	7666
	88-2484CC <i>Five Doors</i>	Glass+TFL							Acid Etched Glass Top +T\$	8169
									Gloss Glass Top +T\$	7283
		Glass+Veneer							Acid Etched Glass Top +W\$	11106
									Gloss Glass Top +W\$	10220
		TFL+HPL	84	24	30	353	41.4	F, G, X, Y / T+P\$	4189	
									H / T+P\$	4288
88-2472CC <i>Four Doors</i>	Veneer+HPL							F, G, X, Y / W+P\$	6418	
								H / W+P\$	6567	
	Veneer							F, G, X, Y / W\$	6754	
								H / W\$	6876	
	Glass+TFL							Acid Etched Glass Top +T\$	7284	
								Gloss Glass Top +T\$	6510	
88-2460CC <i>Three Doors</i>	Glass+Veneer							Acid Etched Glass Top +W\$	9850	
								Gloss Glass Top +W\$	9075	
	TFL+HPL	72	24	30	260	35.6	F, G, X, Y / T+P\$	3384		
								H / T+P\$	3470	
	Veneer+HPL							F, G, X, Y / W+P\$	5268	
								H / W+P\$	5396	
88-2472CC <i>Four Doors</i>	Veneer							F, G, X, Y / W\$	5427	
								H / W\$	5531	
	Glass+TFL							Acid Etched Glass Top +T\$	6140	
								Gloss Glass Top +T\$	5475	
	Glass+Veneer							Acid Etched Glass Top +W\$	8182	
								Gloss Glass Top +W\$	7517	
88-2460CC <i>Three Doors</i>	TFL+HPL	60	24	30	240	29.9	F, G, X, Y / T+P\$	2983		
								H / T+P\$	3055	
	Veneer+HPL							F, G, X, Y / W+P\$	4623	
								H / W+P\$	4732	
	Veneer							F, G, X, Y / W\$	4786	
								H / W\$	4874	
88-2460CC <i>Three Doors</i>	Glass+TFL							Acid Etched Glass Top +T\$	5256	
								Gloss Glass Top +T\$	4702	
	Glass+Veneer							Acid Etched Glass Top +W\$	7059	
								Gloss Glass Top +W\$	6505	

Must Specify (in this order):

- Model #
- Top/Edge Material
- Top/Edge Finish/Color
- Edge Profile
- Chassis Color
- Glass (Y/N)
- Glass Color + Surface Finish
- Pull
- Locking
- Vent
- Waste Bin

Additional 24" Credenzas on Next Page

T= TFL P = HPL W = Veneer

[See Catalyst Overview For Ordering Options](#)

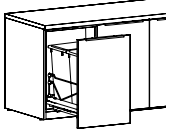
Item	Model No.		W	D	H	Ship Wt	Cubic Ft	Edge Profile + Material	List Price	
<b>CONTINUED FROM PREVIOUS PAGE</b>   <p>Waste Bin Option Shown as Left</p> <p>Must Specify (in this order):                      Model #                      Top/Edge Material                      Top/Edge Finish/Color                      Edge Profile                      Chassis Color                      Glass (Y/N)                      Glass Color + Surface Finish                      Pull                      Vent                      Waste Bin</p>	88-2448CC <i>Two Doors</i>	TFL+HPL	48	24	30	185	20.4	F, G, X, Y / T+P\$ H / T+P\$	2258 2316	
		Veneer+HPL							F, G, X, Y / W+P\$ H / W+P\$	3546 3634
		Veneer							F, G, X, Y / W\$ H / W\$	3713 3784
		Glass+TFL							Acid Etched Glass Top +T\$ Gloss Glass Top +T\$	4049 3606
		Glass+Veneer							Acid Etched Glass Top +W\$ Gloss Glass Top +W\$	5503 5060
		TFL+HPL	88-2436CC <i>Two Doors</i>	36	24	30	150	18.3	F, G, X, Y / T+P\$ H / T+P\$	1909 1953
		Veneer+HPL							F, G, X, Y / W+P\$ H / W+P\$	2846 2915
		Veneer							F, G, X, Y / W\$ H / W\$	3017 3072
		Glass+TFL							Acid Etched Glass Top +T\$ Gloss Glass Top +T\$	3217 2886
		Glass+Veneer							Acid Etched Glass Top +W\$ Gloss Glass Top +W\$	4325 3994

**Description**

- Standard with: One (1) Adjustable Shelf Behind Touch Latch Doors, Top Profile on Approach Side, 2" Wire Management Channel Along Back of Interior Cabinet, Reverse Slip Matched Pattern on Top Surface, and Vertical Grain Direction on Chassis
- Available with Veneer (W), HPL (P), or Back Painted Tempered Glass (Black or White with Gloss or Acid Etched Finish) Top
- When Selecting Back Painted Tempered Glass Top; Must Specify Glass Color, Gloss or Acid Etched Finish and Edge Profile; [See Options](#)
- Tops and Chassis Available in Contrasting Colors; Must Specific Color of Each Component
- Touch Latch Doors Standard Without Pulls, Optional Studio Pulls; Must Specify Pull Color ([See Color Options](#))
- Studio Pulls Will be Added and Centered on Top of Doors When Waste Bin is Selected; Must Specify Pull Color ([See Color Options](#)) and Optional Waste Bin ([See Options](#))
- Knife Edge not Available
- Additional Options: Locking Doors ([See Options Details](#)); Pull Out Waste Bin Available ([See Options Details](#)); Back Panel Vent ([See Options Details](#))



Double Kerf (F) 1 3/16"    Duo (G) 1 3/16"    Fluted (X) 1 3/16"    Square (Y) 1 3/16"    Vertical Square (H) 1 1/2"

T = TFL    P = HPL    W = Veneer

[See Catalyst Overview For Ordering Options](#)

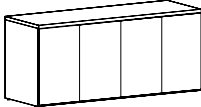
Item	Model No.		W	D	H	Ship Wt	Cubic Ft	Edge Profile + Material	List Price	
<b>20" D CREDENZA</b>  	88-2096CC <i>Five Doors</i>	TFL+HPL	96	20	30	398	39.9	F, G, X, Y / T+P\$	4283	
									H / T+P\$	4378
		Veneer+HPL							F, G, X, Y / W+P\$	6753
									H / W+P\$	6900
		Veneer							F, G, X, Y / W\$	7094
									H / W\$	7210
			Glass+TFL						Acid Etched Glass Top +T\$	7218
									Gloss Glass Top +T\$	6480
			Glass+Veneer						Acid Etched Glass Top +W\$	10029
									Gloss Glass Top +W\$	9291
		88-2084CC <i>Five Doors</i>	TFL+HPL	84	20	30	338	35.1	F, G, X, Y / T+P\$	3909
										H / T+P\$
Veneer+HPL								F, G, X, Y / W+P\$	6026	
								H / W+P\$	6155	
Veneer								F, G, X, Y / W\$	6369	
								H / W\$	6472	
		Glass+TFL						Acid Etched Glass Top +T\$	6443	
								Gloss Glass Top +T\$	5797	
		Glass+Veneer						Acid Etched Glass Top +W\$	8903	
								Gloss Glass Top +W\$	8257	
	88-2072CC <i>Four Doors</i>	TFL+HPL	72	20	30	260	35.6	F, G, X, Y / T+P\$	3141	
									H / T+P\$	3214
Veneer+HPL								F, G, X, Y / W+P\$	4928	
								H / W+P\$	5039	
Veneer								F, G, X, Y / W\$	5093	
								H / W\$	5181	
		Glass+TFL						Acid Etched Glass Top +T\$	5414	
								Gloss Glass Top +T\$	4860	
		Glass+Veneer						Acid Etched Glass Top +W\$	7366	
								Gloss Glass Top +W\$	6812	
	88-2060CC <i>Three Doors</i>	TFL+HPL	60	20	30	220	25.3	F, G, X, Y / T+P\$	2753	
									H / T+P\$	2813
Veneer+HPL								F, G, X, Y / W+P\$	4259	
								H / W+P\$	4353	
Veneer								F, G, X, Y / W\$	4427	
								H / W\$	4501	
		Glass+TFL						Acid Etched Glass Top +T\$	4623	
								Gloss Glass Top +T\$	4163	
		Glass+Veneer						Acid Etched Glass Top +W\$	6298	
								Gloss Glass Top +W\$	5837	

Must Specify (in this order):

- Model #
- Top/Edge Material
- Top/Edge Finish/Color
- Edge Profile
- Chassis Color
- Glass (Y/N)
- Glass Color + Surface Finish
- Pull
- Vent

*Additional 20" Credenzas on Next Page*

T= TFL P = HPL W = Veneer

[See Catalyst Overview For Ordering Options](#)

Item	Model No.		W	D	H	Ship Wt	Cubic Ft	Edge Profile + Material	List Price
<i>CONTINUED FROM PREVIOUS PAGE</i>	88-2048CC	TFL+HPL	48	20	30	165	24.1	F, G, X, Y / T+P\$	2103
		<i>Two Doors</i>						H / T+P\$	2153
		Veneer+HPL						F, G, X, Y / W+P\$	3329
								H / W+P\$	3405
		Veneer						F, G, X, Y / W\$	3499
								H / W\$	3559
		Glass+TFL						Acid Etched Glass Top +T\$	3573
								Gloss Glass Top +T\$	3203
		Glass+Veneer						Acid Etched Glass Top +W\$	4969
								Gloss Glass Top +W\$	4600
	88-2036CC	TFL+HPL	36	20	30	135	15.5	F, G, X, Y / T+P\$	1792
		<i>Two Doors</i>						H / T+P\$	1830
	Veneer+HPL							F, G, X, Y / W+P\$	2688
								H / W+P\$	2747
	Veneer							F, G, X, Y / W\$	2862
								H / W\$	2907
	Glass+TFL							Acid Etched Glass Top +T\$	2860
								Gloss Glass Top +T\$	2582
	Glass+Veneer							Acid Etched Glass Top +W\$	3929
								Gloss Glass Top +W\$	3653

Must Specify (in this order):

- Model #
- Top/Edge Material
- Top/Edge Finish/Color
- Edge Profile
- Chassis Color
- Glass (Y/N)
- Glass Color + Surface Finish
- Pull
- Vent

**Description**

- Standard with: One (1) Adjustable Shelf Behind Touch Latch Doors, Top Profile on Approach Side, 2" Wire Management Channel Along Back of Interior Cabinet, Reverse Slip Matched Pattern on Top Surface, and Vertical Grain Direction on Chassis
- Available with Veneer (W), HPL (P), or Back Painted Tempered Glass (Black or White with Gloss or Acid Etched Finish) Top
- When Selecting Back Painted Tempered Glass Top; Must Specify Glass Color, Gloss or Acid Etched Finish and Edge Profile; [See Options](#)
- Tops and Chassis Available in Contrasting Colors; Must Specific Color of Each Component
- Touch Latch Doors Standard Without Pulls, Optional Studio Pulls; Must Specify Color
- Knife Edge not Available
- Additional Options: Locking Doors ([See Options Details](#)); Back Panel Vent ([See Options Details](#))



Double Kerf (F)  
1 3/16"



Duo (G)  
1 3/16"



Fluted (X)  
1 3/16"



Square (Y)  
1 3/16"



Vertical Square (H)  
1 1/2"

T= TFL P= HPL W= Veneer

[See Catalyst Overview For Ordering Options](#)



Item	Model No.		W	D	H	Ship Wt	Cubic Ft		List Price	
	88-2436SV	TFL+HPL	36	24	36	260	35.6	F, G, X, Y / T+P\$	2585	
									H / T+P\$	2631
		Veneer+HPL							F, G, X, Y / W+P\$	3852
									H / W+P\$	3921
		Veneer							F, G, X, Y / W\$	4023
								H / W\$	4078	

Must Specify (in this order):

- Model #
- Top/Edge Material
- Top/Edge Finish/Color
- Edge Profile
- Optional Grommet

**Description**

- Top Edge Profiled on Approach Side Only (See Edge Options); Must Specify Edge Selection ([See Edge Details](#))
- Two (2) Box Drawers, Open Storage, and Storage Behind Two (2) Doors
- Locking Casters

**Grommet Option: Specify & Add**

1-GRMT	Grommet in Back Panel; Must Specify Black or Silver	\$ 52
--------	---	-------

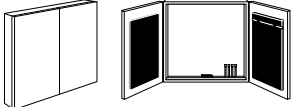
Item	Model No.		W	D	H	Ship Wt	Cubic Ft		List Price
	88-4848VB	TFL	48	5	48	150	11.0	T\$	2956
		Veneer							W\$

Must Specify (in this order):

- Model #
- Color
- Projection Screen
- Tackboard Fabric

**Description**

- Tackboard on Each Door Standard in Black Fabric Unless Specified; Price Valid for Grades 1, 2, & 3 (See Other Pricing Below)
- Display Rail with Adjustable Hooks for Flipchart
- Magnetic Porcelain Non-Glare Writing Surface
- Includes Flipchart, Set of Four (4) Dry Erase Markers and Eraser, Mounting Hardware
- Does Not Feature Soft Close Hinges

**Options: Specify & Add**

	Grade 4	Grade 5	Grade 6	Grade 7	Grade 8	Grade 9	Grade 10	
Tackboard Fabric Change	\$ 278	408	540	728	924	1152	1416	
1-PS	Projection Screen (Requires Field Installation)						\$	1062

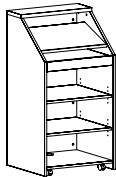
Item	Model No.		W	D	H	Ship Wt	Cubic Ft		List Price	
	88-2650LS	TFL+HPL	26	24	50	130	21.9	F, G, X, Y / T+P\$	1911	
									H / T+P\$	1921
		Veneer+HPL							F, G, X, Y / W+P\$	3451
									H / W+P\$	3477
		Veneer							F, G, X, Y / W\$	3587
								H / W\$	3601	

Must Specify (in this order):

- Model #
- Top/Edge Material
- Top/Edge Finish/Color
- Edge Profile

**Description**

- Top Edge Profiled on Approach Side Only (See Edge Options); Must Specify Edge Selection
- Fixed Shelf Angled for User Comfort, One (1) Pullout Shelf, and Two (2) Adjustable Shelves
- Two (2) Locking and Two (2) Non-Locking Casters
- Wire Management Grommet on Bottom Shelf

Item	Model No.	W	D	H	Ship Wt	Cubic Ft	List Price
MAGNETIC GLASS MARKER BOARD  FOR USE WITH 30"H CREDENZA AND SHELVING	GMB-4048W	48	½	40⅞	67	11.0	\$ 3128
	GMB-4042W	42	½	40⅞	58	9.9	\$ 2644
	GMB-4036W	36	½	40⅞	50	8.8	\$ 2285
	GMB-4030W	30	½	40⅞	42	7.7	\$ 1924

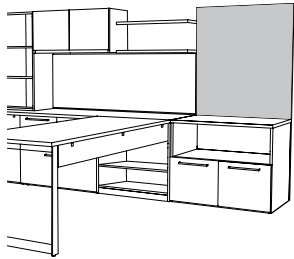

#### Description

- Available in Black (BLMKR) or White (WHMKR), Must Specify
- Tempered Glass Magnetic Marker Boards Include Mounting Brackets
- For Use over 30"H Desks and Credenzas with Wall Mount Hutches or Shelving
- For Rare Earth Magnets, Marker and Eraser Sets; [See Set Options](#)

Must Specify (in this order):

Model #  
Color



Rare Earth Magnets, Marker and Eraser set available; [See Set Options](#)

MAGNETIC GLASS MARKER BOARD  FOR USE WITH 30"H CREDENZA AND SHELVING	GMB-5248W	48	½	52⅞	86	13.5	\$ 3988
	GMB-5242W	42	½	52⅞	76	12.2	\$ 3369
	GMB-5236W	36	½	52⅞	65	10.8	\$ 2904
	GMB-5230W	30	½	52⅞	54	9.5	\$ 2441

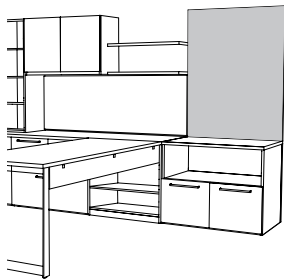

#### Description

- Available in Black (BLMKR) or White (WHMKR), Must Specify
- Tempered Glass Magnetic Marker Boards Include Mounting Brackets
- For Use Next to Tall Surface or Wall Mount Hutches
- For Rare Earth Magnets, Marker and Eraser Sets; [See Set Options](#)

Must Specify (in this order):

Model #  
Color



Rare Earth Magnets, Marker and Eraser set available; [See Set Options](#)

[See Catalyst Overview For Ordering Options](#)

Item	Model No.	W	D	H	Ship Wt	Cubic Ft	List Price
MAGNETIC GLASS MARKER BOARD	GMB-8236W	36	½	82⅞	102	15.8	\$ 4453
FOR USE FROM FLOOR TO TOP OF UNIT	GMB-7036W	36	½	70⅞	87	13.8	\$ 3834
	GMB-5136W	36	½	51⅞	63	10.6	\$ 2802
	GMB-8230W	30	½	82⅞	85	13.8	\$ 3730
	GMB-7030W	30	½	70⅞	72	12.1	\$ 3215
	GMB-5130W	30	½	51⅞	53	9.3	\$ 2354

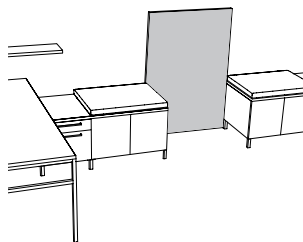

Must Specify (in this order):

Model #  
Color

#### Description

- Available in Black (BLMKR) or White (WHMKR), Must Specify
- Tempered Glass Magnetic Marker Boards Are One (1) Piece with No Seams
- Mounting Brackets Included
- For Use From Floor to Top of Unit
- For Rare Earth Magnets, Marker and Eraser Sets; See Below



Rare Earth Magnets, Marker and Eraser set available; See Below

MARKER AND ERASER SET	01-MRKRSETBL	For Use with Black Marker Boards and Black Glass Doors	\$ 123
	01-MRKRSETWH	For Use with White Marker Boards and White Glass Doors	



#### Description

- 01-MRKRSETWH May Also be Used with Dry Erase Doors and Boards
- Includes 4 Markers and an Eraser

RARE EARTH MAGNET SET	01-MAGBL	For Use with White Marker Boards	\$ 114
	01-MAGWH	For Use with Black Marker Boards	



#### Description

- Includes Set of Five (5) Rare Earth Magnets
- To be Used with Tempered Glass Magnetic Marker Boards
- Comfort Grip with Stylish Protective Plastic Coating

Item	Model No.		W	D	H	Ship Wt	Cubic Ft	List Price
ROUND GROMMET COVER FIELD INSTALLED	01-GRMTBK	Black	-	-	-	-	-	\$ 11
	01-GRMTSL	Silver						

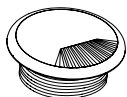

OPEN MARKET ONLY  
(SILVER)

#### Description

- 60mm Round Grommet Cover
- Field Installed

SINGLE POWER SAND DOLLAR	01-SAND60PS	Silver	3	3	4	1	0.2	\$ 98
	01-SAND60PW	White						
	01-SAND60PB	Black						

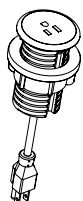

#### Description

- Mounts in 2 $\frac{3}{8}$ " (60mm) Round Grommet
- Single Power Outlet with 6' Cord

DOUBLE USB SAND DOLLAR	01-SAND60US	Silver	3	3	4	1	0.2	\$ 277
	01-SAND60UW	White						
	01-SAND60UB	Black						

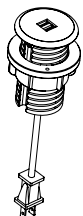

#### Description

- Mounts in 2 $\frac{3}{8}$ " (60mm) Round Grommet
- Dual USB Outlets with 6' Cord

DOCK 950 WIRELESS CHARGER	01-DOCK950W	White	3 $\frac{3}{16}$ "	3 $\frac{3}{16}$ "	-	1	0.2	\$ 265
	01-DOCK950B	Black						



OPEN MARKET ONLY

#### Description

- For Use with Wireless Charging Enabled Devices
- 5 Watts Maximum Output with a Direct Current of 5V 2A and 10 Watts Maximum with Quick Charge 2.0
- LED will Confirm Pairing with Device and Begin Wireless Charging

WIRELESS AND USB CHARGER	01-DOCK150W	White	3	3	3 $\frac{1}{4}$ "	1	0.2	\$ 405
	01-DOCK150B	Black						



OPEN MARKET ONLY

#### Description

- For Use with Wireless Charging Enabled Devices and USB Charging Devices
- 5 Watt Maximum Output with a Direct Current Input of 5V 6A (Wireless Fast Charge)
- Pop-Up is 3 $\frac{1}{4}$ "H and Includes Three (3) USB Ports; One (1) 12 Watt Maximum with 2.4A (USB Fast Charge) and Two (2) 5 Watt with 1A (USB Standard Charge)
- LED Light will Confirm Pairing with Device and Begin Wireless Charging
- UL and cUL Certified

[See Catalyst Overview For Ordering Options](#)

Item	Model No.		W	D	H	Ship Wt	Cubic Ft	List Price
	01-DUOBEZELW	White	6½	2¾	3¼	1	0.2	\$ 675
	01-DUOBEZELB	Black						
	01-DUOBEZELS	Silver						

#### Description

- Sits on Table Top and Includes: Two (2) Power, Two (2) USB, 10' Cord, and All Mounting Hardware
- Independent USB Circuit Controllers Deliver up to 2.1 Amps to Each Post
- FCC Part 15A, UL Recognized for Horizontal and Vertical Applications

	01-TRIOBEZELW	White	9	2¾	3	1	0.2	\$ 725
	01-TRIOBEZELB	Black						
	01-TRIOBEZELS	Silver						

#### Description

- Sits on Table Top and Includes: Three (3) Power Outlets, Two (2) USB Ports, One (1) Open Data Port, 10' Cord, and All Mounting Hardware
- HDMI, VGA, and RJ45 Accessories for Open Data Port; Sold Separately, [See Accessories](#)
- Independent USB Circuit Controllers Deliver up to 2.1 Amps to Each Post
- FCC Part 15A, UL Recognized for Horizontal and Vertical Applications

	01-PDUOBEZELW	White	6½	2¾	3	1	0.2	\$ 668
	01-PDUOBEZELB	Black						
	01-PDUOBEZELS	Silver						

#### Description

- Sits on Table Top and Includes: Two (2) Power, Two (2) USB, 12" Cord, and All Mounting Hardware
- Requires Daisy Chain Power Box; Sold Separately, [See Power Box Details](#)
- Non-Sequential System Allows up to Eight (8) Modules to be Connected with Jumper Cord, [See Jumper Cord Details](#)
- Independent USB Circuit Controllers Deliver up to 2.1 Amps to Each Post
- FCC Part 15A, RU Listed and UL Recognized for Horizontal and Vertical Applications

[See Catalyst Overview For Ordering Options](#)

Item	Model No.		W	D	H	Ship Wt	Cubic Ft	List Price
TRIO BEZEL DAISY CHAIN PLUG	01-PTRIOBEZELW	White	9	2½	3	1	0.2	\$ 715
	01-PTRIOBEZELB	Black						
	01-PTRIOBEZELS	Silver						

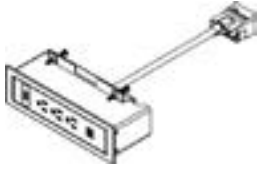

#### Description

- Sits on Table Top and Includes: Three (3) Power Outlets, Two (2) USB Ports, One (1) Open Data Port, 12" Cord, and All Mounting Hardware
- HDMI, VGA, or RJ45 Accessory for Open Data Port; Sold Separately, [See Accessories](#)
- Requires Daisy Chain Power Box, Specified Separately, See Below
- Non-Sequential System Allows up to Eight (8) Modules to be Connected with Jumper Cord, See Below
- Independent USB Circuit Controllers Deliver up to 2.1 Amps to Each Post
- FCC Part 15A, RU Listed and UL Recognized for Horizontal and Vertical Applications

DAISY CHAIN POWER BOX	01-PPOWER		-	-	-	1	0.2	\$ 775
		<i>76" Perimeter, 36" Power Cord</i>						
	01-PPOWER2		-	-	-	1	0.2	\$ 796
		<i>24" Perimeter, 144" Power Cord</i>						



#### Description

- Powers up to Eight (8) Duo and Trio Daisy Chain Units
- One Nema Plug and One Daisy Chain Plug
- 12-Amp System Rating
- 15-Amp Over-Current Protection

DAISY CHAIN JUMPER CORD	01-6JUMP	<i>72" Long</i>	-	-	-	1	0.2	\$ 299
	01-5JUMP	<i>60" Long</i>	-	-	-	1	0.2	\$ 284
	01-4JUMP	<i>48" Long</i>	-	-	-	1	0.2	\$ 240
	01-2JUMP	<i>24" Long</i>	-	-	-	1	0.2	\$ 220



#### Description

- Connects Duo and Trio Daisy Chain Units
- Non-Sequential System Allows up to Eight (8) Modules to be Connected

[See Catalyst Overview For Ordering Options](#)

Item	Model No.	W	D	H	Ship Wt	Cubic Ft	List Price
HDMI DATA PORT ACCESSORY FOR TRIO UNITS	01-LCOMHDMI	-	-	-	1	0.2	\$ 166

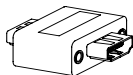

OPEN MARKET ONLY

VGA DATA PORT ACCESSORY FOR TRIO UNITS	01-LCOMVGA	-	-	-	1	0.2	\$ 121
--	------------	---	---	---	---	-----	--------

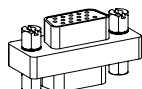

RJ45 DATA PORT ACCESSORY FOR TRIO UNITS	01-LCOMRJ45	-	-	-	1	0.2	\$ 79
---	-------------	---	---	---	---	-----	-------

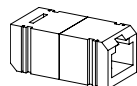

DPORT	01-DPORT4A	Aluminum	8	4	-	7	0.2	\$ 1093
	01-DPORT4B	Black						

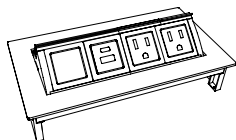
**Description**

- Retracts into Work Surface to Regain Productive Space; One-Touch Access to Power and Data
- Two (2) Power Outlets, One (1) USB A+C, and One (1) Open Port
- Optional Telecom Port Components, [See Compatible Units](#)
- Water-Proof Simplex (Outlets)
- Includes a Voice/Data Adapter Kit to Accept Couplers and Jacks When Required
- 10' Power Cord
- UL Recognized

E2X	01-E2X6A	Aluminum	11	9 <sup>3</sup> / <sub>16</sub>	-	6	0.7	\$ 1625
	01-E2X6B	Black						
	01-E2X4A	Aluminum	8	9 <sup>3</sup> / <sub>16</sub>	-	5	0.5	\$ 1494
	01-E2X4B	Black						

01-E2X4  
SIN PENDING**Description**

- In Surface, Dual Side Application; Soft Touch Access to Power and Data
- Each Side has the Following: 11" Unit Includes Three (3) Power Outlets, One (1) USB A+C, and Two (2) Open Port on Each Side; 8" Unit Includes Two (2) Power Outlets, One (1) USB A+C, and One (1) Open Port
- Optional Telecom Port Components, [See Compatible Units](#)
- 6' Power Cord
- UL Listed

[See Catalyst Overview For Ordering Options](#)

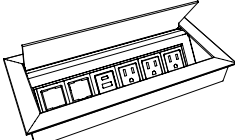
Item	Model No.		W	D	H	Ship Wt	Cubic Ft	Edge Profile + Material	List Price
	01-ELLORA6A	Aluminum	11	5	-	6	0.7	\$	852
	01-ELLORA6B	Black							
	01-ELLORA4A	Aluminum	8	5	-	5	0.5	\$	792
	01-ELLORA4B	Black							

01-ELLORA6  
SIN PENDING

#### Description

- In Surface Application; Soft Touch Access to Power and Data
- 11" Includes Three (3) Power Outlets, One (1) USB A+C, and Two (2) Open Port; 8" Includes Two (2) Power Outlets, One (1) USB A+C, and One (1) Open Port
- Optional Telecom Port Components, See Below for Compatible Units
- 6' Power Cord
- UL Recognized

USB PORT	01-USBPORT		-	-	-	-	-	\$	161
----------	------------	--	---	---	---	---	---	----	-----

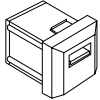

#### Description

- Passive USB-A Port with Increased Transfer Speed Up to 5 gbs/sec
- Simultaneous Read/Write Capability; Idle Device Power Saving State
- 6' Cord
- Compatible with 01-DPORT4A, 01-DPORT4B, ELLORA4A, ELLORA4B, ELLORA6A, ELLORA6B, E2X4A, E2X4B, E2X6A, and E2X6B

VOICE COUPLER	01-VOICE1		-	-	-	-	-	\$	73
---------------	-----------	--	---	---	---	---	---	----	----

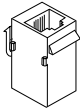

#### Description

- 6-Pin Modular Plug
- Molded Black; Cord Not included
- Compatible with 01-DPORT4A, 01-DPORT4B, ELLORA4A, ELLORA4B, ELLORA6A, ELLORA6B, E2X4A, E2X4B, E2X6A, and E2X6B

DATA PORT	01-RJ4DATA		-	-	-	-	-	\$	167
-----------	------------	--	---	---	---	---	---	----	-----



#### Description

- 8-Pin Modular Plug; Cat6 Ethernet Cable; Pre-terminated Cable
- 10' Cord
- Compatible with 01-DPORT4A, 01-DPORT4B, ELLORA4A, ELLORA4B, ELLORA6A, ELLORA6B, E2X4A, E2X4B, E2X6A, and E2X6B

[See Catalyst Overview For Ordering Options](#)



Item	Model No.	W	D	H	Ship Wt	Cubic Ft	List Price
VGA CONNECTOR ACCESSORY	01-VGACON	-	-	-	1	0.2	\$ 149

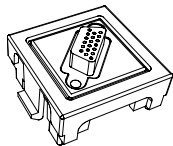

**Description**

- VGA Port for 01-DPORT4A, 01-DPORT4B, ELLORA4A, ELLORA4B, ELLORA6A, ELLORA6B, E2X4A, E2X4B, E2X6A, and E2X6B
- Enables Devices to Remote Display on Monitors
- 10' Cord
- Male/Female Connector

PASSIVE USB-C ACCESSORY	01-PUSBC	-	-	-	1	0.2	\$ 95
-------------------------	----------	---	---	---	---	-----	-------

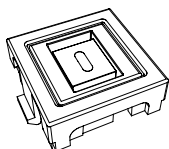

**Description**

- Passive USB-C Port ; Unit Provides Data Connection to Transfer Data Only, No Charging Capabilities
- Compatible with 01-DPORT4A, 01-DPORT4B, ELLORA4A, ELLORA4B, ELLORA6A, ELLORA6B, E2X4A, E2X4B, E2X6A, and E2X6B
- Male/Female Connector

CHARGING USB-A+C ACCESSORY	01-USBAC	-	-	-	1	0.2	\$ 283
----------------------------	----------	---	---	---	---	-----	--------

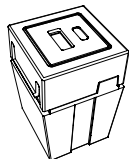

**Description**

- For Charging Devices
- 20 Watt Power Supply
- USB+C Charging Port for 01-DPORT4A, 01-DPORT4B, ELLORA4A, ELLORA4B, ELLORA6A, ELLORA6B, E2X4A, E2X4B, E2X6A, and E2X6B

HDMI CONNECTOR ACCESSORY	01-HDMICON	-	-	-	1	0.2	\$ 124
--------------------------	------------	---	---	---	---	-----	--------

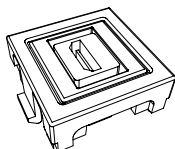

**Description**

- HDMI Port for 01-DPORT4A, 01-DPORT4B, ELLORA4A, ELLORA4B, ELLORA6A, ELLORA6B, E2X4A, E2X4B, E2X6A, and E2X6B
- Connects to High Definition Displays
- Female/Female Connector
- 18" Cord

[See Catalyst Overview For Ordering Options](#)

Item	Model No.		W	D	H	Ship Wt	Cubic Ft	Edge Profile + Material	List Price
INTERACT POWER & DATA	01-INTERACTG2A	Aluminum	9	5 $\frac{3}{8}$	2 $\frac{3}{4}$	5	0.2	\$	891
	01-INTERACTG2B	Black							



#### Description

- Includes: Two (2) Power Outlets, Two (2) USB-A Charging Ports, One (1) Telecom Plate Opening; Two (2) Keystone Openings for Voice/Data Jacks
- One (1) Telecom Plates Included with the Unit: One (1) 01-ABLAB Plate (Consists of One (1) RJ45 Cat 6, One (1) RJ11 Cat 3 Phone Jack)
- Convenience Plug on Bottom
- 6' Power Cord
- UL and CSA Recognized
- Additional Telecom Plates, [See ECA Telecom Plate Options](#)

OASIS MINI POWER & DATA	01-OASISMA	Aluminum	15	9	5	11	0.3	\$	3191
	01-OASISMB	Black							



Top View

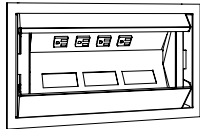

#### Description

- For Use with Conference Tables
- Soft Touch Hinged Lid
- Four (4) Power Outlets, Three (3) Telecom Plate Openings
- Two (2) Telecom Plates Included with the Unit: One (1) 01-ABLAB Plate (Consists of One (1) RJ45 Cat 6, One (1) RJ11 Cat 3 Phone Jack); One (1) 01-ABLB Plate (Consists of One (1) RJ45 Cat 6)
- 9' Power Cord
- UL Listed
- Additional Telecom Plates, [See ECA Telecom Plate Options](#)

DOCK800	01-DOCK800S	Silver	14	9	-			\$	2047
	01-DOCK800B	Black							

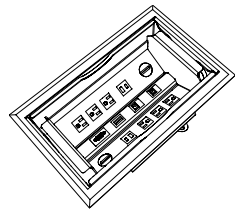

OPEN MARKET ONLY

#### Description

- Stylish Aluminum Housing with Beveled Edges; Soft Touch Access and Closure
- Includes: Six (6) Power Outlets, Two (2) USB-A 5V Ports, Two (2) USB-C Charging Ports, One (1) RJ45 Ethernet Port, One (1) RJ11 Port, One (1) HDMI Port, and One (1) VGA Port
- 10' Power Cord
- UL and cUL Certified

POWER ENTRY HARD WIRED	01-HWPOWERENTRY		72	-	-	1	0.2	\$	322
------------------------	-----------------	--	----	---	---	---	-----	----	-----

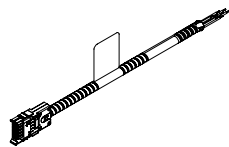

#### Description

- Eight (8) Wire/Four (4) Circuit Hard Wire In-feed
- UL183 Compliant

[See Catalyst Overview For Ordering Options](#)

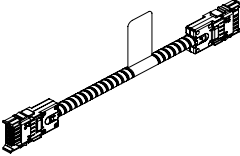
Item	Model No.	W	D	H	Ship Wt	Cubic Ft	List Price
	01-HW2JUMP	24	-	-	1	0.2	\$ 193
	01-HW3JUMP	36	-	-	1	0.2	\$ 206
	01-HW4JUMP	48	-	-	1	0.2	\$ 212
	01-HW5JUMP	60	-	-	1	0.2	\$ 255
	01-HW6JUMP	72	-	-	1	0.2	\$ 270

**Description**

- Eight (8) Wire/Four (4) Circuit Hard Wire Jumper
- UL183 Compliant

QUAD BLOCK HARD WIRED	01-HWQUADBLOCK	-	-	-	1	0.2	\$ 62
-----------------------	----------------	---	---	---	---	-----	-------

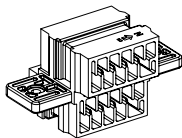
**Description**

- Eight (8) Wire/Four (4) Circuit Hard Wire Connector
- UL183 Compliant
- For Connecting Jumpers and Power Units
- Quantity of Four (4) Female Inputs

WIRE MANAGEMENT CHANNEL	01-WMGR4	16	1½	¾	1	-	\$ 116
-------------------------	----------	----	----	---	---	---	--------

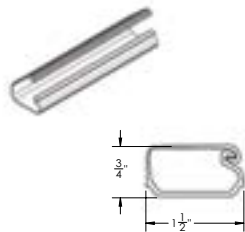
**Description**

- Set of Four (4) Black Plastic Wire Management Channels
- Snap Lock Channel
- Attaches with Adhesive Strips
- Ships via UPS Only

WIRE CHANNEL	01-32125	24	1½	1	.25	0.3	\$ 106
--------------	----------	----	----	---	-----	-----	--------

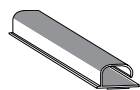
**Description**



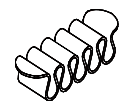

- Available in Black
- Channels Attach with Two (2) Double-Sided Installation Tape
- Open J Channel for Easy Storage of Cables

CABLE GRIP	01-WMGRCB	5%	2%	-	-	-	\$ 17
------------	-----------	----	----	---	---	---	-------

**Description**

- Under Surface Wire Management
- Black

[See Catalyst Overview For Ordering Options](#)

Item	Model No.	Description	List Price
<b>ECA TELECOM PLATES</b>	01-ABL	Telecom Plate, Blank Plate	\$ 41
	01-ABL737373	Telecom Plate, Three (3) RJ45 Cat 5e	\$ 367
Compatible with:	01-ABLAB	Telecom Plate, One (1) RJ45 Cat 6, One (1) RJ11 Cat 3 Phone	\$ 206
	01-ABLAB102	Telecom Plate, One (1) RJ45 Cat 6, One (1) RJ11 Cat 3, One (1) USB W/72" Patch Cord	\$ 320
	01-ABLABB	Telecom Plate, Two (2) RJ45 Cat 6, One (1) RJ11 Cat 3 Phone	\$ 320
Oasis Mini Power & Data 01-OASISMA, 01-OASISMB	01-ABLB	Telecom Plate, One (1) RJ45 Cat 6	\$ 149
	01-ABLBB	Telecom Plate, Two (2) RJ45 Cat 6	\$ 260
	01-ABLBBB	Telecom Plate, Three (3) RJ45 Cat 6	\$ 367
	01-ABLBBBB	Telecom Plate, Four (4) RJ45 Cat 6	\$ 476
	01-ABLBBC51	Telecom Plate, Two (2) RJ45 Cat 6, One (1) 15 Pin HD VGA w/72" Patch Cord	\$ 446
Interact Power & Data 01-INTERACTG2A, 01-INTERACTG2B	01-ABLBC51L	Telecom Plate, One (1) RJ45 Cat 6, One (1) Mini Stereo Inline, One (1) 15 Pin HD VGA w/72" Patch Cord	\$ 410
	01-ABLC3811	Telecom Plate, One (1) RJ45 Cat 6 Data Inline, One (1) RJ11 Cat 3 Phone Inline	\$ 197
	01-ABLC45	Telecom Plate, One (1) HDMI w/36" Patch Cord	\$ 295
Power Center 01-INTRFCIA, 01-INTRFCIB	01-ABLC45C51L	Telecom Plate, One (1) Mini Stereo Inline, One (1) HDMI w/36" Patch Cord, One (1) 15 Pin HD VGA w/72" Patch Cord	\$ 558
	01-ABLC51L	Telecom Plate, One (1) 15 Pin HD VGA & One (1) Mini Stereo Inline Jack	\$ 298
	01-ABLCRDM	Telecom Plate, Three (3) Cord Bushings	\$ 96

Madera creates a variety of looks from rich, refined transitional to fresh, modern contemporary by offering an abundance of options, including premium veneer. Finely crafted in select Cherry, Maple, Walnut, and Oak veneers, Madera features a UV topcoat on all exposed surfaces adding unsurpassed hardness and extreme durability for long lasting office applications.

### CONSTRUCTION

*Madera features a Veneer chassis with your choice of either a Veneer or HPL top. Units ship assembled unless otherwise noted.*

### VENEER

- Choose from premium veneer or select veneer on exposed surfaces in American Black Walnut, White Oak, Cherry, or Maple species
- The American Black Walnut, White Oak, and Cherry veneers are book matched veneer faces, while the Maple is a slip-matched veneer face
- These veneers are carefully selected and matched to assure proper balance and consistency

### TOPS

- Wood Veneer tops have a 5-ply balanced construction while High Pressure Laminate (HPL) tops have a 3-ply balanced construction, 1 $\frac{3}{16}$ " thick, with hardwood rims
- Tops featuring the Bullnose (D), Tri-Round (E), Flute (X), and Square (Y) edge profiles have vertical profiles
- Tops featuring the Radius (A) and Bevel (B) edge profiles have the same construction, but provide a matching reverse profile on connecting edge
- Grain direction runs left to right unless otherwise noted

### CHASSIS

- Tops, end panels, and modesty panels are securely fastened using high quality European style fastening systems and heavy-duty, 16-gauge joining brackets to assure maximum strength
- All units are equipped with heavy-duty, adjustable glides to ensure proper leveling and compensation for uneven floors

### DRAWERS

- All drawer fronts are standard with matched faces
- All drawers feature 5-sided construction allowing for easy removal of drawer fronts
- Fronts are 3-ply construction and are  $\frac{3}{4}$ " thick with matched grain
- Drawer interiors are dovetail construction with  $\frac{7}{16}$ " thick hardwood sides and backs and  $\frac{5}{32}$ " thick hardboard bottoms
- The drawer interiors are sanded, sealed, and finished to provide a smooth, quality feel and appearance
- All drawers feature full extension, progressive action slides with precision steel ball bearings
- Box and file drawers are tested for 100lb capacity
- Lateral files are tested for 200lb capacity
- All suspensions have a limited lifetime warranty

### FILING

- All file drawers are standard with filing systems designed to accommodate a variety of filing requirements
- Letter width file drawers provide letter filing front to back and legal filing side to side
- Lateral file drawers provide legal or letter filing front to back or side to side

### STORAGE

- All hinged doors include soft close hinges, unless noted
- One piece hinge and base plate combination
- Soft close hinges reduce stress placed on the cabinet when the door is closed and offers a quiet closure

### LOCKING

- All credenzas feature locking file drawers; optional locking doors is available on select units
- Removable lock cylinders allow for units to be re-keyed at a later date, if required
- Units are shipped randomly keyed as standard
- Keyed alike units available upon request at no additional charge
- Lock core will match pull color

### CORD MANAGEMENT

- Grommets are available in black or silver, please specify color

### INTERIOR DRAWER DIMENSIONS & FILING CAPABILITIES

#### Models

16-2472SC      16-2072SC

#### Drawers

File

#### W

15 $\frac{1}{32}$ "

#### L

16 $\frac{1}{4}$ "

#### D

8 $\frac{29}{32}$ "

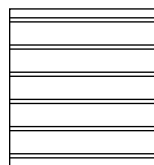

Legal Front to Back

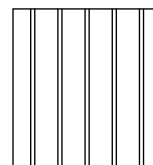

Legal Side to Side

#### Models

16-2466SC

#### Drawers

File

#### W

12 $\frac{1}{32}$ "

#### L

16 $\frac{1}{4}$ "

#### D

8 $\frac{29}{32}$ "

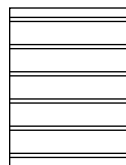

Letter Front to Back

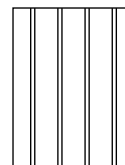

Legal Side to Side

#### Models

14-2072SC

#### Drawers

Box

#### W

15 $\frac{1}{32}$ "

#### L

16 $\frac{1}{4}$ "

#### D

3 $\frac{21}{32}$ "

File

15 $\frac{1}{32}$ "

16 $\frac{1}{4}$ "

8 $\frac{29}{32}$ "

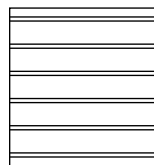

Legal Front to Back

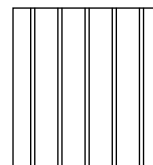

Legal Side to Side

**INTERIOR DRAWER DIMENSIONS & FILING CAPABILITIES (CONTINUED)**

**Models**

14-3670WD2L 14-3670WD2R

**Drawers**

File **W** **L** **D**  
14<sup>9</sup>/<sub>32</sub>" 16<sup>1</sup>/<sub>4</sub>" 8<sup>29</sup>/<sub>32</sub>"



Letter Front to Back

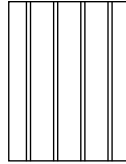

Legal Side to Side

**Models**

14-3670WD1L 14-3670WD1R

**Drawers**

Box **W** **L** **D**  
14<sup>9</sup>/<sub>32</sub>" 16<sup>1</sup>/<sub>4</sub>" 3<sup>2</sup>/<sub>32</sub>"  
File 14<sup>9</sup>/<sub>32</sub>" 16<sup>1</sup>/<sub>4</sub>" 8<sup>29</sup>/<sub>32</sub>"



Letter Front to Back

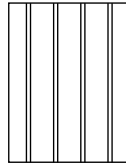

Legal Side to Side

**Models**

14-3670SU2

**Drawers**

Lateral **W** **L** **D**  
32<sup>9</sup>/<sub>32</sub>" 16<sup>1</sup>/<sub>4</sub>" 8<sup>29</sup>/<sub>32</sub>"

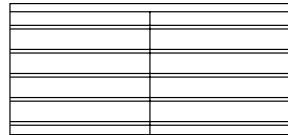

2 Rows Letter Front to Back



1 Row Legal Side to Side

**HOW TO ORDER EXAMPLES**

	Model No.	QTY	Description	Example
<b>TABLE TOP</b>	14-4848CT	1	Top Material	PV
			Finish/Color	MO
			Edge Profile	D
<b>BASE</b>	01-2228STR4	1	Color	ALUM
<b>WORK TABLE</b>	14-3672WT	1	Premium/Standard Veneer	W
			Top Material	P
			Finish/Color	SM
			Edge Profile	Y
<b>CREDENZA</b>	16-2472SC	1	Premium/Standard Veneer	PV
			Top Material	P
			Finish/Color	HW
			Edge Profile	B
			Pull	ABM
<b>WARDROBE</b>	14-3670WD1L	1	Premium/Standard Veneer	W
			Finish/Color	HW
			Edge Profile	D
			Pull	AQD
			Locking Door	WITH LOCKING

**PREMIUM VENEER (PV) AND VENEER (W) OPTIONS**

Veneer features UV Advantage, an ultra-violet finish, on all exposed surfaces by utilizing roll-coat UV technology

AW	Artisan Walnut**	MW	Mahogany Walnut**
AS	Asian Night	MAS	Mesa Sunset*
CO	Columbian Walnut**	MTS	Metropolis Sky
DC	Dark Cherry**	ORW	Oak Riftwood*
DFW	Dark Forest Walnut**	PNW	Pinnacle Walnut
EW	Espresso**	SCH	Select Cherry**
FO	Fawn Oak**,**	SKC	Shaker Cherry**
GC	Golden Cherry**	SM	Sugar Maple
HW	Harvest Walnut**	WTA	Weathered Ash*
HNW	Henna Walnut	WC	Williamsburg Cherry**
LW	Legacy Walnut**		

\* Finish is Low Sheen \*\* Available in Premium Veneer (PV)

**HPL (P) LAMINATE WORKSURFACE OPTIONS**

**WOODGRAIN**

AS	Asian Night	PNW	Pinnacle Walnut
CO	Columbian Walnut	SCH	Select Cherry
EF	Espresso	SKC	Shaker Cherry
GC	Golden Cherry	SM	Sugar Maple
MW	Mahogany Walnut	WC	Williamsburg Cherry
ORW	Oak Riftwood	WTA	Weathered Ash

### PULL OPTIONS

Note: Lock Core will match Pull Color

AAC Arc, Aluminum	AEL Elite, Aluminum
BAC Arc, Black	BEL Elite, Black
ABM Beam, Aluminum	FPL Finger
BBM Beam, Black	AFL Flair, Aluminum
BBT Bow Tie, Black	CFL Flair, Chrome
NBT Bow Tie, Nickel	AFC Focus, Aluminum
ABU Buckle, Aluminum	BFC Focus, Black
BBU Buckle, Black	AQD Quadra, Aluminum
	BQD Quadra, Black

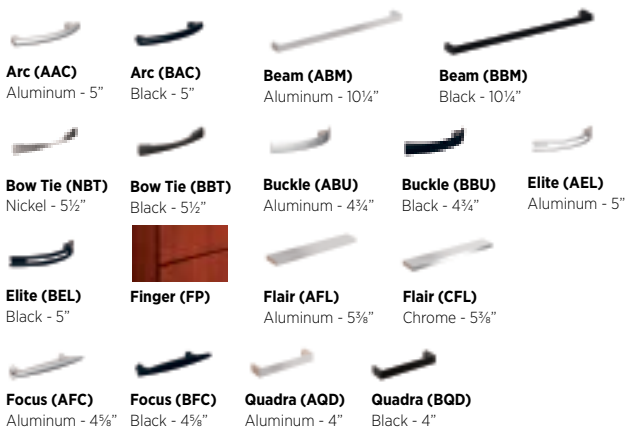

### EDGE PROFILES

B Bevel	A Radius
D Bullnose	Y Square
X Flute	E Tri-Round



### TABLE GROMMET & POWER UNIT OPTIONS

Power units and grommets are sold separately and must be specified separately with surface mount location. Multiple locations may be selected. Only one unit per location.

#### Power units and Grommets Available in Table Surfaces (See Units)

Grommet Specify Color: Black = BLK and Silver = SLV

#### DUO/TRIO BEZEL

01-DUOBEZEL	Available in Black (B), Silver (S), or White (W)
01-TRIOBEZEL	Available in Black (B), Silver (S), or White (W)

#### DOCK 950, DOCK 800 and DOCK 150

DOCK950	Available in Black or White
DOCK150	Available in Black or White
DOCK800	Available in Black or Silver

### TABLE GROMMET & POWER UNIT OPTIONS CONTINUE

#### Other Power Units

DPORT4	Available in Aluminum or Black
INTERACTG	Available in Aluminum or Black
OASISM	Available in Aluminum or Black

#### Power/Data Location Information:

- Designate unit and location when specifying the top model. Power/Data Module need to be ordered separately.
- Power/Data Modules specified at the time of order will be routed for field installation.

E1	Unit on One End
E2	Unit on Each End
OC	Unit on Center

- All power units available **On Center (OC) only** when paired with two (2) or more of the following bases:

Cylinder Base	Square Base
X-Base	Disc
Tubular X-Base	

Grommets and Power Units may be ordered in non-standard locations. Call Customer Service to assist with specification and/or please attach a drawing to the PO showing the location of the grommet. Note additional charges and lead times may apply.

### Top Locations

Power units available on Each End (E1 and E2) and On Center (OC) unless otherwise noted, when paired with any Rectangle Panel Base, Rectangle Box Base or Rectangle Accent Box Base. ([See Unit Details](#))

#### Power units centered at locations below:

36" Tops	centered 18"D	48" Tops	centered 24"D
42" Tops	centered 21"D		

72: OC 36" from end (available with OC Only)

96: OC 48" from end; E1/E2 29" from end

120: OC 60" from end; E1/E2 29" from end

144: OC 72" from end; E1/E2 29" from end

### LOCKING DOORS

Locking doors are available on select units. You must specify WITH LOCKING when ordering and add upcharge.

LKT_HU	36"W Units	\$ 91
LKT_HU	18"W Units	\$ 69

### CERTIFICATIONS & COMPLIANCE

- Intertek Sustainability Certified
- BIFMA level® Certified
- BIFMA Compliant® Certified
- TSCA Title VI (Formerly CARB) Compliance
- US Green Building's LEED® Contribution

**Tops and Tables**



Round Tops  
[\(See Details\)](#)



Rectangle Tops  
[\(See Details\)](#)



Boat Tops  
[\(See Details\)](#)

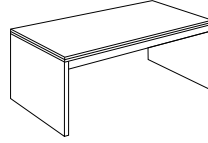

Work/Landing Tables  
[\(See Details\)](#)

**Bases**

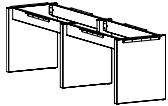

Rectangular Panel  
Bases with Trough  
[\(See Details\)](#)

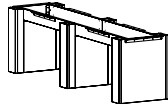

6" Rectangular Bases  
with Trough  
[\(See Details\)](#)

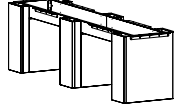

10" Rectangular  
Bases with Trough  
[\(See Details\)](#)

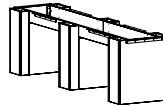

6" Rectangular Accent  
Bases with Trough  
[\(See Details\)](#)

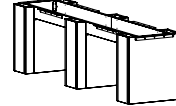

10" Rectangular Accent  
Bases with Trough  
[\(See Details\)](#)

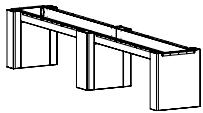

6" + 10" Combo Rectangular  
Bases with Trough  
[\(See Details\)](#)

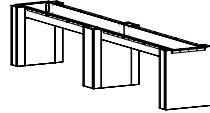

6" + 10" Combo Rectangular  
Accent Bases with Trough  
[\(See Details\)](#)



Disc Bases  
[\(See Details\)](#)

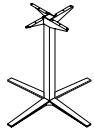

Small and Large X  
Bases [\(See Details\)](#)



HA Pneumatic X Bases  
[\(See Details\)](#)



Metal Bases  
[\(See Details\)](#)

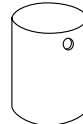

Cylinder Bases  
[\(See Details\)](#)

**Storage Components**

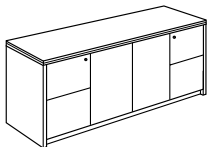

[Full & 3/4 Ped Storage Credenzas](#)

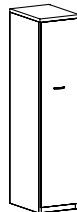
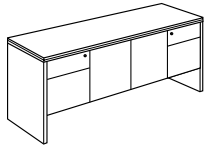

[Wardrobe/Storage](#)

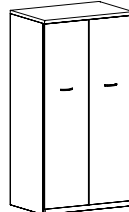

[Double Wardrobe/Storage](#)

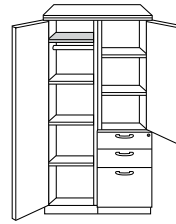

**Wire Management & Power/Data Accessories [\(See Multiple Units\)](#)**



For additional solutions for desking, storage, and accessories, see the [Madera Casegoods](#) and [Accessories](#) Price Lists.

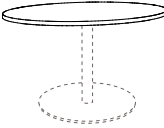

Item	Model No.	Width	Depth	Height	Ship Wt	Cubic Ft	List Price		
 <p>14-4242CT shown with 01-2430DBA (Disc Base) BASES SOLD SEPARATELY</p>	14-4848CT	<i>Accommodates Five (5) Chairs</i>		48	48	30	60	5.7	W/P\$ 2876 PV\$ 3363
	14-4242CT	<i>Accommodates Four (4) Chairs</i>		42	42	30	40	4.4	W/P\$ 2608 PV\$ 3053
	14-3636CT	<i>Accommodates Three (3) to Four (4) Chairs</i>		36	36	30	35	3.4	W/P\$ 2289 PV\$ 2678

### Description

- Available with Premium/Standard Veneer (PV/W) or HPL (P) Top, Must Specify
- Single Base Required; Ordered Separately, [See Details](#)
- Bases Sold Separately
- Power Options not Available

### Must Specify (in this order):

Model #  
Top Material  
Finish/Color  
Edge Profile

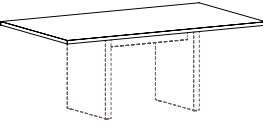
RECTANGULAR TOP	144" or 12' - 2 Piece Tops						
 <p>14-3672RT shown with 88-2034RPB (Rectangle Panel Base) BASES SOLD SEPARATELY</p>	14-48144RT	144	48	1 $\frac{3}{16}$	275	12.3	W/P\$ 2323 PV\$ 2717
	120" or 10' - 2 Piece Tops						
	14-48120RT	120	48	1 $\frac{3}{16}$	225	10.3	W/P\$ 2134 PV\$ 2497
	96" or 8' - 1 Piece Top						
14-4896RT	96	48	1 $\frac{3}{16}$	180	9.4	W/P\$ 2039 PV\$ 2386	
72" or 6' - 1 Piece Top							
14-3672RT	72	36	1 $\frac{3}{16}$	100	6.2	W/P\$ 1282 PV\$ 1501	

### Description

- Grain Runs the Width of the Table
- Available with Veneer (PV/W) or HPL (P) Top; Must Specify
- Heavy-Duty Ganging Mechanisms Connect Two (2) Piece Tops
- See Bases/Legs and Number Required For Each Top Size, Must Order Bases Separately
- Optional Grommets and Power/Data Units; [See Location Options](#), [See Power Units Available](#)

P = HPL W = Veneer PV = Premium Veneer

[See Madera Overview For Ordering Options](#)

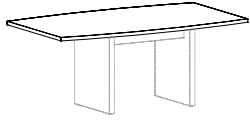
Item	Model No.	Width	Depth	Height	Ship Wt	Cubic Ft	List Price	
 <p>14-3672BT shown with 88-2034RPB (Rectangle Panel Base) BASES SOLD SEPARATELY</p> <p>Must Specify (in this order): Model # Top Material Finish/Color Edge Profile</p>	<b>BOAT TOP</b>							
	<b>144" or 12' - 2 Piece Tops</b>							
	14-48144BT		144	48	1 $\frac{3}{16}$	275	12.3	W/P\$ 4380
	14-48144BT							PV\$ 5124
	<b>120" or 10' - 2 Piece Tops</b>							
	14-48120BT		120	48	1 $\frac{3}{16}$	225	10.3	W/P\$ 3980
	14-48120BT							PV\$ 4656
	<b>96" or 8' - 1 Piece Top</b>							
	14-4896BT		96	48	1 $\frac{3}{16}$	180	9.4	W/P\$ 3228
	14-4896BT							PV\$ 3777
	<b>72" or 6' - 1 Piece Top</b>							
	14-3672BT		72	36	1 $\frac{3}{16}$	100	6.2	W/P\$ 1865
14-3672BT							PV\$ 2182	

**Description**

- Grain Runs the Width of the Table
- Available with Veneer (PV/W) or HPL (P) Top; Must Specify
- Heavy-Duty Ganging Mechanisms Connect Two (2) Piece Tops
- See Bases/Legs and Number Required For Each Top Size, Must Order Bases Separately
- Optional Grommets and Power/Data Units; [See Location Options](#), [See Power Units Available](#)

**RECTANGLE PANEL BASES WITH TROUGH**

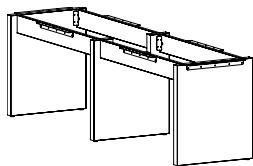

<b>Three (3) Panel Bases - For Use With 48" x 144" Surfaces</b>							
88-24106RPB	Laminate	24	106	28 $\frac{3}{4}$	116	13.8	T\$ 3000
	Veneer						W\$ 3059
<b>Two (2) Panel Bases - For Use With 48" x 120" Surfaces</b>							
88-2482RPB	Laminate	24	82	28 $\frac{3}{4}$	90	6.9	T\$ 2150
	Veneer						W\$ 2201
<b>Two (2) Panel Bases - For Use With 48" x 96" Surfaces</b>							
88-2458RPB	Laminate	24	58	28 $\frac{3}{4}$	84	6.9	T\$ 1880
	Veneer						W\$ 1954
<b>Two (2) Panel Bases - For Use With 36" x 72" Surfaces</b>							
88-2034RPB	Laminate	20	34	28 $\frac{3}{4}$	66	6.7	T\$ 1575
	Veneer						W\$ 1742

Must Specify (in this order):

- Model #
- Material
- Finish / Color

**Description**

- 2" Panel Bases with Trough, Stretcher Rails, and L-Bracket Hardware Included
- Available with TFL (T) or Veneer (W)
- Vertical Grain Direction on Bases
- Bases Require Some Assembly; Attachment Hardware Included
- Tops Sold Separately

[See Madera Overview For Ordering Options](#)

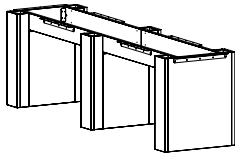
Item	Model No.		Width	Depth	Height	Ship Wt	Cubic Ft	List Price
<b>6" RECTANGLE BASES WITH TROUGH AND REMOVABLE PANEL</b>  	<b>Three (3) 6" Rectangle Bases - For Use With 48" x 144" Surfaces</b>							
	88-2410606RB	Laminate	24	106	28¾	106	19.6	T\$ 4720
		Veneer						W\$ 6457
	<b>Two (2) 6" Rectangle Bases - For Use With 48" x 120" Surfaces</b>							
	88-248206RB	Laminate	24	82	28¾	99	12.9	T\$ 3219
		Veneer						W\$ 4449
	<b>Two (2) 6" Rectangle Bases - For Use With 48" x 96" Surfaces</b>							
	88-245806RB	Laminate	24	58	28¾	93	12.9	T\$ 3023
		Veneer						W\$ 4128
	<b>Two (2) 6" Rectangle Bases - For Use With 36" x 72" Surfaces</b>							
	88-203406RB	Laminate	20	34	28¾	76	12.9	T\$ 2777
		Veneer						W\$ 3820

Must Specify (in this order):

- Model #
- Material
- Finish / Color

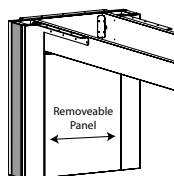

**Description**

- 6" Rectangle Bases with Trough and Stretcher Rails
- Available with TFL (T) or Veneer (W)
- Vertical Grain Direction on Bases
- Bases Include Interior Removable Panel for Wire Management Access; Removable Panel is 15⅞"W for 24" Bases and 11⅞"W for 20" Bases
- Removable Panels Attached with Z Brackets
- Bases Require Some Assembly; Attachment Hardware Included
- Tops Sold Separately

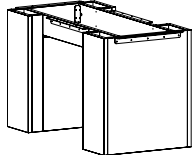
<b>10" RECTANGLE BASES WITH TROUGH AND REMOVABLE PANEL</b>  	<b>Three (3) 10" Rectangle Bases - For Use With 48" x 144" Surfaces</b>							
	88-2410610RB	Laminate	24	106	28¾	141	18.2	T\$ 4841
		Veneer						W\$ 6551
	<b>Two (2) 10" Rectangle Bases - For Use With 48" x 120" Surfaces</b>							
	88-248210RB	Laminate	24	82	28¾	96	12.0	T\$ 3300
		Veneer						W\$ 4512
	<b>Two (2) 10" Rectangle Bases - For Use With 48" x 96" Surfaces</b>							
	88-245810RB	Laminate	24	58	28¾	89	12.0	T\$ 3104
		Veneer						W\$ 4190
	<b>Two (2) 10" Rectangle Bases - For Use With 36" x 72" Surfaces</b>							
	88-203410RB	Laminate	20	34	28¾	72	10.0	T\$ 2857
		Veneer						W\$ 3882

Must Specify (in this order):

- Model #
- Material
- Finish / Color

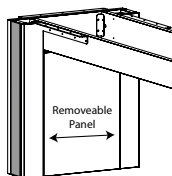

**Description**

- 10" Rectangle Bases with Trough and Stretcher Rails
- Available with TFL (T) or Veneer (W)
- Vertical Grain Direction on Bases
- Bases Include Interior Removable Panel for Wire Management Access; Removable Panel is 15⅞"W for 24" Bases and 11⅞"W for 20" Bases
- Removable Panels Attached with Z Brackets
- Bases Require Some Assembly; Attachment Hardware Included
- Tops Sold Separately

Item	Model No.		Width	Depth	Height	Ship Wt	Cubic Ft	List Price
6" + 10" COMBO RECTANGLE BASES WITH TROUGH AND REMOVABLE PANEL	<b>Three (3) Bases Total: Two (2) 6" and One (1) 10" Rectangle Bases - For Use With 60" / 54" / 48" x 144" Surfaces</b>							
	88-24106C610RB	Laminate	24	106	28¾	141	18.2	T\$ 4760
		Veneer						W\$ 6488

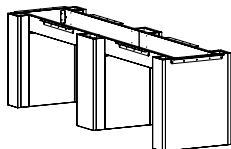

Must Specify (in this order):

- Model #
- Material
- Finish / Color

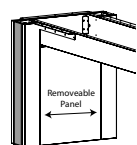

**Description**

- 6" + 10" Rectangle Bases with Trough and Stretcher Rails; 6" Bases on Exterior and 10" Base on Interior
- Available with TFL (T) or Veneer (W)
- Vertical Grain Direction on Bases
- Bases Include Interior Removable Panel for Wire Management; Removable Panel is 15⅞"W and Attaches with Z Brackets.
- Bases Require Some Assembly; Attachment Hardware Included
- Tops Sold Separately

**6" RECTANGLE ACCENT BASES WITH TROUGH AND REMOVABLE PANEL**

6" RECTANGLE ACCENT BASES WITH TROUGH AND REMOVABLE PANEL	<b>Three (3) 6" Rectangle Bases - For Use With 48" x 144" Surfaces</b>							
	88-24106O6RAB	Laminate	24	106	28¾	106	19.6	T\$ 5394
		Veneer						W\$ 7174
	<b>Two (2) 6" Rectangle Bases - For Use With 48" x 120" Surfaces</b>							
	88-248206RAB	Laminate	24	82	28¾	99	12.9	T\$ 4745
		Veneer						W\$ 6436
	<b>Two (2) 6" Rectangle Bases - For Use With 48" x 96" Surfaces</b>							
	88-245806RAB	Laminate	24	58	28¾	93	12.9	T\$ 3480
		Veneer						W\$ 4610
	<b>Two (2) 6" Rectangle Bases - For Use With 36" x 72" Surfaces</b>							
	88-203406RAB	Laminate	20	34	28¾	76	12.9	T\$ 3232
		Veneer						W\$ 4302

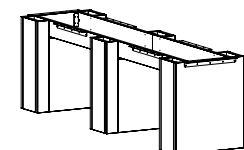

Must Specify (in this order):

- Model #
- Base Finish/Color
- Metal Accent Color
- Accent Panel Finish/Color

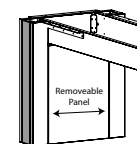

**Description**

- 6" Rectangle Bases with Trough and Stretcher Rails
- Available with TFL (T) or Veneer (W)
- ⅝" Metal Accent Available in Four (4) Colors: Aluminum, Black, Gold, and Platinum; Must Specify Color
- Vertical Grain Direction on Bases
- Bases Include Interior Removable Panel for Wire Management Access; Removable Panel is 15⅞"W for 24" Bases and 11⅞"W for 20" Bases
- Removable Panels Attached with Z Brackets
- Bases Require Some Assembly; Attachment Hardware Included
- Tops Sold Separately

[See Madera Overview For Ordering Options](#)

Item	Model No.		Width	Depth	Height	Ship Wt	Cubic Ft	List Price
<b>10" RECTANGLE ACCENT BASES WITH TROUGH AND REMOVABLE PANEL</b>	<b>Three (3) 10" Rectangle Bases - For Use With 48" x 144" Surfaces</b>							
	88-241061ORAB	Laminate	24	106	28¾	141	18.2	T\$ 5462
		Veneer						W\$ 7258
	<b>Two (2) 10" Rectangle Bases - For Use With 48" x 120" Surfaces</b>							
	88-248210RAB	Laminate	24	82	28¾	96	12.0	T\$ 3717
		Veneer						W\$ 4986
	<b>Two (2) 10" Rectangle Bases - For Use With 48" x 96" Surfaces</b>							
	88-245810RAB	Laminate	24	58	28¾	89	12.0	T\$ 3521
		Veneer						W\$ 4664
	<b>Two (2) 10" Rectangle Bases - For Use With 36" x 72" Surfaces</b>							
	88-203410RAB	Laminate	20	34	28¾	72	10.0	T\$ 3209
		Veneer						W\$ 4276

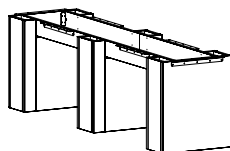

Must Specify (in this order):

- Model #
- Base Finish/Color
- Metal Accent Color
- Accent Panel Finish/Color

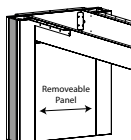

**Description**

- 10" Rectangle Bases with Trough and Stretcher Rails
- Available with TFL (T) or Veneer (W)
- 5/16" Metal Accent Available in Four (4) Colors: Aluminum, Black, Gold, and Platinum; Must Specify Color
- Vertical Grain Direction on Bases
- Bases Include Interior Removable Panel for Wire Management Access; Removable Panel is 15 7/8"W for 24" Bases and 11 7/8"W for 20" Bases
- Removable Panels Attached with Z Brackets
- Bases Require Some Assembly; Attachment Hardware Included
- Tops Sold Separately

<b>6" + 10" COMBO RECTANGLE ACCENT BASES WITH TROUGH AND REMOVABLE PANEL</b>	<b>Three (3) Bases Total: Two (2) 6" and One (1) 10" Rectangle Bases - For Use With 60" / 54" / 48" x 144" Surfaces</b>							
	88-24106C610RAB	Laminate	24	106	28¾	141	18.2	T\$ 5420
		Veneer						W\$ 7205

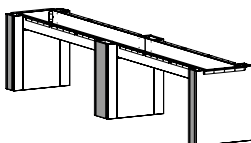

Must Specify (in this order):

- Model #
- Base Finish/Color
- Metal Accent Color
- Accent Panel Finish/Color

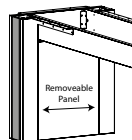

**Description**

- 6" + 10" Rectangle Accent Bases with Trough and Stretcher Rails; 6" Bases on Exterior and 10" Bases on Interior
- Available with TFL (T) or Veneer (W)
- 5/16" Metal Accent Available in Four (4) Colors: Aluminum, Black, Gold, and Platinum; Must Specify Color
- Vertical Grain Direction on Bases
- Bases Include Interior Removable Panel for Wire Management; Removable Panel is 15 7/8"W and Attaches with Z Brackets
- Bases Require Some Assembly; Attachment Hardware Included
- Tops Sold Separately

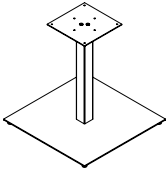
Item	Model No.		Width	Depth	Height	Ship Wt	Cubic Ft	List Price
	<b>For Use With</b> Round Tops: 48" Top Surfaces: 48"x96"							
	01-2630SBB	Black	26	26	27¾	32	3.2	\$ 1163
	01-2630SBA	Aluminum						
	<b>For Use With</b> Round Tops: 42" Top Surfaces: 36"x72"							
	01-2030SBB	Black	20	20	27¾	32	3.2	\$ 956
	01-2030SBA	Aluminum						
	<b>For Use With</b> Round Tops: 36"							
	01-1630SBB	Black	16	16	27¾	32	3.2	\$ 898
	01-1630SBA	Aluminum						

**Description**

- 2¾" Diameter Column
- 12"x12" Mounting Plate at Top of Column
- Stiffener Bar Not Included; Must Order Separately (See Stiffener Bars)
- See Number of Bases Required Per Top Width Below
- Power Units Available On Center When Using Two or More Square Bases
- Some Assembly Required

Table Widths	Round	72"	96"
<b>Number of Bases Required</b>	1	2	2

**TUBULAR X-BASE**

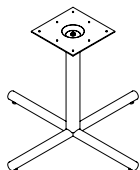

OPEN MARKET ONLY

<b>For Use With</b> Round Tops: 48" Top Surfaces: 48"x96"							
01-3830TXB	Black	38	38	27¾	40	4.2	\$ 699
01-3830TXA	Aluminum						
<b>For Use With</b> Round Tops: 36", 42" Top Surfaces: 36"x72"							
01-3230TXB	Black	32	32	27¾	32	3.2	\$ 633
01-3230TXA	Aluminum						

**Description**

- 3" Diameter Column
- See Number of Bases Required Per Top Width Below
- Power Units Available On Center When Using Two or More Tubular X-Bases
- Some Assembly Required

Table Widths	Round	72"	96"
<b>Number of Bases Required</b>	1	2	2

[See Madera Overview For Ordering Options](#)

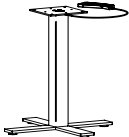
Item	Model No.		Width	Depth	Height	Ship Wt	Cubic Ft	List Price
HEIGHT ADJUSTABLE PNEUMATIC X-BASE  	<b>Maximum Round 42"</b>							
	01-3232HAXBB	Black	32	32	26-45¾	1	0.2	\$ 1721
	01-3232HAXBA	Aluminum						
	<b>Maximum Round 36"</b>							
	01-2626HAXBB	Black	22	22	26-45¾	1	0.2	\$ 1687
	01-2626HAXBA	Aluminum						

**Description**

- Pre-Drilled Boring Pattern May Not Match Underside of Table Top
- Steel Mounting Plate: 8"x 8"x ¼"
- Eight (8) Bolts Included for Assembly
- Some Assembly Required

**METAL X-BASE**

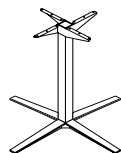

<b>For Use With Round Tops: 42" + 48" Top Surfaces: 48"x96"</b>								
08-2642LXBB	Black	35½	35½	40	33	20.0	\$ 1322	
08-2642LXBA	Aluminum							
<i>For 42"H Tables</i>								
08-2636LXBB	Black	35½	35½	34	30	17.2	\$ 1275	
08-2636LXBA	Aluminum							
<i>For 36"H Tables</i>								
08-2630LXBB	Black	35½	35½	28	27	14.5	\$ 1219	
08-2630LXBA	Aluminum							
<i>For 30"H Tables</i>								
<b>For Use With Round: 36" Top Surfaces: 36"x72"</b>								
08-2042SXBB	Black	29	29	40	27	15.9	\$ 1235	
08-2042SXBA	Aluminum							
<i>For 42"H Tables</i>								
08-2036SXBB	Black	29	29	34	24	13.7	\$ 1185	
08-2036SXBA	Aluminum							
<i>For 36"H Tables</i>								
08-2030SXBB	Black	29	29	28	21	11.6	\$ 1139	
08-2030SXBA	Aluminum							
<i>For 30"H Tables</i>								

**Description**

- See Number of Bases Required Per Top Width Below
- Not Available to be Sold Separately
- Power Units Available On Center When Using Two or More Metal X-Bases
- Ships Assembled

Table Widths	Round	72"	96"
<b>Number of Bases Required</b>	1	2	2

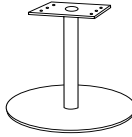
Item	Model No.		Width	Depth	Height	Ship Wt	Cubic Ft	List Price
<b>DISC BASE</b>  	<b>For 48" Round Tops</b>							
	01-3230DBB	Black	30	30	27¾	42	4.1	\$ 1842
	01-3230DBA	Aluminum	30	30	27¾	42	4.1	\$ 1842
	<b>For 36" and 42" Round Tops</b>							
	01-2430DBB	Black	24	24	27¾	32	3.2	\$ 1535
	01-2430DBA	Aluminum	24	24	27¾	32	3.2	\$ 1535

**Description**

- 4" Diameter 14 Gauge Steel Column
- 12"x12" Mounting Plate at Top of Column
- ¼" Thick Disc Plate with 5 Levelers
- Some Assembly Required

**Table Widths**

	Round	72"	96"
<b>Number of Bases Required</b>	1	4	4

<b>CYLINDER BASE</b>  	01-2020CB		20	20	28½	136	11.1	W\$ 1553
		<i>For Use With 42" or 48" Round Top</i>						PV\$ 1813
	01-1616CB		16	16	28½	101	7.2	W\$ 1419
		<i>For Use With 36" Round Top</i>						PV\$ 1660

**Description**

- Veneer Cylinder Base Features Multi-Step, Hand-Finished Catalyzed Finish
- Weighted for Stability
- Two (2) Wire Management Black Grommets Standard at Top with 8" Opening Standard in Bottom

**Options: Specify & Add**

GCB1S	Single Grommet at Top Edge	N/C
NOGC	No Grommets	N/C

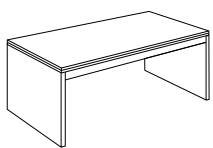
<b>WORK TABLE SEATED HEIGHT</b>  	14-3672WT	72	36	30	195	50.0	W/P\$ 3199
		Kneespace - 69 <sup>1</sup> / <sub>16</sub>					PV\$ 3742
	14-3060WT	60	30	30	134	35.5	W/P\$ 2503
		Kneespace - 57 <sup>1</sup> / <sub>16</sub>					PV\$ 2932

**Description**

- Solid End Panels with Apron Rail
- Available with Premium Veneer (PV), Standard Veneer (W) or HPL (P) Tops with Veneer Chassis; Must Specify
- Ships Fully Assembled

Must Specify (in this order):

- Model #
- Premium or Standard Veneer
- Top Material
- Finish/Color
- Edge Profile

P = HPL W = Veneer PV = Premium Veneer

[See Madera Overview For Ordering Options](#)

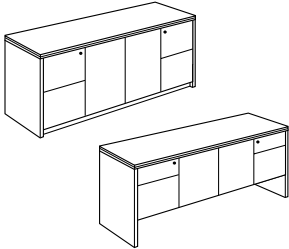

Item	Model No.	Width	Depth	Height	Ship Wt	Cubic Ft	List Price
<b>STORAGE CREDENZA</b>		<b>Full Pedestals</b>					
	16-2472SC	72	24	30	285	35.6	W/P\$ 6020 PV\$ 5758
	16-2466SC	66	24	30	261	32.7	W/P\$ 5509 PV\$ 5758
	16-2072SC	72	20	30	270	30.5	W/P\$ 5682 PV\$ 5758
		<b>¾ Pedestals</b>					
	14-2072SC	72	20	30	227	30.5	W/P\$ 4919 PV\$ 5758

**Must Specify (in this order):**

Model #  
Premium or Standard Veneer  
Top Material  
Finish/Color  
Edge Profile  
Pull

**Description**

- Legal Width, Locking File/File Pedestals (Full) and Legal Width, Locking Box/File Pedestals (¾)
- Fixed Storage Shelf Behind Doors
- Available with Premium Veneer (PV), Standard Veneer (W) or HPL (P) Tops with Veneer Chassis; Must Specify
- Lock Core will Coordinate with Pull Selection

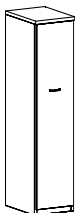
WARDROBE/STORAGE CABINET	Left Hinged	Right Hinged	Width	Depth	Height	Ship Wt	Cubic Ft	List Price
	14-1870WL	14-1870WR	18	24	69¾	153	19.2	W\$ 5263 PV\$ 6159
	14-1870CL	14-1870CR	18	20	69¾	150	18.6	W\$ 4454 PV\$ 5209

Shown as Left

**Must Specify (in this order):**

Model #  
Premium or Standard Veneer  
Finish/Color  
Edge Profile  
Pull  
Locking Door

**Description**

- Standard with: Fixed Top Shelf, Coat Rod, Three Adjustable/Removable Shelves
- Available in Premium Veneer (PV) or Standard Veneer (W); Must Specify
- Knob Pull will be Substituted for Finger Pull
- Optional Locking Door ([See Locking Options](#))

<b>DOUBLE WARDROBE/STORAGE CABINET</b>	14-3670WD	36	24	69¾	290	42.0	W\$ 9291 PV\$ 10875
--	-----------	----	----	-----	-----	------	------------------------

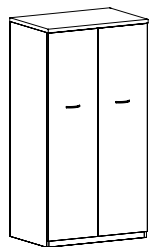
**Must Specify (in this order):**

Model #  
Premium or Standard Veneer  
Finish/Color  
Edge Profile  
Pull  
Locking Door

**Description**

- Standard with: Fixed Top Shelf Behind Each Door, Coat Rod, Three Adjustable/Removable Shelves on Each Side
- Available in Premium Veneer (PV) or Standard Veneer (W); Must Specify
- Knob Pull will be Substituted for Finger Pull
- Optional Locking Door ([See Locking Options](#))

P = HPL W = Veneer PV = Premium Veneer

[See Madera Overview For Ordering Options](#)

Item	Model No.	Width	Depth	Height	Ship Wt	Cubic Ft	List Price
DOUBLE WARDROBE/STORAGE CABINET WITH FILE/FILE	<b>Left Drawers</b>	<b>Right Drawers</b>					
	14-3670WD2L	14-3670WD2R	36	24	69%	315	42.0

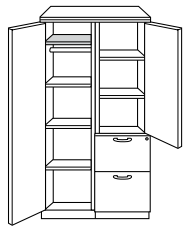

Shown as Right

**Description**

- One Side - Shaded Fixed Top Shelf, Coat Rod, and Three Adjustable Shelves
- One Side - Top Storage with Two Adjustable Shelves, Bottom Locking File/File
- Available in Premium Veneer (PV) or Standard Veneer (W); Must Specify
- Pedestal Determines Left or Right Handed Unit
- Finger Pull Not Available
- Optional Locking Door ([See Locking Options](#))

Must Specify (in this order):

Model #  
Premium or Standard Veneer  
Finish/Color  
Edge Profile  
Pull  
Locking Door

DOUBLE WARDROBE/STORAGE CABINET WITH BOX/BOX/FILE	<b>Left Drawers</b>	<b>Right Drawers</b>					
	14-3670WD1L	14-3670WD1R	36	24	69%	315	42.0



Shown as Right

**Description**

- One Side - Shaded Fixed Top Shelf, Coat Rod, and Three Adjustable Shelves
- One Side - Top Storage with Two Adjustable Shelves, Bottom Locking Box/Box/File
- Available in Premium Veneer (PV) or Standard Veneer (W); Must Specify
- Pedestal Determines Left or Right Handed Unit
- Finger Pull Not Available
- Optional Locking Door ([See Locking Options](#))

Must Specify (in this order):

Model #  
Premium or Standard Veneer  
Finish/Color  
Edge Profile  
Pull  
Locking Door

STORAGE CABINET WITH LATERAL FILE DRAWERS	14-3670SU2	36	24	69%	298	42.0	W\$ 10170 PV\$ 11899
---	------------	----	----	-----	-----	------	-------------------------

**Description**

- Standard with: Two 170° Hinged Doors, Two Adjustable Shelves on Top, Two Locking Lateral File Drawers on Bottom
- Lateral Drawers Provide Letter or Legal Filing Capabilities
- Available in Premium Veneer (PV) or Standard Veneer (W); Must Specify
- Finger Pull Not Available
- Optional Locking Door ([See Locking Options](#))

Must Specify (in this order):

Model #  
Premium or Standard Veneer  
Finish/Color  
Edge Profile  
Pull  
Locking Door

P = HPL W = Veneer PV = Premium Veneer

[See Madera Overview For Ordering Options](#)

Item	Model No.		W	D	H	Ship Wt	Cubic Ft	List Price
SINGLE POWER SAND DOLLAR	01-SAND60PS	Silver	3	3	4	1	0.2	\$ 98
	01-SAND60PW	White						
	01-SAND60PB	Black						

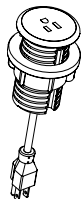
**Description**

- Mounts in 2 $\frac{3}{8}$ " (60mm) Round Grommet
- Single Power Outlet with 6' Cord

DOUBLE USB SAND DOLLAR	01-SAND60US	Silver	3	3	4	1	0.2	\$ 277
	01-SAND60UW	White						
	01-SAND60UB	Black						

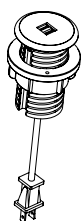
**Description**

- Mounts in 2 $\frac{3}{8}$ " (60mm) Round Grommet
- Dual USB Outlets with 6' Cord

DOCK 950 WIRELESS CHARGER	01-DOCK950W	White	3 $\frac{3}{16}$	3 $\frac{3}{16}$	-	1	0.2	\$ 265
	01-DOCK950B	Black						



OPEN MARKET ONLY

**Description**

- For Use with Wireless Charging Enabled Devices
- 5 Watts Maximum Output with a Direct Current of 5V 2A and 10 Watts Maximum with Quick Charge 2.0
- LED will Confirm Pairing with Device and Begin Wireless Charging

WIRELESS AND USB CHARGER	01-DOCK150W	White	3	3	$\frac{3}{4}$ "	1	0.2	\$ 405
	01-DOCK150B	Black						

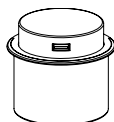

OPEN MARKET ONLY

**Description**

- For Use with Wireless Charging Enabled Devices and USB Charging Devices
- 5 Watt Maximum Output with a Direct Current Input of 5V 6A (Wireless Fast Charge)
- Pop-Up is  $\frac{3}{4}$ "H and Includes Three (3) USB Ports; One (1) 12 Watt Maximum with 2.4A (USB Fast Charge) and Two (2) 5 Watt with 1A (USB Standard Charge)
- LED Light will Confirm Pairing with Device and Begin Wireless Charging
- UL and cUL Certified

Item	Model No.		W	D	H	Ship Wt	Cubic Ft	List Price
 DUO BEZEL NEMA PLUG	01-DUOBEZELW	White	6½	2½	3¼	1	0.2	\$ 675
	01-DUOBEZELB	Black						
	01-DUOBEZELS	Silver						

**Description**

- Sits on Table Top and Includes: Two (2) Power, Two (2) USB, 10' Cord, and All Mounting Hardware
- Independent USB Circuit Controllers Deliver up to 2.1 Amps to Each Post
- FCC Part 15A, UL Recognized for Horizontal and Vertical Applications

 TRIO BEZEL NEMA PLUG	01-TRIOBEZELW	White	9	2½	3	1	0.2	\$ 725
	01-TRIOBEZELB	Black						
	01-TRIOBEZELS	Silver						

**Description**

- Sits on Table Top and Includes: Three (3) Power Outlets, Two (2) USB Ports, One (1) Open Data Port, 10' Cord, and All Mounting Hardware
- HDMI, VGA, and RJ45 Accessories for Open Data Port; Sold Separately, [See Accessories](#)
- Independent USB Circuit Controllers Deliver up to 2.1 Amps to Each Post
- FCC Part 15A, UL Recognized for Horizontal and Vertical Applications

 DUO BEZEL DAISY CHAIN PLUG	01-PDUOBEZELW	White	6½	2½	3	1	0.2	\$ 668
	01-PDUOBEZELB	Black						
	01-PDUOBEZELS	Silver						

**Description**

- Sits on Table Top and Includes: Two (2) Power, Two (2) USB, 12" Cord, and All Mounting Hardware
- Requires Daisy Chain Power Box; Sold Separately, [See Power Box Details](#)
- Non-Sequential System Allows up to Eight (8) Modules to be Connected with Jumper Cord, [See Jumper Cord Details](#)
- Independent USB Circuit Controllers Deliver up to 2.1 Amps to Each Post
- FCC Part 15A, RU Listed and UL Recognized for Horizontal and Vertical Applications

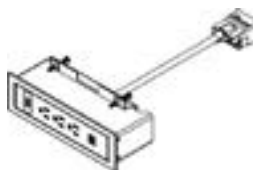
 TRIO BEZEL DAISY CHAIN PLUG	01-PTRIOBEZELW	White	9	2½	3	1	0.2	\$ 715
	01-PTRIOBEZELB	Black						
	01-PTRIOBEZELS	Silver						

**Description**

- Sits on Table Top and Includes: Three (3) Power Outlets, Two (2) USB Ports, One (1) Open Data Port, 12" Cord, and All Mounting Hardware
- HDMI, VGA, or RJ45 Accessory for Open Data Port; Sold Separately, [See Accessories](#)
- Requires Daisy Chain Power Box, Specified Separately, See Next Page
- Non-Sequential System Allows up to Eight (8) Modules to be Connected with Jumper Cord, [See Jumper Cord Details](#)
- Independent USB Circuit Controllers Deliver up to 2.1 Amps to Each Post
- FCC Part 15A, RU Listed and UL Recognized for Horizontal and Vertical Applications

[See Madera Overview For Ordering Options](#)

Item	Model No.	W	D	H	Ship Wt	Cubic Ft	List Price
DAISY CHAIN POWER BOX 	01-PPOWER <i>76" Perimeter, 36" Power Cord</i>	-	-	-	1	0.2	\$ 775
	01-PPOWER2 <i>24" Perimeter, 144" Power Cord</i>	-	-	-	1	0.2	\$ 796

**Description**

- Powers up to Eight (8) Duo and Trio Daisy Chain Units
- One Nema Plug and One Daisy Chain Plug
- 12-Amp System Rating
- 15-Amp Over-Current Protection

DAISY CHAIN JUMPER CORD 	01-6JUMP <i>72" Long</i>	-	-	-	1	0.2	\$ 299
	01-5JUMP <i>60" Long</i>	-	-	-	1	0.2	\$ 284
	01-4JUMP <i>48" Long</i>	-	-	-	1	0.2	\$ 240
	01-2JUMP <i>24" Long</i>	-	-	-	1	0.2	\$ 220

**Description**

- Connects Duo and Trio Daisy Chain Units
- Non-Sequential System Allows up to Eight (8) Modules to be Connected



HDMI DATA PORT ACCESSORY FOR TRIO UNITS 	01-LCOMHDMI	-	-	-	1	0.2	\$ 166
---	-------------	---	---	---	---	-----	--------

OPEN MARKET ONLY

VGA DATA PORT ACCESSORY FOR TRIO UNITS 	01-LCOMVGA	-	-	-	1	0.2	\$ 121
--	------------	---	---	---	---	-----	--------

RJ45 DATA PORT ACCESSORY FOR TRIO UNITS 	01-LCOMRJ45	-	-	-	1	0.2	\$ 79
---	-------------	---	---	---	---	-----	-------

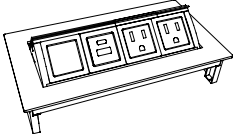
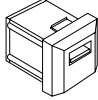
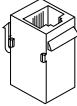
[See Madera Overview For Ordering Options](#)

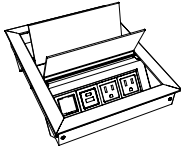
Item	Model No.		W	D	H	Ship Wt	Cubic Ft	List Price
	01-DPORT4A	Aluminum	8	4	-	7	0.2	\$ 1093
	01-DPORT4B	Black						
<b>Description</b>								
<ul style="list-style-type: none"> <li>Retracts into Work Surface to Regain Productive Space; One-Touch Access to Power and Data</li> <li>Two (2) Power Outlets, One (1) USB A+C, and One (1) Open Port</li> <li>Optional Telecom Port Components, <a href="#">See Options</a></li> <li>Water-Proof Simplex (Outlets)</li> <li>Includes a Voice/Data Adapter Kit to Accept Couplers and Jacks When Required</li> <li>10' Power Cord</li> <li>UL Recognized</li> </ul>								
USB PORT	01-USBPORT		-	-	-	-	-	\$ 161
	<b>Description</b>							
<ul style="list-style-type: none"> <li>Passive USB-A Port with Increased Transfer Speed Up to 5 gbs/sec</li> <li>Simultaneous Read/Write Capability; Idle Device Power Saving State</li> <li>6' Cord</li> <li>Compatible with 01-DPORT4A, 01-DPORT4B</li> </ul>								
VOICE COUPLER	01-VOICE1		-	-	-	-	-	\$ 73
	<b>Description</b>							
<ul style="list-style-type: none"> <li>6-Pin Modular Plug</li> <li>Molded Black; Cord Not included</li> <li>Compatible with 01-DPORT4A, 01-DPORT4B</li> </ul>								
DATA PORT	01-RJ4DATA		-	-	-	-	-	\$ 167
	<b>Description</b>							
<ul style="list-style-type: none"> <li>8-Pin Modular Plug; Cat6 Ethernet Cable; Pre-terminated Cable</li> <li>10' Cord</li> <li>Compatible with 01-DPORT4A, 01-DPORT4B</li> </ul>								
 <p>01-E2X4 SIN PENDING</p>	01-E2X6A	Aluminum	11	9 <sup>3</sup> / <sub>16</sub>	-	6	0.7	\$ 1625
	01-E2X6B	Black						
	01-E2X4A	Aluminum	8	9 <sup>3</sup> / <sub>16</sub>	-	5	0.5	\$ 1494
	01-E2X4B	Black						
<b>Description</b>								
<ul style="list-style-type: none"> <li>In Surface, Dual Side Application; Soft Touch Access to Power and Data</li> <li>11" Unit Includes Three (3) Power Outlets, One (1) USB A+C, and Two (2) Open Port on Each Side; 8" Unit Includes Two (2) Power Outlets, One (1) USB A+C, and One (1) Open Port on Each Side</li> <li>Optional Telecom Port Components, <a href="#">See Compatible Units</a></li> <li>6' Power Cord</li> <li>UL Listed</li> </ul>								

[See Madera Overview For Ordering Options](#)

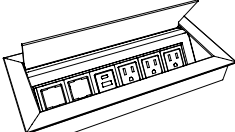
Item	Model No.		W	D	H	Ship Wt	Cubic Ft	List Price
	01-ELLORA6A	Aluminum	11	5	-	6	0.7	\$ 852
	01-ELLORA6B	Black						
	01-ELLORA4A	Aluminum	8	5	-	5	0.5	\$ 792
	01-ELLORA4B	Black						

01-ELLORA6

SIN PENDING

**Description**

- In Surface Application; Soft Touch Access to Power and Data
- 11" Includes Three (3) Power Outlets, One (1) USB A+C, and Two (2) Open Port; 8" Includes Two (2) Power Outlets, One (1) USB A+C, and One (1) Open Port
- Optional Telecom Port Components, See Below for Compatible Units
- 6' Power Cord
- UL Recognized

VGA CONNECTOR ACCESSORY	01-VGACON		-	-	-	1	0.2	\$ 149
-------------------------	-----------	--	---	---	---	---	-----	--------

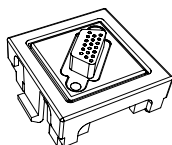
**Description**

- VGA Port for 01-DPORT4A, 01-DPORT4B, ELLORA4A, ELLORA4B, ELLORA6A, ELLORA6B, E2X4A, E2X4B, E2X6A, and E2X6B
- Enables Devices to Remote Display on Monitors
- 10' Cord
- Male/Female Connector

PASSIVE USB-C ACCESSORY	01-PUSBC		-	-	-	1	0.2	\$ 95
-------------------------	----------	--	---	---	---	---	-----	-------

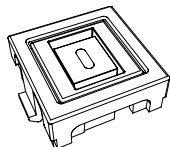
**Description**

- Passive USB-C Port ; Unit Provides Data Connection to Transfer Data Only, No Charging Capabilities
- Compatible with 01-DPORT4A, 01-DPORT4B, ELLORA4A, ELLORA4B, ELLORA6A, ELLORA6B, E2X4A, E2X4B, E2X6A, and E2X6B
- Male/Female Connector

CHARGING USB-A+C ACCESSORY	01-USBAC		-	-	-	1	0.2	\$ 283
----------------------------	----------	--	---	---	---	---	-----	--------

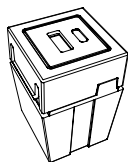
**Description**

- For Charging Devices
- 20 Watt Power Supply
- USB+C Charging Port for 01-DPORT4A, 01-DPORT4B, ELLORA4A, ELLORA4B, ELLORA6A, ELLORA6B, E2X4A, E2X4B, E2X6A, and E2X6B

Item	Model No.		W	D	H	Ship Wt	Cubic Ft	List Price
HDMI CONNECTOR ACCESSORY	01-HDMICON		-	-	-	1	0.2	\$ 124

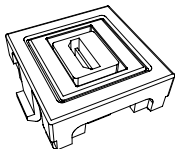

### Description

- HDMI Port for 01-DPORT4A, 01-DPORT4B, ELLORA4A, ELLORA4B, ELLORA6A, ELLORA6B, E2X4A, E2X4B, E2X6A, and E2X6B
- Connects to High Definition Displays
- Female/Female Connector
- 18" Cord

INTERACT POWER & DATA	01-INTERACTG2A	Aluminum	9	5 $\frac{3}{8}$	2 $\frac{3}{4}$	5	0.2	\$ 891
	01-INTERACTG2B	Black						



### Description

- Includes: Two (2) Power Outlets, Two (2) USB-A Charging Ports, One (1) Telecom Plate Opening; Two (2) Keystone Openings for Voice/Data Jacks
- One (1) Telecom Plates Included with the Unit: One (1) 01-ABLAB Plate (Consists of One (1) RJ45 Cat 6, One (1) RJ11 Cat 3 Phone Jack)
- Convenience Plug on Bottom
- 6' Power Cord
- UL and CSA Recognized
- Additional Telecom Plates, [See ECA Telecom Plate Options](#)

OASIS MINI POWER & DATA	01-OASISMA	Aluminum	15	9	5	11	0.3	\$ 3191
	01-OASISMB	Black						



Top View

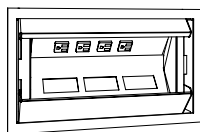

### Description

- Soft Touch Hinged Lid
- Four (4) Power Outlets, Three (3) Telecom Plate Openings
- Two (2) Telecom Plates Included with the Unit: One (1) 01-ABLAB Plate (Consists of One (1) RJ45 Cat 6, One (1) RJ11 Cat 3 Phone Jack); One (1) 01-ABLB Plate (Consists of One (1) RJ45 Cat 6)
- 9' Power Cord
- UL Listed
- Additional Telecom Plates, [See ECA Telecom Plate Options](#)

DOCK800	01-DOCK800S	Silver	14	9	-			\$ 2047
	01-DOCK800B	Black						

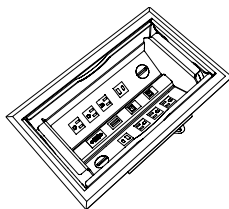

### Description

- Stylish Aluminum Housing with Beveled Edges; Soft Touch Access and Closure
- Includes: Six (6) Power Outlets, Two (2) USB-A 5V Ports, Two (2) USB-C Charging Ports, One (1) RJ45 Ethernet Port, One (1) RJ11 Port, One (1) HDMI Port, and One (1) VGA Port
- 10' Power Cord
- UL and cUL Certified

OPEN MARKET ONLY

[See Madera Overview For Ordering Options](#)



Item	Model No.	W	D	H	Ship Wt	Cubic Ft	List Price
POWER ENTRY HARD WIRED	01-HWPOWERENTRY	72	-	-	1	0.2	\$ 322

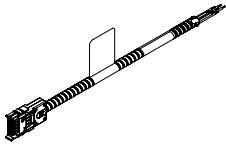

**Description**

- Eight (8) Wire/Four (4) Circuit Hard Wire In-feed
- UL183 Compliant

Item	Model No.	W	D	H	Ship Wt	Cubic Ft	List Price
JUMPER HARD WIRE CABLE	01-HW2JUMP	24	-	-	1	0.2	\$ 193
	01-HW3JUMP	36	-	-	1	0.2	\$ 206
	01-HW4JUMP	48	-	-	1	0.2	\$ 212
	01-HW5JUMP	60	-	-	1	0.2	\$ 255
	01-HW6JUMP	72	-	-	1	0.2	\$ 270

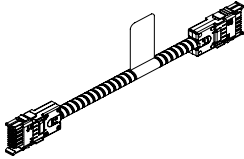

**Description**

- Eight (8) Wire/Four (4) Circuit Hard Wire Jumper
- UL183 Compliant

Item	Model No.	W	D	H	Ship Wt	Cubic Ft	List Price
QUAD BLOCK HARD WIRED	01-HWQUADBLOCK	-	-	-	1	0.2	\$ 62

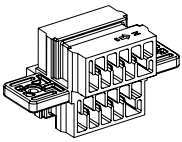

**Description**

- Eight (8) Wire/Four (4) Circuit Hard Wire Connector
- UL183 Compliant
- For Connecting Jumpers and Power Units
- Quantity of Four (4) Female Inputs

Item	Model No.	Width	Depth	Height	Ship Wt	Cubic Ft	List Price
WIRE MANAGEMENT CHANNEL	01-WMGR4	16	1½	¾	1	-	\$ 116

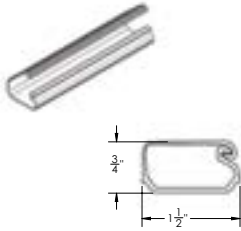

**Description**

- Set of Four (4) Black Plastic Wire Management Channels
- Snap Lock Channel
- Attaches with Adhesive Strips
- Ships via UPS Only

WIRE CHANNEL	01-32125	24	1⅝	1	.25	0.3	\$ 106
--------------	----------	----	----	---	-----	-----	--------

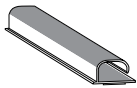

**Description**



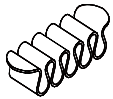

- Available in Black
- Channels Attach with Two (2) Double-Sided Installation Tape
- Open J Channel for Easy Storage of Cables

CABLE GRIP	01-WMGRCB	5⅜	2⅝	-	-	-	\$ 17
------------	-----------	----	----	---	---	---	-------



**Description**

- Under Surface Wire Management
- Black

Item	Model No.	Description	List Price
<b>ECA TELECOM PLATES</b>	01-ABL	Telecom Plate, Blank Plate	\$ 41
Compatible with:	01-ABL737373	Telecom Plate, Three (3) RJ45 Cat 5e	\$ 367
	01-ABLAB	Telecom Plate, One (1) RJ45 Cat 6, One (1) RJ11 Cat 3 Phone	\$ 206
	01-ABLAB102	Telecom Plate, One (1) RJ45 Cat 6, One (1) RJ11 Cat 3, One (1) USB W/72" Patch Cord	\$ 320
Oasis Mini Power & Data 01-OASISMA, 01-OASISMB	01-ABLABB	Telecom Plate, Two (2) RJ45 Cat 6, One (1) RJ11 Cat 3 Phone	\$ 320
	01-ABLB	Telecom Plate, One (1) RJ45 Cat 6	\$ 149
Interact Power & Data 01-INTERACTG2A, 01-INTERACTG2B	01-ABLBB	Telecom Plate, Two (2) RJ45 Cat 6	\$ 260
	01-ABLBBB	Telecom Plate, Three (3) RJ45 Cat 6	\$ 367
Power Center 01-INTRFCIA, 01-INTRFCIB	01-ABLBBB	Telecom Plate, Four (4) RJ45 Cat 6	\$ 476
	01-ABLBBBC51	Telecom Plate, Two (2) RJ45 Cat 6, One (1) 15 Pin HD VGA w/72" Patch Cord	\$ 446
	01-ABLBC51L	Telecom Plate, One (1) RJ45 Cat 6, One (1) Mini Stereo Inline, One (1) 15 Pin HD VGA w/72" Patch Cord	\$ 410
	01-ABLC3811	Telecom Plate, One (1) RJ45 Cat 6 Data Inline, One (1) RJ11 Cat 3 Phone Inline	\$ 197
	01-ABLC45	Telecom Plate, One (1) HDMI w/36" Patch Cord	\$ 295
	01-ABLC45C51L	Telecom Plate, One (1) Mini Stereo Inline, One (1) HDMI w/36" Patch Cord, One (1) 15 Pin HD VGA w/72" Patch Cord	\$ 558
	01-ABLC51L	Telecom Plate, One (1) 15 Pin HD VGA & One (1) Mini Stereo Inline Jack	\$ 298
	01-ABLCRDM	Telecom Plate, Three (3) Cord Bushings	\$ 96



Natta offers an agile solution for a variety of community spaces and meeting applications. With its simplicity of form, it can achieve a subtle effect and still provide an excellent solution for any meeting and breakout environment.

**CONSTRUCTION**

**TOPS**

- NAT-1 and NAT-2 Tops are High Pressure Laminate (HPL) and 3-ply balanced construction, 1½" thick with 1 mm PVC edge band and vertical square edge profile
- MMIT-1 and MMIT-2 Tops have 1½" thick HPL surface with 1mm PVC edge band Square edge profile
- Designer White, Sugar Maple, and Williamsburg Cherry feature ABS edge bands
- Grain direction runs left to right unless otherwise noted

**CHASSIS**

- All frames are made of solid European Beech with double-doweled or mortised and tenoned joints
- MMIT-1 and MMIT-2 Frames are individually hand assembled and sanded prior to being finished; Legs are 9¾"H on the rectangular table and 14"H on the square table and include non-marring nylon glides
- NAT-1 and NAT-2 units are equipped with heavy-duty, adjustable glides to ensure proper leveling and compensation for uneven floors
- All table units ship fully assembled with tops installed

**HOW TO ORDER EXAMPLE**

Model No.	Description	Example
NAT-1	Top Color	SBP
	Leg Finish	SBP
MMIT-2	Top Color	WH
	Leg Finish	BW

**HPL (P) LAMINATE OPTIONS ON TOPS**

**WOODGRAIN**

AS	Asian Night	PTK	Portico Teak
BW	Beigewood	RC	River Cherry
CO	Columbian Walnut	SCH	Select Cherry
EF	Espresso	SPW	Sepia Walnut
FLW	Florence Walnut	SKC	Shaker Cherry
GC	Golden Cherry	SBP	Smoky Brown Pear
KHE	Kirsche	TK	Studio Teak
MW	Mahogany Walnut	SM	Sugar Maple
MNR	Midnight Run	WTA	Weathered Ash
NTM	Natural Marrone	WNB	White Nebbia
ORW	Oak Riftwood	WC	Williamsburg Cherry
PNW	Pinnacle Walnut		

**SOLID**

BL	Black	FHG	Fashion Grey
WH	Designer White	SG	Slate Grey

**WOOD FINISHES AVAILABLE ON BASE/LEGS**

Indiana Furniture uses a multi-step, hand finishing process on all exposed wood frames.

Tables feature a catalyzed varnish finish which offers durability, lasting beauty, and resistance to normal wear.

AW	Artisan Walnut	MAS	Mesa Sunset*
AS	Asian Night	MTS	Metropolis Sky
BW	Beigewood*	MNR	Midnight Run
BL	Black	NTM	Natural Marrone*
CO	Columbian Walnut	ORW	Oak Riftwood*
DC	Dark Cherry	PNW	Pinnacle Walnut
DFW	Dark Forest Walnut*	PTK	Portico Teak*
WH	Designer White	RC	River Cherry*
EF	Espresso	SCH	Select Cherry
FO	Fawn Oak*	SPW	Sepia Walnut*
FLW	Florence Walnut*	SKC	Shaker Cherry
GC	Golden Cherry	SBP	Smoky Brown Pear*
HW	Harvest Walnut	TK	Studio Teak
HNW	Henna Walnut	SM	Sugar Maple
KHE	Kirsche	WTA	Weathered Ash*
LW	Legacy Walnut	WNB	White Nebbia
MW	Mahogany Walnut	WC	Williamsburg Cherry

\* Finish is Low Sheen

**TABLE EDGE PROFILE**



Vertical Square

**CERTIFICATIONS & COMPLIANCE**

- Intertek Sustainability Certified
- BIFMA level® Certified
- BIFMA Compliant Certified
- TSCA Title VI (Formerly CARB) Compliance
- US Green Building's LEED Contribution

**STATEMENT OF LINE**

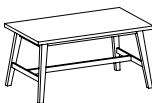

NAT-1: 30"H Table



NAT-2: 42"H Table

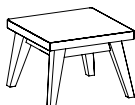

NAT-3:  
Square Table



NAT-4:  
Rectangle Table

See Next Page  
For All Products

## MEETING, COLLABORATIVE + LOUNGE TABLES (NAT SERIES)

Item	Model No.	W	D	H	Ship Wt	Cubic Ft	List Price
30"H MEETING TABLE	NAT-1	61½	35½	30½	106	43.7	\$ 2445

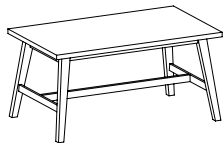

### Description

- Features Square Edge Profile
- Available with Contrasting Top and Leg Color

Must Specify (in this order):

Model #  
Top Color  
Leg Finish

42"H MEETING TABLE	NAT-2	63	39	43	115	64.0	\$ 3023
--------------------	-------	----	----	----	-----	------	---------

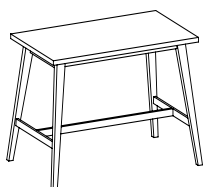

### Description

- Features Square Edge Profile
- Available in Contrasting Top and Leg Color

Must Specify (in this order):

Model #  
Top Color  
Leg Finish

SQUARE TABLE	NAT-3	22	22	16	31	10.8	\$ 1013
--------------	-------	----	----	----	----	------	---------

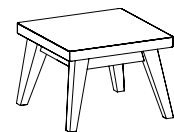

### Description

- Features Square Edge Profile
- Available with Contrasting Top and Leg Color

Must Specify (in this order):

Model #  
Top Color  
Leg Finish

RECTANGLE TABLE	NAT-4	51	22	16	66	25.9	\$ 1381
-----------------	-------	----	----	----	----	------	---------

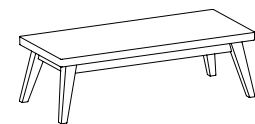

### Description

- Features Square Edge Profile
- Available in Contrasting Surface and Leg Color

Must Specify (in this order):

Model #  
Top Color  
Leg Finish

[See Natta Overview For Ordering Options](#)

One10 Conference provides a scalable aesthetic with a versatile range of tables that provide solutions for casual to formal meetings that can support individual technology, the sharing of personal technology, or communal technology equipment. From conference tables, meeting tables, and TV stands, the collection provides flexibility for tailored applications, virtually anywhere.

**CONSTRUCTION**

**VENEER**

- Exposed surfaces feature select grade plain-sliced hardwood veneers in Cherry, Maple, American Black Walnut, or composite veneers. Veneers are carefully selected and matched to assure proper balance and consistency
- Veneer features either our UVAdvantage, an ultra-violet finish, or our Catalyzed finish (where noted)

**LAMINATE**

- High-Pressure Laminates (HPL) are made of woodgrain and solid color laminates fused to particleboard core; each laminate offers lasting beauty, superior resistance to normal wear, and easy maintenance

**TOPS**

- Tops with the Block Edge are 1½" thick while tops with the Knife Edge are 1¾" thick
- Veneer tops offer 3-ply balanced construction with 1.5mm wood edge band; Laminate tops offer 3-ply balanced construction with 1mm PVC edge band; Designer White, Sugar Maple, and Williamsburg Cherry feature ABS edge bands
- Credenza tops are ¾" thick, 3-ply balanced construction with 0.5mm wood edge-banded rims on Veneer options and 1mm PVC edge-banded rims on Laminate options
- Veneer accent tops are ¾" thick, 3-ply construction with 0.5mm wood edge band while Laminate accent tops are ¾" thick, 3-ply construction with 1mm PVC edge band; Designer White, Sugar Maple, and Williamsburg Cherry feature ABS edge bands
- Grain direction runs left-to-right, unless noted
- The Block Edge profile will be used with Block Bases only, while the Knife Edge profile will be used with Blade Bases only



Block Edge Profile

Knife Edge Profile

**CHASSIS**

- Chassis for storage units are securely fastened using high quality European fastening systems and heavy-duty 16-gauge joining brackets to assure maximum strength
- All units ship with heavy-duty, adjustable leveling glides to ensure proper leveling and compensation for uneven floors

**DRAWERS**

- All drawer fronts are ¾" thick, 3-ply construction with vertical grain direction
- Drawer sides, back, and front are woodgrain vinyl-wrapped ½" thick with ⅛" thick hardboard bottoms
- 5-sided drawer construction allows for easy removal of drawer fronts; All drawer fronts are standard with elegant vertically matched faces
- All drawers feature full extension, progressive action slides with precision steel ball bearings
- Box and file drawers are tested for 100lb capacity
- All suspensions have a limited lifetime warranty

**STORAGE**

- All hinged doors are soft-close, unless otherwise noted
- One piece hinge and base plate combination
- Soft close hinges reduce stress placed on the cabinet when the door is closed and offers a quiet closure

**HOW TO ORDER EXAMPLES**

**SMALL MEETING TABLES**

*Single Column Table*

	QTY	MODEL NO.	DESCRIPTION	EXAMPLE
<b>TOP</b>	1	95-6060SQV	Finish/Color Power/Data Location	FO OC
<b>BASE</b>	1	95-3630BB	Finish/Color	FO
<b>POWER</b>	1	01-DUOBEZELS		

**STANDARD MEETING TABLES**

*Rectangle Shaped with Center Inlay, Block Edge, and Block Bases*

	QTY	MODEL NO.	DESCRIPTION	EXAMPLE
<b>TOP</b>	1	96-60192RTV5	Primary Finish/Color Accent Finish/Color	WTA FHG
<b>BASES</b>	2	96-2428BB	Primary Finish/Color Accent Finish/Color	WTA FHG
	1	96-2428MSL	Primary Finish/Color Accent Finish/Color	WTA FHG
<b>POWER</b>	10	01-DUOS		
	2	01-TRIOS		
	2	LCOMHDMI		

**STORAGE & ACCESSORIES**

*Media Credenza*

	QTY	MODEL NO.	DESCRIPTION	EXAMPLE
	1	95-1872OMC	Finish/Color	SBP

One10

### VENEER (W) OPTIONS ON TOPS, BASES, AND ACCENTS

Veneer features UVAdvantage, an ultra-violet finish, on all exposed surfaces or our Catalyzed finish (where noted), which is a multi-step, finish process that provides years of lasting beauty.

AW	Artisan Walnut	MW	Mahogany Walnut
AS	Asian Night	MAS	Mesa Sunset*
CO	Columbian Walnut	MTS	Metropolis Sky
DC	Dark Cherry	ORW	Oak Riftwood*
DFW	Dark Forest Walnut	PNW	Pinnacle Walnut
EW	Espresso	SCH	Select Cherry
FO	Fawn Oak*	SKC	Shaker Cherry
GC	Golden Cherry	SM	Sugar Maple
HW	Harvest Walnut	WTA	Weathered Ash*
HNW	Henna Walnut	WC	Williamsburg Cherry
LW	Legacy Walnut		

\* Finish is Low Sheen

### HPL (P) LAMINATE OPTIONS ON TOPS, BASES, AND ACCENTS AND TFL (T) FOR BASE ACCENTS

#### WOODGRAIN

AS	Asian Night	PNW	Pinnacle Walnut
BW	Beigewood	PTK	Portico Teak
CO	Columbian Walnut	RC	River Cherry
EF	Espresso	SCH	Select Cherry
FLW	Florence Walnut	SPW	Sepia Walnut
GC	Golden Cherry	SKC	Shaker Cherry
HVM	Harvest Maple	SBP	Smoky Brown Pear
KHE	Kirsche	TK	Studio Teak
MW	Mahogany Walnut	SM	Sugar Maple
MNR	Midnight Run	WTA	Weathered Ash
NTM	Natural Marrone	WNB	White Nebbia
ORW	Oak Riftwood	WC	Williamsburg Cherry

#### SOLID

BL	Black*	FHG	Fashion Grey*
WH	Designer White	SG	Slate Grey*

\* Available as Laminate Accent Only.

### POWER/DATA UNITS & LOCATIONS

#### Square & Round Shaped Tops with Blade Bases

Models:

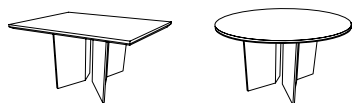

Modules Available (See Unit Details):

01-DUOBEZEL	Available in Black (B), Silver (S), or White (W)
01-TRIOBEZEL	Available in Black (B), Silver (S), or White (W)
01-PDUOBEZEL	Available in Black (B), Silver (S), or White (W)
01-PTRIOBEZEL	Available in Black (B), Silver (S), or White (W)

Note: Only one Power/Data Module Per Top.

#### Power/Data Location:

- All Power/Data Modules will be placed **On Center (OC)** of top.
- Designate "OC" when specifying the top model. Power/Data Module will need to be ordered separately.
- Power/Data Modules specified at the time of order will be routed for field installation.

#### Square & Rectangular Tops for Single and Dual Column Bases

Models:

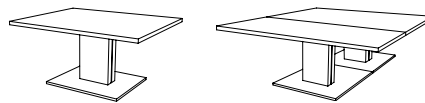

Modules Available (See Unit Details):

01-DUOBEZEL	Available in Black (B), Silver (S), or White (W)
01-TRIOBEZEL	Available in Black (B), Silver (S), or White (W)

Note: Only one Power/Data Module Per Top. Must Order Two (2) Power/Data Modules for Dual Column Tables.

#### Power/Data Location:

- All Power/Data Modules will be placed **On Center (OC)** of each top and installed directly over the base.
- Designate "OC" when specifying the top model. Power/Data Module will need to be ordered separately.
- Power/Data Modules specified at the time of order will be routed for field installation.

#### Rectangular 1 or 2 Piece Tops with Block or Blade Bases

Models:

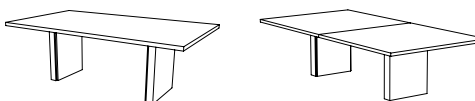

Modules Available (See Unit Details):

Available in Table Surface:

01-DUOBEZEL	Available in Black (B), Silver (S), or White (W)
01-TRIOBEZEL	Available in Black (B), Silver (S), or White (W)
01-PDUOBEZEL	Available in Black (B), Silver (S), or White (W)
01-PTRIOBEZEL	Available in Black (B), Silver (S), or White (W)

Available Under Table Surface:

01-DUO	Available in Black (B), Silver (S), or White (W)
01-TRIO	Available in Black (B), Silver (S), or White (W)
01-PDUO	Available in Black (B), Silver (S), or White (W)
01-PTRIO	Available in Black (B), Silver (S), or White (W)

#### Power/Data Location:

- Power/Data Modules specified at the time of order will be routed for field installation.
- Modules to be mounted under the table surface may be placed anywhere during field installation - No need to specify location when ordering top.

E1	29" Off One End
ELR	29" Off Each End
OC	On Center
OCELR	29" Off Each End and On Center

*OCELR Not Available on Tables 96"W or Less*



**Rectangular and Boat Shaped Tops with Center Inlay**

**Modules Available** (See Unit Details):

- 01-DUO Available in Black (B), Silver (S), or White (W)
- 01-TRIO Available in Black (B), Silver (S), or White (W)

**Power/Data Location:**

- All troughs, included as standard with the tops, have pre-drilled peck-hole locations from the bottom side of the trough for easy field installation. No need to specify location when ordering top.
- Desired Power/Data Modules will need to be ordered separately.
- Field install Power/Data Modules by selecting any or all of the desired pre-marked locations and drill the hole through.

**Locations For: 48"x192" & 60"x192" Models with Center Inlay**

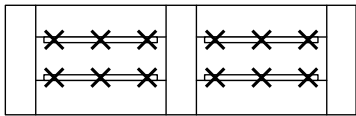

31", 52", and 73" off each end

**Locations For: 48"x168" & 60"x168" Models with Center Inlay**

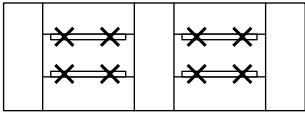

37" and 58" off each end

**Locations For: 48"x144" & 60"x144" Models with Center Inlay**

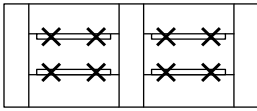

29" and 50" off each end

**Locations For: 48"x120" & 60"x120" Models with Center Inlay**

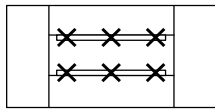

39" and 60" off each end

**Locations For: 48"x108" & 60"x108" Models with Center Inlay**

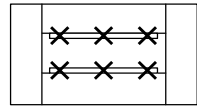

33" and 54" off each end

**Locations For: 48"x96" & 60"x96" Models with Center Inlay**

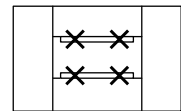

37½" off each end

**CERTIFICATIONS & SUSTAINABILITY**

- Intertek Sustainability Certified
- BIFMA level® Certified
- BIFMA Compliant® Certified
- TSCA Title VI (formerly CARB) Compliance
- US Green Building's LEED® Contribution

**Small Meeting Tables**

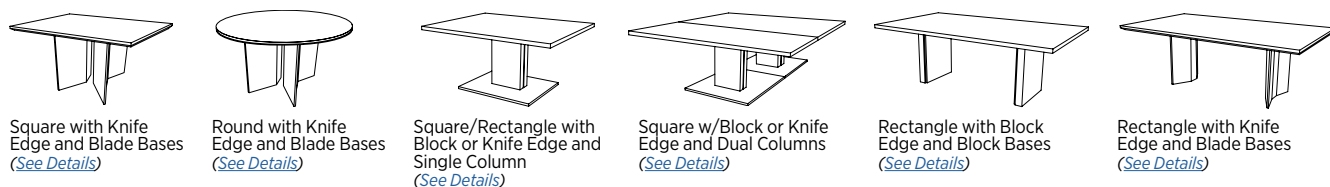

**Standard Meeting Tables**

Select from a variety of tops featuring solid, channels, or inlays in your choice of Block or Knife Edge

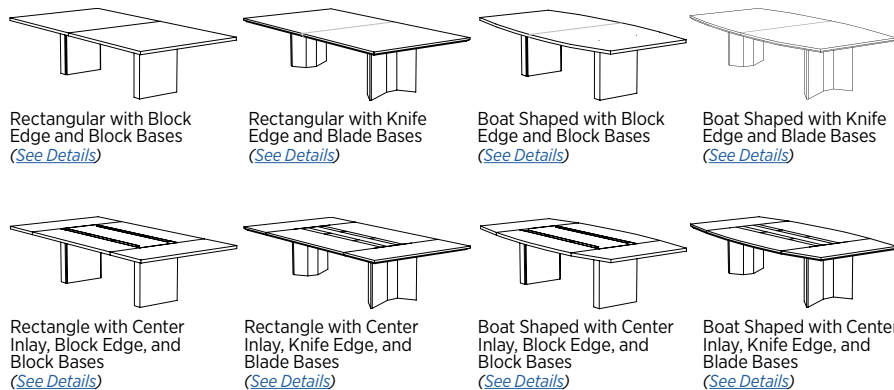
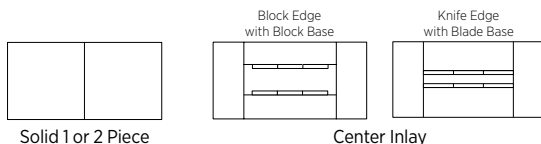

**Wire Management & Power/Data Accessories** [\(See Multiple Unit Details\)](#)

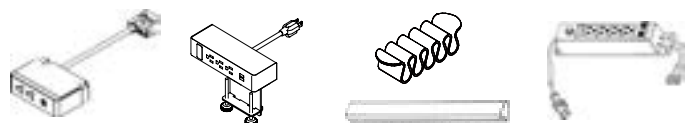

**Storage & Accessories**

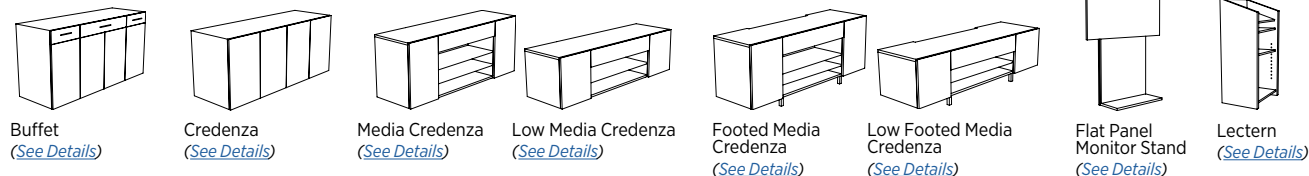

Item	Model No.		W	D	H	Ship Wt	Cubic Ft	List Price
SMALL MEETING TABLES	96-6060SQK	HPL	60	60	1¾	143	8.4	P\$ 2336
	95-6060SQK	Veneer						W\$ 3346
SQUARE TOP BLADE BASE SET KNIFE EDGE	96-5454SQK	HPL	54	54	1¾	114	6.8	P\$ 2141
	95-5454SQK	Veneer						W\$ 3068
	96-4848SQK	HPL	48	48	1¾	90	5.5	P\$ 1856
	95-4848SQK	Veneer						W\$ 2742



Must Specify (in this order):  
Model #  
Finish/Color  
Power/Data Location

**Description**

- Veneer Tops Feature UV Finish on 48"D and Catalyzed Finish on 54"D and 60"D
- Requires One (1) Blade Base Set; Sold Separately, See Below
- Outer Panel can be Specified in a Contrasting Finish/Color from Top Finish/Color
- Power and Data Options Available; Sold Separately, [See Multiple Power Unit Details](#); Unit Will Be Routed On Center. [See Location Details](#)

**BLADE BASE SET**

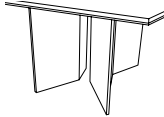

Must Specify (in this order):  
Model #  
Finish/Color

Blade Base Set with Stretchers - Requires One (1) Set								
96-2711BL	HPL		27	10½	28	45	1.9	P\$ 4039
95-2711BL	Veneer							W\$ 5080

**Description**

- Tops Require One (1) Blade Base Set; Sold Separately, See Below
- Outer Panel Features Vertical Grain Direction and can be Specified in a Contrasting Finish/Color from Top Finish/Color

SMALL MEETING TABLES	96-6060CTK	HPL	60	60	1¾	143	8.4	P\$ 2340
	95-6060CTK	Veneer						W\$ 3408
ROUND TOP BLADE BASE SET KNIFE EDGE	96-5454CTK	HPL	54	54	1¾	114	6.8	P\$ 2149
	95-5454CTK	Veneer						W\$ 3133
	96-4848CTK	HPL	48	48	1¾	90	5.5	P\$ 1870
	95-4848CTK	Veneer						W\$ 2797



Must Specify (in this order):  
Model #  
Finish/Color  
Power/Data Location

**Description**

- Veneer Tops Feature UV Finish on 48"D and Catalyzed Finish on 54"D and 60"D
- Requires One (1) Blade Base Set; Sold Separately, See Below
- Outer Panel can be Specified in a Contrasting Finish/Color from Top Finish/Color
- Power and Data Options Available; Sold Separately, [See Multiple Power Unit Details](#); Unit Will Be Routed On Center. [See Location Details](#)

**BLADE BASE SET**



Must Specify (in this order):  
Model #  
Finish/Color

Blade Base Set with Stretchers								
96-2711BL	HPL		27	10½	28	45	1.9	P\$ 4039
95-2711BL	Veneer							W\$ 5080

**Description**

- Tops Require One (1) Blade Base Set; Sold Separately, See Below
- Outer Panel Features Vertical Grain Direction and can be Specified in a Contrasting Finish/Color from Top Finish/Color

P = HPL W = Veneer

[See One10 Overview For Ordering Options](#)

Item	Model No.		W	D	H	Ship Wt	Cubic Ft	List Price
------	-----------	--	---	---	---	---------	----------	------------

**SMALL MEETING TABLES**

**SQUARE/RECTANGULAR  
1 PIECE TOP  
SEATING OR STANDING HEIGHT  
SINGLE COLUMN BASE  
BLOCK OR KNIFE EDGE**

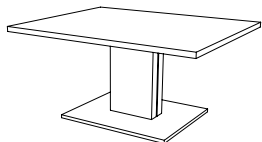

Must Specify (in this order):

- Model #
- Finish/Color
- Power/Data Location

<b>Block Edge</b>								
<i>Square Tops</i>								
96-6060SQV	HPL	60	60	1½	143	8.4	P\$	2004
95-6060SQV	Veneer						W\$	2668
96-5454SQV	HPL	54	54	1½	114	6.8	P\$	1839
95-5454SQV	Veneer						W\$	2381
96-4848SQV	HPL	48	48	1½	90	5.5	P\$	1597
95-4848SQV	Veneer						W\$	1987
<i>Rectangular Tops</i>								
96-4896RTVBB	HPL	48	96	1½	205	17.7	P\$	2020
95-4896RTVBB	Veneer						W\$	2772
96-4884RTV	HPL	48	84	1½	158	9.3	P\$	1960
95-4884RTV	Veneer						W\$	2491
96-4872RTV	HPL	48	72	1½	135	8.1	P\$	1869
95-4872RTV	Veneer						W\$	2220
96-4860RTV	HPL	48	60	1½	112	6.8	P\$	1779
95-4860RTV	Veneer						W\$	1983
<b>Knife Edge</b>								
<i>Square Tops</i>								
96-6060SQK	HPL	60	60	1⅜	143	8.4	P\$	2336
95-6060SQK	Veneer						W\$	3346
96-5454SQK	HPL	54	54	1⅜	114	6.8	P\$	2141
95-5454SQK	Veneer						W\$	3068
96-4848SQK	HPL	48	48	1⅜	90	5.5	P\$	1856
95-4848SQK	Veneer						W\$	2742
<i>Rectangular Tops</i>								
96-4896RTKBB	HPL	48	96	1⅜	180	11.4	P\$	2389
95-4896RTKBB	Veneer						W\$	3281
96-4884RTKBB	HPL	48	84	1⅜	158	10.0	P\$	2316
95-4884RTKBB	Veneer						W\$	2912
96-4872RTKBB	HPL	48	72	1⅜	135	8.1	P\$	2208
95-4872RTKBB	Veneer						W\$	2596
96-4860RTKBB	HPL	48	60	1⅜	112	6.8	P\$	2110
95-4860RTKBB	Veneer						W\$	2333

**Description**

- All Models Feature a 1-piece, 1⅜" Thick Top
- Veneer Tops Feature UV Finish on 48"D and Catalyzed Finish on 54"D and 60"D
- Metal Frame Column Bases For Seated Height or Standing Height Tables; Sold Separately, See Below
- Power and Data Options Available; Sold Separately, [See Multiple Power Unit Details](#); Unit Will Be Routed On Center. [See Location Details](#)

**METAL FRAME COLUMN BASES**

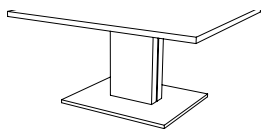

Must Specify (in this order):

- Model #
- Finish/Color

<b>Bases for Tables ≤72"D</b>								
96-3630TBB	42" Standing Height	36	30	40	178	30.4	P\$	3008
95-3630TBB							W\$	3526
96-3630BB	30" Seated Height	36	30	28	168	26.2	P\$	2847
95-3630BB							W\$	3137
<b>Bases for Tables ≥84"D</b>								
96-6030TBB	42" Standing Height	60	30	40	257	49.5	P\$	3908
95-6030TBB							W\$	4382
96-6030BB	30" Seated Height	60	30	28	211	35.7	P\$	3774
95-6030BB							W\$	4060

**Description**

- Aluminum Base Platform and Aluminum Detail Continues Up the Column for Design Appeal
- Base Features Horizontal Grain Direction
- Column Accommodates Wire Management with Removable Panel for Power and Data
- Adjustable Levelers

P = HPL W = Veneer

[See One10 Overview For Ordering Options](#)

Item	Model No.		W	D	H	Ship Wt	Cubic Ft	List Price	
<b>SMALL MEETING TABLES</b>									
<b>Block Edge - 2 Piece Top</b>									
<b>SQUARE SHAPED 2 PIECE TOP SEATING OR STANDING HEIGHT DUAL COLUMN BASE BLOCK OR KNIFE EDGE</b>	96-9696SQV	HPL	96	96	1½	379	21.2	P\$ 4881	
	95-9696SQV	Veneer						W\$ 5066	
	96-8484SQV	HPL	84	84	1½	294	21.2	P\$ 4494	
	95-8484SQV	Veneer						W\$ 4664	
	<b>Knife Edge - 2 Piece Top</b>								
	96-9696SQK	HPL	96	96	1⅝	287	21.2	P\$ 5066	
	95-9696SQK	Veneer						W\$ 6691	
	96-8484SQK	HPL	84	84	1⅝	224	21.2	P\$ 4664	
95-8484SQK	Veneer						W\$ 6120		

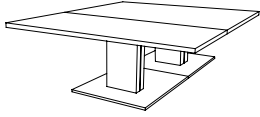

Must Specify (in this order):

Model #  
Finish/Color  
Power/Data Location

**Description**

- All Models Feature a 2-piece, 1½" Thick Top
- Veneer Tops Feature Catalyzed Finish
- Requires Two (2) Metal Frame Column Bases For Seated Height or Standing Height Tables; Sold Separately, See Below
- Power and Data Options Available; Sold Separately, [See Multiple Power Unit Details](#); If Ordering, Must Order Two (2) as Units Will Be Routed On Center of Each Top, Directly Above the Bases. [See Location Details](#)

**METAL FRAME COLUMN BASES**

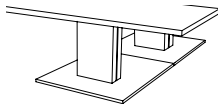

<b>Two (2) Bases Required</b>								
96-6030TBB	42" Standing Height		60	30	40	257	49.5	P\$ 3908
95-6030TBB								W\$ 4382
96-6030BB	30" Seated Height		60	30	28	211	35.7	P\$ 3774
95-6030BB								W\$ 4060

**Description**

- Two (2) Bases Required
- Aluminum Base Platform and Aluminum Detail Continues Up the Column for Design Appeal
- Base Features Horizontal Grain Direction
- Column Accommodates Wire Management with Removable Panel for Power and Data
- Adjustable Levelers

Must Specify (in this order):

Model #  
Finish/Color

P = HPL W = Veneer

[See One10 Overview For Ordering Options](#)

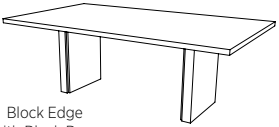
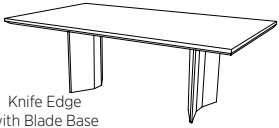
Item	Model No.		W	D	H	Ship Wt	Cubic Ft	List Price
<b>SMALL MEETING TABLES</b>								
<p><b>RECTANGULAR SHAPE 1 PIECE TOP BLOCK EDGE W/BLOCK BASE OR KNIFE EDGE W/BLADE BASE</b></p>  <p>Block Edge with Block Base</p>  <p>Knife Edge with Blade Base</p>	<b>Block Edge (Use with Block Base Only)</b>							
	<i>48"W Tops</i>							
	96-4884RTV	HPL	48	84	1½	158	9.3	P\$ 1960
	95-4884RTV	Veneer						W\$ 2491
	96-4872RTV	HPL	48	72	1½	135	8.1	P\$ 1869
	95-4872RTV	Veneer						W\$ 2220
	<i>42"W Tops</i>							
	96-4296RTV	HPL	42	96	1½	158	9.1	P\$ 1869
	95-4296RTV	Veneer						W\$ 2605
	96-4284RTV	HPL	42	84	1½	138	8.1	P\$ 1791
	95-4284RTV	Veneer						W\$ 2459
	96-4272RTV	HPL	42	72	1½	119	7.1	P\$ 1709
	95-4272RTV	Veneer						W\$ 2003
	<i>36"W Tops</i>							
	96-3696RTV	HPL	36	96	1½	135	8.1	P\$ 1796
	95-3696RTV	Veneer						W\$ 2394
	96-3684RTV	HPL	36	84	1½	119	7.1	P\$ 1726
	95-3684RTV	Veneer						W\$ 2092
	96-3672RTV	HPL	36	72	1½	102	6.2	P\$ 1683
	95-3672RTV	Veneer						W\$ 1898
	<b>Knife Edge (Use with Blade Base Only)</b>							
	<i>48"W Tops</i>							
	96-4884RTK	HPL	48	84	1⅝	158	9.3	P\$ 4270
	95-4884RTK	Veneer						W\$ 5553
96-4872RTK	HPL	48	72	1⅝	135	8.1	P\$ 4047	
95-4872RTK	Veneer						W\$ 4956	
<i>42"W Tops</i>								
96-4296RTK	HPL	42	96	1⅝	158	9.1	P\$ 4541	
95-4296RTK	Veneer						W\$ 5786	
96-4284RTK	HPL	42	84	1⅝	138	8.1	P\$ 4093	
95-4284RTK	Veneer						W\$ 5281	
96-4272RTK	HPL	42	72	1⅝	119	7.1	P\$ 3875	
95-4272RTK	Veneer						W\$ 4909	
<i>36"W Tops</i>								
96-3696RTK	HPL	36	96	1⅝	135	8.1	P\$ 4389	
95-3696RTK	Veneer						W\$ 5682	
96-3684RTK	HPL	36	84	1⅝	119	7.1	P\$ 3990	
95-3684RTK	Veneer						W\$ 5094	
96-3672RTK	HPL	36	72	1⅝	102	6.2	P\$ 3790	
95-3672RTK	Veneer						W\$ 4791	

Must Specify (in this order):

- Model #
- Finish/Color
- Power/Data Location

*Continued on next page.*

P = HPL W = Veneer C = Combination of Wood/Laminate

[See One10 Overview For Ordering Options](#)

Item	Model No.	W	D	H	Ship Wt	Cubic Ft	List Price
------	-----------	---	---	---	---------	----------	------------

Continued from  
Previous Page

**What You Get:**

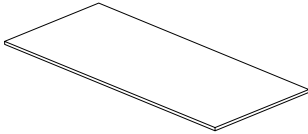

Top

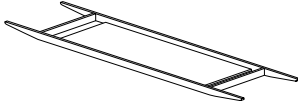

Trough  
(on Knife Edge with Blade Bases Only)

**Description**

- 1½" Thick Rectangular Top with Block Edge or 1⅜" Thick Rectangular Top with Knife Edge
- All Models Feature a 1 Piece Top
- Veneer Tops Feature Catalyzed Finish
- Requires Two (2) Block Bases (Block Edge Only) or Blade Bases (Knife Edge Only); Sold Separately, See Below
- Block Bases Require Stretcher Rails; Sold Separately, See Below
- Blade Bases come with Trough to Reinforce and Support Top
- Power and Data Options Available; Sold Separately, [See Multiple Power Unit Details](#); [See Location Options](#)
- Assembly Required

**Top Grain Direction**

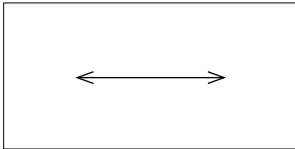

**BASES & STRETCHERS**

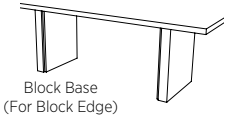

Block Base  
(For Block Edge)

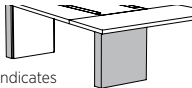

Shaded Indicates  
Accent Area  
(Vertical Grain Direction)

Must Specify (in this order):

- Standard Base Model #
- Stretchers (If needed)
- Primary Finish/Color
- Accent Material
- Accent Finish/Color

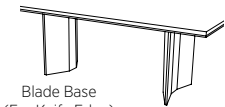

Blade Base  
(For Knife Edge)

Must Specify (in this order):

- Standard Base Model #
- Stretchers (If needed)
- Primary Finish/Color

Block Bases; Must Order - Two (2) Required							
96-2228BB	HPL	22	5¼	28	45	1.9	P\$ 1485
95-2228BB	Veneer						W\$ 2039
95-2228BB	Veneer/TFL						C\$ 2312

Stretcher Sets For Block Bases; Must Order - One (1) Set Required							
<i>For 96"D Tables</i>							
96-0496STR	HPL	54⅜	¾	4⅝	9.2	0.5	P\$ 720
95-0496STR	Veneer						W\$ 865
<i>For 84"D Tables</i>							
96-0484STR	HPL	42⅜	¾	4⅝	7.2	0.4	P\$ 642
95-0484STR	Veneer						W\$ 768
<i>For 72"D Tables</i>							
96-0472STR	HPL	30⅜	¾	4⅝	5.2	0.3	P\$ 597
95-0472STR	Veneer						W\$ 698

Blade Bases; Must Order - Two (2) Required							
96-2828BD	HPL	28	10½	28	52	2.4	P\$ 1290
95-2828BD	Veneer						W\$ 1776

**Description**

- All Tables with a Block Edge Require Two (2) Block Bases and One (1) Set of Stretchers; All Tables with a Knife Edge Require Two (2) Blade Bases
- Bases are Constructed with Removable Interior Panel for Wire Management Installation
- Block Bases Feature Horizontal Grain Direction on Primary Panels and Vertical Grain on Accent Panels
- Block Base Outer Accent Panel can be Specified in a Contrasting Finish/Color from Top Finish/Color
- Blade Bases Feature Vertical Grain Direction
- Adjustable Glides Included

P = HPL W = Veneer C = Combination of Wood/TFL Accent

[See One10 Overview For Ordering Options](#)

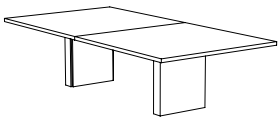
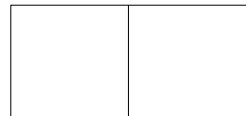
Item	Model No.		W	D	H	Ship Wt	Cubic Ft	List Price	
<b>STANDARD TABLES</b>		<b>60"D Tops</b>							
		<i>192"W: 2 Piece Top</i>							
RECTANGULAR SHAPE 1 OR 2 PIECE TOP BLOCK EDGE BLOCK BASE	96-60192RTV	HPL	192	60	1½	482	28.2	P\$ 9270	
	95-60192RTV	Veneer						W\$ 10051	
		<i>168"W: 2 Piece Top</i>							
	96-60168RTV	HPL	168	60	1½	449	24.8	P\$ 8628	
	95-60168RTV	Veneer						W\$ 9306	
		<i>144"W: 2 Piece Top</i>							
	96-60144RTV	HPL	144	60	1½	388	21.4	P\$ 7220	
	95-60144RTV	Veneer						W\$ 8676	
		<i>120"W: 2 Piece Top</i>							
	96-60120RTV	HPL	120	60	1½	332	18.0	P\$ 6083	
	95-60120RTV	Veneer						W\$ 7165	
		<i>108"W: 1 Piece Top</i>							
	96-60108RTV	HPL	108	60	1½	301	16.3	P\$ 5320	
	95-60108RTV	Veneer						W\$ 7076	
		<i>96"W: 1 Piece Top</i>							
Must Specify (in this order): Model # Finish/Color Power/Data Location	96-6096RTV	HPL	96	60	1½	262	14.6	P\$ 4929	
	95-6096RTV	Veneer						W\$ 5889	
		<b>48"D Tops</b>							
		<i>192"W: 2 Piece Top</i>							
	96-48192RTV	HPL	192	48	1½	426	22.7	P\$ 7815	
	95-48192RTV	Veneer						W\$ 9078	
		<i>168"W: 2 Piece Top</i>							
	96-48168RTV	HPL	168	48	1½	368	19.9	P\$ 7427	
	95-48168RTV	Veneer						W\$ 8522	
		<i>144"W: 2 Piece Top</i>							
Rectangular 1 or 2-Piece Top available with a Knife Edge and coordinating Blade Base.	96-48144RTV	HPL	144	48	1½	318	17.1	P\$ 6109	
	95-48144RTV	Veneer						W\$ 7892	
		<i>120"W: 2 Piece Top</i>							
	96-48120RTV	HPL	120	48	1½	269	14.3	P\$ 5266	
	95-48120RTV	Veneer						W\$ 6194	
		<i>108"W: 1 Piece Top</i>							
	96-48108RTV	HPL	108	48	1½	234	12.9	P\$ 4909	
	95-48108RTV	Veneer						W\$ 5921	
		<i>96"W: 1 Piece Top</i>							
	96-4896RTV	HPL	96	48	1½	205	11.5	P\$ 3849	
	95-4896RTV	Veneer						W\$ 5124	

*Continued on next page.*

P = HPL W = Veneer

[See One10 Overview For Ordering Options](#)



Item	Model No.	W	D	H	Ship Wt	Cubic Ft	List Price
------	-----------	---	---	---	---------	----------	------------

Continued from  
Previous Page

**What You Get:**

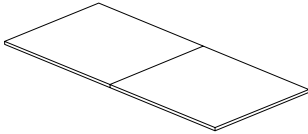

Top

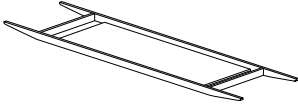

Trough

**Description**

- 1½" Thick Rectangular Top with Block Edge
- Veneer Tops Feature UV Finish on 48"D and Catalyzed Finish on 60"D
- Trough Reinforces and Supports Top
- Requires Two (2) Block Bases; Tables 144"W or Larger Also Require Middle Block Base; Sold Separately, See Below
- Power and Data Options Available; Sold Separately, [See Multiple Power Unit Details](#); [See Location Options](#)
- Assembly Required

**Top Grain Direction**

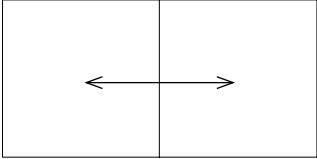

**BLOCK BASES**

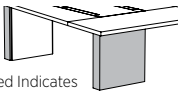
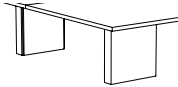

Shaded Indicates  
Accent Area  
(Vertical Grain Direction)

Block Base Options; Must Order							
Standard Block Base - Two (2) Required							
96-2428BB	HPL	24	6	28	52	2.4	P\$ 1580
95-2428BB	Veneer						W\$ 2170
95-2428BB	Veneer/TFL						C\$ 2430
Middle Block Base - Required for Tops 144"W or Larger							
96-2428MSL	HPL	24	7½	28	72	2.8	P\$ 1930
95-2428MSL	Veneer						W\$ 2511
95-2428MSL	Veneer/TFL						C\$ 2859



**Description**

- All Tops Require Two (2) Block Bases; Tables 144"W or Larger Also Require Middle Block Base
- Bases are Constructed with Removable Interior Panel for Wire Management Installation
- Block Bases Feature Horizontal Grain Direction on Primary Panels and Vertical Grain on Accent Panels
- Block Base Outer Accent Panel can be Specified in a Contrasting Finish/Color from Top Finish/Color
- Middle Base Feature Horizontal Grain Direction on Primary Panels and Vertical Grain on Accent Panels
- Adjustable Glides Included

Must Specify (in this order):

- Standard Base Model #
- Primary Finish/Color
- Accent Material
- Accent Finish/Color
- Middle Base Model # (If needed)
- Middle Base Primary Finish/Color
- Middle Base Accent Material
- Middle Base Accent Finish/Color

P = HPL W = Veneer C = Combination of Wood/TFL Accent

Item	Model No.		W	D	H	Ship Wt	Cubic Ft	List Price	
<b>STANDARD TABLES</b>		<b>60"D Tops</b>							
		<i>192"W: 2 Piece Top</i>							
RECTANGULAR SHAPE 1 OR 2 PIECE TOP KNIFE EDGE BLADE BASE	96-60192RTK	HPL	192	60	1 3/16	482	28.2	P\$ 10386	
	95-60192RTK	Veneer						W\$ 11257	
		<i>168"W: 2 Piece Top</i>							
	96-60168RTK	HPL	168	60	1 3/16	449	24.8	P\$ 9661	
	95-60168RTK	Veneer						W\$ 10422	
		<i>144"W: 2 Piece Top</i>							
	96-60144RTK	HPL	144	60	1 3/16	388	21.4	P\$ 8087	
	95-60144RTK	Veneer						W\$ 9721	
		<i>120"W: 2 Piece Top</i>							
	96-60120RTK	HPL	120	60	1 3/16	332	18.0	P\$ 6814	
	95-60120RTK	Veneer						W\$ 8024	
		<i>108"W: 1 Piece Top</i>							
	96-60108RTK	HPL	108	60	1 3/16	301	16.3	P\$ 5960	
	95-60108RTK	Veneer						W\$ 7930	
		<i>96"W: 1 Piece Top</i>							
	96-6096RTK	HPL	96	60	1 3/16	262	14.6	P\$ 5521	
	95-6096RTK	Veneer						W\$ 6595	
		<b>48"D Tops</b>							
		<i>192"W: 2 Piece Top</i>							
	96-48192RTK	HPL	192	48	1 3/16	426	22.7	P\$ 8751	
	95-48192RTK	Veneer						W\$ 10169	
		<i>168"W: 2 Piece Top</i>							
	96-48168RTK	HPL	168	48	1 3/16	368	19.9	P\$ 8318	
	95-48168RTK	Veneer						W\$ 9546	
		<i>144"W: 2 Piece Top</i>							
	96-48144RTK	HPL	144	48	1 3/16	318	17.1	P\$ 6842	
	95-48144RTK	Veneer						W\$ 8837	
		<i>120"W: 2 Piece Top</i>							
	96-48120RTK	HPL	120	48	1 3/16	269	14.3	P\$ 5901	
	95-48120RTK	Veneer						W\$ 6939	
		<i>108"W: 1 Piece Top</i>							
	96-48108RTK	HPL	108	48	1 3/16	234	12.9	P\$ 5498	
	95-48108RTK	Veneer						W\$ 6632	
		<i>96"W: 1 Piece Top</i>							
	96-4896RTK	HPL	96	48	1 3/16	205	11.5	P\$ 4311	
	95-4896RTK	Veneer						W\$ 5743	

Must Specify (in this order):

- Model #
- Finish/Color
- Power/Data Location

Rectangular 1 or 2-Piece Top available with a Block Edge and coordinating Block Base.

[See Details.](#)

*Continued on next page.*

P = HPL W = Veneer

[See One10 Overview For Ordering Options](#)

Item	Model No.	W	D	H	Ship Wt	Cubic Ft	List Price
------	-----------	---	---	---	---------	----------	------------

Continued from  
Previous Page

**What You Get:**

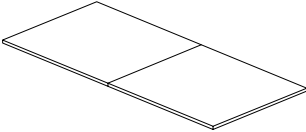

Top

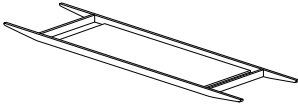

Trough

**Description**

- 1<sup>3</sup>/<sub>16</sub>" Rectangular Top with Knife Edge
- Veneer Tops Feature UV Finish on 48"D and Catalyzed Finish on 60"D
- Trough Reinforces and Supports Top
- Requires Two (2) Blade Bases; Tables 144"W or Larger Also Require Middle Blade Base; Sold Separately, See Below
- Power and Data Options Available; Sold Separately, [See Multiple Power Unit Details](#); [See Location Options](#)
- Assembly Required

**Top Grain Direction**

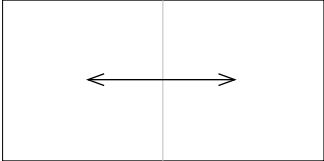

**BLADE BASES**

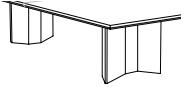

<b>Blade Base Options; Must Order</b>							
<i>Standard Blade Base - Two (2) Required</i>							
96-2828BD	HPL	28	10½	28	52	2.4	P\$ 1290
95-2828BD	Veneer						W\$ 1776
<i>Middle Blade Base - Required for Tops 144"W or Larger</i>							
96-2818MBD	Aluminum	18	3 <sup>3</sup> / <sub>8</sub>	28	72	2.8	\$ 1708
95-2818MBD	Aluminum						\$ 1708

**Description**

- All Tops Require Two (2) Blade Bases; Tables 144"W or Larger Also Require Middle Blade Base
- Bases are Constructed with Removable Interior Aluminum Panel for Wire Management Installation
- Aluminum Middle Blade Base Features Two (2) Aluminum Doors for Wire Management
- Blade Base Outer Panel Feature Vertical Grain Direction and can be Specified in a Contrasting Finish/Color from Top Finish/Color
- Adjustable Glides Included

Must Specify (in this order):

- Standard Base Model #
- Primary Finish/Color
- Middle Base Model # (If needed)

P = HPL W = Veneer

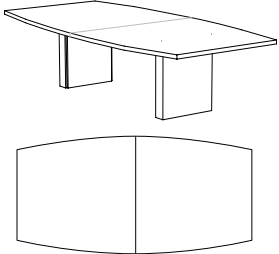
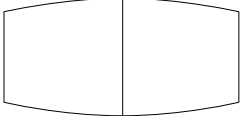
Item	Model No.		W	D	H	Ship Wt	Cubic Ft	List Price	
<b>STANDARD TABLES</b>		<b>60"D Tops</b>							
		<i>192"W: 2 Piece Top</i>							
<b>BOAT SHAPED 1 OR 2 PIECE TOP BLOCK EDGE BLOCK BASE</b>	96-60192BTV	HPL	192	60 - 48	1½	482	28.2	P\$ 9736	
	95-60192BTV	Veneer						W\$ 10854	
		<i>168"W: 2 Piece Top</i>							
	96-60168BTV	HPL	168	60 - 48	1½	449	24.8	P\$ 9059	
	95-60168BTV	Veneer						W\$ 10051	
		<i>144"W: 2 Piece Top</i>							
	96-60144BTV	HPL	144	60 - 48	1½	388	21.4	P\$ 7583	
	95-60144BTV	Veneer						W\$ 9372	
		<i>120"W: 2 Piece Top</i>							
	96-60120BTV	HPL	120	60 - 48	1½	332	18.0	P\$ 6385	
	95-60120BTV	Veneer						W\$ 7520	
		<i>108"W: 1 Piece Top</i>							
	96-60108BTV	HPL	108	60 - 48	1½	301	16.3	P\$ 5586	
	95-60108BTV	Veneer						W\$ 7432	
		<i>96"W: 1 Piece Top</i>							
<u>Must Specify (in this order):</u> Model # Finish/Color Power/Data Location	96-6096BTV	HPL	96	60 - 48	1½	262	14.6	P\$ 5174	
	95-6096BTV	Veneer						W\$ 6183	
		<b>48"D Tops</b>							
		<i>192"W: 2 Piece Top</i>							
	96-48192BTV	HPL	192	48 - 36	1½	426	22.7	P\$ 8208	
	95-48192BTV	Veneer						W\$ 9531	
		<i>168"W: 2 Piece Top</i>							
	96-48168BTV	HPL	168	48 - 36	1½	368	19.9	P\$ 7796	
	95-48168BTV	Veneer						W\$ 8952	
		<i>144"W: 2 Piece Top</i>							
<b>Boat-Shaped 1 or 2-Piece Top available with a Knife Edge and coordinating Blade Base.</b>	96-48144BTV	HPL	144	48 - 36	1½	318	17.1	P\$ 6416	
	95-48144BTV	Veneer						W\$ 8287	
		<i>120"W: 2 Piece Top</i>							
	96-48120BTV	HPL	120	48 - 36	1½	269	14.3	P\$ 5530	
	95-48120BTV	Veneer						W\$ 6506	
		<i>108"W: 1 Piece Top</i>							
<a href="#">See Details.</a>	96-48108BTV	HPL	108	48 - 36	1½	234	12.9	P\$ 5156	
	95-48108BTV	Veneer						W\$ 6217	
		<i>96"W: 1 Piece Top</i>							
	96-4896BTV	HPL	96	48 - 36	1½	205	11.5	P\$ 4042	
	95-4896BTV	Veneer						W\$ 5382	

*Continued on next page.*

P = HPL W = Veneer

[See One10 Overview For Ordering Options](#)

Item	Model No.	W	D	H	Ship Wt	Cubic Ft	List Price
------	-----------	---	---	---	---------	----------	------------

Continued from  
Previous Page

**What You Get:**

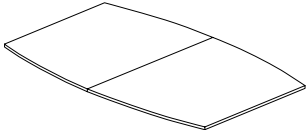

Top

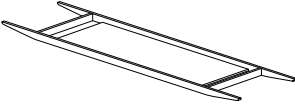

Trough

**Description**

- 1½" Thick Boat-Shaped Top with Block Edge
- Veneer Tops Feature UV Finish on 48"D and Catalyzed Finish on 60"D
- Trough Reinforces and Supports Top
- Requires Two (2) Block Bases; Tables 144"W or Larger Also Require Middle Block Base; Sold Separately, See Below
- Power and Data Options Available; Sold Separately, [See Multiple Power Unit Details](#); [See Location Options](#)
- Assembly Required

**Top Grain Direction**

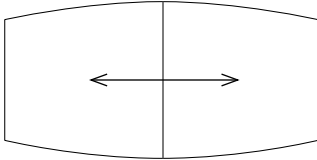

**BLOCK BASES**

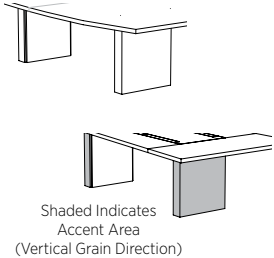

Block Base Options; Must Order							
<i>Standard Block Base - Two (2) Required</i>							
96-2428BB	HPL	24	6	28	52	2.4	P\$ 1580
95-2428BB	Veneer						W\$ 2170
95-2428BB	Veneer/TFL						C\$ 2430
<i>Middle Block Base - Required for Tops 144"W or Larger</i>							
96-2428MSL	HPL	24	7½	28	72	2.8	P\$ 1930
95-2428MSL	Veneer						W\$ 2511
95-2428MSL	Veneer/TFL						C\$ 2859

**Description**

- All Tops Require Two (2) Block Bases; Tables 144"W or Larger Also Require Middle Block Base
- Bases are Constructed with Removable Interior Panel for Wire Management Installation
- Block Bases Feature Horizontal Grain Direction on Primary Panels and Vertical Grain on Accent Panels
- Block Base Outer Accent Panel can be Specified in a Contrasting Finish/Color from Top Finish/Color
- Middle Base Feature Horizontal Grain Direction on Primary Panels and Vertical Grain on Accent Panels
- Adjustable Glides Included

Must Specify (in this order):

- Standard Base Model #
- Primary Finish/Color
- Accent Material
- Accent Finish/Color
- Middle Base Model # (If needed)
- Middle Base Primary Finish/Color
- Middle Base Accent Material
- Middle Base Accent Finish/Color

P = HPL W = Veneer C = Combination of Wood/TFL Accent

[See One10 Overview For Ordering Options](#)

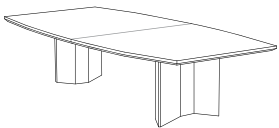
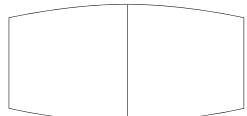
Item	Model No.		W	D	H	Ship Wt	Cubic Ft	List Price	
<b>STANDARD TABLES</b>		<b>60"D Tops</b>							
		<i>192"W: 2 Piece Top</i>							
<b>BOAT SHAPED 1 OR 2 PIECE TOP KNIFE EDGE BLADE BASE</b>	96-60192BTK	HPL	192	60 - 48	1 3/16	482	28.2	P\$ 10904	
	95-60192BTK	Veneer						W\$ 11820	
		<i>168"W: 2 Piece Top</i>							
	96-60168BTK	HPL	168	60 - 48	1 3/16	449	24.8	P\$ 10144	
	95-60168BTK	Veneer						W\$ 10943	
		<i>144"W: 2 Piece Top</i>							
	96-60144BTK	HPL	144	60 - 48	1 3/16	388	21.4	P\$ 8491	
	95-60144BTK	Veneer						W\$ 10204	
		<i>120"W: 2 Piece Top</i>							
	96-60120BTK	HPL	120	60 - 48	1 3/16	332	18.0	P\$ 7153	
	95-60120BTK	Veneer						W\$ 8425	
		<i>108"W: 1 Piece Top</i>							
	96-60108BTK	HPL	108	60 - 48	1 3/16	301	16.3	P\$ 6258	
	95-60108BTK	Veneer						W\$ 8323	
		<i>96"W: 1 Piece Top</i>							
	96-6096BTK	HPL	96	60 - 48	1 3/16	262	14.6	P\$ 5797	
	95-6096BTK	Veneer						W\$ 6922	
		<b>48"D Tops</b>							
		<i>192"W: 2 Piece Top</i>							
	96-48192BTK	HPL	192	48 - 36	1 3/16	426	22.7	P\$ 9191	
	95-48192BTK	Veneer						W\$ 10679	
		<i>168"W: 2 Piece Top</i>							
	96-48168BTK	HPL	168	48 - 36	1 3/16	368	19.9	P\$ 8732	
	95-48168BTK	Veneer						W\$ 10022	
		<i>144"W: 2 Piece Top</i>							
Boat-Shaped 1 or 2-Piece Top available with a Block Edge and coordinating Block Base.	96-48144BTK	HPL	144	48 - 36	1 3/16	318	17.1	P\$ 7181	
	95-48144BTK	Veneer						W\$ 9282	
		<i>120"W: 2 Piece Top</i>							
	96-48120BTK	HPL	120	48 - 36	1 3/16	269	14.3	P\$ 6194	
	95-48120BTK	Veneer						W\$ 7284	
		<i>108"W: 1 Piece Top</i>							
	96-48108BTK	HPL	108	48 - 36	1 3/16	234	12.9	P\$ 5775	
	95-48108BTK	Veneer						W\$ 6966	
		<i>96"W: 1 Piece Top</i>							
	96-4896BTK	HPL	96	48 - 36	1 3/16	205	11.5	P\$ 4527	
	95-4896BTK	Veneer						W\$ 6033	

Must Specify (in this order):

- Model #
- Finish/Color
- Power/Data Location

[See Details.](#)

*Continued on next page.*

P = HPL W = Veneer

[See One10 Overview For Ordering Options](#)

Item	Model No.	W	D	H	Ship Wt	Cubic Ft	List Price
------	-----------	---	---	---	---------	----------	------------

Continued from  
Previous Page

**What You Get:**

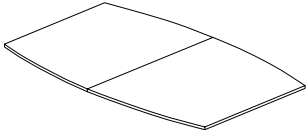

Top

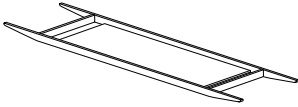

Trough

**Description**

- 1<sup>3</sup>/<sub>16</sub>" Rectangular Top with Knife Edge
- Veneer Tops Feature UV Finish on 48"D and Catalyzed Finish on 60"D
- Trough Reinforces and Supports Top
- Requires Two (2) Blade Bases; Tables 144"W or Larger Also Require Middle Blade Base; Sold Separately, See Below
- Power and Data Options Available; Sold Separately, [See Multiple Power Unit Details](#); [See Location Options](#)
- Assembly Required

**Top Grain Direction**

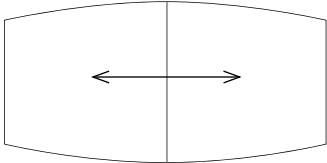

**BLADE BASES**

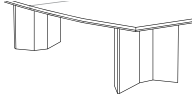

<b>Blade Base Options; Must Order</b>							
<i>Standard Blade Base - Two (2) Required</i>							
96-2828BD	HPL	28	10½	28	52	2.4	P\$ 1290
95-2828BD	Veneer						W\$ 1776
<i>Middle Blade Base - Required for Tops 144"W or Larger</i>							
96-2818MBD	Aluminum	18	3 <sup>3</sup> / <sub>8</sub>	28	72	2.8	\$ 1708
95-2818MBD	Aluminum						\$ 1708

**Description**

- All Tops Require Two (2) Blade Bases; Tables 144"W or Larger Also Require Middle Blade Base
- Bases are Constructed with Removable Interior Aluminum Panel for Wire Management Installation
- Aluminum Middle Blade Base Features Two (2) Aluminum Doors for Wire Management
- Blade Base Outer Panel Feature Vertical Grain Direction and can be Specified in a Contrasting Finish/Color from Top Finish/Color
- Adjustable Glides Included

Must Specify (in this order):  
Standard Base Model #  
Primary Finish/Color  
Middle Base Model # (If needed)

P = HPL W = Veneer

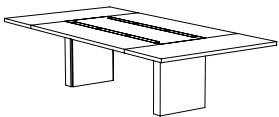
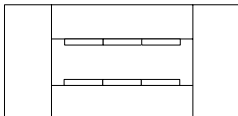
Item	Model No.		W	D	H	Ship Wt	Cubic Ft	List Price	
<b>STANDARD TABLES</b>		<b>60"D Tops</b>							
		<i>192"W: 9 Piece Top - 12 Accent Doors</i>							
<b>RECTANGULAR TOP CENTER INLAY BLOCK EDGE BLOCK BASE</b>	96-60192RTV5	HPL	192	60	1½	435	25.3	P\$ 16291	
	95-60192RTV5	Veneer						W\$ 19254	
	95-60192RTV5	Veneer/HPL						C\$ 19536	
		<i>168"W: 9 Piece Top - 8 Accent Doors</i>							
	96-60168RTV5	HPL	168	60	1½	407	24.9	P\$ 14747	
	95-60168RTV5	Veneer						W\$ 17116	
	95-60168RTV5	Veneer/HPL						C\$ 17563	
		<i>144"W: 9 Piece Top - 8 Accent Doors</i>							
	96-60144RTV5	HPL	144	60	1½	379	24.4	P\$ 14158	
	95-60144RTV5	Veneer						W\$ 16250	
	95-60144RTV5	Veneer/HPL						C\$ 16665	
		<i>120"W: 5 Piece Top - 6 Accent Doors</i>							
	96-60120RTV5	HPL	120	60	1½	339	24.0	P\$ 9227	
	95-60120RTV5	Veneer						W\$ 10922	
	95-60120RTV5	Veneer/HPL						C\$ 11061	
		<i>108"W: 5 Piece Top - 6 Accent Doors</i>							
<u>Must Specify (in this order):</u> Model # Primary Finish/Color Accent Material Accent Finish/Color	96-60108RTV5	HPL	108	60	1½	310	23.6	P\$ 8958	
	95-60108RTV5	Veneer						W\$ 10544	
	95-60108RTV5	Veneer/HPL						C\$ 10667	
		<i>96"W: 5 Piece Top - 4 Accent Doors</i>							
	96-6096RTV5	HPL	96	60	1½	282	23.0	P\$ 8229	
	95-6096RTV5	Veneer						W\$ 9765	
	95-6096RTV5	Veneer/HPL						C\$ 10022	
		<b>48"D Tops</b>							
		<i>192"W: 9 Piece Top - 12 Accent Doors</i>							
Rectangular Table With Center Inlay also available with a Knife Edge and coordinating Blade Base.	96-48192RTV5	HPL	192	48	1½	345	23.9	P\$ 15111	
	95-48192RTV5	Veneer						W\$ 17447	
	95-48192RTV5	Veneer/HPL						C\$ 18184	
		<i>168"W: 9 Piece Top - 8 Accent Doors</i>							
<a href="#">See Details.</a>	96-48168RTV5	HPL	168	48	1½	328	23.7	P\$ 13604	
	95-48168RTV5	Veneer						W\$ 14970	
	95-48168RTV5	Veneer/HPL						C\$ 15737	
		<i>144"W: 9 Piece Top - 8 Accent Doors</i>							
	96-48144RTV5	HPL	144	48	1½	311	23.4	P\$ 13099	
	95-48144RTV5	Veneer						W\$ 14449	
	95-48144RTV5	Veneer/HPL						C\$ 15197	
		<i>120"W: 5 Piece Top - 6 Accent Doors</i>							
	96-48120RTV5	HPL	120	48	1½	282	23.2	P\$ 8491	
	95-48120RTV5	Veneer						W\$ 9682	
	95-48120RTV5	Veneer/HPL						C\$ 10082	
		<i>108"W: 5 Piece Top - 6 Accent Doors</i>							
	96-48108RTV5	HPL	108	48	1½	260	22.8	P\$ 8219	
	95-48108RTV5	Veneer						W\$ 9403	
	95-48108RTV5	Veneer/HPL						C\$ 9789	
		<i>96"W: 5 Piece Top - 4 Accent Doors</i>							
	96-4896RTV5	HPL	96	48	1½	237	23.0	P\$ 7543	
	95-4896RTV5	Veneer						W\$ 8275	
	95-4896RTV5	Veneer/HPL						C\$ 8706	

*Continued on next page.*

P = HPL W = Veneer C = Combination of Wood/HPL

[See One10 Overview For Ordering Options](#)



Item	Model No.	W	D	H	Ship Wt	Cubic Ft	List Price
------	-----------	---	---	---	---------	----------	------------

Continued from  
Previous Page

**What You Get:**

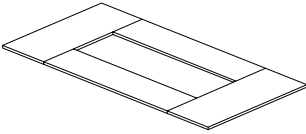

Outer Piece Top

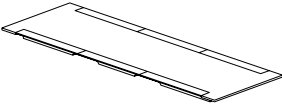

Center Inlay Top

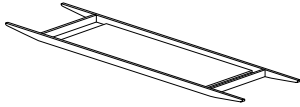

Trough

**Description**

- 1½” Thick Rectangular Top with Block Edge
- Veneer Tops Feature UV Finish
- Center Inlay Includes Aluminum Accent Doors for Wire Management
- Center Inlay Available in Contrasting Laminate or Veneer
- Trough Reinforces and Supports Top
- Requires Two (2) Block Bases; Tables 144”W or Larger Also Require Middle Block Base; Sold Separately, See Below
- Silver Grommet Included for Optional Polycom Installation
- Power and Data Options Available; Sold Separately, [See Multiple Power Unit Details](#); [See Location Options](#)
- Assembly Required

**Top Grain Direction**

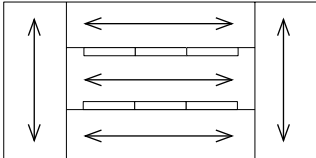

**BLOCK BASES**

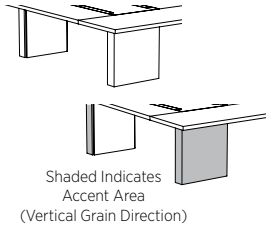

<b>Block Base Options; Must Order</b>							
<i>Standard Block Base - Two (2) Required</i>							
96-2428BB	HPL	24	6	28	52	2.4	P\$ 1580
95-2428BB	Veneer						W\$ 2170
95-2428BB	Veneer/TFL						C\$ 2430
<i>Middle Block Base - Required for Tops 144”W or Larger</i>							
96-2428MSL	HPL	24	7½	28	72	2.8	P\$ 1930
95-2428MSL	Veneer						W\$ 2511
95-2428MSL	Veneer/TFL						C\$ 2859

Must Specify (in this order):

- Standard Base Model #
- Primary Finish/Color
- Accent Material
- Accent Finish/Color
- Middle Base Model # (If needed)
- Middle Base Primary Finish/Color
- Middle Base Accent Material
- Middle Base Accent Finish/Color

**Description**

- All Tops Require Two (2) Block Bases; Tables 144”W or Larger Also Require Middle Block Base
- Bases are Constructed with Removable Interior Panel for Wire Management Installation
- Block Bases Feature Horizontal Grain Direction on Primary Panels and Vertical Grain on Accent Panels
- Block Base Outer Accent Panel can be Specified in a Contrasting Finish/Color from Top Finish/Color
- Middle Base Feature Horizontal Grain Direction on Primary Panels and Vertical Grain on Accent Panels Adjustable Glides Included

P = HPL W = Veneer C = Combination of Wood/TFL Accent

[See One10 Overview For Ordering Options](#)

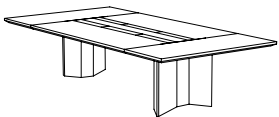
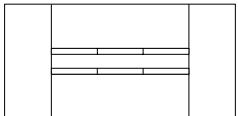
Item	Model No.		W	D	H	Ship Wt	Cubic Ft	List Price	
<b>STANDARD TABLES</b>		<b>60"D Tops</b>							
		<i>192"W: 9 Piece Top - 12 Accent Doors</i>							
<b>RECTANGULAR TOP CENTER INLAY KNIFE EDGE BLADE BASE</b>	96-60192RTK5	HPL	192	60	1 3/16	435	25.3	P\$ 18248	
	95-60192RTK5	Veneer						W\$ 21563	
	95-60192RTK5	Veneer/HPL						C\$ 21930	
		<i>168"W: 9 Piece Top - 8 Accent Doors</i>							
	96-60168RTK5	HPL	168	60	1 3/16	407	24.9	P\$ 16517	
	95-60168RTK5	Veneer						W\$ 19169	
	95-60168RTK5	Veneer/HPL						C\$ 19689	
		<i>144"W: 9 Piece Top - 8 Accent Doors</i>							
	96-60144RTK5	HPL	144	60	1 3/16	379	24.4	P\$ 15856	
	95-60144RTK5	Veneer						W\$ 18202	
	95-60144RTK5	Veneer/HPL						C\$ 18687	
		<i>120"W: 5 Piece Top - 6 Accent Doors</i>							
	96-60120RTK5	HPL	120	60	1 3/16	339	24.0	P\$ 10332	
	95-60120RTK5	Veneer						W\$ 12233	
	95-60120RTK5	Veneer/HPL						C\$ 12420	
		<i>108"W: 5 Piece Top - 6 Accent Doors</i>							
<u>Must Specify (in this order):</u> Model # Primary Finish/Color Accent Material Accent Finish/Color	96-60108RTK5	HPL	108	60	1 3/16	310	23.6	P\$ 10032	
	95-60108RTK5	Veneer						W\$ 11805	
	95-60108RTK5	Veneer/HPL						C\$ 11976	
		<i>96"W: 5 Piece Top - 4 Accent Doors</i>							
	96-6096RTK5	HPL	96	60	1 3/16	282	23.0	P\$ 9216	
	95-6096RTK5	Veneer						W\$ 10935	
	95-6096RTK5	Veneer/HPL						C\$ 11236	
		<b>48"D Tops</b>							
		<i>192"W: 9 Piece Top - 12 Accent Doors</i>							
Rectangular Table With Center Inlay also available with a Block Edge and coordinating Block Base.	96-48192RTK5	HPL	192	48	1 3/16	345	23.9	P\$ 16925	
	95-48192RTK5	Veneer						W\$ 19539	
	95-48192RTK5	Veneer/HPL						C\$ 20352	
		<i>168"W: 9 Piece Top - 8 Accent Doors</i>							
<a href="#">See Details.</a>	96-48168RTK5	HPL	168	48	1 3/16	328	23.7	P\$ 15237	
	95-48168RTK5	Veneer						W\$ 16767	
	95-48168RTK5	Veneer/HPL						C\$ 17596	
		<i>144"W: 9 Piece Top - 8 Accent Doors</i>							
	96-48144RTK5	HPL	144	48	1 3/16	311	23.4	P\$ 14674	
	95-48144RTK5	Veneer						W\$ 16181	
	95-48144RTK5	Veneer/HPL						C\$ 16994	
		<i>120"W: 5 Piece Top - 6 Accent Doors</i>							
	96-48120RTK5	HPL	120	48	1 3/16	282	23.2	P\$ 9511	
	95-48120RTK5	Veneer						W\$ 10845	
	95-48120RTK5	Veneer/HPL						C\$ 11289	
		<i>108"W: 5 Piece Top - 6 Accent Doors</i>							
	96-48108RTK5	HPL	108	48	1 3/16	260	22.8	P\$ 9204	
	95-48108RTK5	Veneer						W\$ 10530	
	95-48108RTK5	Veneer/HPL						C\$ 10957	
		<i>96"W: 5 Piece Top - 4 Accent Doors</i>							
	96-4896RTK5	HPL	96	48	1 3/16	237	23.0	P\$ 8450	
	95-4896RTK5	Veneer						W\$ 9269	
	95-4896RTK5	Veneer/HPL						C\$ 9733	

*Continued on next page.*

P = HPL W = Veneer C = Combination of Wood/HPL

[See One10 Overview For Ordering Options](#)

Item	Model No.	W	D	H	Ship Wt	Cubic Ft	List Price
------	-----------	---	---	---	---------	----------	------------

Continued from  
Previous Page

**What You Get:**

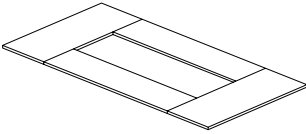

Outer Piece Top

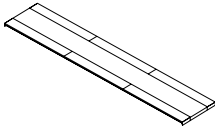

Center Inlay Top

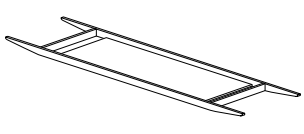

Trough

**Description**

- 1 $\frac{3}{16}$ " Rectangular Top with Knife Edge
- Veneer Tops Feature UV Finish
- Center Inlay Includes Aluminum Accent Doors for Wire Management
- Center Inlay Available in Contrasting Laminate or Veneer
- Trough Reinforces and Supports Top
- Requires Two (2) Blade Bases; Tables 144"W or Larger Also Require Middle Blade Base; Sold Separately, See Below
- Silver Grommet Included for Optional Polycrom Installation
- Power and Data Options Available; Sold Separately, [See Multiple Power Unit Details](#); [See Location Options](#)
- Assembly Required

**Top Grain Direction**

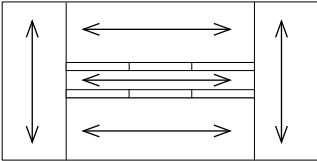

**BLADE BASES**

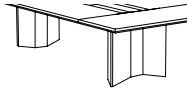

<b>Blade Base Options; Must Order</b>							
<i>Standard Blade Base - Two (2) Required</i>							
96-2828BD	HPL	28	10 $\frac{1}{2}$	28	52	2.4	P\$ 1290
95-2828BD	Veneer						W\$ 1776
<i>Middle Blade Base - Required for Tops 144"W or Larger</i>							
96-2818MBD	Aluminum	18	3 $\frac{3}{8}$	28	72	2.8	\$ 1708
95-2818MBD	Aluminum						\$ 1708

**Description**

- All Tops Require Two (2) Blade Bases; Tables 144"W or Larger Also Require Middle Blade Base
- Bases are Constructed with Removable Interior Aluminum Panel for Wire Management Installation
- Aluminum Middle Blade Base Features Two (2) Aluminum Doors for Wire Management
- Blade Base Outer Panel Feature Vertical Grain Direction and can be Specified in a Contrasting Finish/Color from Top Finish/Color
- Adjustable Glides Included

Must Specify (in this order):  
Standard Base Model #  
Primary Finish/Color  
Middle Base Model # (If needed)

P = HPL W = Veneer

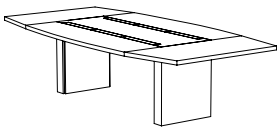
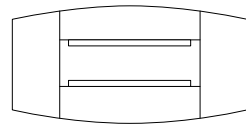
Item	Model No.		W	D	H	Ship Wt	Cubic Ft	List Price	
<b>STANDARD TABLES</b>		<b>60"D Tops</b>							
		<i>192"W: 9 Piece Top - 12 Accent Doors</i>							
<b>BOAT-SHAPED TOP CENTER INLAY BLOCK EDGE BLOCK BASE</b>	96-60192BTV5	HPL	192	60 - 48	1½	435	25.3	P\$ 17103	
	95-60192BTV5	Veneer						W\$ 20215	
	95-60192BTV5	Veneer/HPL						C\$ 20512	
		<i>168"W: 9 Piece Top - 8 Accent Doors</i>							
	96-60168BTV5	HPL	168	60 - 48	1½	407	24.9	P\$ 15486	
	95-60168BTV5	Veneer						W\$ 17972	
	95-60168BTV5	Veneer/HPL						C\$ 18440	
		<i>144"W: 9 Piece Top - 8 Accent Doors</i>							
	96-60144BTV5	HPL	144	60 - 48	1½	379	24.4	P\$ 14867	
	95-60144BTV5	Veneer						W\$ 17062	
	95-60144BTV5	Veneer/HPL						C\$ 17498	
		<i>120"W: 5 Piece Top - 6 Accent Doors</i>							
	96-60120BTV5	HPL	120	60 - 48	1½	339	24.0	P\$ 9689	
	95-60120BTV5	Veneer						W\$ 11469	
	95-60120BTV5	Veneer/HPL						C\$ 11616	
		<i>108"W: 5 Piece Top - 6 Accent Doors</i>							
<b>Must Specify (in this order):</b> Model # Primary Finish/Color Accent Material Accent Finish/Color	96-60108BTV5	HPL	108	60 - 48	1½	310	23.6	P\$ 9407	
	95-60108BTV5	Veneer						W\$ 11071	
	95-60108BTV5	Veneer/HPL						C\$ 11201	
		<i>96"W: 5 Piece Top - 4 Accent Doors</i>							
	96-6096BTV5	HPL	96	60 - 48	1½	282	23.0	P\$ 8640	
	95-6096BTV5	Veneer						W\$ 10253	
	95-6096BTV5	Veneer/HPL						C\$ 10522	
		<b>48"D Tops</b>							
		<i>192"W: 9 Piece Top - 12 Accent Doors</i>							
<b>Boat-Shaped Table With Center Inlay also available with a Knife Edge and coordinating Blade Base.</b>	96-48192BTV5	HPL	192	48 - 36	1½	345	23.9	P\$ 15871	
	95-48192BTV5	Veneer						W\$ 18316	
	95-48192BTV5	Veneer/HPL						C\$ 19091	
		<i>168"W: 9 Piece Top - 8 Accent Doors</i>							
<b>See Details.</b>	96-48168BTV5	HPL	168	48 - 36	1½	328	23.7	P\$ 14284	
	95-48168BTV5	Veneer						W\$ 15716	
	95-48168BTV5	Veneer/HPL						C\$ 16523	
		<i>144"W: 9 Piece Top - 8 Accent Doors</i>							
	96-48144BTV5	HPL	144	48 - 36	1½	311	23.4	P\$ 13756	
	95-48144BTV5	Veneer						W\$ 15169	
	95-48144BTV5	Veneer/HPL						C\$ 15957	
		<i>120"W: 5 Piece Top - 6 Accent Doors</i>							
	96-48120BTV5	HPL	120	48 - 36	1½	282	23.2	P\$ 8915	
	95-48120BTV5	Veneer						W\$ 10167	
	95-48120BTV5	Veneer/HPL						C\$ 10587	
		<i>108"W: 5 Piece Top - 6 Accent Doors</i>							
	96-48108BTV5	HPL	108	48 - 36	1½	260	22.8	P\$ 8631	
	95-48108BTV5	Veneer						W\$ 9872	
	95-48108BTV5	Veneer/HPL						C\$ 10281	
		<i>96"W: 5 Piece Top - 4 Accent Doors</i>							
	96-4896BTV5	HPL	96	48 - 36	1½	237	23.0	P\$ 7922	
	95-4896BTV5	Veneer						W\$ 8692	
	95-4896BTV5	Veneer/HPL						C\$ 9141	

*Continued on next page.*

P = HPL W = Veneer C = Combination of Wood/HPL

[See One10 Overview For Ordering Options](#)

Item	Model No.	W	D	H	Ship Wt	Cubic Ft	List Price
------	-----------	---	---	---	---------	----------	------------

Continued from  
Previous Page

**What You Get:**

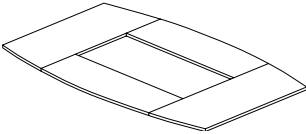

Outer Piece Top

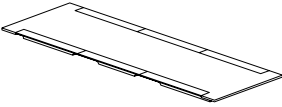

Center Inlay Top

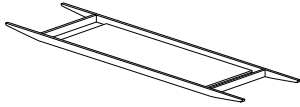

Trough

**Description**

- 1½” Thick Boat-Shaped Top with Block Edge
- Veneer Tops Feature UV Finish
- Center Inlay Includes Aluminum Accent Doors for Wire Management
- Center Inlay Available in Contrasting Laminate or Veneer
- Trough Reinforces and Supports Top
- Requires Two (2) Block Bases; Tables 144”W or Larger Also Require Middle Block Base; Sold Separately, See Below
- Silver Grommet Included for Optional Polycom Installation
- Power and Data Options Available; Sold Separately, [See Multiple Power Unit Details](#); [See Location Options](#)
- Assembly Required

**Top Grain Direction**

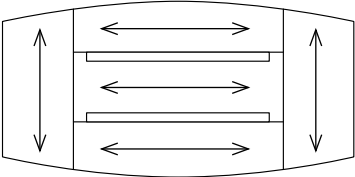

**BLOCK BASES**

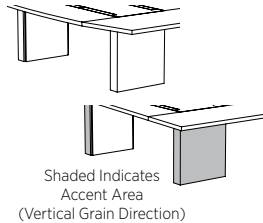

<b>Block Base Options; Must Order</b>							
<i>Standard Block Base - Two (2) Required</i>							
96-2428BB	HPL	24	6	28	52	2.4	P\$ 1580
95-2428BB	Veneer						W\$ 2170
95-2428BB	Veneer/TFL						C\$ 2430
<i>Middle Block Base - Required for Tops 144”W or Larger</i>							
96-2428MSL	HPL	24	7½	28	72	2.8	P\$ 1930
95-2428MSL	Veneer						W\$ 2511
95-2428MSL	Veneer/TFL						C\$ 2859

**Must Specify (in this order):**

- Standard Base Model #
- Primary Finish/Color
- Accent Material
- Accent Finish/Color
- Middle Base Model # (If needed)
- Middle Base Primary Finish/Color
- Middle Base Accent Material
- Middle Base Accent Finish/Color

**Description**

- All Tops Require Two (2) Block Bases; Tables 144”W or Larger Also Require Middle Block Base
- Bases are Constructed with Removable Interior Panel for Wire Management Installation
- Block Bases Feature Horizontal Grain Direction on Primary Panels and Vertical Grain on Accent Panels
- Block Base Outer Accent Panel can be Specified in a Contrasting Finish/Color from Top Finish/Color
- Middle Base Feature Horizontal Grain Direction on Primary Panels and Vertical Grain on Accent Adjustable Glides Included

P = HPL W = Veneer C = Combination of Wood/TFL Accent

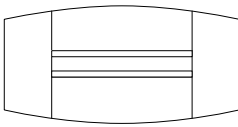
Item	Model No.		W	D	H	Ship Wt	Cubic Ft	List Price	
<b>STANDARD TABLES</b>		<b>60"D Tops</b>							
		<i>192"W: 9 Piece Top - 12 Accent Doors</i>							
<b>BOAT-SHAPED TOP CENTER INLAY KNIFE EDGE BLADE BASE</b>	96-60192BTK5	HPL	192	60 - 48	1 3/16	435	25.3	P\$ 19158	
	95-60192BTK5	Veneer						W\$ 22640	
	95-60192BTK5	Veneer/HPL						C\$ 23024	
		<i>168"W: 9 Piece Top - 8 Accent Doors</i>							
	96-60168BTK5	HPL	168	60 - 48	1 3/16	407	24.9	P\$ 17341	
	95-60168BTK5	Veneer						W\$ 20128	
	95-60168BTK5	Veneer/HPL						C\$ 20674	
		<i>144"W: 9 Piece Top - 8 Accent Doors</i>							
	96-60144BTK5	HPL	144	60 - 48	1 3/16	379	24.4	P\$ 16650	
	95-60144BTK5	Veneer						W\$ 19111	
	95-60144BTK5	Veneer/HPL						C\$ 19623	
		<i>120"W: 5 Piece Top - 6 Accent Doors</i>							
	96-60120BTK5	HPL	120	60 - 48	1 3/16	339	24.0	P\$ 10850	
	95-60120BTK5	Veneer						W\$ 12843	
	95-60120BTK5	Veneer/HPL						C\$ 13041	
		<i>108"W: 5 Piece Top - 6 Accent Doors</i>							
<u>Must Specify (in this order):</u> Model # Primary Finish/Color Accent Material Accent Finish/Color	96-60108BTK5	HPL	108	60 - 48	1 3/16	310	23.6	P\$ 10535	
	95-60108BTK5	Veneer						W\$ 12398	
	95-60108BTK5	Veneer/HPL						C\$ 12576	
		<i>96"W: 5 Piece Top - 4 Accent Doors</i>							
	96-6096BTK5	HPL	96	60 - 48	1 3/16	282	23.0	P\$ 9678	
	95-6096BTK5	Veneer						W\$ 11482	
	95-6096BTK5	Veneer/HPL						C\$ 11797	
		<b>48"D Tops</b>							
		<i>192"W: 9 Piece Top - 12 Accent Doors</i>							
Boat-Shaped Table With Center Inlay also available with a Block Edge and coordinating Block Base.	96-48192BTK5	HPL	192	48 - 36	1 3/16	345	23.9	P\$ 17775	
	95-48192BTK5	Veneer						W\$ 20518	
	95-48192BTK5	Veneer/HPL						C\$ 21371	
		<i>168"W: 9 Piece Top - 8 Accent Doors</i>							
<a href="#">See Details.</a>	96-48168BTK5	HPL	168	48 - 36	1 3/16	328	23.7	P\$ 15998	
	95-48168BTK5	Veneer						W\$ 17604	
	95-48168BTK5	Veneer/HPL						C\$ 18474	
		<i>144"W: 9 Piece Top - 8 Accent Doors</i>							
	96-48144BTK5	HPL	144	48 - 36	1 3/16	311	23.4	P\$ 15405	
	95-48144BTK5	Veneer						W\$ 16994	
	95-48144BTK5	Veneer/HPL						C\$ 17844	
		<i>120"W: 5 Piece Top - 6 Accent Doors</i>							
	96-48120BTK5	HPL	120	48 - 36	1 3/16	282	23.2	P\$ 9987	
	95-48120BTK5	Veneer						W\$ 11387	
	95-48120BTK5	Veneer/HPL						C\$ 11854	
		<i>108"W: 5 Piece Top - 6 Accent Doors</i>							
	96-48108BTK5	HPL	108	48 - 36	1 3/16	260	22.8	P\$ 9667	
	95-48108BTK5	Veneer						W\$ 11056	
	95-48108BTK5	Veneer/HPL						C\$ 11507	
		<i>96"W: 5 Piece Top - 4 Accent Doors</i>							
	96-4896BTK5	HPL	96	48 - 36	1 3/16	237	23.0	P\$ 8870	
	95-4896BTK5	Veneer						W\$ 9731	
	95-4896BTK5	Veneer/HPL						C\$ 10219	

*Continued on next page.*

P = HPL W = Veneer C = Combination of Wood/HPL

[See One10 Overview For Ordering Options](#)

Item	Model No.	W	D	H	Ship Wt	Cubic Ft	List Price
------	-----------	---	---	---	---------	----------	------------

Continued from  
Previous Page

**What You Get:**

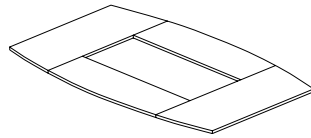

Outer Piece Top

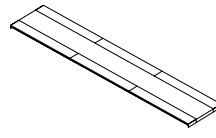

Center Inlay Top

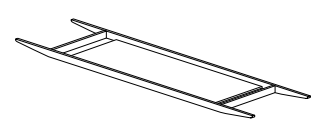

Trough

**Description**

- 1 $\frac{3}{16}$ " Boat-Shaped Top with Knife Edge
- Veneer Tops Feature UV Finish
- Center Inlay Includes Aluminum Accent Doors for Wire Management
- Center Inlay Available in Contrasting Laminate or Veneer
- Trough Reinforces and Supports Top
- Requires Two (2) Blade Bases; Tables 144"W or Larger Also Require Middle Blade Base; Sold Separately, See Below
- Silver Grommet Included for Optional Polycrom Installation
- Power and Data Options Available; Sold Separately, [See Multiple Power Unit Details](#); [See Location Options](#)
- Assembly Required

**Top Grain Direction**

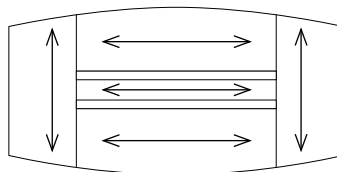

**BLADE BASES**

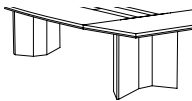

**Blade Base Options; Must Order**

*Standard Blade Base - Two (2) Required*

96-2828BD	HPL	28	10 $\frac{1}{2}$	28	52	2.4	P\$ 1290
95-2828BD	Veneer						W\$ 1776

*Middle Blade Base - Required for Tops 144"W or Larger*

96-2818MBD	Aluminum	18	3 $\frac{3}{8}$	28	72	2.8	\$ 1708
95-2818MBD	Aluminum						\$ 1708

**Description**

- All Tops Require Two (2) Blade Bases; Tables 144"W or Larger Also Require Middle Blade Base
- Bases are Constructed with Removable Aluminum Interior Panel for Wire Management Installation
- Aluminum Middle Blade Base Features Two (2) Aluminum Doors for Wire Management
- Blade Base Outer Panel Feature Vertical Grain Direction and can be Specified in a Contrasting Finish/Color from Top Finish/Color
- Adjustable Glides Included

Must Specify (in this order):

Standard Base Model #

Primary Finish/Color

Middle Base Model # (If needed)

P = HPL W = Veneer

[See One10 Overview For Ordering Options](#)

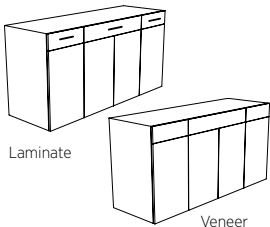
Item	Model No.		W	D	H	Ship Wt	Cubic Ft	List Price		
<b>BUFFET WITH DRAWERS</b>										
<b>4 DOORS &amp; 3 DRAWERS</b>										
	96-2460BF2	HPL	60	24	36	275	34.2	P\$	6095	
	95-2460BF2	Veneer						W\$	7757	
	<b>4 DOORS &amp; 2 DRAWERS</b>									
	96-2460BF1	HPL	60	24	36	275	34.2	P\$	5290	
	95-2460BF1	Veneer						W\$	6689	
<b>2 DOORS &amp; 1 DRAWER</b>										
	96-2430BF	HPL	30	24	36	150	17.6	P\$	2785	
	95-2430BF	Veneer						W\$	3624	

**Description**

- Standard with: Touch Latch Doors, Vertical Grain Direction, Finished Back, Adjustable Glides
- Laminate Unit features Aluminum Beam Pull on Drawers While Veneer Unit Features Finger Pull
- Storage Behind Doors with Adjustable Shelves (Shelves will Match Material Specified)

Must Specify (in this order):

Model #  
Finish/Color

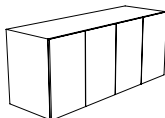
<b>CREDENZA</b>									
	<b>4 DOORS</b>								
	96-2472C	HPL	72	24	30	290	28.0	P\$	4756
	95-2472C	Veneer						W\$	6453
	96-2460C	HPL	60	24	30	250	23.4	P\$	4444
	95-2460C	Veneer						W\$	5688
<b>3 DOORS</b>									
	96-2448C	HPL	48	24	30	210	19.5	P\$	3264
	95-2448C	Veneer						W\$	4311
<b>2 DOORS</b>									
	96-2436C	HPL	36	24	30	150	17.6	P\$	2441
	95-2436C	Veneer						W\$	3289

**Description**

- Standard with: Vertical Grain Direction, Finished Back, Adjustable Glides
- Touch Latch Doors, Veneer Units Also Feature Finger Pulls
- Storage Behind Doors with Adjustable Shelves

Must Specify (in this order):

Model #  
Finish/Color

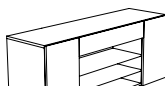
<b>MEDIA CREDENZA</b>									
	96-1872OMC	HPL	72	18	36	175	24.0	P\$	4422
	95-1872OMC	Veneer						W\$	5679
	96-1860OMC	HPL	60	18	36	155	19.5	P\$	4083
	95-1860OMC	Veneer						W\$	5142

**Description**

- Standard with: Vertical Grain Direction, Adjustable Glides
- Touch Latch Closure; Veneer Units Also Feature Finger Pulls
- Storage Behind Two (2) Doors with Adjustable Laminate Shelves
- Open Storage with Two (2) Adjustable Metal Shelves in Middle Section Below Flip Down Door
- Flip Down Door (Does Not Feature Soft Close Hinges)
- Finished Back is Recessed and Open 2" Below Worksurface for Wire Management

Must Specify (in this order):

Model #  
Finish/Color

P = HPL W = Veneer

[See One10 Overview For Ordering Options](#)

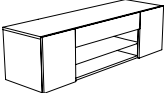

Item	Model No.		W	D	H	Ship Wt	Cubic Ft	List Price	
	96-1872LOMC	HPL	72	18	24	145	24.0	P\$	4061
	95-1872LOMC	Veneer						W\$	5295
	96-1860LOMC	HPL	60	18	24	125	19.5	P\$	3799
	95-1860LOMC	Veneer						W\$	4848

### Description

- Standard with: Vertical Grain Direction, Adjustable Glides
- Touch Latch Doors; Veneer Units Also Feature Finger Pulls
- Storage Behind Two (2) Doors with Adjustable Veneer Shelves
- Open Storage with Adjustable Metal Shelf in Middle Section Below Flip Down Door
- Flip Down Door (Does Not Feature Soft Close Hinges)
- Finished Back is Recessed and Open 2" Below Worksurface for Wire Management

### Must Specify (in this order):

Model #  
Finish/Color

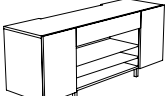
Item	Model No.		W	D	H	Ship Wt	Cubic Ft	List Price	
	96-1872FMC	HPL	72	18	36	175	24.0	P\$	4256
	95-1872FMC	Veneer						W\$	5586
	96-1860FMC	HPL	60	18	36	155	19.5	P\$	4019
	95-1860FMC	Veneer						W\$	5152

### Description

- Standard with: Vertical Grain Direction, Aluminum Post Legs with Adjustable Glides
- Touch Latch Doors; Veneer Units Also Feature Finger Pulls
- Storage Behind Two (2) Doors with Adjustable Shelves (Shelves will Match Material Specified)
- Open Storage with Two (2) Adjustable Metal Shelves in Middle Section Below Flip Down Door
- Flip Down Door (Does Not Feature Soft Close Hinges)
- Finished Back is Recessed and Open 2" Below Worksurface for Wire Management
- Top is Routed to Accommodate Wire Management or Flat Panel Monitor Stand ([See Flat Panel Monitor Stand](#))
- Doors are Hinged from the Inside of the Cabinet and Swing in to Accommodate the Meeting Table

### Must Specify (in this order):

Model #  
Finish/Color

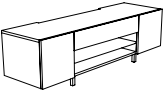
Item	Model No.		W	D	H	Ship Wt	Cubic Ft	List Price	
	96-1872LFMC	HPL	72	18	24	145	24.0	P\$	3782
	95-1872LFMC	Veneer						W\$	4652
	96-1860LFMC	HPL						P\$	3584
	95-1860LFMC	Veneer	60	18	24	125	19.5	W\$	4377

### Description

- Standard with: Vertical Grain Direction, Aluminum Post Legs with Adjustable Glides
- Storage Behind Two (2) Doors with Adjustable Shelves (Shelves will Match Material Specified)
- Open Storage with Adjustable Metal Shelf in Middle Section Below Flip Down Door
- Flip Down Door (Does Not Feature Soft Close Hinges)
- Finished Back is Recessed and Open 2" Below Worksurface for Wire Management
- Top is Routed to Accommodate Wire Management or Flat Panel Monitor Stand ([See Flat Panel Monitor Stand](#))
- Touch Latch Doors; Veneer Units Also Feature Finger Pulls
- Doors are Hinged from the Inside of the Cabinet and Swing in to Accommodate the Meeting Table

### Must Specify (in this order):

Model #  
Finish/Color

P = HPL W = Veneer

[See One10 Overview For Ordering Options](#)

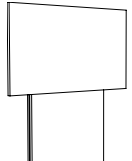
Item	Model No.		W	D	H	Ship Wt	Cubic Ft	List Price	
 <p>Shown with Monitor (Not Included)</p> <p>Must Specify (in this order): Model # Finish/Color</p>	<b>COORDINATES WITH ≥60" MEETING TABLES 42" TALL AND FOOTED MEDIA CRENZAS 36"H</b>								
	96-3067FP	HPL	30½	14	67½	140	16.7	P\$	2238
	95-3067FP	Veneer						W\$	2808
	<b>COORDINATES WITH ≥60" MEETING TABLES 42" TALL AND LOW FOOTED MEDIA CRENZAS 24"H</b>								
	96-3055FP	HPL	30½	14	55½	123	13.8	P\$	2048
	95-3055FP	Veneer						W\$	2522

**Description**

- Standard with: Vertical Grain Direction, Aluminum Metal Base
- Not Freestanding; Must be Used with a Coordinating Product
- Finished Back is Removable for Wire Management
- Accommodates 200, 300, and 400mm VESA Patterns
- Check the Monitor Manufacturer's Specifications for Compliance
- Mounting Hardware Not Included
- Not Responsible for Monitors Improperly Installed or Any Attempt To Use As A Freestanding Unit

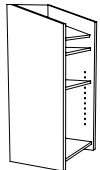
 <p>Must Specify (in this order): Model # Finish/Color</p>	96-2650LS	HPL	24	23	49	130	21.9	P\$	1920
	95-2650LS	Veneer						W\$	3219

**Description**

- Standard with: Vertical Grain Direction, Two (2) Fixed Shelves and One (1) Adjustable Shelf, Two (2) Locking and Two (2) Non-Locking Casters, Top Fixed Shelf Angled for User Comfort
- Wire Management Grommet on Second and Bottom Shelf, Middle Shelf Features Wire Management Grommet Cut Out

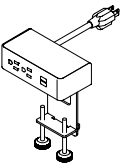
	01-DUOCLAMPW	White	5½	3	7	1	0.2	\$	572
	01-DUOCLAMPB	Black							
	01-DUOCLAMPS	Silver							

**Description**

- Clamps to Table Top and Includes: Two (2) Power, Two (2) USB, 10' Cord, and All Mounting Hardware
- Silver Metal Trim on All Color Options
- Independent USB Circuit Controllers Deliver up to 2.1 Amps to Each Post
- FCC Part 15A, UL Recognized for Horizontal and Vertical Applications

	01-TRIOCLAMPW	White	8	3	7	1	0.2	\$	671
	01-TRIOCLAMPB	Black							
	01-TRIOCLAMPS	Silver							

**Description**

- Clamps to Table Top and Includes: Three (3) Power Outlets, Two (2) USB Ports, One (1) Open Data Port, 10' Cord, and All Mounting Hardware
- HDMI, VGA, and RJ45 Accessories for Open Data Port; Sold Separately, [See Accessories](#)
- Silver Metal Trim on All Color Options
- Independent USB Circuit Controllers Deliver up to 2.1 Amps to Each Post
- FCC Part 15A, UL Recognized for Horizontal and Vertical Applications

P = HPL W = Veneer

[See One10 Overview For Ordering Options](#)

Item	Model No.		W	D	H	Ship Wt	Cubic Ft	List Price
	01-DUOBEZELW	White	6½	2¼	3¼	1	0.2	\$ 675
	01-DUOBEZELB	Black						
	01-DUOBEZELS	Silver						

**Description**

- Sits on Table Top and Includes: Two (2) Power, Two (2) USB, 10' Cord, and All Mounting Hardware
- Independent USB Circuit Controllers Deliver up to 2.1 Amps to Each Post
- FCC Part 15A, UL Recognized for Horizontal and Vertical Applications
- Works with One10 Small Meeting Tables, Standard Tables, and Single Column Meeting Tables

	01-TRIOBEZELW	White	9	2¼	3	1	0.2	\$ 725
	01-TRIOBEZELB	Black						
	01-TRIOBEZELS	Silver						

**Description**

- Sits on Table Top and Includes: Three (3) Power Outlets, Two (2) USB Ports, One (1) Open Data Port, 10' Cord, and All Mounting Hardware
- HDMI, VGA, and RJ45 Accessories for Open Data Port; Sold Separately, [See Accessories](#)
- Independent USB Circuit Controllers Deliver up to 2.1 Amps to Each Post
- FCC Part 15A, UL Recognized for Horizontal and Vertical Applications
- Works with One10 Small Meeting Tables, Standard Tables, and Single Column Meeting Tables

	01-DUOW	White	5½	2	3¼	1	0.2	\$ 711
	01-DUOB	Black						
	01-DUOS	Silver						

**Description**

- Sits Between Worksurfaces or Below the Worksurface and Includes: Two (2) Power, Two (2) USB, 10' Cord, and All Mounting Hardware
- Independent USB Circuit Controllers Deliver up to 2.1 Amps to Each Post
- FCC Part 15A, UL Recognized for Horizontal and Vertical Applications
- Works with One10 Small Meeting Tables and Standard Tables with Center Inlay

	01-TRIOW	White	8	2	3	1	0.2	\$ 733
	01-TRIOB	Black						
	01-TRIOS	Silver						

**Description**

- Sits Between Worksurfaces or Below the Worksurface and Includes: Three (3) Power Outlets, Two (2) USB Ports, One (1) Open Data Port, 10' Cord, and All Mounting Hardware
- HDMI, VGA, and RJ45 Accessories for Open Data Port; Sold Separately, [See Accessories](#)
- Independent USB Circuit Controllers Deliver up to 2.1 Amps to Each Post
- FCC Part 15A, UL Recognized for Horizontal and Vertical Applications
- Works with One10 Small Meeting Tables and Standard Tables with Center Inlay

Item	Model No.		W	D	H	Ship Wt	Cubic Ft	List Price
	01-PDUOBEZELW	White	6½	2½	3	1	0.2	\$ 668
	01-PDUOBEZELB	Black						
	01-PDUOBEZELS	Silver						

**Description**

- Sits on Table Top and Includes: Two (2) Power, Two (2) USB, 12” Cord, and All Mounting Hardware
- Requires Daisy Chain Power Box; Sold Separately, [See Power Box Details](#)
- Non-Sequential System Allows up to Eight (8) Modules to be Connected with Jumper Cord, [See Jumper Cord Details](#)
- Independent USB Circuit Controllers Deliver up to 2.1 Amps to Each Post
- FCC Part 15A, RU Listed and UL Recognized for Horizontal and Vertical Applications
- Works with One10 Small Meeting Tables, Standard Tables, and Single Column Meeting Tables

	01-PTRIOBEZELW	White	9	2½	3	1	0.2	\$ 715
	01-PTRIOBEZELB	Black						
	01-PTRIOBEZELS	Silver						

**Description**

- Sits on Table Top and Includes: Three (3) Power Outlets, Two (2) USB Ports, One (1) Open Data Port, 12” Cord, and All Mounting Hardware
- HDMI, VGA, or RJ45 Accessory for Open Data Port; Sold Separately, [See Accessories](#)
- Requires Daisy Chain Power Box, Specified Separately, See Next Page
- Non-Sequential System Allows up to Eight (8) Modules to be Connected with Jumper Cord, [See Jumper Cord Details](#)
- Independent USB Circuit Controllers Deliver up to 2.1 Amps to Each Post
- FCC Part 15A, RU Listed and UL Recognized for Horizontal and Vertical Applications
- Works with One10 Small Meeting Tables, Standard Tables, and Single Column Meeting Tables

	01-PDUOW	White	5½	2	3	1	0.2	\$ 705
	01-PDUOB	Black						
	01-PDUOS	Silver						

**Description**

- Sits Between Worksurfaces or Below the Worksurface and Includes: Two (2) Power, Two (2) USB, 12” Cord, and All Mounting Hardware
- Requires Daisy Chain Power Box; Sold Separately, [See Power Box Details](#)
- Non-Sequential System Allows up to Eight (8) Modules to be Connected with Jumper Cord, [See Jumper Cord Details](#)
- Independent USB Circuit Controllers Deliver up to 2.1 Amps to Each Post
- FCC Part 15A, RU Listed and UL Recognized for Horizontal and Vertical Applications
- Works with One10 Small Meeting Tables and Standard Tables with Center Inlay

[See One10 Overview For Ordering Options](#)

Item	Model No.		W	D	H	Ship Wt	Cubic Ft	List Price
TRIO DAISY CHAIN PLUG	01-PTRIOW	White	8	2	3	1	0.2	\$ 725
	01-PTRIOB	Black						
	01-PTRIOS	Silver						



**Description**

- Sits on Table Top and Includes: Three (3) Power Outlets, Two (2) USB Ports, One (1) Open Data Port, 12" Cord, and All Mounting Hardware
- HDMI, VGA, or RJ45 Accessory for Open Data Port; Sold Separately, See Accessories Below
- Requires Daisy Chain Power Box; Sold Separately, See Details Below
- Non-Sequential System Allows up to Eight (8) Modules to be Connected with Jumper Cord, [See Jumper Cord Details](#)
- Independent USB Circuit Controllers Deliver up to 2.1 Amps to Each Post
- FCC Part 15A, RU Listed and UL Recognized for Horizontal and Vertical Applications
- Works with One10 Small Meeting Tables and Standard Tables with Center Inlay

HDMI DATA PORT ACCESSORY FOR TRIO UNITS	01-LCOMHDMI		-	-	-	1	0.2	\$ 166
---	-------------	--	---	---	---	---	-----	--------

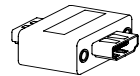

OPEN MARKET ONLY

VGA DATA PORT ACCESSORY FOR TRIO UNITS	01-LCOMVGA		-	-	-	1	0.2	\$ 121
--	------------	--	---	---	---	---	-----	--------

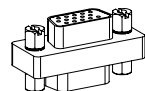

RJ45 DATA PORT ACCESSORY FOR TRIO UNITS	01-LCOMRJ45		-	-	-	1	0.2	\$ 79
---	-------------	--	---	---	---	---	-----	-------

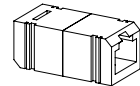

DAISY CHAIN POWER BOX	01-PPOWER		-	-	-	1	0.2	\$ 775
		<i>76" Perimeter, 36" Power Cord</i>						
	01-PPOWER2		-	-	-	1	0.2	\$ 796
		<i>24" Perimeter, 144" Power Cord</i>						



**Description**

- Powers up to Eight (8) Duo and Trio Daisy Chain Units
- One Nema Plug and One Daisy Chain Plug
- 12-Amp System Rating
- 15-Amp Over-Current Protection

[See One10 Overview For Ordering Options](#)

Item	Model No.		W	D	H	Ship Wt	Cubic Ft	List Price
DAISY CHAIN JUMPER CORD 	01-6JUMP	72" Long	-	-	-	1	0.2	\$ 299
	01-5JUMP	60" Long	-	-	-	1	0.2	\$ 284
	01-4JUMP	48" Long	-	-	-	1	0.2	\$ 240
	01-2JUMP	24" Long	-	-	-	1	0.2	\$ 220

**Description**

- Connects Duo and Trio Daisy Chain Units
- Non-Sequential System Allows up to Eight (8) Modules to be Connected

VESTA POWER CENTER	01-PDCTR		10¾	12	28¼	14	2.5	\$ 1776
--------------------	----------	--	-----	----	-----	----	-----	---------

**Description**

- Top Includes One (1) Power Outlet, Two (2) USB Ports and One (1) USBC Port; Base Includes Three (3) Outlet
- Available in White
- 120" Power Cord
- Built with Weight Distribution for Optimal Stability
- Base is 5" Tall

POWER STRIP	01-PRSP		9	2	2	1	-	\$ 205
-------------	---------	--	---	---	---	---	---	--------

**Description**

- Includes Four (4) Outlets and Two (2) Phone Jacks
- Black Plastic with Rocker On/Off Switch
- 13 Amp Circuit Breaker
- 10' Power Cord and Two (2) 14' Phone Hook Up Cords
- UL and CSA Recognized
- Suitable for Surface or Recessed Mounting
- Ships via UPS Only

WIRE MANAGERS	01-WMGR4		16	1½	¾	1	-	\$ 116
---------------	----------	--	----	----	---	---	---	--------

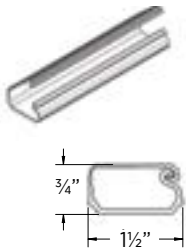
**Description**

- Four (4) Wire Manager Strips
- Black Plastic
- Snap Lock Channel
- Attaches with Adhesive Strips
- Can be Placed on All Units to Route Wires

CABLE GRIP	01-WMGRCB		5¾	2¾	-	-	-	\$ 17
------------	-----------	--	----	----	---	---	---	-------

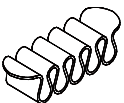
**Description**

- Under Surface Wire Management
- Black

[See One10 Overview For Ordering Options](#)

Crafted in select solids and American veneers, Phoenix's clean, transitional styling is at ease in both contemporary and traditional settings. It is a perfect choice for value-minded companies who want a sophisticated, yet uncomplicated, furniture solution.

### CONSTRUCTION

Phoenix features a Veneer chassis with your choice of a Veneer or HPL top.

### VENEER

- Exposed surfaces feature select grade sliced American Black Walnut or Cherry veneers carefully selected and matched to assure proper balance and consistency

### TOPS

- Veneer tops are 5-ply balanced construction and 1 $\frac{1}{32}$ " thick with solid hardwood rims
- High Pressure Laminate (HPL) tops are 3-ply balanced construction and 1 $\frac{1}{32}$ " thick with solid hardwood rims
- Grain direction runs left to right unless noted

### CHASSIS

- Chassis is securely fastened using high quality European fastening systems and heavy-duty, 16-gauge joining brackets to assure maximum strength
- Units feature finished backs unless otherwise noted
- All units equipped with heavy-duty, adjustable glides to ensure proper leveling and compensate for uneven floors

### DRAWERS

- Drawer fronts standard with matched veneer faces
- Drawer sides, back and front are woodgrain vinyl-wrapped, and are 1/2" thick
- 5-sided drawer construction for easy removal of drawer fronts
- Lateral file drawers feature 1/4" thick bottoms and tested for 200lb capacity
- All drawers feature full extension, progressive action slides with precision steel ball bearings
- All suspensions have a limited lifetime warranty

### FILING

- File drawers are standard with filing systems designed to accommodate a variety of filing requirements
- Letter width file drawers provide letter filing front to back and legal filing side to side

### STORAGE

- All hinged doors include soft close hinges, unless noted
- One piece hinge and base plate combination
- Soft close hinges reduce stress placed on the cabinet when the door is closed and offers a quiet closure

### LOCKING

- Storage credenzas feature standard locking; optional locking on wardrobe/storage cabinets
- Lock core will coordinate with pull selection unless otherwise noted
- Removable lock cylinders allow for units to be re-keyed at a later date if required
- Units are shipped randomly keyed as standard. Keyed alike units available upon request at no additional charge.

### INTERIOR DRAWER DIMENSIONS & FILING CAPABILITIES

#### Models

21-2072SC      21-2066SC

#### Drawers

File      W      L      D  
12 $\frac{1}{8}$ "      16 $\frac{3}{16}$ "      9 $\frac{5}{16}$ "

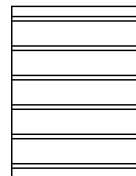

Letter Front to Back

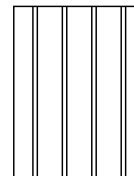

Legal Side to Side

### HOW TO ORDER EXAMPLES

	Model No.	QTY	Description	Example
TABLE TOP	21-4848CT	1	Top Material	P
			Finish/Color	CO
BASE	01-3230DBB	1	Disc Base	
CREDENZA	21-2072SC	1	Top Material	W
			Finish/Color	CO
			Pull	NBT
			Flush Feature	-

### VENEER (W) OPTIONS

Veneer features UV Advantage, an ultra-violet finish, on all exposed surfaces by utilizing roll-coat UV technology.

*Note: Base molding, decorative molding and cylinder base feature multi-step, hand-finished catalyzed finish.*

AW	Artisan Walnut	LW	Legacy Walnut
CO	Columbian Walnut	MW	Mahogany Walnut
DC	Dark Cherry	MTS	Metropolis Sky
DFW	Dark Forest Walnut	PNW	Pinnacle Walnut
EW	Espresso	SCH	Select Cherry
GC	Golden Cherry	SKC	Shaker Cherry
HW	Harvest Walnut	WC	Williamsburg Cherry
HNW	Henna Walnut		

### HPL (P) TOP OPTIONS

#### WOODGRAIN

CO	Columbian Walnut	PNW	Pinnacle Walnut
EF	Espresso	SCH	Select Cherry
GC	Golden Cherry	SKC	Shaker Cherry
MW	Mahogany Walnut	WC	Williamsburg Cherry

### EDGE PROFILE

O Phoenix



### FLUSH FEATURE OPTION

Select units feature multiple flush options allowing units to be placed next to each other. See specific units for details. Must specify when placing ordering.

- FL Flush Left
- FR Flush Right
- FLR Flush Left and Right

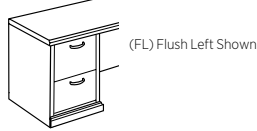

### PULL OPTIONS

Note: Lock Core will match Pull Color

- |                      |                      |
|----------------------|----------------------|
| AAC Arc, Aluminum    | AEL Elite, Aluminum  |
| BAC Arc, Black       | BEL Elite, Black     |
| ABM Beam, Aluminum   | AFL Flair, Aluminum  |
| BBM Beam, Black      | CFL Flair, Chrome    |
| BBT Bow Tie, Black   | AFC Focus, Aluminum  |
| NBT Bow Tie, Nickel  | BFC Focus, Black     |
| ABU Buckle, Aluminum | AQD Quadra, Aluminum |
| BBU Buckle, Black    | BQD Quadra, Black    |



### TABLE GROMMET & POWER UNIT OPTIONS

Power units and grommets are sold separately and must be specified separately with surface mount location. Multiple locations may be selected. Only one unit per location.

#### Power units and Grommets Available in Table Surfaces (See Units)

Grommet Specify Color: Black = BLK and Silver = SLV

#### DUO/TRIO BEZEL

- 01-DUOBEZEL Available in Black (B), Silver (S), or White (W)
- 01-TRIOBEZEL Available in Black (B), Silver (S), or White (W)

#### DOCK 950, DOCK 800 and DOCK 150

- DOCK950 Available in Black or White
- DOCK150 Available in Black or White
- DOCK800 Available in Black or Silver

#### Other Power Units

- DPORT4 Available in Aluminum or Black
- INTERACTG Available in Aluminum or Black
- OASISM Available in Aluminum or Black

### TABLE GROMMET & POWER UNIT OPTIONS CONTINUED

#### Power/Data Location Information:

- Designate unit and location when specifying the top model. Power/Data Module need to be ordered separately.
- Power/Data Modules specified at the time of order will be routed for field installation.
  - E1 Unit on One End
  - E2 Unit on Each End
  - OC Unit on Center

- All power units available **On Center (OC) only** when paired with two (2) or more of the following bases:

- Cylinder Base Square Base
- X-Base Disc
- Tubular X-Base

Grommets and Power Units may be ordered in non-standard locations. Call Customer Service to assist with specification and/or please attach a drawing to the PO showing the location of the grommet. Note additional charges and lead times may apply.

#### Top Locations

Power units available on Each End (E1 and E2) and On Center (OC) unless otherwise noted, when paired with any Rectangle Panel Base, Rectangle Box Base or Rectangle Accent Box Base. (See Unit Details)

#### Power units centered at locations below:

- 36" Tops centered 18"D      48" Tops centered 24"D
- 42" Tops centered 21"D

72: OC 36" from end (available with OC Only)

96: OC 48" from end; E1/E2 29" from end

120: OC 60" from end; E1/E2 29" from end

144: OC 72" from end; E1/E2 29" from end

### LOCKING DOORS

Locking doors are available on Wardrobes. You must specify WITH LOCKING when ordering and add upcharge.

- |        |                   |    |    |
|--------|-------------------|----|----|
| LKT_HU | 36"W - 30"W Units | \$ | 91 |
| LKT_HU | 18"W Units        | \$ | 69 |

### LOCK CORE OPTIONS

Lock core will coordinate with pull color unless otherwise noted.

- BLK Black
- SLV Silver

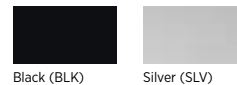

### CERTIFICATIONS & COMPLIANCE

- Intertek Sustainability Certified
- BIFMA level® Certified
- BIFMA Compliant Certified
- TSCA Title VI (formerly CARB) Compliance
- US Green Building's LEED Contribution



**Tops and Bases**



Round Tops  
[\(See Details\)](#)

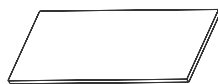

Rectangle Tops  
[\(See Details\)](#)



Boat Tops  
[\(See Details\)](#)

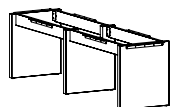

Rectangular Panel  
Bases with Trough  
[\(See Details\)](#)

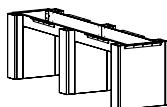

6" Rectangular Bases  
with Trough  
[\(See Details\)](#)

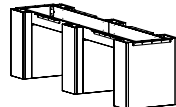

10" Rectangular  
Bases with Trough  
[\(See Details\)](#)

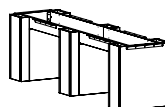

6" Rectangular Accent  
Bases with Trough  
[\(See Details\)](#)

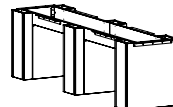

10" Rectangular Accent  
Bases with Trough  
[\(See Details\)](#)

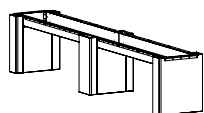

6" + 10" Combo Rectangular  
Bases with Trough  
[\(See Details\)](#)

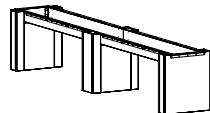

6" + 10" Combo Rectangular  
Accent Bases with Trough  
[\(See Details\)](#)



Disc Bases  
[\(See Details\)](#)

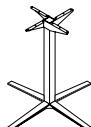

Small and Large X  
Bases [\(See Details\)](#)



HA Pneumatic X  
[\(See Details\)](#)



Metal Bases  
[\(See Details\)](#)

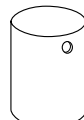

Cylinder  
[\(See Details\)](#)



Queen Anne  
[\(See Details\)](#)

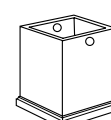

Square  
[\(See Details\)](#)

**Storage Components**

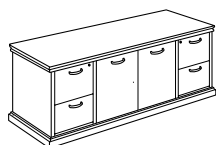

Storage Credenzas  
[\(See Details\)](#)

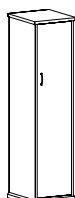

Wardrobe/Storage  
[\(See Details\)](#)

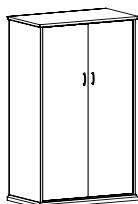

Double Wardrobe/ Storage  
[\(See Details\)](#)

**Wire Management & Power/Data Accessories**

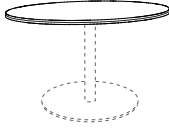

For additional solutions for desking, storage, and accessories, see the [Phoenix Caseloads](#) and [Accessories](#) Price Lists.

Item	Model No.		Width	Depth	Height	Ship Wt	Cubic Ft	List Price
	21-4848CT	<i>Accommodates Five (5) Chairs</i>	48	48	30	60	5.7	P\$ 1587 W\$ 2048
	21-4242CT	<i>Accommodates Four (4) Chairs</i>	42	42	30	40	4.4	P\$ 1471 W\$ 1891
	21-3636CT	<i>Accommodates Three (3) to Four (4) Chairs</i>	36	36	30	35	3.4	P\$ 1363 W\$ 1735

21-4242CT shown with 01-2430DBA  
(Disc Base)  
BASES SOLD SEPARATELY

Must Specify (in this order):

Model #  
Top Material  
Finish/Color  
Edge Profile

**Description**

- Available with Premium/Standard Veneer (PV/W) or HPL (P) Top, Must Specify
- Single Base Required; Ordered Separately, [See Details](#)
- Power Options not Available

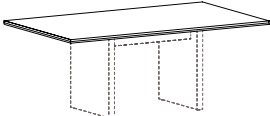
RECTANGULAR TOP	144" or 12' - 2 Piece Tops							
	21-48144RT		144	48	1 $\frac{5}{16}$	275	12.3	P\$ 4423 W\$ 4724
	120" or 10' - 2 Piece Tops							
	21-48120RT		120	48	1 $\frac{5}{16}$	225	10.3	P\$ 4043 W\$ 4270
	96" or 8' - 1 Piece Top							
	21-4896RT		96	48	1 $\frac{5}{16}$	180	9.4	P\$ 2564 W\$ 2805
	72" or 6' - 1 Piece Top							
	21-3672RT		72	36	1 $\frac{5}{16}$	100	6.2	P\$ 1679 W\$ 1778

21-3672RT shown with 88-2034RPB  
(Rectangle Panel Base)  
BASES SOLD SEPARATELY

**Description**

- Grain Runs the Width of the Table
- Available with Veneer (PV/W) or HPL (P) Top; Must Specify
- Heavy-Duty Ganging Mechanisms Connect Two (2) Piece Tops
- See Bases/Legs and Number Required For Each Top Size, [See Multiple Base Options](#); Must Order Separately
- Optional Grommets and Power/Data Units; [See Location Options](#), [See Power Units Available](#)

[See Phoenix Overview For Ordering Options](#)

Item	Model No.	Width	Depth	Height	Ship Wt	Cubic Ft	List Price	
<b>BOAT TOP</b>  21-3672BT shown with 88-2034RPB (Rectangle Panel Base) <b>BASES SOLD SEPARATELY</b>	<b>144" or 12' - 2 Piece Tops</b>							
	21-48144BT	144	48	1 $\frac{3}{16}$	275	12.3	P\$ 5141 W\$ 5533	
	<b>120" or 10' - 2 Piece Tops</b>							
	21-48120BT	120	48	1 $\frac{3}{16}$	225	10.3	P\$ 4680 W\$ 4986	
	<b>96" or 8' - 1 Piece Top</b>							
	21-4896BT	96	48	1 $\frac{3}{16}$	180	9.4	P\$ 3737 W\$ 4041	
	<b>72" or 6' - 1 Piece Top</b>							
	21-3672BT	72	36	1 $\frac{3}{16}$	100	6.2	P\$ 2279 W\$ 2357	

### Description

- Grain Runs the Width of the Table
- Available with Veneer (PV/W) or HPL (P) Top; Must Specify
- Heavy-Duty Ganging Mechanisms Connect Two (2) Piece Tops
- See Bases/Legs and Number Required For Each Top Size, See Below for Multiple Base Options; Must Order Separately
- Optional Grommets and Power/Data Units; [See Location Options](#), [See Power Units Available](#)

### RECTANGLE PANEL BASES WITH TROUGH

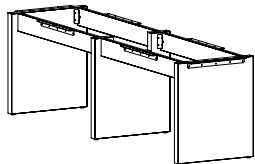

#### Must Specify (in this order):

Model #  
Material  
Finish / Color

<b>Three (3) Panel Bases - For Use With 48" x 144" Surfaces</b>							
88-24106RPB	Laminate	24	106	28 $\frac{3}{4}$	116	13.8	T\$ 3000
	Veneer						W\$ 3059
<b>Two (2) Panel Bases - For Use With 48" x 120" Surfaces</b>							
88-2482RPB	Laminate	24	82	28 $\frac{3}{4}$	90	6.9	T\$ 2150
	Veneer						W\$ 2201
<b>Two (2) Panel Bases - For Use With 48" x 96" Surfaces</b>							
88-2458RPB	Laminate	24	58	28 $\frac{3}{4}$	84	6.9	T\$ 1880
	Veneer						W\$ 1954
<b>Two (2) Panel Bases - For Use With 36" x 72" Surfaces</b>							
88-2034RPB	Laminate	20	34	28 $\frac{3}{4}$	66	6.7	T\$ 1575
	Veneer						W\$ 1742

### Description

- 2" Panel Bases with Trough, Stretcher Rails, and L-Bracket Hardware Included
- Available with TFL (T) or Veneer (W)
- Vertical Grain Direction on Bases
- Bases Require Some Assembly; Attachment Hardware Included
- Tops Sold Separately

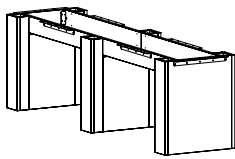
Item	Model No.		Width	Depth	Height	Ship Wt	Cubic Ft	List Price
<b>6" RECTANGLE BASES WITH TROUGH AND REMOVABLE PANEL</b>  	<b>Three (3) 6" Rectangle Bases - For Use With 48" x 144" Surfaces</b>							
	88-2410606RB	Laminate	24	106	28¾	106	19.6	T\$ 4720
		Veneer						W\$ 6457
	<b>Two (2) 6" Rectangle Bases - For Use With 48" x 120" Surfaces</b>							
	88-248206RB	Laminate	24	82	28¾	99	12.9	T\$ 3219
		Veneer						W\$ 4449
	<b>Two (2) 6" Rectangle Bases - For Use With 48" x 96" Surfaces</b>							
	88-245806RB	Laminate	24	58	28¾	93	12.9	T\$ 3023
		Veneer						W\$ 4128
	<b>Two (2) 6" Rectangle Bases - For Use With 36" x 72" Surfaces</b>							
	88-203406RB	Laminate	20	34	28¾	76	12.9	T\$ 2777
		Veneer						W\$ 3820

Must Specify (in this order):

- Model #
- Material
- Finish / Color

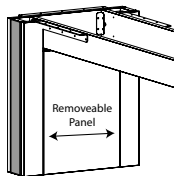

**Description**

- 6" Rectangle Bases with Trough and Stretcher Rails
- Available with TFL (T) or Veneer (W)
- 5/8" Metal Accent Available in Four (4) Colors: Aluminum, Black, Gold, and Platinum; Must Specify Color
- Vertical Grain Direction on Bases
- Bases Include Interior Removable Panel for Wire Management Access. Removable Panel is 15 7/8"W for 24" Bases and 11 7/8"W for 20" Bases
- Removable Panels Attached with Z Brackets
- Bases Require Some Assembly; Attachment Hardware Included
- Tops Sold Separately

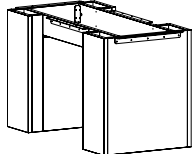
<b>10" RECTANGLE BASES WITH TROUGH AND REMOVABLE PANEL</b>  	<b>Three (3) 10" Rectangle Bases - For Use With 48" x 144" Surfaces</b>							
	88-2410610RB	Laminate	24	106	28¾	141	18.2	T\$ 4841
		Veneer						W\$ 6551
	<b>Two (2) 10" Rectangle Bases - For Use With 48" x 120" Surfaces</b>							
	88-248210RB	Laminate	24	82	28¾	96	12.0	T\$ 3300
		Veneer						W\$ 4512
	<b>Two (2) 10" Rectangle Bases - For Use With 48" x 96" Surfaces</b>							
	88-245810RB	Laminate	24	58	28¾	89	12.0	T\$ 3104
		Veneer						W\$ 4190
	<b>Two (2) 10" Rectangle Bases - For Use With 36" x 72" Surfaces</b>							
	88-203410RB	Laminate	20	34	28¾	72	10.0	T\$ 2857
		Veneer						W\$ 3882

Must Specify (in this order):

- Model #
- Material
- Finish / Color

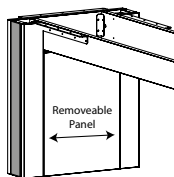

**Description**

- 6" Rectangle Bases with Trough and Stretcher Rails
- Available with TFL (T) or Veneer (W)
- 5/8" Metal Accent Available in Four (4) Colors: Aluminum, Black, Gold, and Platinum; Must Specify Color
- Vertical Grain Direction on Bases
- Bases Include Interior Removable Panel for Wire Management Access. Removable Panel is 15 7/8"W for 24" Bases and 11 7/8"W for 20" Bases
- Removable Panels Attached with Z Brackets
- Bases Require Some Assembly; Attachment Hardware Included
- Tops Sold Separately

[See Phoenix Overview For Ordering Options](#)

Item	Model No.		Width	Depth	Height	Ship Wt	Cubic Ft	List Price
<b>6" + 10" COMBO RECTANGLE BASES WITH TROUGH AND REMOVABLE PANEL</b>	<b>Three (3) Bases Total: Two (2) 6" and One (1) 10" Rectangle Bases - For Use With 60" / 54" / 48" x 144" Surfaces</b>							
	88-24106C610RB	Laminate	24	106	28¾	141	18.2	T\$ 4760
		Veneer						W\$ 6488

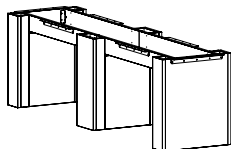

Must Specify (in this order):

- Model #
- Material
- Finish / Color

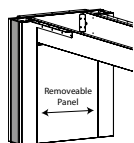

**Description**

- 6" + 10" Rectangle Bases with Trough and Stretcher Rails; 6" Bases on Exterior and 10" Bases on Interior
- Available with TFL (T) or Veneer (W)
- Vertical Grain Direction on Bases
- Bases Include Interior Removable Panel for Wire Management. Removable Panel is 15½"W and Attaches with Z Brackets.
- Bases Require Some Assembly; Attachment Hardware Included
- Tops Sold Separately

**6" RECTANGLE ACCENT BASES WITH TROUGH AND REMOVABLE PANEL**

<b>6" RECTANGLE ACCENT BASES WITH TROUGH AND REMOVABLE PANEL</b>	<b>Three (3) 6" Rectangle Bases - For Use With 48" x 144" Surfaces</b>							
	88-2410606RAB	Laminate	24	106	28¾	106	19.6	T\$ 5394
		Veneer						W\$ 7174
	<b>Two (2) 6" Rectangle Bases - For Use With 48" x 120" Surfaces</b>							
	88-248206RAB	Laminate	24	82	28¾	99	12.9	T\$ 4745
		Veneer						W\$ 6436
	<b>Two (2) 6" Rectangle Bases - For Use With 48" x 96" Surfaces</b>							
	88-245806RAB	Laminate	24	58	28¾	93	12.9	T\$ 3480
		Veneer						W\$ 4610
	<b>Two (2) 6" Rectangle Bases - For Use With 36" x 72" Surfaces</b>							
	88-203406RAB	Laminate	20	34	28¾	76	12.9	T\$ 3232
		Veneer						W\$ 4302

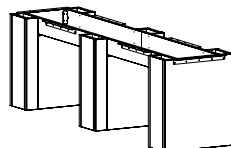

Must Specify (in this order):

- Model #
- Base Finish/Color
- Metal Accent Color
- Accent Panel Finish/Color

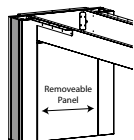

**Description**

- 6" Rectangle Bases with Trough and Stretcher Rails
- Available with TFL (T) or Veneer (W)
- 5/16" Metal Accent Available in Four (4) Colors: Aluminum, Black, Gold, and Platinum; Must Specify Color
- Vertical Grain Direction on Bases
- Bases Include Interior Removable Panel for Wire Management Access. Removable Panel is 15½"W for 24" Bases and 11½"W for 20" Bases
- Removable Panels Attached with Z Brackets
- Bases Require Some Assembly; Attachment Hardware Included
- Tops Sold Separately

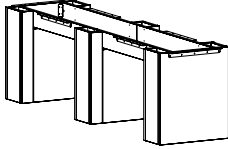
Item	Model No.		Width	Depth	Height	Ship Wt	Cubic Ft	List Price	
<b>10" RECTANGLE ACCENT BASES WITH TROUGH AND REMOVABLE PANEL</b>  	<b>Three (3) 10" Rectangle Bases - For Use With 48" x 144" Surfaces</b>								
	88-2410610RAB	Laminate	24	106	28¾	141	18.2	T\$ 5462	
		Veneer						W\$ 7258	
	<b>Two (2) 10" Rectangle Bases - For Use With 48" x 120" Surfaces</b>								
	88-248210RAB	Laminate	24	82	28¾	96	12.0	T\$ 3717	
		Veneer						W\$ 4986	
	<b>Two (2) 10" Rectangle Bases - For Use With 48" x 96" Surfaces</b>								
	88-245810RAB	Laminate	24	58	28¾	89	12.0	T\$ 3521	
		Veneer						W\$ 4664	
	<b>Two (2) 10" Rectangle Bases - For Use With 36" x 72" Surfaces</b>								
	88-203410RAB	Laminate	20	34	28¾	72	10.0	T\$ 3209	
		Veneer						W\$ 4276	

Must Specify (in this order):

- Model #
- Base Finish/Color
- Metal Accent Color
- Accent Panel Finish/Color

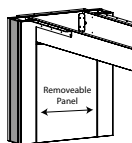

**Description**

- 10" Rectangle Bases with Trough and Stretcher Rails
- Available with TFL (T) or Veneer (W)
- ⅝" Metal Accent Available in Four (4) Colors: Aluminum, Black, Gold, and Platinum; Must Specify Color
- Vertical Grain Direction on Bases
- Bases Include Interior Removable Panel for Wire Management Access. Removable Panel is 15⅞"W for 24" Bases and 11⅞"W for 20" Bases
- Removable Panels Attached with Z Brackets
- Bases Require Some Assembly; Attachment Hardware Included
- Tops Sold Separately

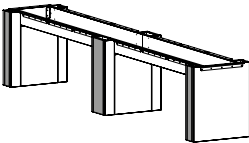
<b>6" + 10" COMBO RECTANGLE ACCENT BASES WITH TROUGH AND REMOVABLE PANEL</b>  	<b>Three (3) Bases Total: Two (2) 6" and One (1) 10" Rectangle Bases - For Use With 60" / 54" / 48" x 144" Surfaces</b>								
	88-24106C610RAB	Laminate	24	106	28¾	141	18.2	T\$ 5420	
		Veneer						W\$ 7205	

Must Specify (in this order):

- Model #
- Base Finish/Color
- Metal Accent Color
- Accent Panel Finish/Color

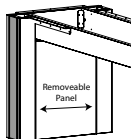

**Description**

- 6" + 10" Rectangle Accent Bases with Trough and Stretcher Rails; 6" Bases on Exterior and 10" Bases on Interior
- Available with TFL (T) or Veneer (W)
- ⅝" Metal Accent Available in Four (4) Colors: Aluminum, Black, Gold, and Platinum; Must Specify Color
- Vertical Grain Direction on Bases
- Bases Include Interior Removable Panel for Wire Management. Removable Panel is 15⅞"W and Attaches with Z Brackets
- Bases Require Some Assembly; Attachment Hardware Included
- Tops Sold Separately

[See Phoenix Overview For Ordering Options](#)

Item	Model No.		Width	Depth	Height	Ship Wt	Cubic Ft	List Price
DISC BASE 	<b>For 48" Round Tops</b>							
	01-3230DBB	Black	30	30	27¾	42	4.1	\$ 1842
	01-3230DBA	Aluminum						
	<b>For 36" and 42" Round Tops</b>							
	01-2430DBB	Black	24	24	27¾	32	3.2	\$ 1535
	01-2430DBA	Aluminum						

**Description**

- 4" Diameter 14 Gauge Steel Column
- 12"x12" Mounting Plate at Top of Column
- ¼" Thick Disc Plate with 5 Levelers
- Some Assembly Required

Table Widths	Round	72"	96"
<b>Number of Bases Required</b>	1	2	2

**METAL X-BASE**

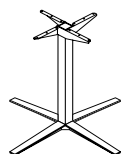

<b>For Use With</b>								
<b>Round Tops: 42" + 48"</b>								
<b>Top Surfaces: 48"x96"</b>								
08-2642LXBB	Black	35½	35½	40	33	20.0	\$	1322
08-2642LXBA	Aluminum							
<i>For 42"H Tables</i>								
08-2636LXBB	Black	35½	35½	34	30	17.2	\$	1275
08-2636LXBA	Aluminum							
<i>For 36"H Tables</i>								
08-2630LXBB	Black	35½	35½	28	27	14.5	\$	1219
08-2630LXBA	Aluminum							
<i>For 30"H Tables</i>								
<b>For Use With</b>								
<b>Round: 36"</b>								
<b>Top Surfaces: 36"x72"</b>								
08-2042SXBB	Black	29	29	40	27	15.9	\$	1235
08-2042SXBA	Aluminum							
<i>For 42"H Tables</i>								
08-2036SXBB	Black	29	29	34	24	13.7	\$	1185
08-2036SXBA	Aluminum							
<i>For 36"H Tables</i>								
08-2030SXBB	Black	29	29	28	21	11.6	\$	1139
08-2030SXBA	Aluminum							
<i>For 30"H Tables</i>								

**Description**

- See Number of Bases Required Per Top Width Below
- Not Available to be Sold Separately
- Power Units Available On Center When Using Two or More Metal X-Bases
- Ships Assembled

Table Widths	Round	72"	96"
<b>Number of Bases Required</b>	1	2	2

P = HPL W = Veneer

For ordering options, see overview at the beginning of this section.

[See Phoenix Overview For Ordering Options](#)

Item	Model No.		Width	Depth	Height	Ship Wt	Cubic Ft	List Price
HEIGHT ADJUSTABLE PNEUMATIC X-BASE 	<b>Maximum Round 42"</b>							
	01-3232HAXBB	Black	32	32	26-45¾	1	0.2	\$ 1721
	01-3232HAXBA	Aluminum						
	<b>Maximum Round 36"</b>							
	01-2626HAXBB	Black	22	22	26-45¾	1	0.2	\$ 1687
	01-2626HAXBA	Aluminum						

**Description**

- Pre-Drilled Boring Pattern May Not Match Underside of Table Top
- Steel Mounting Plate: 8"x 8"x ¼"
- Eight (8) Bolts Included for Assembly
- Some Assembly Required

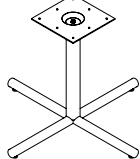
TUBULAR X-BASE 	<b>For Use With Round Tops: 48" Top Surfaces: 48"x96"</b>							
	01-3830TXB	Black	38	38	27¾	40	4.2	\$ 699
	01-3830TXA	Aluminum						
	<b>For Use With Round Tops: 36", 42" Top Surfaces: 36"x72"</b>							
	01-3230TXB	Black	32	32	27¾	32	3.2	\$ 633
	01-3230TXA	Aluminum						

**Description**

- 3" Diameter Column
- See Number of Bases Required Per Top Width Below
- Power Units Available On Center When Using Two or More Tubular X-Bases
- Some Assembly Required

Table Widths	Round	72"	84"	96"
<b>Number of Bases Required</b>	1	2	2	2

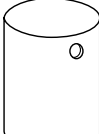
CYLINDER BASE 	<b>For Tables 42"D to 48"D</b>							
	01-2020CB		20	20	28½	136	10.9	W\$ 1553
	<b>For Tables 36"D</b>							
01-1616CB		16	16	28½	101	7.2	W\$ 1419	

**Description**

- Veneer Base Features Multi-Step, Hand-Finished Catalyzed Finish
- Weighted for Stability
- Two (2) Wire Management Black Grommets Standard at Top Edge; 8" Opening Standard at Bottom

**Additional Grommet Options: Specify & Add**

GCB1S	Only One (1) Grommet At Top Edge	\$	N/C
NOGC	No Grommets At Top Edge	\$	N/C

**Must Specify (in this order):**

Model #

Finish

Grommet Options

[See Phoenix Overview For Ordering Options](#)



Item	Model No.	Width	Depth	Height	Ship Wt	Cubic Ft	List Price
QUEEN ANNE BASE	01-0606QB	24	24	28¾	136	11.1	W\$ 1406

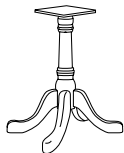

**Description**

- Classic Design Detail on Column
- Base Features Multi-Step, Hand-Finished Catalyzed Finish
- Four (4) Legs with Adjustable Glides

Must Specify (in this order):

Model #  
Finish

SQUARE BASE	21-2020SB	20	20	28¾	57	8.4	W\$ 1183
	<i>For Use with 48" or 42" Tops</i>						
	21-1616SB	16	16	28¾	41	6.0	W\$ 1100
	<i>For Use with 36" Top</i>						

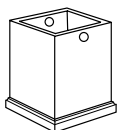

**Description**

- Veneer Base
- Two (2) Wire Management Black Grommets Standard at Top and 8" Wire Management Opening in Bottom

Must Specify (in this order):

Model #  
Finish  
Grommet Options

**Options: Specify & Add**



NOGC	No Grommet at Top Edge	\$	N/C
------	------------------------	----	-----

P = HPL W = Veneer

[See Phoenix Overview For Ordering Options](#)

Item	Model No.	Width	Depth	Height	Ship Wt	Cubic Ft	List Price
STORAGE CREDENZA	21-2072SC	72	20 <sup>7</sup> / <sub>16</sub>	30	349	29.0	P\$ 4360 W\$ 4754
	21-2066SC	66	20 <sup>7</sup> / <sub>16</sub>	30	320	26.6	P\$ 4206 W\$ 4589

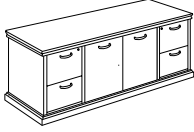

Must Specify (in this order):

Model #  
Top Material  
Finish/Color  
Pull  
Flush Feature

**Description**

- Letter Width Locking File/File Pedestals
- Available with Veneer (W) or HPL (P) Top, Must Specify
- Fixed Storage Shelf Behind Doors
- Profiles on Three (3) Sides for Flush Wall Application Standard
- Flush Feature Available; Must Specify: Flush Left (FL), Flush Right (FR) or Flush Left and Right (FLR)
- Flush Option Reduces Unit by 3/4" Per Side and 1 1/2" for Both Flush Sides

**WARDROBE/STORAGE CABINET**

**Hinged Left      Hinged Right**

21-1872WL	21-1872WR	18	20 <sup>7</sup> / <sub>16</sub>	70 <sup>7</sup> / <sub>8</sub>	152	19.2	W\$ 2981
-----------	-----------	----	---------------------------------	--------------------------------	-----	------	----------

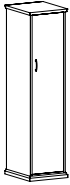

Shown as Right

Must Specify (in this order):

Model #  
Finish  
Pull  
Locking Doors  
Flush Feature

**Description**

- Coat Rod Under Top Fixed Shelf
- Three (3) Adjustable Shelves; Adjustable Shelves can be Removed for Wardrobe Application
- Profiles on Three (3) Sides for Flush Wall Application Standard
- Flush Feature Available; Must Specify: Flush Left (FL), Flush Right (FR) or Flush on Both Sides (FLR)
- Flush Option Reduces Unit by 3/4" Per Side and 1 1/2" if Both Sides Are Selected to be Flush
- Optional Locking Doors ([See Locking Options](#)), Lock Core will Coordinate with Pull Color

**DOUBLE WARDROBE/STORAGE**

21-3672WC		36	20 <sup>7</sup> / <sub>16</sub>	70 <sup>7</sup> / <sub>8</sub>	290	42.0	W\$ 4139
21-3072WC		30	20 <sup>7</sup> / <sub>16</sub>	70 <sup>7</sup> / <sub>8</sub>	240	35.7	W\$ 4030

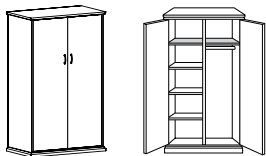

Must Specify (in this order):

Model #  
Finish  
Pull  
Locking Doors  
Flush Feature

**Description**

- Fixed Top Shelf Behind Each Door
- Three (3) Adjustable Shelves on Left Side; Coat Rod Under Fixed Shelf on Right Side
- Profiled on Three (3) Sides for Flush Wall Applications Standard
- Flush Feature Available; Must Specify: Flush Left (FL), Flush Right (FR) or Flush on Both Sides (FLR)
- Flush Option Reduces Unit by 3/4" Per Side and 1 1/2" if Both Sides Are Selected to be Flush
- Optional Locking Doors ([See Locking Options](#)), Lock Core will Coordinate with Pull Color

P = HPL    W = Veneer

[See Phoenix Overview For Ordering Options](#)

Item	Model No.		Width	Depth	Height	Ship Wt	Cubic Ft	List Price
SINGLE POWER SAND DOLLAR	01-SAND60PS	Silver	3	3	4	1	0.2	\$ 98
	01-SAND60PW	White						\$ 98
	01-SAND60PB	Black					\$ 98	

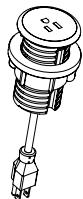
**Description**

- Mounts in 2 $\frac{3}{8}$ " (60mm) Round Grommet
- Single Power Outlet with 6' Cord

DOUBLE USB SAND DOLLAR	01-SAND60US	Silver	3	3	4	1	0.2	\$ 277
	01-SAND60UW	White						\$ 277
	01-SAND60UB	Black					\$ 277	

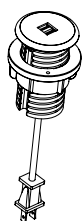
**Description**

- Mounts in 2 $\frac{3}{8}$ " (60mm) Round Grommet
- Dual USB Outlets with 6' Cord

DOCK 950 WIRELESS CHARGER	01-DOCK950W	White	3 $\frac{3}{16}$ "	3 $\frac{3}{16}$ "	-	1	0.2	\$ 265
	01-DOCK950B	Black						\$ 265



OPEN MARKET ONLY

**Description**

- For Use with Wireless Charging Enabled Devices
- 5 Watts Maximum Output with a Direct Current of 5V 2A and 10 Watts Maximum with Quick Charge 2.0
- LED will Confirm Pairing with Device and Begin Wireless Charging

WIRELESS AND USB CHARGER	01-DOCK150W	White	3	3	$\frac{3}{4}$ "	1	0.2	\$ 405
	01-DOCK150B	Black						\$ 405

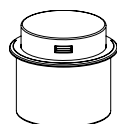

OPEN MARKET ONLY

**Description**

- For Use with Wireless Charging Enabled Devices and USB Charging Devices
- 5 Watt Maximum Output with a Direct Current Input of 5V 6A (Wireless Fast Charge)
- Pop-Up is  $\frac{3}{4}$ "H and Includes Three (3) USB Ports; One (1) 12 Watt Maximum with 2.4A (USB Fast Charge) and Two (2) 5 Watt with 1A (USB Standard Charge)
- LED Light will Confirm Pairing with Device and Begin Wireless Charging
- UL and cUL Certified

Item	Model No.		Width	Depth	Height	Ship Wt	Cubic Ft	List Price
	01-DUOBEZELW	White	6½	2¼	3¼	1	0.2	\$ 675
	01-DUOBEZELB	Black						
	01-DUOBEZELS	Silver						

**Description**

- Sits on Table Top and Includes: Two (2) Power, Two (2) USB, 10' Cord, and All Mounting Hardware
- Independent USB Circuit Controllers Deliver up to 2.1 Amps to Each Post
- FCC Part 15A, UL Recognized for Horizontal and Vertical Applications

	01-TRIOBEZELW	White	9	2¼	3	1	0.2	\$ 725
	01-TRIOBEZELB	Black						
	01-TRIOBEZELS	Silver						

**Description**

- Sits on Table Top and Includes: Three (3) Power Outlets, Two (2) USB Ports, One (1) Open Data Port, 10' Cord, and All Mounting Hardware
- HDMI, VGA, and RJ45 Accessories for Open Data Port; Sold Separately, [See Accessories](#)
- Independent USB Circuit Controllers Deliver up to 2.1 Amps to Each Post
- FCC Part 15A, UL Recognized for Horizontal and Vertical Applications

	01-PDUOBEZELW	White	6½	2¼	3	1	0.2	\$ 668
	01-PDUOBEZELB	Black						
	01-PDUOBEZELS	Silver						

**Description**

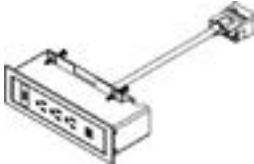

- Sits on Table Top and Includes: Two (2) Power, Two (2) USB, 12" Cord, and All Mounting Hardware
- Requires Daisy Chain Power Box; Sold Separately, [See Power Box Details](#)
- Non-Sequential System Allows up to Eight (8) Modules to be Connected with Jumper Cord, [See Jumper Cord Details](#)
- Independent USB Circuit Controllers Deliver up to 2.1 Amps to Each Post
- FCC Part 15A, RU Listed and UL Recognized for Horizontal and Vertical Applications

	01-PTRIOBEZELW	White	9	2¼	3	1	0.2	\$ 715
	01-PTRIOBEZELB	Black						
	01-PTRIOBEZELS	Silver						



**Description**

- Sits on Table Top and Includes: Three (3) Power Outlets, Two (2) USB Ports, One (1) Open Data Port, 12" Cord, and All Mounting Hardware
- HDMI, VGA, or RJ45 Accessory for Open Data Port; Sold Separately, [See Accessories](#)
- Requires Daisy Chain Power Box, Specified Separately, See Next Page
- Non-Sequential System Allows up to Eight (8) Modules to be Connected with Jumper Cord, [See Jumper Cord Details](#)
- Independent USB Circuit Controllers Deliver up to 2.1 Amps to Each Post
- FCC Part 15A, RU Listed and UL Recognized for Horizontal and Vertical Applications

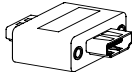
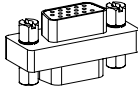
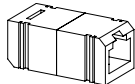
[See Phoenix Overview For Ordering Options](#)

Item	Model No.		Width	Depth	Height	Ship Wt	Cubic Ft	List Price
DAISY CHAIN POWER BOX 	01-PPOWER	<i>76" Perimeter, 36" Power Cord</i>	-	-	-	1	0.2	\$ 775
	01-PPOWER2	<i>24" Perimeter, 144" Power Cord</i>	-	-	-	1	0.2	\$ 796
<b>Description</b> <ul style="list-style-type: none"> <li>• Powers up to Eight (8) Duo and Trio Daisy Chain Units</li> <li>• One Nema Plug and One Daisy Chain Plug</li> <li>• 12-Amp System Rating</li> <li>• 15-Amp Over-Current Protection</li> </ul>								
DAISY CHAIN JUMPER CORD 	01-6JUMP	<i>72" Long</i>	-	-	-	1	0.2	\$ 299
	01-5JUMP	<i>60" Long</i>	-	-	-	1	0.2	\$ 284
	01-4JUMP	<i>48" Long</i>	-	-	-	1	0.2	\$ 240
	01-2JUMP	<i>24" Long</i>	-	-	-	1	0.2	\$ 220
<b>Description</b> <ul style="list-style-type: none"> <li>• Connects Duo and Trio Daisy Chain Units</li> <li>• Non-Sequential System Allows up to Eight (8) Modules to be Connected</li> </ul>								
HDMI DATA PORT ACCESSORY FOR TRIO UNITS 	01-LCOMHDMI		-	-	-	1	0.2	\$ 166
OPEN MARKET ONLY								
VGA DATA PORT ACCESSORY FOR TRIO UNITS 	01-LCOMVGA		-	-	-	1	0.2	\$ 121
RJ45 DATA PORT ACCESSORY FOR TRIO UNITS 	01-LCOMRJ45		-	-	-	1	0.2	\$ 79

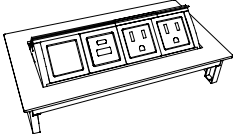
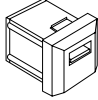
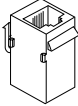
[See Phoenix Overview For Ordering Options](#)

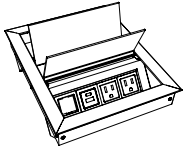
Item	Model No.		Width	Depth	Height	Ship Wt	Cubic Ft	List Price
	01-DPORT4A	Aluminum	8	4	-	7	0.2	\$ 1093
	01-DPORT4B	Black						
<b>Description</b> <ul style="list-style-type: none"> <li>Retracts into Work Surface to Regain Productive Space; One-Touch Access to Power and Data</li> <li>Two (2) Power Outlets, One (1) USB A+C, and One (1) Open Port</li> <li>Optional Telecom Port Components, See Below</li> <li>Water-Proof Simplex (Outlets)</li> <li>Includes a Voice/Data Adapter Kit to Accept Couplers and Jacks When Required</li> <li>10' Power Cord</li> <li>UL Recognized</li> </ul>								
	01-USBPORT		-	-	-	-	-	\$ 161
<b>Description</b> <ul style="list-style-type: none"> <li>Passive USB-A Port with Increased Transfer Speed Up to 5 gbs/sec</li> <li>Simultaneous Read/Write Capability; Idle Device Power Saving State</li> <li>6' Cord</li> <li>Compatible with 01-DPORT4A, 01-DPORT4B</li> </ul>								
	01-VOICE1		-	-	-	-	-	\$ 73
<b>Description</b> <ul style="list-style-type: none"> <li>6-Pin Modular Plug</li> <li>Molded Black; Cord Not included</li> <li>Compatible with 01-DPORT4A, 01-DPORT4B</li> </ul>								
	01-RJ4DATA		-	-	-	-	-	\$ 167
<b>Description</b> <ul style="list-style-type: none"> <li>8-Pin Modular Plug; Cat6 Ethernet Cable; Pre-terminated Cable</li> <li>10' Cord</li> <li>Compatible with 01-DPORT4A, 01-DPORT4B</li> </ul>								
 <p>01-E2X4 SIN PENDING</p>	01-E2X6A	Aluminum	11	9 <sup>13</sup> / <sub>16</sub>	-	6	0.7	\$ 1625
	01-E2X6B	Black						
	01-E2X4A	Aluminum	8	9 <sup>13</sup> / <sub>16</sub>	-	5	0.5	\$ 1494
	01-E2X4B	Black						
<b>Description</b> <ul style="list-style-type: none"> <li>In Surface, Dual Side Application; Soft Touch Access to Power and Data</li> <li>11" Unit Includes Three (3) Power Outlets, One (1) USB A+C, and Two (2) Open Port on Each Side; 8" Unit Includes Two (2) Power Outlets, One (1) USB A+C, and One (1) Open Port on Each Side</li> <li>Optional Telecom Port Components, <a href="#">See Compatible Units</a></li> <li>6' Power Cord</li> <li>UL Listed</li> </ul>								

[See Phoenix Overview For Ordering Options](#)

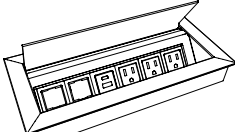
Item	Model No.		Width	Depth	Height	Ship Wt	Cubic Ft	List Price
 <p>01-ELLORA6 SIN PENDING</p>	01-ELLORA6A	Aluminum	11	5	-	6	0.7	\$ 852
	01-ELLORA6B	Black						
	01-ELLORA4A	Aluminum	8	5	-	5	0.5	\$ 792
	01-ELLORA4B	Black						

**Description**

- In Surface Application; Soft Touch Access to Power and Data
- 11" Includes Three (3) Power Outlets, One (1) USB A+C, and Two (2) Open Port; 8" Includes Two (2) Power Outlets, One (1) USB A+C, and One (1) Open Port
- Optional Telecom Port Components, See Below for Compatible Units
- 6' Power Cord
- UL Recognized

<b>VGA CONNECTOR ACCESSORY</b>	01-VGACON		-	-	-	1	0.2	\$ 149
--------------------------------	-----------	--	---	---	---	---	-----	--------

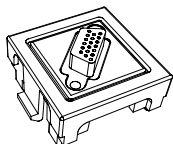
**Description**

- VGA Port for 01-DPORT4A, 01-DPORT4B, ELLORA4A, ELLORA4B, ELLORA6A, ELLORA6B, E2X4A, E2X4B, E2X6A, and E2X6B
- Enables Devices to Remote Display on Monitors
- 10' Cord
- Male/Female Connector

<b>PASSIVE USB-C ACCESSORY</b>	01-PUSBC		-	-	-	1	0.2	\$ 95
--------------------------------	----------	--	---	---	---	---	-----	-------

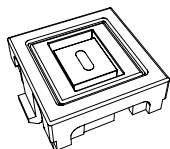
**Description**

- Passive USB-C Port ; Unit Provides Data Connection to Transfer Data Only, No Charging Capabilities
- Compatible with 01-DPORT4A, 01-DPORT4B, ELLORA4A, ELLORA4B, ELLORA6A, ELLORA6B, E2X4A, E2X4B, E2X6A, and E2X6B
- Male/Female Connector

<b>CHARGING USB-A+C ACCESSORY</b>	01-USBAC		-	-	-	1	0.2	\$ 283
-----------------------------------	----------	--	---	---	---	---	-----	--------

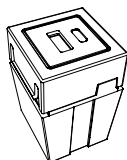
**Description**

- For Charging Devices
- 20 Watt Power Supply
- USB+C Charging Port for 01-DPORT4A, 01-DPORT4B, ELLORA4A, ELLORA4B, ELLORA6A, ELLORA6B, E2X4A, E2X4B, E2X6A, and E2X6B

<b>HDMI CONNECTOR ACCESSORY</b>	01-HDMICON		-	-	-	1	0.2	\$ 124
---------------------------------	------------	--	---	---	---	---	-----	--------

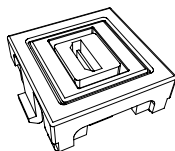
**Description**

- HDMI Port for 01-DPORT4A, 01-DPORT4B, ELLORA4A, ELLORA4B, ELLORA6A, ELLORA6B, E2X4A, E2X4B, E2X6A, and E2X6B
- Connects to High Definition Displays
- Female/Female Connector
- 18" Cord

Item	Model No.		Width	Depth	Height	Ship Wt	Cubic Ft	List Price
INTERACT POWER & DATA	01-INTERACTG2A	Aluminum	9	5½	2¾	5	0.2	\$ 891
	01-INTERACTG2B	Black						



#### Description

- Includes: Two (2) Power Outlets, Two (2) USB-A Charging Ports, One (1) Telecom Plate Opening; Two (2) Keystone Openings for Voice/Data Jacks
- One (1) Telecom Plates Included with the Unit: One (1) 01-ABLAB Plate (Consists of One (1) RJ45 Cat 6, One (1) RJ11 Cat 3 Phone Jack)
- Convenience Plug on Bottom
- 6' Power Cord
- UL and CSA Recognized
- Additional Telecom Plates, [See ECA Telecom Plate Options](#)

OASIS MINI POWER & DATA	01-OASISMA	Aluminum	15	9	5	11	0.3	\$ 3191
	01-OASISMB	Black						



Top View

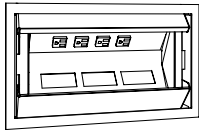

#### Description

- For Use with Conference Tables
- Soft Touch Hinged Lid
- Four (4) Power Outlets, Three (3) Telecom Plate Openings
- Two (2) Telecom Plates Included with the Unit: One (1) 01-ABLAB Plate (Consists of One (1) RJ45 Cat 6, One (1) RJ11 Cat 3 Phone Jack); One (1) 01-ABLB Plate (Consists of One (1) RJ45 Cat 6)
- 9' Power Cord
- UL Listed
- Additional Telecom Plates, [See ECA Telecom Plate Options](#)

DOCK800	01-DOCK800S	Silver	14	9	-			\$ 2047
	01-DOCK800B	Black						

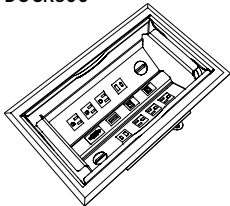

OPEN MARKET ONLY

#### Description

- Stylish Aluminum Housing with Beveled Edges; Soft Touch Access and Closure
- Includes: Six (6) Power Outlets, Two (2) USB-A 5V Ports, Two (2) USB-C Charging Ports, One (1) RJ45 Ethernet Port, One (1) RJ11 Port, One (1) HDMI Port, and One (1) VGA Port
- 10' Power Cord
- UL and cUL Certified

POWER ENTRY HARD WIRED	01-HWPOWERENTRY		72	-	-	1	0.2	\$ 322
------------------------	-----------------	--	----	---	---	---	-----	--------

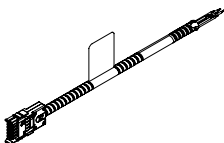

#### Description

- Eight (8) Wire/Four (4) Circuit Hard Wire In-feed
- UL183 Compliant

[See Phoenix Overview For Ordering Options](#)

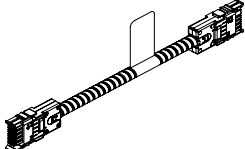

Item	Model No.	Width	Depth	Height	Ship Wt	Cubic Ft	List Price
	01-HW2JUMP	24	-	-	1	0.2	\$ 193
	01-HW3JUMP	36	-	-	1	0.2	\$ 206
	01-HW4JUMP	48	-	-	1	0.2	\$ 212
	01-HW5JUMP	60	-	-	1	0.2	\$ 255
	01-HW6JUMP	72	-	-	1	0.2	\$ 270

**Description**

- Eight (8) Wire/Four (4) Circuit Hard Wire Jumper
- UL183 Compliant

QUAD BLOCK HARD WIRED	01-HWQUADBLOCK	-	-	-	1	0.2	\$ 62
-----------------------	----------------	---	---	---	---	-----	-------

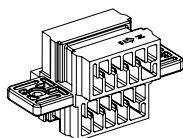
**Description**

- Eight (8) Wire/Four (4) Circuit Hard Wire Connector
- UL183 Compliant
- For Connecting Jumpers and Power Units
- Quantity of Four (4) Female Inputs

WIRE MANAGEMENT CHANNEL	01-WMGR4	16	1½	¾	1	-	\$ 116
-------------------------	----------	----	----	---	---	---	--------

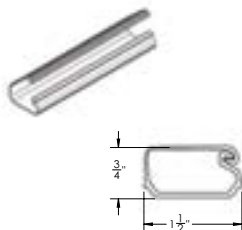
**Description**

- Set of Four (4) Black Plastic Wire Management Channels
- Snap Lock Channel
- Attaches with Adhesive Strips
- Ships via UPS Only

WIRE CHANNEL	01-32125	24	1%	1	.25	0.3	\$ 106
--------------	----------	----	----	---	-----	-----	--------

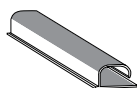
**Description**

- Available in Black
- Channels Attach with Two (2) Double-Sided Installation Tape
- Open J Channel for Easy Storage of Cables

CABLE GRIP	01-WMGRCB	5%	2%	-	-	-	\$ 17
------------	-----------	----	----	---	---	---	-------

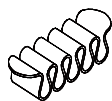
**Description**

- Under Surface Wire Management
- Black

Item	Model No.	Width	Depth	Height	Ship Wt	Cubic Ft	List Price
ECA TELECOM PLATES	01-ABL	Telecom Plate, Blank Plate					\$ 41
	01-ABL737373	Telecom Plate, Three (3) RJ45 Cat 5e					\$ 367
	Compatible with:	01-ABLAB	Telecom Plate, One (1) RJ45 Cat 6, One (1) RJ11 Cat 3 Phone				\$ 206
		01-ABLAB102	Telecom Plate, One (1) RJ45 Cat 6, One (1) RJ11 Cat 3, One (1) USB W/72" Patch Cord				\$ 320
		01-ABLABB	Telecom Plate, Two (2) RJ45 Cat 6, One (1) RJ11 Cat 3 Phone				\$ 320
	Oasis Mini Power & Data 01-OASISMA, 01-OASISMB	01-ABLB	Telecom Plate, One (1) RJ45 Cat 6				\$ 149
		01-ABLBB	Telecom Plate, Two (2) RJ45 Cat 6				\$ 260
	Interact Power & Data 01-INTERACTG2A, 01-INTERACTG2B	01-ABLBBB	Telecom Plate, Three (3) RJ45 Cat 6				\$ 367
		01-ABLBBB51	Telecom Plate, Four (4) RJ45 Cat 6				\$ 476
	Power Center 01-INTRFCIA, 01-INTRFCIB	01-ABLBBC51	Telecom Plate, Two (2) RJ45 Cat 6, One (1) 15 Pin HD VGA w/72" Patch Cord				\$ 446
		01-ABLBC51L	Telecom Plate, One (1) RJ45 Cat 6, One (1) Mini Stereo Inline, One (1) 15 Pin HD VGA w/72" Patch Cord				\$ 410
		01-ABLC3811	Telecom Plate, One (1) RJ45 Cat 6 Data Inline, One (1) RJ11 Cat 3 Phone Inline				\$ 197
		01-ABLC45	Telecom Plate, One (1) HDMI w/36" Patch Cord				\$ 295
		01-ABLC45C51L	Telecom Plate, One (1) Mini Stereo Inline, One (1) HDMI w/36" Patch Cord, One (1) 15 Pin HD VGA w/72" Patch Cord				\$ 558
		01-ABLC51L	Telecom Plate, One (1) 15 Pin HD VGA & One (1) Mini Stereo Inline Jack				\$ 298
		01-ABLCRDM	Telecom Plate, Three (3) Cord Bushings				\$ 96

[See Phoenix Overview For Ordering Options](#)

Dress up a casual drop-in meeting room or add prestige to an executive suite. Strut Tables are designed with precision minimalist lines and angles to establish modern sensibility in any space. With tops available in round, square, rectangle, modern rectangle, and boat shapes, in a range of veneer, laminate, and glass options, and in sizes ranging from 3.5 square feet to 5 by 20 feet, Strut can accommodate small meeting spaces, cafes, private offices, or even large board rooms.

### CONSTRUCTION

#### VENEER

- Exposed surfaces feature select grade plain-sliced hardwood veneers in Cherry, Maple, American Black Walnut, or composite veneers. Veneers are carefully selected and matched to assure proper balance and consistency
- Veneer features UVA Advantage, an ultra-violet finish, on all exposed surfaces by utilizing roll-coat UV technology

#### LAMINATE

- Thermally-Fused Laminate (TFL) and High-Pressure Laminate (HPL) are made of woodgrain and solid color laminates fused to particleboard core; each laminate offers lasting beauty, superior resistance to normal wear, and easy maintenance,

#### TOPS

- Veneer (W) or HPL (P) Tops available in five shapes: Rectangle, Boat, Modern Rectangle, Square and Round with woodgrain patterns following the depth (short) of Veneer (W) table tops while grain patterns follow the width (long) of HPL (P) table tops
- Tops are shaped on all four sides and are available in two thicknesses and six edge profiles
- Double Kerf (F), Duo (G), **Fluted (X)** and Square (Y) available in Veneer (W) and HPL (P) tops with 3-ply balanced construction, 1 $\frac{3}{16}$ " thick and matching 3mm wood or PVC edge bands on profiled edges; Designer White, Sugar Maple, and Williamsburg Cherry feature ABS edge bands
- Knife (K) edge profile tops are 1 $\frac{3}{16}$ " thick with solid wood rims available on both Veneer (W) or HPL (P) tops
- Vertical Square (H) edge profile tops are 1 $\frac{1}{2}$ " thick with 1.5mm wood edge band on Veneer (W) tops and 1mm PVC edge band on HPL (P) tops; Designer White, Sugar Maple, and Williamsburg Cherry feature ABS edge bands
- Tops will include with holes bored on bottom to ensure proper leg placement
- Credenzas, buffets, and other ancillary support models are available in Square (Y), Double Kerf (F), Duo (G), and Vertical Square (H) edge profiles and profiled on approach side only
- All Veneer tops, as well as Laminate tops up to 144" (12 feet), will have matching woodgrain. Laminate tops sized 156" (13 feet) and longer will have non-matching woodgrain**
- All surfaces feature reverse slip matched pattern
- Back Painted, Tempered Glass Tops are 1/4" thick and are attached to a substrate topped with black paper covering
- Tempered glass top has a 1/16" overhang from the sub-top

#### LOCKING

- All units with file drawers feature locking
- Removable lock cylinders allow for units to be re-keyed at a later date, if required Units are shipped randomly keyed as standard
- Keyed alike units available upon request at no additional charge Lock core is predetermined by pull color. Black lock cores are used with black and gold pulls while silver lock cores are used with chrome and aluminum pulls
- Optional locking doors available on buffets and credenzas

#### LEGS

- Available in aluminum (ALUM) or black (BLK)
- Integrated wire management inside of leg to keep your space clean and free of wires
- Each leg has adjustable glides

#### CHASSIS

- All credenzas are available in TFL (T) or Veneer (W) with vertical grain direction
- Chassis for storage units are securely fastened using high quality European fastening systems and heavy-duty 16-gauge joining brackets to assure maximum strength
- All units ship with heavy-duty, adjustable leveling glides to ensure proper leveling and compensation for uneven floors

#### DRAWERS

- Drawers feature 5-sided drawer construction allowing for easy removal of drawer fronts; All drawer fronts are standard with elegant vertically matched faces
- Drawer sides, back, and front are woodgrain vinyl-wrapped 1/2" thick with 1/8" thick hardboard bottoms
- Drawer interiors are dovetail construction with 7/16" thick hardwood sides and backs, and 5/32" thick hardboard bottoms
- All drawers feature full extension, progressive action slides with precision steel ball bearings
- Box drawers are tested for 100lb capacity
- All suspensions have a limited lifetime warranty

#### STORAGE

- All hinged doors are soft-close with one piece hinge and base plate combination
- Soft close hinges reduce stress placed on the cabinet when the door is closed and offers a quiet closure
- All Credenzas feature a 2" W wire management channel along back of the interior cabinet for easy accessibility to wall outlets

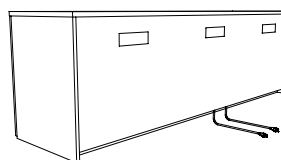

2" wire management channel

### INTERIOR DRAWER DIMENSIONS

#### Models

88-2496BF

	W	L	D
Box Drawers	15 $\frac{3}{4}$ "	16 $\frac{3}{8}$ "	3 $\frac{2}{32}$ "

#### Models

88-2484BF

	W	L	D
Box Drawers	30"	16 $\frac{3}{8}$ "	3 $\frac{2}{32}$ "
	13 $\frac{3}{8}$ "	16 $\frac{3}{8}$ "	3 $\frac{2}{32}$ "

#### Models

88-2472BF

88-2436BF

	W	L	D
Box Drawers	32 $\frac{3}{16}$ "	16 $\frac{3}{8}$ "	3 $\frac{2}{32}$ "

#### Models

88-2460BF

	W	L	D
Box Drawers	16 $\frac{1}{2}$ "	16 $\frac{3}{8}$ "	3 $\frac{2}{32}$ "

#### Models

88-2448BF

	W	L	D
Box Drawers	20 $\frac{15}{16}$ "	16 $\frac{3}{8}$ "	3 $\frac{2}{32}$ "

### INTERIOR CABINET DIMENSIONS

#### Models

88-2496BF

	W	D	H
Double Door	36 $\frac{3}{4}$ "	22 $\frac{3}{8}$ "	23 $\frac{1}{2}$ "
Single Door with Waste Bin	18"	22 $\frac{3}{8}$ "	23 $\frac{1}{2}$ "

#### Models

88-2484BF

	W	D	H
Double Door	32"	22 $\frac{3}{8}$ "	23 $\frac{1}{2}$ "
Single Door with Waste Bin	15 $\frac{1}{2}$ "	22 $\frac{3}{8}$ "	23 $\frac{1}{2}$ "

#### Models

88-2472BF

88-2436BF

	W	D	H
Double Door	34 $\frac{3}{8}$ "	22 $\frac{3}{8}$ "	23 $\frac{1}{2}$ "
Single Door with Waste Bin	16 $\frac{3}{4}$ "	22 $\frac{3}{8}$ "	23 $\frac{1}{2}$ "

#### Models

88-2460BF

	W	D	H
Single Door	18 $\frac{3}{8}$ "	22 $\frac{3}{8}$ "	23 $\frac{1}{2}$ "

#### Models

88-2448BF

	W	D	H
Double Door	46 $\frac{3}{8}$ "	22 $\frac{3}{8}$ "	23 $\frac{1}{2}$ "
Single Door with Waste Bin	22 $\frac{3}{4}$ "	22 $\frac{3}{8}$ "	23 $\frac{1}{2}$ "

#### Models

88-2496CC

	W	D	H
Double Door	36 $\frac{3}{4}$ "	22 $\frac{3}{8}$ "	24 $\frac{3}{8}$ "
Single Door with Waste Bin	18"	22 $\frac{3}{8}$ "	24 $\frac{3}{8}$ "

#### Models

88-2484CC

	W	D	H
Double Door	32"	22 $\frac{3}{8}$ "	24 $\frac{3}{8}$ "
Single Door with Waste Bin	15 $\frac{1}{2}$ "	22 $\frac{3}{8}$ "	24 $\frac{3}{8}$ "

#### Models

88-2472CC

88-2436BF

	W	D	H
Double Door	34 $\frac{3}{8}$ "	22 $\frac{3}{8}$ "	24 $\frac{3}{8}$ "
Single Door with Waste Bin	16 $\frac{3}{4}$ "	22 $\frac{3}{8}$ "	24 $\frac{3}{8}$ "

#### Models

88-2460CC

	W	D	H
Single Door with Waste Bin	18 $\frac{3}{8}$ "	22 $\frac{3}{8}$ "	24 $\frac{3}{8}$ "

#### Models

88-2448CC

	W	D	H
Double Door	46 $\frac{3}{8}$ "	22 $\frac{3}{8}$ "	24 $\frac{3}{8}$ "
Single Door with Waste Bin	22 $\frac{3}{4}$ "	22 $\frac{3}{8}$ "	24 $\frac{3}{8}$ "

#### Models

88-2096CC

	W	D	H
Double Door	36 $\frac{3}{4}$ "	18 $\frac{3}{8}$ "	24 $\frac{3}{8}$ "
Single Door	17 $\frac{3}{8}$ "	18 $\frac{3}{8}$ "	24 $\frac{3}{8}$ "

#### Models

88-2084CC

	W	D	H
Double Door	32"	18 $\frac{3}{8}$ "	24 $\frac{3}{8}$ "
Single Door	15 $\frac{1}{2}$ "	18 $\frac{3}{8}$ "	24 $\frac{3}{8}$ "

### INTERIOR CABINET DIMENSIONS CONTINUED

#### Models

88-2072CC	88-2036CC		
	<b>W</b>	<b>D</b>	<b>H</b>
Single Door	34 $\frac{3}{8}$ "	18 $\frac{3}{8}$ "	24 $\frac{3}{8}$ "

#### Models

88-2060CC			
	<b>W</b>	<b>D</b>	<b>H</b>
Single Door	18 $\frac{3}{8}$ "	18 $\frac{3}{8}$ "	24 $\frac{3}{8}$ "

#### Models

88-2048CC			
	<b>W</b>	<b>D</b>	<b>H</b>
Double Door	46 $\frac{3}{8}$ "	18 $\frac{3}{8}$ "	24 $\frac{3}{8}$ "

### HOW TO ORDER EXAMPLES

#### SQUARE MEETING TABLE

	QTY	MODEL NO.		EXAMPLE
<b>TOP</b>	1	88-4848SQ	Top/Edge Material Finish/Color Edge Profile Glass Top Glass Color/Surface Finish Power/Data Location	P FO 3MMW/F Y GBLG OC
<b>BASE</b>	1	01-2228STR4	Strut Legs (4 legs) Leg Color	ALUM
<b>POWER</b>	1	01-DUOBEZELS		

#### MODERN RECTANGLE MEETING TABLES

	QTY	MODEL NO.		EXAMPLE
<b>TOP</b>	1	88-54192MR	Top/Edge Material Top/Edge Finish/Color Edge Profile Glass Top Glass Color/Surface Finish Grommet/Power/Data Type Grommet/Power/Data Location	W MAS 3MMW/F Y GBLG DPORTA OC
<b>BASES</b>	2	01-2228STR4	Strut Legs (4 legs) Leg Color	BLK
<b>POWER</b>	1	DPORTA		

### STORAGE & ACCESSORIES

#### Buffet Credenza

QTY	MODEL NO.		EXAMPLE
1	88-2472BF	Top/Edge Material Finish/Color Edge Profile Chassis Finish/Color Glass Top Glass Color/Surface Finish Studio Pull Color Locking Drawer Construction Drawer Track Vent Waste Bin	W MAS 3MMW/F ORW Y GBLG GST LKT_BFD DOVE SFTCL VENT WBL

### VENEER (W) OPTIONS ON TOPS / EDGES, BASES, AND ACCENT PANELS

Veneer features UVAdvantage, an ultra-violet finish, on all exposed surfaces or our Catalyzed finish (where noted), which is a multi-step, finish process that provides years of lasting beauty.

AW	Artisan Walnut	MW	Mahogany Walnut
AS	Asian Night	MAS	Mesa Sunset*
CO	Columbian Walnut	MTS	Metropolis Sky
DC	Dark Cherry	ORW	Oak Riftwood*
DFW	Dark Forest Walnut	PNW	Pinnacle Walnut
EW	Espresso	SCH	Select Cherry
FO	Fawn Oak*	SKC	Shaker Cherry
GC	Golden Cherry	SM	Sugar Maple
HVM	Harvest Walnut	WTA	Weathered Ash*
HNW	Henna Walnut	WC	Williamsburg Cherry
LW	Legacy Walnut		

\* Finish is Low Sheen

### TFL (T) OPTIONS FOR BASES / ACCENT PANELS AND HPL (P) LAMINATE OPTIONS ON TOPS / EDGES

#### WOODGRAIN

AS	Asian Night	PNW	Pinnacle Walnut
BW	Beigewood	PTK	Portico Teak
CO	Columbian Walnut	RC	River Cherry
EF	Espresso	SPW	Seppia Walnut
FLW	Florence Walnut	SKC	Shaker Cherry
GC	Golden Cherry	SCH	Select Cherry
HVM	Harvest Maple	SBP	Smoky Brown Pear
KHE	Kirsche	TK	Studio Teak
MW	Mahogany Walnut	SM	Sugar Maple
MNR	Midnight Run	WTA	Weathered Ash
NTM	Natural Marrone	WC	Williamsburg Cherry
ORW	Oak Riftwood	WNB	White Nebbia

#### SOLID

BL	Black	FHG	Fashion Grey
WH	Designer White	SG	Slate Grey

### EDGE PROFILES

Double Kerf (F), Duo (G), **Fluted (X)**, Square (Y) and Knife (K) edge profiles is 1 3/16" thick and available in Veneer (W) and HPL (P) tops. Vertical Square (H) edge profile available is 1 1/2" thick and also available Veneer (W) and HPL (P) tops. Knife (K) edge not available on buffet and credenzas.

**Must specify edge profile.**

#### Laminate (P) Top Edges

3MMP/F	Double Kerf (1 3/16" H)	3MMP/Y	Square (1 3/16" H)
3MMP/G	Duo (1 3/16" H)	RIMP/K	Knife (1 3/16" H)
3MMP/X	<b>Fluted (1 3/16" H)</b>	HP	Vertical Square (1 1/2" H)

#### Veneer (W) Top Edges

3MMW/F	Double Kerf (1 3/16" H)	3MMW/Y	Square (1 3/16" H)
3MMW/G	Duo (1 3/16" H)	RIMW/K	Knife (1 3/16" H)
3MMW/X	<b>Fluted (1 3/16" H)</b>	HW	Vertical Square (1 1/2" H)

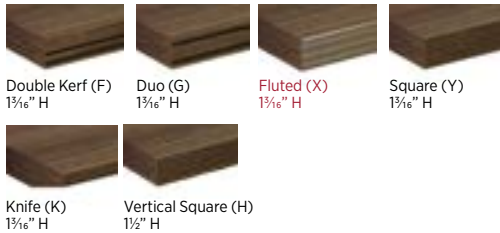

Double Kerf (F) 1 3/16" H    Duo (G) 1 3/16" H    **Fluted (X)** 1 3/16" H    Square (Y) 1 3/16" H

Knife (K) 1 3/16" H    Vertical Square (H) 1 1/2" H

### PULL OPTIONS

Buffets and Credenzas available with pulls on doors. Must specify and select color.

Lock core color is predetermined by pull color.

AST	Studio, Aluminum	CST	Studio, Chrome
BST	Studio, Black	GST	Studio, Gold

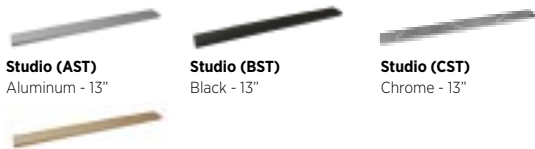

Studio (GST)  
Gold - 13"

### GLASS OPTIONS ON TOPS

Back painted tempered glass tops are 1/4" thick and available in Black or White with Gloss or Acid Etched finish. Glass top sits 1/16" on top of substrate top.

GWHG	White Gloss	GBLG	Black Gloss
GWHA	White Acid Etched	GBLA	Black Acid Etched



White Gloss (GWHG)



Black Gloss (GBLG)

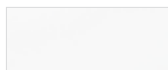

White Acid Etched (GWHA)



Black Acid Etched (GBLA)

### LOCK CORE COLOR OPTIONS

BLK	Black (Used with Black and Gold Pulls)
SLV	Silver (Used with Aluminum and Chrome Pulls)



### GROMMET & POWER UNIT OPTIONS

Power units and grommets are available on Rectangle, Modern Rectangle, and Boat shaped tops. Each unit is sold separately and must be specified separately with surface mount location. Multiple locations may be selected. Only one unit per location.

#### Power units and Grommets Available in Table Surfaces (See Units)

Grommet	\$ 52
---------	-------

Specify Color: Black = BLK and Silver = SLV

#### DUO/TRIO BEZEL

01-DUOBEZEL	Available in Black (B), Silver (S), or White (W)
01-TRIOBEZEL	Available in Black (B), Silver (S), or White (W)

#### DOCK 950, DOCK 800 and DOCK 150

DOCK950	Available in Black or White
DOCK150	Available in Black or White
DOCK800	Available in Black or Silver

#### Other Power Units

DPORT4	Available in Aluminum or Black
ELLORA	Available in Aluminum or Black
E2X	Available in Aluminum or Black
INTERACTG	Available in Aluminum or Black
OASISM	Available in Aluminum or Black

#### Power/Data Location Information:

- Designate unit and location when specifying the top model. Power/Data Module need to be ordered separately.
- Power/Data Modules specified at the time of order will be routed for field installation.
 

E1	Unit on One End
E2	Unit on Each End
OC	Unit on Center

- 72"W tops available with power units **On Center (OC) only**

*Grommets and Power Units may be ordered in non-standard locations. Call Customer Service to assist with specification and/or please attach a drawing to the PO showing the location of the grommet. Note additional charges and lead times may apply.*

#### Top Locations

Power units available on Each End (E1 and E2) and On Center (OC) unless otherwise noted.

#### Power units centered at locations below:

36" Tops	Centered 18"D	54" Tops	Centered 27"D
42" Tops	Centered 21"D	60" Tops	Centered 30"D
48" Tops	Centered 24"D		

**GROMMET OPTIONS & POWER UNIT OPTIONS CONTINUED**

**Top Locations Continued**

- 72: OC 36" from end (available with OC Only)
- 84: OC 42" from end (available with OC Only)
- 96: OC 48" from end; E1/E2 29" from end
- 108 OC 54" from end; E1/E2 29" from end
- 120: OC 60" from end; E1/E2 29" from end
- 132: OC 66" from end; E1/E2 29" from end
- 144: OC 72" from end; E1/E2 29" from end
- 156: OC 78" from end; E1/E2 29" from end
- 168: OC 84" from end; E1/E2 29" from end
- 180: OC 90" from end; E1/E2 36" from end
- 192: OC 96" from end; E1/E2 36" from end
- 204: OC 102" from end; E1/E2 36" from end
- 216: OC 108" from end; E1/E2 36" from end
- 228: OC 114" from end; E1/E2 36" from end
- 240: OC 120" from end; E1/E2 36" from end

Example: 60x204 Modern Rectangle

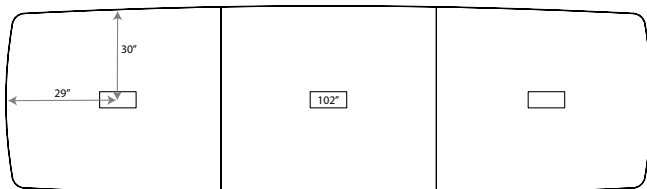

**DRAWER TRACK OPTIONS**

Soft close tracks are available on box drawers only. Soft close drawer tracks have many benefits including reduced stress on the unit, extends the life of the drawer, and ensures a gentle close so fingers don't accidentally get pinched. Must specify when ordering. **Pricing is per Drawer, not per Model/Unit**

SFTCL	Soft Close Drawer Track	\$	34
-------	-------------------------	----	----

**WASTE BIN OPTIONS**

Buffet and 24" Credenzas are available with two (2) 41-quart beige waste bins in a pull out cabinet with silver hardware and divider panel. Adjacent cabinet features one (1) adjustable shelf. Studio pulls applied centered on doors when waste bin is selected. Locking not available.

WBL	Waste Bin on Left	\$	510
WBR	Waste Bin on Right	\$	510

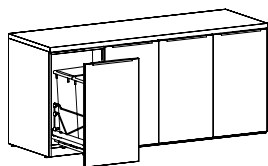

Shown as Left

**VENT OPTION FOR CREDENZAS**

Buffets and Credenzas feature optional ventilation grommets. Includes one vent per compartment.

Vents are 10" Down from top surface on Buffet Credenzas and 2 7/8" on Credenzas.

NONE	No Vent Grommet		
VENT	Vented back panel	\$	68

Number of vents per unit:

36"	1 vent
72" / 48"	2 vents
96" / 84" / 60"	3 vents

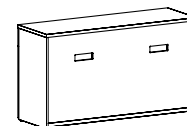

**LOCKING DOORS**

Locking doors are available on Buffets and Credenzas. You must specify WITH LOCKING when ordering and add upcharge.

Note: When locking is selected with optional waste bin, locking will not apply to waste bin door.

LKT_BFD	96"W to 84"W Units	\$	135
LKT_BFD	72"W to 48"W Units	\$	115
LKT_BFD	36"W Units	\$	91

**BASE METAL ACCENT COLOR OPTIONS**

6" and 10" Rectangle Accent Bases feature 5/16" metal trim. Must specify color

ALUM	Aluminum	PLAT	Platinum
BLK	Black	GLD	Gold

### Tops/Shapes + Bases



Square ([See Details](#))



Round ([See Details](#))



Rectangular ([See Details](#))



Modern Rectangular ([See Details](#))



Boat ([See Details](#))

### Strut Legs ([See Details](#))

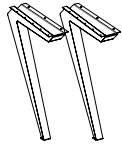

Set of 2 legs

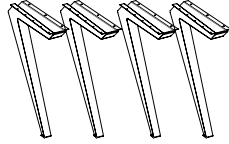

Set of 4 legs

### Storage Components + Accessories

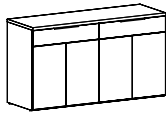

Buffet with Doors + Drawers  
([See Details](#))

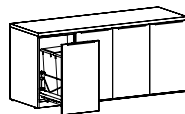

24\"/>

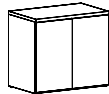

Mobile Serving Cart  
([See Details](#))

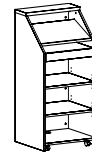

Lectern Stand  
([See Details](#))

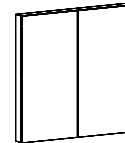

Visual Board  
([See Details](#))

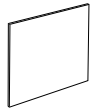
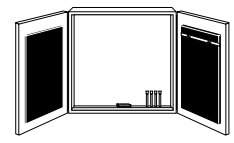

Marker Boards  
([See Multiple Unit Details](#))



Marker, Eraser and Magnet  
Sets ([See Details](#))

### Wire Management + Power/Data Accessories ([See Details](#))

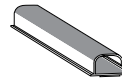
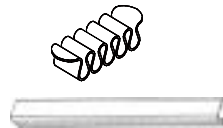
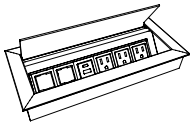



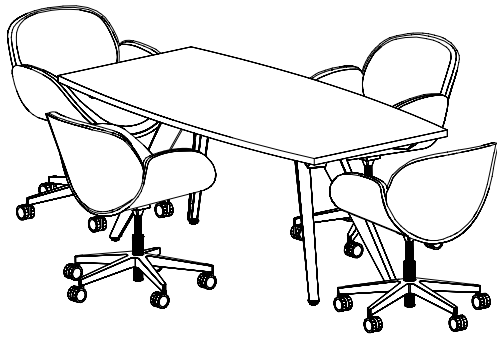
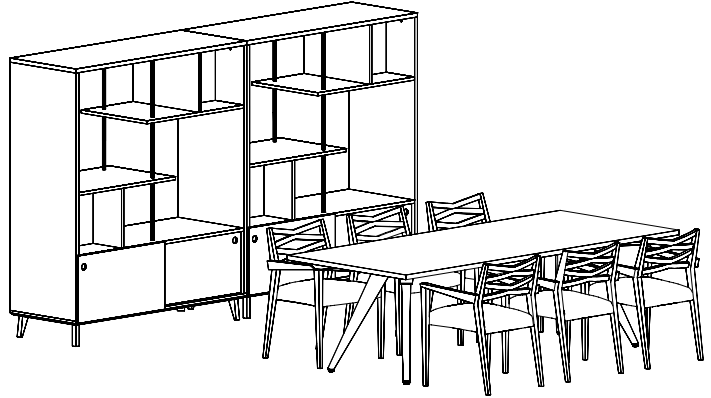
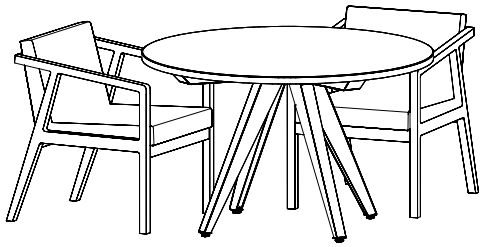

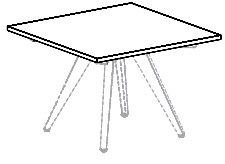
Item	Model No.		W	D	H	Ship Wt	Cubic Ft	Edge Profile + Material	List Price
 <p>88-4242SQ Shown BASES SOLD SEPARATELY</p> <p><u>Must Specify (in this order):</u>                      Model #                      Top/Edge Material                      Top/Edge Finish/Color                      Edge Profile                      Glass (Y/N)                      Glass Color + Surface Finish                      Power/Data                      Power/Data Location</p>	88-4848SQ	Laminate	48	48	1 <sup>3</sup> / <sub>16</sub>	82	7.2	F, G, X, Y / P\$	850
					1 <sup>3</sup> / <sub>16</sub>			K / P\$	1398
					1 <sup>1</sup> / <sub>2</sub>			H / P\$	948
		Veneer	1 <sup>3</sup> / <sub>16</sub>	82	7.2	F, G, X, Y / W\$	967		
			1 <sup>3</sup> / <sub>16</sub>			K / W\$	1620		
			1 <sup>1</sup> / <sub>2</sub>			H / W\$	1146		
	Glass	1 <sup>1</sup> / <sub>4</sub>	82	7.2	Acid Etched Glass Top \$	5455			
		1 <sup>1</sup> / <sub>4</sub>			Gloss Glass Top \$	4541			
	88-4242SQ	Laminate	42	42	1 <sup>3</sup> / <sub>16</sub>	70	3.4	F, G, X, Y / P\$	757
					1 <sup>3</sup> / <sub>16</sub>			K / P\$	1215
1 <sup>1</sup> / <sub>2</sub>					H / P\$			875	
Veneer		1 <sup>3</sup> / <sub>16</sub>	70	3.4	F, G, X, Y / W\$	866			
		1 <sup>3</sup> / <sub>16</sub>			K / W\$	1468			
		1 <sup>1</sup> / <sub>2</sub>			H / W\$	962			
Glass	1 <sup>1</sup> / <sub>4</sub>	70	3.4	Acid Etched Glass Top \$	4396				
	1 <sup>1</sup> / <sub>4</sub>			Gloss Glass Top \$	3695				

**Description**

- Tops Feature a 1-piece, 1<sup>3</sup>/<sub>16</sub>" or 1<sup>1</sup>/<sub>2</sub>" Thick Top in Veneer (W) or HPL (P)
- Must Specify Edge Profile: 1<sup>3</sup>/<sub>16</sub>" Thick/Double Kerf (F), Duo (G), **Fluted (X)**, Square (Y), and Knife (K) Edge Profiles or 1<sup>1</sup>/<sub>2</sub>" Thick/Vertical Square (H)
- Due to Top Sizes and Base Placement, Power is Not Available on Square Tops
- Available with Back Painted Tempered Glass Top; Must Specify Color and Finish; [See Options](#)
- Strut Legs Sold Separately, See [Multiple Base Options](#)



Double Kerf (F)  
1<sup>3</sup>/<sub>16</sub>"



Duo (G)  
1<sup>3</sup>/<sub>16</sub>"



Fluted (X)  
1<sup>3</sup>/<sub>16</sub>"



Square (Y)  
1<sup>3</sup>/<sub>16</sub>"



Knife (K)  
1<sup>3</sup>/<sub>16</sub>"



Vertical Square (H)  
1<sup>1</sup>/<sub>2</sub>"

P = HPL W = Veneer

[See Strut Overview For Ordering Options](#)

Item	Model No.		W	D	H	Ship Wt	Cubic Ft	Edge Profile + Material	List Price		
 <p>88-4848CT Shown BASES SOLD SEPARATELY</p>	88-6060CT	Laminate	60	60	1 <sup>3</sup> / <sub>16</sub>	143	8.4	F, G, X, Y / P\$	1037		
					1 <sup>3</sup> / <sub>16</sub>			K / P\$	2195		
					1 <sup>1</sup> / <sub>2</sub>			H / P\$	1085		
		Veneer	1 <sup>3</sup> / <sub>16</sub>	F, G, X, Y / W\$	1406						
			1 <sup>3</sup> / <sub>16</sub>	K / W\$	2461						
			1 <sup>1</sup> / <sub>2</sub>	H / W\$	1662						
		Glass	1 <sup>1</sup> / <sub>4</sub>	Acid Etched Glass Top \$	8681						
			1 <sup>1</sup> / <sub>4</sub>	Gloss Glass Top \$	7210						
		<p><u>Must Specify (in this order):</u>                      Model #                      Top/Edge Material                      Top/Edge Finish/Color                      Edge Profile                      Glass (Y/N)                      Glass Color + Surface Finish                      Power/Data Type                      Power/Data Location</p>	88-5454CT	Laminate	54	54	1 <sup>3</sup> / <sub>16</sub>	114	6.8	F, G, X, Y / P\$	997
							1 <sup>3</sup> / <sub>16</sub>			K / P\$	2003
1 <sup>1</sup> / <sub>2</sub>	H / P\$						1033				
Veneer	1 <sup>3</sup> / <sub>16</sub>			F, G, X, Y / W\$	1248						
	1 <sup>3</sup> / <sub>16</sub>			K / W\$	2190						
	1 <sup>1</sup> / <sub>2</sub>			H / W\$	1460						
Glass	1 <sup>1</sup> / <sub>4</sub>			Acid Etched Glass Top \$	7267						
	1 <sup>1</sup> / <sub>4</sub>			Gloss Glass Top \$	6073						
88-4848CT	Laminate			48	48	1 <sup>3</sup> / <sub>16</sub>	90	5.5	F, G, X, Y / P\$	904	
						1 <sup>3</sup> / <sub>16</sub>			K / P\$	1894	
		1 <sup>1</sup> / <sub>2</sub>	H / P\$			930					
	Veneer	1 <sup>3</sup> / <sub>16</sub>	F, G, X, Y / W\$	1024							
		1 <sup>3</sup> / <sub>16</sub>	K / W\$	2130							
		1 <sup>1</sup> / <sub>2</sub>	H / W\$	1195							
	Glass	1 <sup>1</sup> / <sub>4</sub>	Acid Etched Glass Top \$	6064							
		1 <sup>1</sup> / <sub>4</sub>	Gloss Glass Top \$	5122							

**Description**

- Tops Feature a 1-piece, 1<sup>3</sup>/<sub>16</sub>" or 1<sup>1</sup>/<sub>2</sub>" Thick Top in Veneer (W) or HPL (P)
- Must Specify Edge Profile: 1<sup>3</sup>/<sub>16</sub>" Thick/Double Kerf (F), Duo (G), Fluted (X), Square (Y), and Knife (K) Edge Profiles or 1<sup>1</sup>/<sub>2</sub>" Thick/Vertical Square (H)
- Due to Top Sizes and Base Placement, Power is Not Available on Round Tops
- Available with Back Painted Tempered Glass Top; Must Specify Color and Finish; [See Options](#)
- 60" and 54" Tops Feature Catalyzed Finish
- Strut Legs Sold Separately, See [Multiple Base Options](#)



Double Kerf (F)  
1<sup>3</sup>/<sub>16</sub>"



Duo (G)  
1<sup>3</sup>/<sub>16</sub>"



Fluted (X)  
1<sup>3</sup>/<sub>16</sub>"



Square (Y)  
1<sup>3</sup>/<sub>16</sub>"



Knife (K)  
1<sup>3</sup>/<sub>16</sub>"



Vertical Square (H)  
1<sup>1</sup>/<sub>2</sub>"

P = HPL W = Veneer

[See Strut Overview For Ordering Options](#)

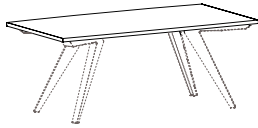
Item	Model No.		W	D	H	Ship Wt	Cubic Ft	Edge Profile + Material	List Price	
<b>RECTANGLE SHAPE MEETING TOP</b> <b>36"D</b>  88-3672RT Shown BASES SOLD SEPARATELY	<b>36"D x 96"W or 8' - 1 Piece Rectangle Top</b>									
	88-3696RT	Laminate	96	36	1 3/16	142	12.9	F, G, X, Y / P\$	1364	
					1 3/16			K / P\$	2150	
					1 1/2			H / P\$	1547	
		Veneer			1 3/16			F, G, X, Y / W\$	1544	
					1 3/16			K / W\$	2556	
					1 1/2			H / W\$	1858	
		Glass			1/4			Acid Etched Glass Top \$	8134	
					1/4			Gloss Glass Top \$	6806	
	<b>36"D x 84"W or 7' - 1 Piece Rectangle Top</b>									
	88-3684RT	Laminate	84	36	1 3/16	126	11.3	F, G, X, Y / P\$	1299	
					1 3/16			K / P\$	2006	
					1 1/2			H / P\$	1489	
		Veneer			1 3/16			F, G, X, Y / W\$	1462	
					1 3/16			K / W\$	2437	
				1 1/2			H / W\$	1707		
	Glass			1/4			Acid Etched Glass Top \$	7313		
				1/4			Gloss Glass Top \$	6151		
<b>36"D x 72"W or 6' - 1 Piece Rectangle Top</b>										
88-3672RT	Laminate	72	36	1 3/16	109	10.3	F, G, X, Y / P\$	1052		
				1 3/16			K / P\$	1695		
				1 1/2			H / P\$	1188		
	Veneer			1 3/16			F, G, X, Y / W\$	1238		
				1 3/16			K / W\$	1957		
				1 1/2			H / W\$	1478		
	Glass			1/4			Acid Etched Glass Top \$	6321		
				1/4			Gloss Glass Top \$	5324		

**Description**

- Tops Available with Veneer (W) or HPL (P) Top in 1 3/16" and 1 1/2" Thicknesses
- Must Specify Edge Profile: 1 3/16" Thick/Double Kerf (F), Duo (G), **Fluted (X)**, Square (Y), and Knife (K) Edge Profiles or 1 1/2" Thick/Vertical Square (H)
- Veneer (W) Top Grain Runs Depth of Top and HPL (P) Top Grain Runs Width of Top
- Available with Back Painted Tempered Glass Top; Must Specify Color and Finish; [See Options](#)
- Strut Legs Sold Separately, [See Strut Legs](#)



Double Kerf (F)  
1 3/16"



Duo (G)  
1 3/16"



Fluted (X)  
1 3/16"



Square (Y)  
1 3/16"



Knife (K)  
1 3/16"



Vertical Square (H)  
1 1/2"

P = HPL W = Veneer

[See Strut Overview For Ordering Options](#)

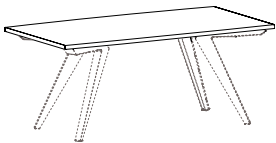
Item	Model No.		W	D	H	Ship Wt	Cubic Ft	Edge Profile + Material	List Price	
<b>RECTANGLE SHAPE MEETING TOP</b> <b>42"D</b>    88-4272RT Shown BASES SOLD SEPARATELY	<b>42"D x 96"W or 8' - 1 Piece Rectangle Top</b>									
	88-4296RT	Laminate	96	42	1 3/16	164	15.0	F, G, X, Y / P\$	1393	
					1 3/16			K / P\$	2337	
					1 1/2			H / P\$	1608	
		Veneer			1 3/16			F, G, X, Y / W\$	1685	
					1 3/16			K / W\$	2697	
					1 1/2			H / W\$	2042	
		Glass			1/4			Acid Etched Glass Top \$	8955	
					1/4			Gloss Glass Top \$	7405	
	<b>42"D x 84"W or 7' - 1 Piece Rectangle Top</b>									
	88-4284RT	Laminate	84	42	1 3/16	145	13.1	F, G, X, Y / P\$	1355	
					1 3/16			K / P\$	2174	
				1 1/2			H / P\$	1542		
	Veneer			1 3/16			F, G, X, Y / W\$	1551		
				1 3/16			K / W\$	2567		
				1 1/2			H / W\$	1867		
	Glass			1/4			Acid Etched Glass Top \$	8002		
				1/4			Gloss Glass Top \$	6647		
<b>42"D x 72"W or 6' - 1 Piece Rectangle Top</b>										
88-4272RT	Laminate	72	42	1 3/16	126	11.3	F, G, X, Y / P\$	1125		
				1 3/16			K / P\$	1906		
				1 1/2			H / P\$	1285		
	Veneer			1 3/16			F, G, X, Y / W\$	1408		
				1 3/16			K / W\$	2134		
				1 1/2			H / W\$	1681		
	Glass			1/4			Acid Etched Glass Top \$	7015		
				1/4			Gloss Glass Top \$	5853		

Must Specify (in this order):

- Model #
- Top/Edge Material
- Top/Edge Finish/Color
- Edge Profile
- Glass (Y/N)
- Glass Color + Surface Finish
- Power/Data Type
- Power/Data Location

**Description**

- Tops Available with Veneer (W) or HPL (P) Top in 1 3/16" and 1 1/2" Thicknesses
- Must Specify Edge Profile: 1 3/16" Thick/Double Kerf (F), Duo (G), **Fluted (X)**, Square (Y), and Knife (K) Edge Profiles or 1 1/2" Thick/Vertical Square (H)
- Veneer (W) Top Grain Runs Depth of Top and HPL (P) Top Grain Runs Width of Top
- Available with Back Painted Tempered Glass Top; Must Specify Color and Finish; [See Options](#)
- Power and Data Options Available; Sold Separately, [See Multiple Power Unit Details](#)
- Strut Legs Sold Separately, [See Strut Legs](#)



Double Kerf (F)  
1 3/16"



Duo (G)  
1 3/16"



Fluted (X)  
1 3/16"



Square (Y)  
1 3/16"



Knife (K)  
1 3/16"



Vertical Square (H)  
1 1/2"

P = HPL W = Veneer

[See Strut Overview For Ordering Options](#)

Item	Model No.		W	D	H	Ship Wt	Cubic Ft	Edge Profile + Material	List Price	
<b>RECTANGLE SHAPE MEETING TOP</b> <b>48" D</b>  88-48216RT Shown BASES SOLD SEPARATELY	<b>48"D x 240"W or 20' - 3 Piece Rectangle Top</b>									
	88-48240RT	Laminate	240	48	1 3/16	460	28.5	F, G, X, Y / P\$	4463	
					1 3/16			K / P\$	7279	
					1 1/2			H / P\$	5088	
		Veneer			1 3/16			F, G, X, Y / W\$	6000	
					1 3/16			K / W\$	8081	
					1 1/2			H / W\$	6974	
		Glass			1/4			Acid Etched Glass Top \$	24958	
					1/4			Gloss Glass Top \$	20531	
	<b>48"D x 228"W or 19' - 3 Piece Rectangle Top</b>									
	88-48228RT	Laminate	228	48	1 3/16	438	27.0	F, G, X, Y / P\$	4419	
					1 3/16			K / P\$	7144	
				1 1/2			H / P\$	5015		
	Veneer			1 3/16			F, G, X, Y / W\$	5743		
				1 3/16			K / W\$	7825		
				1 1/2			H / W\$	6670		
	Glass			1/4			Acid Etched Glass Top \$	23871		
				1/4			Gloss Glass Top \$	19666		
<b>48"D x 216"W or 18' - 3 Piece Rectangle Top</b>										
88-48216RT	Laminate	216	48	1 3/16	416	25.5	F, G, X, Y / P\$	3513		
				1 1/2			K / P\$	5875		
				1 3/16			H / P\$	4077		
	Veneer			1 3/16			F, G, X, Y / W\$	5081		
				1 3/16			K / W\$	6624		
				1 1/2			H / W\$	5961		
	Glass			1/4			Acid Etched Glass Top \$	22339		
				1/4			Gloss Glass Top \$	18355		
<b>48"D x 204"W or 17' - 3 Piece Rectangle Top</b>										
88-48204RT	Laminate	204	48	1 3/16	394	24.0	F, G, X, Y / P\$	3470		
				1 3/16			K / P\$	5739		
				1 1/2			H / P\$	4002		
	Veneer			1 3/16			F, G, X, Y / W\$	4824		
				1 3/16			K / W\$	6599		
				1 1/2			H / W\$	5657		
	Glass			1/4			Acid Etched Glass Top \$	21427		
				1/4			Gloss Glass Top \$	17664		

*Additional 48" Rectangle Shaped Tops on Next Page*



Double Kerf (F) 1 3/16"    Duo (G) 1 3/16"    Fluted (X) 1 3/16"    Square (Y) 1 3/16"    Knife (K) 1 3/16"    Vertical Square (H) 1 1/2"

P = HPL    W = Veneer

[See Strut Overview For Ordering Options](#)

Item	Model No.		W	D	H	Ship Wt	Cubic Ft	Edge Profile + Material	List Price	
<b>48"D x 192"W or 16' - 2 Piece Rectangle Top</b>										
<i>CONTINUED FROM PREVIOUS PAGE</i>	88-48192RT	Laminate	192	48	1 <sup>3</sup> / <sub>16</sub>	372	31.2	F, G, X, Y / P\$	3002	
					1 <sup>3</sup> / <sub>16</sub>			K / P\$	5173	
					1 <sup>1</sup> / <sub>2</sub>			H / P\$	3500	
	Veneer	1 <sup>3</sup> / <sub>16</sub>	F, G, X, Y / W\$	4079						
		1 <sup>3</sup> / <sub>16</sub>	K / W\$	5673						
		1 <sup>1</sup> / <sub>2</sub>	H / W\$	4861						
	Glass		1 <sup>1</sup> / <sub>4</sub>	Acid Etched Glass Top \$	19497					
			1 <sup>1</sup> / <sub>4</sub>	Gloss Glass Top \$	15957					
	<b>48"D x 180"W or 15' - 2 Piece Rectangle Top</b>									
	<i>Must Specify (in this order):</i> Model # Top/Edge Material Top/Edge Finish/Color Edge Profile Glass (Y/N) Glass Color + Surface Finish Power/Data Power/Data Location	88-48180RT	Laminate	180	48	1 <sup>3</sup> / <sub>16</sub>	350	31.2	F, G, X, Y / P\$	2959
						1 <sup>3</sup> / <sub>16</sub>			K / P\$	4936
						1 <sup>1</sup> / <sub>2</sub>			H / P\$	3427
Veneer		1 <sup>3</sup> / <sub>16</sub>	F, G, X, Y / W\$	3910						
		1 <sup>3</sup> / <sub>16</sub>	K / W\$	5556						
		1 <sup>1</sup> / <sub>2</sub>	H / W\$	4646						
Glass			1 <sup>1</sup> / <sub>4</sub>	Acid Etched Glass Top \$	18411					
			1 <sup>1</sup> / <sub>4</sub>	Gloss Glass Top \$	15091					
<b>48"D x 168"W or 14' - 2 Piece Rectangle Top</b>										
		88-48168RT	Laminate	168	48	1 <sup>3</sup> / <sub>16</sub>	328	31.2	F, G, X, Y / P\$	2808
						1 <sup>3</sup> / <sub>16</sub>			K / P\$	4653
						1 <sup>1</sup> / <sub>2</sub>			H / P\$	3245
	Veneer	1 <sup>3</sup> / <sub>16</sub>	F, G, X, Y / W\$	3604						
		1 <sup>3</sup> / <sub>16</sub>	K / W\$	5242						
		1 <sup>1</sup> / <sub>2</sub>	H / W\$	4292						
	Glass		1 <sup>1</sup> / <sub>4</sub>	Acid Etched Glass Top \$	17213					
			1 <sup>1</sup> / <sub>4</sub>	Gloss Glass Top \$	14114					
	<b>48"D x 156"W or 13' - 2 Piece Rectangle Top</b>									
		88-48156RT	Laminate	156	48	1 <sup>3</sup> / <sub>16</sub>	306	31.2	F, G, X, Y / P\$	2766
						1 <sup>3</sup> / <sub>16</sub>			K / P\$	4505
						1 <sup>1</sup> / <sub>2</sub>			H / P\$	3171
Veneer		1 <sup>3</sup> / <sub>16</sub>	F, G, X, Y / W\$	3435						
		1 <sup>3</sup> / <sub>16</sub>	K / W\$	5043						
		1 <sup>1</sup> / <sub>2</sub>	H / W\$	4077						
Glass			1 <sup>1</sup> / <sub>4</sub>	Acid Etched Glass Top \$	16126					
			1 <sup>1</sup> / <sub>4</sub>	Gloss Glass Top \$	13249					

*Additional 48" Rectangle Shaped Tops on Next Page*



Double Kerf (F)  
1<sup>3</sup>/<sub>16</sub>"



Duo (G)  
1<sup>3</sup>/<sub>16</sub>"



Fluted (X)  
1<sup>3</sup>/<sub>16</sub>"



Square (Y)  
1<sup>3</sup>/<sub>16</sub>"



Knife (K)  
1<sup>3</sup>/<sub>16</sub>"



Vertical Square (H)  
1<sup>1</sup>/<sub>2</sub>"

P = HPL W = Veneer

[See Strut Overview For Ordering Options](#)

Item	Model No.		W	D	H	Ship Wt	Cubic Ft	Edge Profile + Material	List Price		
<i>CONTINUED FROM PREVIOUS PAGE</i>	<b>48"D x 144"W or 12' - 2 Piece Rectangle Top</b>										
	88-48144RT	Laminate	144	48	1 3/16	284	23.5	F, G, X, Y / P\$	2304		
					1 3/16			K / P\$	3924		
					1 1/2			H / P\$	2678		
		Veneer			1 3/16			F, G, X, Y / W\$	3197		
					1 3/16			K / W\$	4389		
					1 1/2			H / W\$	3792		
		Glass			1/4			Acid Etched Glass Top \$	15016		
					1/4			Gloss Glass Top \$	12360		
		<b>48"D x 132"W or 11' - 2 Piece Rectangle Top</b>									
	88-48132RT	Laminate	132	48	1 3/16	262	23.5	F, G, X, Y / P\$	2248		
					1 3/16			K / P\$	3775		
					1 1/2			H / P\$	2591		
		Veneer			1 3/16			F, G, X, Y / W\$	2975		
					1 3/16			K / W\$	4144		
					1 1/2			H / W\$	3522		
		Glass			1/4			Acid Etched Glass Top \$	13917		
					1/4			Gloss Glass Top \$	11481		
	<b>48"D x 120"W or 10' - 2 Piece Rectangle Top</b>										
88-48120RT	Laminate	120	48	1 3/16	240	23.5	F, G, X, Y / P\$	2183			
				1 3/16			K / P\$	3529			
				1 1/2			H / P\$	2493			
	Veneer			1 3/16			F, G, X, Y / W\$	2741			
				1 3/16			K / W\$	3975			
				1 1/2			H / W\$	3241			
	Glass			1/4			Acid Etched Glass Top \$	12806			
				1/4			Gloss Glass Top \$	10593			
	<b>48"D x 108"W or 9' - 2 Piece Rectangle Top</b>										
88-48108RT	Laminate	108	48	1 3/16	218	23.5	F, G, X, Y / P\$	2126			
				1 3/16			K / P\$	3361			
				1 1/2			H / P\$	2406			
	Veneer			1 3/16			F, G, X, Y / W\$	2518			
				1 3/16			K / W\$	3756			
				1 1/2			H / W\$	2970			
	Glass			1/4			Acid Etched Glass Top \$	11706			
				1/4			Gloss Glass Top \$	9715			

*Additional 48" Rectangle Shaped Tops on Next Page*



Double Kerf (F)  
1 3/16"



Duo (G)  
1 3/16"



Fluted (X)  
1 3/16"



Square (Y)  
1 3/16"



Knife (K)  
1 3/16"



Vertical Square (H)  
1 1/2"

P = HPL W = Veneer

[See Strut Overview For Ordering Options](#)



Item	Model No.		W	D	H	Ship Wt	Cubic Ft	Edge Profile + Material	List Price	
<b>48"D x 96"W or 8' - 1 Piece Rectangle Top</b>										
<i>CONTINUED FROM PREVIOUS PAGE</i>	88-4896RT	Laminate	96	48	1 3/16"	196	11.3	F, G, X, Y / P\$	1469	
					1 3/16"			K / P\$	2549	
					1 1/2"			H / P\$	1715	
	Veneer	1 3/16"	F, G, X, Y / W\$	1883						
		1 3/16"	K / W\$	2867						
		1 1/2"	H / W\$	2284						
	Glass		1/4"	Acid Etched Glass Top \$	10062					
			1/4"	Gloss Glass Top \$	8291					
	<b>48"D x 84"W or 7' - 1 Piece Rectangle Top</b>									
		88-4884RT	Laminate	84	48	1 3/16"	174	10.0	F, G, X, Y / P\$	1426
1 3/16"						K / P\$			2299	
1 1/2"						H / P\$			1640	
Veneer		1 3/16"	F, G, X, Y / W\$	1658						
		1 3/16"	K / W\$	2650						
		1 1/2"	H / W\$	2013						
Glass			1/4"	Acid Etched Glass Top \$	8910					
			1/4"	Gloss Glass Top \$	7361					
<b>48"D x 72"W or 6' - 1 Piece Rectangle Top</b>										
		88-4872RT	Laminate	72	48	1 3/16"	152	8.6	F, G, X, Y / P\$	1192
	1 3/16"					K / P\$			2048	
	1 1/2"					H / P\$			1376	
	Veneer	1 3/16"	F, G, X, Y / W\$	1569						
		1 3/16"	K / W\$	2307						
		1 1/2"	H / W\$	1876						
	Glass		1/4"	Acid Etched Glass Top \$	7859					
			1/4"	Gloss Glass Top \$	6531					

Must Specify (in this order):

- Model #
- Top/Edge Material
- Top/Edge Finish/Color
- Edge Profile
- Glass (Y/N)
- Glass Color + Surface Finish
- Power/Data
- Power/Data Location

**Description**

- Tops Available with Veneer (W) or HPL (P) Top in 1 3/16" and 1 1/2" Thicknesses
- Must Specify Edge Profile: 1 3/16" Thick/Double Kerf (F), Duo (G), Fluted (X), Square (Y), and Knife (K) Edge Profiles or 1 1/2" Thick/Vertical Square (H)
- Veneer (W) Top Grain Runs Depth of Top and HPL (P) Top Grain Runs Width of Top
- All Veneer Tops, as well as Laminate Tops up to 144" (12 feet), have Matching Woodgrain. Laminate Tops Sized 156" (13 feet) and Longer have Non-Matching Woodgrain
- Available with Back Painted Tempered Glass Top; Must Specify Color and Finish; [See Options](#)
- Power and Data Options Available; Sold Separately, [See Multiple Power Unit Details](#)
- Dock800, Oasis, and E2X Power Units Available on Ends Only (E1 and E2) for 108"D - 156"D and 204"D-240"D Tops
- Strut Legs Sold Separately, [See Strut Legs](#)



Double Kerf (F)  
1 3/16"



Duo (G)  
1 3/16"



Fluted (X)  
1 3/16"



Square (Y)  
1 3/16"



Knife (K)  
1 3/16"



Vertical Square (H)  
1 1/2"

P = HPL W = Veneer

[See Strut Overview For Ordering Options](#)

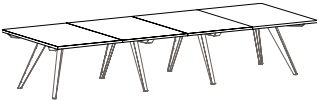
Item	Model No.		W	D	H	Ship Wt	Cubic Ft	Edge Profile + Material	List Price	
<b>RECTANGLE SHAPE MEETING TOP 54"D</b>    88-54156RT Shown in Veneer BASES SOLD SEPARATELY	<b>54"D x 240"W or 20' - 5 Piece Veneer (W) and 3 Piece HPL (P) Rectangle Top</b>									
	88-54240RT	Laminate	240	54	1 3/16"	519	24.0	F, G, X, Y / P\$	4515	
					1 3/16"			K / P\$	7566	
					1 1/2"			H / P\$	5221	
		Veneer			1 3/16"			F, G, X, Y / W\$	7573	
					1 3/16"			K / W\$	9727	
					1 1/2"			H / W\$	8862	
		Glass			1/4"			Acid Etched Glass Top \$	27961	
					1/4"			Gloss Glass Top \$	22981	
	<b>54"D x 228"W or 19' - 5 Piece Veneer (W) and 3 Piece HPL (P) Rectangle Top</b>									
	88-54228RT	Laminate	228	54	1 3/16"	495	23.0	F, G, X, Y / P\$	4467	
					1 3/16"			K / P\$	7418	
					1 1/2"			H / P\$	5139	
		Veneer			1 3/16"			F, G, X, Y / W\$	7340	
					1 3/16"			K / W\$	9434	
				1 1/2"			H / W\$	8576		
	Glass			1/4"			Acid Etched Glass Top \$	26742		
				1/4"			Gloss Glass Top \$	22011		
<b>54"D x 216"W or 18' - 5 Piece Veneer (W) and 3 Piece HPL (P) Rectangle Top</b>										
88-54216RT	Laminate	216	54	1 3/16"	470	22.0	F, G, X, Y / P\$	3873		
				1 3/16"			K / P\$	6460		
				1 1/2"			H / P\$	4508		
	Veneer			1 3/16"			F, G, X, Y / W\$	7107		
				1 3/16"			K / W\$	9142		
				1 1/2"			H / W\$	8291		
	Glass			1/4"			Acid Etched Glass Top \$	25472		
				1/4"			Gloss Glass Top \$	20991		
<b>54"D x 204"W or 17' - 5 Piece Veneer (W) and 3 Piece HPL (P) Rectangle Top</b>										
88-54204RT	Laminate	204	54	1 3/16"	445	21.0	F, G, X, Y / P\$	3826		
				1 3/16"			K / P\$	6312		
				1 1/2"			H / P\$	4427		
	Veneer			1 3/16"			F, G, X, Y / W\$	6874		
				1 3/16"			K / W\$	8849		
				1 1/2"			H / W\$	8007		
	Glass			1/4"			Acid Etched Glass Top \$	24254		
				1/4"			Gloss Glass Top \$	20021		

*Additional 54" Rectangle Shaped Tops on Next Page*



Double Kerf (F)  
1 3/16"



Duo (G)  
1 3/16"



Fluted (X)  
1 3/16"



Square (Y)  
1 3/16"



Knife (K)  
1 3/16"



Vertical Square (H)  
1 1/2"

P = HPL W = Veneer

[See Strut Overview For Ordering Options](#)

Item	Model No.		W	D	H	Ship Wt	Cubic Ft	Edge Profile + Material	List Price		
<i>CONTINUED FROM PREVIOUS PAGE</i>	<b>54"D x 192"W or 16' - 4 Piece Veneer (W) and 2 Piece HPL (P) Rectangle Top</b>										
	88-54192RT	Laminate	192	54	1 3/16"	408	19.0	F, G, X, Y / P\$	3168		
					1 3/16"			K / P\$	5542		
					1 1/2"			H / P\$	3732		
		Veneer			1 3/16"			F, G, X, Y / W\$	5654		
					1 3/16"			K / W\$	7438		
					1 1/2"			H / W\$	6532		
		Glass			1/4"			Acid Etched Glass Top \$	22145		
					1/4"			Gloss Glass Top \$	18160		
		<b>54"D x 180"W or 15' - 4 Piece Veneer (W) and 2 Piece HPL (P) Rectangle Top</b>									
	88-54180RT	Laminate	180	54	1 3/16"	384	18.0	F, G, X, Y / P\$	3122		
					1 3/16"			K / P\$	5393		
					1 1/2"			H / P\$	3649		
		Veneer			1 3/16"			F, G, X, Y / W\$	5440		
				1 3/16"			K / W\$	7163			
				1 1/2"			H / W\$	6265			
	Glass			1/4"			Acid Etched Glass Top \$	20926			
				1/4"			Gloss Glass Top \$	17191			
	<b>54"D x 168"W or 14' - 4 Piece Veneer (W) and 2 Piece HPL (P) Rectangle Top</b>										
88-54168RT	Laminate	168	54	1 3/16"	359	17.0	F, G, X, Y / P\$	3075			
				1 3/16"			K / P\$	5245			
				1 1/2"			H / P\$	3568			
	Veneer			1 3/16"			F, G, X, Y / W\$	5226			
				1 3/16"			K / W\$	6889			
				1 1/2"			H / W\$	5998			
	Glass			1/4"			Acid Etched Glass Top \$	19707			
				1/4"			Gloss Glass Top \$	16222			
	<b>54"D x 156"W or 13' - 4 Piece Veneer (W) and 2 Piece HPL (P) Rectangle Top</b>										
88-54156RT	Laminate	156	54	1 3/16"	334	16.0	F, G, X, Y / P\$	3028			
				1 3/16"			K / P\$	5096			
				1 1/2"			H / P\$	3485			
	Veneer			1 3/16"			F, G, X, Y / W\$	5011			
				1 3/16"			K / W\$	6615			
				1 1/2"			H / W\$	5732			
	Glass			1/4"			Acid Etched Glass Top \$	18489			
				1/4"			Gloss Glass Top \$	15253			

Must Specify (in this order):  
 Model #  
 Top/Edge Material  
 Top/Edge Finish/Color  
 Edge Profile  
 Glass (Y/N)  
 Glass Color + Surface Finish  
 Power/Data Type  
 Power/Data Location

Additional 54" Rectangle Shaped Tops on Next Page



Double Kerf (F)  
1 3/16"



Duo (G)  
1 3/16"



Fluted (X)  
1 3/16"



Square (Y)  
1 3/16"



Knife (K)  
1 3/16"



Vertical Square (H)  
1 1/2"

P = HPL W = Veneer

[See Strut Overview For Ordering Options](#)

Item	Model No.		W	D	H	Ship Wt	Cubic Ft	Edge Profile + Material	List Price	
<i>CONTINUED FROM PREVIOUS PAGE</i>	<b>54"D x 144"W or 12' - 3 Piece Veneer (W) and 2 Piece HPL (P) Rectangle Top</b>									
	88-54144RT	Laminate	144	54	1 $\frac{3}{16}$ "	309	15.0	F, G, X, Y / P\$	2557	
					1 $\frac{3}{16}$ "			K / P\$	4349	
					1 $\frac{1}{2}$ "			H / P\$	2980	
		Veneer			1 $\frac{3}{16}$ "			F, G, X, Y / W\$	4061	
					1 $\frac{3}{16}$ "			K / W\$	5474	
					1 $\frac{1}{2}$ "			H / W\$	4724	
		Glass			1 $\frac{1}{4}$ "			Acid Etched Glass Top \$	17401	
					1 $\frac{1}{4}$ "			Gloss Glass Top \$	14413	
		<b>54"D x 132"W or 11' - 3 Piece Veneer (W) and 2 Piece HPL (P) Rectangle Top</b>								
	88-54132RT	Laminate	132	54	1 $\frac{3}{16}$ "	285	13.2	F, G, X, Y / P\$	2497	
					1 $\frac{3}{16}$ "			K / P\$	4188	
				1 $\frac{1}{2}$ "			H / P\$	2884		
	Veneer			1 $\frac{3}{16}$ "			F, G, X, Y / W\$	3866		
				1 $\frac{3}{16}$ "			K / W\$	5218		
				1 $\frac{1}{2}$ "			H / W\$	4476		
	Glass			1 $\frac{1}{4}$ "			Acid Etched Glass Top \$	16170		
				1 $\frac{1}{4}$ "			Gloss Glass Top \$	13430		
	<b>54"D x 120"W or 10' - 3 Piece Veneer (W) and 2 Piece HPL (P) Rectangle Top</b>									
88-54120RT	Laminate	120	54	1 $\frac{3}{16}$ "	260	12.1	F, G, X, Y / P\$	2436		
				1 $\frac{3}{16}$ "			K / P\$	4026		
				1 $\frac{1}{2}$ "			H / P\$	2788		
	Veneer			1 $\frac{3}{16}$ "			F, G, X, Y / W\$	3670		
				1 $\frac{3}{16}$ "			K / W\$	4963		
				1 $\frac{1}{2}$ "			H / W\$	4229		
	Glass			1 $\frac{1}{4}$ "			Acid Etched Glass Top \$	14938		
				1 $\frac{1}{4}$ "			Gloss Glass Top \$	12448		

Must Specify (in this order):

Model #  
 Top/Edge Material  
 Top/Edge Finish/Color  
 Edge Profile  
 Glass (Y/N)  
 Glass Color + Surface Finish  
 Power/Data  
 Power/Data Location

### Description

- Tops Available with Veneer (W) or HPL (P) Top in 1 $\frac{3}{16}$ " and 1 $\frac{1}{2}$ " Thicknesses
- Must Specify Edge Profile: 1 $\frac{3}{16}$ " Thick/Double Kerf (F), Duo (G), **Fluted (X)**, Square (Y), and Knife (K) Edge Profiles or 1 $\frac{1}{2}$ " Thick/Vertical Square (H)
- Veneer (W) Top Grain Runs Depth of Top and HPL (P) Top Grain Runs Width of Top
- **All Veneer Tops, as well as Laminate Tops up to 144" (12 feet), have Matching Woodgrain. Laminate Tops Sized 156" (13 feet) and Longer have Non-Matching Woodgrain**
- Available with Back Painted Tempered Glass Top; Must Specify Color and Finish; [See Options](#)
- Power and Data Options Available; Sold Separately, [See Multiple Power Unit Details](#)
- Strut Legs Sold Separately, [See Strut Legs](#)



Double Kerf (F)  
1 $\frac{3}{16}$ "



Duo (G)  
1 $\frac{3}{16}$ "



Fluted (X)  
1 $\frac{3}{16}$ "



Square (Y)  
1 $\frac{3}{16}$ "



Knife (K)  
1 $\frac{3}{16}$ "



Vertical Square (H)  
1 $\frac{1}{2}$ "

P = HPL W = Veneer

[See Strut Overview For Ordering Options](#)

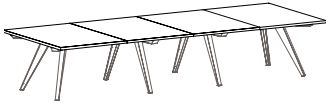
Item	Model No.		W	D	H	Ship Wt	Cubic Ft	Edge Profile + Material	List Price
<b>RECTANGLE SHAPE MEETING TOP</b> <b>60"D</b>  88-60156RT Shown in Veneer BASES SOLD SEPARATELY	<b>60"D x 240"W or 20' - 5 Piece Veneer (W) and 3 Piece HPL (P) Rectangle Top</b>								
	88-60240RT	Laminate	240	60	1 3/16	574	26.3	F, G, X, Y / P\$	4603
					1 3/16			K / P\$	7839
					1 1/2			H / P\$	5390
		Veneer			1 3/16			F, G, X, Y / W\$	8087
					1 3/16			K / W\$	10324
					1 1/2			H / W\$	9485
		Glass			1/4			Acid Etched Glass Top \$	30611
					1/4			Gloss Glass Top \$	25078
	<b>60"D x 228"W or 19' - 5 Piece Veneer (W) and 3 Piece HPL (P) Rectangle Top</b>								
	88-60228RT	Laminate	228	60	1 3/16	547	25.0	F, G, X, Y / P\$	4552
					1 3/16			K / P\$	7678
					1 1/2			H / P\$	5300
		Veneer			1 3/16			F, G, X, Y / W\$	7830
					1 3/16			K / W\$	10003
				1 1/2			H / W\$	9168	
	Glass			1/4			Acid Etched Glass Top \$	29260	
				1/4			Gloss Glass Top \$	24005	
<b>60"D x 216"W or 18' - 5 Piece Veneer (W) and 3 Piece HPL (P) Rectangle Top</b>									
88-60216RT	Laminate	216	60	1 3/16	519	23.7	F, G, X, Y / P\$	3953	
				1 3/16			K / P\$	6708	
				1 1/2			H / P\$	4662	
	Veneer			1 3/16			F, G, X, Y / W\$	7571	
				1 3/16			K / W\$	9681	
				1 1/2			H / W\$	8852	
	Glass			1/4			Acid Etched Glass Top \$	27859	
				1/4			Gloss Glass Top \$	22880	
<b>60"D x 204"W or 17' - 5 Piece Veneer (W) and 3 Piece HPL (P) Rectangle Top</b>									
88-60204RT	Laminate	204	60	1 3/16	492	22.4	F, G, X, Y / P\$	3902	
				1 3/16			K / P\$	6547	
				1 1/2			H / P\$	4572	
	Veneer			1 3/16			F, G, X, Y / W\$	7313	
				1 3/16			K / W\$	9361	
				1 1/2			H / W\$	8537	
	Glass			1/4			Acid Etched Glass Top \$	26509	
				1/4			Gloss Glass Top \$	21806	

Additional 60" Rectangle Shaped Tops on Next Page



Double Kerf (F) 1 3/16" Duo (G) 1 3/16" Fluted (X) 1 3/16" Square (Y) 1 3/16" Knife (K) 1 3/16" Vertical Square (H) 1 1/2"

P = HPL W = Veneer

[See Strut Overview For Ordering Options](#)

Item	Model No.		W	D	H	Ship Wt	Cubic Ft	Edge Profile + Material	List Price	
<i>CONTINUED FROM PREVIOUS PAGE</i>	<b>60"D x 192"W or 16' - 4 Piece Veneer (W) and 2 Piece HPL (P) Rectangle Top</b>									
	88-60192RT	Laminate	192	60	1 <sup>3</sup> / <sub>16</sub>	458	21.1	F, G, X, Y / P\$	3241	
					1 <sup>3</sup> / <sub>16</sub>			K / P\$	5763	
					1 <sup>1</sup> / <sub>2</sub>			H / P\$	3868	
		Veneer			1 <sup>3</sup> / <sub>16</sub>			F, G, X, Y / W\$	6033	
					1 <sup>3</sup> / <sub>16</sub>			K / W\$	7886	
					1 <sup>1</sup> / <sub>2</sub>			H / W\$	6997	
		Glass			1/4			Acid Etched Glass Top \$	24267	
					1/4			Gloss Glass Top \$	19841	
	<b>60"D x 180"W or 15' - 4 Piece Veneer (W) and 2 Piece HPL (P) Rectangle Top</b>									
	88-60180RT	Laminate	180	60	1 <sup>3</sup> / <sub>16</sub>	430	19.8	F, G, X, Y / P\$	3190	
					1 <sup>3</sup> / <sub>16</sub>			K / P\$	5602	
					1 <sup>1</sup> / <sub>2</sub>			H / P\$	3778	
		Veneer			1 <sup>3</sup> / <sub>16</sub>			F, G, X, Y / W\$	5796	
					1 <sup>3</sup> / <sub>16</sub>			K / W\$	7584	
					1 <sup>1</sup> / <sub>2</sub>			H / W\$	6702	
		Glass			1/4			Acid Etched Glass Top \$	22917	
					1/4			Gloss Glass Top \$	18768	
<b>60"D x 168"W or 14' - 4 Piece Veneer (W) and 2 Piece HPL (P) Rectangle Top</b>										
88-60168RT	Laminate	168	60	1 <sup>3</sup> / <sub>16</sub>	403	18.5	F, G, X, Y / P\$	3138		
				1 <sup>3</sup> / <sub>16</sub>			K / P\$	5441		
				1 <sup>1</sup> / <sub>2</sub>			H / P\$	3688		
	Veneer			1 <sup>3</sup> / <sub>16</sub>			F, G, X, Y / W\$	5558		
				1 <sup>3</sup> / <sub>16</sub>			K / W\$	7283		
				1 <sup>1</sup> / <sub>2</sub>			H / W\$	6407		
	Glass			1/4			Acid Etched Glass Top \$	21567		
				1/4			Gloss Glass Top \$	17694		
<b>60"D x 156"W or 13' - 4 Piece Veneer (W) and 2 Piece HPL (P) Rectangle Top</b>										
88-60156RT	Laminate	156	60	1 <sup>3</sup> / <sub>16</sub>	376	17.2	F, G, X, Y / P\$	3087		
				1 <sup>3</sup> / <sub>16</sub>			K / P\$	5280		
				1 <sup>1</sup> / <sub>2</sub>			H / P\$	3597		
	Veneer			1 <sup>3</sup> / <sub>16</sub>			F, G, X, Y / W\$	5320		
				1 <sup>3</sup> / <sub>16</sub>			K / W\$	6982		
				1 <sup>1</sup> / <sub>2</sub>			H / W\$	6112		
	Glass			1/4			Acid Etched Glass Top \$	20218		
				1/4			Gloss Glass Top \$	16621		

Must Specify (in this order):

- Model #
- Top/Edge Material
- Top/Edge Finish/Color
- Edge Profile
- Glass (Y/N)
- Glass Color + Surface Finish
- Power/Data Type
- Power/Data Location

*Additional 60" Rectangle Shaped Tops on Next Page*



Double Kerf (F)  
1<sup>3</sup>/<sub>16</sub>"



Duo (G)  
1<sup>3</sup>/<sub>16</sub>"



Fluted (X)  
1<sup>3</sup>/<sub>16</sub>"



Square (Y)  
1<sup>3</sup>/<sub>16</sub>"



Knife (K)  
1<sup>3</sup>/<sub>16</sub>"



Vertical Square (H)  
1<sup>1</sup>/<sub>2</sub>"

P = HPL W = Veneer

[See Strut Overview For Ordering Options](#)

Item	Model No.		W	D	H	Ship Wt	Cubic Ft	Edge Profile + Material	List Price	
<b>60"D x 144"W or 12' - 3 Piece Veneer (W) and 2 Piece HPL (P) Rectangle Top</b>										
<i>CONTINUED FROM PREVIOUS PAGE</i>	88-60144RT	Laminate	144	60	1 3/16	342	16.0	F, G, X, Y / P\$	2612	
					1 3/16			K / P\$	4520	
					1 1/2			H / P\$	3083	
		Veneer			1 3/16			F, G, X, Y / W\$	4320	
					1 3/16			K / W\$	5789	
					1 1/2			H / W\$	5050	
		Glass			1/4			Acid Etched Glass Top \$	18997	
					1/4			Gloss Glass Top \$	15678	
	<b>60"D x 132"W or 11' - 3 Piece Veneer (W) and 2 Piece HPL (P) Rectangle Top</b>									
		88-60132RT	Laminate	132	60	1 3/16	323	14.6	F, G, X, Y / P\$	2548
					1 3/16			K / P\$	4345	
					1 1/2			H / P\$	2979	
		Veneer			1 3/16			F, G, X, Y / W\$	4104	
					1 3/16			K / W\$	5508	
					1 1/2			H / W\$	4775	
		Glass			1/4			Acid Etched Glass Top \$	17634	
					1/4			Gloss Glass Top \$	14591	
<b>60"D x 120"W or 10' - 3 Piece Veneer (W) and 2 Piece HPL (P) Rectangle Top</b>										
	88-60120RT	Laminate	120	60	1 3/16	287	13.3	F, G, X, Y / P\$	2484	
					1 3/16			K / P\$	4170	
					1 1/2			H / P\$	2875	
		Veneer			1 3/16			F, G, X, Y / W\$	3886	
					1 3/16			K / W\$	5228	
					1 1/2			H / W\$	4500	
		Glass			1/4			Acid Etched Glass Top \$	16271	
					1/4			Gloss Glass Top \$	13505	

Must Specify (in this order):

- Model #
- Top/Edge Material
- Top/Edge Finish/Color
- Edge Profile
- Glass (Y/N)
- Glass Color + Surface Finish
- Power/Data Type
- Power/Data Location

**Description**

- Tops Available with Veneer (W) or HPL (P) Top in 1 3/16" and 1 1/2" Thicknesses
- Must Specify Edge Profile: 1 3/16" Thick/Double Kerf (F), Duo (G), Fluted (X), Square (Y), and Knife (K) Edge Profiles or 1 1/2" Thick/Vertical Square (H)
- Veneer (W) Top Grain Runs Depth of Top and HPL (P) Top Grain Runs Width of Top
- All Veneer Tops, as well as Laminate Tops up to 144" (12 feet), have Matching Woodgrain. Laminate Tops Sized 156" (13 feet) and Longer have Non-Matching Woodgrain
- Available with Back Painted Tempered Glass Top; Must Specify Color and Finish; [See Options](#)
- Power and Data Options Available; Sold Separately, [See Multiple Power Unit Details](#)
- Strut Legs Sold Separately, [See Strut Legs](#)



Double Kerf (F)  
1 3/16"



Duo (G)  
1 3/16"



Fluted (X)  
1 3/16"



Square (Y)  
1 3/16"



Knife (K)  
1 3/16"



Vertical Square (H)  
1 1/2"

P = HPL W = Veneer

[See Strut Overview For Ordering Options](#)

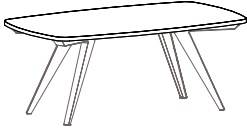
Item	Model No.		W	D	H	Ship Wt	Cubic Ft	Edge Profile + Material	List Price	
<b>MODERN RECTANGLE SHAPE MEETING TOP 36"D</b>   88-3672MR Shown BASES SOLD SEPARATELY	<b>36"D x 96"W or 8' - 1 Piece Modern Rectangle Top</b>									
	88-3696MR	Laminate	96	36	1 3/16	142	12.9	F, G, X, Y / P\$	1424	
					1 3/16			K / P\$	2821	
					1 1/2			H / P\$	1606	
		Veneer			1 3/16			F, G, X, Y / W\$	1613	
					1 3/16			K / W\$	3163	
					1 1/2			H / W\$	1921	
		Glass			1/4			Acid Etched Glass Top \$	8724	
					1/4			Gloss Glass Top \$	7396	
	<b>36"D x 84"W or 7' - 1 Piece Modern Rectangle Top</b>									
		88-3684MR	Laminate	84	36	1 3/16	126	11.3	F, G, X, Y / P\$	1357
						1 3/16			K / P\$	2583
					1 1/2			H / P\$	1547	
		Veneer			1 3/16			F, G, X, Y / W\$	1529	
					1 3/16			K / W\$	2958	
					1 1/2			H / W\$	1768	
		Glass			1/4			Acid Etched Glass Top \$	7821	
					1/4			Gloss Glass Top \$	6659	
<b>36"D x 72"W or 6' - 1 Piece Modern Rectangle Top</b>										
	88-3672MR	Laminate	72	36	1 3/16	109	10.3	F, G, X, Y / P\$	1108	
					1 3/16			K / P\$	2236	
					1 1/2			H / P\$	1245	
		Veneer			1 3/16			F, G, X, Y / W\$	1302	
					1 3/16			K / W\$	2518	
					1 1/2			H / W\$	1537	
		Glass			1/4			Acid Etched Glass Top \$	6829	
					1/4			Gloss Glass Top \$	5832	

Must Specify (in this order):

- Model #
- Top/Edge Material
- Top/Edge Finish/Color
- Edge Profile
- Glass (Y/N)
- Glass Color + Surface Finish
- Power/Data
- Power/Data Location

**Description**

- Tops Available with Veneer (W) or HPL (P) Top in 1 3/16" and 1 1/2" Thicknesses
- Must Specify Edge Profile: 1 3/16" Thick/Double Kerf (F), Duo (G), Fluted (X), Square (Y), and Knife (K) Edge Profiles or 1 1/2" Thick/Vertical Square (H)
- Veneer (W) Top Grain Runs Depth of Top and HPL (P) Top Grain Runs Width of Top
- Available with Back Painted Tempered Glass Top; Must Specify Color and Finish; [See Options](#)
- Power and Data Options Available; Sold Separately, [See Multiple Power Unit Details](#)
- Strut Legs Sold Separately, [See Strut Legs](#)



Double Kerf (F)  
1 3/16"



Duo (G)  
1 3/16"



Fluted (X)  
1 3/16"



Square (Y)  
1 3/16"



Knife (K)  
1 3/16"



Vertical Square (H)  
1 1/2"

P = HPL W = Veneer

[See Strut Overview For Ordering Options](#)

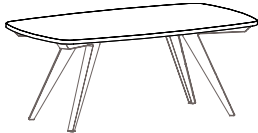

Item	Model No.		W	D	H	Ship Wt	Cubic Ft	Edge Profile + Material	List Price	
<b>MODERN RECTANGLE SHAPE MEETING TOP 42"D</b>    88-4272MR Shown BASES SOLD SEPARATELY	<b>42"D x 96"W or 8' - 1 Piece Modern Rectangle Top</b>									
	88-4296MR	Laminate	96	42	1 3/16	164	15.0	F, G, X, Y / P\$	1453	
					1 3/16			K / P\$	2984	
					1 1/2			H / P\$	1667	
		Veneer			1 3/16			F, G, X, Y / W\$	1752	
					1 3/16			K / W\$	3361	
					1 1/2			H / W\$	2104	
		Glass			1/4			Acid Etched Glass Top \$	9818	
					1/4			Gloss Glass Top \$	8269	
	<b>42"D x 84"W or 7' - 1 Piece Modern Rectangle Top</b>									
	88-4284MR	Laminate	84	42	1 3/16	145	13.1	F, G, X, Y / P\$	1414	
					1 3/16			K / P\$	2769	
				1 1/2			H / P\$	1600		
	Veneer			1 3/16			F, G, X, Y / W\$	1618		
				1 3/16			K / W\$	3102		
				1 1/2			H / W\$	1928		
	Glass			1/4			Acid Etched Glass Top \$	8786		
				1/4			Gloss Glass Top \$	7430		
<b>42"D x 72"W or 6' - 1 Piece Modern Rectangle Top</b>										
88-4272MR	Laminate	72	42	1 3/16	126	11.3	F, G, X, Y / P\$	1182		
				1 3/16			K / P\$	2467		
				1 1/2			H / P\$	1341		
	Veneer			1 3/16			F, G, X, Y / W\$	1473		
				1 3/16			K / W\$	2710		
				1 1/2			H / W\$	1741		
	Glass			1/4			Acid Etched Glass Top \$	7725		

Must Specify (in this order):

- Model #
- Top/Edge Material
- Top/Edge Finish/Color
- Edge Profile
- Glass (Y/N)
- Glass Color + Surface Finish
- Power/Data
- Power/Data Location

**Description**

- Tops Available with Veneer (W) or HPL (P) Top in 1 3/16" and 1 1/2" Thicknesses
- Must Specify Edge Profile: 1 3/16" Thick/Double Kerf (F), Duo (G), Fluted (X), Square (Y), and Knife (K) Edge Profiles or 1 1/2" Thick/Vertical Square (H)
- Veneer (W) Top Grain Runs Depth of Top and HPL (P) Top Grain Runs Width of Top
- Available with Back Painted Tempered Glass Top; Must Specify Color and Finish; [See Options](#)
- Power and Data Options Available; Sold Separately, [See Multiple Power Unit Details](#)
- Strut Legs Sold Separately, [See Strut Legs](#)



Double Kerf (F) 1 3/16"    Duo (G) 1 3/16"    Fluted (X) 1 3/16"    Square (Y) 1 3/16"    Knife (K) 1 3/16"    Vertical Square (H) 1 1/2"

P = HPL    W = Veneer

[See Strut Overview For Ordering Options](#)

Item	Model No.		W	D	H	Ship Wt	Cubic Ft	Edge Profile + Material	List Price	
<b>MODERN RECTANGLE SHAPE MEETING TOP 48"D</b>    88-48216MR Shown BASES SOLD SEPARATELY	<b>48"D x 240"W or 20' - 3 Piece Modern Rectangle Top</b>									
	88-48240MR	Laminate	240	48	1 3/16	460	48.9	F, G, X, Y / P\$	4638	
					1 3/16			K / P\$	8499	
					1 1/2			H / P\$	5257	
		Veneer			1 3/16			F, G, X, Y / W\$	6301	
					1 3/16			K / W\$	9571	
					1 1/2			H / W\$	7153	
		Glass			1/4			Acid Etched Glass Top \$	26634	
					1/4			Gloss Glass Top \$	22207	
	<b>48"D x 228"W or 19' - 3 Piece Modern Rectangle Top</b>									
	88-48228MR	Laminate	228	48	1 3/16	438	48.9	F, G, X, Y / P\$	4594	
					1 3/16			K / P\$	8284	
					1 1/2			H / P\$	5182	
		Veneer			1 3/16			F, G, X, Y / W\$	6037	
					1 3/16			K / W\$	9216	
				1 1/2			H / W\$	6849		
	Glass			1/4			Acid Etched Glass Top \$	25468		
				1/4			Gloss Glass Top \$	21263		
<b>48"D x 216"W or 18' - 3 Piece Modern Rectangle Top</b>										
88-48216MR	Laminate	216	48	1 3/16	416	48.9	F, G, X, Y / P\$	3687		
				1 3/16			K / P\$	7182		
				1 1/2			H / P\$	4244		
	Veneer			1 3/16			F, G, X, Y / W\$	5369		
				1 3/16			K / W\$	8456		
				1 1/2			H / W\$	6139		
	Glass			1/4			Acid Etched Glass Top \$	23917		
				1/4			Gloss Glass Top \$	19933		
<b>48"D x 204"W or 17' - 3 Piece Modern Rectangle Top</b>										
88-48204MR	Laminate	204	48	1 3/16	394	48.9	F, G, X, Y / P\$	3643		
				1 3/16			K / P\$	6968		
				1 1/2			H / P\$	4169		
	Veneer			1 3/16			F, G, X, Y / W\$	5106		
				1 3/16			K / W\$	8101		
				1 1/2			H / W\$	5834		
	Glass			1/4			Acid Etched Glass Top \$	22751		
				1/4			Gloss Glass Top \$	18988		

*Additional 48" Modern Rectangle Shaped Tops on Next Page*



Double Kerf (F)  
1 3/16"



Duo (G)  
1 3/16"



Fluted (X)  
1 3/16"



Square (Y)  
1 3/16"



Knife (K)  
1 3/16"



Vertical Square (H)  
1 1/2"

P = HPL W = Veneer

[See Strut Overview For Ordering Options](#)

Item	Model No.		W	D	H	Ship Wt	Cubic Ft	Edge Profile + Material	List Price	
<b>48"D x 192"W or 16' - 2 Piece Modern Rectangle Top</b>										
<i>CONTINUED FROM PREVIOUS PAGE</i>	88-48192MR	Laminate	192	48	1 <sup>3</sup> / <sub>16</sub> "	372	31.2	F, G, X, Y / P\$	3125	
					1 <sup>3</sup> / <sub>16</sub> "			K / P\$	6249	
					1 <sup>1</sup> / <sub>2</sub> "			H / P\$	3621	
	Veneer	1 <sup>3</sup> / <sub>16</sub> "	F, G, X, Y / W\$	4215						
		1 <sup>3</sup> / <sub>16</sub> "	K / W\$	6996						
		1 <sup>1</sup> / <sub>2</sub> "	H / W\$	4991						
	Glass		1 <sup>1</sup> / <sub>4</sub> "	Acid Etched Glass Top \$	21073					
			1 <sup>1</sup> / <sub>4</sub> "	Gloss Glass Top \$	17531					
	<b>48"D x 180"W or 15' - 2 Piece Modern Rectangle Top</b>									
	<i>Must Specify (in this order):</i> Model # Top/Edge Material Top/Edge Finish/Color Edge Profile Glass (Y/N) Glass Color + Surface Finish Power/Data Power/Data Location	88-48180MR	Laminate	180	48	1 <sup>3</sup> / <sub>16</sub> "	350	31.2	F, G, X, Y / P\$	3080
						1 <sup>3</sup> / <sub>16</sub> "			K / P\$	6034
						1 <sup>1</sup> / <sub>2</sub> "			H / P\$	3547
Veneer		1 <sup>3</sup> / <sub>16</sub> "	F, G, X, Y / W\$	4045						
		1 <sup>3</sup> / <sub>16</sub> "	K / W\$	6679						
		1 <sup>1</sup> / <sub>2</sub> "	H / W\$	4773						
Glass			1 <sup>1</sup> / <sub>4</sub> "	Acid Etched Glass Top \$	19906					
			1 <sup>1</sup> / <sub>4</sub> "	Gloss Glass Top \$	16586					
<b>48"D x 168"W or 14' - 2 Piece Modern Rectangle Top</b>										
		88-48168MR	Laminate	168	48	1 <sup>3</sup> / <sub>16</sub> "	328	31.2	F, G, X, Y / P\$	2928
						1 <sup>3</sup> / <sub>16</sub> "			K / P\$	5708
						1 <sup>1</sup> / <sub>2</sub> "			H / P\$	3363
	Veneer	1 <sup>3</sup> / <sub>16</sub> "	F, G, X, Y / W\$	3736						
		1 <sup>3</sup> / <sub>16</sub> "	K / W\$	6223						
		1 <sup>1</sup> / <sub>2</sub> "	H / W\$	4418						
	Glass		1 <sup>1</sup> / <sub>4</sub> "	Acid Etched Glass Top \$	18629					
			1 <sup>1</sup> / <sub>4</sub> "	Gloss Glass Top \$	15530					
	<b>48"D x 156"W or 13' - 2 Piece Modern Rectangle Top</b>									
		88-48156MR	Laminate	156	48	1 <sup>3</sup> / <sub>16</sub> "	306	31.2	F, G, X, Y / P\$	2885
						1 <sup>3</sup> / <sub>16</sub> "			K / P\$	5363
						1 <sup>1</sup> / <sub>2</sub> "			H / P\$	3288
Veneer		1 <sup>3</sup> / <sub>16</sub> "	F, G, X, Y / W\$	3567						
		1 <sup>3</sup> / <sub>16</sub> "	K / W\$	6039						
		1 <sup>1</sup> / <sub>2</sub> "	H / W\$	4202						
Glass			1 <sup>1</sup> / <sub>4</sub> "	Acid Etched Glass Top \$	17463					
			1 <sup>1</sup> / <sub>4</sub> "	Gloss Glass Top \$	14585					

*Additional 48" Modern Rectangle Shaped Tops on Next Page*



Double Kerf (F) 1<sup>3</sup>/<sub>16</sub>"   Duo (G) 1<sup>3</sup>/<sub>16</sub>"   Fluted (X) 1<sup>3</sup>/<sub>16</sub>"   Square (Y) 1<sup>3</sup>/<sub>16</sub>"   Knife (K) 1<sup>3</sup>/<sub>16</sub>"   Vertical Square (H) 1<sup>1</sup>/<sub>2</sub>"

P = HPL   W = Veneer

[See Strut Overview For Ordering Options](#)

Item	Model No.		W	D	H	Ship Wt	Cubic Ft	Edge Profile + Material	List Price		
<b>48"D x 144"W or 12' - 2 Piece Modern Rectangle Top</b>											
<i>CONTINUED FROM PREVIOUS PAGE</i>	88-48144MR	Laminate	144	48	1 3/16	284	23.5	F, G, X, Y / P\$	2421		
					1 3/16			K / P\$	4847		
					1 1/2			H / P\$	2793		
					Veneer			1 3/16	F, G, X, Y / W\$	3328	
								1 3/16	K / W\$	5521	
								1 1/2	H / W\$	3915	
		Glass	1/4	Acid Etched Glass Top \$	16201						
			1/4	Gloss Glass Top \$	13544						
		<b>48"D x 132"W or 11' - 2 Piece Modern Rectangle Top</b>									
		<i>Must Specify (in this order):</i> Model # Top/Edge Material Top/Edge Finish/Color Edge Profile Glass (Y/N) Glass Color + Surface Finish Power/Data Power/Data Location	88-48132MR	Laminate	132	48	1 3/16	262	23.5	F, G, X, Y / P\$	2365
							1 3/16			K / P\$	4619
							1 1/2			H / P\$	2705
Veneer	1 3/16						F, G, X, Y / W\$			3105	
	1 3/16						K / W\$			5178	
	1 1/2						H / W\$			3645	
Glass	1/4			Acid Etched Glass Top \$	15022						
	1/4			Gloss Glass Top \$	12588						
<b>48"D x 120"W or 10' - 2 Piece Modern Rectangle Top</b>											
	88-48120MR			Laminate	120	48	1 3/16	240	23.5	F, G, X, Y / P\$	2299
							1 3/16			K / P\$	4383
							1 1/2			H / P\$	2609
		Veneer	1 3/16				F, G, X, Y / W\$			2870	
			1 3/16				K / W\$			4823	
			1 1/2				H / W\$			3364	
		Glass	1/4	Acid Etched Glass Top \$	13835						
			1/4	Gloss Glass Top \$	11622						
		<b>48"D x 108"W or 9' - 2 Piece Modern Rectangle Top</b>									
			88-48108MR	Laminate	108	48	1 3/16	218	23.5	F, G, X, Y / P\$	2243
							1 3/16			K / P\$	4063
							1 1/2			H / P\$	2522
Veneer	1 3/16						F, G, X, Y / W\$			2648	
	1 3/16						K / W\$			4575	
	1 1/2						H / W\$			3095	
Glass	1/4			Acid Etched Glass Top \$	12657						
	1/4			Gloss Glass Top \$	10665						

*Additional 48" Modern Rectangle Shaped Tops on Next Page*



Double Kerf (F) 1 3/16"    Duo (G) 1 3/16"    Fluted (X) 1 3/16"    Square (Y) 1 3/16"    Knife (K) 1 3/16"    Vertical Square (H) 1 1/2"

P = HPL    W = Veneer

[See Strut Overview For Ordering Options](#)

Item	Model No.		W	D	H	Ship Wt	Cubic Ft	Edge Profile + Material	List Price	
<b>48"D x 96"W or 8' - 1 Piece Modern Rectangle Top</b>										
<i>CONTINUED FROM PREVIOUS PAGE</i>	88-4896MR	Laminate	96	48	1 3/16"	315	18.0	F, G, X, Y / P\$	1529	
					1 3/16"			K / P\$	3258	
					1 1/2"			H / P\$	1774	
	Veneer	1 3/16"	F, G, X, Y / W\$	1951						
		1 3/16"	K / W\$	3558						
		1 1/2"	H / W\$	2347						
	Glass		1/4"	Acid Etched Glass Top \$	10965					
			1/4"	Gloss Glass Top \$	9194					
	<b>48"D x 84"W or 7' - 1 Piece Modern Rectangle Top</b>									
	<i>Must Specify (in this order):</i> Model # Top/Edge Material Top/Edge Finish/Color Edge Profile Glass (Y/N) Glass Color + Surface Finish Power/Data Power/Data Location	88-4884MR	Laminate	84	48	1 3/16"	164	15.0	F, G, X, Y / P\$	1484
1 3/16"						K / P\$			2899	
1 1/2"						H / P\$			1698	
Veneer		1 3/16"	F, G, X, Y / W\$	1724						
		1 3/16"	K / W\$	3266						
		1 1/2"	H / W\$	2074						
Glass			1/4"	Acid Etched Glass Top \$	9732					
			1/4"	Gloss Glass Top \$	8184					
<b>48"D x 72"W or 6' - 1 Piece Modern Rectangle Top</b>										
		88-4872MR	Laminate	72	48	1 3/16"	142	12.8	F, G, X, Y / P\$	1249
	1 3/16"					K / P\$			2637	
	1 1/2"					H / P\$			1432	
	Veneer	1 3/16"	F, G, X, Y / W\$	1633						
		1 3/16"	K / W\$	2948						
		1 1/2"	H / W\$	1935						
	Glass		1/4"	Acid Etched Glass Top \$	8608					
			1/4"	Gloss Glass Top \$	7280					

**Description**

- Tops Available with Veneer (W) or HPL (P) Top in 1 3/16" and 1 1/2" Thicknesses
- Must Specify Edge Profile: 1 3/16" Thick/Double Kerf (F), Duo (G), Fluted (X), Square (Y), and Knife (K) Edge Profiles or 1 1/2" Thick/Vertical Square (H)
- Veneer (W) Top Grain Runs Depth of Top and HPL (P) Top Grain Runs Width of Top
- All Veneer Tops, as well as Laminate Tops up to 144" (12 feet), have Matching Woodgrain. Laminate Tops Sized 156" (13 feet) and Longer have Non-Matching Woodgrain
- Available with Back Painted Tempered Glass Top; Must Specify Color and Finish; [See Options](#)
- Power and Data Options Available; Sold Separately, [See Multiple Power Unit Details](#)
- Dock800, Oasis, and E2X Power Units Available on Ends Only (E1 and E2) for 108"D - 156"D and 204"D-240"D Tops
- Strut Legs Sold Separately, [See Strut Legs](#)



Double Kerf (F) 1 3/16" Duo (G) 1 3/16" Fluted (X) 1 3/16" Square (Y) 1 3/16" Knife (K) 1 3/16" Vertical Square (H) 1 1/2"

P = HPL W = Veneer

[See Strut Overview For Ordering Options](#)

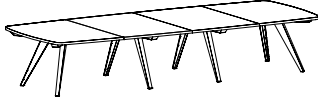
Item	Model No.		W	D	H	Ship Wt	Cubic Ft	Edge Profile + Material	List Price	
<b>MODERN RECTANGLE SHAPE MEETING TOP 54"D</b>    88-54156MR Shown in Veneer BASES SOLD SEPARATELY	<b>54"D x 240"W or 20' - 5 Piece Veneer (W) and 3 Piece HPL (P) Modern Rectangle Top</b>									
	88-54240MR	Laminate	240	54	1 3/16	519	24.0	F, G, X, Y / P\$	4690	
					1 3/16			K / P\$	8773	
					1 1/2			H / P\$	5389	
		Veneer			1 3/16			F, G, X, Y / W\$	7844	
					1 3/16			K / W\$	11557	
					1 1/2			H / W\$	8912	
		Glass			1/4			Acid Etched Glass Top \$	29666	
					1/4			Gloss Glass Top \$	24687	
	<b>54"D x 228"W or 19' - 5 Piece Veneer (W) and 3 Piece HPL (P) Modern Rectangle Top</b>									
	88-54228MR	Laminate	228	54	1 3/16	495	23.0	F, G, X, Y / P\$	4642	
					1 3/16			K / P\$	8545	
				1 1/2			H / P\$	5306		
	Veneer			1 3/16			F, G, X, Y / W\$	7602		
				1 3/16			K / W\$	11159		
				1 1/2			H / W\$	8619		
	Glass			1/4			Acid Etched Glass Top \$	28369		
				1/4			Gloss Glass Top \$	23639		
<b>54"D x 216"W or 18' - 5 Piece Veneer (W) and 3 Piece HPL (P) Modern Rectangle Top</b>										
88-54216MR	Laminate	216	54	1 3/16	470	22.0	F, G, X, Y / P\$	4047		
				1 3/16			K / P\$	7755		
				1 1/2			H / P\$	4676		
	Veneer			1 3/16			F, G, X, Y / W\$	7361		
				1 3/16			K / W\$	10761		
				1 1/2			H / W\$	8327		
	Glass			1/4			Acid Etched Glass Top \$	27037		
				1/4			Gloss Glass Top \$	22556		
<b>54"D x 204"W or 17' - 5 Piece Veneer (W) and 3 Piece HPL (P) Modern Rectangle Top</b>										
88-54204MR	Laminate	204	54	1 3/16	445	21.0	F, G, X, Y / P\$	3999		
				1 3/16			K / P\$	7528		
				1 1/2			H / P\$	4593		
	Veneer			1 3/16			F, G, X, Y / W\$	7119		
				1 3/16			K / W\$	10364		
				1 1/2			H / W\$	8034		
	Glass			1/4			Acid Etched Glass Top \$	25741		
				1/4			Gloss Glass Top \$	21509		

Must Specify (in this order):  
 Model #  
 Top/Edge Material  
 Top/Edge Finish/Color  
 Edge Profile  
 Glass (Y/N)  
 Glass Color + Surface Finish  
 Power/Data  
 Power/Data Location

*Additional 54" Modern Rectangle Shaped Tops on Next Page*

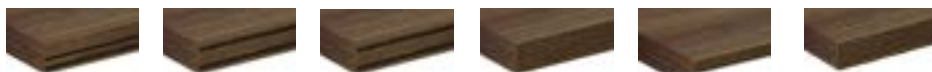

Double Kerf (F) 1 3/16"    Duo (G) 1 3/16"    Fluted (X) 1 3/16"    Square (Y) 1 3/16"    Knife (K) 1 3/16"    Vertical Square (H) 1 1/2"

P = HPL    W = Veneer

[See Strut Overview For Ordering Options](#)

Item	Model No.		W	D	H	Ship Wt	Cubic Ft	Edge Profile + Material	List Price
<b>54"D x 192"W or 16' - 4 Piece Veneer (W) and 2 Piece HPL (P) Modern Rectangle Top</b>									
<i>CONTINUED FROM PREVIOUS PAGE</i>	88-54192MR	Laminate	192	54	1 3/16	408	19.0	F, G, X, Y / P\$	3291
					1 3/16			K / P\$	6606
					1 1/2			H / P\$	3852
		Veneer			1 3/16			F, G, X, Y / W\$	5874
					1 3/16			K / W\$	8938
					1 1/2			H / W\$	6734
		Glass			1/4			Acid Etched Glass Top \$	23748
					1/4			Gloss Glass Top \$	19764
<b>54"D x 180"W or 15' - 4 Piece Veneer (W) and 2 Piece HPL (P) Modern Rectangle Top</b>									
	88-54180MR	Laminate	180	54	1 3/16	384	18.0	F, G, X, Y / P\$	3244
					1 3/16			K / P\$	6379
					1 1/2			H / P\$	3769
		Veneer			1 3/16			F, G, X, Y / W\$	5652
					1 3/16			K / W\$	8560
					1 1/2			H / W\$	6460
		Glass			1/4			Acid Etched Glass Top \$	22451
					1/4			Gloss Glass Top \$	18716
<b>54"D x 168"W or 14' - 4 Piece Veneer (W) and 2 Piece HPL (P) Modern Rectangle Top</b>									
	88-54168MR	Laminate	168	54	1 3/16	359	17.0	F, G, X, Y / P\$	3195
					1 3/16			K / P\$	6151
					1 1/2			H / P\$	3687
		Veneer			1 3/16			F, G, X, Y / W\$	5431
					1 3/16			K / W\$	8182
					1 1/2			H / W\$	6188
		Glass			1/4			Acid Etched Glass Top \$	21154
					1/4			Gloss Glass Top \$	17668
<b>54"D x 156"W or 13' - 4 Piece Veneer (W) and 2 Piece HPL (P) Modern Rectangle Top</b>									
	88-54156MR	Laminate	156	54	1 3/16	334	16.0	F, G, X, Y / P\$	3147
					1 3/16			K / P\$	5923
					1 1/2			H / P\$	3603
		Veneer			1 3/16			F, G, X, Y / W\$	5209
					1 3/16			K / W\$	7802
					1 1/2			H / W\$	5915
		Glass			1/4			Acid Etched Glass Top \$	19856
					1/4			Gloss Glass Top \$	16619

Must Specify (in this order):

- Model #
- Top/Edge Material
- Top/Edge Finish/Color
- Edge Profile
- Glass (Y/N)
- Glass Color + Surface Finish
- Power/Data
- Power/Data Location

*Additional 54" Modern Rectangle Shaped Tops on Next Page*



Double Kerf (F)  
1 3/16"



Duo (G)  
1 3/16"



Fluted (X)  
1 3/16"



Square (Y)  
1 3/16"



Knife (K)  
1 3/16"



Vertical Square (H)  
1 1/2"

P = HPL W = Veneer

[See Strut Overview For Ordering Options](#)

Item	Model No.		W	D	H	Ship Wt	Cubic Ft	Edge Profile + Material	List Price		
<i>CONTINUED FROM PREVIOUS PAGE</i>	<b>54"D x 144"W or 12' - 3 Piece Veneer (W) and 2 Piece HPL (P) Modern Rectangle Top</b>										
	88-54144MR	Laminate	144	54	1 $\frac{3}{16}$ "	309	15.0	F, G, X, Y / P\$	2675		
					1 $\frac{3}{16}$ "			K / P\$	5261		
					1 $\frac{1}{2}$ "			H / P\$	3097		
		Veneer			1 $\frac{3}{16}$ "			F, G, X, Y / W\$	4300		
					1 $\frac{3}{16}$ "			K / W\$	6645		
					1 $\frac{1}{2}$ "			H / W\$	6645		
		Glass			1 $\frac{1}{4}$ "			Acid Etched Glass Top \$	18228		
					1 $\frac{1}{4}$ "			Gloss Glass Top \$	15240		
		<b>54"D x 132"W or 11' - 3 Piece Veneer (W) and 2 Piece HPL (P) Modern Rectangle Top</b>									
	88-54132MR	Laminate	132	54	1 $\frac{3}{16}$ "	285	13.2	F, G, X, Y / P\$	2614		
					1 $\frac{3}{16}$ "			K / P\$	5021		
				1 $\frac{1}{2}$ "			H / P\$	3000			
	Veneer			1 $\frac{3}{16}$ "			F, G, X, Y / W\$	4090			
				1 $\frac{3}{16}$ "			K / W\$	6285			
				1 $\frac{1}{2}$ "			H / W\$	4624			
	Glass			1 $\frac{1}{4}$ "			Acid Etched Glass Top \$	16918			
				1 $\frac{1}{4}$ "			Gloss Glass Top \$	14180			
	<b>54"D x 120"W or 10' - 3 Piece Veneer (W) and 2 Piece HPL (P) Modern Rectangle Top</b>										
88-54120MR	Laminate	120	54	1 $\frac{3}{16}$ "	260	12.1	F, G, X, Y / P\$	2553			
				1 $\frac{3}{16}$ "			K / P\$	4780			
				1 $\frac{1}{2}$ "			H / P\$	2904			
	Veneer			1 $\frac{3}{16}$ "			F, G, X, Y / W\$	3880			
				1 $\frac{3}{16}$ "			K / W\$	5927			
				1 $\frac{1}{2}$ "			H / W\$	4370			
	Glass			1 $\frac{1}{4}$ "			Acid Etched Glass Top \$	15612			
				1 $\frac{1}{4}$ "			Gloss Glass Top \$	13122			

Must Specify (in this order):

- Model #
- Top/Edge Material
- Top/Edge Finish/Color
- Edge Profile
- Glass (Y/N)
- Glass Color + Surface Finish
- Power/Data
- Power/Data Location

### Description

- Tops Available with Veneer (W) or HPL (P) Top in 1 $\frac{3}{16}$ " and 1 $\frac{1}{2}$ " Thicknesses
- Must Specify Edge Profile: 1 $\frac{3}{16}$ " Thick/Double Kerf (F), Duo (G), Fluted (X), Square (Y), and Knife (K) Edge Profiles or 1 $\frac{1}{2}$ " Thick/Vertical Square (H)
- Veneer (W) Top Grain Runs Depth of Top and HPL (P) Top Grain Runs Width of Top
- All Veneer Tops, as well as Laminate Tops up to 144" (12 feet), have Matching Woodgrain. Laminate Tops Sized 156" (13 feet) and Longer have Non-Matching Woodgrain
- Available with Back Painted Tempered Glass Top; Must Specify Color and Finish; [See Options](#)
- Power and Data Options Available; Sold Separately, [See Multiple Power Unit Details](#)
- Strut Legs Sold Separately, [See Strut Legs](#)



Double Kerf (F)  
1 $\frac{3}{16}$ "



Duo (G)  
1 $\frac{3}{16}$ "



Fluted (X)  
1 $\frac{3}{16}$ "



Square (Y)  
1 $\frac{3}{16}$ "



Knife (K)  
1 $\frac{3}{16}$ "



Vertical Square (H)  
1 $\frac{1}{2}$ "

P = HPL W = Veneer

[See Strut Overview For Ordering Options](#)

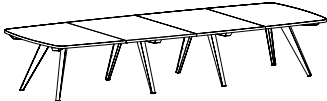

Item	Model No.		W	D	H	Ship Wt	Cubic Ft	Edge Profile + Material	List Price	
<b>MODERN RECTANGLE SHAPE MEETING TOP 60"D</b>    88-60156MR Shown in Veneer BASES SOLD SEPARATELY	<b>60"D x 240"W or 20' - 5 Piece Veneer (W) and 3 Piece HPL (P) Modern Rectangle Top</b>									
	88-60240MR	Laminate	240	60	1 3/16	574	26.3	F, G, X, Y / P\$	4779	
					1 3/16			K / P\$	9084	
					1 1/2			H / P\$	5559	
	Veneer				1 3/16			F, G, X, Y / W\$	8359	
					1 3/16			K / W\$	12204	
					1 1/2			H / W\$	9534	
	Glass				1/4			Acid Etched Glass Top \$	32356	
					1/4			Gloss Glass Top \$	26823	
	<b>60"D x 228"W or 19' - 5 Piece Veneer (W) and 3 Piece HPL (P) Modern Rectangle Top</b>									
	88-60228MR	Laminate	228	60	1 3/16	547	25.0	F, G, X, Y / P\$	4727	
					1 3/16			K / P\$	8844	
				1 1/2			H / P\$	5468		
Veneer				1 3/16			F, G, X, Y / W\$	8092		
				1 3/16			K / W\$	11776		
				1 1/2			H / W\$	9210		
Glass				1/4			Acid Etched Glass Top \$	30928		
				1/4			Gloss Glass Top \$	25671		
<b>60"D x 216"W or 18' - 5 Piece Veneer (W) and 3 Piece HPL (P) Modern Rectangle Top</b>										
88-60216MR	Laminate	216	60	1 3/16	519	23.7	F, G, X, Y / P\$	4127		
				1 3/16			K / P\$	8042		
				1 1/2			H / P\$	4829		
Veneer				1 3/16			F, G, X, Y / W\$	7825		
				1 3/16			K / W\$	11350		
				1 1/2			H / W\$	8888		
Glass				1/4			Acid Etched Glass Top \$	29463		
				1/4			Gloss Glass Top \$	24483		
<b>60"D x 204"W or 17' - 5 Piece Veneer (W) and 3 Piece HPL (P) Modern Rectangle Top</b>										
88-60204MR	Laminate	204	60	1 3/16	492	22.4	F, G, X, Y / P\$	4075		
				1 3/16			K / P\$	7802		
				1 1/2			H / P\$	4738		
Veneer				1 3/16			F, G, X, Y / W\$	7558		
				1 3/16			K / W\$	10922		
				1 1/2			H / W\$	8564		
Glass				1/4			Acid Etched Glass Top \$	28035		
				1/4			Gloss Glass Top \$	23332		

Additional 60" Modern Rectangle Shaped Tops on Next Page



Double Kerf (F) 1 3/16" Duo (G) 1 3/16" Fluted (X) 1 3/16" Square (Y) 1 3/16" Knife (K) 1 3/16" Vertical Square (H) 1 1/2"

P = HPL W = Veneer

[See Strut Overview For Ordering Options](#)

Item	Model No.		W	D	H	Ship Wt	Cubic Ft	Edge Profile + Material	List Price		
<i>CONTINUED FROM PREVIOUS PAGE</i>	<b>60"D x 192"W or 16' - 4 Piece Veneer (W) and 2 Piece HPL (P) Modern Rectangle Top</b>										
	88-60192MR	Laminate	192	60	1 3/16	458	21.1	F, G, X, Y / P\$	3364		
					1 3/16			K / P\$	6866		
					1 1/2			H / P\$	3989		
		Veneer			1 3/16			F, G, X, Y / W\$	6252		
					1 3/16			K / W\$	9435		
					1 1/2			H / W\$	7199		
		Glass			1/4			Acid Etched Glass Top \$	25909		
					1/4			Gloss Glass Top \$	21482		
		<b>60"D x 180"W or 15' - 4 Piece Veneer (W) and 2 Piece HPL (P) Modern Rectangle Top</b>									
	88-60180MR	Laminate	180	60	1 3/16	431	19.8	F, G, X, Y / P\$	3311		
					1 3/16			K / P\$	6625		
					1 1/2			H / P\$	3898		
		Veneer			1 3/16			F, G, X, Y / W\$	6007		
					1 3/16			K / W\$	9030		
					1 1/2			H / W\$	6898		
		Glass			1/4			Acid Etched Glass Top \$	24481		
					1/4			Gloss Glass Top \$	20332		
	<b>60"D x 168"W or 14' - 4 Piece Veneer (W) and 2 Piece HPL (P) Modern Rectangle Top</b>										
88-60168MR	Laminate	168	60	1 3/16	403	18.5	F, G, X, Y / P\$	3259			
				1 3/16			K / P\$	6385			
				1 1/2			H / P\$	3806			
	Veneer			1 3/16			F, G, X, Y / W\$	5762			
				1 3/16			K / W\$	8625			
				1 1/2			H / W\$	6596			
	Glass			1/4			Acid Etched Glass Top \$	23053			
				1/4			Gloss Glass Top \$	19180			
	<b>60"D x 156"W or 13' - 4 Piece Veneer (W) and 2 Piece HPL (P) Modern Rectangle Top</b>										
88-60156MR	Laminate	156	60	1 3/16	376	17.2	F, G, X, Y / P\$	3206			
				1 3/16			K / P\$	6145			
				1 1/2			H / P\$	3715			
	Veneer			1 3/16			F, G, X, Y / W\$	5518			
				1 3/16			K / W\$	8220			
				1 1/2			H / W\$	6295			
	Glass			1/4			Acid Etched Glass Top \$	21624			
				1/4			Gloss Glass Top \$	18028			

Must Specify (in this order):  
 Model #  
 Top/Edge Material  
 Top/Edge Finish/Color  
 Edge Profile  
 Glass (Y/N)  
 Glass Color + Surface Finish  
 Power/Data  
 Power/Data Location

*Additional 60" Modern Rectangle Shaped Tops on Next Page*



Double Kerf (F) 1 3/16"    Duo (G) 1 3/16"    Fluted (X) 1 3/16"    Square (Y) 1 3/16"    Knife (K) 1 3/16"    Vertical Square (H) 1 1/2"

P = HPL    W = Veneer

[See Strut Overview For Ordering Options](#)

Item	Model No.		W	D	H	Ship Wt	Cubic Ft	Edge Profile + Material	List Price	
<b>60"D x 144"W or 12' - 3 Piece Veneer (W) and 2 Piece HPL (P) Modern Rectangle Top</b>										
<i>CONTINUED FROM PREVIOUS PAGE</i>	88-60144MR	Laminate	144	60	1 3/16"	342	16.0	F, G, X, Y / P\$	2731	
					1 3/16"			K / P\$	5470	
					1 1/2"			H / P\$	3200	
		Veneer			1 3/16"			F, G, X, Y / W\$	4568	
					1 3/16"			K / W\$	7008	
					1 1/2"			H / W\$	5205	
		Glass			1/4"			Acid Etched Glass Top \$	19864	
					1/4"			Gloss Glass Top \$	16543	
	<b>60"D x 132"W or 11' - 3 Piece Veneer (W) and 2 Piece HPL (P) Modern Rectangle Top</b>									
	Must Specify (in this order): Model # Top/Edge Material Top/Edge Finish/Color Edge Profile Glass (Y/N) Glass Color + Surface Finish Power/Data Type Power/Data Location	88-60132MR	Laminate	132	60	1 3/16"	323	14.6	F, G, X, Y / P\$	2666
					1 3/16"			K / P\$	5216	
					1 1/2"			H / P\$	3096	
		Veneer			1 3/16"			F, G, X, Y / W\$	4336	
					1 3/16"			K / W\$	6621	
					1 1/2"			H / W\$	4922	
		Glass			1/4"			Acid Etched Glass Top \$	18421	
					1/4"			Gloss Glass Top \$	15378	
<b>60"D x 120"W or 10' - 3 Piece Veneer (W) and 2 Piece HPL (P) Modern Rectangle Top</b>										
		88-60120MR	Laminate	120	60	1 3/16"	287	13.3	F, G, X, Y / P\$	2601
					1 3/16"			K / P\$	4964	
					1 1/2"			H / P\$	2991	
		Veneer			1 3/16"			F, G, X, Y / W\$	4104	
					1 3/16"			K / W\$	6237	
					1 1/2"			H / W\$	4641	
		Glass			1/4"			Acid Etched Glass Top \$	16980	
					1/4"			Gloss Glass Top \$	14214	

**Description**

- Tops Available with Veneer (W) or HPL (P) Top in 1 3/16" and 1 1/2" Thicknesses
- Must Specify Edge Profile: 1 3/16" Thick/Double Kerf (F), Duo (G), Fluted (X), Square (Y), and Knife (K) Edge Profiles or 1 1/2" Thick/Vertical Square (H)
- Veneer (W) Top Grain Runs Depth of Top and HPL (P) Top Grain Runs Width of Top
- All Veneer Tops, as well as Laminate Tops up to 144" (12 feet), have Matching Woodgrain. Laminate Tops Sized 156" (13 feet) and Longer have Non-Matching Woodgrain
- Available with Back Painted Tempered Glass Top; Must Specify Color and Finish; [See Options](#)
- Power and Data Options Available; Sold Separately, [See Multiple Power Unit Details](#)
- Strut Legs Sold Separately, [See Strut Legs](#)



Double Kerf (F)  
1 3/16"



Duo (G)  
1 3/16"



Fluted (X)  
1 3/16"



Square (Y)  
1 3/16"



Knife (K)  
1 3/16"



Vertical Square (H)  
1 1/2"

P = HPL W = Veneer

[See Strut Overview For Ordering Options](#)

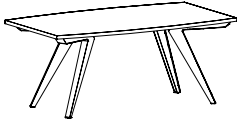
Item	Model No.		W	D	H	Ship Wt	Cubic Ft	Edge Profile + Material	List Price		
<b>BOAT SHAPE MEETING TOP</b> <b>36"D</b>  88-3696BT Shown BASES SOLD SEPARATELY	<b>36"D x 96"W or 8' - 1 Piece Boat Top</b>										
	88-3696BT	Laminate	96	36-30	1 $\frac{3}{16}$ "	142	12.9	F, G, X, Y / P\$	1424		
					1 $\frac{3}{16}$ "			K / P\$	2821		
					1 $\frac{1}{2}$ "			H / P\$	1606		
		Veneer			1 $\frac{3}{16}$ "			F, G, X, Y / W\$	1613		
					1 $\frac{3}{16}$ "			K / W\$	3163		
					1 $\frac{1}{2}$ "			H / W\$	1921		
		Glass						Acid Etched Glass Top \$	8724		
								Gloss Glass Top \$	7396		
		<b>36"D x 84"W or 7' - 1 Piece Boat Top</b>									
	88-3684BT	Laminate	84	36-30	1 $\frac{3}{16}$ "	126	11.3	F, G, X, Y / P\$	1357		
					1 $\frac{3}{16}$ "			K / P\$	2583		
					1 $\frac{1}{2}$ "			H / P\$	1547		
		Veneer			1 $\frac{3}{16}$ "			F, G, X, Y / W\$	1529		
					1 $\frac{3}{16}$ "			K / W\$	2958		
				1 $\frac{1}{2}$ "			H / W\$	1768			
	Glass						Acid Etched Glass Top \$	7821			
							Gloss Glass Top \$	6659			
	<b>36"D x 72"W or 6' - 1 Piece Boat Top</b>										
88-3672BT	Laminate	72	36-30	1 $\frac{3}{16}$ "	109	10.3	F, G, X, Y / P\$	1108			
				1 $\frac{3}{16}$ "			K / P\$	2236			
				1 $\frac{1}{2}$ "			H / P\$	1245			
	Veneer			1 $\frac{3}{16}$ "			F, G, X, Y / W\$	1302			
				1 $\frac{3}{16}$ "			K / W\$	2518			
				1 $\frac{1}{2}$ "			H / W\$	1537			
	Glass						Acid Etched Glass Top \$	6829			
							Gloss Glass Top \$	5832			

Must Specify (in this order):

Model #  
 Top/Edge Material  
 Top/Edge Finish/Color  
 Edge Profile  
 Glass (Y/N)  
 Glass Color + Surface Finish  
 Power/Data  
 Power/Data Location

### Description

- Tops Available with Veneer (W) or HPL (P) Top in 1 $\frac{3}{16}$ " and 1 $\frac{1}{2}$ " Thicknesses
- Must Specify Edge Profile: 1 $\frac{3}{16}$ " Thick/Double Kerf (F), Duo (G), Fluted (X), Square (Y), and Knife (K) Edge Profiles or 1 $\frac{1}{2}$ " Thick/Vertical Square (H)
- Veneer (W) Top Grain Runs Depth of Top and HPL (P) Top Grain Runs Width of Top
- Available with Back Painted Tempered Glass Top; Must Specify Color and Finish; [See Options](#)
- Power and Data Options Available; Sold Separately, [See Multiple Power Unit Details](#)
- Strut Legs Sold Separately, [See Strut Legs](#)



Double Kerf (F)  
1 $\frac{3}{16}$ "



Duo (G)  
1 $\frac{3}{16}$ "



Fluted (X)  
1 $\frac{3}{16}$ "



Square (Y)  
1 $\frac{3}{16}$ "



Knife (K)  
1 $\frac{3}{16}$ "



Vertical Square (H)  
1 $\frac{1}{2}$ "

P = HPL W = Veneer

[See Strut Overview For Ordering Options](#)

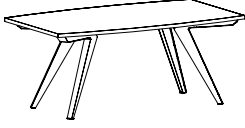
Item	Model No.		W	D	H	Ship Wt	Cubic Ft	Edge Profile + Material	List Price	
<b>BOAT SHAPE MEETING TOP</b> 42"D  <p>88-3696BT Shown BASES SOLD SEPARATELY</p>	<b>42"D x 96"W or 8' - 1 Piece Boat Top</b>									
	88-4296BT	Laminate	96	42-36	1 3/16	164	15.0	F, G, X, Y / P\$	1453	
					1 3/16			K / P\$	2984	
					1 1/2			H / P\$	1667	
		Veneer			1 3/16			F, G, X, Y / W\$	1752	
					1 3/16			K / W\$	3361	
					1 1/2			H / W\$	2104	
		Glass			1/4			Acid Etched Glass Top \$	9818	
					1/4			Gloss Glass Top \$	8269	
	<b>42"D x 84"W or 7' - 1 Piece Boat Top</b>									
	88-4284BT	Laminate	84	42-36	1 3/16	145	13.1	F, G, X, Y / P\$	1414	
					1 3/16			K / P\$	2769	
				1 1/2			H / P\$	1600		
	Veneer			1 3/16			F, G, X, Y / W\$	1618		
				1 3/16			K / W\$	3102		
				1 1/2			H / W\$	1928		
	Glass			1/4			Acid Etched Glass Top \$	8786		
				1/4			Gloss Glass Top \$	7430		
<b>42"D x 72"W or 6' - 1 Piece Boat Top</b>										
88-4272BT	Laminate	72	42-36	1 3/16	164	15.0	F, G, X, Y / P\$	1182		
				1 3/16			K / P\$	2467		
				1 1/2			H / P\$	1341		
	Veneer			1 3/16			F, G, X, Y / W\$	1473		
				1 3/16			K / W\$	2710		
				1 1/2			H / W\$	1741		
	Glass			1/4			Acid Etched Glass Top \$	7725		
				1/4			Gloss Glass Top \$	6563		

Must Specify (in this order):

- Model #
- Top/Edge Material
- Top/Edge Finish/Color
- Edge Profile
- Glass (Y/N)
- Glass Color + Surface Finish
- Power/Data
- Power/Data Location

**Description**

- Tops Available with Veneer (W) or HPL (P) Top in 1 3/16" and 1 1/2" Thicknesses
- Must Specify Edge Profile: 1 3/16" Thick/Double Kerf (F), Duo (G), **Fluted (X)**, Square (Y), and Knife (K) Edge Profiles or 1 1/2" Thick/Vertical Square (H)
- Veneer (W) Top Grain Runs Depth of Top and HPL (P) Top Grain Runs Width of Top
- Available with Back Painted Tempered Glass Top; Must Specify Color and Finish; [See Options](#)
- Power and Data Options Available; Sold Separately, [See Multiple Power Unit Details](#)
- Strut Legs Sold Separately, [See Strut Legs](#)



Double Kerf (F) 1 3/16"   Duo (G) 1 3/16"   **Fluted (X)** 1 3/16"   Square (Y) 1 3/16"   Knife (K) 1 3/16"   Vertical Square (H) 1 1/2"

P = HPL   W = Veneer

[See Strut Overview For Ordering Options](#)

Item	Model No.		W	D	H	Ship Wt	Cubic Ft	Edge Profile + Material	List Price	
<b>BOAT SHAPE MEETING TOP</b> 48"D    88-48216BT Shown BASES SOLD SEPARATELY	<b>48"D x 240"W or 20' - 3 Piece Boat Top</b>									
	88-48240BT	Laminate	240	48-36	1 3/16	460	48.9	F, G, X, Y / P\$	4638	
					1 3/16			K / P\$	8499	
					1 1/2			H / P\$	5257	
		Veneer			1 3/16			F, G, X, Y / W\$	6301	
					1 3/16			K / W\$	9571	
					1 1/2			H / W\$	7153	
		Glass			1/4			Acid Etched Glass Top \$	26634	
					1/4			Gloss Glass Top \$	22207	
	<b>48"D x 228"W or 19' - 3 Piece Boat Top</b>									
	88-48228BT	Laminate	228	48-36	1 3/16	438	48.9	F, G, X, Y / P\$	4594	
					1 3/16			K / P\$	8284	
					1 1/2			H / P\$	5182	
		Veneer			1 3/16			F, G, X, Y / W\$	6037	
					1 3/16			K / W\$	9216	
				1 1/2			H / W\$	6849		
	Glass			1/4			Acid Etched Glass Top \$	25468		
				1/4			Gloss Glass Top \$	21263		
<b>48"D x 216"W or 18' - 3 Piece Boat Top</b>										
88-48216BT	Laminate	216	48-36	1 3/16	416	48.9	F, G, X, Y / P\$	3687		
				1 3/16			K / P\$	7182		
				1 1/2			H / P\$	4244		
	Veneer			1 3/16			F, G, X, Y / W\$	5369		
				1 3/16			K / W\$	8456		
				1 1/2			H / W\$	6139		
	Glass			1/4			Acid Etched Glass Top \$	23917		
				1/4			Gloss Glass Top \$	19933		
<b>48"D x 204"W or 17' - 3 Piece Boat Top</b>										
88-48204BT	Laminate	204	48-36	1 3/16	394	48.9	F, G, X, Y / P\$	3643		
				1 3/16			K / P\$	6968		
				1 1/2			H / P\$	4169		
	Veneer			1 3/16			F, G, X, Y / W\$	5106		
				1 3/16			K / W\$	8101		
				1 1/2			H / W\$	5834		
	Glass			1/4			Acid Etched Glass Top \$	22751		
				1/4			Gloss Glass Top \$	18988		

Must Specify (in this order):  
 Model #  
 Top/Edge Material  
 Top/Edge Finish/Color  
 Edge Profile  
 Glass (Y/N)  
 Glass Color + Surface Finish  
 Power/Data  
 Power/Data Location

Additional 48" Boat Shaped Tops on Next Page



Double Kerf (F)  
1 3/16"



Duo (G)  
1 3/16"



Fluted (X)  
1 3/16"



Square (Y)  
1 3/16"



Knife (K)  
1 3/16"



Vertical Square (H)  
1 1/2"

P = HPL W = Veneer

[See Strut Overview For Ordering Options](#)

Item	Model No.		W	D	H	Ship Wt	Cubic Ft	Edge Profile + Material	List Price		
<i>CONTINUED FROM PREVIOUS PAGE</i>	<b>48"D x 192"W or 16' - 2 Piece Boat Top</b>										
	88-48192BT	Laminate	192	48-36	1 3/16	372	31.2	F, G, X, Y / P\$	3125		
					1 3/16			K / P\$	6249		
					1 1/2			H / P\$	3621		
		Veneer			1 3/16			F, G, X, Y / W\$	4215		
					1 3/16			K / W\$	6996		
					1 1/2			H / W\$	4991		
		Glass			1/4			Acid Etched Glass Top \$	21073		
					1/4			Gloss Glass Top \$	17531		
		<b>48"D x 180"W or 15' - 2 Piece Boat Top</b>									
	88-48180BT	Laminate	180	48-36	1 3/16	350	31.2	F, G, X, Y / P\$	3080		
					1 3/16			K / P\$	6034		
					1 1/2			H / P\$	3547		
		Veneer			1 3/16			F, G, X, Y / W\$	4045		
					1 3/16			K / W\$	6679		
					1 1/2			H / W\$	4773		
		Glass			1/4			Acid Etched Glass Top \$	19906		
					1/4			Gloss Glass Top \$	16586		
	<b>48"D x 168"W or 14' - 2 Piece Boat Top</b>										
88-48168BT	Laminate	168	48-36	1 3/16	328	31.2	F, G, X, Y / P\$	2928			
				1 3/16			K / P\$	5708			
				1 1/2			H / P\$	3363			
	Veneer			1 3/16			F, G, X, Y / W\$	3736			
				1 3/16			K / W\$	6223			
				1 1/2			H / W\$	4418			
	Glass			1/4			Acid Etched Glass Top \$	18629			
				1/4			Gloss Glass Top \$	15530			
	<b>48"D x 156"W or 13' - 2 Piece Boat Top</b>										
88-48156BT	Laminate	156	48-36	1 3/16	306	31.2	F, G, X, Y / P\$	2885			
				1 3/16			K / P\$	5363			
				1 1/2			H / P\$	3288			
	Veneer			1 3/16			F, G, X, Y / W\$	3567			
				1 3/16			K / W\$	6039			
				1 1/2			H / W\$	4202			
	Glass			1/4			Acid Etched Glass Top \$	17463			
				1/4			Gloss Glass Top \$	14585			

Must Specify (in this order):

- Model #
- Top/Edge Material
- Top/Edge Finish/Color
- Edge Profile
- Glass (Y/N)
- Glass Color + Surface Finish
- Power/Data
- Power/Data Location

*Additional 48" Boat Shaped Tops on Next Page*



Double Kerf (F)  
1 3/16"



Duo (G)  
1 3/16"



Fluted (X)  
1 3/16"



Square (Y)  
1 3/16"



Knife (K)  
1 3/16"



Vertical Square (H)  
1 1/2"

P = HPL W = Veneer

[See Strut Overview For Ordering Options](#)

Item	Model No.		W	D	H	Ship Wt	Cubic Ft	Edge Profile + Material	List Price		
<i>CONTINUED FROM PREVIOUS PAGE</i>	<b>48"D x 144"W or 12' - 2 Piece Boat Top</b>										
	88-48144BT	Laminate	144	48-36	1 3/16	284	23.5	F, G, X, Y / P\$	2421		
					1 3/16			K / P\$	4847		
					1 1/2			H / P\$	2793		
		Veneer			1 3/16			F, G, X, Y / W\$	3328		
					1 3/16			K / W\$	5521		
					1 1/2			H / W\$	3915		
		Glass			1/4			Acid Etched Glass Top \$	16201		
					1/4			Gloss Glass Top \$	13544		
		<b>48"D x 132"W or 11' - 2 Piece Boat Top</b>									
	88-48132BT	Laminate	132	48-36	1 3/16	262	23.5	F, G, X, Y / P\$	2365		
					1 3/16			K / P\$	4619		
					1 1/2			H / P\$	2705		
		Veneer			1 3/16			F, G, X, Y / W\$	3105		
					1 3/16			K / W\$	5178		
					1 1/2			H / W\$	3645		
		Glass			1/4			Acid Etched Glass Top \$	15022		
					1/4			Gloss Glass Top \$	12588		
	<b>48"D x 120"W or 10' - 2 Piece Boat Top</b>										
88-48120BT	Laminate	120	48-36	1 3/16	240	23.5	F, G, X, Y / P\$	2299			
				1 3/16			K / P\$	4383			
				1 1/2			H / P\$	2609			
	Veneer			1 3/16			F, G, X, Y / W\$	2870			
				1 3/16			K / W\$	4823			
				1 1/2			H / W\$	3364			
	Glass			1/4			Acid Etched Glass Top \$	13835			
				1/4			Gloss Glass Top \$	11622			
	<b>48"D x 108"W or 9' - 2 Piece Boat Top</b>										
88-48108BT	Laminate	108	48-36	1 3/16	218	23.5	F, G, X, Y / P\$	2243			
				1 3/16			K / P\$	4063			
				1 1/2			H / P\$	2522			
	Veneer			1 3/16			F, G, X, Y / W\$	2648			
				1 3/16			K / W\$	4575			
				1 1/2			H / W\$	3095			
	Glass			1/4			Acid Etched Glass Top \$	12657			
				1/4			Gloss Glass Top \$	10665			

Must Specify (in this order):  
 Model #  
 Top/Edge Material  
 Top/Edge Finish/Color  
 Edge Profile  
 Glass (Y/N)  
 Glass Color + Surface Finish  
 Power/Data  
 Power/Data Location

*Additional 48" Boat Shaped Tops on Next Page*



Double Kerf (F) 1 3/16"    Duo (G) 1 3/16"    Fluted (X) 1 3/16"    Square (Y) 1 3/16"    Knife (K) 1 3/16"    Vertical Square (H) 1 1/2"

P = HPL    W = Veneer

[See Strut Overview For Ordering Options](#)



Item	Model No.		W	D	H	Ship Wt	Cubic Ft	Edge Profile + Material	List Price	
<b>48"D x 96"W or 8' - 1 Piece Boat Top</b>										
<i>CONTINUED FROM PREVIOUS PAGE</i>	88-4896BT	Laminate	96	48-36	1 <sup>3</sup> / <sub>16</sub>	295	27.0	F, G, X, Y / P\$	1529	
					1 <sup>3</sup> / <sub>16</sub>			K / P\$	3258	
					1 <sup>1</sup> / <sub>2</sub>			H / P\$	1774	
	Veneer	1 <sup>3</sup> / <sub>16</sub>	F, G, X, Y / W\$	1951						
		1 <sup>3</sup> / <sub>16</sub>	K / W\$	3558						
		1 <sup>1</sup> / <sub>2</sub>	H / W\$	2347						
	Glass		1 <sup>1</sup> / <sub>4</sub>	Acid Etched Glass Top \$	10965					
			1 <sup>1</sup> / <sub>4</sub>	Gloss Glass Top \$	9194					
	<b>48"D x 84"W or 7' - 1 Piece Boat Top</b>									
	Must Specify (in this order): Model # Top/Edge Material Top/Edge Finish/Color Edge Profile Glass (Y/N) Glass Color + Surface Finish Power/Data Power/Data Location	88-4884BT	Laminate	84	48-36	1 <sup>3</sup> / <sub>16</sub>	164	15.0	F, G, X, Y / P\$	1484
1 <sup>3</sup> / <sub>16</sub>						K / P\$			2899	
1 <sup>1</sup> / <sub>2</sub>						H / P\$			1698	
Veneer		1 <sup>3</sup> / <sub>16</sub>	F, G, X, Y / W\$	1724						
		1 <sup>3</sup> / <sub>16</sub>	K / W\$	3266						
		1 <sup>1</sup> / <sub>2</sub>	H / W\$	2074						
Glass			1 <sup>1</sup> / <sub>4</sub>	Acid Etched Glass Top \$	9732					
			1 <sup>1</sup> / <sub>4</sub>	Gloss Glass Top \$	8184					
<b>48"D x 72"W or 6' - 1 Piece Boat Top</b>										
		88-4872BT	Laminate	72	48-36	1 <sup>3</sup> / <sub>16</sub>	142	12.8	F, G, X, Y / P\$	1249
	1 <sup>3</sup> / <sub>16</sub>					K / P\$			2637	
	1 <sup>1</sup> / <sub>2</sub>					H / P\$			1432	
	Veneer	1 <sup>3</sup> / <sub>16</sub>	F, G, X, Y / W\$	1633						
		1 <sup>3</sup> / <sub>16</sub>	K / W\$	2948						
		1 <sup>1</sup> / <sub>2</sub>	H / W\$	1935						
	Glass		1 <sup>1</sup> / <sub>4</sub>	Acid Etched Glass Top \$	8608					
			1 <sup>1</sup> / <sub>4</sub>	Gloss Glass Top \$	7280					

**Description**

- Tops Available with Veneer (W) or HPL (P) Top in 1<sup>3</sup>/<sub>16</sub>" and 1<sup>1</sup>/<sub>2</sub>" Thicknesses
- Must Specify Edge Profile: 1<sup>3</sup>/<sub>16</sub>" Thick/Double Kerf (F), Duo (G), **Fluted (X)**, Square (Y), and Knife (K) Edge Profiles or 1<sup>1</sup>/<sub>2</sub>" Thick/Vertical Square (H)
- Veneer (W) Top Grain Runs Depth of Top and HPL (P) Top Grain Runs Width of Top
- **All Veneer Tops, as well as Laminate Tops up to 144" (12 feet), have Matching Woodgrain. Laminate Tops Sized 156" (13 feet) and Longer have Non-Matching Woodgrain**
- Available with Back Painted Tempered Glass Top; Must Specify Color and Finish; [See Options](#)
- Power and Data Options Available; Sold Separately, [See Multiple Power Unit Details](#)
- Dock800, Oasis, and E2X Power Units Available on Ends Only (E1 and E2) for 108"D - 156"D and 204"D-240"D Tops
- Strut Legs Sold Separately, [See Strut Legs](#)



Double Kerf (F)  
1<sup>3</sup>/<sub>16</sub>"



Duo (G)  
1<sup>3</sup>/<sub>16</sub>"



Fluted (X)  
1<sup>3</sup>/<sub>16</sub>"



Square (Y)  
1<sup>3</sup>/<sub>16</sub>"



Knife (K)  
1<sup>3</sup>/<sub>16</sub>"



Vertical Square (H)  
1<sup>1</sup>/<sub>2</sub>"

P = HPL W = Veneer

[See Strut Overview For Ordering Options](#)

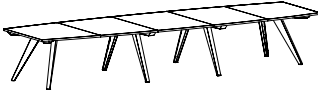
Item	Model No.		W	D	H	Ship Wt	Cubic Ft	Edge Profile + Material	List Price	
<b>BOAT SHAPE MEETING TOP</b> 54"D  <p>88-54204BT shown in Veneer BASES SOLD SEPARATELY</p>	<b>54"D x 240"W or 20' - 5 Piece Veneer (W) and 3 Piece HPL (P) Boat Top</b>									
	88-54240BT	Laminate	240	54-42	1 3/16	519	24.0	F, G, X, Y / P\$	4690	
					1 3/16			K / P\$	8773	
					1 1/2			H / P\$	5389	
		Veneer			1 3/16			F, G, X, Y / W\$	7844	
					1 3/16			K / W\$	11557	
					1 1/2			H / W\$	8912	
		Glass			1/4			Acid Etched Glass Top \$	29666	
					1/4			Gloss Glass Top \$	24687	
	<b>54"D x 228"W or 19' - 5 Piece Veneer (W) and 3 Piece HPL (P) Boat Top</b>									
		88-54228BT	Laminate	228	54-42	1 3/16	495	23.0	F, G, X, Y / P\$	4642
						1 3/16			K / P\$	8545
					1 1/2			H / P\$	5306	
		Veneer			1 3/16			F, G, X, Y / W\$	7602	
					1 3/16			K / W\$	11159	
					1 1/2			H / W\$	8619	
		Glass			1/4			Acid Etched Glass Top \$	28369	
					1/4			Gloss Glass Top \$	23639	
<b>54"D x 216"W or 18' - 5 Piece Veneer (W) and 3 Piece HPL (P) Boat Top</b>										
	88-54216BT	Laminate	216	54-42	1 3/16	470	22.0	F, G, X, Y / P\$	4047	
					1 3/16			K / P\$	7755	
					1 1/2			H / P\$	4676	
		Veneer			1 3/16			F, G, X, Y / W\$	7361	
					1 3/16			K / W\$	10761	
					1 1/2			H / W\$	8327	
		Glass			1/4			Acid Etched Glass Top \$	27037	
					1/4			Gloss Glass Top \$	22556	
<b>54"D x 204"W or 17' - 5 Piece Veneer (W) and 3 Piece HPL (P) Boat Top</b>										
	88-54204BT	Laminate	204	54-42	1 3/16	445	21.0	F, G, X, Y / P\$	3999	
					1 3/16			K / P\$	7528	
					1 1/2			H / P\$	4593	
		Veneer			1 3/16			F, G, X, Y / W\$	7119	
					1 3/16			K / W\$	10364	
					1 1/2			H / W\$	8034	
		Glass			1/4			Acid Etched Glass Top \$	25741	
					1/4			Gloss Glass Top \$	21509	

Must Specify (in this order):

- Model #
- Top/Edge Material
- Top/Edge Finish/Color
- Edge Profile
- Glass (Y/N)
- Glass Color + Surface Finish
- Power/Data
- Power/Data Location

*Additional 54" Boat Shaped Tops on Next Page*



Double Kerf (F)  
1 3/16"



Duo (G)  
1 3/16"



Fluted (X)  
1 3/16"



Square (Y)  
1 3/16"



Knife (K)  
1 3/16"



Vertical Square (H)  
1 1/2"

P = HPL W = Veneer

[See Strut Overview For Ordering Options](#)

Item	Model No.		W	D	H	Ship Wt	Cubic Ft	Edge Profile + Material	List Price		
<i>CONTINUED FROM PREVIOUS PAGE</i>	<b>54"D x 192"W or 16' - 4 Piece Veneer (W) and 2 Piece HPL (P) Boat Top</b>										
	88-54192BT	Laminate	192	54-42	1 <sup>3</sup> / <sub>16</sub>	408	19.0	F, G, X, Y / P\$	3291		
					1 <sup>3</sup> / <sub>16</sub>			K / P\$	6606		
					1 <sup>1</sup> / <sub>2</sub>			H / P\$	3852		
		Veneer			1 <sup>3</sup> / <sub>16</sub>			F, G, X, Y / W\$	5874		
					1 <sup>3</sup> / <sub>16</sub>			K / W\$	8938		
					1 <sup>1</sup> / <sub>2</sub>			H / W\$	6734		
		Glass			1/4			Acid Etched Glass Top \$	23748		
					1/4			Gloss Glass Top \$	19764		
		<b>54"D x 180"W or 15' - 4 Piece Veneer (W) and 2 Piece HPL (P) Boat Top</b>									
		88-54180BT	Laminate	180	54-42	1 <sup>3</sup> / <sub>16</sub>	384	18.0	F, G, X, Y / P\$	3244	
						1 <sup>3</sup> / <sub>16</sub>			K / P\$	6379	
						1 <sup>1</sup> / <sub>2</sub>			H / P\$	3769	
		Veneer			1 <sup>3</sup> / <sub>16</sub>			F, G, X, Y / W\$	5652		
					1 <sup>3</sup> / <sub>16</sub>			K / W\$	8560		
					1 <sup>1</sup> / <sub>2</sub>			H / W\$	6460		
		Glass			1/4			Acid Etched Glass Top \$	22451		
					1/4			Gloss Glass Top \$	18716		
		<b>54"D x 168"W or 14' - 4 Piece Veneer (W) and 2 Piece HPL (P) Boat Top</b>									
		88-54168BT	Laminate	168	54-42	1 <sup>3</sup> / <sub>16</sub>	359	17.0	F, G, X, Y / P\$	3195	
						1 <sup>3</sup> / <sub>16</sub>			K / P\$	6151	
					1 <sup>1</sup> / <sub>2</sub>			H / P\$	3687		
	Veneer			1 <sup>3</sup> / <sub>16</sub>			F, G, X, Y / W\$	5431			
				1 <sup>3</sup> / <sub>16</sub>			K / W\$	8182			
				1 <sup>1</sup> / <sub>2</sub>			H / W\$	6188			
	Glass			1/4			Acid Etched Glass Top \$	21154			
				1/4			Gloss Glass Top \$	17668			
	<b>54"D x 156"W or 13' - 4 Piece Veneer (W) and 2 Piece HPL (P) Boat Top</b>										
	88-54156BT	Laminate	156	54-42	1 <sup>3</sup> / <sub>16</sub>	334	16.0	F, G, X, Y / P\$	3147		
					1 <sup>3</sup> / <sub>16</sub>			K / P\$	5923		
					1 <sup>1</sup> / <sub>2</sub>			H / P\$	3603		
	Veneer			1 <sup>3</sup> / <sub>16</sub>			F, G, X, Y / W\$	5209			
				1 <sup>3</sup> / <sub>16</sub>			K / W\$	7802			
				1 <sup>1</sup> / <sub>2</sub>			H / W\$	5915			
	Glass			1/4			Acid Etched Glass Top \$	19856			
				1/4			Gloss Glass Top \$	16619			

Must Specify (in this order):

- Model #
- Top/Edge Material
- Top/Edge Finish/Color
- Edge Profile
- Glass (Y/N)
- Glass Color + Surface Finish
- Power/Data
- Power/Data Location

*Additional 54" Boat Shaped Tops on Next Page*



Double Kerf (F) 1<sup>3</sup>/<sub>16</sub>" Duo (G) 1<sup>3</sup>/<sub>16</sub>" Fluted (X) 1<sup>3</sup>/<sub>16</sub>" Square (Y) 1<sup>3</sup>/<sub>16</sub>" Knife (K) 1<sup>3</sup>/<sub>16</sub>" Vertical Square (H) 1<sup>1</sup>/<sub>2</sub>"

P = HPL W = Veneer

[See Strut Overview For Ordering Options](#)

Item	Model No.		W	D	H	Ship Wt	Cubic Ft	Edge Profile + Material	List Price	
<i>CONTINUED FROM PREVIOUS PAGE</i>	<b>54"D x 144"W or 12' - 3 Piece Veneer (W) and 2 Piece HPL (P) Boat Top</b>									
	88-54144BT	Laminate	144	54-42	1 $\frac{3}{16}$ "	309	15.0	F, G, X, Y / P\$	2675	
					1 $\frac{3}{16}$ "			K / P\$	5261	
					1 $\frac{1}{2}$ "			H / P\$	3097	
		Veneer			1 $\frac{3}{16}$ "			F, G, X, Y / W\$	4300	
					1 $\frac{3}{16}$ "			K / W\$	6645	
					1 $\frac{1}{2}$ "			H / W\$	4880	
		Glass			$\frac{1}{4}$ "			Acid Etched Glass Top \$	18228	
					$\frac{1}{4}$ "			Gloss Glass Top \$	15240	
	<b>54"D x 132"W or 11' - 3 Piece Veneer (W) and 2 Piece HPL (P) Boat Top</b>									
	88-54132BT	Laminate	132	54-42	1 $\frac{3}{16}$ "	285	13.2	F, G, X, Y / P\$	2614	
					1 $\frac{3}{16}$ "			K / P\$	5021	
					1 $\frac{1}{2}$ "			H / P\$	3000	
		Veneer			1 $\frac{3}{16}$ "			F, G, X, Y / W\$	4090	
					1 $\frac{3}{16}$ "			K / W\$	6285	
				1 $\frac{1}{2}$ "			H / W\$	4624		
	Glass			$\frac{1}{4}$ "			Acid Etched Glass Top \$	16918		
				$\frac{1}{4}$ "			Gloss Glass Top \$	14180		
<b>54"D x 120"W or 10' - 3 Piece Veneer (W) and 2 Piece HPL (P) Boat Top</b>										
88-54120BT	Laminate	120	54-42	1 $\frac{3}{16}$ "	260	12.1	F, G, X, Y / P\$	2553		
				1 $\frac{3}{16}$ "			K / P\$	4780		
				1 $\frac{1}{2}$ "			H / P\$	2904		
	Veneer			1 $\frac{3}{16}$ "			F, G, X, Y / W\$	3880		
				1 $\frac{3}{16}$ "			K / W\$	5927		
				1 $\frac{1}{2}$ "			H / W\$	4370		
	Glass			$\frac{1}{4}$ "			Acid Etched Glass Top \$	15612		
				$\frac{1}{4}$ "			Gloss Glass Top \$	13122		

Must Specify (in this order):

Model #  
 Top/Edge Material  
 Top/Edge Finish/Color  
 Edge Profile  
 Glass (Y/N)  
 Glass Color + Surface Finish  
 Power/Data  
 Power/Data Location

### Description

- Tops Available with Veneer (W) or HPL (P) Top in 1 $\frac{3}{16}$ " and 1 $\frac{1}{2}$ " Thicknesses
- Must Specify Edge Profile: 1 $\frac{3}{16}$ " Thick/Double Kerf (F), Duo (G), **Fluted (X)**, Square (Y), and Knife (K) Edge Profiles or 1 $\frac{1}{2}$ " Thick/Vertical Square (H)
- Veneer (W) Top Grain Runs Depth of Top and HPL (P) Top Grain Runs Width of Top
- **All Veneer Tops, as well as Laminate Tops up to 144" (12 feet), have Matching Woodgrain. Laminate Tops Sized 156" (13 feet) and Longer have Non-Matching Woodgrain**
- Available with Back Painted Tempered Glass Top; Must Specify Color and Finish; [See Options](#)
- Power and Data Options Available; Sold Separately, [See Multiple Power Unit Details](#)
- Strut Legs Sold Separately, [See Strut Legs](#)



Double Kerf (F)  
1 $\frac{3}{16}$ "



Duo (G)  
1 $\frac{3}{16}$ "



Fluted (X)  
1 $\frac{3}{16}$ "



Square (Y)  
1 $\frac{3}{16}$ "



Knife (K)  
1 $\frac{3}{16}$ "



Vertical Square (H)  
1 $\frac{1}{2}$ "

P = HPL W = Veneer

[See Strut Overview For Ordering Options](#)

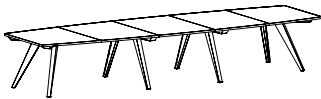
Item	Model No.		W	D	H	Ship Wt	Cubic Ft	Edge Profile + Material	List Price	
<b>BOAT SHAPE MEETING TOP</b> <b>60"D</b>  88-60204BT shown in Veneer BASES SOLD SEPARATELY	<b>60"D x 240"W or 20' - 5 Piece Veneer (W) and 3 Piece HPL (P) Boat Top</b>									
	88-60240BT	Laminate	240	60-48	1 3/16"	574	26.3	F, G, X, Y / P\$	4779	
					1 3/16"			K / P\$	9084	
					1 1/2"			H / P\$	5559	
	Veneer				1 3/16"			F, G, X, Y / W\$	8359	
					1 3/16"			K / W\$	12204	
					1 1/2"			H / W\$	9534	
	Glass				1/4"			Acid Etched Glass Top \$	32356	
					1/4"			Gloss Glass Top \$	26823	
	<b>60"D x 228"W or 19' - 5 Piece Veneer (W) and 3 Piece HPL (P) Boat Top</b>									
	88-60228BT	Laminate	228	60-48	1 3/16"	547	25.0	F, G, X, Y / P\$	4727	
					1 3/16"			K / P\$	8844	
				1 1/2"			H / P\$	5468		
Veneer				1 3/16"			F, G, X, Y / W\$	8092		
				1 3/16"			K / W\$	11776		
				1 1/2"			H / W\$	9210		
Glass				1/4"			Acid Etched Glass Top \$	30928		
				1/4"			Gloss Glass Top \$	25671		
<b>60"D x 216"W or 18' - 5 Piece Veneer (W) and 3 Piece HPL (P) Boat Top</b>										
88-60216BT	Laminate	216	60-48	1 3/16"	519	23.7	F, G, X, Y / P\$	4127		
				1 3/16"			K / P\$	8042		
				1 1/2"			H / P\$	4829		
Veneer				1 3/16"			F, G, X, Y / W\$	7825		
				1 3/16"			K / W\$	11350		
				1 1/2"			H / W\$	8888		
Glass				1/4"			Acid Etched Glass Top \$	29463		
				1/4"			Gloss Glass Top \$	24483		
<b>60"D x 204"W or 17' - 5 Piece Veneer (W) and 3 Piece HPL (P) Boat Top</b>										
88-60204BT	Laminate	204	60-48	1 3/16"	492	22.4	F, G, X, Y / P\$	4075		
				1 3/16"			K / P\$	7802		
				1 1/2"			H / P\$	4738		
Veneer				1 3/16"			F, G, X, Y / W\$	7558		
				1 3/16"			K / W\$	10922		
				1 1/2"			H / W\$	8564		
Glass				1/4"			Acid Etched Glass Top \$	28035		
				1/4"			Gloss Glass Top \$	23332		

*Additional 60" Boat Shaped Tops on Next Page*



Double Kerf (F) 1 3/16"    Duo (G) 1 3/16"    Fluted (X) 1 3/16"    Square (Y) 1 3/16"    Knife (K) 1 3/16"    Vertical Square (H) 1 1/2"

P = HPL    W = Veneer

[See Strut Overview For Ordering Options](#)

Item	Model No.		W	D	H	Ship Wt	Cubic Ft	Edge Profile + Material	List Price		
<i>CONTINUED FROM PREVIOUS PAGE</i>	<b>60"D x 192"W or 16' - 4 Piece Veneer (W) and 2 Piece HPL (P) Boat Top</b>										
	88-60192BT	Laminate	192	60-48	1 3/16	458	21.1	F, G, X, Y / P\$	3364		
					1 3/16			K / P\$	6866		
					1 1/2			H / P\$	3989		
		Veneer			1 3/16			F, G, X, Y / W\$	6252		
					1 3/16			K / W\$	9435		
					1 1/2			H / W\$	7199		
		Glass			1/4			Acid Etched Glass Top \$	25909		
					1/4			Gloss Glass Top \$	21482		
		<b>60"D x 180"W or 15' - 4 Piece Veneer (W) and 2 Piece HPL (P) Boat Top</b>									
		88-60180BT	Laminate	180	60-48	1 3/16	431	19.8	F, G, X, Y / P\$	3311	
						1 3/16			K / P\$	6625	
						1 1/2			H / P\$	3898	
			Veneer			1 3/16			F, G, X, Y / W\$	6007	
						1 3/16			K / W\$	9030	
						1 1/2			H / W\$	6898	
			Glass			1/4			Acid Etched Glass Top \$	24481	
						1/4			Gloss Glass Top \$	20332	
		<b>60"D x 168"W or 14' - 4 Piece Veneer (W) and 2 Piece HPL (P) Boat Top</b>									
		88-60168BT	Laminate	168	60-48	1 3/16	403	18.5	F, G, X, Y / P\$	3259	
						1 3/16			K / P\$	6385	
					1 1/2			H / P\$	3806		
		Veneer			1 3/16			F, G, X, Y / W\$	5762		
					1 3/16			K / W\$	8625		
					1 1/2			H / W\$	6596		
		Glass			1/4			Acid Etched Glass Top \$	23053		
					1/4			Gloss Glass Top \$	19180		
	<b>60"D x 156"W or 13' - 4 Piece Veneer (W) and 2 Piece HPL (P) Boat Top</b>										
	88-60156BT	Laminate	156	60-48	1 3/16	376	17.2	F, G, X, Y / P\$	3206		
					1 3/16			K / P\$	6145		
					1 1/2			H / P\$	3715		
		Veneer			1 3/16			F, G, X, Y / W\$	5518		
					1 3/16			K / W\$	8220		
					1 1/2			H / W\$	6295		
		Glass			1/4			Acid Etched Glass Top \$	21624		
					1/4			Gloss Glass Top \$	18028		

Must Specify (in this order):

- Model #
- Top/Edge Material
- Top/Edge Finish/Color
- Edge Profile
- Glass (Y/N)
- Glass Color + Surface Finish
- Power/Data
- Power/Data Location

*Additional 60" Boat Shaped Tops on Next Page*



Double Kerf (F)  
1 3/16"



Duo (G)  
1 3/16"



Fluted (X)  
1 3/16"



Square (Y)  
1 3/16"



Knife (K)  
1 3/16"



Vertical Square (H)  
1 1/2"

P = HPL W = Veneer

[See Strut Overview For Ordering Options](#)

Item	Model No.		W	D	H	Ship Wt	Cubic Ft	Edge Profile + Material	List Price	
<b>60"D x 144"W or 12' - 3 Piece Veneer (W) and 2 Piece HPL (P) Boat Top</b>										
<i>CONTINUED FROM PREVIOUS PAGE</i>	88-60144BT	Laminate	144	60-48	1 3/16	342	16.0	F, G, X, Y / P\$	2731	
					1 3/16			K / P\$	5470	
					1 1/2			H / P\$	3200	
		Veneer			1 3/16			F, G, X, Y / W\$	4568	
					1 3/16			K / W\$	7008	
					1 1/2			H / W\$	5205	
		Glass			1/4			Acid Etched Glass Top \$	19864	
					1/4			Gloss Glass Top \$	16543	
	<b>60"D x 132"W or 11' - 3 Piece Veneer (W) and 2 Piece HPL (P) Boat Top</b>									
	<u>Must Specify (in this order):</u> Model # Top/Edge Material Top/Edge Finish/Color Edge Profile Glass (Y/N) Glass Color + Surface Finish Power/Data Power/Data Location	88-60132BT	Laminate	132	60-48	1 3/16	323	14.6	F, G, X, Y / P\$	2666
					1 3/16			K / P\$	5216	
					1 1/2			H / P\$	3096	
		Veneer			1 3/16			F, G, X, Y / W\$	4336	
					1 3/16			K / W\$	6621	
					1 1/2			H / W\$	4922	
		Glass			1/4			Acid Etched Glass Top \$	18421	
					1/4			Gloss Glass Top \$	15378	
<b>60"D x 120"W or 10' - 3 Piece Veneer (W) and 2 Piece HPL (P) Boat Top</b>										
		88-60120BT	Laminate	120	60-48	1 3/16	287	13.3	F, G, X, Y / P\$	2601
					1 3/16			K / P\$	4964	
					1 1/2			H / P\$	2991	
		Veneer			1 3/16			F, G, X, Y / W\$	4104	
					1 3/16			K / W\$	6237	
					1 1/2			H / W\$	4641	
		Glass			1/4			Acid Etched Glass Top \$	16980	
					1/4			Gloss Glass Top \$	14214	

**Description**

- Tops Available with Veneer (W) or HPL (P) Top in 1 3/16" and 1 1/2" Thicknesses
- Must Specify Edge Profile: 1 3/16" Thick/Double Kerf (F), Duo (G), **Fluted (X)**, Square (Y), and Knife (K) Edge Profiles or 1 1/2" Thick/Vertical Square (H)
- Veneer (W) Top Grain Runs Depth of Top and HPL (P) Top Grain Runs Width of Top
- **All Veneer Tops, as well as Laminate Tops up to 144" (12 feet), have Matching Woodgrain. Laminate Tops Sized 156" (13 feet) and Longer have Non-Matching Woodgrain**
- Available with Back Painted Tempered Glass Top; Must Specify Color and Finish; [See Options](#)
- Power and Data Options Available; Sold Separately, [See Multiple Power Unit Details](#)
- Strut Legs Sold Separately, [See Strut Legs](#)



Double Kerf (F)  
1 3/16"



Duo (G)  
1 3/16"



Fluted (X)  
1 3/16"



Square (Y)  
1 3/16"



Knife (K)  
1 3/16"



Vertical Square (H)  
1 1/2"

P = HPL W = Veneer

[See Strut Overview For Ordering Options](#)

Item	Model No.		W	D	H	Ship Wt	Cubic Ft	List Price	
STRUT TABLE LEGS	01-2228STR2	1 Pair (2 Legs)	1½	22½	28⅞	32	4.5	\$	1278
	01-2228STR4	2 Pair (4 Legs)	1½	22½	28⅞	64	9.0	\$	2556

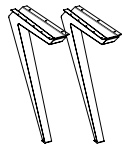

Must Specify (in this order):

Model # and Quantity  
Color

**Description**

- Available in Aluminum (ALUM) or Black (BLK); Must Specify Color
- Integrated Wire Management Inside of Legs to Keep Your Space Clean and Free of Wires
- Stiffener Bars Included with Top for Additional Support
- Each Leg has Adjustable Glides
- Legs not Available To Be Sold Separately

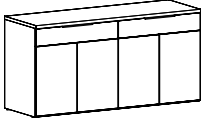

Table Widths	48"	72"	84"	96"	108"	120"	132"	144"
Number of Legs Required	4	4	4	4	6	6	6	6

Table Widths	156"	168"	180"	192"	204"	216"	228"	240"
Number of Legs Required	8	8	8	8	10	10	10	10

T = TFL W = Veneer

[See Strut Overview For Ordering Options](#)



Item	Model No.		W	D	H	Ship Wt	Cubic Ft	Edge Profile + Material	List Price	
<b>BUFFET CREDENZA WITH DRAWERS</b>   Shown: 88-2472BF   Waste Bin Option Shown as Left  Must Specify (in this order): Model # Top/Edge Material Top/Edge Finish/Color Edge Profile Chassis Color Glass (Y/N) Glass Color + Surface Finish Pull Drawer Track Vent Waste Bin	88-2496BF <i>Five Doors + Five Drawers</i>	TFL+HPL	96	24	36	466	56.0	F, G, X, Y / T+P\$	5839	
									H / T+P\$	5952
		Veneer+HPL							F, G, X, Y / W+P\$	8909
									H / W+P\$	9078
		Veneer							F, G, X, Y / W\$	9242
									H / W\$	9379
		Glass+TFL							Acid Etched Glass Top +T\$	9417
									Gloss Glass Top +T\$	8532
		Glass+Veneer							Acid Etched Glass Top +W\$	12818
									Gloss Glass Top +W\$	11934
		88-2484BF <i>Five Doors + Three Drawers</i>	TFL+HPL	84	24	36	404	49.2	F, G, X, Y / T+P\$	5109
										H / T+P\$
Veneer+HPL								F, G, X, Y / W+P\$	7679	
								H / W+P\$	7828	
Veneer								F, G, X, Y / W\$	8015	
								H / W\$	8136	
Glass+TFL								Acid Etched Glass Top +T\$	8204	
								Gloss Glass Top +T\$	7430	
Glass+Veneer								Acid Etched Glass Top +W\$	11111	
								Gloss Glass Top +W\$	10336	
88-2472BF <i>Four Doors + Two Drawers</i>	TFL+HPL		72	24	36	342	42.3	F, G, X, Y / T+P\$	4098	
									H / T+P\$	4183
	Veneer+HPL							F, G, X, Y / W+P\$	6292	
								H / W+P\$	6420	
	Veneer							F, G, X, Y / W\$	6450	
								H / W\$	6556	
	Glass+TFL							Acid Etched Glass Top +T\$	6853	
								Gloss Glass Top +T\$	6189	
	Glass+Veneer							Acid Etched Glass Top +W\$	9205	
								Gloss Glass Top +W\$	8541	
	88-2460BF <i>Three Doors + Three Drawers</i>	TFL+HPL	60	24	36	280	34.5	F, G, X, Y / T+P\$	3940	
									H / T+P\$	4012
Veneer+HPL								F, G, X, Y / W+P\$	5833	
								H / W+P\$	5942	
Veneer								F, G, X, Y / W\$	5996	
								H / W\$	6084	
Glass+TFL								Acid Etched Glass Top +T\$	6213	
								Gloss Glass Top +T\$	5659	
Glass+Veneer								Acid Etched Glass Top +W\$	8269	
								Gloss Glass Top +W\$	7715	

T= TFL P = HPL W = Veneer

*Additional Buffet Credenzas on Next Page*

[See Strut Overview For Ordering Options](#)

Item	Model No.		W	D	H	Ship Wt	Cubic Ft	Edge Profile + Material	List Price
<i>CONTINUED FROM PREVIOUS PAGE</i>	88-2448BF <i>Two Doors + Two Drawers</i>	TFL+HPL	48	24	36	209	28.6	F, G, X, Y / T+P\$	2783
								H / T+P\$	2841
		Veneer+HPL						F, G, X, Y / W+P\$	4296
								H / W+P\$	4385
		Veneer						F, G, X, Y / W\$	4463
								H / W\$	4534
		Glass+TFL						Acid Etched Glass Top +T\$	4574
								Gloss Glass Top +T\$	4131
		Glass+Veneer						Acid Etched Glass Top +W\$	6253
								Gloss Glass Top +W\$	5812
<i>Must Specify (in this order):</i> Model # Top/Edge Material Top/Edge Finish/Color Edge Profile Chassis Color Glass (Y/N) Glass Color + Surface Finish Pull Drawer Track Vent Waste Bin	88-2436BF <i>Two Doors + One Drawer</i>	TFL+HPL	36	24	36	209	28.6	F, G, X, Y / T+P\$	2323
								H / T+P\$	2367
		Veneer+HPL						F, G, X, Y / W+P\$	3424
								H / W+P\$	3492
		Veneer						F, G, X, Y / W\$	3594
								H / W\$	3648
		Glass+TFL						Acid Etched Glass Top +T\$	3631
								Gloss Glass Top +T\$	3299
		Glass+Veneer						Acid Etched Glass Top +W\$	4903
								Gloss Glass Top +W\$	4571

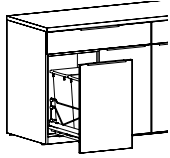

Waste Bin Option  
Shown as Left

**Description**

- Standard with: Touch Latch Doors with One (1) Adjustable Shelf Behind Doors, Top Profile on Approach Side, 2" Wire Management Channel Along Back of Interior Cabinet, Reverse Slip Matched Pattern on Top Surface, and Vertical Grain Direction on Chassis
- Available with Veneer (W), HPL (P), or Back Painted Tempered Glass (Black or White with Gloss or Acid Etched Finish) Top with Veneer (W) or HPL (P) Chassis
- When Selecting Back Painted Tempered Glass Top; Must Specify Glass Color, Gloss or Acid Etched Finish and Edge Profile; [See Options](#)
- Tops and Chassis Available in Contrasting Colors; Must Specific Color of Each Component
- Studio Pull Centered on Drawer Fronts Standard; Must Specify Pull Color ([See Color Options](#))
- Touch Latch Doors Standard Without Pulls, Optional Studio Pulls; Must Specify Pull Color ([See Color Options](#))
- Studio Pulls Will be Added and Centered on Top of Doors When Waste Bin is Selected; Must Specify Pull Color ([See Color Options](#)) and Optional Waste Bin ([See Options](#))
- Knife Edge not Available
- Additional Options: Locking Doors ([See Options Details](#)); Pull Out Waste Bin ([See Options Details](#)); Back Panel Vent ([See Options Details](#)); Soft Close Drawers ([See Soft Close Option](#))



Double Kerf (F) 1 3/16"   Duo (G) 1 3/16"   Fluted (X) 1 3/16"   Square (Y) 1 3/16"   Vertical Square (H) 1 1/2"

T= TFL P= HPL W= Veneer

[See Strut Overview For Ordering Options](#)

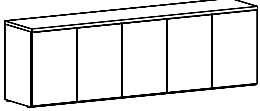
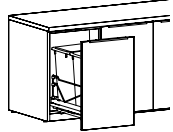
Item	Model No.		W	D	H	Ship Wt	Cubic Ft	Edge Profile + Material	List Price	
<b>24"D CREDENZA</b>  Shown: 88-2496CC  Waste Bin Option Shown as Left	88-2496CC <i>Five Doors</i>	TFL+HPL	96	24	30	415	47.2	F, G, X, Y / T+P\$	4591	
									H / T+P\$	4704
		Veneer+HPL							F, G, X, Y / W+P\$	7195
									H / W+P\$	7365
		Veneer							F, G, X, Y / W\$	7528
									H / W\$	7666
	88-2484CC <i>Five Doors</i>	Glass+TFL							Acid Etched Glass Top +T\$	8169
									Gloss Glass Top +T\$	7283
		Glass+Veneer							Acid Etched Glass Top +W\$	11106
									Gloss Glass Top +W\$	10220
		TFL+HPL	84	24	30	353	41.4	F, G, X, Y / T+P\$	4189	
									H / T+P\$	4288
88-2472CC <i>Four Doors</i>	Veneer+HPL							F, G, X, Y / W+P\$	6418	
								H / W+P\$	6567	
	Veneer							F, G, X, Y / W\$	6754	
								H / W\$	6876	
	Glass+TFL							Acid Etched Glass Top +T\$	7284	
								Gloss Glass Top +T\$	6510	
88-2460CC <i>Three Doors</i>	Glass+Veneer							Acid Etched Glass Top +W\$	9850	
								Gloss Glass Top +W\$	9075	
	TFL+HPL	72	24	30	260	35.6	F, G, X, Y / T+P\$	3384		
								H / T+P\$	3470	
	Veneer+HPL							F, G, X, Y / W+P\$	5268	
								H / W+P\$	5396	
88-2460CC <i>Three Doors</i>	Veneer							F, G, X, Y / W\$	5427	
								H / W\$	5531	
	Glass+TFL							Acid Etched Glass Top +T\$	6140	
								Gloss Glass Top +T\$	5475	
	Glass+Veneer							Acid Etched Glass Top +W\$	8182	
								Gloss Glass Top +W\$	7517	
88-2460CC <i>Three Doors</i>	TFL+HPL	60	24	30	240	29.9	F, G, X, Y / T+P\$	2983		
								H / T+P\$	3055	
	Veneer+HPL							F, G, X, Y / W+P\$	4623	
								H / W+P\$	4732	
	Veneer							F, G, X, Y / W\$	4786	
								H / W\$	4874	
88-2460CC <i>Three Doors</i>	Glass+TFL							Acid Etched Glass Top +T\$	5256	
								Gloss Glass Top +T\$	4702	
	Glass+Veneer							Acid Etched Glass Top +W\$	7059	
								Gloss Glass Top +W\$	6505	

T= TFL P = HPL W = Veneer

Additional 24" Credenzas on Next Page

[See Strut Overview For Ordering Options](#)

Item	Model No.		W	D	H	Ship Wt	Cubic Ft	Edge Profile + Material	List Price
<i>CONTINUED FROM PREVIOUS PAGE</i>	88-2448CC <i>Two Doors</i>	TFL+HPL	48	24	30	185	20.4	F, G, X, Y / T+P\$ H / T+P\$	2258 2316
		Veneer+HPL						F, G, X, Y / W+P\$ H / W+P\$	3546 3634
		Veneer						F, G, X, Y / W\$ H / W\$	3713 3784
		Glass+TFL						Acid Etched Glass Top +T\$ Gloss Glass Top +T\$	4049 3606
		Glass+Veneer						Acid Etched Glass Top +W\$ Gloss Glass Top +W\$	5503 5060
		TFL+HPL	36	24	30	150	18.3	F, G, X, Y / T+P\$ H / T+P\$	1909 1953
		Veneer+HPL						F, G, X, Y / W+P\$ H / W+P\$	2846 2915
		Veneer						F, G, X, Y / W\$ H / W\$	3017 3072
		Glass+TFL						Acid Etched Glass Top +T\$ Gloss Glass Top +T\$	3217 2886
		Glass+Veneer						Acid Etched Glass Top +W\$ Gloss Glass Top +W\$	4325 3994

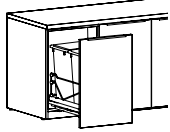

Waste Bin Option  
Shown as Left

Must Specify (in this order):

- Model #
- Top/Edge Material
- Top/Edge Finish/Color
- Edge Profile
- Chassis Color
- Glass (Y/N)
- Glass Color + Surface Finish
- Pull
- Vent
- Waste Bin

**Description**

- Standard with: One (1) Adjustable Shelf Behind Touch Latch Doors, Top Profile on Approach Side, 2" Wire Management Channel Along Back of Interior Cabinet, Reverse Slip Matched Pattern on Top Surface, and Vertical Grain Direction on Chassis
- Available with Veneer (W), HPL (P), or Back Painted Tempered Glass (Black or White with Gloss or Acid Etched Finish) Top
- When Selecting Back Painted Tempered Glass Top; Must Specify Glass Color, Gloss or Acid Etched Finish and Edge Profile; [See Options](#)
- Tops and Chassis Available in Contrasting Colors; Must Specific Color of Each Component
- Studio Pull Centered on Drawer Fronts Standard; Must Specify Pull Color ([See Color Options](#))
- Touch Latch Doors Standard Without Pulls, Optional Studio Pulls; Must Specify Pull Color ([See Color Options](#))
- Studio Pulls Will be Added and Centered on Top of Doors When Waste Bin is Selected; Must Specify Pull Color ([See Color Options](#)) and Optional Waste Bin ([See Options](#))
- Knife Edge not Available
- Additional Options: Locking Doors ([See Options Details](#)); Pull Out Waste Bin ([See Options Details](#)); Back Panel Vent ([See Options Details](#)); Soft Close Drawers ([See Soft Close Option](#))



Double Kerf (F)  
1 3/16"



Duo (G)  
1 3/16"



Fluted (X)  
1 3/16"



Square (Y)  
1 3/16"



Vertical Square (H)  
1 1/2"

T = TFL P = HPL W = Veneer

[See Strut Overview For Ordering Options](#)

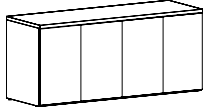
Item	Model No.		W	D	H	Ship Wt	Cubic Ft	Edge Profile + Material	List Price	
	88-2096CC <i>Five Doors</i>	TFL+HPL	96	20	30	398	39.9	F, G, X, Y / T+P\$	4283	
									H / T+P\$	4378
		Veneer+HPL							F, G, X, Y / W+P\$	6753
									H / W+P\$	6900
		Veneer							F, G, X, Y / W\$	7094
									H / W\$	7210
			Glass+TFL						Acid Etched Glass Top +T\$	7218
									Gloss Glass Top +T\$	6480
			Glass+Veneer						Acid Etched Glass Top +W\$	10029
									Gloss Glass Top +W\$	9291
		88-2084CC <i>Five Doors</i>	TFL+HPL	84	20	30	338	35.1	F, G, X, Y / T+P\$	3909
										H / T+P\$
Veneer+HPL								F, G, X, Y / W+P\$	6026	
									H / W+P\$	6155
Veneer								F, G, X, Y / W\$	6369	
									H / W\$	6472
		Glass+TFL						Acid Etched Glass Top +T\$	6443	
								Gloss Glass Top +T\$	5797	
		Glass+Veneer						Acid Etched Glass Top +W\$	8903	
								Gloss Glass Top +W\$	8257	
	88-2072CC <i>Four Doors</i>	TFL+HPL	72	20	30	260	35.6	F, G, X, Y / T+P\$	3141	
									H / T+P\$	3214
Veneer+HPL								F, G, X, Y / W+P\$	4928	
									H / W+P\$	5039
Veneer								F, G, X, Y / W\$	5093	
									H / W\$	5181
		Glass+TFL						Acid Etched Glass Top +T\$	5414	
								Gloss Glass Top +T\$	4860	
		Glass+Veneer						Acid Etched Glass Top +W\$	7366	
								Gloss Glass Top +W\$	6812	
	88-2060CC <i>Three Doors</i>	TFL+HPL	60	20	30	220	25.3	F, G, X, Y / T+P\$	2753	
									H / T+P\$	2813
Veneer+HPL								F, G, X, Y / W+P\$	4259	
									H / W+P\$	4353
Veneer								F, G, X, Y / W\$	4427	
									H / W\$	4501
		Glass+TFL						Acid Etched Glass Top +T\$	4623	
								Gloss Glass Top +T\$	4163	
		Glass+Veneer						Acid Etched Glass Top +W\$	6298	
								Gloss Glass Top +W\$	5837	

Must Specify (in this order):

- Model #
- Top/Edge Material
- Top/Edge Finish/Color
- Edge Profile
- Chassis Color
- Glass (Y/N)
- Glass Color + Surface Finish
- Pull
- Drawer Track
- Vent

*Additional 20" Credenzas on Next Page*

T= TFL P = HPL W = Veneer

[See Strut Overview For Ordering Options](#)

Item	Model No.		W	D	H	Ship Wt	Cubic Ft	Edge Profile + Material	List Price
<i>CONTINUED FROM PREVIOUS PAGE</i>	88-2448CC <i>Two Doors</i>	TFL+HPL	48	24	30	185	20.4	F, G, X, Y / T+P\$	2258
								H / T+P\$	2316
		Veneer+HPL						F, G, X, Y / W+P\$	3546
								H / W+P\$	3634
		Veneer						F, G, X, Y / W\$	3713
								H / W\$	3784
		Glass+TFL						Acid Etched Glass Top +T\$	4049
								Gloss Glass Top +T\$	3606
		Glass+Veneer						Acid Etched Glass Top +W\$	5503
								Gloss Glass Top +W\$	5060
<i>Must Specify (in this order):</i> Model # Top/Edge Material Top/Edge Finish/Color Edge Profile Chassis Color Glass (Y/N) Glass Color + Surface Finish Pull Drawer Track Vent	88-2436CC <i>Two Doors</i>	TFL+HPL	36	24	30	150	18.3	F, G, X, Y / T+P\$	1909
								H / T+P\$	1953
		Veneer+HPL						F, G, X, Y / W+P\$	2846
								H / W+P\$	2915
		Veneer						F, G, X, Y / W\$	3017
								H / W\$	3072
		Glass+TFL						Acid Etched Glass Top +T\$	3217
								Gloss Glass Top +T\$	2886
		Glass+Veneer						Acid Etched Glass Top +W\$	4325
								Gloss Glass Top +W\$	3994

**Description**

- Standard with: One (1) Adjustable Shelf Behind Touch Latch Doors, Top Profile on Approach Side, 2" Wire Management Channel Along Back of Interior Cabinet, Reverse Slip Matched Pattern on Top Surface, and Vertical Grain Direction on Chassis
- Available with Veneer (W), HPL (P), or Back Painted Tempered Glass (Black or White with Gloss or Acid Etched Finish) Top
- When Selecting Back Painted Tempered Glass Top; Must Specify Glass Color, Gloss or Acid Etched Finish and Edge Profile; [See Options](#)
- Tops and Chassis Available in Contrasting Colors; Must Specific Color of Each Component
- Touch Latch Doors Standard Without Pulls, Optional Studio Pulls; Must Specify Pull Color ([See Color Options](#))
- Studio Pulls Will be Added and Centered on Top of Doors When Waste Bin is Selected; Must Specify Pull Color ([See Color Options](#)) and Optional Waste Bin ([See Options](#))
- Knife Edge not Available
- Additional Options: Locking Doors ([See Options Details](#)); Pull Out Waste Bin Available ([See Options Details](#)); Back Panel Vent ([See Options Details](#))



Double Kerf (F)  
1 3/16"



Duo (G)  
1 3/16"



Fluted (X)  
1 3/16"



Square (Y)  
1 3/16"



Vertical Square (H)  
1 1/2"

T= TFL P= HPL W= Veneer

[See Strut Overview For Ordering Options](#)

Item	Model No.		W	D	H	Ship Wt	Cubic Ft		List Price	
	88-2436SV	TFL+HPL	36	24	36	260	35.6	F, G, X, Y / T+P\$	2585	
									H / T+P\$	2631
		Veneer+HPL							F, G, X, Y / W+P\$	3852
									H / W+P\$	3921
		Veneer							F, G, X, Y / W\$	4023
								H / W\$	4078	

Must Specify (in this order):

- Model #
- Top/Edge Material
- Top/Edge Finish/Color
- Edge Profile
- Optional Grommet

**Description**

- Top Edge Profiled on Approach Side Only (See Edge Options); Must Specify Edge Selection ([See Edge Details](#))
- Two (2) Box Drawers, Open Storage, and Storage Behind Two (2) Doors
- Locking Casters

**Grommet Option: Specify & Add**

1-GRMT	Grommet in Back Panel; Must Specify Black or Silver	\$ 52
--------	---	-------

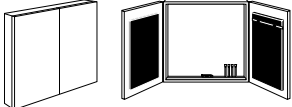
Item	Model No.		W	D	H	Ship Wt	Cubic Ft		List Price
	88-4848VB	TFL	48	5	48	150	11.0	T\$	2956
		Veneer							W\$

Must Specify (in this order):

- Model #
- Color
- Projection Screen
- Tackboard Fabric

**Description**

- Tackboard on Each Door Standard in Black Fabric Unless Specified; Price Valid for Grades 1, 2, & 3 (See Other Pricing Below)
- Display Rail with Adjustable Hooks for Flipchart
- Magnetic Porcelain Non-Glare Writing Surface
- Includes Flipchart, Set of Four (4) Dry Erase Markers and Eraser, Mounting Hardware
- Does Not Feature Soft Close Hinges

**Options: Specify & Add**

	Grade 4	Grade 5	Grade 6	Grade 7	Grade 8	Grade 9	Grade 10	
Tackboard Fabric Change	\$ 278	408	540	728	924	1152	1416	
1-PS	Projection Screen (Requires Field Installation)						\$	1062

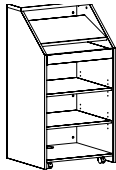
Item	Model No.		W	D	H	Ship Wt	Cubic Ft		List Price	
	88-2650LS	TFL+HPL	26	24	50	130	21.9	F, G, X, Y / T+P\$	1911	
									H / T+P\$	1921
		Veneer+HPL							F, G, X, Y / W+P\$	3451
									H / W+P\$	3477
		Veneer							F, G, X, Y / W\$	3587
								H / W\$	3601	

Must Specify (in this order):

- Model #
- Top/Edge Material
- Top/Edge Finish/Color
- Edge Profile

**Description**

- Top Edge Profiled on Approach Side Only (See Edge Options); Must Specify Edge Selection
- Fixed Shelf Angled for User Comfort, One (1) Pullout Shelf, and Two (2) Adjustable Shelves
- Two (2) Locking and Two (2) Non-Locking Casters
- Wire Management Grommet on Bottom Shelf

Item	Model No.	W	D	H	Ship Wt	Cubic Ft	List Price
MAGNETIC GLASS MARKER BOARD  FOR USE WITH 30"H CREDENZA AND SHELVING	GMB-4048W	48	½	40⅞	67	11.0	\$ 3128
	GMB-4042W	42	½	40⅞	58	9.9	\$ 2644
	GMB-4036W	36	½	40⅞	50	8.8	\$ 2285
	GMB-4030W	30	½	40⅞	42	7.7	\$ 1924

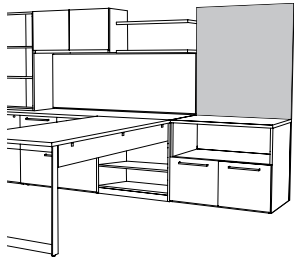

### Description

- Available in Black (BLMKR) or White (WHMKR), Must Specify
- Tempered Glass Magnetic Marker Boards Include Mounting Brackets
- For Use over 30"H Desks and Credenzas with Wall Mount Hitches or Shelving
- For Rare Earth Magnets, Marker and Eraser Sets; [See Set Options](#)

Must Specify (in this order):

Model #  
Color



Rare Earth Magnets, Marker and Eraser set available; [See Set Options](#)

MAGNETIC GLASS MARKER BOARD  FOR USE WITH 30"H CREDENZA AND SHELVING	GMB-5248W	48	½	52⅞	86	13.5	\$ 3988
	GMB-5242W	42	½	52⅞	76	12.2	\$ 3369
	GMB-5236W	36	½	52⅞	65	10.8	\$ 2904
	GMB-5230W	30	½	52⅞	54	9.5	\$ 2441

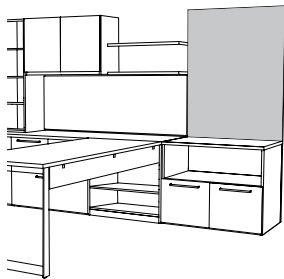

### Description

- Available in Black (BLMKR) or White (WHMKR), Must Specify
- Tempered Glass Magnetic Marker Boards Include Mounting Brackets
- For Use Next to Tall Surface or Wall Mount Hitches
- For Rare Earth Magnets, Marker and Eraser Sets; [See Set Options](#)

Must Specify (in this order):

Model #  
Color



Rare Earth Magnets, Marker and Eraser set available; [See Set Options](#)

[See Strut Overview For Ordering Options](#)



Item	Model No.	W	D	H	Ship Wt	Cubic Ft	List Price
MAGNETIC GLASS MARKER BOARD	GMB-8236W	36	½	82⅞	102	15.8	\$ 4453
FOR USE FROM FLOOR TO TOP OF UNIT	GMB-7036W	36	½	70⅞	87	13.8	\$ 3834
	GMB-5136W	36	½	51⅞	63	10.6	\$ 2802
	GMB-8230W	30	½	82⅞	85	13.8	\$ 3730
	GMB-7030W	30	½	70⅞	72	12.1	\$ 3215
	GMB-5130W	30	½	51⅞	53	9.3	\$ 2354

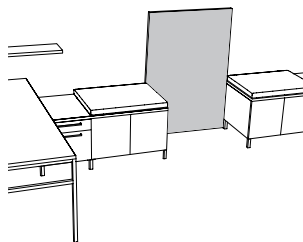

Must Specify (in this order):

Model #

Color

#### Description

- Available in Black (BLMKR) or White (WHMKR), Must Specify
- Tempered Glass Magnetic Marker Boards Are One (1) Piece with No Seams
- Mounting Brackets Included
- For Use From Floor to Top of Unit
- For Rare Earth Magnets, Marker and Eraser Sets; [See Set Options](#)



Rare Earth Magnets, Marker and Eraser set available; [See Set Options](#)

MARKER AND ERASER SET	01-MRKRSETBL	For Use with Black Marker Boards and Black Glass Doors	\$ 123
	01-MRKRSETWH	For Use with White Marker Boards and White Glass Doors	

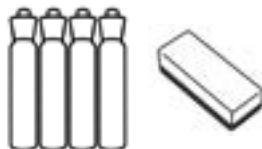

#### Description

- 01-MRKRSETWH May Also be Used with Dry Erase Doors and Boards
- Includes 4 Markers and an Eraser

RARE EARTH MAGNET SET	01-MAGBL	For Use with White Marker Boards	\$ 114
	01-MAGWH	For Use with Black Marker Boards	



#### Description

- Includes Set of Five (5) Rare Earth Magnets
- To be Used with Tempered Glass Magnetic Marker Boards
- Comfort Grip with Stylish Protective Plastic Coating

Item	Model No.		W	D	H	Ship Wt	Cubic Ft	List Price
ROUND GROMMET COVER FIELD INSTALLED	01-GRMTBK	Black	-	-	-	-	-	\$ 11
	01-GRMTSL	Silver						



OPEN MARKET ONLY  
(SILVER)

#### Description

- 60mm Round Grommet Cover
- Field Installed

SINGLE POWER SAND DOLLAR	01-SAND60PS	Silver	3	3	4	1	0.2	\$ 98
	01-SAND60PW	White						
	01-SAND60PB	Black						

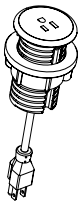

#### Description

- Mounts in 2 $\frac{3}{8}$ " (60mm) Round Grommet
- Single Power Outlet with 6' Cord

DOUBLE USB SAND DOLLAR	01-SAND60US	Silver	3	3	4	1	0.2	\$ 277
	01-SAND60UW	White						
	01-SAND60UB	Black						

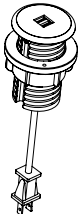

#### Description

- Mounts in 2 $\frac{3}{8}$ " (60mm) Round Grommet
- Dual USB Outlets with 6' Cord

DOCK 950 WIRELESS CHARGER	01-DOCK950W	White	3 $\frac{3}{16}$ "	3 $\frac{3}{16}$ "	-	1	0.2	\$ 265
	01-DOCK950B	Black						



OPEN MARKET ONLY

#### Description

- For Use with Wireless Charging Enabled Devices
- 5 Watts Maximum Output with a Direct Current of 5V 2A and 10 Watts Maximum with Quick Charge 2.0
- LED will Confirm Pairing with Device and Begin Wireless Charging

WIRELESS AND USB CHARGER	01-DOCK150W	White	3	3	3 $\frac{1}{4}$ "	1	0.2	\$ 405
	01-DOCK150B	Black						



OPEN MARKET ONLY

#### Description

- For Use with Wireless Charging Enabled Devices and USB Charging Devices
- 5 Watt Maximum Output with a Direct Current Input of 5V 6A (Wireless Fast Charge)
- Pop-Up is 3 $\frac{1}{4}$ "H and Includes Three (3) USB Ports; One (1) 12 Watt Maximum with 2.4A (USB Fast Charge) and Two (2) 5 Watt with 1A (USB Standard Charge)
- LED Light will Confirm Pairing with Device and Begin Wireless Charging
- UL and cUL Certified

[See Strut Overview For Ordering Options](#)

Item	Model No.		W	D	H	Ship Wt	Cubic Ft	List Price
	01-DUOBEZELW	White	6½	2¼	3¼	1	0.2	\$ 675
	01-DUOBEZELB	Black						
	01-DUOBEZELS	Silver						

#### Description

- Sits on Table Top and Includes: Two (2) Power, Two (2) USB, 10' Cord, and All Mounting Hardware
- Independent USB Circuit Controllers Deliver up to 2.1 Amps to Each Post
- FCC Part 15A, UL Recognized for Horizontal and Vertical Applications

	01-TRIOBEZELW	White	9	2¼	3	1	0.2	\$ 725
	01-TRIOBEZELB	Black						
	01-TRIOBEZELS	Silver						

#### Description

- Sits on Table Top and Includes: Three (3) Power Outlets, Two (2) USB Ports, One (1) Open Data Port, 10' Cord, and All Mounting Hardware
- HDMI, VGA, and RJ45 Accessories for Open Data Port; Sold Separately, [See Accessories](#)
- Independent USB Circuit Controllers Deliver up to 2.1 Amps to Each Post
- FCC Part 15A, UL Recognized for Horizontal and Vertical Applications

	01-PDUOBEZELW	White	6½	2¼	3	1	0.2	\$ 668
	01-PDUOBEZELB	Black						
	01-PDUOBEZELS	Silver						

#### Description

- Sits on Table Top and Includes: Two (2) Power, Two (2) USB, 12" Cord, and All Mounting Hardware
- Requires Daisy Chain Power Box; Sold Separately, [See Power Box Details](#)
- Non-Sequential System Allows up to Eight (8) Modules to be Connected with Jumper Cord, [See Jumper Cord Details](#)
- Independent USB Circuit Controllers Deliver up to 2.1 Amps to Each Post
- FCC Part 15A, RU Listed and UL Recognized for Horizontal and Vertical Applications

[See Strut Overview For Ordering Options](#)

Item	Model No.		W	D	H	Ship Wt	Cubic Ft	List Price
TRIO BEZEL DAISY CHAIN PLUG	01-PTRIOBEZELW	White	9	2½	3	1	0.2	\$ 715
	01-PTRIOBEZELB	Black						
	01-PTRIOBEZELS	Silver						

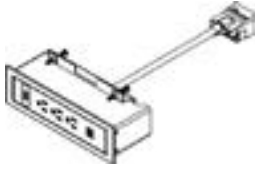

#### Description

- Sits on Table Top and Includes: Three (3) Power Outlets, Two (2) USB Ports, One (1) Open Data Port, 12" Cord, and All Mounting Hardware
- HDMI, VGA, or RJ45 Accessory for Open Data Port; Sold Separately, [See Accessories](#)
- Requires Daisy Chain Power Box, Specified Separately, See Below
- Non-Sequential System Allows up to Eight (8) Modules to be Connected with Jumper Cord, See Below
- Independent USB Circuit Controllers Deliver up to 2.1 Amps to Each Post
- FCC Part 15A, RU Listed and UL Recognized for Horizontal and Vertical Applications

DAISY CHAIN POWER BOX	01-PPOWER		-	-	-	1	0.2	\$ 775
		<i>76" Perimeter, 36" Power Cord</i>						
	01-PPOWER2		-	-	-	1	0.2	\$ 796
		<i>24" Perimeter, 144" Power Cord</i>						



#### Description

- Powers up to Eight (8) Duo and Trio Daisy Chain Units
- One Nema Plug and One Daisy Chain Plug
- 12-Amp System Rating
- 15-Amp Over-Current Protection

DAISY CHAIN JUMPER CORD	01-6JUMP	<i>72" Long</i>	-	-	-	1	0.2	\$ 299
	01-5JUMP	<i>60" Long</i>	-	-	-	1	0.2	\$ 284
	01-4JUMP	<i>48" Long</i>	-	-	-	1	0.2	\$ 240
	01-2JUMP	<i>24" Long</i>	-	-	-	1	0.2	\$ 220



#### Description

- Connects Duo and Trio Daisy Chain Units
- Non-Sequential System Allows up to Eight (8) Modules to be Connected

[See Strut Overview For Ordering Options](#)

Item	Model No.	W	D	H	Ship Wt	Cubic Ft	List Price
HDMI DATA PORT ACCESSORY FOR TRIO UNITS	01-LCOMHDMI	-	-	-	1	0.2	\$ 166

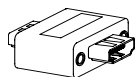

OPEN MARKET ONLY

VGA DATA PORT ACCESSORY FOR TRIO UNITS	01-LCOMVGA	-	-	-	1	0.2	\$ 121
--	------------	---	---	---	---	-----	--------

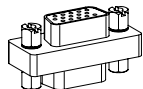

RJ45 DATA PORT ACCESSORY FOR TRIO UNITS	01-LCOMRJ45	-	-	-	1	0.2	\$ 79
---	-------------	---	---	---	---	-----	-------

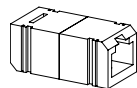

DPORT	01-DPORT4A	Aluminum	8	4	-	7	0.2	\$ 1093
	01-DPORT4B	Black						

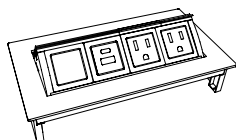
**Description**

- Retracts into Work Surface to Regain Productive Space; One-Touch Access to Power and Data
- Two (2) Power Outlets, One (1) USB A+C, and One (1) Open Port
- Optional Telecom Port Components, [See Compatible Units](#)
- Water-Proof Simplex (Outlets)
- Includes a Voice/Data Adapter Kit to Accept Couplers and Jacks When Required
- 10' Power Cord
- UL Recognized

E2X	01-E2X6A	Aluminum	11	9 <sup>3</sup> / <sub>16</sub>	-	6	0.7	\$ 1625
	01-E2X6B	Black						
	01-E2X4A	Aluminum	8	9 <sup>3</sup> / <sub>16</sub>	-	5	0.5	\$ 1494
	01-E2X4B	Black						

01-E2X4  
SIN PENDING**Description**

- In Surface Application; Soft Touch Access to Power and Data
- Each Side has the Following: 11" Includes Three (3) Power Outlets, One (1) USB A+C, and Two (2) Open Port; 8" Includes Two (2) Power Outlets, One (1) USB A+C, and One (1) Open Port
- Optional Telecom Port Components, [See Compatible Units](#)
- 6' Power Cord
- UL Listed

[See Strut Overview For Ordering Options](#)

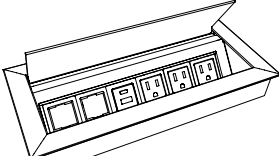
Item	Model No.		W	D	H	Ship Wt	Cubic Ft	Edge Profile + Material	List Price
	01-ELLORA6A	Aluminum	11	5	-	6	0.7	\$	852
	01-ELLORA6B	Black							
	01-ELLORA4A	Aluminum	8	5	-	5	0.5	\$	792
	01-ELLORA4B	Black							

01-ELLORA6  
SIN PENDING

#### Description

- In Surface Application; Soft Touch Access to Power and Data
- 11" Includes Three (3) Power Outlets, One (1) USB A+C, and Two (2) Open Port; 8" Includes Two (2) Power Outlets, One (1) USB A+C, and One (1) Open Port
- Optional Telecom Port Components, See Below for Compatible Units
- 6' Power Cord
- UL Recognized

USB PORT	01-USBPORT		-	-	-	-	-	\$	161
----------	------------	--	---	---	---	---	---	----	-----

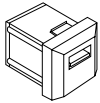

#### Description

- Passive USB-A Port with Increased Transfer Speed Up to 5 gbs/sec
- Simultaneous Read/Write Capability; Idle Device Power Saving State
- 6' Cord
- Compatible with 01-DPORT4A, 01-DPORT4B, ELLORA4A, ELLORA4B, ELLORA6A, ELLORA6B, E2X4A, E2X4B, E2X6A, and E2X6B

VOICE COUPLER	01-VOICE1		-	-	-	-	-	\$	73
---------------	-----------	--	---	---	---	---	---	----	----

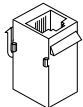

#### Description

- 6-Pin Modular Plug
- Molded Black; Cord Not included
- Compatible with 01-DPORT4A, 01-DPORT4B, ELLORA4A, ELLORA4B, ELLORA6A, ELLORA6B, E2X4A, E2X4B, E2X6A, and E2X6B

DATA PORT	01-RJ4DATA		-	-	-	-	-	\$	167
-----------	------------	--	---	---	---	---	---	----	-----



#### Description

- 8-Pin Modular Plug; Cat6 Ethernet Cable; Pre-terminated Cable
- 10' Cord
- Compatible with 01-DPORT4A, 01-DPORT4B, ELLORA4A, ELLORA4B, ELLORA6A, ELLORA6B, E2X4A, E2X4B, E2X6A, and E2X6B

[See Strut Overview For Ordering Options](#)

Item	Model No.	W	D	H	Ship Wt	Cubic Ft	List Price
VGA CONNECTOR ACCESSORY	01-VGACON	-	-	-	1	0.2	\$ 149

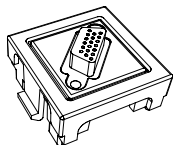
**Description**

- VGA Port for 01-DPORT4A, 01-DPORT4B, ELLORA4A, ELLORA4B, ELLORA6A, ELLORA6B, E2X4A, E2X4B, E2X6A, and E2X6B
- Enables Devices to Remote Display on Monitors
- 10' Cord
- Male/Female Connector

PASSIVE USB-C ACCESSORY	01-PUSBC	-	-	-	1	0.2	\$ 95
-------------------------	----------	---	---	---	---	-----	-------

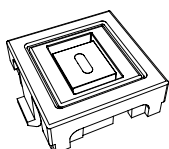
**Description**

- Passive USB-C Port ; Unit Provides Data Connection to Transfer Data Only, No Charging Capabilities
- Compatible with 01-DPORT4A, 01-DPORT4B, ELLORA4A, ELLORA4B, ELLORA6A, ELLORA6B, E2X4A, E2X4B, E2X6A, and E2X6B
- Male/Female Connector

CHARGING USB-A+C ACCESSORY	01-USBAC	-	-	-	1	0.2	\$ 283
----------------------------	----------	---	---	---	---	-----	--------

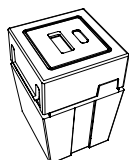
**Description**

- For Charging Devices
- 20 Watt Power Supply
- USB+C Charging Port for 01-DPORT4A, 01-DPORT4B, ELLORA4A, ELLORA4B, ELLORA6A, ELLORA6B, E2X4A, E2X4B, E2X6A, and E2X6B

HDMI CONNECTOR ACCESSORY	01-HDMICON	-	-	-	1	0.2	\$ 124
--------------------------	------------	---	---	---	---	-----	--------

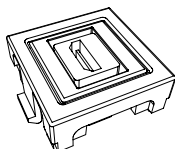
**Description**

- HDMI Port for 01-DPORT4A, 01-DPORT4B, ELLORA4A, ELLORA4B, ELLORA6A, ELLORA6B, E2X4A, E2X4B, E2X6A, and E2X6B
- Connects to High Definition Displays
- Female/Female Connector
- 18" Cord

[See Strut Overview For Ordering Options](#)

Item	Model No.		W	D	H	Ship Wt	Cubic Ft	Edge Profile + Material	List Price
INTERACT POWER & DATA	01-INTERACTG2A	Aluminum	9	5 $\frac{3}{8}$	2 $\frac{3}{4}$	5	0.2	\$	891
	01-INTERACTG2B	Black							



#### Description

- Includes: Two (2) Power Outlets, Two (2) USB-A Charging Ports, One (1) Telecom Plate Opening; Two (2) Keystone Openings for Voice/Data Jacks
- One (1) Telecom Plates Included with the Unit: One (1) 01-ABLAB Plate (Consists of One (1) RJ45 Cat 6, One (1) RJ11 Cat 3 Phone Jack)
- Convenience Plug on Bottom
- 6' Power Cord
- UL and CSA Recognized
- Additional Telecom Plates, [See ECA Telecom Plate Options](#)

OASIS MINI POWER & DATA	01-OASISMA	Aluminum	15	9	5	11	0.3	\$	3191
	01-OASISMB	Black							



Top View

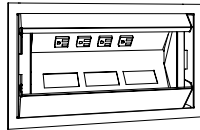

#### Description

- For Use with Conference Tables
- Soft Touch Hinged Lid
- Four (4) Power Outlets, Three (3) Telecom Plate Openings
- Two (2) Telecom Plates Included with the Unit: One (1) 01-ABLAB Plate (Consists of One (1) RJ45 Cat 6, One (1) RJ11 Cat 3 Phone Jack); One (1) 01-ABLB Plate (Consists of One (1) RJ45 Cat 6)
- 9' Power Cord
- UL Listed
- Additional Telecom Plates, [See ECA Telecom Plate Options](#)

DOCK800	01-DOCK800S	Silver	14	9	-			\$	2047
	01-DOCK800B	Black							

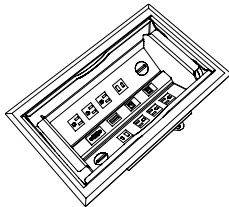

OPEN MARKET ONLY

#### Description

- Stylish Aluminum Housing with Beveled Edges; Soft Touch Access and Closure
- Includes: Six (6) Power Outlets, Two (2) USB-A 5V Ports, Two (2) USB-C Charging Ports, One (1) RJ45 Ethernet Port, One (1) RJ11 Port, One (1) HDMI Port, and One (1) VGA Port
- 10' Power Cord
- UL and cUL Certified

[See Strut Overview For Ordering Options](#)

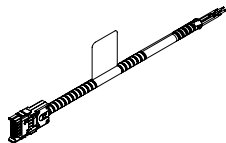

Item	Model No.	W	D	H	Ship Wt	Cubic Ft	List Price
POWER ENTRY HARD WIRED	01-HWPOWERENTRY	72	-	-	1	0.2	\$ 322

**Description**

- Eight (8) Wire/Four (4) Circuit Hard Wire In-feed
- UL183 Compliant

JUMPER HARD WIRE CABLE	01-HW2JUMP	24	-	-	1	0.2	\$ 193
	01-HW3JUMP	36	-	-	1	0.2	\$ 206
	01-HW4JUMP	48	-	-	1	0.2	\$ 212
	01-HW5JUMP	60	-	-	1	0.2	\$ 255
	01-HW6JUMP	72	-	-	1	0.2	\$ 270

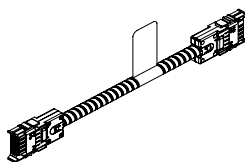
**Description**

- Eight (8) Wire/Four (4) Circuit Hard Wire Jumper
- UL183 Compliant

QUAD BLOCK HARD WIRED	01-HWQUADBLOCK	-	-	-	1	0.2	\$ 62
-----------------------	----------------	---	---	---	---	-----	-------

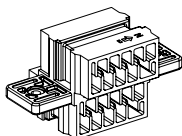
**Description**

- Eight (8) Wire/Four (4) Circuit Hard Wire Connector
- UL183 Compliant
- For Connecting Jumpers and Power Units
- Quantity of Four (4) Female Inputs

Item	Model No.	W	D	H	Ship Wt	Cubic Ft	List Price
WIRE MANAGEMENT CHANNEL	01-WMGR4	16	1½	¾	1	-	\$ 116

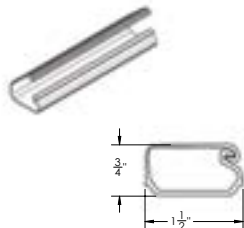
**Description**

- Set of Four (4) Black Plastic Wire Management Channels
- Snap Lock Channel
- Attaches with Adhesive Strips
- Ships via UPS Only

WIRE CHANNEL	01-32125	24	1¾	1	.25	0.3	\$ 106
--------------	----------	----	----	---	-----	-----	--------

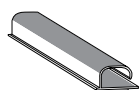

**Description**

- Available in Black
- Channels Attach with Two (2) Double-Sided Installation Tape
- Open J Channel for Easy Storage of Cables

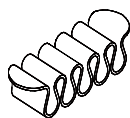
CABLE GRIP	01-WMGRCB	5¾	2¾	-	-	-	\$ 17
------------	-----------	----	----	---	---	---	-------

**Description**

- Under Surface Wire Management
- Black

Item	Model No.	Description	List Price
<b>ECA TELECOM PLATES</b>			
	01-ABL	Telecom Plate, Blank Plate	\$ 41
	01-ABL737373	Telecom Plate, Three (3) RJ45 Cat 5e	\$ 367
Compatible with:	01-ABLAB	Telecom Plate, One (1) RJ45 Cat 6, One (1) RJ11 Cat 3 Phone	\$ 206
	01-ABLAB102	Telecom Plate, One (1) RJ45 Cat 6, One (1) RJ11 Cat 3, One (1) USB W/72" Patch Cord	\$ 320
	01-ABLABB	Telecom Plate, Two (2) RJ45 Cat 6, One (1) RJ11 Cat 3 Phone	\$ 320
Oasis Mini Power & Data 01-OASISMA, 01-OASISMB	01-ABLB	Telecom Plate, One (1) RJ45 Cat 6	\$ 149
	01-ABLBB	Telecom Plate, Two (2) RJ45 Cat 6	\$ 260
Interact Power & Data 01-INTERACTG2A, 01-INTERACTG2B	01-ABLBBB	Telecom Plate, Three (3) RJ45 Cat 6	\$ 367
	01-ABLBBBB	Telecom Plate, Four (4) RJ45 Cat 6	\$ 476
Power Center 01-INTRFCIA, 01-INTRFCIB	01-ABLBBC51	Telecom Plate, Two (2) RJ45 Cat 6, One (1) 15 Pin HD VGA w/72" Patch Cord	\$ 446
	01-ABLBC51L	Telecom Plate, One (1) RJ45 Cat 6, One (1) Mini Stereo Inline, One (1) 15 Pin HD VGA w/72" Patch Cord	\$ 410
	01-ABLC3811	Telecom Plate, One (1) RJ45 Cat 6 Data Inline, One (1) RJ11 Cat 3 Phone Inline	\$ 197
	01-ABLC45	Telecom Plate, One (1) HDMI w/36" Patch Cord	\$ 295
	01-ABLC45C51L	Telecom Plate, One (1) Mini Stereo Inline, One (1) HDMI w/36" Patch Cord, One (1) 15 Pin HD VGA w/72" Patch Cord	\$ 558
	01-ABLC51L	Telecom Plate, One (1) 15 Pin HD VGA & One (1) Mini Stereo Inline Jack	\$ 298
	01-ABLCRDM	Telecom Plate, Three (3) Cord Bushings	\$ 96



Designers Jim Contois and Ramsey Madsen complement existing products with the Tri-One Table Collection. A full offering of training, meeting, and modular tables are available in flexible models that is sure to meet every expectation with integrated power and data capabilities.

### CONSTRUCTION

#### LAMINATE

- Thermally-Fused Laminate (TFL) and High-Pressure Laminate (HPL) are made of woodgrain and solid color laminates fused to particleboard core; each laminate offers lasting beauty, superior resistance to normal wear, and easy maintenance

#### VENEER

- Surfaces feature select-grade, plain-sliced hardwood Cherry, Maple, American Black Walnut, White Oak, and composite veneers; Veneers are carefully selected and matched to assure proper balance and consistency
- Veneer features UVAdvantage, an ultra-violet finish, on all exposed surfaces by utilizing roll-coat UV technology

#### TOPS

- Tops with the Square (Y) edge profile are 1" thick TFL or 1 $\frac{3}{16}$ " HPL with a 3mm PVC rim; or 1 $\frac{3}{16}$ " Veneer with 1.5mm edge banding
- Tops with the Knife (K) edge profile are 1 $\frac{3}{16}$ " HPL with a 3mm PVC rim or 1 $\frac{3}{16}$ " Veneer with 1 $\frac{1}{2}$  mm edge banding
- Laminate colors Designer White, Sugar Maple, and Williamsburg Cherry feature ABS edge bands
- Training and Modular tops feature shaped profiles on the user side while Meeting tops are shaped on all four sides
- Tops are pre-drilled for the specified base assembly and for ganging where applicable
- Grain direction runs left-to-right, unless noted



Knife (K)



Square (Y)

#### LEGS/BASES

- The Envy and Vantage leg/base styles are powder-coated Aluminum and include a 5mm steel mounting plate
- Envy style legs are aluminum extrusions while Vantage style legs are welded steel
- All legs and bases come standard with adjustable glides

#### GANGING

- All Modular and Training tops are pre-drilled with threaded inserts for ganging applications
- Ganging brackets include quick release thumb screws for ease of use; No tools required

#### NESTING

- Training tables offer an exclusive flip mechanism which can be accessed from any position to allow easier nesting of tables
- Optional flip mechanisms are factory installed and must be specified at the time of order

#### POWER/DATA/CORD MANAGEMENT

- Grommets are available in tops, where noted
- Grommets are 2  $\frac{3}{8}$ " in diameter and available in black or silver
- Power/Data units available for under-surface mount, routed into tops, or for use in standard grommet holes (e.g., Sand Dollar)
- Power/Data Units comply with FCC Part 15A and UL
- Standard Power/Data plugs and daisy-chain connections are available; daisy chains are non-sequential; connect up to 8 modules

### HOW TO ORDER EXAMPLES

MODULAR TABLE	QTY	MODEL NO.	EXAMPLE
TOP	4	85-3084MCT	Finish FO
LEG	4	08-0227APL4	
GANGING	3	08-1505GB	
MODESTY	4	85-0884MD	Finish FO
GROMMET/POWER/DATA	4	01-DUOBEZELS	PDC-L

FLEXIBLE SIZE TOP	QTY	MODEL NO.	EXAMPLE
TOP	4	86-FLEXMCT30	Width 79 Color WH
LEG	4	08-0227SPL4	
GANGING	3	08-1505GB	
MODESTY		No Modesty	
GROMMET/POWER/DATA		No Grommet	

MEETING TABLE	QTY	MODEL NO.	EXAMPLE
TOP	1	86-4296MTKH	Color WTA
LEG	1	08-2828YLG84	Finish BLK
GROMMET/POWER/DATA	1	GC	Color BLK

TRAINING TABLE	QTY	MODEL NO.	EXAMPLE
TOP	6	86-2472TTKH	Color PTM
LEG	6	08-2427TLC72	Casters SOFT
GANGING	5	08-1505GB	
NESTING	6	08-FLIP	
MODESTY	6	86-0865HMD	Color PTM
GROMMET/POWER/DATA	6	01-PDUOBEZELW	PDC-C

### TFL (T) & HPL (P) LAMINATE OPTIONS

*Tops with Knife Edge Profile available in HPL Only.*

#### WOODGRAIN

AS	Asian Night	PNW	Pinnacle Walnut
BW	Beigewood	PTK	Portico Teak
CO	Columbian Walnut	RC	River Cherry
EF	Espresso	SCH	Select Cherry
FLW	Florence Walnut	SPW	Sepia Walnut
GC	Golden Cherry	SKC	Shaker Cherry
HVM	Harvest Maple	SBP	Smoky Brown Pear
KHE	Kirsche	TK	Studio Teak
MW	Mahogany Walnut	SM	Sugar Maple
MNR	Midnight Run	WTA	Weathered Ash
NTM	Natural Marrone	WNB	White Nebbia
ORW	Oak Riftwood	WC	Williamsburg Cherry

#### SOLID

BL	Black	FHG	Fashion Grey
WH	Designer White	SG	Slate Grey

### VENEER (W) OPTIONS

Veneer features UVAdvantage, an ultra-violet finish, on all exposed surfaces by utilizing roll-coat UV technology

AW	Artisan Walnut	MW	Mahogany Walnut
AS	Asian Night	MAS	Mesa Sunset*
CO	Columbian Walnut	MTS	Metropolis Sky
DC	Dark Cherry	PNW	Pinnacle Walnut
DFW	Dark Forest Walnut	ORW	Oak Riftwood*
EW	Espresso	SCH	Select Cherry
FO	Fawn Oak*	SKC	Shaker Cherry
GC	Golden Cherry	SM	Sugar Maple
HW	Harvest Walnut	WTA	Weathered Ash*
HNW	Henna Walnut	WC	Williamsburg Cherry
LW	Legacy Walnut		

\* Finish is Low Sheen

### GROMMET OPTIONS & POWER/DATA UNIT LOCATIONS

Grommets are available in modular, meeting, and training tops. Tops may also be ordered without grommets at no additional charge. Please specify NO GROMMET on order.

Power/Data units must be specified separately with surface mount location. Specify location on order, as well as the power/data unit. Routed for field placement at no additional charge.

Grommets are available in standard locations. Please specify using info below. Multiple locations may be selected. Only one grommet/power/data unit per location.

#### GROMMET LOCATIONS (Black = BLK and Silver = SLV)

GC	Grommet, Center - Must Specify BLK or SLV	\$	52
GL	Grommet, Left - Must Specify BLK or SLV	\$	52
GR	Grommet, Right - Must Specify BLK or SLV	\$	52

#### DUO/TRIO BEZEL LOCATIONS (Starting on Page 200)

PDC-C	Bezel, Center
PDC-L	Bezel, Left
PDC-R	Bezel, Right

*Grommets and Power/Data Units may be ordered in non-standard locations. Call Customer Service to assist with specification and/or please attach a drawing to the PO showing the location of the grommet. Note additional charges and lead times may apply.*

#### 24" Modular Tops

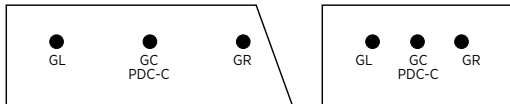

GL/GR: Located 10" from end based on widest dimension, 13 3/8" from user side  
GC/PDC-C: Located 13 3/8" from user side

#### 30" Modular Tops

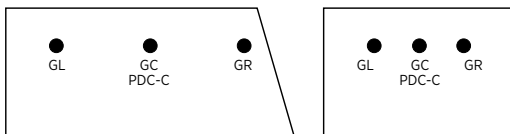

GL/GR: Located 10" from end based on widest dimension, 19 3/8" from user side  
GC/PDC-C: Located 19 3/8" from user side

#### Meeting Tops (Where Applicable)

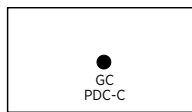

PDC-C: On Center, front to back

#### 18" Training Tables

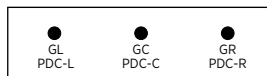

GL/GR/PDC-L/PDC-R: Located 10" from end, 12" from user side  
GC/PDC-C: Located 12" from user side

#### 24" Training Tables

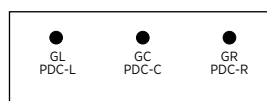

GL/GR: Located 10" from end, 16 1/2" from user side  
GC: Located 16 1/2" from user side

#### 30" Training Tables

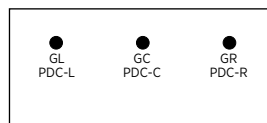

GL/GR: Located 10" from end, 20" from user side  
GC: Located 20" from user side

### CERTIFICATIONS & COMPLIANCE

- Intertek Sustainability Certified
- BIFMA level® Certified
- BIFMA Compliant® Certified
- TSCA Title VI (formerly CARB) Compliance
- US Green Building's LEED® Contribution

**Modular Tops & Legs**



Rectangular Modular Tops in Standard Sizes [\(See Details\)](#)  
Flexible Sizes [\(See Details\)](#)

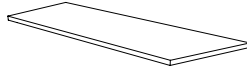

Trapezoid Modular Tops in Standard [\(See Multiple Unit Details\)](#)  
Flexible Sizes [\(See Multiple Unit Details\)](#)



Pentagon Ganging Tops [\(See Details\)](#)

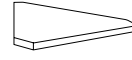

Bridge Ganging Tops [\(See Multiple Unit Details\)](#)



Envy Post Leg [\(See Details\)](#)



Vantage Post Leg [\(See Details\)](#)

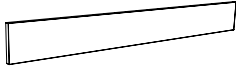

Modesty Panels [\(See Multiple Unit Details\)](#)

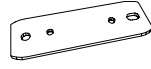

Ganging Brackets [\(See Details\)](#)



Grommets, Power/Data, and Accessories [\(See Multiple Unit Details\)](#)

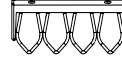

**Meeting Tops & Legs**



Rectangular Meeting Tops [\(See Details\)](#)



Soft Rectangular Meeting Tops [\(See Details\)](#)



Soft View Meeting Tops [\(See Details\)](#)



Ellipse Meeting Tops\* [\(See Details\)](#)

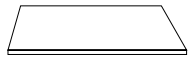

Square Meeting Tops [\(See Details\)](#)

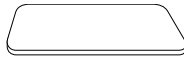

Soft Square Meeting Tops [\(See Details\)](#)



Round Meeting Tops [\(See Details\)](#)



Grommets, Power/Data, and Accessories [\(See Multiple Unit Details\)](#)

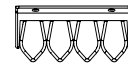
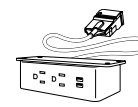

**Bases and Legs** [\(See Multiple Base Options\)](#)



Y-Bases [\(See Details\)](#)

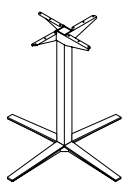

X-Bases [\(See Details\)](#)

\* The Ellipse Meeting Tops will use the Envy Post or Vantage Post Legs

**Training Tops & Legs**

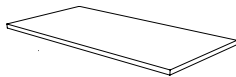

Rectangular Training Tops [\(See Details\)](#)

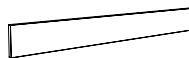

Modesty Panels [\(See Details\)](#)



Grommets, Power/Data, and Accessories [\(See Multiple Unit Details\)](#)

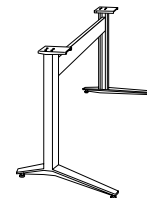

Envy C-Legs [\(See Details\)](#)

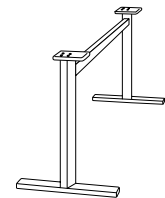

Vantage T-Legs [\(See Details\)](#)

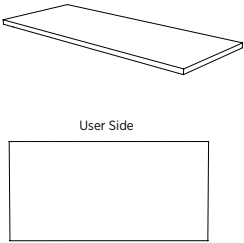
Item	Model No.		W	D	H	Ship Wt	Cubic Ft	List Price
<b>RECTANGULAR MODULAR TOPS</b>								
	<b>Square Edge</b>							
	86-3084MCT	TFL	84	30	-	76.4	6.0	T\$ 1014
	86-3084MCTH	HPL						P\$ 1373
	85-3084MCT	Veneer						W\$ 2034
	86-3072MCT	TFL	72	30	-	65.5	5.1	T\$ 819
	86-3072MCTH	HPL						P\$ 1111
	85-3072MCT	Veneer						W\$ 1647
	86-3060MCT	TFL	60	30	-	54.6	4.3	T\$ 738
	86-3060MCTH	HPL						P\$ 999
	85-3060MCT	Veneer						W\$ 1477
	86-3048MCT	TFL	48	30	-	43.7	3.5	T\$ 550
	86-3048MCTH	HPL						P\$ 747
	85-3048MCT	Veneer						W\$ 1107
	86-2484MCT	TFL	84	24	-	61.1	4.9	T\$ 940
	86-2484MCTH	HPL						P\$ 1277
	85-2484MCT	Veneer						W\$ 1889
	86-2472MCT	TFL	72	24	-	52.4	4.2	T\$ 758
	86-2472MCTH	HPL						P\$ 1026
	85-2472MCT	Veneer						W\$ 1518
	86-2460MCT	TFL	60	24	-	43.7	3.5	T\$ 690
86-2460MCTH	HPL						P\$ 932	
85-2460MCT	Veneer						W\$ 1379	
86-2448MCT	TFL	48	24	-	34.9	2.8	T\$ 510	
86-2448MCTH	HPL						P\$ 693	
85-2448MCT	Veneer						W\$ 1023	
<b>Knife Edge</b>								
	86-3084MCTKH	HPL	84	30	-	76.4	6.0	P\$ 1798
	85-3084MCTK	Veneer						W\$ 2479
	86-3072MCTKH	HPL	72	30	-	65.5	5.1	P\$ 1457
	85-3072MCTK	Veneer						W\$ 2007
	86-3060MCTKH	HPL	60	30	-	54.6	4.3	P\$ 1309
	85-3060MCTK	Veneer						W\$ 1804
	86-3048MCTKH	HPL	48	30	-	43.7	3.5	P\$ 980
	85-3048MCTK	Veneer						W\$ 1352
	86-2484MCTKH	HPL	84	24	-	61.1	4.9	P\$ 1675
	85-2484MCTK	Veneer						W\$ 2303
	86-2472MCTKH	HPL	72	24	-	52.4	4.2	P\$ 1346
	85-2472MCTK	Veneer						W\$ 1855
	86-2460MCTKH	HPL	60	24	-	43.7	3.5	P\$ 1219
	85-2460MCTK	Veneer						W\$ 1681
	86-2448MCTKH	HPL	48	24	-	34.9	2.8	P\$ 903
	85-2448MCTK	Veneer						W\$ 1247

Must Specify (in this order):  
 Model #  
 Top Finish/Color  
 Leg Model #  
 Ganging Brackets  
 Modesty Model # and Finish/Color  
 Grommet/Power/Data Location



Must Order Envy or Vantage Post Legs. [See Leg Options.](#)

**Description**

- Profile on User Side Only
- Flexible Sizes Available, [See Next Page](#)
- Tops 60" or Larger Include Stiffener Bar for Additional Support
- Legs Required (Assembly Required); Sold Separately, [See Leg Options](#)
- Pre-Drilled for Optional Ganging Brackets; Sold Separately, [See Details](#)
- Fixed Modesty Panel Options Available; Sold Separately, [See Modesty Options](#)
- Power & Data Options Available; Sold Separately, [See Multiple Units](#) and [See Locations](#)

T = TFL P = HPL W = Veneer

[See Tri-One Overview For Ordering Options](#)

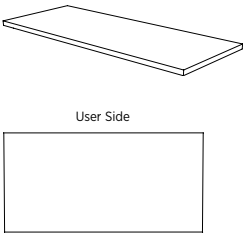

Item	Model No.		W	D	H	Ship Wt	Cubic Ft	List Price	
<b>RECTANGULAR MODULAR TOPS</b> <b>FLEXIBLE SIZES</b>  	<b>Square Edge</b>								
	86-FLEXMCT30	TFL	84-73	30	-	76.4	6.0	T\$ 1014	
	86-FLEXMCTH30	HPL						P\$ 1373	
	85-FLEXMCT30	Veneer						W\$ 2034	
			72-61	30	-	65.5	5.1	T\$ 819	
								P\$ 1111	
								W\$ 1647	
			60-49	30	-	54.6	4.3	T\$ 738	
								P\$ 999	
								W\$ 1477	
			48-36	30	-	43.7	3.5	T\$ 550	
								P\$ 747	
								W\$ 1107	
		86-FLEXMCT24	TFL	84-73	24	-	61.1	4.9	T\$ 940
		86-FLEXMCTH24	HPL						P\$ 1277
	85-FLEXMCT24	Veneer						W\$ 1889	
			72-61	24	-	52.4	4.2	T\$ 758	
								P\$ 1026	
								W\$ 1518	
			60-49	24	-	43.7	3.5	T\$ 690	
								P\$ 932	
								W\$ 1379	
			48-36	24	-	34.9	2.8	T\$ 510	
								P\$ 693	
								W\$ 1023	
	<b>Knife Edge</b>								
	86-FLEXMCTKH30	HPL	84-73	30	-	76.4	6.0	P\$ 1798	
	85-FLEXMCTK30	Veneer						W\$ 2479	
			72-61	30	-	65.5	5.1	P\$ 1457	
								W\$ 2007	
			60-49	30	-	54.6	4.3	P\$ 1309	
								W\$ 1804	
			48-36	30	-	43.7	3.5	P\$ 980	
								W\$ 1352	
	86-FLEXMCTKH24	HPL	84-73	24	-	61.1	4.9	P\$ 1675	
	85-FLEXMCTK24	Veneer						W\$ 2303	
			72-61	24	-	52.4	4.2	P\$ 1346	
								W\$ 1855	
			60-49	24	-	43.7	3.5	P\$ 1219	
								W\$ 1681	
			48-36	24	-	34.9	2.8	P\$ 903	
								W\$ 1247	

Must Specify (in this order):  
 Model #  
 Top Width Measurement  
 Top Finish/Color  
 Leg Model #  
 Ganging Brackets  
 Modesty Model # and Finish/Color  
 Grommet/Power/Data Location

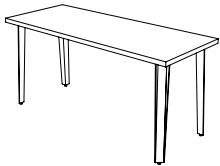

**Must Order Envy or Vantage Post Legs. [See Leg Options.](#)**

**Description**

- Profile on User Side Only
- Must Specify Width In One Inch Increments from 36" to 84"
- Tops 60" or Larger Include Stiffener Bar for Additional Support
- Legs Required (Assembly Required); Sold Separately, [See Leg Options](#)
- Pre-Drilled for Optional Ganging Brackets; Sold Separately, [See Details](#)
- Fixed Modesty Panel Options Available; Sold Separately, [See Modesty Options](#)
- Power & Data Options Available; Sold Separately, [See Multiple Units](#) and [See Locations](#)

T = TFL P = HPL W = Veneer

[See Tri-One Overview For Ordering Options](#)

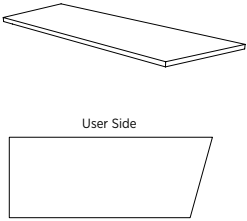
Item	Model No.		W	D	H	Ship Wt	Cubic Ft	List Price
<b>LEFT TRAPEZOID MODULAR TOPS</b>								
<b>Square Edge</b>								
 <p>User Side</p>	86-3084LMCT	TFL	84	30	-	76.4	6.0	T\$ 974
	86-3084LMCTH	HPL						P\$ 1319
	85-3084LMCT	Veneer						W\$ 1952
	86-3072LMCT	TFL	72	30	-	65.5	5.1	T\$ 788
	86-3072LMCTH	HPL						P\$ 1066
	85-3072LMCT	Veneer						W\$ 1577
	86-3060LMCT	TFL	60	30	-	54.6	4.3	T\$ 708
	86-3060LMCTH	HPL						P\$ 962
	85-3060LMCT	Veneer						W\$ 1422
	86-3048LMCT	TFL	48	30	-	43.7	3.5	T\$ 530
	86-3048LMCTH	HPL						P\$ 718
	85-3048LMCT	Veneer						W\$ 1062
	86-2484LMCT	TFL	84	24	-	61.1	4.9	T\$ 903
	86-2484LMCTH	HPL						P\$ 1229
	85-2484LMCT	Veneer						W\$ 1818
	86-2472LMCT	TFL	72	24	-	52.4	4.2	T\$ 725
	86-2472LMCTH	HPL						P\$ 983
	85-2472LMCT	Veneer						W\$ 1456
	86-2460LMCT	TFL	60	24	-	43.7	3.5	T\$ 661
	86-2460LMCTH	HPL						P\$ 894
	85-2460LMCT	Veneer						W\$ 1327
	86-2448LMCT	TFL	48	24	-	34.9	2.8	T\$ 486
	86-2448LMCTH	HPL						P\$ 659
	85-2448LMCT	Veneer						W\$ 976
<b>Knife Edge</b>								
	86-3084LMCTKH	HPL	84	30	-	76.4	6.0	P\$ 1729
	85-3084LMCTK	Veneer						W\$ 2383
	86-3072LMCTKH	HPL	72	30	-	65.5	5.1	P\$ 1395
	85-3072LMCTK	Veneer						W\$ 1924
	86-3060LMCTKH	HPL	60	30	-	54.6	4.3	P\$ 1258
	85-3060LMCTK	Veneer						W\$ 1734
	86-3048LMCTKH	HPL	48	30	-	43.7	3.5	P\$ 939
	85-3048LMCTK	Veneer						W\$ 1294
	86-2484LMCTKH	HPL	84	24	-	61.1	4.9	P\$ 1605
	85-2484LMCTK	Veneer						W\$ 2215
	86-2472LMCTKH	HPL	72	24	-	52.4	4.2	P\$ 1290
	85-2472LMCTK	Veneer						W\$ 1777
	86-2460LMCTKH	HPL	60	24	-	43.7	3.5	P\$ 1173
	85-2460LMCTK	Veneer						W\$ 1618
	86-2448LMCTKH	HPL	48	24	-	34.9	2.8	P\$ 864
	85-2448LMCTK	Veneer						W\$ 1192

Must Specify (in this order):  
 Model #  
 Top Finish/Color  
 Leg Model #  
 Ganging Brackets  
 Modesty Model # and Finish/Color  
 Grommet/Power/Data Location

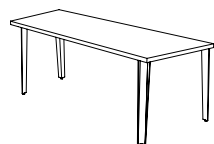

Must Order Envy or Vantage Post Legs. [See Leg Options.](#)

**Description**

- Profile on User Side Only
- Flexible Sizes Available, [See Next Page](#)
- Tops 60" or Larger Include Stiffener Bar for Additional Support
- Legs Required (Assembly Required); Legs Sold Separately, [See Leg Options](#)
- Pre-Drilled for Optional Ganging Brackets; Sold Separately, [See Details](#)
- For Ganging Applications, the Angled End of a Trapezoid Modular Top Must Connect with the Angled End of Another Trapezoid Modular Top; Please Specify a Left and a Right to Gang Tops
- Trapezoid Modular Tops Only Connect to Rectangular Modular Tops on Straight End
- Fixed Modesty Panel Options Available; Sold Separately, [See Modesty Options](#)
- Power & Data Options Available; Sold Separately, [See Multiple Units](#) and [See Locations](#)

T = TFL P = HPL W = Veneer

[See Tri-One Overview For Ordering Options](#)

Item	Model No.		W	D	H	Ship Wt	Cubic Ft	List Price	
LEFT TRAPEZOID MODULAR TOPS FLEXIBLE SIZES	<b>Square Edge</b>								
	86-FLEXLMCT30	TFL	84-73	30	-	76.4	6.0	T\$ 974	
	86-FLEXLMCTH30	HPL						P\$ 1319	
	85-FLEXLMCT30	Veneer						W\$ 1952	
			72-61	30	-	65.5	5.1	T\$ 788	
								P\$ 1066	
								W\$ 1577	
			60-49	30	-	54.6	4.3	T\$ 708	
								P\$ 962	
								W\$ 1422	
			48-36	30	-	43.7	3.5	T\$ 530	
								P\$ 718	
								W\$ 1062	
		86-FLEXLMCT24	TFL	84-73	24	-	61.1	4.9	T\$ 903
		86-FLEXLMCTH24	HPL						P\$ 1229
	85-FLEXLMCT24	Veneer						W\$ 976	
			72-61	24	-	52.4	4.2	T\$ 725	
								P\$ 983	
								W\$ 1456	
			60-49	24	-	43.7	3.5	T\$ 661	
								P\$ 894	
								W\$ 1327	
			48-36	24	-	34.9	2.8	T\$ 486	
								P\$ 659	
								W\$ 976	
	<b>Knife Edge</b>								
	86-FLEXLMCTKH30	HPL	84-73	30	-	76.4	6.0	P\$ 1729	
	85-FLEXLMCTK30	Veneer						W\$ 2383	
			72-61	30	-	65.5	5.1	P\$ 1395	
								W\$ 1924	
			60-49	30	-	54.6	4.3	P\$ 1258	
								W\$ 1734	
			48-36	30	-	43.7	3.5	P\$ 939	
								W\$ 1294	
	86-FLEXLMCTKH24	HPL	84-73	24	-	61.1	4.9	P\$ 1605	
	85-FLEXLMCTK24	Veneer						W\$ 2215	
			72-61	24	-	52.4	4.2	P\$ 1290	
								W\$ 1777	
			60-49	24	-	43.7	3.5	P\$ 1173	
								W\$ 1618	
			48-36	24	-	34.9	2.8	P\$ 864	
								W\$ 1192	

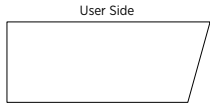
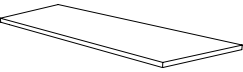

Must Specify (in this order):

- Model #
- Top Width Measurement
- Top Finish/Color
- Leg Model #
- Ganging Brackets
- Modesty Model # and Finish/Color
- Grommet/Power/Data Location

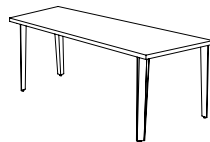

**Must Order Envy or Vantage Post Legs. See Leg Options.**

**Description**

- Profile on User Side Only
- Tops 60" or Larger Include Stiffener Bar for Additional Support
- Legs Required (Assembly Required); Sold Separately, [See Leg Options](#)
- Pre-Drilled for Optional Ganging Brackets; Sold Separately, [See Details](#)
- For Ganging Applications, the Angled End of a Trapezoid Modular Top Must Connect with the Angled End of Another Trapezoid Modular Top; Please Specify a Left and a Right to Gang Tops
- Trapezoid Modular Tops Only Connect to Rectangular Modular Tops on Straight End
- Fixed Modesty Panel Options Available; Sold Separately, [See Modesty Options](#)
- Power & Data Options Available; Sold Separately, [See Multiple Units](#) and [See Locations](#)

T = TFL P = HPL W = Veneer

[See Tri-One Overview For Ordering Options](#)

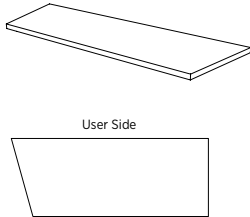
Item	Model No.		W	D	H	Ship Wt	Cubic Ft	List Price
<b>RIGHT TRAPEZOID MODULAR TOPS</b>								
<b>Square Edge</b>								
 <p>User Side</p>	86-3084RMCT	TFL	84	30	-	76.4	6.0	T\$ 974
	86-3084RMCTH	HPL						P\$ 1319
	85-3084RMCT	Veneer						W\$ 1952
	86-3072RMCT	TFL	72	30	-	65.5	5.1	T\$ 788
	86-3072RMCTH	HPL						P\$ 1066
	85-3072RMCT	Veneer						W\$ 1577
	86-3060RMCT	TFL	60	30	-	54.6	4.3	T\$ 708
	86-3060RMCTH	HPL						P\$ 962
	85-3060RMCT	Veneer						W\$ 1422
	86-3048RMCT	TFL	48	30	-	43.7	3.5	T\$ 530
	86-3048RMCTH	HPL						P\$ 718
	85-3048RMCT	Veneer						W\$ 1062
	86-2484RMCT	TFL	84	24	-	61.1	4.9	T\$ 903
	86-2484RMCTH	HPL						P\$ 1229
	85-2484RMCT	Veneer						W\$ 1818
	86-2472RMCT	TFL	72	24	-	52.4	4.2	T\$ 725
	86-2472RMCTH	HPL						P\$ 983
	85-2472RMCT	Veneer						W\$ 1456
86-2460RMCT	TFL	60	24	-	43.7	3.5	T\$ 661	
86-2460RMCTH	HPL						P\$ 894	
85-2460RMCT	Veneer						W\$ 1327	
86-2448RMCT	TFL	48	24	-	34.9	2.8	T\$ 486	
86-2448RMCTH	HPL						P\$ 659	
85-2448RMCT	Veneer						W\$ 976	
<b>Knife Edge</b>								
	86-3084RMCTKH	HPL	84	30	-	76.4	6.0	P\$ 1729
	85-3084RMCTK	Veneer						W\$ 2383
	86-3072RMCTKH	HPL	72	30	-	65.5	5.1	P\$ 1395
	85-3072RMCTK	Veneer						W\$ 1924
	86-3060RMCTKH	HPL	60	30	-	54.6	4.3	P\$ 1258
	85-3060RMCTK	Veneer						W\$ 1734
	86-3048RMCTKH	HPL	48	30	-	43.7	3.5	P\$ 939
	85-3048RMCTK	Veneer						W\$ 1294
	86-2484RMCTKH	HPL	84	24	-	61.1	4.9	P\$ 1605
	85-2484RMCTK	Veneer						W\$ 2215
	86-2472RMCTKH	HPL	72	24	-	52.4	4.2	P\$ 1290
	85-2472RMCTK	Veneer						W\$ 1777
	86-2460RMCTKH	HPL	60	24	-	43.7	3.5	P\$ 1173
	85-2460RMCTK	Veneer						W\$ 1618
	86-2448RMCTKH	HPL	48	24	-	34.9	2.8	P\$ 864
	85-2448RMCTK	Veneer						W\$ 1192

Must Specify (in this order):  
 Model #  
 Top Finish/Color  
 Leg Model #  
 Ganging Brackets  
 Modesty Model # and Finish/Color  
 Grommet/Power/Data Location

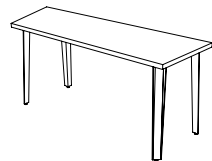

Must Order Envy or Vantage Post Legs. [See Leg Options.](#)

**Description**

- Profile on User Side Only
- Flexible Sizes Available, [See Next Page](#)
- Tops 60" or Larger Include Stiffener Bar for Additional Support
- Legs Required (Assembly Required); Sold Separately, [See Leg Options](#)
- Pre-Drilled for Optional Ganging Brackets; Sold Separately, [See Details](#)
- For Ganging Applications, the Angled End of a Trapezoid Modular Top Must Connect with the Angled End of Another Trapezoid Modular Top; Please Specify a Left and a Right to Gang Tops
- Trapezoid Modular Tops Only Connect to Rectangular Modular Tops on Straight End
- Fixed Modesty Panel Options Available; Sold Separately, [See Modesty Options](#)
- Power & Data Options Available; Sold Separately, [See Multiple Units](#) and [See Locations](#)

T = TFL P = HPL W = Veneer

[See Tri-One Overview For Ordering Options](#)

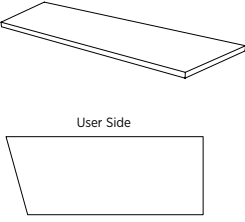
Item	Model No.		W	D	H	Ship Wt	Cubic Ft	List Price	
<b>RIGHT TRAPEZOID MODULAR TOPS</b>			<b>Square Edge</b>						
<b>FLEXIBLE SIZES</b>									
 <p>User Side</p>	86-FLEXRMCT30	TFL	84-73	30	-	76.4	6.0	T\$ 974	
	86-FLEXRMCTH30	HPL						P\$ 1319	
	85-FLEXRMCT30	Veneer						W\$ 1952	
				72-61	30	-	65.5	5.1	T\$ 788
									P\$ 1066
									W\$ 1577
				60-49	30	-	54.6	4.3	T\$ 708
									P\$ 962
									W\$ 1422
				48-36	30	-	43.7	3.5	T\$ 530
									P\$ 718
									W\$ 1062
	86-FLEXRMCT24	TFL	84-73	24	-	61.1	4.9	T\$ 903	
	86-FLEXRMCTH24	HPL						P\$ 1229	
	85-FLEXRMCT24	Veneer						W\$ 1818	
			72-61	24	-	52.4	4.2	T\$ 725	
								P\$ 983	
								W\$ 1456	
			60-49	24	-	43.7	3.5	T\$ 661	
								P\$ 894	
								W\$ 1327	
			48-36	24	-	34.9	2.8	T\$ 486	
								P\$ 659	
								W\$ 976	
			<b>Knife Edge</b>						
	86-FLEXRMCTKH30	HPL	84-73	30	-	76.4	6.0	P\$ 1729	
	85-FLEXRMCTK30	Veneer						W\$ 2383	
			72-61	30	-	65.5	5.1	P\$ 1395	
								W\$ 1924	
			60-49	30	-	54.6	4.3	P\$ 1258	
								W\$ 1734	
			48-36	30	-	43.7	3.5	P\$ 939	
								W\$ 1294	
	86-FLEXRMCTKH24	HPL	84-73	24	-	61.1	4.9	P\$ 1605	
	85-FLEXRMCTK24	Veneer						W\$ 2215	
			72-61	24	-	52.4	4.2	P\$ 1290	
								W\$ 1777	
			60-49	24	-	43.7	3.5	P\$ 1173	
								W\$ 1618	
			48-36	24	-	34.9	2.8	P\$ 864	
								W\$ 1192	

Must Specify (in this order):  
 Model #  
 Top Width Measurement  
 Top Finish/Color  
 Ganging Brackets  
 Ganging Model #  
 Modesty Model # and Finish/Color  
 Grommet/Power/Data Location

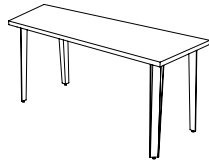

**Must Order Envy or Vantage Post Legs. [See Leg Options.](#)**

**Description**

- Profile on User Side Only
- Tops 60" or Larger Include Stiffener Bar for Additional Support
- Legs Required (Assembly Required); Sold Separately, [See Leg Options](#)
- Pre-Drilled for Optional Ganging Brackets; Sold Separately, [See Details](#)
- For Ganging Applications, the Angled End of a Trapezoid Modular Top Must Connect with the Angled End of Another Trapezoid Modular Top; Please Specify a Left and a Right to Gang Tops
- Trapezoid Modular Tops Only Connect to Rectangular Modular Tops on Straight End
- Fixed Modesty Panel Options Available; Sold Separately, [See Modesty Options](#)
- Power & Data Options Available; Sold Separately, [See Multiple Units](#) and [See Locations](#)

T = TFL P = HPL W = Veneer

[See Tri-One Overview For Ordering Options](#)

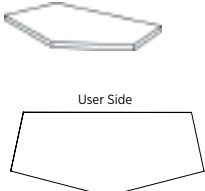
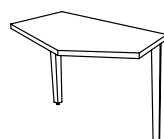
Item	Model No.		W	D	H	Ship Wt	Cubic Ft	List Price	
<b>PENTAGON MODULAR TOPS</b>    User Side  Must Specify (in this order): Model # Top Finish/Color Leg Model # Ganging Brackets    Must Order Envy or Vantage Post Legs. <a href="#">See Leg Options.</a>	<b>Square Edge</b>								
	<i>For Use with 30"D Modular Tops:</i>								
	86-30MCTP	TFL	58-48 $\frac{5}{8}$	18-25	-	44	3.6	T\$	619
	86-30MCTPH	HPL						P\$	837
	85-30MCTP	Veneer						W\$	1240
	<i>For Use with 24"D Modular Tops:</i>								
	86-24MCTP	TFL	46 $\frac{1}{3}$ -37	18-23 $\frac{1}{2}$	-	33.7	3.6	T\$	545
	86-24MCTPH	HPL						P\$	739
	85-24MCTP	Veneer						W\$	1095
	<b>Knife Edge</b>								
	<i>For Use with 30"D Modular Tops:</i>								
	86-30MCTPKH	HPL	58-48 $\frac{5}{8}$	18-25	-	44	3.6	P\$	1099
	85-30MCTPK	Veneer						W\$	1509
	<i>For Use with 24"D Modular Tops:</i>								
	86-24MCTPKH	HPL	46 $\frac{1}{3}$ -37	18-23 $\frac{1}{2}$	-	33.7	3.6	P\$	966
85-24MCTPK	Veneer						W\$	1334	
<b>Description</b>									
<ul style="list-style-type: none"> <li>• Profile on User Side Only</li> <li>• Not a Freestanding Unit</li> <li>• Legs Required (Assembly Required); <a href="#">See Leg Options</a></li> <li>• 24" Tops Require Set of 2 Legs; 30" Tops Require Set of 4 Legs</li> <li>• Pre-Drilled for Required Ganging Brackets</li> </ul>									
<b>Specify &amp; Add: Ganging Brackets - Requires 2 Sets</b>									
08-1505GB	Ganging Bracket Kit - Set of 2 with Thumb Screws							\$	82

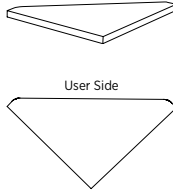
<b>90° BRIDGE MODULAR TOPS</b>    User Side  Must Specify (in this order): Model # Top Finish/Color Ganging Brackets	<b>Square Edge</b>								
	<i>For Use with 30"D Modular Tops:</i>								
	86-3090MCTB	TFL	42 $\frac{2}{5}$	30	-	18.2	2.0	T\$	691
	86-3090MCTBH	HPL						P\$	934
	85-3090MCTB	Veneer						W\$	1382
	<i>For Use with 24"D Modular Tops:</i>								
	86-2490MCTB	TFL	34	24	-	11.6	1.3	T\$	486
	86-2490MCTBH	HPL						P\$	659
	85-2490MCTB	Veneer						W\$	976
	<b>Knife Edge</b>								
	<i>For Use with 30"D Modular Tops:</i>								
	86-3090MCTBKH	HPL	42 $\frac{2}{5}$	30	-	18.2	2.0	P\$	1223
	85-3090MCTBK	Veneer						W\$	1686
	<i>For Use with 24"D Modular Tops:</i>								
	86-2490MCTBKH	HPL	34	24	-	11.6	1.3	P\$	864
85-2490MCTBK	Veneer						W\$	1192	
<b>Description</b>									
<ul style="list-style-type: none"> <li>• Profile on User Side Only</li> <li>• 90° Bridge to Connect Two Table Tops</li> <li>• Not a Freestanding Unit</li> <li>• Pre-Drilled for Required Ganging Brackets</li> </ul>									
<b>Specify &amp; Add: Ganging Brackets - Requires 2 Sets</b>									
08-1505GB	Ganging Bracket Kit - Set of 2 with Thumb Screws							\$	82

T = TFL P = HPL W = Veneer

[See Tri-One Overview For Ordering Options](#)

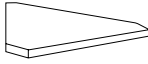
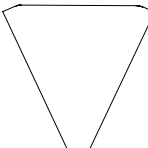
Item	Model No.		W	D	H	Ship Wt	Cubic Ft	List Price	
<b>45° BRIDGE MODULAR TOPS</b>									
<b>Square Edge</b>									
<i>For Use with 30"D Modular Tops:</i>									
 User Side 	86-3045MCTB	TFL	27 <sup>1</sup> / <sub>8</sub>	30	-	16.1	2.0	T\$ 500	
	86-3045MCTBH	HPL						P\$ 678	
	85-3045MCTB	Veneer						W\$ 1005	
<i>For Use with 24"D Modular Tops:</i>									
	86-2445MCTB	TFL	22 <sup>2</sup> / <sub>8</sub>	24	-	10.8	1.4	T\$ 447	
	86-2445MCTBH	HPL						P\$ 608	
	85-2445MCTB	Veneer						W\$ 894	
<b>Knife Edge</b>									
<i>For Use with 30"D Modular Tops:</i>									
	86-3045MCTBKH	HPL	27 <sup>1</sup> / <sub>8</sub>	30	-	16.1	2.0	P\$ 889	
	85-3045MCTBK	Veneer						W\$ 1223	
<i>For Use with 24"D Modular Tops:</i>									
	86-2445MCTBKH	HPL	22 <sup>2</sup> / <sub>8</sub>	24	-	10.8	1.4	P\$ 794	
	85-2445MCTBK	Veneer						W\$ 1094	
<b>Description</b>									
<ul style="list-style-type: none"> <li>• Profile on User Side Only</li> <li>• 45° Bridge to Connect Two Table Tops</li> <li>• Not a Freestanding Unit</li> <li>• Pre-Drilled for Required Ganging Brackets</li> </ul>									
<b>Specify &amp; Add: Ganging Brackets - Requires 2 Sets</b>									
	08-1505GB	Ganging Bracket Kit - Set of 2 with Thumb Screws							\$ 82

Must Specify (in this order):

- Model #
- Top Finish/Color
- Ganging Brackets

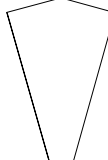
Item	Model No.		W	D	H	Ship Wt	Cubic Ft	List Price	
<b>30° BRIDGE MODULAR TOPS</b>									
<b>Square Edge</b>									
<i>For Use with 30"D Modular Tops:</i>									
 User Side 	86-3030MCTB	TFL	19 <sup>3</sup> / <sub>4</sub>	30	-	11.4	1.5	T\$ 470	
	86-3030MCTBH	HPL						P\$ 635	
	85-3030MCTB	Veneer						W\$ 939	
<i>For Use with 24"D Modular Tops:</i>									
	86-2430MCTB	TFL	16 <sup>2</sup> / <sub>3</sub>	24	-	8.6	1.1	T\$ 427	
	86-2430MCTBH	HPL						P\$ 659	
	85-2430MCTB	Veneer						W\$ 850	
<b>Knife Edge</b>									
<i>For Use with 30"D Modular Tops:</i>									
	86-3030MCTBKH	HPL	19 <sup>3</sup> / <sub>4</sub>	30	-	11.4	1.5	P\$ 833	
	85-3030MCTBK	Veneer						W\$ 1145	
<i>For Use with 24"D Modular Tops:</i>									
	86-2430MCTBKH	HPL	16 <sup>2</sup> / <sub>3</sub>	24	-	8.6	1.1	P\$ 756	
	85-2430MCTBK	Veneer						W\$ 1037	
<b>Description</b>									
<ul style="list-style-type: none"> <li>• Profile on User Side Only</li> <li>• 30° Bridge to Connect Two Table Tops</li> <li>• Not a Freestanding Unit</li> <li>• Pre-Drilled for Required Ganging Brackets</li> </ul>									
<b>Specify &amp; Add: Ganging Brackets - Requires 2 Sets</b>									
	08-1505GB	Ganging Bracket Kit - Set of 2 with Thumb Screws							\$ 82

Must Specify (in this order):

- Model #
- Top Finish/Color
- Ganging Brackets

T = TFL P = HPL W = Veneer

Item	Model No.	Ship Wt	Cubic Ft	List Price
ENVY POST LEG FOR MODULAR TOPS 	08-0227APL2 <i>Set of 2: For Use with 24" Pentagon Modular Tops Only</i>	10	0.8	\$ 498
	08-0227APL4 <i>Set of 4</i>	20	1.6	\$ 864
<b>Description</b>				
<ul style="list-style-type: none"> <li>• Available in Aluminum</li> <li>• Each Leg has Adjustable Glides</li> <li>• Must Specify with Modular Top; Legs Are Not Available To Be Sold Separately</li> </ul>				

VANTAGE POST LEG FOR MODULAR TOPS 	08-0227SPL2 <i>Set of 2: For Use with 24" Pentagon Modular Tops Only</i>	10	0.8	\$ 413
	08-0227SPL4 <i>Set of 4</i>	20	1.6	\$ 699
<b>Description</b>				
<ul style="list-style-type: none"> <li>• Available in Aluminum</li> <li>• Each Leg has Adjustable Glides</li> <li>• Must Specify with Modular Top; Legs Are Not Available To Be Sold Separately</li> </ul>				

GANGING BRACKET FOR MODULAR TOPS 	08-1505GB <i>Set of 2 with Thumb Screws</i>	2	0.5	\$ 82
---	--	---	-----	-------

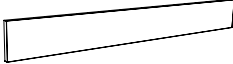
FIXED MODESTY PANEL FOR RECTANGULAR MODULAR TOPS   <small>Must Specify (in this order): Model # Finish/Color</small>	<b>For 84"W TOPS</b>			
	86-0884MD	TFL		T\$ 506
	86-0884MDH	HPL		P\$ 691
	85-0884MD	Veneer		W\$ 1022
	<b>For 72"W TOPS</b>			
	86-0872MD	TFL		T\$ 495
	86-0872MDH	HPL		P\$ 670
	85-0872MD	Veneer		W\$ 992
	<b>For 60"W Tops</b>			
	86-0860MD	TFL		T\$ 468
	86-0860MDH	HPL		P\$ 629
	85-0860MD	Veneer		W\$ 934
	<b>For 48"W Tops</b>			
	86-0848MD	TFL		T\$ 451
	86-0848MDH	HPL		P\$ 612
85-0848MD	Veneer		W\$ 903	
<b>Description</b>				
<ul style="list-style-type: none"> <li>• Modesty Panels are 8"H</li> <li>• Must Specify Color; See <a href="#">HPL/TFL Colors</a> and <a href="#">Veneer Finishes</a></li> </ul>				

T = TFL P = HPL W = Veneer

[See Tri-One Overview For Ordering Options](#)

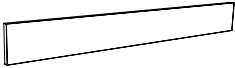

Item	Model No.	Ship Wt	Cubic Ft	List Price
<b>FIXED MODESTY PANEL FOR RECTANGULAR MODULAR TOPS WITH FLEXIBLE SIZES</b>    Must Specify (in this order): Model # Finish/Color	<b>For 84"-73"W TOPS</b>			
	86-FLEXMD84	TFL		T\$ 506
	86-FLEXMDH84	HPL		P\$ 691
	85-FLEXMD84	Veneer		W\$ 1022
	<b>For 72"-61"W TOPS</b>			
	86-FLEXMD72	TFL		T\$ 495
	86-FLEXMDH72	HPL		P\$ 670
	85-FLEXMD72	Veneer		W\$ 992
	<b>For 60"-49"W Tops</b>			
	86-FLEXMD60	TFL		T\$ 468
	86-FLEXMDH60	HPL		P\$ 629
	85-FLEXMD60	Veneer		W\$ 934
	<b>For 48"-36"W Tops</b>			
	86-FLEXMD48	TFL		T\$ 451
	86-FLEXMDH48	HPL		P\$ 612
85-FLEXMD48	Veneer		W\$ 903	

**Description**

- Modesty Panels are 8"H
- Must Specify Color; See [HPL/TFL Colors](#) and [Veneer Finishes](#)

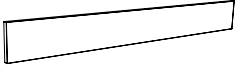
<b>FIXED MODESTY PANEL FOR LEFT &amp; RIGHT TRAPEZOID MODULAR TOPS</b>    Must Specify (in this order): Model # Finish/Color	<b>For 30"D TRAPEZOID TOPS</b>			
	<b>For 84"W TOPS</b>			
	86-0884MDT30	TFL		T\$ 538
	86-0884MDTH30	HPL		P\$ 726
	85-0884MDT30	Veneer		W\$ 1075
	<b>For 72"W TOPS</b>			
	86-0872MDT30	TFL		T\$ 485
	86-0872MDTH30	HPL		P\$ 658
	85-0872MDT30	Veneer		W\$ 974
	<b>For 60"W Tops</b>			
	86-0860MDT30	TFL		T\$ 455
	86-0860MDTH30	HPL		P\$ 619
	85-0860MDT30	Veneer		W\$ 917
	<b>For 48"W Tops</b>			
	86-0848MDT30	TFL		T\$ 431
	86-0848MDTH30	HPL		P\$ 581
	85-0848MDT30	Veneer		W\$ 861
	<b>For 24"D TRAPEZOID TOPS</b>			
	<b>For 84"W TOPS</b>			
	86-0884MDT24	TFL		T\$ 527
	86-0884MDTH24	HPL		P\$ 714
	85-0884MDT24	Veneer		W\$ 1056
	<b>For 72"W TOPS</b>			
	86-0872MDT24	TFL		T\$ 474
	86-0872MDTH24	HPL		P\$ 642
	85-0872MDT24	Veneer		W\$ 949
	<b>For 60"W Tops</b>			
86-0860MDT24	TFL		T\$ 447	
86-0860MDTH24	HPL		P\$ 608	
85-0860MDT24	Veneer		W\$ 894	
<b>For 48"W Tops</b>				
86-0848MDT24	TFL		T\$ 416	
86-0848MDTH24	HPL		P\$ 569	
85-0848MDT24	Veneer		W\$ 842	

**Description**

- Modesty Panels are 8"H
- Must Specify Color; See [HPL/TFL Colors](#) and [Veneer Finishes](#)

T = TFL P = HPL W = Veneer

[See Tri-One Overview For Ordering Options](#)

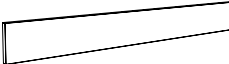
Item	Model No.	Ship Wt	Cubic Ft	List Price	
<b>FIXED MODESTY PANEL FOR LEFT &amp; RIGHT TRAPEZOID MODULAR TOPS WITH FLEXIBLE SIZES</b>  	<b>For 30"D TRAPEZOID TOPS</b>				
	<b>For 84"W-73"W TOPS</b>				
	86-FLEXMDTRP3084	TFL		T\$	538
	86-FLEXMDTRP30H84	HPL		P\$	726
	85-FLEXMDTRP3084	Veneer		W\$	1075
	<b>For 72"W-61"W TOPS</b>				
	86-FLEXMDTRP3072	TFL		T\$	485
	86-FLEXMDTRP30H72	HPL		P\$	658
	85-FLEXMDTRP3072	Veneer		W\$	974
	<b>For 60"W-49"W Tops</b>				
	86-FLEXMDTRP3060	TFL		T\$	455
	86-FLEXMDTRP30H60	HPL		P\$	619
	85-FLEXMDTRP3060	Veneer		W\$	917
	<b>For 48"W-36"W Tops</b>				
	86-FLEXMDTRP3048	TFL		T\$	431
	86-FLEXMDTRP30H48	HPL		P\$	581
	85-FLEXMDTRP3048	Veneer		W\$	861
	<b>For 24"D TRAPEZOID TOPS</b>				
	<b>For 84"W-73"W TOPS</b>				
	86-FLEXMDTRP2484	TFL		T\$	527
	86-FLEXMDTRP24H84	HPL		P\$	714
	85-FLEXMDTRP2484	Veneer		W\$	1056
	<b>For 72"W-61"W TOPS</b>				
	86-FLEXMDTRP2472	TFL		T\$	474
	86-FLEXMDTRP24H72	HPL		P\$	642
	85-FLEXMDTRP2472	Veneer		W\$	949
	<b>For 60"W-49"W Tops</b>				
86-FLEXMDTRP2460	TFL		T\$	447	
86-FLEXMDTRP24H60	HPL		P\$	608	
85-FLEXMDTRP2460	Veneer		W\$	894	
<b>For 48"W-36"W Tops</b>					
86-FLEXMDTRP2448	TFL		T\$	416	
86-FLEXMDTRP24H48	HPL		P\$	569	
85-FLEXMDTRP2448	Veneer		W\$	842	

Must Specify (in this order):



Model #  
Finish/Color

**Description**

- Modesty Panels are 8"H
- Must Specify Color; See [HPL/TFL Colors](#) and [Veneer Finishes](#)

T = TFL P = HPL W = Veneer

[See Tri-One Overview For Ordering Options](#)

Item	Model No.		Kneespace	W	D	H	Ship Wt	Cubic Ft	List Price
<b>RECTANGULAR MEETING TOPS</b>									
<b>Square Edge</b>									
  	86-4296MT	TFL	55	96	42	-	122.2	9.4	T\$ 1166
	86-4296MTH	HPL							P\$ 1580
	85-4296MT	Veneer							W\$ 2341
	86-4284MT	TFL	47	84	42	-	106.9	8.2	T\$ 1096
	86-4284MTH	HPL							P\$ 1485
	85-4284MT	Veneer							W\$ 2196
	86-4272MT	TFL	39	72	42	-	91.7	7.1	T\$ 974
	86-4272MTH	HPL							P\$ 1319
	85-4272MT	Veneer							W\$ 1952
	86-4260MT	TFL	31½	60	42	-	76.4	5.7	T\$ 892
	86-4260MTH	HPL							P\$ 1210
	85-4260MT	Veneer							W\$ 1792
	86-3696MT	TFL	55	96	36	-	104.8	8.1	T\$ 1054
	86-3696MTH	HPL							P\$ 1425
	85-3696MT	Veneer							W\$ 2113
	86-3684MT	TFL	47	84	36	-	92	7.1	T\$ 980
	86-3684MTH	HPL							P\$ 1328
	85-3684MT	Veneer							W\$ 1965
86-3672MT	TFL	39	72	36	-	78.6	6.1	T\$ 891	
86-3672MTH	HPL							P\$ 1207	
85-3672MT	Veneer							W\$ 1788	
86-3660MT	TFL	31½	60	36	-	65.5	5.1	T\$ 818	
86-3660MTH	HPL							P\$ 1110	
85-3660MT	Veneer							W\$ 1645	
<b>Knife Edge</b>									
	86-4296MTKH	HPL	55	96	42	-	122.2	9.4	P\$ 2071
	85-4296MTK	Veneer							W\$ 2855
	86-4284MTKH	HPL	47	84	42	-	106.9	8.2	P\$ 1944
	85-4284MTK	Veneer							W\$ 2679
	86-4272MTKH	HPL	39	72	42	-	91.7	7.1	P\$ 1729
	85-4272MTK	Veneer							W\$ 2383
	86-4260MTKH	HPL	31½	60	42	-	76.4	5.7	P\$ 1587
	85-4260MTK	Veneer							W\$ 2182
	86-3696MTKH	HPL	55	96	36	-	104.8	8.1	P\$ 1869
	85-3696MTK	Veneer							W\$ 2577
	86-3684MTKH	HPL	47	84	36	-	92	7.1	P\$ 1736
	85-3684MTK	Veneer							W\$ 2399
	86-3672MTKH	HPL	39	72	36	-	78.6	6.1	P\$ 1585
	85-3672MTK	Veneer							W\$ 2181
	86-3660MTKH	HPL	31½	60	36	-	65.5	5.1	P\$ 1455
	85-3660MTK	Veneer							W\$ 2004

Must Specify (in this order):  
 Model #  
 Top Finish/Color  
 Leg Model # and Color (if applicable)  
 Grommet/Power/Data Location

Must Order X-Base or Y-Base Separately [See Base/Leg Options.](#)

**Description**

- Profiled on All Four Sides
- Seated Height Base/Legs Required (Assembly Required); Sold Separately, [See Base/Legs Options](#)
- Power & Data Options Available; Sold Separately, [See Multiple Units](#) and [See Locations](#)

T = TFL P = HPL W = Veneer

[See Tri-One Overview For Ordering Options](#)

Item	Model No.		Kneespace	W	D	H	Ship Wt	Cubic Ft	List Price
<b>SOFT RECTANGULAR MEETING TOPS</b>									
<b>Square Edge</b>									
	86-4296SMT	TFL	55	96	42	-	122.2	9.4	T\$ 1127
	86-4296SMTH	HPL							P\$ 1527
	85-4296SMT	Veneer							W\$ 2260
	86-4284SMT	TFL	47	84	42	-	106.9	8.2	T\$ 1061
	86-4284SMTH	HPL							P\$ 1436
	85-4284SMT	Veneer							W\$ 2126
	86-4272SMT	TFL	39	72	42	-	91.7	7.1	T\$ 940
	86-4272SMTH	HPL							P\$ 1277
	85-4272SMT	Veneer							W\$ 1889
	86-4260SMT	TFL	31½	60	42	-	76.4	5.7	T\$ 865
	86-4260SMTH	HPL							P\$ 1173
	85-4260SMT	Veneer							W\$ 1735
86-3696SMT	TFL	55	96	36	-	104.8	8.1	T\$ 1015	
86-3696SMTH	HPL							P\$ 1379	
85-3696SMT	Veneer							W\$ 2035	
86-3684SMT	TFL	47	84	36	-	92	7.1	T\$ 947	
86-3684SMTH	HPL							P\$ 1281	
85-3684SMT	Veneer							W\$ 1898	
86-3672SMT	TFL	39	72	36	-	78.6	6.1	T\$ 863	
86-3672SMTH	HPL							P\$ 1169	
85-3672SMT	Veneer							W\$ 1731	
86-3660SMT	TFL	31½	60	36	-	65.5	5.1	T\$ 795	
86-3660SMTH	HPL							P\$ 1075	
85-3660SMT	Veneer							W\$ 1595	
<b>Knife Edge</b>									
86-4296SMTKH	HPL	55	96	42	-	122.2	9.4	P\$ 2001	
85-4296SMTK	Veneer							W\$ 2756	
86-4284SMTKH	HPL	47	84	42	-	106.9	8.2	P\$ 1883	
85-4284SMTK	Veneer							W\$ 2594	
86-4272SMTKH	HPL	39	72	42	-	91.7	7.1	P\$ 1675	
85-4272SMTK	Veneer							W\$ 2303	
86-4260SMTKH	HPL	31½	60	42	-	76.4	5.7	P\$ 1537	
85-4260SMTK	Veneer							W\$ 2120	
86-3696SMTKH	HPL	55	96	36	-	104.8	8.1	P\$ 1803	
85-3696SMTK	Veneer							W\$ 2480	
86-3684SMTKH	HPL	47	84	36	-	92	7.1	P\$ 1680	
85-3684SMTK	Veneer							W\$ 2314	
86-3672SMTKH	HPL	39	72	36	-	78.6	6.1	P\$ 1530	
85-3672SMTK	Veneer							W\$ 2111	
86-3660SMTKH	HPL	31½	60	36	-	65.5	5.1	P\$ 1412	
85-3660SMTK	Veneer							W\$ 1944	

Must Specify (in this order):  
 Model #  
 Top Finish/Color  
 Leg Model # and Color (if applicable)  
 Grommet/Power/Data Location

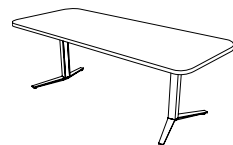

Must Order X-Base or Y-Base Separately [See Base/Leg Options.](#)

**Description**

- Profiled on All Four Sides
- Seated Height Base/Legs Required (Assembly Required); Sold Separately, [See Base/Legs Options](#)
- Power & Data Options Available; Sold Separately, [See Multiple Units](#) and [See Locations](#)

T = TFL P = HPL W = Veneer

[See Tri-One Overview For Ordering Options](#)

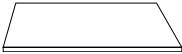
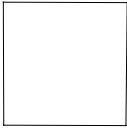
Item	Model No.		W	D	H	Ship Wt	Cubic Ft	List Price	
<b>SQUARE MEETING TOPS</b>		<b>Square Edge</b>							
	86-4242SQ	TFL	42	42	-	70	3.3	T\$ 686	
	86-4242SQH	HPL						P\$ 928	
	85-4242SQ	Veneer						W\$ 1373	
	86-3636SQ	TFL	36	36	-	37	2.5	T\$ 583	
	86-3636SQH	HPL						P\$ 794	
	85-3636SQ	Veneer						W\$ 1173	
	86-3030SQ	TFL	30	30	-	30	2.2	T\$ 514	
	86-3030SQH	HPL						P\$ 698	
	85-3030SQ	Veneer						W\$ 1029	

Must Specify (in this order):

- Model #
- Top Finish/Color
- Leg Model # and Color (if applicable)



Must Order X-Base Separately.  
[See Base/Leg Options.](#)

		<b>Knife Edge</b>							
	86-4242SQKH	HPL	42	42	-	70	3.3	P\$ 1213	
	85-4242SQQ	Veneer						W\$ 1677	
	86-3636SQKH	HPL	36	36	-	37	2.5	P\$ 1037	
	85-3636SQQ	Veneer						W\$ 1429	
	86-3030SQKH	HPL	30	30	-	30	2.2	P\$ 914	
	85-3030SQQ	Veneer						W\$ 1255	

**Description**

- Profiled on All Four Sides
- Base/Legs Required (Assembly Required); Sold Separately, [See Base/Legs Options](#)

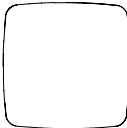
Item	Model No.		W	D	H	Ship Wt	Cubic Ft	List Price	
<b>SOFT SQUARE MEETING TOPS</b>		<b>Square Edge</b>							
	86-4242SSQ	TFL	42	42	-	70	3.3	T\$ 662	
	86-4242SSQH	HPL						P\$ 895	
	85-4242SSQ	Veneer						W\$ 1373	
	86-3636SSQ	TFL	36	36	-	37	2.5	T\$ 569	
	86-3636SSQH	HPL						P\$ 768	
	85-3636SSQ	Veneer						W\$ 1139	
	86-3030SSQ	TFL	30	30	-	30	2.2	T\$ 501	
	86-3030SSQH	HPL						P\$ 680	
	85-3030SSQ	Veneer						W\$ 1009	

Must Specify (in this order):

- Model #
- Top Finish/Color
- Leg Model # and Color (if applicable)





Must Order X-Base Separately.  
[See Base/Leg Options.](#)

		<b>Knife Edge</b>							
	86-4242SSQKH	HPL	42	42	-	70	3.3	P\$ 1174	
	85-4242SSQQ	Veneer						W\$ 1620	
	86-3636SSQKH	HPL	36	36	-	37	2.5	P\$ 1008	
	85-3636SSQQ	Veneer						W\$ 1389	
	86-3030SSQKH	HPL	30	30	-	30	2.2	P\$ 892	
	85-3030SSQQ	Veneer						W\$ 1232	

**Description**

- Profiled on All Four Sides
- Base/Legs Required (Assembly Required); Sold Separately, [See Base/Legs Options](#)

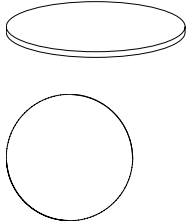
T = TFL P = HPL W = Veneer



Item	Model No.		W	D	H	Ship Wt	Cubic Ft	List Price	
<b>ROUND MEETING TOPS</b>		<b>Square Edge</b>							
	86-4848CT	TFL	48	48	-	95	4.3	T\$ 741	
	86-4848CTH	HPL						P\$ 1005	
	85-4848CT	Veneer						W\$ 1486	
	86-4242CT	TFL	42	42	-	70	3.3	T\$ 643	
	86-4242CTH	HPL						P\$ 873	
	85-4242CT	Veneer						W\$ 1290	
	86-3636CT	TFL	36	36	-	37	2.5	T\$ 563	
	86-3636CTH	HPL						P\$ 762	
	85-3636CT	Veneer						W\$ 1128	
	86-3030CT	TFL	30	30	-	30	2.2	T\$ 498	
86-3030CTH	HPL						P\$ 673		
85-3030CT	Veneer						W\$ 997		
		<b>Knife Edge</b>							
	86-4848CTKH	HPL	48	48	-	95	4.3	P\$ 1315	
	85-4848CTK	Veneer						W\$ 1812	
	86-4242CTKH	HPL	42	42	-	70	3.3	P\$ 1142	
	85-4242CTK	Veneer						W\$ 1573	
	86-3636CTKH	HPL	36	36	-	37	2.5	P\$ 999	
	85-3636CTK	Veneer						W\$ 1378	
	86-3030CTKH	HPL	30	30	-	30	2.2	P\$ 883	
	85-3030CTK	Veneer						W\$ 1215	

Must Specify (in this order):  
 Model #  
 Top Finish/Color  
 Leg Model # and Color (if applicable)

Must Order X-Base Separately. [See Base/Leg Options.](#)

**Description**

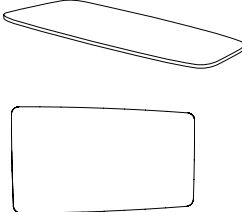
- Profiled on All Sides
- Base/Legs Required (Assembly Required); Sold Separately, [See Base/Leg Options](#)

Item	Model No.		W	D	H	Ship Wt	Cubic Ft	List Price	
<b>SOFT VIEW MEETING TOPS</b>		<b>Square Edge</b>							
	86-4296SVT	TFL	96	42-36	-	122.2	9.4	T\$ 1122	
	86-4296SVTH	HPL						P\$ 1517	
	85-4296SVT	Veneer						W\$ 2247	
	86-4284SVT	TFL	84	42-36	-	106.9	8.2	T\$ 1014	
	86-4284SVTH	HPL						P\$ 1373	
	85-4284SVT	Veneer						W\$ 2034	
	86-4272SVT	TFL	72	42-36	-	91.7	7.1	T\$ 939	
	86-4272SVTH	HPL						P\$ 1276	
	85-4272SVT	Veneer						W\$ 1887	
			<b>Knife Edge</b>						
	86-4296SVTKH	HPL	96	42-36	-	122.2	9.4	P\$ 1989	
	85-4296SVTK	Veneer						W\$ 2743	
	86-4284SVTKH	HPL	84	42-36	-	106.9	8.2	P\$ 1798	
	85-4284SVTK	Veneer						W\$ 2479	
	86-4272SVTKH	HPL	72	42-36	-	91.7	7.1	P\$ 1672	
85-4272SVTK	Veneer						W\$ 2302		

Must Specify (in this order):  
 Model #  
 Top Finish/Color  
 Leg Model # and Color (if applicable)  
 Grommet/Power/Data Location

Must Order X-Base Separately. [See Base/Leg Options.](#)

**Description**

- Profiled on All Four Sides
- Base/Legs Required (Assembly Required); Sold Separately, [See Base/Leg Options](#)
- Power & Data Options Available; Sold Separately, [See Multiple Units](#) and [See Locations](#)

T = TFL P = HPL W = Veneer

[See Tri-One Overview For Ordering Options](#)

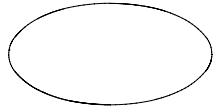
Item	Model No.		W	D	H	Ship Wt	Cubic Ft	List Price
<b>ELLIPSE MEETING TOPS</b>								
<b>Square Edge</b>								
	86-4284EMT	TFL	84	42	-	106.9	8.2	T\$ 1053
	86-4284EMTH	HPL						P\$ 1423
	85-4284EMT	Veneer						W\$ 2108
	86-3672EMT	TFL	72	36	-	78.6	6.1	T\$ 853
	86-3672EMTH	HPL						P\$ 1158
	85-3672EMT	Veneer						W\$ 1714
<b>Knife Edge</b>								
	86-4284EMTKH	HPL	84	42	-	106.9	8.2	P\$ 1864
	85-4284EMTK	Veneer						W\$ 2568
	86-3672EMTKH	HPL	72	36	-	78.6	6.1	P\$ 1515
	85-3672EMTK	Veneer						W\$ 2089

Must Specify (in this order):  
 Model #  
 Top Finish/Color  
 Leg Model #  
 Grommet/Power/Data Location

**Description**

- Includes Stiffener Bar for Additional Support
- Profiled on All Four Sides
- Legs Required (Assembly Required); Sold Separately, See Below
- Power & Data Options Available; Sold Separately, [See Multiple Units](#) and [See Locations](#)

**Specify & Add: Your Choice Of Legs**

08-0227APL4	Envy Post Leg (Set of 4)					20	1.6	\$ 864
	<ul style="list-style-type: none"> <li>• Available in Aluminum</li> <li>• Each Leg has Adjustable Glides</li> <li>• Legs Are Not Available To Be Sold Separately</li> </ul>							
08-0227SPL4	Vantage Post Leg (Set of 4)					20	1.6	\$ 699
	<ul style="list-style-type: none"> <li>• Available in Aluminum</li> <li>• Each Leg has Adjustable Glides</li> <li>• Legs Are Not Available To Be Sold Separately</li> </ul>							

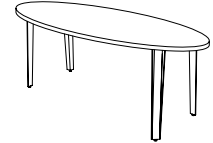

**Must Order Envy or Vantage Post Legs.**

T = TFL P = HPL W = Veneer

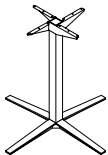
Item	Model No.	Ship Wt	Cubic Ft	List Price
	<b>Large X-Base: For Use with 42"D and 48"D Tops</b>			
	08-2642LXBA	33	20.0	\$ 1322
	<i>For 42"H Tables; Square, Soft Square, and Round Tops Only</i>			
	08-2636LXBA	30	17.2	\$ 1275
	<i>For 36"H Tables; Square, Soft Square, and Round Tops Only</i>			
	08-2630LXBA	27	14.5	\$ 1219
	<i>For 30"H Tables</i>			
	<b>Small X-Base: For Use with 30"D and 36"D Tops</b>			
	08-2042SXBA	27	15.9	\$ 1235
<i>For 42"H Tables; Square, Soft Square, and Round Tops Only</i>				
08-2036SXBA	24	13.7	\$ 1185	
<i>For 36"H Tables; Square, Soft Square, and Round Tops Only</i>				
08-2030SXBA	21	11.6	\$ 1139	
<i>For 30"H Tables</i>				

#### Description

- Available in Aluminum
- Square, Soft Square, and Round Tops Require One (1) Base; All Other Meeting Tops Require Two (2) Seated Height (30"H) Bases
- Bases Are Not Available To Be Sold Separately

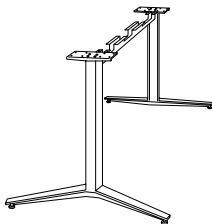
	08-2828YLG96	47	6.5	\$ 1736
	<i>For Use with 96"W Meeting Tops</i>			
	08-2828YLG84	43	5.4	\$ 1713
	<i>For Use with 84"W Meeting Tops</i>			
	08-2828YLG72	39	4.3	\$ 1676
<i>For Use with 72"W Meeting Tops</i>				
08-2828YLG60	35	3.2	\$ 1607	
<i>For Use with 60"W Meeting Tops</i>				

#### Description

- Available in Aluminum
- Y-Base Includes Trough with Removable Panels for Wire Management
- Bases Are Not Available To Be Sold Separately

T = TFL P = HPL W = Veneer

[See Tri-One Overview For Ordering Options](#)

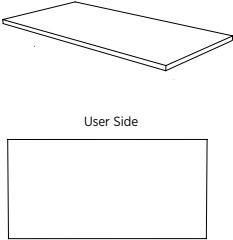

Item	Model No.	Kneespace	W	D	H	Ship Wt	Cubic Ft	List Price
<b>RECTANGULAR TRAINING TOPS</b>								
 <p>User Side</p>	<b>Square Edge</b>							
	86-3072TT	65½	72	30	-	75.5	5.2	T\$ 737
	86-3072TTH							P\$ 997
	86-3060TT	53¾	60	30	-	64.6	4.3	T\$ 656
	86-3060TTH							P\$ 889
	86-3048TT	41½	48	30	-	53.7	3.5	T\$ 598
	86-3048TTH							P\$ 810
	86-2472TT	65½	72	24	-	62.4	4.2	T\$ 671
	86-2472TTH							P\$ 914
	86-2460TT	53¾	60	24	-	53.7	3.5	T\$ 605
	86-2460TTH							P\$ 815
	86-2448TT	41½	48	24	-	44.9	2.8	T\$ 554
	86-2448TTH							P\$ 749
	86-1872TT	65½	72	18	-	49.3	3.2	T\$ 608
	86-1872TTH							P\$ 819
	86-1860TT	53¾	60	18	-	43.7	2.7	T\$ 546
	86-1860TTH							P\$ 741
	86-1848TT	41½	48	18	-	36.2	2.2	T\$ 505
86-1848TTH							P\$ 690	
<b>Knife Edge</b>								
	86-3072TTKH	65½	72	30	-	75.5	5.2	P\$ 1307
	86-3060TTKH	53¾	60	30	-	64.6	4.3	P\$ 1165
	86-3048TTKH	41½	48	30	-	53.7	3.5	P\$ 1061
	86-2472TTKH	65½	72	24	-	62.4	4.2	P\$ 1195
	86-2460TTKH	53¾	60	24	-	53.7	3.5	P\$ 1070
	86-2448TTKH	41½	48	24	-	44.9	2.8	P\$ 982
	86-1872TTKH	65½	72	18	-	49.3	3.2	P\$ 1075
	86-1860TTKH	53¾	60	18	-	42.7	2.7	P\$ 969
	86-1848TTKH	41½	48	18	-	36.2	2.2	P\$ 900

**Must Specify (in this order):**

- Model #
- Top Finish/Color
- Leg Model #
- Ganging Model #
- Nesting Model #
- Grommet/Power/Data Location

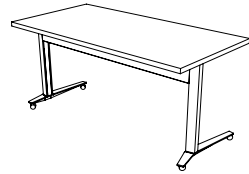

**Must Order Envy C-Leg or Vantage T-Leg Base. See [Envy Details](#) and [Vantage Details](#).**

**Description**

- Profile on User Side Only
- Legs Required (Assembly Required); Sold Separately, See [Envy](#) and [Vantage](#) Details
- Leg Assemblies available with Glides or Casters
- 18"D Tops Available with Envy C-Leg Base Only
- Pre-Drilled for Optional Ganging Brackets, See Below
- Optional Flip Mechanism for Nesting is Available, See Below
- Modesty Panel Standard on Envy C-Leg Base and Optional on Vantage T-Leg Base; Sold Separately, See [Envy C-Leg Base Details](#) and [Vantage T-Leg Base Details](#)
- Power & Data Options Available; Sold Separately, [See Multiple Units](#) and [See Locations](#)

**Options: Specify & Add**

**GANGING**

08-1505GB	Ganging Bracket Kit	\$ 82
	<ul style="list-style-type: none"> <li>• Set of 2 with Thumb Screws</li> <li>• Tops Are Pre-Drilled</li> </ul>	

**NESTING**

08-FLIP	Flip Mechanism for Nesting (Factory Installed)	\$ 503
---------	--	--------

T = TFL P = HPL W = Veneer

[See Tri-One Overview For Ordering Options](#)

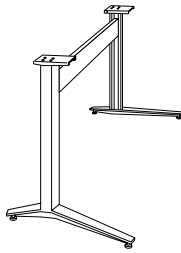
Item	Model No.	Ship Wt	Cubic Ft	List Price
<b>ENVY C-LEG BASE ASSEMBLY FOR TRAINING TOPS</b> 	<b>Large C-Leg Base Assembly: For Use with 24"D and 30"D Tops</b>			
	<b>With Casters: Also Specify Soft Wheel (SOFT) or Hard Wheel (CAST)</b>			
	08-2428CLC72 For 72"W Tops	40	4.3	\$ 1540
	08-2428CLC60 For 60"W Tops	36	3.2	\$ 1483
	08-2428CLC48 For 48"W Tops	32	2.9	\$ 1433
	<b>With Glides:</b>			
	08-2428CLG72 For 72"W Tops	39	4.3	\$ 1406
	08-2428CLG60 For 60"W Tops	35	3.2	\$ 1351
	08-2428CLG48 For 48"W Tops	31	2.9	\$ 1302
	<b>Small C-Leg Base Assembly: For Use with 18"D Tops</b>			
	<b>With Casters: Also Specify Soft Wheel (SOFT) or Hard Wheel (CAST)</b>			
	08-1828CLC72 For 72"W Tops	36	4.3	\$ 1417
	08-1828CLC60 For 60"W Tops	32	3.2	\$ 1362
	08-1828CLC48 For 48"W Tops	28	2.9	\$ 1311
	<b>With Glides:</b>			
08-1828CLG72 For 72"W Tops	35	4.3	\$ 1283	
08-1828CLG60 For 60"W Tops	31	3.2	\$ 1231	
08-1828CLG48 For 48"W Tops	27	2.9	\$ 1179	

Must Specify (in this order):

Model #

Caster Type (if applicable)

#### Description

- Available in Aluminum
- Includes Trough/Modesty
- Legs Feature Removable Panel for Wire Management
- When Casters are Specified, Must Choose Soft Wheel (SOFT) or Hard Wheel (Hard)
- Caster Option Features Two Locking Casters and Two Non-Locking Casters
- Bases Are Not Available To Be Sold Separately

T = TFL P = HPL W = Veneer

[See Tri-One Overview For Ordering Options](#)

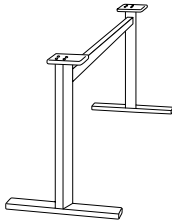
Item	Model No.	Ship Wt	Cubic Ft	List Price	
<b>VANTAGE T-LEG BASE ASSEMBLY FOR TRAINING TOPS</b>    Must Specify (in this order): Model # Caster Type (if applicable) Optional Modesty Optional Modesty Color	<b>Large T-Leg Base Assembly: For Use with 24"D and 30"D Tops</b>				
	<b>With Casters: Also Specify Soft Wheel (SOFT) or Hard Wheel (CAST)</b>				
	08-2428TLC72		36	4.3	\$ 738
		For 72"W Tops			
	08-2428TLC60		32	3.2	\$ 705
		For 60"W Tops			
	08-2428TLC48		28	2.9	\$ 676
		For 48"W Tops			
	<b>With Glides:</b>				
	08-2428TLG72		35	4.3	\$ 708
	For 72"W Tops				
08-2428TLG60		31	3.2	\$ 676	
	For 60"W Tops				
08-2428TLG48		27	2.9	\$ 651	
	For 48"W Tops				

**Description**

- Available in Aluminum
- Not Available for Use on 18"D Tops
- Includes Stretcher Rail
- When Casters are Specified, Must Choose Soft Wheel (SOFT) or Hard Wheel (Hard)
- Caster Option Features Two Locking Casters and Two Non-Locking Casters
- Optional 12"H Modesty Panel, See Below
- Bases Are Not Available To Be Sold Separately

**Optional Modesty Panels: Specify & Add**

**FIXED MODESTY: Used on Standard, Non-Nesting Tables**

86-0872MD	TFL	For 72"W Tops	T\$ 495
86-0872MDH	HPL		P\$ 670
86-0860MD	TFL	For 60"W Tops	T\$ 468
86-0860MDH	HPL		P\$ 629
86-0848MD	TFL	For 48" Tops	T\$ 451
86-0848MDH	HPL		P\$ 612

**HINGED MODESTY: Used on Nesting Tables with Flip Mechanism**

86-0865HMD	TFL	For 72"W Tops	T\$ 495
86-0865HMDH	HPL		P\$ 670
86-0853HMD	TFL	For 60"W Tops	T\$ 469
86-0853HMDH	HPL		P\$ 634
86-0841HMD	TFL	For 48" Tops	T\$ 453
86-0841HMDH	HPL		P\$ 616

T = TFL P = HPL W = Veneer

[See Tri-One Overview For Ordering Options](#)

Item	Model No.		W	D	H	Ship Wt	Cubic Ft	List Price
------	-----------	--	---	---	---	---------	----------	------------

**ROUND GROMMET COVER**

01-GRMTB	Black	2 $\frac{3}{8}$	2 $\frac{3}{8}$	-	1	0.1	\$ 11
01-GRMTSL	Silver						



OPEN MARKET ONLY  
(SILVER)

**Description**

- 2 $\frac{3}{8}$ " (60mm) Round Grommet Cover
- Field Installed

**SINGLE POWER SAND DOLLAR**

01-SAND60PW	White	3	3	4	1	0.2	\$ 98
01-SAND60PB	Black						
01-SAND60PS	Silver						

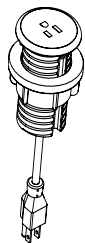
**Description**

- Unit is 2 $\frac{3}{8}$ " Diameter; Mounts in 60mm Round Grommet
- 6' Cord
- Single Power Outlet

**DOUBLE USB SAND DOLLAR**

01-SAND60UW	White	3	3	4	1	0.2	\$ 277
01-SAND60UB	Black						
01-SAND60US	Silver						

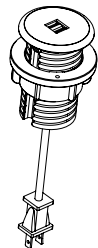
**Description**

- Unit is 2 $\frac{3}{8}$ " Diameter; Mounts in 60mm Round Grommet
- 6' Cord
- Dual USB Outlets

**WIRE MANAGEMENT CHANNEL**

01-WMGR4		16	1 $\frac{1}{2}$	$\frac{3}{4}$	1	-	\$ 116
----------	--	----	-----------------	---------------	---	---	--------

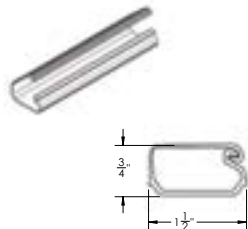
**Description**

- Set of Four (4) Black Plastic Wire Management Channels
- Snap Lock Channel
- Attaches with Adhesive Strips
- Ships via UPS Only

**CABLE GRIP**

01-WMGRCB		5 $\frac{3}{8}$	2 $\frac{3}{8}$	-	-	-	\$ 17
-----------	--	-----------------	-----------------	---	---	---	-------

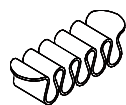
**Description**

- Under Surface Wire Management
- Black

[See Tri-One Overview For Ordering Options](#)

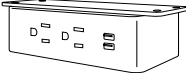
Item	Model No.		W	D	H	Ship Wt	Cubic Ft	List Price
	01-DUOUNDERW	White	6½	2½	3	1	0.2	\$ 546
	01-DUOUNDERB	Black						
	01-DUOUNDEERS	Silver						

**Description**

- Sits Under Table Top and Includes: Two (2) Power, Two (2) USB, 10' Cord, and All Mounting Hardware
- Independent USB Circuit Controllers Deliver up to 2.1 Amps to Each Post
- FCC Part 15A, UL Approved for Horizontal and Vertical Applications
- Works with Tri-One Modular, Meeting, and Training Tables

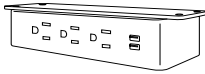
	01-TRIOUNDERW	White	9	2½	3	1	0.2	\$ 655
	01-TRIOUNDERB	Black						
	01-TRIOUNDERS	Silver						

**Description**

- Sits Under Table Top and Includes: Three (3), Power, Two (2) USB, One (1) Open Data, 10' Cord, and All Mounting Hardware
- HDMI, VGA, or RJ45 Accessory for Open Data Port Specified Separately, [See Data Port Options](#)
- Independent USB Circuit Controllers Deliver up to 2.1 Amps to Each Post
- FCC Part 15A, UL Approved for Horizontal and Vertical Applications
- Works with Tri-One Modular, Meeting, and Training Tables

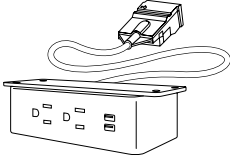
	01-PDUOUNDERW	White	6½	2½	3	1	0.2	\$ 539
	01-PDUOUNDERB	Black						
	01-PDUOUNDEERS	Silver						

**Description**

- Sits Under Table Top and Includes: Two (2) Power, Two (2) USB, 12" Cord, and All Mounting Hardware
- Requires Daisy Chain Power Box, Specified Separately, [See Details](#)
- Non-Sequential System Allows up to 8 Modules to be Connected with Jumper Cord, [See Details](#)
- Independent USB Circuit Controllers Deliver up to 2.1 Amps to Each Post
- FCC Part 15A, RU Listed and UL Recognized for Horizontal Applications
- Works with Tri-One Modular, Meeting, and Training Tables

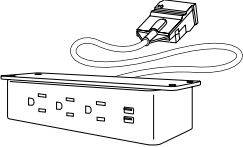
	01-PTRIOUNDERW	White	9	2½	3	1	0.2	\$ 646
	01-PTRIOUNDERB	Black						
	01-PTRIOUNDERS	Silver						

**Description**

- Sits Under Table Top and Includes: Three (3), Power, Two (2) USB, One (1) Open Data, 12" Cord, and All Mounting Hardware
- HDMI, VGA, or RJ45 Accessory for Open Data Port Specified Separately, [See Data Port Options](#)
- Requires Daisy Chain Power Box, Specified Separately, [See Details](#)
- Non-Sequential System Allows up to Eight (8) Modules to be Connected with Jumper Cord, [See Details](#)
- Independent USB Circuit Controllers Deliver up to 2.1 Amps to Each Post
- FCC Part 15A, RU Listed and UL Recognized for Horizontal Applications
- Works with Tri-One Modular, Meeting, and Training Tables

Item	Model No.		W	D	H	Ship Wt	Cubic Ft	List Price
DUO CLAMP NEMA PLUG	01-DUOCLAMPW	White	6½	3	7	1	0.2	\$ 572
	01-DUOCLAMPB	Black						
	01-DUOCLAMP S	Silver						

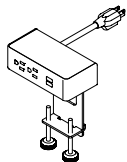

### Description

- Clamps to Table Top and Includes: Two (2) Power, Two (2) USB, 10' Cord, and All Mounting Hardware
- Silver Metal Trim on All Color Options
- Independent USB Circuit Controllers Deliver up to 2.1 Amps to Each Post
- FCC Part 15A, UL Approved for Horizontal and Vertical Applications
- Works with Tri-One Modular, Meeting, and Training Tables

TRIO CLAMP NEMA PLUG	01-TRIOCLAMPW	White	9	3	7	1	0.2	\$ 671
	01-TRIOCLAMPB	Black						
	01-TRIOCLAMP S	Silver						

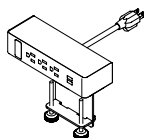

### Description

- Clamps to Table Top and Includes: Three (3), Power, Two (2) USB, One (1) Open Data, 10' Cord, and All Mounting Hardware
- HDMI, VGA, or RJ45 Accessory for Open Data Port Specified Separately, [See Data Port Options](#)
- Silver Metal Trim on All Color Options
- Independent USB Circuit Controllers Deliver up to 2.1 Amps to Each Post
- FCC Part 15A, UL Approved for Horizontal and Vertical Applications
- Works with Tri-One Modular, Meeting, and Training Tables

DUO BEZEL NEMA PLUG	01-DUOBEZELW	White	6½	2½	3¼	1	0.2	\$ 675
	01-DUOBEZELB	Black						
	01-DUOBEZEL S	Silver						



### Description

- Sits on Table Top and Includes: Two (2) Power, Two (2) USB, 10' Cord, and All Mounting Hardware
- Independent USB Circuit Controllers Deliver up to 2.1 Amps to Each Post
- FCC Part 15A, UL Approved for Horizontal and Vertical Applications
- Works with Tri-One Modular, Meeting, and Training Tables

TRIO BEZEL NEMA PLUG	01-TRIOBEZELW	White	9	2½	3	1	0.2	\$ 725
	01-TRIOBEZELB	Black						
	01-TRIOBEZEL S	Silver						



### Description

- Sits on Table Top and Includes: Three (3), Power, Two (2) USB, One (1) Open Data, 10' Cord, and All Mounting Hardware
- HDMI, VGA, or RJ45 Accessory for Open Data Port Specified Separately, [See Data Port Options](#)
- Independent USB Circuit Controllers Deliver up to 2.1 Amps to Each Post
- FCC Part 15A, UL Approved for Horizontal and Vertical Applications
- Works with Tri-One Modular, Meeting, and Training Tables

[See Tri-One Overview For Ordering Options](#)

Item	Model No.		W	D	H	Ship Wt	Cubic Ft	List Price
------	-----------	--	---	---	---	---------	----------	------------

DUO BEZEL DAISY CHAIN PLUG

01-PDUOBEZELW	White	6½	2½	3	1	0.2	\$ 668
01-PDUOBEZELB	Black						
01-PDUOBEZELS	Silver						



**Description**

- Sits on Table Top and Includes: Two (2) Power, Two (2) USB, 12” Cord, and All Mounting Hardware
- Requires Daisy Chain Power Box, Specified Separately, [See Details](#)
- Non-Sequential System Allows up to 8 Modules to be Connected with Jumper Cord, [See Details](#)
- Independent USB Circuit Controllers Deliver up to 2.1 Amps to Each Post
- FCC Part 15A, RU Listed and UL Recognized for Horizontal and Vertical Applications
- Works with Tri-One Modular, Meeting, and Training Tables

TRIO BEZEL DAISY CHAIN PLUG

01-PTRIOBEZELW	White	9	2½	3	1	0.2	\$ 715
01-PTRIOBEZELB	Black						
01-PTRIOBEZELS	Silver						

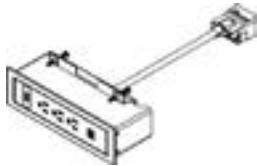

**Description**

- Sits on Table Top and Includes: Three (3), Power, Two (2) USB, One (1) Open Data, 12” Cord, and All Mounting Hardware
- HDMI, VGA, or RJ45 Accessory for Open Data Port Specified Separately, See Below
- Requires Daisy Chain Power Box, Specified Separately, [See Details](#)
- Non-Sequential System Allows up to Eight (8) Modules to be Connected with Jumper Cord, [See Details](#)
- Independent USB Circuit Controllers Deliver up to 2.1 Amps to Each Post
- FCC Part 15A, RU Listed and UL Recognized for Horizontal and Vertical Applications
- Works with Tri-One Modular, Meeting, and Training Tables

HDMI DATA PORT ACCESSORY FOR TRIO UNITS

01-LCOMHDMI		-	-	-	1	0.2	\$ 166
-------------	--	---	---	---	---	-----	--------

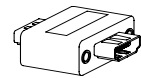

**Description**

- HDMI Port for Trio Units

OPEN MARKET ONLY

VGA DATA PORT ACCESSORY FOR TRIO UNITS

01-LCOMVGA		-	-	-	1	0.2	\$ 121
------------	--	---	---	---	---	-----	--------

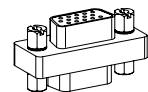

**Description**

- VGA Port for Trio Units

RJ45 DATA PORT ACCESSORY FOR TRIO UNITS

01-LCOMRJ45		-	-	-	1	0.2	\$ 79
-------------	--	---	---	---	---	-----	-------

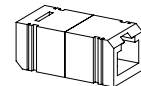

**Description**

- RJ45 Port for Trio Units

Item	Model No.	W	D	H	Ship Wt	Cubic Ft	List Price
 DAISY CHAIN POWER BOX	01-PPOWER	-	-	-	1	0.2	\$ 775
	<i>76" Perimeter, 36" Power Cord</i>						
	01-PPOWER2	-	-	-	1	0.2	\$ 796
	<i>24" Perimeter, 144" Power Cord</i>						

#### Description

- Powers up to Eight (8) Duo and Trio Daisy Chain Units
- One (1) Nema Plug and One (1) Daisy Chain Plug
- 12-Amp System Rating
- 15-Amp Over-Current Protection

 DAISY CHAIN JUMPER CORD	01-6JUMP	<i>72" Long</i>	-	-	-	1	0.2	\$ 299
	01-5JUMP	<i>60" Long</i>	-	-	-	1	0.2	\$ 284
	01-4JUMP	<i>48" Long</i>	-	-	-	1	0.2	\$ 240
	01-2JUMP	<i>24" Long</i>	-	-	-	1	0.2	\$ 220

#### Description

- Connects Duo and Trio Daisy Chain Units
- Non-Sequential System Allows up to 8 Modules to be Connected

POWER STRIP	01-PRSP	9	2	2	1	-	\$ 205
-------------	---------	---	---	---	---	---	--------



#### Description

- Includes Four (4) Outlets and Two (2) Phone Jacks
- Black Plastic with Rocker On/Off Switch
- 13 Amp Circuit Breaker
- 10' Power Cord and Two (2) 14' Phone Hook Up Cords
- UL and CSA Recognized
- Suitable for Surface or Recessed Mounting
- Ships via UPS Only

[See Tri-One Overview For Ordering Options](#)







# Occasional Tables

## **SURFACE MATERIAL DIGITAL IMAGES & BROCHURE**

The finishes represented on Indiana Furniture's Surface Material Finish Brochure were reproduced using the finest technology available. Samples of our finishes and laminates are available for order through our Collateral Store. Please verify your desired finish before ordering as such orders are not subject to return to Indiana Furniture.

Contact your local Indiana Furniture Sales Representative or our Customer Service team should you need assistance.

## **GLIDES**

All tables ship with non-marring glides, some series offering leveling glides as standard. See pricing pages for each series for more information.

## **FINISH**

Indiana Furniture standard occasional table finishes correspond to casegoods and conferencing finishes and laminates. Minor variations in finish color and value may occur due to the natural characteristics of wood. Consult this price list for specific finish availability within each series.

**Special Finishes:** Indiana Furniture is able to accommodate our customer's needs for specific finish matches. Please submit a 3"x5" sample panel to Customer Service for quotation and lead time.

An overview of our finishes and laminate options can be found on the inside of the back cover of this price list.

Arlington offers all the grace and embellishments associated with traditional styling with an added emphasis on value. Finely crafted in select solids with walnut and cherry veneers and high pressure laminate worksurfaces, Arlington ensures quality and expert craftsmanship with a selection of configurations for today's functional workspaces.

**CONSTRUCTION**

- Veneers on exposed surfaces feature select grade, plain sliced American Black Walnut or Cherry veneers, carefully selected and matched to assure proper balance and consistency
- Veneer tops have a 5-ply balanced construction, 1 3/16" thick with solid hardwood rims with butt corners
- HPL tops have a 3-ply balanced construction, 1 3/16" thick, with solid hardwood rims with butt corners
- Grain direction runs left to right
- All units ship with heavy duty, adjustable leveling glides to ensure proper leveling and compensation for uneven floors
- Some Assembly Required

**HOW TO ORDER EXAMPLE**

Model No.	Description	Example
29-2124ET	Top Material Finish	W CO

**VENEER (W) OPTIONS**

Veneer features UVAdvantage, an ultra-violet finish, on all exposed surfaces by utilizing roll-coat UV technology. Apron rails and table legs use a multi-step, hand finished process with a catalyzed finish

AW	Artisan Walnut	HW	Harvest Walnut
CO	Columbian Walnut	LW	Legacy Walnut
DC	Dark Cherry	MW	Mahogany Walnut
DFW	Dark Forest Walnut	PNW	Pinnacle Walnut
EW	Espresso	SCH	Select Cherry
GC	Golden Cherry	SKC	Shaker Cherry
HNW	Henna Walnut	WC	Williamsburg Cherry

**HPL (P) TOP OPTIONS**

**WOODGRAIN**

CO	Columbian Walnut	PNW	Pinnacle Walnut
EF	Espresso	SCH	Select Cherry
GC	Golden Cherry	SKC	Shaker Cherry
MW	Mahogany Walnut	WC	Williamsburg Cherry

**TABLE EDGE PROFILE**



Arlington

**CERTIFICATIONS & COMPLIANCE**

- Intertek Sustainability Certified
- BIFMA level® Certified
- BIFMA Compliant® Certified
- TSCA Title VI (CARB) Compliance
- US Green Building's LEED® Contribution

**STATEMENT OF LINE**



29-2124ET:  
End Table  
[\(See Details\)](#)

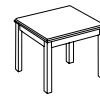

29-2424LT:  
Lamp Table  
[\(See Details\)](#)

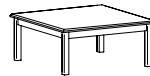

29-3636MT:  
Square Magazine  
Table  
[\(See Details\)](#)

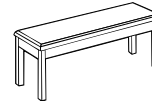

29-1847MT:  
Magazine Table  
[\(See Details\)](#)

Item	Model No.	W	D	H	Ship Wt	Cubic Ft	List Price	
END TABLE	29-2124ET	21	24	21½	25	2.0	P\$ 1027	W\$ 1197

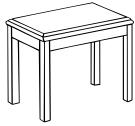

Must Specify (in this order):

- Model #
- Top Material
- Finish/Color

**Description**

- Available with Veneer (W) or HPL (P) Top, Must Specify
- Hardwood Legs
- Some Assembly Required

LAMP TABLE	29-2424LT	24	24	21½	25	2.0	P\$ 1149	W\$ 1233
------------	-----------	----	----	-----	----	-----	----------	----------

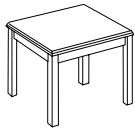

Must Specify (in this order):

- Model #
- Top Material
- Finish/Color

**Description**

- Available with Veneer (W) or HPL (P) Top, Must Specify
- Hardwood Legs
- Some Assembly Required

MAGAZINE TABLE	29-1847MT	47	18	16	47	3.4	P\$ 1233	W\$ 1438
----------------	-----------	----	----	----	----	-----	----------	----------

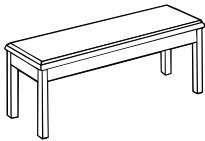

Must Specify (in this order):

- Model #
- Top Material
- Finish/Color
- Leg

**Description**

- Available with Veneer (W) or HPL (P) Top, Must Specify
- Left to Right Grain Direction on Worksurface
- Hardwood Legs
- Some Assembly Required
- Optional 30" Legs; See Below

**Desk Base Molding Options: Must Specify and Add**

SH-36	Optional 30" H Legs	\$ 223
-------	---------------------	--------

SQUARE MAGAZINE TABLE	29-3636MT	36	36	16	60	5.5	P\$ 1317	W\$ 1538
-----------------------	-----------	----	----	----	----	-----	----------	----------

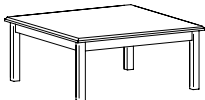

Must Specify (in this order):

- Model #
- Top Material
- Finish/Color

**Description**

- Available with Veneer (W) or HPL (P) Top, Must Specify
- Hardwood Legs
- Some Assembly Required



Wilmington/Arlington

P = HPL W = Veneer

[See Intro Overview For Ordering Options](#)

From lounge areas, to private office, to conference settings, the Bailey Collection can make a statement. Bailey tables are offered in square and rectangular cocktail tables, as well as end tables, in a wide range of veneers and laminates with two edge profiles. Pair Bailey tables with the collection's chairs, settees, sofas, and ottomans.

### CONSTRUCTION

- Bases for tables are manufactured using steel frames with a chrome finish
- The wood veneer tops are made of select grade sliced Black Walnut, Cherry, Maple, or composite veneers for maximum grain and color consistency
- Veneer tops are ¾" with 1mm veneer edge bands
- Laminate tops are ¾" with 1mm PVC edge bands; Designer White, Sugar Maple, and Williamsburg Cherry feature ABS edge bands
- Ships fully assembled

### HOW TO ORDER EXAMPLE

Model No.	Description	Example
720-3030SQ	Finish	TK

### TFL (T) AND HPL (P) LAMINATE OPTIONS

#### WOODGRAIN

AS	Asian Night	PNW	Pinnacle Walnut
BW	Beigewood	SCH	Select Cherry
CO	Columbian Walnut	SKC	Shaker Cherry
EF	Espresso	SBP	Smoky Brown Pear
GC	Golden Cherry	TK	Studio Teak
HVM	Harvest Maple	SM	Sugar Maple
MW	Mahogany Walnut	WTA	Weathered Ash
ORW	Oak Riftwood	WC	Williamsburg Cherry

#### SOLID

BL	Black	PPD	Pepperdust
WH	Designer White	SG	Slate Grey
FHG	Fashion Grey	WHS	White Sand

### VENEER (W) OPTIONS AVAILABLE

Veneer tops feature UVAdvantage, an ultra-violet finish, on all exposed surfaces by utilizing roll-coat UV technology.

AW	Artisan Walnut	MW	Mahogany Walnut
AS	Asian Night	MO	Medium Oak*
CO	Columbian Walnut	ORW	Oak Riftwood*
DC	Dark Cherry	SCH	Select Cherry
DFW	Dark Forest Walnut	SKC	Shaker Cherry
EF	Espresso	SBP	Smoky Brown Pear
FO	Fawn Oak*	SM	Sugar Maple
GC	Golden Cherry	SW	Sunglow Walnut
HW	Harvest Walnut	WTA	Weathered Ash*
LW	Legacy Walnut	WC	Williamsburg Cherry

\* Finish is Low Sheen

### TABLE EDGE PROFILES

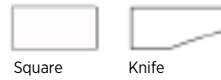

### CERTIFICATIONS & COMPLIANCE

- Intertek Sustainability Certified
- BIFMA level® Certified
- BIFMA Compliant® Certified
- TSCA Title VI (CARB) Compliance
- US Green Building's LEED® Contribution

### STATEMENT OF LINE

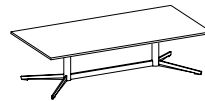

Rectangular  
Cocktail Tables  
[\(See Details\)](#)

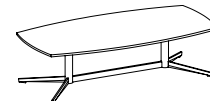

Soft Rectangular  
Cocktail Tables  
[\(See Details\)](#)



Square  
Cocktail Tables  
[\(See Details\)](#)



Soft Square  
Cocktail Tables  
[\(See Details\)](#)



Square  
End Tables  
[\(See Details\)](#)

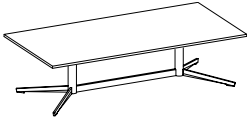
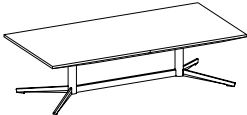

Soft Square  
End Tables  
[\(See Details\)](#)

Item	Model No.		W	D	H	Ship Wt	Cubic Ft	List Price		
<b>RECTANGULAR COCKTAIL TABLE</b>   	<b>SQUARE EDGE</b>									
	720-2550RT	TFL	25	50	14	34.9	3.2	T\$	1440	
	720-2550RTH	HPL	25	50	14	34.9	3.2	P\$	1691	
	719-2550RT	Wood	25	50	14	34.9	3.2	W\$	2045	
	<b>KNIFE EDGE</b>									
	720-2550RTKH	HPL	25	50	14	34.9	3.2	P\$	2096	
719-2550RTK	Wood	25	50	14	34.9	3.2	W\$	2195		

Must Specify (in this order):

Model #  
Finish/Color

#### Description

- Standard with: Chrome Base
- Table Ships Fully Assembled

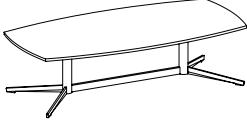
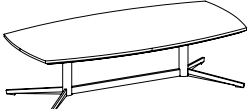
<b>SOFT RECTANGULAR COCKTAIL TABLE</b>   	<b>SQUARE EDGE</b>									
	720-2550SRT	TFL	25	50	14	34.9	3.2	T\$	1440	
	720-2550SRTH	HPL	25	50	14	34.9	3.2	P\$	1691	
	719-2550SRT	Wood	25	50	14	34.9	3.2	W\$	2045	
	<b>KNIFE EDGE</b>									
	720-2550SRTKH	HPL	25	50	14	34.9	3.2	P\$	2096	
719-2550SRTK	Wood	25	50	14	34.9	3.2	W\$	2195		

Must Specify (in this order):

Model #  
Finish/Color

#### Description

- Standard with: Chrome Base
- Table Ships Fully Assembled



Square





Knife

T = TFL P = HPL W = Veneer

[See Intro Overview For Ordering Options](#)





Item	Model No.		W	D	H	Ship Wt	Cubic Ft	List Price		
<b>SQUARE COCKTAIL TABLE</b>    	<b>SQUARE EDGE</b>									
	720-3030SQ	TFL	30	30	14	29.7	2.80	T\$	893	
	720-3030SQH	HPL	30	30	14	29.7	2.80	P\$	1212	
	719-3030SQ	Wood	30	30	14	29.7	2.80	W\$	1407	
	<b>KNIFE EDGE</b>									
	720-3030SQKH	HPL	30	30	14	29.7	2.80	P\$	1528	
719-3030SQK	Wood	30	30	14	29.7	2.80	W\$	1530		

Must Specify (in this order):

Model #  
Finish/Color

**Description**

- Standard with: Chrome Base
- Table Ships Fully Assembled

Item	Model No.		W	D	H	Ship Wt	Cubic Ft	List Price		
<b>SOFT SQUARE COCKTAIL TABLE</b>    	<b>SQUARE EDGE</b>									
	720-3030SSQ	TFL	30	30	14	29.7	2.80	T\$	893	
	720-3030SSQH	HPL	30	30	14	29.7	2.80	P\$	1212	
	719-3030SSQ	Wood	30	30	14	29.7	2.80	W\$	1407	
	<b>KNIFE EDGE</b>									
	720-3030SSQKH	HPL	30	30	14	29.7	2.80	P\$	1528	
719-3030SSQK	Wood	30	30	14	29.7	2.80	W\$	1530		

Must Specify (in this order):

Model #  
Finish/Color

**Description**

- Standard with: Chrome Base
- Table Ships Fully Assembled



Square



Knife

T = TFL P = HPL W = Veneer

[See Intro Overview For Ordering Options](#)

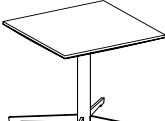
Item	Model No.		W	D	H	Ship Wt	Cubic Ft	List Price	
	<b>SQUARE EDGE</b>								
	720-2020ET	TFL	20	20	20	20	2.0	T\$	976
	720-2020ETH	HPL	20	20	20	20	2.0	P\$	1211
	719-2020ET	Wood	20	20	20	20	2.0	W\$	1284
	<b>KNIFE EDGE</b>								
	720-2020ETKH	HPL	20	20	20	20	2.0	P\$	1349
	719-2020ETK	Wood	20	20	20	20	2.0	W\$	1411

**Description**

- Standard with: Chrome Base
- Table Ships Fully Assembled

Must Specify (in this order):  
Model #  
Finish/Color

Item	Model No.		W	D	H	Ship Wt	Cubic Ft	List Price	
	<b>SQUARE EDGE</b>								
	720-2020SET	TFL	20	20	20	20	2.0	T\$	976
	720-2020SETH	HPL	20	20	20	20	2.0	P\$	1211
	719-2020SET	Wood	20	20	20	20	2.0	W\$	1284
	<b>KNIFE EDGE</b>								
	720-2020SETKH	HPL	20	20	20	20	2.0	P\$	1349
	719-2020SETK	Wood	20	20	20	20	2.0	W\$	1411

**Description**

- Standard with: Chrome Base
- Table Ships Fully Assembled

Must Specify (in this order):  
Model #  
Finish/Color

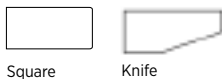

T = TFL P = HPL W = Veneer

[See Intro Overview For Ordering Options](#)

The Britta Collection showcases a Mid-Century Scandinavian aesthetic with an appealing contemporary feel. Available in two edge styles and a broad range of finishes to create an inviting space with warm and energetic sensibility. Pair Britta tables with the collection's guest, single lounge, and settee options, which all feature a wall-saver design, to create an entire setting.

### CONSTRUCTION

- The wood veneer table tops are 1" thick and are made of select grade sliced Walnut, Cherry, or Maple veneers for maximum grain and color consistency
- The knife edge profile features a 5-ply balanced construction with a solid hardwood rim; the square edge profile features a 3-ply balanced construction with a 3mm veneer edge band
- The aprons and legs are solid maple hardwood and ship with adjustable glides
- Ships fully assembled

### HOW TO ORDER EXAMPLE

Model No.	Description	Example
231-1818ET	Finish Edge Profile	DFW K

### VENEER (W) OPTIONS

Veneer tops feature UVAdvantage, an ultra-violet finish, on all exposed surfaces by utilizing roll-coat UV technology. Apron rails and table legs use a multi-step, hand finished process with a catalyzed finish.

AW	Artisan Walnut	LW	Legacy Walnut
CO	Columbian Walnut	MW	Mahogany Walnut
DC	Dark Cherry	MTS	Metropolis Sky
DFW	Dark Forest Walnut	SCH	Select Cherry
EF	Espresso	SKC	Shaker Cherry
GC	Golden Cherry	SM	Sugar Maple
HW	Harvest Walnut	WC	Williamsburg Cherry
HNW	Henna Walnut	PNW	Pinnacle Walnut

### TABLE EDGE PROFILE

Y	Square Edge
K	Knife Edge



Square



Knife

### CERTIFICATIONS & COMPLIANCE

- Intertek Sustainability Certified
- BIFMA level® Certified
- BIFMA Compliant® Certified
- TSCA Title VI (CARB) Compliance
- US Green Building's LEED® Contribution

### STATEMENT OF LINE



231-1818ET: Square  
End Table  
[\(See Details\)](#)

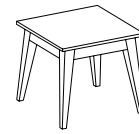

231-2323SCT: Square  
Cocktail Table  
[\(See Details\)](#)



231-4723RCT: Rectangular  
Cocktail Table  
[\(See Details\)](#)

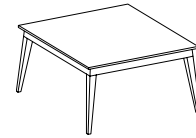

231-3535SCT: Square  
Cocktail Table  
[\(See Details\)](#)

Item	Model No.		W	D	H	Ship Wt	Cubic Ft	List Price	
END TABLE	231-1818ET	Square Edge	18	18	20	18	10.8	Y\$	1438
		Knife Edge						K\$	No Match!



Must Specify (in this order):

Model #  
Finish  
Edge

#### Description

- Standard with: Adjustable Glides
- Available with [Square \(Y\)](#) or [Knife \(K\) Edge](#); Must Specify
- Ships Fully Assembled

SMALL SQUARE COCKTAIL TABLE	231-2323SCT	Square Edge	23	23	16	21	10.8	Y\$	1470
		Knife Edge						K\$	No Match!



Must Specify (in this order):

Model #  
Finish  
Edge

#### Description

- Standard with: Adjustable Glides
- Available with [Square \(Y\)](#) or [Knife \(K\) Edge](#); Must Specify
- Ships Fully Assembled

SQUARE COCKTAIL TABLE	231-3535SCT	Square Edge	34 $\frac{7}{8}$	34 $\frac{7}{8}$	16	45	25.7	Y\$	1762
		Knife Edge						K\$	No Match!

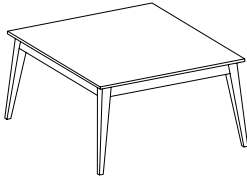

Must Specify (in this order):

Model #  
Finish  
Edge

#### Description

- Standard with: Adjustable Glides
- Available with [Square \(Y\)](#) or [Knife \(K\) Edge](#); Must Specify
- Ships Fully Assembled

RECTANGULAR COCKTAIL TABLE	231-4723RCT	Square Edge	46 $\frac{7}{8}$	23	16	36	23.1	Y\$	1724
		Knife Edge						K\$	No Match!

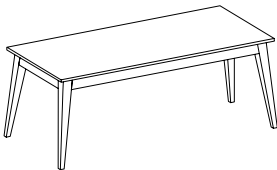

Must Specify (in this order):

Model #  
Finish  
Edge

#### Description

- Standard with: Adjustable Glides
- Available with [Square \(Y\)](#) or [Knife \(K\) Edge](#); Must Specify
- Ships Fully Assembled



Square



Knife

[See Intro Overview For Ordering Options](#)

Always stylish, comfortable and effortlessly adaptable, Canvas enlivens environments with refined aesthetics. Project a fresh, polished attitude with our enhanced selection of multidimensional components. Your creation of an ultra-functional workspace is limited only by your imagination.

### CONSTRUCTION

- Exposed surfaces are produced from wood-grained or solid color laminates fused to a particle-board core.
- TFL chassis are fastened by screws and heavy-duty metal fasteners
- Tops are 1" thick Thermally-Fused (TFL) or High-Pressure (HPL) laminate using 3mm PVC rims on profiled edges Grain direction runs left to right; Designer White, Sugar Maple, and Williamsburg Cherry feature ABS edge bands
- Slab ends come standard with adjustable levelers
- Ships fully assembled

### HOW TO ORDER EXAMPLE

Model No.	Description	Example
66-2424ET	Top Material	T
	Top Color	FHG
	Edge Profile	F
	Chassis Color	WTA

### TFL (T) AND HPL (P) LAMINATE OPTIONS

#### WOODGRAIN

AS	Asian Night	PNW	Pinnacle Walnut
BW	Beigewood	PTK	Portico Teak
CO	Columbian Walnut	RC	River Cherry
EF	Espresso	SCH	Select Cherry
FLW	Florence Walnut	SPW	Sepia Walnut
GC	Golden Cherry	SKC	Shaker Cherry
HVM	Harvest Maple	SBP	Smoky Brown Pear
KHE	Kirsche	TK	Studio Teak
MW	Mahogany Walnut	SM	Sugar Maple
MNR	Midnight Run	WTA	Weathered Ash
NTM	Natural Marrone	WC	Williamsburg Cherry
ORW	Oak Riftwood	WNB	White Nebbia

#### SOLID

BL	Black	FHG	Fashion Grey
WH	Designer White	SG	Slate Grey

### TABLE EDGE PROFILE

F	Double Kerf	Y	Square
G	Duo		
X	Fluted		

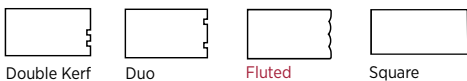

### CERTIFICATIONS & COMPLIANCE

- Intertek Sustainability Certified
- BIFMA level® Certified
- BIFMA Compliant® Certified
- TSCA Title VI (CARB) Compliance
- US Green Building's LEED® Contribution

### STATEMENT OF LINE

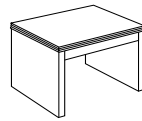

66-2424ET:  
End Table  
[\(See Details\)](#)

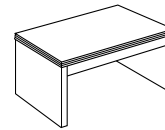

66-2442MT:  
Magazine Table  
[\(See Details\)](#)

Item	Model No.		W	D	H	Ship Wt	Cubic Ft	List Price	
END TABLE	66-2424ET	TFL	24	24	22	65	9.4	T\$	921
		HPL						P\$	1057

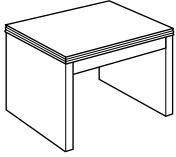

Must Specify (in this order):

- Model #
- Top Material
- Top Color
- Edge
- Chassis Color

**Description**

- Standard with: TFL Slab Ends and Apron Rail, with Adjustable Glides
- Available in Contrasting Top and Chassis Color
- Choose from TFL (T) or HPL (P) Top
- Ships Fully Assembled

MAGAZINE TABLE	66-2442MT	TFL	42	24	16	70	11.9	T\$	970
		HPL						P\$	1136

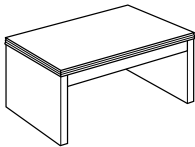

Must Specify (in this order):

- Model #
- Top Material
- Top Color
- Edge
- Chassis Color

**Description**

- Standard with: TFL Slab Ends and Apron Rail, with Adjustable Glides
- Available in Contrasting Top and Chassis Color
- Choose from TFL (T) or HPL (P) Top
- Ships Fully Assembled



Double Kerf



Duo



Square

T=TFL P=HPL

[See Intro Overview For Ordering Options](#)

Carefully matched select veneer tops with solid hardwood legs and aprons form a collection of beautiful wood tables suitable for nearly any application.

### CONSTRUCTION

- Constructed of a 5-ply veneer top, 1½" thick
- Legs are solid Maple hardwood and ship with nylon glides
- Aprons are steam bent with Maple veneer faces
- Grain direction runs left to right
- Elliptical Magazine and Rounded End Tables ship fully assembled; all other models require some assembly

### HOW TO ORDER EXAMPLE

Model No.	Description	Example
294-4222EMT	Finish	HW

### VENEER (W) OPTIONS

Veneer tops feature UVAAdvantage, an ultra-violet finish, on all exposed surfaces by utilizing roll-coat UV technology. Apron rails and table legs use a multi-step, hand finished process with a catalyzed finish

AW	Artisan Walnut	LW	Legacy Walnut
CO	Columbian Walnut	MW	Mahogany Walnut
DC	Dark Cherry	MTS	Metropolis Sky
DFW	Dark Forest Walnut	SCH	Select Cherry
EF	Espresso	SKC	Shaker Cherry
GC	Golden Cherry	SM	Sugar Maple
HW	Harvest Walnut	WC	Williamsburg Cherry
HNW	Henna Walnut	PNW	Pinnacle Walnut

### TABLE EDGE PROFILE

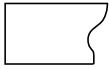

Phoenix

### CERTIFICATIONS & COMPLIANCE

- Intertek Sustainability Certified
- BIFMA level® Certified
- BIFMA Compliant® Certified
- TSCA Title VI (CARB) Compliance
- US Green Building's LEED® Contribution

### STATEMENT OF LINE

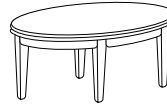

294-4222EMT:  
Elliptical  
Magazine Table  
[\(See Details\)](#)

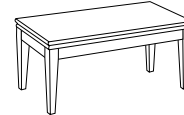

294-4222MT:  
Magazine Table  
[\(See Details\)](#)

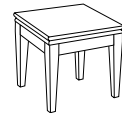

294-2222LT:  
Lamp Table  
[\(See Details\)](#)



294-2622ET:  
End Table  
[\(See Details\)](#)



294-2222RET:  
Rounded End Table  
[\(See Details\)](#)

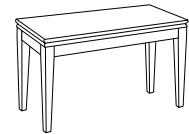

294-4216CT:  
Console Table  
[\(See Details\)](#)

Item	Model No.	W	D	H	Ship Wt	Cubic Ft	List Price
ELLIPTICAL MAGAZINE TABLE	294-4222EMT	42	22	16	48	14.4	\$ 2993



Must Specify (in this order):

Model #  
Finish

**Description**

- Ships Assembled

MAGAZINE TABLE	294-4222MT	42	22	16	33	3.7	\$ 1930
----------------	------------	----	----	----	----	-----	---------

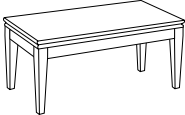

Must Specify (in this order):

Model #  
Finish

**Description**

- Some Assembly Required

LAMP TABLE	294-2222LT	22	22	22	27	2.4	\$ 1473
------------	------------	----	----	----	----	-----	---------



Must Specify (in this order):

Model #  
Finish

**Description**

- Some Assembly Required

END TABLE	294-2622ET	26	22	22	36	2.8	\$ 1553
-----------	------------	----	----	----	----	-----	---------



Must Specify (in this order):

Model #  
Finish

**Description**

- Some Assembly Required

ROUNDED END TABLE	294-2222RET	22	22	22	24	2.4	\$ 2044
-------------------	-------------	----	----	----	----	-----	---------



Must Specify (in this order):

Model #  
Finish

**Description**

- Ships Assembled

CONSOLE TABLE	294-4216CT	42	16	30	36	3.9	\$ 1840
---------------	------------	----	----	----	----	-----	---------

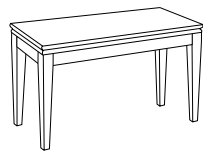

Must Specify (in this order):

Model #  
Finish

**Description**

- Some Assembly Required

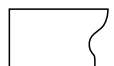

Phoenix

[See Intro Overview For Ordering Options](#)



A foundational suite of casegoods and tables primed to evolve with your needs. Gesso allows you to combine luxurious veneers, top grade laminates and other materials to create stylish, reconfigurable work spaces.

### CONSTRUCTION

- Exposed surfaces feature select grade plain sliced hardwood veneers in Cherry, Maple, American Black Walnut, White Oak, or composite veneers
- Veneer and standard high pressure laminate tops are 3-ply balanced construction and 1 $\frac{3}{8}$ " thick, with 3mm wood edge-banded rims contoured to the selected profile
- Grain direction runs left to right
- All units ship with heavy duty, adjustable leveling glides to ensure proper leveling and compensation for uneven floors
- Ships fully assembled

### HOW TO ORDER EXAMPLE

Model No.	Description	Example
65-2424ET	Top Material	W
	Finish	LW
	Edge Profile	G

### VENEER (W) OPTIONS

Veneer tops feature UVAdvantage, an ultra-violet finish, on all exposed surfaces by utilizing roll-coat UV technology.

AW	Artisan Walnut	MW	Mahogany Walnut
AS	Asian Night	MAS	Mesa Sunset
CO	Columbian Walnut	MTS	Metropolis Sky
DC	Dark Cherry	PNW	Pinnacle Walnut
DFW	Dark Forest Walnut	ORW	Oak Riftwood*
EW	Espresso	SCH	Select Cherry
FO	Fawn Oak*	SKC	Shaker Cherry
GC	Golden Cherry	SM	Sugar Maple
HW	Harvest Walnut	WTA	Weathered Ash*
HNW	Henna Walnut	WC	Williamsburg Cherry
LW	Legacy Walnut		

\* Finish is Low Sheen

### HPL (P) LAMINATE OPTIONS

#### WOODGRAIN

AS	Asian Night	SCH	Select Cherry
CO	Columbian Walnut	SKC	Shaker Cherry
EF	Espresso	SBP	Smoky Brown Pear
GC	Golden Cherry	SM	Sugar Maple
MW	Mahogany Walnut	WTA	Weathered Ash
ORW	Oak Riftwood	WC	Williamsburg Cherry
PNW	Pinnacle Walnut		

#### SOLID

BL	Black	FHG	Fashion Grey
WH	Designer White	SG	Slate Grey

### TABLE EDGE PROFILE

F	Double Kerf	Y	Square
G	Duo		
X	Fluted		

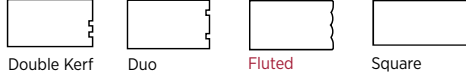

### CERTIFICATIONS & COMPLIANCE

- Intertek Sustainability Certified
- BIFMA level® Certified
- BIFMA Compliant® Certified
- TSCA Title VI (CARB) Compliance
- US Green Building's LEED® Contribution

### STATEMENT OF LINE

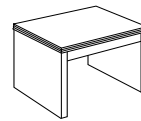

65-2424ET:  
End Table  
[\(See Details\)](#)

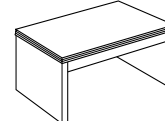

65-2442MT:  
Magazine Table  
[\(See Details\)](#)

Item	Model No.	W	D	H	Ship Wt	Cubic Ft	List Price
END TABLE	65-2424ET	24	24	22	65	9.4	W/P\$ 1632

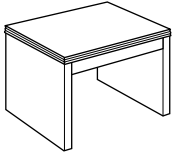

**Description**

- Standard with: Veneer Slab Ends and Apron Rail, with Adjustable Glides
- Choose from HPL (P) or Veneer (W) Top; Must Specify
- Ships Fully Assembled

Must Specify (in this order):

Model #  
Top Material  
Finish/Color  
Edge

MAGAZINE TABLE	65-2442MT	42	24	16	70	11.9	W/P\$ 1718
----------------	-----------	----	----	----	----	------	------------

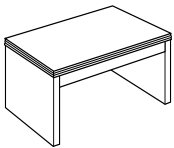

**Description**

- Standard with: Veneer Slab Ends and Apron Rail, with Adjustable Glides
- Choose from HPL (P) or Veneer (W) Top; Must Specify
- Ships Fully Assembled

Must Specify (in this order):

Model #  
Top Material  
Finish/Color  
Edge



Double Kerf



Duo



Square

P = HPL W = Veneer

[See Intro Overview For Ordering Options](#)

Open spaces really come together with Isla Lounge & Tables Collection. Create conversation settings or private areas by mixing components to fit the space and needs of the environment. Power and data options keep everyone working on-the-go.

**CONSTRUCTION**

- External wood parts are kiln-dried hardwoods; internal parts are structurally engineered plywood; European Beech on legs
- Joints are double-doweled or mortised and tenoned, screwed, and glued for maximum strength and durability
- Tops are ¾" thick on occasional tables, 1" thick on Laminate tops, and 1⅜" on Veneer tops
- Non-marring adjustable nylon guides included in each leg at floor level
- Ships fully assembled

**HOW TO ORDER EXAMPLES**

378-1626ET	Top Material	T
	Finish	AS
	Upholstery	Mayer Fedora Topaz
	Leg	WLEG, AS
	Power	PWRUSBA

**TFL (T) LAMINATE TABLE TOP OPTIONS**

WOODGRAIN			
AS	Asian Night	PNW	Pinnacle Walnut
BW	Beigewood	PTK	Portico Teak
CO	Columbian Walnut	RC	River Cherry
EF	Espresso	SPW	Sepia Walnut
FLW	Florence Walnut	SCH	Select Cherry
GC	Golden Cherry	SKC	Shaker Cherry
HVM	Harvest Maple	SBP	Smoky Brown Pear
KHE	Kirsche	TK	Studio Teak
MW	Mahogany Walnut	SM	Sugar Maple
MNR	Midnight Run	WTA	Weathered Ash
NTM	Natural Marrone	WC	Williamsburg Cherry
ORW	Oak Riftwood	WNB	White Nebbia
SOLID			
BL	Black	FHG	Fashion Grey
WH	Designer White	SG	Slate Grey

**VENEER (W) TABLE TOP OPTIONS**

Veneer tops feature UVAdvantage, an ultra-violet finish, on all exposed surfaces by utilizing roll-coat UV technology.

AW	Artisan Walnut	MW	Mahogany Walnut
AS	Asian Night	MAS	Mesa Sunset
CO	Columbian Walnut	MTS	Metropolis Sky
DC	Dark Cherry	ORW	Oak Riftwood*
DFW	Dark Forest Walnut	PNW	Pinnacle Walnut
EF	Espresso	SCH	Select Cherry
FO	Fawn Oak*	SKC	Shaker Cherry
GC	Golden Cherry	SM	Sugar Maple
HW	Harvest Walnut	WTA	Weathered Ash*
HNW	Henna Walnut	WC	Williamsburg Cherry
LW	Legacy Walnut		

\* Finish is Low Sheen

**SOLID SURFACE (S) TABLE TOP OPTIONS**

AR	Arroyo	SNW	Snow White
PE	Pebble Beach	SN	Starry Night
SE	Sedona	TN	Tundra

**SOLID SURFACE EDGE PROFILE OPTIONS**

SI Straight



**LEG OPTIONS**

WLEG	Wood Leg, Specify Finish		Std
CLEG	Chrome Leg		\$ N/C
PLEG	Aluminum Leg		\$ 216
	ALUM Aluminum	BLK Black	
	MIST Mist	OYST Oyster	
	SUGC Sugar Cookie		

**LEG WOOD FINISHES**

Indiana Furniture uses a multi-step, hand-finishing process on all exposed wood frames. Legs feature a catalyzed varnish finish offering durability, lasting beauty, and resistance to normal wear.

AW	Artisan Walnut	MAS	Mesa Sunset
AS	Asian Night	MTS	Metropolis Sky
BW	Beigewood*	MNR	Midnight Run
BL	Black	NTM	Natural Marrone
CO	Columbian Walnut	ORW	Oak Riftwood*
DC	Dark Cherry	PNW	Pinnacle Walnut
DFW	Dark Forest Walnut*	PTK	Portico Teak
WH	Designer White	RC	River Cherry
EF	Espresso	SCH	Select Cherry
FO	Fawn Oak*	SPW	Sepia Walnut
FLW	Florence Walnut	SKC	Shaker Cherry
GC	Golden Cherry	SBP	Smoky Brown Pear
HW	Harvest Walnut	TK	Studio Teak
HNW	Henna Walnut	SM	Sugar Maple
KHE	Kirsche	WTA	Weathered Ash*
LW	Legacy Walnut	WNB	White Nebbia
MW	Mahogany Walnut	WC	Williamsburg Cherry

\* Finish is Low Sheen

**UPHOLSTERY OPTIONS**

Available in single upholstery in a wide variety of graded-in or contract options, including fabric, vinyl, and leather.

**POWER OPTIONS**

PWRUSBA	Power and Two USB Ports, Aluminum	\$ 884
---------	-----------------------------------	--------

**CERTIFICATIONS & COMPLIANCE**

- CAL 117-2013 Compliance
- Intertek Sustainability Certified
- BIFMA level® Certified
- BIFMA Compliant® Certified
- TSCA Title VI (CARB) Compliance
- US Green Building's LEED® Contribution

**Freestanding Tables** (Upholstered Chassis with TFL, Veneer, or Solid Surface Top)

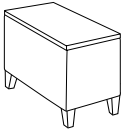

End Table:  
378-1626ET  
[\(See Details\)](#)

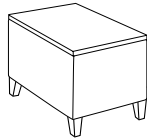

Lamp Table:  
378-2226ET  
[\(See Details\)](#)

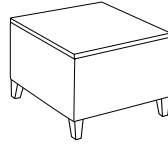

Magazine Table:  
378-2626MT  
[\(See Details\)](#)

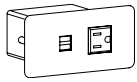

1 Electrical Power  
and 2 USB Outlets

Item	Model No.		W	D	H	Ship Wt	Cubic Ft	List Price	
<b>END TABLE</b>	378-1626ET	TFL	16	26½	15½	42	11.0	T\$	958
		Veneer						W\$	1067
		Solid Surface						S\$	1755



Must Specify (in this order):

- Model #
- Top Material
- Finish/Color
- Fabric
- Leg/Color
- Power

**Description**

- Standard with: Upholstered Chassis and Wood Legs
- Choose TFL (T), Veneer (W), or Solid Surface (S) Top
- Add Upholstery Grade Pricing to Top Material Price
- Optional Leg and Power

Add List Price/Grade	Yards	COM/1	2	3	4	5	6	7	8	9	10	L1	L2
Single Upholstery	1.00	\$ 0	52	96	139	204	270	364	462	576	708	330	471

<b>LAMP TABLE</b>	378-2226ET	TFL	22	26½	15½	48	12.0	T\$	1005
		Veneer						W\$	1235
		Solid Surface						S\$	2079

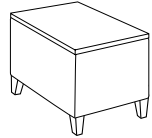

Must Specify (in this order):

- Model #
- Top Material
- Finish/Color
- Fabric
- Leg/Color
- Power

**Description**

- Standard with: Upholstered Chassis and Wood Legs
- Choose TFL (T), Veneer (W), or Solid Surface (S) Top
- Add Upholstery Grade Pricing to Top Material Price
- Optional Leg and Power

Add List Price/Grade	Yards	COM/1	2	3	4	5	6	7	8	9	10	L1	L2
Single Upholstery	1.00	\$ 0	52	96	139	364	270	364	462	576	708	330	471

<b>MAGAZINE TABLE</b>	378-2626MT	TFL	26½	26½	15½	57	15.0	T\$	1064
		Veneer						W\$	1308
		Solid Surface						S\$	2364

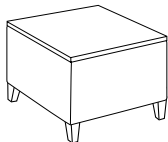

Must Specify (in this order):

- Model #
- Top Material
- Finish/Color
- Fabric
- Leg/Color
- Power

**Description**

- Standard with: Upholstered Chassis and Ganging Hardware
- Choose TFL (T), Veneer (W), or Solid Surface (S) Top
- Add Upholstery Grade Pricing to Top Material Price
- Optional Leg and Power

Add List Price/Grade	Yards	COM/1	2	3	4	5	6	7	8	9	10	L1	L2
Single Upholstery	1.00	\$ 0	52	96	139	204	270	364	462	576	708	330	471

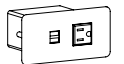

1 Electrical Power and 2 USB Outlets

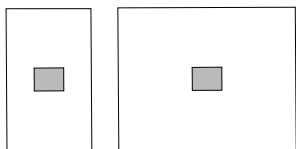

Power is centered into End, Lamp, and Magazine Tables, as shown above

T = TFL W = Veneer S = Solid Surface

[See Intro Overview For Ordering Options](#)



Jefferson echoes history and creates a timeless foundation for today's sophisticated work place. Finely crafted in select solids with walnut veneers, the tailored details of this collection accentuate our expert craftsmanship and perfect attention to detail.

### CONSTRUCTION

- Veneers on exposed surfaces are select grade sliced American Black Walnut and Cherry are carefully selected and matched to assure proper balance and consistency
- Veneer and HPL tops featuring the C2 tops are 5-ply balanced construction, 1 $\frac{3}{16}$ " thick, with solid hardwood mitered rims
- Grain direction runs left to right
- All units ship with heavy duty, adjustable leveling glides to ensure proper leveling and compensation for uneven floors
- Some assembly required

### HOW TO ORDER EXAMPLE

Model No.	Description	Example
46-1824ET	Top Material	W
	Finish	LW

### VENEER (W) AND PREMIUM VENEER (PV) OPTIONS

Veneer tops feature UVAdvantage, an ultra-violet finish, on all exposed surfaces by utilizing roll-coat UV technology. Apron rails and table legs use a multi-step, hand finished process with a catalyzed finish.

AW	Artisan Walnut	LW	Legacy Walnut
CO	Columbian Walnut	MW	Mahogany Walnut
DC	Dark Cherry	MTS	Metropolis Sky
DFW	Dark Forest Walnut	PNW	Pinnacle Walnut
EW	Espresso	SCH	Select Cherry
GC	Golden Cherry	SKC	Shaker Cherry
HNW	Henna Walnut	WC	Williamsburg Cherry
HW	Harvest Walnut		

### HPL (P) TOP OPTIONS

#### WOODGRAIN

CO	Columbian Walnut	PNW	Pinnacle Walnut
EF	Espresso	SCH	Select Cherry
GC	Golden Cherry	SKC	Shaker Cherry
MW	Mahogany Walnut	WC	Williamsburg Cherry

### TABLE EDGE PROFILE



C2

### CERTIFICATIONS & COMPLIANCE

- Intertek Sustainability Certified
- BIFMA level® Certified
- BIFMA Compliant® Certified
- TSCA Title VI (CARB) Compliance
- US Green Building's LEED® Contribution

### STATEMENT OF LINE

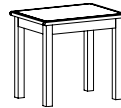

46-1824ET:  
End Table  
[\(See Details\)](#)

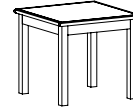

46-2424LT:  
Lamp Table  
[\(See Details\)](#)

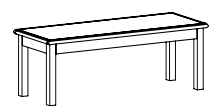

46-1847MT:  
Magazine Table  
[\(See Details\)](#)

Item	Model No.	W	D	H	Ship Wt	Cubic Ft	List Price	
END TABLE	46-1824ET	24	18	21 <sup>13</sup> / <sub>16</sub>	25	2.0	W/P\$	1357
							PV\$	1521

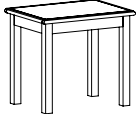

### Description

- Available with Premium/Standard Veneer (PV/W) or HPL (P) Top; Must Specify
- Hardwood Legs
- Some Assembly Required

Must Specify (in this order):

Model #  
Top Material  
Finish/Color

Item	Model No.	W	D	H	Ship Wt	Cubic Ft	List Price	
LAMP TABLE	46-2424LT	24	24	21 <sup>13</sup> / <sub>16</sub>	37	3.3	W/P\$	1728
							PV\$	1935

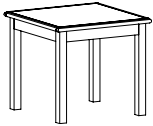

### Description

- Available with Premium/Standard Veneer (PV/W) or HPL (P) Top; Must Specify
- Hardwood Legs
- Some Assembly Required

Must Specify (in this order):

Model #  
Top Material  
Finish/Color

Item	Model No.	W	D	H	Ship Wt	Cubic Ft	List Price	
MAGAZINE TABLE	46-1847MT	47	18	16	42	3.4	W/P\$	1632
							PV\$	1828

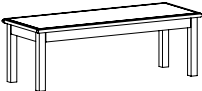

### Description

- Available with Premium/Standard Veneer (PV/W) or HPL (P) Top; Must Specify
- Hardwood Legs
- Optional 30"H Legs
- Some Assembly Required

Must Specify (in this order):

Model #  
Top Material  
Finish/Color  
Optional 30"H Leg

### Options: Specify & Add

SH-46	Optional 30"H Legs	\$	223
-------	--------------------	----	-----



C2

P = HPL W = Veneer

[See Intro Overview For Ordering Options](#)



Discover the perfect table collection that goes anywhere. With a mix of materials, Jot complements a diverse range of interiors from ultra modern to classic. Its metal base, available in five refreshed colors, supports tops in solid surface, veneer, or laminate. Scaled for a perfect fit, Jot makes a great first impression front and center or corner-tucked for convenient storage. Jot's UV Advantage finish features a crystal clear topcoat developed for durability in high traffic areas.

### CONSTRUCTION

- Veneer tops are ¾" thick with veneer edge bands; made of select grade, sliced Black Walnut, Cherry, Maple, or Composite species
- TFL tops are ¾" thick with a 1mm PVC edge band; Designer White, Sugar Maple, and Williamsburg Cherry feature ABS edge bands
- Solid surface tops are ¾" thick and are available in six colors and two edge profiles
- Bases are manufactured using ¾" steel frames and powder coated in your choice of five standard colors
- Joints on bases are mitered and fully welded for maximum strength and durability
- Tops are securely fastened to the bases with metal screws
- Ships fully assembled

### HOW TO ORDER EXAMPLES

410-1412AT	Top Material	T
	Finish	TK
	Edge Detail (if applicable)	-
	Metal Base Color	ALUM

### TFL (T) LAMINATE TABLE TOP OPTIONS

#### WOODGRAIN

AS	Asian Night	PNW	Pinnacle Walnut
BW	Beigewood	PTK	Portico Teak
CO	Columbian Walnut	RC	River Cherry
EF	Espresso	SCH	Select Cherry
FLW	Florence Walnut	SPW	Sepia Walnut
GC	Golden Cherry	SKC	Shaker Cherry
HVM	Harvest Maple	SBP	Smoky Brown Pear
KHE	Kirsche	TK	Studio Teak
MW	Mahogany Walnut	SM	Sugar Maple
MNR	Midnight Run	WTA	Weathered Ash
NTM	Natural Marrone	WC	Williamsburg Cherry
ORW	Oak Riftwood	WNB	White Nebbia

#### SOLID

BL	Black	FHG	Fashion Grey
WH	Designer White	SG	Slate Grey

### VENEER (W) TABLE TOP OPTIONS

Tops feature UV Advantage, an ultra-violet finish, on all exposed surfaces by utilizing roll-coat UV technology.

AW	Artisan Walnut	MW	Mahogany Walnut
AS	Asian Night	MAS	Mesa Sunset
CO	Columbian Walnut	MTS	Metropolis Sky
DC	Dark Cherry	ORW	Oak Riftwood*
DFW	Dark Forest Walnut	PNW	Pinnacle Walnut
EF	Espresso	SCH	Select Cherry
FO	Fawn Oak*	SKC	Shaker Cherry
GC	Golden Cherry	SM	Sugar Maple
HW	Harvest Walnut	WTA	Weathered Ash*
HNW	Henna Walnut	WC	Williamsburg Cherry
LW	Legacy Walnut		

\* Finish is Low Sheen

### SOLID SURFACE (S) TABLE TOP OPTIONS

AR	Arroyo	SNW	Snow White
PE	Pebble Beach	SN	Starry Night
SE	Sedona	TN	Tundra

### SOLID SURFACE EDGE PROFILE OPTIONS

S1	Straight
S2	Roman

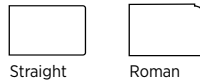

### METAL BASE OPTIONS

ALUM	Aluminum	OYST	Oyster
BLK	Black	SUGC	Sugar Cookie
MIST	Mist		

### CERTIFICATIONS & COMPLIANCE

- Intertek Sustainability Certified
- BIFMA level® Certified
- BIFMA Compliant® Certified
- TSCA Title VI (CARB) Compliance
- US Green Building's LEED® Contribution

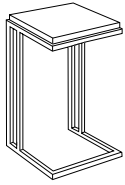

410-1412AT:  
Auxiliary Table  
[\(See Details\)](#)

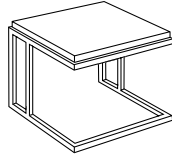

Square End Tables  
410-1818ET: 18"  
410-2424ET: 24"  
[\(See Details\)](#)

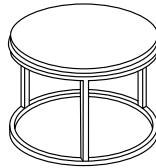

410-2020CT:  
Circular End Table  
[\(See Details\)](#)

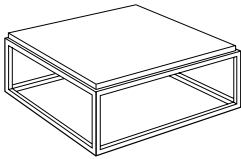

410-3636SQ:  
Square Cocktail  
Table  
[\(See Details\)](#)

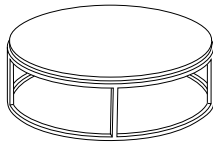

410-3636CT:  
Circular Cocktail  
Table  
[\(See Details\)](#)

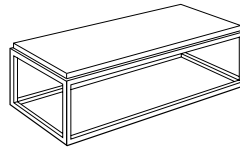

410-2248MT:  
Rectangular Cocktail  
Table  
[\(See Details\)](#)

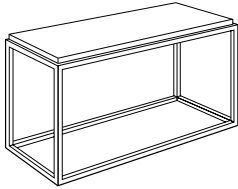

410-1848ST:  
Console Table  
[\(See Details\)](#)

Item	Model No.		W	D	H	Ship Wt	Cubic Ft	List Price
AUXILIARY TABLE	410-1412AT	TFL	12½	14	26½	46	8.6	T\$ 1299
		Veneer						W\$ 1459
		Solid Surface						S\$ 2369

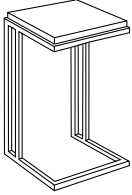

Must Specify (in this order):

Model #  
Top Material  
Finish/Color  
Edge Profile (if applicable)  
Base Color

**Description**

- Standard with: Decorative Metal Base and Nylon Glides
- Select Your Choice of TFL (T), Veneer (W), or Solid Surface (S) Top
- [See Top Options, Base Color Options and Specify](#)

Item	Model No.		W	D	H	Ship Wt	Cubic Ft	List Price
SQUARE END TABLE	410-2424ET	TFL	24	24	20	46	8.6	T\$ 1281
		Veneer						W\$ 1565
		Solid Surface						S\$ 2771
	410-1818ET	TFL	18	18	20	34	5.1	T\$ 1196
		Veneer						W\$ 1411
		Solid Surface						S\$ 2304

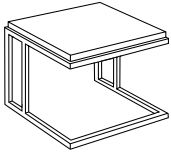

Must Specify (in this order):

Model #  
Top Material  
Finish/Color  
Edge Profile (if applicable)  
Base Color

**Description**

- Standard with: Decorative Metal Base and Nylon Glides
- Select Your Choice of TFL (T), Veneer (W), or Solid Surface (S) Top
- [See Top Options, Base Color Options and Specify](#)

Item	Model No.		W	D	H	Ship Wt	Cubic Ft	List Price
CIRCULAR END TABLE	410-2020CT	TFL	20	20	20	36	6.2	T\$ 1162
		Veneer						W\$ 1484
		Solid Surface						S\$ 4329

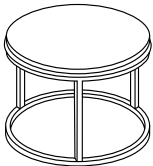

Must Specify (in this order):

Model #  
Top Material  
Finish/Color  
Edge Profile (if applicable)  
Base Color

**Description**

- Standard with: Decorative Metal Base and Adjustable Levelers
- Select Your Choice of TFL (T), Veneer (W), or Solid Surface (S) Top
- [See Top Options, Base Color Options and Specify](#)

Item	Model No.		W	D	H	Ship Wt	Cubic Ft	List Price
SQUARE COCKTAIL TABLE	410-3636SQ	TFL	36	36	15	68	13.4	T\$ 1535
		Veneer						W\$ 1857
		Solid Surface						S\$ 4594

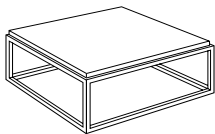

Must Specify (in this order):

Model #  
Top Material  
Finish/Color  
Edge Profile (if applicable)  
Base Color

**Description**

- Standard with: Decorative Metal Base and Nylon Glides
- Select Your Choice of TFL (T), Veneer (W), or Solid Surface (S) Top
- [See Top Options, Base Color Options and Specify](#)

T = TFL W = Veneer S = Solid Surface

[See Intro Overview For Ordering Options](#)

Item	Model No.		W	D	H	Ship Wt	Cubic Ft	List Price
RECTANGULAR COCKTAIL TABLE	410-2248MT	TFL	48	22	15	92	11.0	T\$ 1462
		Veneer						W\$ 1731
		Solid Surface						S\$ 3759

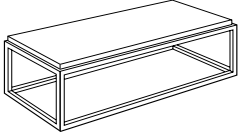

Must Specify (in this order):

Model #  
Top Material  
Finish/Color  
Edge Profile (if applicable)  
Base Color

#### Description

- Standard with: Decorative Metal Base and Nylon Glides
- Select Your Choice of TFL (T), Veneer (W), or Solid Surface (S) Top
- [See Top Options, Base Color Options and Specify](#)

CIRCULAR COCKTAIL TABLE	410-3636CT	TFL	36	36	15	68	13.4	T\$ 1451
		Veneer						W\$ 1844
		Solid Surface						S\$ 6617

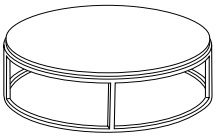

Must Specify (in this order):

Model #  
Top Material  
Finish/Color  
Edge Profile (if applicable)  
Base Color

#### Description

- Standard with: Decorative Metal Base and Adjustable Levelers
- Select Your Choice of TFL (T), Veneer (W), or Solid Surface (S) Top
- [See Top Options, Base Color Options and Specify](#)

CONSOLE TABLE	410-1848ST	TFL	48	18	28	86	17.4	T\$ 1573
		Veneer						W\$ 1871
		Solid Surface						S\$ 3562

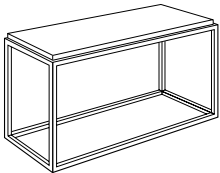

Must Specify (in this order):

Model #  
Top Material  
Finish/Color  
Edge Profile (if applicable)  
Base Color

#### Description

- Standard with: Decorative Metal Base and Adjustable Levelers
- Select Your Choice of TFL (T), Veneer (W), or Solid Surface (S) Top
- [See Top Options, Base Color Options and Specify](#)

T = TFL W = Veneer S = Solid Surface

[See Intro Overview For Ordering Options](#)

Create a variety of looks from refined transitional to clean contemporary with an abundance of finishes and edge details. Madera features ultra violet finish for long lasting beauty in corporate environments, as well as a premium veneer option, which offers a grade of veneer exceeding the general commercial market standards.

### CONSTRUCTION

- Choose from premium veneer or select veneer on exposed surfaces in American Black Walnut, White Oak, Cherry, or Maple species
- Veneer tops are available in the 6 edge profiles and have a 5-ply balanced construction, 1 $\frac{3}{16}$ " thick, with hardwood rims
- High pressure laminate (HPL) tops have a 3-ply balanced construction, 1 $\frac{3}{16}$ " thick, with solid hardwood rims
- Grain direction runs left to right
- All units ship with heavy duty, adjustable leveling glides to ensure proper leveling and compensation for uneven floors
- Ships fully assembled

### HOW TO ORDER EXAMPLE

Model No.	Description	Example
14-1824ET	Top Material	W
	Finish	AW
	Edge Profile	X

### VENEER (W) AND PREMIUM VENEER (PV) OPTIONS

Veneer tops feature UVAdvantage, an ultra-violet finish, on all exposed surfaces by utilizing roll-coat UV technology.

AS	Asian Night	MW	Mahogany Walnut
AW	Artisan Walnut	MAS	Mesa Sunset
CO	Columbian Walnut	MTS	Metropolis Sky
DC	Dark Cherry	ORW	Oak Riftwood
DFW	Dark Forest Walnut	PNW	Pinnacle Walnut
EW	Espresso	SCH	Select Cherry
FO	Fawn Oak*	SKC	Shaker Cherry
GC	Golden Cherry	SM	Sugar Maple
HW	Harvest Walnut	WC	Williamsburg Cherry
HNW	Henna Walnut	WTA	Weathered Ash
LW	Legacy Walnut		

\* Finish is Low Sheen

### HPL (P) LAMINATE OPTIONS

AS	Asian Night	PNW	Pinnacle Walnut
CO	Columbian Walnut	SCH	Select Cherry
EF	Espresso	SKC	Shaker Cherry
GC	Golden Cherry	SM	Sugar Maple
MW	Mahogany Walnut	WC	Williamsburg Cherry
ORW	Oak Riftwood	WTA	Weathered Ash

### TABLE EDGE PROFILE

B	Bevel	A	Radius
D	Bullnose	Y	Square
X	Fluted	E	Tri-Round

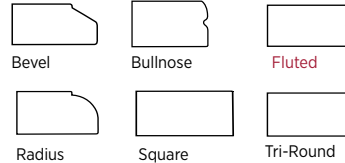

### CERTIFICATIONS & COMPLIANCE

- Intertek Sustainability Certified
- BIFMA level® Certified
- BIFMA Compliant® Certified
- TSCA Title VI (CARB) Compliance
- US Green Building's LEED® Contribution

### STATEMENT OF LINE

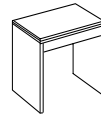

End Table:  
14-1824ET  
[\(See Details\)](#)

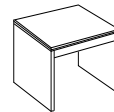

Lamp Table:  
14-2828LT  
[\(See Details\)](#)

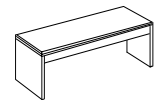

Magazine Table:  
14-1847MT  
[\(See Details\)](#)

Item	Model No.		W	D	H	Ship Wt	Cubic Ft	List Price	
<b>END TABLE</b>	14-1824ET	Veneer or HPL	24	18	21 $\frac{1}{16}$	48	7.6	W/P\$	1365
		Premium Veneer						PV\$	1599

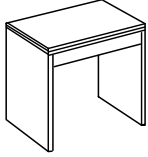

**Description**

- Standard with: Left to Right Grain Direction on Worksurface, Vertical Grain Direction on Solid End Panels
- Available in Premium Veneer (PV) or Standard Veneer (W); Must Specify
- Available with Veneer (PV/W) or HPL (P) Top; Must Specify
- Ships Assembled

Must Specify (in this order):

- Model
- Premium or Standard Veneer
- Chassis
- Top Material
- Finish/Color
- Edge Profile

<b>LAMP TABLE</b>	14-2828LT	Veneer or HPL	28	28	21 $\frac{1}{16}$	56	12.3	W/P\$	1768
		Premium Veneer						PV\$	2072

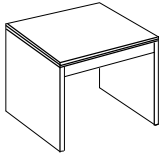

**Description**

- Standard with: Left to Right Grain Direction on Worksurface, Vertical Grain Direction on Solid End Panels
- Available in Premium Veneer (PV) or Standard Veneer (W); Must Specify
- Available with Veneer (PV/W) or HPL (P) Top; Must Specify
- Ships Assembled

Must Specify (in this order):

- Model
- Premium or Standard Veneer
- Chassis
- Top Material
- Finish/Color
- Edge Profile

<b>MAGAZINE TABLE</b>	14-1847MT	Veneer or HPL	47	18	15 $\frac{1}{16}$	75	9.9	W/P\$	1492
		Premium Veneer						PV\$	1747

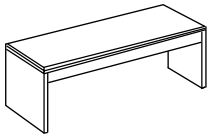

**Description**

- Standard with: Left to Right Grain Direction on Worksurface, Vertical Grain Direction on Solid End Panels
- Available in Premium Veneer (PV) or Standard Veneer (W); Must Specify
- Available with Veneer (PV/W) or HPL (P) Top; Must Specify
- Ships Assembled

Must Specify (in this order):

- Model #
- Top Material
- Finish/Color
- Edge Profile



Bevel



Bullnose



Radius



Square



Tri-Round

P = HPL W = Veneer PV = Premium Veneer

See Intro Overview For Ordering Options

Natta offers an agile solution for a variety of community spaces and meeting applications. With its simplicity of form, it can achieve a subtle effect and still provide an excellent solution for any meeting and breakout environment.

### CONSTRUCTION

- Exposed parts are manufactured using European Beech
- Joints are double-doweled or mortised and tenoned, screwed, and glued for maximum strength and durability
- Frames are individually hand assembled and sanded prior to being finished; Legs are 9¾"H on the rectangular table and 14"H on the square table
- Non-marring nylon glides included in each leg at floor level
- Tables have 1½" thick HPL surface with 1mm PVC edge band Square edge profile; Designer White, Sugar Maple, and Williamsburg Cherry feature ABS edge bands
- Ships fully assembled

### HOW TO ORDER EXAMPLE

Model No.	Description	Example
MMIT-2	Leg Finish Top Color	BW WH

### HPL (P) LAMINATE OPTIONS ON TABLES TOPS

#### WOODGRAIN

AS	Asian Night	PNW	Pinnacle Walnut
BW	Beigewood	PTK	Portico Teak
CO	Columbian Walnut	RC	River Cherry
EF	Espresso	SCH	Select Cherry
FLW	Florence Walnut	SPW	Sepia Walnut
GC	Golden Cherry	SKC	Shaker Cherry
HVM	Harvest Maple	SBP	Smoky Brown Pear
KHE	Kirsche	TK	Studio Teak
MW	Mahogany Walnut	SM	Sugar Maple
MNR	Midnight Run	WTA	Weathered Ash
NTM	Natural Marrone	WNB	White Nebbia
ORW	Oak Riftwood	WC	Williamsburg Cherry

#### SOLID

BL	Black	FHG	Fashion Grey
WH	Designer White	SG	Slate Grey

### WOOD FINISHES AVAILABLE ON LEGS

AW	Artisan Walnut	MAS	Mesa Sunset*
AS	Asian Night	MTS	Metropolis Sky
BW	Beigewood*	MNR	Midnight Run
BL	Black	NTM	Natural Marrone*
CO	Columbian Walnut	ORW	Oak Riftwood*
DC	Dark Cherry	PNW	Pinnacle Walnut
DFW	Dark Forest Walnut*	PTK	Portico Teak*
WH	Designer White	RC	River Cherry*
EF	Espresso	SCH	Select Cherry
FO	Fawn Oak*	SPW	Sepia Walnut*
FLW	Florence Walnut*	SKC	Shaker Cherry
GC	Golden Cherry	SBP	Smoky Brown Pear*
HW	Harvest Walnut	TK	Studio Teak
HNW	Henna Walnut	SM	Sugar Maple
KHE	Kirsche	WTA	Weathered Ash*
LW	Legacy Walnut	WNB	White Nebbia
MW	Mahogany Walnut	WC	Williamsburg Cherry

\* Finish is Low Sheen

### TABLE EDGE PROFILE



Square

### CERTIFICATIONS & COMPLIANCE

- Intertek Sustainability Certified
- BIFMA level® Certified
- BIFMA Compliant® Certified
- TSCA Title VI (CARB) Compliance
- US Green Building's LEED® Contribution

### STATEMENT OF LINE

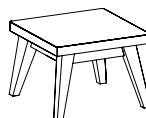

Square Table:  
NAT-3  
[\(See Details\)](#)

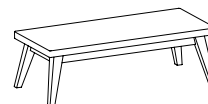

Rectangle Table:  
NAT-2  
[\(See Details\)](#)

Item	Model No.	W	D	H	Ship Wt	Cubic Ft	List Price
SQUARE TABLE	NAT-3	22	22	16	31	10.8	\$ 1013

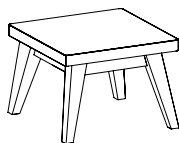

**Description**

- Features Square Edge Profile
- Available with Contrasting Top and Leg Color; [See Colors and Specify](#)

Must Specify (in this order):

Model #  
Leg Finish  
Top Color

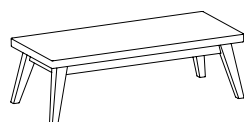
RECTANGLE TABLE	NAT-4	51	22	16	66	25.9	\$ 1381
-----------------	-------	----	----	----	----	------	---------

**Description**

- Features Square Edge Profile
- Available in Contrasting Surface and Leg Color; [See Colors and Specify](#)

Must Specify (in this order):

Model #  
Leg Finish  
Top Color



Crafted in American veneers, Phoenix's clean, transitional styling is at ease in both contemporary and traditional settings. It is a perfect choice for value-minded companies who want a sophisticated, yet uncomplicated, solution.

### CONSTRUCTION

- Veneers on exposed surfaces are select grade sliced American Black Walnut and Cherry, and are carefully selected and matched to assure proper balance and consistency
- Veneer tops are 5-ply balanced construction and 1 $\frac{1}{32}$ " thick. High pressure laminate (HPL) tops are 3-ply balanced construction and 1 $\frac{1}{32}$ " thick
- Grain direction runs left to right
- All units ship with heavy duty, adjustable leveling glides to ensure proper leveling and compensation for uneven floors
- Some assembly required

### HOW TO ORDER EXAMPLE

Model No.	Description	Example
21-1847MT	Top Material	P
	Finish	SKC

### VENEER (W) OPTIONS

Veneer features UVAdvantage, an ultra-violet finish, on all exposed surfaces by utilizing roll-coat UV technology. Apron rails and table legs use a multi-step, hand finished process with a catalyzed finish.

AW	Artisan Walnut	LW	Legacy Walnut
CO	Columbian Walnut	MW	Mahogany Walnut
DC	Dark Cherry	MTS	Metropolis Sky
DFW	Dark Forest Walnut	PNW	Pinnacle Walnut
EW	Espresso	SCH	Select Cherry
GC	Golden Cherry	SKC	Shaker Cherry
HW	Harvest Walnut	WC	Williamsburg Cherry
HNW	Henna Walnut		

### HPL (P) TOP OPTIONS

CO	Columbian Walnut	PNW	Pinnacle Walnut
EF	Espresso	SCH	Select Cherry
GC	Golden Cherry	SKC	Shaker Cherry
MW	Mahogany Walnut	WC	Williamsburg Cherry

### TABLE EDGE PROFILE



Phoenix

### CERTIFICATIONS & COMPLIANCE

- Intertek Sustainability Certified
- BIFMA level® Certified
- BIFMA Compliant® Certified
- TSCA Title VI (CARB) Compliance
- US Green Building's LEED® Contribution

### STATEMENT OF LINE

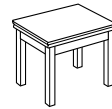

21-1824ET:  
End Table  
([See Details](#))

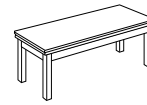

21-1847MT:  
Magazine Table  
([See Details](#))

Item	Model No.		W	D	H	Ship Wt	Cubic Ft	List Price
END TABLE	21-1824ET	HPL Veneer	18	24	22	25	2.0	P\$ 928 W\$ 980

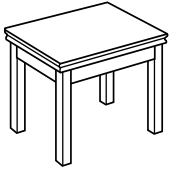

**Description**

- Available with Veneer (W) or HPL (P) Top, Must Specify
- Some Assembly Required

Must Specify (in this order):

Model #  
Top Material  
Finish/Color

MAGAZINE TABLE	21-1847MT	HPL Veneer	47	18	16	42	3.4	P\$ 1210 W\$ 980
----------------	-----------	---------------	----	----	----	----	-----	---------------------

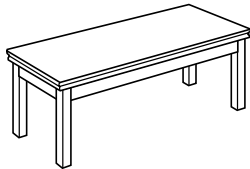

**Description**

- Available with Veneer (W) or HPL (P) Top, Must Specify
- Some Assembly Required
- Optional 30" Leg; See Below

**Leg Option: Specify & Add**

30H-2SQ	30"H Legs					20	0.9	\$ 223
---------	-----------	--	--	--	--	----	-----	--------

Must Specify (in this order):

Model #  
Top Material  
Finish/Color  
Leg



Phoenix

P = HPL W = Veneer

[See Intro Overview For Ordering Options](#)

Plush Lounge seamlessly brings together the endurance needed for commercial spaces with the relaxed comforts of home. Introducing a smart range of freestanding and modular seating components, along with coordinating tables, that provide the flexibility and comfort needed in today's ever-changing environments.

### CONSTRUCTION

- Exposed wood parts are kiln-dried hardwoods, selected from the highest grades of plain sliced hardwood veneers and are free of spirits, discoloration, pits, shakes, and wormholes
- Joints are mortised and tenoned, screwed, and glued for maximum strength and durability
- Maple Wood Legs are 2"Wx2½Dx6"H; Metal Legs are 2"Wx2"Dx6"H
- Non-marring adjustable nylon glides included at floor level
- Table tops are ¾" thick and feature a vertical square profiled edge



- Ships fully assembled

### HOW TO ORDER EXAMPLES

#### TABLE

620-2445CT	Top Material	W
	Finish/Color	ORW
	Cabinet Accent	CAPPD
	Leg	PLALUM
	Leg Finish	-
	Power Location	C
	Power	01-DUOBEZELS

### TABLE LEG OPTIONS

Plush cocktail table comes standard with Black or Aluminum Metal legs. Optional Wood Leg matches our Iconic Caseloads Collection. Must Specify Leg and Color.

PLBLK	Black Metal Leg	STD
PLALUM	Aluminum Metal Leg	STD
ICON	Wood Leg ( <i>Matches the Iconic Collection</i> )	\$ 328



### LEG WOOD FINISHES

Indiana Furniture uses a multi-step, hand finishing process on all exposed wood. Table legs feature a catalyzed varnish finish which offers durability, lasting beauty, and resistance to normal wear.

AW	Artisan Walnut	MAS	Mesa Sunset*
AS	Asian Night	MTS	Metropolis Sky
BW	Beigewood*	MNR	Midnight Run
BL	Black	NTM	Natural Marrone*
CO	Columbian Walnut	ORW	Oak Riftwood*
DC	Dark Cherry	PNW	Pinnacle Walnut
DFW	Dark Forest Walnut*	PTK	Portico Teak*
WH	Designer White	RC	River Cherry*
EF	Espresso	SCH	Select Cherry
FO	Fawn Oak*	SPW	Sepia Walnut*
FLW	Florence Walnut*	SKC	Shaker Cherry
GC	Golden Cherry	SBP	Smoky Brown Pear*
HVM	Harvest Maple	TK	Studio Teak
HW	Harvest Walnut	SM	Sugar Maple
HNW	Henna Walnut	WTA	Weathered Ash*
KHE	Kirsche	WNB	White Nebbia
LW	Legacy Walnut	WC	Williamsburg Cherry
MW	Mahogany Walnut		

\*Finish is Low Sheen

### VENEER TABLES WITH VENEER (W) OR HPL (P) TOP OPTIONS

Veneer tables feature UVAdvantage, an ultra-violet finish, on all exposed surfaces by utilizing roll-coat UV technology.

Veneer tables available with Veneer (W) or HPL (P) Top. Must specify Top Material and Finish Color. Tables are available with contrasting chassis and leg colors.

AW	Artisan Walnut	LW	Legacy Walnut
AS	Asian Night^	MW	Mahogany Walnut
CO	Columbian Walnut^	MAS	Mesa Sunset*
DC	Dark Cherry	MTS	Metropolis Sky
DFW	Dark Forest Walnut	ORW	Oak Riftwood*^
EF	Espresso^	PNW	Pinnacle Walnut^
FO	Fawn Oak*	SCH	Select Cherry
GC	Golden Cherry	SKC	Shaker Cherry^
HVM	Harvest Maple^	SM	Sugar Maple^
HW	Harvest Walnut	WTA	Weathered Ash*^
HNW	Henna Walnut	WC	Williamsburg Cherry^

\*Finish is Low Sheen

^HPL Color Options with Veneer Tables

### TFL TABLES WITH TFL (T) OR HPL (P) TOP OPTIONS

TFL tables available with TFL (T) or HPL (P) Top. Must specify Top Material and Color.

#### WOODGRAIN

AS	Asian Night	PNW	Pinnacle Walnut
BW	Beigewood	PTK	Portico Teak
CO	Columbian Walnut	RC	River Cherry
EF	Espresso	SCH	Select Cherry
FLW	Florence Walnut	SKC	Shaker Cherry
GC	Golden Cherry	SPW	Sepia Walnut
HVM	Harvest Maple	SBP	Smoky Brown Pear
KHE	Kirsche	TK	Studio Teak
MW	Mahogany Walnut	SM	Sugar Maple
MNR	Midnight Run	WTA	Weathered Ash
NTM	Natural Marrone	WNB	White Nebbia
ORW	Oak Riftwood	WC	Williamsburg Cherry

#### SOLID

BL	Black	WH	Designer White
----	-------	----	----------------

### INTERIOR CABINET TABLE ACCENT HPL (P) OPTIONS



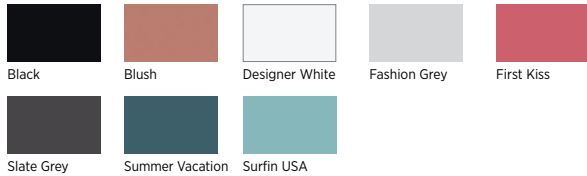

Select Veneer tables feature an optional interior HPL accent color. See specific veneer tables for details.

CABL	Black	CAFK	First Kiss
CABSH	Blush	CASG	Slate Grey
CAWH	Designer White	CASV	Summer Vacation
CAFHG	Fashion Grey	CASUS	Surfin USA





### TABLE POWER OPTIONS

**Power Options + Locations:** Specify the grommet, power, and location.

Grommet	<i>Specify</i>		\$ 52
Black	GBR60		
Silver	GSR60		
D150 Wireless Charger			\$ 405
Wireless & Three (3) USB Ports			
Black	01-DOCK150B		
White	01-DOCK150W		
D950 Wireless & USB Charger			\$ 265
Wireless Charging			
Black	01-DOCK950B		
White	01-DOCK950W		
ECA Cove			\$ 975
One (1) Electrical Power and Two (2) USB Outlets			
Black	01-COVIUBL		
Silver	01-COVIUAL		

### TABLE POWER OPTIONS CONTINUE

DUOBEZEL			\$ 675
Two (2) Electrical Power and Two (2) USB Outlets			
Black	01-DUOBEZELB		
White	01-DUOBEZELS		
Silver	01-DUOBEZELW		

TRIOBEZEL			\$ 725
Three (3) Electrical Power, Two (2) USB Outlets, and One (1) Open Data Port			
Black	01-TRIOBEZELB		
White	01-TRIOBEZELS		
Silver	01-TRIOBEZELW		

#### Open Port Options for TRIOBEZEL

VGA Data Port	01-LCOMVGA	\$ 121
HDMI Data Port (Open Market Only)	01-LCOMHDMI	\$ 166
RJ45 Data Port	01-LCOMRJ45	\$ 79

DPORT4			\$ 1093
Two (2) USB Outlets, and Two (2) Open Data Port			
Aluminum	01-DPORT4A		
Black	01-DPORT4B		

#### Port Options for DPORTS

USB Port	01-USBPORT	\$ 161
Voice Coupler	01-VOICE1	\$ 73
Data Port	01-RJ4DATA	\$ 167

### TABLE POWER LOCATIONS

NONE	None	LC	Left and Centered
C	Centered	RC	Right and Centered
R	Right	LR	Left and Right
L	Left	LCR	Left, Right and Centered

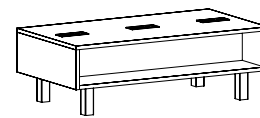

L/R: 6" from ends and 12" from front

C: 22½" from ends and 12" from front

*All power options available in Left, Right and Center.*

Cocktail Table Shown with Metal Leg and Three TRIOBEZEL on Left and Right and Center

### CERTIFICATIONS & COMPLIANCE

- CAL 117-2013 Compliance
- Intertek Sustainability Certified
- BIFMA level® Certified
- BIFMA Compliant® Certified
- TSCA Title VI (CARB) Compliance
- US Green Building's LEED® Contribution

Item	Model No.		W	D	H	Ship Wt	Cubic Ft	List Price	
 COCKTAIL TABLE	620-2445CT	Veneer/HPL	45	24	15	77	9.4	W/P\$	2169
		Veneer Chassis							
	620-2445CTT	TFL	45	24	15	77	9.4	T\$	1325
		TFL Chassis						P\$	1447

Shown with Metal Leg

Must Specify (in this order):  
 Model #  
 Top Material  
 Finish/Color  
 Cabinet Accent Color (Veneer Only)  
 Leg  
 Leg Finish/Color  
 Power Location  
 Power

**Description**

- Standard with: Metal Legs
- Chassis Available in Veneer (W) or TFL (T)
- Top Available with Veneer (W), TFL (T) or HPL (P), Must Specify
- Primary Finish and Wood Legs Available in Contrasting Finish Colors
- 9"D Cubby Area on Both Sides of the Table
- Optional Cabinet Interior Accent Color on Veneer Tables Only; Must Specify Color, [See Color Options](#)
- Optional Wood Leg ([See Color Options](#)) and Power ([See Power Options](#))

**Veneer Table Cabinet Accent Option: Specify Color & Add**

Interior Cabinet Table Accent Color	Available on Veneer Tables Only; <a href="#">See Color Options</a>	\$	191
-------------------------------------	--	----	-----

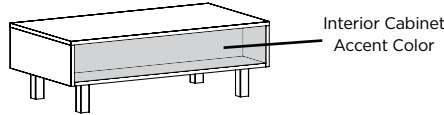



In partnership with Edge Design, a UK-based company, we welcome Spirit.

Spirit has a refined and inviting form, and capitalizes on versatility and comfort. Complete your waiting area, welcoming lobby, or office space with Spirit tables.

### CONSTRUCTION

- Non-marring nylon glides included in each leg at floor level
- Tables have 1" TFL or 1½" HPL surface thickness with 1mm PVC edge band and Square edge profile; Designer White, Sugar Maple, and Williamsburg Cherry feature ABS edge bands
- Bases are comprised of bent wire frames or hardwood legs securely attached to a metal substructure.
- Black or Aluminum Powder Coat, and Chrome wireframes
- Ships fully assembled

### HOW TO ORDER EXAMPLE

Model No.	Description	Example
ST11C	Top Color	WTA
	Base	STWFA

### TFL (T) AND HPL (P) LAMINATE TABLE OPTIONS

#### WOODGRAIN

AS	Asian Night	PNW	Pinnacle Walnut
BW	Beigewood	PTK	Portico Teak
CO	Columbian Walnut	RC	River Cherry
EF	Espresso	SCH	Select Cherry
FLW	Florence Walnut	SPW	Sepia Walnut
GC	Golden Cherry	SKC	Shaker Cherry
HVM	Harvest Maple	SBP	Smoky Brown Pear
KHE	Kirsche	TK	Studio Teak
MW	Mahogany Walnut	SM	Sugar Maple
MNR	Midnight Run	WTA	Weathered Ash
NTM	Natural Marrone	WNB	White Nebbia
ORW	Oak Riftwood	WC	Williamsburg Cherry

#### SOLID

BL	Black	FHG	Fashion Grey
WH	Designer White	SG	Slate Grey

### TABLE BASE OPTIONS

*Not all bases are available on each model. Check availability on pricing pages.*

STWFA	Wireframe, Aluminum	N/C
STWFB	Wireframe, Black	N/C
STWFC	Wireframe, Chrome	\$ 59
SLBO	4-Star Wood Base, Blonde Oak	N/C
SLSPW	4-Star Wood Base, Spiced Walnut	N/C

### TABLE EDGE PROFILE



Square

### CERTIFICATIONS & COMPLIANCE

- Intertek Sustainability Certified
- BIFMA level® Certified
- BIFMA Compliant® Certified
- TSCA Title VI (CARB) Compliance
- US Green Building's LEED® Contribution

### STATEMENT OF LINE



Spirit Square Table

ST11C: TFL  
ST11CH: HPL  
[\(See Details\)](#)

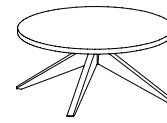

Spirit Round Table

SLT-1W: TFL  
SLT-1WH: HPL  
[\(See Details\)](#)

Item	Model No.		W	D	H	Ship Wt	Cubic Ft	List Price	
SPIRIT SQUARE TABLE	ST11C	TFL	27	27	17	31	11.4	T\$	850
	ST11CH	HPL	27	27	17	31	11.4	P\$	1026

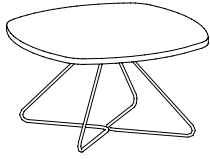

Must Specify (in this order):

- Model #
- Top Color
- Base Color

**Description**

- Standard with: 1" TFL Top or 1½" HPL Top and Wireframe Base; Must Specify Color
- Features Square Edge Profile

**Leg Option: Specify & Add**

STWFA	Wireframe, Aluminum	N/C
STWFB	Wireframe, Black	N/C
STWFC	Wireframe, Chrome	\$ 59

SPIRIT ROUND TABLE	SLT-1W	TFL	31½	31½	14½	31	11.4	T\$	1498
	SLT-1WH	HPL	31½	31½	14½	31	11.4	P\$	1660

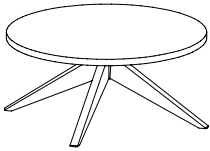

Must Specify (in this order):

- Model #
- Top Color
- Base Color

**Description**

- Standard with: 1" TFL Top or 1½" HPL Top and 4-Star Swivel Wood Base (Select Blonde Oak or Spiced Walnut)
- Features Square Edge Profile



Square

T = TFL P = HPL

[See Intro Overview For Ordering Options](#)



# Space Division

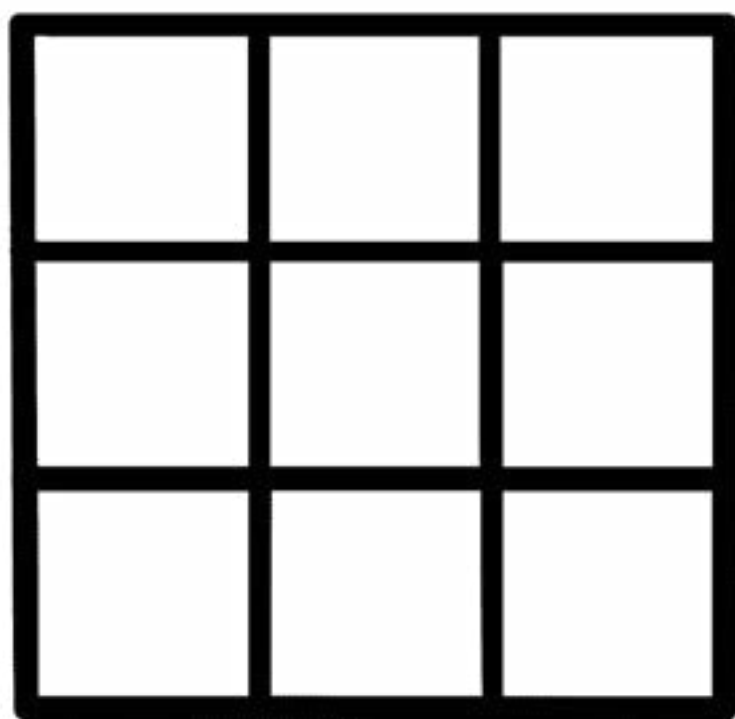

Our functional range of screens and dividers make it easy to create space division within any environment, on nearly any product. Simply add screens to your worksurface, training table, and/or reception desk to create privacy, add protection, or further define personal space.

**CONSTRUCTION**

**ACRYLIC PANELS/SCREENS/DIVIDERS**

- Clear and Frosted Acrylics are ¼" thick, while High Gloss Acrylics are ¾" thick; cut to size and machined for a clean finish

**TFL PANELS/SCREENS/DIVIDERS**

- Made of woodgrain and solid color laminates fused to particle-board core
- Privacy Panels and Above/Below Screens are ¾" thick
- Gallery Screens are 1" thick
- Each laminate offers lasting beauty, superior resistance to normal wear, and easy maintenance

**VENEER PANELS/SCREENS/DIVIDERS**

- Made of select-grade, plain sliced hardwood Cherry, Maple, American Black Walnut, White Oak, or composite veneers; selected and matched to assure proper balance and consistency
- Privacy Panels and Above/Below Screens are ¾" thick
- Gallery Screens are 1" thick
- Veneers feature Indiana Furniture's sustainable UVAdvantage, an ultra-violet topcoat finish, on all exposed surfaces by utilizing roll-coat UV technology

**WIRE MANAGEMENT**

- Grommets may be specified for 51"H Straight Floorstanding Gallery Screens, and are available in black or silver

**CERTIFICATIONS & COMPLIANCE**

- CAL 117-2013 Compliance
- Intertek Sustainability Certified
- BIFMA level® Certified
- BIFMA Compliant Certified
- TSCA Title VI (CARB) Compliance
- US Green Building's LEED Contribution

**HOW TO ORDER EXAMPLES**

SCREEN	QTY	MODEL NO.	DESCRIPTION	EXAMPLE
DIVIDER	2	01-4224SDCA		

ABOVE & BELOW	QTY	MODEL NO.	DESCRIPTION	EXAMPLE
	1	01-6235ABA	Hardware	ALUM

PRIVACY PANEL	QTY	MODEL NO.	DESCRIPTION	EXAMPLE
	4	01-5624PPA	Hardware	CHRM

GALLERY SCREEN	QTY	MODEL NO.	DESCRIPTION	EXAMPLE
	4	65-5173GS	Finish	WTA
			Grommet	DGL, BL
			Grommet	DGR, BL
			Grommet	DGC, BL

**SUPPORT BLOCKS/ATTACHMENT HARDWARE COLOR OPTIONS**

- ALUM Aluminum
- CHRM Chrome

**TFL (T) LAMINATE OPTIONS**

**WOODGRAIN**

AS	Asian Night	PNW	Pinnacle Walnut
BW	Beigewood	PTK	Portico Teak
CO	Columbian Walnut	RC	River Cherry
EF	Espresso	SCH	Select Cherry
FLW	Florence Walnut	SPW	Sepia Walnut
GC	Golden Cherry	SKC	Shaker Cherry
HVM	Harvest Maple	SBP	Smoky Brown Pear
KHE	Kirsche	TK	Studio Teak
MW	Mahogany Walnut	SM	Sugar Maple
MNR	Midnight Run	WTA	Weathered Ash
NTM	Natural Marrone	WC	Williamsburg Cherry
ORW	Oak Riftwood	WNB	White Nebbia

**SOLID**

BL	Black	FHG	Fashion Grey
WH	Designer White	SG	Slate Grey

**VENEER (W) OPTIONS**

AW	Artisan Walnut	MW	Mahogany Walnut
AS	Asian Night	MAS	Mesa Sunset*
CO	Columbian Walnut	MTS	Metropolis Sky
DC	Dark Cherry	PNW	Pinnacle Walnut
DFW	Dark Forest Walnut	ORW	Oak Riftwood*
EW	Espresso	SCH	Select Cherry
FO	Fawn Oak*	SKC	Shaker Cherry
GC	Golden Cherry	SM	Sugar Maple
HW	Harvest Walnut	WTA	Weathered Ash*
HNW	Henna Walnut	WC	Williamsburg Cherry
LW	Legacy Walnut		

\* Finish is Low Sheen

**HIGH GLOSS ACRYLIC OPTIONS**

BLA	Black High Gloss Acrylic
GPA	Graphite High Gloss Acrylic (upcharge)
WHA	White High Gloss Acrylic

**GALLERY SCREEN GROMMET OPTIONS & LOCATIONS**

Multiple grommets may be ordered for each screen.  
Must Specify Model and Color: Black (BLK) or Silver (SLV).

**51"H Gallery Screens**

DGL	Desk Height Left; 6" from end, 5¼" from bottom	\$ 52
DGR	Desk Height Right; 6" from end, 25¼" from bottom	\$ 52
DGC	Desk Height Center; 25¼" from bottom	\$ 52
BGL	Bench Height Left; 6" from end, 15" from bottom	\$ 52
BGR	Bench Height Right; 6" from end, 15" from bottom	\$ 52
BGC	Bench Height Center; 15" from bottom	\$ 52

Grommets may be ordered in non-standard locations. Call Customer Service to assist with specification. Note additional charges and lead times may apply.

# SCREENS+DIVIDERS

## STATEMENT OF LINE

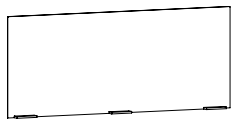

**24" H Privacy Panels**  
*Available in Clear and Frosted Acrylic*  
[\(See Details\)](#)



**12" H Privacy Panels**  
*Available in Frosted and High Gloss Acrylic, TFL, and Veneer*  
[\(See Details\)](#)

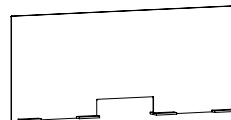

**24" H Privacy Panels with Transaction Slot**  
*Available in Clear Acrylic*  
[\(See Details\)](#)



**24" H Screen Dividers**  
*Available in Clear and Frosted Acrylic*  
[\(See Details\)](#)

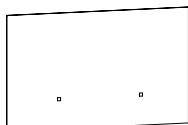

**33" H Above & Below Screens**  
*Available in Frosted Acrylic*  
[\(See Details\)](#)

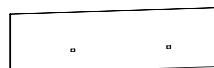

**21" H Above & Below Screen**  
*Available in Frosted and High Gloss Acrylic, TFL, and Veneer*  
[\(See Details\)](#)



**20" H Above & Below Screens**  
*Available in Frosted and High Gloss Acrylic, Tackboard, TFL, and Veneer*  
[\(See Details\)](#)



**17" H Above & Below Screens**  
*Available in Frosted and High Gloss Acrylic, Tackboard, TFL, and Veneer*  
[\(See Details\)](#)



**2-Way & 3-Way Connector Clips**  
*Corner, T, and Straight Connectors for Clear and Frosted Acrylic Options*  
[\(See Details\)](#)

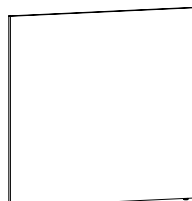

**51" H Straight Gallery Screens**  
*Available in TFL and Veneer*  
[\(See Details\)](#)

# SCREENS+DIVIDERS

IDEA STARTERS

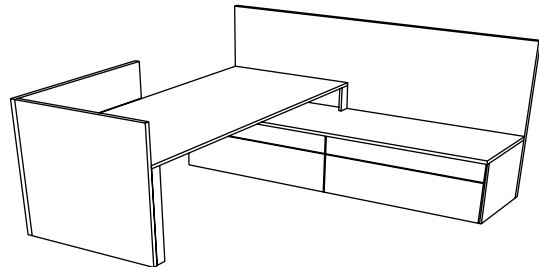
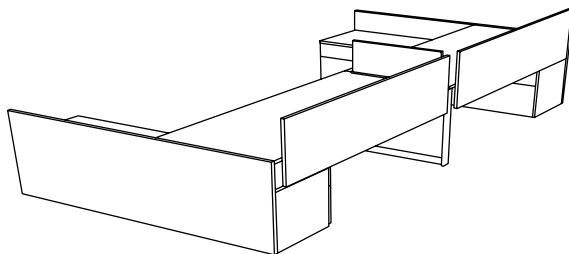
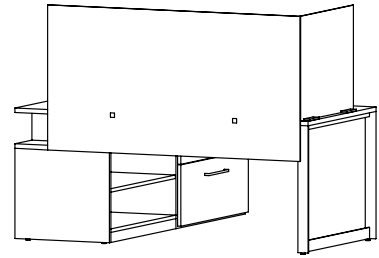
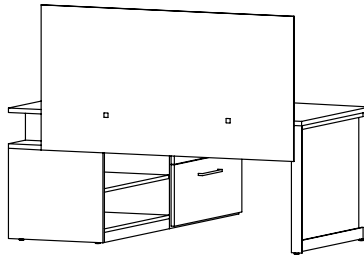
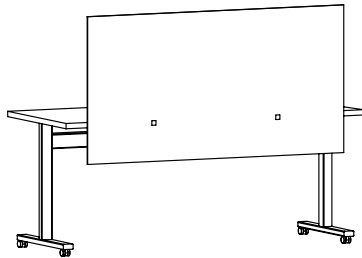
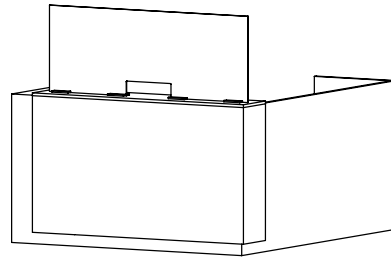
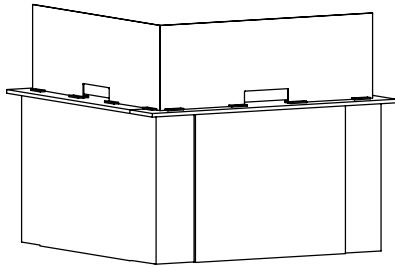
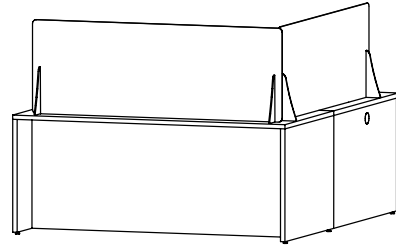
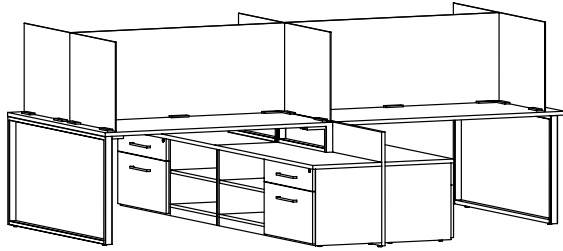

Item	Model No.		W	D	H	Ship Wt	Cubic Ft	List Price	
24"H PRIVACY PANELS 	01-6224PPCA	Clear	62	¼	23½	13.9	2.1	C\$	1162
	01-6224PPA	Frosted						F\$	1457
	01-5624PPCA	Clear	56	¼	23½	11.5	1.9	C\$	1088
	01-5624PPA	Frosted						F\$	1359
	01-2824PPCA	Clear	28	¼	23½	5.8	1.4	C\$	686
	01-2824PPA	Frosted						F\$	831
	01-2224PPCA	Clear	22	¼	23½	4.8	1.2	C\$	614
	01-2224PPA	Frosted						F\$	733

**Description**

- Sets on Surface; Comes with Non-Marring, Removable Adhesive Strip for Surface Attachment
- Available in Clear or Frosted Acrylic
- Acrylic Connector Clips are Recommended for Support on 90° Corner, T Shaped and Straight Applications, [See Connector Clip Details](#)
- Decorative Support Blocks; Must Specify: Aluminum (ALUM) or Chrome (CHRM)
- Some Assembly Required

Item	Model No.		W	D	H	Ship Wt	Cubic Ft	List Price	
12"H PRIVACY PANELS 	66-6812PPA	Frosted	68	¼	12	8	2.2	F\$	982
	66-6812PPGA	High Gloss	68	¾	12	25	2.3	HG\$	1051
	66-6812PPGA	High Gloss Graphite	68	¾	12	25	2.3	GR\$	1233
	66-6812PP	TFL	68	¾	12	26	2.2	T\$	430
	65-6812PP	Veneer	68	¾	12	26	2.2	W\$	761
	66-6212PPA	Frosted	62	¼	12	7	2.0	F\$	925
	66-6212PPGA	High Gloss	62	¾	12	23	2.1	HG\$	979
	66-6212PPGA	High Gloss Graphite	62	¾	12	23	2.1	GR\$	1154
	66-6212PP	TFL	62	¾	12	25	2.0	T\$	419
	65-6212PP	Veneer	62	¾	12	25	2.0	W\$	745
	66-5612PPA	Frosted	56	¼	12	6	1.8	F\$	854
	66-5612PPGA	High Gloss	56	¾	12	22	1.9	HG\$	886
	66-5612PPGA	High Gloss Graphite	56	¾	12	22	1.9	GR\$	1073
	66-5612PP	TFL	56	¾	12	23	1.8	T\$	408
	65-5612PP	Veneer	56	¾	12	23	1.8	W\$	723
	66-2812PPA	Frosted	28	¼	12	8	0.7	F\$	580
	66-2812PPGA	High Gloss	28	¾	12	13	0.9	HG\$	609
	66-2812PPGA	High Gloss Graphite	28	¾	12	13	0.9	GR\$	686
	66-2812PP	TFL	28	¾	12	12	0.9	T\$	355
	65-2812PP	Veneer	28	¾	12	12	0.9	W\$	626
	66-2212PPA	Frosted	22	¼	12	7	0.6	F\$	523
	66-2212PPGA	High Gloss	22	¾	12	11	0.7	HG\$	546
	66-2212PPGA	High Gloss Graphite	22	¾	12	11	0.7	GR\$	605
	66-2212PP	TFL	22	¾	12	10	0.7	T\$	345
	65-2212PP	Veneer	22	¾	12	10	0.7	W\$	612

**Description**

- Sets on Surface
- Available in Frosted or High Gloss Acrylic, TFL, or Veneer; Must Specify; See [TFL Colors](#) or [Veneer Finish](#), and See [High Gloss Acrylic Colors](#)
- Decorative Support Blocks; Must Specify: Aluminum (ALUM) or Chrome (CHRM)
- Some Assembly Required

**Pricing Codes:** C=Clear F=Frosted HG=High Gloss GR=High Gloss Graphite T=TFL W=Veneer

[For ordering options, see overview at the beginning of section.](#)

**SCREENS+DIVIDERS**  
MULTI-USE SPACE DIVISION

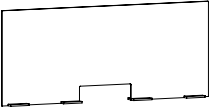
Item	Model No.		W	D	H	Ship Wt	Cubic Ft	List Price
24"H PRIVACY PANELS WITH TRANSACTION SLOT 	01-6224PPSCA	Clear	62	¼	23½	13.9	2.1	\$ 1229
	01-5624PPSCA	Clear	56	¼	23½	11.5	1.9	\$ 1154
	01-5024PPSCA	Clear	50	¼	23½	9.1	1.7	\$ 949
	01-4424PPSCA	Clear	44	¼	23½	6.7	1.5	\$ 877
	01-3824PPSCA	Clear	38	¼	23½	4.3	1.2	\$ 806

**Description**

- Sets on Surface; Comes with Non-Marring Adhesive Strip for Additional Surface Attachment
- Available in Clear Acrylic
- Decorative Support Blocks; Must Specify: Aluminum (ALUM) or Chrome (CHRM)
- Transaction Slot (14"Wx4"H) Always Centered On Panel Along Bottom Edge
- Some Assembly Required

Item	Model No.		W	D	H	Ship Wt	Cubic Ft	List Price
24"H SCREEN DIVIDERS 	01-6624SDCA	Clear	66	¼	23½	11.8	4.7	C\$ 1172
	01-6624SDA	Frosted						F\$ 1424
	01-6024SDCA	Clear	60	¼	23½	10.8	4.2	C\$ 1095
	01-6024SDA	Frosted						F\$ 1327
	01-5424SDCA	Clear	54	¼	23½	9.8	3.7	C\$ 1018
	01-5424SDA	Frosted						F\$ 1228
	01-4824SDCA	Clear	48	¼	23½	8.8	3.2	C\$ 939
	01-4824SDA	Frosted						F\$ 1126
	01-4224SDCA	Clear	42	¼	23½	7.8	2.7	C\$ 864
	01-4224SDA	Frosted						F\$ 1026
	01-3624SDCA	Clear	36	¼	23½	6.8	2.2	C\$ 762
	01-3624SDA	Frosted						F\$ 895
	01-3024SDCA	Clear	30	¼	23½	5.8	1.7	C\$ 709
	01-3024SDA	Frosted						F\$ 830
	01-2424SDCA	Clear	24	¼	23½	4.8	1.2	C\$ 598
	01-2424SDA	Frosted						F\$ 732

**Description**

- Freestanding on Surface
- Available in Clear and Frosted Acrylic
- Supports Constructed of Acrylic; Will Match Screen
- Some Assembly Required

**Pricing Codes:** C=Clear F= Frosted

[For ordering options, see overview at the beginning of section.](#)

# SCREENS+DIVIDERS

## MULTI-USE SPACE DIVISION

Item	Model No.		W	D	H	Ship Wt	Cubic Ft	List Price
33"H ABOVE AND BELOW SCREENS	01-6233ABA	Frosted	62	¼	33	13	3.5	\$ 1792
	01-5633ABA	Frosted	56	¼	33	12	2.9	\$ 1658
	01-5033ABA	Frosted	50	¼	33	11	2.3	\$ 1524
	01-4433ABA	Frosted	44	¼	33	10	1.7	\$ 1389

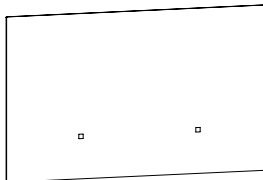

**Description**

- Mounts to Surface
- Available in Frosted Acrylic
- Provides Privacy 24" Above Surface and Modesty 8" Below Surface
- Decorative Attachment Hardware; Must Specify: Aluminum (ALUM) or Chrome (CHRM)

Item	Model No.		W	D	H	Ship Wt	Cubic Ft	List Price
21"H ABOVE AND BELOW SCREENS	66-6821ABA	Frosted	68	¼	21	14	3.3	F\$ 1352
	66-6821ABGA	High Gloss	68	¾	21	44	3.3	HG\$ 1447
	66-6821ABGA	High Gloss Graphite	68	¾	21	44	3.3	GR\$ 1886
	66-6821AB	TFL	68	¾	21	41	3.3	T\$ 471
	65-6821AB	Veneer	68	¾	21	41	3.3	W\$ 840
	66-6221ABA	Frosted	62	¼	21	12	2.8	F\$ 1265
	66-6221ABGA	High Gloss	62	¾	21	41	3	HG\$ 1344
	66-6221ABGA	High Gloss Graphite	62	¾	21	41	3	GR\$ 1747
	66-6221AB	TFL	62	¾	21	39	3	T\$ 459
	65-6221AB	Veneer	62	¾	21	39	3	W\$ 814
	66-5621ABA	Frosted	56	¼	21	10	2.6	F\$ 1177
	66-5621ABGA	High Gloss	56	¾	21	38	2.7	HG\$ 1246
	66-5621ABGA	High Gloss Graphite	56	¾	21	38	2.7	GR\$ 1606
	66-5621AB	TFL	56	¾	21	36	2.7	T\$ 441
	65-5621AB	Veneer	56	¾	21	36	2.7	W\$ 782
	66-5021ABA	Frosted	50	¼	21	9	2.2	F\$ 1088
	66-5021ABGA	High Gloss	50	¾	21	36	2.4	HG\$ 1147
	66-5021ABGA	High Gloss Graphite	50	¾	21	36	2.4	GR\$ 1470
	66-5021AB	TFL	50	¾	21	34	2.4	T\$ 425
	65-5021AB	Veneer	50	¾	21	34	2.4	W\$ 755
	66-4421ABA	Frosted	44	¼	21	8	1.2	F\$ 998
	66-4421ABGA	High Gloss	44	¾	21	33	2.2	HG\$ 1051
	66-4421ABGA	High Gloss Graphite	44	¾	21	33	2.2	GR\$ 1333
	66-4421AB	TFL	44	¾	21	31	2.2	T\$ 408
	65-4421AB	Veneer	44	¾	21	31	2.2	W\$ 723



**Description**

- Mounts to Surface
- Available in Frosted or High Gloss Acrylic, TFL, or Veneer; Must Specify; See [TFL Colors](#) or [Veneer Finish](#), and See [High Gloss Acrylic Colors](#)
- Provides Privacy 12" Above Surface and Modesty 8" Below Surface
- Decorative Attachment Hardware on Frosted Acrylic; Must Specify: Aluminum (ALUM) or Chrome (CHRM)

**Pricing Codes:** F= Frosted HG= High Gloss GR= High Gloss Graphite T = TFL W = Veneer

[For ordering options, see overview at the beginning of section.](#)



# SCREENS+DIVIDERS

## MULTI-USE SPACE DIVISION

Item	Model No.		W	D	H	Ship Wt	Cubic Ft	List Price
20"H ABOVE AND BELOW SCREENS 	PS-5720FA	Frosted	57	¼	20	20	2.2	F\$ 1163
	PS-5720HGA	High Gloss	57	¾	20	36	2.7	HG\$ 1230
	PS-5720HGA	High Gloss Graphite	57	¾	20	36	2.7	GR\$ 1586
	PS-5720TB	Tackboard	57	⅝	20	14	2.2	U\$ see below
	66-5720PS	TFL	57	¾	20	36	2.7	T\$ 438
	65-5720PS	Veneer	57	¾	20	36	2.7	W\$ 768
	PS-5120FA	Frosted	51	¼	20	19	2.1	F\$ 1075
	PS-5120HGA	High Gloss	51	¾	20	34	2.5	HG\$ 1131
	PS-5120HGA	High Gloss Graphite	51	¾	20	34	2.5	GR\$ 1451
	PS-5120TB	Tackboard	51	⅝	20	13	2.2	U\$ see below
	66-5120PS	TFL	51	¾	20	34	2.5	T\$ 420
	65-5120PS	Veneer	51	¾	20	34	2.5	W\$ 742
	PS-4520FA	Frosted	45	¼	20	19	2.0	F\$ 988
	PS-4520HGA	High Gloss	45	¾	20	32	2.3	HG\$ 1032
	PS-4520HGA	High Gloss Graphite	45	¾	20	32	2.3	GR\$ 1313
	PS-4520TB	Tackboard	45	⅝	20	12	2.0	U\$ see below
	66-4520PS	TFL	45	¾	20	32	2.3	T\$ 405
	65-4520PS	Veneer	45	¾	20	32	2.3	W\$ 714
	PS-4120FA	Frosted	41	¼	20	18	1.9	F\$ 951
	PS-4120HGA	High Gloss	41	¾	20	30	2.2	HG\$ 990
PS-4120HGA	High Gloss Graphite	41	¾	20	30	2.2	GR\$ 1261	
PS-4120TB	Tackboard	41	⅝	20	12	1.8	U\$ see below	
66-4120PS	TFL	41	¾	20	30	2.2	T\$ 389	
65-4120PS	Veneer	41	¾	20	30	2.2	W\$ 687	
PS-3920FA	Frosted	39	¼	20	18	1.8	F\$ 918	
PS-3920HGA	High Gloss	39	¾	20	29	2.2	HG\$ 960	
PS-3920HGA	High Gloss Graphite	39	¾	20	29	2.2	GR\$ 1219	
PS-3920TB	Tackboard	39	⅝	20	11	1.8	U\$ see below	
66-3920PS	TFL	39	¾	20	29	2.2	T\$ 375	
65-3920PS	Veneer	39	¾	20	29	2.2	W\$ 662	
PS-3520FA	Frosted	35	¼	20	17	1.7	F\$ 881	
PS-3520HGA	High Gloss	35	¾	20	29	2.2	HG\$ 922	
PS-3520HGA	High Gloss Graphite	35	¾	20	29	2.2	GR\$ 1174	
PS-3520TB	Tackboard	35	⅝	20	11	1.5	U\$ see below	
66-3520PS	TFL	35	¾	20	28	2.1	T\$ 362	
65-3520PS	Veneer	35	¾	20	28	2.1	W\$ 638	
PS-3320FA	Frosted	33	¼	20	17	1.6	F\$ 849	
PS-3320HGA	High Gloss	33	¾	20	27	2.1	HG\$ 889	
PS-3320HGA	High Gloss Graphite	33	¾	20	27	2.1	GR\$ 1133	
PS-3320TB	Tackboard	33	⅝	20	10	1.5	U\$ see below	
66-3320PS	TFL	33	¾	20	27	2.1	T\$ 348	
65-3320PS	Veneer	33	¾	20	27	2.1	W\$ 614	
PS-2920FA	Frosted	29	¼	20	16	1.5	F\$ 814	
PS-2920HGA	High Gloss	29	¾	20	26	1.9	HG\$ 851	
PS-2920HGA	High Gloss Graphite	29	¾	20	26	1.9	GR\$ 1087	
PS-2920TB	Tackboard	29	⅝	20	10	1.5	U\$ see below	
66-2920PS	TFL	29	¾	20	26	1.9	T\$ 335	
65-2920PS	Veneer	29	¾	20	26	1.9	W\$ 589	

**Description**

- Mounts to Surface; Provides Privacy 12" Above Surface and Modesty 7" Below Surface
- Available in Frosted or High Gloss Acrylic, Tackboard, TFL, or Veneer; Must Specify; See [TFL Colors](#) or [Veneer Finish](#), See [High Gloss Acrylic Colors](#), For Upholstery, See Below
- Decorative Hardware on Frosted Acrylic & Tackboards; Must Specify: Aluminum (ALUM) or Chrome (CHRM)
- Great option for Canvas and Gesso Modular Height-Adjustable units

**Tackboards - Must Specify: Model# & Fabric/Grade**

Model	Ydg	COM/Grades 1, 2, 3	Grade 4	Grade 5	Grade 6	Grade 7	Grade 8	Grade 9	Grade 10
PS-5720TB	2.00	\$ 623	\$ 901	\$ 1031	\$ 1163	\$ 1351	\$ 1547	\$ 1775	\$ 2039
PS-5120TB	2.00	\$ 578	\$ 856	\$ 986	\$ 1118	\$ 1306	\$ 1502	\$ 1730	\$ 1994
PS-4520TB	1.75	\$ 513	\$ 756	\$ 870	\$ 986	\$ 1150	\$ 1322	\$ 1521	\$ 1752
PS-4120TB	1.50	\$ 473	\$ 682	\$ 779	\$ 878	\$ 1019	\$ 1166	\$ 1337	\$ 1535
PS-3920TB	1.50	\$ 459	\$ 668	\$ 765	\$ 864	\$ 1005	\$ 1152	\$ 1323	\$ 1521
PS-3520TB	1.50	\$ 443	\$ 652	\$ 749	\$ 848	\$ 989	\$ 1136	\$ 1307	\$ 1505
PS-3320TB	1.25	\$ 404	\$ 578	\$ 659	\$ 742	\$ 859	\$ 982	\$ 1124	\$ 1289
PS-2920TB	1.25	\$ 383	\$ 557	\$ 638	\$ 721	\$ 838	\$ 961	\$ 1103	\$ 1268

For ordering options, see overview at the beginning of section.

# SCREENS+DIVIDERS

## MULTI-USE SPACE DIVISION

Item	Model No.		W	D	H	Ship Wt	Cubic Ft	List Price
17"H ABOVE AND BELOW SCREENS 	PS-6817FA	Frosted	68	¼	17	14	3.3	F\$ 1196
	PS-6817HGA	High Gloss	68	¾	17	24	3.3	HG\$ 1260
	PS-6817HGA	High Gloss Graphite	68	¾	17	24	3.3	GR\$ 1627
	PS-6817TB	Tackboard	68	⅝	17	15	2.5	U\$ see below
	66-6817PS	TFL	68	¾	17	24	3.3	T\$ 450
	65-6817PS	Veneer	68	¾	17	24	3.3	W\$ 791
	PS-6217FA	Frosted	62	¼	17	14	3.1	F\$ 1160
	PS-6217HGA	High Gloss	62	¾	17	22	3.1	HG\$ 1223
	PS-6217HGA	High Gloss Graphite	62	¾	17	22	3.1	GR\$ 1579
	PS-6217TB	Tackboard	62	⅝	17	14	2.5	U\$ see below
	66-6217PS	TFL	62	¾	17	22	3.1	T\$ 437
	65-6217PS	Veneer	62	¾	17	22	3.1	W\$ 767
	PS-5617FA	Frosted	56	¼	17	13	2.9	F\$ 1121
	PS-5617HGA	High Gloss	56	¾	17	20	2.7	HG\$ 1180
	PS-5617HGA	High Gloss Graphite	56	¾	17	20	2.7	GR\$ 1521
	PS-5617TB	Tackboard	56	⅝	17	13	2.2	U\$ see below
	66-5617PS	TFL	56	¾	17	20	2.7	T\$ 419
	65-5617PS	Veneer	56	¾	17	20	2.7	W\$ 741
	PS-5017FA	Frosted	50	¼	17	13	2.7	F\$ 1036
	PS-5017HGA	High Gloss	50	¾	17	18	2.5	HG\$ 1088
	PS-5017HGA	High Gloss Graphite	50	¾	17	18	2.5	GR\$ 1395
	PS-5017TB	Tackboard	50	⅝	17	12	2.0	U\$ see below
	66-5017PS	TFL	50	¾	17	18	2.5	T\$ 405
	65-5017PS	Veneer	50	¾	17	18	2.5	W\$ 714
	PS-4417FA	Frosted	44	¼	17	12	2.5	F\$ 954
	PS-4417HGA	High Gloss	44	¾	17	16	2.3	HG\$ 995
	PS-4417HGA	High Gloss Graphite	44	¾	17	16	2.3	GR\$ 1267
	PS-4417TB	Tackboard	44	⅝	17	11	1.8	U\$ see below
66-4417PS	TFL	44	¾	17	16	2.3	T\$ 390	
65-4417PS	Veneer	44	¾	17	16	2.3	W\$ 690	

**Description**

- Mounts to Surface
- Decorative Attachment Hardware on Frosted Acrylic & Tackboards; Must Specify: Aluminum (ALUM) or Chrome (CHRM)
- Available in Frosted or High Gloss Acrylic, Tackboard, TFL, or Veneer; Must Specify; See [TFL Colors](#) or [Veneer Finish](#), See [High Gloss Acrylic Colors](#), For Upholstery, See Below
- Provides Privacy 12" Above Surface and Modesty 4" Below Surface
- Great option for Canvas and Gesso Modular Height-Adjustable units

**Tackboards - Must Specify: Model# & Fabric/Grade**

Model	Ydg	COM/Grades 1, 2, 3	Grade 4	Grade 5	Grade 6	Grade 7	Grade 8	Grade 9	Grade 10
PS-6817TB	2.00	\$ 642	\$ 920	\$ 1050	\$ 1182	\$ 1370	\$ 1566	\$ 1794	\$ 2058
PS-6217TB	2.00	\$ 602	\$ 880	\$ 1010	\$ 1142	\$ 1330	\$ 1526	\$ 1754	\$ 2018
PS-5617TB	2.00	\$ 549	\$ 827	\$ 957	\$ 1089	\$ 1277	\$ 1473	\$ 1701	\$ 1965
PS-5017TB	2.00	\$ 520	\$ 798	\$ 928	\$ 1060	\$ 1248	\$ 1444	\$ 1672	\$ 1936
PS-4417TB	1.75	\$ 468	\$ 711	\$ 825	\$ 941	\$ 1105	\$ 1277	\$ 1476	\$ 1707

**Pricing Codes:** C=Clear F= Frosted HG= High Gloss GR= High Gloss Graphite U=Tackboard T = TFL W = Veneer

[For ordering options, see overview at the beginning of section.](#)

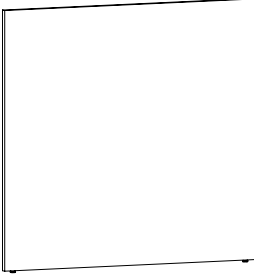

Item	Model No.		W	D	H	Ship Wt	Cubic Ft	List Price
51" GALLERY SCREEN STRAIGHT FLOORSTANDING 	66-5173GS	TFL	73	1	51¼	110	7.9	T\$ 1147
	65-5173GS	Veneer						W\$ 2036
	66-5172GS	TFL	72	1	51¼	110	7.9	T\$ 1139
	65-5172GS	Veneer						W\$ 2021
	66-5167GS	TFL	67	1	51¼	104	7.3	T\$ 1103
	65-5167GS	Veneer						W\$ 1955
	66-5166GS	TFL	66	1	51¼	104	7.3	T\$ 1096
	65-5166GS	Veneer						W\$ 1943
	66-5161GS	TFL	61	1	51¼	98	6.7	T\$ 1057
	65-5161GS	Veneer						W\$ 1874
	66-5160GS	TFL	60	1	51¼	98	6.7	T\$ 1051
	65-5160GS	Veneer						W\$ 1861
	66-5155GS	TFL	55	1	51¼	92	6.1	T\$ 1010
	65-5155GS	Veneer						W\$ 1792
	66-5154GS	TFL	54	1	51¼	92	6.1	T\$ 1003
	65-5154GS	Veneer						W\$ 1778
	66-5149GS	TFL	49	1	51¼	86	5.4	T\$ 964
	65-5149GS	Veneer						W\$ 1711
	66-5148GS	TFL	48	1	51¼	86	5.4	T\$ 957
	65-5148GS	Veneer						W\$ 1695
	66-5143GS	TFL	43	1	51¼	80	4.7	T\$ 920
	65-5143GS	Veneer						W\$ 1632
	66-5142GS	TFL	42	1	51¼	80	4.7	T\$ 913
	65-5142GS	Veneer						W\$ 1620
	66-5137GS	TFL	37	1	51¼	60	4.1	T\$ 795
	65-5137GS	Veneer						W\$ 1413
	66-5136GS	TFL	36	1	51¼	60	4.1	T\$ 772
	65-5136GS	Veneer						W\$ 1369
	66-5131GS	TFL	31	1	51¼	54	3.5	T\$ 724
	65-5131GS	Veneer						W\$ 1283
	66-5130GS	TFL	30	1	51¼	54	3.5	T\$ 713
	65-5130GS	Veneer						W\$ 1266
66-5125GS	TFL	25	1	51¼	48	2.8	T\$ 662	
65-5125GS	Veneer						W\$ 1173	
66-5124GS	TFL	24	1	51¼	48	2.8	T\$ 652	
65-5124GS	Veneer						W\$ 1154	
66-5119GS	TFL	19	1	51¼	42	2.2	T\$ 613	
65-5119GS	Veneer						W\$ 1085	
66-5118GS	TFL	18	1	51¼	42	2.2	T\$ 603	
65-5118GS	Veneer						W\$ 1070	

**Description**

- Horizontal Woodgrain
- Mounts to Back of Modular Credenza for Space Division
- Available in TFL and Veneer; Must Specify Finish/Color, [See Color and Finish Options](#)
- Extend up to 24" Beyond Workstation without Additional Support
- Includes Leveling Glides
- Six (6) Wire Management Grommet Location Options; Must Specify Location/Color, [See Grommet Locations](#)

**Pricing Codes:** T = TFL W = Veneer

[For ordering options, see overview at the beginning of section.](#)

Item	Model No.	W	D	H	Ship Wt	Cubic Ft	List Price
ACRYLIC CONNECTOR CLIPS   	01-2WAY90	1¼	1¼	7⁄8	0.1	0.8	\$ 34
	<i>For Use with 2-Way, 90° Corner Connections</i>						
	01-3WAY90	2	1½	7⁄8	0.1	0.8	\$ 26
<i>For Use with 3-Way, T-Connections</i>							
	01-2WAY180	1⅞	7⁄8	13⁄16	0.1	0.8	\$ 21
<i>For Use with 2-Way, 180° Straight Connections</i>							

**Description**

- Constructed of Metal with a Chrome Finish
- For Use with ¼" Thick Clear and Frosted Acrylics
- Provides a Clean Connection For Adjacent Panels and Screens

**Pricing Codes:** T = TFL W = Veneer

[For ordering options, see overview at the beginning of section.](#)

### STEP 1: PLANNING FOR SQUARE ONE

Planning for Square One is based on configuring 12"x24" and 24"x24" blocks in nearly any manner to create space dividing walls, coves, work zones, and more within open environments.

#### Idea Starters/Typicals:

When you select one of our pre-configured Typicals, everything you need comes specified together, including the blocks, caps and posts, hardware, glides, and more.

- Select the typical number (e.g., 17-4), then specify the finish and hardware color.
- Add optional accessories (see Step #5).

#### Make Your Own Typicals:

There are endless opportunities with Square One, giving you the ability to create unique setups to meet the specific needs of your customers.

- We recommend utilizing our Specification/Drawing Services team, who can help in bringing your vision to life and ensure all the necessary components are included. To get started, just send us a drawing. You can use our easy online request form: [Design Request Form](#)
- Steps #2 - #5 outline the process for specifying your own typical. Please provide a drawing with the order to ensure accuracy.

### STEP 2: SPECIFYING BLOCKS

When making your own typical, choose the quantity of blocks needed to create your design. We offer single blocks in two styles: 24"x24" and 12"x24".

- Blocks can go up to four high (8') and do runs of five wide (10') without a supporting wall or anchor to create stability.
- We recommend using single 12" x 24" blocks on the top or ends. If placing on the bottom or in the center of the design, using two of them together will ensure alignment with the holes bored on attachment items like End Caps, Corner Posts, etc.
- When creating an "L" or "T" design, we suggest going a minimum of three blocks wide to ensure stability without additional support.

### STEP 3: CAPS, POSTS, CONNECTORS, AND SPANNERS

Next, determine what Caps, Posts, Connectors, and Spanners are needed to complete the design.

- End and Top Caps are necessary to ensure a clean and balanced aesthetic (as they hide the attachment hardware/ensure no empty holes are showing where attachments would have been).
- Square One offers connection beams to create 90° turns (Corner Posts), three walls (T-Connectors), four walls (X-Connectors), and span doorways or other openings (Horizontal Beam Spanners).
- End Caps, Posts, and Connectors should always be specified to run longer (taller) than the unit so that the end of the top cap or horizontal rail will not be seen (there are only a few exceptions).

### STEP 4: HARDWARE, LEVELING, AND GENERAL ASSEMBLY

Whether connecting square to square or square to post, individual components come with the necessary hardware. Should you need more, we offer separate Bolt Kits to provide proper installation.

We offer heavy-duty, adjustable leveling glides to compensate for uneven floors. A tool (6mm allen driver bit) is also available to insert the glide nuts. The glides must be ordered separately from the blocks.

We do not offer connection methods to anchor to the floor or wall. We recommend discussing this with the building's facility manager for proper connection. Indiana Furniture will not be liable for wall or floor mounts that are not properly installed.

Assembly Instructions may be found on our website.

### STEP 5: ACCESSORIES

Add function without sacrificing beauty. Acrylic Inserts, Tackable and Acoustical Panels, Dry Erase Boards, and TV mounts can give your space the ability for more privacy, collaboration, or brainstorming.

- Dry Erase Boards and Tackable Panels have onset installation.
- Dry Erase Boards can be mounted either vertically or horizontally.
- Acoustical Panels are either specified onset or inset, and Acrylic Inserts are inset.
- Tackable Panels are fully upholstered, so a clean aesthetic is seen from both sides of the blocks.
- Acrylic Inserts lock into insert retainers which are installed on top of the hardware, inside of the block, allowing for a quick and tight-fitting installation.
- Frosted Acrylic Inserts can be customized with a logo or image, giving you freedom to create a personal touch. Provide a .CDR, .AI, or .EPS file. Extended lead times may apply.
- We offer the Vesta Power Data Center and other similar items to add power within your Square One spaces created.



**Space Division.  
Redefined.**



17-1 (Approximately 10' X 10' X 8')



17-2 (Approximately 8' X 8' X 8')



17-3 (Approximately 12' X 8' X 8')



17-4 (Approximately 10' X 8' X 8')

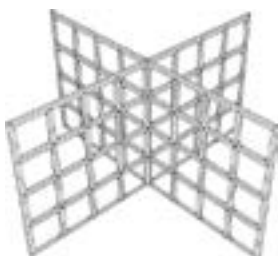

17-5 (Approximately 16' X 16' X 8')



17-6 (Approximately 8' X 8' X 8')



17-7 (Approximately 8' X 8')



17-8 (Approximately 12' X 8' X 8')

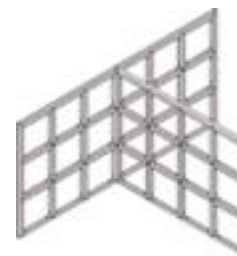

17-9 (Approximately 12' X 8' X 6')



17-10 (Approximately 4' X 8' X 8')



17-11 (Approximately 4' X 4' X 8')



17-12 (Approximately 2' X 4' X 8')



17-13 (Approximately 8' X 8' X 8')

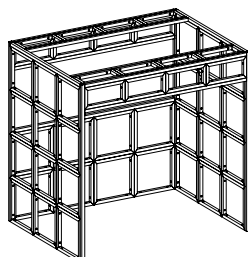

17-14 (Approximately 8' X 6' X 8')

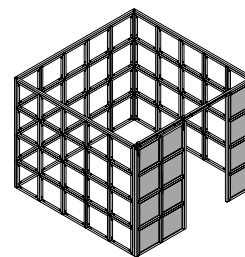

17-15 (Approximately 10' X 10' X 8')

Space Division. Redefined.

Square One is the clean, simple way to provide space division, functionality, and architectural design to any zone within the working environment. With individual building blocks that securely connect to one another and accessories like dry erase boards, barn doors, planter boxes, acrylic inserts, and tackable and acoustical panels, your personalization of Square One is only limited to your imagination. Square One is made of solid wood, providing a sustainable material for the workplace and bringing warmth and beauty to any space.

## CONSTRUCTION

### BLOCKS

- Blocks are manufactured using kiln-dried, solid European Beech and are attached using hardware, available in your choice of nickel or black, for durability and strength

### FINISH

- Indiana Furniture uses a multi-step hand finishing process
- Blocks are pre-sanded for smoothness, then stained and finished with a catalyzed varnish finish which offers durability, lasting beauty, and resistance to normal wear
- Square One finishes were selected to complement casegoods, tables, and seating finishes which allows for easy blending of furniture components

### END & TOP CAPS

- Measure 1¾"W and 1¾"D and come in a variety of lengths
- Used vertically and horizontally to provide a clean, balanced aesthetic by hiding the attachment hardware
- Caps are constructed of kiln-dried, solid European Beech and include blind threaded inserts for installation

### CORNER POSTS

- Measure 1¾"W and 1¾"D and come in a variety of heights
- Used to create 90° turns
- Corner posts are constructed of kiln-dried, solid European Beech and include blind threaded inserts for installation

### T-CONNECTORS

- Measure 1¾"W and 1¾"D and come in a variety of heights
- Used vertically and horizontally to create an intersection for three wall runs
- T-Connectors are constructed of kiln-dried, solid European Beech and include blind threaded inserts for installation

### X-CONNECTORS

- Measure 1¾"W and 1¾"D and come in a variety of heights
- Used vertically to create an intersection for four wall runs
- X-Connectors are constructed of kiln-dried, solid European Beech and include blind threaded inserts for installation

### HORIZONTAL BEAM SPANNERS

- Measure 1¾"D and 1¾"H and come in a variety of widths
- Used horizontally to provide structural support for doorways and other designed openings
- Spanners are constructed of kiln-dried, solid European Beech and include blind threaded inserts for installation

### DRY ERASE BOARDS

- Available in 22½" or 46½" heights and multiple widths
- Installed onset, either vertically or horizontally
- Installation brackets are included; longer bolts for installation on-site are also included

### ACOUSTICAL PANELS

- Constructed of 100% polyester made from up to 50% recycled materials without the use of adhesive or other bonding agents, Acoustical Panels are 100% recyclable
- Panels are ½" (12mm) thick and are available in multiple widths and lengths
- Sound absorption is average NRC 0.75 (50mm air gap) 1.0 NRC in mid-high frequencies
- Panels are installed inset with tabs or onset with dual-lock connectors

### TACKABLE PANELS

- Tackable Panels are constructed of 7/16" corkboard and then covered, on both sides, in the textile of your choice
- Highly-skilled upholsterers hand tailor each unit to meet individual specifications
- Upholstery options include a broad range of styles, all pre-graded in this price list for ease of use
- Panels are installed onset with dual-lock connectors

### ACRYLIC INSERTS

- Acrylic inserts are manufactured using high performance engineering resins and provide translucency, strength, clarity, and versatility
- Inserts are 20½"W and are available in 8½" and 20½" lengths
- Inserts are inset within the blocks with retainers for a tight-fitting installation
- Frosted acrylic options can be customized with logos and other designs as requested

### LEVELING GLIDES

- Heavy-duty, adjustable leveling glides are available in black or nickel and are recommended to ensure proper leveling and compensation for uneven floors
- A tool (6mm allen driver bit) to install glides is also available to ensure proper installation

### BARN DOOR HARDWARE

- Sliding system tracks are constructed of black powder coated steel
- Hardware includes tracks, hangers, track stops, screws, inserts, bracket, and sliding system
- Installation hardware will be shipped attached to components

### PLANTER BOXES

- The planter box is made of ¾" thick thermally-fused laminate (TFL) fused particle-board core
- Grain direction runs horizontal
- Planter boxes are fastened together with screws and heavy-duty metal fasteners
- Optional insert is made of lightweight, fade-resistant, recyclable plastic

### HOW TO ORDER EXAMPLES

#### IDEA STARTERS/TYPICALS

Model No.	Description	Example
17-1	Finish	EF
	Hardware Color	BLK

#### BLOCKS & RAILS

Model No.	Description	Example
17-2424BL	Finish	NB
	Hardware Color	NCKL

#### ACRYLIC INSERTS

Model No.	Description	Example
AI-2020AC	Acrylic Color	FSTA

#### PLANTER BOXES

Model No.	Description	Example
01-1909PL	TFL Color	AS
	Hardware Color	BLK
	Optional Insert	PBI

### veneer (W) OPTIONS

Indiana Furniture uses a multi-step, hand finishing process on all exposed wood frames.

Square One models feature a catalyzed varnish finish which offers durability, lasting beauty, and resistance to normal wear.

AW	Artisan Walnut	MAS	Mesa Sunset*
AS	Asian Night	MTS	Metropolis Sky
AWH	Aspen White	MNR	Midnight Run
BW	Beigewood*	NTM	Natural Marrone*
BL	Black	NB	Natural Beech
CO	Columbian Walnut	ORW	Oak Riftwood*
DC	Dark Cherry	OR	Orchard
DFW	Dark Forest Walnut*	PNW	Pinnacle Walnut
WH	Designer White	PTK	Portico Teak*
EG	Ember Gray	RC	River Cherry*
EF	Espresso	SCH	Select Cherry
FO	Fawn Oak*	SPW	Sepia Walnut*
FLW	Florence Walnut*	SKC	Shaker Cherry
GC	Golden Cherry	SBP	Smoky Brown Pear*
HVM	Harvest Maple*	TK	Studio Teak
HW	Harvest Walnut	SM	Sugar Maple
HNW	Henna Walnut	TR	Truffle Rain
KHE	Kirsche	WTA	Weathered Ash*
LW	Legacy Walnut	WNB	White Nebbia
MW	Mahogany Walnut	WC	Williamsburg Cherry

\* Finish is Low Sheen

### TFL (T) LAMINATE OPTIONS ON PLANTER BOXES

#### WOODGRAIN

AS	Asian Night	PNW	Pinnacle Walnut
BW	Beigewood	PTK	Portico Teak
CO	Columbian Walnut	RC	River Cherry
EF	Espresso	SCH	Select Cherry
FLW	Florence Walnut	SPW	Sepia Walnut
GC	Golden Cherry	SKC	Shaker Cherry
HVM	Harvest Maple	SBP	Smoky Brown Pear
KHE	Kirsche	TK	Studio Teak
MW	Mahogany Walnut	SM	Sugar Maple
MNR	Midnight Run	WTA	Weathered Ash
NTM	Natural Marrone	WNB	White Nebbia
ORW	Oak Riftwood	WC	Williamsburg Cherry

#### SOLID

BL	Black	FHG	Fashion Grey
WH	Designer White	SG	Slate Grey

### HARDWARE/LEVELING GLIDES COLOR OPTIONS

BLK Black NCKL Nickel



Black (BLK)



Nickel (NCKL)

### ACOUSTICAL PANEL OPTIONS

ASH	Ash	MLK	Milky
BLK	Black	TPE	Taupe
GRY	Grey		



Ash (ASH)



Black (BLK)



Grey (GRY)



Milky (MLK)



Taupe (TPE)

### ACRYLIC INSERT OPTIONS

FSTA	Frosted	TGWA	Twigwork
RAFA	Raffia	TNSA	Tinsel
WOVA	Woven		

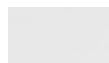

Frosted (FSTA)



Raffia (RAFA)

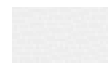

Woven (WOVA)



Twigwork (TGWA)



Tinsel (TNSA)

### TACKABLE PANEL OPTIONS

Available in single upholstery in a wide variety of graded-in or contract options.

### CERTIFICATIONS & COMPLIANCE

- CAL 117-2013 Compliance
- Intertek Sustainability Certified
- BIFMA level® Certified
- BIFMA Compliant® Certified
- TSCA Title VI (CARB) Compliance
- US Green Building's LEED® Contribution



**Building Blocks**

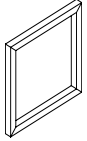

24"x24" Block  
[\(See Details\)](#)

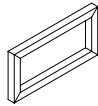

24"x12" Block  
[\(See Details\)](#)

**Hardware**

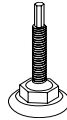

Leveling Glide Kits  
[\(See Details\)](#)

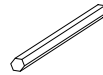

Allen Driver Bit  
[\(See Details\)](#)

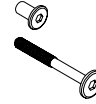

Bolt & Nut Kits  
[\(See Details\)](#)

**Connectors**

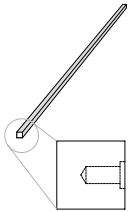

End Caps  
[\(See Details\)](#)

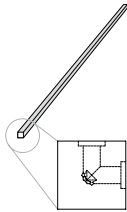

Corner Posts  
[\(See Details\)](#)

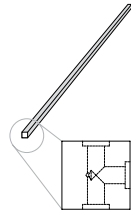

T-Connector Beams  
[\(See Details\)](#)

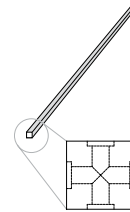

X-Connector Beams  
[\(See Details\)](#)

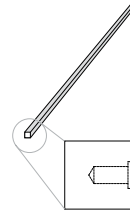

Horizontal Beam Spanners  
[\(See Details\)](#)

**Accessories**

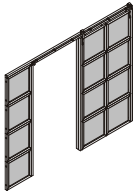

Barn Door Wall  
[\(See Details\)](#)

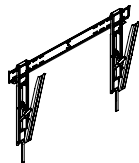

TV Mounts  
[\(See Details\)](#)

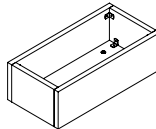

Planter Boxes  
[\(See Details\)](#)



Tic-Tac-Toe Foam Game  
[\(See Details\)](#)



Vesta Power Center  
[\(See Details\)](#)

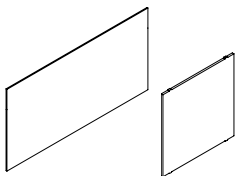

Onset & Inset Acoustical Panels  
[\(See Details\)](#)

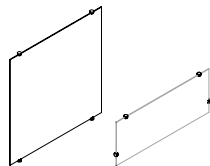





Acrylic Inset Panels  
[\(See Details\)](#)

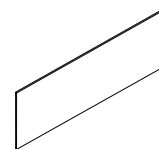



Dry Erase Boards  
[\(See Details\)](#)





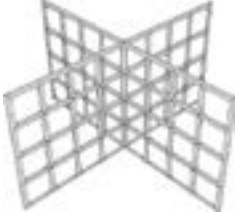

Tackable Panels  
[\(See Details\)](#)

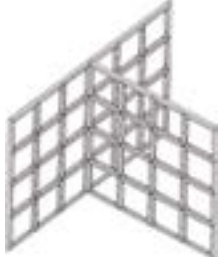
Item	Model No.	Qty	Description	List Price
<b>HUDDLE</b> (APPROXIMATELY 10' X 10' X 8')	17-1_1701			\$ 22036
				
<b>Consists of:</b>				
	17-2424BL	56	Single Block, 24" x 24"	\$ 16464
	17-17596EC	4	End Cap, 96" (used vertically)	\$ 1576
	17-175120EC	2	End Cap, 120" (used horizontally)	\$ 860
	17-17597CP	4	Corner Post, 97¾"	\$ 1588
	17-175120HBS	2	Horizontal Beam Spanner, 120"	\$ 820
	17-LEVKIT	14	Leveler Kit, (2) Levelers	\$ 728
<b>HUDDLE</b> (APPROXIMATELY 8' X 8' X 8')	17-2			\$ 19442
				
<b>Consists of:</b>				
	17-2424BL	48	Single Block, 24" x 24"	\$ 14112
	17-17596EC	6	End Cap, 96" (4 used vertically, 2 used horizontally)	\$ 2364
	17-17597CP	4	Corner Post, 97¾"	\$ 1588
	17-17596HBS	2	Horizontal Beam Spanner, 96"	\$ 754
	17-LEVKIT	12	Leveler Kit, (2) Levelers	\$ 624
<b>HUDDLE</b> (APPROXIMATELY 12' X 8' X 8')	17-3			\$ 19508
				
<b>Consists of:</b>				
	17-2424BL	48	Single Block, 24" x 24"	\$ 14112
	17-17596EC	4	End Cap, 96" (2 used vertically, 2 used horizontally)	\$ 1576
	17-17597EC	2	End Cap, 97¾" (used vertically)	\$ 788
	17-17596CP	2	Corner Post, 96"	\$ 794
	17-17597CP	2	Corner Post, 97¾"	\$ 794
	17-175120HBS	2	Horizontal Beam Spanner, 120"	\$ 820
	17-LEVKIT	12	Leveler Kit, (2) Levelers	\$ 624
<b>H-CONFIGURATION</b> (APPROXIMATELY 10' X 8' X 8')	17-4			\$ 19508
				
<b>Consists of:</b>				
	17-2424BL	48	Single Block, 24" x 24"	\$ 14112
	17-17596EC	2	End Cap, 96" (used horizontally)	\$ 788
	17-17597EC	4	End Cap, 97¾" (used vertically)	\$ 1576
	17-17596CP	4	Corner Post, 96"	\$ 1588
	17-175120HBS	2	Horizontal Beam Spanner, 120"	\$ 820
	17-LEVKIT	12	Leveler Kit, (2) Levelers	\$ 624

[See Overview for Square One Ordering Options.](#)

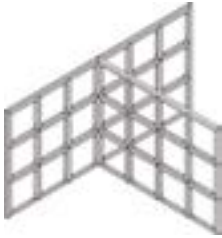
Item	Model No.	Qty	Description	List Price
<b>QUAD-CONFIGURATION</b> (APPROXIMATELY 16' X 16' X 8')	17-5			\$ 23204
	<b>Consists of:</b>			
	17-2424BL	64	Single Block, 24" x 24"	\$ 18816
	17-17596EC	4	End Cap, 96" (used horizontally)	\$ 1576
	17-17597EC	4	End Cap, 97¾" (used vertically)	\$ 1576
	17-17597XB	1	X-Connector Beam, 97¾"	\$ 404
	17-LEVKIT	16	Leveler Kit, (2) Levelers	\$ 832
<b>WALL COVE</b> (APPROXIMATELY 8' X 8' X 8')	17-6			\$ 10457
	<b>Consists of:</b>			
	17-2424BL	24	Single Block, 24" x 24"	\$ 7056
	17-17596EC	3	End Cap, 96" (used horizontally)	\$ 1182
	17-17597EC	4	End Cap, 97¾" (2 used vertically, 2 used horizontally)	\$ 1576
	17-17596CP	1	Corner Post, 96" (used horizontally)	\$ 397
	17-LEVKIT	4	Leveler Kit, (2) Levelers	\$ 208
	17-12MMBOLTKIT	1	12mm Bolt Kit, qty 8	\$ 38
	<i>* This typical is not design for freestanding applications. This unit must be secured at the top to a rigid structure. Attachment hardware not included.</i>			
<b>SINGLE WALL</b> (APPROXIMATELY 8' X 8')	17-7			\$ 6094
	<b>Consists of:</b>			
	17-2424BL	16	Single Block, 24" x 24"	\$ 4704
	17-17596EC	1	End Cap, 96" (used horizontally)	\$ 394
	17-17597EC	2	End Cap, 97¾" (used vertically)	\$ 788
	17-LEVKIT	4	Leveler Kit, (2) Levelers	\$ 208
	<i>* This typical is not design for freestanding applications. This unit must be secured at the top to a rigid structure. Attachment hardware not included.</i>			
<b>T-CONFIGURATION</b> (APPROXIMATELY 12' X 8' X 8')	17-8_1708			\$ 15021
	<b>Consists of:</b>			
	17-2424BL	40	Single Block, 24" x 24"	\$ 11760
	17-17572EC	2	End Cap, 72" (used horizontally)	\$ 764
	17-17596EC	1	End Cap, 96" (used horizontally)	\$ 394
	17-17597EC	3	End Cap, 97¾" (used vertically)	\$ 1182
	17-17597TCB	1	T-Connector Beam, 97¾"	\$ 401
	17-LEVKIT	10	Leveler Kit, (2) Levelers	\$ 520

[See Overview for Square One Ordering Options.](#)

Item	Model No.	Qty	Description	List Price
T-CONFIGURATION (APPROXIMATELY 12' X 8' X 6')	17-9			\$ 12032
	<b>Consists of:</b>			
	17-2424BL	30	Single Block, 24" x 24"	\$ 8820
	17-17572EC	2	End Cap, 72" (used horizontally)	\$ 764
	17-17573EC	3	End Cap, 73¾" (used vertically)	\$ 1146
	17-17596EC	1	End Cap, 96" (used horizontally)	\$ 394
	17-17573TCB	1	T-Connector Beam, 73¾"	\$ 388
	17-LEVKIT	10	Leveler Kit, (2) Levelers	\$ 520
OFFSET DUAL BOOTH (APPROXIMATELY 4' X 8' X 8')	17-10			\$ 15610
	<b>Consists of:</b>			
	17-2424BL	36	Single Block, 24" x 24"	\$ 10584
	17-17548EC	2	End Cap, 48" (used horizontally)	\$ 630
	17-17597EC	4	End Cap, 97¾" (used vertically)	\$ 1576
	17-17524CP	2	Corner Post, 24" (used horizontally)	\$ 612
	17-17548CP	2	Corner Post, 48" (used horizontally)	\$ 634
	17-17548TCB	1	T-Connector Beam, 48"	\$ 318
	17-17596TCB	2	T-Connector Beam, 96"	\$ 802
	17-LEVKIT	8	Leveler Kit, (2) Levelers	\$ 416
	17-12MMBOLTKIT	1	12mm Bolt Kit, qty 8	\$ 38
DUAL BOOTH (APPROXIMATELY 4' X 4' X 8')	17-11			\$ 11273
	<b>Consists of:</b>			
	17-2424BL	24	Single Block, 24" x 24"	\$ 7056
	17-17524EC1711	4	End Cap, 24" (used horizontally)	\$ 1212
	17-17548EC1711	1	End Cap, 48" (used horizontally)	\$ 315
	17-17597EC1711	4	End Cap, 97¾" (used vertically)	\$ 1576
	17-17597TCB1711	2	T-Connector Beam, 97¾"	\$ 802
	17-LEVKIT	6	Leveler Kit, (2) Levelers	\$ 312
L COVE (APPROXIMATELY 2' X 4' X 8')	17-12			\$ 5487
	<b>Consists of:</b>			
	17-2424BL	12	Single Block, 24" x 24"	\$ 3528
	17-17524EC	1	End Cap, 24" (used horizontally)	\$ 303
	17-17548EC	1	End Cap, 48" (used horizontally)	\$ 315
	17-17597EC	2	End Cap, 97¾" (used vertically)	\$ 788
	17-17597CP	1	Corner Post, 97¾"	\$ 397
	17-LEVKIT	3	Leveler Kit, (2) Levelers	\$ 156

[See Overview for Square One Ordering Options.](#)

Item	Model No.	Qty	Description	List Price
C-CONFIGURATION (APPROXIMATELY 8' X 8' X 8')	17-13			\$ 17500

**Consists of:**

17-2424BL	48	Single Block, 24" x 24"	\$ 14112
17-17596EC	3	End Cap, 96" (used horizontally)	\$ 1182
17-17597EC	2	End Cap, 97¾" (used vertically)	\$ 788
17-17597CP	2	Corner Post, 97¾"	\$ 794
17-LEVKIT	12	Leveler Kit, (2) Levelers	\$ 624

**GATEWAY COVE**  
 (APPROXIMATELY 8' X 6' X 8')

17-14			\$ 19278
-------	--	--	----------

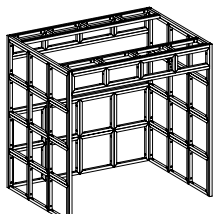
**Consists of:**

17-2424BL	32	Single Block, 24" x 24"	\$ 9408
17-2412BL	16	Single Block, 24" x 12"	\$ 4112
17-17596EC	5	End Cap, 96" (used horizontally)	\$ 1970
17-17572CP	2	Corner Post, 72" (used horizontally)	\$ 772
17-17596CP	2	Corner Post, 96" (used horizontally)	\$ 794
17-17597CP	4	Corner Post, 97¾" (used vertically)	\$ 1588
17-LEVKIT	10	Leveler Kit, (2) Levelers	\$ 520
17-12MMBOLTKit	3	12mm Bolt Kit, qty 8	\$ 114

**MEETING ROOM WITH BARN DOOR**  
 (APPROXIMATELY 10' X 10' X 8')

17-15			\$ 30773
-------	--	--	----------

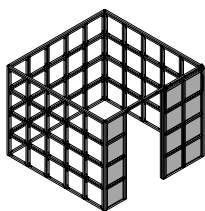
**Consists of:**

17-2424BL	60	Single Block, 24" x 24"	\$ 17640
17-175120EC	3	End Cap, 120" (used horizontally)	\$ 1290
17-17597CP	4	Corner Post, 97¾"	\$ 1588
17-4896BDBR	1	Barn Door Wall, Right	\$ 9475
17-LEVKIT	15	Leveler Kit, (2) Levelers	\$ 780

*\* Must Specify Acrylic and/or Acoustical Inserts for Use in Barn Door Wall (Total 20 Inserts);  
 Note: List Price Shown Above Does NOT Include These Required Inserts Due to Variance in Pricing. See  
 Page 307 for Acrylic and Acoustical Insert options.*

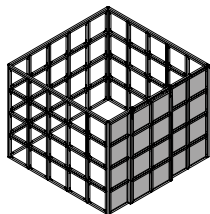

Shown as Right Barn Door

[See Overview for Square One Ordering Options.](#)

Item	Model No.	W	D	H	Ship Wt	Cubic Ft	List Price
SINGLE BLOCK 24" X 24"	17-2424BL	24	1¾	24	12	1.5	\$ 294

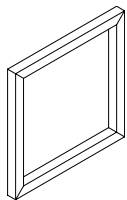

#### Description

- Includes Four (4) Bolts and Nuts for Installation

#### Must Specify (in this order):

Model # and Quantity  
Finish  
Hardware Color

SINGLE BLOCK 24" X 12"	17-2412BL	24	1¾	12	8	1.0	\$ 257
---------------------------	-----------	----	----	----	---	-----	--------

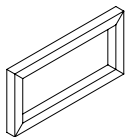

#### Description

- Includes Three (3) Bolts and Nuts for Installation
- Can Be Used Vertically or Horizontally
- Recommended for Use on Top or End of Configuration, Unless Used in Pairs
- We Recommend Using Single 12" x 24" Blocks on the Top or Ends. If Placing on the Bottom or In the Center of the Design, Using Two of Them Together Will Ensure Alignment with the Holes Bored on Attachment Items Like End Caps, Corner Posts, Etc.

#### Must Specify (in this order):

Model # and Quantity  
Finish  
Hardware Color

[See Overview for Square One Ordering Options.](#)

Item	Model No.	W	D	H	Ship Wt	Cubic Ft	List Price
END CAPS	17-175120EC	1¾	1¾	120	14	0.3	\$ 430
	17-175108EC	1¾	1¾	108	13	0.3	\$ 427
	17-17597EC <i>Vertical Use Only</i>	1¾	1¾	97¾	13	0.3	\$ 394
	17-17596EC	1¾	1¾	96	12	0.3	\$ 394
	17-17585EC <i>Vertical Use Only</i>	1¾	1¾	85¾	12	0.3	\$ 386
	17-17584EC	1¾	1¾	84	11	0.3	\$ 386
	17-17573EC <i>Vertical Use Only</i>	1¾	1¾	73¾	11	0.3	\$ 382
	17-17572EC	1¾	1¾	72	11	0.3	\$ 382
	17-17561EC <i>Vertical Use Only</i>	1¾	1¾	61¾	10	0.2	\$ 374
	17-17560EC	1¾	1¾	60	10	0.2	\$ 374
	17-17549EC <i>Vertical Use Only</i>	1¾	1¾	49¾	9	0.1	\$ 315
	17-17548EC	1¾	1¾	48	9	0.1	\$ 315
	17-17537EC <i>Vertical Use Only</i>	1¾	1¾	37¾	8	0.1	\$ 308
	17-17536EC	1¾	1¾	36	8	0.1	\$ 308
	17-17525EC <i>Vertical Use Only</i>	1¾	1¾	25¾	7	0.1	\$ 303
	17-17524EC	1¾	1¾	24	7	0.1	\$ 303
	17-17522EC	1¾	1¾	22¾	7	0.1	\$ 298

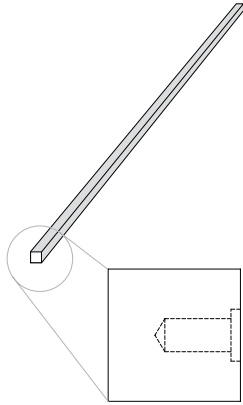

Must Specify (in this order):

Model # and Quantity  
Finish  
Hardware Color

**Description**

- Used Vertically and Horizontally to Provide a Clean, Balanced Aesthetic by Hiding Attachment Hardware
- Includes Bolts for Installation
- Blind-Threaded Insert for Installation

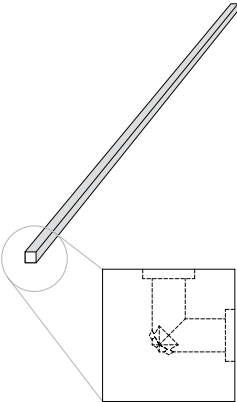
Item	Model No.	W	D	H	Ship Wt	Cubic Ft	List Price
CORNER POSTS 	17-17597CP	1¾	1¾	97¾	13	0.3	\$ 397
	17-17596CP	1¾	1¾	96	12	0.3	\$ 397
	17-17585CP	1¾	1¾	85¾	12	0.2	\$ 390
	17-17584CP	1¾	1¾	84	11	0.2	\$ 390
	17-17573CP	1¾	1¾	73¾	11	0.2	\$ 386
	17-17572CP	1¾	1¾	72	11	0.2	\$ 386
	17-17561CP	1¾	1¾	61¾	10	0.2	\$ 381
	17-17560CP	1¾	1¾	60	10	0.2	\$ 381
	17-17549CP	1¾	1¾	49¾	9	0.1	\$ 317
	17-17548CP	1¾	1¾	48	9	0.1	\$ 317
	17-17537CP	1¾	1¾	37¾	8	0.1	\$ 311
	17-17536CP	1¾	1¾	36	8	0.1	\$ 311
	17-17525CP	1¾	1¾	25¾	7	0.1	\$ 306
	17-17524CP	1¾	1¾	24	7	0.1	\$ 306
	17-17522CP	1¾	1¾	22¾	7	0.1	\$ 299

Must Specify (in this order):

Model # and Quantity

Finish

Hardware Color

**Description**

- Used Vertically to make 90° Turns
- Includes Bolts for Installation
- Blind-Threaded Insert for Installation

[See Overview for Square One Ordering Options.](#)

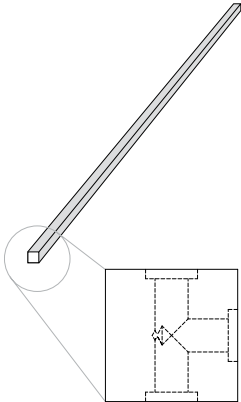

Item	Model No.	W	D	H	Ship Wt	Cubic Ft	List Price
	T-CONNECTOR BEAMS						
	17-17597TCB	1¾	1¾	97¾	13	0.3	\$ 401
	17-17596TCB	1¾	1¾	96	12	0.3	\$ 401
	17-17585TCB	1¾	1¾	85¾	12	0.2	\$ 396
	17-17584TCB	1¾	1¾	84	11	0.2	\$ 396
	17-17573TCB	1¾	1¾	73¾	11	0.2	\$ 388
	17-17572TCB	1¾	1¾	72	11	0.2	\$ 388
	17-17561TCB	1¾	1¾	61¾	10	0.2	\$ 385
	17-17560TCB	1¾	1¾	60	10	0.2	\$ 385
	17-17549TCB	1¾	1¾	49¾	9	0.1	\$ 318
	17-17548TCB	1¾	1¾	48	9	0.1	\$ 318
	17-17537TCB	1¾	1¾	37¾	8	0.1	\$ 314
	17-17536TCB	1¾	1¾	36	8	0.1	\$ 314
	17-17525TCB	1¾	1¾	25¾	7	0.1	\$ 308
17-17524TCB	1¾	1¾	24	7	0.1	\$ 308	
17-17522TCB	1¾	1¾	22¾	7	0.1	\$ 303	

Must Specify (in this order):

Model # and Quantity

Finish

Hardware Color

**Description**

- Used Vertically to Connect Three (3) Walls
- Includes Bolts for Installation
- Blind-Threaded Insert for Installation

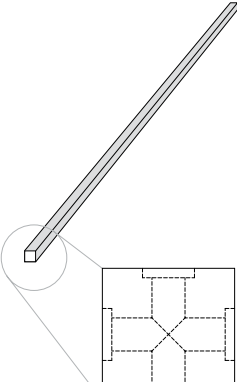
Item	Model No.	W	D	H	Ship Wt	Cubic Ft	List Price
	17-17597XB	1¾	1¾	97¾	13	0.3	\$ 404
	17-17585XB	1¾	1¾	85¾	12	0.2	\$ 400
	17-17573XB	1¾	1¾	73¾	11	0.2	\$ 395
	17-17561XB	1¾	1¾	61¾	10	0.2	\$ 388
	17-17549XB	1¾	1¾	49¾	9	0.1	\$ 320
	17-17537XB	1¾	1¾	37¾	8	0.1	\$ 316
	17-17525XB	1¾	1¾	25¾	7	0.1	\$ 309
	17-17522XB	1¾	1¾	22¾	7	0.1	\$ 306

### Description

- Used Vertically to Connect Four (4) Wall Runs
- Includes Bolts for Installation
- Blind-Threaded Insert for Installation

### Must Specify (in this order):

Model # and Quantity  
Finish  
Hardware Color

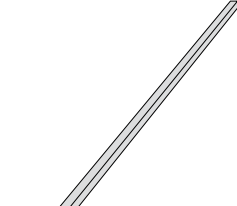
Item	Model No.	W	D	H	Ship Wt	Cubic Ft	List Price
	17-175120HBS	120	1¾	1¾	14	0.3	\$ 410
	17-175108HBS	108	1¾	1¾	12	0.3	\$ 390
	17-17596HBS	96	1¾	1¾	12	0.3	\$ 377
	17-17584HBS	84	1¾	1¾	11	0.2	\$ 357
	17-17572HBS	72	1¾	1¾	11	0.2	\$ 347

### Description

- Used Horizontally to Provide Structural Support for Doorways and Other Openings
- Includes Bolts for Installation
- Blind-Threaded Insert for Installation
- Holes Bored Only on Ends to Accommodate Attachment

### Must Specify (in this order):

Model # and Quantity  
Finish  
Hardware Color

[See Overview for Square One Ordering Options.](#)

Item	Model No.	W	D	H	Ship Wt	Cubic Ft	List Price
BARN DOOR WALL	Left	Right					
	17-4896BDBL	17-4896BDBR	120	4	103	289	271

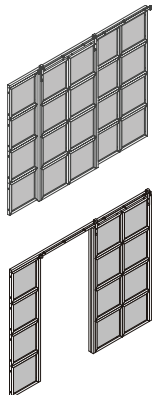

Shown as Right Barn Door

**Must Specify (in this order):**

Model #  
Finish  
Hardware Color  
Acrylic or Acoustic Panels/Color

**Description**

- Standard with: Blocks, Beam Spanner, Four (4) End Caps, and Hardware to Create An *Approximately* 10"W x 8½"H Wall with Barn Door, including Leveling Glides
- Barn Door Features Soft Open and Soft Close to Avoid Door Slamming
- Must Specify Finish and Hardware Color (Door Track Available in Black Only)
- Must Specify Acrylic and/or Acoustical Inserts for Use in Barn Door Wall (Total 20 Inserts); Note: List Price Shown Above Does NOT Include These Required Inserts Due to Variance in Pricing

**Must Specify Insert Options: 20 Acrylic and/or Acoustical Inserts (any combination)**

AP-2020AP	Acoustic Insert - Must Specify Color Option and Add; <a href="#">See Acoustic Color Options</a>		
MLK	Milky		\$ 260
TPE	Taupe		\$ 260
GRY	Grey		\$ 260
ASH	Ash		\$ 260
BLK	Black		\$ 260
AI-2020AC	Acrylic Insert - Must Specify Color Option and Add; <a href="#">See Acrylic Color Options</a>		
FSTA	Frosted		\$ 303
TGWA	Twigwork		\$ 582
WOVA	Woven		\$ 582
RAFA	Raffia		\$ 582
TNSA	Tinsel		\$ 582

PLANTER BOX	01-1909PL	19¼	9½	6	16	2.0	\$ 569
-------------	-----------	-----	----	---	----	-----	--------

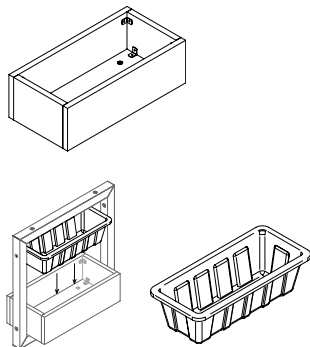
**Description**

- Material is TFL. Must Specify TFL (T) Color; [See Color Options](#)
- Planter Will Ship with Attachment Hardware: Two (2) Black and Two (2) Nickel Bolts
- Horizontal Grain
- Planter Boxes Cannot be Installed on Both Sides of a Corner
- Optional Planter Box Insert Sold Separately

**Option: Specify & Add**

PBI	Planter Box Insert, Black Plastic		\$ 52
-----	-----------------------------------	--	-------

**Must Specify (in this order):**

Model #  
TFL Color  
Optional Planter Insert

[See Overview for Square One Ordering Options.](#)

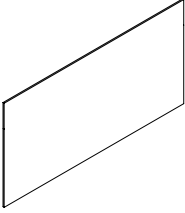
Item	Model No.	W	D	H	Ship Wt	Cubic Ft	List Price
<b>ACOUSTICAL PANEL ONSET INSTALLATION</b>  	<b>46"H Panels</b>						
	AP-4670AP	70¼	½	46¼	13	7.6	\$ 1246
	AP-4658AP	58¼	½	46¼	12	6.3	\$ 1054
	AP-4646AP	46¼	½	46¼	10	5.1	\$ 892
	<b>22"H Panels</b>						
	AP-2270AP	70¼	½	22¼	9	4.1	\$ 628
	AP-2258AP	58¼	½	22¼	8	3.4	\$ 525
	AP-2246AP	46¼	½	22¼	8	2.8	\$ 442
	AP-2234AP	34¼	½	22¼	7	2.1	\$ 368
	AP-2222AP	22¼	½	22¼	6	1.4	\$ 260

Must Specify (in this order):

Model #

Color

#### Description

- Onset Application, Installed with 9" Dual-Lock Connectors
- Sound Absorption Rating Average NRC 0.75 (50 mm Air Gap) 1.0 NRC in Mid-High Frequencies
- Cannot be Used on Same Side as TV Mount
- For Space Planning with Furniture, Note the Onset Application Will Add ½" to the Square One Blocks

#### Color Options: Must Specify; [See Color Options](#)

MLK Milky

TPE Taupe

GRY Grey

ASH Ash

BLK Black

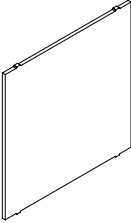
<b>ACOUSTICAL PANEL INSET INSTALLATION</b>  	<b>For 24" Blocks</b>						
	AP-2020AP	20¼	½	20¼	6	1.4	\$ 260
	<b>For 12" Blocks</b>						
	AP-0820AP	20¼	½	8¼	3	0.8	\$ 225

#### Description

- Inset Application; Includes Tabs to Secure in Place
- Sound Absorption Rating Average NRC 0.75 (50 mm Air Gap) 1.0 NRC in Mid-High Frequencies
- Cannot be Used with TV Mount

#### Color Options: Must Specify; [See Color Options](#)

MLK Milky

TPE Taupe

GRY Grey

ASH Ash

BLK Black

Must Specify (in this order):

Model #

Color

[See Overview for Square One Ordering Options.](#)

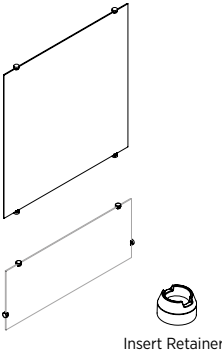
Item	Model No.	W	D	H	Ship Wt	Cubic Ft	List Price	
<b>ACRYLIC INSERTS</b>								
<b>For 24" Blocks</b>								
	AI-2020AC	20¼	½	20¼	7	2.0	\$ See Below	
	<b>For 12" Blocks</b>							
	AI-2008AC	8¾	½	20¼	6	2.0	\$ See Below	
	<i>Vertical Insert Applications</i>							
	AI-0820AC	20¼	½	8¾	6	2.0	\$ See Below	
	<i>Horizontal Insert Applications</i>							
<b>Description</b>								
<ul style="list-style-type: none"> <li>Inserted Into 24" or 12" Blocks with Insert Retainers (Included)</li> <li>Raffia's Linear Pattern will be Installed Vertically on Both AI-2008AC (Vertical) and AI-0820AC (Horizontal)</li> <li>Frosted Acrylic Inserts can be customized with a logo or design using one of the following file types: .CDR, .AI, or .EPS. Email the image to <a href="mailto:customproduct@indianafurniture.com">customproduct@indianafurniture.com</a> for a quote. Additional costs and lead times may apply. Note this as a special on your order when submitting.</li> </ul>								
<b>Color Options: Must Specify; See Color Options</b>								
FSTA	Frosted						24" \$ 303 12" \$ 197	
TGWA	Twigwork						24" \$ 582 12" \$ 316	
WOVA	Woven						24" \$ 582 12" \$ 316	
RAFA	Raffia						24" \$ 582 12" \$ 316	
TNSA	Tinsel						24" \$ 582 12" \$ 316	

Must Specify (in this order):

Model #  
Color  
Special Custom Logo

**For 12" Blocks**

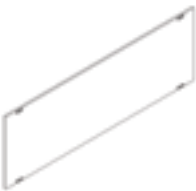

**Raffia (RAFA)**  
Vertical Installation  
Standard

<b>DRY ERASE BOARDS</b>							
<b>46"H Panels</b>							
	17-4670DEB	70¼	¾	46¼	11	0.2	\$ 1749
	17-4658DEB	58¼	¾	46¼	11	0.2	\$ 1451
	17-4646DEB	46¼	¾	46¼	11	0.2	\$ 1151
<b>22"H Panels</b>							
	17-2270DEB	70¼	¾	22¼	11	0.2	\$ 1181
	17-2258DEB	58¼	¾	22¼	11	0.2	\$ 954
	17-2246DEB	46¼	¾	22¼	11	0.2	\$ 759

Must Specify (in this order):

Model #  
Color

**Description**

- Nuts and Bolts Included for Onset Attachment
- May be Applied Horizontally or Vertically
- For Space Planning with Furniture, Note the Onset Application Will Add ¾" to the Square One Blocks

[See Overview for Square One Ordering Options.](#)

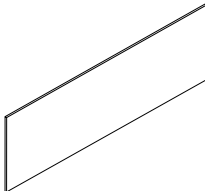
Item	Model No.	W	D	H	YARDS		GRADE COM/1/2/3	GRADE 4	GRADE 5	GRADE 6	GRADE 7	GRADE 8	GRADE 9	GRADE 10	
 <p><b>TACKABLE PANELS</b></p>	<b>46"H Panels (2 pieces)</b>														
	TB-4670TB	70¼	⅝	46¼	8.75	\$	2158	3374	3943	4521	5343	6201	7198	8353	
	TB-4658TB	58¼	⅝	46¼	7.25	\$	1903	2911	3382	3861	4542	5253	6079	7036	
	TB-4646TB	46¼	⅝	46¼	6.00	\$	1647	2481	2871	3267	3831	4419	5103	5895	
	<b>22"H Panels (1 piece)</b>														
	TB-2270TB	70¼	⅝	22¼	4.50	\$	1191	1817	2109	2406	2829	3270	3783	4377	
	TB-2258TB	58¼	⅝	22¼	3.75	\$	1034	1555	1799	2047	2399	2767	3194	3689	
	TB-2246TB	46¼	⅝	22¼	3.00	\$	871	1288	1483	1681	1963	2257	2599	2995	
	TB-2234TB	34¼	⅝	22¼	2.50	\$	711	1059	1221	1386	1621	1866	2151	2481	
	TB-2222TB	22¼	⅝	22¼	1.75	\$	545	788	902	1018	1182	1354	1553	1784	

Must Specify (in this order):

Model #

Fabric Vendor/Pattern/Color

#### Description

- Installed with 9" Dual-Lock Connectors
- Tackable Panels are Fully Upholstered on Both Sides.
- For Space Planning with Furniture, Note the Onset Application Will Add ⅝" to the Square One Blocks

Item	Model No.	W	D	H	Ship Wt	Cubic Ft	List Price
TV BRACKET	01-TVBR	3½	4	3	1	1.0	\$ 139

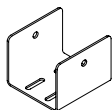

#### Description

- Black Metal
- Coordinates with TV Mount

TV MOUNT	01-TVMT	35¾	⅞	21⅝	15	0.5	\$ 1094
----------	---------	-----	---	-----	----	-----	---------

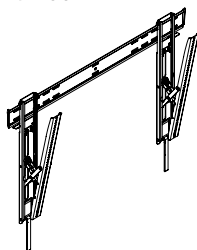

OPEN MARKET ONLY

#### Description

- Available in Black; Provides 12° of Smooth, Fingertip Tilt
- Compatible with Ultra-Thin TVs 2" (51 mm) Deep or Less; Typical Screen Sizes: 37" - 63"
- Weight Capacity: 100 lbs (45.4 kg)
- Can be Installed in Landscape Mode Only
- Must Order Two (2) 01-TVBR to Mount TV
- Not Compatible with Acrylic or Acoustical Inserts; Can be Used with Onset Acoustical Panels when Used on Opposite Sides

LEVELER KIT	17-LEVKIT				1	1.0	\$ 52
-------------	-----------	--	--	--	---	-----	-------

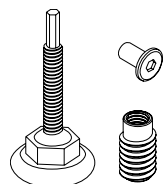

#### Description

- Includes Two (2) Levelers, Two (2) Insert Nuts and Two (2) Cap Nuts
- Must Specify Black (BLK) or Nickel (NCKL)

Must Specify (in this order):

Model # and Quantity

Hardware Color

[See Overview for Square One Ordering Options.](#)

Item	Model No.	W	D	H	Ship Wt	Cubic Ft	List Price
ALLEN DRIVER BIT	17-TOOL	-	-	-	1	1.0	\$ 59

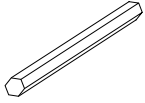
**Description**

- Used for Inserting Glide Insert Nuts for Levelers
- 6mm Allen Driver Bit

80MM BOLT AND NUT KIT	17-80MMBOLTKIT	-	-	-	1	1.0	\$ 50
-----------------------	----------------	---	---	---	---	-----	-------

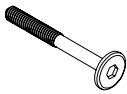

**Description**

- Quantity of Eight (8)
- For Connecting Block to Block
- Must Specify Black (BLK) or Nickel (NCKL)

Must Specify (in this order):

Model # and Quantity  
Hardware Color

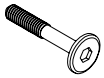
60MM BOLT AND NUT KIT	17-60MMBOLTKIT	-	-	-	1	1.0	\$ 39
-----------------------	----------------	---	---	---	---	-----	-------

**Description**

- Quantity of Eight (8)
- For Connecting Block to Beam, Post, or End Cap
- Must Specify Black (BLK) or Nickel (NCKL)

Must Specify (in this order):

Model # and Quantity  
Hardware Color

12MM BOLT AND NUT KIT	17-12MMBOLTKIT	-	-	-	1	1.0	\$ 38
-----------------------	----------------	---	---	---	---	-----	-------

**Description**

- Quantity of Eight (8)
- For Covering Exposed Holes in Rails Only
- Must Specify Black (BLK) or Nickel (NCKL)

Must Specify (in this order):

Model # and Quantity  
Hardware Color

[See Overview for Square One Ordering Options.](#)

Item	Model No.	W	D	H	Ship Wt	Cubic Ft	List Price
VESTA POWER CENTER	01-PDCTR	10 $\frac{3}{4}$	12	28 $\frac{1}{4}$	14	2.5	\$ 1776



#### Description

- Top Includes One (1) Power Outlet, Two (2) USB Ports and One (1) USBC Port; Base Includes Three (3) Outlet
- Available in White
- 120" Power Cord
- Built with Weight Distribution for Optimal Stability
- Base is 5" Tall

TIC-TAC-TOE FOAM GAME SET	17-XOSET	20 $\frac{3}{8}$	2	20 $\frac{3}{8}$	6	3.0	\$ 361
------------------------------	----------	------------------	---	------------------	---	-----	--------



#### Description

- Set Includes Five (5) Xs (Charcoal Gray) and Four (4) Os (Light Gray)
- Constructed of Polyurethane Foam

[See Overview for Square One Ordering Options.](#)



# Surface Materials

## Wood Finishes and Woodgrain, Solid, and 3D Laminates

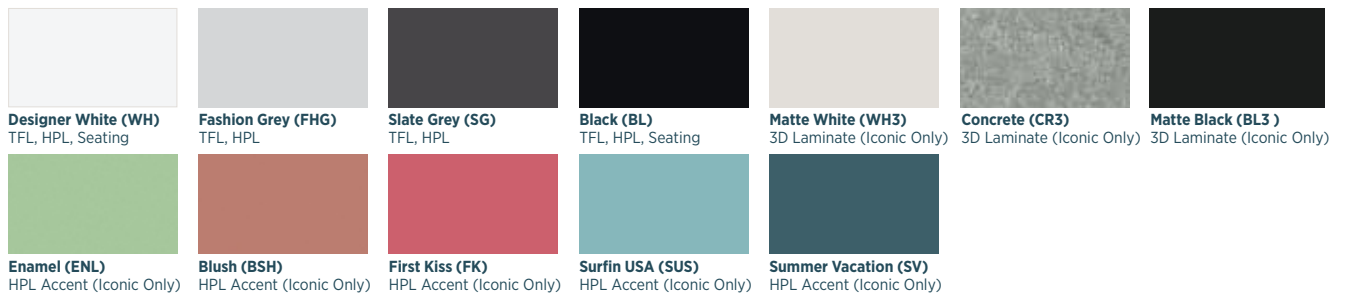
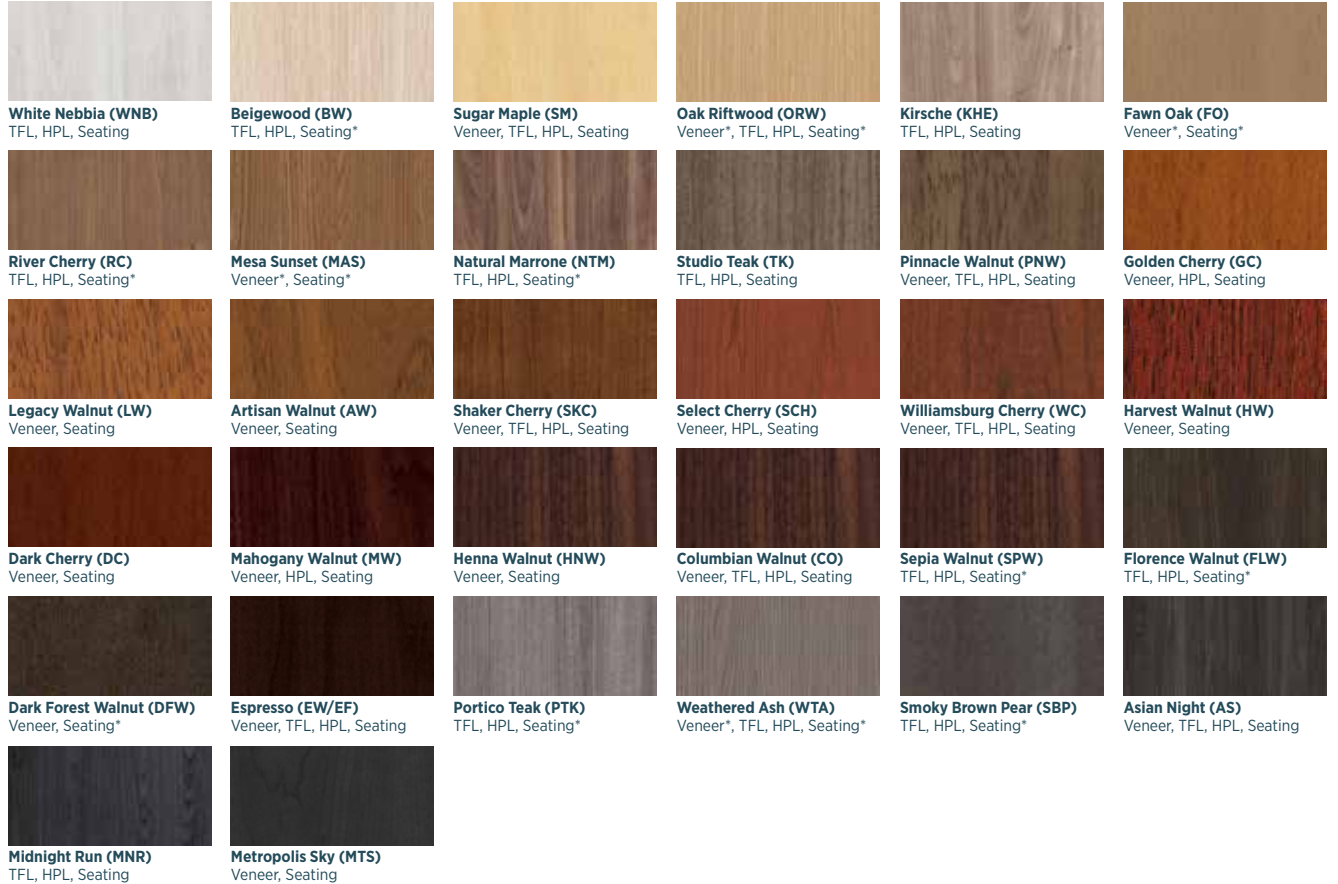

\* Finish is Low Sheen

## Frosted & High Gloss Acrylics



## Solid Surfaces

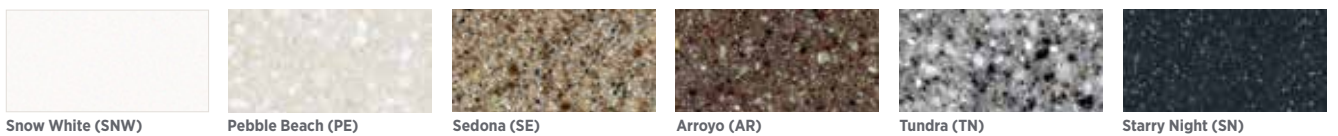

## Metal Options

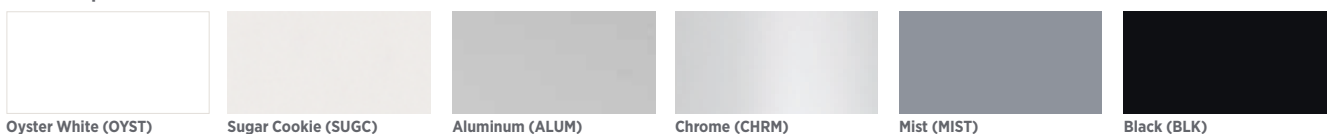

Colors represented are high-resolution reproductions and may vary slightly from the actual product. To order samples, please contact our Customer Service team or order online at [www.indianafurniture.com](http://www.indianafurniture.com). Graining and finish colors may vary yet will continue to complement, across Veneer, HPL, TFL, and Seating products due to the inherent differences of these materials.

# Indiana<sup>®</sup>

FURNITURE

1919 Hospitality Drive, Suite A  
PO Box 270  
Jasper, Indiana 47547-0270

Tel 812.482.5727

Toll 800.422.5727

Fax 812.482.9035

[sales@indianafurniture.com](mailto:sales@indianafurniture.com)

[www.indianafurniture.com](http://www.indianafurniture.com)

Federal Classification: Small Business

©2024 Indiana Furniture 5/24

