

SEATING+ OCC. TABLES

PRICING EFFECTIVE MAY 13, 2024

Indiana
FURNITURE

Being over a century old hasn't slowed us down! Sure, we are still the reliable, ethical company that was born in southern Indiana, steeped in quality, craftsmanship, and service. But have you seen our latest introductions? We are making a splash with design and challenging the concept of modern offices. Go ahead. Take a look. You know you want to.

Our Pledge to People + Our Planet.

We've been making wood furniture longer than just about anyone...and we want to be doing so for a long time to come. That's a large part of why we take a stewardship approach to our resources. We believe that environmental sustainability and business profits need not be mutually exclusive. They can and should exist side by side in a mutually beneficial relationship. And for more than a century, we've been showing how it's done.

We've proven our commitment to a sustainable future by supporting the standards and programs that protect our home planet and human health. Whether it's local sourcing, reducing contaminants, implementing wellness and safety programs, or diverting waste from landfills, social responsibility is a part of every decision we make at Indiana Furniture.

One of the surest ways to reduce our impact on the planet is to make and buy things that last. And this one's a natural for us. Our products are made with craftsmanship and attention to detail that are a part of our more than a century-long legacy in wood manufacturing. And our products are backed by our 12-year warranty, which facilitates maintenance, servicing and reassembly.

All of our product lines:

- Are manufactured and assembled in the USA,
- Meet or exceed Indoor Air quality standards*,
- Meet or exceed BIFMA level® Sustainability standards and certification*,
- Conform to the BIFMA Compliance standards*,
- Comply with TSCA Title VI (CARB) standards,
- and can contribute to U.S. Green Building's LEED Program.

To learn more, simply go to www.IndianaFurniture.com/resources.



Ease of Specification

Whether you're looking to specify your office spaces or simply to visualize them in the options and surface materials you are desiring, we make it easy. You can find the entire Indiana Furniture portfolio on the following third-party, space-planning platforms.



* Recently launched or new products may still be in testing; Cush Pillows is currently not BIFMA Compliant due to no available compliance test.

A modern collection designed to address a wide range of applications for today’s social workplaces and community spaces. KickStart’s flexible lounge and table offerings combine with collaborative elements to create inviting spaces for people to gather, work, re-energize, and learn.

The collection’s classic forms and refined scale are enhanced through precise details, tailored upholstery and a horizontal stitch detail. Two back styles, with or without a pillow, combine with upholstery options to create a versatile aesthetic ranging from sophisticated to casual.

CONSTRUCTION

- Internal wood components and frame are manufactured using Baltic Birch and European Beech
- Frames are individually hand assembled, and all chair joints are mortised and tenoned, screwed and glued for maximum strength and durability
- Metal legs are 9”H and are available in Aluminum or Chrome
- Non-marring Nylon Glides included in each leg at floor level
- High Grade Polyurethane Foam, 3½” thick in the seat and 2” thick in the back
- Optional Accent Pillow Backs, measuring 22½” x 3¼” x 13½” are attached with a nylon hook and loop material
- Modular units and tables connect using pre-installed metal ganging brackets
- Upholstered units ship fully assembled, while tables may require some assembly
- Tablet Arm surface measures 10” x 14” x 1”
- Tablet Arm surface and Tables feature Square edge profile
- Seating rated for users up to 275lbs

HIGH SURROUND UPHOLSTERY OPTIONS

To ensure a proper fit and finish on the High Surround feature of the KickStart models, we will require upholsteries to fit within a specific range of stretch. To make specification easier for you, we have pre-approved upholsteries for the High Surround feature. These are included on the [Stinson Revive Card](#) and [Momentum Kickstart Card](#) and can be found at www.IndianaFurniture.com. They include:

- | | | |
|-------------------|--------------------|-----------------|
| Ace (GR4) | Drift (GR6) | Outlander (GR4) |
| Artisan (GR3) | Ego (GR1) | Ritz (GR4) |
| Baxter (GR4) | Harrison (GR5) | Sarto (GR5) |
| Blip (GR3) | Highlight (GR4) | Scatter (GR1) |
| Bryant Park (GR3) | Inside Track (GR4) | Shift (GR4) |
| Carson CV (GR1) | Lorelai (GR6) | Sprint (GR3) |
| Crespo (GR1) | Moby (GR3) | |
| Cush (GR3) | Nestle (GR1) | |

All other upholsteries need approval prior to application. See the [Approval Form](#) for more information.

HOW TO ORDER EXAMPLE

UPHOLSTERED MODELS

Model No.	Description	Example
550H	Primary Upholstery	Mayer Fedora Fawn
	High Surround Upholstery	CF Stinson Outlander Acorn
	Accent Pillow Upholstery (if applicable)	Mayer Fedora Light Grey
	Leg Color	CHRM
	Tablet Arm Material/Location (if applicable)	TL
	Tablet Arm Color (if applicable)	WTA
	Power/Color/Location (if applicable)	ECSL

TABLES

Model No.	Description	Example
550-2426GT	Table Color/Finish	WTA
	Leg Color	CHRM
	Power/Color/Location	PWRUSBA

UPHOLSTERY RECOMMENDATIONS

Available in single or contrasting upholsteries in a wide variety of graded-in or contract options, including fabric, vinyl, and leather.

The use of upholstery patterns and stripes is highly discouraged as they may result in alignment issues.

SINGLE AND CONTRASTING UPHOLSTERY OPTIONS

Single Upholstery

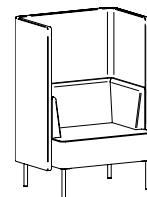
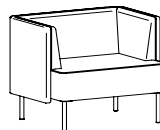

Contrasting Upholstery

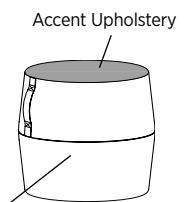
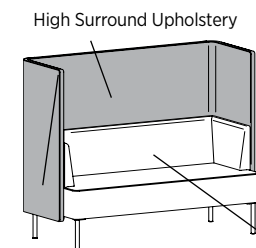
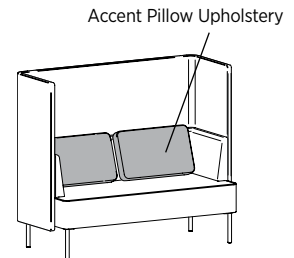
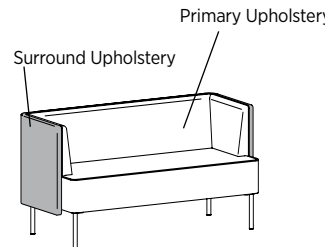

LEG OPTIONS

Must specify leg color.

- ALUM Aluminum Legs
- CHRM Chrome Legs

For Bistro Tables

- ALUM Aluminum Legs STD
- CHRM Chrome Legs \$ 108

TABLET ARM OPTIONS

Note: Specified by Facing the Chair

- TR TFL Tablet, Right \$ 640
- PR HPL Tablet, Right \$ 766
- WR Veneer Tablet, Right \$ 766
- TL TFL Tablet, Left \$ 640
- PL HPL Tablet, Left \$ 766
- WL Veneer Tablet, Left \$ 766

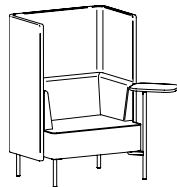
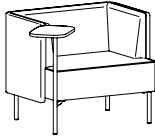

TFL (T) AND HPL (P) LAMINATE OPTIONS

WOODGRAIN

- | | |
|---------------------|------------------------|
| AS Asian Night | PNW Pinnacle Walnut |
| BW Beigewood | PTK Portico Teak |
| CO Columbian Walnut | RC River Cherry |
| EF Espresso | SCH Select Cherry^ |
| FLW Florence Walnut | SPW Sepia Walnut |
| GC Golden Cherry^ | SKC Shaker Cherry |
| KHE Kirsche | SBP Smoky Brown Pear |
| MW Mahogany Walnut^ | TK Studio Teak |
| MNR Midnight Run | SM Sugar Maple |
| NTM Natural Marrone | WTA Weathered Ash |
| ORW Oak Riftwood | WNB White Nebbia |
| | WC Williamsburg Cherry |

^ Color is available in HPL only

SOLID

- BL Black
- WH Designer White
- FHG Fashion Grey
- SG Slate Grey

veneer (W) OPTIONS

Veneer tops feature UV Advantage, an ultra-violet finish, on all exposed surfaces by utilizing roll-coat UV technology.

- | | |
|------------------------|------------------------|
| AW Artisan Walnut | MW Mahogany Walnut |
| AS Asian Night | MAS Mesa Sunset* |
| CO Columbian Walnut | MTS Metropolis Sky |
| DC Dark Cherry | PNW Pinnacle Walnut |
| DFW Dark Forest Walnut | ORW Oak Riftwood* |
| EW Espresso | SCH Select Cherry |
| FO Fawn Oak* | SKC Shaker Cherry |
| GC Golden Cherry | SM Sugar Maple |
| HW Harvest Walnut | WTA Weathered Ash* |
| HNW Henna Walnut | WC Williamsburg Cherry |
| LW Legacy Walnut | |

* Finish is Low Sheen

POWER OPTIONS

Note: Specified by Facing the Chair

Power locations for lounge units are located 1 1/4" up from the glide and 3 1/2" in from the outside of the arm. For modular units, the power is located 1 1/4" up from the glide and 4" in from the outside of the unit.

Up to two (2) ECA power ports may be used in each upholstered unit. ECA Power port comes with one (1) outlet and two (2) USB

- ECSL ECA Cove, Left Port, Silver \$ 975
- ECSR ECA Cove, Right Port, Silver \$ 975
- ECSLR ECA Cove, Left and Right Port, Silver \$ 1950
- ECBL ECA Cove, Left Port, Black \$ 975
- ECBR ECA Cove, Right Port, Black \$ 975
- ECBLR ECA Cove, Left and Right Port, Black \$ 1950

Standard Upholstered Units offer power ports on left and/or right side of unit

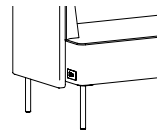

Power installed on left and/or right side

Modular Upholstered Units offer power ports on front left and/or front right of unit

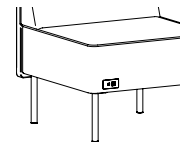

Power installed on front left (shown) and/or front right

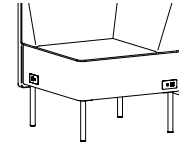

Power for Corner Units is installed on front left and/or front right

Modular Ganging Tables:

Note: Does Not Include Bistro Tables

- EPWRUSBA ECA Cove, Aluminum \$ 884
- EPWRUSBB ECA Cove, Black \$ 884
- 01-DOCK950W Dock 950 Wireless Charger, White, Specify Location \$ 265
- 01-DOCK950B Dock 950 Wireless Charger, Black, Specify Location \$ 265
- 01-DOCK150W Dock 150 Wireless & USB Charger, White, Specify Location \$ 405
- 01-DOCK150B Dock 150 Wireless & USB Charger, Black, Specify Location \$ 405

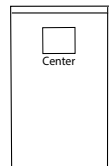

Power installation in In-Line/End Tables

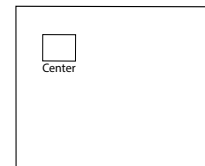

Power Installation in Corner Tables

POWER OPTIONS - ECA COVE CONTINUED

Media Table:

01-DUOBEZELW	Duo Bezel, White, Specify Location	\$ 675
01-DUOBEZELB	Duo Bezel, Black, Specify Location	\$ 675
01-DUOBEZELS	Duo Bezel, Silver, Specify Location	\$ 675
01-TRIOBEZELW	Trio Bezel, White, Specify Location	\$ 725
01-TRIOBEZELB	Trio Bezel, Black, Specify Location	\$ 725
01-TRIOBEZELS	Trio Bezel, Silver, Specify Location	\$ 725
01-DOCK950W	Dock 950 Wireless Charger, White, Specify Location	\$ 265
01-DOCK950B	Dock 950 Wireless Charger, Black, Specify Location	\$ 265
01-DOCK150W	Dock 150 Wireless & USB Charger, White, Specify Location	\$ 405
01-DOCK150B	Dock 150 Wireless & USB Charger, Black, Specify Location	\$ 405

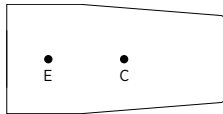

Power locations for Media Table are
End, Center, or End and Center

E = End C = Center EC = End and Center

E = 12" from monitor end
C = Centered

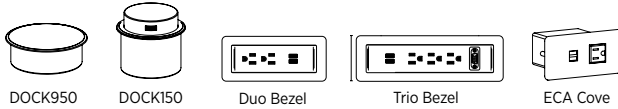

CERTIFICATIONS & COMPLIANCE

- CAL 117-2013 Compliance
- Intertek Sustainability Certified
- BIFMA level® Certified
- BIFMA Compliant® Certified
- TSCA Title VI (CARB) Compliance
- US Green Building's LEED® Contribution

Standard Components

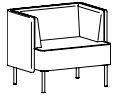

Club Chair:
550
[\(See Details\)](#)

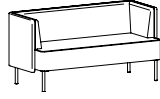

Settee:
5502
[\(See Details\)](#)



Sofa:
5503
[\(See Details\)](#)

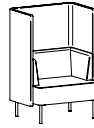

Club Chair with High Surround:
550H
[\(See Details\)](#)

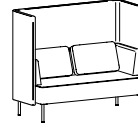

Settee with High Surround: 5502H
(Shown with optional pillows)
[\(See Details\)](#)

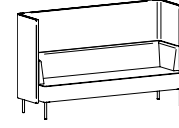

Sofa with High Surround: 5503H
[\(See Details\)](#)



Pouffe:
550-1617PF
[\(See Details\)](#)

Booth Settee with High Surround:
5502HR (Right)
5502HL (Left)
[\(See Details\)](#)

Booth Sofa with High Surround:
5503HR (Right)
5503HL (Left)
[\(See Details\)](#)

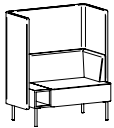

Club Nook with High Surround:
550HNR (Right)
550HNL (Left)
[\(See Details\)](#)

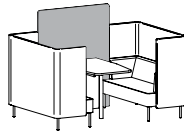

High Surround Center Panel:
5560HP (TFL)
5560HPV (Veneer)
5560HPU (Upholstered)
[\(See Details\)](#)

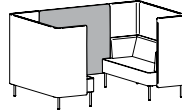

Low Surround Center Panel:
5540HP (TFL)
5540HPV (Veneer)
5540HPU (Upholstered)
[\(See Details\)](#)

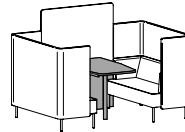

Media Peninsula:
550-3072MPS (TFL)
550-3072MPSH (HPL)
550-3072MPSV (Veneer)
550-3048MPS (TFL)
550-3048MPSH (HPL)
550-3048MPSV (Veneer)
[\(See Details\)](#)

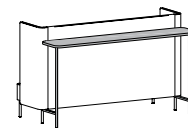

Bistro Table:
550-1681BT (TFL)
550-1681BTH (HPL)
550-1681BTV (Veneer)
550-1657BT (TFL)
550-1657BTH (HPL)
550-1657BTV (Veneer)
[\(See Details\)](#)



Purse Hook:
01-HOOK
[\(See Details\)](#)

Modular Components



Modular Club Chair: 550N
[\(See Details\)](#)

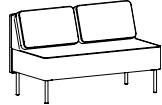

Modular Settee: 5502N
(Shown with optional pillows)
[\(See Details\)](#)

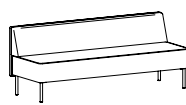

Modular Sofa: 5503N
[\(See Details\)](#)



Modular Chaise Settee:
5502CR (Right)
5502CL (Left)
[\(See Details\)](#)

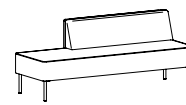

Modular Chaise Sofa:
5503CR (Right)
5503CL (Left)
[\(See Details\)](#)

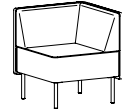

Modular Corner Unit:
550-90C
[\(See Details\)](#)

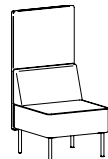

Modular Club Chair with High Surround: 550NH
[\(See Details\)](#)

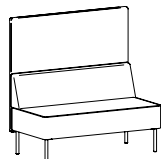

Modular Settee with High Surround:
5502NH
[\(See Details\)](#)

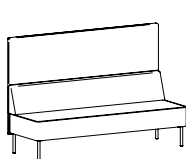

Modular Sofa with High Surround: 5503NH
[\(See Details\)](#)

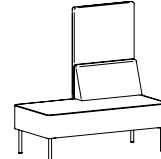

Modular Chaise Settee with High Surround:
5502CHR (Right)
5502CHL (Left)
[\(See Details\)](#)

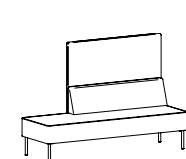

Modular Chaise Sofa with High Surround:
5503CHR (Right)
5503CHL (Left)
[\(See Details\)](#)

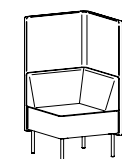

Modular Corner Unit with High Surround:
550-90CH
[\(See Details\)](#)

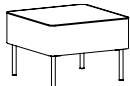

Ottoman:
550-2424OT
[\(See Details\)](#)

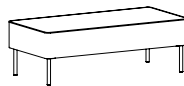

Bench:
550-5024RT
[\(See Details\)](#)

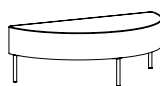

Half Round Bench:
550-5024HR
[\(See Details\)](#)

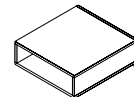

In-Line Table:
550-2426GT (TFL)
550-2426GTH (HPL)
550-2426GTV (Veneer)
550-1826GT (TFL)
550-1826GTH (HPL)
550-1826GTV (Veneer)
[\(See Details\)](#)

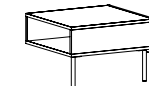

End Table:
550-2426ET (TFL)
550-2426ETH (HPL)
550-2426ETV (Veneer)
550-1826ET (TFL)
550-1826ETH (HPL)
550-1826ETV (Veneer)
[\(See Details\)](#)

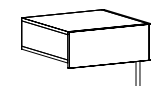

Corner Table:
550-9026CGT (TFL)
550-9026CGTH (HPL)
550-9026CGTV (Veneer)
[\(See Details\)](#)

Power + Accessories

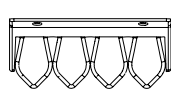
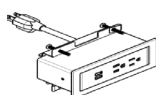

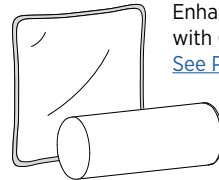
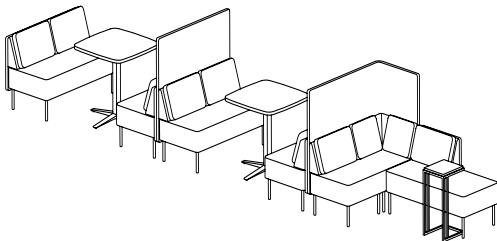
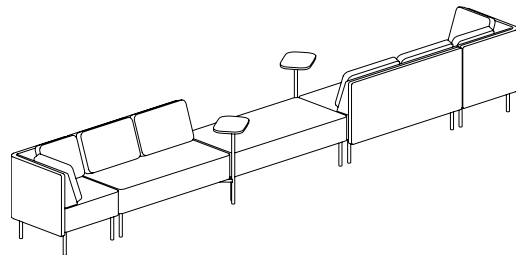
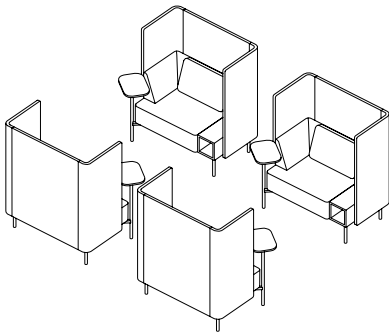
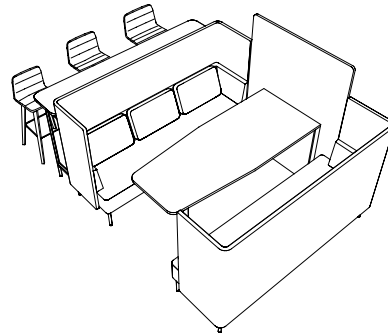
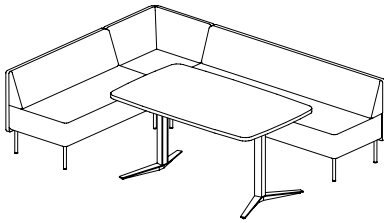
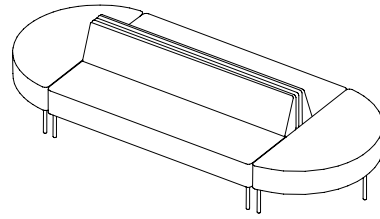
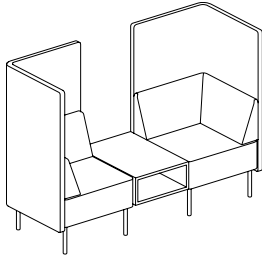
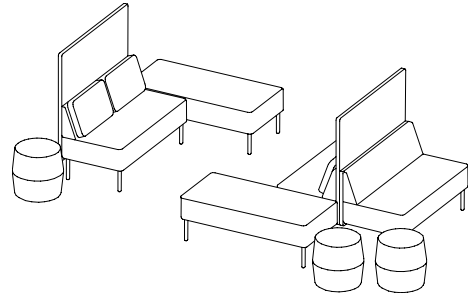
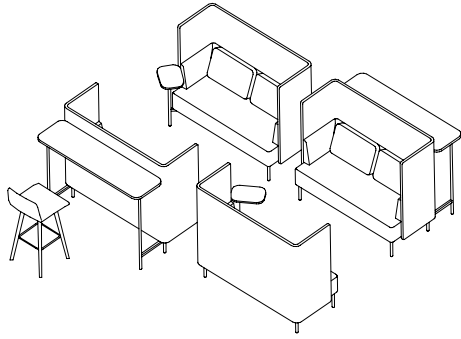

Enhance your space
with Cush Pillows.
[See Product Details.](#)

Item	Model No.	Width	Depth	Height	Ship Wt	Cubic Ft	List Price
HIGH SURROUNDS AND BISTRO TABLES	550-1	126	152	49	665	277.6	29681

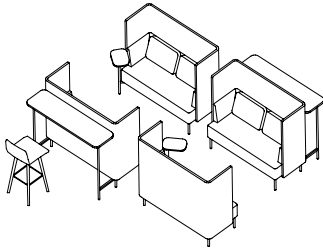

CONSISTS OF:		QTY		
5502H	2	Settee with High Surround (Gr 1) Shown with Optional Pillows	\$	12976
5502H	1	Settee with High Surround (Gr 1) Shown with Optional Pillows and HPL Tablet Arm, Left	\$	6488
5502H	1	Settee with High Surround (Gr 1) Shown with Optional Pillows and HPL Tablet Arm, Right	\$	6488
550-1657BTH	2	Bistro Table, HPL with Aluminum Leg	\$	2298
NAS-1C	1	Natta Stool (Gr 1)	\$	1431

Products are available as left or right and with other features, where applicable
 Width includes 12" between settees and Depth includes 48" between facing settees
 Grade 1 single upholstery and standard aluminum table leg pricing
 List prices do not include optional pillows or tablet arm

HIGH SURROUND BOOTH AND BISTRO TABLE	550-2	116 ½	81	60	623	252.8	20565
--------------------------------------	-------	-------	----	----	-----	-------	-------

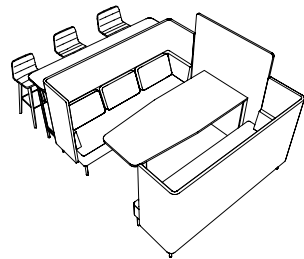

CONSISTS OF:		QTY		
5503HL	1	Booth Sofa with High Surround, Left (Gr 1) Shown with Optional Pillows	\$	8341
5503HR	1	Booth Sofa with High Surround, Right (Gr 1) Shown with Optional Pillows	\$	8341
5560HPU	1	Upholstered High Surround Center Panel for Media Table (Gr 1)	\$	1078
550-3072MPS	1	Media Peninsula, TFL	\$	1776
550-1681BT	1	Bistro Table, TFL with Aluminum Leg	\$	1029

Products are available as left or right and with other features, where applicable
 Grade 1 with standard metal leg pricing
 List prices do not include optional pillows

SETTEE + BENCHES + POUFFES	550-4	156	96	49	264	178.4	16806
----------------------------	-------	-----	----	----	-----	-------	-------

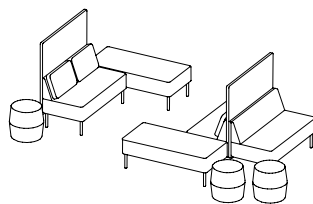

CONSISTS OF:		QTY		
5502N	1	Modular Settee (Gr 1)	\$	3369
550-1617PF	3	Pouffe (Gr 1)	\$	2295
5502NH	2	Modular Settee with High Surround Shown with Optional Pillows	\$	7654
550-5024RT	2	Modular Bench (Gr 1)	\$	3488

Products are available as left or right and with other features, where applicable
 Grade 1 with standard metal leg pricing
 List prices do not include optional pillows

For ordering options, [see overview at the beginning of this section.](#)

Item	Model No.	Width	Depth	Height	Ship Wt	Cubic Ft	List Price
OVAL SHAPED UNIT	550-5	120	50	29 1/8	242	224.6	\$ 11162

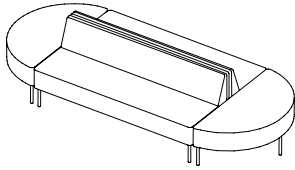

CONSISTS OF:		QTY			
5503N	2	Modular Sofa (Gr 1)		\$	8264
550-5024HR	2	Modular Half Round Bench (Gr 1)		\$	2898

Products are available as left or right and with other features, where applicable
Grade 1 with standard metal leg pricing

L GROUP WITH TABLE	550-10	96	72	29 1/8	354	147.9	\$ 12956
--------------------	--------	----	----	--------	-----	-------	----------

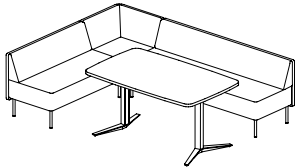

CONSISTS OF:		QTY			
5503N	1	Modular Sofa (GR 1)		\$	4132
550-90C	1	Modular Corner Unit (Gr 1)		\$	2984
5502N	1	Modular Settee (Gr 1)		\$	3369
86-3660SMT	1	Tri-One Soft Rectangle Meeting Table, TFL, Square Edge		\$	795
08-2828YLG72	1	Tri-One Y Base		\$	1676

Products are available as left or right and with other features, where applicable
Grade 1 with standard metal leg pricing

CAFE GROUPING	550-13	168	48	49	730	404.6	\$ 28471
---------------	--------	-----	----	----	-----	-------	----------

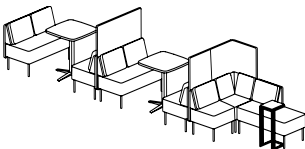

CONSISTS OF:		QTY			
5502NH	2	Modular Settee with High Surround (Gr 1) Shown with Optional Pillows		\$	7654
5502N	2	Modular Settee (Gr 1) Shown with Optional Pillows		\$	6738
86-3030SSQ	2	Tri-One Soft Square Meeting Top, TFL		\$	1002
08-2030SXB	2	X Base, Aluminum		\$	2278
550NH	1	Modular Club Chair (Gr 1) Shown with Optional Pillows		\$	2902
550-90CH	1	Modular Corner Unit with High Surround (Gr 1) Shown with Optional Pillows		\$	3526
5502CL	1	Modular Chaise Settee, Left (Gr 1) Shown with Optional Pillows		\$	3072
410-1412AT	1	Jot Auxillary Table, TFL		\$	1299

Products are available as left or right and with other features, where applicable
Grade 1 with standard metal leg pricing
List prices do not include optional pillows

For ordering options, [see overview at the beginning of this section.](#)

Item	Model No.	Chair Width	Chair Depth	Chair Height	Seat Width	Seat Depth	Seat Height	Arm Height	Ship Wt	Cubic Ft
CLUB CHAIR	550	33	26¼	29⅞	24	18¾	17½	29⅞	80	24

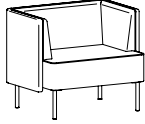

Description

- Available with Contrasting Upholstery ([See Details](#))
- Select Aluminum (ALUM) or Chrome (CHRM) Legs; Must Specify Leg Color
- For Optional Pillow Back; Add Pillow Pricing Below and [See Pillow Upholstery Options](#)
- Additional Options: [Tablet Arm Options](#), and [Power Locations](#)

Must Specify (in this order):

- Model #
- Primary Upholstery
- Surround Upholstery
- Pillow Upholstery
- Leg Color
- Tablet Arm
- Tablet Color
- Power

List Price/Grade	Yards	COM/1	2	3	4	5	6	7	8	9	10	L1	L2
Single Upholstery	5.25	\$ 3412	3685	3916	4142	4483	4830	5323	5838	6436	7129	5145	5885
Contrasting Upholstery													
Primary	3.00	\$ 3412	3568	3700	3829	4024	4222	4504	4798	5140	5536	4402	4825
Surround	2.25	\$ 0	117	216	313	459	608	819	1040	1296	1593	743	1060
Optional Pillow (1)	1.25	\$ 298	363	418	472	553	636	753	876	1018	1183	711	887

SETTEE

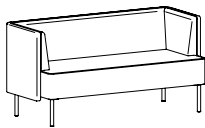

5502	57	26¼	29⅞	48	18¾	17½	29⅞	103	43.2
------	----	-----	-----	----	-----	-----	-----	-----	------

Description

- Available with Contrasting Upholstery ([See Details](#))
- Select Aluminum (ALUM) or Chrome (CHRM) Legs; Must Specify Leg Color
- For Optional Pillow Back; Add Pillow Pricing Below and [See Pillow Upholstery Options](#)
- Additional Options: [Tablet Arm Options](#), and [Power Locations](#)

Must Specify (in this order):

- Model #
- Primary Upholstery
- Surround Upholstery
- Pillow Upholstery
- Leg Color
- Tablet Arm
- Tablet Color
- Power

List Price/Grade	Yards	COM/1	2	3	4	5	6	7	8	9	10	L1	L2
Single Upholstery	7.25	\$ 4949	5326	5645	5957	6428	6907	7588	8299	9125	10082	7342	8364
Contrasting Upholstery													
Primary	4.50	\$ 4949	5183	5381	5575	5867	6164	6587	7028	7541	8135	6434	7069
Surround	2.75	\$ 0	143	264	382	561	743	1001	1271	1584	1947	908	1295
Optional Pillows (2)	1.50	\$ 543	621	687	752	849	948	1089	1236	1407	1605	1038	1250

SOFA



5503	81	26¼	29⅞	72	18¾	17½	29⅞	130	69.1
------	----	-----	-----	----	-----	-----	-----	-----	------

Description

- Available with Contrasting Upholstery ([See Details](#))
- Select Aluminum (ALUM) or Chrome (CHRM) Legs; Must Specify Leg Color
- For Optional Pillow Back; Add Pillow Pricing Below and [See Pillow Upholstery Options](#)
- Additional Options: [Tablet Arm Options](#), and [Power Locations](#)

Must Specify (in this order):

- Model #
- Primary Upholstery
- Surround Upholstery
- Pillow Upholstery
- Leg Color
- Tablet Arm
- Tablet Color
- Power

List Price/Grade	Yards	COM/1	2	3	4	5	6	7	8	9	10	L1	L2
Single Upholstery	8.75	\$ 6792	7247	7632	8008	8577	9155	9977	10835	11832	12987	9680	10913
Contrasting Upholstery													
Primary	5.25	\$ 6792	7065	7296	7522	7863	8210	8703	9218	9816	10509	8525	9265
Surround	3.50	\$ 0	182	336	486	714	945	1274	1617	2016	2478	1155	1648
Optional Pillows (3)	2.00	\$ 802	906	994	1080	1210	1342	1530	1726	1954	2218	1462	1744

For ordering options, [see overview at the beginning of this section.](#)

Item	Model No.	Chair Width	Chair Depth	Chair Height	Seat Width	Seat Depth	Seat Height	Arm Height	Ship Wt	Cubic Ft
CLUB CHAIR WITH HIGH SURROUND	550H	33	26¼	49	24	18¾	17½	29⅝	109	34.4

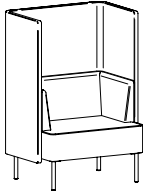

Description

- Available with Contrasting Upholstery ([See Details](#))
- Select Aluminum (ALUM) or Chrome (CHRM) Legs; Must Specify Leg Color
- For Optional Pillow Back; Add Pillow Pricing Below and [See Pillow Upholstery Options](#)
- Additional Options: [Tablet Arm Options](#), and [Power Locations](#)
- For High Surround, Select from Pre-Approved Upholsteries or Submit Approval Form; [See Approval Form](#)

Must Specify (in this order):

- Model #
- Primary Upholstery
- High Surround Upholstery
- Pillow Upholstery
- Leg Color
- Tablet Arm
- Tablet Color
- Power

List Price/Grade	Yards	COM/1	2	3	4	5	6	7	8	9	10
Single Upholstery	7.50	\$ 4908	5298	5628	5951	6438	6933	7638	8373	9228	10218
Contrasting Upholstery											
Primary	3.00	\$ 4908	5064	5196	5325	5520	5718	6000	6294	6636	7032
High Surround	4.50	\$ 0	234	432	626	918	1215	1638	2079	2592	3186
Optional Pillow (1)	1.25	\$ 298	363	418	472	553	636	753	876	1018	1183

SETTEE WITH HIGH SURROUND	5502H	57	26¼	49	48	18¾	17½	29⅝	144	61.9
---------------------------	-------	----	-----	----	----	-----	-----	-----	-----	------

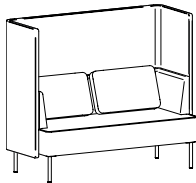

Shown with Optional Pillows

Description

- Available with Contrasting Upholstery ([See Details](#))
- Select Aluminum (ALUM) or Chrome (CHRM) Legs; Must Specify Leg Color
- For Optional Pillow Back; Add Pillow Pricing Below and [See Pillow Upholstery Options](#)
- Additional Options: [Tablet Arm Options](#), and [Power Locations](#)
- For High Surround, Select from Pre-Approved Upholsteries or Submit Approval Form; [See Approval Form](#)

Must Specify (in this order):

- Model #
- Primary Upholstery
- High Surround Upholstery
- Pillow Upholstery
- Leg Color
- Tablet Arm
- Tablet Color
- Power

List Price/Grade	Yards	COM/1	2	3	4	5	6	7	8	9	10
Single Upholstery	9.75	\$ 6488	6995	7424	7843	8477	9121	10037	10993	12104	13391
Contrasting Upholstery											
Primary	4.50	\$ 6488	6722	6920	7114	7406	7703	8126	8567	9080	9674
High Surround	5.25	\$ 0	273	504	729	1071	1418	1911	2426	3024	3717
Optional Pillows (2)	1.50	\$ 543	621	687	752	849	948	1089	1236	1407	1605

SOFA WITH HIGH SURROUND	5503H	81	26¼	49	72	18¾	17½	29⅝	180	98.9
-------------------------	-------	----	-----	----	----	-----	-----	-----	-----	------

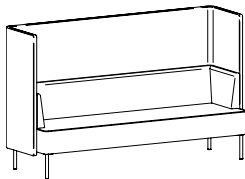

Description

- Available with Contrasting Upholstery ([See Details](#))
- Select Aluminum (ALUM) or Chrome (CHRM) Legs; Must Specify Leg Color
- For Optional Pillow Back; Add Pillow Pricing Below and [See Pillow Upholstery Options](#)
- Additional Options: [Tablet Arm Options](#), and [Power Locations](#)
- For High Surround, Select from Pre-Approved Upholsteries or Submit Approval Form; [See Approval Form](#)

Must Specify (in this order):

- Model #
- Primary Upholstery
- High Surround Upholstery
- Pillow Upholstery
- Leg Color
- Tablet Arm
- Tablet Color
- Power

List Price/Grade	Yards	COM/1	2	3	4	5	6	7	8	9	10
Single Upholstery	8.75	\$ 8341	8965	9493	10009	10789	11581	12709	13885	15253	16837
Contrasting Upholstery											
Primary	5.25	\$ 8341	8614	8845	9071	9412	9759	10252	10767	11365	12058
Surround	3.50	\$ 0	351	648	938	1377	1822	2457	3118	3888	4779
Optional Pillows (3)	2.00	\$ 802	906	994	1080	1210	1342	1530	1726	1954	2218

For ordering options, [see overview at the beginning of this section.](#)

Item	Model No.	Chair Width	Chair Depth	Chair Height	Seat Width	Seat Depth	Seat Height	Arm Height	Ship Wt	Cubic Ft	
CLUB NOOK WITH HIGH SURROUND	Seat on Left										
	Seat on Right										
	550HNL	550HNR	44½	26¼	49	27¼	18¾	17½	29⅝	121	52.9

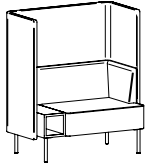

Shown as Right

Must Specify (in this order):

- Model #
- Primary Upholstery
- High Surround Upholstery
- Pillow Upholstery
- Nook Material
- Nook Color
- Leg Color
- Tablet Arm
- Tablet Color
- Power

Description

- Available with Contrasting Upholstery ([See Details](#))
- Nook Measures 8 ¼" x 14" x 8 ¼"; TFL Standard, Optional Veneer (W) or HPL (H). See Below for Upcharge
- Select Aluminum (ALUM) or Chrome (CHRM) Legs; Must Specify Leg Color
- For Optional Pillow Back; Add Pillow Pricing Below and [See Pillow Upholstery Options](#)
- Additional Options: [Tablet Arm Options](#), and [Power Locations](#)
- For High Surround, Select from Pre-Approved Upholsteries or Submit Approval Form; [See Approval Form](#)

List Price/Grade	Yards	COM/1	2	3	4	5	6	7	8	9	10
Single Upholstery	8.25	\$ 5934	6363	6726	7081	7617	8162	8937	9746	10686	11775
Contrasting Upholstery											
Primary	3.00	\$ 5934	6090	6222	6351	6546	6744	7026	7320	7662	8058
High Surround	5.25	\$ 0	273	504	730	1071	1418	1911	2426	3024	3717
Optional Pillow (1)	1.25	\$ 298	363	418	472	553	636	753	876	1018	1183

Nook Material: Specify & Add

H	HPL - Must Specify Color										\$ 179
W	Veneer - Must Specify Color										\$ 436

POUFFE	550-1617PF		16	16	17½	-	-	-	-	10	5.7
--------	------------	--	----	----	-----	---	---	---	---	----	-----

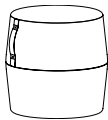

Must Specify (in this order):

- Model #
- Primary Upholstery
- Accent Upholstery

Description

- Standard with: Brown Leather Handle and Black Vinyl Bottom
- Upholstery Patterns or Stripes as the Primary Upholstery is Highly Discouraged Due to Alignment Issues
- Available with Contrasting Upholsteries

List Price/Grade	Yards	COM/1	2	3	4	5	6	7	8	9	10
Single Upholstery	2.50	\$ 765	895	1005	1113	1275	1440	1675	1920	2205	2535
Contrasting Upholstery											
Primary	1.75	\$ 765	856	933	1008	1122	1238	1402	1574	1773	2004
Accent	0.75	\$ 0	39	72	105	153	202	273	346	432	531

Item	Model No.	Chair Width	Chair Depth	Chair Height	Seat Width	Seat Depth	Seat Height	Arm Height	Ship Wt	Cubic Ft	
BOOTH SETTEE WITH HIGH SURROUND	Left										
	Right										
	5502HL	5502HR	57	26¼	49	48	18¾	17½	29⅝	144	61.9

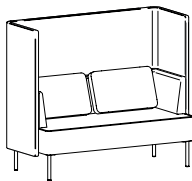

Shown with Optional Pillows

Must Specify (in this order):

- Model #
- Primary Upholstery
- High Surround Upholstery
- Pillow Upholstery
- Leg Color
- Tablet Arm
- Tablet Color
- Power

Description

- To Be Used With a High Surround Center Panel Model; Compatible With Media Table
- Center Panel Attaches to Lounge Unit With Hidden Clips; Reconfiguration Not Recommended
- Available with Contrasting Upholstery ([See Details](#))
- Select Aluminum (ALUM) or Chrome (CHRM) Legs; Must Specify Leg Color
- For Optional Pillow Back; Add Pillow Pricing Below and [See Pillow Upholstery Options](#)
- Additional Options: [Tablet Arm Options](#), and [Power Locations](#)
- For High Surround, Select from Pre-Approved Upholsteries or Submit Approval Form; [See Approval Form](#)

List Price/Grade	Yards	COM/1	2	3	4	5	6	7	8	9	10
Single Upholstery	9.75	\$ 6488	6995	7424	7843	8477	9121	10037	10993	12104	13391
Contrasting Upholstery											
Primary	4.50	\$ 6488	6722	6920	7114	7406	7703	8126	8567	9080	9674
High Surround	5.25	\$ 0	273	504	729	1071	1418	1911	2426	3024	3717
Optional Pillows (2)	1.50	\$ 543	621	687	752	849	948	1089	1236	1407	1605

For ordering options, [see overview at the beginning of this section.](#)

Item	Model No.	Chair Width	Chair Depth	Chair Height	Seat Width	Seat Depth	Seat Height	Arm Height	Ship Wt	Cubic Ft
BOOTH SOFA WITH HIGH SURROUND	Left	Right								
	5503HL	5503HR	81	26¼	49	72	18¾	17½	29¾	180

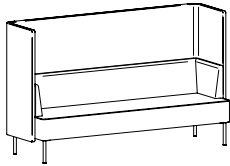

Must Specify (in this order):
 Model #
 Primary Upholstery
 High Surround Upholstery
 Pillow Upholstery
 Leg Color
 Tablet Arm
 Tablet Color
 Power

Description

- To Be Used With a High Surround Center Panel Model; Compatible With Media Table
- Center Panel Attaches to Lounge Unit With Hidden Clips; Reconfiguration Not Recommended
- Available with Contrasting Upholstery ([See Details](#))
- Select Aluminum (ALUM) or Chrome (CHRM) Legs; Must Specify Leg Color
- For Optional Pillow Back; Add Pillow Pricing Below and [See Pillow Upholstery Options](#)
- Additional Options: [Tablet Arm Options](#), and [Power Locations](#)
- For High Surround, Select from Pre-Approved Upholsteries or Submit Approval Form; [See Approval Form](#)

List Price/Grade	Yards	COM/1	2	3	4	5	6	7	8	9	10
Single Upholstery	12.00	\$ 8341	8965	9493	10009	10789	11581	12709	13885	15253	16837
Contrasting Upholstery											
Primary	5.25	\$ 8341	8614	8845	9071	9412	9759	10252	10767	11365	12058
High Surround	6.75	\$ 0	351	648	938	1377	1822	2457	3118	3888	4779
Optional Pillows (3)	2.00	\$ 802	906	994	1080	1210	1342	1530	1726	1954	2218

Item	Model No.	Width	Depth	Height	Ship Wt	Cubic Ft	List Price
MEDIA PENINSULA	72"W						
	550-3072MPS	TFL	72	30	30	153	43.9 T\$ 1776
	550-3072MPSH	HPL	72	30	30	153	43.9 P\$ 1984
	550-3072MPSV	Veneer	72	30	30	153	43.9 W\$ 2764
	48"W						
	550-3048MPS	TFL	48	30	30	112	28.4 T\$ 1536
	550-3048MPSH	HPL	48	30	30	112	28.4 P\$ 1687
	550-3048MPSV	Veneer	48	30	30	112	28.4 W\$ 2485

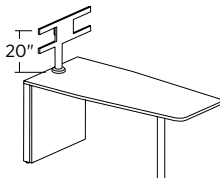
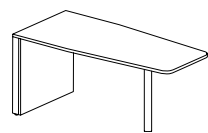

Shown with MTSD Option

Must Specify (in this order):
 Model #
 Finish/Color
 Leg Color
 Power
 Monitor Stand

Description

- Use with 60" High Surround Center Panels
- Not Recommended for Freestanding Application Due To Open Back
- Standard with: Square Edge and 2" Metal Tube Leg (Installed 15" from Front)
- 72" Units Feature a 51" Kneespace; 48" Units Feature 27" Kneespace
- Select from Aluminum or Chrome Legs; [See Leg Options](#) and Specify Leg Color
- End Panel Support Allows for Easy Routing and Concealing of Cables Through Wide, In-Column Channel
- Optional Monitor Stand and Power; Monitor Stand Fits Most 32" - 52" Screens (Mounting Pattern Range: VESA® 100x100mm - 600x400mm); Must Specify and Add (See Below)
- Wire Management Trough Included; 4¼" W x 46¾" L x 31½" H
- Some Assembly Required

Optional Monitor Stand: Specify & Add

MTSD	Monitor Stand	\$	675
------	---------------	----	-----

For ordering options, [see overview at the beginning of this section.](#)

Item	Model No.		Width	Depth	Height	Ship Wt	Cubic Ft	List Price	
HIGH SURROUND CENTER PANEL FOR MEDIA TABLE	5560HP	TFL	48	1	60	73.5	7.2	T\$	711
	5560HPV	Veneer	48	1	60	73.5	7.2	W\$	1064
	5560HPU	Upholstered	48	1	60	73.5	7.2	See Below	

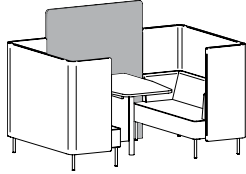
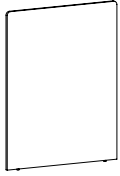

Description

- For Use with The Media Table; Requires Two Booth Settee or Booth Sofa Models (Specify Separately)
- Upholstery which is Railroad Cut (Across the Roll) Will Have a Seam Approximately 8" from Bottom
- Center Panel Sets on Floor; No Gap at Floor
- Attaches to Lounge Units with Hidden Fasteners; Reconfiguration Not Recommended
- For Upholstery, Select from Pre-Approved Upholsteries or Submit Approval Form; [See Approval Form](#)

List Price/Grade	Yards	COM/1	2	3	4	5	6	7	8	9	10
Single Upholstery	4.50	\$ 1078	1312	1510	1704	1996	2293	2716	3157	3670	4264

Must Specify (in this order):
Model #
Finish/Color/Upholstery

Item	Model No.		Width	Depth	Height	Ship Wt	Cubic Ft	List Price	
LOW SURROUND CENTER PANEL	5540HP	TFL	48	1	40	49	4.9	T\$	573
	5540HPV	Veneer	48	1	40	49	4.9	W\$	854
	5540HPU	Upholstered	48	1	40	49	4.9	See Below	

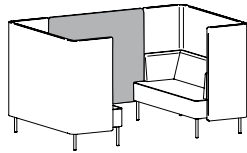

Description

- Requires Two Booth Settee or Booth Sofa Models (Specify Separately)
- Not Recommended for Use with Media Table
- Center Panel Aligns with Bottom of High Surround; 9" Gap at Floor
- Attaches to Lounge Units with Hidden Fasteners; Reconfiguration Not Recommended
- For Upholstery, Select from Pre-Approved Upholsteries or Submit Approval Form; [See Approval Form](#)

List Price/Grade	Yards	COM/1	2	3	4	5	6	7	8	9	10
Single Upholstery	3.25	\$ 868	1037	1180	1320	1531	1746	2051	2370	2740	3169

Must Specify (in this order):
Model #
Finish/Color/Upholstery

For ordering options, [see overview at the beginning of this section.](#)

Item	Model No.	Chair Width	Chair Depth	Chair Height	Seat Width	Seat Depth	Seat Height	Arm Height	Ship Wt	Cubic Ft
MODULAR CLUB CHAIR	550N	24	24	29½	24	18¼	17½	-	40	24



Must Specify (in this order):

- Model #
- Primary Upholstery
- Surround Upholstery
- Pillow Upholstery
- Leg Color
- Tablet Arm
- Tablet Color
- Power

Description

- Available with Contrasting Upholstery ([See Details](#))
- Includes Ganging Hardware
- Select Aluminum (ALUM) or Chrome (CHRM) Legs; Must Specify Leg Color
- For Optional Pillow Back; Add Pillow Pricing Below and [See Pillow Upholstery Options](#)
- Additional Options: [Tablet Arm Options](#), and [Power Locations](#)

List Price/Grade	Yards	COM/1	2	3	4	5	6	7	8	9	10	L1	L2
Single Upholstery	3.25	\$ 2539	2708	2851	2991	3202	3417	3722	4041	4411	4840	3612	4070
Contrasting Upholstery													
Primary	2.25	\$ 2539	2656	2755	2852	2998	3147	3358	3579	3835	4132	3282	3599
Surround	1.00	\$ 0	52	96	139	204	270	364	462	576	708	330	471
Optional Pillow (1)	1.25	\$ 298	363	418	472	553	636	753	876	1018	1183	711	887

MODULAR SETTEE	5502N	48	24	29½	48	18¼	17½	-	68	43.2
----------------	-------	----	----	-----	----	-----	-----	---	----	------

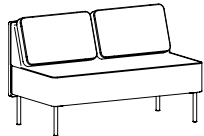

Shown with Optional Pillows

Must Specify (in this order):

- Model #
- Primary Upholstery
- Surround Upholstery
- Pillow Upholstery
- Leg Color
- Tablet Arm
- Tablet Color
- Power

Description

- Available with Contrasting Upholstery ([See Details](#))
- Includes Ganging Hardware
- Select Aluminum (ALUM) or Chrome (CHRM) Legs; Must Specify Leg Color
- For Optional Pillow Back; Add Pillow Pricing Below and [See Pillow Upholstery Options](#)
- Additional Options: [Tablet Arm Options](#), and [Power Locations](#)

List Price/Grade	Yards	COM/1	2	3	4	5	6	7	8	9	10	L1	L2
Single Upholstery	4.50	\$ 3369	3603	3801	3995	4287	4584	5007	5448	5961	6555	4854	5489
Contrasting Upholstery													
Primary	3.00	\$ 3369	3525	3657	3786	3981	4179	4461	4755	5097	5493	4359	4782
Surround	1.50	\$ 0	78	144	209	306	405	546	693	864	1062	495	707
Optional Pillows (2)	1.50	\$ 543	621	687	752	849	948	1089	1236	1407	1605	1038	1250

SOFA	5503N	72	24	29½	72	18¼	17½	-	88	69.1
------	-------	----	----	-----	----	-----	-----	---	----	------



Must Specify (in this order):

- Model #
- Primary Upholstery
- Surround Upholstery
- Pillow Upholstery
- Leg Color
- Tablet Arm
- Tablet Color
- Power

Description

- Available with Contrasting Upholstery ([See Details](#))
- Includes Ganging Hardware
- Select Aluminum (ALUM) or Chrome (CHRM) Legs; Must Specify Leg Color
- For Optional Pillow Back; Add Pillow Pricing Below and [See Pillow Upholstery Options](#)
- Additional Options: [Tablet Arm Options](#), and [Power Locations](#)

List Price/Grade	Yards	COM/1	2	3	4	5	6	7	8	9	10	L1	L2
Single Upholstery	6.25	\$ 4132	4457	4732	5001	5407	5820	6407	7020	7732	8557	6195	7076
Contrasting Upholstery													
Primary	4.25	4132	4353	4540	4723	4999	5280	5679	6096	6580	7141	5535	6134
Surround	2.00	0	104	192	278	408	540	728	924	1152	1416	660	942
Optional Pillows (3)	2.00	802	906	994	1080	1210	1342	1530	1726	1954	2218	1462	1744

For ordering options, [see overview at the beginning of this section.](#)

Item	Model No.	Chair Width	Chair Depth	Chair Height	Seat Width	Seat Depth	Seat Height	Arm Height	Ship Wt	Cubic Ft
MODULAR CLUB CHAIR WITH HIGH SURROUND	550NH	24	24	49	24	18¼	17½	-	50	43.2

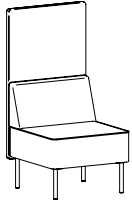

Must Specify (in this order):

- Model #
- Primary Upholstery
- High Surround Upholstery
- Pillow Upholstery
- Leg Color
- Tablet Arm
- Tablet Color
- Power

Description

- Available with Contrasting Upholstery ([See Details](#))
- Includes Ganging Hardware
- Select Aluminum (ALUM) or Chrome (CHRM) Legs; Must Specify Leg Color
- For Optional Pillow Back; Add Pillow Pricing Below and [See Pillow Upholstery Options](#)
- Additional Options: [Tablet Arm Options](#), and [Power Locations](#)
- For High Surround, Select from Pre-Approved Upholsteries or Submit Approval Form; [See Approval Form](#)

List Price/Grade	Yards	COM/1	2	3	4	5	6	7	8	9	10
Single Upholstery	5.00	\$ 2902	3162	3382	3597	3922	4252	4722	5212	5782	6442
Contrasting Upholstery											
Primary	2.25	\$ 2902	3019	3118	3215	3361	3510	3721	3942	4198	4495
High Surround	2.75	\$ 0	143	264	382	561	742	1001	1270	1584	1947
Optional Pillow (1)	1.25	\$ 298	363	418	472	553	636	753	876	1018	1183

MODULAR SETTEE WITH HIGH SURROUND	5502NH	48	24	49	48	18¼	17½	-	88	61.9
-----------------------------------	--------	----	----	----	----	-----	-----	---	----	------

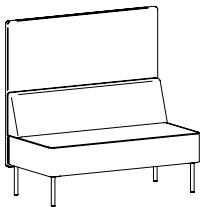

Must Specify (in this order):

- Model #
- Primary Upholstery
- High Surround Upholstery
- Pillow Upholstery
- Leg Color
- Tablet Arm
- Tablet Color
- Power

Description

- Available with Contrasting Upholstery ([See Details](#))
- Includes Ganging Hardware
- Select Aluminum (ALUM) or Chrome (CHRM) Legs; Must Specify Leg Color
- For Optional Pillow Back; Add Pillow Pricing Below and [See Pillow Upholstery Options](#)
- Additional Options: [Tablet Arm Options](#), and [Power Locations](#)
- For High Surround, Select from Pre-Approved Upholsteries or Submit Approval Form; [See Approval Form](#)

List Price/Grade	Yards	COM/1	2	3	4	5	6	7	8	9	10
Single Upholstery	6.25	\$ 3827	4152	4427	4696	5102	5515	6102	6715	7427	8252
Contrasting Upholstery											
Primary	3.00	\$ 3827	3983	4115	4244	4439	4637	4919	5213	5555	5951
High Surround	3.25	\$ 0	169	312	452	663	878	1183	1502	1872	2301
Optional Pillows (2)	1.50	\$ 543	621	687	752	849	948	1089	1236	1407	1605

MODULAR SOFA WITH HIGH SURROUND	5503NH	72	24	49	72	18¼	17½	-	118	99.0
---------------------------------	--------	----	----	----	----	-----	-----	---	-----	------

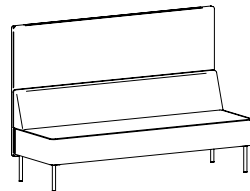

Must Specify (in this order):

- Model #
- Primary Upholstery
- High Surround Upholstery
- Pillow Upholstery
- Leg Color
- Tablet Arm
- Tablet Color
- Power

Description

- Available with Contrasting Upholstery ([See Details](#))
- Select Aluminum (ALUM) or Chrome (CHRM) Legs; Must Specify Leg Color
- Includes Ganging Hardware
- For Optional Pillow Back; Add Pillow Pricing Below and [See Pillow Upholstery Options](#)
- Additional Options: [Tablet Arm Options](#), and [Power Locations](#)
- For High Surround, Select from Pre-Approved Upholsteries or Submit Approval Form; [See Approval Form](#)

List Price/Grade	Yards	COM/1	2	3	4	5	6	7	8	9	10
Single Upholstery	8.75	\$ 4862	5317	5702	6078	6647	7225	8047	8905	9902	11057
Contrasting Upholstery											
Primary	4.25	\$ 4862	5083	5270	5453	5729	6010	6409	6826	7310	7871
High Surround	4.50	\$ 0	234	432	625	918	1215	1638	2079	2592	3186
Optional Pillows (3)	2.00	\$ 802	906	994	1080	1210	1342	1530	1726	1954	2218

For ordering options, [see overview at the beginning of this section.](#)

Item	Model No.	Chair Width	Chair Depth	Chair Height	Seat Width	Seat Depth	Seat Height	Arm Height	Ship Wt	Cubic Ft	
MODULAR CHAISE SETTEE	Back on Left										
	Back on Right										
	5502CL	5502CR	48	24	29½	48	18¼	17½	-	50	43.2

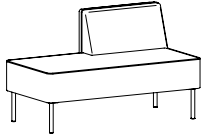

Shown as Right

Must Specify (in this order):

- Model #
- Primary Upholstery
- Surround Upholstery
- Pillow Upholstery
- Leg Color
- Tablet Arm
- Tablet Color
- Power

Description

- Available with Contrasting Upholstery ([See Details](#))
- Includes Ganging Hardware
- Select Aluminum (ALUM) or Chrome (CHRM) Legs; Must Specify Leg Color
- For Optional Pillow Back; Add Pillow Pricing Below and [See Pillow Upholstery Options](#)
- Additional Options: [Tablet Arm Options](#), and [Power Locations](#)

List Price/Grade	Yards	COM/1	2	3	4	5	6	7	8	9	10	L1	L2
Single Upholstery	4.00	\$ 3072	3280	3456	3628	3888	4152	4528	4920	5376	5904	4392	4956
Contrasting Upholstery													
Primary	3.00	\$ 3072	3228	3360	3489	3684	3882	4164	4458	4800	5196	4062	4485
Surround	1.00	\$ 0	52	96	139	204	270	364	462	576	708	330	471
Optional Pillow (1)	1.25	\$ 298	363	418	472	553	636	753	876	1018	1183	711	887

Item	Model No.	Chair Width	Chair Depth	Chair Height	Seat Width	Seat Depth	Seat Height	Arm Height	Ship Wt	Cubic Ft	
MODULAR CHAISE SOFA	Back on Left										
	Back on Right										
	5503CL	5503CR	72	24	29½	72	18¼	17½	-	78	69.1

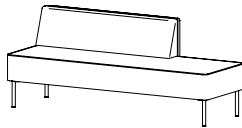

Shown as Left

Must Specify (in this order):

- Model #
- Primary Upholstery
- Surround Upholstery
- Pillow Upholstery
- Leg Color
- Tablet Arm
- Tablet Color
- Power

Description

- Available with Contrasting Upholstery ([See Details](#))
- Includes Ganging Hardware
- Select Aluminum (ALUM) or Chrome (CHRM) Legs; Must Specify Leg Color
- For Optional Pillow Back; Add Pillow Pricing Below and [See Pillow Upholstery Options](#)
- Additional Options: [Tablet Arm Options](#), and [Power Locations](#)

List Price/Grade	Yards	COM/1	2	3	4	5	6	7	8	9	10	L1	L2
Single Upholstery	5.75	\$ 4061	4360	4613	4860	5234	5614	6154	6718	7373	8132	5959	6769
Contrasting Upholstery													
Primary	4.25	\$ 4061	4282	4469	4652	4928	5209	5608	6025	6509	7070	5464	6063
Surround	1.50	\$ 0	78	144	208	306	405	546	693	864	1062	495	706
Optional Pillows (2)	1.50	\$ 543	621	687	752	849	948	1089	1236	1407	1605	1038	1250

Item	Model No.	Chair Width	Chair Depth	Chair Height	Seat Width	Seat Depth	Seat Height	Arm Height	Ship Wt	Cubic Ft
MODULAR CORNER UNIT	550-90C	24	24	29½	18¼	18¼	17½	29%	85	24

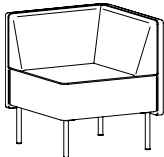

Must Specify (in this order):

- Model #
- Primary Upholstery
- Surround Upholstery
- Pillow Upholstery
- Leg Color
- Power

Description

- Available with Contrasting Upholstery ([See Details](#))
- Tablet Arm Not Available
- Includes Ganging Hardware
- Select Aluminum (ALUM) or Chrome (CHRM) Legs; Must Specify Leg Color
- For Optional Pillow Back; Add Pillow Pricing Below and [See Pillow Upholstery Options](#)
- Additional Options: [Tablet Arm Options](#), and [Power Locations](#)

List Price/Grade	Yards	COM/1	2	3	4	5	6	7	8	9	10	L1	L2
Single Upholstery	4.00	\$ 2984	3192	3368	3540	3800	4064	4440	4832	5288	5816	4304	4868
Contrasting Upholstery													
Primary	2.50	\$ 2984	3114	3224	3332	3494	3659	3894	4139	4424	4754	3809	4162
Surround	1.50	\$ 0	78	144	208	306	405	546	693	864	1062	495	706
Optional Pillows (2)	1.50	\$ 543	621	687	752	849	948	1089	1236	1407	1605	1038	1250

For ordering options, [see overview at the beginning of this section.](#)

Item	Model No.	Chair Width	Chair Depth	Chair Height	Seat Width	Seat Depth	Seat Height	Arm Height	Ship Wt	Cubic Ft	
MODULAR CHAISE SETTEE WITH HIGH SURROUND	Back on Left										
	Back on Right										
	5502CHL	5502CHR	48	24	49	48	18¼	17½	-	60	61.9

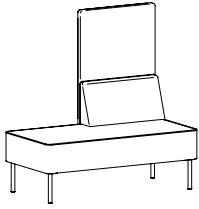

Shown as Right

Must Specify (in this order):

- Model #
- Primary Upholstery
- High Surround Upholstery
- Pillow Upholstery
- Leg Color
- Tablet Arm
- Tablet Color
- Power

Description

- Available with Contrasting Upholstery ([See Details](#))
- Includes Ganging Hardware
- Select Aluminum (ALUM) or Chrome (CHRM) Legs; Must Specify Leg Color
- For Optional Pillow Back; Add Pillow Pricing Below and [See Pillow Upholstery Options](#)
- Additional Options: [Tablet Arm Options](#), and [Power Locations](#)
- For High Surround, Select from Pre-Approved Upholsteries or Submit Approval Form; [See Approval Form](#)

List Price/Grade	Yards	COM/1	2	3	4	5	6	7	8	9	10
Single Upholstery	5.75	\$ 3431	3730	3983	4230	4604	4984	5524	6088	6743	7502
Contrasting Upholstery											
Primary	3.00	\$ 3431	3587	3719	3848	4043	4241	4523	4817	5159	5555
High Surround	2.75	\$ 0	143	264	382	561	742	1001	1270	1584	1947
Optional Pillow (1)	1.25	\$ 298	363	418	472	553	636	753	876	1018	1183

MODULAR CHAISE SOFA WITH HIGH SURROUND

Back on Left										
Back on Right										
5503CHL	5503CHR	72	24	49	72	18¼	17½	-	98	98.2

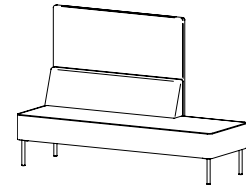

Shown as Left

Must Specify (in this order):

- Model #
- Primary Upholstery
- High Surround Upholstery
- Pillow Upholstery
- Leg Color
- Tablet Arm
- Tablet Color
- Power

Description

- Available with Contrasting Upholstery ([See Details](#))
- Includes Ganging Hardware
- Select Aluminum (ALUM) or Chrome (CHRM) Legs; Must Specify Leg Color
- For Optional Pillow Back; Add Pillow Pricing Below and [See Pillow Upholstery Options](#)
- Additional Options: [Tablet Arm Options](#), and [Power Locations](#)
- For High Surround, Select from Pre-Approved Upholsteries or Submit Approval Form; [See Approval Form](#)

List Price/Grade	Yards	COM/1	2	3	4	5	6	7	8	9	10
Single Upholstery	7.50	\$ 4557	4947	5277	5600	6087	6582	7287	8022	8877	9867
Contrasting Upholstery											
Primary	4.25	\$ 4557	4778	4965	5148	5424	5705	6104	6521	7005	7566
High Surround	3.25	\$ 0	169	312	452	663	877	1183	1501	1872	2301
Optional Pillows (2)	1.50	\$ 543	621	687	752	849	948	1089	1236	1407	1605

MODULAR CORNER UNIT WITH HIGH SURROUND

550-90CH	24	24	49	18¼	18¼	17½	29%	104	34.4
----------	----	----	----	-----	-----	-----	-----	-----	------

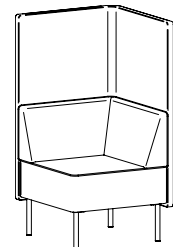

Description

- Available with Contrasting Upholstery ([See Details](#))
- Tablet Arm Not Available
- Includes Ganging Hardware
- Select Aluminum (ALUM) or Chrome (CHRM) Legs; Must Specify Leg Color
- For Optional Pillow Back; Add Pillow Pricing Below and [See Pillow Upholstery Options](#)
- Additional Options: [Tablet Arm Options](#), and [Power Locations](#)
- For High Surround, Select from Pre-Approved Upholsteries or Submit Approval Form; [See Approval Form](#)

List Price/Grade	Yards	COM/1	2	3	4	5	6	7	8	9	10
Single Upholstery	5.25	\$ 3526	3799	4030	4256	4597	4944	5437	5952	6550	7243
Contrasting Upholstery											
Primary	2.50	\$ 3526	3656	3766	3874	4036	4201	4436	4681	4966	5296
High Surround	2.75	\$ 0	143	264	382	561	743	1001	1271	1584	1947
Optional Pillows (2)	1.50	\$ 543	621	687	752	849	948	1089	1236	1407	1605

Must Specify (in this order):

- Model #
- Primary Upholstery
- High Surround Upholstery
- Pillow Upholstery
- Leg Color
- Power

For ordering options, [see overview at the beginning of this section.](#)

Item	Model No.	Chair Width	Chair Depth	Chair Height	Seat Width	Seat Depth	Seat Height	Arm Height	Ship Wt	Cubic Ft
MODULAR OTTOMAN	550-2424OT	-	-	-	24	24	17½	-	23	18.3

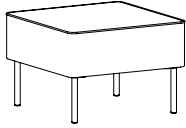

Must Specify (in this order):

- Model #
- Upholstery
- Leg Color
- Tablet Arm
- Tablet Color
- Power

Description

- Includes Ganging Hardware
- Select Aluminum (ALUM) or Chrome (CHRM) Legs; Must Specify Leg Color
- Additional Options: [Tablet Arm Options](#) and [Power Locations](#)

List Price/Grade	Yards	COM/1	2	3	4	5	6	7	8	9	10	L1	L2
Single Upholstery	1.50	\$ 1180	1258	1324	1389	1486	1585	1726	1873	2044	2242	1675	1887

MODULAR BENCH	550-5024RT	-	-	-	50	24	17½	-	32	43.2
---------------	------------	---	---	---	----	----	-----	---	----	------



Must Specify (in this order):

- Model #
- Upholstery
- Leg Color
- Tablet Arm
- Tablet Color
- Power

Description

- **For Freestanding Use or May** Used to “Cap” Two Units Placed Back to Back (For Example, [See 550-4](#))
- Includes Ganging Hardware
- Select Aluminum (ALUM) or Chrome (CHRM) Legs; Must Specify Leg Color
- Additional Options: [Tablet Arm Options](#) and [Power Locations](#)

List Price/Grade	Yards	COM/1	2	3	4	5	6	7	8	9	10	L1	L2
Single Upholstery	2.25	\$ 1744	1861	1960	2057	2203	2352	2563	2784	3040	3337	2487	2804

MODULAR HALF ROUND BENCH	550-5024HR	-	-	-	50	24	17½	-	33	43.2
--------------------------	------------	---	---	---	----	----	-----	---	----	------

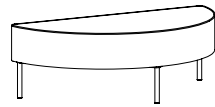

Must Specify (in this order):

- Model #
- Upholstery
- Leg Color
- Tablet Arm
- Tablet Color
- Power

Description

- **For Freestanding Use or May** Used to “Cap” Two Units Placed Back to Back (For Example, [See 550-5](#))
- Select Aluminum (ALUM) or Chrome (CHRM) Legs; Must Specify Leg Color
- Tablet Arm Not Available
- Includes Ganging Hardware

List Price/Grade	Yards	COM/1	2	3	4	5	6	7	8	9	10	L1	L2
Single Upholstery	2.50	\$ 1449	1579	1689	1797	1959	2124	2359	2604	2889	3219	2274	2627

Item	Model No.	Width	Depth	Height	Ship Wt	Cubic Ft	List Price
------	-----------	-------	-------	--------	---------	----------	------------

MODULAR GANGING TABLE

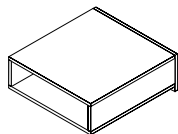

Must Specify (in this order):

- Model #
- Finish/Color
- Power

24”W							
550-2426GT	TFL	24	24	9¼	46	4.7	T\$ 794
550-2426GTH	HPL	24	24	9¼	46	4.7	P\$ 929
550-2426GTV	Veneer	24	24	9¼	46	4.7	W\$ 1459
18”W							
550-1826GT	TFL	18	24	9¼	36	3.9	T\$ 751
550-1826GTH	HPL	18	24	9¼	36	3.9	P\$ 893
550-1826GTV	Veneer	18	24	9¼	36	3.9	W\$ 1365

Description

- Includes Ganging Hardware
- Optional Power; [See Location Options](#)

T = TFL P = HPL W = Veneer

For ordering options, [see overview at the beginning of this section.](#)

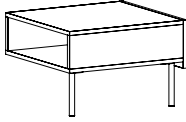
Item	Model No.		Width	Depth	Height	Ship Wt	Cubic Ft	List Price
 MODULAR GANGING END TABLE	550-2426ET	TFL	24	24	17	46	4.7	T\$ 932
	550-2426ETH	HPL	24	24	17	46	4.7	P\$ 1070
	550-2426ETV	Veneer	24	24	17	46	4.7	W\$ 1628
	550-1826ET	TFL	18	24	17	36	3.9	T\$ 886
	550-1826ETH	HPL	18	24	17	36	3.9	P\$ 1027
	550-1826ETV	Veneer	18	24	17	36	3.9	W\$ 1488

Must Specify (in this order):
 Model #
 Finish/Color
 Leg Color
 Power

Description

- Front to Back Grain Direction
- Select Aluminum (ALUM) or Chrome (CHRM) Legs; Must Specify Leg Color
- Includes Ganging Hardware
- Optional Power; [See Location Options](#)
- Some Assembly Required; Legs Installed on Left or Right in Field

 MODULAR GANGING CORNER TABLE	550-9026CGT	TFL	24	24	17½	49	8.3	T\$ 876
	550-9026CGTH	HPL	24	24	17½	49	8.3	P\$ 998
	550-9026CGTV	Veneer	24	24	17½	49	8.3	W\$ 1517

Must Specify (in this order):
 Model #
 Finish/Color
 Leg Color
 Power

Description

- Select Aluminum (ALUM) or Chrome (CHRM) Legs; Must Specify Leg Color
- Includes Ganging Hardware
- Optional Power; [See Location Options](#)
- Some Assembly Required

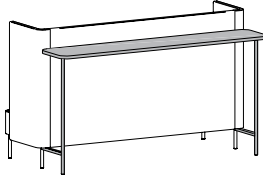
BISTRO TABLE	For Use with Sofas							
		550-1681BT	TFL	81	16	42	36	3.9
550-1681BTH		HPL	81	16	42	36	3.9	P\$ 1232
550-1681BTV		Veneer	81	16	42	36	3.9	W\$ 1422
For Use with Settees								
	550-1657BT	TFL	57	16	42	36	2.6	T\$ 963
	550-1657BTH	HPL	57	16	42	36	2.6	P\$ 1149
	550-1657BTV	Veneer	57	16	42	36	2.6	W\$ 1335

Must Specify (in this order):
 Model #
 Finish/Color
 Leg Color
 Hook

Description

- Must be Used with High Surround Booth Application
- Select Aluminum (ALUM) or Chrome (CHRM) Legs; Must Specify Leg Color
- Includes Installation Hardware
- Some Assembly Required

Leg Options: Specify & Add

ALUM	Aluminum	STD
CHRM	Chrome	\$ 108

Optional Purse Hook: Specify & Add

01-HOOK	Black Purse Hook	\$ 79
2" x 2 5/8"; Includes Mounting Hardware		



T = TFL P = HPL W = Veneer

For ordering options, [see overview at the beginning of this section.](#)

Item	Model No.	Width	Depth	Height	Ship Wt	Cubic Ft	List Price
CABLE GRIP	01-WMGRCB	-	-	-	1	0.1	\$ 17

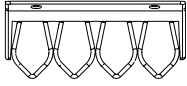
**Description**

- Under Surface Wire Management
- Black

WIRE CHANNEL	01-32125	24	1½	1	.25	0.3	\$ 106
--------------	----------	----	----	---	-----	-----	--------

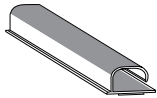
**Description**

- Available in Black
- Includes (2) Double-Sided Tape Ribbons for Easy Installation
- Open J Channel for Easy Wire Management

VESTA POWER CENTER	01-PDCTR	10¾	12	28¾	14	2.5	\$ 1776
--------------------	----------	-----	----	-----	----	-----	---------

**Description**

- Top Includes One (1) Power Outlet, Two (2) USB Ports and One (1) USBC Port; Base Includes Three (3) Outlet
- Available in White
- 120" Power Cord
- Built with Weight Distribution for Optimal Stability
- Base is 5" Tall

WIRELESS AND USB CHARGER	01-DOCK150W	White	3	3	¾"	1	0.2	\$ 405
	01-DOCK150B	Black						



Open Market Only

Description

- For Use with Wireless Charging Enabled Devices and USB Charging Devices
- 5 Watt Maximum Output with a Direct Current Input of 5V 6A (Wireless Fast Charge)
- Pop-Up is ¾"H and Includes Three (3) USB Ports; One (1) 12 Watt Maximum with 2.4A (USB Fast Charge) and Two (2) 5 Watt with 1A (USB Standard Charge)
- Mounts in 76mm Round Cut-Out
- LED Light will Confirm Pairing with Device and Begin Wireless Charging
- UL and cUL Certified

For ordering options, [see overview at the beginning of this section.](#)

Item	Model No.		Width	Depth	Height	Ship Wt	Cubic Ft	List Price
WIRELESS CHARGER	01-DOCK950W	White	3 $\frac{3}{16}$	3 $\frac{3}{16}$	-	1	0.2	\$ 265
	01-DOCK950B	Black						



Open Market Only

Description

- For Use with Wireless Charging Enabled Devices
- 5 Watts Maximum Output with a Direct Current of 5V 2A and 10 Watts Maximum with Quick Charge 2.0
- Mounts in 76mm Round Cut-Out
- LED will Confirm Pairing with Device and Begin Wireless Charging

DUO BEZEL NEMA PLUG	01-DUOBEZELS	Silver	9	2 $\frac{1}{2}$	3	1	0.2	\$ 675
	01-DUOBEZELW	White						
	01-DUOBEZELB	Black						

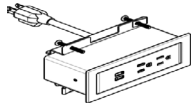

Description

- Worksurface Must Be Routed To Accept Unit, Which Sits Down Into Worksurface Supported By Attractive Slim Fit Bezel
- Two (2) Power/Two (2) USB Power
- Independent USB Circuit Controllers Deliver up to 2.1 Amps to Each Post
- All Mounting Hardware Included
- FCC Part 15A and UL Approved for Horizontal and Vertical Applications
- 10' Cord

TRIO BEZEL NEMA PLUG	01-TRIOBEZELS	Silver	6 $\frac{1}{2}$	2 $\frac{1}{2}$	3 $\frac{3}{16}$	1	0.2	\$ 725
	01-TRIOBEZELW	White						
	01-TRIOBEZELB	Black						

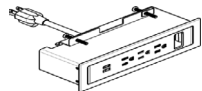

Description

- Worksurface Must Be Routed To Accept Unit, Which Sits Down Into Worksurface Supported By Attractive Slim Fit Bezel
- Three (3) Power/Two (2) USB Power/One (1) Open Data
- Independent USB Circuit Controllers Deliver up to 2.1 Amps to Each Post
- HDMI, VGA, or RJ45 Accessories Sold Separately
- All Mounting Hardware Included
- FCC Part 15A and UL Approved for Horizontal and Vertical Applications
- 10' Cord

For ordering options, [see overview at the beginning of this section.](#)

Item	Model No.		Width	Depth	Height	Ship Wt	Cubic Ft	List Price
DUO CLAMP NEMA PLUG	01-DUOCLAMPS	Silver	5½	3	7	1	0.2	\$ 572
	01-DUOCLAMPW	White						
	01-DUOCLAMPB	Black						

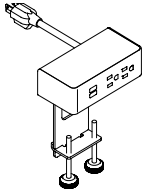

Description

- Silver Metal Trim
- Clamps to Top
- Two (2) Power/Two (2) USB Power
- Independent USB Circuit Controllers Deliver up to 2.1 Amps to Each Post
- All Mounting Hardware Included
- FCC Part 15A and UL Approved for Horizontal and Vertical Applications
- 10' Cord

TRIO CLAMP NEMA PLUG	01-TRIOCLAMPS	Silver	8	3	7	1	0.2	\$ 671
	01-TRIOCLAMPW	White						
	01-TRIOCLAMPS	Black						

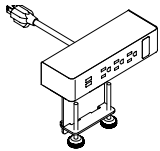

Description

- Silver Metal Trim
- Clamps to Top
- Three (3) Power/Two (2) USB Power/One (1) Open Data; 10' Cord
- Independent USB Circuit Controllers Deliver up to 2.1 Amps to Each Post
- HDMI, VGA, or RJ45 Accessories Sold Separately; See Below
- All Mounting Hardware Included
- FCC Part 15A and UL Approved for Horizontal and Vertical Applications

TRIO VGA DATA PORT ACCESSORY	01-LCOMVGA							\$ 121
---------------------------------	------------	--	--	--	--	--	--	--------

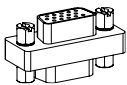

Description

- VGA Ports for Trio Units

TRIO HDMI DATA PORT ACCESSORY	01-LCOMHDMI							\$ 166
----------------------------------	-------------	--	--	--	--	--	--	--------

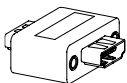

Open Market Only

Description

- HDMI Ports for Trio Units

TRIO RJ45 DATA PORT ACCESSORY	01-LCOMRJ45							\$ 79
----------------------------------	-------------	--	--	--	--	--	--	-------

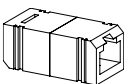

Description

- RJ45 Ports for Trio Units

For ordering options, [see overview at the beginning of this section.](#)

This form is also available online at www.IndianaFurniture.com on the KickStart product page.

Not all standard upholsteries are suitable for all of our products. This is due to the range of stretch across textiles and the application and sewing techniques required to effectively upholster the various forms and features.

To ensure a proper fit and finish on the High Surround feature of our KickStart lounge models, we will require upholsteries to fit within a specific range of stretch. Further, upholstery patterns and stripes are highly discouraged on the High Surround as they will result in alignment issues on the feature itself and with other sections of the overall model.

To make specification easier for you, we have pre-approved upholsteries for use on the High Surround feature. These are included on the [Stinson Revive Card](#) and [Momentum Kickstart Card](#) and can be found under [our Textile Program](#). They include:

- | | | |
|-------------------|--------------------|-----------------|
| Ace (GR4) | Drift (GR6) | Outlander (GR4) |
| Artisan (GR3) | Ego (GR1) | Ritz (GR4) |
| Baxter (GR4) | Harrison (GR5) | Sarto (GR5) |
| Blip (GR3) | Highlight (GR3) | Scatter (GR1) |
| Bryant Park (GR3) | Inside Track (GR3) | Shift (GR3) |
| Carson CV (GR1) | Lorelai (GR6) | Sprint (GR3) |
| Crespo (GR1) | Moby (GR3) | |
| Cush (GR3) | Nestle (GR1) | |

We recognize that special needs may arise and we are pleased to accommodate customer selections, as long as they are approved through the below process.

Note: if upholstery is customer's own, a COM/COL Form will also need to be completed.

KICKSTART HIGH SURROUND APPROVAL INSTRUCTIONS:

Fill out the form below and attach a 6"x6" sample. Failure to complete this form and supply samples will delay the scheduling of the purchase order. Orders will not be scheduled and upholstery should not be ordered until Indiana Furniture has verified usage and provided approval.

Dealer Name _____ Phone _____ Email _____
 Contact Person _____ City _____ State _____ Zip _____
 Mill/Supplier _____ Pattern _____ Color _____

Attach 6"x6" swatch to this form. Send completed form and upholstery swatch to:

Indiana Furniture
 Attn: Customer Service
 1919 Hospitality Dr., Ste. A
 Jasper, IN 47546

FOR OFFICE USE ONLY:

Approved Not Approved Signed: _____ Date _____
 Indiana Furniture Production/Quality

Advise Dealer of Decision: _____ Signed: _____
 CSR

Notes: _____

COM/COL & Graded-In Programs

COM - CUSTOMER'S OWN MATERIAL

All Indiana Furniture seating is available with material furnished by the customer. Refer to grade 1 for list prices. Refer to individual model number for COM yardage requirements. The listed COM yardage requirement is based on the use of non-directional upholstery 54" wide for a quantity of one chair. Extra upholstery is required to match any pattern with a repeat, either vertically or horizontally. Use the chart below as a guide to add to plain COM yardage requirements listed in the price list.

For multiple chair quantities, contact customer service to optimize the yardage per chair at 800-422-5727.

Upholstery	Plain	2"- 14"	15"- 27"	28"- 36"
Width	Upholstery	Repeat	Repeat	Repeat
54"	0%	10%	25%	30%

Note: Upholsteries less than 54" wide will not be accepted.

Due to the upholstering process used by Indiana Furniture, some COM upholsteries are considered directional that may not be considered directional by the upholstery supplier. All Upholstery COM's are cut "up the roll" and all vinyls are cut "across the roll" by Indiana Furniture unless otherwise directed by the customer (see below). All directional upholsteries on Indiana Furniture frames match both vertically and horizontally. If you do not desire repeat match, please specify on order.

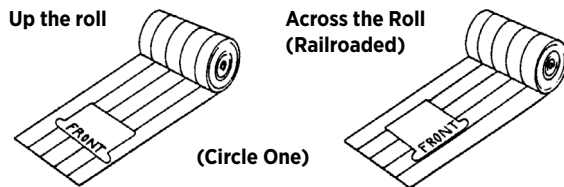

Note: Directional upholsteries, such as stripes, patterns and plaids may not meet your satisfaction due to contoured shapes and tufting of some models. Should you require such a selection, we will upholster as perfect as possible, but such orders are not subject to return. If in doubt, contact your Indiana Furniture Customer Service Representative prior to placing the order.

COM/COL ORDERING INSTRUCTIONS:

Fill out the form below and attach sample according to instructions on reverse side of form. **COM's/COL's must meet and include written confirmation from the supplier verifying CALTB 117-2013 compliance and you must designate the flammability materials within for the TB 117-2013 label.** Check the box above to comply with California Business and Professions Code Section 19094. Failure to complete these forms and supply samples will delay the scheduling of the purchase order. Orders will not be scheduled until upholstery is received from the supplier. Upholstery should not be ordered until Indiana Furniture has verified the yardage required.

Check one: COM COL

Dealer Name _____ Phone _____ Email _____

Contact Person _____ City _____ State _____ Zip _____

Mill/Supplier _____ Pattern _____ Color _____

Repeat Inches: Horizontal _____ Vertical _____ Directional: Up the Roll / RailRoad

Note: Required upholstery width is 54".

Face Reversible: Yes / No

Product COM/COL is to be applied to:

1) Model # _____ Qty* _____ Ydg. Ea. _____ x Repeat _____ = _____ Yds.

2) Model # _____ Qty* _____ Ydg. Ea. _____ x Repeat _____ = _____ Yds.

* For multiple chair quantities, contact customer service to optimize the yardage required.

FOR OFFICE USE ONLY:

Advise dealer of COM/COL Rqd: _____ Signed: _____

CSR

Notes: _____

COL - CUSTOMER'S OWN LEATHER

Indiana Furniture is pleased to accommodate COL selections whenever this special need arises. Refer to grade 1 for list prices. To calculate COL requirements, multiply the COM yardage required times 18 (1 yard of upholstery = 18 sq. ft. of usable leather). Customer's own leather specifications for Indiana Furniture seating shown within the price list are based on an average hide size of 45-50 square feet.

All square footage requirements are based on usable footage. The shape of a hide and the usable, clean footage may make it necessary for us to request more leather after COL is received.

Please note leather is a natural product, and variation in texture is a pleasing quality belonging exclusively to high grade, full top grain leathers.

Indiana Furniture reserves the right to inspect, approve, or reject any COM/COL upholstery. Once approved, Indiana Furniture cannot assume responsibility for the durability or tailoring quality of COM/COL material.

COM/COL Ordering Instructions:

1. Include a 6" sample of the upholstery stapled to the order indicating which side is to be exposed.
2. If COM has a pattern or stripe, indicate whether to apply vertically or horizontally. All stripes will be applied vertically unless specified otherwise.
3. Specify the upholstery supplier's name, upholstery pattern, pattern color, and pattern number.

For TB 117-2013, the upholstery materials in this product (check one):

_____ contain added flame retardant chemicals

_____ contain NO added flame retardant chemicals

TOP

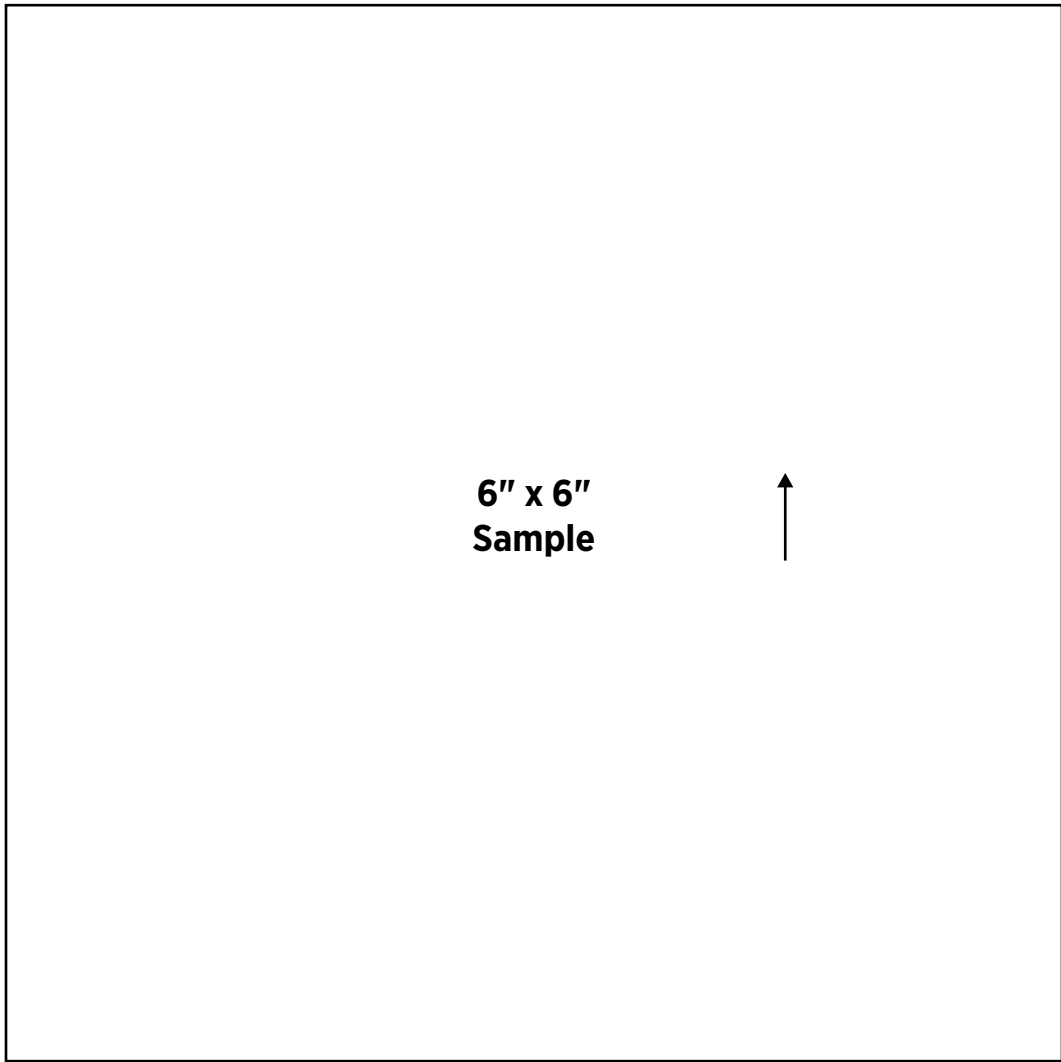

TOP

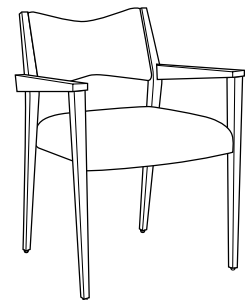

NOTE IMPORTANT REQUIRED INSTRUCTIONS:

Attach sample showing exposed side and mark direction upholstery is to be applied.

Form & Upholstery Swatch should be sent to:

Indiana Furniture
Attn Customer Service
1919 Hospitality Dr., Ste. A
Jasper, IN 47546

COM/COL should be sent to:

Indiana Furniture
1095 W. 100 S.
Dock 1
Jasper, IN 47546

Checklist

Have you completed the following requirements?

- 1) ___ Attached Sample
- 2) ___ Marked Direction
- 3) ___ Verified Yardage with Indiana Furniture
- 4) ___ Have upholstery tagged with your company name
- 5) ___ Have upholstery tagged with your purchase order #
- 6) ___ Have your vendor list their name, pattern, color and yardage on the packing list

A Packing Slip Must Be Included

Do Not Order Upholstery Until Indiana Furniture Has Calculated Yardage

Pattern Name	Price Grade	Pattern Name	Price Grade	Pattern Name	Price Grade
A New Twist	4	Mammoth Deception	7	Wishes	4
April	8	Mesa	6	Wow	4
Assumed Luxury	8	Metal Mesh	8	Zulu	5
Baby Bear	5	Metro	5	Zyon	5
Bacci	6	Mind Bender	6		
Baltic- O	6	Minimize	6		
Beach Blanket	6	Minotaurus	7		
Bonnie	4	Miragi - O	7		
Brazos	6	Mock Croc	5		
Buckaroo	7	Mohair Magic	10		
Bull's Eye	8	Mooskin	7		
Bye Bye Birdie	5	Morph	6		
Calf Crazy	7	My Way	7		
Canyon	3	Not-A-Hide	4		
Capri	5	Pacific-O	6		
Catwalk	9	Parley	3		
Cheap Seats	5	Party Boat	7		
Chimera	6	Patina Glaze	4		
Cocoon	3	Phantasea	8		
Copy Cow	3	Phoenix	3		
Cornered	6	Plastic Basket	4		
Cowtown	5	Quietude	6		
Crosshatch	4	Reflection	5		
Cuddle	5	Renna	5		
Dash of Color	5	Ritzi	4		
Dazzler	7	Roseus Regatta	8		
Diamond Rock	6	Sabine	3		
E-Scape	7	Shagreen	4		
Extra Celestial	6	Shiki Silk	4		
Feigned Fancy	8	Shiny Hide	7		
Fionna	4	Silicone Grid	7		
First Class	3	Silicone Mountain	7		
Focus	6	Silicone Prime	7		
Fowl Play	8	Silicone Slopes	7		
Free Time	7	Simply Hyde	5		
Fulton	3	Sky Writing	5		
Gelato	6	Sleek	5		
Glaze	4	Soul Space	5		
Grit	6	Splash	5		
Haywire	6	Spree	7		
Hemp Canvas	5	Sticks and Strings	5		
Highland	5	Stitch In Time	6		
Horizon	6	Stripes	7		
Impulse	8	Tartan	7		
Inner Circle	9	Tas	8		
Intertwine	5	Taurus	7		
Jigsaw	5	Technohound	4		
Just Kidding	7	The Keys	5		
Kapow	4	Top Coats	6		
Kazam	4	Travel Roadies	4		
Kri	7	Twinkle Sky	6		
La Piazza	6	Twinkle Tapestry	6		
Lafayette	4	Udderly Perfected	7		
Lamb of Luxury	8	Ultra Air	7		
Limerick	8	Uptick	6		
Lucid Lines	7	Varick	3		
Lumber Jack	8	Vintage Glaze	5		
Lumber Jane	8	Westerly	5		
Luzon	7	Western Willie	5		

Indiana Furniture strives to make as many upholsteries available as possible. However, it is not practical for us to test every offering on every chair as it is made available. If you have any concerns about our ability to upholster your selection on a particular frame please contact us and we will be glad to order a memo sample from this supplier for testing. Call Customer Service at 800.422.5727.

Pattern Name	Price Grade	Pattern Name	Price Grade	Pattern Name	Price Grade	Pattern Name	Price Grade
Aberdeen	6	Francesca Wool	7	Polished	5	Tudor Rose	9
Alpine	6	Francesca Wool li	7	Pound	7	Typography	6
Ambiance	4	Frontier	3	Provence	9	Vanderbilt	5
Angle	5	Gamma	4	Quest	7	Vault	5
Apex	6	Gardenia	5	Radius	6	Velocity	6
Apollo	5	Gatsby	4	Raya	5	Venture	7
Arabesque	5	Gem	4	Reality Check	5	Victoria	6
Astor	5	Glam	5	Rio	5	Vivo	5
Athena	5	Glinda	6	River	6	Volt	8
Atlas	4	Glo	5	Rodeo	3	Wanderer	7
Atmosphere	2	Great Wall	6	Rodeo 2	3	Watson	3
Atomic	6	Grid	5	Roundabout	4	Welsh Check	7
Aura	3	Hanji	6	Samsara	4	Windlass	7
Bali	7	Harlequin	6	Sanganeri	5	Wrangler	3
Block Petal	6	High Rise	5	Santa Fe	6	X Pattern	8
Boardwalk	4	Highlands	6	Santorini	6	York Plaid	7
Bocce	5	Hush	5	Saxon	6	Zip	7
Bronco	5	Hush 2	5	Sea Willow	6		
Burkina	6	I Pattern	7	Seascape	4		
Cadence	5	Illusion	3	Sector	5		
Calais Stripe	6	Illusion 2	3	Sedona	4		
Caress	7	Infrastructure	8	Sherlock	4		
Carnival	5	Insight	2	Sherlock 2	4		
Cavo	6	Intaglio	5	Shimmer	4		
Centering Stripe	5	Intaglio 2	5	Shimmer 2	4		
Ceramica	6	Interstate	5	Silk Road	4		
Channel	5	Iona	4	Silverado	4		
Chroma	4	Isabella	4	Silverado 2	4		
Cirque	6	Journey	6	Skye	6		
Compass	6	Kaolin	5	Soho	3		
Connect	7	Kuba	6	Solar	2		
Contour	4	Legacy	5	Solitude	6		
Cosmos	5	Legend	6	Sonata Stripe	6		
Crescendo	6	Linea	5	Speckle	4		
Crystal	4	Lore	5	Spectrum	4		
Cutting Edge	10	Lunette	7	Sphere	7		
Dakota	4	Luxe	6	Spin	6		
Dakota 2	4	Majorca	6	Spirit	4		
Daytona	6	Marquee	6	Splash	3		
Delta	4	Mason	6	Staccato	6		
Drifter	4	Mason Stripe	6	Stallion	3		
Durango	3	Montage	6	Stetson	3		
Dynasty	5	Moon Beam	5	Strata	4		
Eden	5	Moon Beam 2	5	Streamline	4		
Elementary	7	Morgan	5	Sukhala	6		
Elevado	5	Morocco	6	Summit	3		
Embrace	4	Mustang	4	Sundial	6		
Emerson	3	Nahouri	6	Sync	5		
Empress	4	Network	8	Tailored	5		
Empress 2	4	Oculus	5	Talavera	8		
Encore	4	Palatine	5	Tally	4		
Engrave	5	Palatine 2	5	Tectonic	4		
Equinox	4	Paragon	7	The Plaid	7		
Etch	5	Parenthesis	8	Tick-Tock	5		
Everest	4	Patina	6	Tiebele	6		
Evolution	7	Paxton	6	Tilde	7		
Fiji	5	Perspective	5	Top Notch	10		
Flora	2	Pinnacle	4	Transform	3		
Fragment	7	Pixel	5	Traverse	5		

Indiana Furniture strives to make as many upholsteries available as possible. However, it is not practical for us to test every offering on every chair as it is made available. If you have any concerns about our ability to upholster your selection on a particular frame please contact us and we will be glad to order a memo sample from this supplier for testing. Call Customer Service at 800.422.5727.

Pattern Name	Price Grade	Pattern Name	Price Grade	Pattern Name	Price Grade	Pattern Name	Price Grade
45 RPM.....	3	Boardwalk.....	7	Clydesdale.....	3	English Leather.....	4
57 Chevron.....	6	Bobbin.....	3	Coachella.....	4	English Suede.....	5
78 RPM.....	4	Boheme.....	4	Coalesce.....	6	Enthusiast.....	6
Abbey Road.....	5	Boston.....	5	Coconut Grove.....	6	Epingle.....	4
Aberdeen.....	9	Boucle.....	5	Coexist.....	6	Equestrian.....	6
Adare Manor.....	4	Boudoir.....	4	Collins Ave.....	6	Equus.....	4
Adlon.....	7	Boyle.....	9	Community.....	6	Escapade.....	3
Admiral.....	5	Bozeman.....	3	Connect.....	8	Estoile.....	6
Affinity.....	5	Brera.....	3	Connery.....	4	Evolution.....	4
Aficionado.....	5	Brick and Mortar.....	4	Cool Comfort.....	4	Excel.....	5
Alcantara.....	11	Brigantine.....	5	Coral Gables.....	6	Excursion.....	6
Allure.....	6	Brisco.....	4	Corddry.....	5	Fabiana.....	5
Amagansett.....	6	Britannia.....	5	Corinthian.....	4	Fairground.....	5
Amenity.....	4	Brixton.....	9	Couture.....	5	Fashionista.....	5
Americas Cup.....	4	Brompton.....	4	Cozy.....	4	Filly.....	5
Andromeda.....	5	Bryn Mawr.....	7	Craft.....	6	Financier.....	3
Anemone.....	6	Buccaneer.....	5	Crazy Horse.....	4	Fine Gauge.....	7
Angora Mohair.....	11	Buenos Aires.....	5	Crepon.....	4	First Class.....	6
Animal.....	5	Burlington.....	4	Crescendo.....	5	Fit.....	5
Annual.....	6	Cabin.....	6	Crew.....	4	Flagship.....	4
Antico.....	6	Calabaras.....	5	Crossover.....	4	Flannella.....	6
Aperture.....	4	Caledonian.....	4	Cruise.....	7	Flex.....	4
Aphrodisiac.....	5	Calf.....	8	Cupertino.....	7	Flights of Fancy.....	6
Array.....	6	Calyx.....	6	Cupid.....	4	Flourish.....	6
Artesima.....	8	Cambric.....	5	Cutting Edge.....	6	Flow.....	3
Askriigg.....	9	Cancan.....	5	Dakar.....	4	Flower Market.....	5
Astronomy.....	6	Cane.....	6	Dakota.....	5	Foiled.....	4
Aura.....	5	Cape Town.....	5	Danbury.....	3	Folio.....	3
Autobahn.....	4	Caracas.....	6	Dance Line.....	6	Follow the Leader.....	5
Aventura.....	5	Cardigan.....	5	Dance Party.....	4	Fridays.....	4
Awaken.....	4	Casco.....	6	Dante.....	6	Friendship.....	5
B and B.....	4	Catch Me If You Can.....	5	Dapple.....	7	Frolic.....	5
Badlands.....	5	Catwalk.....	5	Dash.....	4	Fronde.....	7
Bal Harbour.....	5	Cavern Club.....	5	Daydream.....	3	Front Desk.....	4
Balance.....	8	Cetus.....	5	Debonair.....	3	Furstenberg.....	3
Balcony.....	5	Chain Link.....	4	Debutante.....	6	Gala.....	5
Bamboozled.....	5	Chaise.....	5	Deco District.....	6	Galleon.....	4
Bargello.....	6	Chambray.....	7	Deepdale.....	9	Gargrave.....	9
Barnard.....	7	Chamomile.....	4	Diamant.....	5	Gecko.....	7
Bauble.....	6	Champagne.....	5	Digital.....	7	Gemma.....	5
Baxter.....	4	Charleston.....	4	District.....	3	Getaway.....	7
Bayside.....	6	Charlotte.....	4	Division.....	7	Gia.....	6
Beachcomb.....	6	Charted.....	7	Draper.....	5	Gilded Age.....	7
Beaucoup.....	4	Charted Reverse.....	7	Drizzle.....	4	Glamis.....	9
Beehive.....	4	Chaucer.....	9	Dublin.....	3	Glint.....	4
Bellevue.....	9	Chauffeur.....	4	Duotone.....	6	Glissette.....	5
Belsize.....	9	Chenille Waistcoat.....	4	Dupioni.....	4	Glitz.....	5
Ben Day.....	4	Chesham.....	9	Dusk.....	5	Gloucester.....	9
Bergerac.....	5	Chetlenham.....	9	Ease.....	4	Good Day Sunshine.....	6
Berkshire.....	4	Chindi.....	6	Echelon.....	5	Grasscloth.....	3
Bermuda.....	6	Chronicle.....	6	Edge.....	5	Great Dane.....	6
Biarritz.....	4	Cirque.....	5	Editor.....	7	Great Pretender.....	4
Bibury.....	9	Cirrus.....	6	Edwardian.....	5	Greenwich.....	5
Big Bird.....	5	Classic.....	7	Elegant.....	3	Grenelle.....	6
Big Game.....	5	Cleo.....	5	Element.....	5	Griffin.....	5
Billow.....	6	Clipper.....	5	Elite.....	5	Haberdasher.....	4
Biscayne.....	7	Clique.....	5	Emergent.....	7	Hampstead.....	4
Bliss.....	5	Cloud Nine.....	3	Enamored.....	3	Hanbel.....	5

Architex continues on next page.

Indiana Furniture strives to make as many upholsteries available as possible. However, it is not practical for us to test every offering on every chair as it is made available. If you have any concerns about our ability to upholster your selection on a particular frame please contact us and we will be glad to order a memo sample from this supplier for testing. Call Customer Service at 800.422.5727.

Pattern Name	Price Grade	Pattern Name	Price Grade	Pattern Name	Price Grade	Pattern Name	Price Grade
Happy	7	Lakota	4	Muslin	3	Prescription	5
Harbor Lights	4	Lanai	3	Mustang	3	Presence	6
Harmony	6	Las Palmas	3	Nakoda	4	Prestige	3
Hashtag	6	Lavish	4	Natura	4	Printemps	6
Haute Seat	7	Layers	5	Nest	7	Privateer	7
Havana	7	Leatheretta	4	New Deal	5	Progress	7
Hawes	9	Legend	5	No Strings Attached	5	Propel	4
Healthy	7	Leisure	4	Noble	5	Pumice	5
Heritage	5	Lennon	6	Nourish	3	Purcell	6
Hero	4	Line Drive	4	Ocean Drive	6	Pureachic	4
Hgi Reed	3	Linea	4	Officine	5	Pureapex	5
High Noon	4	Lodge	4	Optimum	5	Pureasana	4
Highway	4	Logoro	6	Orchestra	7	Purebotanica	6
Himalayan	7	Lombard	4	Organza	5	Purebrindle	4
Hint	4	Long Play	4	Orion	5	Purechallis	5
Hit Parade	4	Loom	3	Otto	7	Purechenille	4
Hive	7	Loose Ends	6	Outfit	4	Purechic	4
Holloway	9	Luca	3	Pagoda	4	Purecoco	5
Holmes	6	Lucy In The Sky	6	Palm Desert	5	Purecorduroy	5
Holstein	4	Lusso	6	Palo Alto	7	Purecurlucie	5
Holyoke	7	Luster	4	Paola	5	Puredeco	6
Homespun	5	Macallan	4	Paragon	6	Purefelt	4
Hook	3	Mademoiselle	5	Paramour	5	Purefleece	5
How Dashing	5	Madore	6	Particle	5	Pureflow	4
Hurlingham	3	Mahony	6	Patent	5	Pureglint	5
Hush	3	Malham	9	Pathway	6	Puregratitude	4
Hyde	5	Manifest	8	Pearlescent	6	Pureherringbone	5
Icon	6	Mantle	5	Pelle	7	Purehopsack	5
Ikat	8	Manzanita	7	Pendlesome	6	Purekimbo	5
Indio	4	Marais	5	Peony	5	Purelinen	4
Ingenious	7	Marcona	3	Percheron	2	Puremeditation	4
Inline	5	Maroc	7	Pergola	5	Puremindfulness	4
Inner Circle	8	Marqueyssac	6	Perlato	5	Puremod	6
Insideout	8	Marquissette	5	Piazza	4	Puremontrose	6
Inspire	6	Marylebone	9	Piet	6	Purenubuck	4
Interlock	5	Maxim	6	Pinkerton	5	Purepanama	5
Intersect	5	McQueen	5	Pinna	7	Purepeace	4
Intricato	6	Membership	5	Pinwale	4	Pureplait	5
Inverness	4	Merchant	5	Pinyon	3	Purepoint	5
Irving	3	Meridian	5	Pipeline	5	Pureshimmer	5
Isla	6	Merrill	6	Pisa	7	Puretwill	5
Jackpot	5	Metallurgic	5	Piscina	4	Purevelour	3
James Dean	5	Mid Century	5	Pisco	3	Purevelvet	4
Jasper	3	Midday	5	Pivot	6	Purevogue	6
Javelin	3	Milano	6	Pixel	3	Pureweave	5
Jump For Joy	6	Mime	4	Plaid All Over	5	Purewicker	4
Just Dandy	3	Mineral	6	Plaited	5	Qbert	4
Kainai	4	Mingle	3	Plateau	4	Quarry	5
Kent	6	Miramar	3	Platform	4	Quilt	4
Kettering	6	Missing Link	5	Plenty	2	Radiant	4
Kindred	6	Missonly	4	Plunge	6	Rainbow	5
Kingham	9	Moda	4	Poise	3	Rebel	5
Kismet	5	Mon Petit	2	Poplin	3	Reed	3
Knowledge	7	Monarchy	5	Port Of Call	6	Reef	6
Koi Lily	6	Monolith	4	Porter	6	Reel Leather	6
Laceum	8	Montauk	6	Positano	6	Relax	3
Laguna	8	Montmartre	5	Posy	7	Resort	7
Lake Como	5	Moxie	5	Preppy Handbook	4	Revel	5

Architex continues on next page.

Indiana Furniture strives to make as many upholsteries available as possible. However, it is not practical for us to test every offering on every chair as it is made available. If you have any concerns about our ability to upholster your selection on a particular frame please contact us and we will be glad to order a memo sample from this supplier for testing. Call Customer Service at 800.422.5727.

Pattern Name	Price Grade	Pattern Name	Price Grade	Pattern Name	Price Grade
Revival.....	5	Steed	5	Ultraflannel	6
Richmond.....	3	Stoneham.....	9	Ultraluscious.....	6
Riva.....	6	Straight Talk	6	Ultraposh.....	6
Rocky Mountain.....	5	Straight Up.....	5	Unity	4
Roman.....	4	Stylist.....	4	Unwind.....	3
Room Service.....	3	Subculture.....	4	Urban.....	5
Rose Hill.....	4	Submariner	6	Vache.....	8
Royale.....	5	Sullivan.....	7	Valais	5
Rugged	6	Sultan	3	Valencia	6
Ryder	5	Sun Kissed.....	7	Valloires	6
Sag Harbor.....	7	Sunfair	3	Vassar.....	7
Salt Spring	6	Sunnyvale.....	7	Veloce.....	6
Salter	4	Surface.....	6	Venue	4
Sandbox.....	4	Suri.....	3	Verve.....	5
Sandwashed.....	5	Sutherland.....	4	Vitality.....	4
Savant	4	Swerve.....	3	Voila	5
Schooner	6	Sybarite.....	6	Waistcoat	3
Science.....	6	Sylk.....	7	Wardrobe	4
Scottie.....	5	Tailor Made	3	Wellesley	7
Scottsdale	5	Takes Two To Tangle	3	Westminster	9
Seabed	7	Tampa Bay	4	What The Fray	3
Seamstress.....	4	Tattered Tale.....	4	Whitehall	5
Seaside.....	4	Tech Tweed.....	5	Winfield	3
Seine	4	Telegraph.....	4	Winston.....	2
Serena	4	Templeton.....	4	Wish.....	6
Set Sail	4	Tenacious.....	4	Wisteria.....	6
Shabby and Chic.....	4	Tendril.....	6	Wormwood.....	5
Sharkskin.....	5	Terroir	7	Worsted	5
Shetland.....	5	Tessellation	7	Yellowstone	5
Shibori Linen.....	8	Textura	4	Yorkville	4
Shilling.....	5	Theatre District.....	4	Your Bird Can Sing	6
Shine.....	4	Theorem	4	Zenith	6
Shoreline.....	7	Thornton.....	9		
Shower	7	Thoroughbred.....	2		
Sightsee.....	3	Tickle	5		
Silicone Swayed.....	6	Timeless.....	2		
Silicone Tussah	6	Tinseltown.....	4		
Skipper.....	4	Tonic	4		
Skyway	4	Topsy Turvy	6		
Slow Dance.....	4	Toronto	5		
Soft Spot	5	Toulouse	5		
Sojourn.....	4	Trapeze	6		
Soothe.....	8	Trapunto	7		
Sound Bite	7	Tribeca	4		
Southgate.....	9	Trident.....	3		
Space Oddity	6	Triumph.....	5		
Spectacle.....	5	Tru Chenille Waistcoat.....	2		
Spencer.....	8	Tru Plenty	2		
Spin Art.....	9	Tuatara	3		
Spoonful	4	Turnabout.....	4		
Sport Jacket	3	Turtle Bay	3		
Spotlight.....	5	Tussar	7		
Spree	5	Tweed.....	3		
Spritz	4	Tweedledee	5		
St Barts	4	Tweedsmuir	4		
Stage Bill	4	Twickenham.....	9		
Stagecoach.....	4	Twinkle.....	5		
Starboard	6	Tycoon.....	4		
Starlight.....	4	Ultrachevron.....	6		
Static.....	4	Ultracrush.....	6		

Indiana Furniture strives to make as many upholsteries available as possible. However, it is not practical for us to test every offering on every chair as it is made available. If you have any concerns about our ability to upholster your selection on a particular frame please contact us and we will be glad to order a memo sample from this supplier for testing. Call Customer Service at 800.422.5727.

Effective 5/2024

For Architex Samples Call 800.621.0827 or Visit www.architex-ljh.com

Pattern Name	Price Grade
24/7 Flax	5
Aquarius	4
Blazer.....	5
Blazer Lite	4
Carlow	2
Craggan Flax.....	6
Era	2
Era 66 (Panel).....	3
Gravity.....	3
Halcyon - Aspen.....	5
Halcyon - Blossom.....	5
Halcyon - Cedar.....	5
Hemp.....	5
Kork.....	7
Kyoto	4
Lucia	3
Main Line Flax.....	5
Main Line Twist.....	5
Molto.....	4
Nexus.....	3
Oceanic	4
Patternmaker	6
Penta	4
Port	3
Quest.....	3
Regent.....	5
Replay Zero	3
Revolutionary By Camira.....	6
Rivet.....	3
Silk.....	6
Sonus.....	3
Sprint.....	3
Sumi.....	4
Synergy.....	5
Synergy 66 (Panel)	5
Synergy Quilt Channel	6
Synergy Quilt Chevron	6
Synergy Quilt Hourglass.....	6
Touch.....	4
Track	6
Yoredale.....	6

Indiana Furniture strives to make as many upholsteries available as possible. However, it is not practical for us to test every offering on every chair as it is made available. If you have any concerns about our ability to upholster your selection on a particular frame please contact us and we will be glad to order a memo sample from this supplier for testing. Call Customer Service at 800.422.5727.

Pattern Name	Price Grade	Pattern Name	Price Grade	Pattern Name	Price Grade	Pattern Name	Price Grade
Acapella.....	6	Fine Line.....	7	Palomino.....	6	Theory.....	3
Aerial.....	4	Fizzy.....	6	Panorama.....	7	Tilt.....	6
Alex.....	8	Float.....	6	Parade.....	6	Tone.....	6
Allegro.....	9	Folklore.....	6	Paramour.....	5	Topknot.....	3
Allure.....	3	Formation.....	6	Perspective.....	6	Touch.....	4
Alphacoustic.....	10	Framework.....	6	Petal.....	6	Trefoil.....	7
Alu Net.....	11	Fusion.....	6	Pigment.....	4	Trek.....	6
Amplify.....	5	Gammacoustic.....	10	Pike Print.....	7	Triad.....	7
Anagram.....	8	Glaze.....	6	Pinwheel.....	8	Triad Stripe.....	7
Arcade.....	4	Globe.....	11	Plain & Simple.....	3	Triathlon.....	7
Aria.....	14	Grasscloth.....	4	Ponte.....	9	Tune.....	5
Avenue.....	7	Gumption.....	5	Porto.....	8	Turmalin.....	8
Axiom.....	7	Halina.....	14	Porto Fino.....	9	Twill.....	4
Basket.....	7	Halina Stripe.....	14	Porto Flora.....	10	Ultra.....	6
Beam.....	7	Helix Print.....	7	Porto Largo.....	9	Vector.....	5
Bedrock.....	4	Herba.....	10	Prato.....	10	Vestige.....	5
Bespoke.....	4	Hide.....	5	Precision.....	4	Weave.....	4
Betacoustic.....	11	Hinge.....	6	Primacoustic.....	11	Zest.....	6
Bevel.....	7	Hive.....	7	Primary.....	3	Zetacoustic.....	12
Bijoux.....	7	Honeycomb.....	7	Prime.....	4	Zig Zag.....	4
Boggle.....	6	Hue.....	7	Printacoustic Horizon.....	13		
Boomerang.....	8	Impress.....	4	Printacoustic Moment.....	13		
Boomerang Print.....	7	Improv.....	7	Puzzle.....	7		
Boulevard.....	7	Index.....	3	Quartz.....	6		
Brushstroke.....	6	Instinct.....	5	Reflectacoustic.....	12		
Buff.....	6	Jewel.....	7	Relay.....	8		
Camden.....	6	Jigsaw.....	6	Rendezvous.....	4		
Casa.....	8	Juno Print.....	7	Repose.....	6		
Casanova.....	7	Keystone.....	6	Reverb.....	7		
Chamois.....	9	Kid.....	6	Reverie.....	4		
Choreography.....	7	Kismet.....	4	Revolve.....	7		
Chroma.....	8	Labyrinth.....	6	Revolve Print.....	7		
Code.....	5	Lexicon.....	6	Rhythm.....	8		
Collage.....	8	Lithograph.....	5	Rise.....	4		
Color Riot.....	6	Luna.....	7	Roxy.....	5		
Colorado.....	6	Lush.....	5	Sanibel.....	6		
Colorado.....	6	Lyon.....	3	Santana.....	10		
Constant.....	4	Malta.....	10	Savile.....	5		
Corso UN.....	11	Maxim.....	5	Scherzo.....	9		
Countryside.....	6	Maxwell Print.....	7	Scholar.....	5		
Covet.....	4	Maxwell Street.....	7	Shoreline.....	7		
Cross Stitch.....	8	Maze.....	7	Siam.....	11		
Dance Floor.....	7	Maze Print.....	7	Sigmacoustic.....	10		
Dapple.....	6	Medley Stripe.....	7	Silent.....	17		
Deltacoustic.....	12	Melody.....	5	Siltech Grain.....	6		
Dive.....	5	Meraki Stripe.....	6	Siltech Press.....	6		
Diverge.....	4	Merge.....	6	Sketch.....	3		
Diverge II.....	4	Meta.....	4	Soiree Print.....	7		
Dotty.....	8	Mineral.....	4	Solstice.....	6		
Dotty Print.....	7	Montage.....	7	Sonata.....	4		
Drift.....	5	Moto.....	7	Sonnet.....	6		
Dune.....	7	Mustang.....	4	Soprano.....	8		
Echo.....	6	Naxos.....	8	Space.....	12		
Elite.....	3	Odyssey.....	4	Stellar.....	15		
Emblem.....	7	Orenda Plaid.....	8	Sumi.....	7		
Entwine.....	6	Origin.....	6	Tandem.....	6		
Equinox.....	6	Outline.....	6	Tartan.....	6		
Escapade.....	5	Page Turner.....	7	Tartan Print.....	7		
Facet.....	4	Palette.....	7	Terzacoustic.....	10		

Indiana Furniture strives to make as many upholsteries available as possible. However, it is not practical for us to test every offering on every chair as it is made available. If you have any concerns about our ability to upholster your selection on a particular frame please contact us and we will be glad to order a memo sample from this supplier for testing. Call Customer Service at 800.422.5727.

Effective 5/2024

For Carnegie Samples Call 800.727.6770 or Visit www.carnegiefabrics.com

Pattern Name	Price Grade	Pattern Name	Price Grade	Pattern Name	Price Grade
Aberdeen.....	4	Jasper	3	Thera.....	4
Affinity	6	Journey	6	Topo	5
Alter	6	Jubilee.....	6	Trapeze	3
Andes	4	Latitude.....	4	Trek	4
Apex.....	5	Linen	6	Tribeca	4
Arc.....	6	Liquid Leather.....	4	Triumph.....	5
Arcade.....	5	Loop.....	4	Trove.....	4
Argon.....	3	Lorie	4	Twist.....	5
Arion Stripes	6	Lumiere.....	5	Valiant	6
Ascend	4	Luxe	6	Vector	6
Ascot	5	Lyon	2	Verdant	4
Asteria.....	5	Majestic.....	4	Versa.....	6
Baubles	3	Manta.....	6	Verve	6
Bliss.....	4	Marble	6	Vibrato	4
Bloom	6	Maze.....	5	Viper	4
Bonita	4	Meru	3	Voltage	5
Brilliant	6	Monaco	3	Voyager.....	4
Bristol	3	Morse Code.....	5	Wander	5
Cambridge	3	Napoli.....	4	Warp.....	5
Canyon.....	2	Nappa.....	6	Wayfarer.....	6
Carthage	3	Natuur	4	Weathered Metal.....	4
Castle.....	2	Oasis	4		
Chakra	6	Odyssey	6		
Chester.....	4	Onward	5		
Confetti.....	5	Orb	5		
Connection.....	5	Ostro.....	4		
Contour.....	6	Pascal	6		
Core.....	4	Pebbled.....	6		
Crushed.....	5	Perret	4		
Cubist	6	Piazza	6		
Dakar	4	Pixel	4		
Dalliance	6	Plume	5		
Deco	6	Polo.....	3		
Delirium	5	Recess	4		
Doodle.....	6	Regent.....	4		
Dresden.....	4	Rendezvous	5		
Drive	6	Revive.....	5		
Dublin	4	Ripple	4		
Dynasty.....	6	Rise	3		
Ebb N Flow	5	Riva	4		
Eclat	4	Rustique.....	4		
Embark	3	Sanctuary	3		
Emu.....	4	Sarto	3		
Essential.....	4	Savile Row	6		
Flare.....	3	Scatter.....	6		
Flash	4	Scoria.....	6		
Flow	4	Scotia.....	4		
Flux	5	Sebago.....	4		
Gilded II	4	Serene	6		
Granite	5	Serpent	4		
Granular	4	Sirocco	4		
Grove	5	Skye	2		
Guardian.....	4	Soave.....	3		
Heritage.....	4	Solitaire.....	5		
Highlands	6	Speckle	4		
Hopscotch.....	6	Spectra.....	5		
Inception	3	Terra	5		
Interlock.....	6	Terrain	4		
Isle.....	4	Thalia	4		

Indiana Furniture strives to make as many upholsteries available as possible. However, it is not practical for us to test every offering on every chair as it is made available. If you have any concerns about our ability to upholster your selection on a particular frame please contact us and we will be glad to order a memo sample from this supplier for testing. Call Customer Service at 800.422.5727.

Pattern Name	Price Grade	Pattern Name	Price Grade	Pattern Name	Price Grade	Pattern Name	Price Grade
Adler	4	Gather	3	Myddleton	10	Sorano	3
Airy- launching May 2024	6	Geometric II	8	Nagano Crypton®	4	Speckle Boucle	6
Alcazar	4	Glamp	9	Nest	6	Spin	5
Alphabet	3	Gleam	6	Net	7	Spree	6
Amwell	10	Glimmer	5	Nook	4	Stamp	6
Angle	7	Grenoble Crypton®	4	Opulent	4	Standard	7
Appleseed	5	Habitat	7	Oslo Crypton®	4	Starburst	7
Arne	4	Handsome Plaid	8	Overtone	2	Stitch	5
Aspect	3	Hashtag	4	Particle	7	Stockholm Crypton®	4
Atria	6	Hatchmark	7	Pause	5	Stratum	7
Barcelona Crypton®	4	Heather	6	Pave	5	Sunburst	7
Bark Cloth	5	Helsinki Crypton®	4	Pennant	7	Tack Cloth	7
Beguiled By The Wild	5	Hem Stitch	5	Pennant CELLIAN®	9	Tailor	7
Big Dot	5	Hillside	7	Pentimento	7	Tangram	5
Big Texture	6	Hint	6	Phenomena	6	Terra	5
Billiard Cloth	5	Holmes	7	Picnic	7	The Thames	6
Billiard Panel	4	Hyde	3	Piezo	9	Tilt	7
Birdseye	3	Imprint	7	Pika	4	Tiny Boucle	5
BitDrift	6	Ink	7	Pivot	5	Tiny Herringbone	6
Bixby Macro	7	Interlude	6	Pixel	7	Tour	3
Bloomer	7	Interplay	7	Pixel Cloud	7	Traveler	5
Boucle Houndstooth	5	Iota	3	Plaid	7	Treeline	6
Boucle Melange	7	Jacquard I	7	Plexus	8	Trim	7
Brushed Flannel	3	Jumper	7	Plus	7	Trouville	7
Building Blocks	6	Kami	7	Plush Grid	6	Trove	4
Burrard	8	Keen	5	Prime	3	Tweed Multi	4
Burrard Ground Cloth	6	Kin	4	Queue	6	Tweedy Twill	3
Bute Storr	12	Kindred	5	Raia	6	Ulster	3
Chamonix Crypton®	4	Kith	4	Rainwater	6	Ulster Upholstery	3
Check	6	Lake Placid Crypton®	4	Rein	3	Velvet Corduroy	7
Chenille Chevron	7	Lambert	8	Reppweave	4	Vero	5
Chunky Tweed	6	Large Scale Geometric	9	Rider	5	Vertex	7
Circle Jacquard	8	Layer	4	Rise	4	Vine	6
Circulate	7	Leap	5	River Lea	6	W	5
Clad CELLIAN®	4	Line Up	5	Road Trip	6	Wanderer	4
Clerkenwell	10	Line Variations	6	Rocket	3	Wend	4
Cloud Velvet	4	Linen Like	5	Rodenbach	8	Whim	5
Concentric	7	Linnen	5	Rome Crypton®	4	Wildflower	7
Corded	7	Little Dot	5	Rotary	7	Wonder	7
Cozy Texture	3	London Crypton®	4	Roundel	7	Woolish	4
CrissCross	6	Loop to Loop	7	Sail	7	Woven Texture	10
Crossweave	3	Lounge	4	Salt Lake Crypton®	4	Wrap	6
Crosswind	5	Lumi	7	Samba	7		
Cube Geo	6	Luster	5	Sapporo Crypton®	4		
Cubitt	6	Mackintosh	4	Senecal	2		
Current	5	Mark	4	Sidetrack	4		
Curve	5	Mateo	5	Silicone Cheer	7		
Dapple	7	Measure	4	Silicone Element	6		
Distressed Texture	6	Melange	4	Silicone Element CELLIAN®	8		
Double Weave	7	Metallo	5	Silicone Glee	7		
Everywhere Texture	5	Metta	4	Silicone Lane	7		
Felt 2mm	8	Mexico City Crypton®	4	Silicone Level	7		
Five Cities	6	Microgrid	5	Silicone Nappa	6		
Flow	7	Mirth	7	Silicone Range	7		
FOMO	5	Mohair Plus	10	Silicone Reveal	7		
Forestbound	5	Montreal Crypton®	4	Silicone Roundabout	7		
Gale	5	Moquette	10	Silicone Skyline	7		
Gamut	3	Motley	5	Sketch	6		
Gamut CELLIAN®	4	Mountainous	8	Social Dance	6		

Indiana Furniture strives to make as many upholsteries available as possible. However, it is not practical for us to test every offering on every chair as it is made available. If you have any concerns about our ability to upholster your selection on a particular frame please contact us and we will be glad to order a memo sample from this supplier for testing. Call Customer Service at 800.422.5727.

Pattern Name	Price Grade
Amaze (Panel)	1
Anchorage	2
Axiom (Panel).....	2
Bailey (Panel).....	2
Broadcast (Panel).....	1
Cape Cod (Panel).....	2
Chase (Panel).....	1
Couture	2
Crosstown (Panel).....	2
Dashing (Panel).....	2
Dune (Panel).....	1
Emerge	2
Essence (Panel).....	1
Felt (Panel).....	2
Framework (Panel).....	1
Frolic	2
Input	1
Intermix (Panel)	2
Intuition	2
Jane	2
Lido (Panel).....	2
Marin (Panel).....	2
Metallation (Panel).....	2
Moguls	2
Off the Grid (Panel)	1
Open House	2
Palette	2
Palette with Crypton	3
Palette with Crypton	3
Pebble	2
Phrase	2
Poseidon	3
Poseidon	3
Punch Card	2
Purpose (Panel)	2
Pursuit (Panel).....	1
Quadrille	2
Reeds (Panel).....	2
Reframe	2
Reframe	2
Revival	3
Rise	2
Rise	2
Shift	2
Spinel (Panel).....	2
Sprite (Panel).....	2
Stitch	2
Strata (Panel).....	2
Studio 54 (Panel).....	3
Synopsis	2
Tempest (Panel).....	2
Theory (Panel).....	1
Tidal	2
Tidal	2
To the Point	2
Tweed (Panel).....	2
Whisper (Panel)	1

Indiana Furniture strives to make as many upholsteries available as possible. However, it is not practical for us to test every offering on every chair as it is made available. If you have any concerns about our ability to upholster your selection on a particular frame please contact us and we will be glad to order a memo sample from this supplier for testing. Call Customer Service at 800.422.5727.

<u>Pattern Name</u>	<u>Price Grade</u>	<u>Pattern Name</u>	<u>Price Grade</u>	<u>Pattern Name</u>	<u>Price Grade</u>	<u>Pattern Name</u>	<u>Price Grade</u>
Abacus.....	6	Cozy Cord.....	3	It's Complicated.....	7	Premier.....	6
Aegean.....	7	Cross Tech.....	3	Ita.....	17	Prep.....	5
Alignment.....	6	Crossroad.....	4	Jaipur.....	14	Prestini.....	5
All Star.....	10	Cummings.....	12	Jasmine.....	9	Presto.....	4
Alter Ego.....	8	Currents.....	6	Journey.....	5	Prim.....	5
Amore.....	10	Dapper.....	8	Juno.....	7	Prince Hairy.....	11
Andissa.....	9	Day Tripper.....	5	Kabuki.....	7	Puff.....	4
Arber.....	13	Delite.....	3	Kamani.....	9	Pullman.....	5
Arezzo.....	10	Demure.....	8	Kampala.....	8	Quark.....	8
Argyle.....	5	Diamond Days.....	12	Katazome.....	8	Radiance.....	6
Arrondissement.....	8	Digi Velvet.....	13	Kaya CR.....	6	Ransom.....	5
Aswan.....	10	Diva.....	5	Keaton.....	5	Rebel.....	7
Atelier.....	9	Djenne.....	10	Kimono.....	8	Retreat.....	6
Atlas.....	7	Doily.....	14	Kinabalu.....	9	Rivers.....	7
Attire.....	5	Dottie.....	4	Knoll Felt.....	6	Rivington.....	9
Aurora.....	7	Double Agent.....	8	Knoll Hopsack.....	5	Roam.....	5
Axiom.....	5	Duchess.....	11	Knoll Velvet.....	14	Roundtrip.....	7
Bavaria.....	12	Dune.....	6	Lagos.....	7	Rush Hour.....	5
Baxter.....	6	Durand.....	6	Liberty.....	8	Rutledge.....	12
Belize.....	7	Dynamic.....	12	Limani.....	16	Sahara ND.....	7
Bella.....	14	Earthwork.....	7	Little Devil.....	5	Sandis.....	12
Biscayne.....	8	Eclat Weave.....	8	Looped In.....	8	Sashiko.....	6
Bistro.....	5	Entourage.....	7	Lore CR.....	7	Sequin CR.....	7
Block Party.....	4	Entwine.....	5	Ludlow.....	5	Seurat.....	7
Bocce.....	5	Essence.....	5	Magnolia.....	6	Shadow Play.....	4
Boundary.....	5	Facet.....	3	Mamba.....	10	Sherman.....	8
Brigadoon.....	4	Fancy Twill.....	8	Mariner.....	6	Shima.....	8
Buzz.....	6	Feeling Plaid.....	8	Marquee.....	8	Sideline.....	7
Byron.....	14	Ferry.....	5	Melange.....	8	Snclair.....	7
Cairo.....	7	Firefly.....	9	Melody.....	4	Smart.....	7
Calais Cotton Velvet.....	10	Floressence.....	9	Menagerie.....	7	Soiree.....	5
Calypso.....	5	Flower Power.....	6	Meroe.....	7	Soliloquy.....	4
Cameo.....	7	Forza.....	7	Midpoint.....	7	Sonnet.....	4
Cato.....	12	Gala II.....	6	Milestone.....	7	Soon.....	8
Catwalk.....	9	Gibson.....	10	Mod Plaid.....	8	Spencer.....	11
Cavalier.....	8	Glider.....	8	Modern Tweed.....	8	Spree.....	5
Century.....	9	Grande.....	6	Monarch.....	5	Stacks.....	4
Chain Link.....	6	Grandview.....	7	Nature Walk.....	7	Stepping Stones.....	8
Chameleon.....	5	Greenwich.....	6	Night Life.....	8	Stretch Appeal.....	9
Chance.....	4	Groovy.....	5	North Island.....	13	Striae Stripe.....	9
Charm.....	7	Guise.....	12	Off the Grid.....	6	Stripe It.....	9
Chic.....	10	Hastings.....	10	Oh La La.....	4	Stripemania.....	4
Chiseled.....	9	Haze.....	9	Olema.....	12	Summit.....	5
Chronicle.....	6	Helios.....	4	On Point.....	5	Sutton.....	5
Circa.....	8	Highland.....	8	Origins.....	7	Swank.....	9
Circle Point.....	6	Holbrook.....	5	Overture.....	4	Swing.....	8
Classic Boucle.....	8	Homage.....	6	Palisade.....	5	Synth.....	5
Cleo.....	7	Honour.....	14	Panache CR.....	8	Tabloid.....	5
Close Knit.....	7	Hourglass.....	4	Paradigm.....	7	Tara.....	9
Code.....	6	Hudson.....	7	Patchwork.....	6	Tempest.....	7
Color Collage.....	8	Ikat Square.....	8	Pathway.....	5	Texnet.....	7
Color Field.....	5	Ikat Stripe.....	7	Petal Pusher.....	5	Tight Rope.....	6
Common Ground.....	6	Imprint.....	7	Piper.....	11	Tilden.....	6
Commuter Cloth.....	3	In Step.....	10	Placid.....	7	Tinge.....	4
Constance.....	11	In Stitches.....	8	Plaid On.....	5	Tivoli.....	9
Contour.....	4	Infinite.....	3	Plaidtastic.....	6	Topos.....	4
Cornaro.....	9	Instinct.....	5	Ponder.....	3	Tosca.....	12
Coterie.....	8	Island.....	7	Prairie.....	4	Totem.....	8

Indiana Furniture strives to make as many upholsteries available as possible. However, it is not practical for us to test every offering on every chair as it is made available. If you have any concerns about our ability to upholster your selection on a particular frame please contact us and we will be glad to order a memo sample from this supplier for testing. Call Customer Service at 800.422.5727.

Pattern Name	Price Grade
Tower Grid.....	6
Trophy.....	4
Tryst.....	9
Tudor.....	10
Tweed Frieze.....	10
Twist Tie.....	9
Ultrasuede®.....	9
Uni-Form.....	4
Utmost II.....	6
Utopia.....	5
Utrillo.....	9
Vast.....	4
Vatera.....	7
Venue.....	4
Versa.....	5
Vert.....	8
Vibe II.....	5
Vice Versa.....	6
Vinyl.....	6
Westwood.....	5
Whip.....	7
Wild Thing.....	4
Wit.....	6
Woodland II.....	6
World Piece.....	10
Wow Factor.....	6
Yeni.....	5
Zari CR.....	8
Zen Wave.....	6
Zoom.....	8

Indiana Furniture strives to make as many upholsteries available as possible. However, it is not practical for us to test every offering on every chair as it is made available. If you have any concerns about our ability to upholster your selection on a particular frame please contact us and we will be glad to order a memo sample from this supplier for testing. Call Customer Service at 800.422.5727.

Pattern Name	Price Grade	Pattern Name	Price Grade
Aaren	10	Remix 3	5
Alle	7	Remix Screen	7
Apparel	9	Revive 1	6
Ara	7	Ria	11
Arda	8	Rumor	7
Argo 2	16	Sabi	7
Atlas	6	Savanna	7
Atom	9	Sisu	9
Atrium Outdoor	6	Sonar 3	10
Autumn	3	Sone	6
Balder 3	8	Sport	4
Basel	5	Sprinkles	8
Broken Twill Weave	6	Steelcut 3	6
Byram	12	Steelcut Beat	5
Canvas 2	5	Steelcut Quartet	7
Clara 2	5	Steelcut Trio 3	6
Coda 2	8	Still	6
Colline 2	7	Sunniva 3	7
Divina 3	6	Suunta	6
Divina MD	6	Tambourine Hallingdal	12
Divina Melange 3	6	Technicolor Fleck	7
Drop	8	Tero Outdoor	6
Einar	14	Tonica 2	6
Encircle	6	Tonus 4	6
Field 2	6	Triangle	9
Fiord 2	7	Twill Weave	6
Floyd	6	Uniform Melange	8
Floyd Screen	5	Vanir	9
Foss	7	Vidar 4	9
Fuse	10		
Gentle 2	10		
Haku	5		
Hallingdal 65	7		
Harald 3	7		
Helia	10		
Hero 2	5		
Hero Heather	5		
Husk	8		
Jaali	7		
Letters	10		
Maple	6		
Melange Nap	6		
Memory 2	7		
Mizmaze	7		
Molly 2	6		
Mosaic 2	9		
Naveli	6		
Patio Outdoor	6		
Phlox	7		
Planum	7		
Plecto	8		
Raas	7		
Razzle Dazzle	8		
Re-wool	6		
Recheck	6		
Reflect	4		
Reflect Screen	5		
Reflex	10		

Indiana Furniture strives to make as many upholsteries available as possible. However, it is not practical for us to test every offering on every chair as it is made available. If you have any concerns about our ability to upholster your selection on a particular frame please contact us and we will be glad to order a memo sample from this supplier for testing. Call Customer Service at 800.422.5727.

Pattern Name	Price Grade	Pattern Name	Price Grade	Pattern Name	Price Grade	Pattern Name	Price Grade
Ample.....	8	Equate.....	6	Melange Tweed	10	Scuba.....	5
Amulet.....	9	Etch.....	9	Meld.....	4	Scute.....	6
Anagram.....	7	Exaggerated Plaid	10	Merit.....	4	Scuttle.....	6
Analog.....	7	Facets.....	10	Mesh.....	8	Segmented Stripe.....	9
Apex.....	6	Factor.....	6	Messenger.....	4	Sendal.....	6
Apt.....	7	Fathom.....	5	Metaphor.....	3	Serried.....	7
Arabesque.....	10	Feature.....	6	Metered Stripe.....	9	Shadow.....	6
Arcade.....	8	Felix.....	7	Method.....	3	Shake.....	8
Aria.....	9	Festoon.....	7	Metric.....	4	Shift.....	8
Article.....	4	Firma.....	7	Mexidot.....	7	Sift.....	9
Beck.....	6	Flex.....	7	Micro.....	5	Silk Canvas.....	9
Beryl.....	6	Flint.....	7	Mikado.....	10	Site.....	5
Bind.....	8	Flock (Panel).....	5	Minicheck.....	10	Small Dot Pattern	9
Bluff.....	5	Fluent Crypton.....	7	Mister.....	7	Sort.....	5
Bond.....	6	Flurry.....	9	Mode.....	4	Spare.....	9
Boundary.....	6	Fluted Silk.....	10	Monsoon.....	8	Spindle.....	9
Bright Angle.....	8	Fold.....	7	Multiply.....	5	Spiral (Panel).....	4
Bright Cube.....	8	Fore.....	9	Murmur.....	4	Stature.....	5
Bright Grid.....	8	Frequency.....	6	Muse.....	3	Structure.....	4
Brim.....	7	Fruit.....	9	Names.....	10	Strum.....	6
Brindle.....	5	Gale.....	7	Nestle.....	9	Study.....	8
Brio.....	6	Gemma.....	7	Nico.....	5	Sudden.....	7
Buffer.....	6	Gemma Multi.....	7	Nimble.....	6	Sundry.....	8
Campana.....	7	Geometri.....	10	Note.....	5	Swathe.....	8
Canopy.....	5	Gild.....	6	Offset.....	8	Switch.....	6
Caper.....	5	Ginkgo.....	6	Optik.....	10	Taper.....	8
Chalet.....	7	Glaze.....	10	Overlapping Stripe.....	10	Taut Linen.....	10
Chasm.....	6	Glen.....	4	Oxbow.....	7	Tempera.....	7
Checker.....	10	Grove.....	7	Pallet.....	4	Tempo.....	5
Checker Split.....	10	Gust.....	6	Parallel (Panel).....	5	Terra.....	9
Chime.....	5	Hearth.....	8	Parched Silk.....	10	Tessera.....	6
Circles.....	9	Hewn.....	8	Pare.....	6	Tracery.....	8
Circles.....	10	Hive.....	5	Parquet.....	3	Transmit (Panel).....	3
Clamber.....	5	Houndstooth.....	9	Passage.....	7	Tress.....	10
Coin.....	5	Idle.....	9	Pepitas.....	8	Trestle.....	7
Compound.....	6	Imbue.....	9	Pepper.....	5	Trigon.....	6
Concord Stripe.....	9	Inlay.....	9	Perspective.....	10	Trundle.....	5
Conduit.....	5	Instill.....	5	Petra.....	7	Turret.....	5
Confetti.....	9	Isa.....	7	Pitch.....	5	Twist.....	8
Cosset.....	6	Jasper.....	6	Platform.....	4	Unisol.....	10
Cove.....	9	Keen.....	5	Plume.....	9	Valley.....	5
Cumulus.....	4	Lariat.....	4	Point.....	10	Valor.....	9
Cursive.....	7	League.....	4	Prompt.....	5	Veer.....	5
Cycle.....	5	Lean.....	5	Province.....	7	Veld.....	8
Darning Sampler.....	8	Ledger.....	5	Quatrefoil.....	10	Washi.....	9
Darning Sampler Large.....	8	Lens.....	6	Quay.....	5	Wend.....	6
Darning Sampler Plaid.....	9	Levity.....	6	Quell.....	10	Wide Corduroy.....	10
Distill.....	5	Lift.....	7	Rail.....	7	Willow.....	5
Dot Pattern.....	9	Limn.....	8	Range.....	8	Wool Check.....	10
Dots.....	9	Linden.....	6	Ratio.....	10		
Double Triangles.....	10	Loop.....	5	Reef.....	9		
Drape.....	7	Luce.....	7	Regatta.....	7		
Eave.....	5	Lumen (Panel).....	4	Relay.....	8		
Edges.....	9	Lunar.....	5	Ribbed Weave.....	7		
Ellipsis.....	6	Manner.....	4	Rill.....	5		
Elm.....	4	Mantle.....	5	Roman.....	8		
Emit.....	5	Mechanism.....	8	Route.....	6		
Enmesh.....	6	Medium.....	4	Runner.....	7		
Entwine.....	8	Mela.....	10	Scope.....	7		

Indiana Furniture strives to make as many upholsteries available as possible. However, it is not practical for us to test every offering on every chair as it is made available. If you have any concerns about our ability to upholster your selection on a particular frame please contact us and we will be glad to order a memo sample from this supplier for testing. Call Customer Service at 800.422.5727.

MAYERFABRICS

MAYER FABRIC GRADING

Pattern Name	Price Grade	Pattern Name	Price Grade	Pattern Name	Price Grade	Pattern Name	Price Grade
Abbey	3	Etch	2	Milagro	6	Theory 10	2
Acuco	6	Fanfare	5	Milano	3	Truss	4
Adler	1	Fedora	2	Mimic (Panel)	2	Utopia	3
Align	2	Fiji	2	Mingle	3	Variant 10	2
All Seasons	2	Fitz	4	Mira	2	Vector	5
Ankara	4	Flair (Panel)	2	Mode	3	Venetian	8
Antique	3	Florentino	2	Molecule	5	Verona	3
Apollo Silicone	6	Form	4	Moonscape	2	Vertex	5
Arc	4	Forte	1	Multi Crepe (Panel)	2	Villa	5
Arcade	4	Foundation 10	2	Neo	3	Vintage Mohair	10
Balance	3	Fractal	5	Nexus (Panel)	2	Vinyl Stat - Esd	4
Bali	2	Fresco (Panel)	2	Niche	4	Volante	8
Basic (Panel)	1	Function	3	Nirvana	5	Voyager	4
Beaux	3	Furrow (Panel)	1	Noble	2	Webster	5
Belmont	5	Gala	4	Nomad	4	Whirligig	6
Blueprint (Panel)	1	Galveston	3	Nylon-Stat	5	Whirlwind (Panel)	2
Bolero	4	Gatsby	3	Odessa	4	Wilson	5
Boro	5	Gem	2	Omega	3	Wool Boucle	7
Botany	5	Graph (Panel)	1	Optic 10	2	Xanadu	5
Boteh	6	Gravity	4	Outback	2	Zen	5
Caressa	3	Gridline (Panel)	2	Palermo	4	Zip	2
Carousel	5	Haarlem	6	Paragon (Panel)	2		
Caspian	3	Harper	5	Patio	2		
Catwalk	4	Havana	2	Pebble Beach (Panel)	2		
Centric	4	Haven	3	Plaza	4		
Channel	3	Hexagon	3	Polygon	3		
Chaps	3	Huipil	5	Prism 10	2		
Chequers	4	Icon	3	Prospect	3		
Cipher (Panel)	1	Imprint	2	Puno	5		
Cirque	3	Infinity	5	Quattro	2		
Code (Panel)	1	Interlace	3	Ranchero	1		
Collage	6	Interlude (Panel)	2	Reflector	5		
Comalapa	6	Jekyll & Hyde	3	Refuge	5		
Connect	4	Jive	2	Relativity	5		
Continuum 10	2	Kantha	5	Retro	6		
Copa (Panel)	2	Kensington	3	Rio	3		
Cosmopolitan	3	Key Largo	2	Rumba	1		
Crazy Quilt	5	Labyrinth	6	Samba	2		
Cross Check	2	Lancaster	2	Saori	5		
Curator	4	Landscape	4	Score	4		
Dande	3	Lavish	3	Scout	3		
Darning	6	Legacy	3	Seville	2		
Delano	2	Leoni	5	Shift	4		
Delmar	2	Links	3	Signs	6		
Denali	5	Longhorn	4	Silverweave	3		
Discovery	4	Loop	3	Sketch	3		
Divert (Panel)	2	Luminary (Panel)	2	Soleil	5		
Durango	2	Lyric	2	Sonnet	3		
Duraweave 10	1	Malibu	3	Spacer Mesh	2		
Echo	3	Mandala	6	Spartan	2		
Editor	4	Marathon	1	Splendor	4		
Elevation	4	Marmara	4	Spokes	5		
Empire Silicone	6	Matka	3	Static	5		
Engrave	2	Matter	4	Strata (Panel)	2		
Ephesus	5	Maverick	2	Sula	6		
Equal (Panel)	2	Metal Strips	5	Sydney	2		
Essence	3	Midway	2	Tango	2		

Indiana Furniture strives to make as many upholsteries available as possible. However, it is not practical for us to test every offering on every chair as it is made available. If you have any concerns about our ability to upholster your selection on a particular frame please contact us and we will be glad to order a memo sample from this supplier for testing. Call Customer Service at 800.422.5727.

Pattern Name	Price Grade	Pattern Name	Price Grade	Pattern Name	Price Grade	Pattern Name	Price Grade
3D Grid.....	8	Clip 544.....	8	Floater.....	3	Lapland 531.....	9
Ace.....	3	Coda.....	5	Flock.....	3	Lark.....	4
Acoustic.....	7	Coffee Berry II 480.....	5	Flux.....	7	Lasanna CV.....	4
Acrobat.....	5	Collect.....	5	Focal.....	2	Lasso CV.....	5
Agora II.....	4	Color Works 543.....	8	Fold.....	7	Lateral.....	5
Aldo.....	8	Colorwheel.....	6	Folklore 455.....	9	Layers 408.....	8
Alhambra 401.....	7	Confetti 450.....	7	Follow CV.....	5	Leafdot CV.....	5
Allover 372.....	7	Cotton CV.....	5	Foray.....	5	Ledge.....	4
Almanac.....	7	Cover Cloth.....	2	Foundation.....	5	Lella.....	5
Amenity II.....	6	Cozy 456.....	7	Fragments 540.....	7	Leno.....	6
Amuse.....	4	Crespo.....	1	Free.....	3	Lens.....	3
Anthology CV.....	4	Croquet.....	5	Frida CV.....	5	Level.....	6
Anywhere 371.....	7	Crossing Colors.....	8	Fuse.....	3	Light 522.....	7
Aquavit 536.....	7	Crossing Lines 407.....	7	Glassworks.....	5	Lina.....	7
Archer.....	6	Crosswise.....	4	Glide.....	5	Linen CV.....	4
Archipelago 537.....	8	Cube.....	6	Glint (Panel).....	2	Lines ON Stripes 490.....	7
Artisanal Epu.....	4	Culture.....	5	Gradient 492.....	7	Lineup.....	3
Ascend.....	5	Current.....	3	Graph.....	1	Linguine II 484.....	5
Audubon.....	7	Curtain Call (Panel).....	2	Grid.....	2	Lore.....	6
Bandwidth II.....	6	Cutout.....	6	Groove Epu.....	4	Lucio.....	9
Bangle.....	2	Cycle.....	4	Guideline.....	6	Mandala.....	5
Banter.....	7	Dart.....	3	Guild.....	1	Mapping Ideas.....	8
Beachcomber II 482.....	5	Dash.....	4	Guru.....	3	Marathon 460.....	7
Beeline Epu.....	4	Decode.....	2	Habit.....	3	Marathon C-Zero.....	2
Beep.....	3	Deka.....	3	Hacienda II 481.....	6	Meander (Panel).....	2
Beta.....	3	Delano.....	7	Halo.....	6	Measure 436.....	7
Bloko.....	7	Destinations 315.....	8	Hearsay.....	7	Mello.....	3
Blurred Plaid 527.....	7	Dexter Epu.....	3	Highline.....	6	Mezzanine.....	5
Bobby.....	3	Docket.....	7	Hitch.....	5	Mezzotint 545.....	7
Boheme.....	5	Domain.....	5	Hobnob.....	3	Mikro.....	6
Bold Plaid 530.....	8	Domani 357.....	8	Honeycomb 521.....	7	Millennium C-Zero.....	2
Boom II.....	4	Dome CV.....	3	Hop.....	5	Mix 477.....	8
Borders.....	6	Drawing Lines.....	7	Hue.....	3	Mixer Epu.....	4
Boxcar.....	5	Drift.....	6	Hyde CV.....	3	Mixology CV.....	3
Bravo II.....	3	Ebb.....	7	Icon 494.....	7	Modern Plaid 546.....	7
Breeze 423.....	5	Edison.....	7	Illumina.....	9	Mogul Epu.....	4
Brink.....	6	Ego.....	1	Imperial Mohair.....	11	Mossy 474.....	7
Brisk.....	6	Encore (Panel).....	2	Improv CV.....	3	Nestle.....	1
Build.....	5	Endurance Epu.....	2	Infinity C-Zero.....	2	Nifty.....	4
Cairns.....	7	Eon Epu.....	4	Infusion.....	6	Nimble.....	7
Calypso II 483.....	5	Epic.....	3	Insight.....	2	Northern Lights 470.....	8
Camber.....	7	Essay.....	6	Interim.....	7	Note CV.....	3
Cameo (Panel).....	2	Etude.....	7	Iota.....	6	Nubble.....	5
Canter Epu.....	2	Eureka 389.....	6	Jackpot CV.....	5	Oath.....	5
Caravan.....	4	Everywhere Epu 495.....	5	Jitney.....	5	Obi Stripe 444.....	8
Carlo.....	8	Evo CV.....	3	Jot.....	3	Odyssey C-Zero.....	2
Carson CV.....	1	Explore.....	6	Journal.....	7	Ona.....	9
Cashmere II.....	4	Expo.....	2	Just Add Plaid 501.....	8	Origin.....	1
Central.....	5	Expression.....	5	Kayak.....	5	Otto.....	3
Centric.....	6	Faux Felt.....	3	Keeper CV.....	4	Ovals 542.....	7
Chameleon 520.....	7	Faux MO.....	5	Keynote.....	4	Overpass.....	5
Channel.....	5	Felt.....	7	Kindred.....	6	Overshot 475.....	9
Chant.....	6	Felt Melange.....	7	Kinect (Panel).....	2	Pact (Panel).....	2
Chime CV.....	5	Feltro.....	3	Kinney.....	3	Painting Strokes.....	7
Chipper.....	7	Fern II 486.....	5	Kit.....	4	Palazzo 360.....	8
Chromatic.....	6	Fidget CV.....	5	Knack.....	3	Palette 476.....	9
Civil.....	6	Fletcher.....	5	Lana.....	9	Panorama.....	7
Clang.....	3	Flicker 500.....	8	Landmark 503.....	7	Pantheon.....	6
Climb.....	6	Fling 497.....	5	Landscape 472.....	8	Parable.....	6

Indiana Furniture strives to make as many upholsteries available as possible. However, it is not practical for us to test every offering on every chair as it is made available. If you have any concerns about our ability to upholster your selection on a particular frame please contact us and we will be glad to order a memo sample from this supplier for testing. Call Customer Service at 800.422.5727.

<u>Pattern Name</u>	<u>Price Grade</u>	<u>Pattern Name</u>	<u>Price Grade</u>	<u>Pattern Name</u>	<u>Price Grade</u>
Parachute.....	5	Silica.....	5	Stroll.....	3
Paradiso.....	8	Silica Andy.....	6	Strum.....	5
Parenthesis.....	1	Silica Arc.....	6	Strut.....	4
Pax.....	6	Silica Bauble.....	6	Subdivide.....	6
Perk.....	2	Silica Blend.....	5	Sunbeam 523.....	7
Photon.....	7	Silica Bracket.....	6	Sunny.....	5
Phrase.....	6	Silica Bubbler.....	6	Sweater 533.....	7
Pierre.....	8	Silica Checker.....	6	Swim.....	2
Ping.....	2	Silica Chopsticks.....	4	Synergy.....	5
Pip.....	4	Silica Compass.....	6	Syntax.....	3
Piper.....	4	Silica Cusp.....	6	Tack.....	3
Pique.....	2	Silica Deflect.....	6	Tactic.....	7
Pixelate.....	4	Silica Effloresce.....	6	Tag.....	4
Places Spaces Faces.....	7	Silica Etc.....	6	Tanner.....	3
Plan.....	4	Silica Etch.....	5	Tech Weave.....	10
Platform.....	5	Silica Excursion.....	6	Tenor (Panel).....	2
Plaza 502.....	8	Silica Fiona.....	6	Terrace 493.....	8
Plus.....	7	Silica Flick.....	6	Tesla.....	6
Pod.....	8	Silica Fresco.....	6	Thick And Thin 547.....	7
Poetic CV.....	3	Silica Fritz.....	6	Tilt.....	5
Point.....	2	Silica Gidget.....	6	Tivoli 534.....	7
Polka.....	6	Silica Hiatus.....	6	Toggle.....	3
Pop UP.....	8	Silica Hoop.....	6	Tradewinds CV.....	5
Prato.....	9	Silica Jig.....	6	Tradition C-Zero.....	2
Printwork Epu.....	4	Silica Kip.....	6	Trefoil.....	5
Propel.....	6	Silica Leather.....	5	Triangles 491.....	8
Proverb (Panel).....	2	Silica Likely.....	6	Tribeca CV.....	3
Proximity.....	7	Silica Motive.....	4	Trilogy.....	5
Pursue.....	5	Silica Reach.....	6	Trivia.....	6
Quince.....	7	Silica Roam.....	6	Tufted.....	7
Raft.....	6	Silica Scout.....	6	Turkish Delight 434.....	4
Rattan.....	9	Silica Spoke.....	6	Tweedy 548.....	7
Rein II.....	4	Silica Strata.....	6	Twill Epu.....	4
Revolve.....	7	Silica Stride.....	6	Universe (Panel).....	2
Ribbons 421.....	5	Silica Suede.....	5	Vanguard CV.....	4
Ring.....	6	Silica Tao.....	6	Vanish.....	5
Ringer CV.....	5	Silica Tech.....	5	Velocity.....	4
Rise.....	3	Silica Thatch.....	6	Via.....	3
Rivet.....	2	Silica Today Here Now.....	6	Villa II 487.....	5
Rombu.....	7	Silica Triad.....	6	Vox.....	3
Ronda.....	7	Silica Waltz.....	6	Wander.....	4
Roster.....	7	Silica Wifi.....	6	Waver.....	5
Row.....	4	Silk Struktur.....	8	Weaving Palettes.....	7
Rubato.....	5	Site Line.....	7	Well Well Well.....	8
Rush Hour.....	7	Sketching Air.....	7	Whim.....	6
Rustic 528.....	8	Skip.....	3	Whisp.....	5
Sail.....	5	Slice.....	3	Whit Epu.....	4
Sandy Shores 312.....	6	Small Talk.....	6	Why Why Why.....	7
Santa FE Sun 290.....	8	Smart Soft.....	4	Widget.....	2
Sanya CV.....	4	Solace.....	4	Wish 485.....	5
Sartorial.....	11	Solar Canvas 287.....	5	Witzel CV.....	4
Scatter.....	1	Solitaire.....	4	Wool Boucle 512.....	10
Score.....	5	Speakeasy CV.....	4	Wool Multi 513.....	9
Scrabble.....	2	Sport.....	4	Wool Structure 511.....	9
Script (Panel).....	2	Sprinter 464.....	7	Wool Weave 510.....	9
Seacoast 538.....	7	Spunk CV.....	4	Woven Felt.....	15
Sensory CV.....	3	Staircase 541.....	7	Yarnplay CV.....	5
Shuttle.....	5	Starboard.....	5	Zipped.....	6
Sidestep.....	6	Story.....	6		

Indiana Furniture strives to make as many upholsteries available as possible. However, it is not practical for us to test every offering on every chair as it is made available. If you have any concerns about our ability to upholster your selection on a particular frame please contact us and we will be glad to order a memo sample from this supplier for testing. Call Customer Service at 800.422.5727.



PALLAS

PALLAS TEXTILES GRADING

Pattern Name	Price Grade	Pattern Name	Price Grade	Pattern Name	Price Grade
Adele.....	5	Haven.....	6	Rove.....	5
Alea.....	5	Hearth.....	5	Sandstone.....	4
Allure.....	6	Holy Cow.....	5	Selvedge.....	5
Allusion.....	5	Holy Cow Too.....	5	Shear.....	5
Amari.....	5	Icon.....	3	Sherlock.....	5
Ample.....	5	Infinite Helix.....	5	Shift.....	6
Aphrodite.....	4	Iota.....	4	Simile.....	3
Arc.....	6	Jaunt.....	6	Sisal.....	4
Arch.....	5	Jet Set.....	6	Sonnet.....	6
Arjuna.....	3	Juggernaut.....	5	Spot On.....	4
Artemis.....	6	Kwaart.....	5	Stipple.....	5
Asha.....	5	Lattice.....	6	Stippling.....	5
Asymmetric.....	5	Le Fleur.....	5	Stitch.....	5
Athalie.....	5	Line.....	4	Suji Stripe.....	5
Awe.....	5	Lore.....	3	Surface.....	5
Axis.....	5	Louver.....	5	Sway.....	5
Ballad.....	6	Lull.....	5	Taboo.....	5
Basket.....	5	Lumiere.....	3	Tartan.....	6
Bedford.....	5	Lyric.....	5	Tech.....	4
Bend.....	5	Magique.....	5	Terra.....	4
Bonnaroo.....	5	Marbles.....	5	Tessellation.....	4
Brio.....	6	Marrakesh Express.....	4	Threads.....	5
Brogue.....	5	Melody Maker.....	5	Tilt.....	5
Burnish.....	5	Merge.....	4	Translation.....	5
Chic.....	6	Mesh.....	5	Trapunto.....	6
Chitra.....	5	Metaphor.....	5	Trek.....	5
Coco.....	5	Mix.....	5	Trellis.....	5
Composition.....	5	Mod.....	5	Tulips.....	5
Construct.....	5	Mode.....	5	Twine.....	4
Craft.....	3	Modern Blaze.....	5	Unraveled.....	5
Curio.....	5	Mosaic.....	4	Unspun.....	6
Cybele.....	5	Mystere.....	5	Urbanized.....	3
Decked Out.....	5	Nap.....	3	Utopia.....	5
Deeply Rooted.....	6	Nappa.....	5	Veer.....	5
Deflect.....	5	Neo.....	6	Verse.....	4
Deflection.....	4	Night Cap.....	5	Vertices.....	5
Déjà Vu.....	4	Nomad.....	5	Vespa.....	4
Demeter.....	6	Ode.....	6	Vignette.....	5
Demi.....	6	On The Fringe.....	6	Wander.....	3
Drift.....	5	Ooh La Lana.....	5	West Bengal.....	4
Edge.....	5	Origin.....	3		
Essence.....	5	Panache.....	3		
Etch.....	5	Patagonia.....	5		
Ethos.....	5	Patina.....	4		
Flow.....	5	Perception.....	5		
Flux.....	5	Petals.....	4		
Folie.....	6	Phenomena.....	5		
Fracture.....	5	Pinch Pleat.....	5		
Fresh.....	3	Pivot.....	5		
Frieze.....	4	Plush.....	5		
Fuse.....	6	Polka Dotty.....	5		
Gather.....	4	Popcorn.....	4		
Gene Pool.....	5	Posh.....	5		
Glam.....	5	Promenade.....	5		
Glitz.....	4	Prose.....	6		
Graph.....	4	Purl.....	5		
Grille.....	5	Reflection.....	4		
Groove.....	6	Reverie.....	3		
Halftone.....	5	Rogue.....	4		
Harmony.....	5	Round.....	5		

Indiana Furniture strives to make as many upholsteries available as possible. However, it is not practical for us to test every offering on every chair as it is made available. If you have any concerns about our ability to upholster your selection on a particular frame please contact us and we will be glad to order a memo sample from this supplier for testing. Call Customer Service at 800.422.5727.

Effective 5/2024

For Pallas Textiles Samples Call 800.472.5527 or Visit www.pallastextiles.com

Pattern Name	Price Grade	Pattern Name	Price Grade	Pattern Name	Price Grade	Pattern Name	Price Grade
Abstract	6	Citadel 2.0	3	Grand Sierra 2.0	3	Metropolis	9
Ace	3	Cityscape	5	Graph	4	Mica 2.0	3
Acrobat	6	Clean Slate 2.0	3	Gravity	4	Mixed Media	3
Adagio	4	Collage	7	Grille 2.0	3	Moby	2
Aerie (Panel)	2	Collins (Panel)	2	Handwork	5	Moccasin 2.0	3
Aero	2	Color Block	6	Happy Tappy	6	Mod	6
Affinity 2.0	5	Colorguard 2.0	2	Harrison - MB	4	Modena 2.0	5
Alamo	2	Concourse	6	Hashtag	5	Modernist	7
Alfresco	5	Connect 2.0	3	Hexie	6	Monhegan	5
Alignment	6	Continuum	4	Hi-Fi	3	Montage	4
Ally (Panel)	2	Core 2.0	2	Highlands	3	Montana 2.0	3
Amplify	2	Corium	5	Hive	3	Myth	6
Aperture (Panel)	2	Criss Cross 2.0	3	Honeycomb Shag	3	Natural World 2.0	5
Apprentice	2	Current	6	Hopsack	3	Naugasoft	3
Arbor	3	Cush	2	Hush	5	Network	5
Archer	3	Cycle	5	Imprint (Panel)	2	New Hempstead	3
Ardent	3	Dapple (Panel)	2	Infinity Plush	6	Night Life	5
Arioso	5	Dart	3	Inked	6	Nikko (Panel)	2
Armature	6	Detail	2	Intermix (Panel)	2	Nishiki 2.0	3
Array (Panel)	2	Didi	5	Intersect	6	Nubbly	5
Artisan	2	District	5	Ishi	6	Obscura	4
Attache'	3	Divvy	7	Jambi Stripe Too!	5	Odeon	6
Avant	3	Drift	5	Jillian	2	Offset	6
Backdrop (Panel)	2	Duet	5	Juxy 2.0	5	Olivia	2
Bandwidth	6	Dynamic	6	Kalahari	5	Olympus 2.0	5
Banyan	3	Eddy	7	Kennebunk	6	Orbit 2.0	3
Bari 2.0	5	Effervescence 2.0	6	Kid	5	Origami	6
Batik	6	Eli 2.0	4	Kilkenny Tweed 2.0	3	Orvilla	6
Baxter	3	English Pub	3	Kinetic	5	Outlander	3
Bespoke	4	Entrada	2	Kingsman	4	Overlay	4
Bijou	5	Equator	6	Kusari 2.0	3	Oxford 2.0	3
Binary (Panel)	3	Essential	2	La Scalina	6	Pacificafica	6
Blink Ombre	4	Etch	6	Lara	2	Paradox	6
Blip	2	Euclid	2	Laredo	3	Patriot Plus II 2.0	3
Bliss	6	Excursion	1	Lateral	2	Pebble Trail	5
Bloom	7	Faux Bois	6	Latitude	1	Perimeter	4
Bond	5	Feature	7	Lattice	2	Perspective 2.0	5
Boomerang	6	Fenestra Too!	6	Lava 2.0	6	Petal Dots	6
Borderline	5	Fiberdrill	5	Level 2.0	3	Pinball	5
Boucle Two Way	4	Fiddlesticks	7	Lexie	6	Ping Pong	5
Box Chain	2	Fidget	5	Linea (Panel)	3	Plaid-itude	5
Breton	5	Figment	5	Live Wire	5	Pod	5
Brilliant	3	Finley	4	Loophole 2.0	3	Polka	3
Brixton	6	Fizz 2.0	4	Lorelai - MB	4	Polygon	5
Broadband	6	Flanders	3	Lulu (Panel)	2	Posh	4
Brushwork	5	Flare	7	Lunaria	5	Power Grid	5
Bubblerrake 2.0	6	Flex	2	Luster	5	Premier	4
Burkshire	3	Focus (Panel)	2	Luther II (Panel)	2	Prime (Panel)	2
Calibration	5	Formation	6	Mandala	5	Printemps	5
Cannon Beach	7	Fractal	5	Mantra	6	Prisma	4
Cassidy 2.0	3	Frequency 2.0	4	Marquetry	5	Prodigy	7
Catalina	5	Fuse 2.0	2	Martini 2.0	5	Profile	2
Ceremony	5	Gabby	2	Mason (Panel)	2	Promenade 2.0	4
Channel 2.0	3	Galileo 2.0	5	Matrix	3	Queue	5
Chaos	7	Genesis (Panel)	2	Maze	6	Raffia 2.0	4
Charlotte	3	GeoMet	3	Median	5	Rain Pool	6
Chroma (Color Porcini Only)	4	Gesture	7	Menagerie	7	Rally	3
Cinema	5	Glimpse	5	Mesa	8	Raya	5
Cirque 2.0	4	Graffiti	6	Meteor	5	Retrograde	3

Stinson continues on next page.

Indiana Furniture strives to make as many upholsteries available as possible. However, it is not practical for us to test every offering on every chair as it is made available. If you have any concerns about our ability to upholster your selection on a particular frame please contact us and we will be glad to order a memo sample from this supplier for testing. Call Customer Service at 800.422.5727.

Pattern Name	Price Grade	Pattern Name	Price Grade
Revolve 2.0	6	Stuff	8
Rhythm	7	Summit	5
Rialto	3	Sundance w/StaKleen™	5
Riddle	2	Surf (Panel)	2
Ripple 2.0	6	Swift (Panel)	2
Ritz	3	Swipe	5
River	6	Switchboard	4
Rivera	3	Swivel	6
Riverstone	3	Sylvan	6
Roadmap	4	Symphony Classic	3
Rogue II	3	Sync	6
Round Trip	5	System	4
Route	3	Tally (Panel)	3
Rubric	5	Tangram	4
Runway	3	Tender	8
Salinas	7	Tendril 2.0	3
San Simeon	7	Terra	6
Sarto	4	Tessuto 2.0	3
Satchel	3	Thrive	6
Scoprena	6	Tidbit	5
Scout 2.0	3	Tilt	3
Script 2.0	4	Tinker	5
Season	6	Torus	5
Sedona	8	Touch Base	4
Sensor	6	Touchstone	3
Sentiero	3	Tranquility	6
Sentry - HC 2.0	3	Traverse	7
Sequence	3	Trio	6
Serene	7	Truss	6
Shantung 2.0	3	Tuft	5
Shift	3	Turn	9
Shimmy	4	Tussah (Panel)	2
Shuffle	7	Twist	6
Sight Line (Panel)	2	Upgrade	5
Silicone-Avail	7	Valise	1
Silicone-Downtown	7	Vapor	6
Silicone-Uptown	7	Vector	3
Sirocco	5	Verge	6
Sleek 2.0	3	Volterra-HC	8
Sleeping Bear Dunes	5	Vortexia 2.0	6
Smoothie 2.0	3	Walk the Line 2.0	5
Soft Spot	3	Watercolor Grid	6
Solitaire	2	Waterwand 2.0	6
Spirit Millennium	3	Weft	2
Splice	7	Whirl	6
Spree (Panel)	2	Whisper 2.0	3
Sprint	2	Wicker 2.0	5
Square One	3	Winnly	4
Stage	4	Wish	8
Stallion	5	Wyatt	3
Staple	2	Ybor	4
Stat-Con	5	Zanzibar	7
Stellar	3	Ziggy 2.0	3
Stitch in Time	2		
Storyboard	7		
Strand	4		
Stratford	8		
Stride	3		
Studio	4		

Indiana Furniture strives to make as many upholsteries available as possible. However, it is not practical for us to test every offering on every chair as it is made available. If you have any concerns about our ability to upholster your selection on a particular frame please contact us and we will be glad to order a memo sample from this supplier for testing. Call Customer Service at 800.422.5727.

C O R T I N A

L E A T H E R S

Pattern Name	Price Grade
Caprone	L1
Davenport	L1
Old English.....	L1

For Cortina Samples Call 800.356.1177 or Visit www.cortinaleathers.com



G R E E N
H I D E S

Pattern Name	Price Grade
Fabian.....	L2
Lena	L1
Milana	L2
Ranch.....	L2

Pista	L2	Windsor	L1
Safari.....	L1		
Sierra	L1		
Vulcano	L1		

For Green Hides Leather Samples Call 888.326.0122 or Visit www.greenhides.com

SPRADLING®

Pattern Name	Price Grade
Dolce.....	3
Genero.....	2
Maglia.....	2
Modena	1
Silvertex	2
Whisper	2

For Spradling Fabric Samples Call 800.333.0955 or Visit spradling.group/en-us

Ultrafabrics®

Pattern Name	Price Grade
Brisa Distressed.....	4
Fresco	6
Brisa Original.....	4
Impasto.....	2
Lino	2
Montage.....	2
Fusion.....	6

Fusion Shimmer	6	Volar Bio.....	6
Ultraleather Original	4	Eco Tech	6
Ultraleather Pearlized.....	6	Wired.....	6
Ultraleather Pro	6	Ultraleather Anti-Static.....	6
Promessa.....	4		
Reef.....	6		
Tottori.....	4		

For Ultrafabric Samples Call 877.309.6648 or Visit www.ultrafabricsinc.com

ORDERING INFORMATION

All orders should be emailed to neworders@indianafurniture.com. Orders can be faxed to 812-482-9035 or mailed to:

Indiana Furniture
P.O. Box 270, 1919 Hospitality Dr., Ste. A
Jasper, IN 47547-0270

ORDER PROCEDURE

All orders must include purchase order number, billing address, ship-to address and phone number, and any special instructions.

When ordering casegoods or tables, give complete quantity, model number, finish and any other options.

When ordering seating, give complete quantity, model number, finish, fabric and any other options.

Within each series, an example of "How to Order" is illustrated at the beginning of each series section. For further clarification of order procedure, contact Customer Service.

PRICING

All prices shown are suggested retail prices F.O.B. Point of Origin, freight prepaid and allowed to one continental US destination. Prices, specifications and materials are subject to change without notice. Possession and/or distribution of this price list does not in itself constitute an offer to sell. Orders can be received only from authorized Indiana Furniture dealers. Orders will be billed at prices prevailing at time of shipment, unless acknowledged prior to the effective date of the price change, in which case billing will be at the price acknowledged.

ACKNOWLEDGMENT

All orders will be acknowledged promptly, showing how the order was entered, its approximate shipping date and other pertinent information. This acknowledgment is the final agreement between the customer and Indiana Furniture and is the exclusive statement of the terms thereof. Please examine this acknowledgment carefully and advise Indiana Furniture immediately of any discrepancies. Note: Shipping fees will not be listed on the acknowledgment.

BUYER'S OBLIGATION: RIGHTS OF SELLER

If Indiana Furniture shall at any time doubt Buyer's financial responsibility, Indiana Furniture may decline to make shipments hereunder except upon receipt of cash payment in advance or security or other proof of responsibility satisfactory to Indiana Furniture. If buyer fails in any way to fulfill the terms and conditions set forth herein, Indiana Furniture may defer shipments until such default is corrected. Remedies provided herein shall be in addition to, and not in lieu of other remedies. Buyer agrees to abide by payment terms as listed on invoice. Buyer shall pay all reasonable costs and expenses, including attorney and collection fees, and late fees, incurred by Seller in connection with any amounts due for goods ordered.

CANCELLATIONS AND CHANGES

Due to immediate production on build-to-order items, all orders are considered firm and are not subject to cancellation or change without approval from Indiana Furniture. All approved changes are subject to additional charges and revised lead times.

PRODUCT DESIGN AND SPECIFICATION CHANGES

Indiana Furniture reserves the right to make changes in design and construction or discontinue products without prior notice.

REPAIR CHARGES

Indiana Furniture will only pay repair charges if Customer Service gives prior written authorization. No repair charge will be paid without advance approval at which time you will be issued a repair authorization number that will allow you to invoice Indiana Furniture for the completed work.

WAREHOUSE STORAGE CHARGES

If a shipment is held beyond 14 calendar days at your request, a **.084% per calendar day** (2.52% per month) storage charge will be assessed. The effective date will be 14 calendar days after the acknowledged ship date. Further, the prices applied to the order will be those in effect at the time of shipment.

DAMAGED MERCHANDISE

The consignee is responsible for filing claims with the carrier for damage and shortages. Claims for both obvious and concealed damage must be filed within 15 calendar days, and the damaged merchandise must not have been moved from the original receiving location. All damaged merchandise, including the cartons and packing materials, must be retained for inspection by either the carrier or by an Indiana Furniture Sales Representative. Indiana Furniture reserves the right to select the most cost effective way to repair or replace the damaged item. Once you have notified the carrier, please contact Customer Service for further assistance.

GENERAL INFORMATION & CONDITIONS OF SALE

Obvious Damage/Missing Cartons — Do not refuse merchandise damaged in transit. Indiana Furniture recommends the consignee inspect all merchandise upon arrival. If a shipment is received damaged or short, note all information on carrier's copy and your copy of freight bill and delivery receipt. Notify the delivering carrier and file a claim immediately. Pending the results of your claim, either Indiana Furniture or the carrier will cover 100% of the cost to repair or replace the damaged or missing item.

Concealed Damage — If concealed damage is discovered, notify the delivering carrier at once and request an inspection. This must be done within 15 calendar days of delivery. If the carrier will not perform the inspection, you should prepare an affidavit that you contacted them, noting the time and date, and that they failed to comply with your request. This, along with the other papers in your possession, will support the claim. Pending the results of your claim, the cost to repair or replace the item will be covered 1/3 by the carrier and 2/3 by Indiana Furniture for shipments less than a full truckload and 100% by Indiana Furniture for shipments of full truck loads.

RETURN MERCHANDISE

Merchandise will not be accepted for return without a RGA (Return Goods Authorization) issued by Indiana Furniture. We will consider issuing RGAs for the following reasons:

1. Manufacturing defect (inspected by Indiana Furniture representative)
2. Indiana Furniture order processing error
3. Shipping error
4. Mis-marked cartons
5. Duplicated shipments

If you have any questions as to whether your reason for return qualifies for consideration, please contact your Customer Service Representative. Merchandise must be returned within 60 days of the RGA issued date, or within 60 days upon receipt of replacement product to receive credit. Returns due to mis-marked cartons must also be returned in the original cartoning, with shipping labels intact, to receive credit.

All merchandise being returned must be properly packed and protected to ensure no further damage is incurred during transportation back to an Indiana Furniture facility. Upon receipt, all returned merchandise will be thoroughly inspected and the results compared to the reason for return stated on the RGA. Any discrepancies, such as additional damage, signs of usage, missing parts, etc., will result in an adjustment to the amount of credit issued.

DELIVERY AND FREIGHT CHARGES

All shipments are F.O.B. Point of Origin, Jasper, IN, freight prepaid and allowed dock to dock on 53' trailer. Ownership and responsibility of the merchandise becomes that of the buyer upon delivery to the freight company. Shipments into Alaska, Hawaii, Canada, Mexico, Puerto Rico and other exports are freight prepaid and allowed to port of exit.

Indiana Furniture reserves the right to select the most appropriate carrier and routing on all shipments. Indiana Furniture will attempt to accommodate requests for favored carriers and delivery times. Deliveries requested Monday through Thursday, after 3pm, will be assessed a \$300 per truck after hours fee. Deliveries requested after 3pm on Friday or on weekends, will be assessed a \$600 per truck weekend delivery fee.

Inside delivery and installation services are not included in the pricing shown. Any deviation from dock-to-dock delivery, such as but not limited to, non-dock, residential, or inside delivery must be specified on the order. Should these services be requested or required, all charges incurred will be charged to the "Sold To" of the order.

Shipments totaling less than \$3000 (net value, product only) will be assessed a small order fee of \$300 net per shipment. This fee will be reduced for items shipped via small package carriers. For order shipments of \$100 or less, shipped by small package carrier, the fee is \$18. For order shipments over \$100, shipped by small package carrier, the fee is \$40. All shipping fees will be added at the time of invoicing.

BIFMA AND ANSI TESTING

Indiana Furniture is a member of the Business and Institutional Furniture Manufacturer's Association (BIFMA). Tests developed by the BIFMA and approved by the American National Standards Institute (ANSI) determine the strength and durability of casegoods and seating in its everyday use. Although this testing does not serve as a warranty or guarantee, Indiana Furniture products within this price list have been tested by an independent verifying body and meet or exceed applicable BIFMA and ANSI standards.

Subject to the limitations set forth in this warranty, Indiana Furniture Industries, Inc. (“**Indiana Furniture**”) warrants to the original purchaser all product in this price list (“**Product**”) to be free from defects in material and workmanship given normal use for a 12-year period from the date of manufacture. During the applicable warranty period, Indiana Furniture, as its sole obligation, will repair or replace (in Indiana Furniture’s sole discretion) any Product, part, or component covered by this warranty and sold after May 13, 2024, which fails under normal use as a result of a defect in material or workmanship. Normal use is defined as the equivalent of a single shift, 40-hour work week. Indiana Furniture will repair or replace the defective Product, part, or component with a comparable Product, part, or component.

Warranty periods are limited for certain Products and parts as follows:

12-year Warranty (from the date of manufacture)

- Seating Mechanisms
- Veneers
- Laminates
- Casters and Glides

7-year Warranty (from the date of shipment)

- Pneumatic Table Lift
- Electric Table Lift

5-year Warranty (from the date of manufacture)

- Triple Play Series
- Electrical Components
- Pneumatic Cylinders
- Textiles, Foam, and Decorative Trim
- Swivel Arm Pads
- Keyboard Kits
- Lighting
- All Height Adjustable Mechanisms

3-year Warranty (from date of shipment)

- Dock 950 Wireless Charger
- Dock 150 Wireless and USB Charger

THIS WARRANTY DOES NOT COVER:

- Damage caused by a carrier or third party
- Normal or routine wear and tear
- Appearance, durability, quality, behavior, colorfastness, or any other attribute of customer’s own materials or any non-standard Indiana Furniture material (including CF Stinson, Maharam, Momentum, Mayer, UltraFabrics, Architex, and other alliance programs) specified by the customer and applied to a Product
- Color, grain or texture of wood, laminate and other covering materials
- Changes in wood or fabric color due to aging or exposure to light

As the manufacturer of the Product, Indiana Furniture stands behind its craftsmanship and pledges to do everything it can to reasonably resolve, as quickly as possible, any problems you may have with the Product within the terms and conditions of this warranty.

If you encounter a defect covered by the foregoing warranty, contact the dealer from whom you purchased the Product. If the dealer is unable to resolve your warranty issues, you should contact Indiana Furniture. Please ensure that you have all of the pertinent facts when contacting the dealer or Indiana Furniture, including the model number and factory order number from the inspection label attached to the Product.

INDIANA FURNITURE IS NOT PROVIDING, AND SPECIFICALLY DISCLAIMS, ANY OTHER WARRANTIES FOR THE PRODUCTS, EXPRESS OR IMPLIED, INCLUDING ANY IMPLIED WARRANTY OF MERCHANTABILITY OR FITNESS FOR A PARTICULAR PURPOSE. INDIANA FURNITURE SHALL NOT BE LIABLE TO THE PURCHASER OR ANY THIRD PARTY FOR CONSEQUENTIAL, INCIDENTAL, INDIRECT, OR SPECIAL DAMAGES, INCLUDING, WITHOUT LIMITATION, DAMAGES ARISING OUT OF OR RESULTING IN ANY MALFUNCTIONS, DELAYS, LOSS OF PROFIT, INTERRUPTION OF BUSINESS, PERSONAL INJURY, BODILY INJURY, DEATH, DISMEMBERMENT, OR PROPERTY DAMAGE.

Indiana Furniture Industries, Inc.
Attn: Customer Service
1919 Hospitality Dr., Ste. A
P.O. Box 270
Jasper, Indiana 47547-0270
800.422.5727
Fax 812.482.9035
custserv@indianafurniture.com

GRADED-IN PROGRAMS

As a special service to our customers, Indiana Furniture has graded-in upholsteries from multiple fabric partners.

For the entire list of graded-in patterns, memo sample information and contact information, please see the list below and the [COM/ COL Graded-In section](#) for more details.

- Anzea
- Arc-Com
- Architex
- CF Stinson
- Camira
- Carnegie
- Concertex
- Cortina
- Designtex
- Guilford of Maine
- Green Hides
- KnollTextiles
- Maharam
- Mayer
- Momentum
- Pallas Textiles
- Spradling
- Ultra Fabrics

PHOTOGRAPHIC FABRIC CARDS

The fabrics represented on Indiana Furniture photographic cards were reproduced using the finest technology available. Each Indiana Furniture photo card has an 800 phone # for your use while ordering free fabric swatches or samples. Please verify your desired fabric before ordering as such orders are not subject to return to Indiana Furniture.

FABRIC REPEATS

Indiana Furniture will make every attempt to match obvious patterns within a single chair from the seat to the back, vertically and horizontally.

Matching fabric patterns from chair to chair may require extra yardage and must be noted on the order to avoid delays in shipments. If the order will require COM to be matched from chair to chair, please contact Customer Service at 800-422-5757 to optimize the yardage for multiple quantities and pattern matching.

FRAMES & GLIDES

All wood frame chairs feature kiln-dried hardwoods which are double-doweled, securely glued, and screwed for maximum joint stability.

Guest chairs ship with nylon glides as standard. Felt glides (FELT) are also available on many of our wood Guest Chairs at no additional charge. Must be specified on the order.

UPHOLSTERY FOAM

All Indiana Furniture chairs consist of a high grade polyurethane foam that meets CAL 117-2013.

FINISH

Indiana Furniture standard seating finishes correspond to casegoods and conferencing finishes and laminates. Minor variations in finish color and value may occur due to the natural characteristics of wood. Consult this price list for specific finish availability within each series.

Special Finishes: Indiana Furniture is able to accommodate our customer's needs for specific finish matches. Please submit a 3"x5" sample panel to Customer Service for quotation and lead time.

FINISH CONTINUED

All Indiana Furniture Chairs feature a catalyzed varnish finish which offers lasting beauty and resistance to normal wear.

Tables will feature our UVAdvantage finish or a catalyzed varnish finish. See individual series for specific information.

An overview of our finishes and laminate options can be found on the inside of the back cover of this price list.

CASTERS & NAIL TRIM

Indiana Furniture contemporary swivel chairs are standard with black hooded dual wheel carpet casters.

All Indiana Furniture traditional seating has brass accents (casters and nail trim) where applicable. Silver accents are available. Please specify (SLVR) at no additional charge.

In addition, some of our traditional seating is available with no nail trim as requested (NONT) at no additional charge. Must be specified on order.

CONTROL OPTIONS

See individual series within this price list for control options and pricing.

Knee-Tilt Control

The Knee-Tilt control features a heavy-duty torsion bar or a spring tension control which allows variable tension for different body sizes and weights, and minimal rise of the seat's front edge. This allows the user's feet to remain planted while reclining to a relaxing position.

CAL 133 CERTIFICATION

California Technical Bulletin 133 (TB133 or CAL133) is a composite fire test for fully-assembled seating manufactured for use in certain public buildings. As such, the certification is specific to the fabric that is used in conjunction with the frame and the barrier. Many Indiana Furniture seating products, in combination with some of our standard fabrics, can be manufactured to meet the requirements for certification. Depending on the frame style, a fire-retardant barrier or fire-retardant foam will be incorporated in the chair construction to provide the best opportunity for a successful CAL133 burn test.

The cost of the test is \$1122 (net) which includes the test, freight to the test facility and the fully-assembled test sample. Once payment has been made, please allow approximately 6-8 weeks for the production of the chair and the completion of the test. Once we receive the successful certification, the order may be placed allowing for 1 week extra lead time using the "CAL" prefix on the model number with an upcharge of \$170 list per chair. Please contact Customer Service at 800.422.5727 to order the test.

If you do not need the actual Certification, but wish to have the chairs manufactured to meet the regulation, we can upholster the chair using the fire-retardant components at the \$154 list upcharge per chair. Please order the appropriate frame allowing for 1 week extra lead time, using the "CAL" prefix in front of the model number.

CAL	California Test Cost (NET)	\$ 1122
	Up Charge Per Chair	\$ 170

Please note that if you wish to have Certification on a COM material, Indiana Furniture must approve the fabric according to the COM policy as well.

Surface Materials

Wood Finishes and Woodgrain, Solid, and 3D Laminates

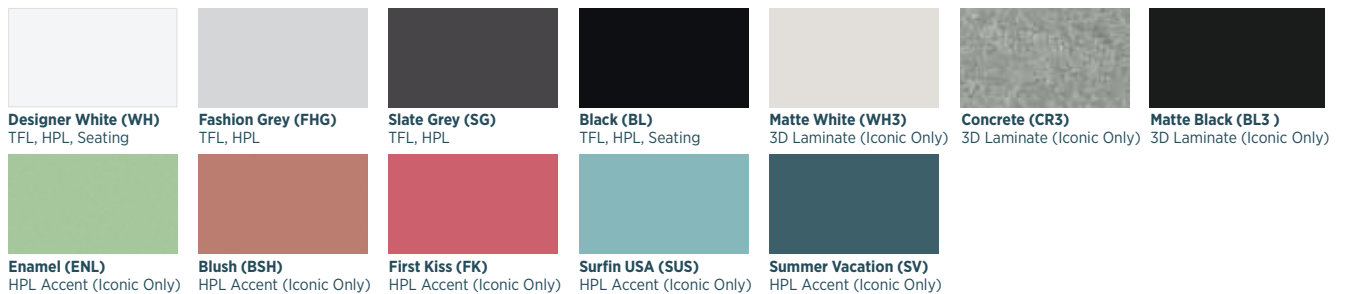
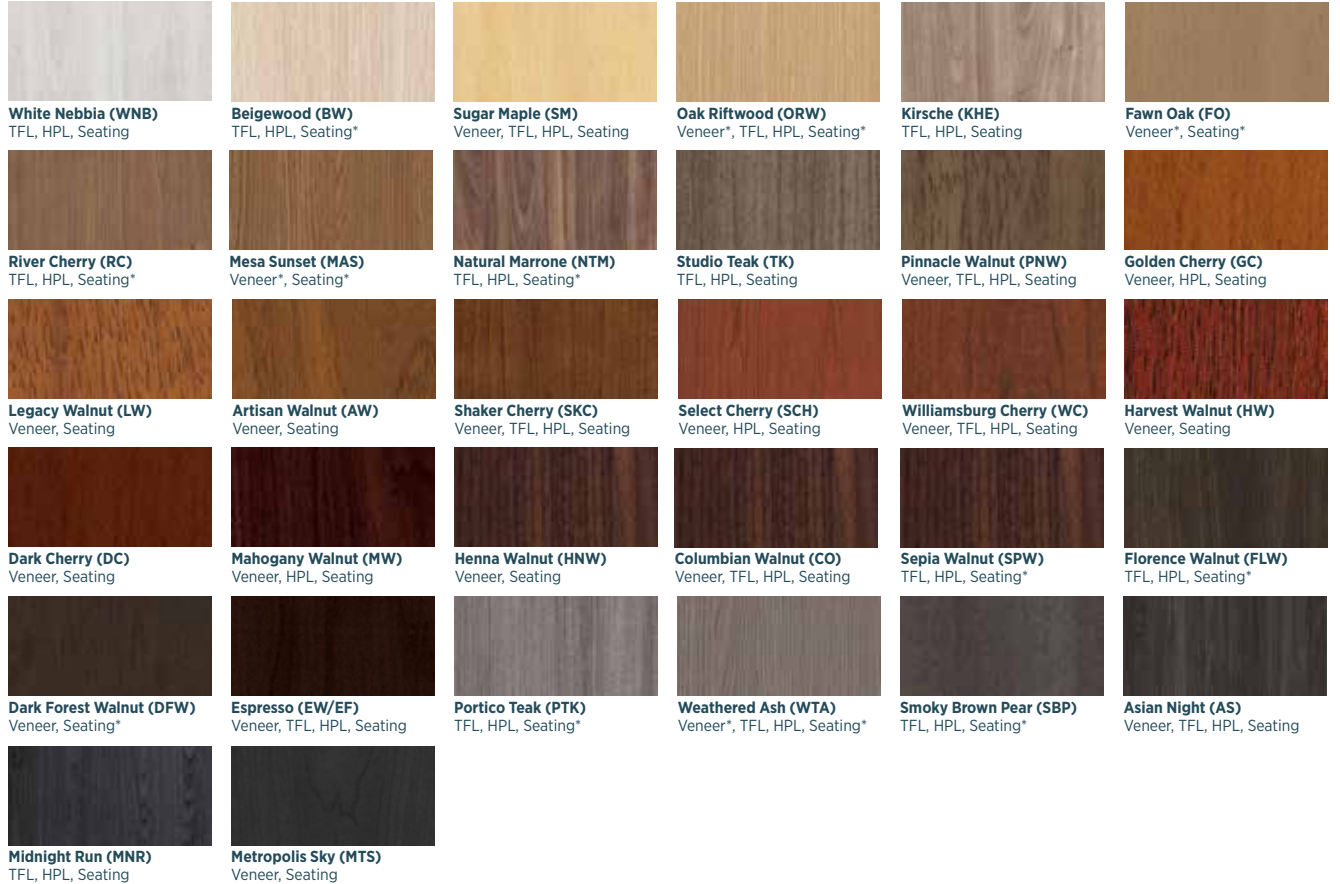

* Finish is Low Sheen

Frosted & High Gloss Acrylics



Solid Surfaces

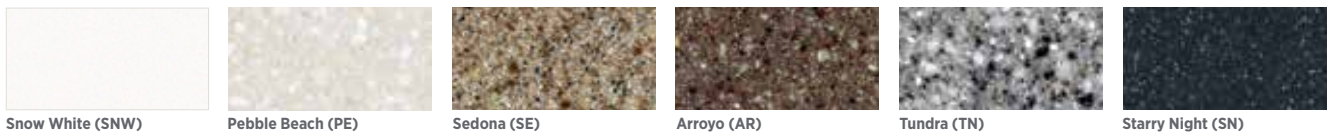

Metal Options

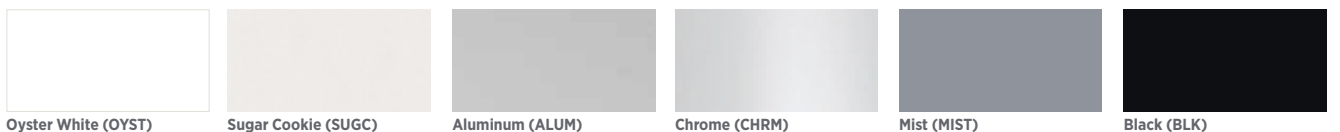

Colors represented are high-resolution reproductions and may vary slightly from the actual product. To order samples, please contact our Customer Service team or order online at www.indianafurniture.com. Graining and finish colors may vary yet will continue to complement, across Veneer, HPL, TFL, and Seating products due to the inherent differences of these materials.

Indiana[®] FURNITURE

1919 Hospitality Drive, Suite A
PO Box 270
Jasper, Indiana 47547-0270

Tel 812.482.5727

Toll 800.422.5727

Fax 812.482.9035

sales@indianafurniture.com

www.indianafurniture.com

Federal Classification: Small Business

©2024 Indiana Furniture 5/24

