



# CATALYST

TABLE SOLUTIONS

Indiana  
FURNITURE



## A CATALYST FOR BUSINESS.

Today's spaces have the need for tables that allow for people to collaborate, brainstorm, discuss, share, present, and, ultimately, continue driving business. Catalyst Tables blend desired aesthetics, functionality, and technology to deliver a comprehensive solution for all types of meeting needs and spaces.

This line boasts a broad selection of veneers, laminates, and glass, a variety of top shapes, a vast range of sizes spanning from 30"D to 60"D and 30"W to 240"W, integrated power/data, and a variety of heights, including work, counter, and bar. However, the real beauty is in the mix of veneer, laminate, and metal base options. But it doesn't stop there. An assortment of storage and accessory units, like buffets, integrated waste bins, lecterns, and more, provide the ability to complete an entire space.





## Design Freedom.

Choose from a broad offering of veneers, laminates, and glass options, a variety of top shapes, and a vast range of sizes. Add functionality with integrated power/data, easy wire management, and a smart selection of storage pieces and accessories to complete any space.

The veneer and laminate bases feature a built-in trough, smart wire management, and accent elements to personalize the overall look and style. The design versatility feels nearly endless.





## Timeless Beauty.

Today's spaces have the need for tables that allow for people to collaborate, brainstorm, discuss, share, present, and, ultimately, continue driving business. No matter what time of the day it is.

Create stunning spaces with our glass options, available in gloss or acid-etched (soft, matte appearance) finishes, and in your choice of black or white.



Gloss White (GWHG)

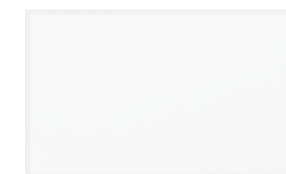

Acid Etched White (GWAH)

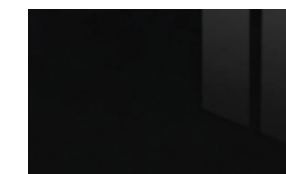

Gloss Black (GBLG)



Acid Etched Black (GBLA)





## Broad Versatility.

Whether you're looking to outfit a small meeting space, café, board room, huddle spot, or private office, Catalyst accommodates all types of meeting and gathering spaces.

And the stylish simplicity of our metal bases, available in both aluminum or black, allows them to fluidly complement other furniture to create a seamless integration across environments.

Add a buffet, lectern, or waste bin for effortless functionality.

# Statement of Line

## Tops/Shapes

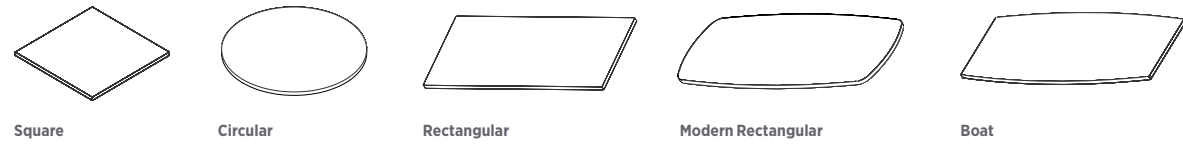

Square

Circular

Rectangular

Modern Rectangular

Boat

## Bases

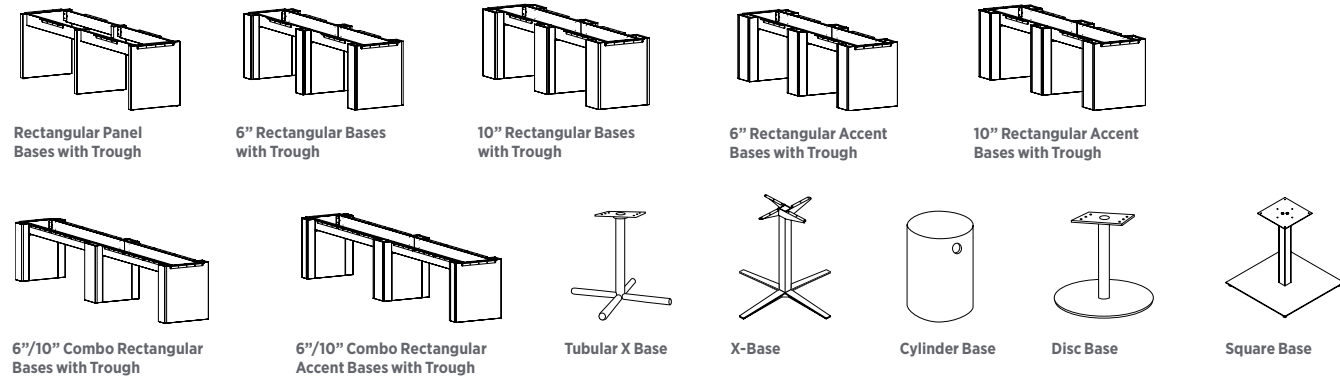

Rectangular Panel Bases with Trough

6" Rectangular Bases with Trough

10" Rectangular Bases with Trough

6" Rectangular Accent Bases with Trough

10" Rectangular Accent Bases with Trough

6"/10" Combo Rectangular Bases with Trough

6"/10" Combo Rectangular Accent Bases with Trough

Tubular X Base

X-Base

Cylinder Base

Disc Base

Square Base

## Storage Components + Accessories

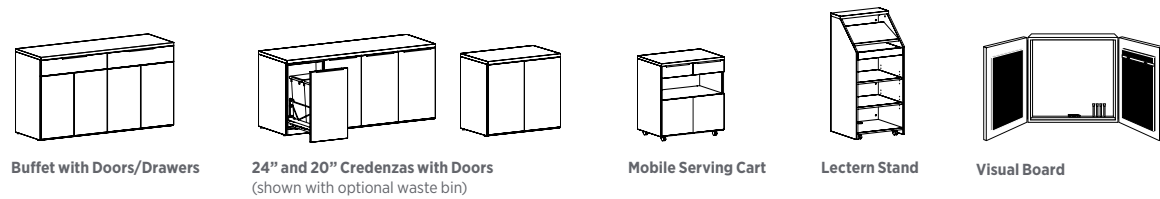

Buffet with Doors/Drawers

24" and 20" Credenzas with Doors (shown with optional waste bin)

Mobile Serving Cart

Lectern Stand

Visual Board

## Wire Management + Power/Data Accessories

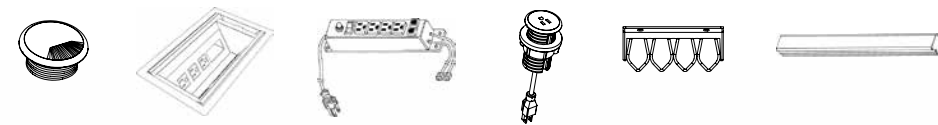

# Surface Materials

## Veneer and Laminate Options

Our veneer tables feature our UV top finish, UVAdvantage. The result is a low-emitting finish that provides exceptional depth, clarity, durability and chemical resistance throughout the life of the product.

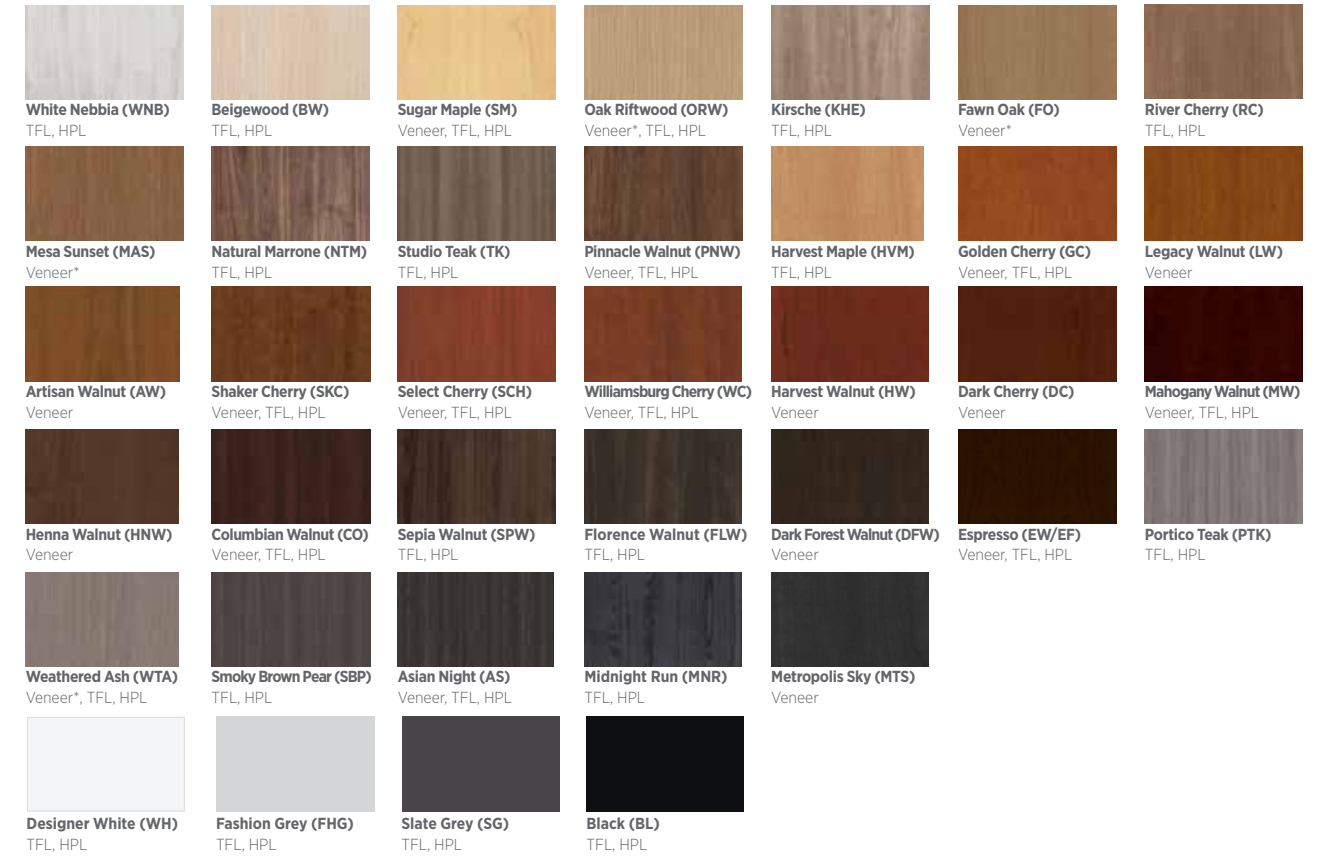

\* Veneer is Low Sheen

## Metal Finish Options

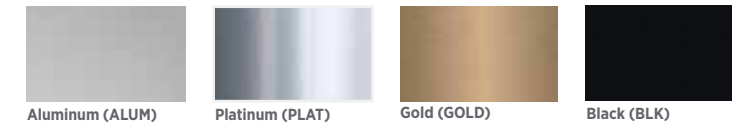

Aluminum (ALUM)

Platinum (PLAT)

Gold (GOLD)

Black (BLK)

## Glass Top Options

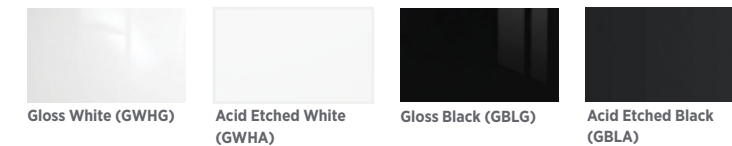

Gloss White (GWHG)

Acid Etched White (GWAH)

Gloss Black (GBLG)

Acid Etched Black (GBLA)

## Edge Profiles:

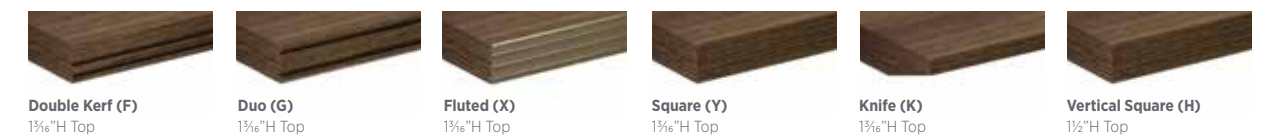

**Double Kerf (F)**  
1 3/8" H Top

**Duo (G)**  
1 3/8" H Top

**Fluted (X)**  
1 3/8" H Top

**Square (Y)**  
1 3/8" H Top

**Knife (K)**  
1 3/8" H Top

**Vertical Square (H)**  
1 3/8" H Top

## Pull Options:



**Studio (AST)**  
Aluminum - 13"

**Studio (BST)**  
Black - 13"

**Studio (CST)**  
Chrome - 13"

**Studio (GST)**  
Gold - 13"





# Indiana FURNITURE

1919 Hospitality Dr., Ste. A  
PO Box 270  
Jasper, Indiana 47547-0270

Tel 812.482.5727

Toll 800.422.5727

Fax 812.482.9035

[sales@indianafurniture.com](mailto:sales@indianafurniture.com)

[www.indianafurniture.com](http://www.indianafurniture.com)

