

Indiana
FURNITURE



**TABLES +
SPACE DIVISION**

PRICING EFFECTIVE MARCH 27, 2023
(REV. 11/27/23)

Being over a century old hasn't slowed us down! Sure, we are still the reliable, ethical company that was born in southern Indiana, steeped in quality, craftsmanship, and service. But have you seen our latest introductions? We are making a splash with design and challenging the concept of modern offices. Go ahead. Take a look. You know you want to.

Our Pledge to People + Our Planet.

We've been making wood furniture longer than just about anyone...and we want to be doing so for a long time to come. That's a large part of why we take a stewardship approach to our resources. We believe that environmental sustainability and business profits need not be mutually exclusive. They can and should exist side by side in a mutually beneficial relationship. And for more than a century, we've been showing how it's done.

We've proven our commitment to a sustainable future by supporting the standards and programs that protect our home planet and human health. Whether it's local sourcing, reducing contaminants, implementing wellness and safety programs, or diverting waste from landfills, social responsibility is a part of every decision we make at Indiana Furniture.

One of the surest ways to reduce our impact on the planet is to make and buy things that last. And this one's a natural for us. Our products are made with craftsmanship and attention to detail that are a part of our more than a century-long legacy in wood manufacturing. And our products are backed by our 12-year warranty, which facilitates maintenance, servicing and reassembly.

All of our product lines:

- Are manufactured and assembled in the USA,
- Meet or exceed Indoor Air quality standards*,
- Meet or exceed BIFMA level® Sustainability standards and certification*,
- Conform to the BIFMA Compliance standards*,
- Comply with TSCA Title VI (CARB) standards,
- and can contribute to U.S. Green Building's LEED Program.

To learn more, simply go to www.IndianaFurniture.com/resources.



Ease of Specification

Whether you're looking to specify your office spaces or simply to visualize them in the options and surface materials you are desiring, we make it easy. You can find the entire Indiana Furniture portfolio on the following third-party, space-planning platforms.



* Recently launched or new products may still be in testing; Cush Pillows is currently not BIFMA Compliant due to no available compliance test.

<u>General Information + Conditions of Sale</u>	<u>2</u>
<u>Warranty</u>	<u>3</u>
<u>Tables+Storage</u>	<u>5</u>
<u>Arlington (2900 Series)</u>	<u>7</u>
<u>Cameo (9100 Series)</u>	<u>19</u>
<u>Catalyst (8800 Series)</u>	<u>41</u>
<u>Madera (1400/1600 Series)</u>	<u>121</u>
<u>Natta by Edge Design (NAT Series)</u>	<u>143</u>
<u>One10 (9600 Series)</u>	<u>145</u>
<u>Phoenix (2100 Series)</u>	<u>179</u>
<u>Strut (8800 Series)</u>	<u>199</u>
<u>Tri-One (8500/8600 Series)</u>	<u>263</u>
<u>Occasional Tables</u>	<u>289</u>
General Occasional Tables Information	<u>298</u>
<u>Arlington End, Lamp + Magazine Tables (2900 Series)</u>	<u>299</u>
<u>Bailey End + Cocktail Tables (720 Series)</u>	<u>301</u>
<u>Britta End + Cocktail (230 Series)</u>	<u>305</u>
<u>Canvas End + Magazine Tables (6600 Series)</u>	<u>307</u>
<u>Cicero End, Lamp, Magazine + Console Tables (290 Series)</u>	<u>309</u>
<u>Gesso End + Magazine Tables (6500 Series)</u>	<u>311</u>
<u>Isla End, Lamp + Magazine Tables (370 Series)</u>	<u>313</u>
<u>Jefferson End, Lamp & Magazine Tables (4600 Series)</u>	<u>317</u>
<u>Jot Auxiliary, End, Cocktail + Console Tables (410 Series)</u>	<u>319</u>
<u>Madera End, Lamp + Magazine Tables (1400 Series)</u>	<u>323</u>
<u>Me, Myself & I Tables by Edge Design (MMI Series)</u>	<u>325</u>
<u>Phoenix End + Magazine Tables (2100 Series)</u>	<u>327</u>
<u>Plush Cocktail Tables (620 Series)</u>	<u>329</u>
<u>Spirit Tables by Edge Design (S Series)</u>	<u>333</u>
<u>Space Division</u>	<u>335</u>
<u>Screens+Dividers</u>	<u>357</u>
<u>Square One (1700 Series)</u>	<u>347</u>

ORDERING INFORMATION

All orders should be emailed to neworders@indianafurniture.com. Orders can be faxed to 812-482-9035 or mailed to:

Indiana Furniture
P.O. Box 270, 1919 Hospitality Drive, Ste. A
Jasper, IN 47547-0270

ORDER PROCEDURE

All orders must include purchase order number, billing address, ship-to address and phone number, and any special instructions.

When ordering casegoods or tables, give complete quantity, model number, finish and any other options.

When ordering seating, give complete quantity, model number, finish, fabric and any other options.

Within each series, an example of "How to Order" is illustrated at the beginning of each series section. For further clarification of order procedure, contact Customer Service.

PRICING

All prices shown are suggested retail prices F.O.B. Point of Origin, freight prepaid and allowed to one continental US destination. Prices, specifications and materials are subject to change without notice. Possession and/or distribution of this price list does not in itself constitute an offer to sell. Orders can be received only from authorized Indiana Furniture dealers. Orders will be billed at prices prevailing at time of shipment, unless acknowledged prior to the effective date of the price change, in which case billing will be at the price acknowledged.

ACKNOWLEDGMENT

All orders will be acknowledged promptly, showing how the order was entered, its approximate shipping date and other pertinent information. This acknowledgment is the final agreement between the customer and Indiana Furniture and is the exclusive statement of the terms thereof. Please examine this acknowledgment carefully and advise Indiana Furniture immediately of any discrepancies.

Note: Shipping fees will not be listed on the acknowledgment.

BUYER'S OBLIGATION: RIGHTS OF SELLER

If Indiana Furniture shall at any time doubt Buyer's financial responsibility, Indiana Furniture may decline to make shipments hereunder except upon receipt of cash payment in advance or security or other proof of responsibility satisfactory to Indiana Furniture. If buyer fails in any way to fulfill the terms and conditions set forth herein, Indiana Furniture may defer shipments until such default is corrected. Remedies provided herein shall be in addition to, and not in lieu of other remedies. Buyer agrees to abide by payment terms as listed on invoice. Buyer shall pay all reasonable costs and expenses, including attorney and collection fees, and late fees, incurred by Seller in connection with any amounts due for goods ordered.

CANCELLATIONS AND CHANGES

Due to immediate production on build-to-order items, all orders are considered firm and are not subject to cancellation or change without approval from Indiana Furniture. All approved changes are subject to additional charges and revised lead times.

PRODUCT DESIGN AND SPECIFICATION CHANGES

Indiana Furniture reserves the right to make changes in design and construction or discontinue products without prior notice.

REPAIR CHARGES

Indiana Furniture will only pay repair charges if Customer Service gives prior written authorization. No repair charge will be paid without advance approval at which time you will be issued a repair authorization number that will allow you to invoice Indiana Furniture for the completed work.

WAREHOUSE STORAGE CHARGES

If a shipment is held beyond 14 calendar days at your request, a **.084% per calendar day** (2.52% per month) storage charge will be assessed. The effective date will be 14 calendar days after the acknowledged ship date. Further, the prices applied to the order will be those in effect at the time of shipment.

DAMAGED MERCHANDISE

The consignee is responsible for filing claims with the carrier for damage and shortages. Claims for both obvious and concealed damage must be filed within 15 calendar days, and the damaged merchandise must not have been moved from the original receiving location. All damaged merchandise, including the cartons and packing materials, must be retained for inspection by either the carrier or by an Indiana Furniture Sales Representative. Indiana Furniture reserves the right to select the most cost effective way to repair or replace the damaged item. Once you have notified the carrier, please contact Customer Service for further assistance.

Obvious Damage/Missing Cartons — Do not refuse merchandise damaged in transit. Indiana Furniture recommends the consignee inspect all merchandise upon arrival. If a shipment is received damaged or short, note all information on carrier's copy and your copy of freight bill and delivery receipt. Notify the delivering carrier and file a claim immediately. Pending the results of your claim, either Indiana Furniture or the carrier will cover 100% of the cost to repair or replace the damaged or missing item.

Concealed Damage — If concealed damage is discovered, notify the delivering carrier at once and request an inspection. This must be done within 15 calendar days of delivery. If the carrier will not perform the inspection, you should prepare an affidavit that you contacted them, noting the time and date, and that they failed to comply with your request. This, along with the other papers in your possession, will support the claim. Pending the results of your claim, the cost to repair or replace the item will be covered 1/3 by the carrier and 2/3 by Indiana Furniture for shipments less than a full truckload and 100% by Indiana Furniture for shipments of full truck loads.

RETURN MERCHANDISE

Merchandise will not be accepted for return without a RGA (Return Goods Authorization) issued by Indiana Furniture. We will consider issuing RGAs for the following reasons:

1. Manufacturing defect (inspected by Indiana Furniture representative)
2. Indiana Furniture order processing error
3. Shipping error
4. Mis-marked cartons
5. Duplicated shipments

If you have any questions as to whether your reason for return qualifies for consideration, please contact your Customer Service Representative. Merchandise must be returned within 60 days of the RGA issued date, or within 60 days upon receipt of replacement product to receive credit. Returns due to mis-marked cartons must also be returned in the original cartoning, with shipping labels intact, to receive credit.

All merchandise being returned must be properly packed and protected to ensure no further damage is incurred during transportation back to an Indiana Furniture facility. Upon receipt, all returned merchandise will be thoroughly inspected and the results compared to the reason for return stated on the RGA. Any discrepancies, such as additional damage, signs of usage, missing parts, etc., will result in an adjustment to the amount of credit issued.

DELIVERY AND FREIGHT CHARGES

All shipments are F.O.B. Point of Origin, Jasper, IN, freight prepaid and allowed dock to dock on 53' trailer. Ownership and responsibility of the merchandise becomes that of the buyer upon delivery to the freight company. Shipments into Alaska, Hawaii, Canada, Mexico, Puerto Rico and other exports are freight prepaid and allowed to port of exit.

Indiana Furniture reserves the right to select the most appropriate carrier and routing on all shipments. Indiana Furniture will attempt to accommodate requests for favored carriers and delivery times. Deliveries requested Monday through Thursday, after 3pm, will be assessed a \$300 per truck after hours fee. Deliveries requested after 3pm on Friday or on weekends, will be assessed a \$600 per truck weekend delivery fee.

Inside delivery and installation services are not included in the pricing shown. Any deviation from dock-to-dock delivery, such as but not limited to, non-dock, residential, or inside delivery must be specified on the order. Should these services be requested or required, all charges incurred will be charged to the "Sold To" of the order.

Shipments totaling less than \$3000 (net value, product only) will be assessed a small order fee of \$300 net per shipment. This fee will be reduced for items shipped via small package carriers. For order shipments of \$100 or less, shipped by small package carrier, the fee is \$18. For order shipments over \$100, shipped by small package carrier, the fee is \$40. **All shipping fees will be added at the time of invoicing.**

BIFMA AND ANSI TESTING

Indiana Furniture is a member of the Business and Institutional Furniture Manufacturer's Association (BIFMA). Tests developed by the BIFMA and approved by the American National Standards Institute (ANSI) determine the strength and durability of casegoods and seating in its everyday use. Although this testing does not serve as a warranty or guarantee, Indiana Furniture products within this price list have been tested by an independent verifying body and meet or exceed applicable BIFMA and ANSI standards.

Subject to the limitations set forth in this warranty, Indiana Furniture Industries, Inc. (“**Indiana Furniture**”) warrants to the original purchaser all product in this price list (“**Product**”) to be free from defects in material and workmanship given normal use for a 12-year period from the date of manufacture. During the applicable warranty period, Indiana Furniture, as its sole obligation, will repair or replace (in Indiana Furniture’s sole discretion) any Product, part, or component covered by this warranty and sold after November 27, 2023, which fails under normal use as a result of a defect in material or workmanship. Normal use is defined as the equivalent of a single shift, 40-hour work week. Indiana Furniture will repair or replace the defective Product, part, or component with a comparable Product, part, or component.

Warranty periods are limited for certain Products and parts as follows:

12-year Warranty (from the date of manufacture)

- Seating Mechanisms
- Veneers
- Laminates
- Casters and Glides

7-year Warranty (from the date of shipment)

- Pneumatic Table Lift
- Electric Table Lift

5-year Warranty (from the date of manufacture)

- Triple Play Series
- Electrical Components
- Pneumatic Cylinders
- Textiles, Foam, and Decorative Trim
- Swivel Arm Pads
- Keyboard Kits
- Lighting
- All Height Adjustable Mechanisms

3-year Warranty (from date of shipment)

- Dock 950 Wireless Charger
- Dock 150 Wireless and USB Charger

THIS WARRANTY DOES NOT COVER:

- Damage caused by a carrier or third party
- Normal or routine wear and tear
- Appearance, durability, quality, behavior, colorfastness, or any other attribute of customer’s own materials or any non-standard Indiana Furniture material (including CF Stinson, Maharam, Momentum, Mayer, UltraFabrics, Architex, and other alliance programs) specified by the customer and applied to a Product
- Color, grain or texture of wood, laminate and other covering materials
- Changes in wood or fabric color due to aging or exposure to light

As the manufacturer of the Product, Indiana Furniture stands behind its craftsmanship and pledges to do everything it can to reasonably resolve, as quickly as possible, any problems you may have with the Product within the terms and conditions of this warranty.

If you encounter a defect covered by the foregoing warranty, contact the dealer from whom you purchased the Product. If the dealer is unable to resolve your warranty issues, you should contact Indiana Furniture. Please ensure that you have all of the pertinent facts when contacting the dealer or Indiana Furniture, including the model number and factory order number from the inspection label attached to the Product.

INDIANA FURNITURE IS NOT PROVIDING, AND SPECIFICALLY DISCLAIMS, ANY OTHER WARRANTIES FOR THE PRODUCTS, EXPRESS OR IMPLIED, INCLUDING ANY IMPLIED WARRANTY OF MERCHANTABILITY OR FITNESS FOR A PARTICULAR PURPOSE. INDIANA FURNITURE SHALL NOT BE LIABLE TO THE PURCHASER OR ANY THIRD PARTY FOR CONSEQUENTIAL, INCIDENTAL, INDIRECT, OR SPECIAL DAMAGES, INCLUDING, WITHOUT LIMITATION, DAMAGES ARISING OUT OF OR RESULTING IN ANY MALFUNCTIONS, DELAYS, LOSS OF PROFIT, INTERRUPTION OF BUSINESS, PERSONAL INJURY, BODILY INJURY, DEATH, DISMEMBERMENT, OR PROPERTY DAMAGE.

Indiana Furniture Industries, Inc.
Attn: Customer Service
1919 Hospitality Dr., Ste A, P.O. Box 270
Jasper, Indiana 47547-0270
800.422.5727
Fax 812.482.9035
custserv@indianafurniture.com



Tables+Storage

Arlington offers all the grace and embellishments associated with traditional styling with an added emphasis on value. Finely crafted in select solids with walnut and cherry veneers and high pressure laminate worksurfaces, Arlington ensures quality and expert craftsmanship with a selection of configurations for today's functional workspaces.

CONSTRUCTION

Arlington features a Veneer chassis with your choice of a Veneer or HPL top. Units ship assembled unless otherwise noted.

VENEER

- Exposed surfaces feature select grade, plain sliced American Black Walnut or Cherry veneers, carefully selected and matched to assure proper balance and consistency

TOPS

- Veneer tops are 5-ply balanced construction and 1 3/16" thick with solid hardwood rims with butt corners
- High Pressure Laminate (HPL) tops are 3-ply balanced construction and 1 3/16" thick with solid hardwood rims with butt corners
- Grain direction runs left to right unless noted

CHASSIS

- Chassis is securely fastened using high quality European fastening systems and heavy-duty, 16-gauge joining brackets to assure maximum strength
- All units ship with heavy-duty, adjustable leveling glides to ensure proper leveling and compensation for uneven floors
- Bases are solid hardwood with mitered corners
- Construction offers tight tolerances and long term durability
- Vertical grain direction on chassis

DRAWERS

- Drawer fronts standard with matched veneer faces
- Drawer sides, back and front are woodgrain vinyl-wrapped, and are 1/2" thick
- 5-sided drawer construction for easy removal of drawer front
- Box and file drawers have 1/8" thick hardboard bottoms and tested for 100lb capacity
- Lateral file drawers feature 1/4" thick bottoms and tested for 200lb capacity
- All drawers feature full extension, progressive action slides with precision steel ball bearings
- All suspensions have a limited lifetime warranty

FILING

- All file drawers are standard with filing systems designed to accommodate a variety of filing requirements
- Letter width file drawers provide letter filing front to back and legal filing side to side
- Lateral file drawers provide legal or letter filing front to back or side to side

STORAGE

- All hinged doors include soft close hinges, unless noted
- One piece hinge and base plate combination
- Soft close hinges reduce stress placed on the cabinet when the door is closed and offers a quiet closure

LOCKING

- See [locking details](#) for locking door and drawer options
- Lock core available in black or silver and will coordinate with pull selection; See [locking details](#)
- Removable lock cylinders allow for units to be re-keyed at a later date if required
- Units are shipped randomly keyed as standard. Keyed alike units available upon request at no additional charge.

CORD MANAGEMENT

- Grommets are available in black or silver, please specify color
- See [optional grommet locations](#)
- Undersurface Wire Managers available for additional cord management; See [Accessories](#)

INTERIOR DRAWER DIMENSIONS & FILING CAPABILITIES

Model

29-2072SC 29-2066SC

Drawers

	W	L	D
Box	15 3/8"	16 1/2"	3 1/2"
File	15 3/8"	16 1/2"	8 2 1/2"

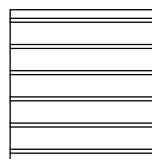

Legal Front to Back

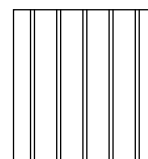

Legal Side to Side

Model

29-2072DL

Drawers

	W	L	D
Lateral File	24 7/8"	16 1/2"	9 7/32"

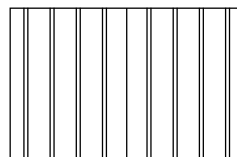

1 Row Letter or Legal Side to Side

HOW TO ORDER EXAMPLES

	QTY	Model No.	Description	Example
TOP/BASE	1	29-4296RT	Top Material	W
			Finish	CO
			Grommet/Power/ Data Location	OC
			Finish	CO
BASES	1	29-2828TB	Finish	CO
PORT	1	01-INTRFCIA		
CREDENZA	1	29-2072SC	Top Material	W
			Finish	CO
			Base Molding	BM3600
			Decorative Molding	M3600
			Pull	ARA
			Locking	LKT-HU
			Drawer Construction	STD

VENEER (W) OPTIONS

Veneer features UVAdvantage, an ultra-violet finish, on all exposed surfaces by utilizing roll-coat UV technology.

Note: Base and decorative molding feature multi-step, hand-finished catalyzed finish.

AW	Artisan Walnut	HW	Harvest Walnut
CO	Columbian Walnut	LW	Legacy Walnut
DC	Dark Cherry	MW	Mahogany Walnut
DFW	Dark Forest Walnut	PNW	Pinnacle Walnut
EW	Espresso	SCH	Select Cherry
GC	Golden Cherry	SKC	Shaker Cherry
HNW	Henna Walnut	WC	Williamsburg Cherry

HPL (P) TOP OPTIONS

WOODGRAIN

CO	Columbian Walnut	PNW	Pinnacle Walnut
EF	Espresso	SCH	Select Cherry
GC	Golden Cherry	SKC	Shaker Cherry
MW	Mahogany Walnut	WC	Williamsburg Cherry

EDGE PROFILES

R Arlington



MOLDING LOCATIONS AND OPTIONS

Base Molding

Arlington and Wilmington Base Molding are skillfully applied on Credenzas to front and both sides with no molding on back for flush wall applications.



Arlington Base Molding



Wilmington Base Molding

Decorative Molding

Optional Decorative Molding is available with the Wilmington Base Molding package. Credenzas will feature decorative molding on the left and right sides only.



Wilmington Decorative Molding



No Decorative Molding

Molding selection must be specified on order.

Arlington Molding

BM2900 Arlington Base Molding \$ N/C

Wilmington Molding

BM3600 Wilmington Base Molding \$ N/C

M3600 Optional Wilmington Decorative Molding \$ 134

Note: Base and Decorative Molding features multi-step, hand-finished catalyzed finish

DRAWER AND DOOR PULL OPTIONS

Units with doors and drawers will feature coordinating pulls however door and drawer pulls cannot be intermixed.

ARA	Arlington A, Antique Brass	JEF	Jefferson, Antique Brass
ARB	Arlington B, Antique Brass	ALB	Liberty, Aluminum
WLM	Wilmington, Antique Brass		



Arlington A (ARA)
Antique Brass - 5/4"



Arlington B (ARB)
Antique Brass - 5/4"



Jefferson (JEF)
Antique Brass - 5/4"



Wilmington (WLM)
Antique Brass - 5/4"



Liberty (ALB)
Aluminum - 4/4"

LOCK CORE OPTIONS

Lock core will be black if Arlington, Wilmington or Jefferson pulls are selected. Lock core will be silver if Liberty Pulls are selected.

BLK	Black
SLV	Silver



Black (BLK)

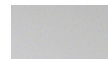

Silver (SLV)

CREDENZA LOCKING DOORS AND DRAWERS

Locking doors and drawers are available on credenzas. Please specify applicable code on order with model/unit and add upcharge.

Storage credenzas offer locking pedestals and locking doors with the lock positioned in the face of the drawer nearest to doors. Door lock is positioned in top right corner of left door.

LKT_P	Double Pedestal Lock	\$ 396
LKT_HU	Double Pedestal and Double Door Locking	\$ 475

LOCKING DOORS

Locking doors are available on specific units, where noted. You must specify WITH LOCKING when ordering and add upcharge.

LKT_HU	36"W to 28"W Units	\$ 88
LKT_HU	18"W Units	\$ 67

DRAWER OPTIONS

Units with drawers come standard with woodgrain vinyl-wrapped drawers with mitered corners. Optional wood dove tail construction for all box, file, and lateral file drawers is available. Must specify when ordering.

Pricing is per Drawer, not per Model/Unit.

MITER	Mitered Fold Construction	STD
DOVE	Wood Dove Tail Construction	\$ 43

CONFERENCE AND MEETING TABLE GROMMET OPTIONS

Arlington Meeting and Conference Tables offer Power/Data and grommets at a variety of locations. Available Power/Data and Grommets may be found on Pages 21 to 23

Must Specify Black (BLK) or Silver (SLV)

Grommet Locations

OC	On Center	CL	5½" Left of Center
EL	24½" from Left End	CR	5½" Right of Center
ER	24½" from Right End	BB	Centered Between Bases

Panel Base Location Availability by Top Size

96"W Tops	OC, EL+ER	
120"W Tops	BB, CL, CR, CL+EL+ER, CR+EL+ER	
144"W Tops	BB, CL, CR, CL+CR, EL+ER, CL+EL+ER, CR+EL+ER	

Power and Grommet Units only available **On Center (OC)** when Queen Anne Bases are selected.



Arlington Work Tables offer grommets at left/right and on center locations.

Must Specify Black (BLK) or Silver (SLV) Grommets

		Per Grommet
Locations Availability by Model		\$ 50
29-3672WT	GL/GR: Grommet Left and Right; 12" from end and 23" from user (Requires 2 grommets)	
	GC: Grommet Center; 23" from user	
29-3060WT	GL/GR: Grommet Left and Right; 9" from end and 23" from user (Requires 2 grommets)	
	GC: Grommet Center; 9" from user	

CERTIFICATIONS & COMPLIANCE

- Intertek Sustainability Certified
- BIFMA level® Certified
- BIFMA Compliant® Certified
- TSCA Title VI (formerly CARB) Compliance
- US Green Building's LEED® Contribution

Tops and Tables



Round Tops
[\(See Details\)](#)



1-Piece Rectangle Tops
[\(See Details\)](#)



2-Piece Rectangle Tops
[\(See Details\)](#)

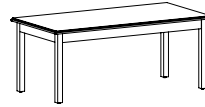

Work Tables
[\(See Details\)](#)

Bases

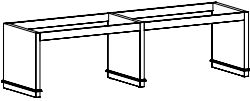

Rectangle Bases
1-Pc Top [\(See Details\)](#)
2-Pc Top [\(See Details\)](#)

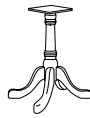

Queen Anne Bases
Round Tops [\(See Details\)](#)
1-Pc Top [\(See Details\)](#)
2-Pc Top [\(See Details\)](#)

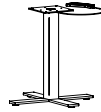

Height Adjustable Pneumatic
X-Bases [\(See Details\)](#)

Storage Components

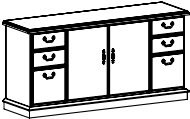

Storage Credenza
[\(See Details\)](#)

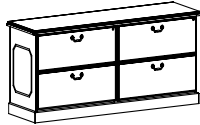

Credenza with Double Lateral
[\(See Details\)](#)



Door Bookcases
[\(See Details\)](#)



Wardrobe/Storage
[\(See Details\)](#)

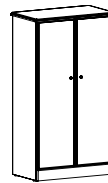

Double Wardrobe/Storage
[\(See Details\)](#)

Wire Management & Power/Data Accessories

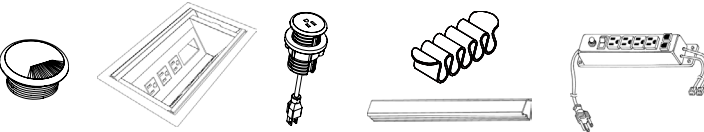

For additional solutions for desking, storage, and accessories, see the [Arlington Casegoods](#) and [Accessories](#) Price Lists.

Item	Model No.	Width	Depth	Height	Ship Wt	Cubic Ft	List Price
	29-4848CT <i>Accommodates Five (5) Chairs</i>	48	48	30	58	5.9	P\$ 2536 W\$ 2979
	29-4242CT <i>Accommodates Four (4) Chairs</i>	42	42	30	51	4.5	P\$ 1767 W\$ 2171
	29-3636CT <i>Accommodates Three (3) Chairs</i>	36	36	30	50	3.3	P\$ 1536 W\$ 1893

Top Must Specify (in this order):

- Model #
- Top Material
- Finish/Color

Base Must Specify (in this order):

- Model #
- Finish/Color

Description

- Available with Veneer (W) or HPL (P) Top, Must Specify
- See Below for Queen Anne Base and Height Adjustable Pneumatic X-Base; Order Separately
- Power Options not Available

Base Options: Must Order & Add

Queen Anne Base

01-0606QB	Optional Queen Anne Base (1 Required)	54	22.4	\$ 1358
-----------	---------------------------------------	----	------	---------



Description

- Queen Anne Base Features Multi-Step, Hand-Finished Catalyzed Finish
- Four Legs with Adjustable Glides

Height Adjustable Pneumatic X-Bases

Maximum Round 42", Maximum Square 36"

01-3232HAXBB	Black	32	32	26-45¾	1	0.2	\$ 1663
01-3232HAXBA	Aluminum	32	32	26-45¾	1	0.2	\$ 1663



Maximum Round 36", Maximum Square 30"

01-2626HAXBB	Black	22	22	26-45¾	1	0.2	\$ 1630
01-2626HAXBA	Aluminum	22	22	26-45¾	1	0.2	\$ 1630

Description

- Pre-Drilled Boring Pattern May Not Match Underside of Table Top
- Steel Mounting Plate: 8"x 8"x ¼"
- Eight (8) *MM Bolts Included for Assembly
- Some Assembly Required

Item	Model No.	Width	Depth	Height	Ship Wt	Cubic Ft	List Price
	29-4296RT <i>Accommodates Eight (8) Chairs</i>	96	42	30	140	12.5	P\$ 3598 W\$ 4239
	29-3672RT <i>Accommodates Six (6) Chairs</i>	72	36	30	91	6.6	P\$ 2981 W\$ 3474

Must Specify (in this order):

- Model #
- Top Material
- Finish/Color
- Grommet/Power/Data Location
- Base Model #
- Base Finish

Description

- One (1) Piece Top
- Available with Veneer (W) or HPL (P) Top, Must Specify
- Top and Bases Shipped Separately
- Bases Must Specified. Top Price Includes Standard Two (2) Rectangle Bases with Two (2) Stretchers, Optional Queen Anne Bases Available (See Below)
- Queen Anne Base Features Multi-Step, Hand-Finished Catalyzed Finish
- Optional Power/Data/Grommets are Available ([See Details](#)), Must Order Separately

Options: Must Specify and Add

29-2828TB	Rectangular Bases (Includes Two (2) Bases and Two (2) Stretchers)	104	7.0	Included
01-0606QB	Queen Anne Base Upgrade (Includes Two (2) Bases)	54	22.4	\$ 911

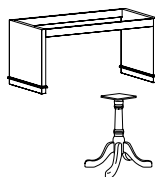

P = HPL W = Veneer

[See Arlington Overview For Ordering Options](#)

Item	Model No.	Width	Depth	Height	Ship Wt	Cubic Ft	List Price
2-PIECE TOPS & BASES 	29-48144RT <i>Accommodates Twelve (12) Chairs</i>	144	48	30	315	22.0	P\$ 7450 W\$ 8522
	29-48120RT <i>Accommodates Ten (10) Chairs</i>	120	48	30	198	22.0	P\$ 4537 W\$ 5395

Must Specify (in this order):

- Model #
- Top Material
- Finish/Color
- Grommet/Power/Data Location
- Base Model #
- Base Finish

Description

- Two (2) Piece Top
- Available with Veneer (W) or HPL (P) Top, Must Specify
- Top and Bases Shipped Separately
- Bases Must Specified. Top Price Includes Standard Two (2) Rectangle Bases with Two (2) Stretchers, Optional Queen Anne Bases Available (See Below)
- Queen Anne Base Features Multi-Step, Hand-Finished Catalyzed Finish
- Optional Power/Data/Grommets are Available ([See Details](#)), Must Order Separately

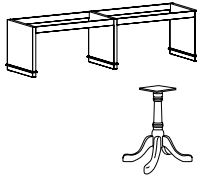

Options: Must Specify and Add

29-2828TB	Rectangular Bases (Includes Three (3) Bases and Four (4) Stretchers)	104	7.0	Included
01-0606QB	Queen Anne Base Upgrade (Includes Three (3) Bases)	80	33.6	\$ 1366

Item	Model No.	Width	Depth	Height	Ship Wt	Cubic Ft	List Price
WORK TABLES 	29-3672WT <i>64" Kneespace</i>	72	36	30	125	11.4	P\$ 2159 W\$ 2547
	29-3060WT <i>52" Kneespace</i>	60	30	30	89	8.0	P\$ 1777 W\$ 2078

Must Specify (in this order):

- Model #
- Top Material
- Finish/Color
- Grommet Location/Color

Description

- Available with Veneer (W) or HPL (P) Top, Must Specify
- Left to Right Grain Direction on Worksurface
- Optional Factory-Installed, Worksurface Grommets Available; See Locations Below, Must Specify Grommet Color: Black (BLK) or Silver (SLV)
- Some Assembly Required
- Optional Wire Management ([See Units](#)), Power/Data/Grommets are Available ([See Details](#)), Must Order Separately

P = HPL W = Veneer

[See Arlington Overview For Ordering Options](#)

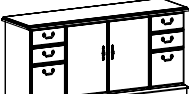
Item	Model No.	Width	Depth	Height	Ship Wt	Cubic Ft	List Price
	29-2072SC	72	20	30	237	30.5	P\$ 4101 W\$ 4451
	29-2066SC	66	20	30	217	30.5	P\$ 3562 W\$ 3896

Shown with Jefferson Drawer and Door Pulls (JEF)

Must Specify (in this order):

- Model #
- Top Material
- Finish/Color
- Base Molding
- Decorative Molding
- Pull
- Locking
- Drawer Construction

Description

- Standard With: Letter Width Box/Box/File in Pedestals, Left to Right Grain Direction on Worksurface
- Available with Veneer (W) or HPL (P) Top, Must Specify
- Top Profiled on only Three (3) Sides for Flush Wall Application
- Door Pull will Coordinate with Drawer Pull, [See Pull Options](#)
- Base Molding on Sides and User Side, Must Specify: Arlington or Wilmington (See Below)
- Standard with No Decorative Molding; Optional Wilmington Decorative Molding; Must Specify (See Below and [Molding Details](#))
- Optional Locking Pedestals (LKT-P) or Locking Pedestals and Doors (LKT-HU), ([See Details](#))
- Additional Options: Wood Dove Tail Drawers ([See Details](#))

Molding Options: Must Specify and Add

Arlington Molding Options

BM2900	Arlington Base Molding	N/C
--------	------------------------	-----

Wilmington Molding Options

BM3600	Wilmington Base Molding	N/C
M3600	Optional Wilmington Decorative Molding	\$ 134

Note: Wilmington Decorative Molding may only be used with Wilmington Base Molding

CREDENZA WITH DOUBLE LATERAL FILE	29-2072DL	72	20	30	270	30.5	P\$ 4715 W\$ 5065
--	-----------	----	----	----	-----	------	--------------------------------------

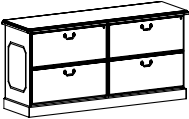

Shown with Jefferson Drawer and Door Pulls (JEF) and Optional Wilmington Decorative Molding

Must Specify (in this order):

- Model #
- Top Material
- Finish/Color
- Base Molding
- Decorative Molding
- Pull
- Drawer Construction

Description

- Standard With: Four Locking Lateral File Drawers, Left to Right Grain Direction on Worksurface
- Available with Veneer (W) or HPL (P) Top, Must Specify
- Top Profiled on only Three (3) Sides for Flush Wall Application
- Base Molding on Sides and User Side, Must Specify: Arlington or Wilmington (See Below)
- Standard with No Decorative Molding; Optional Wilmington Decorative Molding; Must Specify (See Below and [Molding Details](#))
- Additional Options: Wood Dove Tail Drawers ([See Details](#))

Molding Options: Must Specify and Add

Arlington Molding Options

BM2900	Arlington Base Molding	N/C
--------	------------------------	-----

Wilmington Molding Options

BM3600	Wilmington Base Molding	N/C
M3600	Optional Wilmington Decorative Molding	\$ 134

Note: Wilmington Decorative Molding may only be used with Wilmington Base Molding

P = HPL W = Veneer

[See Arlington Overview For Ordering Options](#)

Item	Model No.	Width	Depth	Height	Ship Wt	Cubic Ft	List Price
DOOR BOOKCASE	29-2870DB	28	15	70 $\frac{1}{2}$	78	17.8	\$ 2504

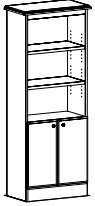

Shown with Arlington (ARB) Door Pull

Description

- Open Bookcase with Two (2) 1" Thick Adjustable Shelves
- Storage Behind Doors; One (1) Adjustable Shelf
- Top Profiled on only Three (3) Sides for Flush Wall Application
- Vertical Woodgrain
- Optional Locking Doors, [See Locking Options](#)

Must Specify (in this order):

- Model #
- Finish
- Pull
- Locking

WARDROBE/STORAGE CABINET	Hinged Left	Hinged Right	Width	Depth	Height	Ship Wt	Cubic Ft	List Price
	29-1870WL	29-1870WR						

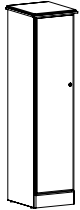

Shown as Left

Description

- Coat Rod Under Top Fixed Shelf and Three (3) Adjustable Shelves
- Adjustable Shelves can be Removed for Wardrobe Application
- Top Profiled on only Three (3) Sides for Flush Wall Application
- Must Specify Door Pull: Arlington B (ARB), Jefferson (JEF), and Liberty (ALB)
- Vertical Woodgrain
- Optional Locking Door, [See Locking Options](#)

Must Specify (in this order):

- Model #
- Finish
- Pull
- Locking

DOUBLE WARDROBE/STORAGE CABINET	29-3670WD	36	20	70 $\frac{1}{2}$	310	34.2	\$ 5209
---------------------------------	-----------	----	----	------------------	-----	------	---------

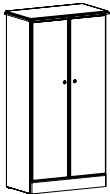

Description

- Three (3) Adjustable Shelves on Both Sides; Coat Rod Under Top Fixed Shelf on Right
- Recommended Against Wall
- Top Profiled on only Three (3) Sides for Flush Wall Application
- Must Specify Door Pull: Arlington B (ARB), Jefferson (JEF), and Liberty (ALB)
- Vertical Woodgrain
- Optional Locking Door, [See Locking Options](#)

Must Specify (in this order):

- Model #
- Finish
- Pull
- Locking

ROUND GROMMET COVER	01-GRMTBK	Black	2 $\frac{3}{8}$	2 $\frac{3}{8}$	-	1	0.1	\$ 11
	01-GRMTSL	Silver	2 $\frac{3}{8}$	2 $\frac{3}{8}$	-	1	0.1	\$ 11



OPEN MARKET ONLY (SILVER)

Description

- 2 $\frac{3}{8}$ " (60mm) Round Grommet Cover
- Field Installed

[See Arlington Overview For Ordering Options](#)

Item	Model No.		Width	Depth	Height	Ship Wt	Cubic Ft	List Price
SINGLE POWER SAND DOLLAR	01-SAND60PS	Silver	3	3	4	1	0.2	\$ 95
	01-SAND60PW	White						
	01-SAND60PB	Black						

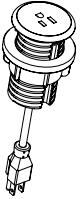

Description

- Mounts in 2 3/8" (60mm) Round Grommet
- Single Power Outlet with 6' Cord

DOUBLE USB SAND DOLLAR	01-SAND60US	Silver	3	3	4	1	0.2	\$ 268
	01-SAND60UW	White						
	01-SAND60UB	Black						

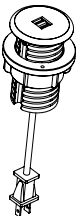

Description

- Mounts in 2 3/8" (60mm) Round Grommet
- Dual USB Outlets with 6' Cord

DUO CLAMP NEMA PLUG	01-DUOCLAMPS	Silver	5 1/2	3	7	1	0.2	\$ 553
	01-DUOCLAMPW	White						
	01-DUOCLAMPB	Black						

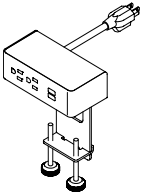

Description

- Standard with: Two (2) Power Outlet, Two (2) USB Ports, 10' Cord
- Clamps to Top and Features Silver Metal Trim
- Independent USB Circuit Controllers Deliver up to 2.1 Amps to Each Post
- All Mounting Hardware Included
- FCC Part 15A and UL Approved for Horizontal and Vertical Applications

OASIS MINI POWER & DATA	01-OASISMA	Aluminum	14 1/4	6 3/8	2 7/8	11	0.3	\$ 3083
	01-OASISMB	Black						



Top View

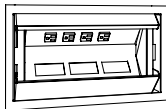

Description

- For Use with Conference Tables
- Plate Includes: Two (2) Data and Four (4) Power Outlets, 9' Power Cord
- Two (2) Telecom Plates Included with the Unit: One (1) 01-ABLAB Plate (Consists of One (1) RJ45 Cat 6, One (1) RJ11 Cat 3 Phone Jack); One (1) 01-ABLB Plate (Consists of One (1) RJ45 Cat 6)
- Soft Touch Hinged Lid
- UL Listed
- Additional Telecom Plates, [See Telecom Plate Options](#)

[See Arlington Overview For Ordering Options](#)

Item	Model No.		Width	Depth	Height	Ship Wt	Cubic Ft	List Price
INTERACT POWER & DATA	01-INTERACTG2A	Aluminum	9	5 $\frac{5}{8}$	2 $\frac{3}{4}$	5	0.2	\$ 861
	01-INTERACTG2B	Black						

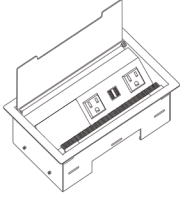

Description

- Includes: Two (2) Power Outlets, Two (2) USB-A Charging Ports, One (1) Telecom Plate Opening; Two (2) Keystone Openings for Voice/Data Jacks
- One (1) Telecom Plates Included with the Unit: One (1) 01-ABLAB Plate (Consists of One (1) RJ45 Cat 6, One (1) RJ11 Cat 3 Phone Jack)
- Convenience Plug on Bottom
- 6' Power Cord
- UL and CSA Recognized
- Additional Telecom Plates, [See Telecom Plate Options](#)

WORKSURFACE POWER CENTER	01-INTRFC1A	Aluminum	14 $\frac{1}{4}$	6 $\frac{3}{8}$	2 $\frac{7}{8}$	11	0.3	\$ 1994
	01-INTRFC1B	Black						

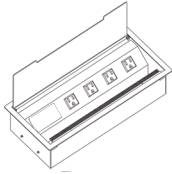

Description

- For Use with Conference Tables
- Four (4) Power Outlets, Three (3) Telecom Plate Openings
- Two (2) Telecom Plates Included with the Unit: One (1) 01-ABLAB Plate (Consists of One (1) RJ45 Cat 6, One (1) RJ11 Cat 3 Phone Jack); One (1) 01-ABLBB Plate (Consists of Two (2) RJ45 Cat 6)
- 6' Power Cord
- Convenience Plug on Bottom
- UL Listed/CSA Certified
- Additional Telecom Plates, [See Telecom Plate Options](#)

WIRE MANAGEMENT CHANNEL	01-WMGR4		16	1 $\frac{1}{2}$	$\frac{3}{4}$	1	-	\$ 112
-------------------------	----------	--	----	-----------------	---------------	---	---	--------

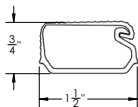

Description

- Set of Four (4) Black Plastic Wire Management Channels
- Snap Lock Channel
- Attaches with Adhesive Strips
- Ships via UPS Only

CABLE GRIP	01-WMGRCB		5 $\frac{3}{8}$	2 $\frac{5}{8}$	-	-	-	\$ 16
------------	-----------	--	-----------------	-----------------	---	---	---	-------

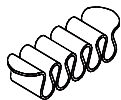

Description

- Under Surface Wire Management
- Black

[See Arlington Overview For Ordering Options](#)

Item	Model No.	Description	List Price
ECA TELECOM PLATES	01-ABL	Telecom Plate, Blank Plate	\$ 40
	01-ABL737373	Telecom Plate, Three (3) RJ45 Cat 5e	\$ 355
	01-ABLAB	Telecom Plate, One (1) RJ45 Cat 6, One (1) RJ11 Cat 3 Phone	\$ 199
	01-ABLAB102	Telecom Plate, One (1) RJ45 Cat 6, One (1) RJ11 Cat 3, One (1) USB W/72" Patch Cord	\$ 309
	01-ABLABB	Telecom Plate, Two (2) RJ45 Cat 6, One (1) RJ11 Cat 3 Phone	\$ 309
	01-ABLB	Telecom Plate, One (1) RJ45 Cat 6	\$ 144
	01-ABLBB	Telecom Plate, Two (2) RJ45 Cat 6	\$ 251
	01-ABLBBB	Telecom Plate, Three (3) RJ45 Cat 6	\$ 355
	01-ABLBBBB	Telecom Plate, (4) RJ45 Cat 6	\$ 460
	01-ABLBBC51	Telecom Plate, Two (2) RJ45 Cat 6, One (1) 15 Pin HD VGA w/72" Patch Cord	\$ 431
	01-ABLBC51L	Telecom Plate, One (1) RJ45 Cat 6, One (1) Mini Stereo Inline, One (1) 15 Pin HD VGA w/72" Patch Cord	\$ 396
	01-ABL3811	Telecom Plate, One (1) RJ45 Cat 6 Data Inline, One (1) RJ11 Cat 3 Phone Inline	\$ 190
	01-ABLC45	Telecom Plate, One (1) HDMI w/36" Patch Cord	\$ 285
	01-ABLC45C51L	Telecom Plate, One (1) Mini Stereo Inline, One (1) HDMI w/36" Patch Cord, One (1) 15 Pin HD VGA w/72" Patch Cord	\$ 539
	01-ABLC51L	Telecom Plate, One (1) 15 Pin HD VGA & One (1) Mini Stereo Inline Jack	\$ 288
	01-ABLCRDM	Telecom Plate, Three (3) Cord Bushings	\$ 93

Compatible with:



Interact Power & Data
01-INTERACTG2A, 01-INTERACTG2B

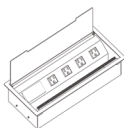

Power Center
01-INTRFCIA, 01-INTRFCIB

Traditional components echo history and create timeless foundations for meeting rooms that complement our Jefferson and Arlington casegoods collections, and Cameo and Jefferson Reception options. Facilitate presentations with lecterns and visual presentation boards. Mobile serving carts and buffet height credenzas provide additional in-room utility.

CONSTRUCTION

Cameo Tables and Components feature your choice of either a Veneer or HPL top, Veneer bases, and Veneer chassis (where applicable).

VENEERS

- Veneers on exposed surfaces are select grade sliced American Black Walnut and are carefully selected and matched to assure proper balance and consistency

LAMINATES

- Exposed surfaces are produced from wood grained laminates fused to a particle-board core
- Each laminate offers lasting beauty, superior resistance to normal wear, and easy maintenance

TOPS

- Wood Veneer tops are 5-ply balanced construction and High Pressure Laminate (HPL) tops are 3-ply balanced construction
- Tops are 1 $\frac{3}{16}$ " thick with solid hardwood rims
- All buffets, credenzas, serving carts, video cabinets, and storage/wardrobe cabinets are shaped on user side only
- Grain direction runs left to right unless otherwise noted

CHASSIS

- Tops and end panels are securely fastened using high quality
- European fastening systems to ensure maximum strength
- All units are equipped with heavy-duty, adjustable glides to ensure proper leveling and compensation for uneven floors

DRAWERS

- All drawer fronts are standard with elegant vertically matched walnut veneer faces
- Drawers feature 5-sided construction with $\frac{3}{4}$ " 3-ply fronts, $\frac{7}{16}$ " thick hardwood sides and $\frac{5}{32}$ " hardboard bottoms
- Units with 36" wide file drawers feature $\frac{1}{4}$ " thick drawer bottoms for maximum storage strength
- Drawer interiors are sanded, sealed, and finished to provide for a smooth, quality feel and appearance
- All drawers feature full extension, progressive action slides with precision steel ball bearings
- Box and file drawers are tested for 100lb capacity
- Lateral files are tested for 200lb capacity
- All suspensions have a limited lifetime warranty

STORAGE

- All hinged doors include soft close hinges, unless otherwise noted
- One piece hinge and base plate combination
- Soft close hinges reduce stress placed on the cabinet when the door is closed and offers a quiet closure

LOCKING

- All units with file drawers feature locking
- Removable lock cylinders allow for units to be re-keyed at a later date if required
- Units are shipped randomly keyed as standard. Keyed alike units available upon request at no additional charge.
- Keyed alike units available upon request at no additional charge
- Lock cores match pull color

INTERIOR DRAWER DIMENSIONS & FILING CAPABILITIES

Models

91-2472BFD 91-2436SV

Drawers

Box

W

14 $\frac{17}{32}$ "

L

19 $\frac{1}{4}$ "

D

3 $\frac{21}{32}$ "

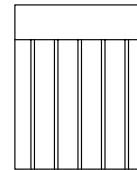
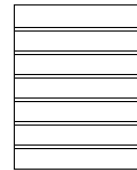

Models

91-2436BF 91-2472BF

Drawers

Box

W

32 $\frac{9}{16}$ "

L

19 $\frac{1}{4}$ "

D

3 $\frac{21}{32}$ "

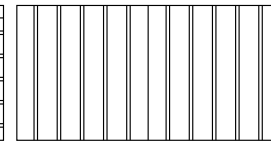
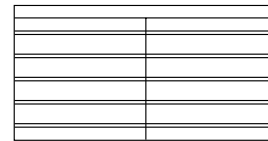

Models

91-2472SBF

Drawers

Box

W

14 $\frac{17}{32}$ "

L

19 $\frac{1}{4}$ "

D

3 $\frac{21}{32}$ "

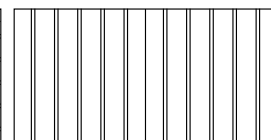
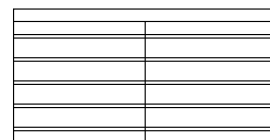
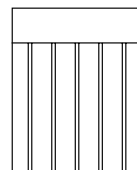
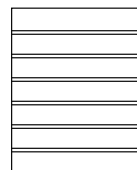

HOW TO ORDER EXAMPLES

	QTY	MODEL NO.	DESCRIPTION	EXAMPLE
TOP	1	91-4296RT	Top Material Finish/Color Edge Profile Grommet/Power/ Data Location	W EW C2 EL
BASES	2	01-2028TB	Finish	EW
PORTS	2	01-OASISMA		
TELECOM PLATE	1	01-ABLAB		
MOBILE CART	1	91-2436SV	Top Material Finish/Color Edge Profile Pull Back Panel Grommet Grommet Color	P EW C2 ALB 1-GRMT Black

VENEER (W) OPTIONS

Veneer features UVAdvantage, an ultra-violet finish, on all exposed surfaces by utilizing roll-coat UV technology

AW	Artisan Walnut	LW	Legacy Walnut
CO	Columbian Walnut	MW	Mahogany Walnut
DC	Dark Cherry	MTS	Metropolis Sky
DFW	Dark Forest Walnut	PNW	Pinnacle Walnut
EW	Espresso	SCH	Select Cherry
GC	Golden Cherry	SKC	Shaker Cherry
HW	Harvest Walnut	WC	Williamsburg Cherry
HNW	Henna Walnut		

HPL (P) LAMINATE

WOODGRAIN

CO	Columbian Walnut	PNW	Pinnacle Walnut
EF	Espresso	SCH	Select Cherry
GC	Golden Cherry	SKC	Shaker Cherry
MW	Mahogany Walnut	WC	Williamsburg Cherry

EDGE PROFILES

C2 Jefferson
R Arlington



Jefferson (C2)



Arlington (R)

PULL OPTIONS

ARA	Arlington A, Brass	ALB	Liberty, Aluminum
ARB	Arlington B, Brass	WLM	Wilmington, Brass
JEF	Jefferson, Brass		



Arlington A (ARA)
Antique Brass - 5¼"



Arlington B (ARB)
Antique Brass - 5¼"



Jefferson (JEF)
Antique Brass - 5¼"



Wilmington (WLM)
Antique Brass - 5¼"



Liberty (ALB)
Aluminum - 4¼"

GROMMET/POWER/DATA OPTIONS & LOCATIONS

See units and options in [accessories section](#) and the [general power and locations information section](#)

LOCKING DOORS

Locking doors are available on specific units, where noted. You must specify WITH LOCKING when ordering and add upcharge.

Lock core will be black if Arlington, Jefferson, and Wilmington brass pulls are selected and silver if Liberty Aluminum pulls are selected.

LKT_HU	72" W - 48" W Units	\$	111
LKT_HU	42" W - 24" W Units	\$	88
LKT_HU	18" W Units	\$	67

CERTIFICATIONS & COMPLIANCE

- Intertek Sustainability Certified
- BIFMA level® Certified
- BIFMA Compliant® Certified
- TSCA Title VI (formerly CARB) Compliance
- US Green Building's LEED® Contribution

Tops/Shapes

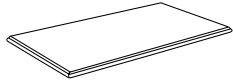

Rectangular [\(See Details\)](#)

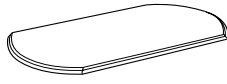

Arc Rectangular [\(See Details\)](#)



Racetrack [\(See Details\)](#)



Boat-Shaped [\(See Details\)](#)

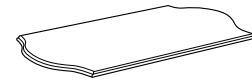

Wave-Rectangular [\(See Details\)](#)

Bases

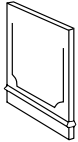

Rectangular [\(See Details\)](#)

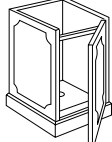

Square [\(See Details\)](#)

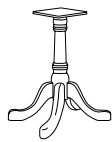

Queen Anne Base [\(See Details\)](#)

Storage Components

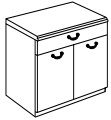

Two Door Buffet w/Drawer [\(See Details\)](#)

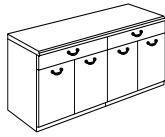

Four Door Buffet w/2 Drawers [\(See Details\)](#)

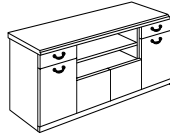

Four Door Buffet w/2 Drawers & Open Storage [\(See Details\)](#)

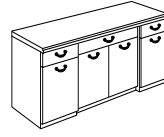

Four Door Buffet w/3 Drawers [\(See Details\)](#)

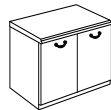

Two Door Credenza [\(See Details\)](#)

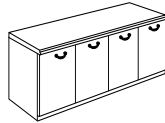

Four Door Credenza [\(See Details\)](#)

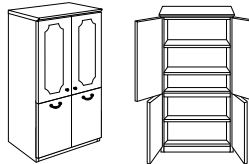

Storage Cabinet Double Doors [\(See Details\)](#)

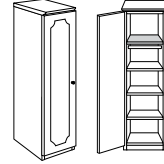

Wardrobe/Storage Cabinet [\(See Details\)](#)



Mobile Serving Cart [\(See Details\)](#)

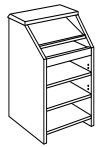

Lectern Stand [\(See Details\)](#)

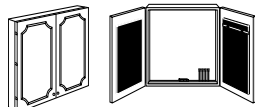

Visual Board [\(See Details\)](#)

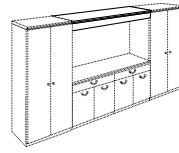

Visor Rail [\(See Details\)](#)

Wire Management & Power/Data Accessories

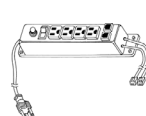
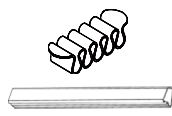
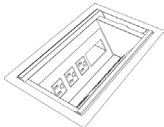

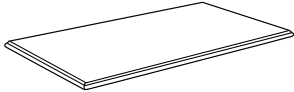
Item	Model No.	W	D	H	Ship Wt	Cubic Ft	List Price
RECTANGULAR TOPS 	192" or 16' - 2 Piece Tops						
	91-48192RT	192	48	1 1/16	375	15.5	P\$ 7537 W\$ 9477
	168" or 14' - 2 Piece Tops						
	91-48168RT	168	48	1 1/16	325	13.6	P\$ 7430 W\$ 8831
	144" or 12' - 2 Piece Tops						
	91-48144RT	144	48	1 1/16	275	12.3	P\$ 6249 W\$ 7327
	120" or 10' - 2 Piece Tops						
	91-48120RT	120	48	1 1/16	225	10.3	P\$ 5600 W\$ 6461
	96" or 8' - 1 Piece Top						
	91-4296RT	96	42	1 1/16	180	9.4	P\$ 4202 W\$ 4845
	72" or 6' - 1 Piece Top						
	91-3672RT	72	36	1 1/16	100	6.2	P\$ 2735 W\$ 3228

Must Specify (in this order):

- Model #
- Top Material
- Finish/Color
- Edge Profile
- Grommet/Power/Data Location

Description

- Grain Runs the Width of the Table
- Heavy-Duty Ganging Mechanisms Connect Two (2) Piece Tops
- See Bases and Number Required For Each Top Size, [See Multiple Base Options](#); Must Order Separately
- Optional Grommets and Power/Data; For Locations See [Power and Locations Information Section](#), See Units and Unit Options in [Accessories Section](#)

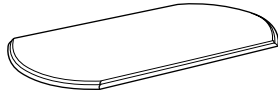
Item	Model No.	W	D	H	Ship Wt	Cubic Ft	List Price
ARC RECTANGULAR TOPS 	192" or 16' - 2 Piece Tops						
	91-48192AR	192	48	1 1/16	375	15.5	P\$ 7969 W\$ 9907
	168" or 14' - 2 Piece Tops						
	91-48168AR	168	48	1 1/16	325	13.6	P\$ 7862 W\$ 9262
	144" or 12' - 2 Piece Tops						
	91-48144AR	144	48	1 1/16	275	12.3	P\$ 6677 W\$ 7752
	120" or 10' - 2 Piece Tops						
	91-48120AR	120	48	1 1/16	225	10.3	P\$ 6032 W\$ 6894
	96" or 8' - 1 Piece Top						
	91-4296AR	96	42	1 1/16	180	9.4	P\$ 4738 W\$ 5383
	72" or 6' - 1 Piece Top						
	91-3672AR	72	36	1 1/16	100	6.2	P\$ 3018 W\$ 3510

Must Specify (in this order):

- Model #
- Top Material
- Finish/Color
- Edge Profile
- Grommet/Power/Data Location

Description

- Grain Runs the Width of the Table
- Heavy-Duty Ganging Mechanisms Connect (2) Piece Tops
- See Bases and Number Required For Each Top Size, [See Multiple Base Options](#); Must Order Separately
- Optional Grommets and Power/Data; For Locations See [Power and Locations Information Section](#), See Units and Unit Options in [Accessories Section](#)

W = Veneer P = HPL

[See Cameo Overview For Ordering Options](#)

Item	Model No.	W	D	H	Ship Wt	Cubic Ft	List Price	
 <p>RACETRACK TOPS</p> <p>Must Specify (in this order): Model # Top Material Finish/Color Edge Profile Grommet/Power/Data Location</p>	192" or 16' - 2 Piece Tops							
	91-48192AT	192	48	1 $\frac{3}{16}$	375	15.5	P\$ 9262 W\$ 11198	
	168" or 14' - 2 Piece Tops							
	91-48168AT	168	48	1 $\frac{3}{16}$	325	13.6	P\$ 8939 W\$ 10338	
	144" or 12' - 2 Piece Tops							
	91-48144AT	144	48	1 $\frac{3}{16}$	275	12.3	P\$ 7646 W\$ 8724	
	120" or 10' - 2 Piece Tops							
	91-48120AT	120	48	1 $\frac{3}{16}$	225	10.3	P\$ 6787 W\$ 7646	
	96" or 8' - 1 Piece Top							
	91-4296AT	96	42	1 $\frac{3}{16}$	180	9.4	P\$ 5166 W\$ 5814	
72" or 6' - 1 Piece Top								
91-3672AT	72	36	1 $\frac{3}{16}$	100	6.2	P\$ 3599 W\$ 4090		

Description

- Grain Runs the Width of the Table
- Heavy-Duty Ganging Mechanisms Connect (2) Piece Tops
- See Bases and Number Required For Each Top Size, [See Multiple Base Options](#); Must Order Separately
- Optional Grommets and Power/Data; For Locations See [Power and Locations Information Section](#), See Units and Unit Options in [Accessories Section](#)

 <p>BOAT-SHAPED TOPS</p> <p>Must Specify (in this order): Model # Top Material Finish/Color Edge Profile Grommet/Power/Data Location</p>	192" or 16' - 2 Piece Tops							
	91-48192BT	192	48	1 $\frac{3}{16}$	375	15.5	P\$ 9262 W\$ 11198	
	168" or 14' - 2 Piece Tops							
	91-48168BT	168	48	1 $\frac{3}{16}$	325	13.6	P\$ 8939 W\$ 10338	
	144" or 12' - 2 Piece Tops							
	91-48144BT	144	48	1 $\frac{3}{16}$	275	12.3	P\$ 7646 W\$ 8724	
	120" or 10' - 2 Piece Tops							
	91-48120BT	120	48	1 $\frac{3}{16}$	225	10.3	P\$ 6787 W\$ 7646	
	96" or 8' - 1 Piece Top							
	91-4296BT	96	42	1 $\frac{3}{16}$	180	9.4	P\$ 5166 W\$ 5814	
72" or 6' - 1 Piece Top								
91-3672BT	72	36	1 $\frac{3}{16}$	100	6.2	P\$ 3599 W\$ 4090		

Description

- Grain Runs the Width of the Table
- Heavy-Duty Ganging Mechanisms Connect (2) Piece Tops
- See Bases and Number Required For Each Top Size, [See Multiple Base Options](#); Must Order Separately
- Optional Grommets and Power/Data; For Locations See [Power and Locations Information Section](#), See Units and Unit Options in [Accessories Section](#)

W = Veneer P = HPL

[See Cameo Overview For Ordering Options](#)

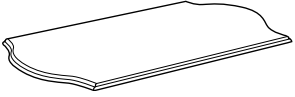
Item	Model No.	W	D	H	Ship Wt	Cubic Ft	List Price
WAVE-RECTANGULAR TOPS 	192" or 16' - 2 Piece Tops						
	91-48192WR	192	48	1¾"	375	15.5	P\$ 7969 W\$ 9907
	168" or 14' - 2 Piece Tops						
	91-48168WR	168	48	1¾"	325	13.6	P\$ 7862 W\$ 9262
	144" or 12' - 2 Piece Tops						
	91-48144WR	144	48	1¾"	275	12.3	P\$ 6677 W\$ 7752
	120" or 10' - 2 Piece Tops						
	91-48120WR	120	48	1¾"	225	10.3	P\$ 6032 W\$ 6894
	96" or 8' - 1 Piece Top						
	91-4296WR	96	42	1¾"	180	9.4	P\$ 4738 W\$ 5383
72" or 6' - 1 Piece Top							
91-3672WR	72	36	1¾"	100	6.2	P\$ 3018 W\$ 3510	

Must Specify (in this order):

- Model #
- Top Material
- Finish/Color
- Edge Profile
- Grommet/Power/Data Location

Description

- Grain Runs the Width of the Table
- Heavy-Duty Ganging Mechanisms Connect (2) Piece Tops
- See Bases and Number Required For Each Top Size, [See Multiple Base Options](#); Must Order Separately
- Optional Grommets and Power/Data; For Locations See [Power and Locations Information Section](#), See Units and Unit Options in [Accessories Section](#)

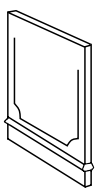
RECTANGULAR BASE TRADITIONAL 	For Use with 48"D Tops							
	01-2428TB	24	2	28½"	38	2.7	W\$ 1439	
	For Use with 42"D or Less Tops							
	01-2028TB	20	2	28½"	32	2.3	W\$ 1350	
	Description							
	<ul style="list-style-type: none"> • Veneer Panel Base • Traditional Molding on Outer Side Standard; For No Decorative Molding Option, Must Specify (See Below) • Stretchers are Included in Pricing; Must Specify Model (See Below) 							
	Molding Option: Specify							
	NONE	No Decorative Molding					\$	N/C

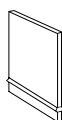

Must Specify (in this order):

- Model # and Quantity
- Finish
- No Molding
- Stretcher Rail

Table Width	72"	96"	120"	144"	168"	192"
Number of Bases Required	2	2	3	3	3	5
Stretcher Rail Needed	01-72STR	01-96STR	01-120STR	01-144STR	01-168STR	01-192STR

Note: Molding is applied to one side of outer extreme bases. If 3 or more bases are required, center bases will not have molding on either side.

W = Veneer P = HPL

[See Cameo Overview For Ordering Options](#)

Item	Model No.	W	D	H	Ship Wt	Cubic Ft	List Price
SQUARE BASE TRADITIONAL	01-2020TSB	20	20	28½	57	8.4	W\$ 1964

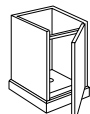
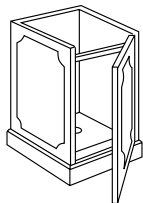
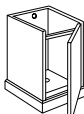
No Molding
OptionGrommet
Option**Description**

- Panel Access Door Features Soft Close Hinges
- Traditional Molding Standard on All Sides; For No Decorative Molding Option, Must Specify (See Below)
- 2" Wire Management Opening Above Door; 2¾" (60mm) Wire Management Opening in Bottom
- Optional Grommet at Top Edge, Must Specify (See Below)

Options: Specify & Add

NONE	No Decorative Molding	\$	N/C
GCB1S	Grommet at Top Edge One (1) - Factory Installed	\$	50

Table Width	72"	96"	120"	144"	168"	192"
Number of Bases Required	2	2	3	3	3	3

Note: Recommended on tables 72"W or Larger. If specified on smaller tables, a ballast must be ordered separately. Contact Customer Service for more information.

Must Specify (in this order):

- Model # and Quantity
- Finish
- No Molding
- Grommet Option

QUEEN ANNE BASE	01-0606QB	24	24	28¾	35	10.8	W\$ 1358
-----------------	-----------	----	----	-----	----	------	----------

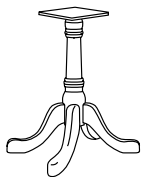
**Description**

- Classic Design Detail on Column
- Queen Anne Base Features Multi-Step, Hand-Finished Catalyzed Finish
- Four (4) Legs with Adjustable Glides

Table Width	72"	96"	120"	144"	168"	192"
Number of Bases Required	2	2	3	3	3	5

Must Specify (in this order):

- Model # and Quantity
- Finish

W = Veneer P = HPL

[See Cameo Overview For Ordering Options](#)

Item	Model No.	W	D	H	Ship Wt	Cubic Ft	List Price
TWO DOOR BUFFET WITH DRAWER	91-2436BF	36	24	36	189	21.7	P\$ 4071 W\$ 4145

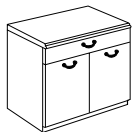
**Description**

- Top Edge Profiled on Approach Side Only ([See Edge Options](#)); Must Specify Edge Selection
- One (1) Drawer and Storage Behind Two (2) Doors with One (1) Adjustable Shelf

Must Specify (in this order):

Model #
Top Material
Finish/Color
Edge Profile
Pull

FOUR DOOR BUFFET WITH TWO DRAWERS	91-2472BF	72	24	36	342	45.6	P\$ 7734 W\$ 7862
--	-----------	----	----	----	-----	------	----------------------

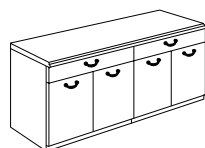
**Description**

- Top Edge Profiled on Approach Side Only ([See Edge Options](#)); Must Specify Edge Selection
- Two (2) Drawers and Storage Behind Four (4) Doors with Two (2) Adjustable Shelves

Must Specify (in this order):

Model #
Top Material
Finish/Color
Edge Profile
Pull

FOUR DOOR BUFFET WITH TWO DRAWERS AND OPEN STORAGE	91-2472BFD	72	24	36	337	45.6	P\$ 8919 W\$ 9049
---	------------	----	----	----	-----	------	----------------------

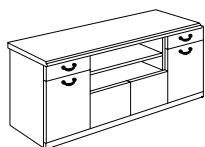
**Description**

- Top Edge Profiled on Approach Side Only ([See Edge Options](#)); Must Specify Edge Selection
- Two (2) Drawers with Open Storage with One (1) Adjustable Shelf
- Left and Right Storage Behind Doors with One (1) Adjustable Shelf
- Storage Behind Center Doors

Must Specify (in this order):

Model #
Top Material
Finish/Color
Edge Profile
Pull

FOUR DOOR BUFFET WITH THREE DRAWERS	91-2472SBF	72	24	36	362	45.6	P\$ 8919 W\$ 9049
--	------------	----	----	----	-----	------	----------------------

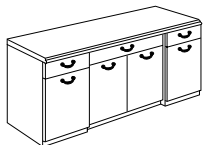
**Description**

- Top Edge Profiled on Approach Side Only ([See Edge Options](#)); Must Specify Edge Selection
- Three (3) Drawers and Storage Behind Four (4) Doors with Three (3) Adjustable Shelves
- Center Section is Stepped Back

Must Specify (in this order):

Model #
Top Material
Finish/Color
Edge Profile
Pull

W = Veneer P = HPL

[See Cameo Overview For Ordering Options](#)

Item	Model No.	W	D	H	Ship Wt	Cubic Ft	List Price
TWO DOOR CREDENZA	91-2436CC	36	24	30	150	17.6	P\$ 3154 W\$ 3228

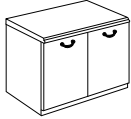

Must Specify (in this order):

- Model #
- Top Material
- Finish/Color
- Edge Profile
- Pull
- Locking Option

Description

- Top Edge Profiled on Approach Side Only ([See Edge Options](#)); Must Specify Edge Selection
- Two (2) Doors with One (1) Adjustable Shelf Behind Doors
- Additional Option: Locking Doors ([See Locking Options](#))

FOUR DOOR CREDENZA	91-2472CC	72	24	30	290	34.2	P\$ 6389 W\$ 6518
--------------------	-----------	----	----	----	-----	------	----------------------

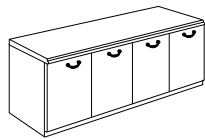

Must Specify (in this order):

- Model #
- Top Material
- Finish/Color
- Edge Profile
- Pull
- Locking Option

Description

- Top Edge Profiled on Approach Side Only ([See Edge Options](#)); Must Specify Edge Selection
- Four (4) Doors with Two (2) Adjustable Shelves Behind Doors
- Additional Option: Locking Doors ([See Locking Options](#))

DOUBLE DOOR STORAGE CABINET	91-3672SUD	36	24	72	285	42.0	W\$ 6555
-----------------------------	------------	----	----	----	-----	------	----------

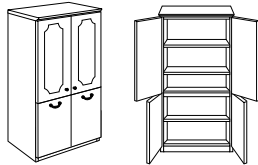

Must Specify (in this order):

- Model #
- Finish
- Edge Profile
- Knob
- Pull
- No Molding

Description

- Top Section has Two (2) Adjustable Shelves; Bottom Section has One (1) Adjustable Shelf
- Two (2) Knobs on Top Doors, Available with Antique Brass (TKN) Door Knob or Aluminum (ALK) Door Knob; Must Specify; Selection of Pulls on Bottom Doors

Options: Specify

NONE	No Decorative Molding	\$	N/C
------	-----------------------	----	-----

WARDROBE/STORAGE CABINET	HINGED LEFT	HINGED RIGHT	W	D	H	Ship Wt	Cubic Ft	List Price
	91-1872WL	91-1872WR	18	24	72	155	22.0	W\$ 5219

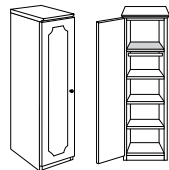

Must Specify (in this order):

- Model #
- Finish
- Edge Profile
- Knob
- No Molding

Description

- Available with Antique Brass (TKN) Door Knob or Aluminum (ALK) Door Knob; Must Specify
- Fixed Top Shelf; Coat Rod Under Fixed Shelf
- Three (3) Adjustable Shelves Behind Door
- Adjustable Shelves can be Removed for Wardrobe Application

Options: Specify

NONE	No Decorative Molding	\$	N/C
------	-----------------------	----	-----

W = Veneer P = HPL

[See Cameo Overview For Ordering Options](#)

Item	Model No.	W	D	H	Ship Wt	Cubic Ft	List Price
VISOR RAIL	91-2472VR	72	24	5 ³ / ₁₆	100	8.9	W\$ 1347

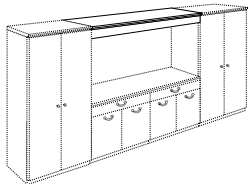

Must Specify (in this order):
Model #
Finish
Projection Screen
Task Light

Description

- Overhead Rail Creates Wall Unit
- For Use with 72" High Cabinets and Credenzas/Bufets (Ordered Separately)

Options: Specify & Add

1-PS	Projection Screen (Requires Field Installation)	\$ 1026
TL-0848	Task Light (Requires Field Installation)	\$ 430

SERVING CART	91-2436SV	36	24	36	149	24.0	P\$ 4881 W\$ 4958
--------------	-----------	----	----	----	-----	------	----------------------



Must Specify (in this order):
Model #
Top Material
Finish/Color
Edge Profile
Pull
Grommet Option

Description

- Top Edge Profiled on Approach Side Only; Must Specify Edge Selection
- Two (2) Box Drawers with Storage Behind Two (2) Doors
- Open Storage
- Locking Casters

Grommet Option: Specify & Add

1-GRMT	Grommet in Back Panel; Must Specify Black or Silver	\$ 50
--------	---	-------

LECTERN STAND	91-2650LS	26	24	50	130	21.9	W\$ 3881
---------------	-----------	----	----	----	-----	------	----------

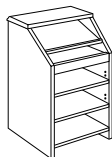

Must Specify (in this order):
Model #
Finish
Edge Profile

Description

- Top Edge Profiled on Approach Side Only; Must Specify Edge Selection
- Fixed Reading Shelf
- Pullout Shelf
- Two (2) Adjustable Storage Shelves in Lower Compartment
- Two (2) Locking and Two (2) Non-Locking Casters
- Wire Management Grommet in Bottom Shelf

VISUAL BOARD	91-4848VB	48	5	48	150	11.0	W\$ 5600
--------------	-----------	----	---	----	-----	------	----------

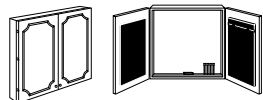

Must Specify (in this order):
Model #
Finish
Project Screen
Tackboard Fabric
Pull

Description

- Tackboard on Each Door Standard in Black Fabric Unless Specified; Price Valid for Grades 1, 2, & 3 (See Other Pricing Below)
- Display Rail with Adjustable Hooks for Flipchart
- Magnetic Door Closure and Porcelain Non-Glare Writing Surface
- Includes Flipchart, Set of Four (4) Dry Erase Markers and Eraser, Mounting Hardware
- Does Not Feature Soft Close Hinges

Options: Specify & Add

	Grade 4	Grade 5	Grade 6	Grade 7	Grade 8	Grade 9	Grade 10
Tackboard Fabric Change	\$ 268	394	522	704	892	1114	1368
1-PS	Projection Screen (Requires Field Installation)						\$ 1026

W = Veneer P = HPL

[See Cameo Overview For Ordering Options](#)

Item	Model No.	W	D	H	Ship Wt	Cubic Ft	List Price
TABLE POWER & DATA VAULT	01-CVAULTG2A	4½	15⅝	4¼	10	0.4	\$ 1878



OPEN MARKET ONLY

Description

- Electric Drive Motor Rotates the Surface Technology 180° to the Proper Position
- Photo-Electronic Eye Prevents Rotation When Obstructed
- Two (2) Data Ports, Three (3) Power Outlets, and One (1) HDMI and Two (2) 5V USB
- 6' Power Cord
- UL and CSA Recognized

Item	Model No.	Material	W	D	H	Ship Wt	Cubic Ft	List Price
WORKSURFACE POWER CENTER	01-INTRFC1A	Aluminum	14¼	6⅝	2⅞	11	0.3	\$ 1994
	01-INTRFC1B	Black						

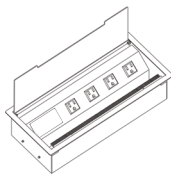
**Description**

- For Use with Conference Tables
- Four (4) Power Outlets, Three (3) Telecom Plate Openings
- Two (2) Telecom Plates Included with the Unit: One (1) 01-ABLAB Plate (Consists of One (1) RJ45 Cat 6, One (1) RJ11 Cat 3 Phone Jack); One (1) 01-ABLBB Plate (Consists of Two (2) RJ45 Cat 6)
- 6' Power Cord
- Convenience Plug on Bottom
- UL Listed/CSA Certified
- Additional Telecom Plates, [See Telecom Plate Options](#)

Item	Model No.	Material	W	D	H	Ship Wt	Cubic Ft	List Price
OASIS MINI POWER & DATA	01-OASISMA	Aluminum	14¼	6⅝	2⅞	11	0.3	\$ 3083
	01-OASISMB	Black						

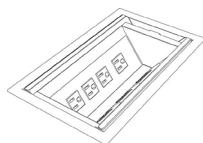

Top View

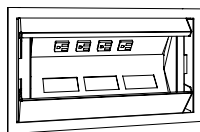
**Description**



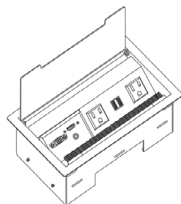

- For Use with Conference Tables
- Soft Touch Hinged Lid
- Four (4) Power Outlets, Three (3) Telecom Plate Openings
- Two (2) Telecom Plates Included with the Unit: One (1) 01-ABLAB Plate (Consists of One (1) RJ45 Cat 6, One (1) RJ11 Cat 3 Phone Jack); One (1) 01-ABLB Plate (Consists of One (1) RJ45 Cat 6)
- 9' Power Cord
- UL Listed
- Additional Telecom Plates, [See Telecom Plate Options](#)

Item	Model No.	Material	W	D	H	Ship Wt	Cubic Ft	List Price
INTERACT POWER & DATA	01-INTERACTG2A	Aluminum	9	5⅝	2¾	5	0.2	\$ 861
	01-INTERACTG2B	Black						

**Description**

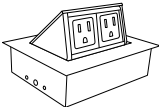
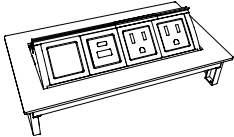
- Includes: Two (2) Power Outlets, Two (2) USB-A Charging Ports, One (1) Telecom Plate Opening; Two (2) Keystone Openings for Voice/Data Jacks
- One (1) Telecom Plates Included with the Unit: One (1) 01-ABLAB Plate (Consists of One (1) RJ45 Cat 6, One (1) RJ11 Cat 3 Phone Jack)
- Convenience Plug on Bottom
- 6' Power Cord
- UL and CSA Recognized
- Additional Telecom Plates, [See Telecom Plate Options](#)

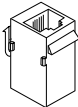
[See Cameo Overview For Ordering Options](#)

Item	Model No.		W	D	H	Ship Wt	Cubic Ft	List Price
POWER 440 	01-DATA440A	Aluminum	5 $\frac{5}{16}$	4 $\frac{3}{8}$	-	5	0.2	\$ 931
	01-DATA440B	Black						
	Description							
	<ul style="list-style-type: none"> • Two (2) Power Outlets • Soft Touch Hinged Lid • 6' Power Cord • UL and CSA Recognized 							
POWER DATA PORT 	01-DPORT4A	Aluminum	8	4	-	7	0.2	\$ 1056
	01-DPORT4B	Black						
	Description							
	<ul style="list-style-type: none"> • Retracts into Work Surface to Regain Productive Space; One-Touch Access to Power and Data • Two (2) Power Outlets and Two (2) Open Ports for Data • Additional Telecom Plates, See Telecom Plate Options • Water-Proof Simplex (Outlets) • Includes a Voice/Data Adapter Kit to Accept Couplers and Jacks When Required • 6' Power Cord • UL and CSA Recognized 							
USB PORT 	01-USBPORT		-	-	-	-	-	\$ 156
	Description							
	<ul style="list-style-type: none"> • Passive USB-A Port with Increased Transfer Speed Up to 5 gbs/sec • Simultaneous Read/Write Capability; Idle Device Power Saving State • 6' Cord • Compatible with 01-DPORT4 							
VOICE COUPLER 	01-VOICE1		-	-	-	-	-	\$ 71
	Description							
	<ul style="list-style-type: none"> • 6-Pin Modular Plug • Molded Black; Cord Not included • Compatible with 01-DPORT4 							
DATA PORT 	01-RJ4DATA		-	-	-	-	-	\$ 161
	Description							
	<ul style="list-style-type: none"> • 8-Pin Modular Plug; Cat6 Ethernet Cable; Pre-terminated Cable • 10' Cord • Compatible with 01-DPORT4 							

[See Cameo Overview For Ordering Options](#)

Item	Model No.		W	D	H	Ship Wt	Cubic Ft	List Price
ROUND GROMMET COVER	01-GRMTBK	Black	2 $\frac{3}{8}$	2 $\frac{3}{8}$	-	1	0.1	\$ 11
	01-GRMTSL	Silver	2 $\frac{3}{8}$	2 $\frac{3}{8}$	-	1	0.1	\$ 11



OPEN MARKET ONLY
(SILVER)

Description

- 2 $\frac{3}{8}$ " (60mm) Round Grommet Cover
- Field Installed

SINGLE POWER SAND DOLLAR	01-SAND60PS	Silver	3	3	4	1	0.2	\$ 95
	01-SAND60PW	White						
	01-SAND60PB	Black						

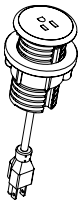

Description

- Mounts in 2 $\frac{3}{8}$ " (60mm) Round Grommet
- Single Power Outlet with 6' Cord

DOUBLE USB SAND DOLLAR	01-SAND60US	Silver	3	3	4	1	0.2	\$ 268
	01-SAND60UW	White						
	01-SAND60UB	Black						

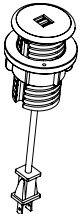

Description

- Mounts in 2 $\frac{3}{8}$ " (60mm) Round Grommet
- Dual USB Outlets with 6' Cord

DUO BEZEL CLAMP NEMA PLUG	01-DUOCLAMPS	Silver	5 $\frac{1}{2}$	3	7	1	0.2	\$ 553
	01-DUOCLAMPW	White						
	01-DUOCLAMPB	Black						

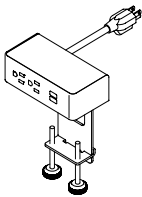

Description

- Silver Metal Trim
- Clamps to Top
- Two (2) Power/Two (2) USB; 10' Cord
- Independent USB Circuit Controllers Deliver up to 2.1 Amps to Each Post
- All Mounting Hardware Included
- FCC Part 15A and UL Approved for Horizontal and Vertical Applications

[See Cameo Overview For Ordering Options](#)

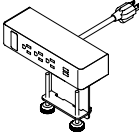
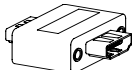
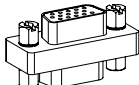
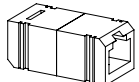
Item	Model No.		W	D	H	Ship Wt	Cubic Ft	List Price
TRIO BEZEL CLAMP NEMA PLUG 	01-TRIOCLAMPS	Silver	8	3	7	1	0.2	\$ 648
	01-TRIOCLAMPW	White						
	01-TRIOCLAMPS	Black						
Description <ul style="list-style-type: none"> • Silver Metal Trim • Clamps to Top • Three (3) Power/Two (2) USB Power/One (1) Open Data; 10' Cord • Independent USB Circuit Controllers Deliver up to 2.1 Amps to Each Post • HDMI, VGA, or RJ45 Accessories Sold Separately; See Below • All Mounting Hardware Included • FCC Part 15A and UL Approved for Horizontal and Vertical Applications 								
HDMI DATA PORT ACCESSORY FOR TRIO UNITS 	01-LCOMHDMI		-	-	-	1	0.2	\$ 160
Description <ul style="list-style-type: none"> • HDMI Port for Trio Bezel Units 								
OPEN MARKET ONLY								
VGA DATA PORT ACCESSORY FOR TRIO UNITS 	01-LCOMVGA		-	-	-	1	0.2	\$ 117
Description <ul style="list-style-type: none"> • VGA Port for Trio Bezel Units 								
RJ45 DATA PORT ACCESSORY FOR TRIO UNITS 	01-LCOMRJ45		-	-	-	1	0.2	\$ 76
Description <ul style="list-style-type: none"> • RJ45 Port for Trio Bezel Units 								

[See Cameo Overview For Ordering Options](#)

Item	Model No.	W	D	H	Ship Wt	Cubic Ft	List Price
VESTA POWER CENTER	01-PDCTR	10 $\frac{3}{4}$	12	28 $\frac{1}{4}$	14	2.5	\$ 1716



Description

- Top Includes One (1) Power Outlet, Two (2) USB Ports and One (1) USBC Port; Base Includes Three (3) Outlets
- Available in White
- 120" Power Cord
- Built with Weight Distribution for Optimal Stability
- Base is 5" Tall

WIRE MANAGERS

01-WMGR4	16	1 $\frac{1}{2}$	$\frac{3}{4}$	1	-	\$ 112
----------	----	-----------------	---------------	---	---	--------

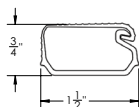
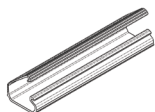

Description

- Four (4) Wire Manager Strips
- Black Plastic
- Snap Lock Channel
- Attaches with Adhesive Strips
- Can be Placed on All Units to Route Wires

CABLE GRIP

01-WMGRCB	5 $\frac{3}{8}$	2 $\frac{5}{8}$	-	-	-	\$ 16
-----------	-----------------	-----------------	---	---	---	-------

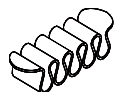

Description

- Under Surface Wire Management
- Black

POWER STRIP

01-PRSP	9	2	2	1	-	\$ 198
---------	---	---	---	---	---	--------

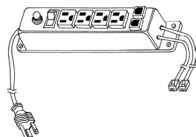

Description

- Includes Four (4) Outlets and Two (2) Phone Jacks
- Black Plastic with Rocker On/Off Switch
- 13 Amp Circuit Breaker
- 10' Power Cord and Two (2) 14' Phone Hook Up Cords
- UL Listed and CSA Certified
- Suitable for Surface or Recessed Mounting
- Ships via UPS Only

Item	Model No.	Description	List Price
ECA TELECOM PLATES	01-ABL	Telecom Plate, Blank Plate	\$ 40
	01-ABL737373	Telecom Plate, Three (3) RJ45 Cat 5e	\$ 355
	Compatible with:		
	01-ABLAB	Telecom Plate, One (1) RJ45 Cat 6, One (1) RJ11 Cat 3 Phone	\$ 199
	01-ABLAB102	Telecom Plate, One (1) RJ45 Cat 6, One (1) RJ11 Cat 3, One (1) USB W/72" Patch Cord	\$ 309
	01-ABLABB	Telecom Plate, Two (2) RJ45 Cat 6, One (1) RJ11 Cat 3 Phone	\$ 309
	01-ABLB	Telecom Plate, One (1) RJ45 Cat 6	\$ 144
	01-ABLB	Telecom Plate, Two (2) RJ45 Cat 6	\$ 251
	01-ABLB	Telecom Plate, Three (3) RJ45 Cat 6	\$ 355
	01-ABLB	Telecom Plate, Four (4) RJ45 Cat 6	\$ 460
	01-ABLBB	Telecom Plate, Two (2) RJ45 Cat 6, One (1) 15 Pin HD VGA w/72" Patch Cord	\$ 431
	01-ABLBB	Telecom Plate, One (1) RJ45 Cat 6, One (1) Mini Stereo Inline, One (1) 15 Pin HD VGA w/72" Patch Cord	\$ 396
	01-ABLBB	Telecom Plate, One (1) RJ45 Cat 6 Data Inline, One (1) RJ11 Cat 3 Phone Inline	\$ 190
	01-ABLBB	Telecom Plate, One (1) HDMI w/36" Patch Cord	\$ 285
	01-ABLBB	Telecom Plate, One (1) Mini Stereo Inline, One (1) HDMI w/36" Patch Cord, One (1) 15 Pin HD VGA w/72" Patch Cord	\$ 539
	01-ABLBB	Telecom Plate, One (1) 15 Pin HD VGA & One (1) Mini Stereo Inline Jack	\$ 288
	01-ABLBB	Telecom Plate, Three (3) Cord Bushings	\$ 93

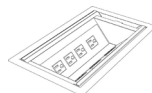

Oasis Mini Power & Data
01-OASISMA, 01-OASISMB



Interact Power & Data
01-INTERACTG2A, 01-INTERACTG2B

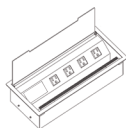

Power Center
01-INTRFCIA, 01-INTRFCIB

Standard Cutout Types & General Location Information

- Grommets can be specified, at an upcharge, add \$11 for a field installed grommet cover or add \$50 for a factory installed grommet (unless otherwise noted).
- Power/Data Modules can be specified in standard locations at no additional charge.
- The selection of both the Power/Data Module and Base will determine cutout locations for each table size, as well as placement over or between bases.
- [See exact measurements of Module locations.](#)
- For specific locations available by table size see series pages, [see Cameo locations.](#)

Cutout Locations Available

OC = On Center
BB = Between Bases (*requires 2 modules*)
CL = Left of Center
CR = Right of Center
EL = End Left
ER = End Right
ML = Middle Left
MR = Middle Right

General Location of Cutouts

*For Tables with **Two (2) Bases** and **One (1) Location**:*

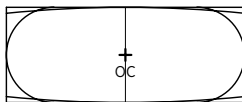

On Center
(OC)



One End
(EL)

*For Tables with **Two (2) Bases** and **Two (2) Locations**:*

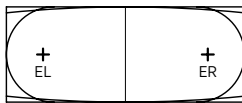

Both Ends
(EL + ER)

*For Tables with **Three (3) Bases** and **One (1) Location**:*

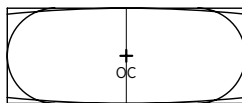

On Center
(OC)



One End
(EL)

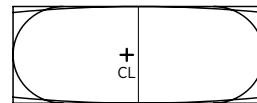

Off Center
(CL)

*For Tables with **Three (3) Bases** and **Two (2) Locations**:*

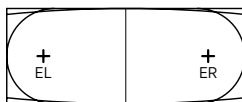

Both Ends
(EL + ER)

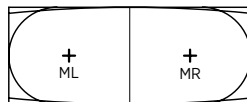

Middle of Each End
(ML + RL)

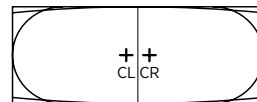

Off Center Left and Right
(CL + CR)

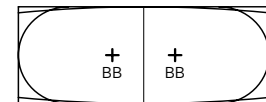

Between the Bases
(BB, Slightly Off Center Between Bases)

*For Tables with **Three (3) Bases** and **Three (3) Locations**:*

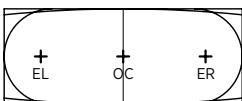

On Center and Both Ends
(OC + EL + ER)

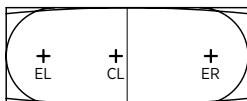

Left of Center and Both Ends
(CL + EL + ER)

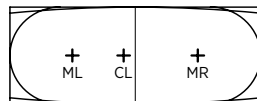

Off Center and Middle of Each End
(CL + ML + MR)

Continued on Next Page.

[See Cameo Overview For Ordering Options](#)

Standard Cutout Types & General Location Information (Continued)

- Grommets can be specified, at an upcharge, add \$11 for a field installed grommet cover or add \$50 for a factory installed grommet (unless otherwise noted).
- Power/Data Modules can be specified in standard locations at no additional charge.
- The selection of both the Power/Data Module and Base will determine cutout locations for each table size, as well as placement over or between bases.
- [See exact measurements of Module locations.](#)
- For specific locations available by table size see series pages, [see Cameo locations.](#)

Cutout Locations Available

OC = On Center
BB = Between Bases (*requires 2 modules*)
CL = Left of Center
CR = Right of Center
EL = End Left
ER = End Right
ML = Middle Left
MR = Middle Right

General Location of Cutouts

Continued from Previous Page

*For Tables with **Three (3) Bases** and **Four (4) Locations**:*

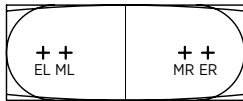

Middle of Each End and Both Ends
(ML + MR + EL + ER)

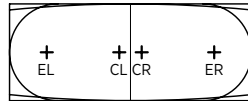

Off Center and Both Ends
(CL + CR + EL + ER)

*For Tables with **Five (5) Bases** and **One (1) Location**:*

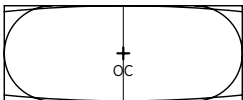

On Center
(OC)



One End
(EL)

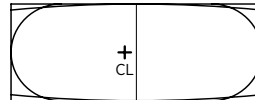

Off Center
(CL)

*For Tables with **Five (5) Bases** and **Two (2) Locations**:*



Both Ends
(EL + ER)



Middle of Each End
(ML + MR)

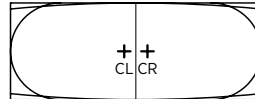

Off Center Left and Right
(CL + CR)

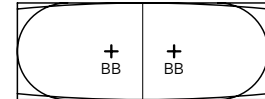

Between the Bases
(BB, Slightly Off Center Between Bases)

*For Tables with **Five (5) Bases** and **Three (3) Locations**:*

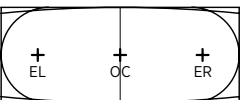

On Center and Both Ends
(OC + EL + ER)

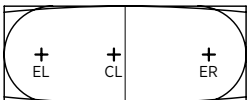

Left of Center and Both Ends
(CL + EL + ER)

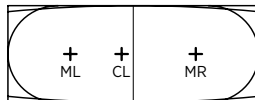

Off Center and Middle of Each End
(CL + ML + MR)

*For Tables with **Five (5) Bases** and **Four (4) Locations**:*

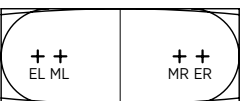

Middle of Each End and Both Ends
(ML + MR + EL + ER)

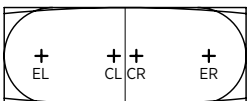







Off Center and Both Ends
(CL + CR + EL + ER)

[See Cameo Overview For Ordering Options](#)

Location Measurements By Module



	72" Tops	96" Tops	120", 144" & 168" Tops	192" Tops
	OC On Center BB Between Bases (requires 2 modules)		CL Left of Center CR Right of Center	EL End Left ER End Right ML Middle Left MR Middle Right
GROMMET 	OC Center of Table	OC Center of Table EL, EL + ER 24½" from end	CL, CL + CR 5½" from center EL, EL + ER 24½" from end CL + EL + ER, CL + CR + EL + ER 5½" from center and 24½" from end BB Slightly off centered between bases	CL, CL + CR 5½" from center EL, EL + ER 24½" from end CL + EL + ER, CL + CR + EL + ER 5½" from center and 24½" from end BB Slightly off centered between bases ML + MR 48" from end CL + ML + MR, CL + CR + ML + MR 5½" from center and 48" from end
POWER 440  INTERACT 	OC Center of Table	OC Center of Table EL, EL + ER 25" from end	OC Splits seam in center of bases EL, EL + ER 25" from end CL, CL + CR 5" from center CL + EL + ER, CL + CR + EL + ER 5" from center and 25" from end BB Slightly off centered between bases	OC Splits seam in center of bases EL, EL + ER 25" from end CL, CL + CR 5" from center CL + EL + ER, CL + CR + EL + ER 5" from center and 25" from end BB Slightly off centered between bases ML + MR 48" from end CL + ML + MR, CL + CR + ML + MR 5" from center and 48" from end
DPORT 4A  OASIS MINI,  INTRFC1  POWER & DATA VAULT 	OC Center of Table	OC Center of Table EL, EL + ER 29" from end	OC Splits seam in center of bases EL, EL + ER 29" from end CL + EL + ER, CL + CR + EL + ER 9½" from center and 29" from end CL, CL + CR 9½" from center BB Slightly off centered between bases	OC Splits seam in center of bases EL, EL + ER 29" from end CL + EL + ER, CL + CR + EL + ER 9½" from center and 29" from end CL, CL + CR 9½" from center BB Slightly off centered between bases ML + MR 48" from end OC+ EL + ER Splits center seam and 29" from end OC+ ML + MR Splits center seam and 48" from end CL + ML + MR, CL + CR + ML + MR 9½" from center and 48" from end

[See Cameo Overview For Ordering Options](#)



36"x72" & 42"x96" TOPS

For General Location Information, [See Cut Out Locations](#); For Exact Measurements of Locations, [See Details](#).

TOP LOCATIONS AVAILABLE BY BASE & MODULE COMBINATION

OC On Center

BB Between Bases (requires 2 modules)

CL Left of Center











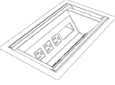

CR Right of Center

EL End Left

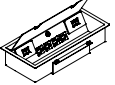
ER End Right

ML Middle Left

MR Middle Right

36x72				42x96			
	RECTANGLE	SQUARE	QUEEN ANNE		RECTANGLE	SQUARE	QUEEN ANNE
GROMMET 	OC	OC	OC	GROMMET 	OC EL EL + ER	OC EL EL + ER	OC
POWER & DATA VAULT 	OC			POWER & DATA VAULT 	OC EL EL + ER	OC EL EL + ER	OC
OASIS MINI 	OC			OASIS MINI 	OC EL EL + ER	OC EL EL + ER	OC
INTERACT 	OC			INTERACT 	OC EL EL + ER	OC EL EL + ER	OC
INTRFC1 	OC			INTRFC1 	OC EL EL + ER	OC EL EL + ER	OC
POWER 440 	OC	OC	OC	POWER 440 	OC EL EL + ER	OC EL EL + ER	OC
DPORT4A 	OC	OC	OC	DPORT4A 	OC EL EL + ER	OC EL EL + ER	OC

[See Cameo Overview For Ordering Options](#)

















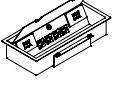



48"x120" & 48"x144" TOPS

For General Location Information, [See Cut Out Locations](#); For Exact Measurements of Locations, [See Details](#).

TOP LOCATIONS AVAILABLE BY BASE & MODULE COMBINATION

OC On Center **CL** Left of Center **EL** End Left **ML** Middle Left
BB Between Bases (requires 2 modules) **CR** Right of Center **ER** End Right **MR** Middle Right

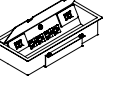
	48x120		
	RECTANGLE 	SQUARE 	QUEEN ANNE 
GROMMET 	BB, CL or EL CL + CR EL + ER CL + EL + ER CL + CR + EL + ER	BB, CL or EL CL + CR EL + ER CL + EL + ER CL + CR + EL + ER	BB
POWER & DATA VAULT 	BB, CL or EL CL + CR EL + ER CL + EL + ER CL + CR + EL + ER	OC EL EL + ER OC + EL + ER	
OASIS MINI 	BB, CL or EL CL + CR EL + ER CL + EL + ER CL + CR + EL + ER	OC EL EL + ER OC + EL + ER	
INTERACT 	BB, CL or EL CL + CR EL + ER CL + EL + ER CL + CR + EL + ER	OC EL EL + ER OC + EL + ER	BB
INTRFC1 	BB, CL or EL CL + CR EL + ER CL + EL + ER CL + CR + EL + ER	OC EL EL + ER OC + EL + ER	BB
POWER 440 	BB, CL or EL CL + CR EL + ER CL + EL + ER CL + CR + EL + ER	BB, CL or EL CL + CR EL + ER CL + EL + ER CL + CR + EL + ER	BB
DPORT4A 	BB, CL or EL CL + CR EL + ER CL + EL + ER CL + CR + EL + ER	OC EL EL + ER OC + EL + ER	BB

	48x144		
	RECTANGLE 	SQUARE 	QUEEN ANNE 
GROMMET 	BB, CL or EL CL + CR EL + ER CL + EL + ER CL + CR + EL + ER	BB, CL or EL CL + CR EL + ER CL + EL + ER CL + CR + EL + ER	BB
POWER & DATA VAULT 	BB, CL or EL CL + CR EL + ER CL + EL + ER CL + CR + EL + ER	OC BB EL EL + ER OC + EL + ER	BB
OASIS MINI 	BB, CL or EL CL + CR EL + ER CL + EL + ER CL + CR + EL + ER	OC BB EL EL + ER OC + EL + ER	BB
INTERACT 	BB, CL or EL CL + CR EL + ER CL + EL + ER CL + CR + EL + ER	OC BB EL EL + ER OC + EL + ER	BB
POWER CENTER 	BB, CL or EL CL + CR EL + ER CL + EL + ER CL + CR + EL + ER	OC BB EL EL + ER OC + EL + ER	BB
POWER 440 	BB, CL or EL CL + CR EL + ER CL + EL + ER CL + CR + EL + ER	BB, CL or EL CL + CR EL + ER CL + EL + ER CL + CR + EL + ER	BB
DPORT4A 	BB, CL or EL CL + CR EL + ER CL + EL + ER CL + CR + EL + ER	OC BB EL EL + ER OC + EL + ER	BB

[See Cameo Overview For Ordering Options](#)



48"x168" & 48"x192" TOPS

For General Location Information, [See Cut Out Locations](#); For Exact Measurements of Locations, [See Details](#).

TOP LOCATIONS AVAILABLE BY BASE & MODULE COMBINATION

OC On Center

BB Between Bases (requires 2 modules)

CL Left of Center

CR Right of Center

EL End Left

ER End Right

ML Middle Left

MR Middle Right

48x168			
	RECTANGLE	SQUARE	QUEEN ANNE
	BB, CL or EL CL + CR EL + ER CL + EL + ER CL + CR + EL + ER	BB, CL or EL CL + CR EL + ER CL + EL + ER CL + CR + EL + ER	BB
	BB, CL or EL CL + CR EL + ER CL + EL + ER CL + CR + EL + ER	OC, BB or EL EL + ER OC + EL + ER	BB
	BB, CL or EL CL + CR EL + ER CL + EL + ER CL + CR + EL + ER	OC, BB or EL EL + ER OC + EL + ER	BB
	BB, CL or EL CL + CR EL + ER CL + EL + ER CL + CR + EL + ER	OC, BB or EL EL + ER OC + EL + ER	BB
	BB, CL or EL CL + CR EL + ER CL + EL + ER CL + CR + EL + ER	OC, BB or EL EL + ER OC + EL + ER	BB
	BB, CL or EL CL + CR EL + ER CL + EL + ER CL + CR + EL + ER	BB, CL or EL CL + CR EL + ER CL + EL + ER CL + CR + EL + ER	BB
	BB, CL or EL CL + CR EL + ER CL + EL + ER CL + CR + EL + ER	OC, BB or EL EL + ER OC + EL + ER	BB

48x192			
	RECTANGLE	SQUARE	QUEEN ANNE
	CL or EL CL + CR EL + ER ML + MR CL + EL + ER CL + ML + MR CL + CR + EL + ER CL + CR + ML + MR	BB, CL or EL CL + CR EL + ER ML + MR CL + EL + ER CL + ML + MR CL + CR + EL + ER CL + CR + ML + MR	BB ML + MR
	CL or EL CL + CR EL + ER ML + MR CL + EL + ER CL + ML + MR CL + CR + EL + ER CL + CR + ML + MR	OC, BB or EL EL + ER ML + MR OC + EL + ER OC + ML + MR	BB ML + MR
	CL or EL CL + CR EL + ER ML + MR CL + EL + ER CL + ML + MR CL + CR + EL + ER CL + CR + ML + MR	OC, BB or EL EL + ER ML + MR OC + EL + ER OC + ML + MR	BB ML + MR
	CL or EL CL + CR EL + ER ML + MR CL + EL + ER CL + ML + MR CL + CR + EL + ER CL + CR + ML + MR	OC, BB or EL EL + ER ML + MR OC + EL + ER OC + ML + MR	BB ML + MR
	CL or EL CL + CR EL + ER ML + MR CL + EL + ER CL + ML + MR CL + CR + EL + ER CL + CR + ML + MR	OC, BB or EL EL + ER ML + MR OC + EL + ER OC + ML + MR	BB ML + MR
	CL or EL CL + CR EL + ER ML + MR CL + EL + ER CL + ML + MR CL + CR + EL + ER CL + CR + ML + MR	BB, CL or EL CL + CR EL + ER ML + MR CL + EL + ER CL + ML + MR CL + CR + EL + ER CL + CR + ML + MR	BB ML + MR
	CL or EL CL + CR EL + ER ML + MR CL + EL + ER CL + ML + MR CL + CR + EL + ER CL + CR + ML + MR	OC, BB or EL EL + ER ML + MR OC + EL + ER OC + ML + MR	BB ML + MR

[See Cameo Overview For Ordering Options](#)

Catalyst Tables blend desired aesthetics, functionality, and technology to deliver a comprehensive solution for all types of meeting needs and spaces. The line boasts a broad selection of veneers, laminates, and glass with a variety of top shapes, and a vast range of sizes spanning from 36"D to 60"D and 36"W to 240"W, integrated power/data, and a variety of heights, including work, counter, and bar. Buffets, Credenzas, Waste Bins, and more will help to complete your space.

CONSTRUCTION

VENEER

- Exposed surfaces feature select grade plain-sliced hardwood veneers in Cherry, Maple, American Black Walnut, or composite veneers. Veneers are carefully selected and matched to assure proper balance and consistency
- Veneer features UVAdvantage, an ultra-violet finish, on all exposed surfaces by utilizing roll-coat UV technology

LAMINATE

- Thermally-Fused Laminate (TFL) and High-Pressure Laminate (HPL) are made of woodgrain and solid color laminates fused to particleboard core; each laminate offers lasting beauty, superior resistance to normal wear, and easy maintenance

TOPS

- Veneer (W) or HPL (P) Tops available in five shapes: Rectangle, Boat, Modern Rectangle, Square and Round with woodgrain patterns following the depth (short) of Veneer (W) table tops while grain patterns follow the width (long) of HPL (P) table tops
- Tops are shaped on all four sides and are available in two thicknesses and five edge profiles
- Double Kerf (F), Duo (G) and Square (Y) available in Veneer (W) and HPL (P) tops with 3-ply balanced construction, 1 $\frac{3}{16}$ " thick and matching 3mm wood or PVC rims on profiled edges
- Knife (K) edge profile tops are 1 $\frac{3}{16}$ " thick with solid wood rims available on both Veneer (W) or HPL (P) tops
- Vertical Square (H) edge profile tops are 1 $\frac{1}{2}$ " thick with 1.5mm wood edge-banded rims on Veneer (W) tops and 1mm PVC edge-banded rims on HPL (P) tops
- Credenzas, buffets, and other ancillary support models are available in Square (Y), Double Kerf (F), Duo (G), and Vertical Square (H) edge profiles and profiled on approach side only
- All surfaces feature reverse slip matched pattern
- Back Painted, Tempered Glass Tops are 1/4" thick and are attached to a substrate topped with black paper covering
- Tempered glass top has a 1/8" overhang from the sub-top

LOCKING

- All box drawers feature locking
- Removable lock cylinders allow for units to be re-keyed at a later date, if required
- Units are shipped randomly keyed as standard
- Keyed alike units available upon request at no additional charge
- Lock core is predetermined by pull color. Black lock cores are used with black and gold pulls while silver lock cores are used with chrome and aluminum pulls
- Optional locking doors available on buffets and credenzas

BASES

- All rectangle bases are available in TFL (T) or Veneer (W), feature vertical grain direction and include L-bracket hardware for easy installation
- Rectangle box bases include removable access panel and wire management and support trough
- Rectangle Accent bases feature 5/16" metal accent available in four colors including Aluminum, Black, Gold, and Platinum
- All units ship with heavy-duty, adjustable leveling glides to ensure proper leveling and compensation for uneven floors

CHASSIS

- All credenzas are available in TFL (T) or Veneer (W) with vertical grain direction
- Chassis for storage units are securely fastened using high quality European fastening systems and heavy-duty 16-gauge joining brackets to assure maximum strength
- All units ship with heavy-duty, adjustable leveling glides to ensure proper leveling and compensation for uneven floors

DRAWERS

- Drawers feature 5-sided drawer construction allowing for easy removal of drawer fronts; All drawer fronts are standard with elegant vertically matched faces
- Drawer sides, back, and front are woodgrain vinyl-wrapped 1/2" thick with 1/8" thick hardboard bottoms
- Drawer interiors are dovetail construction with 7/16" thick hardwood sides and backs, and 5/32" thick hardboard bottoms
- All drawers feature full extension, progressive action slides with precision steel ball bearings
- Box drawers are tested for 100lb capacity
- All suspensions have a limited lifetime warranty

STORAGE

- All hinged doors are soft-close with one piece hinge and base plate combination
- Soft close hinges reduce stress placed on the cabinet when the door is closed and offers a quiet closure
- All Credenzas feature a 2"W wire management channel along back of the interior cabinet for easy accessibility to wall outlets

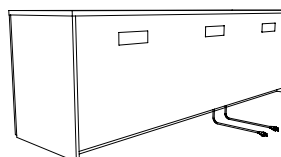

2"W wire management channel

INTERIOR DRAWER DIMENSIONS

Models

88-2496BF

	W	L	D
Box Drawers	15 $\frac{3}{4}$ "	16 $\frac{3}{8}$ "	3 $\frac{2}{32}$ "

Models

88-2484BF

	W	L	D
Box Drawers	30"	16 $\frac{3}{8}$ "	3 $\frac{2}{32}$ "
	13 $\frac{3}{8}$ "	16 $\frac{3}{8}$ "	3 $\frac{2}{32}$ "

Models

88-2472BF

88-2436BF

	W	L	D
Box Drawers	32 $\frac{3}{16}$ "	16 $\frac{3}{8}$ "	3 $\frac{2}{32}$ "

Models

88-2460BF

	W	L	D
Box Drawers	16 $\frac{1}{2}$ "	16 $\frac{3}{8}$ "	3 $\frac{2}{32}$ "

Models

88-2448BF

	W	L	D
Box Drawers	20 $\frac{15}{16}$ "	16 $\frac{3}{8}$ "	3 $\frac{2}{32}$ "

INTERIOR CABINET DIMENSIONS

Models

88-2496BF

	W	D	H
Double Door	36 $\frac{3}{4}$ "	22 $\frac{3}{8}$ "	23 $\frac{1}{2}$ "
Single Door with Waste Bin	18"	22 $\frac{3}{8}$ "	23 $\frac{1}{2}$ "

Models

88-2484BF

	W	D	H
Double Door	32"	22 $\frac{3}{8}$ "	23 $\frac{1}{2}$ "
Single Door with Waste Bin	15 $\frac{1}{2}$ "	22 $\frac{3}{8}$ "	23 $\frac{1}{2}$ "

Models

88-2472BF

88-2436BF

	W	D	H
Double Door	34 $\frac{3}{8}$ "	22 $\frac{3}{8}$ "	23 $\frac{1}{2}$ "
Single Door with Waste Bin	16 $\frac{3}{4}$ "	22 $\frac{3}{8}$ "	23 $\frac{1}{2}$ "

Models

88-2460BF

	W	D	H
Single Door	18 $\frac{3}{8}$ "	22 $\frac{3}{8}$ "	23 $\frac{1}{2}$ "

Models

88-2448BF

	W	D	H
Double Door	46 $\frac{3}{8}$ "	22 $\frac{3}{8}$ "	23 $\frac{1}{2}$ "
Single Door with Waste Bin	22 $\frac{3}{4}$ "	22 $\frac{3}{8}$ "	23 $\frac{1}{2}$ "

Models

88-2496CC

	W	D	H
Double Door	36 $\frac{3}{4}$ "	22 $\frac{3}{8}$ "	24 $\frac{3}{8}$ "
Single Door with Waste Bin	18"	22 $\frac{3}{8}$ "	24 $\frac{3}{8}$ "

Models

88-2484CC

	W	D	H
Double Door	32"	22 $\frac{3}{8}$ "	24 $\frac{3}{8}$ "
Single Door with Waste Bin	15 $\frac{1}{2}$ "	22 $\frac{3}{8}$ "	24 $\frac{3}{8}$ "

Models

88-2472CC

88-2436BF

	W	D	H
Double Door	34 $\frac{3}{8}$ "	22 $\frac{3}{8}$ "	24 $\frac{3}{8}$ "
Single Door with Waste Bin	16 $\frac{3}{4}$ "	22 $\frac{3}{8}$ "	24 $\frac{3}{8}$ "

Models

88-2460CC

	W	D	H
Single Door with Waste Bin	18 $\frac{3}{8}$ "	22 $\frac{3}{8}$ "	24 $\frac{3}{8}$ "

Models

88-2448CC

	W	D	H
Double Door	46 $\frac{3}{8}$ "	22 $\frac{3}{8}$ "	24 $\frac{3}{8}$ "
Single Door with Waste Bin	22 $\frac{3}{4}$ "	22 $\frac{3}{8}$ "	24 $\frac{3}{8}$ "

Models

88-2096CC

	W	D	H
Double Door	36 $\frac{3}{4}$ "	18 $\frac{3}{8}$ "	24 $\frac{3}{8}$ "
Single Door	17 $\frac{3}{8}$ "	18 $\frac{3}{8}$ "	24 $\frac{3}{8}$ "

Models

88-2084CC

	W	D	H
Double Door	32"	18 $\frac{3}{8}$ "	24 $\frac{3}{8}$ "
Single Door	15 $\frac{1}{2}$ "	18 $\frac{3}{8}$ "	24 $\frac{3}{8}$ "

INTERIOR CABINET DIMENSIONS CONTINUED

Models

88-2072CC	88-2036CC		
	W	D	H
Single Door	34 ³ / ₈ "	18 ³ / ₈ "	24 ³ / ₈ "

Models

88-2060CC			
	W	D	H
Single Door	18 ³ / ₈ "	18 ³ / ₈ "	24 ³ / ₈ "

Models

88-2048CC			
	W	D	H
Double Door	46 ³ / ₈ "	18 ³ / ₈ "	24 ³ / ₈ "

HOW TO ORDER EXAMPLES

SQUARE MEETING TABLE

	QTY	MODEL NO.		EXAMPLE
TOP	1	88-4848SQ	Top/Edge Material Finish/Color Edge Profile Glass Top Glass Color/Surface Finish Power/Data Location	P FO 3MMW/F Y GBLG OC
BASE	1	08-2642LXBA		
POWER	1	01-DUOBEZELS		

MODERN RECTANGLE MEETING TABLES

	QTY	MODEL NO.		EXAMPLE
TOP	1	88-54192MR	Top/Edge Material Top/Edge Finish/Color Edge Profile Glass Top Glass Color/Surface Finish Grommet/Power/Data Type Grommet/Power/Data Location	W MAS 3MMW/F Y GBLG DPORTA OC
BASES	1	88-2415406RAB	Base Material Base Finish/Color Accent Finish/Color Metal Accent Color	W MAS BL GLD
POWER	1	DPORTA		

STORAGE & ACCESSORIES

Buffet Credenza			
QTY	MODEL NO.		EXAMPLE
1	88-2472BF	Top/Edge Material Finish/Color Edge Profile Chassis Finish/Color Glass Top Glass Color/Surface Finish Studio Pull Color Locking Drawer Construction Drawer Track Vent Waste Bin	W MAS 3MMW/F ORW Y GBLG GST LKT_BFD DOVE SFTCL VENT WBL

VENEER (W) OPTIONS ON TOPS / EDGES, BASES, AND ACCENT PANELS

Veneer features UVAdvantage, an ultra-violet finish, on all exposed surfaces or our Catalyzed finish (where noted), which is a multi-step, finish process that provides years of lasting beauty.

AW	Artisan Walnut	MW	Mahogany Walnut
AS	Asian Night	MAS	Mesa Sunset*
CO	Columbian Walnut	MTS	Metropolis Sky
DC	Dark Cherry	ORW	Oak Riftwood*
DFW	Dark Forest Walnut	PNW	Pinnacle Walnut
EW	Espresso	SCH	Select Cherry
FO	Fawn Oak*	SKC	Shaker Cherry
GC	Golden Cherry	SM	Sugar Maple
HW	Harvest Walnut	WTA	Weathered Ash*
HNW	Henna Walnut	WC	Williamsburg Cherry
LW	Legacy Walnut		

* Finish is Low Sheen

TFL (T) OPTIONS FOR BASES / ACCENT PANELS AND HPL (P) LAMINATE OPTIONS ON TOPS / EDGES

WOODGRAIN

AS	Asian Night	PNW	Pinnacle Walnut
BW	Beigewood	PTK	Portico Teak
CO	Columbian Walnut	RC	River Cherry
EF	Espresso	SPW	Sepia Walnut
FLW	Florence Walnut	SKC	Shaker Cherry
GC	Golden Cherry*	SCH	Select Cherry*
KHE	Kirsche	SBP	Smoky Brown Pear
MW	Mahogany Walnut*	TK	Studio Teak
MNR	Midnight Run	SM	Sugar Maple
NTM	Natural Marrone	WTA	Weathered Ash
ORW	Oak Riftwood	WC	Williamsburg Cherry
		WNB	White Nebbia

SOLID

BL	Black	FHG	Fashion Grey
WH	Designer White	SG	Slate Grey

* Available On Top Surfaces Only.

BASE METAL ACCENT COLOR OPTIONS

6" and 10" Rectangle Accent Bases feature 5/16" metal trim. Must specify color

ALUM	Aluminum	PLAT	Platinum
BLK	Black	GLD	Gold

EDGE PROFILES

Double Kerf (F), Duo (G), Square (Y) and Knife (K) edge profiles are 1 3/16" thick and available in Veneer (W) and HPL (P) tops. Vertical Square (H) edge profile available is 1 1/2" thick and also available Veneer (W) and HPL (P) tops. Must specify edge profile.

Knife (K) edge not available on buffet and credenzas

Laminate (P) Top Edges

3MMP/F	Double Kerf (1 3/16"H)	RIMP/K	Knife (1 3/16"H)
3MMP/G	Duo (1 3/16"H)	HP	Vertical Square (1 1/2"H)
3MMP/Y	Square (1 3/16"H)		

Veneer (W) Top Edges

3MMW/F	Double Kerf (1 3/16"H)	RIMW/K	Knife (1 3/16"H)
3MMW/G	Duo (1 3/16"H)	HW	Vertical Square (1 1/2"H)
3MMW/Y	Square (1 3/16"H)		



Double Kerf (F) 1 3/16" H Duo (G) 1 3/16" H Square (Y) 1 3/16" H Knife (K) 1 3/16" H Vertical Square (H) 1 1/2" H

PULL OPTIONS

Buffets and Credenzas available with pulls on doors. Must specify and select color.

Lock core color is predetermined by pull color.

AST	Studio, Aluminum	CST	Studio, Chrome
BST	Studio, Black	GST	Studio, Gold



Studio (GST)
Gold - 13"

GLASS OPTIONS ON TOPS

Back painted tempered glass tops are 1/4" thick and available in Black or White with Gloss or Acid Etched finish. Glass top sits 1/16" on top of substrate top. Must specify color and finish.

GWHG	White Gloss	GBLG	Black Gloss
GWHA	White Acid Etched	GBLA	Black Acid Etched



White Gloss (GWHG)



Black Gloss (GBLG)

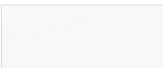

White Acid Etched (GWHA)



Black Acid Etched (GBLA)

LOCK CORE COLOR OPTIONS

BLK	Black (Used with Black and Gold Pulls)
SLV	Silver (Used with Aluminum and Chrome Pulls)

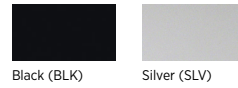

GROMMET & POWER UNIT OPTIONS

Power units and grommets are available on Rectangle, Modern Rectangle, and Boat shaped tops. Each unit is sold separately and must be specified separately with surface mount location. Multiple locations may be selected. Only one unit per location.

Power units and Grommets Available in Table Surfaces (See Units)

Grommet	\$ 50
Specify Color: Black = BLK and Silver = SLV	

DUO/TRIO BEZEL

01-DUOBEZEL	Available in Black (B), Silver (S), or White (W)
01-TRIOBEZEL	Available in Black (B), Silver (S), or White (W)

DOCK 950, DOCK 800 and DOCK 150

DOCK950	Available in Black or White
DOCK150	Available in Black or White
DOCK800	Available in Black or Silver

Other Power Units

DPORT4	Available in Aluminum or Black
ELLORA	Available in Aluminum or Black
E2X	Available in Aluminum or Black
INTERACTG	Available in Aluminum or Black
OASISM	Available in Aluminum or Black

Power/Data Location Information:

- Designate unit and location when specifying the top model. Power/Data Module need to be ordered separately.
- Power/Data Modules specified at the time of order will be routed for field installation.

E1	Unit on One End
E2	Unit on Each End
OC	Unit on Center

All power units available **On Center (OC)** only when paired with two (2) or more of the following bases:

Cylinder Base	Square Base
X-Base	Disc
Tubular X-Base	

Grommets and Power Units may be ordered in non-standard locations. Call Customer Service to assist with specification and/or please attach a drawing to the PO showing the location of the grommet. Note additional charges and lead times may apply.

Top Locations

Power units available on Each End (E1 and E2) and On Center (OC) unless otherwise noted, when paired with any Rectangle Panel Base, Rectangle Box Base or Rectangle Accent Box Base.

Power units centered at locations below:

36" Tops	Centered 18"D	54" Tops	Centered 27"D
42" Tops	Centered 21"D	60" Tops	Centered 30"D
48" Tops	Centered 24"D		

GROMMET OPTIONS & POWER UNIT OPTIONS CONTINUED

Top Locations Continued

- 72: OC 36" from end (available with OC Only)
- 84: OC 42" from end; E1/E2 24½" from end
- 96: OC 48" from end; E1/E2 29" from end
- 108 OC 54" from end; E1/E2 29" from end
- 120: OC 60" from end; E1/E2 29" from end
- 132: OC 66" from end; E1/E2 29" from end
- 144: OC 72" from end; E1/E2 29" from end
- 156: OC 78" from end; E1/E2 29" from end
- 168: OC 84" from end; E1/E2 29" from end
- 180: OC 90" from end; E1/E2 36" from end
- 192: OC 96" from end; E1/E2 36" from end
- 204: OC 102" from end; E1/E2 36" from end
- 216: OC 108" from end; E1/E2 36" from end
- 228: OC 114" from end; E1/E2 36" from end
- 240: OC 120" from end; E1/E2 36" from end

Example: 60x204 Modern Rectangle

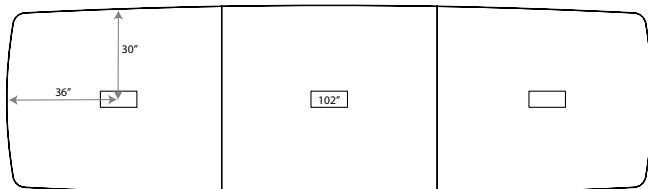

DRAWER TRACK OPTIONS

Soft close tracks are available on box drawers. Soft close drawer tracks have many benefits including reduced stress on the unit, extends the life of the drawer, and ensures a gentle close so fingers don't accidentally get pinched. Must specify when ordering.

Pricing is per Drawer, not per Model/Unit

SFTCL	Soft Close Drawer Track	\$ 33
-------	-------------------------	-------

VENT OPTION FOR CREDENZAS

Buffets and Credenzas feature optional ventilation grommets. Includes one vent per compartment.

Vents are 10" Down from top surface on Buffet Credenzas and 2⅞" on Credenzas.

NONE	No Vent Grommet	
VENT	Vented back panel	\$ 66

Number of vents per unit:

36"	1 vent
72" / 48"	2 vents
96" / 84" / 60"	3 vents

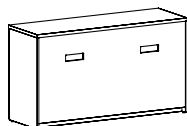

WASTE BIN OPTIONS

Buffet and 24" Credenzas are available with two (2) 41-quart beige waste bins in a pull out cabinet with silver hardware and divider panel. Adjacent cabinet features one (1) adjustable shelf. Studio pulls applied centered on doors when waste bin is selected. Locking not available.

WBL	Waste Bin on Left	\$ 493
WBR	Waste Bin on Right	\$ 493

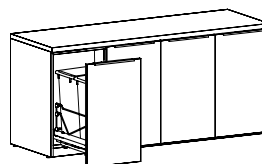

Shown as Left

LOCKING DOORS

Locking doors are available on Buffets and Credenzas. You must specify WITH LOCKING when ordering and add upcharge.

Note: When locking is selected with optional waste bin, locking will not apply to waste bin door.

LKT_BFD	96"W to 84"W Units	\$ 130
LKT_BFD	72"W to 48"W Units	\$ 111
LKT_BFD	36"W Units	\$ 88

CERTIFICATIONS & COMPLIANCE

- Intertek Sustainability Certified
- BIFMA level® Certified
- BIFMA Compliant® Certified
- TSCA Title VI (Formerly CARB) Compliance
- US Green Building's LEED® Contribution

Tops/Shapes



Square ([See Details](#))

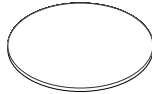

Round ([See Details](#))



Rectangular ([See Details](#))



Modern Rectangular ([See Details](#))



Boat ([See Details](#))

Bases

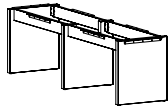

Rectangular Panel Bases with Trough ([See Details](#))

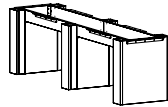

6" Rectangular Bases with Trough ([See Details](#))

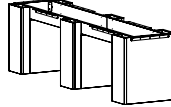

10" Rectangular Bases with Trough ([See Details](#))

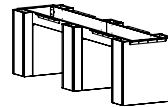

6" Rectangular Accent Bases with Trough ([See Details](#))

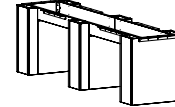

10" Rectangular Accent Bases with Trough ([See Details](#))

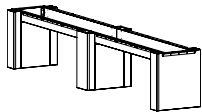

6" + 10" Combo Rectangular Bases with Trough ([See Details](#))

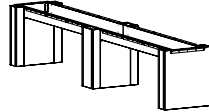

6" + 10" Combo Rectangular Accent Bases with Trough ([See Details](#))



Metal ([See Details](#))

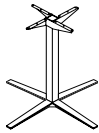

X-Base ([See Details](#))

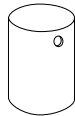

Cylinder ([See Details](#))



Disc Base ([See Details](#))

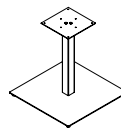

Square Base ([See Details](#))

Storage Components + Accessories

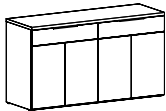

Buffet with Doors + Drawers ([See Details](#))

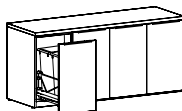

24" + 20" Credenzas with Doors ([See Details](#))

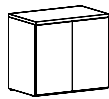

Mobile Serving Cart ([See Details](#))

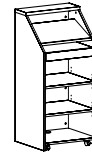

Lectern Stand ([See Details](#))

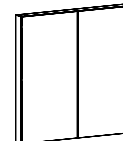

Visual Board ([See Details](#))

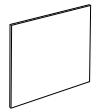
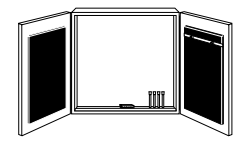

Marker Boards ([See Multiple Unit Details](#))



Marker, Eraser and Magnet Sets ([See Details](#))

Wire Management + Power/Data Accessories ([See Details](#))

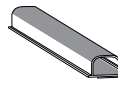
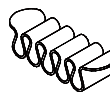
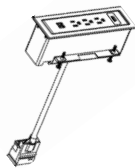
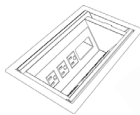
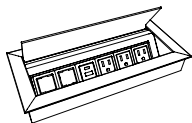

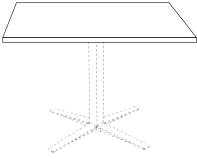

Item	Model No.		W	D	H	Ship Wt	Cubic Ft	Edge Profile + Material	List Price	
 <p>88-3636SQ shown with 08-2036SXB (Metal X-Base) BASES SOLD SEPARATELY</p> <p><u>Must Specify (in this order):</u> Model # Top/Edge Material Top/Edge Finish/Color Edge Profile Glass (Y/N) Glass Color + Surface Finish</p>	88-4848SQ	Laminate	48	48	1 ³ / ₁₆	82	7.2	F, G, Y / P\$	821	
					1 ³ / ₁₆			K / P\$	1351	
					1 ¹ / ₂			H / P\$	916	
					Veneer			1 ³ / ₁₆	F, G, Y / W\$	934
								1 ³ / ₁₆	K / W\$	1565
								1 ¹ / ₂	H / W\$	1107
		Glass		1/4	Acid Etched Glass Top \$	5271				
				1/4	Gloss Glass Top \$	4387				
	88-4242SQ	Laminate	42	42	1 ³ / ₁₆	70	3.4	F, G, Y / P\$	731	
					1 ³ / ₁₆			K / P\$	1174	
					1 ¹ / ₂			H / P\$	845	
					Veneer			1 ³ / ₁₆	F, G, Y / W\$	837
					1 ³ / ₁₆			K / W\$	1418	
					1 ¹ / ₂			H / W\$	929	
	Glass		1/4	Acid Etched Glass Top \$	4247					
			1/4	Gloss Glass Top \$	3570					
88-3636SQ	Laminate	36	36	1 ³ / ₁₆	37	2.5	F, G, Y / P\$	626		
				1 ³ / ₁₆			K / P\$	935		
				1 ¹ / ₂			H / P\$	723		
				Veneer			1 ³ / ₁₆	F, G, Y / W\$	799	
							1 ³ / ₁₆	K / W\$	1213	
							1 ¹ / ₂	H / W\$	855	
	Glass		1/4	Acid Etched Glass Top \$	3279					
			1/4	Gloss Glass Top \$	2782					
88-3030SQ	Laminate	30	30	1 ³ / ₁₆	30	2.3	F, G, Y / P\$	531		
				1 ³ / ₁₆			K / P\$	796		
				1 ¹ / ₂			H / P\$	599		
				Veneer			1 ³ / ₁₆	F, G, Y / W\$	611	
							1 ³ / ₁₆	K / W\$	943	
							1 ¹ / ₂	H / W\$	653	
	Glass		1/4	Acid Etched Glass Top \$	2509					
			1/4	Gloss Glass Top \$	2162					

Description

- Tops Feature a 1-piece, 1³/₁₆" or 1¹/₂" Thick Top in Veneer (W) or HPL (P)
- Must Specify Edge Profile: 1³/₁₆" Thick/Double Kerf (F), Duo (G), Square (Y), and Knife (K) Edge Profiles or 1¹/₂" Thick/Vertical Square (H)
- Due to Top Sizes and Base Placement, Power is Not Available on Square Tops
- Available with Back Painted Tempered Glass Top; Must Specify Color and Finish; [See Options](#)
- Bases Sold Separately, See [Multiple Base Options](#)



Double Kerf (F) 1³/₁₆"
Duo (G) 1³/₁₆"
Square (Y) 1³/₁₆"
Knife (K) 1³/₁₆"
Vertical Square (H) 1¹/₂"
P = HPL W = Veneer

[See Catalyst Overview For Ordering Options](#)

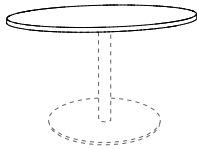
Item	Model No.		W	D	H	Ship Wt	Cubic Ft	Edge Profile + Material	List Price
 <p>88-4848CT shown with 01-3230DBB (Disc Base) BASES SOLD SEPARATELY</p> <p><u>Must Specify (in this order):</u> Model # Top/Edge Material Top/Edge Finish/Color Edge Profile Glass (Y/N) Glass Color + Surface Finish</p>	88-6060CT	Laminate	60	60	1 3/16	143	8.4	F, G, Y / P\$	1002
					1 3/16			K / P\$	2121
					1 1/2			H / P\$	1048
		Veneer	1 3/16	F, G, Y / W\$	1358				
			1 3/16	K / W\$	2378				
			1 1/2	H / W\$	1606				
	Glass	1/4	Acid Etched Glass Top \$	8387					
		1/4	Gloss Glass Top \$	6966					
	88-5454CT	Laminate	54	54	1 3/16	114	6.8	F, G, Y / P\$	963
					1 3/16			K / P\$	1935
					1 1/2			H / P\$	998
			Veneer	1 3/16	F, G, Y / W\$	1206			
1 3/16				K / W\$	2116				
1 1/2				H / W\$	1411				
Glass		1/4	Acid Etched Glass Top \$	7021					
		1/4	Gloss Glass Top \$	5868					
88-4848CT		Laminate	48	48	1 3/16	90	5.5	F, G, Y / P\$	873
					1 3/16			K / P\$	1830
					1 1/2			H / P\$	899
			Veneer	1 3/16	F, G, Y / W\$	989			
	1 3/16			K / W\$	2058				
	1 1/2			H / W\$	1155				
	Glass	1/4	Acid Etched Glass Top \$	5859					
		1/4	Gloss Glass Top \$	4949					
	88-4242CT	Laminate	42	42	1 3/16	70	3.4	F, G, Y / P\$	779
					1 3/16			K / P\$	1577
					1 1/2			H / P\$	841
			Veneer	1 3/16	F, G, Y / W\$	892			
1 3/16				K / W\$	1831				
1 1/2				H / W\$	974				
Glass		1/4	Acid Etched Glass Top \$	4725					
		1/4	Gloss Glass Top \$	4033					

Additional Round Tops on Next Page.



Double Kerf (F)
1 3/16"



Duo (G)
1 3/16"



Square (Y)
1 3/16"



Knife (K)
1 3/16"



Vertical Square (H)
1 1/2"

P = HPL W = Veneer

[See Catalyst Overview For Ordering Options](#)

Item	Model No.		W	D	H	Ship Wt	Cubic Ft	Edge Profile + Material	List Price	
<i>CONTINUED FROM PREVIOUS PAGE</i>	88-3636CT	Laminate	36	36	1 ³ / ₁₆	37	2.5	F, G, Y / P\$	676	
					1 ³ / ₁₆			K / P\$	1390	
					1 ¹ / ₂			H / P\$	767	
		Veneer	36	36	1 ³ / ₁₆	37	2.5	F, G, Y / W\$	851	
					1 ³ / ₁₆			K / W\$	1662	
					1 ¹ / ₂			H / W\$	863	
	Glass	36	36	1 ¹ / ₄	37	2.5	Acid Etched Glass Top \$	3771		
				1 ¹ / ₄			Gloss Glass Top \$	3259		
		88-3030CT	Laminate	30	30	1 ³ / ₁₆	30	2.3	F, G, Y / P\$	589
						1 ³ / ₁₆			K / P\$	1156
						1 ¹ / ₂			H / P\$	616
			Veneer	30	30	1 ³ / ₁₆	30	2.3	F, G, Y / W\$	661
1 ³ / ₁₆						K / W\$			1287	
1 ¹ / ₂						H / W\$			711	
Glass		30	30	1 ¹ / ₄	30	2.3	Acid Etched Glass Top \$	3346		
				1 ¹ / ₄			Gloss Glass Top \$	2989		

Must Specify (in this order):

- Model #
- Top/Edge Material
- Top/Edge Finish/Color
- Edge Profile
- Glass (Y/N)
- Glass Color + Surface Finish

Description

- Tops Feature a 1-piece, 1³/₁₆" or 1¹/₂" Thick Top in Veneer (W) or HPL (P)
- Must Specify Edge Profile: 1³/₁₆" Thick/Double Kerf (F), Duo (G), Square (Y), and Knife (K) Edge Profiles or 1¹/₂" Thick/Vertical Square (H)
- 60" and 54" Tops Feature Catalyzed Finish
- Due to Top Sizes and Base Placement, Power is Not Available on Round Tops
- Available with Back Painted Tempered Glass Top; Must Specify Color and Finish; [See Options](#)
- Bases Sold Separately, See [Multiple Base Options](#)



Double Kerf (F) 1³/₁₆" Duo (G) 1³/₁₆" Square (Y) 1³/₁₆" Knife (K) 1³/₁₆" Vertical Square (H) 1¹/₂"

P = HPL W = Veneer C = Combination of Wood/Laminate

[See Catalyst Overview For Ordering Options](#)

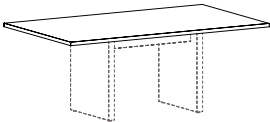
Item	Model No.		W	D	H	Ship Wt	Cubic Ft	Edge Profile + Material	List Price	
RECTANGLE SHAPE MEETING TOP 36"D  88-3672RT shown with 88-2034RPB (Rectangle Panel Base) BASES SOLD SEPARATELY	36"D x 96"W or 8' - 1 Piece Rectangle Top									
	88-3696RT	Laminate	96	36	1 3/16	142	12.9	F, G, Y / P\$	1318	
					1 3/16			K / P\$	2077	
					1 1/2			H / P\$	1495	
		Veneer			1 3/16			F, G, Y / W\$	1492	
					1 3/16			K / W\$	2470	
					1 1/2			H / W\$	1795	
		Glass			1/4			Acid Etched Glass Top \$	7859	
					1/4			Gloss Glass Top \$	6576	
	36"D x 84"W or 7' - 1 Piece Rectangle Top									
	88-3684RT	Laminate	84	36	1 3/16	126	11.3	F, G, Y / P\$	1255	
					1 3/16			K / P\$	1938	
					1 1/2			H / P\$	1439	
		Veneer			1 3/16			F, G, Y / W\$	1413	
					1 3/16			K / W\$	2355	
				1 1/2			H / W\$	1649		
	Glass			1/4			Acid Etched Glass Top \$	7066		
				1/4			Gloss Glass Top \$	5943		
36"D x 72"W or 6' - 1 Piece Rectangle Top										
88-3672RT	Laminate	72	36	1 3/16	109	10.3	F, G, Y / P\$	1016		
				1 3/16			K / P\$	1638		
				1 1/2			H / P\$	1148		
	Veneer			1 3/16			F, G, Y / W\$	1196		
				1 3/16			K / W\$	1891		
				1 1/2			H / W\$	1428		
	Glass			1/4			Acid Etched Glass Top \$	6107		
				1/4			Gloss Glass Top \$	5144		

Must Specify (in this order):

- Model #
- Top/Edge Material
- Top/Edge Finish/Color
- Edge Profile
- Glass (Y/N)
- Glass Color + Surface Finish
- Power/Data Type
- Power/Data Location

Description

- Tops Available with Veneer (W) or HPL (P) Top in 1 3/16" and 1 1/2" Thicknesses
- Must Specify Edge Profile: 1 3/16" Thick/Double Kerf (F), Duo (G), Square (Y), and Knife (K) Edge Profiles or 1 1/2" Thick/Vertical Square (H)
- Veneer (W) Top Grain Runs Depth of Top and HPL (P) Top Grain Runs Width of Top
- Available with Back Painted Tempered Glass Top; Must Specify Color and Finish; [See Options](#)
- Power and Data Options Available; Sold Separately, [See Multiple Power Unit Details](#)
- Bases Sold Separately, See [Multiple Base Options](#)



Double Kerf (F)
1 3/16"
Duo (G)
1 3/16"
Square (Y)
1 3/16"
Knife (K)
1 3/16"
Vertical Square (H)
1 1/2"
P = HPL W = Veneer

[See Catalyst Overview For Ordering Options](#)

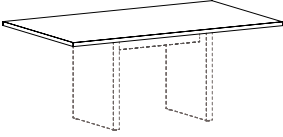
Item	Model No.		W	D	H	Ship Wt	Cubic Ft	Edge Profile + Material	List Price	
RECTANGLE SHAPE MEETING TOP 42"D  88-4272RT shown with 88-2034RPB (Rectangle Panel Base) BASES SOLD SEPARATELY	42"D x 120"W or 10' - 2 Piece Rectangle Top									
	88-42120RT	Laminate	120	42	1 3/16	268	27.0	F, G, Y / P\$	1828	
					1 3/16			K / P\$	2973	
					1 1/2			H / P\$	2089	
		Veneer			1 3/16			F, G, Y / W\$	2126	
					1 3/16			K / W\$	3374	
					1 1/2			H / W\$	2556	
		Glass			1/4			Acid Etched Glass Top \$	10845	
					1/4			Gloss Glass Top \$	8974	
	42"D x 108"W or 9' - 2 Piece Rectangle Top									
	88-42108RT	Laminate	108	42	1 3/16	260	27.0	F, G, Y / P\$	1790	
					1 3/16			K / P\$	2801	
					1 1/2			H / P\$	2026	
		Veneer			1 3/16			F, G, Y / W\$	1992	
					1 3/16			K / W\$	3245	
				1 1/2			H / W\$	2382		
	Glass			1/4			Acid Etched Glass Top \$	9923		
				1/4			Gloss Glass Top \$	8239		
42"D x 96"W or 8' - 1 Piece Rectangle Top										
88-4296RT	Laminate	96	42	1 3/16	164	15.0	F, G, Y / P\$	1346		
				1 3/16			K / P\$	2258		
				1 1/2			H / P\$	1554		
	Veneer			1 3/16			F, G, Y / W\$	1628		
				1 3/16			K / W\$	2606		
				1 1/2			H / W\$	1973		
	Glass			1/4			Acid Etched Glass Top \$	8652		
				1/4			Gloss Glass Top \$	7155		
42"D x 84"W or 7' - 1 Piece Rectangle Top										
88-4284RT	Laminate	84	42	1 3/16	145	13.1	F, G, Y / P\$	1309		
				1 3/16			K / P\$	2100		
				1 1/2			H / P\$	1490		
	Veneer			1 3/16			F, G, Y / W\$	1499		
				1 3/16			K / W\$	2480		
				1 1/2			H / W\$	1804		
	Glass			1/4			Acid Etched Glass Top \$	7731		
				1/4			Gloss Glass Top \$	6422		

Additional 42" Rectangle Shaped Tops on Next Page



P = HPL W = Veneer

[See Catalyst Overview For Ordering Options](#)

Item	Model No.		W	D	H	Ship Wt	Cubic Ft	Edge Profile + Material	List Price
<i>CONTINUED FROM PREVIOUS PAGE</i>	42"D x 72"W or 6' - 1 Piece Rectangle Top								
	88-4272RT	Laminate	72	42	1 3/16	126	11.3	F, G, Y / P\$	1087
					1 3/16			K / P\$	1842
					1 1/2			H / P\$	1242
		Veneer			1 3/16			F, G, Y / W\$	1360
					1 3/16			K / W\$	2062
					1 1/2			H / W\$	1624
		Glass			1/4			Acid Etched Glass Top \$	6778
					1/4			Gloss Glass Top \$	5655

Must Specify (in this order):

- Model #
- Top/Edge Material
- Top/Edge Finish/Color
- Edge Profile
- Glass (Y/N)
- Glass Color + Surface Finish
- Power/Data Type
- Power/Data Location

Description

- Tops Available with Veneer (W) or HPL (P) Top in 1 3/16" and 1 1/2" Thicknesses
- Must Specify Edge Profile: 1 3/16" Thick/Double Kerf (F), Duo (G), Square (Y), and Knife (K) Edge Profiles or 1 1/2" Thick/Vertical Square (H)
- Veneer (W) Top Grain Runs Depth of Top and HPL (P) Top Grain Runs Width of Top
- Available with Back Painted Tempered Glass Top; Must Specify Color and Finish; [See Options](#)
- Power and Data Options Available; Sold Separately, [See Multiple Power Unit Details](#)
- Bases Sold Separately, See [Multiple Base Options](#)



Double Kerf (F)
1 3/16"



Duo (G)
1 3/16"



Square (Y)
1 3/16"



Knife (K)
1 3/16"



Vertical Square (H)
1 1/2"

P = HPL W = Veneer

[See Catalyst Overview For Ordering Options](#)

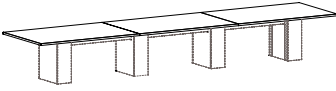
Item	Model No.		W	D	H	Ship Wt	Cubic Ft	Edge Profile + Material	List Price	
RECTANGLE SHAPE MEETING TOP 48" D  <p>88-48216RT shown with 88-2417810RB (10" Rectangle Base) BASES SOLD SEPARATELY</p> <p>Must Specify (in this order): Model # Top/Edge Material Top/Edge Finish/Color Edge Profile Glass (Y/N) Glass Color + Surface Finish Power/Data Type Power/Data Location</p>	48"D x 240"W or 20' - 3 Piece Rectangle Top									
	88-48240RT	Laminate	240	48	1 3/16	460	28.5	F, G, Y / P\$	4312	
					1 3/16			K / P\$	7033	
					1 1/2			H / P\$	4916	
		Veneer			1 3/16			F, G, Y / W\$	5797	
					1 3/16			K / W\$	7808	
					1 1/2			H / W\$	6738	
		Glass			1/4			Acid Etched Glass Top \$	24114	
					1/4			Gloss Glass Top \$	19837	
	48"D x 228"W or 19' - 3 Piece Rectangle Top									
	88-48228RT	Laminate	228	48	1 3/16	438	27.0	F, G, Y / P\$	4270	
					1 3/16			K / P\$	6902	
					1 1/2			H / P\$	4845	
		Veneer			1 3/16			F, G, Y / W\$	5549	
					1 3/16			K / W\$	7560	
				1 1/2			H / W\$	6444		
	Glass			1/4			Acid Etched Glass Top \$	23064		
				1/4			Gloss Glass Top \$	19001		
48"D x 216"W or 18' - 3 Piece Rectangle Top										
88-48216RT	Laminate	216	48	1 3/16	416	25.5	F, G, Y / P\$	3394		
				1 1/2			K / P\$	5676		
				1 3/16			H / P\$	3939		
	Veneer			1 3/16			F, G, Y / W\$	4909		
				1 3/16			K / W\$	6400		
				1 1/2			H / W\$	5759		
	Glass			1/4			Acid Etched Glass Top \$	21584		
				1/4			Gloss Glass Top \$	17734		
48"D x 204"W or 17' - 3 Piece Rectangle Top										
88-48204RT	Laminate	204	48	1 3/16	394	24.0	F, G, Y / P\$	3353		
				1 3/16			K / P\$	5545		
				1 1/2			H / P\$	3867		
	Veneer			1 3/16			F, G, Y / W\$	4661		
				1 3/16			K / W\$	6376		
				1 1/2			H / W\$	5466		
	Glass			1/4			Acid Etched Glass Top \$	20702		
				1/4			Gloss Glass Top \$	17067		

Additional 48" Rectangle Shaped Tops on Next Page



Double Kerf (F) 1 3/16" Duo (G) 1 3/16" Square (Y) 1 3/16" Knife (K) 1 3/16" Vertical Square (H) 1 1/2"

P = HPL W = Veneer

[See Catalyst Overview For Ordering Options](#)

Item	Model No.		W	D	H	Ship Wt	Cubic Ft	Edge Profile + Material	List Price		
48"D x 192"W or 16' - 2 Piece Rectangle Top											
<i>CONTINUED FROM PREVIOUS PAGE</i>	88-48192RT	Laminate	192	48	1 3/16	372	31.2	F, G, Y / P\$	2900		
					1 3/16			K / P\$	4998		
					1 1/2			H / P\$	3382		
					Veneer			1 3/16	F, G, Y / W\$	3941	
								1 3/16	K / W\$	5481	
								1 1/2	H / W\$	4697	
		Glass	1/4	Acid Etched Glass Top \$	18838						
			1/4	Gloss Glass Top \$	15417						
		48"D x 180"W or 15' - 2 Piece Rectangle Top									
		<i>Must Specify (in this order):</i> Model # Top/Edge Material Top/Edge Finish/Color Edge Profile Glass (Y/N) Glass Color + Surface Finish Power/Data Power/Data Location	88-48180RT	Laminate	180	48	1 3/16	350	31.2	F, G, Y / P\$	2859
							1 3/16			K / P\$	4769
							1 1/2			H / P\$	3311
Veneer	1 3/16						F, G, Y / W\$			3778	
	1 3/16						K / W\$			5368	
	1 1/2						H / W\$			4489	
Glass	1/4			Acid Etched Glass Top \$	17788						
	1/4			Gloss Glass Top \$	14581						
48"D x 168"W or 14' - 2 Piece Rectangle Top											
	88-48168RT			Laminate	168	48	1 3/16	328	31.2	F, G, Y / P\$	2713
							1 3/16			K / P\$	4496
							1 1/2			H / P\$	3135
		Veneer	1 3/16				F, G, Y / W\$			3482	
			1 3/16				K / W\$			5065	
			1 1/2				H / W\$			4147	
		Glass	1/4	Acid Etched Glass Top \$	16631						
			1/4	Gloss Glass Top \$	13637						
		48"D x 156"W or 13' - 2 Piece Rectangle Top									
			88-48156RT	Laminate	156	48	1 3/16	306	31.2	F, G, Y / P\$	2672
							1 3/16			K / P\$	4353
							1 1/2			H / P\$	3064
Veneer	1 3/16						F, G, Y / W\$			3319	
	1 3/16						K / W\$			4872	
	1 1/2						H / W\$			3939	
Glass	1/4			Acid Etched Glass Top \$	15581						
	1/4			Gloss Glass Top \$	12801						

Additional 48" Rectangle Shaped Tops on Next Page



Double Kerf (F) 1 3/16" Duo (G) 1 3/16" Square (Y) 1 3/16" Knife (K) 1 3/16" Vertical Square (H) 1 1/2"

P = HPL W = Veneer

[See Catalyst Overview For Ordering Options](#)

Item	Model No.		W	D	H	Ship Wt	Cubic Ft	Edge Profile + Material	List Price		
<i>CONTINUED FROM PREVIOUS PAGE</i>	48"D x 144"W or 12' - 2 Piece Rectangle Top										
	88-48144RT	Laminate	144	48	1 3/16	284	23.5	F, G, Y / P\$	2226		
					1 3/16			K / P\$	3791		
					1 1/2			H / P\$	2587		
		Veneer			1 3/16			F, G, Y / W\$	3089		
					1 3/16			K / W\$	4241		
					1 1/2			H / W\$	3664		
		Glass			1/4			Acid Etched Glass Top \$	14508		
					1/4			Gloss Glass Top \$	11942		
		48"D x 132"W or 11' - 2 Piece Rectangle Top									
	88-48132RT	Laminate	132	48	1 3/16	262	23.5	F, G, Y / P\$	2172		
					1 3/16			K / P\$	3647		
					1 1/2			H / P\$	2503		
		Veneer			1 3/16			F, G, Y / W\$	2874		
					1 3/16			K / W\$	4004		
				1 1/2			H / W\$	3403			
	Glass			1/4			Acid Etched Glass Top \$	13446			
				1/4			Gloss Glass Top \$	11093			
	48"D x 120"W or 10' - 2 Piece Rectangle Top										
88-48120RT	Laminate	120	48	1 3/16	240	23.5	F, G, Y / P\$	2109			
				1 3/16			K / P\$	3410			
				1 1/2			H / P\$	2409			
	Veneer			1 3/16			F, G, Y / W\$	2648			
				1 3/16			K / W\$	3841			
				1 1/2			H / W\$	3131			
	Glass			1/4			Acid Etched Glass Top \$	12373			
				1/4			Gloss Glass Top \$	10235			
	48"D x 108"W or 9' - 2 Piece Rectangle Top										
88-48108RT	Laminate	108	48	1 3/16	218	23.5	F, G, Y / P\$	2054			
				1 3/16			K / P\$	3247			
				1 1/2			H / P\$	2325			
	Veneer			1 3/16			F, G, Y / W\$	2433			
				1 3/16			K / W\$	3629			
				1 1/2			H / W\$	2870			
	Glass			1/4			Acid Etched Glass Top \$	11310			
				1/4			Gloss Glass Top \$	9386			

Must Specify (in this order):

- Model #
- Top/Edge Material
- Top/Edge Finish/Color
- Edge Profile
- Glass (Y/N)
- Glass Color + Surface Finish
- Power/Data Type
- Power/Data Location

Additional 48" Rectangle Shaped Tops on Next Page



Double Kerf (F)
1 3/16"

Duo (G)
1 3/16"

Square (Y)
1 3/16"

Knife (K)
1 3/16"

Vertical Square (H)
1 1/2"

P = HPL W = Veneer

[See Catalyst Overview For Ordering Options](#)

Item	Model No.		W	D	H	Ship Wt	Cubic Ft	Edge Profile + Material	List Price		
<i>CONTINUED FROM PREVIOUS PAGE</i>	48"D x 96"W or 8' - 1 Piece Rectangle Top										
	88-4896RT	Laminate	96	48	1 3/16	196	11.3	F, G, Y / P\$	1419		
					1 3/16			K / P\$	2463		
					1 1/2			H / P\$	1657		
		Veneer			1 3/16			F, G, Y / W\$	1819		
					1 3/16			K / W\$	2770		
					1 1/2			H / W\$	2207		
		Glass			1/4			Acid Etched Glass Top \$	9722		
					1/4			Gloss Glass Top \$	8011		
		48"D x 84"W or 7' - 1 Piece Rectangle Top									
	88-4884RT	Laminate	84	48	1 3/16	174	10.0	F, G, Y / P\$	1378		
					1 3/16			K / P\$	2221		
					1 1/2			H / P\$	1585		
		Veneer			1 3/16			F, G, Y / W\$	1602		
					1 3/16			K / W\$	2560		
				1 1/2			H / W\$	1945			
	Glass			1/4			Acid Etched Glass Top \$	8609			
				1/4			Gloss Glass Top \$	7112			
	48"D x 72"W or 6' - 1 Piece Rectangle Top										
88-4872RT	Laminate	72	48	1 3/16	152	8.6	F, G, Y / P\$	1152			
				1 3/16			K / P\$	1979			
				1 1/2			H / P\$	1329			
	Veneer			1 3/16			F, G, Y / W\$	1516			
				1 3/16			K / W\$	2229			
				1 1/2			H / W\$	1813			
	Glass			1/4			Acid Etched Glass Top \$	7593			
				1/4			Gloss Glass Top \$	6310			

Must Specify (in this order):

- Model #
- Top/Edge Material
- Top/Edge Finish/Color
- Edge Profile
- Glass (Y/N)
- Glass Color + Surface Finish
- Power/Data
- Power/Data Location

Description

- Tops Available with Veneer (W) or HPL (P) Top in 1 3/16" and 1 1/2" Thicknesses
- Must Specify Edge Profile: 1 3/16" Thick/Double Kerf (F), Duo (G), Square (Y), and Knife (K) Edge Profiles or 1 1/2" Thick/Vertical Square (H)
- Veneer (W) Top Grain Runs Depth of Top and HPL (P) Top Grain Runs Width of Top
- Available with Back Painted Tempered Glass Top; Must Specify Color and Finish; [See Options](#)
- Power and Data Options Available; Sold Separately, [See Multiple Power Unit Details](#)
- Dock800, Oasis, and E2X Power Units Available on Ends Only (E2 and E2) for 108"D - 156"D and 204"D-240"D Tops Bases Sold Separately, See [Multiple Base Options](#)



P = HPL W = Veneer

[See Catalyst Overview For Ordering Options](#)

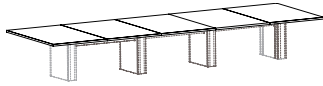
Item	Model No.		W	D	H	Ship Wt	Cubic Ft	Edge Profile + Material	List Price	
RECTANGLE SHAPE MEETING TOP 54"D  88-54204RT shown in Veneer with 88-2416606RAB (6" Rectangle Accent Base) BASES SOLD SEPARATELY Must Specify (in this order): Model # Top/Edge Material Top/Edge Finish/Color Edge Profile Glass (Y/N) Glass Color + Surface Finish Power/Data Power/Data Location	54"D x 240"W or 20' - 5 Piece Veneer (W) and 3 Piece HPL (P) Rectangle Top									
	88-54240RT	Laminate	240	54	1 3/16"	519	24.0	F, G, Y / P\$	4362	
					1 3/16"			K / P\$	7310	
					1 1/2"			H / P\$	5044	
		Veneer			1 3/16"			F, G, Y / W\$	7317	
					1 3/16"			K / W\$	9398	
					1 1/2"			H / W\$	8562	
		Glass			1/4"			Acid Etched Glass Top \$	27015	
					1/4"			Gloss Glass Top \$	22204	
	54"D x 228"W or 19' - 5 Piece Veneer (W) and 3 Piece HPL (P) Rectangle Top									
	88-54228RT	Laminate	228	54	1 3/16"	495	23.0	F, G, Y / P\$	4316	
					1 3/16"			K / P\$	7167	
					1 1/2"			H / P\$	4965	
		Veneer			1 3/16"			F, G, Y / W\$	7092	
					1 3/16"			K / W\$	9115	
				1 1/2"			H / W\$	8286		
	Glass			1/4"			Acid Etched Glass Top \$	25838		
				1/4"			Gloss Glass Top \$	21267		
54"D x 216"W or 18' - 5 Piece Veneer (W) and 3 Piece HPL (P) Rectangle Top										
88-54216RT	Laminate	216	54	1 3/16"	470	22.0	F, G, Y / P\$	3742		
				1 3/16"			K / P\$	6242		
				1 1/2"			H / P\$	4356		
	Veneer			1 3/16"			F, G, Y / W\$	6867		
				1 3/16"			K / W\$	8833		
				1 1/2"			H / W\$	8011		
	Glass			1/4"			Acid Etched Glass Top \$	24611		
				1/4"			Gloss Glass Top \$	20281		
54"D x 204"W or 17' - 5 Piece Veneer (W) and 3 Piece HPL (P) Rectangle Top										
88-54204RT	Laminate	204	54	1 3/16"	445	21.0	F, G, Y / P\$	3697		
				1 3/16"			K / P\$	6099		
				1 1/2"			H / P\$	4277		
	Veneer			1 3/16"			F, G, Y / W\$	6642		
				1 3/16"			K / W\$	8550		
				1 1/2"			H / W\$	7736		
	Glass			1/4"			Acid Etched Glass Top \$	23434		
				1/4"			Gloss Glass Top \$	19344		

Additional 54" Rectangle Shaped Tops on Next Page



P = HPL W = Veneer

[See Catalyst Overview For Ordering Options](#)

Item	Model No.		W	D	H	Ship Wt	Cubic Ft	Edge Profile + Material	List Price		
<i>CONTINUED FROM PREVIOUS PAGE</i>	54"D x 192"W or 16' - 4 Piece Veneer (W) and 2 Piece HPL (P) Rectangle Top										
	88-54192RT	Laminate	192	54	1 3/16	408	19.0	F, G, Y / P\$	3061		
					1 3/16			K / P\$	5355		
					1 1/2			H / P\$	3606		
		Veneer			1 3/16			F, G, Y / W\$	5463		
					1 3/16			K / W\$	7186		
					1 1/2			H / W\$	6311		
		Glass			1/4			Acid Etched Glass Top \$	21396		
					1/4			Gloss Glass Top \$	17546		
		54"D x 180"W or 15' - 4 Piece Veneer (W) and 2 Piece HPL (P) Rectangle Top									
	88-54180RT	Laminate	180	54	1 3/16	384	18.0	F, G, Y / P\$	3016		
					1 3/16			K / P\$	5211		
					1 1/2			H / P\$	3526		
		Veneer			1 3/16			F, G, Y / W\$	5256		
					1 3/16			K / W\$	6921		
				1 1/2			H / W\$	6053			
	Glass			1/4			Acid Etched Glass Top \$	20218			
				1/4			Gloss Glass Top \$	16610			
	54"D x 168"W or 14' - 4 Piece Veneer (W) and 2 Piece HPL (P) Rectangle Top										
88-54168RT	Laminate	168	54	1 3/16	359	17.0	F, G, Y / P\$	2971			
				1 3/16			K / P\$	5068			
				1 1/2			H / P\$	3447			
	Veneer			1 3/16			F, G, Y / W\$	5049			
				1 3/16			K / W\$	6656			
				1 1/2			H / W\$	5795			
	Glass			1/4			Acid Etched Glass Top \$	19041			
				1/4			Gloss Glass Top \$	15673			
	54"D x 156"W or 13' - 4 Piece Veneer (W) and 2 Piece HPL (P) Rectangle Top										
88-54156RT	Laminate	156	54	1 3/16	334	16.0	F, G, Y / P\$	2926			
				1 3/16			K / P\$	4924			
				1 1/2			H / P\$	3367			
	Veneer			1 3/16			F, G, Y / W\$	4842			
				1 3/16			K / W\$	6391			
				1 1/2			H / W\$	5538			
	Glass			1/4			Acid Etched Glass Top \$	17864			
				1/4			Gloss Glass Top \$	14737			

Must Specify (in this order):

- Model #
- Top/Edge Material
- Top/Edge Finish/Color
- Edge Profile
- Glass (Y/N)
- Glass Color + Surface Finish
- Power/Data Type
- Power/Data Location

Additional 54" Rectangle Shaped Tops on Next Page



Double Kerf (F)
1 3/16"



Duo (G)
1 3/16"



Square (Y)
1 3/16"



Knife (K)
1 3/16"



Vertical Square (H)
1 1/2"

P = HPL W = Veneer

[See Catalyst Overview For Ordering Options](#)

Item	Model No.		W	D	H	Ship Wt	Cubic Ft	Edge Profile + Material	List Price		
<i>CONTINUED FROM PREVIOUS PAGE</i>	54"D x 144"W or 12' - 3 Piece Veneer (W) and 2 Piece HPL (P) Rectangle Top										
	88-54144RT	Laminate	144	54	1 3/16	309	15.0	F, G, Y / P\$	2471		
					1 3/16			K / P\$	4202		
					1 1/2			H / P\$	2879		
		Veneer			1 3/16			F, G, Y / W\$	3924		
					1 3/16			K / W\$	5289		
					1 1/2			H / W\$	4564		
		Glass			1/4			Acid Etched Glass Top \$	16813		
					1/4			Gloss Glass Top \$	13926		
		54"D x 132"W or 11' - 3 Piece Veneer (W) and 2 Piece HPL (P) Rectangle Top									
	88-54132RT	Laminate	132	54	1 3/16	285	13.2	F, G, Y / P\$	2413		
					1 3/16			K / P\$	4046		
					1 1/2			H / P\$	2786		
		Veneer			1 3/16			F, G, Y / W\$	3735		
					1 3/16			K / W\$	5042		
				1 1/2			H / W\$	4325			
	Glass			1/4			Acid Etched Glass Top \$	15623			
				1/4			Gloss Glass Top \$	12976			
	54"D x 120"W or 10' - 3 Piece Veneer (W) and 2 Piece HPL (P) Rectangle Top										
88-54120RT	Laminate	120	54	1 3/16	260	12.1	F, G, Y / P\$	2354			
				1 3/16			K / P\$	3890			
				1 1/2			H / P\$	2694			
	Veneer			1 3/16			F, G, Y / W\$	3546			
				1 3/16			K / W\$	4795			
				1 1/2			H / W\$	4086			
	Glass			1/4			Acid Etched Glass Top \$	14433			
				1/4			Gloss Glass Top \$	12027			

Must Specify (in this order):

- Model #
- Top/Edge Material
- Top/Edge Finish/Color
- Edge Profile
- Glass (Y/N)
- Glass Color + Surface Finish
- Power/Data
- Power/Data Location

Description

- Tops Available with Veneer (W) or HPL (P) Top in 1 3/16" and 1 1/2" Thicknesses
- Must Specify Edge Profile: 1 3/16" Thick/Double Kerf (F), Duo (G), Square (Y), and Knife (K) Edge Profiles or 1 1/2" Thick/Vertical Square (H)
- Veneer (W) Top Grain Runs Depth of Top and HPL (P) Top Grain Runs Width of Top
- Available with Back Painted Tempered Glass Top; Must Specify Color and Finish; [See Options](#)
- Power and Data Options Available; Sold Separately, [See Multiple Power Unit Details](#)
- Bases Sold Separately, See [Multiple Base Options](#)



Double Kerf (F) 1 3/16" Duo (G) 1 3/16" Square (Y) 1 3/16" Knife (K) 1 3/16" Vertical Square (H) 1 1/2"

P = HPL W = Veneer

[See Catalyst Overview For Ordering Options](#)

Item	Model No.		W	D	H	Ship Wt	Cubic Ft	Edge Profile + Material	List Price
RECTANGLE SHAPE MEETING TOP 60"D									
60"D x 240"W or 20' - 5 Piece Veneer (W) and 3 Piece HPL (P) Rectangle Top									
	88-60240RT	Laminate	240	60	1 3/16"	574	26.3	F, G, Y / P\$	4447
					1 3/16"			K / P\$	7574
					1 1/2"			H / P\$	5208
		Veneer			1 3/16"			F, G, Y / W\$	7814
					1 3/16"			K / W\$	9975
					1 1/2"			H / W\$	9164
		Glass			1/4"			Acid Etched Glass Top \$	29576
					1/4"			Gloss Glass Top \$	24230
60"D x 228"W or 19' - 5 Piece Veneer (W) and 3 Piece HPL (P) Rectangle Top									
	88-60228RT	Laminate	228	60	1 3/16"	547	25.0	F, G, Y / P\$	4398
					1 3/16"			K / P\$	7418
					1 1/2"			H / P\$	5121
		Veneer			1 3/16"			F, G, Y / W\$	7565
					1 3/16"			K / W\$	9665
					1 1/2"			H / W\$	8858
		Glass			1/4"			Acid Etched Glass Top \$	28271
					1/4"			Gloss Glass Top \$	23193
60"D x 216"W or 18' - 5 Piece Veneer (W) and 3 Piece HPL (P) Rectangle Top									
	88-60216RT	Laminate	216	60	1 3/16"	519	23.7	F, G, Y / P\$	3819
					1 3/16"			K / P\$	6481
					1 1/2"			H / P\$	4504
		Veneer			1 3/16"			F, G, Y / W\$	7315
					1 3/16"			K / W\$	9354
					1 1/2"			H / W\$	8553
		Glass			1/4"			Acid Etched Glass Top \$	26917
					1/4"			Gloss Glass Top \$	22106
60"D x 204"W or 17' - 5 Piece Veneer (W) and 3 Piece HPL (P) Rectangle Top									
	88-60204RT	Laminate	204	60	1 3/16"	492	22.4	F, G, Y / P\$	3770
					1 3/16"			K / P\$	6326
					1 1/2"			H / P\$	4417
		Veneer			1 3/16"			F, G, Y / W\$	7066
					1 3/16"			K / W\$	9044
					1 1/2"			H / W\$	8248
		Glass			1/4"			Acid Etched Glass Top \$	25613
					1/4"			Gloss Glass Top \$	21069

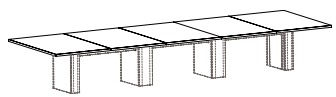

88-60204RT Shown in Veneer with 88-24166C610RAB (6" + 10" Combo Rectangle Accent Base) BASES SOLD SEPARATELY

Must Specify (in this order):
 Model #
 Top/Edge Material
 Top/Edge Finish/Color
 Edge Profile
 Glass (Y/N)
 Glass Color + Surface Finish
 Power/Data Type
 Power/Data Location

Additional 60" Rectangle Shaped Tops on Next Page



P = HPL W = Veneer

[See Catalyst Overview For Ordering Options](#)

Item	Model No.		W	D	H	Ship Wt	Cubic Ft	Edge Profile + Material	List Price		
<i>CONTINUED FROM PREVIOUS PAGE</i>	60"D x 192"W or 16' - 4 Piece Veneer (W) and 2 Piece HPL (P) Rectangle Top										
	88-60192RT	Laminate	192	60	1 3/16	458	21.1	F, G, Y / P\$	3131		
					1 3/16			K / P\$	5568		
					1 1/2			H / P\$	3737		
		Veneer			1 3/16			F, G, Y / W\$	5829		
					1 3/16			K / W\$	7619		
					1 1/2			H / W\$	6760		
		Glass			1/4			Acid Etched Glass Top \$	23446		
					1/4			Gloss Glass Top \$	19170		
		60"D x 180"W or 15' - 4 Piece Veneer (W) and 2 Piece HPL (P) Rectangle Top									
	88-60180RT	Laminate	180	60	1 3/16	430	19.8	F, G, Y / P\$	3082		
					1 3/16			K / P\$	5413		
					1 1/2			H / P\$	3650		
		Veneer			1 3/16			F, G, Y / W\$	5600		
					1 3/16			K / W\$	7328		
				1 1/2			H / W\$	6475			
	Glass			1/4			Acid Etched Glass Top \$	22142			
				1/4			Gloss Glass Top \$	18133			
	60"D x 168"W or 14' - 4 Piece Veneer (W) and 2 Piece HPL (P) Rectangle Top										
88-60168RT	Laminate	168	60	1 3/16	403	18.5	F, G, Y / P\$	3032			
				1 3/16			K / P\$	5257			
				1 1/2			H / P\$	3563			
	Veneer			1 3/16			F, G, Y / W\$	5370			
				1 3/16			K / W\$	7037			
				1 1/2			H / W\$	6190			
	Glass			1/4			Acid Etched Glass Top \$	20838			
				1/4			Gloss Glass Top \$	17096			
	60"D x 156"W or 13' - 4 Piece Veneer (W) and 2 Piece HPL (P) Rectangle Top										
88-60156RT	Laminate	156	60	1 3/16	376	17.2	F, G, Y / P\$	2983			
				1 3/16			K / P\$	5101			
				1 1/2			H / P\$	3475			
	Veneer			1 3/16			F, G, Y / W\$	5140			
				1 3/16			K / W\$	6746			
				1 1/2			H / W\$	5905			
	Glass			1/4			Acid Etched Glass Top \$	19534			
				1/4			Gloss Glass Top \$	16059			

Additional 60" Rectangle Shaped Tops on Next Page



Double Kerf (F)
1 3/16"



Duo (G)
1 3/16"



Square (Y)
1 3/16"



Knife (K)
1 3/16"



Vertical Square (H)
1 1/2"

P = HPL W = Veneer

[See Catalyst Overview For Ordering Options](#)

Item	Model No.		W	D	H	Ship Wt	Cubic Ft	Edge Profile + Material	List Price	
60"D x 144"W or 12' - 3 Piece Veneer (W) and 2 Piece HPL (P) Rectangle Top										
<i>CONTINUED FROM PREVIOUS PAGE</i>	88-60144RT	Laminate	144	60	1 3/16	342	16.0	F, G, Y / P\$	2524	
					1 3/16			K / P\$	4367	
					1 1/2			H / P\$	2979	
		Veneer			1 3/16			F, G, Y / W\$	4174	
					1 3/16			K / W\$	5593	
					1 1/2			H / W\$	4879	
		Glass			1/4			Acid Etched Glass Top \$	18355	
					1/4			Gloss Glass Top \$	15148	
	60"D x 132"W or 11' - 3 Piece Veneer (W) and 2 Piece HPL (P) Rectangle Top									
		88-60132RT	Laminate	132	60	1 3/16	323	14.6	F, G, Y / P\$	2462
					1 3/16			K / P\$	4198	
					1 1/2			H / P\$	2878	
		Veneer			1 3/16			F, G, Y / W\$	3965	
					1 3/16			K / W\$	5322	
					1 1/2			H / W\$	4614	
		Glass			1/4			Acid Etched Glass Top \$	17038	
					1/4			Gloss Glass Top \$	14098	
60"D x 120"W or 10' - 3 Piece Veneer (W) and 2 Piece HPL (P) Rectangle Top										
	88-60120RT	Laminate	120	60	1 3/16	287	13.3	F, G, Y / P\$	2400	
					1 3/16			K / P\$	4029	
					1 1/2			H / P\$	2778	
		Veneer			1 3/16			F, G, Y / W\$	3755	
					1 3/16			K / W\$	5051	
					1 1/2			H / W\$	4348	
		Glass			1/4			Acid Etched Glass Top \$	15721	
					1/4			Gloss Glass Top \$	13048	

Must Specify (in this order):

- Model #
- Top/Edge Material
- Top/Edge Finish/Color
- Edge Profile
- Glass (Y/N)
- Glass Color + Surface Finish
- Power/Data Type
- Power/Data Location

Description

- Tops Available with Veneer (W) or HPL (P) Top in 1 3/16" and 1 1/2" Thicknesses
- Must Specify Edge Profile: 1 3/16" Thick/Double Kerf (F), Duo (G), Square (Y), and Knife (K) Edge Profiles or 1 1/2" Thick/Vertical Square (H)
- Veneer (W) Top Grain Runs Depth of Top and HPL (P) Top Grain Runs Width of Top
- Available with Back Painted Tempered Glass Top; Must Specify Color and Finish; [See Options](#)
- Power and Data Options Available; Sold Separately, [See Multiple Power Unit Details](#)
- Bases Sold Separately, See [Multiple Base Options](#)



Double Kerf (F) 1 3/16" Duo (G) 1 3/16" Square (Y) 1 3/16" Knife (K) 1 3/16" Vertical Square (H) 1 1/2"

P = HPL W = Veneer

[See Catalyst Overview For Ordering Options](#)

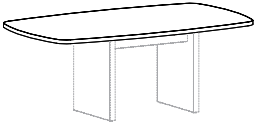
Item	Model No.		W	D	H	Ship Wt	Cubic Ft	Edge Profile + Material	List Price	
MODERN RECTANGLE SHAPE MEETING TOP 36"D  88-3672MR shown with 88-2034RPB (Rectangle Panel Base) BASES SOLD SEPARATELY	36"D x 96"W or 8' - 1 Piece Modern Rectangle Top									
	88-3696MR	Laminate	96	36	1 3/16"	142	12.9	F, G, Y / P\$	1376	
					1 3/16"			K / P\$	2726	
					1 1/2"			H / P\$	1552	
		Veneer			1 3/16"			F, G, Y / W\$	1558	
					1 3/16"			K / W\$	3056	
					1 1/2"			H / W\$	1856	
		Glass			1/4"			Acid Etched Glass Top \$	8429	
					1/4"			Gloss Glass Top \$	7146	
	36"D x 84"W or 7' - 1 Piece Modern Rectangle Top									
	88-3684MR	Laminate	84	36	1 3/16"	126	11.3	F, G, Y / P\$	1311	
					1 3/16"			K / P\$	2496	
					1 1/2"			H / P\$	1495	
		Veneer			1 3/16"			F, G, Y / W\$	1477	
					1 3/16"			K / W\$	2858	
				1 1/2"			H / W\$	1708		
	Glass			1/4"			Acid Etched Glass Top \$	7557		
				1/4"			Gloss Glass Top \$	6434		
36"D x 72"W or 6' - 1 Piece Modern Rectangle Top										
88-3672MR	Laminate	72	36	1 3/16"	109	10.3	F, G, Y / P\$	1071		
				1 3/16"			K / P\$	2160		
				1 1/2"			H / P\$	1203		
	Veneer			1 3/16"			F, G, Y / W\$	1258		
				1 3/16"			K / W\$	2433		
				1 1/2"			H / W\$	1485		
	Glass			1/4"			Acid Etched Glass Top \$	6598		
				1/4"			Gloss Glass Top \$	5635		

Must Specify (in this order):

- Model #
- Top/Edge Material
- Top/Edge Finish/Color
- Edge Profile
- Glass (Y/N)
- Glass Color + Surface Finish
- Power/Data
- Power/Data Location

Description

- Tops Available with Veneer (W) or HPL (P) Top in 1 3/16" and 1 1/2" Thicknesses
- Must Specify Edge Profile: 1 3/16" Thick/Double Kerf (F), Duo (G), Square (Y), and Knife (K) Edge Profiles or 1 1/2" Thick/Vertical Square (H)
- Veneer (W) Top Grain Runs Depth of Top and HPL (P) Top Grain Runs Width of Top
- Available with Back Painted Tempered Glass Top; Must Specify Color and Finish; [See Options](#)
- Power and Data Options Available; Sold Separately, [See Multiple Power Unit Details](#)
- Bases Sold Separately, See [Multiple Base Options](#)



Double Kerf (F)
1 3/16"

Duo (G)
1 3/16"

Square (Y)
1 3/16"

Knife (K)
1 3/16"

Vertical Square (H)
1 1/2"

P = HPL W = Veneer

[See Catalyst Overview For Ordering Options](#)

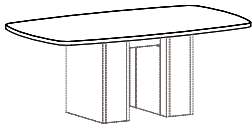
Item	Model No.		W	D	H	Ship Wt	Cubic Ft	Edge Profile + Material	List Price	
MODERN RECTANGLE SHAPE MEETING TOP 42"D  88-42108MR shown with 88-203406RAB (Rectangle Panel Base) BASES SOLD SEPARATELY	42"D x 120"W or 10' - 2 Piece Modern Rectangle Top									
	88-42120MR	Laminate	120	42	1 3/16	268	27.0	F, G, Y / P\$	1940	
					1 3/16			K / P\$	3716	
					1 1/2			H / P\$	2201	
		Veneer			1 3/16			F, G, Y / W\$	2251	
					1 3/16			K / W\$	4186	
					1 1/2			H / W\$	2675	
		Glass			1/4			Acid Etched Glass Top \$	11802	
					1/4			Gloss Glass Top \$	9931	
	42"D x 108"W or 9' - 2 Piece Modern Rectangle Top									
	88-42108MR	Laminate	108	42	1 3/16	260	27.0	F, G, Y / P\$	1903	
					1 3/16			K / P\$	3507	
					1 1/2			H / P\$	2138	
		Veneer			1 3/16			F, G, Y / W\$	2118	
					1 3/16			K / W\$	3926	
				1 1/2			H / W\$	2502		
	Glass			1/4			Acid Etched Glass Top \$	10804		
				1/4			Gloss Glass Top \$	9120		
42"D x 96"W or 8' - 1 Piece Modern Rectangle Top										
88-4296MR	Laminate	96	42	1 3/16	164	15.0	F, G, Y / P\$	1404		
				1 3/16			K / P\$	2883		
				1 1/2			H / P\$	1611		
	Veneer			1 3/16			F, G, Y / W\$	1693		
				1 3/16			K / W\$	3247		
				1 1/2			H / W\$	2033		
	Glass			1/4			Acid Etched Glass Top \$	9486		
				1/4			Gloss Glass Top \$	7989		
42"D x 84"W or 7' - 1 Piece Modern Rectangle Top										
88-4284MR	Laminate	84	42	1 3/16	145	13.1	F, G, Y / P\$	1366		
				1 3/16			K / P\$	2675		
				1 1/2			H / P\$	1546		
	Veneer			1 3/16			F, G, Y / W\$	1563		
				1 3/16			K / W\$	2997		
				1 1/2			H / W\$	1863		
	Glass			1/4			Acid Etched Glass Top \$	8489		
				1/4			Gloss Glass Top \$	7179		

Additional 42" Modern Rectangle Shaped Tops on Next Page



Double Kerf (F)
1 3/16"



Duo (G)
1 3/16"



Square (Y)
1 3/16"



Knife (K)
1 3/16"



Vertical Square (H)
1 1/2"

P = HPL W = Veneer

[See Catalyst Overview For Ordering Options](#)

Item	Model No.		W	D	H	Ship Wt	Cubic Ft	Edge Profile + Material	List Price	
<i>CONTINUED FROM PREVIOUS PAGE</i>	42"D x 72"W or 6' - 1 Piece Modern Rectangle Top									
	88-4272MR	Laminate	72	42	1 3/16	126	11.3	F, G, Y / P\$	1142	
					1 3/16			K / P\$	2384	
					1 1/2			H / P\$	1296	
		Veneer			1 3/16			F, G, Y / W\$	1423	
					1 3/16			K / W\$	2618	
					1 1/2			H / W\$	1682	
		Glass			1/4			Acid Etched Glass Top \$	7464	
					1/4			Gloss Glass Top \$	6341	

Must Specify (in this order):

- Model #
- Top/Edge Material
- Top/Edge Finish/Color
- Edge Profile
- Glass (Y/N)
- Glass Color + Surface Finish
- Power/Data
- Power/Data Location

Description

- Tops Available with Veneer (W) or HPL (P) Top in 1 3/16" and 1 1/2" Thicknesses
- Must Specify Edge Profile: 1 3/16" Thick/Double Kerf (F), Duo (G), Square (Y), and Knife (K) Edge Profiles or 1 1/2" Thick/Vertical Square (H)
- Veneer (W) Top Grain Runs Depth of Top and HPL (P) Top Grain Runs Width of Top
- Available with Back Painted Tempered Glass Top; Must Specify Color and Finish; [See Options](#)
- Power and Data Options Available; Sold Separately, [See Multiple Power Unit Details](#)
- Bases Sold Separately, See [Multiple Base Options](#)



Double Kerf (F)
1 3/16"



Duo (G)
1 3/16"



Square (Y)
1 3/16"



Knife (K)
1 3/16"



Vertical Square (H)
1 1/2"

P = HPL W = Veneer

[See Catalyst Overview For Ordering Options](#)

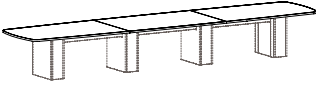
Item	Model No.		W	D	H	Ship Wt	Cubic Ft	Edge Profile + Material	List Price	
MODERN RECTANGLE SHAPE MEETING TOP 48"D  88-48216MR shown in HPL with 88-24178C610RAB (10" Rectangle Accent Base) BASES SOLD SEPARATELY	48"D x 240"W or 20' - 3 Piece Modern Rectangle Top									
	88-48240MR	Laminate	240	48	1 3/16	460	48.9	F, G, Y / P\$	4481	
					1 3/16			K / P\$	8212	
					1 1/2			H / P\$	5079	
		Veneer			1 3/16			F, G, Y / W\$	6088	
					1 3/16			K / W\$	9247	
					1 1/2			H / W\$	6911	
		Glass			1/4			Acid Etched Glass Top \$	25733	
					1/4			Gloss Glass Top \$	21456	
	48"D x 228"W or 19' - 3 Piece Modern Rectangle Top									
	88-48228MR	Laminate	228	48	1 3/16	438	48.9	F, G, Y / P\$	4439	
					1 3/16			K / P\$	8004	
					1 1/2			H / P\$	5007	
		Veneer			1 3/16			F, G, Y / W\$	5833	
					1 3/16			K / W\$	8904	
				1 1/2			H / W\$	6617		
	Glass			1/4			Acid Etched Glass Top \$	24607		
				1/4			Gloss Glass Top \$	20544		
48"D x 216"W or 18' - 3 Piece Modern Rectangle Top										
88-48216MR	Laminate	216	48	1 3/16	416	48.9	F, G, Y / P\$	3562		
				1 3/16			K / P\$	6939		
				1 1/2			H / P\$	4100		
	Veneer			1 3/16			F, G, Y / W\$	5187		
				1 3/16			K / W\$	8170		
				1 1/2			H / W\$	5931		
	Glass			1/4			Acid Etched Glass Top \$	23108		
				1/4			Gloss Glass Top \$	19259		
48"D x 204"W or 17' - 3 Piece Modern Rectangle Top										
88-48204MR	Laminate	204	48	1 3/16	394	48.9	F, G, Y / P\$	3520		
				1 3/16			K / P\$	6732		
				1 1/2			H / P\$	4028		
	Veneer			1 3/16			F, G, Y / W\$	4933		
				1 3/16			K / W\$	7827		
				1 1/2			H / W\$	5637		
	Glass			1/4			Acid Etched Glass Top \$	21982		
				1/4			Gloss Glass Top \$	18346		

Must Specify (in this order):
 Model #
 Top/Edge Material
 Top/Edge Finish/Color
 Edge Profile
 Glass (Y/N)
 Glass Color + Surface Finish
 Power/Data
 Power/Data Location

Additional 48" Modern Rectangle Shaped Tops on Next Page



P = HPL W = Veneer

[See Catalyst Overview For Ordering Options](#)

Item	Model No.		W	D	H	Ship Wt	Cubic Ft	Edge Profile + Material	List Price	
<i>CONTINUED FROM PREVIOUS PAGE</i>	48"D x 192"W or 16' - 2 Piece Modern Rectangle Top									
	88-48192MR	Laminate	192	48	1 3/16	372	31.2	F, G, Y / P\$	3019	
					1 3/16			K / P\$	6038	
					1 1/2			H / P\$	3499	
		Veneer			1 3/16			F, G, Y / W\$	4072	
					1 3/16			K / W\$	6759	
					1 1/2			H / W\$	4822	
		Glass			1/4			Acid Etched Glass Top \$	20360	
					1/4			Gloss Glass Top \$	16938	
	48"D x 180"W or 15' - 2 Piece Modern Rectangle Top									
	88-48180MR	Laminate	180	48	1 3/16	350	31.2	F, G, Y / P\$	2976	
					1 3/16			K / P\$	5830	
					1 1/2			H / P\$	3427	
		Veneer			1 3/16			F, G, Y / W\$	3908	
					1 3/16			K / W\$	6453	
					1 1/2			H / W\$	4612	
		Glass			1/4			Acid Etched Glass Top \$	19233	
					1/4			Gloss Glass Top \$	16025	
48"D x 168"W or 14' - 2 Piece Modern Rectangle Top										
88-48168MR	Laminate	168	48	1 3/16	328	31.2	F, G, Y / P\$	2829		
				1 3/16			K / P\$	5515		
				1 1/2			H / P\$	3249		
	Veneer			1 3/16			F, G, Y / W\$	3610		
				1 3/16			K / W\$	6013		
				1 1/2			H / W\$	4269		
	Glass			1/4			Acid Etched Glass Top \$	17999		
				1/4			Gloss Glass Top \$	15005		
48"D x 156"W or 13' - 2 Piece Modern Rectangle Top										
88-48156MR	Laminate	156	48	1 3/16	306	31.2	F, G, Y / P\$	2787		
				1 3/16			K / P\$	5182		
				1 1/2			H / P\$	3177		
	Veneer			1 3/16			F, G, Y / W\$	3446		
				1 3/16			K / W\$	5835		
				1 1/2			H / W\$	4060		
	Glass			1/4			Acid Etched Glass Top \$	16872		
				1/4			Gloss Glass Top \$	14092		

Must Specify (in this order):

- Model #
- Top/Edge Material
- Top/Edge Finish/Color
- Edge Profile
- Glass (Y/N)
- Glass Color + Surface Finish
- Power/Data
- Power/Data Location

Additional 48" Modern Rectangle Shaped Tops on Next Page



P = HPL W = Veneer

[See Catalyst Overview For Ordering Options](#)

Item	Model No.		W	D	H	Ship Wt	Cubic Ft	Edge Profile + Material	List Price	
48"D x 144"W or 12' - 2 Piece Modern Rectangle Top										
<i>CONTINUED FROM PREVIOUS PAGE</i>	88-48144MR	Laminate	144	48	1 ³ / ₁₆	284	23.5	F, G, Y / P\$	2339	
					1 ³ / ₁₆			K / P\$	4683	
					1 ¹ / ₂			H / P\$	2699	
	Veneer							F, G, Y / W\$	3215	
								1 ³ / ₁₆	K / W\$	5334
								1 ¹ / ₂	H / W\$	3783
	Glass							Acid Etched Glass Top \$	15653	
									Gloss Glass Top \$	13086
	48"D x 132"W or 11' - 2 Piece Modern Rectangle Top									
	<i>Must Specify (in this order):</i> Model # Top/Edge Material Top/Edge Finish/Color Edge Profile Glass (Y/N) Glass Color + Surface Finish Power/Data Power/Data Location	88-48132MR	Laminate	132	48	1 ³ / ₁₆	262	23.5	F, G, Y / P\$	2285
1 ³ / ₁₆						K / P\$			4463	
1 ¹ / ₂						H / P\$			2614	
Veneer								F, G, Y / W\$	3000	
								1 ³ / ₁₆	K / W\$	5003
								1 ¹ / ₂	H / W\$	3522
Glass								Acid Etched Glass Top \$	14514	
									Gloss Glass Top \$	12162
48"D x 120"W or 10' - 2 Piece Modern Rectangle Top										
		88-48120MR	Laminate	120	48	1 ³ / ₁₆	240	23.5	F, G, Y / P\$	2221
	1 ³ / ₁₆					K / P\$			4235	
	1 ¹ / ₂					H / P\$			2521	
	Veneer							F, G, Y / W\$	2773	
								1 ³ / ₁₆	K / W\$	4660
								1 ¹ / ₂	H / W\$	3250
	Glass							Acid Etched Glass Top \$	13367	
									Gloss Glass Top \$	11229
	48"D x 108"W or 9' - 2 Piece Modern Rectangle Top									
		88-48108MR	Laminate	108	48	1 ³ / ₁₆	218	23.5	F, G, Y / P\$	2167
1 ³ / ₁₆						K / P\$			3926	
1 ¹ / ₂						H / P\$			2437	
Veneer								F, G, Y / W\$	2558	
								1 ³ / ₁₆	K / W\$	4420
								1 ¹ / ₂	H / W\$	2990
Glass								Acid Etched Glass Top \$	12229	
									Gloss Glass Top \$	10304

Additional 48" Modern Rectangle Shaped Tops on Next Page



Double Kerf (F)
1³/₁₆"



Duo (G)
1³/₁₆"



Square (Y)
1³/₁₆"



Knife (K)
1³/₁₆"



Vertical Square (H)
1¹/₂"

P = HPL W = Veneer

[See Catalyst Overview For Ordering Options](#)

Item	Model No.		W	D	H	Ship Wt	Cubic Ft	Edge Profile + Material	List Price		
<i>CONTINUED FROM PREVIOUS PAGE</i>	48"D x 96"W or 8' - 1 Piece Modern Rectangle Top										
	88-4896MR	Laminate	96	48	1 3/16	315	18.0	F, G, Y / P\$	1477		
					1 3/16			K / P\$	3148		
					1 1/2			H / P\$	1714		
		Veneer			1 3/16			F, G, Y / W\$	1885		
					1 3/16			K / W\$	3438		
					1 1/2			H / W\$	2268		
		Glass			1/4			Acid Etched Glass Top \$	10594		
					1/4			Gloss Glass Top \$	8883		
		48"D x 84"W or 7' - 1 Piece Modern Rectangle Top									
	88-4884MR	Laminate	84	48	1 3/16	164	15.0	F, G, Y / P\$	1434		
					1 3/16			K / P\$	2801		
					1 1/2			H / P\$	1641		
		Veneer			1 3/16			F, G, Y / W\$	1666		
					1 3/16			K / W\$	3156		
				1 1/2			H / W\$	2004			
	Glass			1/4			Acid Etched Glass Top \$	9403			
				1/4			Gloss Glass Top \$	7907			
	48"D x 72"W or 6' - 1 Piece Modern Rectangle Top										
88-4872MR	Laminate	72	48	1 3/16	142	12.8	F, G, Y / P\$	1207			
				1 3/16			K / P\$	2548			
				1 1/2			H / P\$	1384			
	Veneer			1 3/16			F, G, Y / W\$	1578			
				1 3/16			K / W\$	2848			
				1 1/2			H / W\$	1870			
	Glass			1/4			Acid Etched Glass Top \$	8317			
				1/4			Gloss Glass Top \$	7034			

Must Specify (in this order):

- Model #
- Top/Edge Material
- Top/Edge Finish/Color
- Edge Profile
- Glass (Y/N)
- Glass Color + Surface Finish
- Power/Data
- Power/Data Location

Description

- Tops Available with Veneer (W) or HPL (P) Top in 1 3/16" and 1 1/2" Thicknesses
- Must Specify Edge Profile: 1 3/16" Thick/Double Kerf (F), Duo (G), Square (Y), and Knife (K) Edge Profiles or 1 1/2" Thick/Vertical Square (H)
- Veneer (W) Top Grain Runs Depth of Top and HPL (P) Top Grain Runs Width of Top
- Available with Back Painted Tempered Glass Top; Must Specify Color and Finish; [See Options](#)
- Power and Data Options Available; Sold Separately, [See Multiple Power Unit Details](#)
- Bases Sold Separately, See [Multiple Base Options](#)



Double Kerf (F) 1 3/16"
Duo (G) 1 3/16"
Square (Y) 1 3/16"
Knife (K) 1 3/16"
Vertical Square (H) 1 1/2"
P = HPL W = Veneer

[See Catalyst Overview For Ordering Options](#)

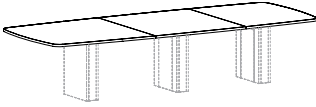
Item	Model No.		W	D	H	Ship Wt	Cubic Ft	Edge Profile + Material	List Price	
MODERN RECTANGLE SHAPE MEETING TOP 54"D  88-54156MR shown in HPL with 88-2411806RAB (6" Rectangle Accent Base) BASES SOLD SEPARATELY Must Specify (in this order): Model # Top/Edge Material Top/Edge Finish/Color Edge Profile Glass (Y/N) Glass Color + Surface Finish Power/Data Power/Data Location	54"D x 240"W or 20' - 5 Piece Veneer (W) and 3 Piece HPL (P) Modern Rectangle Top									
	88-54240MR	Laminate	240	54	1 3/16	519	24.0	F, G, Y / P\$	4531	
					1 3/16			K / P\$	8476	
					1 1/2			H / P\$	5207	
		Veneer			1 3/16			F, G, Y / W\$	7579	
					1 3/16			K / W\$	11166	
					1 1/2			H / W\$	8611	
		Glass			1/4			Acid Etched Glass Top \$	28663	
					1/4			Gloss Glass Top \$	23852	
	54"D x 228"W or 19' - 5 Piece Veneer (W) and 3 Piece HPL (P) Modern Rectangle Top									
	88-54228MR	Laminate	228	54	1 3/16	495	23.0	F, G, Y / P\$	4485	
					1 3/16			K / P\$	8256	
					1 1/2			H / P\$	5127	
		Veneer			1 3/16			F, G, Y / W\$	7345	
					1 3/16			K / W\$	10782	
				1 1/2			H / W\$	8328		
	Glass			1/4			Acid Etched Glass Top \$	27410		
				1/4			Gloss Glass Top \$	22840		
54"D x 216"W or 18' - 5 Piece Veneer (W) and 3 Piece HPL (P) Modern Rectangle Top										
88-54216MR	Laminate	216	54	1 3/16	470	22.0	F, G, Y / P\$	3910		
				1 3/16			K / P\$	7493		
				1 1/2			H / P\$	4518		
	Veneer			1 3/16			F, G, Y / W\$	7112		
				1 3/16			K / W\$	10397		
				1 1/2			H / W\$	8045		
	Glass			1/4			Acid Etched Glass Top \$	26123		
				1/4			Gloss Glass Top \$	21793		
54"D x 204"W or 17' - 5 Piece Veneer (W) and 3 Piece HPL (P) Modern Rectangle Top										
88-54204MR	Laminate	204	54	1 3/16	445	21.0	F, G, Y / P\$	3864		
				1 3/16			K / P\$	7273		
				1 1/2			H / P\$	4438		
	Veneer			1 3/16			F, G, Y / W\$	6878		
				1 3/16			K / W\$	10014		
				1 1/2			H / W\$	7762		
	Glass			1/4			Acid Etched Glass Top \$	24871		
				1/4			Gloss Glass Top \$	20782		

Additional 54" Modern Rectangle Shaped Tops on Next Page



P = HPL W = Veneer

[See Catalyst Overview For Ordering Options](#)

Item	Model No.		W	D	H	Ship Wt	Cubic Ft	Edge Profile + Material	List Price	
<i>CONTINUED FROM PREVIOUS PAGE</i>	54"D x 192"W or 16' - 4 Piece Veneer (W) and 2 Piece HPL (P) Modern Rectangle Top									
	88-54192MR	Laminate	192	54	1 3/16	408	19.0	F, G, Y / P\$	3180	
					1 3/16			K / P\$	6383	
					1 1/2			H / P\$	3722	
		Veneer			1 3/16			F, G, Y / W\$	5675	
					1 3/16			K / W\$	8636	
					1 1/2			H / W\$	6506	
		Glass			1/4			Acid Etched Glass Top \$	22945	
					1/4			Gloss Glass Top \$	19096	
	54"D x 180"W or 15' - 4 Piece Veneer (W) and 2 Piece HPL (P) Modern Rectangle Top									
	88-54180MR	Laminate	180	54	1 3/16	384	18.0	F, G, Y / P\$	3134	
					1 3/16			K / P\$	6163	
					1 1/2			H / P\$	3642	
		Veneer			1 3/16			F, G, Y / W\$	5461	
					1 3/16			K / W\$	8271	
				1 1/2			H / W\$	6242		
	Glass			1/4			Acid Etched Glass Top \$	21692		
				1/4			Gloss Glass Top \$	18083		
54"D x 168"W or 14' - 4 Piece Veneer (W) and 2 Piece HPL (P) Modern Rectangle Top										
88-54168MR	Laminate	168	54	1 3/16	359	17.0	F, G, Y / P\$	3087		
				1 3/16			K / P\$	5943		
				1 1/2			H / P\$	3562		
	Veneer			1 3/16			F, G, Y / W\$	5247		
				1 3/16			K / W\$	7905		
				1 1/2			H / W\$	5979		
	Glass			1/4			Acid Etched Glass Top \$	20439		
				1/4			Gloss Glass Top \$	17071		
54"D x 156"W or 13' - 4 Piece Veneer (W) and 2 Piece HPL (P) Modern Rectangle Top										
88-54156MR	Laminate	156	54	1 3/16	334	16.0	F, G, Y / P\$	3041		
				1 3/16			K / P\$	5723		
				1 1/2			H / P\$	3481		
	Veneer			1 3/16			F, G, Y / W\$	5033		
				1 3/16			K / W\$	7538		
				1 1/2			H / W\$	5715		
	Glass			1/4			Acid Etched Glass Top \$	19185		
				1/4			Gloss Glass Top \$	16057		

Must Specify (in this order):
 Model #
 Top/Edge Material
 Top/Edge Finish/Color
 Edge Profile
 Glass (Y/N)
 Glass Color + Surface Finish
 Power/Data
 Power/Data Location

Additional 54" Modern Rectangle Shaped Tops on Next Page



Double Kerf (F) 1 3/16" Duo (G) 1 3/16" Square (Y) 1 3/16" Knife (K) 1 3/16" Vertical Square (H) 1 1/2"

P = HPL W = Veneer

[See Catalyst Overview For Ordering Options](#)

Item	Model No.		W	D	H	Ship Wt	Cubic Ft	Edge Profile + Material	List Price	
54"D x 144"W or 12' - 3 Piece Veneer (W) and 2 Piece HPL (P) Modern Rectangle Top										
<i>CONTINUED FROM PREVIOUS PAGE</i>	88-54144MR	Laminate	144	54	1 3/16	309	15.0	F, G, Y / P\$	2585	
					1 3/16			K / P\$	5083	
					1 1/2			H / P\$	2992	
		Veneer			1 3/16			F, G, Y / W\$	4155	
					1 3/16			K / W\$	6420	
					1 1/2			H / W\$	6420	
		Glass			1/4			Acid Etched Glass Top \$	17612	
					1/4			Gloss Glass Top \$	14725	
	54"D x 132"W or 11' - 3 Piece Veneer (W) and 2 Piece HPL (P) Modern Rectangle Top									
	Must Specify (in this order): Model # Top/Edge Material Top/Edge Finish/Color Edge Profile Glass (Y/N) Glass Color + Surface Finish Power/Data Power/Data Location	88-54132MR	Laminate	132	54	1 3/16	285	13.2	F, G, Y / P\$	2526
					1 3/16			K / P\$	4851	
					1 1/2			H / P\$	2899	
		Veneer			1 3/16			F, G, Y / W\$	3952	
					1 3/16			K / W\$	6072	
					1 1/2			H / W\$	4468	
		Glass			1/4			Acid Etched Glass Top \$	16346	
					1/4			Gloss Glass Top \$	13700	
54"D x 120"W or 10' - 3 Piece Veneer (W) and 2 Piece HPL (P) Modern Rectangle Top										
		88-54120MR	Laminate	120	54	1 3/16	260	12.1	F, G, Y / P\$	2467
					1 3/16			K / P\$	4618	
					1 1/2			H / P\$	2806	
		Veneer			1 3/16			F, G, Y / W\$	3749	
					1 3/16			K / W\$	5727	
					1 1/2			H / W\$	4222	
		Glass			1/4			Acid Etched Glass Top \$	15084	
					1/4			Gloss Glass Top \$	12678	

Description

- Tops Available with Veneer (W) or HPL (P) Top in 1 3/16" and 1 1/2" Thicknesses
- Must Specify Edge Profile: 1 3/16" Thick/Double Kerf (F), Duo (G), Square (Y), and Knife (K) Edge Profiles or 1 1/2" Thick/Vertical Square (H)
- Veneer (W) Top Grain Runs Depth of Top and HPL (P) Top Grain Runs Width of Top
- Available with Back Painted Tempered Glass Top; Must Specify Color and Finish; [See Options](#)
- Power and Data Options Available; Sold Separately, [See Multiple Power Unit Details](#)
- Bases Sold Separately, See [Multiple Base Options](#)



Double Kerf (F)
1 3/16"



Duo (G)
1 3/16"



Square (Y)
1 3/16"



Knife (K)
1 3/16"



Vertical Square (H)
1 1/2"

P = HPL W = Veneer

[See Catalyst Overview For Ordering Options](#)

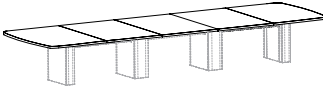
Item	Model No.		W	D	H	Ship Wt	Cubic Ft	Edge Profile + Material	List Price	
MODERN RECTANGLE SHAPE MEETING TOP 60"D  88-60204MR shown in Veneer with 88-24166C6I06RAB (6" + 10" Combo Rectangle Accent Base) BASES SOLD SEPARATELY	60"D x 240"W or 20' - 5 Piece Veneer (W) and 3 Piece HPL (P) Modern Rectangle Top									
	88-60240MR	Laminate	240	60	1 3/16	574	26.3	F, G, Y / P\$	4617	
					1 3/16			K / P\$	8777	
					1 1/2			H / P\$	5371	
		Veneer			1 3/16			F, G, Y / W\$	8076	
					1 3/16			K / W\$	11791	
					1 1/2			H / W\$	9212	
		Glass			1/4			Acid Etched Glass Top \$	31262	
					1/4			Gloss Glass Top \$	25916	
	60"D x 228"W or 19' - 5 Piece Veneer (W) and 3 Piece HPL (P) Modern Rectangle Top									
	88-60228MR	Laminate	228	60	1 3/16	547	25.0	F, G, Y / P\$	4567	
					1 3/16			K / P\$	8545	
					1 1/2			H / P\$	5283	
		Veneer			1 3/16			F, G, Y / W\$	7818	
					1 3/16			K / W\$	11378	
				1 1/2			H / W\$	8899		
	Glass			1/4			Acid Etched Glass Top \$	29882		
				1/4			Gloss Glass Top \$	24803		
60"D x 216"W or 18' - 5 Piece Veneer (W) and 3 Piece HPL (P) Modern Rectangle Top										
88-60216MR	Laminate	216	60	1 3/16	519	23.7	F, G, Y / P\$	3987		
				1 3/16			K / P\$	7770		
				1 1/2			H / P\$	4666		
	Veneer			1 3/16			F, G, Y / W\$	7560		
				1 3/16			K / W\$	10966		
				1 1/2			H / W\$	8587		
	Glass			1/4			Acid Etched Glass Top \$	28467		
				1/4			Gloss Glass Top \$	23655		
60"D x 204"W or 17' - 5 Piece Veneer (W) and 3 Piece HPL (P) Modern Rectangle Top										
88-60204MR	Laminate	204	60	1 3/16	492	22.4	F, G, Y / P\$	3937		
				1 3/16			K / P\$	7538		
				1 1/2			H / P\$	4578		
	Veneer			1 3/16			F, G, Y / W\$	7302		
				1 3/16			K / W\$	10553		
				1 1/2			H / W\$	8274		
	Glass			1/4			Acid Etched Glass Top \$	27087		
				1/4			Gloss Glass Top \$	22543		

Must Specify (in this order):
 Model #
 Top/Edge Material
 Top/Edge Finish/Color
 Edge Profile
 Glass (Y/N)
 Glass Color + Surface Finish
 Power/Data Type
 Power/Data Location

Additional 60" Modern Rectangle Shaped Tops on Next Page



P = HPL W = Veneer

[See Catalyst Overview For Ordering Options](#)

Item	Model No.		W	D	H	Ship Wt	Cubic Ft	Edge Profile + Material	List Price	
<i>CONTINUED FROM PREVIOUS PAGE</i>	60"D x 192"W or 16' - 4 Piece Veneer (W) and 2 Piece HPL (P) Modern Rectangle Top									
	88-60192MR	Laminate	192	60	1 3/16	458	21.1	F, G, Y / P\$	3250	
					1 3/16			K / P\$	6634	
					1 1/2			H / P\$	3854	
		Veneer			1 3/16			F, G, Y / W\$	6041	
					1 3/16			K / W\$	9116	
					1 1/2			H / W\$	6956	
		Glass			1/4			Acid Etched Glass Top \$	25033	
					1/4			Gloss Glass Top \$	20756	
		60"D x 180"W or 15' - 4 Piece Veneer (W) and 2 Piece HPL (P) Modern Rectangle Top								
	88-60180MR	Laminate	180	60	1 3/16	431	19.8	F, G, Y / P\$	3199	
					1 3/16			K / P\$	6401	
					1 1/2			H / P\$	3766	
		Veneer			1 3/16			F, G, Y / W\$	5804	
					1 3/16			K / W\$	8725	
					1 1/2			H / W\$	6665	
		Glass			1/4			Acid Etched Glass Top \$	23653	
					1/4			Gloss Glass Top \$	19644	
	60"D x 168"W or 14' - 4 Piece Veneer (W) and 2 Piece HPL (P) Modern Rectangle Top									
88-60168MR	Laminate	168	60	1 3/16	403	18.5	F, G, Y / P\$	3149		
				1 3/16			K / P\$	6169		
				1 1/2			H / P\$	3677		
	Veneer			1 3/16			F, G, Y / W\$	5567		
				1 3/16			K / W\$	8333		
				1 1/2			H / W\$	6373		
	Glass			1/4			Acid Etched Glass Top \$	22273		
				1/4			Gloss Glass Top \$	18531		
	60"D x 156"W or 13' - 4 Piece Veneer (W) and 2 Piece HPL (P) Modern Rectangle Top									
88-60156MR	Laminate	156	60	1 3/16	376	17.2	F, G, Y / P\$	3098		
				1 3/16			K / P\$	5937		
				1 1/2			H / P\$	3589		
	Veneer			1 3/16			F, G, Y / W\$	5331		
				1 3/16			K / W\$	7942		
				1 1/2			H / W\$	6082		
	Glass			1/4			Acid Etched Glass Top \$	20893		
				1/4			Gloss Glass Top \$	17418		

Must Specify (in this order):
 Model #
 Top/Edge Material
 Top/Edge Finish/Color
 Edge Profile
 Glass (Y/N)
 Glass Color + Surface Finish
 Power/Data
 Power/Data Location

Additional 60" Modern Rectangle Shaped Tops on Next Page



Double Kerf (F) 1 3/16" Duo (G) 1 3/16" Square (Y) 1 3/16" Knife (K) 1 3/16" Vertical Square (H) 1 1/2"

P = HPL W = Veneer

[See Catalyst Overview For Ordering Options](#)

Item	Model No.		W	D	H	Ship Wt	Cubic Ft	Edge Profile + Material	List Price		
<i>CONTINUED FROM PREVIOUS PAGE</i>	60"D x 144"W or 12' - 3 Piece Veneer (W) and 2 Piece HPL (P) Modern Rectangle Top										
	88-60144MR	Laminate	144	60	1 3/16	342	16.0	F, G, Y / P\$	2639		
					1 3/16			K / P\$	5285		
					1 1/2			H / P\$	3092		
		Veneer			1 3/16			F, G, Y / W\$	4414		
					1 3/16			K / W\$	6771		
					1 1/2			H / W\$	5029		
		Glass			1/4			Acid Etched Glass Top \$	19192		
					1/4			Gloss Glass Top \$	15984		
		60"D x 132"W or 11' - 3 Piece Veneer (W) and 2 Piece HPL (P) Modern Rectangle Top									
	88-60132MR	Laminate	132	60	1 3/16	323	14.6	F, G, Y / P\$	2576		
					1 3/16			K / P\$	5040		
					1 1/2			H / P\$	2991		
		Veneer			1 3/16			F, G, Y / W\$	4189		
					1 3/16			K / W\$	6397		
				1 1/2			H / W\$	4756			
	Glass			1/4			Acid Etched Glass Top \$	17798			
				1/4			Gloss Glass Top \$	14858			
	60"D x 120"W or 10' - 3 Piece Veneer (W) and 2 Piece HPL (P) Modern Rectangle Top										
88-60120MR	Laminate	120	60	1 3/16	287	13.3	F, G, Y / P\$	2513			
				1 3/16			K / P\$	4796			
				1 1/2			H / P\$	2890			
	Veneer			1 3/16			F, G, Y / W\$	3965			
				1 3/16			K / W\$	6026			
				1 1/2			H / W\$	4484			
	Glass			1/4			Acid Etched Glass Top \$	16406			
				1/4			Gloss Glass Top \$	13733			

Must Specify (in this order):
 Model #
 Top/Edge Material
 Top/Edge Finish/Color
 Edge Profile
 Glass (Y/N)
 Glass Color + Surface Finish
 Power/Data Type
 Power/Data Location

Description

- Tops Available with Veneer (W) or HPL (P) Top in 1 3/16" and 1 1/2" Thicknesses
- Must Specify Edge Profile: 1 3/16" Thick/Double Kerf (F), Duo (G), Square (Y), and Knife (K) Edge Profiles or 1 1/2" Thick/Vertical Square (H)
- Veneer (W) Top Grain Runs Depth of Top and HPL (P) Top Grain Runs Width of Top
- Available with Back Painted Tempered Glass Top; Must Specify Color and Finish; [See Options](#)
- Power and Data Options Available; Sold Separately, [See Multiple Power Unit Details](#)
- Bases Sold Separately, See [Multiple Base Options](#)



Double Kerf (F)
1 3/16"

Duo (G)
1 3/16"

Square (Y)
1 3/16"

Knife (K)
1 3/16"

Vertical Square (H)
1 1/2"

P = HPL W = Veneer

[See Catalyst Overview For Ordering Options](#)

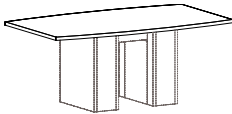
Item	Model No.		W	D	H	Ship Wt	Cubic Ft	Edge Profile + Material	List Price	
BOAT SHAPE MEETING TOP 36"D  88-3696BT shown with 88-203406RAB (6" Rectangle Accent Base) BASES SOLD SEPARATELY	36"D x 96"W or 8' - 1 Piece Boat Top									
	88-3696BT	Laminate	96	36-30	1 3/16	142	12.9	F, G, Y / P\$	1376	
					1 3/16			K / P\$	2726	
					1 1/2			H / P\$	1552	
		Veneer			1 3/16			F, G, Y / W\$	1558	
					1 3/16			K / W\$	3056	
					1 1/2			H / W\$	1856	
		Glass			1/4			Acid Etched Glass Top \$	8429	
					1/4			Gloss Glass Top \$	7146	
	36"D x 84"W or 7' - 1 Piece Boat Top									
	88-3684BT	Laminate	84	36-30	1 3/16	126	11.3	F, G, Y / P\$	1311	
					1 3/16			K / P\$	2496	
					1 1/2			H / P\$	1495	
		Veneer			1 3/16			F, G, Y / W\$	1477	
					1 3/16			K / W\$	2858	
				1 1/2			H / W\$	1708		
	Glass			1/4			Acid Etched Glass Top \$	7557		
				1/4			Gloss Glass Top \$	6434		
36"D x 72"W or 6' - 1 Piece Boat Top										
88-3672BT	Laminate	72	36-30	1 3/16	109	10.3	F, G, Y / P\$	1071		
				1 3/16			K / P\$	2160		
				1 1/2			H / P\$	1203		
	Veneer			1 3/16			F, G, Y / W\$	1258		
				1 3/16			K / W\$	2433		
				1 1/2			H / W\$	1485		
	Glass			1/4			Acid Etched Glass Top \$	6598		
				1/4			Gloss Glass Top \$	5635		

Must Specify (in this order):

- Model #
- Top/Edge Material
- Top/Edge Finish/Color
- Edge Profile
- Glass (Y/N)
- Glass Color + Surface Finish
- Power/Data
- Power/Data Location

Description

- Tops Available with Veneer (W) or HPL (P) Top in 1 3/16" and 1 1/2" Thicknesses
- Must Specify Edge Profile: 1 3/16" Thick/Double Kerf (F), Duo (G), Square (Y), and Knife (K) Edge Profiles or 1 1/2" Thick/Vertical Square (H)
- Veneer (W) Top Grain Runs Depth of Top and HPL (P) Top Grain Runs Width of Top
- Available with Back Painted Tempered Glass Top; Must Specify Color and Finish; [See Options](#)
- Power and Data Options Available; Sold Separately, [See Multiple Power Unit Details](#)
- Bases Sold Separately, See [Multiple Base Options](#)



Double Kerf (F)
1 3/16"



Duo (G)
1 3/16"



Square (Y)
1 3/16"



Knife (K)
1 3/16"



Vertical Square (H)
1 1/2"

P = HPL W = Veneer

[See Catalyst Overview For Ordering Options](#)

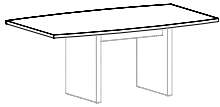
Item	Model No.		W	D	H	Ship Wt	Cubic Ft	Edge Profile + Material	List Price	
BOAT SHAPE MEETING TOP 42"D  88-4272BT shown with 88-2034RPB (Rectangle Panel Base) BASES SOLD SEPARATELY	42"D x 120"W or 10' - 2 Piece Boat Top									
	88-42120BT	Laminate	120	42-36	1 3/16	268	27.0	F, G, Y / P\$	1940	
					1 3/16			K / P\$	3716	
					1 1/2			H / P\$	2201	
		Veneer			1 3/16			F, G, Y / W\$	2251	
					1 3/16			K / W\$	4186	
					1 1/2			H / W\$	2675	
		Glass			1/4			Acid Etched Glass Top \$	11802	
					1/4			Gloss Glass Top \$	9931	
	42"D x 108"W or 9' - 2 Piece Boat Top									
	88-42108BT	Laminate	108	42-36	1 3/16	260	27.0	F, G, Y / P\$	1903	
					1 3/16			K / P\$	3507	
					1 1/2			H / P\$	2138	
		Veneer			1 3/16			F, G, Y / W\$	2118	
					1 3/16			K / W\$	3926	
				1 1/2			H / W\$	2502		
	Glass			1/4			Acid Etched Glass Top \$	10804		
				1/4			Gloss Glass Top \$	9120		
42"D x 96"W or 8' - 1 Piece Boat Top										
88-4296BT	Laminate	96	42-36	1 3/16	164	15.0	F, G, Y / P\$	1404		
				1 3/16			K / P\$	2883		
				1 1/2			H / P\$	1611		
	Veneer			1 3/16			F, G, Y / W\$	1693		
				1 3/16			K / W\$	3247		
				1 1/2			H / W\$	2033		
	Glass			1/4			Acid Etched Glass Top \$	9486		
				1/4			Gloss Glass Top \$	7989		
42"D x 84"W or 7' - 1 Piece Boat Top										
88-4284BT	Laminate	84	42-36	1 3/16	145	13.1	F, G, Y / P\$	1366		
				1 3/16			K / P\$	2675		
				1 1/2			H / P\$	1546		
	Veneer			1 3/16			F, G, Y / W\$	1563		
				1 3/16			K / W\$	2997		
				1 1/2			H / W\$	1863		
	Glass			1/4			Acid Etched Glass Top \$	8489		
				1/4			Gloss Glass Top \$	7179		

Must Specify (in this order):
 Model #
 Top/Edge Material
 Top/Edge Finish/Color
 Edge Profile
 Glass (Y/N)
 Glass Color + Surface Finish
 Power/Data
 Power/Data Location

Additional 42" Boat Shaped Tops on Next Page



P = HPL W = Veneer

[See Catalyst Overview For Ordering Options](#)

Item	Model No.		W	D	H	Ship Wt	Cubic Ft	Edge Profile + Material	List Price	
<i>CONTINUED FROM PREVIOUS PAGE</i>	42"D x 72"W or 6' - 1 Piece Boat Top									
	88-4272BT	Laminate	72	42-36	1 3/16	164	15.0	F, G, Y / P\$	1142	
					1 3/16			K / P\$	2384	
					1 1/2			H / P\$	1296	
		Veneer			1 3/16			F, G, Y / W\$	1423	
					1 3/16			K / W\$	2618	
					1 1/2			H / W\$	1682	
		Glass			1/4			Acid Etched Glass Top \$	7464	
					1/4			Gloss Glass Top \$	6341	

Must Specify (in this order):

- Model #
- Top/Edge Material
- Top/Edge Finish/Color
- Edge Profile
- Glass (Y/N)
- Glass Color + Surface Finish
- Power/Data
- Power/Data Location

Description

- Tops Available with Veneer (W) or HPL (P) Top in 1 3/16" and 1 1/2" Thicknesses
- Must Specify Edge Profile: 1 3/16" Thick/Double Kerf (F), Duo (G), Square (Y), and Knife (K) Edge Profiles or 1 1/2" Thick/Vertical Square (H)
- Veneer (W) Top Grain Runs Depth of Top and HPL (P) Top Grain Runs Width of Top
- Available with Back Painted Tempered Glass Top; Must Specify Color and Finish; [See Options](#)
- Power and Data Options Available; Sold Separately, [See Multiple Power Unit Details](#)
- Bases Sold Separately, See [Multiple Base Options](#)



Double Kerf (F)
1 3/16"



Duo (G)
1 3/16"



Square (Y)
1 3/16"



Knife (K)
1 3/16"



Vertical Square (H)
1 1/2"

P = HPL W = Veneer

[See Catalyst Overview For Ordering Options](#)

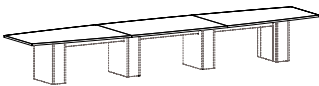
Item	Model No.		W	D	H	Ship Wt	Cubic Ft	Edge Profile + Material	List Price	
BOAT SHAPE MEETING TOP 48"D  88-48216BT shown with 88-2417810RAB (10" Rectangle Accent Base) BASES SOLD SEPARATELY	48"D x 240"W or 20' - 3 Piece Boat Top									
	88-48240BT	Laminate	240	48-36	1 3/16	460	48.9	F, G, Y / P\$	4481	
					1 3/16			K / P\$	8212	
					1 1/2			H / P\$	5079	
		Veneer			1 3/16			F, G, Y / W\$	6088	
					1 3/16			K / W\$	9247	
					1 1/2			H / W\$	6911	
		Glass			1/4			Acid Etched Glass Top \$	25733	
					1/4			Gloss Glass Top \$	21456	
	48"D x 228"W or 19' - 3 Piece Boat Top									
	88-48228BT	Laminate	228	48-36	1 3/16	438	48.9	F, G, Y / P\$	4439	
					1 3/16			K / P\$	8004	
					1 1/2			H / P\$	5007	
		Veneer			1 3/16			F, G, Y / W\$	5833	
					1 3/16			K / W\$	8904	
				1 1/2			H / W\$	6617		
	Glass			1/4			Acid Etched Glass Top \$	24607		
				1/4			Gloss Glass Top \$	20544		
48"D x 216"W or 18' - 3 Piece Boat Top										
88-48216BT	Laminate	216	48-36	1 3/16	416	48.9	F, G, Y / P\$	3562		
				1 3/16			K / P\$	6939		
				1 1/2			H / P\$	4100		
	Veneer			1 3/16			F, G, Y / W\$	5187		
				1 3/16			K / W\$	8170		
				1 1/2			H / W\$	5931		
	Glass			1/4			Acid Etched Glass Top \$	23108		
				1/4			Gloss Glass Top \$	19259		
48"D x 204"W or 17' - 3 Piece Boat Top										
88-48204BT	Laminate	204	48-36	1 3/16	394	48.9	F, G, Y / P\$	3520		
				1 3/16			K / P\$	6732		
				1 1/2			H / P\$	4028		
	Veneer			1 3/16			F, G, Y / W\$	4933		
				1 3/16			K / W\$	7827		
				1 1/2			H / W\$	5637		
	Glass			1/4			Acid Etched Glass Top \$	21982		
				1/4			Gloss Glass Top \$	18346		

Must Specify (in this order):
 Model #
 Top/Edge Material
 Top/Edge Finish/Color
 Edge Profile
 Glass (Y/N)
 Glass Color + Surface Finish
 Power/Data
 Power/Data Location

Additional 48" Boat Shaped Tops on Next Page



P = HPL W = Veneer

[See Catalyst Overview For Ordering Options](#)

Item	Model No.		W	D	H	Ship Wt	Cubic Ft	Edge Profile + Material	List Price	
48"D x 192"W or 16' - 2 Piece Boat Top										
<i>CONTINUED FROM PREVIOUS PAGE</i>	88-48192BT	Laminate	192	48-36	1 3/16	372	31.2	F, G, Y / P\$	3019	
					1 3/16			K / P\$	6038	
					1 1/2			H / P\$	3499	
		Veneer			1 3/16			F, G, Y / W\$	4072	
					1 3/16			K / W\$	6759	
					1 1/2			H / W\$	4822	
		Glass			1/4			Acid Etched Glass Top \$	20360	
					1/4			Gloss Glass Top \$	16938	
	48"D x 180"W or 15' - 2 Piece Boat Top									
	Must Specify (in this order): Model # Top/Edge Material Top/Edge Finish/Color Edge Profile Glass (Y/N) Glass Color + Surface Finish Power/Data Power/Data Location	88-48180BT	Laminate	180	48-36	1 3/16	350	31.2	F, G, Y / P\$	2976
					1 3/16			K / P\$	5830	
					1 1/2			H / P\$	3427	
		Veneer			1 3/16			F, G, Y / W\$	3908	
					1 3/16			K / W\$	6453	
					1 1/2			H / W\$	4612	
		Glass			1/4			Acid Etched Glass Top \$	19233	
					1/4			Gloss Glass Top \$	16025	
48"D x 168"W or 14' - 2 Piece Boat Top										
		88-48168BT	Laminate	168	48-36	1 3/16	328	31.2	F, G, Y / P\$	2829
					1 3/16			K / P\$	5515	
					1 1/2			H / P\$	3249	
		Veneer			1 3/16			F, G, Y / W\$	3610	
					1 3/16			K / W\$	6013	
					1 1/2			H / W\$	4269	
		Glass			1/4			Acid Etched Glass Top \$	17999	
					1/4			Gloss Glass Top \$	15005	
	48"D x 156"W or 13' - 2 Piece Boat Top									
		88-48156BT	Laminate	156	48-36	1 3/16	306	31.2	F, G, Y / P\$	2787
					1 3/16			K / P\$	5182	
					1 1/2			H / P\$	3177	
		Veneer			1 3/16			F, G, Y / W\$	3446	
					1 3/16			K / W\$	5835	
					1 1/2			H / W\$	4060	
		Glass			1/4			Acid Etched Glass Top \$	16872	
					1/4			Gloss Glass Top \$	14092	

Additional 48" Boat Shaped Tops on Next Page



Double Kerf (F)
1 3/16"



Duo (G)
1 3/16"



Square (Y)
1 3/16"



Knife (K)
1 3/16"



Vertical Square (H)
1 1/2"

P = HPL W = Veneer

[See Catalyst Overview For Ordering Options](#)

Item	Model No.		W	D	H	Ship Wt	Cubic Ft	Edge Profile + Material	List Price		
<i>CONTINUED FROM PREVIOUS PAGE</i>	48"D x 144"W or 12' - 2 Piece Boat Top										
	88-48144BT	Laminate	144	48-36	1 3/16	284	23.5	F, G, Y / P\$	2339		
					1 3/16			K / P\$	4683		
					1 1/2			H / P\$	2699		
		Veneer			1 3/16			F, G, Y / W\$	3215		
					1 3/16			K / W\$	5334		
					1 1/2			H / W\$	3783		
		Glass			1/4			Acid Etched Glass Top \$	15653		
					1/4			Gloss Glass Top \$	13086		
		48"D x 132"W or 11' - 2 Piece Boat Top									
	88-48132BT	Laminate	132	48-36	1 3/16	262	23.5	F, G, Y / P\$	2285		
					1 3/16			K / P\$	4463		
					1 1/2			H / P\$	2614		
		Veneer			1 3/16			F, G, Y / W\$	3000		
					1 3/16			K / W\$	5003		
				1 1/2			H / W\$	3522			
	Glass			1/4			Acid Etched Glass Top \$	14514			
				1/4			Gloss Glass Top \$	12162			
	48"D x 120"W or 10' - 2 Piece Boat Top										
88-48120BT	Laminate	120	48-36	1 3/16	240	23.5	F, G, Y / P\$	2221			
				1 3/16			K / P\$	4235			
				1 1/2			H / P\$	2521			
	Veneer			1 3/16			F, G, Y / W\$	2773			
				1 3/16			K / W\$	4660			
				1 1/2			H / W\$	3250			
	Glass			1/4			Acid Etched Glass Top \$	13367			
				1/4			Gloss Glass Top \$	11229			
	48"D x 108"W or 9' - 2 Piece Boat Top										
88-48108BT	Laminate	108	48-36	1 3/16	218	23.5	F, G, Y / P\$	2167			
				1 3/16			K / P\$	3926			
				1 1/2			H / P\$	2437			
	Veneer			1 3/16			F, G, Y / W\$	2558			
				1 3/16			K / W\$	4420			
				1 1/2			H / W\$	2990			
	Glass			1/4			Acid Etched Glass Top \$	12229			
				1/4			Gloss Glass Top \$	10304			

Must Specify (in this order):
 Model #
 Top/Edge Material
 Top/Edge Finish/Color
 Edge Profile
 Glass (Y/N)
 Glass Color + Surface Finish
 Power/Data
 Power/Data Location

Additional 48" Boat Shaped Tops on Next Page



Double Kerf (F) 1 3/16" Duo (G) 1 3/16" Square (Y) 1 3/16" Knife (K) 1 3/16" Vertical Square (H) 1 1/2"

P = HPL W = Veneer

[See Catalyst Overview For Ordering Options](#)

Item	Model No.		W	D	H	Ship Wt	Cubic Ft	Edge Profile + Material	List Price		
<i>CONTINUED FROM PREVIOUS PAGE</i>	48"D x 96"W or 8' - 1 Piece Boat Top										
	88-4896BT	Laminate	96	48-36	1 3/16	295	27.0	F, G, Y / P\$	1477		
					1 3/16			K / P\$	3148		
					1 1/2			H / P\$	1714		
		Veneer			1 3/16			F, G, Y / W\$	1885		
					1 3/16			K / W\$	3438		
					1 1/2			H / W\$	2268		
		Glass			1/4			Acid Etched Glass Top \$	10594		
					1/4			Gloss Glass Top \$	8883		
		48"D x 84"W or 7' - 1 Piece Boat Top									
	88-4884BT	Laminate	84	48-36	1 3/16	164	15.0	F, G, Y / P\$	1434		
					1 3/16			K / P\$	2801		
					1 1/2			H / P\$	1641		
		Veneer			1 3/16			F, G, Y / W\$	1666		
					1 3/16			K / W\$	3156		
				1 1/2			H / W\$	2004			
	Glass			1/4			Acid Etched Glass Top \$	9403			
				1/4			Gloss Glass Top \$	7907			
	48"D x 72"W or 6' - 1 Piece Boat Top										
88-4872BT	Laminate	72	48-36	1 3/16	142	12.8	F, G, Y / P\$	1207			
				1 3/16			K / P\$	2548			
				1 1/2			H / P\$	1384			
	Veneer			1 3/16			F, G, Y / W\$	1578			
				1 3/16			K / W\$	2848			
				1 1/2			H / W\$	1870			
	Glass			1/4			Acid Etched Glass Top \$	8317			
				1/4			Gloss Glass Top \$	7034			

Must Specify (in this order):

- Model #
- Top/Edge Material
- Top/Edge Finish/Color
- Edge Profile
- Glass (Y/N)
- Glass Color + Surface Finish
- Power/Data
- Power/Data Location

Description

- Tops Available with Veneer (W) or HPL (P) Top in 1 3/16" and 1 1/2" Thicknesses
- Must Specify Edge Profile: 1 3/16" Thick/Double Kerf (F), Duo (G), Square (Y), and Knife (K) Edge Profiles or 1 1/2" Thick/Vertical Square (H)
- Veneer (W) Top Grain Runs Depth of Top and HPL (P) Top Grain Runs Width of Top
- Available with Back Painted Tempered Glass Top; Must Specify Color and Finish; [See Options](#)
- Power and Data Options Available; Sold Separately, [See Multiple Power Unit Details](#)
- Bases Sold Separately, See [Multiple Base Options](#)



Double Kerf (F)
1 3/16"
Duo (G)
1 3/16"
Square (Y)
1 3/16"
Knife (K)
1 3/16"
Vertical Square (H)
1 1/2"

P = HPL W = Veneer

[See Catalyst Overview For Ordering Options](#)

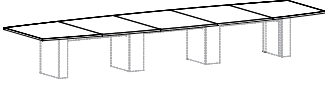
Item	Model No.		W	D	H	Ship Wt	Cubic Ft	Edge Profile + Material	List Price	
BOAT SHAPE MEETING TOP 54"D  88-54204BT shown in Veneer with 88-241661ORB (10" Rectangle Base) BASES SOLD SEPARATELY	54"D x 240"W or 20' - 5 Piece Veneer (W) and 3 Piece HPL (P) Boat Top									
	88-54240BT	Laminate	240	54-42	1 3/16"	519	24.0	F, G, Y / P\$	4531	
					1 3/16"			K / P\$	8476	
					1 1/2"			H / P\$	5207	
		Veneer			1 3/16"			F, G, Y / W\$	7579	
					1 3/16"			K / W\$	11166	
					1 1/2"			H / W\$	8611	
		Glass			1/4"			Acid Etched Glass Top \$	28663	
					1/4"			Gloss Glass Top \$	23852	
	54"D x 228"W or 19' - 5 Piece Veneer (W) and 3 Piece HPL (P) Boat Top									
	88-54228BT	Laminate	228	54-42	1 3/16"	495	23.0	F, G, Y / P\$	4485	
					1 3/16"			K / P\$	8256	
					1 1/2"			H / P\$	5127	
	Veneer			1 3/16"			F, G, Y / W\$	7345		
				1 3/16"			K / W\$	10782		
				1 1/2"			H / W\$	8328		
	Glass			1/4"			Acid Etched Glass Top \$	27410		
				1/4"			Gloss Glass Top \$	22840		
54"D x 216"W or 18' - 5 Piece Veneer (W) and 3 Piece HPL (P) Boat Top										
88-54216BT	Laminate	216	54-42	1 3/16"	470	22.0	F, G, Y / P\$	3910		
				1 3/16"			K / P\$	7493		
				1 1/2"			H / P\$	4518		
	Veneer			1 3/16"			F, G, Y / W\$	7112		
				1 3/16"			K / W\$	10397		
				1 1/2"			H / W\$	8045		
	Glass			1/4"			Acid Etched Glass Top \$	26123		
				1/4"			Gloss Glass Top \$	21793		
54"D x 204"W or 17' - 5 Piece Veneer (W) and 3 Piece HPL (P) Boat Top										
88-54204BT	Laminate	204	54-42	1 3/16"	445	21.0	F, G, Y / P\$	3864		
				1 3/16"			K / P\$	7273		
				1 1/2"			H / P\$	4438		
	Veneer			1 3/16"			F, G, Y / W\$	6878		
				1 3/16"			K / W\$	10014		
				1 1/2"			H / W\$	7762		
	Glass			1/4"			Acid Etched Glass Top \$	24871		
				1/4"			Gloss Glass Top \$	20782		

Additional 54" Boat Shaped Tops on Next Page



Double Kerf (F) 1 3/16" Duo (G) 1 3/16" Square (Y) 1 3/16" Knife (K) 1 3/16" Vertical Square (H) 1 1/2"

P = HPL W = Veneer

[See Catalyst Overview For Ordering Options](#)

Item	Model No.		W	D	H	Ship Wt	Cubic Ft	Edge Profile + Material	List Price			
54"D x 192"W or 16' - 4 Piece Veneer (W) and 2 Piece HPL (P) Boat Top												
<i>CONTINUED FROM PREVIOUS PAGE</i>	88-54192BT	Laminate	192	54-42	1 ³ / ₁₆ "	408	19.0	F, G, Y / P\$	3180			
					1 ³ / ₁₆ "			K / P\$	6383			
					1 ¹ / ₂ "			H / P\$	3722			
		Veneer								F, G, Y / W\$	5675	
										1 ³ / ₁₆ "	K / W\$	8636
										1 ¹ / ₂ "	H / W\$	6506
		Glass								Acid Etched Glass Top \$	22945	
										1 ¹ / ₂ "	Gloss Glass Top \$	19096
		54"D x 180"W or 15' - 4 Piece Veneer (W) and 2 Piece HPL (P) Boat Top										
		<i>Must Specify (in this order):</i> Model # Top/Edge Material Top/Edge Finish/Color Edge Profile Glass (Y/N) Glass Color + Surface Finish Power/Data Power/Data Location	88-54180BT	Laminate	180	54-42	1 ³ / ₁₆ "	384	18.0	F, G, Y / P\$	3134	
							1 ³ / ₁₆ "			K / P\$	6163	
							1 ¹ / ₂ "			H / P\$	3642	
Veneer										F, G, Y / W\$	5461	
										1 ³ / ₁₆ "	K / W\$	8271
										1 ¹ / ₂ "	H / W\$	6242
Glass										Acid Etched Glass Top \$	21692	
										1 ¹ / ₂ "	Gloss Glass Top \$	18083
54"D x 168"W or 14' - 4 Piece Veneer (W) and 2 Piece HPL (P) Boat Top												
	88-54168BT			Laminate	168	54-42	1 ³ / ₁₆ "	359	17.0	F, G, Y / P\$	3087	
							1 ³ / ₁₆ "			K / P\$	5943	
							1 ¹ / ₂ "			H / P\$	3562	
		Veneer								F, G, Y / W\$	5247	
										1 ³ / ₁₆ "	K / W\$	7905
										1 ¹ / ₂ "	H / W\$	5979
		Glass								Acid Etched Glass Top \$	20439	
										1 ¹ / ₂ "	Gloss Glass Top \$	17071
		54"D x 156"W or 13' - 4 Piece Veneer (W) and 2 Piece HPL (P) Boat Top										
			88-54156BT	Laminate	156	54-42	1 ³ / ₁₆ "	334	16.0	F, G, Y / P\$	3041	
							1 ³ / ₁₆ "			K / P\$	5723	
							1 ¹ / ₂ "			H / P\$	3481	
Veneer										F, G, Y / W\$	5033	
										1 ³ / ₁₆ "	K / W\$	7538
										1 ¹ / ₂ "	H / W\$	5715
Glass										Acid Etched Glass Top \$	19185	
										1 ¹ / ₂ "	Gloss Glass Top \$	16057

Additional 54" Boat Shaped Tops on Next Page



Double Kerf (F) 1³/₁₆" Duo (G) 1³/₁₆" Square (Y) 1³/₁₆" Knife (K) 1³/₁₆" Vertical Square (H) 1¹/₂"

P = HPL W = Veneer

[See Catalyst Overview For Ordering Options](#)

Item	Model No.		W	D	H	Ship Wt	Cubic Ft	Edge Profile + Material	List Price		
<i>CONTINUED FROM PREVIOUS PAGE</i>	54"D x 144"W or 12' - 3 Piece Veneer (W) and 2 Piece HPL (P) Boat Top										
	88-54144BT	Laminate	144	54-42	1 3/16	309	15.0	F, G, Y / P\$	2585		
					1 3/16			K / P\$	5083		
					1 1/2			H / P\$	2992		
		Veneer			1 3/16			F, G, Y / W\$	4155		
					1 3/16			K / W\$	6420		
					1 1/2			H / W\$	4715		
		Glass			1/4			Acid Etched Glass Top \$	17612		
					1/4			Gloss Glass Top \$	14725		
		54"D x 132"W or 11' - 3 Piece Veneer (W) and 2 Piece HPL (P) Boat Top									
	88-54132BT	Laminate	132	54-42	1 3/16	285	13.2	F, G, Y / P\$	2526		
					1 3/16			K / P\$	4851		
					1 1/2			H / P\$	2899		
		Veneer			1 3/16			F, G, Y / W\$	3952		
					1 3/16			K / W\$	6072		
				1 1/2			H / W\$	4468			
	Glass			1/4			Acid Etched Glass Top \$	16346			
				1/4			Gloss Glass Top \$	13700			
	54"D x 120"W or 10' - 3 Piece Veneer (W) and 2 Piece HPL (P) Boat Top										
88-54120BT	Laminate	120	54-42	1 3/16	260	12.1	F, G, Y / P\$	2467			
				1 3/16			K / P\$	4618			
				1 1/2			H / P\$	2806			
	Veneer			1 3/16			F, G, Y / W\$	3749			
				1 3/16			K / W\$	5727			
				1 1/2			H / W\$	4222			
	Glass			1/4			Acid Etched Glass Top \$	15084			
				1/4			Gloss Glass Top \$	12678			

Must Specify (in this order):
 Model #
 Top/Edge Material
 Top/Edge Finish/Color
 Edge Profile
 Glass (Y/N)
 Glass Color + Surface Finish
 Power/Data
 Power/Data Location

Description

- Tops Available with Veneer (W) or HPL (P) Top in 1 3/16" and 1 1/2" Thicknesses
- Must Specify Edge Profile: 1 3/16" Thick/Double Kerf (F), Duo (G), Square (Y), and Knife (K) Edge Profiles or 1 1/2" Thick/Vertical Square (H)
- Veneer (W) Top Grain Runs Depth of Top and HPL (P) Top Grain Runs Width of Top
- Available with Back Painted Tempered Glass Top; Must Specify Color and Finish; [See Options](#)
- Power and Data Options Available; Sold Separately, [See Multiple Power Unit Details](#)
- Bases Sold Separately, See [Multiple Base Options](#)



Double Kerf (F)
1 3/16"

Duo (G)
1 3/16"

Square (Y)
1 3/16"

Knife (K)
1 3/16"

Vertical Square (H)
1 1/2"

P = HPL W = Veneer

[See Catalyst Overview For Ordering Options](#)

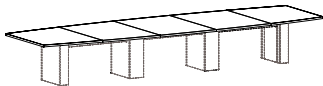
Item	Model No.		W	D	H	Ship Wt	Cubic Ft	Edge Profile + Material	List Price	
BOAT SHAPE MEETING TOP 60"D  88-60204BT shown in Veneer with 88-24166C610RB (6" + 10" Combo Rectangle Base) BASES SOLD SEPARATELY Must Specify (in this order): Model # Top/Edge Material Top/Edge Finish/Color Edge Profile Glass (Y/N) Glass Color + Surface Finish Power/Data Power/Data Location	60"D x 240"W or 20' - 5 Piece Veneer (W) and 3 Piece HPL (P) Boat Top									
	88-60240BT	Laminate	240	60-48	1 3/16"	574	26.3	F, G, Y / P\$	4617	
					1 3/16"			K / P\$	8777	
					1 1/2"			H / P\$	5371	
	Veneer				1 3/16"			F, G, Y / W\$	8076	
					1 3/16"			K / W\$	11791	
					1 1/2"			H / W\$	9212	
	Glass				1/4"			Acid Etched Glass Top \$	31262	
					1/4"			Gloss Glass Top \$	25916	
	60"D x 228"W or 19' - 5 Piece Veneer (W) and 3 Piece HPL (P) Boat Top									
	88-60228BT	Laminate	228	60-48	1 3/16"	547	25.0	F, G, Y / P\$	4567	
					1 3/16"			K / P\$	8545	
					1 1/2"			H / P\$	5283	
	Veneer				1 3/16"			F, G, Y / W\$	7818	
					1 3/16"			K / W\$	11378	
				1 1/2"			H / W\$	8899		
Glass				1/4"			Acid Etched Glass Top \$	29882		
				1/4"			Gloss Glass Top \$	24803		
60"D x 216"W or 18' - 5 Piece Veneer (W) and 3 Piece HPL (P) Boat Top										
88-60216BT	Laminate	216	60-48	1 3/16"	519	23.7	F, G, Y / P\$	3987		
				1 3/16"			K / P\$	7770		
				1 1/2"			H / P\$	4666		
Veneer				1 3/16"			F, G, Y / W\$	7560		
				1 3/16"			K / W\$	10966		
				1 1/2"			H / W\$	8587		
Glass				1/4"			Acid Etched Glass Top \$	28467		
				1/4"			Gloss Glass Top \$	23655		
60"D x 204"W or 17' - 5 Piece Veneer (W) and 3 Piece HPL (P) Boat Top										
88-60204BT	Laminate	204	60-48	1 3/16"	492	22.4	F, G, Y / P\$	3937		
				1 3/16"			K / P\$	7538		
				1 1/2"			H / P\$	4578		
Veneer				1 3/16"			F, G, Y / W\$	7302		
				1 3/16"			K / W\$	10553		
				1 1/2"			H / W\$	8274		
Glass				1/4"			Acid Etched Glass Top \$	27087		
				1/4"			Gloss Glass Top \$	22543		

Additional 60" Boat Shaped Tops on Next Page



P = HPL W = Veneer

[See Catalyst Overview For Ordering Options](#)

Item	Model No.		W	D	H	Ship Wt	Cubic Ft	Edge Profile + Material	List Price		
<i>CONTINUED FROM PREVIOUS PAGE</i>	60"D x 192"W or 16' - 4 Piece Veneer (W) and 2 Piece HPL (P) Boat Top										
	88-60192BT	Laminate	192	60-48	1 3/16"	458	21.1	F, G, Y / P\$	3250		
					1 3/16"			K / P\$	6634		
					1 1/2"			H / P\$	3854		
		Veneer			1 3/16"			F, G, Y / W\$	6041		
					1 3/16"			K / W\$	9116		
					1 1/2"			H / W\$	6956		
		Glass			1/4"			Acid Etched Glass Top \$	25033		
					1/4"			Gloss Glass Top \$	20756		
		60"D x 180"W or 15' - 4 Piece Veneer (W) and 2 Piece HPL (P) Boat Top									
	88-60180BT	Laminate	180	60-48	1 3/16"	431	19.8	F, G, Y / P\$	3199		
					1 3/16"			K / P\$	6401		
					1 1/2"			H / P\$	3766		
		Veneer			1 3/16"			F, G, Y / W\$	5804		
					1 3/16"			K / W\$	8725		
				1 1/2"			H / W\$	6665			
	Glass			1/4"			Acid Etched Glass Top \$	23653			
				1/4"			Gloss Glass Top \$	19644			
	60"D x 168"W or 14' - 4 Piece Veneer (W) and 2 Piece HPL (P) Boat Top										
88-60168BT	Laminate	168	60-48	1 3/16"	403	18.5	F, G, Y / P\$	3149			
				1 3/16"			K / P\$	6169			
				1 1/2"			H / P\$	3677			
	Veneer			1 3/16"			F, G, Y / W\$	5567			
				1 3/16"			K / W\$	8333			
				1 1/2"			H / W\$	6373			
	Glass			1/4"			Acid Etched Glass Top \$	22273			
				1/4"			Gloss Glass Top \$	18531			
	60"D x 156"W or 13' - 4 Piece Veneer (W) and 2 Piece HPL (P) Boat Top										
88-60156BT	Laminate	156	60-48	1 3/16"	376	17.2	F, G, Y / P\$	3098			
				1 3/16"			K / P\$	5937			
				1 1/2"			H / P\$	3589			
	Veneer			1 3/16"			F, G, Y / W\$	5331			
				1 3/16"			K / W\$	7942			
				1 1/2"			H / W\$	6082			
	Glass			1/4"			Acid Etched Glass Top \$	20893			
				1/4"			Gloss Glass Top \$	17418			

Must Specify (in this order):

- Model #
- Top/Edge Material
- Top/Edge Finish/Color
- Edge Profile
- Glass (Y/N)
- Glass Color + Surface Finish
- Power/Data
- Power/Data Location

Additional 60" Boat Shaped Tops on Next Page



Double Kerf (F)
1 3/16"

Duo (G)
1 3/16"

Square (Y)
1 3/16"

Knife (K)
1 3/16"

Vertical Square (H)
1 1/2"

P = HPL W = Veneer

[See Catalyst Overview For Ordering Options](#)

Item	Model No.		W	D	H	Ship Wt	Cubic Ft	Edge Profile + Material	List Price		
60"D x 144"W or 12' - 3 Piece Veneer (W) and 2 Piece HPL (P) Boat Top											
<i>CONTINUED FROM PREVIOUS PAGE</i>	88-60144BT	Laminate	144	60-48	1 3/16"	342	16.0	F, G, Y / P\$	2639		
					1 3/16"			K / P\$	5285		
					1 1/2"			H / P\$	3092		
		Veneer	1 3/16"	F, G, Y / W\$	4414						
			1 3/16"	K / W\$	6771						
			1 1/2"	H / W\$	5029						
		Glass	1/4"	Acid Etched Glass Top \$	19192						
			1/4"	Gloss Glass Top \$	15984						
		60"D x 132"W or 11' - 3 Piece Veneer (W) and 2 Piece HPL (P) Boat Top									
		<u>Must Specify (in this order):</u> Model # Top/Edge Material Top/Edge Finish/Color Edge Profile Glass (Y/N) Glass Color + Surface Finish Power/Data Power/Data Location	88-60132BT	Laminate	132	60-48	1 3/16"	323	14.6	F, G, Y / P\$	2576
1 3/16"	K / P\$						5040				
1 1/2"	H / P\$						2991				
Veneer	1 3/16"			F, G, Y / W\$	4189						
	1 3/16"			K / W\$	6397						
	1 1/2"			H / W\$	4756						
Glass	1/4"			Acid Etched Glass Top \$	17798						
	1/4"			Gloss Glass Top \$	14858						
60"D x 120"W or 10' - 3 Piece Veneer (W) and 2 Piece HPL (P) Boat Top											
	88-60120BT			Laminate	120	60-48	1 3/16"	287	13.3	F, G, Y / P\$	2513
		1 3/16"	K / P\$				4796				
		1 1/2"	H / P\$				2890				
		Veneer	1 3/16"	F, G, Y / W\$	3965						
			1 3/16"	K / W\$	6026						
			1 1/2"	H / W\$	4484						
		Glass	1/4"	Acid Etched Glass Top \$	16406						
			1/4"	Gloss Glass Top \$	13733						

Description

- Tops Available with Veneer (W) or HPL (P) Top in 1 3/16" and 1 1/2" Thicknesses
- Must Specify Edge Profile: 1 3/16" Thick/Double Kerf (F), Duo (G), Square (Y), and Knife (K) Edge Profiles or 1 1/2" Thick/Vertical Square (H)
- Veneer (W) Top Grain Runs Depth of Top and HPL (P) Top Grain Runs Width of Top
- Available with Back Painted Tempered Glass Top; Must Specify Color and Finish; [See Options](#)
- Power and Data Options Available; Sold Separately, [See Multiple Power Unit Details](#)
- Bases Sold Separately, See [Multiple Base Options](#)



Double Kerf (F)
1 3/16"



Duo (G)
1 3/16"



Square (Y)
1 3/16"



Knife (K)
1 3/16"



Vertical Square (H)
1 1/2"

P = HPL W = Veneer

[See Catalyst Overview For Ordering Options](#)

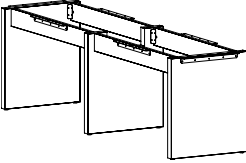
Item	Model No.		W	D	H	Ship Wt	Cubic Ft	List Price	
RECTANGLE PANEL BASES WITH TROUGH 24"W	Four (4) Panel Bases - For Use With 60" / 54" / 48" x 240" Surfaces								
	88-24202RPB	Laminate	24	202	28¾	159	14.3	T\$	4291
		Veneer						W\$	4348
	Four (4) Panel Bases - For Use With 60" / 54" / 48" x 228" Surfaces								
	88-24190RPB	Laminate	24	190	28¾	158	14.3	T\$	4246
		Veneer						W\$	4296
	Four (4) Panel Bases - For Use With 60" / 54" / 48" x 216" Surfaces								
	88-24178RPB	Laminate	24	178	28¾	156	14.3	T\$	4215
		Veneer						W\$	4265
	Four (4) Panel Bases - For Use With 60" / 54" / 48" x 204" Surfaces								
	88-24166RPB	Laminate	24	166	28¾	155	14.3	T\$	4169
		Veneer						W\$	4213
	Three (3) Panel Bases - For Use With 60" / 54" / 48" x 192" Surfaces								
	88-24154RPB	Laminate	24	154	28¾	122	13.8	T\$	3333
		Veneer						W\$	3551
	Three (3) Panel Bases - For Use With 60" / 54" / 48" x 180" Surfaces								
	88-24142RPB	Laminate	24	142	28¾	120	13.8	T\$	3029
		Veneer						W\$	3064
	Three (3) Panel Bases - For Use With 60" / 54" / 48" x 168" Surfaces								
	88-24130RPB	Laminate	24	130	28¾	119	13.8	T\$	3005
		Veneer						W\$	3028
	Three (3) Panel Bases - For Use With 60" / 54" / 48" x 156" Surfaces								
	88-24118RPB	Laminate	24	118	28¾	118	13.8	T\$	2967
		Veneer						W\$	2992
	Three (3) Panel Bases - For Use With 60" / 54" / 48" x 144" Surfaces								
	88-24106RPB	Laminate	24	106	28¾	116	13.8	T\$	2899
		Veneer						W\$	2956
	Three (3) Panel Bases - For Use With 60" / 54" / 48" x 132" Surfaces								
	88-2494RPB	Laminate	24	94	28¾	115	13.8	T\$	2576
		Veneer						W\$	2687
	Two (2) Panel Bases - For Use With 60" / 54" / 48" x 120" Surfaces								
	88-2482RPB	Laminate	24	82	28¾	90	6.9	T\$	2077
		Veneer						W\$	2127

Shown: 88-2494RPB

TOPS SOLD SEPARATELY

Must Specify (in this order):

Model #

Material

Finish / Color

Additional Rectangle Panel Bases on Next Page

T = TFL W = Veneer

[See Catalyst Overview For Ordering Options](#)

Item	Model No.		W	D	H	Ship Wt	Cubic Ft	List Price	
RECTANGLE PANEL BASES WITH TROUGH 24" + 20"W	24"W Bases Continued								
	Two (2) Panel Bases - For Use With 48" x 108" Surfaces								
	88-2470RPB	Laminate	24	70	28¾	87	6.9	T\$	1854
		Veneer						W\$	1924
	Two (2) Panel Bases - For Use With 48" x 96" Surfaces								
	88-2458RPB	Laminate	24	58	28¾	84	6.9	T\$	1816
		Veneer						W\$	1888
	Two (2) Panel Bases - For Use With 48" x 84" Surfaces								
	88-2446RPB	Laminate	24	46	28¾	81	6.9	T\$	1620
		Veneer						W\$	1736
	Two (2) Panel Bases - For Use With 48" x 72" Surfaces								
	88-2434RPB	Laminate	24	34	28¾	78	6.9	T\$	1548
		Veneer						W\$	1699
	20"W Bases								
	Two (2) Panel Bases - For Use With 42" x 120" Surfaces								
	88-2082RPB	Laminate	20	82	28¾	78	6.7	T\$	2060
		Veneer						W\$	2101
	Two (2) Panel Bases - For Use With 42" x 108" Surfaces								
88-2070RPB	Laminate	20	70	28¾	75	6.7	T\$	1828	
	Veneer						W\$	1908	
Two (2) Panel Bases - For Use With 36" / 42" x 96" Surfaces									
88-2058RPB	Laminate	20	58	28¾	72	6.7	T\$	1790	
	Veneer						W\$	1872	
Two (2) Panel Bases - For Use With 36" / 42" x 84" Surfaces									
88-2046RPB	Laminate	20	46	28¾	69	6.7	T\$	1595	
	Veneer						W\$	1719	
Two (2) Panel Bases - For Use With 36" / 42" x 72" Surfaces									
88-2034RPB	Laminate	20	34	28¾	66	6.7	T\$	1522	
	Veneer						W\$	1683	

Must Specify (in this order):

- Model #
- Material
- Finish / Color

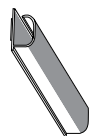

Wire Management Channel

Description

- 2" Panel Bases with Trough, Stretcher Rails, and L-Bracket Hardware Included
- Available with TFL (T) or Veneer (W)
- Vertical Grain Direction on Bases
- Wire Management Channel Included; Two (2) Base Units Include One (1) Wire Management Channel and Three (3) Base Units Includes Two (2) Wire Management Channel
- Bases Require Some Assembly; Attachment Hardware Included
- Tops Sold Separately, [See Multiple Unit Details](#)

T = TFL W = Veneer

[See Catalyst Overview For Ordering Options](#)

Item	Model No.		W	D	H	Ship Wt	Cubic Ft	List Price	
6" RECTANGLE BASES WITH TROUGH AND REMOVABLE PANEL 24"W	Four (4) 6" Rectangle Bases - For Use With 60" / 54" / 48" x 240" Surfaces								
	88-2420206RB	Laminate	24	202	28¾	158	26.3	T\$	6348
		Veneer						W\$	8636
	Four (4) 6" Rectangle Bases - For Use With 60" / 54" / 48" x 228" Surfaces								
	88-2419006RB	Laminate	24	190	28¾	156	26.3	T\$	6302
		Veneer						W\$	8598
	Four (4) 6" Rectangle Bases - For Use With 60" / 54" / 48" x 216" Surfaces								
	88-2417806RB	Laminate	24	178	28¾	154	26.3	T\$	6271
		Veneer						W\$	8567
	Four (4) 6" Rectangle Bases - For Use With 60" / 54" / 48" x 204" Surfaces								
	88-2416606RB	Laminate	24	166	28¾	152	26.3	T\$	6226
		Veneer						W\$	8515
	Three (3) 6" Rectangle Bases - For Use With 60" / 54" / 48" x 192" Surfaces								
	88-2415406RB	Laminate	24	154	28¾	114	19.6	T\$	4937
		Veneer						W\$	6861
	Three (3) 6" Rectangle Bases - For Use With 60" / 54" / 48" x 180" Surfaces								
	88-2414206RB	Laminate	24	142	28¾	112	19.6	T\$	4901
		Veneer						W\$	6624
	Three (3) 6" Rectangle Bases - For Use With 60" / 54" / 48" x 168" Surfaces								
	88-2413006RB	Laminate	24	130	28¾	110	19.6	T\$	4632
		Veneer						W\$	6315
	Three (3) 6" Rectangle Bases - For Use With 60" / 54" / 48" x 156" Surfaces								
	88-2411806RB	Laminate	24	118	28¾	108	19.6	T\$	4596
		Veneer						W\$	6277
	Three (3) 6" Rectangle Bases - For Use With 60" / 54" / 48" x 144" Surfaces								
	88-2410606RB	Laminate	24	106	28¾	106	19.6	T\$	4560
		Veneer						W\$	6239
	Three (3) 6" Rectangle Bases - For Use With 60" / 54" / 48" x 132" Surfaces								
	88-249406RB	Laminate	24	94	28¾	102	12.9	T\$	4292
		Veneer						W\$	5886
	Two (2) 6" Rectangle Bases - For Use With 60" / 54" / 48" x 120" Surfaces								
	88-248206RB	Laminate	24	82	28¾	99	12.9	T\$	3110
		Veneer						W\$	4299

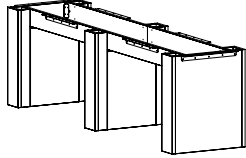

Shown: 88-249406RB

TOPS SOLD SEPARATELY

Must Specify (in this order):

Model #

Material

Finish / Color

Additional 6" Rectangle Panel Bases on Next Page

T = TFL W = Veneer

[See Catalyst Overview For Ordering Options](#)

Item	Model No.		W	D	H	Ship Wt	Cubic Ft	List Price	
CONTINUED FROM PREVIOUS PAGE -	24"W Bases Continued								
	Two (2) 6" Rectangle Bases - For Use With 48" x 108" Surfaces								
6" RECTANGLE BASES WITH TROUGH AND REMOVABLE PANEL 24" + 20"W	88-247006RB	Laminate	24	70	28¾	96	12.9	T\$	2958
		Veneer						W\$	4019
	Two (2) 6" Rectangle Bases - For Use With 48" x 96" Surfaces								
	88-245806RB	Laminate	24	58	28¾	93	12.9	T\$	2921
		Veneer						W\$	3988
	Two (2) 6" Rectangle Bases - For Use With 48" x 84" Surfaces								
	88-244606RB	Laminate	24	46	28¾	90	12.9	T\$	2769
		Veneer						W\$	3792
	Two (2) 6" Rectangle Bases - For Use With 48" x 72" Surfaces								
	88-243406RB	Laminate	24	34	28¾	87	12.9	T\$	2733
		Veneer						W\$	3720
<u>Must Specify (in this order):</u> Model # Material Finish / Color	20"W Bases								
	Two (2) 6" Rectangle Bases - For Use With 42" x 120" Surfaces								
	88-208206RB	Laminate	20	82	28¾	89	12.9	T\$	3060
		Veneer						W\$	4270
	Two (2) 6" Rectangle Bases - For Use With 42" x 108" Surfaces								
	88-207006RB	Laminate	20	70	28¾	86	12.9	T\$	2907
		Veneer						W\$	3990
	Two (2) 6" Rectangle Bases - For Use With 36" / 42" x 96" Surfaces								
	88-205806RB	Laminate	20	58	28¾	82	12.9	T\$	2871
		Veneer						W\$	3959
	Two (2) 6" Rectangle Bases - For Use With 36" / 42" x 84" Surfaces								
	88-204606RB	Laminate	20	46	28¾	79	12.9	T\$	2719
		Veneer						W\$	3763
	Two (2) 6" Rectangle Bases - For Use With 36" / 42" x 72" Surfaces								
	88-203406RB	Laminate	20	34	28¾	76	12.9	T\$	2683
		Veneer						W\$	3691

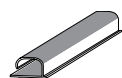
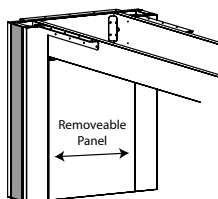

Wire Management Channel

Description

- 6" Rectangle Bases with Trough, Stretcher Rails, and L-Bracket Hardware Included
- Available with TFL (T) or Veneer (W)
- Vertical Grain Direction on Bases
- Bases Include Interior Removable Panel for Wire Management Access; Removable Panel is 15⅞"W for 24" Bases and 11⅞"W for 20" Bases
- Wire Management Channel Included; Two (2) Base Units Include One (1) Wire Management Channel and Three (3) Base Units Includes Two (2) Wire Management Channel
- Removable Panels Attached with Z Brackets.
- Bases Require Some Assembly; Attachment Hardware Included
- Tops Sold Separately, [See Multiple Unit Details](#)

T = TFL W = Veneer

[See Catalyst Overview For Ordering Options](#)

Item	Model No.		W	D	H	Ship Wt	Cubic Ft	List Price	
10" RECTANGLE BASES WITH TROUGH AND REMOVABLE PANEL 24"W	Four (4) 10" Rectangle Bases - For Use With 60" / 54" / 48" x 240" Surfaces								
	88-242021ORB	Laminate	24	202	28¾	205	24.6	T\$	6503
		Veneer						W\$	8756
	Four (4) 10" Rectangle Bases - For Use With 60" / 54" / 48" x 228" Surfaces								
	88-241901ORB	Laminate	24	190	28¾	202	24.6	T\$	6458
		Veneer						W\$	8718
	Four (4) 10" Rectangle Bases - For Use With 60" / 54" / 48" x 216" Surfaces								
	88-241781ORB	Laminate	24	178	28¾	198	24.6	T\$	6426
		Veneer						W\$	8687
	Four (4) 10" Rectangle Bases - For Use With 60" / 54" / 48" x 204" Surfaces								
	88-241661ORB	Laminate	24	166	28¾	195	24.6	T\$	6381
		Veneer						W\$	8635
	Three (3) 10" Rectangle Bases - For Use With 60" / 54" / 48" x 192" Surfaces								
	88-241541ORB	Laminate	24	154	28¾	155	18.2	T\$	5054
		Veneer						W\$	6951
	Three (3) 10" Rectangle Bases - For Use With 60" / 54" / 48" x 180" Surfaces								
	88-241421ORB	Laminate	24	142	28¾	151	18.2	T\$	5017
		Veneer						W\$	6714
	Three (3) 10" Rectangle Bases - For Use With 60" / 54" / 48" x 168" Surfaces								
	88-241301ORB	Laminate	24	130	28¾	148	18.2	T\$	4749
		Veneer						W\$	6405
	Three (3) 10" Rectangle Bases - For Use With 60" / 54" / 48" x 156" Surfaces								
	88-241181ORB	Laminate	24	118	28¾	144	18.2	T\$	4713
		Veneer						W\$	6367
	Three (3) 10" Rectangle Bases - For Use With 60" / 54" / 48" x 144" Surfaces								
	88-241061ORB	Laminate	24	106	28¾	141	18.2	T\$	4677
		Veneer						W\$	6329
	Three (3) 10" Rectangle Bases - For Use With 60" / 54" / 48" x 132" Surfaces								
	88-24941ORB	Laminate	24	94	28¾	137	18.2	T\$	4408
		Veneer						W\$	5976
	Two (2) 10" Rectangle Bases - For Use With 60" / 54" / 48" x 120" Surfaces								
	88-24821ORB	Laminate	24	82	28¾	96	12.0	T\$	3188
		Veneer						W\$	4359

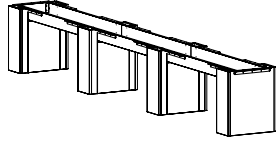

Shown: 88-241901ORB

TOPS SOLD SEPARATELY

Must Specify (in this order):

Model #

Material

Finish / Color

Additional 10" Rectangle Panel Bases on Next Page

T = TFL W = Veneer

[See Catalyst Overview For Ordering Options](#)

Item	Model No.		W	D	H	Ship Wt	Cubic Ft	List Price	
<i>CONTINUED FROM PREVIOUS PAGE</i>		24"W Bases Continued							
10" RECTANGLE BASES WITH TROUGH AND REMOVABLE PANEL 24" + 20"W		Two (2) 10" Rectangle Bases - For Use With 48" x 108" Surfaces							
	88-24701ORB	Laminate	24	70	28¾	93	12.0	T\$	3035
		Veneer						W\$	4079
		Two (2) 10" Rectangle Bases - For Use With 48" x 96" Surfaces							
	88-24581ORB	Laminate	24	58	28¾	89	12.0	T\$	2999
		Veneer						W\$	4048
		Two (2) 10" Rectangle Bases - For Use With 48" x 84" Surfaces							
	88-24461ORB	Laminate	24	46	28¾	86	12.0	T\$	2847
		Veneer						W\$	3852
		Two (2) 10" Rectangle Bases - For Use With 48" x 72" Surfaces							
	88-24341ORB	Laminate	24	34	28¾	82	12.0	T\$	2747
		Veneer						W\$	3702
		20"W Bases							
		Two (2) 10" Rectangle Bases - For Use With 42" x 120" Surfaces							
	88-20821ORB	Laminate	20	82	28¾	86	10.0	T\$	3137
		Veneer						W\$	4330
		Two (2) 10" Rectangle Bases - For Use With 42" x 108" Surfaces							
	88-20701ORB	Laminate	20	70	28¾	82	10.0	T\$	2985
		Veneer						W\$	4050
		Two (2) 10" Rectangle Bases - For Use With 36" / 42" x 96" Surfaces							
	88-20581ORB	Laminate	20	58	28¾	79	10.0	T\$	2949
		Veneer						W\$	4019
		Two (2) 10" Rectangle Bases - For Use With 36" / 42" x 84" Surfaces							
	88-20461ORB	Laminate	20	46	28¾	75	10.0	T\$	2796
		Veneer						W\$	3823
		Two (2) 10" Rectangle Bases - For Use With 36" / 42" x 72" Surfaces							
	88-20341ORB	Laminate	20	34	28¾	72	10.0	T\$	2760
		Veneer						W\$	3751

Must Specify (in this order):

Model #

Material

Finish / Color

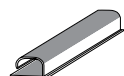
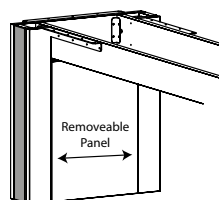

Wire Management Channel

Description

- 10" Rectangle Bases with Trough and Stretcher Rails
- Available with TFL (T) or Veneer (W)
- Vertical Grain Direction on Bases
- Bases Include Interior Removable Panel for Wire Management Access; Removable Panel is 15⁷/₈"W for 24" Bases and 11⁷/₈"W for 20" Bases
- Wire Management Channel Included; Two (2) Base Units Include One (1) Wire Management Channel and Three (3) Base Units Includes Two (2) Wire Management Channel
- Removable Panels Attached with Z Brackets.
- Bases Require Some Assembly; Attachment Hardware Included
- Tops Sold Separately, [See Multiple Unit Details](#)

T = TFL W = Veneer

[See Catalyst Overview For Ordering Options](#)

Item	Model No.		W	D	H	Ship Wt	Cubic Ft	List Price	
6" + 10" COMBO RECTANGLE BASES WITH TROUGH AND REMOVABLE PANEL 24"W	Four (4) Bases Total: Two (2) 6" and Two (2) 10" Rectangle Bases - For Use With 60" / 54" / 48" x 240" Surfaces								
	88-24202C610RB	Laminate	24	202	28¾	205	24.6	T\$	6425
		Veneer						W\$	8710
	Four (4) Bases Total: Two (2) 6" and Two (2) 10" Rectangle Bases - For Use With 60" / 54" / 48" x 228" Surfaces								
	88-24190C610RB	Laminate	24	190	28¾	202	24.6	T\$	6380
		Veneer						W\$	8658
	Four (4) Bases Total: Two (2) 6" and Two (2) 10" Rectangle Bases - For Use With 60" / 54" / 48" x 216" Surfaces								
	88-24178C610RB	Laminate	24	178	28¾	198	24.6	T\$	6348
		Veneer						W\$	8627
	Four (4) Bases Total: Two (2) 6" and Two (2) 10" Rectangle Bases - For Use With 60" / 54" / 48" x 204" Surfaces								
	88-24166C610RB	Laminate	24	166	28¾	195	24.6	T\$	6303
		Veneer						W\$	8575
	Three (3) Bases Total: Two (2) 6" and One (1) 10" Rectangle Bases - For Use With 60" / 54" / 48" x 192" Surfaces								
	88-24154C610RB	Laminate	24	154	28¾	155	18.2	T\$	5357
		Veneer						W\$	7358
	Three (3) Bases Total: Two (2) 6" and One (1) 10" Rectangle Bases - For Use With 60" / 54" / 48" x 180" Surfaces								
	88-24142C610RB	Laminate	24	142	28¾	151	18.2	T\$	4940
		Veneer						W\$	6654
	Three (3) Bases Total: Two (2) 6" and One (1) 10" Rectangle Bases - For Use With 60" / 54" / 48" x 168" Surfaces								
	88-24130C610RB	Laminate	24	130	28¾	148	18.2	T\$	4671
		Veneer						W\$	6345
	Three (3) Bases Total: Two (2) 6" and One (1) 10" Rectangle Bases - For Use With 60" / 54" / 48" x 156" Surfaces								
	88-24118C610RB	Laminate	24	118	28¾	144	18.2	T\$	4635
		Veneer						W\$	6307
	Three (3) Bases Total: Two (2) 6" and One (1) 10" Rectangle Bases - For Use With 60" / 54" / 48" x 144" Surfaces								
	88-24106C610RB	Laminate	24	106	28¾	141	18.2	T\$	4599
		Veneer						W\$	6269
	Three (3) Bases Total: Two (2) 6" and One (1) 10" Rectangle Bases - For Use With 60" / 54" / 48" x 132" Surfaces								
	88-2494C610RB	Laminate	24	94	28¾	137	18.2	T\$	4330
		Veneer						W\$	5916

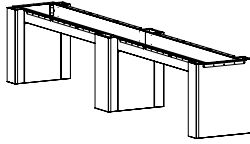

Shown: 88-24142C610RB

TOPS SOLD SEPARATELY

Must Specify (in this order):

Model #
Material
Finish / Color

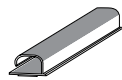
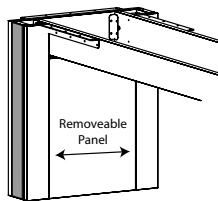

Wire Management Channel

Description

- 6" + 10" Rectangle Bases with Trough and Stretcher Rails; 6" Bases on Exterior and 10" Bases on Interior
- Available with TFL (T) or Veneer (W)
- Vertical Grain Direction on Bases
- Wire Management Channel Included; Two (2) Base Units Include One (1) Wire Management Channel and Three (3) Base Units Includes Two (2) Wire Management Channel
- Bases Include Interior Removable Panel for Wire Management. Removable Panel is 15⅞"W and Attaches with Z Brackets.
- Bases Require Some Assembly; Attachment Hardware Included
- Tops Sold Separately, [See Multiple Unit Details](#)

T = TFL W = Veneer

[See Catalyst Overview For Ordering Options](#)

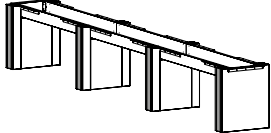
Item	Model No.		W	D	H	Ship Wt	Cubic Ft	List Price	
6" RECTANGLE ACCENT BASES WITH TROUGH AND REMOVABLE PANEL 24"W	Four (4) 6" Rectangle Bases - For Use With 60" / 54" / 48" x 240" Surfaces								
	88-2420206RAB	Laminate	24	202	28¾	158	26.3	T\$	7211
		Veneer						W\$	9553
	Four (4) 6" Rectangle Bases - For Use With 60" / 54" / 48" x 228" Surfaces								
	88-2419006RAB	Laminate	24	190	28¾	156	26.3	T\$	7166
		Veneer						W\$	9514
Shown: 88-2419006RAB TOPS SOLD SEPARATELY	Four (4) 6" Rectangle Bases - For Use With 60" / 54" / 48" x 216" Surfaces								
	88-2417806RAB	Laminate	24	178	28¾	154	26.3	T\$	7134
		Veneer						W\$	9483
	Four (4) 6" Rectangle Bases - For Use With 60" / 54" / 48" x 204" Surfaces								
	88-2416606RAB	Laminate	24	166	28¾	152	26.3	T\$	7089
		Veneer						W\$	9432
Must Specify (in this order): Model # Base Finish/Color Metal Accent Color Accent Panel Finish/Color	Three (3) 6" Rectangle Bases - For Use With 60" / 54" / 48" x 192" Surfaces								
	88-2415406RAB	Laminate	24	154	28¾	114	19.6	T\$	5589
		Veneer						W\$	7553
	Three (3) 6" Rectangle Bases - For Use With 60" / 54" / 48" x 180" Surfaces								
	88-2414206RAB	Laminate	24	142	28¾	112	19.6	T\$	5553
		Veneer						W\$	7315
	Three (3) 6" Rectangle Bases - For Use With 60" / 54" / 48" x 168" Surfaces								
	88-2413006RAB	Laminate	24	130	28¾	110	19.6	T\$	5284
		Veneer						W\$	7007
	Three (3) 6" Rectangle Bases - For Use With 60" / 54" / 48" x 156" Surfaces								
	88-2411806RAB	Laminate	24	118	28¾	108	19.6	T\$	5248
		Veneer						W\$	6969
	Three (3) 6" Rectangle Bases - For Use With 60" / 54" / 48" x 144" Surfaces								
	88-2410606RAB	Laminate	24	106	28¾	106	19.6	T\$	5212
		Veneer						W\$	6931
	Three (3) 6" Rectangle Bases - For Use With 60" / 54" / 48" x 132" Surfaces								
	88-249406RAB	Laminate	24	94	28¾	102	12.9	T\$	4944
		Veneer						W\$	6578
	Two (2) 6" Rectangle Bases - For Use With 60" / 54" / 48" x 120" Surfaces								
	88-248206RAB	Laminate	24	82	28¾	99	12.9	T\$	4585
		Veneer						W\$	6218

Additional 6" Rectangle Accent Bases on Next Page.

T = TFL W = Veneer

[See Catalyst Overview For Ordering Options](#)

Item	Model No.		W	D	H	Ship Wt	Cubic Ft	List Price
CONTINUED FROM PREVIOUS PAGE 6" RECTANGLE ACCENT BASES WITH TROUGH AND REMOVABLE PANEL 24" + 20"W	24"W Bases Continued							
	Two (2) 6" Rectangle Bases - For Use With 48" x 108" Surfaces							
	88-247006RAB	Laminate	24	70	28 ³ / ₄	96	12.9	T\$ 3398
		Veneer						W\$ 4485
	Two (2) 6" Rectangle Bases - For Use With 48" x 96" Surfaces							
	88-245806RAB	Laminate	24	58	28 ³ / ₄	93	12.9	T\$ 3362
		Veneer						W\$ 4454
	Two (2) 6" Rectangle Bases - For Use With 48" x 84" Surfaces							
	88-244606RAB	Laminate	24	46	28 ³ / ₄	90	12.9	T\$ 3210
		Veneer						W\$ 4259
	Two (2) 6" Rectangle Bases - For Use With 48" x 72" Surfaces							
	88-243406RAB	Laminate	24	34	28 ³ / ₄	87	12.9	T\$ 3173
		Veneer						W\$ 4186
	20"W Bases							
	Two (2) 6" Rectangle Bases - For Use With 42" x 120" Surfaces							
	88-208206RAB	Laminate	20	82	28 ³ / ₄	89	12.9	T\$ 3500
		Veneer						W\$ 4736
	Two (2) 6" Rectangle Bases - For Use With 42" x 108" Surfaces							
	88-207006RAB	Laminate	20	70	28 ³ / ₄	86	12.9	T\$ 3348
		Veneer						W\$ 4456
	Two (2) 6" Rectangle Bases - For Use With 36" / 42" x 96" Surfaces							
	88-205806RAB	Laminate	20	58	28 ³ / ₄	82	12.9	T\$ 3312
		Veneer						W\$ 4425
	Two (2) 6" Rectangle Bases - For Use With 36" / 42" x 84" Surfaces							
88-204606RAB	Laminate	20	46	28 ³ / ₄	79	12.9	T\$ 3159	
	Veneer						W\$ 4230	
Two (2) 6" Rectangle Bases - For Use With 36" / 42" x 72" Surfaces								
88-203406RAB	Laminate	20	34	28 ³ / ₄	76	12.9	T\$ 3123	
	Veneer						W\$ 4157	

Must Specify (in this order):

Model #
Base Finish/Color
Metal Accent Color
Accent Panel Finish/Color

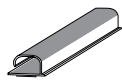
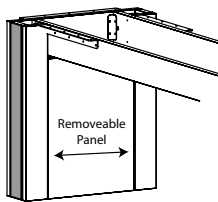

Wire Management Channel

Description

- 6" Rectangle Bases with Trough and Stretcher Rails
- Available with TFL (T) or Veneer (W)
- 5/8" Metal Accent Available in Four (4) Colors: Aluminum, Black, Gold, and Platinum; Must Specify Color
- Vertical Grain Direction on Bases
- Bases Include Interior Removable Panel for Wire Management Access; Removable Panel is 15 1/8"W for 24" Bases and 11 7/8"W for 20" Bases
- Wire Management Channel Included; Two (2) Base Units Include One (1) Wire Management Channel and Three (3) Base Units Includes Two (2) Wire Management Channel
- Removable Panels Attached with Z Brackets.
- Bases Require Some Assembly; Attachment Hardware Included
- Tops Sold Separately, [See Multiple Unit Details](#)

T = TFL W = Veneer

[See Catalyst Overview For Ordering Options](#)

Item	Model No.		W	D	H	Ship Wt	Cubic Ft	List Price	
10" RECTANGLE ACCENT BASES WITH TROUGH AND REMOVABLE PANEL 24"W	Four (4) 10" Rectangle Bases - For Use With 60" / 54" / 48" x 240" Surfaces								
	88-242021ORAB	Laminate	24	202	28¾	205	24.6	T\$	7300
		Veneer						W\$	9664
	Four (4) 10" Rectangle Bases - For Use With 60" / 54" / 48" x 228" Surfaces								
	88-241901ORAB	Laminate	24	190	28¾	202	24.6	T\$	7255
		Veneer						W\$	9626
	Four (4) 10" Rectangle Bases - For Use With 60" / 54" / 48" x 216" Surfaces								
	88-241781ORAB	Laminate	24	178	28¾	198	24.6	T\$	7224
		Veneer						W\$	9595
	Four (4) 10" Rectangle Bases - For Use With 60" / 54" / 48" x 204" Surfaces								
	88-241661ORAB	Laminate	24	166	28¾	195	24.6	T\$	7178
		Veneer						W\$	9543
	Three (3) 10" Rectangle Bases - For Use With 60" / 54" / 48" x 192" Surfaces								
	88-241541ORAB	Laminate	24	154	28¾	155	18.2	T\$	5654
		Veneer						W\$	7635
	Three (3) 10" Rectangle Bases - For Use With 60" / 54" / 48" x 180" Surfaces								
	88-241421ORAB	Laminate	24	142	28¾	151	18.2	T\$	5618
		Veneer						W\$	7397
	Three (3) 10" Rectangle Bases - For Use With 60" / 54" / 48" x 168" Surfaces								
	88-241301ORAB	Laminate	24	130	28¾	148	18.2	T\$	5349
		Veneer						W\$	7089
	Three (3) 10" Rectangle Bases - For Use With 60" / 54" / 48" x 156" Surfaces								
	88-241181ORAB	Laminate	24	118	28¾	144	18.2	T\$	5313
		Veneer						W\$	7051
	Three (3) 10" Rectangle Bases - For Use With 60" / 54" / 48" x 144" Surfaces								
	88-241061ORAB	Laminate	24	106	28¾	141	18.2	T\$	5277
		Veneer						W\$	7013
	Three (3) 10" Rectangle Bases - For Use With 60" / 54" / 48" x 132" Surfaces								
	88-24941ORAB	Laminate	24	94	28¾	137	18.2	T\$	5008
		Veneer						W\$	6659
	Two (2) 10" Rectangle Bases - For Use With 60" / 54" / 48" x 120" Surfaces								
	88-24821ORAB	Laminate	24	82	28¾	96	12.0	T\$	3591
		Veneer						W\$	4817

Additional 10" Rectangle Accent Bases on Next Page.

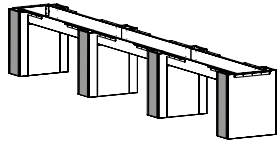

Shown: 88-241901ORAB
Shown with Gray Accent Panel

TOPS SOLD SEPARATELY

Must Specify (in this order):

- Model #
- Base Finish/Color
- Metal Accent Color
- Accent Panel Finish/Color

T = TFL W = Veneer

[See Catalyst Overview For Ordering Options](#)

Item	Model No.		W	D	H	Ship Wt	Cubic Ft	List Price		
CONTINUED FROM PREVIOUS PAGE	24"W Bases Continued									
	Two (2) 10" Rectangle Bases - For Use With 48" x 108" Surfaces									
	10" RECTANGLE ACCENT BASES WITH TROUGH AND REMOVABLE PANEL 24" + 20"W	88-247010RAB	Laminate	24	70	28¾	93	12.0	T\$	3438
			Veneer						W\$	4537
	Two (2) 10" Rectangle Bases - For Use With 48" x 96" Surfaces									
		88-245810RAB	Laminate	24	58	28¾	89	12.0	T\$	3402
			Veneer						W\$	4506
	Two (2) 10" Rectangle Bases - For Use With 48" x 84" Surfaces									
		88-244610RAB	Laminate	24	46	28¾	86	12.0	T\$	3250
			Veneer						W\$	4310
	Two (2) 10" Rectangle Bases - For Use With 48" x 72" Surfaces									
		88-243410RAB	Laminate	24	34	28¾	82	12.0	T\$	3150
		Veneer						W\$	4160	
Must Specify (in this order):	20"W Bases									
Model #	Two (2) 10" Rectangle Bases - For Use With 42" x 120" Surfaces									
Base Finish/Color	88-208210RAB	Laminate	20	82	28¾	86	10.0	T\$	3540	
Metal Accent Color		Veneer						W\$	4788	
Accent Panel Finish/Color	Two (2) 10" Rectangle Bases - For Use With 42" x 108" Surfaces									
	88-207010RAB	Laminate	20	70	28¾	82	10.0	T\$	3388	
		Veneer						W\$	4508	
Two (2) 10" Rectangle Bases - For Use With 36" / 42" x 96" Surfaces										
	88-205810RAB	Laminate	20	58	28¾	79	10.0	T\$	3352	
		Veneer						W\$	4477	
Two (2) 10" Rectangle Bases - For Use With 36" / 42" x 84" Surfaces										
	88-204610RAB	Laminate	20	46	28¾	75	10.0	T\$	3199	
		Veneer						W\$	4281	
Two (2) 10" Rectangle Bases - For Use With 36" / 42" x 72" Surfaces										
	88-203410RAB	Laminate	20	34	28¾	72	10.0	T\$	3100	
		Veneer						W\$	4131	

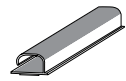
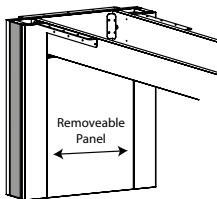

Wire Management
Channel

Description

- 10" Rectangle Bases with Trough and Stretcher Rails
- Available with TFL (T) or Veneer (W)
- 5/16" Metal Accent Available in Four (4) Colors: Aluminum, Black, Gold, and Platinum; Must Specify Color
- Vertical Grain Direction on Bases
- Bases Include Interior Removable Panel for Wire Management Access; Removable Panel is 15 7/8"W for 24" Bases and 11 7/8"W for 20" Bases
- Wire Management Channel Included; Two (2) Base Units Include One (1) Wire Management Channel and Three (3) Base Units Includes Two (2) Wire Management Channel
- Removable Panels Attached with Z Brackets.
- Bases Require Some Assembly; Attachment Hardware Included
- Tops Sold Separately, [See Multiple Unit Details](#)

T = TFL W = Veneer

[See Catalyst Overview For Ordering Options](#)

Item	Model No.		W	D	H	Ship Wt	Cubic Ft	List Price
6" + 10" COMBO RECTANGLE ACCENT BASES WITH TROUGH AND REMOVABLE PANEL 24"W	Four (4) Bases Total: Two (2) 6" and Two (2) 10" Rectangle Bases - For Use With 60" / 54" / 48" x 240" Surfaces							
	88-24202C610RAB	Laminate	24	202	28¾	205	24.6	T\$ 7260
		Veneer					W\$ 9627	
	Four (4) Bases Total: Two (2) 6" and Two (2) 10" Rectangle Bases - For Use With 60" / 54" / 48" x 228" Surfaces							
	88-24190C610RAB	Laminate	24	190	28¾	202	24.6	T\$ 7215
		Veneer					W\$ 9574	
	Four (4) Bases Total: Two (2) 6" and Two (2) 10" Rectangle Bases - For Use With 60" / 54" / 48" x 216" Surfaces							
	88-24178C610RAB	Laminate	24	178	28¾	198	24.6	T\$ 7183
		Veneer					W\$ 9543	
	Four (4) Bases Total: Two (2) 6" and Two (2) 10" Rectangle Bases - For Use With 60" / 54" / 48" x 204" Surfaces							
	88-24166C610RAB	Laminate	24	166	28¾	195	24.6	T\$ 7138
		Veneer					W\$ 9492	
	Three (3) Bases Total: Two (2) 6" and One (1) 10" Rectangle Bases - For Use With 60" / 54" / 48" x 192" Surfaces							
	88-24154C610RAB	Laminate	24	154	28¾	155	18.2	T\$ 5614
		Veneer					W\$ 7583	
	Three (3) Bases Total: Two (2) 6" and One (1) 10" Rectangle Bases - For Use With 60" / 54" / 48" x 180" Surfaces							
	88-24142C610RAB	Laminate	24	142	28¾	151	18.2	T\$ 5578
		Veneer					W\$ 7345	
	Three (3) Bases Total: Two (2) 6" and One (1) 10" Rectangle Bases - For Use With 60" / 54" / 48" x 168" Surfaces							
	88-24130C610RAB	Laminate	24	130	28¾	148	18.2	T\$ 5309
		Veneer					W\$ 7037	
	Three (3) Bases Total: Two (2) 6" and One (1) 10" Rectangle Bases - For Use With 60" / 54" / 48" x 156" Surfaces							
	88-24118C610RAB	Laminate	24	118	28¾	144	18.2	T\$ 5273
		Veneer					W\$ 6999	
	Three (3) Bases Total: Two (2) 6" and One (1) 10" Rectangle Bases - For Use With 60" / 54" / 48" x 144" Surfaces							
	88-24106C610RAB	Laminate	24	106	28¾	141	18.2	T\$ 5237
		Veneer					W\$ 6961	
	Three (3) Bases Total: Two (2) 6" and One (1) 10" Rectangle Bases - For Use With 60" / 54" / 48" x 132" Surfaces							
	88-2494C610RAB	Laminate	24	94	28¾	137	18.2	T\$ 4968
		Veneer					W\$ 6608	

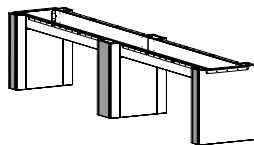

Shown: 88-24142C610RAB
Shown with Gray Accent Panel

TOPS SOLD SEPARATELY

Must Specify (in this order):

- Model #
- Base Finish/Color
- Metal Accent Color
- Accent Panel Finish/Color

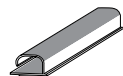
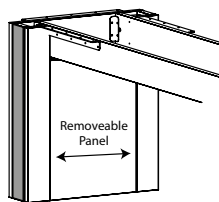

Wire Management Channel

Description

- 6" + 10" Rectangle Accent Bases with Trough and Stretcher Rails; 6" Bases on Exterior and 10" Bases on Interior
- Available with TFL (T) or Veneer (W)
- 5/16" Metal Accent Available in Four (4) Colors: Aluminum, Black, Gold, and Platinum; Must Specify Color
- Vertical Grain Direction on Bases
- Bases Include Interior Removable Panel for Wire Management. Removable Panel is 15 7/8"W and Attaches with Z Brackets.
- Wire Management Channel Included; Two (2) Base Units Include One (1) Wire Management Channel and Three (3) Base Units Includes Two (2) Wire Management Channel
- Bases Require Some Assembly; Attachment Hardware Included
- Tops Sold Separately, [See Multiple Unit Details](#)

T = TFL W = Veneer

[See Catalyst Overview For Ordering Options](#)

Item	Model No.		W	D	H	Ship Wt	Cubic Ft	List Price
DISC BASE 	Heavy Duty For Use With Round Tops: 54" + 60" Square Tops: 48"							
	01-2432HDBB	Black	32	32	27¾	42	4.1	\$ 2438
	01-2432HDBA	Aluminum						
	For Use With Round Tops: 48" Square Tops: 42" Top Surfaces: 48"x96", 48"x84", 48"x72", 42"x96", 42"x84", 42"x72"							
	01-3230DBB	Black	32	32	27¾	32	3.2	\$ 1780
	01-3230DBA	Aluminum						
	For Use With Round Tops: 30", 36", 42" Square Tops: 36" Top Surfaces: 36"x96", 36"x84", 36"x72"							
	01-2430DBB	Black	24	24	27¾	32	3.2	\$ 1483
	01-2430DBA	Aluminum						

Description

- 4" Diameter 14 Gauge Steel Column with 12"x12" Mounting Plate at Top of Column
- ¼" Thick Disc Plate with 5 Levelers
- Stiffener Bar Not Included; Must Order Separately ([See Stiffener Bars](#))
- See Number of Bases Required Per Top Width Below
- Power Units Available On Center When Using Two or More Disc Bases
- Some Assembly Required

Table Widths	Round+Square	72"	84"	96"
Number of Bases Required	1	2	2	2

SQUARE BASE

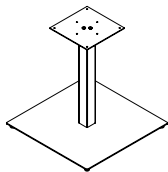

For Use With Round Tops: 48" Square Tops: 42" Top Surfaces: 48"x96", 48"x84", 48"x72", 42"x96", 42"x84", 42"x72"							
01-2630SBB	Black	26	26	27¾	32	3.2	\$ 1124
01-2630SBA	Aluminum						
For Use With Round Tops: 42" Square Tops: 36" Top Surfaces: 36"x96", 36"x84", 36"x72"							
01-2030SBB	Black	20	20	27¾	32	3.2	\$ 924
01-2030SBA	Aluminum						
For Use With Round Tops: 36" Square Tops: 30"							
01-1630SBB	Black	16	16	27¾	32	3.2	\$ 868
01-1630SBA	Aluminum						

Description

- 2¾" Diameter Column with 12"x12" Mounting Plate at Top of Column
- Stiffener Bar Not Included; Must Order Separately ([See Stiffener Bars](#))
- See Number of Bases Required Per Top Width Below
- Power Units Available On Center When Using Two or More Square Bases
- Some Assembly Required

Table Widths	Round+Square	72"	84"	96"
Number of Bases Required	1	2	2	2

[See Catalyst Overview For Ordering Options](#)

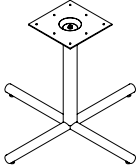
Item	Model No.		W	D	H	Ship Wt	Cubic Ft	List Price
TUBULAR X-BASE 	For Use With Round Tops: 48" Square Tops: 42" Top Surfaces: 48"x96", 48"x84", 48"x72", 42"x96", 42"x84", 42"x72"							
	01-3830TXB	Black	38	38	27¾	40	4.2	\$ 675
	01-3830TXA	Aluminum						
	For Use With Round Tops: 36" + 42" Square Tops: 36" Top Surfaces: 36"x96", 36"x84", 36"x72"							
	01-3230TXB	Black	32	32	27¾	32	3.2	\$ 612
	01-3230TXA	Aluminum						

Description

- 3" Diameter Column
- See Number of Bases Required Per Top Width Below
- Stiffener Bar Not Included; Must Order Separately ([See Stiffener Bars](#))
- Power Units Available On Center When Using Two or More Tubular X-Bases
- Some Assembly Required

Table Widths	Round+Square	72"	84"	96"
Number of Bases Required	1	2	2	2

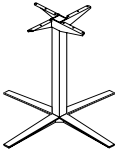
METAL X-BASE 	For Use With Round + Square Tops: 42" + 48" Top Surfaces: 48"x96", 48"x84", 48"x72", 42"x96", 42"x84", 42"x72"							
	08-2642LXBB	Black	35½	35½	40	33	20.0	\$ 1277
	08-2642LXBA	Aluminum						
	<i>For 42"H Tables</i>							
	08-2636LXBB	Black	35½	35½	34	30	17.2	\$ 1232
	08-2636LXBA	Aluminum						
	<i>For 36"H Tables</i>							
	08-2630LXBB	Black	35½	35½	28	27	14.5	\$ 1178
	08-2630LXBA	Aluminum						
	<i>For 30"H Tables</i>							
	For Use With Round + Square Tops: 30" + 36" Top Surfaces: 36"x96", 36"x84", 36"x72"							
	08-2042SXBB	Black	29	29	40	27	15.9	\$ 1193
	08-2042SXBA	Aluminum						
	<i>For 42"H Tables</i>							
08-2036SXBB	Black	29	29	34	24	13.7	\$ 1145	
08-2036SXBA	Aluminum							
<i>For 36"H Tables</i>								
08-2030SXBB	Black	29	29	28	21	11.6	\$ 1100	
08-2030SXBA	Aluminum							
<i>For 30"H Tables</i>								

Description

- See Number of Bases Required Per Top Width Below
- Not Available to be Sold Separately
- Stiffener Bar Not Included; Must Order Separately ([See Stiffener Bars](#))
- Power Units Available On Center When Using Two or More Metal X-Bases
- Ships Assembled

Table Widths	Round+Square	72"	84"	96"
Number of Bases Required	1	2	2	2

[See Catalyst Overview For Ordering Options](#)

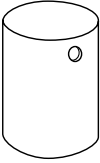
Item	Model No.	W	D	H	Ship Wt	Cubic Ft	List Price
CYLINDER BASE 	For Use With Round Tops: 54" + 60" Square Tops: 48"						
	01-3030CB	30	30	28½	136	10.9	W\$ 3791
	For Use With Round Tops: 42" + 48" Square Tops: 36" + 42" Top Surfaces: 48"x96", 48"x84", 48"x72", 42"x96", 42"x84", 42"x72"						
	01-2020CB	20	20	28½	136	10.9	W\$ 1500
	For Use With Round Tops: 36" Square Tops: 30" Top Surfaces: 36"x96", 36"x84", 36"x72"						
	01-1616CB	16	16	28½	101	7.2	W\$ 1371

Must Specify (in this order):

Model # and Quantity

Finish

Grommet Options

Description

- Veneer Cylinder Base Features Multi-Step, Hand-Finished Catalyzed Finish
- Weighted for Stability
- Two (2) Wire Management Black Grommets Standard at Top Edge; 8" Wire Management Opening Standard at Bottom
- See Number of Bases Required Per Top Width Below
- Power Units Available On Center When Using Two or More Cylinder Bases

Additional Grommet Options: Specify & Add

GCB1S	Only One (1) Grommet At Top Edge	\$	N/C
NOGC	No Grommets At Top Edge	\$	N/C

Table Widths	Round+Square	72"	84"	96"
Number of Bases Required	1	2	2	2

STIFFENER BAR	01-00060SB	60	1¾	¾	8	0.3	\$	125
	01-00048SB	48	1¾	¾	5	0.3	\$	117

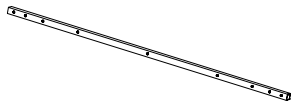

Description

- Reinforce Worksurfaces with Large Kneespace Widths
- Includes End Caps to Cover Sharp Edges
- Recommended in Kneespaces 60" or Greater
- Field Installed

[See Catalyst Overview For Ordering Options](#)

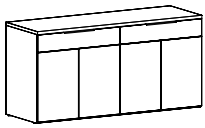
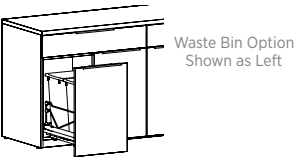
Item	Model No.		W	D	H	Ship Wt	Cubic Ft	Edge Profile + Material	List Price	
BUFFET CREDENZA WITH DRAWERS  Shown: 88-2472BF  Waste Bin Option Shown as Left Must Specify (in this order): Model # Top/Edge Material Top/Edge Finish/Color Edge Profile Chassis Color Glass (Y/N) Glass Color + Surface Finish Pull Locking Drawer Track Vent Waste Bin	88-2496BF <i>Five Doors + Five Drawers</i>	TFL+HPL	96	24	36	466	56.0	F, G, Y / T+P\$	5642	
									H / T+P\$	5751
		Veneer+HPL							F, G, Y / W+P\$	8608
									H / W+P\$	8771
		Veneer							F, G, Y / W\$	8929
									H / W\$	9062
		Glass+TFL							Acid Etched Glass Top +T\$	9099
									Gloss Glass Top +T\$	8243
		Glass+Veneer							Acid Etched Glass Top +W\$	12385
									Gloss Glass Top +W\$	11530
		88-2484BF <i>Five Doors + Three Drawers</i>	TFL+HPL	84	24	36	404	49.2	F, G, Y / T+P\$	4936
										H / T+P\$
Veneer+HPL								F, G, Y / W+P\$	7419	
								H / W+P\$	7563	
Veneer								F, G, Y / W\$	7744	
								H / W\$	7861	
Glass+TFL								Acid Etched Glass Top +T\$	7927	
								Gloss Glass Top +T\$	7179	
Glass+Veneer								Acid Etched Glass Top +W\$	10735	
								Gloss Glass Top +W\$	9986	
88-2472BF <i>Four Doors + Two Drawers</i>	TFL+HPL			72	24	36	342	42.3	F, G, Y / T+P\$	3959
										H / T+P\$
		Veneer+HPL						F, G, Y / W+P\$	6079	
								H / W+P\$	6203	
		Veneer						F, G, Y / W\$	6232	
								H / W\$	6334	
		Glass+TFL						Acid Etched Glass Top +T\$	6621	
								Gloss Glass Top +T\$	5980	
		Glass+Veneer						Acid Etched Glass Top +W\$	8894	
								Gloss Glass Top +W\$	8252	
		88-2460BF <i>Three Doors + Three Drawers</i>	TFL+HPL	60	24	36	280	34.5	F, G, Y / T+P\$	3807
										H / T+P\$
Veneer+HPL								F, G, Y / W+P\$	5636	
								H / W+P\$	5741	
Veneer								F, G, Y / W\$	5793	
								H / W\$	5878	
Glass+TFL								Acid Etched Glass Top +T\$	6003	
								Gloss Glass Top +T\$	5468	
Glass+Veneer								Acid Etched Glass Top +W\$	7989	
								Gloss Glass Top +W\$	7454	

T= TFL P = HPL W = Veneer

Additional Buffet Credenzas on Next Page

[See Catalyst Overview For Ordering Options](#)

Item	Model No.		W	D	H	Ship Wt	Cubic Ft	Edge Profile + Material	List Price
<i>CONTINUED FROM PREVIOUS PAGE</i>	88-2448BF <i>Two Doors + Two Drawers</i>	TFL+HPL	48	24	36	209	28.6	F, G, Y / T+P\$	2689
								H / T+P\$	2745
		Veneer+HPL						F, G, Y / W+P\$	4151
								H / W+P\$	4237
		Veneer						F, G, Y / W\$	4312
								H / W\$	4381
		Glass+TFL						Acid Etched Glass Top +T\$	4419
								Gloss Glass Top +T\$	3991
		Glass+Veneer						Acid Etched Glass Top +W\$	6042
								Gloss Glass Top +W\$	5615
<i>Must Specify (in this order):</i> Model # Top/Edge Material Top/Edge Finish/Color Edge Profile Chassis Color Glass (Y/N) Glass Color + Surface Finish Pull Drawer Track Vent Waste Bin	88-2436BF <i>Two Doors + One Drawer</i>	TFL+HPL	36	24	36	209	28.6	F, G, Y / T+P\$	2244
								H / T+P\$	2287
		Veneer+HPL						F, G, Y / W+P\$	3308
								H / W+P\$	3374
		Veneer						F, G, Y / W\$	3472
								H / W\$	3525
		Glass+TFL						Acid Etched Glass Top +T\$	3508
								Gloss Glass Top +T\$	3187
		Glass+Veneer						Acid Etched Glass Top +W\$	4737
								Gloss Glass Top +W\$	4416

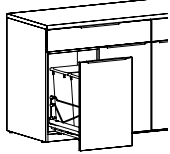

Waste Bin Option Shown as Left

Description

- Standard with: Touch Latch Doors with One (1) Adjustable Shelf Behind Doors, Top Profile on Approach Side, 2" Wire Management Channel Along Back of Interior Cabinet, Reverse Slip Matched Pattern on Top Surface, and Vertical Grain Direction on Chassis
- Available with Veneer (W), HPL (P), or Back Painted Tempered Glass (Black or White with Gloss or Acid Etched Finish) Top with Veneer (W) or HPL (P) Chassis
- When Selecting Back Painted Tempered Glass Top; Must Specify Glass Color, Gloss or Acid Etched Finish and Edge Profile; [See Options](#)
- Tops and Chassis Available in Contrasting Colors; Must Specific Color of Each Component
- Studio Pull Centered on Drawer Fronts Standard; Must Specify Pull Color ([See Color Options](#))
- Touch Latch Doors Standard Without Pulls, Optional Studio Pulls; Must Specify Pull Color ([See Color Options](#))
- Studio Pulls Will be Added and Centered on Top of Doors When Waste Bin is Selected; Must Specify Pull Color ([See Color Options](#)) and Optional Waste Bin ([See Options](#))
- Knife Edge not Available
- Additional Options: Locking Doors ([See Options Details](#)); Pull Out Waste Bin ([See Options Details](#)); Back Panel Vent ([See Options Details](#)); Soft Close Drawers ([See Soft Close Option](#))



Double Kerf (F)
1 3/16"



Duo (G)
1 3/16"



Square (Y)
1 3/16"



Vertical Square (H)
1 1/2"

T= TFL P= HPL W= Veneer

[See Catalyst Overview For Ordering Options](#)

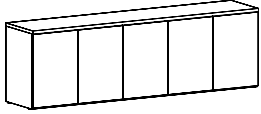
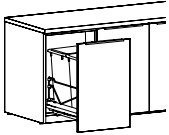
Item	Model No.		W	D	H	Ship Wt	Cubic Ft	Edge Profile + Material	List Price		
24"D CREDENZA  Shown: 88-2496CC  Waste Bin Option Shown as Left	88-2496CC <i>Five Doors</i>	TFL+HPL	96	24	30	415	47.2	F, G, Y / T+P\$	4436		
									H / T+P\$	4545	
		Veneer+HPL							F, G, Y / W+P\$	6952	
									H / W+P\$	7116	
		Veneer							F, G, Y / W\$	7273	
									H / W\$	7407	
		Glass+TFL							Acid Etched Glass Top +T\$	7893	
									Gloss Glass Top +T\$	7037	
		Glass+Veneer							Acid Etched Glass Top +W\$	10730	
									Gloss Glass Top +W\$	9874	
		88-2484CC <i>Five Doors</i>	TFL+HPL		84	24	30	353	41.4	F, G, Y / T+P\$	4047
											H / T+P\$
Veneer+HPL									F, G, Y / W+P\$	6201	
									H / W+P\$	6345	
Veneer									F, G, Y / W\$	6526	
									H / W\$	6643	
Glass+TFL									Acid Etched Glass Top +T\$	7038	
									Gloss Glass Top +T\$	6290	
Glass+Veneer									Acid Etched Glass Top +W\$	9517	
									Gloss Glass Top +W\$	8768	
88-2472CC <i>Four Doors</i>	TFL+HPL				72	24	30	260	35.6	F, G, Y / T+P\$	3270
											H / T+P\$
		Veneer+HPL							F, G, Y / W+P\$	5090	
									H / W+P\$	5214	
		Veneer							F, G, Y / W\$	5243	
									H / W\$	5344	
		Glass+TFL							Acid Etched Glass Top +T\$	5932	
									Gloss Glass Top +T\$	5290	
		Glass+Veneer							Acid Etched Glass Top +W\$	7905	
									Gloss Glass Top +W\$	7263	
		88-2460CC <i>Three Doors</i>	TFL+HPL		60	24	30	240	29.9	F, G, Y / T+P\$	2882
											H / T+P\$
Veneer+HPL									F, G, Y / W+P\$	4467	
									H / W+P\$	4572	
Veneer									F, G, Y / W\$	4624	
									H / W\$	4709	
Glass+TFL									Acid Etched Glass Top +T\$	5078	
									Gloss Glass Top +T\$	4543	
Glass+Veneer									Acid Etched Glass Top +W\$	6820	
									Gloss Glass Top +W\$	6285	

Must Specify (in this order):

- Model #
- Top/Edge Material
- Top/Edge Finish/Color
- Edge Profile
- Chassis Color
- Glass (Y/N)
- Glass Color + Surface Finish
- Pull
- Locking
- Vent
- Waste Bin

Additional 24" Credenzas on Next Page

T= TFL P = HPL W = Veneer

[See Catalyst Overview For Ordering Options](#)

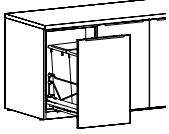
Item	Model No.		W	D	H	Ship Wt	Cubic Ft	Edge Profile + Material	List Price
 <p>Waste Bin Option Shown as Left</p> <p>Must Specify (in this order): Model # Top/Edge Material Top/Edge Finish/Color Edge Profile Chassis Color Glass (Y/N) Glass Color + Surface Finish Pull Vent Waste Bin</p>	88-2448CC <i>Two Doors</i>	TFL+HPL	48	24	30	185	20.4	F, G, Y / T+P\$ H / T+P\$	2182 2238
		Veneer+HPL						F, G, Y / W+P\$ H / W+P\$	3426 3511
		Veneer						F, G, Y / W\$ H / W\$	3587 3656
		Glass+TFL						Acid Etched Glass Top +T\$ Gloss Glass Top +T\$	3912 3484
		Glass+Veneer						Acid Etched Glass Top +W\$ Gloss Glass Top +W\$	5317 4889
		88-2436CC <i>Two Doors</i>	TFL+HPL	36	24	30	150	18.3	F, G, Y / T+P\$ H / T+P\$
	Veneer+HPL							F, G, Y / W+P\$ H / W+P\$	2750 2816
	Veneer							F, G, Y / W\$ H / W\$	2915 2968
	Glass+TFL							Acid Etched Glass Top +T\$ Gloss Glass Top +T\$	3108 2788
	Glass+Veneer							Acid Etched Glass Top +W\$ Gloss Glass Top +W\$	4179 3859

Description

- Standard with: One (1) Adjustable Shelf Behind Touch Latch Doors, Top Profile on Approach Side, 2" Wire Management Channel Along Back of Interior Cabinet, Reverse Slip Matched Pattern on Top Surface, and Vertical Grain Direction on Chassis
- Available with Veneer (W), HPL (P), or Back Painted Tempered Glass (Black or White with Gloss or Acid Etched Finish) Top
- When Selecting Back Painted Tempered Glass Top; Must Specify Glass Color, Gloss or Acid Etched Finish and Edge Profile; [See Options](#)
- Tops and Chassis Available in Contrasting Colors; Must Specific Color of Each Component
- Touch Latch Doors Standard Without Pulls, Optional Studio Pulls; Must Specify Pull Color ([See Color Options](#))
- Studio Pulls Will be Added and Centered on Top of Doors When Waste Bin is Selected; Must Specify Pull Color ([See Color Options](#)) and Optional Waste Bin ([See Options](#))
- Knife Edge not Available
- Additional Options: Locking Doors ([See Options Details](#)); Pull Out Waste Bin Available ([See Options Details](#)); Back Panel Vent ([See Options Details](#))



Double Kerf (F) 1 3/16" Duo (G) 1 3/16" Square (Y) 1 3/16" Vertical Square (H) 1 1/2"

T = TFL P = HPL W = Veneer

[See Catalyst Overview For Ordering Options](#)

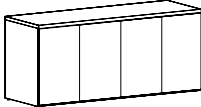
Item	Model No.		W	D	H	Ship Wt	Cubic Ft	Edge Profile + Material	List Price	
20" D CREDENZA 	88-2096CC <i>Five Doors</i>	TFL+HPL	96	20	30	398	39.9	F, G, Y / T+P\$	4138	
									H / T+P\$	4230
		Veneer+HPL							F, G, Y / W+P\$	6525
									H / W+P\$	6667
		Veneer							F, G, Y / W\$	6854
									H / W\$	6966
			Glass+TFL						Acid Etched Glass Top +T\$	6974
									Gloss Glass Top +T\$	6261
			Glass+Veneer						Acid Etched Glass Top +W\$	9690
									Gloss Glass Top +W\$	8977
		88-2084CC <i>Five Doors</i>	TFL+HPL	84	20	30	338	35.1	F, G, Y / T+P\$	3777
									H / T+P\$	3858
Veneer+HPL								F, G, Y / W+P\$	5822	
								H / W+P\$	5947	
Veneer								F, G, Y / W\$	6154	
								H / W\$	6253	
		Glass+TFL						Acid Etched Glass Top +T\$	6225	
								Gloss Glass Top +T\$	5601	
		Glass+Veneer						Acid Etched Glass Top +W\$	8602	
								Gloss Glass Top +W\$	7978	
	88-2072CC <i>Four Doors</i>	TFL+HPL	72	20	30	260	35.6	F, G, Y / T+P\$	3035	
								H / T+P\$	3105	
Veneer+HPL								F, G, Y / W+P\$	4761	
								H / W+P\$	4869	
Veneer								F, G, Y / W\$	4921	
								H / W\$	5006	
		Glass+TFL						Acid Etched Glass Top +T\$	5231	
								Gloss Glass Top +T\$	4696	
		Glass+Veneer						Acid Etched Glass Top +W\$	7117	
								Gloss Glass Top +W\$	6582	
	88-2060CC <i>Three Doors</i>	TFL+HPL	60	20	30	220	25.3	F, G, Y / T+P\$	2660	
								H / T+P\$	2718	
Veneer+HPL								F, G, Y / W+P\$	4115	
								H / W+P\$	4206	
Veneer								F, G, Y / W\$	4277	
								H / W\$	4349	
		Glass+TFL						Acid Etched Glass Top +T\$	4467	
								Gloss Glass Top +T\$	4022	
		Glass+Veneer						Acid Etched Glass Top +W\$	6085	
								Gloss Glass Top +W\$	5640	

T= TFL P= HPL W= Veneer

Additional 20" Credenzas on Next Page

[See Catalyst Overview For Ordering Options](#)

Item	Model No.		W	D	H	Ship Wt	Cubic Ft	Edge Profile + Material	List Price
<i>CONTINUED FROM PREVIOUS PAGE</i>	88-2048CC <i>Two Doors</i>	TFL+HPL	48	20	30	165	24.1	F, G, Y / T+P\$	2032
								H / T+P\$	2080
			Veneer+HPL					F, G, Y / W+P\$	3216
								H / W+P\$	3290
			Veneer					F, G, Y / W\$	3381
								H / W\$	3439
			Glass+TFL					Acid Etched Glass Top +T\$	3452
								Gloss Glass Top +T\$	3095
			Glass+Veneer					Acid Etched Glass Top +W\$	4801
								Gloss Glass Top +W\$	4444
	88-2036CC <i>Two Doors</i>	TFL+HPL	36	20	30	135	15.5	F, G, Y / T+P\$	1731
								H / T+P\$	1768
			Veneer+HPL					F, G, Y / W+P\$	2597
								H / W+P\$	2654
			Veneer					F, G, Y / W\$	2765
								H / W\$	2809
			Glass+TFL					Acid Etched Glass Top +T\$	2763
								Gloss Glass Top +T\$	2495
			Glass+Veneer					Acid Etched Glass Top +W\$	3796
								Gloss Glass Top +W\$	3529

Must Specify (in this order):

- Model #
- Top/Edge Material
- Top/Edge Finish/Color
- Edge Profile
- Chassis Color
- Glass (Y/N)
- Glass Color + Surface Finish
- Pull
- Vent

Description

- Standard with: One (1) Adjustable Shelf Behind Touch Latch Doors, Top Profile on Approach Side, 2" Wire Management Channel Along Back of Interior Cabinet, Reverse Slip Matched Pattern on Top Surface, and Vertical Grain Direction on Chassis
- Available with Veneer (W), HPL (P), or Back Painted Tempered Glass (Black or White with Gloss or Acid Etched Finish) Top
- When Selecting Back Painted Tempered Glass Top; Must Specify Glass Color, Gloss or Acid Etched Finish and Edge Profile; [See Options](#)
- Tops and Chassis Available in Contrasting Colors; Must Specific Color of Each Component
- Touch Latch Doors Standard Without Pulls, Optional Studio Pulls; Must Specify Color
- Knife Edge not Available
- Additional Options: Locking Doors ([See Options Details](#)); Back Panel Vent ([See Options Details](#))



Double Kerf (F)
1 3/16"



Duo (G)
1 3/16"



Square (Y)
1 3/16"



Vertical Square (H)
1 1/2"

T= TFL P= HPL W= Veneer

[See Catalyst Overview For Ordering Options](#)

Item	Model No.		W	D	H	Ship Wt	Cubic Ft		List Price	
	88-2436SV	TFL+HPL	36	24	36	260	35.6	F, G, Y / T+P\$	2498	
									H / T+P\$	2542
		Veneer+HPL							F, G, Y / W+P\$	3722
									H / W+P\$	3788
		Veneer							F, G, Y / W\$	3887
								H / W\$	3940	

Must Specify (in this order):

- Model #
- Top/Edge Material
- Top/Edge Finish/Color
- Edge Profile
- Optional Grommet

Description

- Top Edge Profiled on Approach Side Only (See Edge Options); Must Specify Edge Selection ([See Edge Details](#))
- Two (2) Box Drawers, Open Storage, and Storage Behind Two (2) Doors
- Locking Casters

Grommet Option: Specify & Add

1-GRMT	Grommet in Back Panel; Must Specify Black or Silver	\$ 50
--------	---	-------

Item	Model No.		W	D	H	Ship Wt	Cubic Ft		List Price
	88-4848VB	TFL	48	5	48	150	11.0	T\$	2856
		Veneer							W\$

Must Specify (in this order):

- Model #
- Color
- Projection Screen
- Tackboard Fabric

Description

- Tackboard on Each Door Standard in Black Fabric Unless Specified; Price Valid for Grades 1, 2, & 3 (See Other Pricing Below)
- Display Rail with Adjustable Hooks for Flipchart
- Magnetic Porcelain Non-Glare Writing Surface
- Includes Flipchart, Set of Four (4) Dry Erase Markers and Eraser, Mounting Hardware
- Does Not Feature Soft Close Hinges

Options: Specify & Add

	Grade 4	Grade 5	Grade 6	Grade 7	Grade 8	Grade 9	Grade 10	
Tackboard Fabric Change	\$ 268	394	522	704	892	1114	1368	
1-PS	Projection Screen (Requires Field Installation)						\$	1026

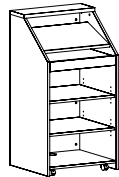
Item	Model No.		W	D	H	Ship Wt	Cubic Ft		List Price	
	88-2650LS	TFL+HPL	26	24	50	130	21.9	F, G, Y / T+P\$	1846	
									H / T+P\$	1856
		Veneer+HPL							F, G, Y / W+P\$	3334
									H / W+P\$	3359
		Veneer							F, G, Y / W\$	3466
								H / W\$	3479	

Must Specify (in this order):

- Model #
- Top/Edge Material
- Top/Edge Finish/Color
- Edge Profile

Description

- Top Edge Profiled on Approach Side Only (See Edge Options); Must Specify Edge Selection
- Fixed Shelf Angled for User Comfort, One (1) Pullout Shelf, and Two (2) Adjustable Shelves
- Two (2) Locking and Two (2) Non-Locking Casters
- Wire Management Grommet on Bottom Shelf

Item	Model No.	W	D	H	Ship Wt	Cubic Ft	List Price
MAGNETIC GLASS MARKER BOARD FOR USE WITH 30"H CREDENZA AND SHELVING	GMB-4048W	48	½	40⅞	67	11.0	\$ 3022
	GMB-4042W	42	½	40⅞	58	9.9	\$ 2555
	GMB-4036W	36	½	40⅞	50	8.8	\$ 2208
	GMB-4030W	30	½	40⅞	42	7.7	\$ 1859

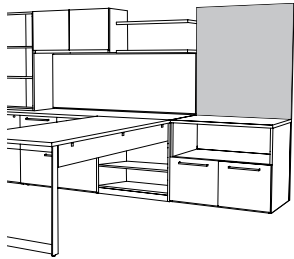

Description

- Available in Black (BLMKR) or White (WHMKR), Must Specify
- Tempered Glass Magnetic Marker Boards Include Mounting Brackets
- For Use over 30"H Desks and Credenzas with Wall Mount Hutches or Shelving
- For Rare Earth Magnets, Marker and Eraser Sets; [See Set Options](#)

Must Specify (in this order):

Model #
Color



Rare Earth Magnets, Marker and Eraser set available; [See Set Options](#)

MAGNETIC GLASS MARKER BOARD FOR USE WITH 30"H CREDENZA AND SHELVING	GMB-5248W	48	½	52⅞	86	13.5	\$ 3853
	GMB-5242W	42	½	52⅞	76	12.2	\$ 3255
	GMB-5236W	36	½	52⅞	65	10.8	\$ 2806
	GMB-5230W	30	½	52⅞	54	9.5	\$ 2358

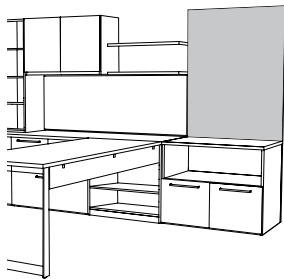

Description

- Available in Black (BLMKR) or White (WHMKR), Must Specify
- Tempered Glass Magnetic Marker Boards Include Mounting Brackets
- For Use Next to Tall Surface or Wall Mount Hutches
- For Rare Earth Magnets, Marker and Eraser Sets; [See Set Options](#)

Must Specify (in this order):

Model #
Color



Rare Earth Magnets, Marker and Eraser set available; [See Set Options](#)

[See Catalyst Overview For Ordering Options](#)

Item	Model No.	W	D	H	Ship Wt	Cubic Ft	List Price
MAGNETIC GLASS MARKER BOARD	GMB-8236W	36	½	82⅞	102	15.8	\$ 4302
FOR USE FROM FLOOR TO TOP OF UNIT	GMB-7036W	36	½	70⅞	87	13.8	\$ 3704
	GMB-5136W	36	½	51⅞	63	10.6	\$ 2707
	GMB-8230W	30	½	82⅞	85	13.8	\$ 3604
	GMB-7030W	30	½	70⅞	72	12.1	\$ 3106
	GMB-5130W	30	½	51⅞	53	9.3	\$ 2274

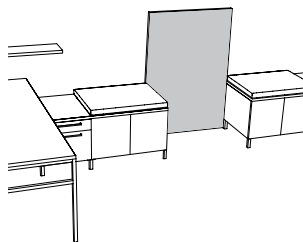

Must Specify (in this order):

Model #
Color

Description

- Available in Black (BLMKR) or White (WHMKR), Must Specify
- Tempered Glass Magnetic Marker Boards Are One (1) Piece with No Seams
- Mounting Brackets Included
- For Use From Floor to Top of Unit
- For Rare Earth Magnets, Marker and Eraser Sets; See Below



Rare Earth Magnets, Marker and Eraser set available; See Below

MARKER AND ERASER SET	01-MRKRSETBL	For Use with Black Marker Boards and Black Glass Doors	\$ 119
	01-MRKRSETWH	For Use with White Marker Boards and White Glass Doors	

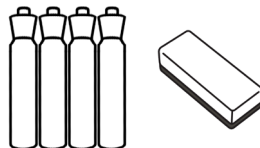

Description

- 01-MRKRSETWH May Also be Used with Dry Erase Doors and Boards
- Includes 4 Markers and an Eraser

RARE EARTH MAGNET SET	01-MAGBL	For Use with White Marker Boards	\$ 110
	01-MAGWH	For Use with Black Marker Boards	



Description

- Includes Set of Five (5) Rare Earth Magnets
- To be Used with Tempered Glass Magnetic Marker Boards
- Comfort Grip with Stylish Protective Plastic Coating

[See Catalyst Overview For Ordering Options](#)

Item	Model No.		W	D	H	Ship Wt	Cubic Ft	List Price
ROUND GROMMET COVER FIELD INSTALLED	01-GRMTBK	Black	-	-	-	-	-	\$ 11
	01-GRMTSL	Silver						



OPEN MARKET ONLY
(SILVER)

Description

- 60mm Round Grommet Cover
- Field Installed

SINGLE POWER SAND DOLLAR	01-SAND60PS	Silver	3	3	4	1	0.2	\$ 95
	01-SAND60PW	White						
	01-SAND60PB	Black						

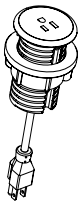

Description

- Mounts in 2 $\frac{3}{8}$ " (60mm) Round Grommet
- Single Power Outlet with 6' Cord

DOUBLE USB SAND DOLLAR	01-SAND60US	Silver	3	3	4	1	0.2	\$ 268
	01-SAND60UW	White						
	01-SAND60UB	Black						

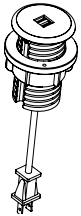

Description

- Mounts in 2 $\frac{3}{8}$ " (60mm) Round Grommet
- Dual USB Outlets with 6' Cord

DOCK 950 WIRELESS CHARGER	01-DOCK950W	White	3 $\frac{3}{16}$ "	3 $\frac{3}{16}$ "	-	1	0.2	\$ 256
	01-DOCK950B	Black						

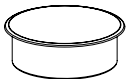

OPEN MARKET ONLY

Description

- For Use with Wireless Charging Enabled Devices
- 5 Watts Maximum Output with a Direct Current of 5V 2A and 10 Watts Maximum with Quick Charge 2.0
- LED will Confirm Pairing with Device and Begin Wireless Charging

WIRELESS AND USB CHARGER	01-DOCK150W	White	3	3	$\frac{3}{4}$ "	1	0.2	\$ 391
	01-DOCK150B	Black						



OPEN MARKET ONLY

Description

- For Use with Wireless Charging Enabled Devices and USB Charging Devices
- 5 Watt Maximum Output with a Direct Current Input of 5V 6A (Wireless Fast Charge)
- Pop-Up is $\frac{3}{4}$ "H and Includes Three (3) USB Ports; One (1) 12 Watt Maximum with 2.4A (USB Fast Charge) and Two (2) 5 Watt with 1A (USB Standard Charge)
- LED Light will Confirm Pairing with Device and Begin Wireless Charging
- UL and cUL Certified

[See Catalyst Overview For Ordering Options](#)

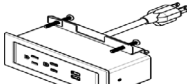
Item	Model No.		W	D	H	Ship Wt	Cubic Ft	List Price
 DUO BEZEL NEMA PLUG	01-DUOBEZELW	White	6½	2½	3¼	1	0.2	\$ 652
	01-DUOBEZELB	Black						
	01-DUOBEZELS	Silver						

Description

- Sits on Table Top and Includes: Two (2) Power, Two (2) USB, 10' Cord, and All Mounting Hardware
- Independent USB Circuit Controllers Deliver up to 2.1 Amps to Each Post
- FCC Part 15A, UL Recognized for Horizontal and Vertical Applications

 TRIO BEZEL NEMA PLUG	01-TRIOBEZELW	White	9	2½	3	1	0.2	\$ 700
	01-TRIOBEZELB	Black						
	01-TRIOBEZELS	Silver						

Description

- Sits on Table Top and Includes: Three (3) Power Outlets, Two (2) USB Ports, One (1) Open Data Port, 10' Cord, and All Mounting Hardware
- HDMI, VGA, and RJ45 Accessories for Open Data Port; Sold Separately, [See Accessories](#)
- Independent USB Circuit Controllers Deliver up to 2.1 Amps to Each Post
- FCC Part 15A, UL Recognized for Horizontal and Vertical Applications

 DUO BEZEL DAISY CHAIN PLUG	01-PDUOBEZELW	White	6½	2½	3	1	0.2	\$ 645
	01-PDUOBEZELB	Black						
	01-PDUOBEZELS	Silver						

Description

- Sits on Table Top and Includes: Two (2) Power, Two (2) USB, 12" Cord, and All Mounting Hardware
- Requires Daisy Chain Power Box; Sold Separately, [See Power Box Details](#)
- Non-Sequential System Allows up to Eight (8) Modules to be Connected with Jumper Cord, [See Jumper Cord Details](#)
- Independent USB Circuit Controllers Deliver up to 2.1 Amps to Each Post
- FCC Part 15A, RU Listed and UL Recognized for Horizontal and Vertical Applications

[See Catalyst Overview For Ordering Options](#)

Item	Model No.		W	D	H	Ship Wt	Cubic Ft	List Price
TRIO BEZEL DAISY CHAIN PLUG	01-PTRIOBEZELW	White	9	2½	3	1	0.2	\$ 691
	01-PTRIOBEZELB	Black						
	01-PTRIOBEZELS	Silver						

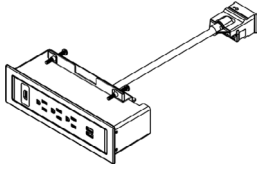

Description

- Sits on Table Top and Includes: Three (3) Power Outlets, Two (2) USB Ports, One (1) Open Data Port, 12" Cord, and All Mounting Hardware
- HDMI, VGA, or RJ45 Accessory for Open Data Port; Sold Separately, [See Accessories](#)
- Requires Daisy Chain Power Box, Specified Separately, See Below
- Non-Sequential System Allows up to Eight (8) Modules to be Connected with Jumper Cord, See Below
- Independent USB Circuit Controllers Deliver up to 2.1 Amps to Each Post
- FCC Part 15A, RU Listed and UL Recognized for Horizontal and Vertical Applications

DAISY CHAIN POWER BOX	01-PPOWER		-	-	-	1	0.2	\$ 749
		<i>76" Perimeter, 36" Power Cord</i>						
	01-PPOWER2		-	-	-	1	0.2	\$ 769
		<i>24" Perimeter, 144" Power Cord</i>						

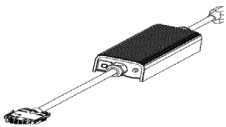

Description

- Powers up to Eight (8) Duo and Trio Daisy Chain Units
- One Nema Plug and One Daisy Chain Plug
- 12-Amp System Rating
- 15-Amp Over-Current Protection

DAISY CHAIN JUMPER CORD	01-6JUMP	<i>72" Long</i>	-	-	-	1	0.2	\$ 289
	01-5JUMP	<i>60" Long</i>	-	-	-	1	0.2	\$ 274
	01-4JUMP	<i>48" Long</i>	-	-	-	1	0.2	\$ 232
	01-2JUMP	<i>24" Long</i>	-	-	-	1	0.2	\$ 213

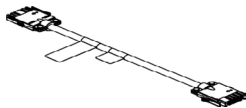

Description

- Connects Duo and Trio Daisy Chain Units
- Non-Sequential System Allows up to Eight (8) Modules to be Connected

[See Catalyst Overview For Ordering Options](#)

Item	Model No.	W	D	H	Ship Wt	Cubic Ft	List Price
HDMI DATA PORT ACCESSORY FOR TRIO UNITS	01-LCOMHDMI	-	-	-	1	0.2	\$ 160

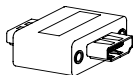

OPEN MARKET ONLY

VGA DATA PORT ACCESSORY FOR TRIO UNITS	01-LCOMVGA	-	-	-	1	0.2	\$ 117
--	------------	---	---	---	---	-----	--------

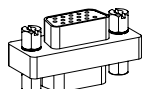

RJ45 DATA PORT ACCESSORY FOR TRIO UNITS	01-LCOMRJ45	-	-	-	1	0.2	\$ 76
---	-------------	---	---	---	---	-----	-------

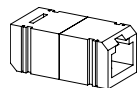

DPORT	01-DPORT4A	Aluminum	8	4	-	7	0.2	\$ 1056
	01-DPORT4B	Black						

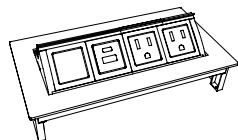
**Description**

- Retracts into Work Surface to Regain Productive Space; One-Touch Access to Power and Data
- Two (2) Power Outlets, One (1) USB A+C, and One (1) Open Port
- Optional Telecom Port Components, [See Compatible Units](#)
- Water-Proof Simplex (Outlets)
- Includes a Voice/Data Adapter Kit to Accept Couplers and Jacks When Required
- 10' Power Cord
- UL Recognized

E2X	01-E2X6A	Aluminum	11	9 ³ / ₁₆	-	6	0.7	\$ 1570
	01-E2X6B	Black						
	01-E2X4A	Aluminum	8	9 ³ / ₁₆	-	5	0.5	\$ 1443
	01-E2X4B	Black						

01-E2X4
SIN PENDING**Description**

- In Surface, Dual Side Application; Soft Touch Access to Power and Data
- Each Side has the Following: 11" Unit Includes Three (3) Power Outlets, One (1) USB A+C, and Two (2) Open Port on Each Side; 8" Unit Includes Two (2) Power Outlets, One (1) USB A+C, and One (1) Open Port
- Optional Telecom Port Components, [See Compatible Units](#)
- 6' Power Cord
- UL Listed

[See Catalyst Overview For Ordering Options](#)

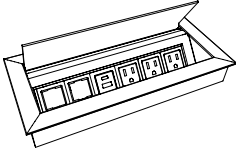
Item	Model No.		W	D	H	Ship Wt	Cubic Ft	Edge Profile + Material	List Price
	01-ELLORA6A	Aluminum	11	5	-	6	0.7	\$	823
	01-ELLORA6B	Black							
	01-ELLORA4A	Aluminum	8	5	-	5	0.5	\$	765
	01-ELLORA4B	Black							

01-ELLORA6
SIN PENDING

Description

- In Surface Application; Soft Touch Access to Power and Data
- 11" Includes Three (3) Power Outlets, One (1) USB A+C, and Two (2) Open Port; 8" Includes Two (2) Power Outlets, One (1) USB A+C, and One (1) Open Port
- Optional Telecom Port Components, See Below for Compatible Units
- 6' Power Cord
- UL Recognized

USB PORT	01-USBPORT		-	-	-	-	-	\$	156
----------	------------	--	---	---	---	---	---	----	-----

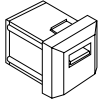

Description

- Passive USB-A Port with Increased Transfer Speed Up to 5 gbs/sec
- Simultaneous Read/Write Capability; Idle Device Power Saving State
- 6' Cord
- Compatible with 01-DPORT4A, 01-DPORT4B, ELLORA4A, ELLORA4B, ELLORA6A, ELLORA6B, E2X4A, E2X4B, E2X6A, and E2X6B

VOICE COUPLER	01-VOICE1		-	-	-	-	-	\$	71
---------------	-----------	--	---	---	---	---	---	----	----

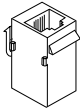

Description

- 6-Pin Modular Plug
- Molded Black; Cord Not included
- Compatible with 01-DPORT4A, 01-DPORT4B, ELLORA4A, ELLORA4B, ELLORA6A, ELLORA6B, E2X4A, E2X4B, E2X6A, and E2X6B

DATA PORT	01-RJ4DATA		-	-	-	-	-	\$	161
-----------	------------	--	---	---	---	---	---	----	-----



Description

- 8-Pin Modular Plug; Cat6 Ethernet Cable; Pre-terminated Cable
- 10' Cord
- Compatible with 01-DPORT4A, 01-DPORT4B, ELLORA4A, ELLORA4B, ELLORA6A, ELLORA6B, E2X4A, E2X4B, E2X6A, and E2X6B

[See Catalyst Overview For Ordering Options](#)

Item	Model No.	W	D	H	Ship Wt	Cubic Ft	List Price
VGA CONNECTOR ACCESSORY	01-VGACON	-	-	-	1	0.2	\$ 144

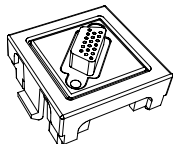
Description

- VGA Port for 01-DPORT4A, 01-DPORT4B, ELLORA4A, ELLORA4B, ELLORA6A, ELLORA6B, E2X4A, E2X4B, E2X6A, and E2X6B
- Enables Devices to Remote Display on Monitors
- 10' Cord
- Male/Female Connector

PASSIVE USB-C ACCESSORY	01-PUSBC	-	-	-	1	0.2	\$ 92
-------------------------	----------	---	---	---	---	-----	-------

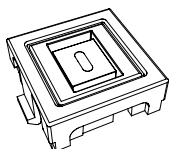
Description

- Passive USB-C Port ; Unit Provides Data Connection to Transfer Data Only, No Charging Capabilities
- Compatible with 01-DPORT4A, 01-DPORT4B, ELLORA4A, ELLORA4B, ELLORA6A, ELLORA6B, E2X4A, E2X4B, E2X6A, and E2X6B
- Male/Female Connector

CHARGING USB-A+C ACCESSORY	01-USBAC	-	-	-	1	0.2	\$ 273
----------------------------	----------	---	---	---	---	-----	--------

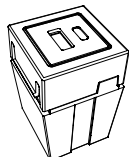
Description

- For Charging Devices
- 20 Watt Power Supply
- USB+C Charging Port for 01-DPORT4A, 01-DPORT4B, ELLORA4A, ELLORA4B, ELLORA6A, ELLORA6B, E2X4A, E2X4B, E2X6A, and E2X6B

HDMI CONNECTOR ACCESSORY	01-HDMICON	-	-	-	1	0.2	\$ 120
--------------------------	------------	---	---	---	---	-----	--------

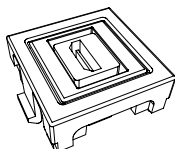
Description

- HDMI Port for 01-DPORT4A, 01-DPORT4B, ELLORA4A, ELLORA4B, ELLORA6A, ELLORA6B, E2X4A, E2X4B, E2X6A, and E2X6B
- Connects to High Definition Displays
- Female/Female Connector
- 18" Cord

[See Catalyst Overview For Ordering Options](#)

Item	Model No.		W	D	H	Ship Wt	Cubic Ft	Edge Profile + Material	List Price
INTERACT POWER & DATA	01-INTERACTG2A	Aluminum	9	5 $\frac{3}{8}$	2 $\frac{3}{4}$	5	0.2	\$	861
	01-INTERACTG2B	Black							

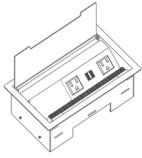

Description

- Includes: Two (2) Power Outlets, Two (2) USB-A Charging Ports, One (1) Telecom Plate Opening; Two (2) Keystone Openings for Voice/Data Jacks
- One (1) Telecom Plates Included with the Unit: One (1) 01-ABLAB Plate (Consists of One (1) RJ45 Cat 6, One (1) RJ11 Cat 3 Phone Jack)
- Convenience Plug on Bottom
- 6' Power Cord
- UL and CSA Recognized
- Additional Telecom Plates, [See ECA Telecom Plate Options](#)

OASIS MINI POWER & DATA	01-OASISMA	Aluminum	15	9	5	11	0.3	\$	3083
	01-OASISMB	Black							

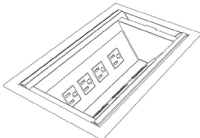

Top View

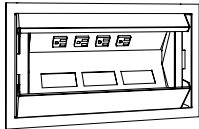

Description

- For Use with Conference Tables
- Soft Touch Hinged Lid
- Four (4) Power Outlets, Three (3) Telecom Plate Openings
- Two (2) Telecom Plates Included with the Unit: One (1) 01-ABLAB Plate (Consists of One (1) RJ45 Cat 6, One (1) RJ11 Cat 3 Phone Jack); One (1) 01-ABLB Plate (Consists of One (1) RJ45 Cat 6)
- 9' Power Cord
- UL Listed
- Additional Telecom Plates, [See ECA Telecom Plate Options](#)

DOCK800	01-DOCK800S	Silver	14	9	-			\$	1978
	01-DOCK800B	Black							

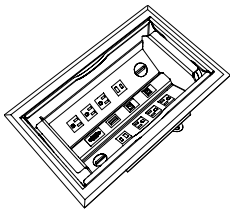

OPEN MARKET ONLY

Description

- Stylish Aluminum Housing with Beveled Edges; Soft Touch Access and Closure
- Includes: Six (6) Power Outlets, Two (2) USB-A 5V Ports, Two (2) USB-C Charging Ports, One (1) RJ45 Ethernet Port, One (1) RJ11 Port, One (1) HDMI Port, and One (1) VGA Port
- 10' Power Cord
- UL and cUL Certified

POWER ENTRY HARD WIRED	01-HWPOWERENTRY		72	-	-	1	0.2	\$	311
------------------------	-----------------	--	----	---	---	---	-----	----	-----

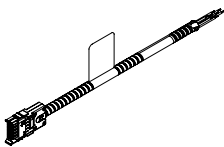

Description

- Eight (8) Wire/Four (4) Circuit Hard Wire In-feed
- UL183 Compliant

[See Catalyst Overview For Ordering Options](#)

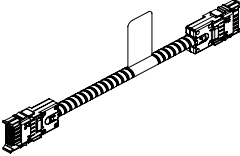
Item	Model No.	W	D	H	Ship Wt	Cubic Ft	List Price
	01-HW2JUMP	24	-	-	1	0.2	\$ 186
	01-HW3JUMP	36	-	-	1	0.2	\$ 199
	01-HW4JUMP	48	-	-	1	0.2	\$ 205
	01-HW5JUMP	60	-	-	1	0.2	\$ 246
	01-HW6JUMP	72	-	-	1	0.2	\$ 261

Description

- Eight (8) Wire/Four (4) Circuit Hard Wire Jumper
- UL183 Compliant

QUAD BLOCK HARD WIRED	01-HWQUADBLOCK	-	-	-	1	0.2	\$ 60
-----------------------	----------------	---	---	---	---	-----	-------

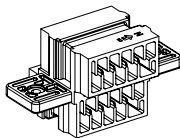
**Description**

- Eight (8) Wire/Four (4) Circuit Hard Wire Connector
- UL183 Compliant
- For Connecting Jumpers and Power Units
- Quantity of Four (4) Female Inputs

WIRE MANAGEMENT CHANNEL	01-WMGR4	16	1½	¾	1	-	\$ 112
-------------------------	----------	----	----	---	---	---	--------

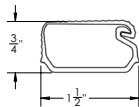
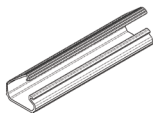
**Description**

- Set of Four (4) Black Plastic Wire Management Channels
- Snap Lock Channel
- Attaches with Adhesive Strips
- Ships via UPS Only

WIRE CHANNEL	01-32125	24	1½	1	.25	0.3	\$ 102
--------------	----------	----	----	---	-----	-----	--------

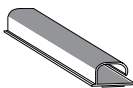

**Description**

- Available in Black
- Channels Attach with Two (2) Double-Sided Installation Tape
- Open J Channel for Easy Storage of Cables

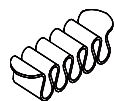
CABLE GRIP	01-WMGRCB	5%	2%	-	-	-	\$ 16
------------	-----------	----	----	---	---	---	-------

**Description**

- Under Surface Wire Management
- Black

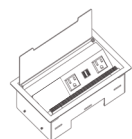
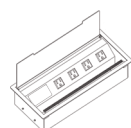
Item	Model No.	Description	List Price
ECA TELECOM PLATES			
	01-ABL	Telecom Plate, Blank Plate	\$ 40
	01-ABL737373	Telecom Plate, Three (3) RJ45 Cat 5e	\$ 355
Compatible with:	01-ABLAB	Telecom Plate, One (1) RJ45 Cat 6, One (1) RJ11 Cat 3 Phone	\$ 199
	01-ABLAB102	Telecom Plate, One (1) RJ45 Cat 6, One (1) RJ11 Cat 3, One (1) USB W/72" Patch Cord	\$ 309
	01-ABLABB	Telecom Plate, Two (2) RJ45 Cat 6, One (1) RJ11 Cat 3 Phone	\$ 309
Oasis Mini Power & Data 01-OASISMA, 01-OASISMB	01-ABLB	Telecom Plate, One (1) RJ45 Cat 6	\$ 144
	01-ABLBB	Telecom Plate, Two (2) RJ45 Cat 6	\$ 251
Interact Power & Data 01-INTERACTG2A, 01-INTERACTG2B	01-ABLBBB	Telecom Plate, Three (3) RJ45 Cat 6	\$ 355
	01-ABLBBBB	Telecom Plate, Four (4) RJ45 Cat 6	\$ 460
Power Center 01-INTRFCIA, 01-INTRFCIB	01-ABLBBC51	Telecom Plate, Two (2) RJ45 Cat 6, One (1) 15 Pin HD VGA w/72" Patch Cord	\$ 431
	01-ABLBC51L	Telecom Plate, One (1) RJ45 Cat 6, One (1) Mini Stereo Inline, One (1) 15 Pin HD VGA w/72" Patch Cord	\$ 396
	01-ABLC3811	Telecom Plate, One (1) RJ45 Cat 6 Data Inline, One (1) RJ11 Cat 3 Phone Inline	\$ 190
	01-ABLC45	Telecom Plate, One (1) HDMI w/36" Patch Cord	\$ 285
	01-ABLC45C51L	Telecom Plate, One (1) Mini Stereo Inline, One (1) HDMI w/36" Patch Cord, One (1) 15 Pin HD VGA w/72" Patch Cord	\$ 539
	01-ABLC51L	Telecom Plate, One (1) 15 Pin HD VGA & One (1) Mini Stereo Inline Jack	\$ 288
	01-ABLCRDM	Telecom Plate, Three (3) Cord Bushings	\$ 93

Madera creates a variety of looks from rich, refined transitional to fresh, modern contemporary by offering an abundance of options, including premium veneer. Finely crafted in select Cherry, Maple, Walnut, and Oak veneers, Madera features a UV topcoat on all exposed surfaces adding unsurpassed hardness and extreme durability for long lasting office applications.

CONSTRUCTION

Madera features a Veneer chassis with your choice of either a Veneer or HPL top. Units ship assembled unless otherwise noted.

VENEER

- Choose from premium veneer or select veneer on exposed surfaces in American Black Walnut, White Oak, Cherry, or Maple species
- The American Black Walnut, White Oak, and Cherry veneers are book matched veneer faces, while the Maple is a slip-matched veneer face
- These veneers are carefully selected and matched to assure proper balance and consistency

TOPS

- Wood Veneer tops have a 5-ply balanced construction while High Pressure Laminate (HPL) tops have a 3-ply balanced construction, 1 $\frac{3}{16}$ " thick, with hardwood rims
- Tops featuring the Bullnose (D), Tri-Round (E), Flute (X), and Square (Y) edge profiles have vertical profiles
- Tops featuring the Radius (A) and Bevel (B) edge profiles have the same construction, but provide a matching reverse profile on connecting edge
- Grain direction runs left to right unless otherwise noted

CHASSIS

- Tops, end panels, and modesty panels are securely fastened using high quality European style fastening systems and heavy-duty, 16-gauge joining brackets to assure maximum strength
- All units are equipped with heavy-duty, adjustable glides to ensure proper leveling and compensation for uneven floors

DRAWERS

- All drawer fronts are standard with matched faces
- All drawers feature 5-sided construction allowing for easy removal of drawer fronts
- Fronts are 3-ply construction and are $\frac{3}{4}$ " thick with matched grain
- Drawer interiors are dovetail construction with $\frac{7}{16}$ " thick hardwood sides and backs and $\frac{5}{32}$ " thick hardboard bottoms
- The drawer interiors are sanded, sealed, and finished to provide a smooth, quality feel and appearance
- All drawers feature full extension, progressive action slides with precision steel ball bearings
- Box and file drawers are tested for 100lb capacity
- Lateral files are tested for 200lb capacity
- All suspensions have a limited lifetime warranty

FILING

- All file drawers are standard with filing systems designed to accommodate a variety of filing requirements
- Letter width file drawers provide letter filing front to back and legal filing side to side
- Lateral file drawers provide legal or letter filing front to back or side to side

STORAGE

- All hinged doors include soft close hinges, unless noted
- One piece hinge and base plate combination
- Soft close hinges reduce stress placed on the cabinet when the door is closed and offers a quiet closure

LOCKING

- All credenzas feature locking file drawers; optional locking doors is available on select units
- Removable lock cylinders allow for units to be re-keyed at a later date, if required
- Units are shipped randomly keyed as standard
- Keyed alike units available upon request at no additional charge
- Lock core will match pull color

CORD MANAGEMENT

- Grommets are available in black or silver, please specify color

INTERIOR DRAWER DIMENSIONS & FILING CAPABILITIES

Models

16-2472SC 16-2072SC

Drawers

File

W

15 $\frac{1}{32}$ "

L

16 $\frac{1}{4}$ "

D

8 $\frac{29}{32}$ "

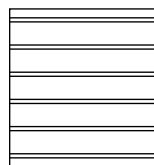

Legal Front to Back

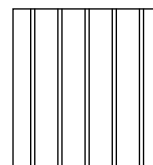

Legal Side to Side

Models

16-2466SC

Drawers

File

W

12 $\frac{1}{32}$ "

L

16 $\frac{1}{4}$ "

D

8 $\frac{29}{32}$ "

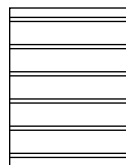

Letter Front to Back

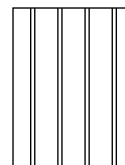

Legal Side to Side

Models

14-2072SC

Drawers

Box

W

15 $\frac{1}{32}$ "

L

16 $\frac{1}{4}$ "

D

3 $\frac{21}{32}$ "

File

15 $\frac{1}{32}$ "

16 $\frac{1}{4}$ "

8 $\frac{29}{32}$ "

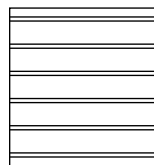

Legal Front to Back

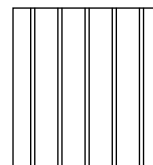

Legal Side to Side

INTERIOR DRAWER DIMENSIONS & FILING CAPABILITIES (CONTINUED)

Models

14-3670WD2L 14-3670WD2R

Drawers

File **W** **L** **D**
 14⁹/₃₂" 16¹/₄" 8²⁹/₃₂"

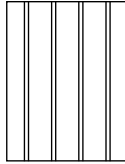

Letter Front to Back

Legal Side to Side

Models

14-3670WD1L 14-3670WD1R

Drawers

Box **W** **L** **D**
 14⁹/₃₂" 16¹/₄" 3²/₃₂"
 File 14⁹/₃₂" 16¹/₄" 8²⁹/₃₂"

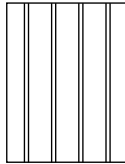

Letter Front to Back

Legal Side to Side

Models

14-3670SU2

Drawers

Lateral **W** **L** **D**
 32⁹/₃₂" 16¹/₄" 8²⁹/₃₂"

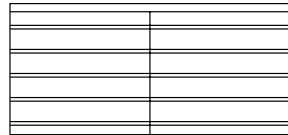

2 Rows Letter Front to Back



1 Row Legal Side to Side

HOW TO ORDER EXAMPLES

	Model No.	QTY	Description	Example
TABLE TOP	14-4848CT	1	Top Material	PV
			Finish/Color	MO
			Edge Profile	D
BASE	01-2228STR4	1	Color	ALUM
WORK TABLE	14-3672WT	1	Premium/Standard Veneer	W
			Top Material	P
			Finish/Color	SM
			Edge Profile	Y
CREDENZA	16-2472SC	1	Premium/Standard Veneer	PV
			Top Material	P
			Finish/Color	HW
			Edge Profile	B
			Pull	ABM
WARDROBE	14-3670WD1L	1	Premium/Standard Veneer	W
			Finish/Color	HW
			Edge Profile	D
			Pull	AQD
			Locking Door	WITH LOCKING

PREMIUM VENEER (PV) AND VENEER (W) OPTIONS

Veneer features UV Advantage, an ultra-violet finish, on all exposed surfaces by utilizing roll-coat UV technology

AW	Artisan Walnut**	MW	Mahogany Walnut**
AS	Asian Night	MAS	Mesa Sunset*
CO	Columbian Walnut**	MTS	Metropolis Sky
DC	Dark Cherry**	ORW	Oak Riftwood*
DFW	Dark Forest Walnut**	PNW	Pinnacle Walnut
EW	Espresso**	SCH	Select Cherry**
FO	Fawn Oak**,**	SKC	Shaker Cherry**
GC	Golden Cherry**	SM	Sugar Maple
HW	Harvest Walnut**	WTA	Weathered Ash*
HNW	Henna Walnut	WC	Williamsburg Cherry**
LW	Legacy Walnut**		

* Finish is Low Sheen ** Available in Premium Veneer (PV)

HPL (P) LAMINATE WORKSURFACE OPTIONS

WOODGRAIN

AS	Asian Night	PNW	Pinnacle Walnut
CO	Columbian Walnut	SCH	Select Cherry
EF	Espresso	SKC	Shaker Cherry
GC	Golden Cherry	SM	Sugar Maple
MW	Mahogany Walnut	WC	Williamsburg Cherry
ORW	Oak Riftwood	WTA	Weathered Ash

PULL OPTIONS

Note: Lock Core will match Pull Color

AAC Arc, Aluminum	AEL Elite, Aluminum
BAC Arc, Black	BEL Elite, Black
ABM Beam, Aluminum	FPL Finger
BBM Beam, Black	AFL Flair, Aluminum
BBT Bow Tie, Black	CFL Flair, Chrome
NBT Bow Tie, Nickel	AFC Focus, Aluminum
ABU Buckle, Aluminum	BFC Focus, Black
BBU Buckle, Black	AQD Quadra, Aluminum
	BQD Quadra, Black

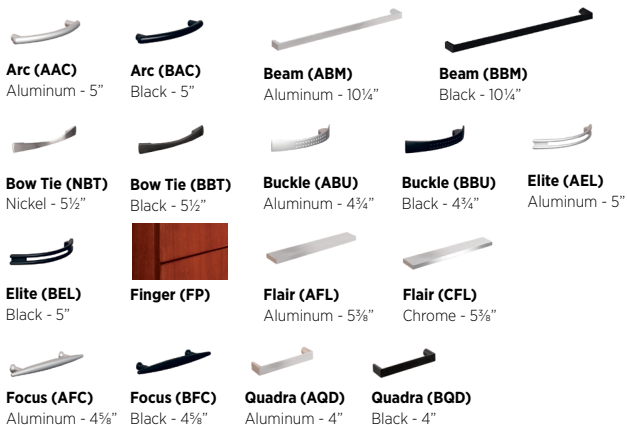

EDGE PROFILES

B Bevel	Y Square
D Bullnose	E Tri-Round
A Radius	

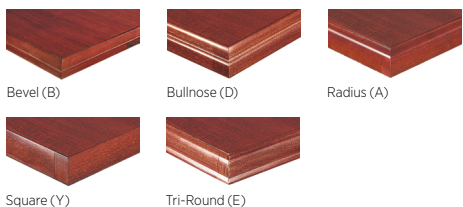

TABLE GROMMET & POWER UNIT OPTIONS

Power units and grommets are sold separately and must be specified separately with surface mount location. Multiple locations may be selected. Only one unit per location.

Power units and Grommets Available in Table Surfaces (See Units)

Grommet Specify Color: Black = BLK and Silver = SLV

DUO/TRIO BEZEL

01-DUOBEZEL	Available in Black (B), Silver (S), or White (W)
01-TRIOBEZEL	Available in Black (B), Silver (S), or White (W)

DOCK 950, DOCK 800 and DOCK 150

DOCK950	Available in Black or White
DOCK150	Available in Black or White
DOCK800	Available in Black or Silver

TABLE GROMMET & POWER UNIT OPTIONS CONTINUE

Other Power Units

DPORT4	Available in Aluminum or Black
INTERACTG	Available in Aluminum or Black
OASISM	Available in Aluminum or Black

Power/Data Location Information:

- Designate unit and location when specifying the top model. Power/Data Module need to be ordered separately.
- Power/Data Modules specified at the time of order will be routed for field installation.

E1	Unit on One End
E2	Unit on Each End
OC	Unit on Center

- All power units available **On Center (OC) only** when paired with two (2) or more of the following bases:

Cylinder Base	Square Base
X-Base	Disc
Tubular X-Base	

Grommets and Power Units may be ordered in non-standard locations. Call Customer Service to assist with specification and/or please attach a drawing to the PO showing the location of the grommet. Note additional charges and lead times may apply.

Top Locations

Power units available on Each End (E1 and E2) and On Center (OC) unless otherwise noted, when paired with any Rectangle Panel Base, Rectangle Box Base or Rectangle Accent Box Base. ([See Unit Details](#))

Power units centered at locations below:

36" Tops	centered 18"D	48" Tops	centered 24"D
42" Tops	centered 21"D		

72: OC 36" from end (available with OC Only)

96: OC 48" from end; E1/E2 29" from end

120: OC 60" from end; E1/E2 29" from end

144: OC 72" from end; E1/E2 29" from end

LOCKING DOORS

Locking doors are available on select units. You must specify WITH LOCKING when ordering and add upcharge.

LKT_HU	36"W Units	\$ 88
LKT_HU	18"W Units	\$ 67

CERTIFICATIONS & COMPLIANCE

- Intertek Sustainability Certified
- BIFMA level® Certified
- BIFMA Compliant® Certified
- TSCA Title VI (Formerly CARB) Compliance
- US Green Building's LEED® Contribution

Tops and Tables



Round Tops
[\(See Details\)](#)



Rectangle Tops
[\(See Details\)](#)



Boat Tops
[\(See Details\)](#)

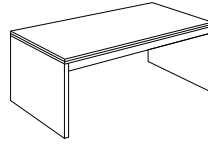

Work/Landing Tables
[\(See Details\)](#)

Bases

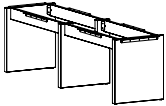

Rectangular Panel
Bases with Trough
[\(See Details\)](#)

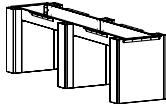

6" Rectangular Bases
with Trough
[\(See Details\)](#)

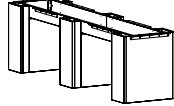

10" Rectangular
Bases with Trough
[\(See Details\)](#)

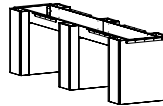

6" Rectangular Accent
Bases with Trough
[\(See Details\)](#)

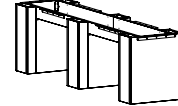

10" Rectangular Accent
Bases with Trough
[\(See Details\)](#)

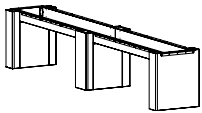

6" + 10" Combo Rectangular
Bases with Trough
[\(See Details\)](#)

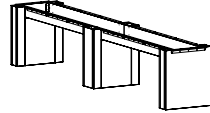

6" + 10" Combo Rectangular
Accent Bases with Trough
[\(See Details\)](#)



Disc Bases
[\(See Details\)](#)

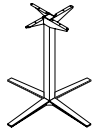

Small and Large X
Bases [\(See Details\)](#)



HA Pneumatic X Bases
[\(See Details\)](#)



Metal Bases
[\(See Details\)](#)

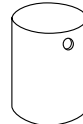

Cylinder Bases
[\(See Details\)](#)

Storage Components

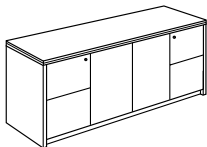

[Full & 3/4 Ped Storage Credenzas](#)

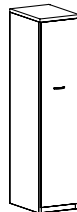
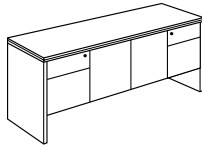

[Wardrobe/Storage](#)

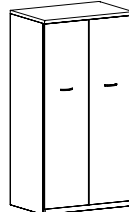

[Double Wardrobe/Storage](#)



Wire Management & Power/Data Accessories [\(See Multiple Units\)](#)

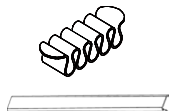
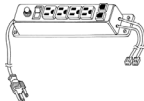

For additional solutions for desking, storage, and accessories, see the [Madera Casegoods](#) and [Accessories](#) Price Lists.

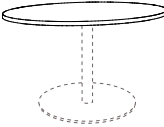
Item	Model No.	Width	Depth	Height	Ship Wt	Cubic Ft	List Price		
 <p>14-4242CT shown with 01-2430DBA (Disc Base) BASES SOLD SEPARATELY</p>	14-4848CT	<i>Accommodates Five (5) Chairs</i>		48	48	30	60	5.7	W/P\$ 2779 PV\$ 3249
	14-4242CT	<i>Accommodates Four (4) Chairs</i>		42	42	30	40	4.4	W/P\$ 2520 PV\$ 2950
	14-3636CT	<i>Accommodates Three (3) to Four (4) Chairs</i>		36	36	30	35	3.4	W/P\$ 2212 PV\$ 2587

Description

- Available with Premium/Standard Veneer (PV/W) or HPL (P) Top, Must Specify
- Single Base Required; Ordered Separately, [See Details](#)
- Bases Sold Separately
- Power Options not Available

Must Specify (in this order):

Model #
Top Material
Finish/Color
Edge Profile

RECTANGULAR TOP

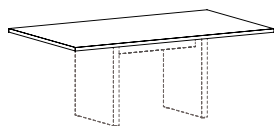

14-3672RT shown with 88-2034RPB (Rectangle Panel Base)
BASES SOLD SEPARATELY

Must Specify (in this order):

Model #
Top Material
Finish/Color
Edge Profile

144" or 12' - 2 Piece Tops		Width	Depth	Height	Ship Wt	Cubic Ft	List Price
14-48144RT		144	48	1 $\frac{3}{16}$	275	12.3	W/P\$ 2244 PV\$ 2625
120" or 10' - 2 Piece Tops							
14-48120RT		120	48	1 $\frac{3}{16}$	225	10.3	W/P\$ 2062 PV\$ 2413
96" or 8' - 1 Piece Top							
14-4896RT		96	48	1 $\frac{3}{16}$	180	9.4	W/P\$ 1970 PV\$ 2305
72" or 6' - 1 Piece Top							
14-3672RT		72	36	1 $\frac{3}{16}$	100	6.2	W/P\$ 1239 PV\$ 1450

Description

- Grain Runs the Width of the Table
- Available with Veneer (PV/W) or HPL (P) Top; Must Specify
- Heavy-Duty Ganging Mechanisms Connect Two (2) Piece Tops
- See Bases/Legs and Number Required For Each Top Size, Must Order Bases Separately
- Optional Grommets and Power/Data Units; [See Location Options](#), [See Power Units Available](#)

P = HPL W = Veneer PV = Premium Veneer

[See Madera Overview For Ordering Options](#)

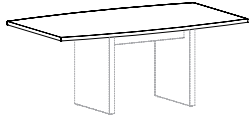
Item	Model No.	Width	Depth	Height	Ship Wt	Cubic Ft	List Price	
 <p>14-3672BT shown with 88-2034RPB (Rectangle Panel Base) BASES SOLD SEPARATELY</p> <p><u>Must Specify (in this order):</u> Model # Top Material Finish/Color Edge Profile</p>	BOAT TOP							
	144" or 12' - 2 Piece Tops							
	14-48144BT		144	48	1 $\frac{3}{16}$	275	12.3	W/P\$ 4232
	14-48144BT							PV\$ 4951
	120" or 10' - 2 Piece Tops							
	14-48120BT		120	48	1 $\frac{3}{16}$	225	10.3	W/P\$ 3845
	14-48120BT							PV\$ 4499
	96" or 8' - 1 Piece Top							
	14-4896BT		96	48	1 $\frac{3}{16}$	180	9.4	W/P\$ 3119
	14-4896BT							PV\$ 3649
	72" or 6' - 1 Piece Top							
	14-3672BT		72	36	1 $\frac{3}{16}$	100	6.2	W/P\$ 1802
14-3672BT							PV\$ 2108	

Description

- Grain Runs the Width of the Table
- Available with Veneer (PV/W) or HPL (P) Top; Must Specify
- Heavy-Duty Ganging Mechanisms Connect Two (2) Piece Tops
- See Bases/Legs and Number Required For Each Top Size, Must Order Bases Separately
- Optional Grommets and Power/Data Units; [See Location Options](#), [See Power Units Available](#)

RECTANGLE PANEL BASES WITH TROUGH

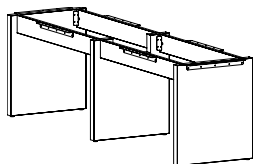

Three (3) Panel Bases - For Use With 48" x 144" Surfaces							
88-24106RPB	Laminate	24	106	28 $\frac{3}{4}$	116	13.8	T\$ 2899
	Veneer						W\$ 2956
Two (2) Panel Bases - For Use With 48" x 120" Surfaces							
88-2482RPB	Laminate	24	82	28 $\frac{3}{4}$	90	6.9	T\$ 2077
	Veneer						W\$ 2127
Two (2) Panel Bases - For Use With 48" x 96" Surfaces							
88-2458RPB	Laminate	24	58	28 $\frac{3}{4}$	84	6.9	T\$ 1816
	Veneer						W\$ 1888
Two (2) Panel Bases - For Use With 36" x 72" Surfaces							
88-2034RPB	Laminate	20	34	28 $\frac{3}{4}$	66	6.7	T\$ 1522
	Veneer						W\$ 1683

Must Specify (in this order):

- Model #
- Material
- Finish / Color

Description

- 2" Panel Bases with Trough, Stretcher Rails, and L-Bracket Hardware Included
- Available with TFL (T) or Veneer (W)
- Vertical Grain Direction on Bases
- Bases Required Some Assembly; Attachment Hardware Included
- Tops Sold Separately

[See Madera Overview For Ordering Options](#)

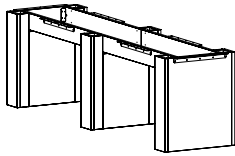
Item	Model No.		Width	Depth	Height	Ship Wt	Cubic Ft	List Price
6" RECTANGLE BASES WITH TROUGH AND REMOVABLE PANEL 	Three (3) 6" Rectangle Bases - For Use With 48" x 144" Surfaces							
	88-2410606RB	Laminate	24	106	28¾	106	19.6	T\$ 4560
		Veneer						W\$ 6239
	Two (2) 6" Rectangle Bases - For Use With 48" x 120" Surfaces							
	88-248206RB	Laminate	24	82	28¾	99	12.9	T\$ 3110
		Veneer						W\$ 4299
	Two (2) 6" Rectangle Bases - For Use With 48" x 96" Surfaces							
	88-245806RB	Laminate	24	58	28¾	93	12.9	T\$ 2921
		Veneer						W\$ 3988
	Two (2) 6" Rectangle Bases - For Use With 36" x 72" Surfaces							
	88-203406RB	Laminate	20	34	28¾	76	12.9	T\$ 2683
		Veneer						W\$ 3691

Must Specify (in this order):

Model #
Material
Finish / Color

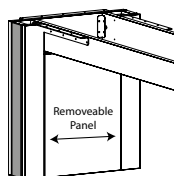

Description

- 6" Rectangle Bases with Trough and Stretcher Rails
- Available with TFL (T) or Veneer (W)
- Vertical Grain Direction on Bases
- Bases Include Interior Removable Panel for Wire Management Access; Removable Panel is 15⅞"W for 24" Bases and 11⅞"W for 20" Bases
- Removable Panels Attached with Z Brackets
- Bases Required Some Assembly; Attachment Hardware Included
- Tops Sold Separately

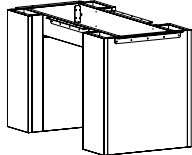
10" RECTANGLE BASES WITH TROUGH AND REMOVABLE PANEL 	Three (3) 10" Rectangle Bases - For Use With 48" x 144" Surfaces							
	88-2410610RB	Laminate	24	106	28¾	141	18.2	T\$ 4677
		Veneer						W\$ 6329
	Two (2) 10" Rectangle Bases - For Use With 48" x 120" Surfaces							
	88-248210RB	Laminate	24	82	28¾	96	12.0	T\$ 3188
		Veneer						W\$ 4359
	Two (2) 10" Rectangle Bases - For Use With 48" x 96" Surfaces							
	88-245810RB	Laminate	24	58	28¾	89	12.0	T\$ 2999
		Veneer						W\$ 4048
	Two (2) 10" Rectangle Bases - For Use With 36" x 72" Surfaces							
	88-203410RB	Laminate	20	34	28¾	72	10.0	T\$ 2760
		Veneer						W\$ 3751

Must Specify (in this order):

Model #
Material
Finish / Color

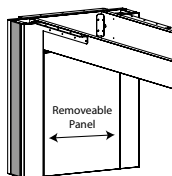

Description

- 10" Rectangle Bases with Trough and Stretcher Rails
- Available with TFL (T) or Veneer (W)
- Vertical Grain Direction on Bases
- Bases Include Interior Removable Panel for Wire Management Access; Removable Panel is 15⅞"W for 24" Bases and 11⅞"W for 20" Bases
- Removable Panels Attached with Z Brackets
- Bases Required Some Assembly; Attachment Hardware Included
- Tops Sold Separately

Item	Model No.		Width	Depth	Height	Ship Wt	Cubic Ft	List Price
6" + 10" COMBO RECTANGLE BASES WITH TROUGH AND REMOVABLE PANEL	Three (3) Bases Total: Two (2) 6" and One (1) 10" Rectangle Bases - For Use With 60" / 54" / 48" x 144" Surfaces							
	88-24106C610RB	Laminate	24	106	28¾	141	18.2	T\$ 4599
		Veneer						W\$ 6269

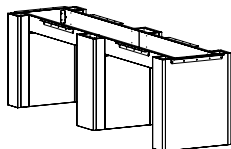

Must Specify (in this order):

- Model #
- Material
- Finish / Color

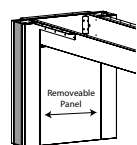

Description

- 6" + 10" Rectangle Bases with Trough and Stretcher Rails; 6" Bases on Exterior and 10" Base on Interior
- Available with TFL (T) or Veneer (W)
- Vertical Grain Direction on Bases
- Bases Include Interior Removable Panel for Wire Management; Removable Panel is 15⅞"W and Attaches with Z Brackets.
- Bases Required Some Assembly; Attachment Hardware Included
- Tops Sold Separately

6" RECTANGLE ACCENT BASES WITH TROUGH AND REMOVABLE PANEL

6" RECTANGLE ACCENT BASES WITH TROUGH AND REMOVABLE PANEL	Three (3) 6" Rectangle Bases - For Use With 48" x 144" Surfaces							
	88-24106O6RAB	Laminate	24	106	28¾	106	19.6	T\$ 5212
		Veneer						W\$ 6931
	Two (2) 6" Rectangle Bases - For Use With 48" x 120" Surfaces							
	88-248206RAB	Laminate	24	82	28¾	99	12.9	T\$ 4585
		Veneer						W\$ 6218
	Two (2) 6" Rectangle Bases - For Use With 48" x 96" Surfaces							
	88-245806RAB	Laminate	24	58	28¾	93	12.9	T\$ 3362
		Veneer						W\$ 4454
	Two (2) 6" Rectangle Bases - For Use With 36" x 72" Surfaces							
	88-203406RAB	Laminate	20	34	28¾	76	12.9	T\$ 3123
		Veneer						W\$ 4157

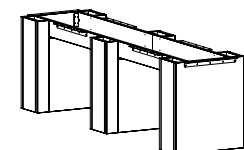

Must Specify (in this order):

- Model #
- Base Finish/Color
- Metal Accent Color
- Accent Panel Finish/Color

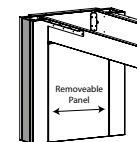

Description

- 6" Rectangle Bases with Trough and Stretcher Rails
- Available with TFL (T) or Veneer (W)
- ⅝" Metal Accent Available in Four (4) Colors: Aluminum, Black, Gold, and Platinum; Must Specify Color
- Vertical Grain Direction on Bases
- Bases Include Interior Removable Panel for Wire Management Access; Removable Panel is 15⅞"W for 24" Bases and 11⅞"W for 20" Bases
- Removable Panels Attached with Z Brackets
- Bases Required Some Assembly; Attachment Hardware Included
- Tops Sold Separately

[See Madera Overview For Ordering Options](#)

Item	Model No.		Width	Depth	Height	Ship Wt	Cubic Ft	List Price
10" RECTANGLE ACCENT BASES WITH TROUGH AND REMOVABLE PANEL	Three (3) 10" Rectangle Bases - For Use With 48" x 144" Surfaces							
	88-241061ORAB	Laminate	24	106	28¾	141	18.2	T\$ 5277
		Veneer						W\$ 7013
	Two (2) 10" Rectangle Bases - For Use With 48" x 120" Surfaces							
	88-248210RAB	Laminate	24	82	28¾	96	12.0	T\$ 3591
		Veneer						W\$ 4817
	Two (2) 10" Rectangle Bases - For Use With 48" x 96" Surfaces							
	88-245810RAB	Laminate	24	58	28¾	89	12.0	T\$ 3402
		Veneer						W\$ 4506
	Two (2) 10" Rectangle Bases - For Use With 36" x 72" Surfaces							
	88-203410RAB	Laminate	20	34	28¾	72	10.0	T\$ 3100
		Veneer						W\$ 4131

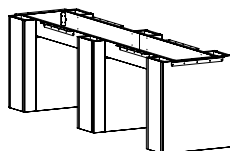

Must Specify (in this order):

- Model #
- Base Finish/Color
- Metal Accent Color
- Accent Panel Finish/Color

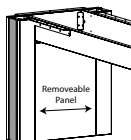

Description

- 10" Rectangle Bases with Trough and Stretcher Rails
- Available with TFL (T) or Veneer (W)
- 5/16" Metal Accent Available in Four (4) Colors: Aluminum, Black, Gold, and Platinum; Must Specify Color
- Vertical Grain Direction on Bases
- Bases Include Interior Removable Panel for Wire Management Access; Removable Panel is 15 7/8"W for 24" Bases and 11 7/8"W for 20" Bases
- Removable Panels Attached with Z Brackets
- Bases Required Some Assembly; Attachment Hardware Included
- Tops Sold Separately

6" + 10" COMBO RECTANGLE ACCENT BASES WITH TROUGH AND REMOVABLE PANEL	Three (3) Bases Total: Two (2) 6" and One (1) 10" Rectangle Bases - For Use With 60" / 54" / 48" x 144" Surfaces							
	88-24106C610RAB	Laminate	24	106	28¾	141	18.2	T\$ 5237
		Veneer						W\$ 6961

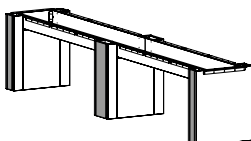

Must Specify (in this order):

- Model #
- Base Finish/Color
- Metal Accent Color
- Accent Panel Finish/Color

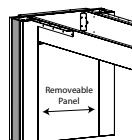

Description

- 6" + 10" Rectangle Accent Bases with Trough and Stretcher Rails; 6" Bases on Exterior and 10" Bases on Interior
- Available with TFL (T) or Veneer (W)
- 5/16" Metal Accent Available in Four (4) Colors: Aluminum, Black, Gold, and Platinum; Must Specify Color
- Vertical Grain Direction on Bases
- Bases Include Interior Removable Panel for Wire Management; Removable Panel is 15 7/8"W and Attaches with Z Brackets
- Bases Required Some Assembly; Attachment Hardware Included
- Tops Sold Separately

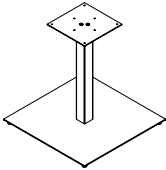
Item	Model No.		Width	Depth	Height	Ship Wt	Cubic Ft	List Price
	For Use With Round Tops: 48" Top Surfaces: 48"x96"							
	01-2630SBB	Black	26	26	27¾	32	3.2	\$ 1124
	01-2630SBA	Aluminum						
	For Use With Round Tops: 42" Top Surfaces: 36"x72"							
	01-2030SBB	Black	20	20	27¾	32	3.2	\$ 924
	01-2030SBA	Aluminum						
	For Use With Round Tops: 36"							
	01-1630SBB	Black	16	16	27¾	32	3.2	\$ 868
	01-1630SBA	Aluminum						

Description

- 2¾" Diameter Column
- 12"x12" Mounting Plate at Top of Column
- Stiffener Bar Not Included; Must Order Separately (See Stiffener Bars)
- See Number of Bases Required Per Top Width Below
- Power Units Available On Center When Using Two or More Square Bases
- Some Assembly Required

Table Widths	Round	72"	96"
Number of Bases Required	1	2	2

TUBULAR X-BASE

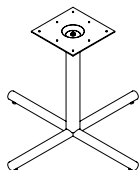

OPEN MARKET ONLY

For Use With Round Tops: 48" Top Surfaces: 48"x96"							
01-3830TXB	Black	38	38	27¾	40	4.2	\$ 675
01-3830TXA	Aluminum						
For Use With Round Tops: 36", 42" Top Surfaces: 36"x72"							
01-3230TXB	Black	32	32	27¾	32	3.2	\$ 612
01-3230TXA	Aluminum						

Description

- 3" Diameter Column
- See Number of Bases Required Per Top Width Below
- Power Units Available On Center When Using Two or More Tubular X-Bases
- Some Assembly Required

Table Widths	Round	72"	96"
Number of Bases Required	1	2	2

[See Madera Overview For Ordering Options](#)

Item	Model No.	Width	Depth	Height	Ship Wt	Cubic Ft	List Price
HEIGHT ADJUSTABLE PNEUMATIC X-BASE 	Maximum Round 42"						
	01-3232HAXBB	Black	32	32	26-45¾	1	\$ 1663
	01-3232HAXBA	Aluminum	32	32	26-45¾	1	\$ 1663
	Maximum Round 36"						
	01-2626HAXBB	Black	22	22	26-45¾	1	\$ 1630
	01-2626HAXBA	Aluminum	22	22	26-45¾	1	\$ 1630

Description

- Pre-Drilled Boring Pattern May Not Match Underside of Table Top
- Steel Mounting Plate: 8"x 8"x ¼"
- Eight (8) Bolts Included for Assembly
- Some Assembly Required

METAL X-BASE

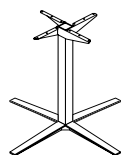

For Use With		Width	Depth	Height	Ship Wt	Cubic Ft	List Price
Round Tops: 42" + 48"							
Top Surfaces: 48"x96"							
08-2642LXBB	Black	35½	35½	40	33	20.0	\$ 1277
08-2642LXBA	Aluminum						
<i>For 42"H Tables</i>							
08-2636LXBB	Black	35½	35½	34	30	17.2	\$ 1232
08-2636LXBA	Aluminum						
<i>For 36"H Tables</i>							
08-2630LXBB	Black	35½	35½	28	27	14.5	\$ 1178
08-2630LXBA	Aluminum						
<i>For 30"H Tables</i>							
For Use With		Width	Depth	Height	Ship Wt	Cubic Ft	List Price
Round: 36"							
Top Surfaces: 36"x72"							
08-2042SXBB	Black	29	29	40	27	15.9	\$ 1193
08-2042SXBA	Aluminum						
<i>For 42"H Tables</i>							
08-2036SXBB	Black	29	29	34	24	13.7	\$ 1145
08-2036SXBA	Aluminum						
<i>For 36"H Tables</i>							
08-2030SXBB	Black	29	29	28	21	11.6	\$ 1100
08-2030SXBA	Aluminum						
<i>For 30"H Tables</i>							

Description

- See Number of Bases Required Per Top Width Below
- Not Available to be Sold Separately
- Power Units Available On Center When Using Two or More Metal X-Bases
- Ships Assembled

Table Widths	Round	72"	96"
Number of Bases Required	1	2	2

Item	Model No.		Width	Depth	Height	Ship Wt	Cubic Ft	List Price
DISC BASE 	For 48" Round Tops							
	01-3230DBB	Black	30	30	27¾	42	4.1	\$ 1780
	01-3230DBA	Aluminum	30	30	27¾	42	4.1	\$ 1780
	For 36" and 42" Round Tops							
	01-2430DBB	Black	24	24	27¾	32	3.2	\$ 1483
	01-2430DBA	Aluminum	24	24	27¾	32	3.2	\$ 1483

Description

- 4" Diameter 14 Gauge Steel Column
- 12"x12" Mounting Plate at Top of Column
- ¼" Thick Disc Plate with 5 Levelers
- Some Assembly Required

Table Widths

	Round	72"	96"
Number of Bases Required	1	4	4

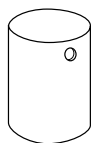
CYLINDER BASEMust Specify (in this order):

Model
Finish/Color
Grommet
Grommet Color

01-2020CB		20	20	28½	136	11.1	W\$ 1500 PV\$ 1752
<i>For Use With 42" or 48" Round Top</i>							
01-1616CB		16	16	28½	101	7.2	W\$ 1371 PV\$ 1604
<i>For Use With 36" Round Top</i>							

Description

- Veneer Cylinder Base Features Multi-Step, Hand-Finished Catalyzed Finish
- Weighted for Stability
- Two (2) Wire Management Black Grommets Standard at Top with 8" Opening Standard in Bottom

Options: Specify & Add

GCB1S	Single Grommet at Top Edge	N/C
NOGC	No Grommets	N/C

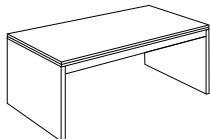
**WORK TABLE
SEATED HEIGHT**Must Specify (in this order):

Model #
Premium or Standard Veneer
Top Material
Finish/Color
Edge Profile

14-3672WT		72	36	30	195	50.0	W/P\$ 3091 PV\$ 3615
Kneespace - 69 ¹ / ₁₆							
14-3060WT		60	30	30	134	35.5	W/P\$ 2418 PV\$ 2833
Kneespace - 57 ¹ / ₁₆							

Description

- Solid End Panels with Apron Rail
- Available with Premium Veneer (PV), Standard Veneer (W) or HPL (P) Tops with Veneer Chassis; Must Specify
- Ships Fully Assembled

P = HPL W = Veneer PV = Premium Veneer

[See Madera Overview For Ordering Options](#)

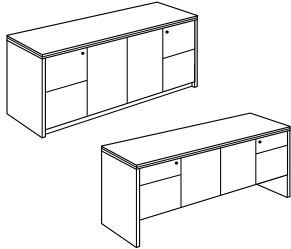
Item	Model No.	Width	Depth	Height	Ship Wt	Cubic Ft	List Price
STORAGE CREDENZA 	Full Pedestals						
	16-2472SC	72	24	30	285	35.6	W/P\$ 5816 PV\$ 5563
	16-2466SC	66	24	30	261	32.7	W/P\$ 5323 PV\$ 5563
	16-2072SC	72	20	30	270	30.5	W/P\$ 5490 PV\$ 5563
	¾ Pedestals						
	14-2072SC	72	20	30	227	30.5	W/P\$ 4753 PV\$ 5563

Must Specify (in this order):

Model #
 Premium or Standard Veneer
 Top Material
 Finish/Color
 Edge Profile
 Pull

Description

- Legal Width, Locking File/File Pedestals (Full) and Legal Width, Locking Box/File Pedestals (¾)
- Fixed Storage Shelf Behind Doors
- Available with Premium Veneer (PV), Standard Veneer (W) or HPL (P) Tops with Veneer Chassis; Must Specify
- Lock Core will Coordinate with Pull Selection

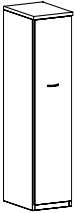
WARDROBE/STORAGE CABINET	Left Hinged	Right Hinged	Width	Depth	Height	Ship Wt	Cubic Ft	List Price
	Model No.	Model No.						
	14-1870WL	14-1870WR	18	24	69¾	153	19.2	W\$ 5085 PV\$ 5951
	14-1870CL	14-1870CR	18	20	69¾	150	18.6	W\$ 4303 PV\$ 5033

Shown as Left

Description

- Standard with: Fixed Top Shelf, Coat Rod, Three Adjustable/Removable Shelves
- Available in Premium Veneer (PV) or Standard Veneer (W); Must Specify
- Knob Pull will be Substituted for Finger Pull
- Optional Locking Door ([See Locking Options](#))

Must Specify (in this order):

Model #
 Premium or Standard Veneer
 Finish/Color
 Edge Profile
 Pull
 Locking Door

DOUBLE WARDROBE/STORAGE CABINET	14-3670WD	36	24	69¾	290	42.0	W\$ 8977 PV\$ 10507
--	-----------	----	----	-----	-----	------	------------------------

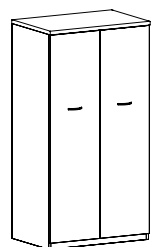

Description

- Standard with: Fixed Top Shelf Behind Each Door, Coat Rod, Three Adjustable/Removable Shelves on Each Side
- Available in Premium Veneer (PV) or Standard Veneer (W); Must Specify
- Knob Pull will be Substituted for Finger Pull
- Optional Locking Door ([See Locking Options](#))

Must Specify (in this order):

Model #
 Premium or Standard Veneer
 Finish/Color
 Edge Profile
 Pull
 Locking Door

P = HPL W = Veneer PV = Premium Veneer

[See Madera Overview For Ordering Options](#)

Item	Model No.	Width	Depth	Height	Ship Wt	Cubic Ft	List Price
DOUBLE WARDROBE/STORAGE CABINET WITH FILE/FILE	Left Drawers	Right Drawers					
	14-3670WD2L	14-3670WD2R	36	24	69%	315	42.0



Shown as Right

Must Specify (in this order):

Model #
 Premium or Standard Veneer
 Finish/Color
 Edge Profile
 Pull
 Locking Door

Description

- One Side - Shaded Fixed Top Shelf, Coat Rod, and Three Adjustable Shelves
- One Side - Top Storage with Two Adjustable Shelves, Bottom Locking File/File
- Available in Premium Veneer (PV) or Standard Veneer (W); Must Specify
- Pedestal Determines Left or Right Handed Unit
- Finger Pull Not Available
- Optional Locking Door ([See Locking Options](#))

DOUBLE WARDROBE/STORAGE CABINET WITH BOX/BOX/FILE

Left Drawers	Right Drawers	Width	Depth	Height	Ship Wt	Cubic Ft	List Price
14-3670WD1L	14-3670WD1R	36	24	69%	315	42.0	W\$ 10270 PV\$ 12017



Shown as Right

Must Specify (in this order):

Model #
 Premium or Standard Veneer
 Finish/Color
 Edge Profile
 Pull
 Locking Door

Description

- One Side - Shaded Fixed Top Shelf, Coat Rod, and Three Adjustable Shelves
- One Side - Top Storage with Two Adjustable Shelves, Bottom Locking Box/Box/File
- Available in Premium Veneer (PV) or Standard Veneer (W); Must Specify
- Pedestal Determines Left or Right Handed Unit
- Finger Pull Not Available
- Optional Locking Door ([See Locking Options](#))

STORAGE CABINET WITH LATERAL FILE DRAWERS

14-3670SU2	36	24	69%	298	42.0	W\$ 9826 PV\$ 11497
------------	----	----	-----	-----	------	------------------------

**Description**

- Standard with: Two 170° Hinged Doors, Two Adjustable Shelves on Top, Two Locking Lateral File Drawers on Bottom
- Lateral Drawers Provide Letter or Legal Filing Capabilities
- Available in Premium Veneer (PV) or Standard Veneer (W); Must Specify
- Finger Pull Not Available
- Optional Locking Door ([See Locking Options](#))

Must Specify (in this order):

Model #
 Premium or Standard Veneer
 Finish/Color
 Edge Profile
 Pull
 Locking Door

P = HPL W = Veneer PV = Premium Veneer

[See Madera Overview For Ordering Options](#)

Item	Model No.		W	D	H	Ship Wt	Cubic Ft	List Price
SINGLE POWER SAND DOLLAR	01-SAND60PS	Silver	3	3	4	1	0.2	\$ 95
	01-SAND60PW	White						
	01-SAND60PB	Black						

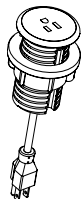
**Description**

- Mounts in 2 $\frac{3}{8}$ " (60mm) Round Grommet
- Single Power Outlet with 6' Cord

DOUBLE USB SAND DOLLAR	01-SAND60US	Silver	3	3	4	1	0.2	\$ 268
	01-SAND60UW	White						
	01-SAND60UB	Black						

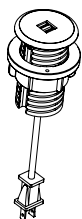
**Description**

- Mounts in 2 $\frac{3}{8}$ " (60mm) Round Grommet
- Dual USB Outlets with 6' Cord

DOCK 950 WIRELESS CHARGER	01-DOCK950W	White	3 $\frac{3}{16}$ "	3 $\frac{3}{16}$ "	-	1	0.2	\$ 256
	01-DOCK950B	Black						



OPEN MARKET ONLY

Description

- For Use with Wireless Charging Enabled Devices
- 5 Watts Maximum Output with a Direct Current of 5V 2A and 10 Watts Maximum with Quick Charge 2.0
- LED will Confirm Pairing with Device and Begin Wireless Charging

WIRELESS AND USB CHARGER	01-DOCK150W	White	3	3	$\frac{3}{4}$ "	1	0.2	\$ 391
	01-DOCK150B	Black						



OPEN MARKET ONLY

Description

- For Use with Wireless Charging Enabled Devices and USB Charging Devices
- 5 Watt Maximum Output with a Direct Current Input of 5V 6A (Wireless Fast Charge)
- Pop-Up is $\frac{3}{4}$ "H and Includes Three (3) USB Ports; One (1) 12 Watt Maximum with 2.4A (USB Fast Charge) and Two (2) 5 Watt with 1A (USB Standard Charge)
- LED Light will Confirm Pairing with Device and Begin Wireless Charging
- UL and cUL Certified

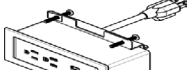
Item	Model No.		W	D	H	Ship Wt	Cubic Ft	List Price
	01-DUOBEZELW	White	6½	2½	3¼	1	0.2	\$ 652
	01-DUOBEZELB	Black						
	01-DUOBEZELS	Silver						

Description

- Sits on Table Top and Includes: Two (2) Power, Two (2) USB, 10' Cord, and All Mounting Hardware
- Independent USB Circuit Controllers Deliver up to 2.1 Amps to Each Post
- FCC Part 15A, UL Recognized for Horizontal and Vertical Applications

	01-TRIOBEZELW	White	9	2½	3	1	0.2	\$ 700
	01-TRIOBEZELB	Black						
	01-TRIOBEZELS	Silver						

Description

- Sits on Table Top and Includes: Three (3) Power Outlets, Two (2) USB Ports, One (1) Open Data Port, 10' Cord, and All Mounting Hardware
- HDMI, VGA, and RJ45 Accessories for Open Data Port; Sold Separately, [See Accessories](#)
- Independent USB Circuit Controllers Deliver up to 2.1 Amps to Each Post
- FCC Part 15A, UL Recognized for Horizontal and Vertical Applications

	01-PDUOBEZELW	White	6½	2½	3	1	0.2	\$ 645
	01-PDUOBEZELB	Black						
	01-PDUOBEZELS	Silver						

Description

- Sits on Table Top and Includes: Two (2) Power, Two (2) USB, 12" Cord, and All Mounting Hardware
- Requires Daisy Chain Power Box; Sold Separately, [See Power Box Details](#)
- Non-Sequential System Allows up to Eight (8) Modules to be Connected with Jumper Cord, [See Jumper Cord Details](#)
- Independent USB Circuit Controllers Deliver up to 2.1 Amps to Each Post
- FCC Part 15A, RU Listed and UL Recognized for Horizontal and Vertical Applications

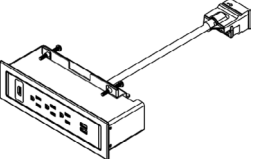
	01-PTRIOBEZELW	White	9	2½	3	1	0.2	\$ 691
	01-PTRIOBEZELB	Black						
	01-PTRIOBEZELS	Silver						

Description

- Sits on Table Top and Includes: Three (3) Power Outlets, Two (2) USB Ports, One (1) Open Data Port, 12" Cord, and All Mounting Hardware
- HDMI, VGA, or RJ45 Accessory for Open Data Port; Sold Separately, [See Accessories](#)
- Requires Daisy Chain Power Box, Specified Separately, See Next Page
- Non-Sequential System Allows up to Eight (8) Modules to be Connected with Jumper Cord, [See Jumper Cord Details](#)
- Independent USB Circuit Controllers Deliver up to 2.1 Amps to Each Post
- FCC Part 15A, RU Listed and UL Recognized for Horizontal and Vertical Applications

[See Madera Overview For Ordering Options](#)

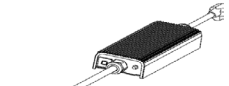
Item	Model No.	W	D	H	Ship Wt	Cubic Ft	List Price
DAISY CHAIN POWER BOX 	01-PPOWER <i>76" Perimeter, 36" Power Cord</i>	-	-	-	1	0.2	\$ 749
	01-PPOWER2 <i>24" Perimeter, 144" Power Cord</i>	-	-	-	1	0.2	\$ 769

Description

- Powers up to Eight (8) Duo and Trio Daisy Chain Units
- One Nema Plug and One Daisy Chain Plug
- 12-Amp System Rating
- 15-Amp Over-Current Protection

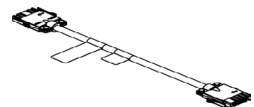
DAISY CHAIN JUMPER CORD 	01-6JUMP <i>72" Long</i>	-	-	-	1	0.2	\$ 289
	01-5JUMP <i>60" Long</i>	-	-	-	1	0.2	\$ 274
	01-4JUMP <i>48" Long</i>	-	-	-	1	0.2	\$ 232
	01-2JUMP <i>24" Long</i>	-	-	-	1	0.2	\$ 213

Description

- Connects Duo and Trio Daisy Chain Units
- Non-Sequential System Allows up to Eight (8) Modules to be Connected





HDMI DATA PORT ACCESSORY FOR TRIO UNITS 	01-LCOMHDMI	-	-	-	1	0.2	\$ 160
---	-------------	---	---	---	---	-----	--------

OPEN MARKET ONLY

VGA DATA PORT ACCESSORY FOR TRIO UNITS 	01-LCOMVGA	-	-	-	1	0.2	\$ 117
--	------------	---	---	---	---	-----	--------

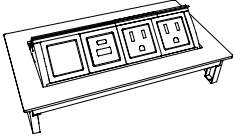
RJ45 DATA PORT ACCESSORY FOR TRIO UNITS 	01-LCOMRJ45	-	-	-	1	0.2	\$ 76
---	-------------	---	---	---	---	-----	-------

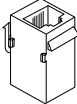
[See Madera Overview For Ordering Options](#)

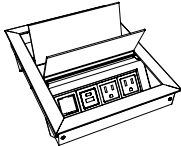
Item	Model No.		W	D	H	Ship Wt	Cubic Ft	List Price
	01-DPORT4A	Aluminum	8	4	-	7	0.2	\$ 1056
	01-DPORT4B	Black						
Description <ul style="list-style-type: none"> Retracts into Work Surface to Regain Productive Space; One-Touch Access to Power and Data Two (2) Power Outlets, One (1) USB A+C, and One (1) Open Port Optional Telecom Port Components, See Options Water-Proof Simplex (Outlets) Includes a Voice/Data Adapter Kit to Accept Couplers and Jacks When Required 10' Power Cord UL Recognized 								
	01-USBPORT		-	-	-	-	-	\$ 156
Description <ul style="list-style-type: none"> Passive USB-A Port with Increased Transfer Speed Up to 5 gbs/sec Simultaneous Read/Write Capability; Idle Device Power Saving State 6' Cord Compatible with 01-DPORT4A, 01-DPORT4B 								
	01-VOICE1		-	-	-	-	-	\$ 71
Description <ul style="list-style-type: none"> 6-Pin Modular Plug Molded Black; Cord Not included Compatible with 01-DPORT4A, 01-DPORT4B 								
	01-RJ4DATA		-	-	-	-	-	\$ 161
Description <ul style="list-style-type: none"> 8-Pin Modular Plug; Cat6 Ethernet Cable; Pre-terminated Cable 10' Cord Compatible with 01-DPORT4A, 01-DPORT4B 								
 <p>01-E2X4 SIN PENDING</p>	01-E2X6A	Aluminum	11	9 ³ / ₁₆	-	6	0.7	\$ 1570
	01-E2X6B	Black						
	01-E2X4A	Aluminum	8	9 ³ / ₁₆	-	5	0.5	\$ 1443
	01-E2X4B	Black						
Description <ul style="list-style-type: none"> In Surface, Dual Side Application; Soft Touch Access to Power and Data 11" Unit Includes Three (3) Power Outlets, One (1) USB A+C, and Two (2) Open Port on Each Side; 8" Unit Includes Two (2) Power Outlets, One (1) USB A+C, and One (1) Open Port on Each Side Optional Telecom Port Components, See Compatible Units 6' Power Cord UL Listed 								

[See Madera Overview For Ordering Options](#)

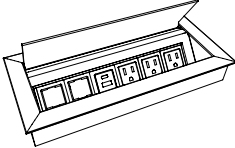
Item	Model No.		W	D	H	Ship Wt	Cubic Ft	List Price
	01-ELLORA6A	Aluminum	11	5	-	6	0.7	\$ 823
	01-ELLORA6B	Black						
	01-ELLORA4A	Aluminum	8	5	-	5	0.5	\$ 765
	01-ELLORA4B	Black						

01-ELLORA6

SIN PENDING

Description

- In Surface Application; Soft Touch Access to Power and Data
- 11" Includes Three (3) Power Outlets, One (1) USB A+C, and Two (2) Open Port; 8" Includes Two (2) Power Outlets, One (1) USB A+C, and One (1) Open Port
- Optional Telecom Port Components, See Below for Compatible Units
- 6' Power Cord
- UL Recognized

VGA CONNECTOR ACCESSORY	01-VGACON		-	-	-	1	0.2	\$ 144
-------------------------	-----------	--	---	---	---	---	-----	--------

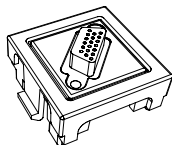
**Description**

- VGA Port for 01-DPORT4A, 01-DPORT4B, ELLORA4A, ELLORA4B, ELLORA6A, ELLORA6B, E2X4A, E2X4B, E2X6A, and E2X6B
- Enables Devices to Remote Display on Monitors
- 10' Cord
- Male/Female Connector

PASSIVE USB-C ACCESSORY	01-PUSBC		-	-	-	1	0.2	\$ 92
-------------------------	----------	--	---	---	---	---	-----	-------

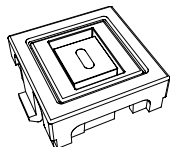
**Description**

- Passive USB-C Port ; Unit Provides Data Connection to Transfer Data Only, No Charging Capabilities
- Compatible with 01-DPORT4A, 01-DPORT4B, ELLORA4A, ELLORA4B, ELLORA6A, ELLORA6B, E2X4A, E2X4B, E2X6A, and E2X6B
- Male/Female Connector

CHARGING USB-A+C ACCESSORY	01-USBAC		-	-	-	1	0.2	\$ 273
----------------------------	----------	--	---	---	---	---	-----	--------

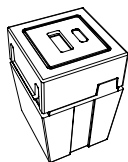
**Description**

- For Charging Devices
- 20 Watt Power Supply
- USB+C Charging Port for 01-DPORT4A, 01-DPORT4B, ELLORA4A, ELLORA4B, ELLORA6A, ELLORA6B, E2X4A, E2X4B, E2X6A, and E2X6B

Item	Model No.		W	D	H	Ship Wt	Cubic Ft	List Price
HDMI CONNECTOR ACCESSORY	01-HDMICON		-	-	-	1	0.2	\$ 120

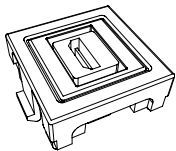

Description

- HDMI Port for 01-DPORT4A, 01-DPORT4B, ELLORA4A, ELLORA4B, ELLORA6A, ELLORA6B, E2X4A, E2X4B, E2X6A, and E2X6B
- Connects to High Definition Displays
- Female/Female Connector
- 18" Cord

INTERACT POWER & DATA	01-INTERACTG2A	Aluminum	9	5 $\frac{3}{8}$	2 $\frac{3}{4}$	5	0.2	\$ 861
	01-INTERACTG2B	Black						

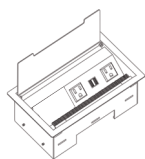

Description

- Includes: Two (2) Power Outlets, Two (2) USB-A Charging Ports, One (1) Telecom Plate Opening; Two (2) Keystone Openings for Voice/Data Jacks
- One (1) Telecom Plates Included with the Unit: One (1) 01-ABLAB Plate (Consists of One (1) RJ45 Cat 6, One (1) RJ11 Cat 3 Phone Jack)
- Convenience Plug on Bottom
- 6' Power Cord
- UL and CSA Recognized
- Additional Telecom Plates, [See ECA Telecom Plate Options](#)

OASIS MINI POWER & DATA	01-OASISMA	Aluminum	15	9	5	11	0.3	\$ 3083
	01-OASISMB	Black						

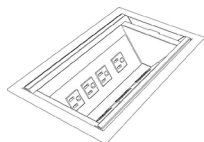

Top View

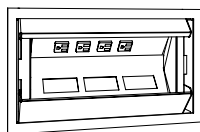

Description

- Soft Touch Hinged Lid
- Four (4) Power Outlets, Three (3) Telecom Plate Openings
- Two (2) Telecom Plates Included with the Unit: One (1) 01-ABLAB Plate (Consists of One (1) RJ45 Cat 6, One (1) RJ11 Cat 3 Phone Jack); One (1) 01-ABLB Plate (Consists of One (1) RJ45 Cat 6)
- 9' Power Cord
- UL Listed
- Additional Telecom Plates, [See ECA Telecom Plate Options](#)

DOCK800	01-DOCK800S	Silver	14	9	-			\$ 1978
	01-DOCK800B	Black						

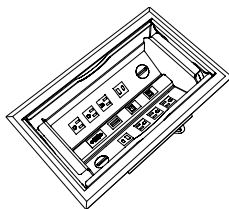

Description

- Stylish Aluminum Housing with Beveled Edges; Soft Touch Access and Closure
- Includes: Six (6) Power Outlets, Two (2) USB-A 5V Ports, Two (2) USB-C Charging Ports, One (1) RJ45 Ethernet Port, One (1) RJ11 Port, One (1) HDMI Port, and One (1) VGA Port
- 10' Power Cord
- UL and cUL Certified

OPEN MARKET ONLY

[See Madera Overview For Ordering Options](#)

Item	Model No.	W	D	H	Ship Wt	Cubic Ft	List Price
POWER ENTRY HARD WIRED	01-HWPOWERENTRY	72	-	-	1	0.2	\$ 311

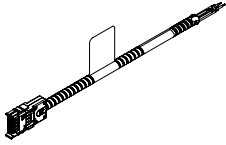

Description

- Eight (8) Wire/Four (4) Circuit Hard Wire In-feed
- UL183 Compliant

Item	Model No.	W	D	H	Ship Wt	Cubic Ft	List Price
JUMPER HARD WIRE CABLE	01-HW2JUMP	24	-	-	1	0.2	\$ 186
	01-HW3JUMP	36	-	-	1	0.2	\$ 199
	01-HW4JUMP	48	-	-	1	0.2	\$ 205
	01-HW5JUMP	60	-	-	1	0.2	\$ 246
	01-HW6JUMP	72	-	-	1	0.2	\$ 261

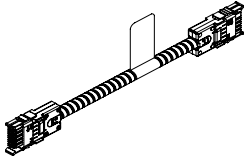

Description

- Eight (8) Wire/Four (4) Circuit Hard Wire Jumper
- UL183 Compliant

Item	Model No.	W	D	H	Ship Wt	Cubic Ft	List Price
QUAD BLOCK HARD WIRED	01-HWQUADBLOCK	-	-	-	1	0.2	\$ 60

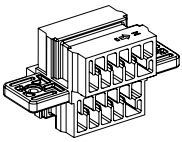

Description

- Eight (8) Wire/Four (4) Circuit Hard Wire Connector
- UL183 Compliant
- For Connecting Jumpers and Power Units
- Quantity of Four (4) Female Inputs

Item	Model No.	Width	Depth	Height	Ship Wt	Cubic Ft	List Price
WIRE MANAGEMENT CHANNEL	01-WMGR4	16	1½	¾	1	-	\$ 112

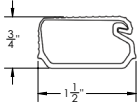
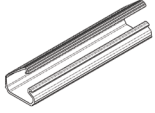

Description

- Set of Four (4) Black Plastic Wire Management Channels
- Snap Lock Channel
- Attaches with Adhesive Strips
- Ships via UPS Only

WIRE CHANNEL	01-32125	24	1⅝	1	.25	0.3	\$ 102
--------------	----------	----	----	---	-----	-----	--------

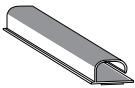

Description

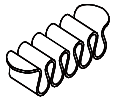

- Available in Black
- Channels Attach with Two (2) Double-Sided Installation Tape
- Open J Channel for Easy Storage of Cables

CABLE GRIP	01-WMGRCB	5⅜	2⅝	-	-	-	\$ 16
------------	-----------	----	----	---	---	---	-------



Description

- Under Surface Wire Management
- Black

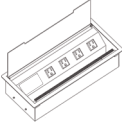
Item	Model No.	Description	List Price
ECA TELECOM PLATES	01-ABL	Telecom Plate, Blank Plate	\$ 40
Compatible with:	01-ABL737373	Telecom Plate, Three (3) RJ45 Cat 5e	\$ 355
	01-ABLAB	Telecom Plate, One (1) RJ45 Cat 6, One (1) RJ11 Cat 3 Phone	\$ 199
	01-ABLAB102	Telecom Plate, One (1) RJ45 Cat 6, One (1) RJ11 Cat 3, One (1) USB W/72" Patch Cord	\$ 309
Oasis Mini Power & Data 01-OASISMA, 01-OASISMB	01-ABLABB	Telecom Plate, Two (2) RJ45 Cat 6, One (1) RJ11 Cat 3 Phone	\$ 309
	01-ABLB	Telecom Plate, One (1) RJ45 Cat 6	\$ 144
Interact Power & Data 01-INTERACTG2A, 01-INTERACTG2B	01-ABLBB	Telecom Plate, Two (2) RJ45 Cat 6	\$ 251
	01-ABLBBB	Telecom Plate, Three (3) RJ45 Cat 6	\$ 355
Power Center 01-INTRFCIA, 01-INTRFCIB	01-ABLBBB	Telecom Plate, Four (4) RJ45 Cat 6	\$ 460
	01-ABLBBBC51	Telecom Plate, Two (2) RJ45 Cat 6, One (1) 15 Pin HD VGA w/72" Patch Cord	\$ 431
	01-ABLBC51L	Telecom Plate, One (1) RJ45 Cat 6, One (1) Mini Stereo Inline, One (1) 15 Pin HD VGA w/72" Patch Cord	\$ 396
	01-ABLC3811	Telecom Plate, One (1) RJ45 Cat 6 Data Inline, One (1) RJ11 Cat 3 Phone Inline	\$ 190
	01-ABLC45	Telecom Plate, One (1) HDMI w/36" Patch Cord	\$ 285
	01-ABLC45C51L	Telecom Plate, One (1) Mini Stereo Inline, One (1) HDMI w/36" Patch Cord, One (1) 15 Pin HD VGA w/72" Patch Cord	\$ 539
	01-ABLC51L	Telecom Plate, One (1) 15 Pin HD VGA & One (1) Mini Stereo Inline Jack	\$ 288
	01-ABLCRDM	Telecom Plate, Three (3) Cord Bushings	\$ 93

Natta offers an agile solution for a variety of community spaces and meeting applications. With its simplicity of form, it can achieve a subtle effect and still provide an excellent solution for any meeting and breakout environment.

CONSTRUCTION

Natta Tables feature a wood base with HPL top.

TOPS

- High Pressure Laminate (HPL) tops are 3-ply balanced construction, 1½" thick with 1 mm PVC edge band and vertical square edge profile; Designer White, Sugar Maple, and Williamsburg Cherry feature ABS edge bands
- Grain direction runs left to right unless otherwise noted

CHASSIS

- All frames are made of solid European Beech with double-doweled or mortised and tenoned joints
- Units are equipped with heavy-duty, adjustable glides to ensure proper leveling and compensation for uneven floors
- All table units ship fully assembled with tops installed

HOW TO ORDER EXAMPLE

Model No.	Description	Example
NAT-1	Top Color	SBP
	Leg Finish	SBP

HPL (P) LAMINATE OPTIONS ON TOPS

WOODGRAIN

AS	Asian Night	PTK	Portico Teak
BW	Beigewood	RC	River Cherry
CO	Columbian Walnut	SCH	Select Cherry
EF	Espresso	SPW	Sepia Walnut
FLW	Florence Walnut	SKC	Shaker Cherry
GC	Golden Cherry	SBP	Smoky Brown Pear
KHE	Kirsche	TK	Studio Teak
MW	Mahogany Walnut	SM	Sugar Maple
MNR	Midnight Run	WTA	Weathered Ash
NTM	Natural Marrone	WNB	White Nebbia
ORW	Oak Riftwood	WC	Williamsburg Cherry
PNW	Pinnacle Walnut		

SOLID

BL	Black	FHG	Fashion Grey
WH	Designer White	SG	Slate Grey

TABLE EDGE PROFILE



Vertical
Square

WOOD FINISHES AVAILABLE ON BASE/LEGS

Indiana Furniture uses a multi-step, hand finishing process on all exposed wood frames.

Tables feature a catalyzed varnish finish which offers durability, lasting beauty, and resistance to normal wear.

AW	Artisan Walnut	MAS	Mesa Sunset*
AS	Asian Night	MTS	Metropolis Sky
BW	Beigewood*	MNR	Midnight Run
BL	Black	NTM	Natural Marrone*
CO	Columbian Walnut	ORW	Oak Riftwood*
DC	Dark Cherry	PNW	Pinnacle Walnut
DFW	Dark Forest Walnut*	PTK	Portico Teak*
WH	Designer White	RC	River Cherry*
EF	Espresso	SCH	Select Cherry
FO	Fawn Oak*	SPW	Sepia Walnut*
FLW	Florence Walnut*	SKC	Shaker Cherry
GC	Golden Cherry	SBP	Smoky Brown Pear*
HW	Harvest Walnut	TK	Studio Teak
HNW	Henna Walnut	SM	Sugar Maple
KHE	Kirsche	WTA	Weathered Ash*
LW	Legacy Walnut	WNB	White Nebbia
MW	Mahogany Walnut	WC	Williamsburg Cherry

* Finish is Low Sheen

CERTIFICATIONS & COMPLIANCE

- Intertek Sustainability Certified
- BIFMA level® Certified
- BIFMA Compliant Certified
- TSCA Title VI (Formerly CARB) Compliance
- US Green Building's LEED Contribution

STATEMENT OF LINE

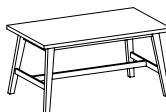

NAT-1: 30"H Table
([See Details](#))

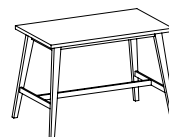

NAT-2: 42"H Table
([See Details](#))

Item	Model No.	W	D	H	Ship Wt	Cubic Ft	List Price
30"H MEETING TABLE	NAT-1	61½	35½	30½	106	43.7	\$ 2362

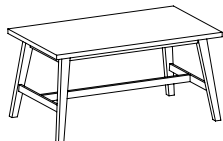

Description

- Features Square Edge Profile
- Available with Contrasting Top and Leg Color

Must Specify (in this order):

- Model #
- Top Color
- Leg Finish

42"H MEETING TABLE	NAT-2	63	39	43	115	64.0	\$ 2921
--------------------	-------	----	----	----	-----	------	---------

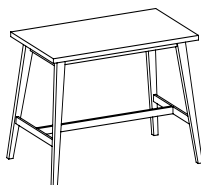

Description

- Features Square Edge Profile
- Available in Contrasting Top and Leg Color

Must Specify (in this order):

- Model #
- Top Color
- Leg Finish

[See Natta Overview For Ordering Options](#)

One10 Conference provides a scalable aesthetic with a versatile range of tables that provide solutions for casual to formal meetings that can support individual technology, the sharing of personal technology, or communal technology equipment. From conference tables, meeting tables, and TV stands, the collection provides flexibility for tailored applications, virtually anywhere.

CONSTRUCTION

VENEER

- Exposed surfaces feature select grade plain-sliced hardwood veneers in Cherry, Maple, American Black Walnut, or composite veneers. Veneers are carefully selected and matched to assure proper balance and consistency
- Veneer features either our UVAdvantage, an ultra-violet finish, or our Catalyzed finish (where noted)

LAMINATE

- High-Pressure Laminates (HPL) are made of woodgrain and solid color laminates fused to particleboard core; each laminate offers lasting beauty, superior resistance to normal wear, and easy maintenance

TOPS

- Tops with the Block Edge are 1½" thick while tops with the Knife Edge are 1¾" thick
- Veneer tops offer 3-ply balanced construction with 1.5mm wood edge-banded rims; Laminate tops offer 3-ply balanced construction with 1mm PVC edge-banded rims; Laminate colors Designer White, Sugar Maple, and Williamsburg Cherry feature ABS edge bands
- Credenza tops are ¾" thick, 3-ply balanced construction with 0.5mm wood edge-banded rims on Veneer options and 1mm PVC edge-banded rims on Laminate options
- Veneer accent tops are ¾" thick, 3-ply construction with 0.5mm wood edge-banded rims while Laminate accent tops are ¾" thick, 3-ply construction with 1mm PVC edge-banded rims; Laminate colors Designer White, Sugar Maple, and Williamsburg Cherry feature ABS edge bands
- Grain direction runs left-to-right, unless noted
- The Block Edge profile will be used with Block Bases only, while the Knife Edge profile will be used with Blade Bases only



Block Edge Profile

Knife Edge Profile

CHASSIS

- Chassis for storage units are securely fastened using high quality European fastening systems and heavy-duty 16-gauge joining brackets to assure maximum strength
- All units ship with heavy-duty, adjustable leveling glides to ensure proper leveling and compensation for uneven floors

DRAWERS

- All drawer fronts are ¾" thick, 3-ply construction with vertical grain direction
- Drawer sides, back, and front are woodgrain vinyl-wrapped ½" thick with ⅛" thick hardboard bottoms
- 5-sided drawer construction allows for easy removal of drawer fronts; All drawer fronts are standard with elegant vertically matched faces
- All drawers feature full extension, progressive action slides with precision steel ball bearings

DRAWERS

- Box and file drawers are tested for 100lb capacity
- All suspensions have a limited lifetime warranty

STORAGE

- All hinged doors are soft-close, unless otherwise noted
- One piece hinge and base plate combination
- Soft close hinges reduce stress placed on the cabinet when the door is closed and offers a quiet closure

HOW TO ORDER EXAMPLES

SMALL MEETING TABLES

Single Column Table

	QTY	MODEL NO.	DESCRIPTION	EXAMPLE
TOP	1	95-6060SQV	Finish/Color Power/Data Location	FO OC
BASE	1	95-3630BB	Finish/Color	FO
POWER	1	01-DUOBEZELS		

STANDARD MEETING TABLES

Rectangle Shaped with Center Inlay, Block Edge, and Block Bases

	QTY	MODEL NO.	DESCRIPTION	EXAMPLE
TOP	1	96-60192RTV5	Primary Finish/Color Accent Finish/Color	WTA FHG
BASES	2	96-2428BB	Primary Finish/Color Accent Finish/Color	WTA FHG
	1	96-2428MSL	Primary Finish/Color Accent Finish/Color	WTA FHG
POWER	10	01-DUOS		
	2	01-TRIOS		
	2	LCOMHDMI		

STORAGE & ACCESSORIES

Media Credenza

	QTY	MODEL NO.	DESCRIPTION	EXAMPLE
	1	95-1872OMC	Finish/Color	SBP

VENEER (W) OPTIONS ON TOPS, BASES, AND ACCENTS

Veneer features UVAdvantage, an ultra-violet finish, on all exposed surfaces or our Catalyzed finish (where noted), which is a multi-step, finish process that provides years of lasting beauty.

AW	Artisan Walnut	MW	Mahogany Walnut
AS	Asian Night	MAS	Mesa Sunset*
CO	Columbian Walnut	MTS	Metropolis Sky
DC	Dark Cherry	ORW	Oak Riftwood*
DFW	Dark Forest Walnut	PNW	Pinnacle Walnut
EW	Espresso	SCH	Select Cherry
FO	Fawn Oak*	SKC	Shaker Cherry
GC	Golden Cherry	SM	Sugar Maple
HW	Harvest Walnut	WTA	Weathered Ash*
HNW	Henna Walnut	WC	Williamsburg Cherry
LW	Legacy Walnut		

* Finish is Low Sheen

HPL (P) LAMINATE OPTIONS ON TOPS, BASES, AND ACCENTS AND TFL (T) FOR BASE ACCENTS

WOODGRAIN

AS	Asian Night	PTK	Portico Teak
BW	Beigewood	RC	River Cherry
CO	Columbian Walnut	SCH	Select Cherry
EF	Espresso	SPW	Sepia Walnut
FLW	Florence Walnut	SKC	Shaker Cherry^
GC	Golden Cherry^	SBP	Smoky Brown Pear
KHE	Kirsche	TK	Studio Teak
MW	Mahogany Walnut^	SM	Sugar Maple
MNR	Midnight Run	WTA	Weathered Ash
NTM	Natural Marrone	WNB	White Nebbia
ORW	Oak Riftwood	WC	Williamsburg Cherry
PNW	Pinnacle Walnut		

SOLID

BL	Black*	FHG	Fashion Grey*
WH	Designer White	SG	Slate Grey*

* Available as Laminate Accent Only.

^ Available on Accent Bases Only.

POWER/DATA UNITS & LOCATIONS

Square & Round Shaped Tops with Blade Bases

Models:

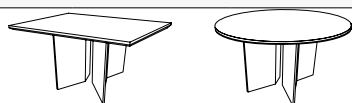

Modules Available (See Unit Details):

01-DUOBEZEL	Available in Black (B), Silver (S), or White (W)
01-TRIOBEZEL	Available in Black (B), Silver (S), or White (W)
01-PDUOBEZEL	Available in Black (B), Silver (S), or White (W)
01-PTRIOBEZEL	Available in Black (B), Silver (S), or White (W)

Note: Only one Power/Data Module Per Top.

Power/Data Location:

- All Power/Data Modules will be placed **On Center (OC)** of top.
- Designate "OC" when specifying the top model. Power/Data Module will need to be ordered separately.
- Power/Data Modules specified at the time of order will be routed for field installation.

Square & Rectangular Tops for Single and Dual Column Bases

Models:

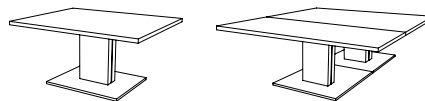

Modules Available (See Unit Details):

01-DUOBEZEL	Available in Black (B), Silver (S), or White (W)
01-TRIOBEZEL	Available in Black (B), Silver (S), or White (W)

Note: Only one Power/Data Module Per Top. Must Order Two (2) Power/Data Modules for Dual Column Tables.

Power/Data Location:

- All Power/Data Modules will be placed **On Center (OC)** of each top and installed directly over the base.
- Designate "OC" when specifying the top model. Power/Data Module will need to be ordered separately.
- Power/Data Modules specified at the time of order will be routed for field installation.

Rectangular 1 or 2 Piece Tops with Block or Blade Bases

Models:

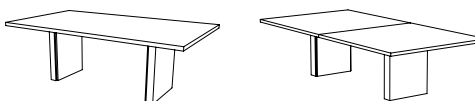

Modules Available (See Unit Details):

Available in Table Surface:

01-DUOBEZEL	Available in Black (B), Silver (S), or White (W)
01-TRIOBEZEL	Available in Black (B), Silver (S), or White (W)
01-PDUOBEZEL	Available in Black (B), Silver (S), or White (W)
01-PTRIOBEZEL	Available in Black (B), Silver (S), or White (W)

Available Under Table Surface:

01-DUO	Available in Black (B), Silver (S), or White (W)
01-TRIO	Available in Black (B), Silver (S), or White (W)
01-PDUO	Available in Black (B), Silver (S), or White (W)
01-PTRIO	Available in Black (B), Silver (S), or White (W)

Power/Data Location:

- Power/Data Modules specified at the time of order will be routed for field installation.
- Modules to be mounted under the table surface may be placed anywhere during field installation - No need to specify location when ordering top.

E1	29" Off One End
ELR	29" Off Each End
OC	On Center
OCELR	29" Off Each End and On Center

OCELR Not Available on Tables 96"W or Less

Rectangular and Boat Shaped Tops with Center Inlay

Modules Available (See Unit Details):

- 01-DUO Available in Black (B), Silver (S), or White (W)
- 01-TRIO Available in Black (B), Silver (S), or White (W)

Power/Data Location:

- All troughs, included as standard with the tops, have pre-drilled peck-hole locations from the bottom side of the trough for easy field installation. No need to specify location when ordering top.
- Desired Power/Data Modules will need to be ordered separately.
- Field install Power/Data Modules by selecting any or all of the desired pre-marked locations and drill the hole through.

Locations For: 48"x192" & 60"x192" Models with Center Inlay

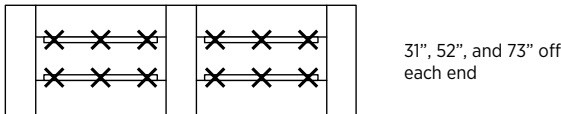

Locations For: 48"x168" & 60"x168" Models with Center Inlay

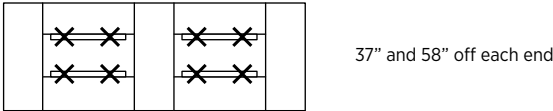

Locations For: 48"x144" & 60"x144" Models with Center Inlay

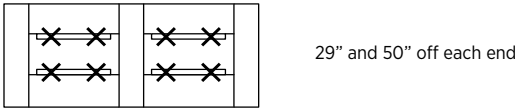

Locations For: 48"x120" & 60"x120" Models with Center Inlay

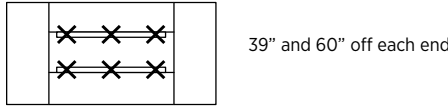

Locations For: 48"x108" & 60"x108" Models with Center Inlay

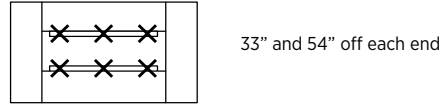

Locations For: 48"x96" & 60"x96" Models with Center Inlay

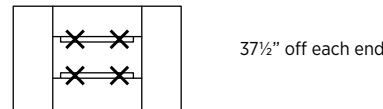

CERTIFICATIONS & SUSTAINABILITY

- Intertek Sustainability Certified
- BIFMA level® Certified
- BIFMA Compliant® Certified
- TSCA Title VI (formerly CARB) Compliance
- US Green Building's LEED® Contribution

Small Meeting Tables

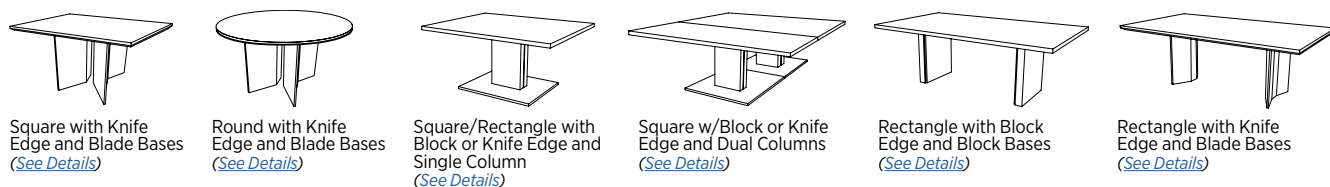

Standard Meeting Tables

Select from a variety of tops featuring solid, channels, or inlays in your choice of Block or Knife Edge

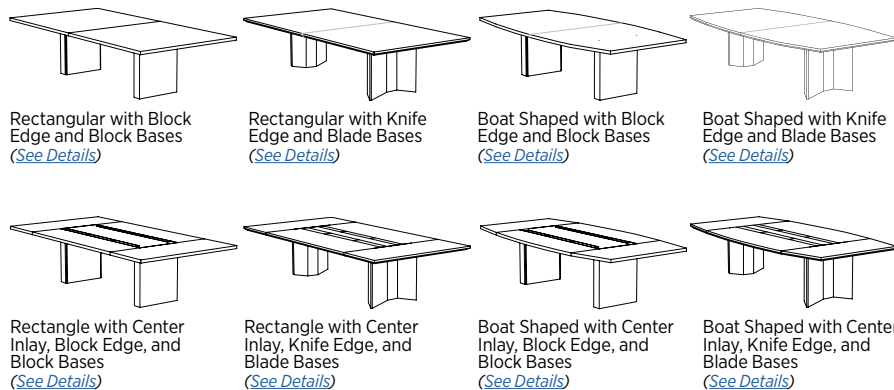
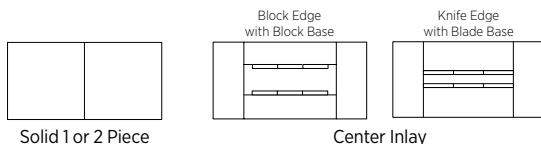

Wire Management & Power/Data Accessories [\(See Multiple Unit Details\)](#)

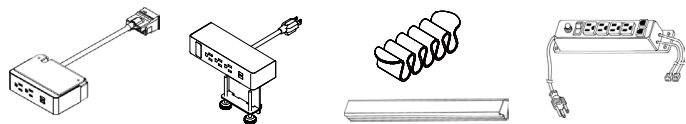

Storage & Accessories

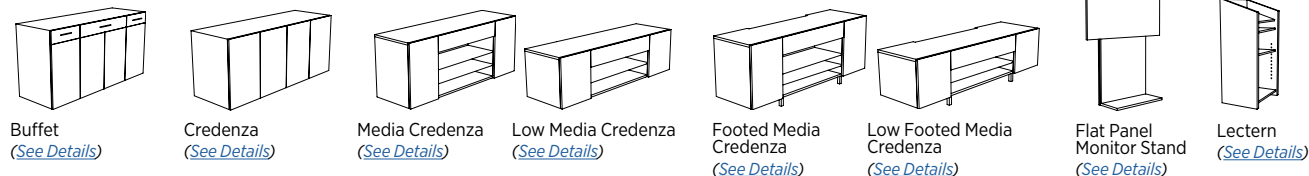

Item	Model No.		W	D	H	Ship Wt	Cubic Ft	List Price
SMALL MEETING TABLES	96-6060SQK	HPL	60	60	1¾	143	8.4	P\$ 2257
	95-6060SQK	Veneer						W\$ 3233
SQUARE TOP BLADE BASE SET KNIFE EDGE	96-5454SQK	HPL	54	54	1¾	114	6.8	P\$ 2069
	95-5454SQK	Veneer						W\$ 2964
	96-4848SQK	HPL	48	48	1¾	90	5.5	P\$ 1793
	95-4848SQK	Veneer						W\$ 2649



Must Specify (in this order):
 Model #
 Finish/Color
 Power/Data Location

Description

- Veneer Tops Feature UV Finish on 48"D and Catalyzed Finish on 54"D and 60"D
- Requires One (1) Blade Base Set; Sold Separately, See Below
- Outer Panel can be Specified in a Contrasting Finish/Color from Top Finish/Color
- Power and Data Options Available; Sold Separately, [See Multiple Power Unit Details](#); Unit Will Be Routed On Center. [See Location Details](#)

BLADE BASE SET

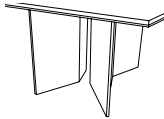

Must Specify (in this order):
 Model #
 Finish/Color

Blade Base Set with Stretchers - Requires One (1) Set								
96-2711BL	HPL		27	10½	28	45	1.9	P\$ 3902
95-2711BL	Veneer							W\$ 4908

SMALL MEETING TABLES	96-6060CTK	HPL	60	60	1¾	143	8.4	P\$ 2261
	95-6060CTK	Veneer						W\$ 3293
ROUND TOP BLADE BASE SET KNIFE EDGE	96-5454CTK	HPL	54	54	1¾	114	6.8	P\$ 2076
	95-5454CTK	Veneer						W\$ 3027
	96-4848CTK	HPL	48	48	1¾	90	5.5	P\$ 1807
	95-4848CTK	Veneer						W\$ 2702



Must Specify (in this order):
 Model #
 Finish/Color
 Power/Data Location

Description

- Veneer Tops Feature UV Finish on 48"D and Catalyzed Finish on 54"D and 60"D
- Requires One (1) Blade Base Set; Sold Separately, See Below
- Outer Panel can be Specified in a Contrasting Finish/Color from Top Finish/Color
- Power and Data Options Available; Sold Separately, [See Multiple Power Unit Details](#); Unit Will Be Routed On Center. [See Location Details](#)

BLADE BASE SET

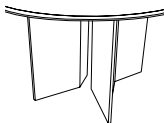

Must Specify (in this order):
 Model #
 Finish/Color

Blade Base Set with Stretchers								
96-2711BL	HPL		27	10½	28	45	1.9	P\$ 3902
95-2711BL	Veneer							W\$ 4908

P = HPL W = Veneer

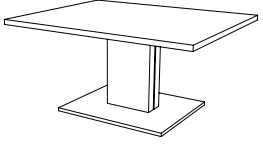
Item	Model No.		W	D	H	Ship Wt	Cubic Ft	List Price
SMALL MEETING TABLES								
SQUARE/RECTANGULAR 1 PIECE TOP SEATING OR STANDING HEIGHT SINGLE COLUMN BASE BLOCK OR KNIFE EDGE 	Block Edge							
	<i>Square Tops</i>							
	96-6060SQV	HPL	60	60	1½	143	8.4	P\$ 1936
	95-6060SQV	Veneer						W\$ 2578
	96-5454SQV	HPL	54	54	1½	114	6.8	P\$ 1777
	95-5454SQV	Veneer						W\$ 2300
	96-4848SQV	HPL	48	48	1½	90	5.5	P\$ 1543
	95-4848SQV	Veneer						W\$ 1920
	<i>Rectangular Tops</i>							
	96-4896RTVBB	HPL	48	96	1½	205	17.7	P\$ 1952
	95-4896RTVBB	Veneer						W\$ 2678
	96-4884RTV	HPL	48	84	1½	158	9.3	P\$ 1894
	95-4884RTV	Veneer						W\$ 2407
	96-4872RTV	HPL	48	72	1½	135	8.1	P\$ 1806
	95-4872RTV	Veneer						W\$ 2145
	96-4860RTV	HPL	48	60	1½	112	6.8	P\$ 1719
	95-4860RTV	Veneer						W\$ 1916
	Knife Edge							
	<i>Square Tops</i>							
	96-6060SQK	HPL	60	60	1⅜	143	8.4	P\$ 2257
	95-6060SQK	Veneer						W\$ 3233
	96-5454SQK	HPL	54	54	1⅜	114	6.8	P\$ 2069
	95-5454SQK	Veneer						W\$ 2964
	96-4848SQK	HPL	48	48	1⅜	90	5.5	P\$ 1793
95-4848SQK	Veneer						W\$ 2649	
<i>Rectangular Tops</i>								
96-4896RTKBB	HPL	48	96	1⅜	180	11.4	P\$ 2308	
95-4896RTKBB	Veneer						W\$ 3170	
96-4884RTKBB	HPL	48	84	1⅜	158	10.0	P\$ 2238	
95-4884RTKBB	Veneer						W\$ 2814	
96-4872RTKBB	HPL	48	72	1⅜	135	8.1	P\$ 2133	
95-4872RTKBB	Veneer						W\$ 2508	
96-4860RTKBB	HPL	48	60	1⅜	112	6.8	P\$ 2039	
95-4860RTKBB	Veneer						W\$ 2254	

Must Specify (in this order):

- Model #
- Finish/Color
- Power/Data Location

Description

- All Models Feature a 1-piece, 1⅜" Thick Top
- Veneer Tops Feature UV Finish on 48"D and Catalyzed Finish on 54"D and 60"D
- Metal Frame Column Bases For Seated Height or Standing Height Tables; Sold Separately, See Below
- Power and Data Options Available; Sold Separately, [See Multiple Power Unit Details](#); Unit Will Be Routed On Center. [See Location Details](#)

METAL FRAME COLUMN BASES

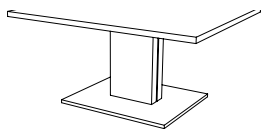

Must Specify (in this order):

- Model #
- Finish/Color

Bases for Tables ≤72"D								
96-3630TBB	42" Standing Height	36	30	40	178	30.4	P\$ 2906	
95-3630TBB							W\$ 3407	
96-3630BB	30" Seated Height	36	30	28	168	26.2	P\$ 2751	
95-3630BB							W\$ 3031	
Bases for Tables ≥84"D								
96-6030TBB	42" Standing Height	60	30	40	257	49.5	P\$ 3776	
95-6030TBB							W\$ 4234	
96-6030BB	30" Seated Height	60	30	28	211	35.7	P\$ 3646	
95-6030BB							W\$ 3923	

Description

- Aluminum Base Platform and Aluminum Detail Continues Up the Column for Design Appeal
- Column Accommodates Wire Management with Removable Panel for Power and Data
- Adjustable Levelers

P = HPL W = Veneer

[See One10 Overview For Ordering Options](#)

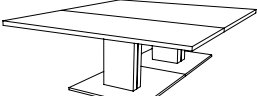
Item	Model No.		W	D	H	Ship Wt	Cubic Ft	List Price	
SMALL MEETING TABLES									
Block Edge - 2 Piece Top									
SQUARE SHAPED 2 PIECE TOP SEATING OR STANDING HEIGHT DUAL COLUMN BASE BLOCK OR KNIFE EDGE 	96-9696SQV	HPL	96	96	1½	379	21.2	P\$ 4716	
	95-9696SQV	Veneer						W\$ 4895	
	96-8484SQV	HPL	84	84	1½	294	21.2	P\$ 4342	
	95-8484SQV	Veneer						W\$ 4506	
	Knife Edge - 2 Piece Top								
	96-9696SQK	HPL	96	96	1⅝	287	21.2	P\$ 4895	
	95-9696SQK	Veneer						W\$ 6465	
	96-8484SQK	HPL	84	84	1⅝	224	21.2	P\$ 4506	
95-8484SQK	Veneer						W\$ 5913		

Must Specify (in this order):
 Model #
 Finish/Color
 Power/Data Location

Description

- All Models Feature a 2-piece, 1½" Thick Top
- Veneer Tops Feature Catalyzed Finish
- Requires Two (2) Metal Frame Column Bases For Seated Height or Standing Height Tables; Sold Separately, See Below
- Power and Data Options Available; Sold Separately, [See Multiple Power Unit Details](#); If Ordering, Must Order Two (2) as Units Will Be Routed On Center of Each Top, Directly Above the Bases. [See Location Details](#)

METAL FRAME COLUMN BASES

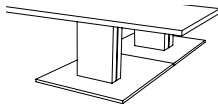

Two (2) Bases Required								
96-6030TBB	42" Standing Height		60	30	40	257	49.5	P\$ 3776
95-6030TBB								W\$ 4234
96-6030BB	30" Seated Height		60	30	28	211	35.7	P\$ 3646
95-6030BB								W\$ 3923

Description

- Two (2) Bases Required
- Aluminum Base Platform and Aluminum Detail Continues Up the Column for Design Appeal
- Column Accommodates Wire Management with Removable Panel for Power and Data
- Adjustable Levelers

Must Specify (in this order):
 Model #
 Finish/Color

P = HPL W = Veneer

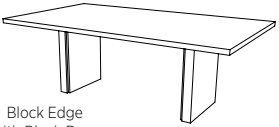
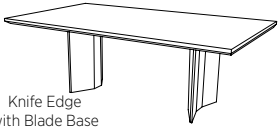
Item	Model No.		W	D	H	Ship Wt	Cubic Ft	List Price
SMALL MEETING TABLES								
<p>RECTANGULAR SHAPE 1 PIECE TOP BLOCK EDGE W/BLOCK BASE OR KNIFE EDGE W/BLADE BASE</p>  <p>Block Edge with Block Base</p>  <p>Knife Edge with Blade Base</p>	Block Edge (Use with Block Base Only)							
	<i>48"W Tops</i>							
	96-4884RTV	HPL	48	84	1½	158	9.3	P\$ 1894
	95-4884RTV	Veneer						W\$ 2407
	96-4872RTV	HPL	48	72	1½	135	8.1	P\$ 1806
	95-4872RTV	Veneer						W\$ 2145
	<i>42"W Tops</i>							
	96-4296RTV	HPL	42	96	1½	158	9.1	P\$ 1806
	95-4296RTV	Veneer						W\$ 2517
	96-4284RTV	HPL	42	84	1½	138	8.1	P\$ 1730
	95-4284RTV	Veneer						W\$ 2376
	96-4272RTV	HPL	42	72	1½	119	7.1	P\$ 1651
	95-4272RTV	Veneer						W\$ 1935
	<i>36"W Tops</i>							
	96-3696RTV	HPL	36	96	1½	135	8.1	P\$ 1735
	95-3696RTV	Veneer						W\$ 2313
	96-3684RTV	HPL	36	84	1½	119	7.1	P\$ 1668
	95-3684RTV	Veneer						W\$ 2021
	96-3672RTV	HPL	36	72	1½	102	6.2	P\$ 1626
	95-3672RTV	Veneer						W\$ 1834
Knife Edge (Use with Blade Base Only)								
<i>48"W Tops</i>								
96-4884RTK	HPL	48	84	1¾	158	9.3	P\$ 4126	
95-4884RTK	Veneer						W\$ 5365	
96-4872RTK	HPL	48	72	1¾	135	8.1	P\$ 3910	
95-4872RTK	Veneer						W\$ 4788	
<i>42"W Tops</i>								
96-4296RTK	HPL	42	96	1¾	158	9.1	P\$ 4387	
95-4296RTK	Veneer						W\$ 5590	
96-4284RTK	HPL	42	84	1¾	138	8.1	P\$ 3955	
95-4284RTK	Veneer						W\$ 5102	
96-4272RTK	HPL	42	72	1¾	119	7.1	P\$ 3744	
95-4272RTK	Veneer						W\$ 4743	
<i>36"W Tops</i>								
96-3696RTK	HPL	36	96	1¾	135	8.1	P\$ 4241	
95-3696RTK	Veneer						W\$ 5490	
96-3684RTK	HPL	36	84	1¾	119	7.1	P\$ 3855	
95-3684RTK	Veneer						W\$ 4922	
96-3672RTK	HPL	36	72	1¾	102	6.2	P\$ 3662	
95-3672RTK	Veneer						W\$ 4629	

Must Specify (in this order):

- Model #
- Finish/Color
- Power/Data Location

Continued on next page.

P = HPL W = Veneer

[See One10 Overview For Ordering Options](#)

Item	Model No.	W	D	H	Ship Wt	Cubic Ft	List Price
------	-----------	---	---	---	---------	----------	------------

Continued from
Previous Page

What You Get:

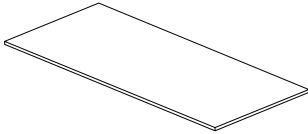

Top

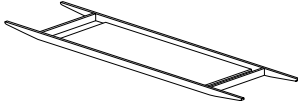

Trough
(on Knife Edge with Blade Bases Only)

Description

- 1½" Thick Rectangular Top with Block Edge or 1¾" Thick Rectangular Top with Knife Edge
- All Models Feature a 1 Piece Top
- Veneer Tops Feature Catalyzed Finish
- Requires Two (2) Block Bases (Block Edge Only) or Blade Bases (Knife Edge Only); Sold Separately, See Below
- Block Bases Require Stretcher Rails; Sold Separately, See Below
- Blade Bases come with Trough to Reinforce and Support Top
- Power and Data Options Available; Sold Separately, [See Multiple Power Unit Details](#); [See Location Options](#)
- Assembly Required

Top Grain Direction

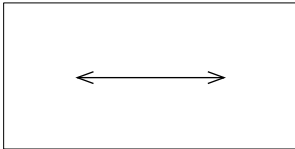

BASES & STRETCHERS

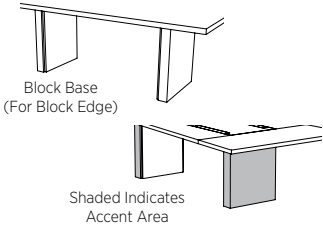

Block Base
(For Block Edge)

Shaded Indicates
Accent Area

Must Specify (in this order):

- Standard Base Model #
- Stretchers (If needed)
- Primary Finish/Color
- Accent Material
- Accent Finish/Color

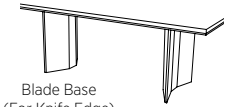

Blade Base
(For Knife Edge)

Must Specify (in this order):

- Standard Base Model #
- Stretchers (If needed)
- Primary Finish/Color

Block Bases; Must Order - Two (2) Required								
96-2228BB	HPL	22	5¼	28	45	1.9	P\$	1435
95-2228BB	Veneer						W\$	1970
95-2228BB	Veneer/TFL						C\$	2234
Stretcher Sets For Block Bases; Must Order - One (1) Set Required								
<i>For 96"D Tables</i>								
96-0496STR	HPL	54¾	¾	4⅝	9.2	0.5	P\$	696
95-0496STR	Veneer						W\$	836
<i>For 84"D Tables</i>								
96-0484STR	HPL	42¾	¾	4⅝	7.2	0.4	P\$	620
95-0484STR	Veneer						W\$	742
<i>For 72"D Tables</i>								
96-0472STR	HPL	30¾	¾	4⅝	5.2	0.3	P\$	577
95-0472STR	Veneer						W\$	674
Blade Bases; Must Order - Two (2) Required								
96-2828BD	HPL	28	10½	28	52	2.4	P\$	1246
95-2828BD	Veneer						W\$	1716

Description

- All Tables with a Block Edge Require Two (2) Block Bases and One (1) Set of Stretchers; All Tables with a Knife Edge Require Two (2) Blade Bases
- Bases are Constructed with Removable Interior Panel for Wire Management Installation
- Outer Panel can be Specified in a Contrasting Finish/Color from Top Finish/Color
- Adjustable Glides Included

P = HPL W = Veneer C = Combination of Wood/TFL Accent

[See One10 Overview For Ordering Options](#)

Item	Model No.		W	D	H	Ship Wt	Cubic Ft	List Price	
STANDARD TABLES		60"D Tops							
		<i>192"W: 2 Piece Top</i>							
RECTANGULAR SHAPE 1 OR 2 PIECE TOP BLOCK EDGE BLOCK BASE	96-60192RTV	HPL	192	60	1½	482	28.2	P\$ 8957	
	95-60192RTV	Veneer						W\$ 9711	
	<i>168"W: 2 Piece Top</i>								
	96-60168RTV	HPL	168	60	1½	449	24.8	P\$ 8336	
	95-60168RTV	Veneer						W\$ 8991	
	<i>144"W: 2 Piece Top</i>								
	96-60144RTV	HPL	144	60	1½	388	21.4	P\$ 6976	
	95-60144RTV	Veneer						W\$ 8383	
	<i>120"W: 2 Piece Top</i>								
	96-60120RTV	HPL	120	60	1½	332	18.0	P\$ 5877	
95-60120RTV	Veneer						W\$ 6923		
<i>108"W: 1 Piece Top</i>									
96-60108RTV	HPL	108	60	1½	301	16.3	P\$ 5140		
95-60108RTV	Veneer						W\$ 6837		
<i>96"W: 1 Piece Top</i>									
96-6096RTV	HPL	96	60	1½	262	14.6	P\$ 4762		
95-6096RTV	Veneer						W\$ 5690		
		48"D Tops							
		<i>192"W: 2 Piece Top</i>							
<p>Must Specify (in this order):</p> <ul style="list-style-type: none"> Model # Finish/Color Power/Data Location <p>Rectangular 1 or 2-Piece Top available with a Knife Edge and coordinating Blade Base.</p> <p>See Details.</p>	96-48192RTV	HPL	192	48	1½	426	22.7	P\$ 7551	
	95-48192RTV	Veneer						W\$ 8771	
	<i>168"W: 2 Piece Top</i>								
	96-48168RTV	HPL	168	48	1½	368	19.9	P\$ 7176	
	95-48168RTV	Veneer						W\$ 8234	
	<i>144"W: 2 Piece Top</i>								
	96-48144RTV	HPL	144	48	1½	318	17.1	P\$ 5902	
	95-48144RTV	Veneer						W\$ 7625	
	<i>120"W: 2 Piece Top</i>								
	96-48120RTV	HPL	120	48	1½	269	14.3	P\$ 5088	
95-48120RTV	Veneer						W\$ 5985		
<i>108"W: 1 Piece Top</i>									
96-48108RTV	HPL	108	48	1½	234	12.9	P\$ 4743		
95-48108RTV	Veneer						W\$ 5721		
<i>96"W: 1 Piece Top</i>									
96-4896RTV	HPL	96	48	1½	205	11.5	P\$ 3719		
95-4896RTV	Veneer						W\$ 4951		

Continued on next page.

P = HPL W = Veneer

[See One10 Overview For Ordering Options](#)

Item	Model No.	W	D	H	Ship Wt	Cubic Ft	List Price
------	-----------	---	---	---	---------	----------	------------

Continued from
Previous Page

What You Get:

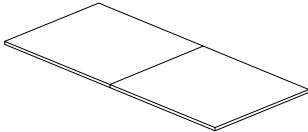

Top

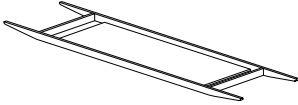

Trough

Description

- 1½” Thick Rectangular Top with Block Edge
- Veneer Tops Feature UV Finish on 48”D and Catalyzed Finish on 60”D
- Trough Reinforces and Supports Top
- Requires Two (2) Block Bases; Tables 144”W or Larger Also Require Middle Block Base; Sold Separately, See Below
- Power and Data Options Available; Sold Separately, [See Multiple Power Unit Details](#); [See Location Options](#)
- Assembly Required

Top Grain Direction

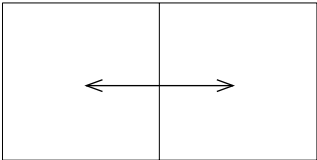

BLOCK BASES

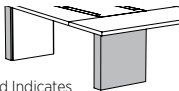
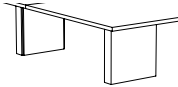

Shaded Indicates
Accent Area

Block Base Options; Must Order							
<i>Standard Block Base - Two (2) Required</i>							
96-2428BB	HPL	24	6	28	52	2.4	P\$ 1527
95-2428BB	Veneer						W\$ 2097
95-2428BB	Veneer/TFL						C\$ 2348
<i>Middle Block Base - Required for Tops 144”W or Larger</i>							
96-2428MSL	HPL	24	7½	28	72	2.8	P\$ 1865
95-2428MSL	Veneer						W\$ 2426
95-2428MSL	Veneer/TFL						C\$ 2762



Description

- All Tops Require Two (2) Block Bases; Tables 144”W or Larger Also Require Middle Block Base
- Bases are Constructed with Removable Interior Panel for Wire Management Installation
- Outer Panel can be Specified in a Contrasting Finish/Color from Top Finish/Color
- Adjustable Glides Included

Must Specify (in this order):

- Standard Base Model #
- Primary Finish/Color
- Accent Material
- Accent Finish/Color
- Middle Base Model # (If needed)
- Middle Base Primary Finish/Color
- Middle Base Accent Material
- Middle Base Accent Finish/Color

P = HPL W = Veneer C = Combination of Wood/TFL Accent

Item	Model No.		W	D	H	Ship Wt	Cubic Ft	List Price	
STANDARD TABLES		60"D Tops							
		<i>192"W: 2 Piece Top</i>							
RECTANGULAR SHAPE 1 OR 2 PIECE TOP KNIFE EDGE BLADE BASE	96-60192RTK	HPL	192	60	1 3/16	482	28.2	P\$ 10035	
	95-60192RTK	Veneer						W\$ 10876	
		<i>168"W: 2 Piece Top</i>							
	96-60168RTK	HPL	168	60	1 3/16	449	24.8	P\$ 9334	
	95-60168RTK	Veneer						W\$ 10070	
		<i>144"W: 2 Piece Top</i>							
	96-60144RTK	HPL	144	60	1 3/16	388	21.4	P\$ 7814	
	95-60144RTK	Veneer						W\$ 9392	
		<i>120"W: 2 Piece Top</i>							
	96-60120RTK	HPL	120	60	1 3/16	332	18.0	P\$ 6584	
	95-60120RTK	Veneer						W\$ 7753	
		<i>108"W: 1 Piece Top</i>							
	96-60108RTK	HPL	108	60	1 3/16	301	16.3	P\$ 5758	
	95-60108RTK	Veneer						W\$ 7662	
		<i>96"W: 1 Piece Top</i>							
Must Specify (in this order): Model # Finish/Color Power/Data Location	96-6096RTK	HPL	96	60	1 3/16	262	14.6	P\$ 5334	
	95-6096RTK	Veneer						W\$ 6372	
		48"D Tops							
		<i>192"W: 2 Piece Top</i>							
	96-48192RTK	HPL	192	48	1 3/16	426	22.7	P\$ 8455	
	95-48192RTK	Veneer						W\$ 9825	
		<i>168"W: 2 Piece Top</i>							
Rectangular 1 or 2-Piece Top available with a Block Edge and coordinating Block Base.	96-48168RTK	HPL	168	48	1 3/16	368	19.9	P\$ 8037	
	95-48168RTK	Veneer						W\$ 9223	
		<i>144"W: 2 Piece Top</i>							
See Details.	96-48144RTK	HPL	144	48	1 3/16	318	17.1	P\$ 6611	
	95-48144RTK	Veneer						W\$ 8538	
		<i>120"W: 2 Piece Top</i>							
	96-48120RTK	HPL	120	48	1 3/16	269	14.3	P\$ 5701	
	95-48120RTK	Veneer						W\$ 6704	
		<i>108"W: 1 Piece Top</i>							
	96-48108RTK	HPL	108	48	1 3/16	234	12.9	P\$ 5312	
	95-48108RTK	Veneer						W\$ 6408	
		<i>96"W: 1 Piece Top</i>							
	96-4896RTK	HPL	96	48	1 3/16	205	11.5	P\$ 4165	
	95-4896RTK	Veneer						W\$ 5549	

Continued on next page.

P = HPL W = Veneer

[See One10 Overview For Ordering Options](#)

Item	Model No.	W	D	H	Ship Wt	Cubic Ft	List Price
------	-----------	---	---	---	---------	----------	------------

Continued from
Previous Page

What You Get:

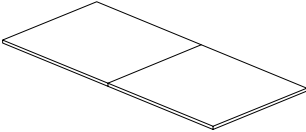

Top

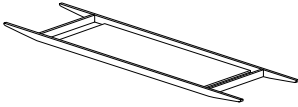

Trough

Description

- 1 $\frac{3}{16}$ " Rectangular Top with Knife Edge
- Veneer Tops Feature UV Finish on 48"D and Catalyzed Finish on 60"D
- Trough Reinforces and Supports Top
- Requires Two (2) Blade Bases; Tables 144"W or Larger Also Require Middle Blade Base; Sold Separately, See Below
- Power and Data Options Available; Sold Separately, [See Multiple Power Unit Details](#); [See Location Options](#)
- Assembly Required

Top Grain Direction

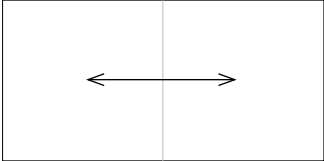

BLADE BASES

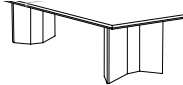

Blade Base Options; Must Order							
<i>Standard Blade Base - Two (2) Required</i>							
96-2828BD	HPL	28	10 $\frac{1}{2}$	28	52	2.4	P\$ 1246
95-2828BD	Veneer						W\$ 1716
<i>Middle Blade Base - Required for Tops 144"W or Larger</i>							
96-2818MBD	Aluminum	18	3 $\frac{3}{8}$	28	72	2.8	\$ 1650
95-2818MBD	Aluminum						\$ 1650

Description

- All Tops Require Two (2) Blade Bases; Tables 144"W or Larger Also Require Middle Blade Base
- Bases are Constructed with Removable Interior Aluminum Panel for Wire Management Installation
- Aluminum Middle Blade Base Features Two (2) Aluminum Doors for Wire Management
- Outer Panel of Standard Blade Base can be Specified in a Contrasting Finish/Color from Top Finish/Color
- Adjustable Glides Included

Must Specify (in this order):

- Standard Base Model #
- Primary Finish/Color
- Middle Base Model # (If needed)

P = HPL W = Veneer

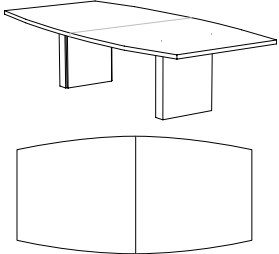
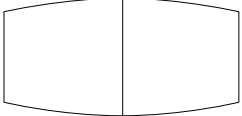
Item	Model No.		W	D	H	Ship Wt	Cubic Ft	List Price
STANDARD TABLES								
60"D Tops								
<i>192"W: 2 Piece Top</i>								
BOAT SHAPED 1 OR 2 PIECE TOP BLOCK EDGE BLOCK BASE	96-60192BTV	HPL	192	60 - 48	1½	482	28.2	P\$ 9407
	95-60192BTV	Veneer						W\$ 10487
<i>168"W: 2 Piece Top</i>								
	96-60168BTV	HPL	168	60 - 48	1½	449	24.8	P\$ 8753
	95-60168BTV	Veneer						W\$ 9711
<i>144"W: 2 Piece Top</i>								
	96-60144BTV	HPL	144	60 - 48	1½	388	21.4	P\$ 7327
	95-60144BTV	Veneer						W\$ 9055
<i>120"W: 2 Piece Top</i>								
	96-60120BTV	HPL	120	60 - 48	1½	332	18.0	P\$ 6169
	95-60120BTV	Veneer						W\$ 7266
<i>108"W: 1 Piece Top</i>								
	96-60108BTV	HPL	108	60 - 48	1½	301	16.3	P\$ 5397
	95-60108BTV	Veneer						W\$ 7181
<i>96"W: 1 Piece Top</i>								
<u>Must Specify (in this order):</u> Model # Finish/Color Power/Data Location	96-6096BTV	HPL	96	60 - 48	1½	262	14.6	P\$ 4999
	95-6096BTV	Veneer						W\$ 5974
48"D Tops								
<i>192"W: 2 Piece Top</i>								
	96-48192BTV	HPL	192	48 - 36	1½	426	22.7	P\$ 7930
	95-48192BTV	Veneer						W\$ 9209
<i>168"W: 2 Piece Top</i>								
	96-48168BTV	HPL	168	48 - 36	1½	368	19.9	P\$ 7532
	95-48168BTV	Veneer						W\$ 8649
<i>144"W: 2 Piece Top</i>								
Boat-Shaped 1 or 2-Piece Top available with a Knife Edge and coordinating Blade Base.	96-48144BTV	HPL	144	48 - 36	1½	318	17.1	P\$ 6199
	95-48144BTV	Veneer						W\$ 8007
<i>120"W: 2 Piece Top</i>								
	96-48120BTV	HPL	120	48 - 36	1½	269	14.3	P\$ 5343
	95-48120BTV	Veneer						W\$ 6286
<i>108"W: 1 Piece Top</i>								
	96-48108BTV	HPL	108	48 - 36	1½	234	12.9	P\$ 4982
	95-48108BTV	Veneer						W\$ 6007
<i>96"W: 1 Piece Top</i>								
See Details.	96-4896BTV	HPL	96	48 - 36	1½	205	11.5	P\$ 3905
	95-4896BTV	Veneer						W\$ 5200

Continued on next page.

P = HPL W = Veneer

[See One10 Overview For Ordering Options](#)

Item	Model No.	W	D	H	Ship Wt	Cubic Ft	List Price
------	-----------	---	---	---	---------	----------	------------

Continued from Previous Page

What You Get:

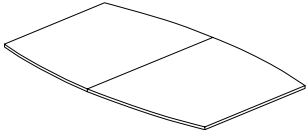

Top

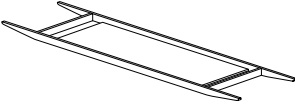

Trough

Description

- 1½" Thick Boat-Shaped Top with Block Edge
- Veneer Tops Feature UV Finish on 48"D and Catalyzed Finish on 60"D
- Trough Reinforces and Supports Top
- Requires Two (2) Block Bases; Tables 144"W or Larger Also Require Middle Block Base; Sold Separately, See Below
- Power and Data Options Available; Sold Separately, [See Multiple Power Unit Details](#); [See Location Options](#)
- Assembly Required

Top Grain Direction

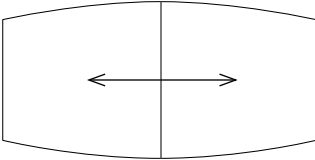

BLOCK BASES

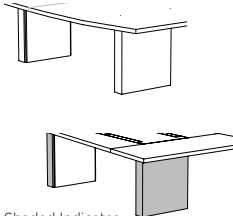

Shaded Indicates Accent Area

Block Base Options; Must Order							
Standard Block Base - Two (2) Required							
96-2428BB	HPL	24	6	28	52	2.4	P\$ 1527
95-2428BB	Veneer						W\$ 2097
95-2428BB	Veneer/TFL						C\$ 2348
Middle Block Base - Required for Tops 144"W or Larger							
96-2428MSL	HPL	24	7½	28	72	2.8	P\$ 1865
95-2428MSL	Veneer						W\$ 2426
95-2428MSL	Veneer/TFL						C\$ 2762

Description

- All Tops Require Two (2) Block Bases; Tables 144"W or Larger Also Require Middle Block Base
- Bases are Constructed with Removable Interior Panel for Wire Management Installation
- Outer Panel of can be Specified in a Contrasting Finish/Color from Top Finish/Color
- Adjustable Glides Included

Must Specify (in this order):

- Standard Base Model #
- Primary Finish/Color
- Accent Material
- Accent Finish/Color
- Middle Base Model # (If needed)
- Middle Base Primary Finish/Color
- Middle Base Accent Material
- Middle Base Accent Finish/Color

P = HPL W = Veneer C = Combination of Wood/TFL Accent

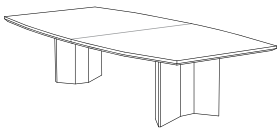
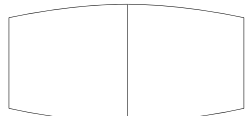
Item	Model No.		W	D	H	Ship Wt	Cubic Ft	List Price	
STANDARD TABLES		60"D Tops							
		<i>192"W: 2 Piece Top</i>							
BOAT SHAPED 1 OR 2 PIECE TOP KNIFE EDGE BLADE BASE	96-60192BTK	HPL	192	60 - 48	1¾	482	28.2	P\$ 10535	
	95-60192BTK	Veneer						W\$ 11420	
		<i>168"W: 2 Piece Top</i>							
	96-60168BTK	HPL	168	60 - 48	1¾	449	24.8	P\$ 9801	
	95-60168BTK	Veneer						W\$ 10573	
		<i>144"W: 2 Piece Top</i>							
	96-60144BTK	HPL	144	60 - 48	1¾	388	21.4	P\$ 8204	
	95-60144BTK	Veneer						W\$ 9859	
		<i>120"W: 2 Piece Top</i>							
	96-60120BTK	HPL	120	60 - 48	1¾	332	18.0	P\$ 6911	
	95-60120BTK	Veneer						W\$ 8140	
		<i>108"W: 1 Piece Top</i>							
	96-60108BTK	HPL	108	60 - 48	1¾	301	16.3	P\$ 6046	
	95-60108BTK	Veneer						W\$ 8042	
		<i>96"W: 1 Piece Top</i>							
	96-6096BTK	HPL	96	60 - 48	1¾	262	14.6	P\$ 5601	
	95-6096BTK	Veneer						W\$ 6688	
		48"D Tops							
		<i>192"W: 2 Piece Top</i>							
	96-48192BTK	HPL	192	48 - 36	1¾	426	22.7	P\$ 8880	
	95-48192BTK	Veneer						W\$ 10318	
		<i>168"W: 2 Piece Top</i>							
	96-48168BTK	HPL	168	48 - 36	1¾	368	19.9	P\$ 8437	
	95-48168BTK	Veneer						W\$ 9683	
		<i>144"W: 2 Piece Top</i>							
Boat-Shaped 1 or 2-Piece Top available with a Block Edge and coordinating Block Base.	96-48144BTK	HPL	144	48 - 36	1¾	318	17.1	P\$ 6938	
	95-48144BTK	Veneer						W\$ 8968	
		<i>120"W: 2 Piece Top</i>							
	96-48120BTK	HPL	120	48 - 36	1¾	269	14.3	P\$ 5985	
	95-48120BTK	Veneer						W\$ 7038	
		<i>108"W: 1 Piece Top</i>							
	96-48108BTK	HPL	108	48 - 36	1¾	234	12.9	P\$ 5580	
	95-48108BTK	Veneer						W\$ 6730	
		<i>96"W: 1 Piece Top</i>							
	96-4896BTK	HPL	96	48 - 36	1¾	205	11.5	P\$ 4374	
	95-4896BTK	Veneer						W\$ 5829	

Must Specify (in this order):

- Model #
- Finish/Color
- Power/Data Location

[See Details.](#)

Continued on next page.

P = HPL W = Veneer

[See One10 Overview For Ordering Options](#)

Item	Model No.	W	D	H	Ship Wt	Cubic Ft	List Price
------	-----------	---	---	---	---------	----------	------------

Continued from Previous Page

What You Get:

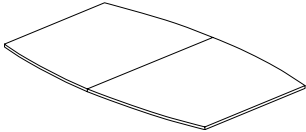

Top

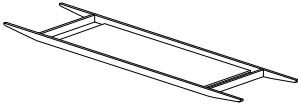

Trough

Description

- 1³/₁₆" Rectangular Top with Knife Edge
- Veneer Tops Feature UV Finish on 48"D and Catalyzed Finish on 60"D
- Trough Reinforces and Supports Top
- Requires Two (2) Blade Bases; Tables 144"W or Larger Also Require Middle Blade Base; Sold Separately, See Below
- Power and Data Options Available; Sold Separately, [See Multiple Power Unit Details](#); [See Location Options](#)
- Assembly Required

Top Grain Direction

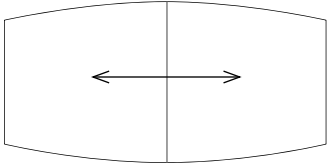

BLADE BASES

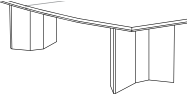

Blade Base Options; Must Order							
<i>Standard Blade Base - Two (2) Required</i>							
96-2828BD	HPL	28	10½	28	52	2.4	P\$ 1246
95-2828BD	Veneer						W\$ 1716
<i>Middle Blade Base - Required for Tops 144"W or Larger</i>							
96-2818MBD	Aluminum	18	3 ³ / ₈	28	72	2.8	\$ 1650
95-2818MBD	Aluminum						\$ 1650

Must Specify (in this order):
 Standard Base Model #
 Primary Finish/Color
 Middle Base Model # (If needed)

Description

- All Tops Require Two (2) Blade Bases; Tables 144"W or Larger Also Require Middle Blade Base
- Bases are Constructed with Removable Interior Aluminum Panel for Wire Management Installation
- Aluminum Middle Blade Base Features Two (2) Aluminum Doors for Wire Management
- Outer Panel of Standard Blade Base can be Specified in a Contrasting Finish/Color from Top Finish/Color
- Adjustable Glides Included

P = HPL W = Veneer

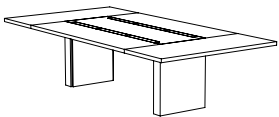
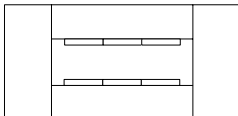
Item	Model No.		W	D	H	Ship Wt	Cubic Ft	List Price	
STANDARD TABLES		60"D Tops							
		<i>192"W: 9 Piece Top - 12 Accent Doors</i>							
RECTANGULAR TOP CENTER INLAY BLOCK EDGE BLOCK BASE	96-60192RTV5	HPL	192	60	1½	435	25.3	P\$ 15740	
	95-60192RTV5	Veneer						W\$ 18603	
	95-60192RTV5	Veneer/HPL						C\$ 18875	
		<i>168"W: 9 Piece Top - 8 Accent Doors</i>							
	96-60168RTV5	HPL	168	60	1½	407	24.9	P\$ 14248	
	95-60168RTV5	Veneer						W\$ 16537	
	95-60168RTV5	Veneer/HPL						C\$ 16969	
		<i>144"W: 9 Piece Top - 8 Accent Doors</i>							
	96-60144RTV5	HPL	144	60	1½	379	24.4	P\$ 13679	
	95-60144RTV5	Veneer						W\$ 15700	
	95-60144RTV5	Veneer/HPL						C\$ 16101	
		<i>120"W: 5 Piece Top - 6 Accent Doors</i>							
	96-60120RTV5	HPL	120	60	1½	339	24.0	P\$ 8915	
	95-60120RTV5	Veneer						W\$ 10553	
	95-60120RTV5	Veneer/HPL						C\$ 10687	
		<i>108"W: 5 Piece Top - 6 Accent Doors</i>							
<u>Must Specify (in this order):</u> Model # Primary Finish/Color Accent Material Accent Finish/Color	96-60108RTV5	HPL	108	60	1½	310	23.6	P\$ 8655	
	95-60108RTV5	Veneer						W\$ 10187	
	95-60108RTV5	Veneer/HPL						C\$ 10306	
		<i>96"W: 5 Piece Top - 4 Accent Doors</i>							
	96-6096RTV5	HPL	96	60	1½	282	23.0	P\$ 7951	
	95-6096RTV5	Veneer						W\$ 9435	
	95-6096RTV5	Veneer/HPL						C\$ 9683	
		48"D Tops							
		<i>192"W: 9 Piece Top - 12 Accent Doors</i>							
Rectangular Table With Center Inlay also available with a Knife Edge and coordinating Blade Base.	96-48192RTV5	HPL	192	48	1½	345	23.9	P\$ 14600	
	95-48192RTV5	Veneer						W\$ 16857	
	95-48192RTV5	Veneer/HPL						C\$ 17569	
		<i>168"W: 9 Piece Top - 8 Accent Doors</i>							
See Details.	96-48168RTV5	HPL	168	48	1½	328	23.7	P\$ 13144	
	95-48168RTV5	Veneer						W\$ 14464	
	95-48168RTV5	Veneer/HPL						C\$ 15205	
		<i>144"W: 9 Piece Top - 8 Accent Doors</i>							
	96-48144RTV5	HPL	144	48	1½	311	23.4	P\$ 12656	
	95-48144RTV5	Veneer						W\$ 13960	
	95-48144RTV5	Veneer/HPL						C\$ 14683	
		<i>120"W: 5 Piece Top - 6 Accent Doors</i>							
	96-48120RTV5	HPL	120	48	1½	282	23.2	P\$ 8204	
	95-48120RTV5	Veneer						W\$ 9355	
	95-48120RTV5	Veneer/HPL						C\$ 9741	
		<i>108"W: 5 Piece Top - 6 Accent Doors</i>							
	96-48108RTV5	HPL	108	48	1½	260	22.8	P\$ 7941	
	95-48108RTV5	Veneer						W\$ 9085	
	95-48108RTV5	Veneer/HPL						C\$ 9458	
		<i>96"W: 5 Piece Top - 4 Accent Doors</i>							
	96-4896RTV5	HPL	96	48	1½	237	23.0	P\$ 7288	
	95-4896RTV5	Veneer						W\$ 7995	
	95-4896RTV5	Veneer/HPL						C\$ 8412	

Continued on next page.

P = HPL W = Veneer C = Combination of Wood/HPL

[See One10 Overview For Ordering Options](#)

Item	Model No.	W	D	H	Ship Wt	Cubic Ft	List Price
------	-----------	---	---	---	---------	----------	------------

Continued from
Previous Page

What You Get:

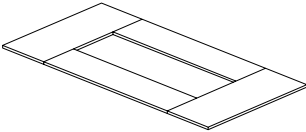

Outer Piece Top

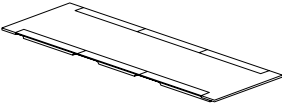

Center Inlay Top

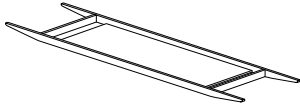

Trough

Description

- 1½” Thick Rectangular Top with Block Edge
- Veneer Tops Feature UV Finish
- Center Inlay Includes Aluminum Accent Doors for Wire Management
- Center Inlay Available in Contrasting Laminate or Veneer
- Trough Reinforces and Supports Top
- Requires Two (2) Block Bases; Tables 144”W or Larger Also Require Middle Block Base; Sold Separately, See Below
- Silver Grommet Included for Optional Polycym Installation
- Power and Data Options Available; Sold Separately, [See Multiple Power Unit Details](#); [See Location Options](#)
- Assembly Required

Top Grain Direction

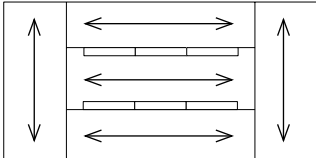

BLOCK BASES

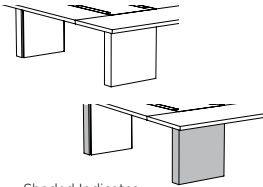

Shaded Indicates
Accent Area

Block Base Options; Must Order							
<i>Standard Block Base - Two (2) Required</i>							
96-2428BB	HPL	24	6	28	52	2.4	P\$ 1527
95-2428BB	Veneer						W\$ 2097
95-2428BB	Veneer/TFL						C\$ 2348
<i>Middle Block Base - Required for Tops 144”W or Larger</i>							
96-2428MSL	HPL	24	7½	28	72	2.8	P\$ 1865
95-2428MSL	Veneer						W\$ 2426
95-2428MSL	Veneer/TFL						C\$ 2762

Must Specify (in this order):

- Standard Base Model #
- Primary Finish/Color
- Accent Material
- Accent Finish/Color
- Middle Base Model # (If needed)
- Middle Base Primary Finish/Color
- Middle Base Accent Material
- Middle Base Accent Finish/Color

Description

- All Tops Require Two (2) Block Bases; Tables 144”W or Larger Also Require Middle Block Base
- Bases are Constructed with Removable Interior Panel for Wire Management Installation
- Outer Panel can be Specified in Contrasting Finish/Color from Top Finish/Color
- Adjustable Glides Included

P = HPL W = Veneer C = Combination of Wood/TFL Accent

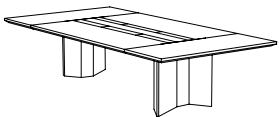
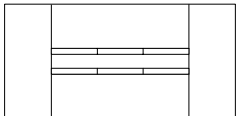
Item	Model No.		W	D	H	Ship Wt	Cubic Ft	List Price	
STANDARD TABLES		60"D Tops							
		<i>192"W: 9 Piece Top - 12 Accent Doors</i>							
RECTANGULAR TOP CENTER INLAY KNIFE EDGE BLADE BASE	96-60192RTK5	HPL	192	60	1 3/16	435	25.3	P\$ 17631	
	95-60192RTK5	Veneer						W\$ 20834	
	95-60192RTK5	Veneer/HPL						C\$ 21188	
		<i>168"W: 9 Piece Top - 8 Accent Doors</i>							
	96-60168RTK5	HPL	168	60	1 3/16	407	24.9	P\$ 15958	
	95-60168RTK5	Veneer						W\$ 18521	
	95-60168RTK5	Veneer/HPL						C\$ 19023	
		<i>144"W: 9 Piece Top - 8 Accent Doors</i>							
	96-60144RTK5	HPL	144	60	1 3/16	379	24.4	P\$ 15320	
	95-60144RTK5	Veneer						W\$ 17586	
	95-60144RTK5	Veneer/HPL						C\$ 18055	
		<i>120"W: 5 Piece Top - 6 Accent Doors</i>							
	96-60120RTK5	HPL	120	60	1 3/16	339	24.0	P\$ 9983	
	95-60120RTK5	Veneer						W\$ 11819	
	95-60120RTK5	Veneer/HPL						C\$ 12000	
		<i>108"W: 5 Piece Top - 6 Accent Doors</i>							
<u>Must Specify (in this order):</u> Model # Primary Finish/Color Accent Material Accent Finish/Color	96-60108RTK5	HPL	108	60	1 3/16	310	23.6	P\$ 9693	
	95-60108RTK5	Veneer						W\$ 11406	
	95-60108RTK5	Veneer/HPL						C\$ 11571	
		<i>96"W: 5 Piece Top - 4 Accent Doors</i>							
	96-6096RTK5	HPL	96	60	1 3/16	282	23.0	P\$ 8904	
	95-6096RTK5	Veneer						W\$ 10565	
	95-6096RTK5	Veneer/HPL						C\$ 10856	
		48"D Tops							
		<i>192"W: 9 Piece Top - 12 Accent Doors</i>							
Rectangular Table With Center Inlay also available with a Block Edge and coordinating Block Base.	96-48192RTK5	HPL	192	48	1 3/16	345	23.9	P\$ 16353	
	95-48192RTK5	Veneer						W\$ 18878	
	95-48192RTK5	Veneer/HPL						C\$ 19664	
		<i>168"W: 9 Piece Top - 8 Accent Doors</i>							
See Details.	96-48168RTK5	HPL	168	48	1 3/16	328	23.7	P\$ 14722	
	95-48168RTK5	Veneer						W\$ 16200	
	95-48168RTK5	Veneer/HPL						C\$ 17001	
		<i>144"W: 9 Piece Top - 8 Accent Doors</i>							
	96-48144RTK5	HPL	144	48	1 3/16	311	23.4	P\$ 14178	
	95-48144RTK5	Veneer						W\$ 15634	
	95-48144RTK5	Veneer/HPL						C\$ 16419	
		<i>120"W: 5 Piece Top - 6 Accent Doors</i>							
	96-48120RTK5	HPL	120	48	1 3/16	282	23.2	P\$ 9189	
	95-48120RTK5	Veneer						W\$ 10478	
	95-48120RTK5	Veneer/HPL						C\$ 10907	
		<i>108"W: 5 Piece Top - 6 Accent Doors</i>							
	96-48108RTK5	HPL	108	48	1 3/16	260	22.8	P\$ 8893	
	95-48108RTK5	Veneer						W\$ 10174	
	95-48108RTK5	Veneer/HPL						C\$ 10586	
		<i>96"W: 5 Piece Top - 4 Accent Doors</i>							
	96-4896RTK5	HPL	96	48	1 3/16	237	23.0	P\$ 8164	
	95-4896RTK5	Veneer						W\$ 8956	
	95-4896RTK5	Veneer/HPL						C\$ 9404	

Continued on next page.

P = HPL W = Veneer C = Combination of Wood/HPL

[See One10 Overview For Ordering Options](#)

Item	Model No.	W	D	H	Ship Wt	Cubic Ft	List Price
------	-----------	---	---	---	---------	----------	------------

Continued from
Previous Page

What You Get:

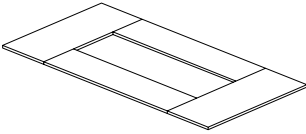

Outer Piece Top

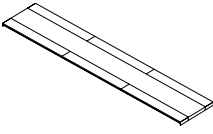

Center Inlay Top

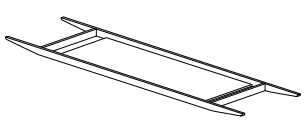

Trough

Description

- 1 $\frac{3}{16}$ " Rectangular Top with Knife Edge
- Veneer Tops Feature UV Finish
- Center Inlay Includes Aluminum Accent Doors for Wire Management
- Center Inlay Available in Contrasting Laminate or Veneer
- Trough Reinforces and Supports Top
- Requires Two (2) Blade Bases; Tables 144"W or Larger Also Require Middle Blade Base; Sold Separately, See Below
- Silver Grommet Included for Optional Polycom Installation
- Power and Data Options Available; Sold Separately, [See Multiple Power Unit Details](#); [See Location Options](#)
- Assembly Required

Top Grain Direction

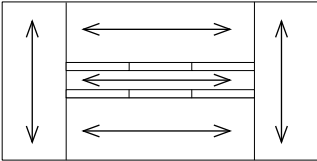

BLADE BASES

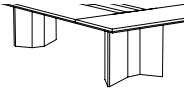

Blade Base Options; Must Order							
<i>Standard Blade Base - Two (2) Required</i>							
96-2828BD	HPL	28	10 $\frac{1}{2}$	28	52	2.4	P\$ 1246
95-2828BD	Veneer						W\$ 1716
<i>Middle Blade Base - Required for Tops 144"W or Larger</i>							
96-2818MBD	Aluminum	18	3 $\frac{7}{8}$	28	72	2.8	\$ 1650
95-2818MBD	Aluminum						\$ 1650

Description

- All Tops Require Two (2) Blade Bases; Tables 144"W or Larger Also Require Middle Blade Base
- Bases are Constructed with Removable Interior Aluminum Panel for Wire Management Installation
- Aluminum Middle Blade Base Features Two (2) Aluminum Doors for Wire Management
- Outer Panel of Standard Blade Base can be Specified in a Contrasting Finish/Color from Top Finish/Color
- Adjustable Glides Included

Must Specify (in this order):

- Standard Base Model #
- Primary Finish/Color
- Middle Base Model # (If needed)

P = HPL W = Veneer

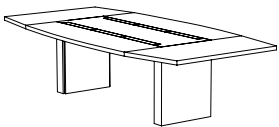
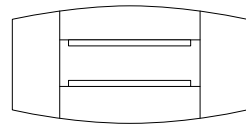
Item	Model No.		W	D	H	Ship Wt	Cubic Ft	List Price	
STANDARD TABLES		60"D Tops							
		<i>192"W: 9 Piece Top - 12 Accent Doors</i>							
BOAT-SHAPED TOP CENTER INLAY BLOCK EDGE BLOCK BASE	96-60192BTV5	HPL	192	60 - 48	1½	435	25.3	P\$ 16525	
	95-60192BTV5	Veneer						W\$ 19531	
	95-60192BTV5	Veneer/HPL						C\$ 19818	
		<i>168"W: 9 Piece Top - 8 Accent Doors</i>							
	96-60168BTV5	HPL	168	60 - 48	1½	407	24.9	P\$ 14962	
	95-60168BTV5	Veneer						W\$ 17364	
	95-60168BTV5	Veneer/HPL						C\$ 17816	
		<i>144"W: 9 Piece Top - 8 Accent Doors</i>							
	96-60144BTV5	HPL	144	60 - 48	1½	379	24.4	P\$ 14364	
	95-60144BTV5	Veneer						W\$ 16485	
	95-60144BTV5	Veneer/HPL						C\$ 16906	
		<i>120"W: 5 Piece Top - 6 Accent Doors</i>							
	96-60120BTV5	HPL	120	60 - 48	1½	339	24.0	P\$ 9361	
	95-60120BTV5	Veneer						W\$ 11081	
	95-60120BTV5	Veneer/HPL						C\$ 11223	
		<i>108"W: 5 Piece Top - 6 Accent Doors</i>							
Must Specify (in this order): Model # Primary Finish/Color Accent Material Accent Finish/Color	96-60108BTV5	HPL	108	60 - 48	1½	310	23.6	P\$ 9089	
	95-60108BTV5	Veneer						W\$ 10697	
	95-60108BTV5	Veneer/HPL						C\$ 10822	
		<i>96"W: 5 Piece Top - 4 Accent Doors</i>							
	96-6096BTV5	HPL	96	60 - 48	1½	282	23.0	P\$ 8348	
	95-6096BTV5	Veneer						W\$ 9906	
	95-6096BTV5	Veneer/HPL						C\$ 10166	
		48"D Tops							
		<i>192"W: 9 Piece Top - 12 Accent Doors</i>							
Boat-Shaped Table With Center Inlay also available with a Knife Edge and coordinating Blade Base.	96-48192BTV5	HPL	192	48 - 36	1½	345	23.9	P\$ 15334	
	95-48192BTV5	Veneer						W\$ 17697	
	95-48192BTV5	Veneer/HPL						C\$ 18445	
		<i>168"W: 9 Piece Top - 8 Accent Doors</i>							
See Details.	96-48168BTV5	HPL	168	48 - 36	1½	328	23.7	P\$ 13801	
	95-48168BTV5	Veneer						W\$ 15185	
	95-48168BTV5	Veneer/HPL						C\$ 15964	
		<i>144"W: 9 Piece Top - 8 Accent Doors</i>							
	96-48144BTV5	HPL	144	48 - 36	1½	311	23.4	P\$ 13291	
	95-48144BTV5	Veneer						W\$ 14656	
	95-48144BTV5	Veneer/HPL						C\$ 15417	
		<i>120"W: 5 Piece Top - 6 Accent Doors</i>							
	96-48120BTV5	HPL	120	48 - 36	1½	282	23.2	P\$ 8614	
	95-48120BTV5	Veneer						W\$ 9823	
	95-48120BTV5	Veneer/HPL						C\$ 10229	
		<i>108"W: 5 Piece Top - 6 Accent Doors</i>							
	96-48108BTV5	HPL	108	48 - 36	1½	260	22.8	P\$ 8339	
	95-48108BTV5	Veneer						W\$ 9538	
	95-48108BTV5	Veneer/HPL						C\$ 9933	
		<i>96"W: 5 Piece Top - 4 Accent Doors</i>							
	96-4896BTV5	HPL	96	48 - 36	1½	237	23.0	P\$ 7654	
	95-4896BTV5	Veneer						W\$ 8398	
	95-4896BTV5	Veneer/HPL						C\$ 8832	

Continued on next page.

P = HPL W = Veneer C = Combination of Wood/HPL

[See One10 Overview For Ordering Options](#)

Item	Model No.	W	D	H	Ship Wt	Cubic Ft	List Price
------	-----------	---	---	---	---------	----------	------------

Continued from
Previous Page

What You Get:

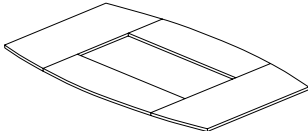

Outer Piece Top

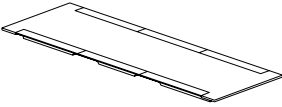

Center Inlay Top

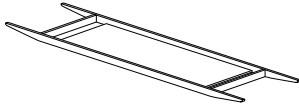

Trough

Description

- 1½” Thick Boat-Shaped Top with Block Edge
- Veneer Tops Feature UV Finish
- Center Inlay Includes Aluminum Accent Doors for Wire Management
- Center Inlay Available in Contrasting Laminate or Veneer
- Trough Reinforces and Supports Top
- Requires Two (2) Block Bases; Tables 144”W or Larger Also Require Middle Block Base; Sold Separately, See Below
- Silver Grommet Included for Optional Polycom Installation
- Power and Data Options Available; Sold Separately, [See Multiple Power Unit Details](#); [See Location Options](#)
- Assembly Required

Top Grain Direction

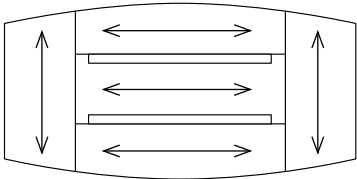

BLOCK BASES

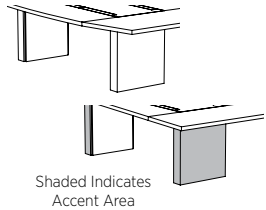

Block Base Options; Must Order								
<i>Standard Block Base - Two (2) Required</i>								
96-2428BB	HPL	24	6	28	52	2.4	P\$	1527
95-2428BB	Veneer						W\$	2097
95-2428BB	Veneer/TFL						C\$	2348
<i>Middle Block Base - Required for Tops 144”W or Larger</i>								
96-2428MSL	HPL	24	7½	28	72	2.8	P\$	1865
95-2428MSL	Veneer						W\$	2426
95-2428MSL	Veneer/TFL						C\$	2762

Must Specify (in this order):

- Standard Base Model #
- Primary Finish/Color
- Accent Material
- Accent Finish/Color
- Middle Base Model # (If needed)
- Middle Base Primary Finish/Color
- Middle Base Accent Material
- Middle Base Accent Finish/Color

Description

- All Tops Require Two (2) Block Bases; Tables 144”W or Larger Also Require Middle Block Base
- Bases are Constructed with Removable Interior Panel for Wire Management Installation
- Outer Panel can be Specified in a Contrasting Finish/Color from Top Finish/Color
- Adjustable Glides Included

P = HPL W = Veneer C = Combination of Wood/TFL Accent

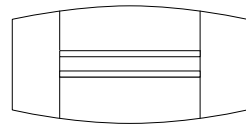
Item	Model No.		W	D	H	Ship Wt	Cubic Ft	List Price	
STANDARD TABLES		60"D Tops							
		<i>192"W: 9 Piece Top - 12 Accent Doors</i>							
BOAT-SHAPED TOP CENTER INLAY KNIFE EDGE BLADE BASE	96-60192BTK5	HPL	192	60 - 48	1 3/16	435	25.3	P\$ 18510	
	95-60192BTK5	Veneer						W\$ 21874	
	95-60192BTK5	Veneer/HPL						C\$ 22245	
		<i>168"W: 9 Piece Top - 8 Accent Doors</i>							
	96-60168BTK5	HPL	168	60 - 48	1 3/16	407	24.9	P\$ 16755	
	95-60168BTK5	Veneer						W\$ 19447	
	95-60168BTK5	Veneer/HPL						C\$ 19975	
		<i>144"W: 9 Piece Top - 8 Accent Doors</i>							
	96-60144BTK5	HPL	144	60 - 48	1 3/16	379	24.4	P\$ 16087	
	95-60144BTK5	Veneer						W\$ 18465	
	95-60144BTK5	Veneer/HPL						C\$ 18959	
		<i>120"W: 5 Piece Top - 6 Accent Doors</i>							
	96-60120BTK5	HPL	120	60 - 48	1 3/16	339	24.0	P\$ 10483	
	95-60120BTK5	Veneer						W\$ 12409	
	95-60120BTK5	Veneer/HPL						C\$ 12600	
		<i>108"W: 5 Piece Top - 6 Accent Doors</i>							
<u>Must Specify (in this order):</u> Model # Primary Finish/Color Accent Material Accent Finish/Color	96-60108BTK5	HPL	108	60 - 48	1 3/16	310	23.6	P\$ 10179	
	95-60108BTK5	Veneer						W\$ 11979	
	95-60108BTK5	Veneer/HPL						C\$ 12151	
		<i>96"W: 5 Piece Top - 4 Accent Doors</i>							
	96-6096BTK5	HPL	96	60 - 48	1 3/16	282	23.0	P\$ 9351	
	95-6096BTK5	Veneer						W\$ 11094	
	95-6096BTK5	Veneer/HPL						C\$ 11398	
		48"D Tops							
		<i>192"W: 9 Piece Top - 12 Accent Doors</i>							
Boat-Shaped Table With Center Inlay also available with a Block Edge and coordinating Block Base.	96-48192BTK5	HPL	192	48 - 36	1 3/16	345	23.9	P\$ 17174	
	95-48192BTK5	Veneer						W\$ 19824	
	95-48192BTK5	Veneer/HPL						C\$ 20648	
		<i>168"W: 9 Piece Top - 8 Accent Doors</i>							
See Details.	96-48168BTK5	HPL	168	48 - 36	1 3/16	328	23.7	P\$ 15457	
	95-48168BTK5	Veneer						W\$ 17009	
	95-48168BTK5	Veneer/HPL						C\$ 17849	
		<i>144"W: 9 Piece Top - 8 Accent Doors</i>							
	96-48144BTK5	HPL	144	48 - 36	1 3/16	311	23.4	P\$ 14884	
	95-48144BTK5	Veneer						W\$ 16419	
	95-48144BTK5	Veneer/HPL						C\$ 17241	
		<i>120"W: 5 Piece Top - 6 Accent Doors</i>							
	96-48120BTK5	HPL	120	48 - 36	1 3/16	282	23.2	P\$ 9649	
	95-48120BTK5	Veneer						W\$ 11002	
	95-48120BTK5	Veneer/HPL						C\$ 11453	
		<i>108"W: 5 Piece Top - 6 Accent Doors</i>							
	96-48108BTK5	HPL	108	48 - 36	1 3/16	260	22.8	P\$ 9340	
	95-48108BTK5	Veneer						W\$ 10682	
	95-48108BTK5	Veneer/HPL						C\$ 11118	
		<i>96"W: 5 Piece Top - 4 Accent Doors</i>							
	96-4896BTK5	HPL	96	48 - 36	1 3/16	237	23.0	P\$ 8570	
	95-4896BTK5	Veneer						W\$ 9402	
	95-4896BTK5	Veneer/HPL						C\$ 9873	

Continued on next page.

P = HPL W = Veneer C = Combination of Wood/HPL

[See One10 Overview For Ordering Options](#)

Item	Model No.	W	D	H	Ship Wt	Cubic Ft	List Price
------	-----------	---	---	---	---------	----------	------------

Continued from
Previous Page

What You Get:

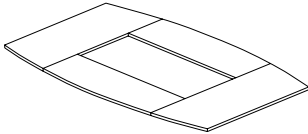

Outer Piece Top

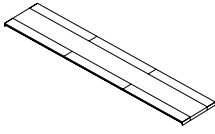

Center Inlay Top

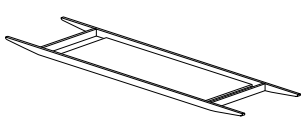

Trough

Description

- 1 $\frac{3}{16}$ " Boat-Shaped Top with Knife Edge
- Veneer Tops Feature UV Finish
- Center Inlay Includes Aluminum Accent Doors for Wire Management
- Center Inlay Available in Contrasting Laminate or Veneer
- Trough Reinforces and Supports Top
- Requires Two (2) Blade Bases; Tables 144"W or Larger Also Require Middle Blade Base; Sold Separately, See Below
- Silver Grommet Included for Optional Polycrom Installation
- Power and Data Options Available; Sold Separately, [See Multiple Power Unit Details](#); [See Location Options](#)
- Assembly Required

Top Grain Direction

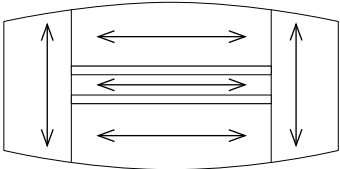

BLADE BASES

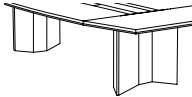

Blade Base Options; Must Order							
<i>Standard Blade Base - Two (2) Required</i>							
96-2828BD	HPL	28	10 $\frac{1}{2}$	28	52	2.4	P\$ 1246
95-2828BD	Veneer						W\$ 1716
<i>Middle Blade Base - Required for Tops 144"W or Larger</i>							
96-2818MBD	Aluminum	18	3 $\frac{7}{8}$	28	72	2.8	\$ 1650
95-2818MBD	Aluminum						\$ 1650

Description

- All Tops Require Two (2) Blade Bases; Tables 144"W or Larger Also Require Middle Blade Base
- Bases are Constructed with Removable Aluminum Interior Panel for Wire Management Installation
- Aluminum Middle Blade Base Features Two (2) Aluminum Doors for Wire Management
- Outer Panel of Standard Blade Base can be Specified in a Contrasting Finish/Color from Top Finish/Color
- Adjustable Glides Included

Must Specify (in this order):
Standard Base Model #
Primary Finish/Color
Middle Base Model # (If needed)

P = HPL W = Veneer

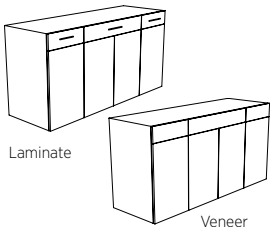
Item	Model No.		W	D	H	Ship Wt	Cubic Ft	List Price		
	4 DOORS & 3 DRAWERS									
	96-2460BF2	HPL	60	24	36	275	34.2	P\$	5889	
	95-2460BF2	Veneer						W\$	7495	
	4 DOORS & 2 DRAWERS									
	96-2460BF1	HPL	60	24	36	275	34.2	P\$	5111	
	95-2460BF1	Veneer						W\$	6463	
	2 DOORS & 1 DRAWER									
	96-2430BF	HPL	30	24	36	150	17.6	P\$	2691	
	95-2430BF	Veneer						W\$	3501	

Must Specify (in this order):

Model #
Finish/Color

Description

- Touch Latch Doors
- Laminate Unit features Aluminum Beam Pull on Drawers While Veneer Unit Features Finger Pull
- Storage Behind Doors with Adjustable Shelves (Laminate or Veneer Shelves, Depending Upon Unit Specified)
- Adjustable Glides
- Finished Back

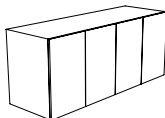
Item	Model No.		W	D	H	Ship Wt	Cubic Ft	List Price		
	4 DOORS									
	96-2472C	HPL	72	24	30	290	28.0	P\$	4595	
	95-2472C	Veneer						W\$	6235	
	96-2460C	HPL	60	24	30	250	23.4	P\$	4294	
	95-2460C	Veneer						W\$	5496	
	3 DOORS									
	96-2448C	HPL	48	24	30	210	19.5	P\$	3154	
	95-2448C	Veneer						W\$	4165	
	2 DOORS									
	96-2436C	HPL	36	24	30	150	17.6	P\$	2358	
95-2436C	Veneer						W\$	3178		

Must Specify (in this order):

Model #
Finish/Color

Description

- Touch Latch Doors; Veneer Units Also Feature Finger Pulls
- Storage Behind Doors with Adjustable Shelves
- Adjustable Glides
- Finished Back

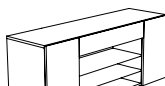
Item	Model No.		W	D	H	Ship Wt	Cubic Ft	List Price		
	MEDIA CREDENZA									
	96-1872OMC	HPL	72	18	36	175	24.0	P\$	4272	
	95-1872OMC	Veneer						W\$	5487	
	96-1860OMC	HPL	60	18	36	155	19.5	P\$	3945	
95-1860OMC	Veneer						W\$	4968		

Must Specify (in this order):

Model #
Finish/Color

Description

- Storage Behind Two (2) Doors with Adjustable Laminate Shelves
- Open Storage with Two (2) Adjustable Metal Shelves in Middle Section Below Flip Down Door
- Flip Down Door (Does Not Feature Soft Close Hinges)
- Finished Back is Recessed and Open 2" Below Worksurface for Wire Management
- Touch Latch Closure; Veneer Units Also Feature Finger Pulls
- Adjustable Glides

P = HPL W = Veneer

[See One10 Overview For Ordering Options](#)

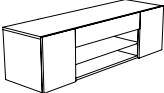
Item	Model No.		W	D	H	Ship Wt	Cubic Ft	List Price	
	96-1872LOMC	HPL	72	18	24	145	24.0	P\$	3924
	95-1872LOMC	Veneer						W\$	5116
	96-1860LOMC	HPL	60	18	24	125	19.5	P\$	3671
	95-1860LOMC	Veneer						W\$	4684

Must Specify (in this order):
 Model #
 Finish/Color

Description

- Storage Behind Two (2) Doors with Adjustable Veneer Shelves
- Open Storage with Adjustable Metal Shelf in Middle Section Below Flip Down Door
- Flip Down Door (Does Not Feature Soft Close Hinges)
- Finished Back is Recessed and Open 2" Below Worksurface for Wire Management
- Touch Latch Doors; Veneer Units Also Feature Finger Pulls
- Adjustable Glides

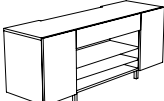
	96-1872FMC	HPL	72	18	36	175	24.0	P\$	4112
	95-1872FMC	Veneer						W\$	5397
	96-1860FMC	HPL	60	18	36	155	19.5	P\$	3883
	95-1860FMC	Veneer						W\$	4978

Must Specify (in this order):
 Model #
 Finish/Color

Description

- Storage Behind Two (2) Doors with Adjustable Shelves (Laminate or Veneer Shelves, Depending Upon Unit Specified)
- Open Storage with Two (2) Adjustable Metal Shelves in Middle Section Below Flip Down Door
- Flip Down Door (Does Not Feature Soft Close Hinges)
- Finished Back is Recessed and Open 2" Below Worksurface for Wire Management
- Top is Routed to Accommodate Wire Management or Flat Panel Monitor Stand ([See Flat Panel Monitor Stand](#))
- Touch Latch Doors; Veneer Units Also Feature Finger Pulls
- Doors are Hinged from the Inside of the Cabinet and Swing in to Accommodate the Meeting Table
- Aluminum Post Legs with Adjustable Glides

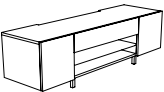
	96-1872LFMC	HPL	72	18	24	145	24.0	P\$	3654
	95-1872LFMC	Veneer						W\$	4495
	96-1860LFMC	HPL						P\$	3463
	95-1860LFMC	Veneer	60	18	24	125	19.5	W\$	4229

Must Specify (in this order):
 Model #
 Finish/Color

Description

- Storage Behind Two (2) Doors with Adjustable Shelves (Laminate or Veneer Shelves, Depending Upon Unit Specified)
- Open Storage with Adjustable Metal Shelf in Middle Section Below Flip Down Door
- Flip Down Door (Does Not Feature Soft Close Hinges)
- Finished Back is Recessed and Open 2" Below Worksurface for Wire Management
- Top is Routed to Accommodate Wire Management or Flat Panel Monitor Stand ([See Flat Panel Monitor Stand](#))
- Touch Latch Doors; Veneer Units Also Feature Finger Pulls
- Doors are Hinged from the Inside of the Cabinet and Swing in to Accommodate the Meeting Table
- Aluminum Post Legs with Adjustable Glides

P = HPL W = Veneer

[See One10 Overview For Ordering Options](#)

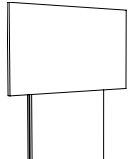
Item	Model No.		W	D	H	Ship Wt	Cubic Ft	List Price	
 <p>Shown with Monitor (Not Included)</p> <p>Must Specify (in this order): Model # Finish/Color</p>	COORDINATES WITH ≥60" MEETING TABLES 42" TALL AND FOOTED MEDIA CREDENZAS 36"H								
	96-3067FP	HPL	30½	14	67%	140	16.7	P\$	2162
	95-3067FP	Veneer						W\$	2713
	COORDINATES WITH ≥60" MEETING TABLES 42" TALL AND LOW FOOTED MEDIA CREDENZAS 24"H								
	96-3055FP	HPL	30½	14	55%	123	13.8	P\$	1979
	95-3055FP	Veneer						W\$	2437

Description

- Not Freestanding; Must be Used with a Coordinating Product
- Finished Back is Removable for Wire Management
- Grain Direction is Vertical
- Aluminum Metal Base
- Accommodates 200, 300, and 400mm VESA Patterns
- Check the Monitor Manufacturer's Specifications for Compliance
- Mounting Hardware Not Included
- Not Responsible for Monitors Improperly Installed or Any Attempt To Use As A Freestanding Unit

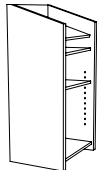
 <p>Must Specify (in this order): Model # Finish/Color</p>	96-2650LS	HPL	24	23	49	130	21.9	P\$	1855
	95-2650LS	Veneer						W\$	3110

Description

- Top Fixed Shelf Angled for User Comfort
- Two (2) Fixed Shelves and One (1) Adjustable Shelf
- Two (2) Locking and Two (2) Non-Locking Casters
- Wire Management Grommet on Second and Bottom Shelf, Middle Shelf Features Wire Management Grommet Cut Out

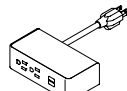
	01-DUOCLAMPW	White	5½	3	7	1	0.2	\$	553
	01-DUOCLAMPB	Black						\$	553
	01-DUOCLAMPS	Silver						\$	553

Description

- Clamps to Table Top and Includes: Two (2) Power, Two (2) USB, 10' Cord, and All Mounting Hardware
- Silver Metal Trim on All Color Options
- Independent USB Circuit Controllers Deliver up to 2.1 Amps to Each Post
- FCC Part 15A, UL Recognized for Horizontal and Vertical Applications

	01-TRIOCLAMPW	White	8	3	7	1	0.2	\$	648
	01-TRIOCLAMPB	Black						\$	648
	01-TRIOCLAMPS	Silver						\$	648

Description

- Clamps to Table Top and Includes: Three (3) Power Outlets, Two (2) USB Ports, One (1) Open Data Port, 10' Cord, and All Mounting Hardware
- HDMI, VGA, and RJ45 Accessories for Open Data Port; Sold Separately, [See Accessories](#)
- Silver Metal Trim on All Color Options
- Independent USB Circuit Controllers Deliver up to 2.1 Amps to Each Post
- FCC Part 15A, UL Recognized for Horizontal and Vertical Applications

P = HPL W = Veneer

[See One10 Overview For Ordering Options](#)

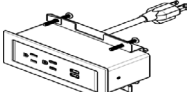
Item	Model No.		W	D	H	Ship Wt	Cubic Ft	List Price
	01-DUOBEZELW	White	6½	2¼	3⅞	1	0.2	\$ 652
	01-DUOBEZELB	Black						\$ 652
	01-DUOBEZELS	Silver						\$ 652

Description

- Sits on Table Top and Includes: Two (2) Power, Two (2) USB, 10' Cord, and All Mounting Hardware
- Independent USB Circuit Controllers Deliver up to 2.1 Amps to Each Post
- FCC Part 15A, UL Recognized for Horizontal and Vertical Applications
- Works with One10 Small Meeting Tables, Standard Tables, and Single Column Meeting Tables

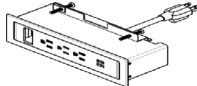
	01-TRIOBEZELW	White	9	2¼	3	1	0.2	\$ 700
	01-TRIOBEZELB	Black						\$ 700
	01-TRIOBEZELS	Silver						\$ 700

Description

- Sits on Table Top and Includes: Three (3) Power Outlets, Two (2) USB Ports, One (1) Open Data Port, 10' Cord, and All Mounting Hardware
- HDMI, VGA, and RJ45 Accessories for Open Data Port; Sold Separately, [See Accessories](#)
- Independent USB Circuit Controllers Deliver up to 2.1 Amps to Each Post
- FCC Part 15A, UL Recognized for Horizontal and Vertical Applications
- Works with One10 Small Meeting Tables, Standard Tables, and Single Column Meeting Tables

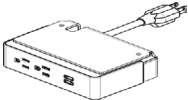
	01-DUOW	White	5½	2	3⅞	1	0.2	\$ 687
	01-DUOB	Black						\$ 687
	01-DUOS	Silver						\$ 687

Description

- Sits Between Worksurfaces or Below the Worksurface and Includes: Two (2) Power, Two (2) USB, 10' Cord, and All Mounting Hardware
- Independent USB Circuit Controllers Deliver up to 2.1 Amps to Each Post
- FCC Part 15A, UL Recognized for Horizontal and Vertical Applications
- Works with One10 Small Meeting Tables and Standard Tables with Center Inlay

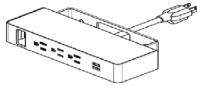
	01-TRIOW	White	8	2	3	1	0.2	\$ 708
	01-TRIOB	Black						\$ 708
	01-TRIOS	Silver						\$ 708

Description

- Sits Between Worksurfaces or Below the Worksurface and Includes: Three (3) Power Outlets, Two (2) USB Ports, One (1) Open Data Port, 10' Cord, and All Mounting Hardware
- HDMI, VGA, and RJ45 Accessories for Open Data Port; Sold Separately, [See Accessories](#)
- Independent USB Circuit Controllers Deliver up to 2.1 Amps to Each Post
- FCC Part 15A, UL Recognized for Horizontal and Vertical Applications
- Works with One10 Small Meeting Tables and Standard Tables with Center Inlay

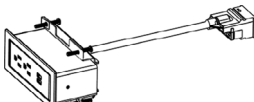
Item	Model No.		W	D	H	Ship Wt	Cubic Ft	List Price
	01-PDUOBEZELW	White	6½	2½	3	1	0.2	\$ 645
	01-PDUOBEZELB	Black						\$ 645
	01-PDUOBEZELS	Silver						\$ 645

Description

- Sits on Table Top and Includes: Two (2) Power, Two (2) USB, 12” Cord, and All Mounting Hardware
- Requires Daisy Chain Power Box; Sold Separately, [See Power Box Details](#)
- Non-Sequential System Allows up to Eight (8) Modules to be Connected with Jumper Cord, [See Jumper Cord Details](#)
- Independent USB Circuit Controllers Deliver up to 2.1 Amps to Each Post
- FCC Part 15A, RU Listed and UL Recognized for Horizontal and Vertical Applications
- Works with One10 Small Meeting Tables, Standard Tables, and Single Column Meeting Tables

	01-PTRIOBEZELW	White	9	2½	3	1	0.2	\$ 691
	01-PTRIOBEZELB	Black						\$ 691
	01-PTRIOBEZELS	Silver						\$ 691

Description

- Sits on Table Top and Includes: Three (3) Power Outlets, Two (2) USB Ports, One (1) Open Data Port, 12” Cord, and All Mounting Hardware
- HDMI, VGA, or RJ45 Accessory for Open Data Port; Sold Separately, [See Accessories](#)
- Requires Daisy Chain Power Box, Specified Separately, See Next Page
- Non-Sequential System Allows up to Eight (8) Modules to be Connected with Jumper Cord, [See Jumper Cord Details](#)
- Independent USB Circuit Controllers Deliver up to 2.1 Amps to Each Post
- FCC Part 15A, RU Listed and UL Recognized for Horizontal and Vertical Applications
- Works with One10 Small Meeting Tables, Standard Tables, and Single Column Meeting Tables

	01-PDUOW	White	5½	2	3	1	0.2	\$ 681
	01-PDUOB	Black						\$ 681
	01-PDUOS	Silver						\$ 681

Description

- Sits Between Worksurfaces or Below the Worksurface and Includes: Two (2) Power, Two (2) USB, 12” Cord, and All Mounting Hardware
- Requires Daisy Chain Power Box; Sold Separately, [See Power Box Details](#)
- Non-Sequential System Allows up to Eight (8) Modules to be Connected with Jumper Cord, [See Jumper Cord Details](#)
- Independent USB Circuit Controllers Deliver up to 2.1 Amps to Each Post
- FCC Part 15A, RU Listed and UL Recognized for Horizontal and Vertical Applications
- Works with One10 Small Meeting Tables and Standard Tables with Center Inlay

[See One10 Overview For Ordering Options](#)

Item	Model No.		W	D	H	Ship Wt	Cubic Ft	List Price
TRIO DAISY CHAIN PLUG	01-PTRIOW	White	8	2	3	1	0.2	\$ 700
	01-PTRIOB	Black						\$ 700
	01-PTRIOS	Silver						\$ 700

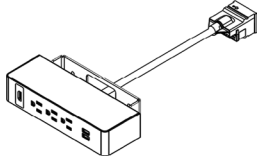

Description

- Sits on Table Top and Includes: Three (3) Power Outlets, Two (2) USB Ports, One (1) Open Data Port, 12" Cord, and All Mounting Hardware
- HDMI, VGA, or RJ45 Accessory for Open Data Port; Sold Separately, See Accessories Below
- Requires Daisy Chain Power Box; Sold Separately, See Details Below
- Non-Sequential System Allows up to Eight (8) Modules to be Connected with Jumper Cord, [See Jumper Cord Details](#)
- Independent USB Circuit Controllers Deliver up to 2.1 Amps to Each Post
- FCC Part 15A, RU Listed and UL Recognized for Horizontal and Vertical Applications
- Works with One10 Small Meeting Tables and Standard Tables with Center Inlay

HDMI DATA PORT ACCESSORY FOR TRIO UNITS	01-LCOMHDMI		-	-	-	1	0.2	\$ 160
---	-------------	--	---	---	---	---	-----	--------

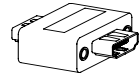

OPEN MARKET ONLY

VGA DATA PORT ACCESSORY FOR TRIO UNITS	01-LCOMVGA		-	-	-	1	0.2	\$ 117
--	------------	--	---	---	---	---	-----	--------

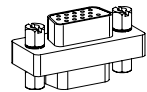

RJ45 DATA PORT ACCESSORY FOR TRIO UNITS	01-LCOMRJ45		-	-	-	1	0.2	\$ 76
---	-------------	--	---	---	---	---	-----	-------

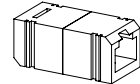

DAISY CHAIN POWER BOX	01-PPOWER		-	-	-	1	0.2	\$ 749
		<i>76" Perimeter, 36" Power Cord</i>						
	01-PPOWER2		-	-	-	1	0.2	\$ 769
		<i>24" Perimeter, 144" Power Cord</i>						

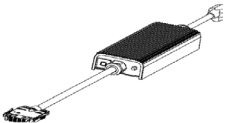

Description

- Powers up to Eight (8) Duo and Trio Daisy Chain Units
- One Nema Plug and One Daisy Chain Plug
- 12-Amp System Rating
- 15-Amp Over-Current Protection

[See One10 Overview For Ordering Options](#)

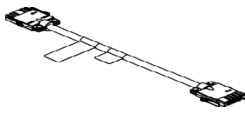
Item	Model No.		W	D	H	Ship Wt	Cubic Ft	List Price
DAISY CHAIN JUMPER CORD 	01-6JUMP	72" Long	-	-	-	1	0.2	\$ 289
	01-5JUMP	60" Long	-	-	-	1	0.2	\$ 274
	01-4JUMP	48" Long	-	-	-	1	0.2	\$ 232
	01-2JUMP	24" Long	-	-	-	1	0.2	\$ 213

Description

- Connects Duo and Trio Daisy Chain Units
- Non-Sequential System Allows up to Eight (8) Modules to be Connected

VESTA POWER CENTER	01-PDCTR		10¾	12	28¼	14	2.5	\$ 1716
--------------------	----------	--	-----	----	-----	----	-----	---------

**Description**

- Top Includes One (1) Power Outlet, Two (2) USB Ports and One (1) USBC Port; Base Includes Three (3) Outlet
- Available in White
- 120" Power Cord
- Built with Weight Distribution for Optimal Stability
- Base is 5" Tall

POWER STRIP	01-PRSP		9	2	2	1	-	\$ 198
-------------	---------	--	---	---	---	---	---	--------

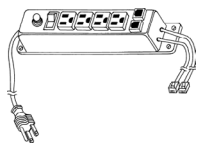
**Description**

- Includes Four (4) Outlets and Two (2) Phone Jacks
- Black Plastic with Rocker On/Off Switch
- 13 Amp Circuit Breaker
- 10' Power Cord and Two (2) 14' Phone Hook Up Cords
- UL and CSA Recognized
- Suitable for Surface or Recessed Mounting
- Ships via UPS Only

WIRE MANAGERS	01-WMGR4		16	1½	¾	1	-	\$ 112
---------------	----------	--	----	----	---	---	---	--------

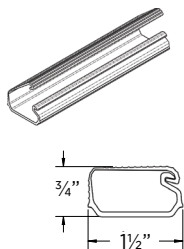
**Description**

- Four (4) Wire Manager Strips
- Black Plastic
- Snap Lock Channel
- Attaches with Adhesive Strips
- Can be Placed on All Units to Route Wires

CABLE GRIP	01-WMGRCB		5¾	2¾	-	-	-	\$ 16
------------	-----------	--	----	----	---	---	---	-------

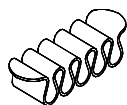
**Description**

- Under Surface Wire Management
- Black

[See One10 Overview For Ordering Options](#)

FLUSH FEATURE OPTION

Select units feature multiple flush options allowing units to be placed next to each other. See specific units for details. Must specify when placing ordering.

- FL Flush Left
- FR Flush Right
- FLR Flush Left and Right

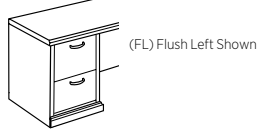

PULL OPTIONS

Note: Lock Core will match Pull Color

- | | |
|----------------------|----------------------|
| AAC Arc, Aluminum | AEL Elite, Aluminum |
| BAC Arc, Black | BEL Elite, Black |
| ABM Beam, Aluminum | AFL Flair, Aluminum |
| BBM Beam, Black | CFL Flair, Chrome |
| BBT Bow Tie, Black | AFC Focus, Aluminum |
| NBT Bow Tie, Nickel | BFC Focus, Black |
| ABU Buckle, Aluminum | AQD Quadra, Aluminum |
| BBU Buckle, Black | BQD Quadra, Black |

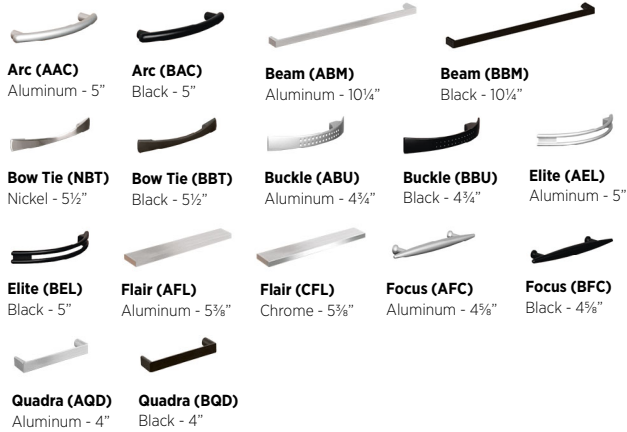

TABLE GROMMET & POWER UNIT OPTIONS

Power units and grommets are sold separately and must be specified separately with surface mount location. Multiple locations may be selected. Only one unit per location.

Power units and Grommets Available in Table Surfaces (See Units)

Grommet Specify Color: Black = BLK and Silver = SLV

DUO/TRIO BEZEL

- 01-DUOBEZEL Available in Black (B), Silver (S), or White (W)
- 01-TRIOBEZEL Available in Black (B), Silver (S), or White (W)

DOCK 950, DOCK 800 and DOCK 150

- DOCK950 Available in Black or White
- DOCK150 Available in Black or White
- DOCK800 Available in Black or Silver

Other Power Units

- DPORT4 Available in Aluminum or Black
- INTERACTG Available in Aluminum or Black
- OASISM Available in Aluminum or Black

TABLE GROMMET & POWER UNIT OPTIONS CONTINUED

Power/Data Location Information:

- Designate unit and location when specifying the top model. Power/Data Module need to be ordered separately.
- Power/Data Modules specified at the time of order will be routed for field installation.
 - E1 Unit on One End
 - E2 Unit on Each End
 - OC Unit on Center

- All power units available **On Center (OC) only** when paired with two (2) or more of the following bases:

- Cylinder Base Square Base
- X-Base Disc
- Tubular X-Base

Grommets and Power Units may be ordered in non-standard locations. Call Customer Service to assist with specification and/or please attach a drawing to the PO showing the location of the grommet. Note additional charges and lead times may apply.

Top Locations

Power units available on Each End (E1 and E2) and On Center (OC) unless otherwise noted, when paired with any Rectangle Panel Base, Rectangle Box Base or Rectangle Accent Box Base. (See Unit Details)

Power units centered at locations below:

- 36" Tops centered 18"D 48" Tops centered 24"D
- 42" Tops centered 21"D

72: OC 36" from end (available with OC Only)

96: OC 48" from end; E1/E2 29" from end

120: OC 60" from end; E1/E2 29" from end

144: OC 72" from end; E1/E2 29" from end

LOCKING DOORS

Locking doors are available on Wardrobes. You must specify WITH LOCKING when ordering and add upcharge.

- | | | | |
|--------|-------------------|----|----|
| LKT_HU | 36"W - 30"W Units | \$ | 88 |
| LKT_HU | 18"W Units | \$ | 67 |

LOCK CORE OPTIONS

Lock core will coordinate with pull color unless otherwise noted.

- BLK Black
- SLV Silver



CERTIFICATIONS & COMPLIANCE

- Intertek Sustainability Certified
- BIFMA level® Certified
- BIFMA Compliant Certified
- TSCA Title VI (formerly CARB) Compliance
- US Green Building's LEED Contribution

Tops and Bases



Round Tops
[\(See Details\)](#)



Rectangle Tops
[\(See Details\)](#)



Boat Tops
[\(See Details\)](#)

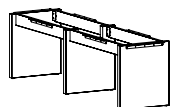

Rectangular Panel
Bases with Trough
[\(See Details\)](#)

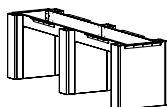

6" Rectangular Bases
with Trough
[\(See Details\)](#)

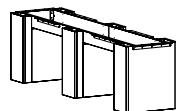

10" Rectangular
Bases with Trough
[\(See Details\)](#)

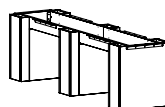

6" Rectangular Accent
Bases with Trough
[\(See Details\)](#)

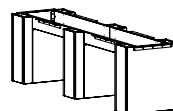

10" Rectangular Accent
Bases with Trough
[\(See Details\)](#)

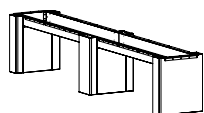

6" + 10" Combo Rectangular
Bases with Trough
[\(See Details\)](#)

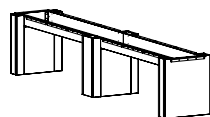

6" + 10" Combo Rectangular
Accent Bases with Trough
[\(See Details\)](#)



Disc Bases
[\(See Details\)](#)

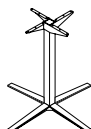

Small and Large X
Bases [\(See Details\)](#)

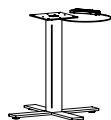

HA Pneumatic X
[\(See Details\)](#)



Metal Bases
[\(See Details\)](#)

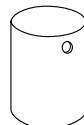

Cylinder
[\(See Details\)](#)



Queen Anne
[\(See Details\)](#)

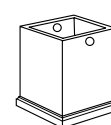

Square
[\(See Details\)](#)

Storage Components

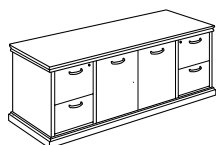

Storage Credenzas
[\(See Details\)](#)

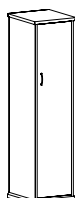

Wardrobe/Storage
[\(See Details\)](#)

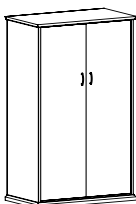

Double Wardrobe/ Storage
[\(See Details\)](#)

Wire Management & Power/Data Accessories

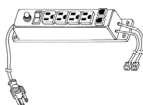
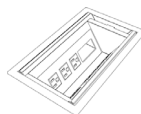

For additional solutions for desking, storage, and accessories, see the [Phoenix Caseloads](#) and [Accessories](#) Price Lists.

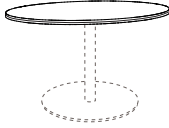
Item	Model No.		Width	Depth	Height	Ship Wt	Cubic Ft	List Price	
ROUND TABLE TOP 	21-4848CT	<i>Accommodates Five (5) Chairs</i>	48	48	30	60	5.7	P\$	1533
								W\$	1979
	21-4242CT	<i>Accommodates Four (4) Chairs</i>	42	42	30	40	4.4	P\$	1421
								W\$	1827
	21-3636CT	<i>Accommodates Three (3) to Four (4) Chairs</i>	36	36	30	35	3.4	P\$	1317
								W\$	1676

21-4242CT shown with 01-2430DBA
(Disc Base)
BASES SOLD SEPARATELY

Must Specify (in this order):

Model #
Top Material
Finish/Color
Edge Profile

Description

- Available with Premium/Standard Veneer (PV/W) or HPL (P) Top, Must Specify
- Single Base Required; Ordered Separately, [See Details](#)
- Power Options not Available

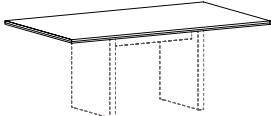
RECTANGULAR TOP	144" or 12' - 2 Piece Tops								
	21-48144RT		144	48	1 $\frac{1}{6}$	275	12.3	P\$	4273
								W\$	4564
	120" or 10' - 2 Piece Tops								
	21-48120RT		120	48	1 $\frac{1}{6}$	225	10.3	P\$	3906
								W\$	4126
	96" or 8' - 1 Piece Top								
	21-4896RT		96	48	1 $\frac{1}{6}$	180	9.4	P\$	2477
								W\$	2710
	72" or 6' - 1 Piece Top								
	21-3672RT		72	36	1 $\frac{1}{6}$	100	6.2	P\$	1622
								W\$	1718

21-3672RT shown with 88-2034RPB
(Rectangle Panel Base)
BASES SOLD SEPARATELY

Description

- Grain Runs the Width of the Table
- Available with Veneer (PV/W) or HPL (P) Top; Must Specify
- Heavy-Duty Ganging Mechanisms Connect Two (2) Piece Tops
- See Bases/Legs and Number Required For Each Top Size, [See Multiple Base Options](#); Must Order Separately
- Optional Grommets and Power/Data Units; [See Location Options](#), [See Power Units Available](#)

[See Phoenix Overview For Ordering Options](#)

Item	Model No.	Width	Depth	Height	Ship Wt	Cubic Ft	List Price
 <p>21-3672BT shown with 88-2034RPB (Rectangle Panel Base) BASES SOLD SEPARATELY</p>	144" or 12' - 2 Piece Tops						
	21-48144BT	144	48	1 $\frac{3}{16}$	275	12.3	P\$ 4967 W\$ 5346
	120" or 10' - 2 Piece Tops						
	21-48120BT	120	48	1 $\frac{3}{16}$	225	10.3	P\$ 4522 W\$ 4817
	96" or 8' - 1 Piece Top						
	21-4896BT	96	48	1 $\frac{3}{16}$	180	9.4	P\$ 3611 W\$ 3904
	72" or 6' - 1 Piece Top						
	21-3672BT	72	36	1 $\frac{3}{16}$	100	6.2	P\$ 2202 W\$ 2277

Description

- Grain Runs the Width of the Table
- Available with Veneer (PV/W) or HPL (P) Top; Must Specify
- Heavy-Duty Ganging Mechanisms Connect Two (2) Piece Tops
- See Bases/Legs and Number Required For Each Top Size, See Below for Multiple Base Options; Must Order Separately
- Optional Grommets and Power/Data Units; [See Location Options](#), [See Power Units Available](#)

RECTANGLE PANEL BASES WITH TROUGH

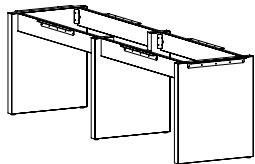

Must Specify (in this order):

Model #
Material
Finish / Color

Three (3) Panel Bases - For Use With 48" x 144" Surfaces							
88-24106RPB	Laminate	24	106	28 $\frac{3}{4}$	116	13.8	T\$ 2899
	Veneer						W\$ 2956
Two (2) Panel Bases - For Use With 48" x 120" Surfaces							
88-2482RPB	Laminate	24	82	28 $\frac{3}{4}$	90	6.9	T\$ 2077
	Veneer						W\$ 2127
Two (2) Panel Bases - For Use With 48" x 96" Surfaces							
88-2458RPB	Laminate	24	58	28 $\frac{3}{4}$	84	6.9	T\$ 1816
	Veneer						W\$ 1888
Two (2) Panel Bases - For Use With 36" x 72" Surfaces							
88-2034RPB	Laminate	20	34	28 $\frac{3}{4}$	66	6.7	T\$ 1522
	Veneer						W\$ 1683

Description

- 2" Panel Bases with Trough, Stretcher Rails, and L-Bracket Hardware Included
- Available with TFL (T) or Veneer (W)
- Vertical Grain Direction on Bases
- Bases Require Some Assembly; Attachment Hardware Included
- Tops Sold Separately

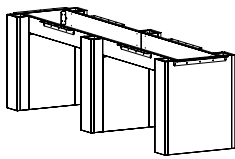
Item	Model No.		Width	Depth	Height	Ship Wt	Cubic Ft	List Price
6" RECTANGLE BASES WITH TROUGH AND REMOVABLE PANEL 	Three (3) 6" Rectangle Bases - For Use With 48" x 144" Surfaces							
	88-2410606RB	Laminate	24	106	28¾	106	19.6	T\$ 4560
		Veneer						W\$ 6239
	Two (2) 6" Rectangle Bases - For Use With 48" x 120" Surfaces							
	88-248206RB	Laminate	24	82	28¾	99	12.9	T\$ 3110
		Veneer						W\$ 4299
	Two (2) 6" Rectangle Bases - For Use With 48" x 96" Surfaces							
	88-245806RB	Laminate	24	58	28¾	93	12.9	T\$ 2921
		Veneer						W\$ 3988
	Two (2) 6" Rectangle Bases - For Use With 36" x 72" Surfaces							
	88-203406RB	Laminate	20	34	28¾	76	12.9	T\$ 2683
		Veneer						W\$ 3691

Must Specify (in this order):

- Model #
- Material
- Finish / Color

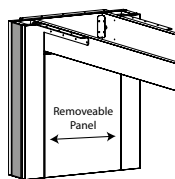

Description

- 6" Rectangle Bases with Trough and Stretcher Rails
- Available with TFL (T) or Veneer (W)
- 5/8" Metal Accent Available in Four (4) Colors: Aluminum, Black, Gold, and Platinum; Must Specify Color
- Vertical Grain Direction on Bases
- Bases Include Interior Removable Panel for Wire Management Access. Removable Panel is 15 7/8"W for 24" Bases and 11 7/8"W for 20" Bases
- Removable Panels Attached with Z Brackets
- Bases Require Some Assembly; Attachment Hardware Included
- Tops Sold Separately

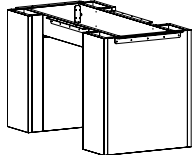
10" RECTANGLE BASES WITH TROUGH AND REMOVABLE PANEL 	Three (3) 10" Rectangle Bases - For Use With 48" x 144" Surfaces							
	88-2410610RB	Laminate	24	106	28¾	141	18.2	T\$ 4677
		Veneer						W\$ 6329
	Two (2) 10" Rectangle Bases - For Use With 48" x 120" Surfaces							
	88-248210RB	Laminate	24	82	28¾	96	12.0	T\$ 3188
		Veneer						W\$ 4359
	Two (2) 10" Rectangle Bases - For Use With 48" x 96" Surfaces							
	88-245810RB	Laminate	24	58	28¾	89	12.0	T\$ 2999
		Veneer						W\$ 4048
	Two (2) 10" Rectangle Bases - For Use With 36" x 72" Surfaces							
	88-203410RB	Laminate	20	34	28¾	72	10.0	T\$ 2760
		Veneer						W\$ 3751

Must Specify (in this order):

- Model #
- Material
- Finish / Color

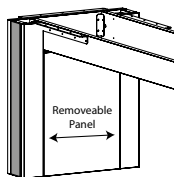

Description

- 6" Rectangle Bases with Trough and Stretcher Rails
- Available with TFL (T) or Veneer (W)
- 5/8" Metal Accent Available in Four (4) Colors: Aluminum, Black, Gold, and Platinum; Must Specify Color
- Vertical Grain Direction on Bases
- Bases Include Interior Removable Panel for Wire Management Access. Removable Panel is 15 7/8"W for 24" Bases and 11 7/8"W for 20" Bases
- Removable Panels Attached with Z Brackets
- Bases Require Some Assembly; Attachment Hardware Included
- Tops Sold Separately

[See Phoenix Overview For Ordering Options](#)

Item	Model No.		Width	Depth	Height	Ship Wt	Cubic Ft	List Price
6" + 10" COMBO RECTANGLE BASES WITH TROUGH AND REMOVABLE PANEL	Three (3) Bases Total: Two (2) 6" and One (1) 10" Rectangle Bases - For Use With 60" / 54" / 48" x 144" Surfaces							
	88-24106C610RB	Laminate	24	106	28¾	141	18.2	T\$ 4599
		Veneer						W\$ 6269

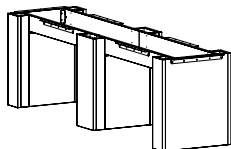

Must Specify (in this order):

- Model #
- Material
- Finish / Color

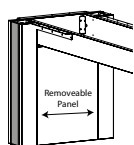

Description

- 6" + 10" Rectangle Bases with Trough and Stretcher Rails; 6" Bases on Exterior and 10" Bases on Interior
- Available with TFL (T) or Veneer (W)
- Vertical Grain Direction on Bases
- Bases Include Interior Removable Panel for Wire Management. Removable Panel is 15½"W and Attaches with Z Brackets.
- Bases Require Some Assembly; Attachment Hardware Included
- Tops Sold Separately

6" RECTANGLE ACCENT BASES WITH TROUGH AND REMOVABLE PANEL

6" RECTANGLE ACCENT BASES WITH TROUGH AND REMOVABLE PANEL	Three (3) 6" Rectangle Bases - For Use With 48" x 144" Surfaces							
	88-2410606RAB	Laminate	24	106	28¾	106	19.6	T\$ 5212
		Veneer						W\$ 6931
	Two (2) 6" Rectangle Bases - For Use With 48" x 120" Surfaces							
	88-248206RAB	Laminate	24	82	28¾	99	12.9	T\$ 4585
		Veneer						W\$ 6218
	Two (2) 6" Rectangle Bases - For Use With 48" x 96" Surfaces							
	88-245806RAB	Laminate	24	58	28¾	93	12.9	T\$ 3362
		Veneer						W\$ 4454
	Two (2) 6" Rectangle Bases - For Use With 36" x 72" Surfaces							
	88-203406RAB	Laminate	20	34	28¾	76	12.9	T\$ 3123
		Veneer						W\$ 4157

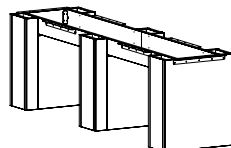

Must Specify (in this order):

- Model #
- Base Finish/Color
- Metal Accent Color
- Accent Panel Finish/Color

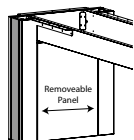

Description

- 6" Rectangle Bases with Trough and Stretcher Rails
- Available with TFL (T) or Veneer (W)
- 5/16" Metal Accent Available in Four (4) Colors: Aluminum, Black, Gold, and Platinum; Must Specify Color
- Vertical Grain Direction on Bases
- Bases Include Interior Removable Panel for Wire Management Access. Removable Panel is 15½"W for 24" Bases and 11½"W for 20" Bases
- Removable Panels Attached with Z Brackets
- Bases Require Some Assembly; Attachment Hardware Included
- Tops Sold Separately

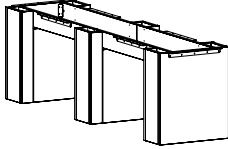
Item	Model No.		Width	Depth	Height	Ship Wt	Cubic Ft	List Price	
10" RECTANGLE ACCENT BASES WITH TROUGH AND REMOVABLE PANEL 	Three (3) 10" Rectangle Bases - For Use With 48" x 144" Surfaces								
	88-2410610RAB	Laminate	24	106	28¾	141	18.2	T\$ 5277	
		Veneer						W\$ 7013	
	Two (2) 10" Rectangle Bases - For Use With 48" x 120" Surfaces								
	88-248210RAB	Laminate	24	82	28¾	96	12.0	T\$ 3591	
		Veneer						W\$ 4817	
	Two (2) 10" Rectangle Bases - For Use With 48" x 96" Surfaces								
	88-245810RAB	Laminate	24	58	28¾	89	12.0	T\$ 3402	
		Veneer						W\$ 4506	
	Two (2) 10" Rectangle Bases - For Use With 36" x 72" Surfaces								
	88-203410RAB	Laminate	20	34	28¾	72	10.0	T\$ 3100	
		Veneer						W\$ 4131	

Must Specify (in this order):

- Model #
- Base Finish/Color
- Metal Accent Color
- Accent Panel Finish/Color

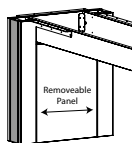

Description

- 10" Rectangle Bases with Trough and Stretcher Rails
- Available with TFL (T) or Veneer (W)
- ⅝" Metal Accent Available in Four (4) Colors: Aluminum, Black, Gold, and Platinum; Must Specify Color
- Vertical Grain Direction on Bases
- Bases Include Interior Removable Panel for Wire Management Access. Removable Panel is 15⅞"W for 24" Bases and 11⅞"W for 20" Bases
- Removable Panels Attached with Z Brackets
- Bases Require Some Assembly; Attachment Hardware Included
- Tops Sold Separately

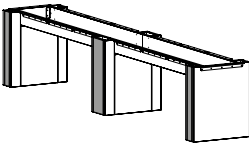
6" + 10" COMBO RECTANGLE ACCENT BASES WITH TROUGH AND REMOVABLE PANEL 	Three (3) Bases Total: Two (2) 6" and One (1) 10" Rectangle Bases - For Use With 60" / 54" / 48" x 144" Surfaces								
	88-24106C610RAB	Laminate	24	106	28¾	141	18.2	T\$ 5237	
		Veneer						W\$ 6961	

Must Specify (in this order):

- Model #
- Base Finish/Color
- Metal Accent Color
- Accent Panel Finish/Color

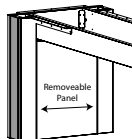

Description

- 6" + 10" Rectangle Accent Bases with Trough and Stretcher Rails; 6" Bases on Exterior and 10" Bases on Interior
- Available with TFL (T) or Veneer (W)
- ⅝" Metal Accent Available in Four (4) Colors: Aluminum, Black, Gold, and Platinum; Must Specify Color
- Vertical Grain Direction on Bases
- Bases Include Interior Removable Panel for Wire Management. Removable Panel is 15⅞"W and Attaches with Z Brackets
- Bases Require Some Assembly; Attachment Hardware Included
- Tops Sold Separately

[See Phoenix Overview For Ordering Options](#)

Item	Model No.		Width	Depth	Height	Ship Wt	Cubic Ft	List Price	
DISC BASE 	For 48" Round Tops								
	01-3230DBB	Black	30	30	27¾	42	4.1	\$ 1780	
	01-3230DBA	Aluminum	30	30	27¾	42	4.1		
	For 36" and 42" Round Tops								
	01-2430DBB	Black	24	24	27¾	32	3.2	\$ 1483	
	01-2430DBA	Aluminum	24	24	27¾	32	3.2		

Description

- 4" Diameter 14 Gauge Steel Column
- 12"x12" Mounting Plate at Top of Column
- ¼" Thick Disc Plate with 5 Levelers
- Some Assembly Required

Table Widths	Round	72"	96"
Number of Bases Required	1	2	2

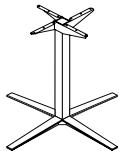
Item	Model No.		Width	Depth	Height	Ship Wt	Cubic Ft	List Price	
METAL X-BASE 	For Use With								
	Round Tops: 42" + 48"								
	Top Surfaces: 48"x96"								
	08-2642LXBB	Black	35½	35½	40	33	20.0	\$ 1277	
	08-2642LXBA	Aluminum							
	<i>For 42"H Tables</i>								
	08-2636LXBB	Black	35½	35½	34	30	17.2	\$ 1232	
	08-2636LXBA	Aluminum							
	<i>For 36"H Tables</i>								
	08-2630LXBB	Black	35½	35½	28	27	14.5	\$ 1178	
	08-2630LXBA	Aluminum							
	<i>For 30"H Tables</i>								
	For Use With								
	Round: 36"								
	Top Surfaces: 36"x72"								
	08-2042SXBB	Black	29	29	40	27	15.9	\$ 1193	
08-2042SXBA	Aluminum								
<i>For 42"H Tables</i>									
08-2036SXBB	Black	29	29	34	24	13.7	\$ 1145		
08-2036SXBA	Aluminum								
<i>For 36"H Tables</i>									
08-2030SXBB	Black	29	29	28	21	11.6	\$ 1100		
08-2030SXBA	Aluminum								
<i>For 30"H Tables</i>									

Description

- See Number of Bases Required Per Top Width Below
- Not Available to be Sold Separately
- Power Units Available On Center When Using Two or More Metal X-Bases
- Ships Assembled

Table Widths	Round	72"	96"
Number of Bases Required	1	2	2

P = HPL W = Veneer

For ordering options, see overview at the beginning of this section.

[See Phoenix Overview For Ordering Options](#)

Item	Model No.		Width	Depth	Height	Ship Wt	Cubic Ft	List Price	
HEIGHT ADJUSTABLE PNEUMATIC X-BASE 	Maximum Round 42"								
	01-3232HAXBB	Black	32	32	26-45¾	1	0.2	\$ 1663	
	01-3232HAXBA	Aluminum	32	32	26-45¾	1	0.2		
	Maximum Round 36"								
	01-2626HAXBB	Black	22	22	26-45¾	1	0.2	\$ 1630	
	01-2626HAXBA	Aluminum	22	22	26-45¾	1	0.2		

Description

- Pre-Drilled Boring Pattern May Not Match Underside of Table Top
- Steel Mounting Plate: 8"x 8"x ¼"
- Eight (8) Bolts Included for Assembly
- Some Assembly Required

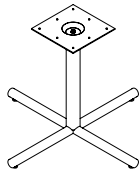
TUBULAR X-BASE 	For Use With Round Tops: 48" Top Surfaces: 48"x96"								
	01-3830TXB	Black	38	38	27¾	40	4.2	\$ 675	
	01-3830TXA	Aluminum							
	For Use With Round Tops: 36", 42" Top Surfaces: 36"x72"								
	01-3230TXB	Black	32	32	27¾	32	3.2	\$ 612	
	01-3230TXA	Aluminum							

Description

- 3" Diameter Column
- See Number of Bases Required Per Top Width Below
- Power Units Available On Center When Using Two or More Tubular X-Bases
- Some Assembly Required

Table Widths	Round	72"	84"	96"
Number of Bases Required	1	2	2	2

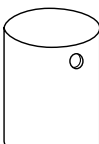
CYLINDER BASE 	For Tables 42"D to 48"D							
	01-2020CB		20	20	28½	136	10.9	W\$ 1500
	For Tables 36"D							
01-1616CB		16	16	28½	101	7.2	W\$ 1371	

Description

- Veneer Base Features Multi-Step, Hand-Finished Catalyzed Finish
- Weighted for Stability
- Two (2) Wire Management Black Grommets Standard at Top Edge; 8" Opening Standard at Bottom

Additional Grommet Options: Specify & Add

GCB1S	Only One (1) Grommet At Top Edge	\$	N/C
NOGC	No Grommets At Top Edge	\$	N/C

Must Specify (in this order):

- Model #
- Finish
- Grommet Options

[See Phoenix Overview For Ordering Options](#)

Item	Model No.	Width	Depth	Height	Ship Wt	Cubic Ft	List Price
QUEEN ANNE BASE	01-0606QB	24	24	28¾	136	11.1	W\$ 1358

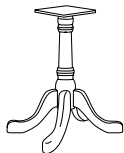

Description

- Classic Design Detail on Column
- Base Features Multi-Step, Hand-Finished Catalyzed Finish
- Four (4) Legs with Adjustable Glides

Must Specify (in this order):

Model #
Finish

SQUARE BASE	21-2020SB	20	20	28¾	57	8.4	W\$ 1143
-------------	-----------	----	----	-----	----	-----	----------

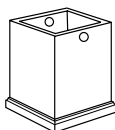

For Use with 48" or 42" Tops

	21-1616SB	16	16	28¾	41	6.0	W\$ 1063
--	-----------	----	----	-----	----	-----	----------

For Use with 36" Top

Description

- Veneer Base
- Two (2) Wire Management Black Grommets Standard at Top and 8" Wire Management Opening in Bottom

Must Specify (in this order):

Model #
Finish
Grommet Options



Options: Specify & Add

NOGC	No Grommet at Top Edge	\$	N/C
------	------------------------	----	-----

P = HPL W = Veneer

[See Phoenix Overview For Ordering Options](#)

Item	Model No.	Width	Depth	Height	Ship Wt	Cubic Ft	List Price
STORAGE CREDENZA	21-2072SC	72	20 ⁷ / ₁₆	30	349	29.0	P\$ 4213 W\$ 4593
	21-2066SC	66	20 ⁷ / ₁₆	30	320	26.6	P\$ 4064 W\$ 4434

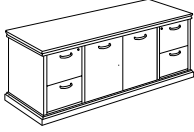

Must Specify (in this order):

- Model #
- Top Material
- Finish/Color
- Pull
- Flush Feature

Description

- Letter Width Locking File/File Pedestals
- Available with Veneer (W) or HPL (P) Top, Must Specify
- Fixed Storage Shelf Behind Doors
- Profiles on Three (3) Sides for Flush Wall Application Standard
- Flush Feature Available; Must Specify: Flush Left (FL), Flush Right (FR) or Flush Left and Right (FLR)
- Flush Option Reduces Unit by 3/4" Per Side and 1 1/2" for Both Flush Sides

WARDROBE/STORAGE CABINET	Hinged Left	Hinged Right	Width	Depth	Height	Ship Wt	Cubic Ft	List Price
	21-1872WL	21-1872WR						

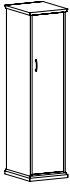

Shown as Right

Must Specify (in this order):

- Model #
- Finish
- Pull
- Locking Doors
- Flush Feature

Description

- Coat Rod Under Top Fixed Shelf
- Three (3) Adjustable Shelves; Adjustable Shelves can be Removed for Wardrobe Application
- Profiles on Three (3) Sides for Flush Wall Application Standard
- Flush Feature Available; Must Specify: Flush Left (FL), Flush Right (FR) or Flush on Both Sides (FLR)
- Flush Option Reduces Unit by 3/4" Per Side and 1 1/2" if Both Sides Are Selected to be Flush
- Optional Locking Doors ([See Locking Options](#)), Lock Core will Coordinate with Pull Color

DOUBLE WARDROBE/STORAGE	21-3672WC	36	20 ⁷ / ₁₆	70 ⁷ / ₈	290	42.0	W\$ 3999
	21-3072WC	30	20 ⁷ / ₁₆	70 ⁷ / ₈	240	35.7	W\$ 3894

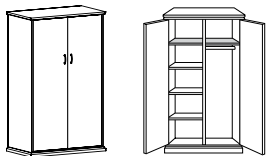

Must Specify (in this order):

- Model #
- Finish
- Pull
- Locking Doors
- Flush Feature

Description

- Fixed Top Shelf Behind Each Door
- Three (3) Adjustable Shelves on Left Side; Coat Rod Under Fixed Shelf on Right Side
- Profiled on Three (3) Sides for Flush Wall Applications Standard
- Flush Feature Available; Must Specify: Flush Left (FL), Flush Right (FR) or Flush on Both Sides (FLR)
- Flush Option Reduces Unit by 3/4" Per Side and 1 1/2" if Both Sides Are Selected to be Flush
- Optional Locking Doors ([See Locking Options](#)), Lock Core will Coordinate with Pull Color

P = HPL W = Veneer

[See Phoenix Overview For Ordering Options](#)

Item	Model No.		Width	Depth	Height	Ship Wt	Cubic Ft	List Price
SINGLE POWER SAND DOLLAR	01-SAND60PS	Silver	3	3	4	1	0.2	\$ 95
	01-SAND60PW	White						\$ 95
	01-SAND60PB	Black					\$ 95	

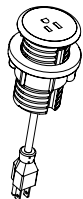
Description

- Mounts in 2 $\frac{3}{8}$ " (60mm) Round Grommet
- Single Power Outlet with 6' Cord

DOUBLE USB SAND DOLLAR	01-SAND60US	Silver	3	3	4	1	0.2	\$ 268
	01-SAND60UW	White						\$ 268
	01-SAND60UB	Black					\$ 268	

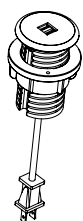
Description

- Mounts in 2 $\frac{3}{8}$ " (60mm) Round Grommet
- Dual USB Outlets with 6' Cord

DOCK 950 WIRELESS CHARGER	01-DOCK950W	White	3 $\frac{3}{16}$	3 $\frac{3}{16}$	-	1	0.2	\$ 256
	01-DOCK950B	Black						\$ 256



OPEN MARKET ONLY

Description

- For Use with Wireless Charging Enabled Devices
- 5 Watts Maximum Output with a Direct Current of 5V 2A and 10 Watts Maximum with Quick Charge 2.0
- LED will Confirm Pairing with Device and Begin Wireless Charging

WIRELESS AND USB CHARGER	01-DOCK150W	White	3	3	$\frac{3}{4}$ "	1	0.2	\$ 391
	01-DOCK150B	Black						\$ 391

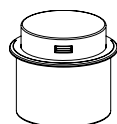

OPEN MARKET ONLY

Description

- For Use with Wireless Charging Enabled Devices and USB Charging Devices
- 5 Watt Maximum Output with a Direct Current Input of 5V 6A (Wireless Fast Charge)
- Pop-Up is $\frac{3}{4}$ "H and Includes Three (3) USB Ports; One (1) 12 Watt Maximum with 2.4A (USB Fast Charge) and Two (2) 5 Watt with 1A (USB Standard Charge)
- LED Light will Confirm Pairing with Device and Begin Wireless Charging
- UL and cUL Certified

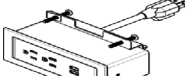
Item	Model No.		Width	Depth	Height	Ship Wt	Cubic Ft	List Price
	01-DUOBEZELW	White	6½	2¼	3¼	1	0.2	\$ 652
	01-DUOBEZELB	Black						
	01-DUOBEZELS	Silver						

Description

- Sits on Table Top and Includes: Two (2) Power, Two (2) USB, 10' Cord, and All Mounting Hardware
- Independent USB Circuit Controllers Deliver up to 2.1 Amps to Each Post
- FCC Part 15A, UL Recognized for Horizontal and Vertical Applications

	01-TRIOBEZELW	White	9	2¼	3	1	0.2	\$ 700
	01-TRIOBEZELB	Black						
	01-TRIOBEZELS	Silver						

Description

- Sits on Table Top and Includes: Three (3) Power Outlets, Two (2) USB Ports, One (1) Open Data Port, 10' Cord, and All Mounting Hardware
- HDMI, VGA, and RJ45 Accessories for Open Data Port; Sold Separately, [See Accessories](#)
- Independent USB Circuit Controllers Deliver up to 2.1 Amps to Each Post
- FCC Part 15A, UL Recognized for Horizontal and Vertical Applications

	01-PDUOBEZELW	White	6½	2¼	3	1	0.2	\$ 645
	01-PDUOBEZELB	Black						
	01-PDUOBEZELS	Silver						

Description

- Sits on Table Top and Includes: Two (2) Power, Two (2) USB, 12" Cord, and All Mounting Hardware
- Requires Daisy Chain Power Box; Sold Separately, [See Power Box Details](#)
- Non-Sequential System Allows up to Eight (8) Modules to be Connected with Jumper Cord, [See Jumper Cord Details](#)
- Independent USB Circuit Controllers Deliver up to 2.1 Amps to Each Post
- FCC Part 15A, RU Listed and UL Recognized for Horizontal and Vertical Applications

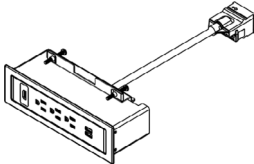
	01-PTRIOBEZELW	White	9	2¼	3	1	0.2	\$ 691
	01-PTRIOBEZELB	Black						
	01-PTRIOBEZELS	Silver						



Description

- Sits on Table Top and Includes: Three (3) Power Outlets, Two (2) USB Ports, One (1) Open Data Port, 12" Cord, and All Mounting Hardware
- HDMI, VGA, or RJ45 Accessory for Open Data Port; Sold Separately, [See Accessories](#)
- Requires Daisy Chain Power Box, Specified Separately, See Next Page
- Non-Sequential System Allows up to Eight (8) Modules to be Connected with Jumper Cord, [See Jumper Cord Details](#)
- Independent USB Circuit Controllers Deliver up to 2.1 Amps to Each Post
- FCC Part 15A, RU Listed and UL Recognized for Horizontal and Vertical Applications

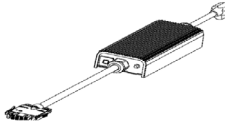
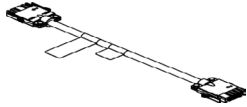
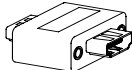
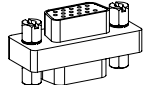
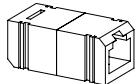
[See Phoenix Overview For Ordering Options](#)

Item	Model No.		Width	Depth	Height	Ship Wt	Cubic Ft	List Price
DAISY CHAIN POWER BOX 	01-PPOWER	<i>76" Perimeter, 36" Power Cord</i>	-	-	-	1	0.2	\$ 749
	01-PPOWER2	<i>24" Perimeter, 144" Power Cord</i>	-	-	-	1	0.2	\$ 769
Description <ul style="list-style-type: none"> • Powers up to Eight (8) Duo and Trio Daisy Chain Units • One Nema Plug and One Daisy Chain Plug • 12-Amp System Rating • 15-Amp Over-Current Protection 								
DAISY CHAIN JUMPER CORD 	01-6JUMP	<i>72" Long</i>	-	-	-	1	0.2	\$ 289
	01-5JUMP	<i>60" Long</i>	-	-	-	1	0.2	\$ 274
	01-4JUMP	<i>48" Long</i>	-	-	-	1	0.2	\$ 232
	01-2JUMP	<i>24" Long</i>	-	-	-	1	0.2	\$ 213
Description <ul style="list-style-type: none"> • Connects Duo and Trio Daisy Chain Units • Non-Sequential System Allows up to Eight (8) Modules to be Connected 								
HDMI DATA PORT ACCESSORY FOR TRIO UNITS 	01-LCOMHDMI		-	-	-	1	0.2	\$ 160
OPEN MARKET ONLY								
VGA DATA PORT ACCESSORY FOR TRIO UNITS 	01-LCOMVGA		-	-	-	1	0.2	\$ 117
RJ45 DATA PORT ACCESSORY FOR TRIO UNITS 	01-LCOMRJ45		-	-	-	1	0.2	\$ 76

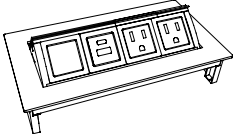
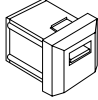
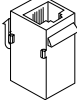
[See Phoenix Overview For Ordering Options](#)

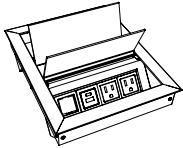
Item	Model No.		Width	Depth	Height	Ship Wt	Cubic Ft	List Price
	01-DPORT4A	Aluminum	8	4	-	7	0.2	\$ 1056
	01-DPORT4B	Black						
<p>Description</p> <ul style="list-style-type: none"> Retracts into Work Surface to Regain Productive Space; One-Touch Access to Power and Data Two (2) Power Outlets, One (1) USB A+C, and One (1) Open Port Optional Telecom Port Components, See Options Water-Proof Simplex (Outlets) Includes a Voice/Data Adapter Kit to Accept Couplers and Jacks When Required 10' Power Cord UL Recognized 								
	01-USBPORT		-	-	-	-	-	\$ 156
<p>Description</p> <ul style="list-style-type: none"> Passive USB-A Port with Increased Transfer Speed Up to 5 gbs/sec Simultaneous Read/Write Capability; Idle Device Power Saving State 6' Cord Compatible with 01-DPORT4A, 01-DPORT4B 								
	01-VOICE1		-	-	-	-	-	\$ 71
<p>Description</p> <ul style="list-style-type: none"> 6-Pin Modular Plug Molded Black; Cord Not included Compatible with 01-DPORT4A, 01-DPORT4B 								
	01-RJ4DATA		-	-	-	-	-	\$ 161
<p>Description</p> <ul style="list-style-type: none"> 8-Pin Modular Plug; Cat6 Ethernet Cable; Pre-terminated Cable 10' Cord Compatible with 01-DPORT4A, 01-DPORT4B 								
 <p>01-E2X4 SIN PENDING</p>	01-E2X6A	Aluminum	11	9 ¹³ / ₁₆	-	6	0.7	\$ 1570
	01-E2X6B	Black						
	01-E2X4A	Aluminum	8	9 ¹³ / ₁₆	-	5	0.5	\$ 1443
	01-E2X4B	Black						
<p>Description</p> <ul style="list-style-type: none"> In Surface, Dual Side Application; Soft Touch Access to Power and Data 11" Unit Includes Three (3) Power Outlets, One (1) USB A+C, and Two (2) Open Port on Each Side; 8" Unit Includes Two (2) Power Outlets, One (1) USB A+C, and One (1) Open Port on Each Side Optional Telecom Port Components, See Compatible Units 6' Power Cord UL Listed 								

[See Phoenix Overview For Ordering Options](#)

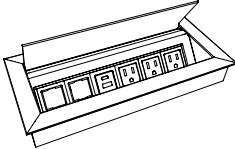
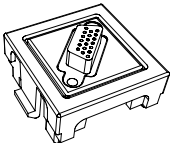
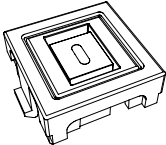
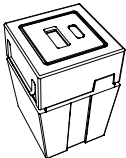
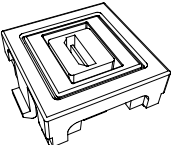
Item	Model No.		Width	Depth	Height	Ship Wt	Cubic Ft	List Price	
 <p>01-ELLORA6 SIN PENDING</p>	01-ELLORA6A	Aluminum	11	5	-	6	0.7	\$ 823	
	01-ELLORA6B	Black							
	01-ELLORA4A	Aluminum	8	5	-	5	0.5	\$ 765	
	01-ELLORA4B	Black							
Description			<ul style="list-style-type: none"> In Surface Application; Soft Touch Access to Power and Data 11" Includes Three (3) Power Outlets, One (1) USB A+C, and Two (2) Open Port; 8" Includes Two (2) Power Outlets, One (1) USB A+C, and One (1) Open Port Optional Telecom Port Components, See Below for Compatible Units 6' Power Cord UL Recognized 						
VGA CONNECTOR ACCESSORY	01-VGACON		-	-	-	1	0.2	\$ 144	
	Description								
	<ul style="list-style-type: none"> VGA Port for 01-DPORT4A, 01-DPORT4B, ELLORA4A, ELLORA4B, ELLORA6A, ELLORA6B, E2X4A, E2X4B, E2X6A, and E2X6B Enables Devices to Remote Display on Monitors 10' Cord Male/Female Connector 								
PASSIVE USB-C ACCESSORY	01-PUSBC		-	-	-	1	0.2	\$ 92	
	Description								
	<ul style="list-style-type: none"> Passive USB-C Port ; Unit Provides Data Connection to Transfer Data Only, No Charging Capabilities Compatible with 01-DPORT4A, 01-DPORT4B, ELLORA4A, ELLORA4B, ELLORA6A, ELLORA6B, E2X4A, E2X4B, E2X6A, and E2X6B Male/Female Connector 								
CHARGING USB-A+C ACCESSORY	01-USBAC		-	-	-	1	0.2	\$ 273	
	Description								
	<ul style="list-style-type: none"> For Charging Devices 20 Watt Power Supply USB+C Charging Port for 01-DPORT4A, 01-DPORT4B, ELLORA4A, ELLORA4B, ELLORA6A, ELLORA6B, E2X4A, E2X4B, E2X6A, and E2X6B 								
HDMI CONNECTOR ACCESSORY	01-HDMICON		-	-	-	1	0.2	\$ 120	
	Description								
	<ul style="list-style-type: none"> HDMI Port for 01-DPORT4A, 01-DPORT4B, ELLORA4A, ELLORA4B, ELLORA6A, ELLORA6B, E2X4A, E2X4B, E2X6A, and E2X6B Connects to High Definition Displays Female/Female Connector 18" Cord 								

[See Phoenix Overview For Ordering Options](#)

Item	Model No.		Width	Depth	Height	Ship Wt	Cubic Ft	List Price
INTERACT POWER & DATA	01-INTERACTG2A	Aluminum	9	5¾	2¾	5	0.2	\$ 861
	01-INTERACTG2B	Black						

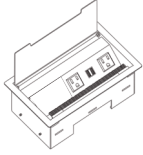

Description

- Includes: Two (2) Power Outlets, Two (2) USB-A Charging Ports, One (1) Telecom Plate Opening; Two (2) Keystone Openings for Voice/Data Jacks
- One (1) Telecom Plates Included with the Unit: One (1) 01-ABLAB Plate (Consists of One (1) RJ45 Cat 6, One (1) RJ11 Cat 3 Phone Jack)
- Convenience Plug on Bottom
- 6' Power Cord
- UL and CSA Recognized
- Additional Telecom Plates, [See ECA Telecom Plate Options](#)

OASIS MINI POWER & DATA	01-OASISMA	Aluminum	15	9	5	11	0.3	\$ 3083
	01-OASISMB	Black						



Top View

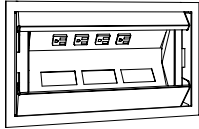

Description

- For Use with Conference Tables
- Soft Touch Hinged Lid
- Four (4) Power Outlets, Three (3) Telecom Plate Openings
- Two (2) Telecom Plates Included with the Unit: One (1) 01-ABLAB Plate (Consists of One (1) RJ45 Cat 6, One (1) RJ11 Cat 3 Phone Jack); One (1) 01-ABLB Plate (Consists of One (1) RJ45 Cat 6)
- 9' Power Cord
- UL Listed
- Additional Telecom Plates, [See ECA Telecom Plate Options](#)

DOCK800	01-DOCK800S	Silver	14	9	-			\$ 1978
	01-DOCK800B	Black						

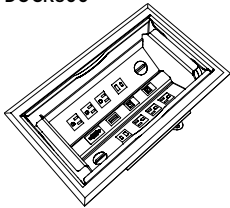

OPEN MARKET ONLY

Description

- Stylish Aluminum Housing with Beveled Edges; Soft Touch Access and Closure
- Includes: Six (6) Power Outlets, Two (2) USB-A 5V Ports, Two (2) USB-C Charging Ports, One (1) RJ45 Ethernet Port, One (1) RJ11 Port, One (1) HDMI Port, and One (1) VGA Port
- 10' Power Cord
- UL and cUL Certified

POWER ENTRY HARD WIRED	01-HWPOWERENTRY		72	-	-	1	0.2	\$ 311
------------------------	-----------------	--	----	---	---	---	-----	--------

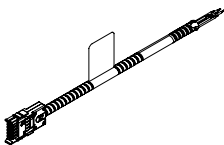

Description

- Eight (8) Wire/Four (4) Circuit Hard Wire In-feed
- UL183 Compliant

[See Phoenix Overview For Ordering Options](#)

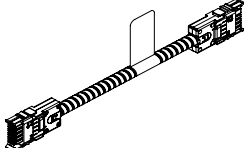
Item	Model No.	Width	Depth	Height	Ship Wt	Cubic Ft	List Price
	01-HW2JUMP	24	-	-	1	0.2	\$ 186
	01-HW3JUMP	36	-	-	1	0.2	\$ 199
	01-HW4JUMP	48	-	-	1	0.2	\$ 205
	01-HW5JUMP	60	-	-	1	0.2	\$ 246
	01-HW6JUMP	72	-	-	1	0.2	\$ 261

Description

- Eight (8) Wire/Four (4) Circuit Hard Wire Jumper
- UL183 Compliant

QUAD BLOCK HARD WIRED	01-HWQUADBLOCK	-	-	-	1	0.2	\$ 60
-----------------------	----------------	---	---	---	---	-----	-------

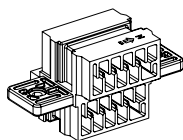
**Description**

- Eight (8) Wire/Four (4) Circuit Hard Wire Connector
- UL183 Compliant
- For Connecting Jumpers and Power Units
- Quantity of Four (4) Female Inputs

WIRE MANAGEMENT CHANNEL	01-WMGR4	16	1½	¾	1	-	\$ 112
-------------------------	----------	----	----	---	---	---	--------

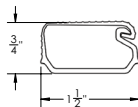
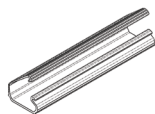
**Description**

- Set of Four (4) Black Plastic Wire Management Channels
- Snap Lock Channel
- Attaches with Adhesive Strips
- Ships via UPS Only

WIRE CHANNEL	01-32125	24	1%	1	.25	0.3	\$ 102
--------------	----------	----	----	---	-----	-----	--------

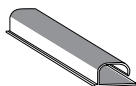
**Description**

- Available in Black
- Channels Attach with Two (2) Double-Sided Installation Tape
- Open J Channel for Easy Storage of Cables

CABLE GRIP	01-WMGRCB	5%	2%	-	-	-	\$ 16
------------	-----------	----	----	---	---	---	-------

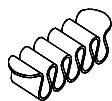
**Description**

- Under Surface Wire Management
- Black

Item	Model No.	Width	Depth	Height	Ship Wt	Cubic Ft	List Price
ECA TELECOM PLATES	01-ABL	Telecom Plate, Blank Plate					\$ 40
	01-ABL737373	Telecom Plate, Three (3) RJ45 Cat 5e					\$ 355
	Compatible with:	01-ABLAB	Telecom Plate, One (1) RJ45 Cat 6, One (1) RJ11 Cat 3 Phone				\$ 199
		01-ABLAB102	Telecom Plate, One (1) RJ45 Cat 6, One (1) RJ11 Cat 3, One (1) USB W/72" Patch Cord				\$ 309
		01-ABLABB	Telecom Plate, Two (2) RJ45 Cat 6, One (1) RJ11 Cat 3 Phone				\$ 309
	Oasis Mini Power & Data 01-OASISMA, 01-OASISMB	01-ABLB	Telecom Plate, One (1) RJ45 Cat 6				\$ 144
		01-ABLBB	Telecom Plate, Two (2) RJ45 Cat 6				\$ 251
	Interact Power & Data 01-INTERACTG2A, 01-INTERACTG2B	01-ABLBBB	Telecom Plate, Three (3) RJ45 Cat 6				\$ 355
		01-ABLBBB	Telecom Plate, Four (4) RJ45 Cat 6				\$ 460
	Power Center 01-INTRFCIA, 01-INTRFCIB	01-ABLBBC51	Telecom Plate, Two (2) RJ45 Cat 6, One (1) 15 Pin HD VGA w/72" Patch Cord				\$ 431
		01-ABLBC51L	Telecom Plate, One (1) RJ45 Cat 6, One (1) Mini Stereo Inline, One (1) 15 Pin HD VGA w/72" Patch Cord				\$ 396
		01-ABLC3811	Telecom Plate, One (1) RJ45 Cat 6 Data Inline, One (1) RJ11 Cat 3 Phone Inline				\$ 190
		01-ABLC45	Telecom Plate, One (1) HDMI w/36" Patch Cord				\$ 285
		01-ABLC45C51L	Telecom Plate, One (1) Mini Stereo Inline, One (1) HDMI w/36" Patch Cord, One (1) 15 Pin HD VGA w/72" Patch Cord				\$ 539
		01-ABLC51L	Telecom Plate, One (1) 15 Pin HD VGA & One (1) Mini Stereo Inline Jack				\$ 288
		01-ABLCRDM	Telecom Plate, Three (3) Cord Bushings				\$ 93

[See Phoenix Overview For Ordering Options](#)

Dress up a casual drop-in meeting room or add prestige to an executive suite. Strut Tables are designed with precision minimalist lines and angles to establish modern sensibility in any space. With tops available in round, square, rectangle, modern rectangle, and boat shapes, in a range of veneer, laminate, and glass options, and in sizes ranging from 3.5 square feet to 5 by 20 feet, Strut can accommodate small meeting spaces, cafes, private offices, or even large board rooms.

CONSTRUCTION

VENEER

- Exposed surfaces feature select grade plain-sliced hardwood veneers in Cherry, Maple, American Black Walnut, or composite veneers. Veneers are carefully selected and matched to assure proper balance and consistency
- Veneer features UV Advantage, an ultra-violet finish, on all exposed surfaces by utilizing roll-coat UV technology

LAMINATE

- Thermally-Fused Laminate (TFL) and High-Pressure Laminate (HPL) are made of woodgrain and solid color laminates fused to particleboard core; each laminate offers lasting beauty, superior resistance to normal wear, and easy maintenance,

TOPS

- Veneer (W) or HPL (P) Tops available in five shapes: Rectangle, Boat, Modern Rectangle, Square and Round with woodgrain patterns following the depth (short) of Veneer (W) table tops while grain patterns follow the width (long) of HPL (P) table tops
- Tops are shaped on all four sides and are available in two thicknesses and five edge profiles
- Double Kerf (F), Duo (G) and Square (Y) available in Veneer (W) and HPL (P) tops with 3-ply balanced construction, 1 $\frac{3}{16}$ " thick and matching 3mm wood or PVC rims on profiled edges; Laminate colors Designer White, Sugar Maple, and Williamsburg Cherry feature ABS edge bands
- Knife (K) edge profile tops are 1 $\frac{3}{16}$ " thick with solid wood rims available on both Veneer (W) or HPL (P) tops
- Vertical Square (H) edge profile tops are 1 $\frac{1}{2}$ " thick with 1.5mm wood edge-banded rims on Veneer (W) tops and 1mm PVC edge-banded rims on HPL (P) tops; Laminate colors Designer White, Sugar Maple, and Williamsburg Cherry feature ABS edge bands
- Tops will include with holes bored on bottom to ensure proper leg placement
- Credenzas, buffets, and other ancillary support models are available in Square (Y), Double Kerf (F), Duo (G), and Vertical Square (H) edge profiles and profiled on approach side only
- All surfaces feature reverse slip matched pattern
- Back Painted, Tempered Glass Tops are $\frac{1}{4}$ " thick and are attached to a substrate topped with black paper covering
- Tempered glass top has a $\frac{1}{16}$ " overhang from the sub-top

LOCKING

- All units with file drawers feature locking
- Removable lock cylinders allow for units to be re-keyed at a later date, if required Units are shipped randomly keyed as standard
- Keyed alike units available upon request at no additional charge Lock core is predetermined by pull color. Black lock cores are used with black and gold pulls while silver lock cores are used with chrome and aluminum pulls
- Optional locking doors available on buffets and credenzas

LEGS

- Available in aluminum (ALUM) or black (BLK)
- Integrated wire management inside of leg to keep your space clean and free of wires
- Each leg has adjustable glides

CHASSIS

- All credenzas are available in TFL (T) or Veneer (W) with vertical grain direction
- Chassis for storage units are securely fastened using high quality European fastening systems and heavy-duty 16-gauge joining brackets to assure maximum strength
- All units ship with heavy-duty, adjustable leveling glides to ensure proper leveling and compensation for uneven floors

DRAWERS

- Drawers feature 5-sided drawer construction allowing for easy removal of drawer fronts; All drawer fronts are standard with elegant vertically matched faces
- Drawer sides, back, and front are woodgrain vinyl-wrapped $\frac{1}{2}$ " thick with $\frac{1}{8}$ " thick hardboard bottoms
- Drawer interiors are dovetail construction with $\frac{7}{16}$ " thick hardwood sides and backs, and $\frac{5}{32}$ " thick hardboard bottoms
- All drawers feature full extension, progressive action slides with precision steel ball bearings
- Box drawers are tested for 100lb capacity
- All suspensions have a limited lifetime warranty

STORAGE

- All hinged doors are soft-close with one piece hinge and base plate combination
- Soft close hinges reduce stress placed on the cabinet when the door is closed and offers a quiet closure
- All Credenzas feature a 2" W wire management channel along back of the interior cabinet for easy accessibility to wall outlets

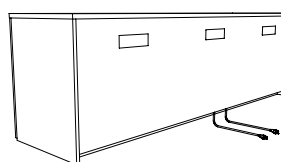

2" wire management channel

INTERIOR DRAWER DIMENSIONS

Models

88-2496BF

	W	L	D
Box Drawers	15 $\frac{3}{4}$ "	16 $\frac{3}{8}$ "	3 $\frac{2}{32}$ "

Models

88-2484BF

	W	L	D
Box Drawers	30"	16 $\frac{3}{8}$ "	3 $\frac{2}{32}$ "
	13 $\frac{3}{8}$ "	16 $\frac{3}{8}$ "	3 $\frac{2}{32}$ "

Models

88-2472BF

88-2436BF

	W	L	D
Box Drawers	32 $\frac{3}{16}$ "	16 $\frac{3}{8}$ "	3 $\frac{2}{32}$ "

Models

88-2460BF

	W	L	D
Box Drawers	16 $\frac{1}{2}$ "	16 $\frac{3}{8}$ "	3 $\frac{2}{32}$ "

Models

88-2448BF

	W	L	D
Box Drawers	20 $\frac{15}{16}$ "	16 $\frac{3}{8}$ "	3 $\frac{2}{32}$ "

INTERIOR CABINET DIMENSIONS

Models

88-2496BF

	W	D	H
Double Door	36 $\frac{3}{4}$ "	22 $\frac{3}{8}$ "	23 $\frac{1}{2}$ "
Single Door with Waste Bin	18"	22 $\frac{3}{8}$ "	23 $\frac{1}{2}$ "

Models

88-2484BF

	W	D	H
Double Door	32"	22 $\frac{3}{8}$ "	23 $\frac{1}{2}$ "
Single Door with Waste Bin	15 $\frac{1}{2}$ "	22 $\frac{3}{8}$ "	23 $\frac{1}{2}$ "

Models

88-2472BF

88-2436BF

	W	D	H
Double Door	34 $\frac{3}{8}$ "	22 $\frac{3}{8}$ "	23 $\frac{1}{2}$ "
Single Door with Waste Bin	16 $\frac{3}{4}$ "	22 $\frac{3}{8}$ "	23 $\frac{1}{2}$ "

Models

88-2460BF

	W	D	H
Single Door	18 $\frac{3}{8}$ "	22 $\frac{3}{8}$ "	23 $\frac{1}{2}$ "

Models

88-2448BF

	W	D	H
Double Door	46 $\frac{3}{8}$ "	22 $\frac{3}{8}$ "	23 $\frac{1}{2}$ "
Single Door with Waste Bin	22 $\frac{3}{4}$ "	22 $\frac{3}{8}$ "	23 $\frac{1}{2}$ "

Models

88-2496CC

	W	D	H
Double Door	36 $\frac{3}{4}$ "	22 $\frac{3}{8}$ "	24 $\frac{3}{8}$ "
Single Door with Waste Bin	18"	22 $\frac{3}{8}$ "	24 $\frac{3}{8}$ "

Models

88-2484CC

	W	D	H
Double Door	32"	22 $\frac{3}{8}$ "	24 $\frac{3}{8}$ "
Single Door with Waste Bin	15 $\frac{1}{2}$ "	22 $\frac{3}{8}$ "	24 $\frac{3}{8}$ "

Models

88-2472CC

88-2436BF

	W	D	H
Double Door	34 $\frac{3}{8}$ "	22 $\frac{3}{8}$ "	24 $\frac{3}{8}$ "
Single Door with Waste Bin	16 $\frac{3}{4}$ "	22 $\frac{3}{8}$ "	24 $\frac{3}{8}$ "

Models

88-2460CC

	W	D	H
Single Door with Waste Bin	18 $\frac{3}{8}$ "	22 $\frac{3}{8}$ "	24 $\frac{3}{8}$ "

Models

88-2448CC

	W	D	H
Double Door	46 $\frac{3}{8}$ "	22 $\frac{3}{8}$ "	24 $\frac{3}{8}$ "
Single Door with Waste Bin	22 $\frac{3}{4}$ "	22 $\frac{3}{8}$ "	24 $\frac{3}{8}$ "

Models

88-2096CC

	W	D	H
Double Door	36 $\frac{3}{4}$ "	18 $\frac{3}{8}$ "	24 $\frac{3}{8}$ "
Single Door	17 $\frac{3}{8}$ "	18 $\frac{3}{8}$ "	24 $\frac{3}{8}$ "

Models

88-2084CC

	W	D	H
Double Door	32"	18 $\frac{3}{8}$ "	24 $\frac{3}{8}$ "
Single Door	15 $\frac{1}{2}$ "	18 $\frac{3}{8}$ "	24 $\frac{3}{8}$ "

INTERIOR CABINET DIMENSIONS CONTINUED

Models			
88-2072CC	88-2036CC		
	W	D	H
Single Door	34 ³ / ₈ "	18 ³ / ₈ "	24 ³ / ₈ "
Models			
88-2060CC			
	W	D	H
Single Door	18 ³ / ₈ "	18 ³ / ₈ "	24 ³ / ₈ "
Models			
88-2048CC			
	W	D	H
Double Door	46 ³ / ₈ "	18 ³ / ₈ "	24 ³ / ₈ "

HOW TO ORDER EXAMPLES

SQUARE MEETING TABLE			
	QTY	MODEL NO.	EXAMPLE
TOP	1	88-4848SQ	Top/Edge Material P Finish/Color FO Edge Profile 3MMW/F Glass Top Y Glass Color/Surface Finish GBLG Power/Data Location OC
BASE	1	01-2228STR4	Strut Legs (4 legs) Leg Color ALUM
POWER	1	01-DUOBEZELS	

MODERN RECTANGLE MEETING TABLES

	QTY	MODEL NO.	EXAMPLE
TOP	1	88-54192MR	Top/Edge Material W Top/Edge Finish/Color MAS Edge Profile 3MMW/F Glass Top Y Glass Color/Surface Finish GBLG Grommet/Power/Data Type DPORTA Grommet/Power/Data Location OC
BASES	2	01-2228STR4	Strut Legs (4 legs) Leg Color BLK
POWER	1	DPORTA	

STORAGE & ACCESSORIES

Buffet Credenza			
	QTY	MODEL NO.	EXAMPLE
	1	88-2472BF	Top/Edge Material W Finish/Color MAS Edge Profile 3MMW/F Chassis Finish/Color ORW Glass Top Y Glass Color/Surface Finish GBLG Studio Pull Color GST Locking LKT_BFD Drawer Construction DOVE Drawer Track SFTCL Vent VENT Waste Bin WBL

VENEER (W) OPTIONS ON TOPS / EDGES, BASES, AND ACCENT PANELS

Veneer features UVAdvantage, an ultra-violet finish, on all exposed surfaces or our Catalyzed finish (where noted), which is a multi-step, finish process that provides years of lasting beauty.

AW	Artisan Walnut	MW	Mahogany Walnut
AS	Asian Night	MAS	Mesa Sunset*
CO	Columbian Walnut	MTS	Metropolis Sky
DC	Dark Cherry	ORW	Oak Riftwood*
DFW	Dark Forest Walnut	PNW	Pinnacle Walnut
EW	Espresso	SCH	Select Cherry
FO	Fawn Oak*	SKC	Shaker Cherry
GC	Golden Cherry	SM	Sugar Maple
HVM	Harvest Walnut	WTA	Weathered Ash*
HNW	Henna Walnut	WC	Williamsburg Cherry
LW	Legacy Walnut		

* Finish is Low Sheen

TFL (T) OPTIONS FOR BASES / ACCENT PANELS AND HPL (P) LAMINATE OPTIONS ON TOPS / EDGES

WOODGRAIN			
AS	Asian Night	PNW	Pinnacle Walnut
BW	Beigewood	PTK	Portico Teak
CO	Columbian Walnut	RC	River Cherry
EF	Espresso	SPW	Seppia Walnut
FLW	Florence Walnut	SKC	Shaker Cherry
GC	Golden Cherry*	SCH	Select Cherry*
KHE	Kirsche	SBP	Smoky Brown Pear
MW	Mahogany Walnut*	TK	Studio Teak
MNR	Midnight Run	SM	Sugar Maple
NTM	Natural Marrone	WTA	Weathered Ash
ORW	Oak Riftwood	WC	Williamsburg Cherry
		WNB	White Nebbia
SOLID			
BL	Black	FHG	Fashion Grey
WH	Designer White	SG	Slate Grey

* Available On Top Surfaces Only.

EDGE PROFILES

Double Kerf (F), Duo (G), Square (Y) and Knife (K) edge profiles is 1 3/16" thick and available in Veneer (W) and HPL (P) tops. Vertical Square (H) edge profile available is 1 1/2" thick and also available Veneer (W) and HPL (P) tops. Must specify edge profile.

Knife (K) edge not available on buffet and credenzas

Laminate (P) Top Edges

3MMP/F	Double Kerf (1 3/16" H)	RIMP/K	Knife (1 3/16" H)
3MMP/G	Duo (1 3/16" H)	HP	Vertical Square (1 1/2" H)
3MMP/Y	Square (1 3/16" H)		

Veneer (W) Top Edges

3MMW/F	Double Kerf (1 3/16" H)	RIMW/K	Knife (1 3/16" H)
3MMW/G	Duo (1 3/16" H)	HW	Vertical Square (1 1/2" H)
3MMW/Y	Square (1 3/16" H)		



Double Kerf (F) 1 3/16" H Duo (G) 1 3/16" H Square (Y) 1 3/16" H Knife (K) 1 3/16" H Vertical Square (H) 1 1/2" H

PULL OPTIONS

Buffets and Credenzas available with pulls on doors. Must specify and select color.

Lock core color is predetermined by pull color.

AST	Studio, Aluminum	CST	Studio, Chrome
BST	Studio, Black	GST	Studio, Gold



Studio (GST)
Gold - 13"

GLASS OPTIONS ON TOPS

Back painted tempered glass tops are 1/4" thick and available in Black or White with Gloss or Acid Etched finish. Glass top sits 1/16" on top of substrate top.

GWHG	White Gloss	GBLG	Black Gloss
GWHA	White Acid Etched	GBLA	Black Acid Etched



White Gloss
(GWHG)



Black Gloss
(GBLG)

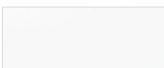

White Acid Etched
(GWHA)



Black Acid Etched
(GBLA)

LOCK CORE COLOR OPTIONS

BLK	Black (Used with Black and Gold Pulls)
SLV	Silver (Used with Aluminum and Chrome Pulls)

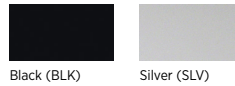

GROMMET & POWER UNIT OPTIONS

Power units and grommets are available on Rectangle, Modern Rectangle, and Boat shaped tops. Each unit is sold separately and must be specified separately with surface mount location. Multiple locations may be selected. Only one unit per location.

Power units and Grommets Available in Table Surfaces (See Units)

Grommet	\$ 50
---------	-------

Specify Color: Black = BLK and Silver = SLV

DUO/TRIO BEZEL

01-DUOBEZEL Available in Black (B), Silver (S), or White (W)

01-TRIOBEZEL Available in Black (B), Silver (S), or White (W)

DOCK 950, DOCK 800 and DOCK 150

DOCK950 Available in Black or White

DOCK150 Available in Black or White

DOCK800 Available in Black or Silver

Other Power Units

DPORT4 Available in Aluminum or Black

ELLORA Available in Aluminum or Black

E2X Available in Aluminum or Black

INTERACTG Available in Aluminum or Black

OASISM Available in Aluminum or Black

Power/Data Location Information:

- Designate unit and location when specifying the top model. Power/Data Module need to be ordered separately.
- Power/Data Modules specified at the time of order will be routed for field installation.

E1	Unit on One End
E2	Unit on Each End
OC	Unit on Center

- 72"W tops available with power units **On Center (OC) only**

Grommets and Power Units may be ordered in non-standard locations. Call Customer Service to assist with specification and/or please attach a drawing to the PO showing the location of the grommet. Note additional charges and lead times may apply.

Top Locations

Power units available on Each End (E1 and E2) and On Center (OC) unless otherwise noted.

Power units centered at locations below:

36" Tops	Centered 18"D	54" Tops	Centered 27"D
42" Tops	Centered 21"D	60" Tops	Centered 30"D
48" Tops	Centered 24"D		

GROMMET OPTIONS & POWER UNIT OPTIONS CONTINUED

Top Locations Continued

- 72: OC 36" from end (available with OC Only)
- 84: OC 42" from end (available with OC Only)
- 96: OC 48" from end; E1/E2 29" from end
- 108 OC 54" from end; E1/E2 29" from end
- 120: OC 60" from end; E1/E2 29" from end
- 132: OC 66" from end; E1/E2 29" from end
- 144: OC 72" from end; E1/E2 29" from end
- 156: OC 78" from end; E1/E2 29" from end
- 168: OC 84" from end; E1/E2 29" from end
- 180: OC 90" from end; E1/E2 36" from end
- 192: OC 96" from end; E1/E2 36" from end
- 204: OC 102" from end; E1/E2 36" from end
- 216: OC 108" from end; E1/E2 36" from end
- 228: OC 114" from end; E1/E2 36" from end
- 240: OC 120" from end; E1/E2 36" from end

Example: 60x204 Modern Rectangle

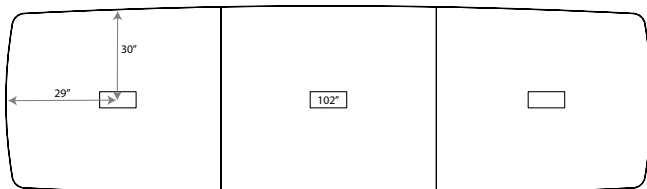

DRAWER TRACK OPTIONS

Soft close tracks are available on box drawers only. Soft close drawer tracks have many benefits including reduced stress on the unit, extends the life of the drawer, and ensures a gentle close so fingers don't accidentally get pinched. Must specify when ordering. **Pricing is per Drawer, not per Model/Unit**

SFTCL	Soft Close Drawer Track	\$	33
-------	-------------------------	----	----

WASTE BIN OPTIONS

Buffet and 24" Credenzas are available with two (2) 41-quart beige waste bins in a pull out cabinet with silver hardware and divider panel. Adjacent cabinet features one (1) adjustable shelf. Studio pulls applied centered on doors when waste bin is selected. Locking not available.

WBL	Waste Bin on Left	\$	493
WBR	Waste Bin on Right	\$	493

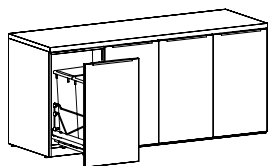

Shown as Left

VENT OPTION FOR CREDENZAS

Buffets and Credenzas feature optional ventilation grommets. Includes one vent per compartment.

Vents are 10" Down from top surface on Buffet Credenzas and 2 7/8" on Credenzas.

NONE	No Vent Grommet		
VENT	Vented back panel	\$	66

Number of vents per unit:

36"	1 vent
72" / 48"	2 vents
96" / 84" / 60"	3 vents

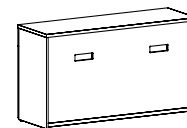

LOCKING DOORS

Locking doors are available on Buffets and Credenzas. You must specify WITH LOCKING when ordering and add upcharge.

Note: When locking is selected with optional waste bin, locking will not apply to waste bin door.

LKT_BFD	96"W to 84"W Units	\$	130
LKT_BFD	72"W to 48"W Units	\$	111
LKT_BFD	36"W Units	\$	88

BASE METAL ACCENT COLOR OPTIONS

6" and 10" Rectangle Accent Bases feature 5/16" metal trim. Must specify color

ALUM	Aluminum	PLAT	Platinum
BLK	Black	GLD	Gold

Tops/Shapes + Bases



Square ([See Details](#))

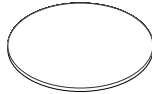

Round ([See Details](#))



Rectangular ([See Details](#))



Modern Rectangular ([See Details](#))



Boat ([See Details](#))

Strut Legs ([See Details](#))

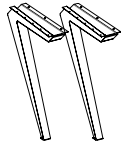

Set of 2 legs

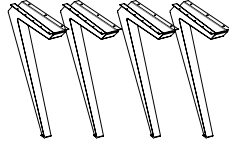

Set of 4 legs

Storage Components + Accessories

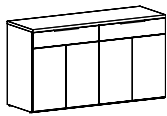

Buffet with Doors + Drawers
([See Details](#))

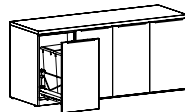

24" + 20" Credenzas with Doors
([See Details](#))

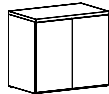

Mobile Serving Cart
([See Details](#))

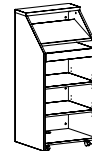

Lectern Stand
([See Details](#))

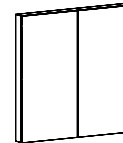

Visual Board
([See Details](#))

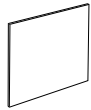
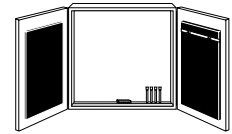

Marker Boards
([See Multiple Unit Details](#))



Marker, Eraser and Magnet
Sets ([See Details](#))

Wire Management + Power/Data Accessories ([See Details](#))

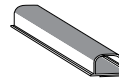
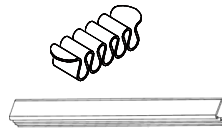
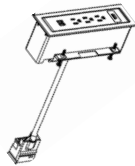
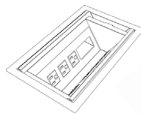
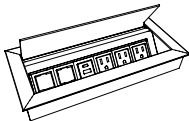

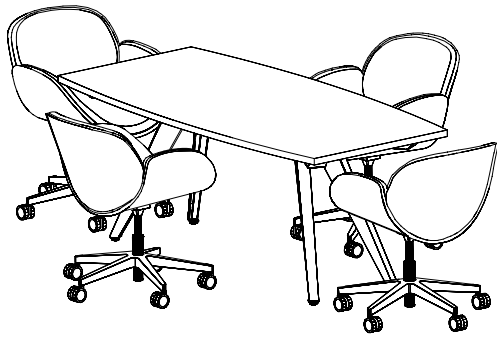
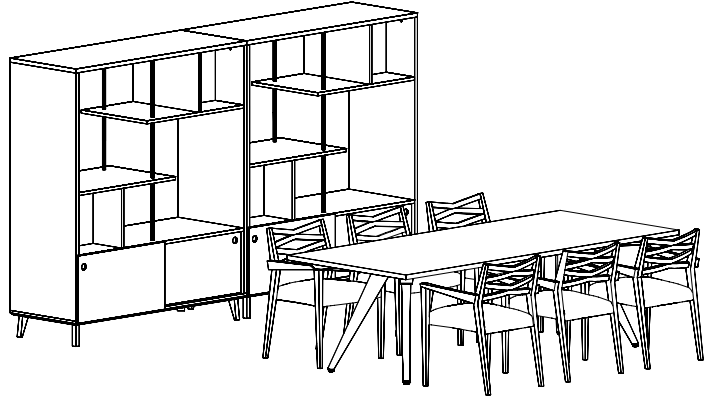
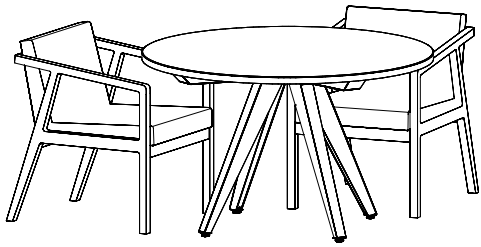

Item	Model No.		W	D	H	Ship Wt	Cubic Ft	Edge Profile + Material	List Price		
 <p>88-4242SQ Shown BASES SOLD SEPARATELY</p> <p><u>Must Specify (in this order):</u> Model # Top/Edge Material Top/Edge Finish/Color Edge Profile Glass (Y/N) Glass Color + Surface Finish Power/Data Power/Data Location</p>	88-4848SQ	Laminate	48	48	1 ³ / ₁₆	82	7.2	F, G, Y / P\$	821		
					1 ³ / ₁₆			K / P\$	1351		
					1 ¹ / ₂			H / P\$	916		
		Veneer	1 ³ / ₁₆							F, G, Y / W\$	934
			1 ³ / ₁₆							K / W\$	1565
			1 ¹ / ₂							H / W\$	1107
	Glass	1 ¹ / ₄							Acid Etched Glass Top \$	5271	
		1 ¹ / ₄							Gloss Glass Top \$	4387	
	88-4242SQ	Laminate	42	42	1 ³ / ₁₆	70	3.4		F, G, Y / P\$	731	
					1 ³ / ₁₆				K / P\$	1174	
					1 ¹ / ₂				H / P\$	845	
		Veneer	1 ³ / ₁₆							F, G, Y / W\$	837
1 ³ / ₁₆			K / W\$							1418	
1 ¹ / ₂			H / W\$							929	
Glass	1 ¹ / ₄							Acid Etched Glass Top \$	4247		
	1 ¹ / ₄							Gloss Glass Top \$	3570		

Description

- Tops Feature a 1-piece, 1³/₁₆" or 1¹/₂" Thick Top in Veneer (W) or HPL (P)
- Must Specify Edge Profile: 1³/₁₆" Thick/Double Kerf (F), Duo (G), Square (Y), and Knife (K) Edge Profiles or 1¹/₂" Thick/Vertical Square (H)
- Due to Top Sizes and Base Placement, Power is Not Available on Square Tops
- Available with Back Painted Tempered Glass Top; Must Specify Color and Finish; [See Options](#)
- Strut Legs Sold Separately, See [Multiple Base Options](#)



Double Kerf (F) 1³/₁₆" Duo (G) 1³/₁₆" Square (Y) 1³/₁₆" Knife (K) 1³/₁₆" Vertical Square (H) 1¹/₂"

P = HPL W = Veneer

[See Strut Overview For Ordering Options](#)

Item	Model No.		W	D	H	Ship Wt	Cubic Ft	Edge Profile + Material	List Price		
 <p>88-4848CT Shown BASES SOLD SEPARATELY</p>	88-6060CT	Laminate	60	60	1 ³ / ₁₆	143	8.4	F, G, Y / P\$	1002		
					1 ³ / ₁₆			K / P\$	2121		
					1 ¹ / ₂			H / P\$	1048		
		Veneer	60	60	1 ³ / ₁₆	F, G, Y / W\$	1358				
					1 ³ / ₁₆	K / W\$	2378				
					1 ¹ / ₂	H / W\$	1606				
		Glass	60	60	1/4	Acid Etched Glass Top \$	8387				
					1/4	Gloss Glass Top \$	6966				
		<p><u>Must Specify (in this order):</u> Model # Top/Edge Material Top/Edge Finish/Color Edge Profile Glass (Y/N) Glass Color + Surface Finish Power/Data Type Power/Data Location</p>	88-5454CT	Laminate	54	54	1 ³ / ₁₆	114	6.8	F, G, Y / P\$	963
							1 ³ / ₁₆			K / P\$	1935
1 ¹ / ₂	H / P\$						998				
Veneer	54			54	1 ³ / ₁₆	F, G, Y / W\$	1206				
					1 ³ / ₁₆	K / W\$	2116				
					1 ¹ / ₂	H / W\$	1411				
Glass	54			54	1/4	Acid Etched Glass Top \$	7021				
					1/4	Gloss Glass Top \$	5868				
88-4848CT	88-4848CT			Laminate	48	48	1 ³ / ₁₆	90	5.5	F, G, Y / P\$	873
							1 ³ / ₁₆			K / P\$	1830
		1 ¹ / ₂	H / P\$				899				
		Veneer	48	48	1 ³ / ₁₆	F, G, Y / W\$	989				
					1 ³ / ₁₆	K / W\$	2058				
					1 ¹ / ₂	H / W\$	1155				
		Glass	48	48	1/4	Acid Etched Glass Top \$	5859				
					1/4	Gloss Glass Top \$	4949				

Description

- Tops Feature a 1-piece, 1³/₁₆" or 1¹/₂" Thick Top in Veneer (W) or HPL (P)
- Must Specify Edge Profile: 1³/₁₆" Thick/Double Kerf (F), Duo (G), Square (Y), and Knife (K) Edge Profiles or 1¹/₂" Thick/Vertical Square (H)
- Due to Top Sizes and Base Placement, Power is Not Available on Round Tops
- Available with Back Painted Tempered Glass Top; Must Specify Color and Finish; [See Options](#)
- 60" and 54" Tops Feature Catalyzed Finish
- Strut Legs Sold Separately, See [Multiple Base Options](#)



Double Kerf (F)
1³/₁₆"



Duo (G)
1³/₁₆"



Square (Y)
1³/₁₆"



Knife (K)
1³/₁₆"



Vertical Square (H)
1¹/₂"

P = HPL W = Veneer

[See Strut Overview For Ordering Options](#)

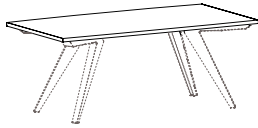
Item	Model No.		W	D	H	Ship Wt	Cubic Ft	Edge Profile + Material	List Price	
RECTANGLE SHAPE MEETING TOP 36"D  88-3672RT Shown BASES SOLD SEPARATELY	36"D x 96"W or 8' - 1 Piece Rectangle Top									
	88-3696RT	Laminate	96	36	1 $\frac{3}{16}$ "	142	12.9	F, G, Y / P\$	1318	
					1 $\frac{3}{16}$ "			K / P\$	2077	
					1 $\frac{1}{2}$ "			H / P\$	1495	
		Veneer			1 $\frac{3}{16}$ "			F, G, Y / W\$	1492	
					1 $\frac{3}{16}$ "			K / W\$	2470	
					1 $\frac{1}{2}$ "			H / W\$	1795	
		Glass			1 $\frac{1}{4}$ "			Acid Etched Glass Top \$	7859	
					1 $\frac{1}{4}$ "			Gloss Glass Top \$	6576	
	36"D x 84"W or 7' - 1 Piece Rectangle Top									
	88-3684RT	Laminate	84	36	1 $\frac{3}{16}$ "	126	11.3	F, G, Y / P\$	1255	
					1 $\frac{3}{16}$ "			K / P\$	1938	
					1 $\frac{1}{2}$ "			H / P\$	1439	
		Veneer			1 $\frac{3}{16}$ "			F, G, Y / W\$	1413	
					1 $\frac{3}{16}$ "			K / W\$	2355	
				1 $\frac{1}{2}$ "			H / W\$	1649		
	Glass			1 $\frac{1}{4}$ "			Acid Etched Glass Top \$	7066		
				1 $\frac{1}{4}$ "			Gloss Glass Top \$	5943		
36"D x 72"W or 6' - 1 Piece Rectangle Top										
88-3672RT	Laminate	72	36	1 $\frac{3}{16}$ "	109	10.3	F, G, Y / P\$	1016		
				1 $\frac{3}{16}$ "			K / P\$	1638		
				1 $\frac{1}{2}$ "			H / P\$	1148		
	Veneer			1 $\frac{3}{16}$ "			F, G, Y / W\$	1196		
				1 $\frac{3}{16}$ "			K / W\$	1891		
				1 $\frac{1}{2}$ "			H / W\$	1428		
	Glass			1 $\frac{1}{4}$ "			Acid Etched Glass Top \$	6107		
				1 $\frac{1}{4}$ "			Gloss Glass Top \$	5144		

Description

- Tops Available with Veneer (W) or HPL (P) Top in 1 $\frac{3}{16}$ " and 1 $\frac{1}{2}$ " Thicknesses
- Must Specify Edge Profile: 1 $\frac{3}{16}$ " Thick/Double Kerf (F), Duo (G), Square (Y), and Knife (K) Edge Profiles or 1 $\frac{1}{2}$ " Thick/Vertical Square (H)
- Veneer (W) Top Grain Runs Depth of Top and HPL (P) Top Grain Runs Width of Top
- Available with Back Painted Tempered Glass Top; Must Specify Color and Finish; [See Options](#)
- Strut Legs Sold Separately, [See Strut Legs](#)



Double Kerf (F)
1 $\frac{3}{16}$ "



Duo (G)
1 $\frac{3}{16}$ "



Square (Y)
1 $\frac{3}{16}$ "



Knife (K)
1 $\frac{3}{16}$ "



Vertical Square (H)
1 $\frac{1}{2}$ "

P = HPL W = Veneer

[See Strut Overview For Ordering Options](#)

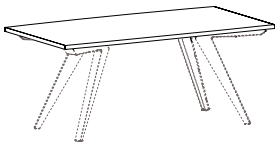
Item	Model No.		W	D	H	Ship Wt	Cubic Ft	Edge Profile + Material	List Price	
RECTANGLE SHAPE MEETING TOP 42"D  88-4272RT Shown BASES SOLD SEPARATELY	42"D x 96"W or 8' - 1 Piece Rectangle Top									
	88-4296RT	Laminate	96	42	1 3/16	164	15.0	F, G, Y / P\$	1346	
					1 3/16			K / P\$	2258	
					1 1/2			H / P\$	1554	
		Veneer			1 3/16			F, G, Y / W\$	1628	
					1 3/16			K / W\$	2606	
					1 1/2			H / W\$	1973	
		Glass			1/4			Acid Etched Glass Top \$	8652	
					1/4			Gloss Glass Top \$	7155	
	42"D x 84"W or 7' - 1 Piece Rectangle Top									
	88-4284RT	Laminate	84	42	1 3/16	145	13.1	F, G, Y / P\$	1309	
					1 3/16			K / P\$	2100	
					1 1/2			H / P\$	1490	
		Veneer			1 3/16			F, G, Y / W\$	1499	
					1 3/16			K / W\$	2480	
				1 1/2			H / W\$	1804		
	Glass			1/4			Acid Etched Glass Top \$	7731		
				1/4			Gloss Glass Top \$	6422		
42"D x 72"W or 6' - 1 Piece Rectangle Top										
88-4272RT	Laminate	72	42	1 3/16	126	11.3	F, G, Y / P\$	1087		
				1 3/16			K / P\$	1842		
				1 1/2			H / P\$	1242		
	Veneer			1 3/16			F, G, Y / W\$	1360		
				1 3/16			K / W\$	2062		
				1 1/2			H / W\$	1624		
	Glass			1/4			Acid Etched Glass Top \$	6778		
				1/4			Gloss Glass Top \$	5655		

Must Specify (in this order):

- Model #
- Top/Edge Material
- Top/Edge Finish/Color
- Edge Profile
- Glass (Y/N)
- Glass Color + Surface Finish
- Power/Data Type
- Power/Data Location

Description

- Tops Available with Veneer (W) or HPL (P) Top in 1 3/16" and 1 1/2" Thicknesses
- Must Specify Edge Profile: 1 3/16" Thick/Double Kerf (F), Duo (G), Square (Y), and Knife (K) Edge Profiles or 1 1/2" Thick/Vertical Square (H)
- Veneer (W) Top Grain Runs Depth of Top and HPL (P) Top Grain Runs Width of Top
- Available with Back Painted Tempered Glass Top; Must Specify Color and Finish; [See Options](#)
- Power and Data Options Available; Sold Separately, [See Multiple Power Unit Details](#)
- Strut Legs Sold Separately, [See Strut Legs](#)



Double Kerf (F) 1 3/16" Duo (G) 1 3/16" Square (Y) 1 3/16" Knife (K) 1 3/16" Vertical Square (H) 1 1/2"

P = HPL W = Veneer

[See Strut Overview For Ordering Options](#)

Item	Model No.		W	D	H	Ship Wt	Cubic Ft	Edge Profile + Material	List Price	
RECTANGLE SHAPE MEETING TOP 48" D  88-48216RT Shown BASES SOLD SEPARATELY	48"D x 240"W or 20' - 3 Piece Rectangle Top									
	88-48240RT	Laminate	240	48	1 3/16	460	28.5	F, G, Y / P\$	4312	
					1 3/16			K / P\$	7033	
					1 1/2			H / P\$	4916	
		Veneer			1 3/16			F, G, Y / W\$	5797	
					1 3/16			K / W\$	7808	
					1 1/2			H / W\$	6738	
		Glass			1/4			Acid Etched Glass Top \$	24114	
					1/4			Gloss Glass Top \$	19837	
	48"D x 228"W or 19' - 3 Piece Rectangle Top									
	88-48228RT	Laminate	228	48	1 3/16	438	27.0	F, G, Y / P\$	4270	
					1 3/16			K / P\$	6902	
					1 1/2			H / P\$	4845	
		Veneer			1 3/16			F, G, Y / W\$	5549	
					1 3/16			K / W\$	7560	
				1 1/2			H / W\$	6444		
	Glass			1/4			Acid Etched Glass Top \$	23064		
				1/4			Gloss Glass Top \$	19001		
48"D x 216"W or 18' - 3 Piece Rectangle Top										
88-48216RT	Laminate	216	48	1 3/16	416	25.5	F, G, Y / P\$	3394		
				1 1/2			K / P\$	5676		
				1 3/16			H / P\$	3939		
	Veneer			1 3/16			F, G, Y / W\$	4909		
				1 3/16			K / W\$	6400		
				1 1/2			H / W\$	5759		
	Glass			1/4			Acid Etched Glass Top \$	21584		
				1/4			Gloss Glass Top \$	17734		
48"D x 204"W or 17' - 3 Piece Rectangle Top										
88-48204RT	Laminate	204	48	1 3/16	394	24.0	F, G, Y / P\$	3353		
				1 3/16			K / P\$	5545		
				1 1/2			H / P\$	3867		
	Veneer			1 3/16			F, G, Y / W\$	4661		
				1 3/16			K / W\$	6376		
				1 1/2			H / W\$	5466		
	Glass			1/4			Acid Etched Glass Top \$	20702		
				1/4			Gloss Glass Top \$	17067		

Additional 48" Rectangle Shaped Tops on Next Page



Double Kerf (F) 1 3/16" Duo (G) 1 3/16" Square (Y) 1 3/16" Knife (K) 1 3/16" Vertical Square (H) 1 1/2"

P = HPL W = Veneer

[See Strut Overview For Ordering Options](#)

Item	Model No.		W	D	H	Ship Wt	Cubic Ft	Edge Profile + Material	List Price	
48"D x 192"W or 16' - 2 Piece Rectangle Top										
<i>CONTINUED FROM PREVIOUS PAGE</i>	88-48192RT	Laminate	192	48	1 3/16	372	31.2	F, G, Y / P\$	2900	
					1 3/16			K / P\$	4998	
					1 1/2			H / P\$	3382	
		Veneer			1 3/16			F, G, Y / W\$	3941	
					1 3/16			K / W\$	5481	
					1 1/2			H / W\$	4697	
	Glass	1/4	Acid Etched Glass Top \$	18838						
		1/4	Gloss Glass Top \$	15417						
	48"D x 180"W or 15' - 2 Piece Rectangle Top									
	<i>Must Specify (in this order):</i> Model # Top/Edge Material Top/Edge Finish/Color Edge Profile Glass (Y/N) Glass Color + Surface Finish Power/Data Power/Data Location	88-48180RT	Laminate	180	48	1 3/16	350	31.2	F, G, Y / P\$	2859
						1 3/16			K / P\$	4769
						1 1/2			H / P\$	3311
Veneer			1 3/16			F, G, Y / W\$			3778	
			1 3/16			K / W\$			5368	
			1 1/2			H / W\$			4489	
Glass		1/4	Acid Etched Glass Top \$	17788						
		1/4	Gloss Glass Top \$	14581						
48"D x 168"W or 14' - 2 Piece Rectangle Top										
		88-48168RT	Laminate	168	48	1 3/16	328	31.2	F, G, Y / P\$	2713
						1 3/16			K / P\$	4496
						1 1/2			H / P\$	3135
	Veneer		1 3/16			F, G, Y / W\$			3482	
			1 3/16			K / W\$			5065	
			1 1/2			H / W\$			4147	
	Glass	1/4	Acid Etched Glass Top \$	16631						
		1/4	Gloss Glass Top \$	13637						
	48"D x 156"W or 13' - 2 Piece Rectangle Top									
		88-48156RT	Laminate	156	48	1 3/16	306	31.2	F, G, Y / P\$	2672
						1 3/16			K / P\$	4353
						1 1/2			H / P\$	3064
Veneer			1 3/16			F, G, Y / W\$			3319	
			1 3/16			K / W\$			4872	
			1 1/2			H / W\$			3939	
Glass		1/4	Acid Etched Glass Top \$	15581						
		1/4	Gloss Glass Top \$	12801						

Additional 48" Rectangle Shaped Tops on Next Page



Double Kerf (F) 1 3/16" Duo (G) 1 3/16" Square (Y) 1 3/16" Knife (K) 1 3/16" Vertical Square (H) 1 1/2"

P = HPL W = Veneer

[See Strut Overview For Ordering Options](#)

Item	Model No.		W	D	H	Ship Wt	Cubic Ft	Edge Profile + Material	List Price	
<i>CONTINUED FROM PREVIOUS PAGE</i>	48"D x 144"W or 12' - 2 Piece Rectangle Top									
	88-48144RT	Laminate	144	48	1 3/16	284	23.5	F, G, Y / P\$	2226	
					1 3/16			K / P\$	3791	
					1 1/2			H / P\$	2587	
		Veneer			1 3/16			F, G, Y / W\$	3089	
					1 3/16			K / W\$	4241	
					1 1/2			H / W\$	3664	
		Glass			1/4			Acid Etched Glass Top \$	14508	
					1/4			Gloss Glass Top \$	11942	
	48"D x 132"W or 11' - 2 Piece Rectangle Top									
	88-48132RT	Laminate	132	48	1 3/16	262	23.5	F, G, Y / P\$	2172	
					1 3/16			K / P\$	3647	
					1 1/2			H / P\$	2503	
		Veneer			1 3/16			F, G, Y / W\$	2874	
					1 3/16			K / W\$	4004	
				1 1/2			H / W\$	3403		
	Glass			1/4			Acid Etched Glass Top \$	13446		
				1/4			Gloss Glass Top \$	11093		
48"D x 120"W or 10' - 2 Piece Rectangle Top										
88-48120RT	Laminate	120	48	1 3/16	240	23.5	F, G, Y / P\$	2109		
				1 3/16			K / P\$	3410		
				1 1/2			H / P\$	2409		
	Veneer			1 3/16			F, G, Y / W\$	2648		
				1 3/16			K / W\$	3841		
				1 1/2			H / W\$	3131		
	Glass			1/4			Acid Etched Glass Top \$	12373		
				1/4			Gloss Glass Top \$	10235		
48"D x 108"W or 9' - 2 Piece Rectangle Top										
88-48108RT	Laminate	108	48	1 3/16	218	23.5	F, G, Y / P\$	2054		
				1 3/16			K / P\$	3247		
				1 1/2			H / P\$	2325		
	Veneer			1 3/16			F, G, Y / W\$	2433		
				1 3/16			K / W\$	3629		
				1 1/2			H / W\$	2870		
	Glass			1/4			Acid Etched Glass Top \$	11310		
				1/4			Gloss Glass Top \$	9386		

Must Specify (in this order):

- Model #
- Top/Edge Material
- Top/Edge Finish/Color
- Edge Profile
- Glass (Y/N)
- Glass Color + Surface Finish
- Power/Data Type
- Power/Data Location

Additional 48" Rectangle Shaped Tops on Next Page



Double Kerf (F) 1 3/16" Duo (G) 1 3/16" Square (Y) 1 3/16" Knife (K) 1 3/16" Vertical Square (H) 1 1/2"

P = HPL W = Veneer

[See Strut Overview For Ordering Options](#)

Item	Model No.		W	D	H	Ship Wt	Cubic Ft	Edge Profile + Material	List Price	
48"D x 96"W or 8' - 1 Piece Rectangle Top										
<i>CONTINUED FROM PREVIOUS PAGE</i>	88-4896RT	Laminate	96	48	1 3/16"	196	11.3	F, G, Y / P\$	1419	
					1 3/16"			K / P\$	2463	
					1 1/2"			H / P\$	1657	
		Veneer			1 3/16"			F, G, Y / W\$	1819	
					1 3/16"			K / W\$	2770	
					1 1/2"			H / W\$	2207	
		Glass			1/4"			Acid Etched Glass Top \$	9722	
					1/4"			Gloss Glass Top \$	8011	
	48"D x 84"W or 7' - 1 Piece Rectangle Top									
		88-4884RT	Laminate	84	48	1 3/16"	174	10.0	F, G, Y / P\$	1378
					1 3/16"			K / P\$	2221	
					1 1/2"			H / P\$	1585	
		Veneer			1 3/16"			F, G, Y / W\$	1602	
					1 3/16"			K / W\$	2560	
					1 1/2"			H / W\$	1945	
		Glass			1/4"			Acid Etched Glass Top \$	8609	
					1/4"			Gloss Glass Top \$	7112	
48"D x 72"W or 6' - 1 Piece Rectangle Top										
		88-4872RT	Laminate	72	48	1 3/16"	152	8.6	F, G, Y / P\$	1152
					1 3/16"			K / P\$	1979	
					1 1/2"			H / P\$	1329	
		Veneer			1 3/16"			F, G, Y / W\$	1516	
					1 3/16"			K / W\$	2229	
					1 1/2"			H / W\$	1813	
		Glass			1/4"			Acid Etched Glass Top \$	7593	
					1/4"			Gloss Glass Top \$	6310	

Must Specify (in this order):

- Model #
- Top/Edge Material
- Top/Edge Finish/Color
- Edge Profile
- Glass (Y/N)
- Glass Color + Surface Finish
- Power/Data
- Power/Data Location

Description

- Tops Available with Veneer (W) or HPL (P) Top in 1 3/16" and 1 1/2" Thicknesses
- Must Specify Edge Profile: 1 3/16" Thick/Double Kerf (F), Duo (G), Square (Y), and Knife (K) Edge Profiles or 1 1/2" Thick/Vertical Square (H)
- Veneer (W) Top Grain Runs Depth of Top and HPL (P) Top Grain Runs Width of Top
- Available with Back Painted Tempered Glass Top; Must Specify Color and Finish; [See Options](#)
- Power and Data Options Available; Sold Separately, [See Multiple Power Unit Details](#)
- Dock800, Oasis, and E2X Power Units Available on Ends Only (E1 and E2) for 108"D - 156"D and 204"D-240"D Tops
- Strut Legs Sold Separately, [See Strut Legs](#)



P = HPL W = Veneer

[See Strut Overview For Ordering Options](#)

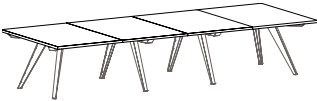
Item	Model No.		W	D	H	Ship Wt	Cubic Ft	Edge Profile + Material	List Price	
RECTANGLE SHAPE MEETING TOP 54"D  88-54156RT Shown in Veneer BASES SOLD SEPARATELY	54"D x 240"W or 20' - 5 Piece Veneer (W) and 3 Piece HPL (P) Rectangle Top									
	88-54240RT	Laminate	240	54	1 3/16	519	24.0	F, G, Y / P\$	4362	
					1 3/16			K / P\$	7310	
					1 1/2			H / P\$	5044	
		Veneer			1 3/16			F, G, Y / W\$	7317	
					1 3/16			K / W\$	9398	
					1 1/2			H / W\$	8562	
		Glass			1/4			Acid Etched Glass Top \$	27015	
					1/4			Gloss Glass Top \$	22204	
	54"D x 228"W or 19' - 5 Piece Veneer (W) and 3 Piece HPL (P) Rectangle Top									
	88-54228RT	Laminate	228	54	1 3/16	495	23.0	F, G, Y / P\$	4316	
					1 3/16			K / P\$	7167	
				1 1/2			H / P\$	4965		
	Veneer			1 3/16			F, G, Y / W\$	7092		
				1 3/16			K / W\$	9115		
				1 1/2			H / W\$	8286		
	Glass			1/4			Acid Etched Glass Top \$	25838		
				1/4			Gloss Glass Top \$	21267		
54"D x 216"W or 18' - 5 Piece Veneer (W) and 3 Piece HPL (P) Rectangle Top										
88-54216RT	Laminate	216	54	1 3/16	470	22.0	F, G, Y / P\$	3742		
				1 3/16			K / P\$	6242		
				1 1/2			H / P\$	4356		
	Veneer			1 3/16			F, G, Y / W\$	6867		
				1 3/16			K / W\$	8833		
				1 1/2			H / W\$	8011		
	Glass			1/4			Acid Etched Glass Top \$	24611		
				1/4			Gloss Glass Top \$	20281		
54"D x 204"W or 17' - 5 Piece Veneer (W) and 3 Piece HPL (P) Rectangle Top										
88-54204RT	Laminate	204	54	1 3/16	445	21.0	F, G, Y / P\$	3697		
				1 3/16			K / P\$	6099		
				1 1/2			H / P\$	4277		
	Veneer			1 3/16			F, G, Y / W\$	6642		
				1 3/16			K / W\$	8550		
				1 1/2			H / W\$	7736		
	Glass			1/4			Acid Etched Glass Top \$	23434		
				1/4			Gloss Glass Top \$	19344		

Additional 54" Rectangle Shaped Tops on Next Page



Double Kerf (F) 1 3/16" Duo (G) 1 3/16" Square (Y) 1 3/16" Knife (K) 1 3/16" Vertical Square (H) 1 1/2"

P = HPL W = Veneer

[See Strut Overview For Ordering Options](#)

Item	Model No.		W	D	H	Ship Wt	Cubic Ft	Edge Profile + Material	List Price	
<i>CONTINUED FROM PREVIOUS PAGE</i>	54"D x 192"W or 16' - 4 Piece Veneer (W) and 2 Piece HPL (P) Rectangle Top									
	88-54192RT	Laminate	192	54	1 3/16	408	19.0	F, G, Y / P\$	3061	
					1 3/16			K / P\$	5355	
					1 1/2			H / P\$	3606	
		Veneer			1 3/16			F, G, Y / W\$	5463	
					1 3/16			K / W\$	7186	
					1 1/2			H / W\$	6311	
		Glass			1/4			Acid Etched Glass Top \$	21396	
					1/4			Gloss Glass Top \$	17546	
	54"D x 180"W or 15' - 4 Piece Veneer (W) and 2 Piece HPL (P) Rectangle Top									
	88-54180RT	Laminate	180	54	1 3/16	384	18.0	F, G, Y / P\$	3016	
					1 3/16			K / P\$	5211	
					1 1/2			H / P\$	3526	
		Veneer			1 3/16			F, G, Y / W\$	5256	
					1 3/16			K / W\$	6921	
				1 1/2			H / W\$	6053		
	Glass			1/4			Acid Etched Glass Top \$	20218		
				1/4			Gloss Glass Top \$	16610		
54"D x 168"W or 14' - 4 Piece Veneer (W) and 2 Piece HPL (P) Rectangle Top										
88-54168RT	Laminate	168	54	1 3/16	359	17.0	F, G, Y / P\$	2971		
				1 3/16			K / P\$	5068		
				1 1/2			H / P\$	3447		
	Veneer			1 3/16			F, G, Y / W\$	5049		
				1 3/16			K / W\$	6656		
				1 1/2			H / W\$	5795		
	Glass			1/4			Acid Etched Glass Top \$	19041		
				1/4			Gloss Glass Top \$	15673		
54"D x 156"W or 13' - 4 Piece Veneer (W) and 2 Piece HPL (P) Rectangle Top										
88-54156RT	Laminate	156	54	1 3/16	334	16.0	F, G, Y / P\$	2926		
				1 3/16			K / P\$	4924		
				1 1/2			H / P\$	3367		
	Veneer			1 3/16			F, G, Y / W\$	4842		
				1 3/16			K / W\$	6391		
				1 1/2			H / W\$	5538		
	Glass			1/4			Acid Etched Glass Top \$	17864		
				1/4			Gloss Glass Top \$	14737		

Must Specify (in this order):
 Model #
 Top/Edge Material
 Top/Edge Finish/Color
 Edge Profile
 Glass (Y/N)
 Glass Color + Surface Finish
 Power/Data Type
 Power/Data Location

Additional 54" Rectangle Shaped Tops on Next Page



Double Kerf (F) 1 3/16" Duo (G) 1 3/16" Square (Y) 1 3/16" Knife (K) 1 3/16" Vertical Square (H) 1 1/2"

P = HPL W = Veneer

[See Strut Overview For Ordering Options](#)

Item	Model No.		W	D	H	Ship Wt	Cubic Ft	Edge Profile + Material	List Price		
<i>CONTINUED FROM PREVIOUS PAGE</i>	54"D x 144"W or 12' - 3 Piece Veneer (W) and 2 Piece HPL (P) Rectangle Top										
	88-54144RT	Laminate	144	54	1 3/16	309	15.0	F, G, Y / P\$	2471		
					1 3/16			K / P\$	4202		
					1 1/2			H / P\$	2879		
		Veneer			1 3/16			F, G, Y / W\$	3924		
					1 3/16			K / W\$	5289		
					1 1/2			H / W\$	4564		
		Glass			1/4			Acid Etched Glass Top \$	16813		
					1/4			Gloss Glass Top \$	13926		
		54"D x 132"W or 11' - 3 Piece Veneer (W) and 2 Piece HPL (P) Rectangle Top									
	88-54132RT	Laminate	132	54	1 3/16	285	13.2	F, G, Y / P\$	2413		
					1 3/16			K / P\$	4046		
					1 1/2			H / P\$	2786		
		Veneer			1 3/16			F, G, Y / W\$	3735		
					1 3/16			K / W\$	5042		
				1 1/2			H / W\$	4325			
	Glass			1/4			Acid Etched Glass Top \$	15623			
				1/4			Gloss Glass Top \$	12976			
	54"D x 120"W or 10' - 3 Piece Veneer (W) and 2 Piece HPL (P) Rectangle Top										
88-54120RT	Laminate	120	54	1 3/16	260	12.1	F, G, Y / P\$	2354			
				1 3/16			K / P\$	3890			
				1 1/2			H / P\$	2694			
	Veneer			1 3/16			F, G, Y / W\$	3546			
				1 3/16			K / W\$	4795			
				1 1/2			H / W\$	4086			
	Glass			1/4			Acid Etched Glass Top \$	14433			
				1/4			Gloss Glass Top \$	12027			

Must Specify (in this order):

- Model #
- Top/Edge Material
- Top/Edge Finish/Color
- Edge Profile
- Glass (Y/N)
- Glass Color + Surface Finish
- Power/Data
- Power/Data Location

Description

- Tops Available with Veneer (W) or HPL (P) Top in 1 3/16" and 1 1/2" Thicknesses
- Must Specify Edge Profile: 1 3/16" Thick/Double Kerf (F), Duo (G), Square (Y), and Knife (K) Edge Profiles or 1 1/2" Thick/Vertical Square (H)
- Veneer (W) Top Grain Runs Depth of Top and HPL (P) Top Grain Runs Width of Top
- Available with Back Painted Tempered Glass Top; Must Specify Color and Finish; [See Options](#)
- Power and Data Options Available; Sold Separately, [See Multiple Power Unit Details](#)
- Strut Legs Sold Separately, [See Strut Legs](#)



Double Kerf (F)
1 3/16"



Duo (G)
1 3/16"



Square (Y)
1 3/16"



Knife (K)
1 3/16"



Vertical Square (H)
1 1/2"

P = HPL W = Veneer

[See Strut Overview For Ordering Options](#)

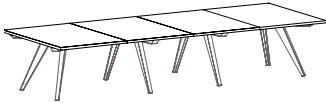
Item	Model No.		W	D	H	Ship Wt	Cubic Ft	Edge Profile + Material	List Price
RECTANGLE SHAPE MEETING TOP 60"D  88-60156RT Shown in Veneer BASES SOLD SEPARATELY	60"D x 240"W or 20' - 5 Piece Veneer (W) and 3 Piece HPL (P) Rectangle Top								
	88-60240RT	Laminate	240	60	1 3/16"	574	26.3	F, G, Y / P\$	4447
					1 3/16"			K / P\$	7574
					1 1/2"			H / P\$	5208
	Veneer				1 3/16"			F, G, Y / W\$	7814
					1 3/16"			K / W\$	9975
					1 1/2"			H / W\$	9164
	Glass				1/4"			Acid Etched Glass Top \$	29576
					1/4"			Gloss Glass Top \$	24230
	60"D x 228"W or 19' - 5 Piece Veneer (W) and 3 Piece HPL (P) Rectangle Top								
	88-60228RT	Laminate	228	60	1 3/16"	547	25.0	F, G, Y / P\$	4398
					1 3/16"			K / P\$	7418
					1 1/2"			H / P\$	5121
	Veneer				1 3/16"			F, G, Y / W\$	7565
					1 3/16"			K / W\$	9665
				1 1/2"			H / W\$	8858	
Glass				1/4"			Acid Etched Glass Top \$	28271	
				1/4"			Gloss Glass Top \$	23193	
60"D x 216"W or 18' - 5 Piece Veneer (W) and 3 Piece HPL (P) Rectangle Top									
88-60216RT	Laminate	216	60	1 3/16"	519	23.7	F, G, Y / P\$	3819	
				1 3/16"			K / P\$	6481	
				1 1/2"			H / P\$	4504	
Veneer				1 3/16"			F, G, Y / W\$	7315	
				1 3/16"			K / W\$	9354	
				1 1/2"			H / W\$	8553	
Glass				1/4"			Acid Etched Glass Top \$	26917	
				1/4"			Gloss Glass Top \$	22106	
60"D x 204"W or 17' - 5 Piece Veneer (W) and 3 Piece HPL (P) Rectangle Top									
88-60204RT	Laminate	204	60	1 3/16"	492	22.4	F, G, Y / P\$	3770	
				1 3/16"			K / P\$	6326	
				1 1/2"			H / P\$	4417	
Veneer				1 3/16"			F, G, Y / W\$	7066	
				1 3/16"			K / W\$	9044	
				1 1/2"			H / W\$	8248	
Glass				1/4"			Acid Etched Glass Top \$	25613	
				1/4"			Gloss Glass Top \$	21069	

Additional 60" Rectangle Shaped Tops on Next Page



Double Kerf (F)
1 3/16"



Duo (G)
1 3/16"



Square (Y)
1 3/16"



Knife (K)
1 3/16"



Vertical Square (H)
1 1/2"

P = HPL W = Veneer

[See Strut Overview For Ordering Options](#)

Item	Model No.		W	D	H	Ship Wt	Cubic Ft	Edge Profile + Material	List Price		
<i>CONTINUED FROM PREVIOUS PAGE</i>	60"D x 192"W or 16' - 4 Piece Veneer (W) and 2 Piece HPL (P) Rectangle Top										
	88-60192RT	Laminate	192	60	1 3/16	458	21.1	F, G, Y / P\$	3131		
					1 3/16			K / P\$	5568		
					1 1/2			H / P\$	3737		
		Veneer			1 3/16			F, G, Y / W\$	5829		
					1 3/16			K / W\$	7619		
					1 1/2			H / W\$	6760		
		Glass			1/4			Acid Etched Glass Top \$	23446		
					1/4			Gloss Glass Top \$	19170		
		60"D x 180"W or 15' - 4 Piece Veneer (W) and 2 Piece HPL (P) Rectangle Top									
	88-60180RT	Laminate	180	60	1 3/16	430	19.8	F, G, Y / P\$	3082		
					1 3/16			K / P\$	5413		
					1 1/2			H / P\$	3650		
		Veneer			1 3/16			F, G, Y / W\$	5600		
					1 3/16			K / W\$	7328		
				1 1/2			H / W\$	6475			
	Glass			1/4			Acid Etched Glass Top \$	22142			
				1/4			Gloss Glass Top \$	18133			
	60"D x 168"W or 14' - 4 Piece Veneer (W) and 2 Piece HPL (P) Rectangle Top										
88-60168RT	Laminate	168	60	1 3/16	403	18.5	F, G, Y / P\$	3032			
				1 3/16			K / P\$	5257			
				1 1/2			H / P\$	3563			
	Veneer			1 3/16			F, G, Y / W\$	5370			
				1 3/16			K / W\$	7037			
				1 1/2			H / W\$	6190			
	Glass			1/4			Acid Etched Glass Top \$	20838			
				1/4			Gloss Glass Top \$	17096			
	60"D x 156"W or 13' - 4 Piece Veneer (W) and 2 Piece HPL (P) Rectangle Top										
88-60156RT	Laminate	156	60	1 3/16	376	17.2	F, G, Y / P\$	2983			
				1 3/16			K / P\$	5101			
				1 1/2			H / P\$	3475			
	Veneer			1 3/16			F, G, Y / W\$	5140			
				1 3/16			K / W\$	6746			
				1 1/2			H / W\$	5905			
	Glass			1/4			Acid Etched Glass Top \$	19534			
				1/4			Gloss Glass Top \$	16059			

Additional 60" Rectangle Shaped Tops on Next Page



Double Kerf (F) 1 3/16" Duo (G) 1 3/16" Square (Y) 1 3/16" Knife (K) 1 3/16" Vertical Square (H) 1 1/2"

P = HPL W = Veneer

[See Strut Overview For Ordering Options](#)

Item	Model No.		W	D	H	Ship Wt	Cubic Ft	Edge Profile + Material	List Price		
60"D x 144"W or 12' - 3 Piece Veneer (W) and 2 Piece HPL (P) Rectangle Top											
<i>CONTINUED FROM PREVIOUS PAGE</i>	88-60144RT	Laminate	144	60	1 3/16"	342	16.0	F, G, Y / P\$	2524		
					1 3/16"			K / P\$	4367		
					1 1/2"			H / P\$	2979		
		Veneer							F, G, Y / W\$	4174	
									K / W\$	5593	
									H / W\$	4879	
		Glass							Acid Etched Glass Top \$	18355	
									Gloss Glass Top \$	15148	
		60"D x 132"W or 11' - 3 Piece Veneer (W) and 2 Piece HPL (P) Rectangle Top									
			88-60132RT	Laminate	132	60	1 3/16"	323	14.6	F, G, Y / P\$	2462
1 3/16"	K / P\$						4198				
1 1/2"	H / P\$						2878				
Veneer									F, G, Y / W\$	3965	
									K / W\$	5322	
									H / W\$	4614	
Glass									Acid Etched Glass Top \$	17038	
									Gloss Glass Top \$	14098	
60"D x 120"W or 10' - 3 Piece Veneer (W) and 2 Piece HPL (P) Rectangle Top											
	88-60120RT			Laminate	120	60	1 3/16"	287	13.3	F, G, Y / P\$	2400
		1 3/16"	K / P\$				4029				
		1 1/2"	H / P\$				2778				
		Veneer							F, G, Y / W\$	3755	
									K / W\$	5051	
									H / W\$	4348	
		Glass							Acid Etched Glass Top \$	15721	
									Gloss Glass Top \$	13048	

Must Specify (in this order):

- Model #
- Top/Edge Material
- Top/Edge Finish/Color
- Edge Profile
- Glass (Y/N)
- Glass Color + Surface Finish
- Power/Data Type
- Power/Data Location

Description

- Tops Available with Veneer (W) or HPL (P) Top in 1 3/16" and 1 1/2" Thicknesses
- Must Specify Edge Profile: 1 3/16" Thick/Double Kerf (F), Duo (G), Square (Y), and Knife (K) Edge Profiles or 1 1/2" Thick/Vertical Square (H)
- Veneer (W) Top Grain Runs Depth of Top and HPL (P) Top Grain Runs Width of Top
- Available with Back Painted Tempered Glass Top; Must Specify Color and Finish; [See Options](#)
- Power and Data Options Available; Sold Separately, [See Multiple Power Unit Details](#)
- Strut Legs Sold Separately, [See Strut Legs](#)



Double Kerf (F) 1 3/16" Duo (G) 1 3/16" Square (Y) 1 3/16" Knife (K) 1 3/16" Vertical Square (H) 1 1/2"

P = HPL W = Veneer

[See Strut Overview For Ordering Options](#)

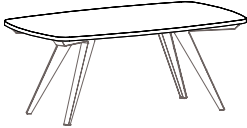
Item	Model No.		W	D	H	Ship Wt	Cubic Ft	Edge Profile + Material	List Price	
MODERN RECTANGLE SHAPE MEETING TOP 36"D  88-3672MR Shown BASES SOLD SEPARATELY	36"D x 96"W or 8' - 1 Piece Modern Rectangle Top									
	88-3696MR	Laminate	96	36	1 3/16	142	12.9	F, G, Y / P\$	1376	
					1 3/16			K / P\$	2726	
					1 1/2			H / P\$	1552	
		Veneer			1 3/16			F, G, Y / W\$	1558	
					1 3/16			K / W\$	3056	
					1 1/2			H / W\$	1856	
		Glass			1/4			Acid Etched Glass Top \$	8429	
					1/4			Gloss Glass Top \$	7146	
	36"D x 84"W or 7' - 1 Piece Modern Rectangle Top									
	88-3684MR	Laminate	84	36	1 3/16	126	11.3	F, G, Y / P\$	1311	
					1 3/16			K / P\$	2496	
					1 1/2			H / P\$	1495	
		Veneer			1 3/16			F, G, Y / W\$	1477	
					1 3/16			K / W\$	2858	
				1 1/2			H / W\$	1708		
	Glass			1/4			Acid Etched Glass Top \$	7557		
				1/4			Gloss Glass Top \$	6434		
36"D x 72"W or 6' - 1 Piece Modern Rectangle Top										
88-3672MR	Laminate	72	36	1 3/16	109	10.3	F, G, Y / P\$	1071		
				1 3/16			K / P\$	2160		
				1 1/2			H / P\$	1203		
	Veneer			1 3/16			F, G, Y / W\$	1258		
				1 3/16			K / W\$	2433		
				1 1/2			H / W\$	1485		
	Glass			1/4			Acid Etched Glass Top \$	6598		
				1/4			Gloss Glass Top \$	5635		

Must Specify (in this order):

- Model #
- Top/Edge Material
- Top/Edge Finish/Color
- Edge Profile
- Glass (Y/N)
- Glass Color + Surface Finish
- Power/Data
- Power/Data Location

Description

- Tops Available with Veneer (W) or HPL (P) Top in 1 3/16" and 1 1/2" Thicknesses
- Must Specify Edge Profile: 1 3/16" Thick/Double Kerf (F), Duo (G), Square (Y), and Knife (K) Edge Profiles or 1 1/2" Thick/Vertical Square (H)
- Veneer (W) Top Grain Runs Depth of Top and HPL (P) Top Grain Runs Width of Top
- Available with Back Painted Tempered Glass Top; Must Specify Color and Finish; [See Options](#)
- Power and Data Options Available; Sold Separately, [See Multiple Power Unit Details](#)
- Strut Legs Sold Separately, [See Strut Legs](#)



Double Kerf (F)
1 3/16"



Duo (G)
1 3/16"



Square (Y)
1 3/16"



Knife (K)
1 3/16"



Vertical Square (H)
1 1/2"

P = HPL W = Veneer

[See Strut Overview For Ordering Options](#)

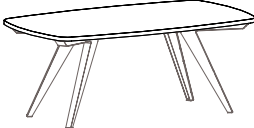
Item	Model No.		W	D	H	Ship Wt	Cubic Ft	Edge Profile + Material	List Price	
MODERN RECTANGLE SHAPE MEETING TOP 42"D  88-4272MR Shown BASES SOLD SEPARATELY	42"D x 96"W or 8' - 1 Piece Modern Rectangle Top									
	88-4296MR	Laminate	96	42	1 3/16	164	15.0	F, G, Y / P\$	1404	
					1 3/16			K / P\$	2883	
					1 1/2			H / P\$	1611	
		Veneer			1 3/16			F, G, Y / W\$	1693	
					1 3/16			K / W\$	3247	
					1 1/2			H / W\$	2033	
		Glass			1/4			Acid Etched Glass Top \$	9486	
					1/4			Gloss Glass Top \$	7989	
	42"D x 84"W or 7' - 1 Piece Modern Rectangle Top									
	88-4284MR	Laminate	84	42	1 3/16	145	13.1	F, G, Y / P\$	1366	
					1 3/16			K / P\$	2675	
					1 1/2			H / P\$	1546	
		Veneer			1 3/16			F, G, Y / W\$	1563	
					1 3/16			K / W\$	2997	
				1 1/2			H / W\$	1863		
	Glass			1/4			Acid Etched Glass Top \$	8489		
				1/4			Gloss Glass Top \$	7179		
42"D x 72"W or 6' - 1 Piece Modern Rectangle Top										
88-4272MR	Laminate	72	42	1 3/16	126	11.3	F, G, Y / P\$	1142		
				1 3/16			K / P\$	2384		
				1 1/2			H / P\$	1296		
	Veneer			1 3/16			F, G, Y / W\$	1423		
				1 3/16			K / W\$	2618		
				1 1/2			H / W\$	1682		
	Glass			1/4			Acid Etched Glass Top \$	7464		
				1/4			Gloss Glass Top \$	6341		

Must Specify (in this order):

- Model #
- Top/Edge Material
- Top/Edge Finish/Color
- Edge Profile
- Glass (Y/N)
- Glass Color + Surface Finish
- Power/Data
- Power/Data Location

Description

- Tops Available with Veneer (W) or HPL (P) Top in 1 3/16" and 1 1/2" Thicknesses
- Must Specify Edge Profile: 1 3/16" Thick/Double Kerf (F), Duo (G), Square (Y), and Knife (K) Edge Profiles or 1 1/2" Thick/Vertical Square (H)
- Veneer (W) Top Grain Runs Depth of Top and HPL (P) Top Grain Runs Width of Top
- Available with Back Painted Tempered Glass Top; Must Specify Color and Finish; [See Options](#)
- Power and Data Options Available; Sold Separately, [See Multiple Power Unit Details](#)
- Strut Legs Sold Separately, [See Strut Legs](#)



Double Kerf (F) 1 3/16" Duo (G) 1 3/16" Square (Y) 1 3/16" Knife (K) 1 3/16" Vertical Square (H) 1 1/2"

P = HPL W = Veneer

[See Strut Overview For Ordering Options](#)

Item	Model No.		W	D	H	Ship Wt	Cubic Ft	Edge Profile + Material	List Price	
MODERN RECTANGLE SHAPE MEETING TOP 48"D  88-48216MR Shown BASES SOLD SEPARATELY	48"D x 240"W or 20' - 3 Piece Modern Rectangle Top									
	88-48240MR	Laminate	240	48	1 3/16	460	48.9	F, G, Y / P\$	4481	
					1 3/16			K / P\$	8212	
					1 1/2			H / P\$	5079	
		Veneer			1 3/16			F, G, Y / W\$	6088	
					1 3/16			K / W\$	9247	
					1 1/2			H / W\$	6911	
		Glass			1/4			Acid Etched Glass Top \$	25733	
					1/4			Gloss Glass Top \$	21456	
	48"D x 228"W or 19' - 3 Piece Modern Rectangle Top									
	88-48228MR	Laminate	228	48	1 3/16	438	48.9	F, G, Y / P\$	4439	
					1 3/16			K / P\$	8004	
					1 1/2			H / P\$	5007	
		Veneer			1 3/16			F, G, Y / W\$	5833	
					1 3/16			K / W\$	8904	
				1 1/2			H / W\$	6617		
	Glass			1/4			Acid Etched Glass Top \$	24607		
				1/4			Gloss Glass Top \$	20544		
48"D x 216"W or 18' - 3 Piece Modern Rectangle Top										
88-48216MR	Laminate	216	48	1 3/16	416	48.9	F, G, Y / P\$	3562		
				1 3/16			K / P\$	6939		
				1 1/2			H / P\$	4100		
	Veneer			1 3/16			F, G, Y / W\$	5187		
				1 3/16			K / W\$	8170		
				1 1/2			H / W\$	5931		
	Glass			1/4			Acid Etched Glass Top \$	23108		
				1/4			Gloss Glass Top \$	19259		
48"D x 204"W or 17' - 3 Piece Modern Rectangle Top										
88-48204MR	Laminate	204	48	1 3/16	394	48.9	F, G, Y / P\$	3520		
				1 3/16			K / P\$	6732		
				1 1/2			H / P\$	4028		
	Veneer			1 3/16			F, G, Y / W\$	4933		
				1 3/16			K / W\$	7827		
				1 1/2			H / W\$	5637		
	Glass			1/4			Acid Etched Glass Top \$	21982		
				1/4			Gloss Glass Top \$	18346		

Additional 48" Modern Rectangle Shaped Tops on Next Page



Double Kerf (F) 1 3/16" Duo (G) 1 3/16" Square (Y) 1 3/16" Knife (K) 1 3/16" Vertical Square (H) 1 1/2"

P = HPL W = Veneer

[See Strut Overview For Ordering Options](#)

Item	Model No.		W	D	H	Ship Wt	Cubic Ft	Edge Profile + Material	List Price		
48"D x 192"W or 16' - 2 Piece Modern Rectangle Top											
<i>CONTINUED FROM PREVIOUS PAGE</i>	88-48192MR	Laminate	192	48	1 ³ / ₁₆ "	372	31.2	F, G, Y / P\$	3019		
					1 ³ / ₁₆ "			K / P\$	6038		
					1 ¹ / ₂ "			H / P\$	3499		
					Veneer			1 ³ / ₁₆ "	F, G, Y / W\$	4072	
								1 ³ / ₁₆ "	K / W\$	6759	
								1 ¹ / ₂ "	H / W\$	4822	
		Glass		1 ¹ / ₄ "	Acid Etched Glass Top \$	20360					
				1 ¹ / ₄ "	Gloss Glass Top \$	16938					
		48"D x 180"W or 15' - 2 Piece Modern Rectangle Top									
		<i>Must Specify (in this order):</i> Model # Top/Edge Material Top/Edge Finish/Color Edge Profile Glass (Y/N) Glass Color + Surface Finish Power/Data Power/Data Location	88-48180MR	Laminate	180	48	1 ³ / ₁₆ "	350	31.2	F, G, Y / P\$	2976
							1 ³ / ₁₆ "			K / P\$	5830
							1 ¹ / ₂ "			H / P\$	3427
Veneer							1 ³ / ₁₆ "			F, G, Y / W\$	3908
							1 ³ / ₁₆ "			K / W\$	6453
							1 ¹ / ₂ "			H / W\$	4612
Glass				1 ¹ / ₄ "	Acid Etched Glass Top \$	19233					
				1 ¹ / ₄ "	Gloss Glass Top \$	16025					
48"D x 168"W or 14' - 2 Piece Modern Rectangle Top											
	88-48168MR			Laminate	168	48	1 ³ / ₁₆ "	328	31.2	F, G, Y / P\$	2829
							1 ³ / ₁₆ "			K / P\$	5515
							1 ¹ / ₂ "			H / P\$	3249
		Veneer					1 ³ / ₁₆ "			F, G, Y / W\$	3610
							1 ³ / ₁₆ "			K / W\$	6013
							1 ¹ / ₂ "			H / W\$	4269
		Glass		1 ¹ / ₄ "	Acid Etched Glass Top \$	17999					
				1 ¹ / ₄ "	Gloss Glass Top \$	15005					
		48"D x 156"W or 13' - 2 Piece Modern Rectangle Top									
			88-48156MR	Laminate	156	48	1 ³ / ₁₆ "	306	31.2	F, G, Y / P\$	2787
							1 ³ / ₁₆ "			K / P\$	5182
							1 ¹ / ₂ "			H / P\$	3177
Veneer							1 ³ / ₁₆ "			F, G, Y / W\$	3446
							1 ³ / ₁₆ "			K / W\$	5835
							1 ¹ / ₂ "			H / W\$	4060
Glass				1 ¹ / ₄ "	Acid Etched Glass Top \$	16872					
				1 ¹ / ₄ "	Gloss Glass Top \$	14092					

Additional 48" Modern Rectangle Shaped Tops on Next Page



Double Kerf (F) 1³/₁₆" Duo (G) 1³/₁₆" Square (Y) 1³/₁₆" Knife (K) 1³/₁₆" Vertical Square (H) 1¹/₂"

P = HPL W = Veneer

[See Strut Overview For Ordering Options](#)

Item	Model No.		W	D	H	Ship Wt	Cubic Ft	Edge Profile + Material	List Price			
48"D x 144"W or 12' - 2 Piece Modern Rectangle Top												
<i>CONTINUED FROM PREVIOUS PAGE</i>	88-48144MR	Laminate	144	48	1 ³ / ₁₆	284	23.5	F, G, Y / P\$	2339			
					1 ³ / ₁₆			K / P\$	4683			
					1 ¹ / ₂			H / P\$	2699			
		Veneer								F, G, Y / W\$	3215	
										1 ³ / ₁₆	K / W\$	5334
										1 ¹ / ₂	H / W\$	3783
		Glass								Acid Etched Glass Top \$	15653	
											Gloss Glass Top \$	13086
		48"D x 132"W or 11' - 2 Piece Modern Rectangle Top										
		<i>Must Specify (in this order):</i> Model # Top/Edge Material Top/Edge Finish/Color Edge Profile Glass (Y/N) Glass Color + Surface Finish Power/Data Power/Data Location	88-48132MR	Laminate	132	48	1 ³ / ₁₆	262	23.5	F, G, Y / P\$	2285	
							1 ³ / ₁₆			K / P\$	4463	
							1 ¹ / ₂			H / P\$	2614	
Veneer										F, G, Y / W\$	3000	
										1 ³ / ₁₆	K / W\$	5003
										1 ¹ / ₂	H / W\$	3522
Glass										Acid Etched Glass Top \$	14514	
											Gloss Glass Top \$	12162
48"D x 120"W or 10' - 2 Piece Modern Rectangle Top												
	88-48120MR			Laminate	120	48	1 ³ / ₁₆	240	23.5	F, G, Y / P\$	2221	
							1 ³ / ₁₆			K / P\$	4235	
							1 ¹ / ₂			H / P\$	2521	
		Veneer								F, G, Y / W\$	2773	
										1 ³ / ₁₆	K / W\$	4660
										1 ¹ / ₂	H / W\$	3250
		Glass								Acid Etched Glass Top \$	13367	
											Gloss Glass Top \$	11229
		48"D x 108"W or 9' - 2 Piece Modern Rectangle Top										
			88-48108MR	Laminate	108	48	1 ³ / ₁₆	218	23.5	F, G, Y / P\$	2167	
							1 ³ / ₁₆			K / P\$	3926	
							1 ¹ / ₂			H / P\$	2437	
Veneer										F, G, Y / W\$	2558	
										1 ³ / ₁₆	K / W\$	4420
										1 ¹ / ₂	H / W\$	2990
Glass										Acid Etched Glass Top \$	12229	
											Gloss Glass Top \$	10304

Additional 48" Modern Rectangle Shaped Tops on Next Page



Double Kerf (F) 1³/₁₆" Duo (G) 1³/₁₆" Square (Y) 1³/₁₆" Knife (K) 1³/₁₆" Vertical Square (H) 1¹/₂"

P = HPL W = Veneer

[See Strut Overview For Ordering Options](#)

Item	Model No.		W	D	H	Ship Wt	Cubic Ft	Edge Profile + Material	List Price			
48"D x 96"W or 8' - 1 Piece Modern Rectangle Top												
<i>CONTINUED FROM PREVIOUS PAGE</i>	88-4896MR	Laminate	96	48	1 ³ / ₁₆ "	315	18.0	F, G, Y / P\$	1477			
					1 ³ / ₁₆ "			K / P\$	3148			
					1 ¹ / ₂ "			H / P\$	1714			
		Veneer								F, G, Y / W\$	1885	
										1 ³ / ₁₆ "	K / W\$	3438
										1 ¹ / ₂ "	H / W\$	2268
		Glass								Acid Etched Glass Top \$	10594	
											Gloss Glass Top \$	8883
		48"D x 84"W or 7' - 1 Piece Modern Rectangle Top										
		<u>Must Specify (in this order):</u> Model # Top/Edge Material Top/Edge Finish/Color Edge Profile Glass (Y/N) Glass Color + Surface Finish Power/Data Power/Data Location	88-4884MR	Laminate	84	48	1 ³ / ₁₆ "	164	15.0	F, G, Y / P\$	1434	
1 ³ / ₁₆ "	K / P\$						2801					
1 ¹ / ₂ "	H / P\$						1641					
Veneer										F, G, Y / W\$	1666	
										1 ³ / ₁₆ "	K / W\$	3156
										1 ¹ / ₂ "	H / W\$	2004
Glass										Acid Etched Glass Top \$	9403	
											Gloss Glass Top \$	7907
48"D x 72"W or 6' - 1 Piece Modern Rectangle Top												
	88-4872MR			Laminate	72	48	1 ³ / ₁₆ "	142	12.8	F, G, Y / P\$	1207	
		1 ³ / ₁₆ "	K / P\$				2548					
		1 ¹ / ₂ "	H / P\$				1384					
		Veneer								F, G, Y / W\$	1578	
										1 ³ / ₁₆ "	K / W\$	2848
										1 ¹ / ₂ "	H / W\$	1870
		Glass								Acid Etched Glass Top \$	8317	
											Gloss Glass Top \$	7034

Description

- Tops Available with Veneer (W) or HPL (P) Top in 1³/₁₆" and 1¹/₂" Thicknesses
- Must Specify Edge Profile: 1³/₁₆" Thick/Double Kerf (F), Duo (G), Square (Y), and Knife (K) Edge Profiles or 1¹/₂" Thick/Vertical Square (H)
- Veneer (W) Top Grain Runs Depth of Top and HPL (P) Top Grain Runs Width of Top
- Available with Back Painted Tempered Glass Top; Must Specify Color and Finish; [See Options](#)
- Power and Data Options Available; Sold Separately, [See Multiple Power Unit Details](#)
- Dock800, Oasis, and E2X Power Units Available on Ends Only (E1 and E2) for 108"D - 156"D and 204"D-240"D Tops
- Strut Legs Sold Separately, [See Strut Legs](#)



Double Kerf (F)
1³/₁₆"



Duo (G)
1³/₁₆"



Square (Y)
1³/₁₆"



Knife (K)
1³/₁₆"



Vertical Square (H)
1¹/₂"

P = HPL W = Veneer

[See Strut Overview For Ordering Options](#)

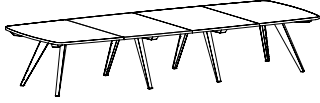
Item	Model No.		W	D	H	Ship Wt	Cubic Ft	Edge Profile + Material	List Price	
MODERN RECTANGLE SHAPE MEETING TOP 54"D  88-54156MR Shown in Veneer BASES SOLD SEPARATELY	54"D x 240"W or 20' - 5 Piece Veneer (W) and 3 Piece HPL (P) Modern Rectangle Top									
	88-54240MR	Laminate	240	54	1 3/16	519	24.0	F, G, Y / P\$	4531	
					1 3/16			K / P\$	8476	
					1 1/2			H / P\$	5207	
		Veneer			1 3/16			F, G, Y / W\$	7579	
					1 3/16			K / W\$	11166	
					1 1/2			H / W\$	8611	
		Glass			1/4			Acid Etched Glass Top \$	28663	
					1/4			Gloss Glass Top \$	23852	
	54"D x 228"W or 19' - 5 Piece Veneer (W) and 3 Piece HPL (P) Modern Rectangle Top									
	88-54228MR	Laminate	228	54	1 3/16	495	23.0	F, G, Y / P\$	4485	
					1 3/16			K / P\$	8256	
					1 1/2			H / P\$	5127	
		Veneer			1 3/16			F, G, Y / W\$	7345	
					1 3/16			K / W\$	10782	
				1 1/2			H / W\$	8328		
	Glass			1/4			Acid Etched Glass Top \$	27410		
				1/4			Gloss Glass Top \$	22840		
54"D x 216"W or 18' - 5 Piece Veneer (W) and 3 Piece HPL (P) Modern Rectangle Top										
88-54216MR	Laminate	216	54	1 3/16	470	22.0	F, G, Y / P\$	3910		
				1 3/16			K / P\$	7493		
				1 1/2			H / P\$	4518		
	Veneer			1 3/16			F, G, Y / W\$	7112		
				1 3/16			K / W\$	10397		
				1 1/2			H / W\$	8045		
	Glass			1/4			Acid Etched Glass Top \$	26123		
				1/4			Gloss Glass Top \$	21793		
54"D x 204"W or 17' - 5 Piece Veneer (W) and 3 Piece HPL (P) Modern Rectangle Top										
88-54204MR	Laminate	204	54	1 3/16	445	21.0	F, G, Y / P\$	3864		
				1 3/16			K / P\$	7273		
				1 1/2			H / P\$	4438		
	Veneer			1 3/16			F, G, Y / W\$	6878		
				1 3/16			K / W\$	10014		
				1 1/2			H / W\$	7762		
	Glass			1/4			Acid Etched Glass Top \$	24871		
				1/4			Gloss Glass Top \$	20782		

Must Specify (in this order):

- Model #
- Top/Edge Material
- Top/Edge Finish/Color
- Edge Profile
- Glass (Y/N)
- Glass Color + Surface Finish
- Power/Data
- Power/Data Location

Additional 54" Modern Rectangle Shaped Tops on Next Page



Double Kerf (F)
1 3/16"

Duo (G)
1 3/16"

Square (Y)
1 3/16"

Knife (K)
1 3/16"

Vertical Square (H)
1 1/2"

P = HPL W = Veneer

[See Strut Overview For Ordering Options](#)

Item	Model No.		W	D	H	Ship Wt	Cubic Ft	Edge Profile + Material	List Price	
54"D x 192"W or 16' - 4 Piece Veneer (W) and 2 Piece HPL (P) Modern Rectangle Top										
<i>CONTINUED FROM PREVIOUS PAGE</i>	88-54192MR	Laminate	192	54	1 3/16"	408	19.0	F, G, Y / P\$	3180	
					1 3/16"			K / P\$	6383	
					1 1/2"			H / P\$	3722	
		Veneer			1 3/16"			F, G, Y / W\$	5675	
					1 3/16"			K / W\$	8636	
					1 1/2"			H / W\$	6506	
		Glass			1/4"			Acid Etched Glass Top \$	22945	
					1/4"			Gloss Glass Top \$	19096	
	54"D x 180"W or 15' - 4 Piece Veneer (W) and 2 Piece HPL (P) Modern Rectangle Top									
	Must Specify (in this order): Model # Top/Edge Material Top/Edge Finish/Color Edge Profile Glass (Y/N) Glass Color + Surface Finish Power/Data Power/Data Location	88-54180MR	Laminate	180	54	1 3/16"	384	18.0	F, G, Y / P\$	3134
					1 3/16"			K / P\$	6163	
					1 1/2"			H / P\$	3642	
		Veneer			1 3/16"			F, G, Y / W\$	5461	
					1 3/16"			K / W\$	8271	
					1 1/2"			H / W\$	6242	
		Glass			1/4"			Acid Etched Glass Top \$	21692	
					1/4"			Gloss Glass Top \$	18083	
54"D x 168"W or 14' - 4 Piece Veneer (W) and 2 Piece HPL (P) Modern Rectangle Top										
		88-54168MR	Laminate	168	54	1 3/16"	359	17.0	F, G, Y / P\$	3087
					1 3/16"			K / P\$	5943	
					1 1/2"			H / P\$	3562	
		Veneer			1 3/16"			F, G, Y / W\$	5247	
					1 3/16"			K / W\$	7905	
					1 1/2"			H / W\$	5979	
		Glass			1/4"			Acid Etched Glass Top \$	20439	
					1/4"			Gloss Glass Top \$	17071	
	54"D x 156"W or 13' - 4 Piece Veneer (W) and 2 Piece HPL (P) Modern Rectangle Top									
		88-54156MR	Laminate	156	54	1 3/16"	334	16.0	F, G, Y / P\$	3041
					1 3/16"			K / P\$	5723	
					1 1/2"			H / P\$	3481	
		Veneer			1 3/16"			F, G, Y / W\$	5033	
					1 3/16"			K / W\$	7538	
					1 1/2"			H / W\$	5715	
		Glass			1/4"			Acid Etched Glass Top \$	19185	
					1/4"			Gloss Glass Top \$	16057	

Additional 54" Modern Rectangle Shaped Tops on Next Page



Double Kerf (F) 1 3/16" Duo (G) 1 3/16" Square (Y) 1 3/16" Knife (K) 1 3/16" Vertical Square (H) 1 1/2"

P = HPL W = Veneer

[See Strut Overview For Ordering Options](#)

Item	Model No.		W	D	H	Ship Wt	Cubic Ft	Edge Profile + Material	List Price		
<i>CONTINUED FROM PREVIOUS PAGE</i>	54"D x 144"W or 12' - 3 Piece Veneer (W) and 2 Piece HPL (P) Modern Rectangle Top										
	88-54144MR	Laminate	144	54	1 $\frac{3}{16}$	309	15.0	F, G, Y / P\$	2585		
					1 $\frac{3}{16}$			K / P\$	5083		
					1 $\frac{1}{2}$			H / P\$	2992		
		Veneer			1 $\frac{3}{16}$			F, G, Y / W\$	4155		
					1 $\frac{3}{16}$			K / W\$	6420		
					1 $\frac{1}{2}$			H / W\$	6420		
		Glass			1 $\frac{1}{4}$			Acid Etched Glass Top \$	17612		
					1 $\frac{1}{4}$			Gloss Glass Top \$	14725		
		54"D x 132"W or 11' - 3 Piece Veneer (W) and 2 Piece HPL (P) Modern Rectangle Top									
	88-54132MR	Laminate	132	54	1 $\frac{3}{16}$	285	13.2	F, G, Y / P\$	2526		
					1 $\frac{3}{16}$			K / P\$	4851		
					1 $\frac{1}{2}$			H / P\$	2899		
		Veneer			1 $\frac{3}{16}$			F, G, Y / W\$	3952		
					1 $\frac{3}{16}$			K / W\$	6072		
				1 $\frac{1}{2}$			H / W\$	4468			
	Glass			1 $\frac{1}{4}$			Acid Etched Glass Top \$	16346			
				1 $\frac{1}{4}$			Gloss Glass Top \$	13700			
	54"D x 120"W or 10' - 3 Piece Veneer (W) and 2 Piece HPL (P) Modern Rectangle Top										
88-54120MR	Laminate	120	54	1 $\frac{3}{16}$	260	12.1	F, G, Y / P\$	2467			
				1 $\frac{3}{16}$			K / P\$	4618			
				1 $\frac{1}{2}$			H / P\$	2806			
	Veneer			1 $\frac{3}{16}$			F, G, Y / W\$	3749			
				1 $\frac{3}{16}$			K / W\$	5727			
				1 $\frac{1}{2}$			H / W\$	4222			
	Glass			1 $\frac{1}{4}$			Acid Etched Glass Top \$	15084			
				1 $\frac{1}{4}$			Gloss Glass Top \$	12678			

Must Specify (in this order):

Model #
 Top/Edge Material
 Top/Edge Finish/Color
 Edge Profile
 Glass (Y/N)
 Glass Color + Surface Finish
 Power/Data
 Power/Data Location

Description

- Tops Available with Veneer (W) or HPL (P) Top in 1 $\frac{3}{16}$ " and 1 $\frac{1}{2}$ " Thicknesses
- Must Specify Edge Profile: 1 $\frac{3}{16}$ " Thick/Double Kerf (F), Duo (G), Square (Y), and Knife (K) Edge Profiles or 1 $\frac{1}{2}$ " Thick/Vertical Square (H)
- Veneer (W) Top Grain Runs Depth of Top and HPL (P) Top Grain Runs Width of Top
- Available with Back Painted Tempered Glass Top; Must Specify Color and Finish; [See Options](#)
- Power and Data Options Available; Sold Separately, [See Multiple Power Unit Details](#)
- Strut Legs Sold Separately, [See Strut Legs](#)



Double Kerf (F)
1 $\frac{3}{16}$ "



Duo (G)
1 $\frac{3}{16}$ "



Square (Y)
1 $\frac{3}{16}$ "



Knife (K)
1 $\frac{3}{16}$ "



Vertical Square (H)
1 $\frac{1}{2}$ "

P = HPL W = Veneer

[See Strut Overview For Ordering Options](#)

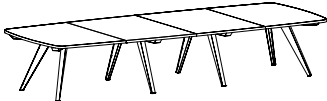
Item	Model No.		W	D	H	Ship Wt	Cubic Ft	Edge Profile + Material	List Price	
MODERN RECTANGLE SHAPE MEETING TOP 60"D  88-60156MR Shown in Veneer BASES SOLD SEPARATELY	60"D x 240"W or 20' - 5 Piece Veneer (W) and 3 Piece HPL (P) Modern Rectangle Top									
	88-60240MR	Laminate	240	60	1 3/16	574	26.3	F, G, Y / P\$	4617	
					1 3/16			K / P\$	8777	
					1 1/2			H / P\$	5371	
		Veneer			1 3/16			F, G, Y / W\$	8076	
					1 3/16			K / W\$	11791	
					1 1/2			H / W\$	9212	
		Glass			1/4			Acid Etched Glass Top \$	31262	
					1/4			Gloss Glass Top \$	25916	
	60"D x 228"W or 19' - 5 Piece Veneer (W) and 3 Piece HPL (P) Modern Rectangle Top									
	88-60228MR	Laminate	228	60	1 3/16	547	25.0	F, G, Y / P\$	4567	
					1 3/16			K / P\$	8545	
					1 1/2			H / P\$	5283	
		Veneer			1 3/16			F, G, Y / W\$	7818	
					1 3/16			K / W\$	11378	
				1 1/2			H / W\$	8899		
	Glass			1/4			Acid Etched Glass Top \$	29882		
				1/4			Gloss Glass Top \$	24803		
60"D x 216"W or 18' - 5 Piece Veneer (W) and 3 Piece HPL (P) Modern Rectangle Top										
88-60216MR	Laminate	216	60	1 3/16	519	23.7	F, G, Y / P\$	3987		
				1 3/16			K / P\$	7770		
				1 1/2			H / P\$	4666		
	Veneer			1 3/16			F, G, Y / W\$	7560		
				1 3/16			K / W\$	10966		
				1 1/2			H / W\$	8587		
	Glass			1/4			Acid Etched Glass Top \$	28467		
				1/4			Gloss Glass Top \$	23655		
60"D x 204"W or 17' - 5 Piece Veneer (W) and 3 Piece HPL (P) Modern Rectangle Top										
88-60204MR	Laminate	204	60	1 3/16	492	22.4	F, G, Y / P\$	3937		
				1 3/16			K / P\$	7538		
				1 1/2			H / P\$	4578		
	Veneer			1 3/16			F, G, Y / W\$	7302		
				1 3/16			K / W\$	10553		
				1 1/2			H / W\$	8274		
	Glass			1/4			Acid Etched Glass Top \$	27087		
				1/4			Gloss Glass Top \$	22543		

Must Specify (in this order):

- Model #
- Top/Edge Material
- Top/Edge Finish/Color
- Edge Profile
- Glass (Y/N)
- Glass Color + Surface Finish
- Power/Data Type
- Power/Data Location

Additional 60" Modern Rectangle Shaped Tops on Next Page



Double Kerf (F) 1 3/16" Duo (G) 1 3/16" Square (Y) 1 3/16" Knife (K) 1 3/16" Vertical Square (H) 1 1/2"

P = HPL W = Veneer

[See Strut Overview For Ordering Options](#)

Item	Model No.		W	D	H	Ship Wt	Cubic Ft	Edge Profile + Material	List Price		
<i>CONTINUED FROM PREVIOUS PAGE</i>	60"D x 192"W or 16' - 4 Piece Veneer (W) and 2 Piece HPL (P) Modern Rectangle Top										
	88-60192MR	Laminate	192	60	1 3/16	458	21.1	F, G, Y / P\$	3250		
					1 3/16			K / P\$	6634		
					1 1/2			H / P\$	3854		
		Veneer			1 3/16			F, G, Y / W\$	6041		
					1 3/16			K / W\$	9116		
					1 1/2			H / W\$	6956		
		Glass			1/4			Acid Etched Glass Top \$	25033		
					1/4			Gloss Glass Top \$	20756		
		60"D x 180"W or 15' - 4 Piece Veneer (W) and 2 Piece HPL (P) Modern Rectangle Top									
	88-60180MR	Laminate	180	60	1 3/16	431	19.8	F, G, Y / P\$	3199		
					1 3/16			K / P\$	6401		
					1 1/2			H / P\$	3766		
		Veneer			1 3/16			F, G, Y / W\$	5804		
					1 3/16			K / W\$	8725		
					1 1/2			H / W\$	6665		
		Glass			1/4			Acid Etched Glass Top \$	23653		
					1/4			Gloss Glass Top \$	19644		
	60"D x 168"W or 14' - 4 Piece Veneer (W) and 2 Piece HPL (P) Modern Rectangle Top										
88-60168MR	Laminate	168	60	1 3/16	403	18.5	F, G, Y / P\$	3149			
				1 3/16			K / P\$	6169			
				1 1/2			H / P\$	3677			
	Veneer			1 3/16			F, G, Y / W\$	5567			
				1 3/16			K / W\$	8333			
				1 1/2			H / W\$	6373			
	Glass			1/4			Acid Etched Glass Top \$	22273			
				1/4			Gloss Glass Top \$	18531			
	60"D x 156"W or 13' - 4 Piece Veneer (W) and 2 Piece HPL (P) Modern Rectangle Top										
88-60156MR	Laminate	156	60	1 3/16	376	17.2	F, G, Y / P\$	3098			
				1 3/16			K / P\$	5937			
				1 1/2			H / P\$	3589			
	Veneer			1 3/16			F, G, Y / W\$	5331			
				1 3/16			K / W\$	7942			
				1 1/2			H / W\$	6082			
	Glass			1/4			Acid Etched Glass Top \$	20893			
				1/4			Gloss Glass Top \$	17418			

Must Specify (in this order):
 Model #
 Top/Edge Material
 Top/Edge Finish/Color
 Edge Profile
 Glass (Y/N)
 Glass Color + Surface Finish
 Power/Data
 Power/Data Location

Additional 60" Modern Rectangle Shaped Tops on Next Page



Double Kerf (F) 1 3/16" Duo (G) 1 3/16" Square (Y) 1 3/16" Knife (K) 1 3/16" Vertical Square (H) 1 1/2"

P = HPL W = Veneer

[See Strut Overview For Ordering Options](#)

Item	Model No.		W	D	H	Ship Wt	Cubic Ft	Edge Profile + Material	List Price	
60"D x 144"W or 12' - 3 Piece Veneer (W) and 2 Piece HPL (P) Modern Rectangle Top										
<i>CONTINUED FROM PREVIOUS PAGE</i>	88-60144MR	Laminate	144	60	1 3/16"	342	16.0	F, G, Y / P\$	2639	
					1 3/16"			K / P\$	5285	
					1 1/2"			H / P\$	3092	
		Veneer			1 3/16"			F, G, Y / W\$	4414	
					1 3/16"			K / W\$	6771	
					1 1/2"			H / W\$	5029	
		Glass			1/4"			Acid Etched Glass Top \$	19192	
					1/4"			Gloss Glass Top \$	15984	
	60"D x 132"W or 11' - 3 Piece Veneer (W) and 2 Piece HPL (P) Modern Rectangle Top									
	<i>Must Specify (in this order):</i> Model # Top/Edge Material Top/Edge Finish/Color Edge Profile Glass (Y/N) Glass Color + Surface Finish Power/Data Type Power/Data Location	88-60132MR	Laminate	132	60	1 3/16"	323	14.6	F, G, Y / P\$	2576
					1 3/16"			K / P\$	5040	
					1 1/2"			H / P\$	2991	
		Veneer			1 3/16"			F, G, Y / W\$	4189	
					1 3/16"			K / W\$	6397	
					1 1/2"			H / W\$	4756	
		Glass			1/4"			Acid Etched Glass Top \$	17798	
					1/4"			Gloss Glass Top \$	14858	
60"D x 120"W or 10' - 3 Piece Veneer (W) and 2 Piece HPL (P) Modern Rectangle Top										
		88-60120MR	Laminate	120	60	1 3/16"	287	13.3	F, G, Y / P\$	2513
					1 3/16"			K / P\$	4796	
					1 1/2"			H / P\$	2890	
		Veneer			1 3/16"			F, G, Y / W\$	3965	
					1 3/16"			K / W\$	6026	
					1 1/2"			H / W\$	4484	
		Glass			1/4"			Acid Etched Glass Top \$	16406	
					1/4"			Gloss Glass Top \$	13733	

Description

- Tops Available with Veneer (W) or HPL (P) Top in 1 3/16" and 1 1/2" Thicknesses
- Must Specify Edge Profile: 1 3/16" Thick/Double Kerf (F), Duo (G), Square (Y), and Knife (K) Edge Profiles or 1 1/2" Thick/Vertical Square (H)
- Veneer (W) Top Grain Runs Depth of Top and HPL (P) Top Grain Runs Width of Top
- Available with Back Painted Tempered Glass Top; Must Specify Color and Finish; [See Options](#)
- Power and Data Options Available; Sold Separately, [See Multiple Power Unit Details](#)
- Strut Legs Sold Separately, [See Strut Legs](#)



Double Kerf (F) 1 3/16" Duo (G) 1 3/16" Square (Y) 1 3/16" Knife (K) 1 3/16" Vertical Square (H) 1 1/2"

P = HPL W = Veneer

[See Strut Overview For Ordering Options](#)

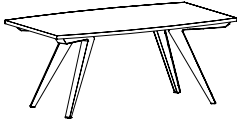
Item	Model No.		W	D	H	Ship Wt	Cubic Ft	Edge Profile + Material	List Price	
BOAT SHAPE MEETING TOP 36"D  88-3696BT Shown BASES SOLD SEPARATELY	36"D x 96"W or 8' - 1 Piece Boat Top									
	88-3696BT	Laminate	96	36-30	1 ³ / ₁₆	142	12.9	F, G, Y / P\$	1376	
					1 ³ / ₁₆			K / P\$	2726	
					1 ¹ / ₂			H / P\$	1552	
		Veneer			1 ³ / ₁₆			F, G, Y / W\$	1558	
					1 ³ / ₁₆			K / W\$	3056	
					1 ¹ / ₂			H / W\$	1856	
		Glass			1/4			Acid Etched Glass Top \$	8429	
					1/4			Gloss Glass Top \$	7146	
	36"D x 84"W or 7' - 1 Piece Boat Top									
	88-3684BT	Laminate	84	36-30	1 ³ / ₁₆	126	11.3	F, G, Y / P\$	1311	
					1 ³ / ₁₆			K / P\$	2496	
					1 ¹ / ₂			H / P\$	1495	
		Veneer			1 ³ / ₁₆			F, G, Y / W\$	1477	
					1 ³ / ₁₆			K / W\$	2858	
				1 ¹ / ₂			H / W\$	1708		
	Glass			1/4			Acid Etched Glass Top \$	7557		
				1/4			Gloss Glass Top \$	6434		
36"D x 72"W or 6' - 1 Piece Boat Top										
88-3672BT	Laminate	72	36-30	1 ³ / ₁₆	109	10.3	F, G, Y / P\$	1071		
				1 ³ / ₁₆			K / P\$	2160		
				1 ¹ / ₂			H / P\$	1203		
	Veneer			1 ³ / ₁₆			F, G, Y / W\$	1258		
				1 ³ / ₁₆			K / W\$	2433		
				1 ¹ / ₂			H / W\$	1485		
	Glass			1/4			Acid Etched Glass Top \$	6598		
				1/4			Gloss Glass Top \$	5635		

Must Specify (in this order):

- Model #
- Top/Edge Material
- Top/Edge Finish/Color
- Edge Profile
- Glass (Y/N)
- Glass Color + Surface Finish
- Power/Data
- Power/Data Location

Description

- Tops Available with Veneer (W) or HPL (P) Top in 1³/₁₆" and 1¹/₂" Thicknesses
- Must Specify Edge Profile: 1³/₁₆" Thick/Double Kerf (F), Duo (G), Square (Y), and Knife (K) Edge Profiles or 1¹/₂" Thick/Vertical Square (H)
- Veneer (W) Top Grain Runs Depth of Top and HPL (P) Top Grain Runs Width of Top
- Available with Back Painted Tempered Glass Top; Must Specify Color and Finish; [See Options](#)
- Power and Data Options Available; Sold Separately, [See Multiple Power Unit Details](#)
- Strut Legs Sold Separately, [See Strut Legs](#)



Double Kerf (F)
1³/₁₆"



Duo (G)
1³/₁₆"



Square (Y)
1³/₁₆"



Knife (K)
1³/₁₆"



Vertical Square (H)
1¹/₂"

P = HPL W = Veneer

[See Strut Overview For Ordering Options](#)

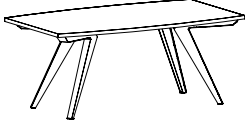
Item	Model No.		W	D	H	Ship Wt	Cubic Ft	Edge Profile + Material	List Price	
BOAT SHAPE MEETING TOP 42"D  <p>88-3696BT Shown BASES SOLD SEPARATELY</p>	42"D x 96"W or 8' - 1 Piece Boat Top									
	88-4296BT	Laminate	96	42-36	1 3/16	164	15.0	F, G, Y / P\$	1404	
					1 3/16			K / P\$	2883	
					1 1/2			H / P\$	1611	
		Veneer			1 3/16			F, G, Y / W\$	1693	
					1 3/16			K / W\$	3247	
					1 1/2			H / W\$	2033	
		Glass			1/4			Acid Etched Glass Top \$	9486	
					1/4			Gloss Glass Top \$	7989	
	42"D x 84"W or 7' - 1 Piece Boat Top									
	88-4284BT	Laminate	84	42-36	1 3/16	145	13.1	F, G, Y / P\$	1366	
					1 3/16			K / P\$	2675	
				1 1/2			H / P\$	1546		
	Veneer			1 3/16			F, G, Y / W\$	1563		
				1 3/16			K / W\$	2997		
				1 1/2			H / W\$	1863		
	Glass			1/4			Acid Etched Glass Top \$	8489		
				1/4			Gloss Glass Top \$	7179		
42"D x 72"W or 6' - 1 Piece Boat Top										
88-4272BT	Laminate	72	42-36	1 3/16	164	15.0	F, G, Y / P\$	1142		
				1 3/16			K / P\$	2384		
				1 1/2			H / P\$	1296		
	Veneer			1 3/16			F, G, Y / W\$	1423		
				1 3/16			K / W\$	2618		
				1 1/2			H / W\$	1682		
	Glass			1/4			Acid Etched Glass Top \$	7464		
				1/4			Gloss Glass Top \$	6341		

Must Specify (in this order):

- Model #
- Top/Edge Material
- Top/Edge Finish/Color
- Edge Profile
- Glass (Y/N)
- Glass Color + Surface Finish
- Power/Data
- Power/Data Location

Description

- Tops Available with Veneer (W) or HPL (P) Top in 1 3/16" and 1 1/2" Thicknesses
- Must Specify Edge Profile: 1 3/16" Thick/Double Kerf (F), Duo (G), Square (Y), and Knife (K) Edge Profiles or 1 1/2" Thick/Vertical Square (H)
- Veneer (W) Top Grain Runs Depth of Top and HPL (P) Top Grain Runs Width of Top
- Available with Back Painted Tempered Glass Top; Must Specify Color and Finish; [See Options](#)
- Power and Data Options Available; Sold Separately, [See Multiple Power Unit Details](#)
- Strut Legs Sold Separately, [See Strut Legs](#)



Double Kerf (F) 1 3/16" Duo (G) 1 3/16" Square (Y) 1 3/16" Knife (K) 1 3/16" Vertical Square (H) 1 1/2"

P = HPL W = Veneer

[See Strut Overview For Ordering Options](#)

Item	Model No.		W	D	H	Ship Wt	Cubic Ft	Edge Profile + Material	List Price	
BOAT SHAPE MEETING TOP 48"D  88-48216BT Shown BASES SOLD SEPARATELY	48"D x 240"W or 20' - 3 Piece Boat Top									
	88-48240BT	Laminate	240	48-36	1 3/16	460	48.9	F, G, Y / P\$	4481	
					1 3/16			K / P\$	8212	
					1 1/2			H / P\$	5079	
		Veneer			1 3/16			F, G, Y / W\$	6088	
					1 3/16			K / W\$	9247	
					1 1/2			H / W\$	6911	
		Glass			1/4			Acid Etched Glass Top \$	25733	
					1/4			Gloss Glass Top \$	21456	
	48"D x 228"W or 19' - 3 Piece Boat Top									
	88-48228BT	Laminate	228	48-36	1 3/16	438	48.9	F, G, Y / P\$	4439	
					1 3/16			K / P\$	8004	
					1 1/2			H / P\$	5007	
		Veneer			1 3/16			F, G, Y / W\$	5833	
					1 3/16			K / W\$	8904	
				1 1/2			H / W\$	6617		
	Glass			1/4			Acid Etched Glass Top \$	24607		
				1/4			Gloss Glass Top \$	20544		
48"D x 216"W or 18' - 3 Piece Boat Top										
88-48216BT	Laminate	216	48-36	1 3/16	416	48.9	F, G, Y / P\$	3562		
				1 3/16			K / P\$	6939		
				1 1/2			H / P\$	4100		
	Veneer			1 3/16			F, G, Y / W\$	5187		
				1 3/16			K / W\$	8170		
				1 1/2			H / W\$	5931		
	Glass			1/4			Acid Etched Glass Top \$	23108		
				1/4			Gloss Glass Top \$	19259		
48"D x 204"W or 17' - 3 Piece Boat Top										
88-48204BT	Laminate	204	48-36	1 3/16	394	48.9	F, G, Y / P\$	3520		
				1 3/16			K / P\$	6732		
				1 1/2			H / P\$	4028		
	Veneer			1 3/16			F, G, Y / W\$	4933		
				1 3/16			K / W\$	7827		
				1 1/2			H / W\$	5637		
	Glass			1/4			Acid Etched Glass Top \$	21982		
				1/4			Gloss Glass Top \$	18346		

Must Specify (in this order):
 Model #
 Top/Edge Material
 Top/Edge Finish/Color
 Edge Profile
 Glass (Y/N)
 Glass Color + Surface Finish
 Power/Data
 Power/Data Location

Additional 48" Boat Shaped Tops on Next Page



Double Kerf (F) 1 3/16" Duo (G) 1 3/16" Square (Y) 1 3/16" Knife (K) 1 3/16" Vertical Square (H) 1 1/2"

P = HPL W = Veneer

[See Strut Overview For Ordering Options](#)

Item	Model No.		W	D	H	Ship Wt	Cubic Ft	Edge Profile + Material	List Price	
48"D x 192"W or 16' - 2 Piece Boat Top										
<i>CONTINUED FROM PREVIOUS PAGE</i>	88-48192BT	Laminate	192	48-36	1 ³ / ₁₆ "	372	31.2	F, G, Y / P\$	3019	
					1 ³ / ₁₆ "			K / P\$	6038	
					1 ¹ / ₂ "			H / P\$	3499	
		Veneer			1 ³ / ₁₆ "			F, G, Y / W\$	4072	
					1 ³ / ₁₆ "			K / W\$	6759	
					1 ¹ / ₂ "			H / W\$	4822	
		Glass			1/4"			Acid Etched Glass Top \$	20360	
					1/4"			Gloss Glass Top \$	16938	
	48"D x 180"W or 15' - 2 Piece Boat Top									
	Must Specify (in this order): Model # Top/Edge Material Top/Edge Finish/Color Edge Profile Glass (Y/N) Glass Color + Surface Finish Power/Data Power/Data Location	88-48180BT	Laminate	180	48-36	1 ³ / ₁₆ "	350	31.2	F, G, Y / P\$	2976
					1 ³ / ₁₆ "			K / P\$	5830	
					1 ¹ / ₂ "			H / P\$	3427	
		Veneer			1 ³ / ₁₆ "			F, G, Y / W\$	3908	
					1 ³ / ₁₆ "			K / W\$	6453	
					1 ¹ / ₂ "			H / W\$	4612	
		Glass			1/4"			Acid Etched Glass Top \$	19233	
					1/4"			Gloss Glass Top \$	16025	
48"D x 168"W or 14' - 2 Piece Boat Top										
		88-48168BT	Laminate	168	48-36	1 ³ / ₁₆ "	328	31.2	F, G, Y / P\$	2829
					1 ³ / ₁₆ "			K / P\$	5515	
					1 ¹ / ₂ "			H / P\$	3249	
		Veneer			1 ³ / ₁₆ "			F, G, Y / W\$	3610	
					1 ³ / ₁₆ "			K / W\$	6013	
					1 ¹ / ₂ "			H / W\$	4269	
		Glass			1/4"			Acid Etched Glass Top \$	17999	
					1/4"			Gloss Glass Top \$	15005	
	48"D x 156"W or 13' - 2 Piece Boat Top									
		88-48156BT	Laminate	156	48-36	1 ³ / ₁₆ "	306	31.2	F, G, Y / P\$	2787
					1 ³ / ₁₆ "			K / P\$	5182	
					1 ¹ / ₂ "			H / P\$	3177	
		Veneer			1 ³ / ₁₆ "			F, G, Y / W\$	3446	
					1 ³ / ₁₆ "			K / W\$	5835	
					1 ¹ / ₂ "			H / W\$	4060	
		Glass			1/4"			Acid Etched Glass Top \$	16872	
					1/4"			Gloss Glass Top \$	14092	

Additional 48" Boat Shaped Tops on Next Page



Double Kerf (F)
1³/₁₆"



Duo (G)
1³/₁₆"



Square (Y)
1³/₁₆"



Knife (K)
1³/₁₆"



Vertical Square (H)
1¹/₂"

P = HPL W = Veneer

[See Strut Overview For Ordering Options](#)

Item	Model No.		W	D	H	Ship Wt	Cubic Ft	Edge Profile + Material	List Price		
<i>CONTINUED FROM PREVIOUS PAGE</i>	48"D x 144"W or 12' - 2 Piece Boat Top										
	88-48144BT	Laminate	144	48-36	1 3/16	284	23.5	F, G, Y / P\$	2339		
					1 3/16			K / P\$	4683		
					1 1/2			H / P\$	2699		
		Veneer			1 3/16			F, G, Y / W\$	3215		
					1 3/16			K / W\$	5334		
					1 1/2			H / W\$	3783		
		Glass			1/4			Acid Etched Glass Top \$	15653		
					1/4			Gloss Glass Top \$	13086		
		48"D x 132"W or 11' - 2 Piece Boat Top									
	88-48132BT	Laminate	132	48-36	1 3/16	262	23.5	F, G, Y / P\$	2285		
					1 3/16			K / P\$	4463		
					1 1/2			H / P\$	2614		
		Veneer			1 3/16			F, G, Y / W\$	3000		
					1 3/16			K / W\$	5003		
				1 1/2			H / W\$	3522			
	Glass			1/4			Acid Etched Glass Top \$	14514			
				1/4			Gloss Glass Top \$	12162			
	48"D x 120"W or 10' - 2 Piece Boat Top										
88-48120BT	Laminate	120	48-36	1 3/16	240	23.5	F, G, Y / P\$	2221			
				1 3/16			K / P\$	4235			
				1 1/2			H / P\$	2521			
	Veneer			1 3/16			F, G, Y / W\$	2773			
				1 3/16			K / W\$	4660			
				1 1/2			H / W\$	3250			
	Glass			1/4			Acid Etched Glass Top \$	13367			
				1/4			Gloss Glass Top \$	11229			
	48"D x 108"W or 9' - 2 Piece Boat Top										
88-48108BT	Laminate	108	48-36	1 3/16	218	23.5	F, G, Y / P\$	2167			
				1 3/16			K / P\$	3926			
				1 1/2			H / P\$	2437			
	Veneer			1 3/16			F, G, Y / W\$	2558			
				1 3/16			K / W\$	4420			
				1 1/2			H / W\$	2990			
	Glass			1/4			Acid Etched Glass Top \$	12229			
				1/4			Gloss Glass Top \$	10304			

Must Specify (in this order):
 Model #
 Top/Edge Material
 Top/Edge Finish/Color
 Edge Profile
 Glass (Y/N)
 Glass Color + Surface Finish
 Power/Data
 Power/Data Location

Additional 48" Boat Shaped Tops on Next Page



Double Kerf (F) 1 3/16" Duo (G) 1 3/16" Square (Y) 1 3/16" Knife (K) 1 3/16" Vertical Square (H) 1 1/2"

P = HPL W = Veneer

[See Strut Overview For Ordering Options](#)

Item	Model No.		W	D	H	Ship Wt	Cubic Ft	Edge Profile + Material	List Price	
48"D x 96"W or 8' - 1 Piece Boat Top										
<i>CONTINUED FROM PREVIOUS PAGE</i>	88-4896BT	Laminate	96	48-36	1 ³ / ₁₆	295	27.0	F, G, Y / P\$	1477	
					1 ³ / ₁₆			K / P\$	3148	
					1 ¹ / ₂			H / P\$	1714	
	Veneer	1 ³ / ₁₆	F, G, Y / W\$	1885						
		1 ³ / ₁₆	K / W\$	3438						
		1 ¹ / ₂	H / W\$	2268						
	Glass		1 ⁴ / ₄	Acid Etched Glass Top \$	10594					
			1 ⁴ / ₄	Gloss Glass Top \$	8883					
	48"D x 84"W or 7' - 1 Piece Boat Top									
	<u>Must Specify (in this order):</u> Model # Top/Edge Material Top/Edge Finish/Color Edge Profile Glass (Y/N) Glass Color + Surface Finish Power/Data Power/Data Location	88-4884BT	Laminate	84	48-36	1 ³ / ₁₆	164	15.0	F, G, Y / P\$	1434
1 ³ / ₁₆						K / P\$			2801	
1 ¹ / ₂						H / P\$			1641	
Veneer		1 ³ / ₁₆	F, G, Y / W\$	1666						
		1 ³ / ₁₆	K / W\$	3156						
		1 ¹ / ₂	H / W\$	2004						
Glass			1 ⁴ / ₄	Acid Etched Glass Top \$	9403					
			1 ⁴ / ₄	Gloss Glass Top \$	7907					
48"D x 72"W or 6' - 1 Piece Boat Top										
		88-4872BT	Laminate	72	48-36	1 ³ / ₁₆	142	12.8	F, G, Y / P\$	1207
	1 ³ / ₁₆					K / P\$			2548	
	1 ¹ / ₂					H / P\$			1384	
	Veneer	1 ³ / ₁₆	F, G, Y / W\$	1578						
		1 ³ / ₁₆	K / W\$	2848						
		1 ¹ / ₂	H / W\$	1870						
	Glass		1 ⁴ / ₄	Acid Etched Glass Top \$	8317					
			1 ⁴ / ₄	Gloss Glass Top \$	7034					

Description

- Tops Available with Veneer (W) or HPL (P) Top in 1³/₁₆" and 1¹/₂" Thicknesses
- Must Specify Edge Profile: 1³/₁₆" Thick/Double Kerf (F), Duo (G), Square (Y), and Knife (K) Edge Profiles or 1¹/₂" Thick/Vertical Square (H)
- Veneer (W) Top Grain Runs Depth of Top and HPL (P) Top Grain Runs Width of Top
- Available with Back Painted Tempered Glass Top; Must Specify Color and Finish; [See Options](#)
- Power and Data Options Available; Sold Separately, [See Multiple Power Unit Details](#)
- Dock800, Oasis, and E2X Power Units Available on Ends Only (E1 and E2) for 108"D - 156"D and 204"D-240"D Tops
- Strut Legs Sold Separately, [See Strut Legs](#)



Double Kerf (F)
1³/₁₆"



Duo (G)
1³/₁₆"



Square (Y)
1³/₁₆"



Knife (K)
1³/₁₆"



Vertical Square (H)
1¹/₂"

P = HPL W = Veneer

[See Strut Overview For Ordering Options](#)

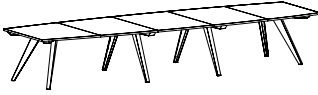
Item	Model No.		W	D	H	Ship Wt	Cubic Ft	Edge Profile + Material	List Price	
BOAT SHAPE MEETING TOP 54"D  88-54204BT shown in Veneer BASES SOLD SEPARATELY	54"D x 240"W or 20' - 5 Piece Veneer (W) and 3 Piece HPL (P) Boat Top									
	88-54240BT	Laminate	240	54-42	1 3/16	519	24.0	F, G, Y / P\$	4531	
					1 3/16			K / P\$	8476	
					1 1/2			H / P\$	5207	
		Veneer			1 3/16			F, G, Y / W\$	7579	
					1 3/16			K / W\$	11166	
					1 1/2			H / W\$	8611	
		Glass			1/4			Acid Etched Glass Top \$	28663	
					1/4			Gloss Glass Top \$	23852	
	54"D x 228"W or 19' - 5 Piece Veneer (W) and 3 Piece HPL (P) Boat Top									
	88-54228BT	Laminate	228	54-42	1 3/16	495	23.0	F, G, Y / P\$	4485	
					1 3/16			K / P\$	8256	
					1 1/2			H / P\$	5127	
		Veneer			1 3/16			F, G, Y / W\$	7345	
					1 3/16			K / W\$	10782	
				1 1/2			H / W\$	8328		
	Glass			1/4			Acid Etched Glass Top \$	27410		
				1/4			Gloss Glass Top \$	22840		
54"D x 216"W or 18' - 5 Piece Veneer (W) and 3 Piece HPL (P) Boat Top										
88-54216BT	Laminate	216	54-42	1 3/16	470	22.0	F, G, Y / P\$	3910		
				1 3/16			K / P\$	7493		
				1 1/2			H / P\$	4518		
	Veneer			1 3/16			F, G, Y / W\$	7112		
				1 3/16			K / W\$	10397		
				1 1/2			H / W\$	8045		
	Glass			1/4			Acid Etched Glass Top \$	26123		
				1/4			Gloss Glass Top \$	21793		
54"D x 204"W or 17' - 5 Piece Veneer (W) and 3 Piece HPL (P) Boat Top										
88-54204BT	Laminate	204	54-42	1 3/16	445	21.0	F, G, Y / P\$	3864		
				1 3/16			K / P\$	7273		
				1 1/2			H / P\$	4438		
	Veneer			1 3/16			F, G, Y / W\$	6878		
				1 3/16			K / W\$	10014		
				1 1/2			H / W\$	7762		
	Glass			1/4			Acid Etched Glass Top \$	24871		
				1/4			Gloss Glass Top \$	20782		

Additional 54" Boat Shaped Tops on Next Page



Double Kerf (F)
1 3/16"



Duo (G)
1 3/16"



Square (Y)
1 3/16"



Knife (K)
1 3/16"



Vertical Square (H)
1 1/2"

P = HPL W = Veneer

[See Strut Overview For Ordering Options](#)

Item	Model No.		W	D	H	Ship Wt	Cubic Ft	Edge Profile + Material	List Price			
54"D x 192"W or 16' - 4 Piece Veneer (W) and 2 Piece HPL (P) Boat Top												
<i>CONTINUED FROM PREVIOUS PAGE</i>	88-54192BT	Laminate	192	54-42	1 ³ / ₁₆	408	19.0	F, G, Y / P\$	3180			
					1 ³ / ₁₆			K / P\$	6383			
					1 ¹ / ₂			H / P\$	3722			
		Veneer								F, G, Y / W\$	5675	
										1 ³ / ₁₆	K / W\$	8636
										1 ¹ / ₂	H / W\$	6506
		Glass								Acid Etched Glass Top \$	22945	
											Gloss Glass Top \$	19096
		54"D x 180"W or 15' - 4 Piece Veneer (W) and 2 Piece HPL (P) Boat Top										
		<i>Must Specify (in this order):</i> Model # Top/Edge Material Top/Edge Finish/Color Edge Profile Glass (Y/N) Glass Color + Surface Finish Power/Data Power/Data Location	88-54180BT	Laminate	180	54-42	1 ³ / ₁₆	384	18.0	F, G, Y / P\$	3134	
							1 ³ / ₁₆			K / P\$	6163	
							1 ¹ / ₂			H / P\$	3642	
Veneer										F, G, Y / W\$	5461	
										1 ³ / ₁₆	K / W\$	8271
										1 ¹ / ₂	H / W\$	6242
Glass										Acid Etched Glass Top \$	21692	
											Gloss Glass Top \$	18083
54"D x 168"W or 14' - 4 Piece Veneer (W) and 2 Piece HPL (P) Boat Top												
	88-54168BT			Laminate	168	54-42	1 ³ / ₁₆	359	17.0	F, G, Y / P\$	3087	
							1 ³ / ₁₆			K / P\$	5943	
							1 ¹ / ₂			H / P\$	3562	
		Veneer								F, G, Y / W\$	5247	
										1 ³ / ₁₆	K / W\$	7905
										1 ¹ / ₂	H / W\$	5979
		Glass								Acid Etched Glass Top \$	20439	
											Gloss Glass Top \$	17071
		54"D x 156"W or 13' - 4 Piece Veneer (W) and 2 Piece HPL (P) Boat Top										
			88-54156BT	Laminate	156	54-42	1 ³ / ₁₆	334	16.0	F, G, Y / P\$	3041	
							1 ³ / ₁₆			K / P\$	5723	
							1 ¹ / ₂			H / P\$	3481	
Veneer										F, G, Y / W\$	5033	
										1 ³ / ₁₆	K / W\$	7538
										1 ¹ / ₂	H / W\$	5715
Glass										Acid Etched Glass Top \$	19185	
											Gloss Glass Top \$	16057

Additional 54" Boat Shaped Tops on Next Page



Double Kerf (F) 1³/₁₆" Duo (G) 1³/₁₆" Square (Y) 1³/₁₆" Knife (K) 1³/₁₆" Vertical Square (H) 1¹/₂"

P = HPL W = Veneer

[See Strut Overview For Ordering Options](#)

Item	Model No.		W	D	H	Ship Wt	Cubic Ft	Edge Profile + Material	List Price		
<i>CONTINUED FROM PREVIOUS PAGE</i>	54"D x 144"W or 12' - 3 Piece Veneer (W) and 2 Piece HPL (P) Boat Top										
	88-54144BT	Laminate	144	54-42	1 $\frac{3}{16}$ "	309	15.0	F, G, Y / P\$	2585		
					1 $\frac{3}{16}$ "			K / P\$	5083		
					1 $\frac{1}{2}$ "			H / P\$	2992		
		Veneer			1 $\frac{3}{16}$ "			F, G, Y / W\$	4155		
					1 $\frac{3}{16}$ "			K / W\$	6420		
					1 $\frac{1}{2}$ "			H / W\$	4715		
		Glass			$\frac{1}{4}$ "			Acid Etched Glass Top \$	17612		
					$\frac{1}{4}$ "			Gloss Glass Top \$	14725		
		54"D x 132"W or 11' - 3 Piece Veneer (W) and 2 Piece HPL (P) Boat Top									
	88-54132BT	Laminate	132	54-42	1 $\frac{3}{16}$ "	285	13.2	F, G, Y / P\$	2526		
					1 $\frac{3}{16}$ "			K / P\$	4851		
					1 $\frac{1}{2}$ "			H / P\$	2899		
		Veneer			1 $\frac{3}{16}$ "			F, G, Y / W\$	3952		
					1 $\frac{3}{16}$ "			K / W\$	6072		
				1 $\frac{1}{2}$ "			H / W\$	4468			
	Glass			$\frac{1}{4}$ "			Acid Etched Glass Top \$	16346			
				$\frac{1}{4}$ "			Gloss Glass Top \$	13700			
	54"D x 120"W or 10' - 3 Piece Veneer (W) and 2 Piece HPL (P) Boat Top										
88-54120BT	Laminate	120	54-42	1 $\frac{3}{16}$ "	260	12.1	F, G, Y / P\$	2467			
				1 $\frac{3}{16}$ "			K / P\$	4618			
				1 $\frac{1}{2}$ "			H / P\$	2806			
	Veneer			1 $\frac{3}{16}$ "			F, G, Y / W\$	3749			
				1 $\frac{3}{16}$ "			K / W\$	5727			
				1 $\frac{1}{2}$ "			H / W\$	4222			
	Glass			$\frac{1}{4}$ "			Acid Etched Glass Top \$	15084			
				$\frac{1}{4}$ "			Gloss Glass Top \$	12678			

Must Specify (in this order):

Model #
 Top/Edge Material
 Top/Edge Finish/Color
 Edge Profile
 Glass (Y/N)
 Glass Color + Surface Finish
 Power/Data
 Power/Data Location

Description

- Tops Available with Veneer (W) or HPL (P) Top in 1 $\frac{3}{16}$ " and 1 $\frac{1}{2}$ " Thicknesses
- Must Specify Edge Profile: 1 $\frac{3}{16}$ " Thick/Double Kerf (F), Duo (G), Square (Y), and Knife (K) Edge Profiles or 1 $\frac{1}{2}$ " Thick/Vertical Square (H)
- Veneer (W) Top Grain Runs Depth of Top and HPL (P) Top Grain Runs Width of Top
- Available with Back Painted Tempered Glass Top; Must Specify Color and Finish; [See Options](#)
- Power and Data Options Available; Sold Separately, [See Multiple Power Unit Details](#)
- Strut Legs Sold Separately, [See Strut Legs](#)



Double Kerf (F)
1 $\frac{3}{16}$ "



Duo (G)
1 $\frac{3}{16}$ "



Square (Y)
1 $\frac{3}{16}$ "



Knife (K)
1 $\frac{3}{16}$ "



Vertical Square (H)
1 $\frac{1}{2}$ "

P = HPL W = Veneer

[See Strut Overview For Ordering Options](#)

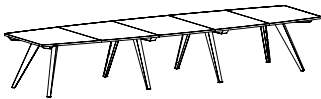
Item	Model No.		W	D	H	Ship Wt	Cubic Ft	Edge Profile + Material	List Price	
BOAT SHAPE MEETING TOP 60"D  88-60204BT shown in Veneer BASES SOLD SEPARATELY	60"D x 240"W or 20' - 5 Piece Veneer (W) and 3 Piece HPL (P) Boat Top									
	88-60240BT	Laminate	240	60-48	1 3/16"	574	26.3	F, G, Y / P\$	4617	
					1 3/16"			K / P\$	8777	
					1 1/2"			H / P\$	5371	
		Veneer			1 3/16"			F, G, Y / W\$	8076	
					1 3/16"			K / W\$	11791	
					1 1/2"			H / W\$	9212	
		Glass			1/4"			Acid Etched Glass Top \$	31262	
					1/4"			Gloss Glass Top \$	25916	
	60"D x 228"W or 19' - 5 Piece Veneer (W) and 3 Piece HPL (P) Boat Top									
	88-60228BT	Laminate	228	60-48	1 3/16"	547	25.0	F, G, Y / P\$	4567	
					1 3/16"			K / P\$	8545	
					1 1/2"			H / P\$	5283	
		Veneer			1 3/16"			F, G, Y / W\$	7818	
					1 3/16"			K / W\$	11378	
				1 1/2"			H / W\$	8899		
	Glass			1/4"			Acid Etched Glass Top \$	29882		
				1/4"			Gloss Glass Top \$	24803		
60"D x 216"W or 18' - 5 Piece Veneer (W) and 3 Piece HPL (P) Boat Top										
88-60216BT	Laminate	216	60-48	1 3/16"	519	23.7	F, G, Y / P\$	3987		
				1 3/16"			K / P\$	7770		
				1 1/2"			H / P\$	4666		
	Veneer			1 3/16"			F, G, Y / W\$	7560		
				1 3/16"			K / W\$	10966		
				1 1/2"			H / W\$	8587		
	Glass			1/4"			Acid Etched Glass Top \$	28467		
				1/4"			Gloss Glass Top \$	23655		
60"D x 204"W or 17' - 5 Piece Veneer (W) and 3 Piece HPL (P) Boat Top										
88-60204BT	Laminate	204	60-48	1 3/16"	492	22.4	F, G, Y / P\$	3937		
				1 3/16"			K / P\$	7538		
				1 1/2"			H / P\$	4578		
	Veneer			1 3/16"			F, G, Y / W\$	7302		
				1 3/16"			K / W\$	10553		
				1 1/2"			H / W\$	8274		
	Glass			1/4"			Acid Etched Glass Top \$	27087		
				1/4"			Gloss Glass Top \$	22543		

Additional 60" Boat Shaped Tops on Next Page



Double Kerf (F) 1 3/16" Duo (G) 1 3/16" Square (Y) 1 3/16" Knife (K) 1 3/16" Vertical Square (H) 1 1/2"

P = HPL W = Veneer

[See Strut Overview For Ordering Options](#)

Item	Model No.		W	D	H	Ship Wt	Cubic Ft	Edge Profile + Material	List Price		
<i>CONTINUED FROM PREVIOUS PAGE</i>	60"D x 192"W or 16' - 4 Piece Veneer (W) and 2 Piece HPL (P) Boat Top										
	88-60192BT	Laminate	192	60-48	1 3/16	458	21.1	F, G, Y / P\$	3250		
					1 3/16			K / P\$	6634		
					1 1/2			H / P\$	3854		
		Veneer			1 3/16			F, G, Y / W\$	6041		
					1 3/16			K / W\$	9116		
					1 1/2			H / W\$	6956		
		Glass			1/4			Acid Etched Glass Top \$	25033		
					1/4			Gloss Glass Top \$	20756		
		60"D x 180"W or 15' - 4 Piece Veneer (W) and 2 Piece HPL (P) Boat Top									
	88-60180BT	Laminate	180	60-48	1 3/16	431	19.8	F, G, Y / P\$	3199		
					1 3/16			K / P\$	6401		
					1 1/2			H / P\$	3766		
		Veneer			1 3/16			F, G, Y / W\$	5804		
					1 3/16			K / W\$	8725		
				1 1/2			H / W\$	6665			
	Glass			1/4			Acid Etched Glass Top \$	23653			
				1/4			Gloss Glass Top \$	19644			
	60"D x 168"W or 14' - 4 Piece Veneer (W) and 2 Piece HPL (P) Boat Top										
88-60168BT	Laminate	168	60-48	1 3/16	403	18.5	F, G, Y / P\$	3149			
				1 3/16			K / P\$	6169			
				1 1/2			H / P\$	3677			
	Veneer			1 3/16			F, G, Y / W\$	5567			
				1 3/16			K / W\$	8333			
				1 1/2			H / W\$	6373			
	Glass			1/4			Acid Etched Glass Top \$	22273			
				1/4			Gloss Glass Top \$	18531			
	60"D x 156"W or 13' - 4 Piece Veneer (W) and 2 Piece HPL (P) Boat Top										
88-60156BT	Laminate	156	60-48	1 3/16	376	17.2	F, G, Y / P\$	3098			
				1 3/16			K / P\$	5937			
				1 1/2			H / P\$	3589			
	Veneer			1 3/16			F, G, Y / W\$	5331			
				1 3/16			K / W\$	7942			
				1 1/2			H / W\$	6082			
	Glass			1/4			Acid Etched Glass Top \$	20893			
				1/4			Gloss Glass Top \$	17418			

Must Specify (in this order):

- Model #
- Top/Edge Material
- Top/Edge Finish/Color
- Edge Profile
- Glass (Y/N)
- Glass Color + Surface Finish
- Power/Data
- Power/Data Location

Additional 60" Boat Shaped Tops on Next Page



Double Kerf (F)
1 3/16"



Duo (G)
1 3/16"



Square (Y)
1 3/16"



Knife (K)
1 3/16"



Vertical Square (H)
1 1/2"

P = HPL W = Veneer

[See Strut Overview For Ordering Options](#)

Item	Model No.		W	D	H	Ship Wt	Cubic Ft	Edge Profile + Material	List Price	
60"D x 144"W or 12' - 3 Piece Veneer (W) and 2 Piece HPL (P) Boat Top										
<i>CONTINUED FROM PREVIOUS PAGE</i>	88-60144BT	Laminate	144	60-48	1 3/16"	342	16.0	F, G, Y / P\$	2639	
					1 3/16"			K / P\$	5285	
					1 1/2"			H / P\$	3092	
		Veneer			1 3/16"			F, G, Y / W\$	4414	
					1 3/16"			K / W\$	6771	
					1 1/2"			H / W\$	5029	
		Glass			1/4"			Acid Etched Glass Top \$	19192	
					1/4"			Gloss Glass Top \$	15984	
	60"D x 132"W or 11' - 3 Piece Veneer (W) and 2 Piece HPL (P) Boat Top									
	<i>Must Specify (in this order):</i>	88-60132BT	Laminate	132	60-48	1 3/16"	323	14.6	F, G, Y / P\$	2576
					1 3/16"			K / P\$	5040	
					1 1/2"			H / P\$	2991	
		Veneer			1 3/16"			F, G, Y / W\$	4189	
					1 3/16"			K / W\$	6397	
					1 1/2"			H / W\$	4756	
		Glass			1/4"			Acid Etched Glass Top \$	17798	
					1/4"			Gloss Glass Top \$	14858	
60"D x 120"W or 10' - 3 Piece Veneer (W) and 2 Piece HPL (P) Boat Top										
		88-60120BT	Laminate	120	60-48	1 3/16"	287	13.3	F, G, Y / P\$	2513
					1 3/16"			K / P\$	4796	
					1 1/2"			H / P\$	2890	
		Veneer			1 3/16"			F, G, Y / W\$	3965	
					1 3/16"			K / W\$	6026	
					1 1/2"			H / W\$	4484	
		Glass			1/4"			Acid Etched Glass Top \$	16406	
					1/4"			Gloss Glass Top \$	13733	

Description

- Tops Available with Veneer (W) or HPL (P) Top in 1 3/16" and 1 1/2" Thicknesses
- Must Specify Edge Profile: 1 3/16" Thick/Double Kerf (F), Duo (G), Square (Y), and Knife (K) Edge Profiles or 1 1/2" Thick/Vertical Square (H)
- Veneer (W) Top Grain Runs Depth of Top and HPL (P) Top Grain Runs Width of Top
- Available with Back Painted Tempered Glass Top; Must Specify Color and Finish; [See Options](#)
- Power and Data Options Available; Sold Separately, [See Multiple Power Unit Details](#)
- Strut Legs Sold Separately, [See Strut Legs](#)



Double Kerf (F)
1 3/16"



Duo (G)
1 3/16"



Square (Y)
1 3/16"



Knife (K)
1 3/16"



Vertical Square (H)
1 1/2"

P = HPL W = Veneer

[See Strut Overview For Ordering Options](#)

Item	Model No.		W	D	H	Ship Wt	Cubic Ft	List Price	
STRUT TABLE LEGS	01-2228STR2	1 Pair (2 Legs)	1½	22½	28⅞	32	4.5	\$	1235
	01-2228STR4	2 Pair (4 Legs)	1½	22½	28⅞	64	9.0	\$	2470

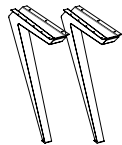

Must Specify (in this order):

Model # and Quantity
Color

Description



- Available in Aluminum (ALUM) or Black (BLK); Must Specify Color
- Integrated Wire Management Inside of Legs to Keep Your Space Clean and Free of Wires
- Stiffener Bars Included with Top for Additional Support
- Each Leg has Adjustable Glides
- Legs not Available To Be Sold Separately

Table Widths	48"	72"	84"	96"	108"	120"	132"	144"
Number of Legs Required	4	4	4	4	6	6	6	6

Table Widths	156"	168"	180"	192"	204"	216"	228"	240"
Number of Legs Required	8	8	8	8	10	10	10	10

T = TFL W = Veneer

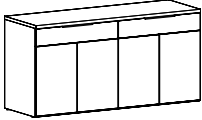
[See Strut Overview For Ordering Options](#)

Item	Model No.		W	D	H	Ship Wt	Cubic Ft	Edge Profile + Material	List Price	
BUFFET CREDENZA WITH DRAWERS  Shown: 88-2472BF  Waste Bin Option Shown as Left Must Specify (in this order): Model # Top/Edge Material Top/Edge Finish/Color Edge Profile Chassis Color Glass (Y/N) Glass Color + Surface Finish Pull Drawer Track Vent Waste Bin	88-2496BF	TFL+HPL	96	24	36	466	56.0	F, G, Y / T+P\$	5642	
								H / T+P\$	5751	
		Veneer+HPL						F, G, Y / W+P\$	8608	
								H / W+P\$	8771	
		Veneer						F, G, Y / W\$	8929	
								H / W\$	9062	
		Glass+TFL						Acid Etched Glass Top +T\$	9099	
								Gloss Glass Top +T\$	8243	
		Glass+Veneer						Acid Etched Glass Top +W\$	12385	
								Gloss Glass Top +W\$	11530	
	88-2484BF	TFL+HPL		84	24	36	404	49.2	F, G, Y / T+P\$	4936
									H / T+P\$	5032
	Veneer+HPL							F, G, Y / W+P\$	7419	
								H / W+P\$	7563	
	Veneer							F, G, Y / W\$	7744	
								H / W\$	7861	
	Glass+TFL							Acid Etched Glass Top +T\$	7927	
								Gloss Glass Top +T\$	7179	
	Glass+Veneer							Acid Etched Glass Top +W\$	10735	
								Gloss Glass Top +W\$	9986	
88-2472BF	TFL+HPL		72	24	36	342	42.3	F, G, Y / T+P\$	3959	
								H / T+P\$	4042	
	Veneer+HPL							F, G, Y / W+P\$	6079	
								H / W+P\$	6203	
	Veneer							F, G, Y / W\$	6232	
								H / W\$	6334	
	Glass+TFL							Acid Etched Glass Top +T\$	6621	
								Gloss Glass Top +T\$	5980	
	Glass+Veneer							Acid Etched Glass Top +W\$	8894	
								Gloss Glass Top +W\$	8252	
88-2460BF	TFL+HPL		60	24	36	280	34.5	F, G, Y / T+P\$	3807	
								H / T+P\$	3876	
	Veneer+HPL							F, G, Y / W+P\$	5636	
								H / W+P\$	5741	
	Veneer							F, G, Y / W\$	5793	
								H / W\$	5878	
	Glass+TFL							Acid Etched Glass Top +T\$	6003	
								Gloss Glass Top +T\$	5468	
	Glass+Veneer							Acid Etched Glass Top +W\$	7989	
								Gloss Glass Top +W\$	7454	

T= TFL P = HPL W = Veneer

Additional Buffet Credenzas on Next Page

[See Strut Overview For Ordering Options](#)

Item	Model No.		W	D	H	Ship Wt	Cubic Ft	Edge Profile + Material	List Price
<i>CONTINUED FROM PREVIOUS PAGE</i>	88-2448BF <i>Two Doors + Two Drawers</i>	TFL+HPL	48	24	36	209	28.6	F, G, Y / T+P\$ H / T+P\$	2689 2745
		Veneer+HPL						F, G, Y / W+P\$ H / W+P\$	4151 4237
		Veneer						F, G, Y / W\$ H / W\$	4312 4381
		Glass+TFL						Acid Etched Glass Top +T\$ Gloss Glass Top +T\$	4419 3991
		Glass+Veneer						Acid Etched Glass Top +W\$ Gloss Glass Top +W\$	6042 5615
		TFL+HPL	36	24	36	209	28.6	F, G, Y / T+P\$ H / T+P\$	2244 2287
		Veneer+HPL						F, G, Y / W+P\$ H / W+P\$	3308 3374
		Veneer						F, G, Y / W\$ H / W\$	3472 3525
		Glass+TFL						Acid Etched Glass Top +T\$ Gloss Glass Top +T\$	3508 3187
		Glass+Veneer						Acid Etched Glass Top +W\$ Gloss Glass Top +W\$	4737 4416

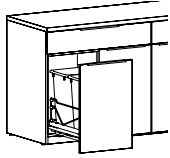

Waste Bin Option
Shown as Left

Must Specify (in this order):

- Model #
- Top/Edge Material
- Top/Edge Finish/Color
- Edge Profile
- Chassis Color
- Glass (Y/N)
- Glass Color + Surface Finish
- Pull
- Drawer Track
- Vent
- Waste Bin

Description

- Standard with: Touch Latch Doors with One (1) Adjustable Shelf Behind Doors, Top Profile on Approach Side, 2" Wire Management Channel Along Back of Interior Cabinet, Reverse Slip Matched Pattern on Top Surface, and Vertical Grain Direction on Chassis
- Available with Veneer (W), HPL (P), or Back Painted Tempered Glass (Black or White with Gloss or Acid Etched Finish) Top with Veneer (W) or HPL (P) Chassis
- When Selecting Back Painted Tempered Glass Top; Must Specify Glass Color, Gloss or Acid Etched Finish and Edge Profile; [See Options](#)
- Tops and Chassis Available in Contrasting Colors; Must Specific Color of Each Component
- Studio Pull Centered on Drawer Fronts Standard; Must Specify Pull Color ([See Color Options](#))
- Touch Latch Doors Standard Without Pulls, Optional Studio Pulls; Must Specify Pull Color ([See Color Options](#))
- Studio Pulls Will be Added and Centered on Top of Doors When Waste Bin is Selected; Must Specify Pull Color ([See Color Options](#)) and Optional Waste Bin ([See Options](#))
- Knife Edge not Available
- Additional Options: Locking Doors ([See Options Details](#)); Pull Out Waste Bin ([See Options Details](#)); Back Panel Vent ([See Options Details](#)); Soft Close Drawers ([See Soft Close Option](#))



Double Kerf (F)
1 3/16"



Duo (G)
1 3/16"



Square (Y)
1 3/16"



Vertical Square (H)
1 1/2"

T= TFL P= HPL W= Veneer

[See Strut Overview For Ordering Options](#)

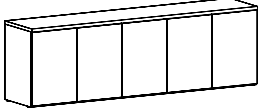
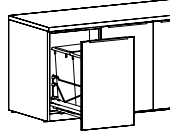
Item	Model No.		W	D	H	Ship Wt	Cubic Ft	Edge Profile + Material	List Price	
24"D CREDENZA  Shown: 88-2496CC  Waste Bin Option Shown as Left	88-2496CC	TFL+HPL	96	24	30	415	47.2	F, G, Y / T+P\$	4436	
								H / T+P\$	4545	
			Veneer+HPL						F, G, Y / W+P\$	6952
									H / W+P\$	7116
			Veneer						F, G, Y / W\$	7273
									H / W\$	7407
			Glass+TFL						Acid Etched Glass Top +T\$	7893
									Gloss Glass Top +T\$	7037
			Glass+Veneer						Acid Etched Glass Top +W\$	10730
									Gloss Glass Top +W\$	9874
		88-2484CC	TFL+HPL	84	24	30	353	41.4	F, G, Y / T+P\$	4047
									H / T+P\$	4143
		Veneer+HPL						F, G, Y / W+P\$	6201	
								H / W+P\$	6345	
		Veneer						F, G, Y / W\$	6526	
								H / W\$	6643	
		Glass+TFL						Acid Etched Glass Top +T\$	7038	
								Gloss Glass Top +T\$	6290	
		Glass+Veneer						Acid Etched Glass Top +W\$	9517	
								Gloss Glass Top +W\$	8768	
	88-2472CC	TFL+HPL	72	24	30	260	35.6	F, G, Y / T+P\$	3270	
								H / T+P\$	3353	
		Veneer+HPL						F, G, Y / W+P\$	5090	
								H / W+P\$	5214	
		Veneer						F, G, Y / W\$	5243	
								H / W\$	5344	
		Glass+TFL						Acid Etched Glass Top +T\$	5932	
								Gloss Glass Top +T\$	5290	
		Glass+Veneer						Acid Etched Glass Top +W\$	7905	
								Gloss Glass Top +W\$	7263	
	88-2460CC	TFL+HPL	60	24	30	240	29.9	F, G, Y / T+P\$	2882	
								H / T+P\$	2952	
		Veneer+HPL						F, G, Y / W+P\$	4467	
								H / W+P\$	4572	
		Veneer						F, G, Y / W\$	4624	
								H / W\$	4709	
		Glass+TFL						Acid Etched Glass Top +T\$	5078	
								Gloss Glass Top +T\$	4543	
		Glass+Veneer						Acid Etched Glass Top +W\$	6820	
								Gloss Glass Top +W\$	6285	

Must Specify (in this order):

- Model #
- Top/Edge Material
- Top/Edge Finish/Color
- Edge Profile
- Chassis Color
- Glass (Y/N)
- Glass Color + Surface Finish
- Pull
- Vent
- Waste Bin

Additional 24" Credenzas on Next Page

T= TFL P = HPL W = Veneer

[See Strut Overview For Ordering Options](#)

Item	Model No.		W	D	H	Ship Wt	Cubic Ft	Edge Profile + Material	List Price
<i>CONTINUED FROM PREVIOUS PAGE</i>	88-2448CC <i>Two Doors</i>	TFL+HPL	48	24	30	185	20.4	F, G, Y / T+P\$	2182
								H / T+P\$	2238
		Veneer+HPL						F, G, Y / W+P\$	3426
								H / W+P\$	3511
		Veneer						F, G, Y / W\$	3587
								H / W\$	3656
		Glass+TFL						Acid Etched Glass Top +T\$	3912
								Gloss Glass Top +T\$	3484
		Glass+Veneer						Acid Etched Glass Top +W\$	5317
								Gloss Glass Top +W\$	4889
	88-2436CC <i>Two Doors</i>	TFL+HPL	36	24	30	150	18.3	F, G, Y / T+P\$	1844
								H / T+P\$	1887
		Veneer+HPL						F, G, Y / W+P\$	2750
								H / W+P\$	2816
		Veneer						F, G, Y / W\$	2915
								H / W\$	2968
		Glass+TFL						Acid Etched Glass Top +T\$	3108
								Gloss Glass Top +T\$	2788
		Glass+Veneer						Acid Etched Glass Top +W\$	4179
								Gloss Glass Top +W\$	3859

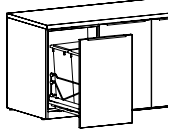

Waste Bin Option
Shown as Left

Must Specify (in this order):

- Model #
- Top/Edge Material
- Top/Edge Finish/Color
- Edge Profile
- Chassis Color
- Glass (Y/N)
- Glass Color + Surface Finish
- Pull
- Vent
- Waste Bin

Description

- Standard with: One (1) Adjustable Shelf Behind Touch Latch Doors, Top Profile on Approach Side, 2" Wire Management Channel Along Back of Interior Cabinet, Reverse Slip Matched Pattern on Top Surface, and Vertical Grain Direction on Chassis
- Available with Veneer (W), HPL (P), or Back Painted Tempered Glass (Black or White with Gloss or Acid Etched Finish) Top
- When Selecting Back Painted Tempered Glass Top; Must Specify Glass Color, Gloss or Acid Etched Finish and Edge Profile; [See Options](#)
- Tops and Chassis Available in Contrasting Colors; Must Specific Color of Each Component
- Studio Pull Centered on Drawer Fronts Standard; Must Specify Pull Color ([See Color Options](#))
- Touch Latch Doors Standard Without Pulls, Optional Studio Pulls; Must Specify Pull Color ([See Color Options](#))
- Studio Pulls Will be Added and Centered on Top of Doors When Waste Bin is Selected; Must Specify Pull Color ([See Color Options](#)) and Optional Waste Bin ([See Options](#))
- Knife Edge not Available
- Additional Options: Locking Doors ([See Options Details](#)); Pull Out Waste Bin ([See Options Details](#)); Back Panel Vent ([See Options Details](#)); Soft Close Drawers ([See Soft Close Option](#))



Double Kerf (F)
1 3/16"



Duo (G)
1 3/16"



Square (Y)
1 3/16"



Vertical Square (H)
1 1/2"

T = TFL P = HPL W = Veneer

[See Strut Overview For Ordering Options](#)

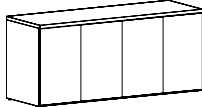
Item	Model No.		W	D	H	Ship Wt	Cubic Ft	Edge Profile + Material	List Price	
	88-2096CC <i>Five Doors</i>	TFL+HPL	96	20	30	398	39.9	F, G, Y / T+P\$	4138	
									H / T+P\$	4230
		Veneer+HPL							F, G, Y / W+P\$	6525
									H / W+P\$	6667
		Veneer							F, G, Y / W\$	6854
									H / W\$	6966
			Glass+TFL						Acid Etched Glass Top +T\$	6974
									Gloss Glass Top +T\$	6261
			Glass+Veneer						Acid Etched Glass Top +W\$	9690
									Gloss Glass Top +W\$	8977
		88-2084CC <i>Five Doors</i>	TFL+HPL	84	20	30	338	35.1	F, G, Y / T+P\$	3777
										H / T+P\$
Veneer+HPL									F, G, Y / W+P\$	5822
									H / W+P\$	5947
Veneer									F, G, Y / W\$	6154
									H / W\$	6253
		Glass+TFL						Acid Etched Glass Top +T\$	6225	
								Gloss Glass Top +T\$	5601	
		Glass+Veneer						Acid Etched Glass Top +W\$	8602	
								Gloss Glass Top +W\$	7978	
	88-2072CC <i>Four Doors</i>	TFL+HPL	72	20	30	260	35.6	F, G, Y / T+P\$	3035	
									H / T+P\$	3105
Veneer+HPL									F, G, Y / W+P\$	4761
									H / W+P\$	4869
Veneer									F, G, Y / W\$	4921
									H / W\$	5006
		Glass+TFL						Acid Etched Glass Top +T\$	5231	
								Gloss Glass Top +T\$	4696	
		Glass+Veneer						Acid Etched Glass Top +W\$	7117	
								Gloss Glass Top +W\$	6582	
	88-2060CC <i>Three Doors</i>	TFL+HPL	60	20	30	220	25.3	F, G, Y / T+P\$	2660	
									H / T+P\$	2718
Veneer+HPL									F, G, Y / W+P\$	4115
									H / W+P\$	4206
Veneer									F, G, Y / W\$	4277
									H / W\$	4349
		Glass+TFL						Acid Etched Glass Top +T\$	4467	
								Gloss Glass Top +T\$	4022	
		Glass+Veneer						Acid Etched Glass Top +W\$	6085	
								Gloss Glass Top +W\$	5640	

Must Specify (in this order):

- Model #
- Top/Edge Material
- Top/Edge Finish/Color
- Edge Profile
- Chassis Color
- Glass (Y/N)
- Glass Color + Surface Finish
- Pull
- Drawer Track
- Vent

Additional 20" Credenzas on Next Page

T= TFL P = HPL W = Veneer

[See Strut Overview For Ordering Options](#)

Item	Model No.		W	D	H	Ship Wt	Cubic Ft	Edge Profile + Material	List Price	
<i>CONTINUED FROM PREVIOUS PAGE</i>	88-2448CC <i>Two Doors</i>	TFL+HPL	48	24	30	185	20.4	F, G, Y / T+P\$ H / T+P\$	2182 2238	
		Veneer+HPL						F, G, Y / W+P\$ H / W+P\$	3426 3511	
		Veneer						F, G, Y / W\$ H / W\$	3587 3656	
		Glass+TFL						Acid Etched Glass Top +T\$ Gloss Glass Top +T\$	3912 3484	
		Glass+Veneer						Acid Etched Glass Top +W\$ Gloss Glass Top +W\$	5317 4889	
		88-2436CC <i>Two Doors</i>	TFL+HPL	36	24	30	150	18.3	F, G, Y / T+P\$ H / T+P\$	1844 1887
			Veneer+HPL						F, G, Y / W+P\$ H / W+P\$	2750 2816
			Veneer						F, G, Y / W\$ H / W\$	2915 2968
			Glass+TFL						Acid Etched Glass Top +T\$ Gloss Glass Top +T\$	3108 2788
			Glass+Veneer						Acid Etched Glass Top +W\$ Gloss Glass Top +W\$	4179 3859

Must Specify (in this order):

- Model #
- Top/Edge Material
- Top/Edge Finish/Color
- Edge Profile
- Chassis Color
- Glass (Y/N)
- Glass Color + Surface Finish
- Pull
- Drawer Track
- Vent

Description

- Standard with: One (1) Adjustable Shelf Behind Touch Latch Doors, Top Profile on Approach Side, 2" Wire Management Channel Along Back of Interior Cabinet, Reverse Slip Matched Pattern on Top Surface, and Vertical Grain Direction on Chassis
- Available with Veneer (W), HPL (P), or Back Painted Tempered Glass (Black or White with Gloss or Acid Etched Finish) Top
- When Selecting Back Painted Tempered Glass Top; Must Specify Glass Color, Gloss or Acid Etched Finish and Edge Profile; [See Options](#)
- Tops and Chassis Available in Contrasting Colors; Must Specific Color of Each Component
- Touch Latch Doors Standard Without Pulls, Optional Studio Pulls; Must Specify Pull Color ([See Color Options](#))
- Studio Pulls Will be Added and Centered on Top of Doors When Waste Bin is Selected; Must Specify Pull Color ([See Color Options](#)) and Optional Waste Bin ([See Options](#))
- Knife Edge not Available
- Additional Options: Locking Doors ([See Options Details](#)); Pull Out Waste Bin Available ([See Options Details](#)); Back Panel Vent ([See Options Details](#))



Double Kerf (F)
1 3/16"



Duo (G)
1 3/16"



Square (Y)
1 3/16"



Vertical Square (H)
1 1/2"

T= TFL P= HPL W= Veneer

[See Strut Overview For Ordering Options](#)

Item	Model No.		W	D	H	Ship Wt	Cubic Ft		List Price	
	88-2436SV	TFL+HPL	36	24	36	260	35.6	F, G, Y / T+P\$	2498	
									H / T+P\$	2542
		Veneer+HPL							F, G, Y / W+P\$	3722
									H / W+P\$	3788
		Veneer							F, G, Y / W\$	3887
								H / W\$	3940	

Must Specify (in this order):

- Model #
- Top/Edge Material
- Top/Edge Finish/Color
- Edge Profile
- Optional Grommet

Description

- Top Edge Profiled on Approach Side Only (See Edge Options); Must Specify Edge Selection ([See Edge Details](#))
- Two (2) Box Drawers, Open Storage, and Storage Behind Two (2) Doors
- Locking Casters

Grommet Option: Specify & Add

1-GRMT	Grommet in Back Panel; Must Specify Black or Silver	\$ 50
--------	---	-------

Item	Model No.		W	D	H	Ship Wt	Cubic Ft		List Price
	88-4848VB	TFL	48	5	48	150	11.0	T\$	2856
		Veneer							W\$

Must Specify (in this order):

- Model #
- Color
- Projection Screen
- Tackboard Fabric

Description

- Tackboard on Each Door Standard in Black Fabric Unless Specified; Price Valid for Grades 1, 2, & 3 (See Other Pricing Below)
- Display Rail with Adjustable Hooks for Flipchart
- Magnetic Porcelain Non-Glare Writing Surface
- Includes Flipchart, Set of Four (4) Dry Erase Markers and Eraser, Mounting Hardware
- Does Not Feature Soft Close Hinges

Options: Specify & Add

	Grade 4	Grade 5	Grade 6	Grade 7	Grade 8	Grade 9	Grade 10	
Tackboard Fabric Change	\$ 268	394	522	704	892	1114	1368	
1-PS	Projection Screen (Requires Field Installation)						\$	1026

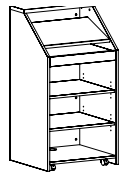
Item	Model No.		W	D	H	Ship Wt	Cubic Ft		List Price	
	88-2650LS	TFL+HPL	26	24	50	130	21.9	F, G, Y / T+P\$	1846	
									H / T+P\$	1856
		Veneer+HPL							F, G, Y / W+P\$	3334
									H / W+P\$	3359
		Veneer							F, G, Y / W\$	3466
								H / W\$	3479	

Must Specify (in this order):

- Model #
- Top/Edge Material
- Top/Edge Finish/Color
- Edge Profile

Description

- Top Edge Profiled on Approach Side Only (See Edge Options); Must Specify Edge Selection
- Fixed Shelf Angled for User Comfort, One (1) Pullout Shelf, and Two (2) Adjustable Shelves
- Two (2) Locking and Two (2) Non-Locking Casters
- Wire Management Grommet on Bottom Shelf

Item	Model No.	W	D	H	Ship Wt	Cubic Ft	List Price
MAGNETIC GLASS MARKER BOARD FOR USE WITH 30"H CREDENZA AND SHELVING	GMB-4048W	48	½	40⅞	67	11.0	\$ 3022
	GMB-4042W	42	½	40⅞	58	9.9	\$ 2555
	GMB-4036W	36	½	40⅞	50	8.8	\$ 2208
	GMB-4030W	30	½	40⅞	42	7.7	\$ 1859

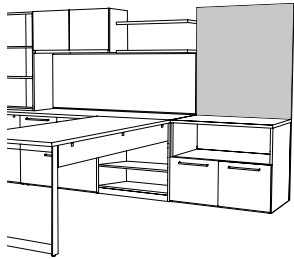

Description

- Available in Black (BLMKR) or White (WHMKR), Must Specify
- Tempered Glass Magnetic Marker Boards Include Mounting Brackets
- For Use over 30"H Desks and Credenzas with Wall Mount Hitches or Shelving
- For Rare Earth Magnets, Marker and Eraser Sets; [See Set Options](#)

Must Specify (in this order):

Model #
Color



Rare Earth Magnets, Marker and Eraser set available; [See Set Options](#)

MAGNETIC GLASS MARKER BOARD FOR USE WITH 30"H CREDENZA AND SHELVING	GMB-5248W	48	½	52⅞	86	13.5	\$ 3853
	GMB-5242W	42	½	52⅞	76	12.2	\$ 3255
	GMB-5236W	36	½	52⅞	65	10.8	\$ 2806
	GMB-5230W	30	½	52⅞	54	9.5	\$ 2358

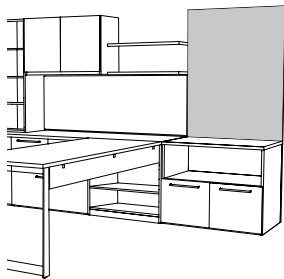

Description

- Available in Black (BLMKR) or White (WHMKR), Must Specify
- Tempered Glass Magnetic Marker Boards Include Mounting Brackets
- For Use Next to Tall Surface or Wall Mount Hitches
- For Rare Earth Magnets, Marker and Eraser Sets; [See Set Options](#)

Must Specify (in this order):

Model #
Color



Rare Earth Magnets, Marker and Eraser set available; [See Set Options](#)

[See Strut Overview For Ordering Options](#)

Item	Model No.	W	D	H	Ship Wt	Cubic Ft	List Price
MAGNETIC GLASS MARKER BOARD	GMB-8236W	36	½	82⅞	102	15.8	\$ 4302
FOR USE FROM FLOOR TO TOP OF UNIT	GMB-7036W	36	½	70⅞	87	13.8	\$ 3704
	GMB-5136W	36	½	51⅞	63	10.6	\$ 2707
	GMB-8230W	30	½	82⅞	85	13.8	\$ 3604
	GMB-7030W	30	½	70⅞	72	12.1	\$ 3106
	GMB-5130W	30	½	51⅞	53	9.3	\$ 2274

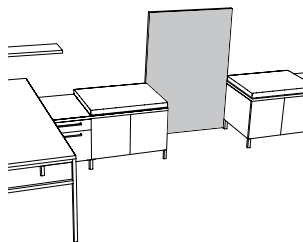

Must Specify (in this order):

Model #

Color

Description

- Available in Black (BLMKR) or White (WHMKR), Must Specify
- Tempered Glass Magnetic Marker Boards Are One (1) Piece with No Seams
- Mounting Brackets Included
- For Use From Floor to Top of Unit
- For Rare Earth Magnets, Marker and Eraser Sets; [See Set Options](#)

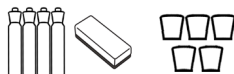

Rare Earth Magnets, Marker and Eraser set available; [See Set Options](#)

MARKER AND ERASER SET

01-MRKRSETBL For Use with Black Marker Boards and Black Glass Doors

\$ 1119

01-MRKRSETWH For Use with White Marker Boards and White Glass Doors

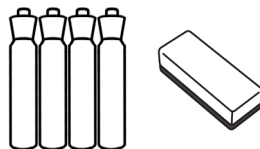

Description

- 01-MRKRSETWH May Also be Used with Dry Erase Doors and Boards
- Includes 4 Markers and an Eraser

RARE EARTH MAGNET SET

01-MAGBL For Use with White Marker Boards

\$ 1110

01-MAGWH For Use with Black Marker Boards



Description

- Includes Set of Five (5) Rare Earth Magnets
- To be Used with Tempered Glass Magnetic Marker Boards
- Comfort Grip with Stylish Protective Plastic Coating

[See Strut Overview For Ordering Options](#)

Item	Model No.		W	D	H	Ship Wt	Cubic Ft	List Price
ROUND GROMMET COVER FIELD INSTALLED	01-GRMTBK	Black	-	-	-	-	-	\$ 11
	01-GRMTSL	Silver						



OPEN MARKET ONLY
(SILVER)

Description

- 60mm Round Grommet Cover
- Field Installed

SINGLE POWER SAND DOLLAR	01-SAND60PS	Silver	3	3	4	1	0.2	\$ 95
	01-SAND60PW	White						
	01-SAND60PB	Black						

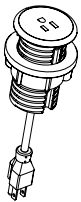

Description

- Mounts in 2 $\frac{3}{8}$ " (60mm) Round Grommet
- Single Power Outlet with 6' Cord

DOUBLE USB SAND DOLLAR	01-SAND60US	Silver	3	3	4	1	0.2	\$ 268
	01-SAND60UW	White						
	01-SAND60UB	Black						

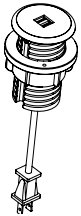

Description

- Mounts in 2 $\frac{3}{8}$ " (60mm) Round Grommet
- Dual USB Outlets with 6' Cord

DOCK 950 WIRELESS CHARGER	01-DOCK950W	White	3 $\frac{3}{16}$ "	3 $\frac{3}{16}$ "	-	1	0.2	\$ 256
	01-DOCK950B	Black						



OPEN MARKET ONLY

Description

- For Use with Wireless Charging Enabled Devices
- 5 Watts Maximum Output with a Direct Current of 5V 2A and 10 Watts Maximum with Quick Charge 2.0
- LED will Confirm Pairing with Device and Begin Wireless Charging

WIRELESS AND USB CHARGER	01-DOCK150W	White	3	3	$\frac{3}{4}$ "	1	0.2	\$ 391
	01-DOCK150B	Black						



OPEN MARKET ONLY

Description

- For Use with Wireless Charging Enabled Devices and USB Charging Devices
- 5 Watt Maximum Output with a Direct Current Input of 5V 6A (Wireless Fast Charge)
- Pop-Up is $\frac{3}{4}$ "H and Includes Three (3) USB Ports; One (1) 12 Watt Maximum with 2.4A (USB Fast Charge) and Two (2) 5 Watt with 1A (USB Standard Charge)
- LED Light will Confirm Pairing with Device and Begin Wireless Charging
- UL and cUL Certified

[See Strut Overview For Ordering Options](#)

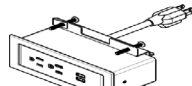
Item	Model No.		W	D	H	Ship Wt	Cubic Ft	List Price
	01-DUOBEZELW	White	6½	2½	3¼	1	0.2	\$ 652
	01-DUOBEZELB	Black						
	01-DUOBEZELS	Silver						

Description

- Sits on Table Top and Includes: Two (2) Power, Two (2) USB, 10' Cord, and All Mounting Hardware
- Independent USB Circuit Controllers Deliver up to 2.1 Amps to Each Post
- FCC Part 15A, UL Recognized for Horizontal and Vertical Applications

	01-TRIOBEZELW	White	9	2½	3	1	0.2	\$ 700
	01-TRIOBEZELB	Black						
	01-TRIOBEZELS	Silver						

Description

- Sits on Table Top and Includes: Three (3) Power Outlets, Two (2) USB Ports, One (1) Open Data Port, 10' Cord, and All Mounting Hardware
- HDMI, VGA, and RJ45 Accessories for Open Data Port; Sold Separately, [See Accessories](#)
- Independent USB Circuit Controllers Deliver up to 2.1 Amps to Each Post
- FCC Part 15A, UL Recognized for Horizontal and Vertical Applications

	01-PDUOBEZELW	White	6½	2½	3	1	0.2	\$ 645
	01-PDUOBEZELB	Black						
	01-PDUOBEZELS	Silver						

Description

- Sits on Table Top and Includes: Two (2) Power, Two (2) USB, 12" Cord, and All Mounting Hardware
- Requires Daisy Chain Power Box; Sold Separately, [See Power Box Details](#)
- Non-Sequential System Allows up to Eight (8) Modules to be Connected with Jumper Cord, [See Jumper Cord Details](#)
- Independent USB Circuit Controllers Deliver up to 2.1 Amps to Each Post
- FCC Part 15A, RU Listed and UL Recognized for Horizontal and Vertical Applications

[See Strut Overview For Ordering Options](#)

Item	Model No.		W	D	H	Ship Wt	Cubic Ft	List Price
TRIO BEZEL DAISY CHAIN PLUG	01-PTRIOBEZELW	White	9	2½	3	1	0.2	\$ 691
	01-PTRIOBEZELB	Black						
	01-PTRIOBEZELS	Silver						

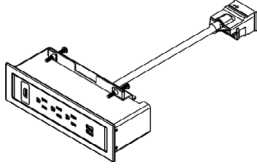

Description

- Sits on Table Top and Includes: Three (3) Power Outlets, Two (2) USB Ports, One (1) Open Data Port, 12" Cord, and All Mounting Hardware
- HDMI, VGA, or RJ45 Accessory for Open Data Port; Sold Separately, [See Accessories](#)
- Requires Daisy Chain Power Box, Specified Separately, See Below
- Non-Sequential System Allows up to Eight (8) Modules to be Connected with Jumper Cord, See Below
- Independent USB Circuit Controllers Deliver up to 2.1 Amps to Each Post
- FCC Part 15A, RU Listed and UL Recognized for Horizontal and Vertical Applications

DAISY CHAIN POWER BOX	01-PPOWER		-	-	-	1	0.2	\$ 749
		<i>76" Perimeter, 36" Power Cord</i>						
	01-PPOWER2		-	-	-	1	0.2	\$ 769
		<i>24" Perimeter, 144" Power Cord</i>						

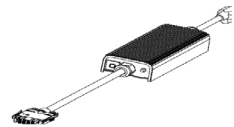

Description

- Powers up to Eight (8) Duo and Trio Daisy Chain Units
- One Nema Plug and One Daisy Chain Plug
- 12-Amp System Rating
- 15-Amp Over-Current Protection

DAISY CHAIN JUMPER CORD	01-6JUMP	<i>72" Long</i>	-	-	-	1	0.2	\$ 289
	01-5JUMP	<i>60" Long</i>	-	-	-	1	0.2	\$ 274
	01-4JUMP	<i>48" Long</i>	-	-	-	1	0.2	\$ 232
	01-2JUMP	<i>24" Long</i>	-	-	-	1	0.2	\$ 213

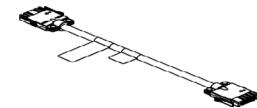

Description

- Connects Duo and Trio Daisy Chain Units
- Non-Sequential System Allows up to Eight (8) Modules to be Connected

[See Strut Overview For Ordering Options](#)

Item	Model No.	W	D	H	Ship Wt	Cubic Ft	List Price
HDMI DATA PORT ACCESSORY FOR TRIO UNITS	01-LCOMHDMI	-	-	-	1	0.2	\$ 160

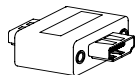

OPEN MARKET ONLY

VGA DATA PORT ACCESSORY FOR TRIO UNITS	01-LCOMVGA	-	-	-	1	0.2	\$ 117
--	------------	---	---	---	---	-----	--------

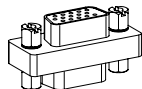

RJ45 DATA PORT ACCESSORY FOR TRIO UNITS	01-LCOMRJ45	-	-	-	1	0.2	\$ 76
---	-------------	---	---	---	---	-----	-------

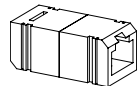

DPORT	01-DPORT4A	Aluminum	8	4	-	7	0.2	\$ 1056
	01-DPORT4B	Black						

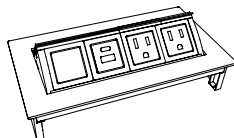
**Description**

- Retracts into Work Surface to Regain Productive Space; One-Touch Access to Power and Data
- Two (2) Power Outlets, One (1) USB A+C, and One (1) Open Port
- Optional Telecom Port Components, [See Compatible Units](#)
- Water-Proof Simplex (Outlets)
- Includes a Voice/Data Adapter Kit to Accept Couplers and Jacks When Required
- 10' Power Cord
- UL Recognized

E2X	01-E2X6A	Aluminum	11	9 ³ / ₁₆	-	6	0.7	\$ 1570
	01-E2X6B	Black						
	01-E2X4A	Aluminum	8	9 ³ / ₁₆	-	5	0.5	\$ 1443
	01-E2X4B	Black						

01-E2X4
SIN PENDING**Description**

- In Surface Application; Soft Touch Access to Power and Data
- Each Side has the Following: 11" Includes Three (3) Power Outlets, One (1) USB A+C, and Two (2) Open Port; 8" Includes Two (2) Power Outlets, One (1) USB A+C, and One (1) Open Port
- Optional Telecom Port Components, [See Compatible Units](#)
- 6' Power Cord
- UL Listed

[See Strut Overview For Ordering Options](#)

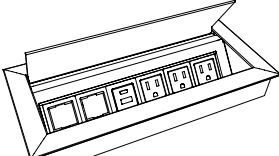
Item	Model No.		W	D	H	Ship Wt	Cubic Ft	Edge Profile + Material	List Price
	01-ELLORA6A	Aluminum	11	5	-	6	0.7	\$	823
	01-ELLORA6B	Black							
	01-ELLORA4A	Aluminum	8	5	-	5	0.5	\$	765
	01-ELLORA4B	Black							

01-ELLORA6
SIN PENDING

Description

- In Surface Application; Soft Touch Access to Power and Data
- 11" Includes Three (3) Power Outlets, One (1) USB A+C, and Two (2) Open Port; 8" Includes Two (2) Power Outlets, One (1) USB A+C, and One (1) Open Port
- Optional Telecom Port Components, See Below for Compatible Units
- 6' Power Cord
- UL Recognized

USB PORT	01-USBPORT		-	-	-	-	-	\$	156
----------	------------	--	---	---	---	---	---	----	-----

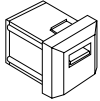

Description

- Passive USB-A Port with Increased Transfer Speed Up to 5 gbs/sec
- Simultaneous Read/Write Capability; Idle Device Power Saving State
- 6' Cord
- Compatible with 01-DPORT4A, 01-DPORT4B, ELLORA4A, ELLORA4B, ELLORA6A, ELLORA6B, E2X4A, E2X4B, E2X6A, and E2X6B

VOICE COUPLER	01-VOICE1		-	-	-	-	-	\$	71
---------------	-----------	--	---	---	---	---	---	----	----

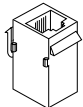

Description

- 6-Pin Modular Plug
- Molded Black; Cord Not included
- Compatible with 01-DPORT4A, 01-DPORT4B, ELLORA4A, ELLORA4B, ELLORA6A, ELLORA6B, E2X4A, E2X4B, E2X6A, and E2X6B

DATA PORT	01-RJ4DATA		-	-	-	-	-	\$	161
-----------	------------	--	---	---	---	---	---	----	-----



Description

- 8-Pin Modular Plug; Cat6 Ethernet Cable; Pre-terminated Cable
- 10' Cord
- Compatible with 01-DPORT4A, 01-DPORT4B, ELLORA4A, ELLORA4B, ELLORA6A, ELLORA6B, E2X4A, E2X4B, E2X6A, and E2X6B

[See Strut Overview For Ordering Options](#)

Item	Model No.	W	D	H	Ship Wt	Cubic Ft	List Price
VGA CONNECTOR ACCESSORY	01-VGACON	-	-	-	1	0.2	\$ 144

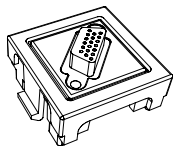
Description

- VGA Port for 01-DPORT4A, 01-DPORT4B, ELLORA4A, ELLORA4B, ELLORA6A, ELLORA6B, E2X4A, E2X4B, E2X6A, and E2X6B
- Enables Devices to Remote Display on Monitors
- 10' Cord
- Male/Female Connector

PASSIVE USB-C ACCESSORY	01-PUSBC	-	-	-	1	0.2	\$ 92
-------------------------	----------	---	---	---	---	-----	-------

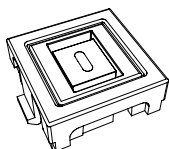
Description

- Passive USB-C Port ; Unit Provides Data Connection to Transfer Data Only, No Charging Capabilities
- Compatible with 01-DPORT4A, 01-DPORT4B, ELLORA4A, ELLORA4B, ELLORA6A, ELLORA6B, E2X4A, E2X4B, E2X6A, and E2X6B
- Male/Female Connector

CHARGING USB-A+C ACCESSORY	01-USBAC	-	-	-	1	0.2	\$ 273
----------------------------	----------	---	---	---	---	-----	--------

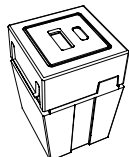
Description

- For Charging Devices
- 20 Watt Power Supply
- USB+C Charging Port for 01-DPORT4A, 01-DPORT4B, ELLORA4A, ELLORA4B, ELLORA6A, ELLORA6B, E2X4A, E2X4B, E2X6A, and E2X6B

HDMI CONNECTOR ACCESSORY	01-HDMICON	-	-	-	1	0.2	\$ 120
--------------------------	------------	---	---	---	---	-----	--------

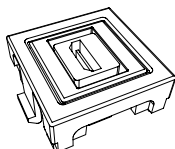
Description

- HDMI Port for 01-DPORT4A, 01-DPORT4B, ELLORA4A, ELLORA4B, ELLORA6A, ELLORA6B, E2X4A, E2X4B, E2X6A, and E2X6B
- Connects to High Definition Displays
- Female/Female Connector
- 18" Cord

[See Strut Overview For Ordering Options](#)

Item	Model No.		W	D	H	Ship Wt	Cubic Ft	Edge Profile + Material	List Price
INTERACT POWER & DATA	01-INTERACTG2A	Aluminum	9	5 $\frac{3}{8}$	2 $\frac{3}{4}$	5	0.2	\$	861
	01-INTERACTG2B	Black							

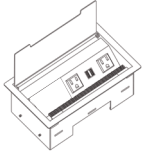

Description

- Includes: Two (2) Power Outlets, Two (2) USB-A Charging Ports, One (1) Telecom Plate Opening; Two (2) Keystone Openings for Voice/Data Jacks
- One (1) Telecom Plates Included with the Unit: One (1) 01-ABLAB Plate (Consists of One (1) RJ45 Cat 6, One (1) RJ11 Cat 3 Phone Jack)
- Convenience Plug on Bottom
- 6' Power Cord
- UL and CSA Recognized
- Additional Telecom Plates, [See ECA Telecom Plate Options](#)

OASIS MINI POWER & DATA	01-OASISMA	Aluminum	15	9	5	11	0.3	\$	3083
	01-OASISMB	Black							

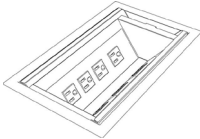

Top View

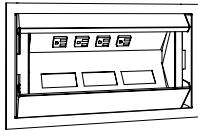

Description

- For Use with Conference Tables
- Soft Touch Hinged Lid
- Four (4) Power Outlets, Three (3) Telecom Plate Openings
- Two (2) Telecom Plates Included with the Unit: One (1) 01-ABLAB Plate (Consists of One (1) RJ45 Cat 6, One (1) RJ11 Cat 3 Phone Jack); One (1) 01-ABLB Plate (Consists of One (1) RJ45 Cat 6)
- 9' Power Cord
- UL Listed
- Additional Telecom Plates, [See ECA Telecom Plate Options](#)

DOCK800	01-DOCK800S	Silver	14	9	-			\$	1978
	01-DOCK800B	Black							

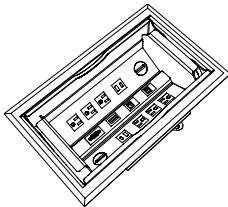

OPEN MARKET ONLY

Description

- Stylish Aluminum Housing with Beveled Edges; Soft Touch Access and Closure
- Includes: Six (6) Power Outlets, Two (2) USB-A 5V Ports, Two (2) USB-C Charging Ports, One (1) RJ45 Ethernet Port, One (1) RJ11 Port, One (1) HDMI Port, and One (1) VGA Port
- 10' Power Cord
- UL and cUL Certified

[See Strut Overview For Ordering Options](#)

Item	Model No.	W	D	H	Ship Wt	Cubic Ft	List Price
POWER ENTRY HARD WIRED	01-HWPOWERENTRY	72	-	-	1	0.2	\$ 311

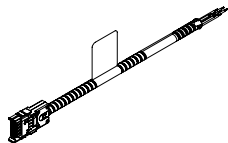
Description

- Eight (8) Wire/Four (4) Circuit Hard Wire In-feed
- UL183 Compliant

Item	Model No.	W	D	H	Ship Wt	Cubic Ft	List Price
JUMPER HARD WIRE CABLE	01-HW2JUMP	24	-	-	1	0.2	\$ 186
	01-HW3JUMP	36	-	-	1	0.2	\$ 199
	01-HW4JUMP	48	-	-	1	0.2	\$ 205
	01-HW5JUMP	60	-	-	1	0.2	\$ 246
	01-HW6JUMP	72	-	-	1	0.2	\$ 261

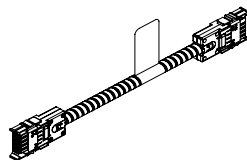
Description

- Eight (8) Wire/Four (4) Circuit Hard Wire Jumper
- UL183 Compliant

Item	Model No.	W	D	H	Ship Wt	Cubic Ft	List Price
QUAD BLOCK HARD WIRED	01-HWQUADBLOCK	-	-	-	1	0.2	\$ 60

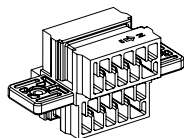
Description

- Eight (8) Wire/Four (4) Circuit Hard Wire Connector
- UL183 Compliant
- For Connecting Jumpers and Power Units
- Quantity of Four (4) Female Inputs

Item	Model No.	W	D	H	Ship Wt	Cubic Ft	List Price
WIRE MANAGEMENT CHANNEL	01-WMGR4	16	1½	¾	1	-	\$ 112

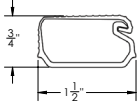
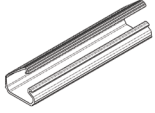
Description

- Set of Four (4) Black Plastic Wire Management Channels
- Snap Lock Channel
- Attaches with Adhesive Strips
- Ships via UPS Only

WIRE CHANNEL	01-32125	24	1¾	1	.25	0.3	\$ 102
--------------	----------	----	----	---	-----	-----	--------

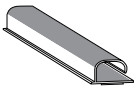
Description

- Available in Black
- Channels Attach with Two (2) Double-Sided Installation Tape
- Open J Channel for Easy Storage of Cables

CABLE GRIP	01-WMGRCB	5¾	2¾	-	-	-	\$ 16
------------	-----------	----	----	---	---	---	-------

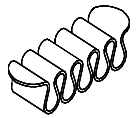
Description

- Under Surface Wire Management
- Black

Item	Model No.	Description	List Price
ECA TELECOM PLATES			
	01-ABL	Telecom Plate, Blank Plate	\$ 40
	01-ABL737373	Telecom Plate, Three (3) RJ45 Cat 5e	\$ 355
Compatible with:	01-ABLAB	Telecom Plate, One (1) RJ45 Cat 6, One (1) RJ11 Cat 3 Phone	\$ 199
	01-ABLAB102	Telecom Plate, One (1) RJ45 Cat 6, One (1) RJ11 Cat 3, One (1) USB W/72" Patch Cord	\$ 309
	01-ABLABB	Telecom Plate, Two (2) RJ45 Cat 6, One (1) RJ11 Cat 3 Phone	\$ 309
Oasis Mini Power & Data 01-OASISMA, 01-OASISMB	01-ABLB	Telecom Plate, One (1) RJ45 Cat 6	\$ 144
	01-ABLBB	Telecom Plate, Two (2) RJ45 Cat 6	\$ 251
Interact Power & Data 01-INTERACTG2A, 01-INTERACTG2B	01-ABLBBB	Telecom Plate, Three (3) RJ45 Cat 6	\$ 355
	01-ABLBBBB	Telecom Plate, Four (4) RJ45 Cat 6	\$ 460
Power Center 01-INTRFCIA, 01-INTRFCIB	01-ABLBBC51	Telecom Plate, Two (2) RJ45 Cat 6, One (1) 15 Pin HD VGA w/72" Patch Cord	\$ 431
	01-ABLBC51L	Telecom Plate, One (1) RJ45 Cat 6, One (1) Mini Stereo Inline, One (1) 15 Pin HD VGA w/72" Patch Cord	\$ 396
	01-ABLC3811	Telecom Plate, One (1) RJ45 Cat 6 Data Inline, One (1) RJ11 Cat 3 Phone Inline	\$ 190
	01-ABLC45	Telecom Plate, One (1) HDMI w/36" Patch Cord	\$ 285
	01-ABLC45C51L	Telecom Plate, One (1) Mini Stereo Inline, One (1) HDMI w/36" Patch Cord, One (1) 15 Pin HD VGA w/72" Patch Cord	\$ 539
	01-ABLC51L	Telecom Plate, One (1) 15 Pin HD VGA & One (1) Mini Stereo Inline Jack	\$ 288
	01-ABLCRDM	Telecom Plate, Three (3) Cord Bushings	\$ 93

Designers Jim Contois and Ramsey Madsen complement existing products with the Tri-One Table Collection. A full offering of training, meeting, and modular tables are available in flexible models that is sure to meet every expectation with integrated power and data capabilities.

CONSTRUCTION

LAMINATE

- Thermally-Fused Laminate (TFL) and High-Pressure Laminate (HPL) are made of woodgrain and solid color laminates fused to particleboard core; each laminate offers lasting beauty, superior resistance to normal wear, and easy maintenance

VENEER

- Surfaces feature select-grade, plain-sliced hardwood Cherry, Maple, American Black Walnut, White Oak, and composite veneers; Veneers are carefully selected and matched to assure proper balance and consistency
- Veneer features UVAdvantage, an ultra-violet finish, on all exposed surfaces by utilizing roll-coat UV technology

TOPS

- Tops with the Square (Y) edge profile are 1" thick TFL or 1 3/16" HPL with a 3mm PVC rim; or 1 3/16" Veneer with 1.5mm edge banding
- Tops with the Knife (K) edge profile are 1 3/16" HPL with a 3mm PVC rim or 1 3/16" Veneer with 1 1/2 mm edge banding
- Laminate colors Designer White, Sugar Maple, and Williamsburg Cherry feature ABS edge bands
- Training and Modular tops feature shaped profiles on the user side while Meeting tops are shaped on all four sides
- Tops are pre-drilled for the specified base assembly and for ganging where applicable
- Grain direction runs left-to-right, unless noted



Knife (K)

Square (Y)

LEGS/BASES

- The Envy and Vantage leg/base styles are powder-coated Aluminum and include a 5mm steel mounting plate
- Envy style legs are aluminum extrusions while Vantage style legs are welded steel
- All legs and bases come standard with adjustable glides

GANGING

- All Modular and Training tops are pre-drilled with threaded inserts for ganging applications
- Ganging brackets include quick release thumb screws for ease of use; No tools required

NESTING

- Training tables offer an exclusive flip mechanism which can be accessed from any position to allow easier nesting of tables
- Optional flip mechanisms are factory installed and must be specified at the time of order

POWER/DATA/CORD MANAGEMENT

- Grommets are available in tops, where noted
- Grommets are 2 3/8" in diameter and available in black or silver
- Power/Data units available for under-surface mount, routed into tops, or for use in standard grommet holes (e.g., Sand Dollar)
- Power/Data Units comply with FCC Part 15A and UL
- Standard Power/Data plugs and daisy-chain connections are available; daisy chains are non-sequential; connect up to 8 modules

HOW TO ORDER EXAMPLES

MODULAR TABLE	QTY	MODEL NO.	EXAMPLE
TOP	4	85-3084MCT	Finish FO
LEG	4	08-0227APL4	
GANGING	3	08-1505GB	
MODESTY	4	85-0884MD	Finish FO
GROMMET/POWER/DATA	4	01-DUOBEZELS	PDC-L

FLEXIBLE SIZE TOP	QTY	MODEL NO.	EXAMPLE
TOP	4	86-FLEXMCT30	Width 79 Color WH
LEG	4	08-0227SPL4	
GANGING	3	08-1505GB	
MODESTY		No Modesty	
GROMMET/POWER/DATA		No Grommet	

MEETING TABLE	QTY	MODEL NO.	EXAMPLE
TOP	1	86-4296MTKH	Color WTA
LEG	1	08-2828YLG84	Finish BLK
GROMMET/POWER/DATA	1	GC	Color BLK

TRAINING TABLE	QTY	MODEL NO.	EXAMPLE
TOP	6	86-2472TTKH	Color PTM
LEG	6	08-2427TLC72	Casters SOFT
GANGING	5	08-1505GB	
NESTING	6	08-FLIP	
MODESTY	6	86-0865HMD	Color PTM
GROMMET/POWER/DATA	6	01-PDUOBEZELW	PDC-C

TFL (T) & HPL (P) LAMINATE OPTIONS

Tops with Knife Edge Profile available in HPL Only.

WOODGRAIN

AS	Asian Night	PNW	Pinnacle Walnut
BW	Beigewood	PTK	Portico Teak
CO	Columbian Walnut	RC	River Cherry
EF	Espresso	SCH	Select Cherry^
FLW	Florence Walnut	SPW	Sepia Walnut
GC	Golden Cherry^	SKC	Shaker Cherry
KHE	Kirsche	SBP	Smoky Brown Pear
MW	Mahogany Walnut^	TK	Studio Teak
MNR	Midnight Run	SM	Sugar Maple
NTM	Natural Marrone	WTA	Weathered Ash
ORW	Oak Riftwood	WNB	White Nebbia
		WC	Williamsburg Cherry

SOLID

BL	Black	FHG	Fashion Grey
WH	Designer White	SG	Slate Grey

VENEER (W) OPTIONS

Veneer features UVAdvantage, an ultra-violet finish, on all exposed surfaces by utilizing roll-coat UV technology

AW	Artisan Walnut	MW	Mahogany Walnut
AS	Asian Night	MAS	Mesa Sunset*
CO	Columbian Walnut	MTS	Metropolis Sky
DC	Dark Cherry	PNW	Pinnacle Walnut
DFW	Dark Forest Walnut	ORW	Oak Riftwood*
EW	Espresso	SCH	Select Cherry
FO	Fawn Oak*	SKC	Shaker Cherry
GC	Golden Cherry	SM	Sugar Maple
HW	Harvest Walnut	WTA	Weathered Ash*
HNW	Henna Walnut	WC	Williamsburg Cherry
LW	Legacy Walnut		

* Finish is Low Sheen

GROMMET OPTIONS & POWER/DATA UNIT LOCATIONS

Grommets are available in modular, meeting, and training tops. Tops may also be ordered without grommets at no additional charge. Please specify NO GROMMET on order.

Power/Data units must be specified separately with surface mount location. Specify location on order, as well as the power/data unit. Routed for field placement at no additional charge.

Grommets are available in standard locations. Please specify using info below. Multiple locations may be selected. Only one grommet/power/data unit per location.

GROMMET LOCATIONS (Black = BLK and Silver = SLV)

GC	Grommet, Center - Must Specify BLK or SLV	\$	50
GL	Grommet, Left - Must Specify BLK or SLV	\$	50
GR	Grommet, Right - Must Specify BLK or SLV	\$	50

DUO/TRIO BEZEL LOCATIONS (Starting on Page 200)

PDC-C	Bezel, Center
PDC-L	Bezel, Left
PDC-R	Bezel, Right

Grommets and Power/Data Units may be ordered in non-standard locations. Call Customer Service to assist with specification and/or please attach a drawing to the PO showing the location of the grommet. Note additional charges and lead times may apply.

24" Modular Tops

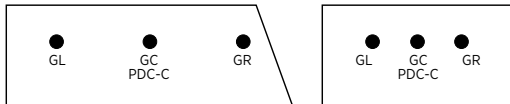

GL/GR: Located 10" from end based on widest dimension, 13 3/8" from user side
GC/PDC-C: Located 13 3/8" from user side

30" Modular Tops

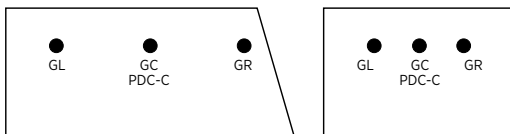

GL/GR: Located 10" from end based on widest dimension, 19 3/8" from user side
GC/PDC-C: Located 19 3/8" from user side

Meeting Tops (Where Applicable)

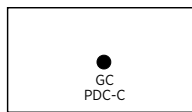

PDC-C: On Center, front to back

18" Training Tables



GL/GR/PDC-L/PDC-R: Located 10" from end, 12" from user side
GC/PDC-C: Located 12" from user side

24" Training Tables

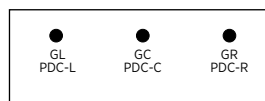

GL/GR: Located 10" from end, 16 1/2" from user side
GC: Located 16 1/2" from user side

30" Training Tables

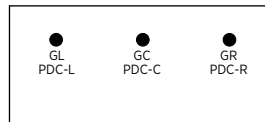

GL/GR: Located 10" from end, 20" from user side
GC: Located 20" from user side

CERTIFICATIONS & COMPLIANCE

- Intertek Sustainability Certified
- BIFMA level® Certified
- BIFMA Compliant® Certified
- TSCA Title VI (formerly CARB) Compliance
- US Green Building's LEED® Contribution

Modular Tops & Legs

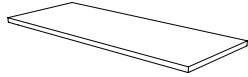

Rectangular Modular Tops in Standard Sizes [\(See Details\)](#)
Flexible Sizes [\(See Details\)](#)



Trapezoid Modular Tops in Standard [\(See Multiple Unit Details\)](#)
Flexible Sizes [\(See Multiple Unit Details\)](#)



Pentagon Ganging Tops [\(See Details\)](#)



Bridge Ganging Tops [\(See Multiple Unit Details\)](#)



Envy Post Leg [\(See Details\)](#)



Vantage Post Leg [\(See Details\)](#)

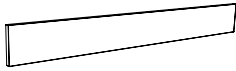

Modesty Panels [\(See Multiple Unit Details\)](#)

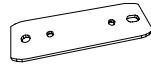

Ganging Brackets [\(See Details\)](#)



Grommets, Power/Data, and Accessories [\(See Multiple Unit Details\)](#)

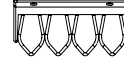
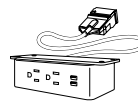

Meeting Tops & Legs



Rectangular Meeting Tops [\(See Details\)](#)



Soft Rectangular Meeting Tops [\(See Details\)](#)



Soft View Meeting Tops [\(See Details\)](#)



Ellipse Meeting Tops* [\(See Details\)](#)

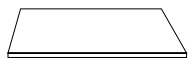

Square Meeting Tops [\(See Details\)](#)



Soft Square Meeting Tops [\(See Details\)](#)



Round Meeting Tops [\(See Details\)](#)



Grommets, Power/Data, and Accessories [\(See Multiple Unit Details\)](#)

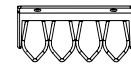
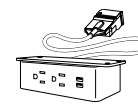

Bases and Legs [\(See Multiple Base Options\)](#)



Y-Bases [\(See Details\)](#)

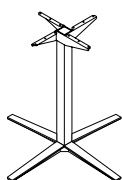

X-Bases [\(See Details\)](#)

* The Ellipse Meeting Tops will use the Envy Post or Vantage Post Legs

Training Tops & Legs

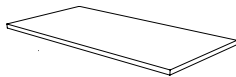

Rectangular Training Tops [\(See Details\)](#)

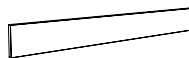

Modesty Panels [\(See Details\)](#)



Grommets, Power/Data, and Accessories [\(See Multiple Unit Details\)](#)

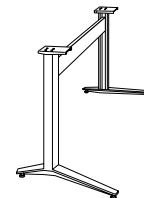

Envy C-Legs [\(See Details\)](#)

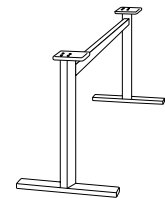

Vantage T-Legs [\(See Details\)](#)

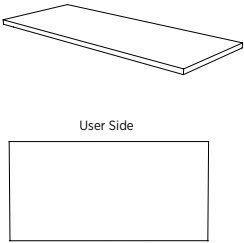
Item	Model No.		W	D	H	Ship Wt	Cubic Ft	List Price
RECTANGULAR MODULAR TOPS								
	Square Edge							
	86-3084MCT	TFL	84	30	-	76.4	6.0	T\$ 980
	86-3084MCTH	HPL						P\$ 1327
	85-3084MCT	Veneer						W\$ 1965
	86-3072MCT	TFL	72	30	-	65.5	5.1	T\$ 791
	86-3072MCTH	HPL						P\$ 1073
	85-3072MCT	Veneer						W\$ 1591
	86-3060MCT	TFL	60	30	-	54.6	4.3	T\$ 713
	86-3060MCTH	HPL						P\$ 965
	85-3060MCT	Veneer						W\$ 1427
	86-3048MCT	TFL	48	30	-	43.7	3.5	T\$ 531
	86-3048MCTH	HPL						P\$ 722
	85-3048MCT	Veneer						W\$ 1070
	86-2484MCT	TFL	84	24	-	61.1	4.9	T\$ 908
	86-2484MCTH	HPL						P\$ 1234
	85-2484MCT	Veneer						W\$ 1825
	86-2472MCT	TFL	72	24	-	52.4	4.2	T\$ 732
	86-2472MCTH	HPL						P\$ 991
	85-2472MCT	Veneer						W\$ 1467
	86-2460MCT	TFL	60	24	-	43.7	3.5	T\$ 667
86-2460MCTH	HPL						P\$ 900	
85-2460MCT	Veneer						W\$ 1332	
86-2448MCT	TFL	48	24	-	34.9	2.8	T\$ 493	
86-2448MCTH	HPL						P\$ 670	
85-2448MCT	Veneer						W\$ 988	
Knife Edge								
	86-3084MCTKH	HPL	84	30	-	76.4	6.0	P\$ 1737
	85-3084MCTK	Veneer						W\$ 2395
	86-3072MCTKH	HPL	72	30	-	65.5	5.1	P\$ 1408
	85-3072MCTK	Veneer						W\$ 1939
	86-3060MCTKH	HPL	60	30	-	54.6	4.3	P\$ 1265
	85-3060MCTK	Veneer						W\$ 1743
	86-3048MCTKH	HPL	48	30	-	43.7	3.5	P\$ 947
	85-3048MCTK	Veneer						W\$ 1306
	86-2484MCTKH	HPL	84	24	-	61.1	4.9	P\$ 1618
	85-2484MCTK	Veneer						W\$ 2225
	86-2472MCTKH	HPL	72	24	-	52.4	4.2	P\$ 1300
	85-2472MCTK	Veneer						W\$ 1792
	86-2460MCTKH	HPL	60	24	-	43.7	3.5	P\$ 1178
	85-2460MCTK	Veneer						W\$ 1624
	86-2448MCTKH	HPL	48	24	-	34.9	2.8	P\$ 872
	85-2448MCTK	Veneer						W\$ 1205

Must Specify (in this order):
 Model #
 Top Finish/Color
 Leg Model #
 Ganging Brackets
 Modesty Model # and Finish/Color
 Grommet/Power/Data Location



Must Order Envy or Vantage Post Legs. [See Leg Options.](#)

Description

- Profile on User Side Only
- Flexible Sizes Available, [See Next Page](#)
- Tops 60" or Larger Include Stiffener Bar for Additional Support
- Legs Required (Assembly Required); Sold Separately, [See Leg Options](#)
- Pre-Drilled for Optional Ganging Brackets; Sold Separately, [See Details](#)
- Fixed Modesty Panel Options Available; Sold Separately, [See Modesty Options](#)
- Power & Data Options Available; Sold Separately, [See Multiple Units](#) and [See Locations](#)

T = TFL P = HPL W = Veneer

[See Tri-One Overview For Ordering Options](#)

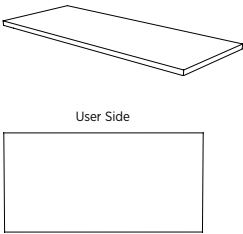
Item	Model No.		W	D	H	Ship Wt	Cubic Ft	List Price	
RECTANGULAR MODULAR TOPS FLEXIBLE SIZES 	Square Edge								
	86-FLEXMCT30	TFL	84-73	30	-	76.4	6.0	T\$ 980	
	86-FLEXMCTH30	HPL						P\$ 1327	
	85-FLEXMCT30	Veneer						W\$ 1965	
			72-61	30	-	65.5	5.1	T\$ 791	
								P\$ 1073	
								W\$ 1591	
			60-49	30	-	54.6	4.3	T\$ 713	
								P\$ 965	
								W\$ 1427	
			48-36	30	-	43.7	3.5	T\$ 531	
								P\$ 722	
								W\$ 1070	
		86-FLEXMCT24	TFL	84-73	24	-	61.1	4.9	T\$ 908
		86-FLEXMCTH24	HPL						P\$ 1234
	85-FLEXMCT24	Veneer						W\$ 1825	
			72-61	24	-	52.4	4.2	T\$ 732	
								P\$ 991	
								W\$ 1467	
			60-49	24	-	43.7	3.5	T\$ 667	
								P\$ 900	
								W\$ 1332	
			48-36	24	-	34.9	2.8	T\$ 493	
								P\$ 670	
								W\$ 988	
	Knife Edge								
	86-FLEXMCTKH30	HPL	84-73	30	-	76.4	6.0	P\$ 1737	
	85-FLEXMCTK30	Veneer						W\$ 2395	
			72-61	30	-	65.5	5.1	P\$ 1408	
								W\$ 1939	
			60-49	30	-	54.6	4.3	P\$ 1265	
								W\$ 1743	
			48-36	30	-	43.7	3.5	P\$ 947	
								W\$ 1306	
	86-FLEXMCTKH24	HPL	84-73	24	-	61.1	4.9	P\$ 1618	
	85-FLEXMCTK24	Veneer						W\$ 2225	
			72-61	24	-	52.4	4.2	P\$ 1300	
								W\$ 1792	
			60-49	24	-	43.7	3.5	P\$ 1178	
								W\$ 1624	
			48-36	24	-	34.9	2.8	P\$ 872	
								W\$ 1205	

Must Specify (in this order):
 Model #
 Top Width Measurement
 Top Finish/Color
 Leg Model #
 Ganging Brackets
 Modesty Model # and Finish/Color
 Grommet/Power/Data Location

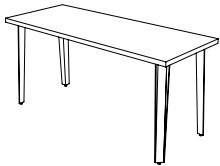

Must Order Envy or Vantage Post Legs. See Leg Options.

Description

- Profile on User Side Only
- Must Specify Width In One Inch Increments from 36" to 84"
- Tops 60" or Larger Include Stiffener Bar for Additional Support
- Legs Required (Assembly Required); Sold Separately, [See Leg Options](#)
- Pre-Drilled for Optional Ganging Brackets; Sold Separately, [See Details](#)
- Fixed Modesty Panel Options Available; Sold Separately, [See Modesty Options](#)
- Power & Data Options Available; Sold Separately, [See Multiple Units](#) and [See Locations](#)

T = TFL P = HPL W = Veneer

[See Tri-One Overview For Ordering Options](#)

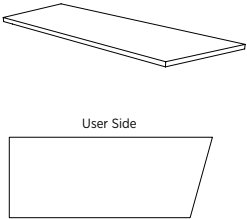
Item	Model No.		W	D	H	Ship Wt	Cubic Ft	List Price
LEFT TRAPEZOID MODULAR TOPS								
Square Edge								
	86-3084LMCT	TFL	84	30	-	76.4	6.0	T\$ 941
	86-3084LMCTH	HPL						P\$ 1274
	85-3084LMCT	Veneer						W\$ 1886
	86-3072LMCT	TFL	72	30	-	65.5	5.1	T\$ 761
	86-3072LMCTH	HPL						P\$ 1030
	85-3072LMCT	Veneer						W\$ 1524
	86-3060LMCT	TFL	60	30	-	54.6	4.3	T\$ 684
	86-3060LMCTH	HPL						P\$ 929
	85-3060LMCT	Veneer						W\$ 1374
	86-3048LMCT	TFL	48	30	-	43.7	3.5	T\$ 512
	86-3048LMCTH	HPL						P\$ 694
	85-3048LMCT	Veneer						W\$ 1026
	86-2484LMCT	TFL	84	24	-	61.1	4.9	T\$ 872
	86-2484LMCTH	HPL						P\$ 1187
	85-2484LMCT	Veneer						W\$ 1757
	86-2472LMCT	TFL	72	24	-	52.4	4.2	T\$ 700
	86-2472LMCTH	HPL						P\$ 950
	85-2472LMCT	Veneer						W\$ 1407
86-2460LMCT	TFL	60	24	-	43.7	3.5	T\$ 639	
86-2460LMCTH	HPL						P\$ 864	
85-2460LMCT	Veneer						W\$ 1282	
86-2448LMCT	TFL	48	24	-	34.9	2.8	T\$ 470	
86-2448LMCTH	HPL						P\$ 637	
85-2448LMCT	Veneer						W\$ 943	
Knife Edge								
	86-3084LMCTKH	HPL	84	30	-	76.4	6.0	P\$ 1671
	85-3084LMCTK	Veneer						W\$ 2302
	86-3072LMCTKH	HPL	72	30	-	65.5	5.1	P\$ 1348
	85-3072LMCTK	Veneer						W\$ 1859
	86-3060LMCTKH	HPL	60	30	-	54.6	4.3	P\$ 1215
	85-3060LMCTK	Veneer						W\$ 1675
	86-3048LMCTKH	HPL	48	30	-	43.7	3.5	P\$ 907
	85-3048LMCTK	Veneer						W\$ 1250
	86-2484LMCTKH	HPL	84	24	-	61.1	4.9	P\$ 1551
	85-2484LMCTK	Veneer						W\$ 2140
	86-2472LMCTKH	HPL	72	24	-	52.4	4.2	P\$ 1246
	85-2472LMCTK	Veneer						W\$ 1717
	86-2460LMCTKH	HPL	60	24	-	43.7	3.5	P\$ 1133
	85-2460LMCTK	Veneer						W\$ 1563
	86-2448LMCTKH	HPL	48	24	-	34.9	2.8	P\$ 835
	85-2448LMCTK	Veneer						W\$ 1152

Must Specify (in this order):
 Model #
 Top Finish/Color
 Leg Model #
 Ganging Brackets
 Modesty Model # and Finish/Color
 Grommet/Power/Data Location

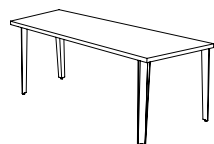

Must Order Envy or Vantage Post Legs. [See Leg Options.](#)

Description

- Profile on User Side Only
- Flexible Sizes Available, [See Next Page](#)
- Tops 60" or Larger Include Stiffener Bar for Additional Support
- Legs Required (Assembly Required); Legs Sold Separately, [See Leg Options](#)
- Pre-Drilled for Optional Ganging Brackets; Sold Separately, [See Details](#)
- For Ganging Applications, the Angled End of a Trapezoid Modular Top Must Connect with the Angled End of Another Trapezoid Modular Top; Please Specify a Left and a Right to Gang Tops
- Trapezoid Modular Tops Only Connect to Rectangular Modular Tops on Straight End
- Fixed Modesty Panel Options Available; Sold Separately, [See Modesty Options](#)
- Power & Data Options Available; Sold Separately, [See Multiple Units](#) and [See Locations](#)

T = TFL P = HPL W = Veneer

[See Tri-One Overview For Ordering Options](#)

Item	Model No.		W	D	H	Ship Wt	Cubic Ft	List Price	
LEFT TRAPEZOID MODULAR TOPS FLEXIBLE SIZES	Square Edge								
	86-FLEXLMCT30	TFL	84-73	30	-	76.4	6.0	T\$ 941	
	86-FLEXLMCTH30	HPL						P\$ 1274	
	85-FLEXLMCT30	Veneer						W\$ 1886	
			72-61	30	-	65.5	5.1	T\$ 761	
								P\$ 1030	
								W\$ 1524	
			60-49	30	-	54.6	4.3	T\$ 684	
								P\$ 929	
								W\$ 1374	
			48-36	30	-	43.7	3.5	T\$ 512	
								P\$ 694	
								W\$ 1026	
		86-FLEXLMCT24	TFL	84-73	24	-	61.1	4.9	T\$ 872
		86-FLEXLMCTH24	HPL						P\$ 1187
	85-FLEXLMCT24	Veneer						W\$ 943	
			72-61	24	-	52.4	4.2	T\$ 700	
								P\$ 950	
								W\$ 1407	
			60-49	24	-	43.7	3.5	T\$ 639	
								P\$ 864	
								W\$ 1282	
			48-36	24	-	34.9	2.8	T\$ 470	
								P\$ 637	
								W\$ 943	
	Knife Edge								
	86-FLEXLMCTKH30	HPL	84-73	30	-	76.4	6.0	P\$ 1671	
	85-FLEXLMCTK30	Veneer						W\$ 2302	
			72-61	30	-	65.5	5.1	P\$ 1348	
								W\$ 1859	
			60-49	30	-	54.6	4.3	P\$ 1215	
								W\$ 1675	
			48-36	30	-	43.7	3.5	P\$ 907	
								W\$ 1250	
	86-FLEXLMCTKH24	HPL	84-73	24	-	61.1	4.9	P\$ 1551	
	85-FLEXLMCTK24	Veneer						W\$ 2140	
			72-61	24	-	52.4	4.2	P\$ 1246	
								W\$ 1717	
			60-49	24	-	43.7	3.5	P\$ 1133	
								W\$ 1563	
			48-36	24	-	34.9	2.8	P\$ 835	
								W\$ 1152	

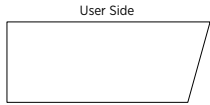
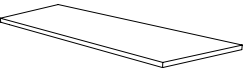

Must Specify (in this order):

- Model #
- Top Width Measurement
- Top Finish/Color
- Leg Model #
- Ganging Brackets
- Modesty Model # and Finish/Color
- Grommet/Power/Data Location

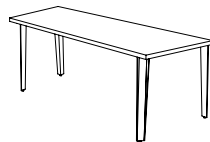

Must Order Envy or Vantage Post Legs. [See Leg Options.](#)

Description

- Profile on User Side Only
- Tops 60" or Larger Include Stiffener Bar for Additional Support
- Legs Required (Assembly Required); Sold Separately, [See Leg Options](#)
- Pre-Drilled for Optional Ganging Brackets; Sold Separately, [See Details](#)
- For Ganging Applications, the Angled End of a Trapezoid Modular Top Must Connect with the Angled End of Another Trapezoid Modular Top; Please Specify a Left and a Right to Gang Tops
- Trapezoid Modular Tops Only Connect to Rectangular Modular Tops on Straight End
- Fixed Modesty Panel Options Available; Sold Separately, [See Modesty Options](#)
- Power & Data Options Available; Sold Separately, [See Multiple Units](#) and [See Locations](#)

T = TFL P = HPL W = Veneer

[See Tri-One Overview For Ordering Options](#)

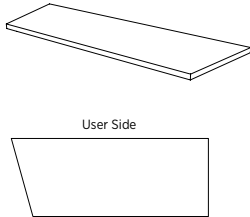
Item	Model No.		W	D	H	Ship Wt	Cubic Ft	List Price
RIGHT TRAPEZOID MODULAR TOPS								
Square Edge								
 <p>User Side</p>	86-3084RMCT	TFL	84	30	-	76.4	6.0	T\$ 941
	86-3084RMCTH	HPL						P\$ 1274
	85-3084RMCT	Veneer						W\$ 1886
	86-3072RMCT	TFL	72	30	-	65.5	5.1	T\$ 761
	86-3072RMCTH	HPL						P\$ 1030
	85-3072RMCT	Veneer						W\$ 1524
	86-3060RMCT	TFL	60	30	-	54.6	4.3	T\$ 684
	86-3060RMCTH	HPL						P\$ 929
	85-3060RMCT	Veneer						W\$ 1374
	86-3048RMCT	TFL	48	30	-	43.7	3.5	T\$ 512
	86-3048RMCTH	HPL						P\$ 694
	85-3048RMCT	Veneer						W\$ 1026
	86-2484RMCT	TFL	84	24	-	61.1	4.9	T\$ 872
	86-2484RMCTH	HPL						P\$ 1187
	85-2484RMCT	Veneer						W\$ 1757
	86-2472RMCT	TFL	72	24	-	52.4	4.2	T\$ 700
	86-2472RMCTH	HPL						P\$ 950
	85-2472RMCT	Veneer						W\$ 1407
86-2460RMCT	TFL	60	24	-	43.7	3.5	T\$ 639	
86-2460RMCTH	HPL						P\$ 864	
85-2460RMCT	Veneer						W\$ 1282	
86-2448RMCT	TFL	48	24	-	34.9	2.8	T\$ 470	
86-2448RMCTH	HPL						P\$ 637	
85-2448RMCT	Veneer						W\$ 943	
Knife Edge								
	86-3084RMCTKH	HPL	84	30	-	76.4	6.0	P\$ 1671
	85-3084RMCTK	Veneer						W\$ 2302
	86-3072RMCTKH	HPL	72	30	-	65.5	5.1	P\$ 1348
	85-3072RMCTK	Veneer						W\$ 1859
	86-3060RMCTKH	HPL	60	30	-	54.6	4.3	P\$ 1215
	85-3060RMCTK	Veneer						W\$ 1675
	86-3048RMCTKH	HPL	48	30	-	43.7	3.5	P\$ 907
	85-3048RMCTK	Veneer						W\$ 1250
	86-2484RMCTKH	HPL	84	24	-	61.1	4.9	P\$ 1551
	85-2484RMCTK	Veneer						W\$ 2140
	86-2472RMCTKH	HPL	72	24	-	52.4	4.2	P\$ 1246
	85-2472RMCTK	Veneer						W\$ 1717
	86-2460RMCTKH	HPL	60	24	-	43.7	3.5	P\$ 1133
	85-2460RMCTK	Veneer						W\$ 1563
	86-2448RMCTKH	HPL	48	24	-	34.9	2.8	P\$ 835
	85-2448RMCTK	Veneer						W\$ 1152

Must Specify (in this order):
 Model #
 Top Finish/Color
 Leg Model #
 Ganging Brackets
 Modesty Model # and Finish/Color
 Grommet/Power/Data Location

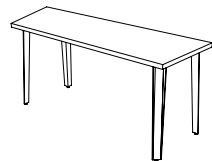

Must Order Envy or Vantage Post Legs. [See Leg Options.](#)

Description

- Profile on User Side Only
- Flexible Sizes Available, [See Next Page](#)
- Tops 60" or Larger Include Stiffener Bar for Additional Support
- Legs Required (Assembly Required); Sold Separately, [See Leg Options](#)
- Pre-Drilled for Optional Ganging Brackets; Sold Separately, [See Details](#)
- For Ganging Applications, the Angled End of a Trapezoid Modular Top Must Connect with the Angled End of Another Trapezoid Modular Top; Please Specify a Left and a Right to Gang Tops
- Trapezoid Modular Tops Only Connect to Rectangular Modular Tops on Straight End
- Fixed Modesty Panel Options Available; Sold Separately, [See Modesty Options](#)
- Power & Data Options Available; Sold Separately, [See Multiple Units](#) and [See Locations](#)

T = TFL P = HPL W = Veneer

[See Tri-One Overview For Ordering Options](#)

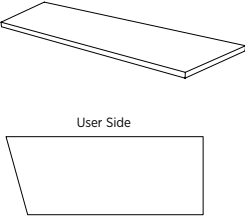
Item	Model No.		W	D	H	Ship Wt	Cubic Ft	List Price	
RIGHT TRAPEZOID MODULAR TOPS			Square Edge						
FLEXIBLE SIZES									
 <p>User Side</p>	86-FLEXRMCT30	TFL	84-73	30	-	76.4	6.0	T\$ 941	
	86-FLEXRMCTH30	HPL						P\$ 1274	
	85-FLEXRMCT30	Veneer						W\$ 1886	
				72-61	30	-	65.5	5.1	T\$ 761
									P\$ 1030
									W\$ 1524
				60-49	30	-	54.6	4.3	T\$ 684
									P\$ 929
									W\$ 1374
				48-36	30	-	43.7	3.5	T\$ 512
									P\$ 694
									W\$ 1026
	86-FLEXRMCT24	TFL	84-73	24	-	61.1	4.9	T\$ 872	
	86-FLEXRMCTH24	HPL						P\$ 1187	
	85-FLEXRMCT24	Veneer						W\$ 1757	
			72-61	24	-	52.4	4.2	T\$ 700	
								P\$ 950	
								W\$ 1407	
			60-49	24	-	43.7	3.5	T\$ 639	
								P\$ 864	
								W\$ 1282	
			48-36	24	-	34.9	2.8	T\$ 470	
								P\$ 637	
								W\$ 943	
Knife Edge									
	86-FLEXRMCTKH30	HPL	84-73	30	-	76.4	6.0	P\$ 1671	
	85-FLEXRMCTK30	Veneer						W\$ 2302	
			72-61	30	-	65.5	5.1	P\$ 1348	
								W\$ 1859	
			60-49	30	-	54.6	4.3	P\$ 1215	
								W\$ 1675	
			48-36	30	-	43.7	3.5	P\$ 907	
								W\$ 1250	
	86-FLEXRMCTKH24	HPL	84-73	24	-	61.1	4.9	P\$ 1551	
	85-FLEXRMCTK24	Veneer						W\$ 2140	
			72-61	24	-	52.4	4.2	P\$ 1246	
								W\$ 1717	
			60-49	24	-	43.7	3.5	P\$ 1133	
								W\$ 1563	
			48-36	24	-	34.9	2.8	P\$ 835	
								W\$ 1152	

Must Specify (in this order):
 Model #
 Top Width Measurement
 Top Finish/Color
 Ganging Brackets
 Ganging Model #
 Modesty Model # and Finish/Color
 Grommet/Power/Data Location

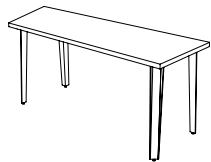

Must Order Envy or Vantage Post Legs. [See Leg Options.](#)

Description

- Profile on User Side Only
- Tops 60" or Larger Include Stiffener Bar for Additional Support
- Legs Required (Assembly Required); Sold Separately, [See Leg Options](#)
- Pre-Drilled for Optional Ganging Brackets; Sold Separately, [See Details](#)
- For Ganging Applications, the Angled End of a Trapezoid Modular Top Must Connect with the Angled End of Another Trapezoid Modular Top; Please Specify a Left and a Right to Gang Tops
- Trapezoid Modular Tops Only Connect to Rectangular Modular Tops on Straight End
- Fixed Modesty Panel Options Available; Sold Separately, [See Modesty Options](#)
- Power & Data Options Available; Sold Separately, [See Multiple Units](#) and [See Locations](#)

T = TFL P = HPL W = Veneer

[See Tri-One Overview For Ordering Options](#)

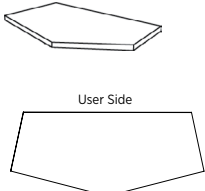
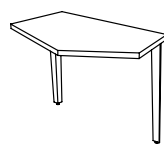
Item	Model No.		W	D	H	Ship Wt	Cubic Ft	List Price	
PENTAGON MODULAR TOPS									
Square Edge									
<i>For Use with 30"D Modular Tops:</i>									
 <p>User Side</p>	86-30MCTP	TFL	58-48 $\frac{5}{8}$	18-25	-	44	3.6	T\$ 598	
	86-30MCTPH	HPL						P\$ 809	
	85-30MCTP	Veneer						W\$ 1198	
<i>For Use with 24"D Modular Tops:</i>									
	86-24MCTP	TFL	46 $\frac{1}{3}$ -37	18-23 $\frac{1}{2}$	-	33.7	3.6	T\$ 527	
	86-24MCTPH	HPL						P\$ 714	
	85-24MCTP	Veneer						W\$ 1058	
Knife Edge									
<i>For Use with 30"D Modular Tops:</i>									
	86-30MCTPKH	HPL	58-48 $\frac{5}{8}$	18-25	-	44	3.6	P\$ 1062	
	85-30MCTPK	Veneer						W\$ 1458	
<i>For Use with 24"D Modular Tops:</i>									
	86-24MCTPKH	HPL	46 $\frac{1}{3}$ -37	18-23 $\frac{1}{2}$	-	33.7	3.6	P\$ 933	
	85-24MCTPK	Veneer						W\$ 1289	
Description									
<ul style="list-style-type: none"> • Profile on User Side Only • Not a Freestanding Unit • Legs Required (Assembly Required); See Leg Options • 24" Tops Require Set of 2 Legs; 30" Tops Require Set of 4 Legs • Pre-Drilled for Required Ganging Brackets 									
Must Specify (in this order):									
Model #									
Top Finish/Color									
Leg Model #									
Ganging Brackets									
									
Must Order Envy or Vantage Post Legs. See Leg Options.									
Specify & Add: Ganging Brackets - Requires 2 Sets									
08-1505GB	Ganging Bracket Kit - Set of 2 with Thumb Screws							\$	79

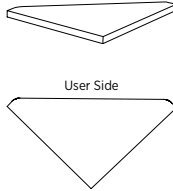
90° BRIDGE MODULAR TOPS									
Square Edge									
<i>For Use with 30"D Modular Tops:</i>									
 <p>User Side</p>	86-3090MCTB	TFL	42 $\frac{2}{5}$	30	-	18.2	2.0	T\$ 668	
	86-3090MCTBH	HPL						P\$ 902	
	85-3090MCTB	Veneer						W\$ 1335	
<i>For Use with 24"D Modular Tops:</i>									
	86-2490MCTB	TFL	34	24	-	11.6	1.3	T\$ 470	
	86-2490MCTBH	HPL						P\$ 637	
	85-2490MCTB	Veneer						W\$ 943	
Knife Edge									
<i>For Use with 30"D Modular Tops:</i>									
	86-3090MCTBKH	HPL	42 $\frac{2}{5}$	30	-	18.2	2.0	P\$ 1182	
	85-3090MCTBK	Veneer						W\$ 1629	
<i>For Use with 24"D Modular Tops:</i>									
	86-2490MCTBKH	HPL	34	24	-	11.6	1.3	P\$ 835	
	85-2490MCTBK	Veneer						W\$ 1152	
Description									
<ul style="list-style-type: none"> • Profile on User Side Only • 90° Bridge to Connect Two Table Tops • Not a Freestanding Unit • Pre-Drilled for Required Ganging Brackets 									
Specify & Add: Ganging Brackets - Requires 2 Sets									
08-1505GB	Ganging Bracket Kit - Set of 2 with Thumb Screws							\$	79

T = TFL P = HPL W = Veneer

[See Tri-One Overview For Ordering Options](#)

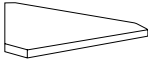
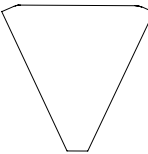
Item	Model No.		W	D	H	Ship Wt	Cubic Ft	List Price	
45° BRIDGE MODULAR TOPS									
Square Edge									
<i>For Use with 30"D Modular Tops:</i>									
	86-3045MCTB	TFL	27 ¹ / ₈	30	-	16.1	2.0	T\$ 483	
	86-3045MCTBH	HPL						P\$ 655	
	85-3045MCTB	Veneer						W\$ 971	
<i>For Use with 24"D Modular Tops:</i>									
	86-2445MCTB	TFL	22 ² / ₈	24	-	10.8	1.4	T\$ 432	
	86-2445MCTBH	HPL						P\$ 587	
	85-2445MCTB	Veneer						W\$ 864	
Knife Edge									
<i>For Use with 30"D Modular Tops:</i>									
	86-3045MCTBKH	HPL	27 ¹ / ₈	30	-	16.1	2.0	P\$ 859	
	85-3045MCTBK	Veneer						W\$ 1182	
<i>For Use with 24"D Modular Tops:</i>									
	86-2445MCTBKH	HPL	22 ² / ₈	24	-	10.8	1.4	P\$ 767	
	85-2445MCTBK	Veneer						W\$ 1057	
Description									
<ul style="list-style-type: none"> • Profile on User Side Only • 45° Bridge to Connect Two Table Tops • Not a Freestanding Unit • Pre-Drilled for Required Ganging Brackets 									
Specify & Add: Ganging Brackets - Requires 2 Sets									
	08-1505GB	Ganging Bracket Kit - Set of 2 with Thumb Screws							\$ 79

Must Specify (in this order):

- Model #
- Top Finish/Color
- Ganging Brackets

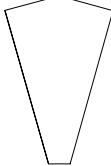
Item	Model No.		W	D	H	Ship Wt	Cubic Ft	List Price	
30° BRIDGE MODULAR TOPS									
Square Edge									
<i>For Use with 30"D Modular Tops:</i>									
	86-3030MCTB	TFL	19 ³ / ₄	30	-	11.4	1.5	T\$ 454	
	86-3030MCTBH	HPL						P\$ 614	
	85-3030MCTB	Veneer						W\$ 907	
<i>For Use with 24"D Modular Tops:</i>									
	86-2430MCTB	TFL	16 ² / ₃	24	-	8.6	1.1	T\$ 413	
	86-2430MCTBH	HPL						P\$ 637	
	85-2430MCTB	Veneer						W\$ 821	
Knife Edge									
<i>For Use with 30"D Modular Tops:</i>									
	86-3030MCTBKH	HPL	19 ³ / ₄	30	-	11.4	1.5	P\$ 805	
	85-3030MCTBK	Veneer						W\$ 1106	
<i>For Use with 24"D Modular Tops:</i>									
	86-2430MCTBKH	HPL	16 ² / ₃	24	-	8.6	1.1	P\$ 730	
	85-2430MCTBK	Veneer						W\$ 1002	
Description									
<ul style="list-style-type: none"> • Profile on User Side Only • 30° Bridge to Connect Two Table Tops • Not a Freestanding Unit • Pre-Drilled for Required Ganging Brackets 									
Specify & Add: Ganging Brackets - Requires 2 Sets									
	08-1505GB	Ganging Bracket Kit - Set of 2 with Thumb Screws							\$ 79

Must Specify (in this order):

- Model #
- Top Finish/Color
- Ganging Brackets

T = TFL P = HPL W = Veneer

[See Tri-One Overview For Ordering Options](#)

Item	Model No.	Ship Wt	Cubic Ft	List Price
ENVY POST LEG FOR MODULAR TOPS 	08-0227APL2 <i>Set of 2: For Use with 24" Pentagon Modular Tops Only</i>	10	0.8	\$ 481
	08-0227APL4 <i>Set of 4</i>	20	1.6	\$ 835

Description

- Available in Aluminum
- Each Leg has Adjustable Glides
- Must Specify with Modular Top; Legs Are Not Available To Be Sold Separately

VANTAGE POST LEG FOR MODULAR TOPS 	08-0227SPL2 <i>Set of 2: For Use with 24" Pentagon Modular Tops Only</i>	10	0.8	\$ 399
	08-0227SPL4 <i>Set of 4</i>	20	1.6	\$ 675

Description

- Available in Aluminum
- Each Leg has Adjustable Glides
- Must Specify with Modular Top; Legs Are Not Available To Be Sold Separately

GANGING BRACKET FOR MODULAR TOPS 	08-1505GB <i>Set of 2 with Thumb Screws</i>	2	0.5	\$ 79
---	--	---	-----	-------

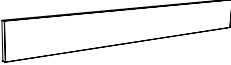
FIXED MODESTY PANEL FOR RECTANGULAR MODULAR TOPS  <small>Must Specify (in this order): Model # Finish/Color</small>	For 84"W TOPS			
	86-0884MD	TFL		T\$ 489
	86-0884MDH	HPL		P\$ 668
	85-0884MD	Veneer		W\$ 987
	For 72"W TOPS			
	86-0872MD	TFL		T\$ 478
	86-0872MDH	HPL		P\$ 647
	85-0872MD	Veneer		W\$ 958
	For 60"W Tops			
	86-0860MD	TFL		T\$ 452
	86-0860MDH	HPL		P\$ 608
	85-0860MD	Veneer		W\$ 902
	For 48"W Tops			
	86-0848MD	TFL		T\$ 436
	86-0848MDH	HPL		P\$ 591
85-0848MD	Veneer		W\$ 872	

Description

- Modesty Panels are 8"H
- Must Specify Color; See [HPL/TFL Colors](#) and [Veneer Finishes](#)

T = TFL P = HPL W = Veneer

[See Tri-One Overview For Ordering Options](#)

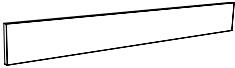
Item	Model No.	Ship Wt	Cubic Ft	List Price
FIXED MODESTY PANEL FOR RECTANGULAR MODULAR TOPS WITH FLEXIBLE SIZES  Must Specify (in this order): Model # Finish/Color	For 84"-73"W TOPS			
	86-FLEXMD84	TFL		T\$ 489
	86-FLEXMDH84	HPL		P\$ 668
	85-FLEXMD84	Veneer		W\$ 987
	For 72"-61"W TOPS			
	86-FLEXMD72	TFL		T\$ 478
	86-FLEXMDH72	HPL		P\$ 647
	85-FLEXMD72	Veneer		W\$ 958
	For 60"-49"W Tops			
	86-FLEXMD60	TFL		T\$ 452
	86-FLEXMDH60	HPL		P\$ 608
	85-FLEXMD60	Veneer		W\$ 902
	For 48"-36"W Tops			
	86-FLEXMD48	TFL		T\$ 436
	86-FLEXMDH48	HPL		P\$ 591
85-FLEXMD48	Veneer		W\$ 872	

Description

- Modesty Panels are 8"H
- Must Specify Color; See [HPL/TFL Colors](#) and [Veneer Finishes](#)

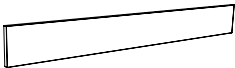
FIXED MODESTY PANEL FOR LEFT & RIGHT TRAPEZOID MODULAR TOPS  Must Specify (in this order): Model # Finish/Color	For 30"D TRAPEZOID TOPS			
	For 84"W TOPS			
	86-0884MDT30	TFL		T\$ 520
	86-0884MDTH30	HPL		P\$ 701
	85-0884MDT30	Veneer		W\$ 1039
	For 72"W TOPS			
	86-0872MDT30	TFL		T\$ 469
	86-0872MDTH30	HPL		P\$ 636
	85-0872MDT30	Veneer		W\$ 941
	For 60"W Tops			
	86-0860MDT30	TFL		T\$ 440
	86-0860MDTH30	HPL		P\$ 598
	85-0860MDT30	Veneer		W\$ 886
	For 48"W Tops			
	86-0848MDT30	TFL		T\$ 416
	86-0848MDTH30	HPL		P\$ 561
	85-0848MDT30	Veneer		W\$ 832
	For 24"D TRAPEZOID TOPS			
	For 84"W TOPS			
	86-0884MDT24	TFL		T\$ 509
	86-0884MDTH24	HPL		P\$ 690
	85-0884MDT24	Veneer		W\$ 1020
	For 72"W TOPS			
	86-0872MDT24	TFL		T\$ 458
	86-0872MDTH24	HPL		P\$ 620
	85-0872MDT24	Veneer		W\$ 917
	For 60"W Tops			
86-0860MDT24	TFL		T\$ 432	
86-0860MDTH24	HPL		P\$ 587	
85-0860MDT24	Veneer		W\$ 864	
For 48"W Tops				
86-0848MDT24	TFL		T\$ 402	
86-0848MDTH24	HPL		P\$ 550	
85-0848MDT24	Veneer		W\$ 814	

Description

- Modesty Panels are 8"H
- Must Specify Color; See [HPL/TFL Colors](#) and [Veneer Finishes](#)

T = TFL P = HPL W = Veneer

[See Tri-One Overview For Ordering Options](#)

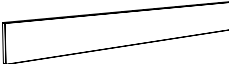
Item	Model No.	Ship Wt	Cubic Ft	List Price
FIXED MODESTY PANEL FOR LEFT & RIGHT TRAPEZOID MODULAR TOPS WITH FLEXIBLE SIZES 	For 30"D TRAPEZOID TOPS			
	For 84"W-73"W TOPS			
	86-FLEXMDTRP3084	TFL		T\$ 520
	86-FLEXMDTRP30H84	HPL		P\$ 701
	85-FLEXMDTRP3084	Veneer		W\$ 1039
	For 72"W-61"W TOPS			
	86-FLEXMDTRP3072	TFL		T\$ 469
	86-FLEXMDTRP30H72	HPL		P\$ 636
	85-FLEXMDTRP3072	Veneer		W\$ 941
	For 60"W-49"W Tops			
	86-FLEXMDTRP3060	TFL		T\$ 440
	86-FLEXMDTRP30H60	HPL		P\$ 598
	85-FLEXMDTRP3060	Veneer		W\$ 886
	For 48"W-36"W Tops			
	86-FLEXMDTRP3048	TFL		T\$ 416
	86-FLEXMDTRP30H48	HPL		P\$ 561
	85-FLEXMDTRP3048	Veneer		W\$ 832
	For 24"D TRAPEZOID TOPS			
	For 84"W-73"W TOPS			
	86-FLEXMDTRP2484	TFL		T\$ 509
	86-FLEXMDTRP24H84	HPL		P\$ 690
	85-FLEXMDTRP2484	Veneer		W\$ 1020
	For 72"W-61"W TOPS			
	86-FLEXMDTRP2472	TFL		T\$ 458
	86-FLEXMDTRP24H72	HPL		P\$ 620
	85-FLEXMDTRP2472	Veneer		W\$ 917
	For 60"W-49"W Tops			
	86-FLEXMDTRP2460	TFL		T\$ 432
	86-FLEXMDTRP24H60	HPL		P\$ 587
	85-FLEXMDTRP2460	Veneer		W\$ 864
For 48"W-36"W Tops				
86-FLEXMDTRP2448	TFL		T\$ 402	
86-FLEXMDTRP24H48	HPL		P\$ 550	
85-FLEXMDTRP2448	Veneer		W\$ 814	

Must Specify (in this order):

Model #
Finish/Color

Description

- Modesty Panels are 8"H
- Must Specify Color; See [HPL/TFL Colors](#) and [Veneer Finishes](#)

T = TFL P = HPL W = Veneer

[See Tri-One Overview For Ordering Options](#)

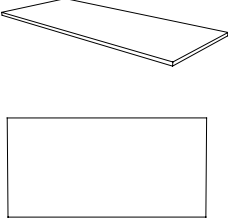
Item	Model No.		Kneespace	W	D	H	Ship Wt	Cubic Ft	List Price
RECTANGULAR MEETING TOPS									
Square Edge									
	86-4296MT	TFL	55	96	42	-	122.2	9.4	T\$ 1127
	86-4296MTH	HPL							P\$ 1527
	85-4296MT	Veneer							W\$ 2262
	86-4284MT	TFL	47	84	42	-	106.9	8.2	T\$ 1059
	86-4284MTH	HPL							P\$ 1435
	85-4284MT	Veneer							W\$ 2122
	86-4272MT	TFL	39	72	42	-	91.7	7.1	T\$ 941
	86-4272MTH	HPL							P\$ 1274
	85-4272MT	Veneer							W\$ 1886
	86-4260MT	TFL	31½	60	42	-	76.4	5.7	T\$ 862
	86-4260MTH	HPL							P\$ 1169
	85-4260MT	Veneer							W\$ 1731
	86-3696MT	TFL	55	96	36	-	104.8	8.1	T\$ 1018
	86-3696MTH	HPL							P\$ 1377
	85-3696MT	Veneer							W\$ 2042
	86-3684MT	TFL	47	84	36	-	92	7.1	T\$ 947
	86-3684MTH	HPL							P\$ 1283
	85-3684MT	Veneer							W\$ 1899
86-3672MT	TFL	39	72	36	-	78.6	6.1	T\$ 861	
86-3672MTH	HPL							P\$ 1166	
85-3672MT	Veneer							W\$ 1728	
86-3660MT	TFL	31½	60	36	-	65.5	5.1	T\$ 790	
86-3660MTH	HPL							P\$ 1072	
85-3660MT	Veneer							W\$ 1589	
Knife Edge									
86-4296MTKH	HPL	55	96	42	-	122.2	9.4	P\$ 2001	
85-4296MTK	Veneer							W\$ 2758	
86-4284MTKH	HPL	47	84	42	-	106.9	8.2	P\$ 1878	
85-4284MTK	Veneer							W\$ 2588	
86-4272MTKH	HPL	39	72	42	-	91.7	7.1	P\$ 1671	
85-4272MTK	Veneer							W\$ 2302	
86-4260MTKH	HPL	31½	60	42	-	76.4	5.7	P\$ 1533	
85-4260MTK	Veneer							W\$ 2108	
86-3696MTKH	HPL	55	96	36	-	104.8	8.1	P\$ 1806	
85-3696MTK	Veneer							W\$ 2490	
86-3684MTKH	HPL	47	84	36	-	92	7.1	P\$ 1677	
85-3684MTK	Veneer							W\$ 2318	
86-3672MTKH	HPL	39	72	36	-	78.6	6.1	P\$ 1531	
85-3672MTK	Veneer							W\$ 2107	
86-3660MTKH	HPL	31½	60	36	-	65.5	5.1	P\$ 1406	
85-3660MTK	Veneer							W\$ 1936	

Must Specify (in this order):
 Model #
 Top Finish/Color
 Leg Model # and Color (if applicable)
 Grommet/Power/Data Location





Must Order X-Base or Y-Base Separately [See Base/Leg Options.](#)

Description

- Profiled on All Four Sides
- Seated Height Base/Legs Required (Assembly Required); Sold Separately, [See Base/Legs Options](#)
- Power & Data Options Available; Sold Separately, [See Multiple Units](#) and [See Locations](#)

T = TFL P = HPL W = Veneer

[See Tri-One Overview For Ordering Options](#)

Item	Model No.		Kneespace	W	D	H	Ship Wt	Cubic Ft	List Price
SOFT RECTANGULAR MEETING TOPS									
Square Edge									
 	86-4296SMT	TFL	55	96	42	-	122.2	9.4	T\$ 1089
	86-4296SMTH	HPL							P\$ 1475
	85-4296SMT	Veneer							W\$ 2184
	86-4284SMT	TFL	47	84	42	-	106.9	8.2	T\$ 1025
	86-4284SMTH	HPL							P\$ 1387
	85-4284SMT	Veneer							W\$ 2054
	86-4272SMT	TFL	39	72	42	-	91.7	7.1	T\$ 908
	86-4272SMTH	HPL							P\$ 1234
	85-4272SMT	Veneer							W\$ 1825
	86-4260SMT	TFL	31½	60	42	-	76.4	5.7	T\$ 836
	86-4260SMTH	HPL							P\$ 1133
	85-4260SMT	Veneer							W\$ 1676
	86-3696SMT	TFL	55	96	36	-	104.8	8.1	T\$ 981
	86-3696SMTH	HPL							P\$ 1332
	85-3696SMT	Veneer							W\$ 1966
	86-3684SMT	TFL	47	84	36	-	92	7.1	T\$ 915
	86-3684SMTH	HPL							P\$ 1238
	85-3684SMT	Veneer							W\$ 1834
86-3672SMT	TFL	39	72	36	-	78.6	6.1	T\$ 834	
86-3672SMTH	HPL							P\$ 1129	
85-3672SMT	Veneer							W\$ 1672	
86-3660SMT	TFL	31½	60	36	-	65.5	5.1	T\$ 768	
86-3660SMTH	HPL							P\$ 1039	
85-3660SMT	Veneer							W\$ 1541	
Knife Edge									
	86-4296SMTKH	HPL	55	96	42	-	122.2	9.4	P\$ 1933
	85-4296SMTK	Veneer							W\$ 2663
	86-4284SMTKH	HPL	47	84	42	-	106.9	8.2	P\$ 1819
	85-4284SMTK	Veneer							W\$ 2506
	86-4272SMTKH	HPL	39	72	42	-	91.7	7.1	P\$ 1618
	85-4272SMTK	Veneer							W\$ 2225
	86-4260SMTKH	HPL	31½	60	42	-	76.4	5.7	P\$ 1485
	85-4260SMTK	Veneer							W\$ 2048
	86-3696SMTKH	HPL	55	96	36	-	104.8	8.1	P\$ 1742
	85-3696SMTK	Veneer							W\$ 2396
	86-3684SMTKH	HPL	47	84	36	-	92	7.1	P\$ 1623
	85-3684SMTK	Veneer							W\$ 2236
	86-3672SMTKH	HPL	39	72	36	-	78.6	6.1	P\$ 1478
	85-3672SMTK	Veneer							W\$ 2040
	86-3660SMTKH	HPL	31½	60	36	-	65.5	5.1	P\$ 1364
	85-3660SMTK	Veneer							W\$ 1878

Must Specify (in this order):
 Model #
 Top Finish/Color
 Leg Model # and Color (if applicable)
 Grommet/Power/Data Location

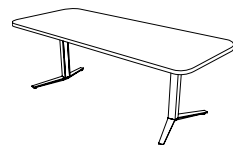

Must Order X-Base or Y-Base Separately [See Base/Leg Options.](#)

Description

- Profiled on All Four Sides
- Seated Height Base/Legs Required (Assembly Required); Sold Separately, [See Base/Legs Options](#)
- Power & Data Options Available; Sold Separately, [See Multiple Units](#) and [See Locations](#)

T = TFL P = HPL W = Veneer

[See Tri-One Overview For Ordering Options](#)

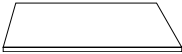
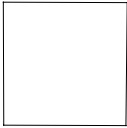
Item	Model No.		W	D	H	Ship Wt	Cubic Ft	List Price	
SQUARE MEETING TOPS		Square Edge							
	86-4242SQ	TFL	42	42	-	70	3.3	T\$ 663	
	86-4242SQH	HPL						P\$ 897	
	85-4242SQ	Veneer						W\$ 1327	
	86-3636SQ	TFL	36	36	-	37	2.5	T\$ 563	
	86-3636SQH	HPL						P\$ 767	
	85-3636SQ	Veneer						W\$ 1133	
	86-3030SQ	TFL	30	30	-	30	2.2	T\$ 497	
	86-3030SQH	HPL						P\$ 674	
	85-3030SQ	Veneer						W\$ 994	

Must Specify (in this order):

- Model #
- Top Finish/Color
- Leg Model # and Color (if applicable)



Must Order X-Base Separately.
[See Base/Leg Options.](#)

		Knife Edge							
	86-4242SQKH	HPL	42	42	-	70	3.3	P\$ 1172	
	85-4242SQQ	Veneer						W\$ 1620	
	86-3636SQKH	HPL	36	36	-	37	2.5	P\$ 1002	
	85-3636SQQ	Veneer						W\$ 1381	
	86-3030SQKH	HPL	30	30	-	30	2.2	P\$ 883	
	85-3030SQQ	Veneer						W\$ 1213	

Description

- Profiled on All Four Sides
- Base/Legs Required (Assembly Required); Sold Separately, [See Base/Legs Options](#)

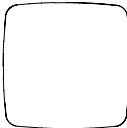
SOFT SQUARE MEETING TOPS		Square Edge							
	86-4242SSQ	TFL	42	42	-	70	3.3	T\$ 640	
	86-4242SSQH	HPL						P\$ 865	
	85-4242SSQ	Veneer						W\$ 1327	
	86-3636SSQ	TFL	36	36	-	37	2.5	T\$ 550	
	86-3636SSQH	HPL						P\$ 742	
	85-3636SSQ	Veneer						W\$ 1100	
	86-3030SSQ	TFL	30	30	-	30	2.2	T\$ 484	
	86-3030SSQH	HPL						P\$ 657	
	85-3030SSQ	Veneer						W\$ 975	

Must Specify (in this order):

- Model #
- Top Finish/Color
- Leg Model # and Color (if applicable)





Must Order X-Base Separately.
[See Base/Leg Options.](#)

		Knife Edge							
	86-4242SSQKH	HPL	42	42	-	70	3.3	P\$ 1134	
	85-4242SSQQ	Veneer						W\$ 1565	
	86-3636SSQKH	HPL	36	36	-	37	2.5	P\$ 974	
	85-3636SSQQ	Veneer						W\$ 1342	
	86-3030SSQKH	HPL	30	30	-	30	2.2	P\$ 862	
	85-3030SSQQ	Veneer						W\$ 1190	

Description

- Profiled on All Four Sides
- Base/Legs Required (Assembly Required); Sold Separately, [See Base/Legs Options](#)

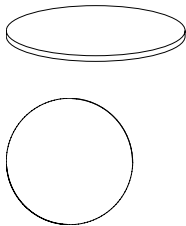
T = TFL P = HPL W = Veneer



Item	Model No.		W	D	H	Ship Wt	Cubic Ft	List Price	
ROUND MEETING TOPS		Square Edge							
	86-4848CT	TFL	48	48	-	95	4.3	T\$ 716	
	86-4848CTH	HPL						P\$ 971	
	85-4848CT	Veneer						W\$ 1436	
	86-4242CT	TFL	42	42	-	70	3.3	T\$ 621	
	86-4242CTH	HPL						P\$ 843	
	85-4242CT	Veneer						W\$ 1246	
	86-3636CT	TFL	36	36	-	37	2.5	T\$ 544	
	86-3636CTH	HPL						P\$ 736	
	85-3636CT	Veneer						W\$ 1090	
	86-3030CT	TFL	30	30	-	30	2.2	T\$ 481	
86-3030CTH	HPL						P\$ 650		
85-3030CT	Veneer						W\$ 963		
		Knife Edge							
	86-4848CTKH	HPL	48	48	-	95	4.3	P\$ 1271	
	85-4848CTK	Veneer						W\$ 1751	
	86-4242CTKH	HPL	42	42	-	70	3.3	P\$ 1103	
	85-4242CTK	Veneer						W\$ 1520	
	86-3636CTKH	HPL	36	36	-	37	2.5	P\$ 965	
	85-3636CTK	Veneer						W\$ 1331	
	86-3030CTKH	HPL	30	30	-	30	2.2	P\$ 853	
	85-3030CTK	Veneer						W\$ 1174	

Must Specify (in this order):
 Model #
 Top Finish/Color
 Leg Model # and Color (if applicable)

Must Order X-Base Separately. [See Base/Leg Options.](#)

Description

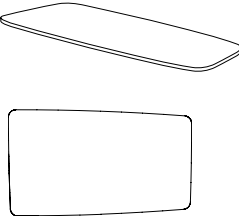
- Profiled on All Sides
- Base/Legs Required (Assembly Required); Sold Separately, [See Base/Leg Options](#)

Item	Model No.		W	D	H	Ship Wt	Cubic Ft	List Price	
SOFT VIEW MEETING TOPS		Square Edge							
	86-4296SVT	TFL	96	42-36	-	122.2	9.4	T\$ 1084	
	86-4296SVTH	HPL						P\$ 1466	
	85-4296SVT	Veneer						W\$ 2171	
	86-4284SVT	TFL	84	42-36	-	106.9	8.2	T\$ 980	
	86-4284SVTH	HPL						P\$ 1327	
	85-4284SVT	Veneer						W\$ 1965	
	86-4272SVT	TFL	72	42-36	-	91.7	7.1	T\$ 907	
	86-4272SVTH	HPL						P\$ 1233	
	85-4272SVT	Veneer						W\$ 1823	
			Knife Edge						
	86-4296SVTKH	HPL	96	42-36	-	122.2	9.4	P\$ 1922	
	85-4296SVTK	Veneer						W\$ 2650	
	86-4284SVTKH	HPL	84	42-36	-	106.9	8.2	P\$ 1737	
	85-4284SVTK	Veneer						W\$ 2395	
	86-4272SVTKH	HPL	72	42-36	-	91.7	7.1	P\$ 1615	
	85-4272SVTK	Veneer						W\$ 2224	

Must Specify (in this order):
 Model #
 Top Finish/Color
 Leg Model # and Color (if applicable)
 Grommet/Power/Data Location

Must Order X-Base Separately. [See Base/Leg Options.](#)

Description

- Profiled on All Four Sides
- Base/Legs Required (Assembly Required); Sold Separately, [See Base/Leg Options](#)
- Power & Data Options Available; Sold Separately, [See Multiple Units](#) and [See Locations](#)

T = TFL P = HPL W = Veneer

[See Tri-One Overview For Ordering Options](#)

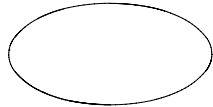
Item	Model No.		W	D	H	Ship Wt	Cubic Ft	List Price
ELLIPSE MEETING TOPS								
Square Edge								
	86-4284EMT	TFL	84	42	-	106.9	8.2	T\$ 1017
	86-4284EMTH	HPL						P\$ 1375
	85-4284EMT	Veneer						W\$ 2037
	86-3672EMT	TFL	72	36	-	78.6	6.1	T\$ 824
	86-3672EMTH	HPL						P\$ 1119
	85-3672EMT	Veneer						W\$ 1656
Knife Edge								
	86-4284EMTKH	HPL	84	42	-	106.9	8.2	P\$ 1801
	85-4284EMTK	Veneer						W\$ 2481
	86-3672EMTKH	HPL	72	36	-	78.6	6.1	P\$ 1464
	85-3672EMTK	Veneer						W\$ 2018

Must Specify (in this order):
 Model #
 Top Finish/Color
 Leg Model #
 Grommet/Power/Data Location

Description

- Includes Stiffener Bar for Additional Support
- Profiled on All Four Sides
- Legs Required (Assembly Required); Sold Separately, See Below
- Power & Data Options Available; Sold Separately, [See Multiple Units](#) and [See Locations](#)

Specify & Add: Your Choice Of Legs

08-0227APL4	Envy Post Leg (Set of 4)		20	1.6		\$ 835
	<ul style="list-style-type: none"> • Available in Aluminum • Each Leg has Adjustable Glides • Legs Are Not Available To Be Sold Separately 					
08-0227SPL4	Vantage Post Leg (Set of 4)		20	1.6		\$ 675
	<ul style="list-style-type: none"> • Available in Aluminum • Each Leg has Adjustable Glides • Legs Are Not Available To Be Sold Separately 					

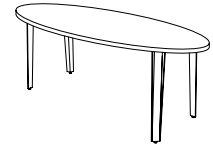

Must Order Envy or Vantage Post Legs.

T = TFL P = HPL W = Veneer

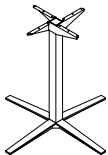
Item	Model No.	Ship Wt	Cubic Ft	List Price
	Large X-Base: For Use with 42"D and 48"D Tops			
	08-2642LXBA	33	20.0	\$ 1277
	<i>For 42"H Tables; Square, Soft Square, and Round Tops Only</i>			
	08-2636LXBA	30	17.2	\$ 1232
	<i>For 36"H Tables; Square, Soft Square, and Round Tops Only</i>			
	08-2630LXBA	27	14.5	\$ 1178
	<i>For 30"H Tables</i>			
	Small X-Base: For Use with 30"D and 36"D Tops			
	08-2042SXBA	27	15.9	\$ 1193
<i>For 42"H Tables; Square, Soft Square, and Round Tops Only</i>				
08-2036SXBA	24	13.7	\$ 1145	
<i>For 36"H Tables; Square, Soft Square, and Round Tops Only</i>				
08-2030SXBA	21	11.6	\$ 1100	
<i>For 30"H Tables</i>				

Description

- Available in Aluminum
- Square, Soft Square, and Round Tops Require One (1) Base; All Other Meeting Tops Require Two (2) Seated Height (30"H) Bases
- Bases Are Not Available To Be Sold Separately

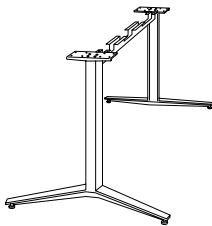

	08-2828YLG96	47	6.5	\$ 1677
	<i>For Use with 96"W Meeting Tops</i>			
	08-2828YLG84	43	5.4	\$ 1655
	<i>For Use with 84"W Meeting Tops</i>			
	08-2828YLG72	39	4.3	\$ 1619
<i>For Use with 72"W Meeting Tops</i>				
08-2828YLG60	35	3.2	\$ 1553	
<i>For Use with 60"W Meeting Tops</i>				

Description

- Available in Aluminum
- Y-Base Includes Trough with Removable Panels for Wire Management
- Bases Are Not Available To Be Sold Separately

T = TFL P = HPL W = Veneer

[See Tri-One Overview For Ordering Options](#)

Item	Model No.	Kneespace	W	D	H	Ship Wt	Cubic Ft	List Price
RECTANGULAR TRAINING TOPS								
Square Edge								
 <p>User Side</p> 	86-3072TT	65½	72	30	-	75.5	5.2	T\$ 712
	86-3072TTH							P\$ 963
	86-3060TT	53¾	60	30	-	64.6	4.3	T\$ 634
	86-3060TTH							P\$ 859
	86-3048TT	41½	48	30	-	53.7	3.5	T\$ 578
	86-3048TTH							P\$ 783
	86-2472TT	65½	72	24	-	62.4	4.2	T\$ 648
	86-2472TTH							P\$ 883
	86-2460TT	53¾	60	24	-	53.7	3.5	T\$ 585
	86-2460TTH							P\$ 787
	86-2448TT	41½	48	24	-	44.9	2.8	T\$ 535
	86-2448TTH							P\$ 724
	86-1872TT	65½	72	18	-	49.3	3.2	T\$ 587
	86-1872TTH							P\$ 791
	86-1860TT	53¾	60	18	-	43.7	2.7	T\$ 528
	86-1860TTH							P\$ 716
	86-1848TT	41½	48	18	-	36.2	2.2	T\$ 488
	86-1848TTH							P\$ 667
Knife Edge								
	86-3072TTKH	65½	72	30	-	75.5	5.2	P\$ 1263
	86-3060TTKH	53¾	60	30	-	64.6	4.3	P\$ 1126
	86-3048TTKH	41½	48	30	-	53.7	3.5	P\$ 1025
	86-2472TTKH	65½	72	24	-	62.4	4.2	P\$ 1155
	86-2460TTKH	53¾	60	24	-	53.7	3.5	P\$ 1034
	86-2448TTKH	41½	48	24	-	44.9	2.8	P\$ 949
	86-1872TTKH	65½	72	18	-	49.3	3.2	P\$ 1039
	86-1860TTKH	53¾	60	18	-	42.7	2.7	P\$ 936
	86-1848TTKH	41½	48	18	-	36.2	2.2	P\$ 870

Must Specify (in this order):

- Model #
- Top Finish/Color
- Leg Model #
- Ganging Model #
- Nesting Model #
- Grommet/Power/Data Location

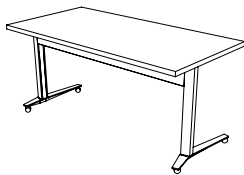

Must Order Envy C-Leg or Vantage T-Leg Base. See [Envy Details](#) and [Vantage Details](#).

Description

- Profile on User Side Only
- Legs Required (Assembly Required); Sold Separately, See [Envy](#) and [Vantage](#) Details
- Leg Assemblies available with Glides or Casters
- 18"D Tops Available with Envy C-Leg Base Only
- Pre-Drilled for Optional Ganging Brackets, See Below
- Optional Flip Mechanism for Nesting is Available, See Below
- Modesty Panel Standard on Envy C-Leg Base and Optional on Vantage T-Leg Base; Sold Separately, See [Envy C-Leg Base Details](#) and [Vantage T-Leg Base Details](#)
- Power & Data Options Available; Sold Separately, [See Multiple Units](#) and [See Locations](#)

Options: Specify & Add

GANGING

08-1505GB	Ganging Bracket Kit	\$ 79
	<ul style="list-style-type: none"> • Set of 2 with Thumb Screws • Tops Are Pre-Drilled 	

NESTING

08-FLIP	Flip Mechanism for Nesting (Factory Installed)	\$ 486
---------	--	--------

T = TFL P = HPL W = Veneer

[See Tri-One Overview For Ordering Options](#)

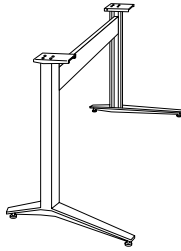
Item	Model No.	Ship Wt	Cubic Ft	List Price
ENVY C-LEG BASE ASSEMBLY FOR TRAINING TOPS 	Large C-Leg Base Assembly: For Use with 24"D and 30"D Tops			
	With Casters: Also Specify Soft Wheel (SOFT) or Hard Wheel (CAST)			
	08-2428CLC72 For 72"W Tops	40	4.3	\$ 1488
	08-2428CLC60 For 60"W Tops	36	3.2	\$ 1433
	08-2428CLC48 For 48"W Tops	32	2.9	\$ 1385
	With Glides:			
	08-2428CLG72 For 72"W Tops	39	4.3	\$ 1358
	08-2428CLG60 For 60"W Tops	35	3.2	\$ 1305
	08-2428CLG48 For 48"W Tops	31	2.9	\$ 1258
	Small C-Leg Base Assembly: For Use with 18"D Tops			
	With Casters: Also Specify Soft Wheel (SOFT) or Hard Wheel (CAST)			
	08-1828CLC72 For 72"W Tops	36	4.3	\$ 1369
	08-1828CLC60 For 60"W Tops	32	3.2	\$ 1316
	08-1828CLC48 For 48"W Tops	28	2.9	\$ 1267
	With Glides:			
08-1828CLG72 For 72"W Tops	35	4.3	\$ 1240	
08-1828CLG60 For 60"W Tops	31	3.2	\$ 1189	
08-1828CLG48 For 48"W Tops	27	2.9	\$ 1139	

Must Specify (in this order):

Model #

Caster Type (if applicable)

Description

- Available in Aluminum
- Includes Trough/Modesty
- Legs Feature Removable Panel for Wire Management
- When Casters are Specified, Must Choose Soft Wheel (SOFT) or Hard Wheel (Hard)
- Caster Option Features Two Locking Casters and Two Non-Locking Casters
- Bases Are Not Available To Be Sold Separately

T = TFL P = HPL W = Veneer

[See Tri-One Overview For Ordering Options](#)

Item	Model No.	Ship Wt	Cubic Ft	List Price
------	-----------	---------	----------	------------

VANTAGE T-LEG BASE ASSEMBLY FOR TRAINING TOPS

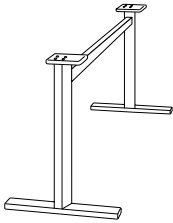

Must Specify (in this order):

- Model #
- Caster Type (if applicable)
- Optional Modesty
- Optional Modesty Color

Large T-Leg Base Assembly: For Use with 24"D and 30"D Tops

With Casters: Also Specify Soft Wheel (SOFT) or Hard Wheel (CAST)

08-2428TLC72	36	4.3	\$ 713
For 72"W Tops			

08-2428TLC60	32	3.2	\$ 681
For 60"W Tops			

08-2428TLC48	28	2.9	\$ 653
For 48"W Tops			

With Glides:

08-2428TLG72	35	4.3	\$ 684
For 72"W Tops			

08-2428TLG60	31	3.2	\$ 653
For 60"W Tops			

08-2428TLG48	27	2.9	\$ 629
For 48"W Tops			

Description

- Available in Aluminum
- Not Available for Use on 18"D Tops
- Includes Stretcher Rail
- When Casters are Specified, Must Choose Soft Wheel (SOFT) or Hard Wheel (Hard)
- Caster Option Features Two Locking Casters and Two Non-Locking Casters
- Optional 12"H Modesty Panel, See Below
- Bases Are Not Available To Be Sold Separately

Optional Modesty Panels: Specify & Add

FIXED MODESTY: Used on Standard, Non-Nesting Tables

86-0872MD	TFL	For 72"W Tops	T\$ 478
86-0872MDH	HPL		P\$ 647
86-0860MD	TFL	For 60"W Tops	T\$ 452
86-0860MDH	HPL		P\$ 608
86-0848MD	TFL	For 48" Tops	T\$ 436
86-0848MDH	HPL		P\$ 591

HINGED MODESTY: Used on Nesting Tables with Flip Mechanism

86-0865HMD	TFL	For 72"W Tops	T\$ 478
86-0865HMDH	HPL		P\$ 647
86-0853HMD	TFL	For 60"W Tops	T\$ 453
86-0853HMDH	HPL		P\$ 613
86-0841HMD	TFL	For 48" Tops	T\$ 438
86-0841HMDH	HPL		P\$ 595

T = TFL P = HPL W = Veneer

[See Tri-One Overview For Ordering Options](#)

Item	Model No.		W	D	H	Ship Wt	Cubic Ft	List Price
------	-----------	--	---	---	---	---------	----------	------------

ROUND GROMMET COVER

01-GRMTB	Black	2 $\frac{3}{8}$	2 $\frac{3}{8}$	-	1	0.1	\$ 11
01-GRMTSL	Silver						



OPEN MARKET ONLY
(SILVER)

Description

- 2 $\frac{3}{8}$ " (60mm) Round Grommet Cover
- Field Installed

SINGLE POWER SAND DOLLAR

01-SAND60PW	White	3	3	4	1	0.2	\$ 95
01-SAND60PB	Black						
01-SAND60PS	Silver						

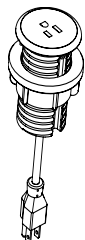
Description

- Unit is 2 $\frac{3}{8}$ " Diameter; Mounts in 60mm Round Grommet
- 6' Cord
- Single Power Outlet

DOUBLE USB SAND DOLLAR

01-SAND60UW	White	3	3	4	1	0.2	\$ 268
01-SAND60UB	Black						
01-SAND60US	Silver						

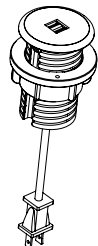
Description

- Unit is 2 $\frac{3}{8}$ " Diameter; Mounts in 60mm Round Grommet
- 6' Cord
- Dual USB Outlets

WIRE MANAGEMENT CHANNEL

01-WMGR4		16	1 $\frac{1}{2}$	$\frac{3}{4}$	1	-	\$ 112
----------	--	----	-----------------	---------------	---	---	--------

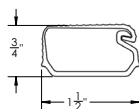
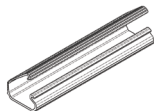
Description

- Set of Four (4) Black Plastic Wire Management Channels
- Snap Lock Channel
- Attaches with Adhesive Strips
- Ships via UPS Only

CABLE GRIP

01-WMGRCB		5 $\frac{3}{8}$	2 $\frac{3}{8}$	-	-	-	\$ 16
-----------	--	-----------------	-----------------	---	---	---	-------

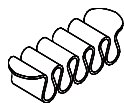
Description

- Under Surface Wire Management
- Black

[See Tri-One Overview For Ordering Options](#)

Item	Model No.		W	D	H	Ship Wt	Cubic Ft	List Price
	01-DUOUNDERW	White	6½	2½	3	1	0.2	\$ 528
	01-DUOUNDERB	Black						
	01-DUOUNDEERS	Silver						

Description

- Sits Under Table Top and Includes: Two (2) Power, Two (2) USB, 10' Cord, and All Mounting Hardware
- Independent USB Circuit Controllers Deliver up to 2.1 Amps to Each Post
- FCC Part 15A, UL Approved for Horizontal and Vertical Applications
- Works with Tri-One Modular, Meeting, and Training Tables

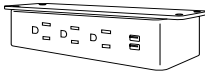
	01-TRIOUNDERW	White	9	2½	3	1	0.2	\$ 633
	01-TRIOUNDERB	Black						
	01-TRIOUNDERS	Silver						

Description

- Sits Under Table Top and Includes: Three (3), Power, Two (2) USB, One (1) Open Data, 10' Cord, and All Mounting Hardware
- HDMI, VGA, or RJ45 Accessory for Open Data Port Specified Separately, [See Data Port Options](#)
- Independent USB Circuit Controllers Deliver up to 2.1 Amps to Each Post
- FCC Part 15A, UL Approved for Horizontal and Vertical Applications
- Works with Tri-One Modular, Meeting, and Training Tables

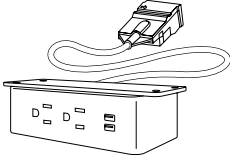
	01-PDUOUNDERW	White	6½	2½	3	1	0.2	\$ 521
	01-PDUOUNDERB	Black						
	01-PDUOUNDEERS	Silver						

Description

- Sits Under Table Top and Includes: Two (2) Power, Two (2) USB, 12" Cord, and All Mounting Hardware
- Requires Daisy Chain Power Box, Specified Separately, [See Details](#)
- Non-Sequential System Allows up to 8 Modules to be Connected with Jumper Cord, [See Details](#)
- Independent USB Circuit Controllers Deliver up to 2.1 Amps to Each Post
- FCC Part 15A, RU Listed and UL Recognized for Horizontal Applications
- Works with Tri-One Modular, Meeting, and Training Tables

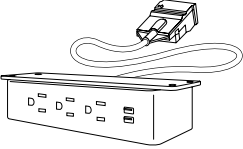
	01-PTRIOUNDERW	White	9	2½	3	1	0.2	\$ 624
	01-PTRIOUNDERB	Black						
	01-PTRIOUNDERS	Silver						

Description

- Sits Under Table Top and Includes: Three (3), Power, Two (2) USB, One (1) Open Data, 12" Cord, and All Mounting Hardware
- HDMI, VGA, or RJ45 Accessory for Open Data Port Specified Separately, [See Data Port Options](#)
- Requires Daisy Chain Power Box, Specified Separately, [See Details](#)
- Non-Sequential System Allows up to Eight (8) Modules to be Connected with Jumper Cord, [See Details](#)
- Independent USB Circuit Controllers Deliver up to 2.1 Amps to Each Post
- FCC Part 15A, RU Listed and UL Recognized for Horizontal Applications
- Works with Tri-One Modular, Meeting, and Training Tables

Item	Model No.		W	D	H	Ship Wt	Cubic Ft	List Price
DUO CLAMP NEMA PLUG	01-DUOCLAMPW	White	6½	3	7	1	0.2	\$ 553
	01-DUOCLAMPB	Black						
	01-DUOCLAMP S	Silver						

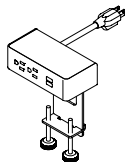

Description

- Clamps to Table Top and Includes: Two (2) Power, Two (2) USB, 10' Cord, and All Mounting Hardware
- Silver Metal Trim on All Color Options
- Independent USB Circuit Controllers Deliver up to 2.1 Amps to Each Post
- FCC Part 15A, UL Approved for Horizontal and Vertical Applications
- Works with Tri-One Modular, Meeting, and Training Tables

TRIO CLAMP NEMA PLUG	01-TRIOCLAMPW	White	9	3	7	1	0.2	\$ 648
	01-TRIOCLAMPB	Black						
	01-TRIOCLAMP S	Silver						

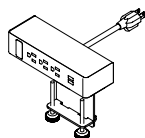

Description

- Clamps to Table Top and Includes: Three (3), Power, Two (2) USB, One (1) Open Data, 10' Cord, and All Mounting Hardware
- HDMI, VGA, or RJ45 Accessory for Open Data Port Specified Separately, [See Data Port Options](#)
- Silver Metal Trim on All Color Options
- Independent USB Circuit Controllers Deliver up to 2.1 Amps to Each Post
- FCC Part 15A, UL Approved for Horizontal and Vertical Applications
- Works with Tri-One Modular, Meeting, and Training Tables

DUO BEZEL NEMA PLUG	01-DUOBEZELW	White	6½	2½	3¼	1	0.2	\$ 652
	01-DUOBEZELB	Black						
	01-DUOBEZEL S	Silver						

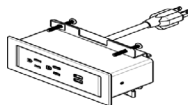

Description

- Sits on Table Top and Includes: Two (2) Power, Two (2) USB, 10' Cord, and All Mounting Hardware
- Independent USB Circuit Controllers Deliver up to 2.1 Amps to Each Post
- FCC Part 15A, UL Approved for Horizontal and Vertical Applications
- Works with Tri-One Modular, Meeting, and Training Tables

TRIO BEZEL NEMA PLUG	01-TRIOBEZELW	White	9	2½	3	1	0.2	\$ 700
	01-TRIOBEZELB	Black						
	01-TRIOBEZEL S	Silver						

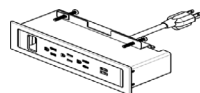

Description

- Sits on Table Top and Includes: Three (3), Power, Two (2) USB, One (1) Open Data, 10' Cord, and All Mounting Hardware
- HDMI, VGA, or RJ45 Accessory for Open Data Port Specified Separately, [See Data Port Options](#)
- Independent USB Circuit Controllers Deliver up to 2.1 Amps to Each Post
- FCC Part 15A, UL Approved for Horizontal and Vertical Applications
- Works with Tri-One Modular, Meeting, and Training Tables

[See Tri-One Overview For Ordering Options](#)

Item	Model No.		W	D	H	Ship Wt	Cubic Ft	List Price
------	-----------	--	---	---	---	---------	----------	------------

DUO BEZEL DAISY CHAIN PLUG

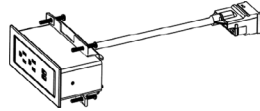

01-PDUOBEZELW	White	6½	2½	3	1	0.2	\$ 645
01-PDUOBEZELB	Black						
01-PDUOBEZELS	Silver						

Description

- Sits on Table Top and Includes: Two (2) Power, Two (2) USB, 12” Cord, and All Mounting Hardware
- Requires Daisy Chain Power Box, Specified Separately, [See Details](#)
- Non-Sequential System Allows up to 8 Modules to be Connected with Jumper Cord, [See Details](#)
- Independent USB Circuit Controllers Deliver up to 2.1 Amps to Each Post
- FCC Part 15A, RU Listed and UL Recognized for Horizontal and Vertical Applications
- Works with Tri-One Modular, Meeting, and Training Tables

TRIO BEZEL DAISY CHAIN PLUG

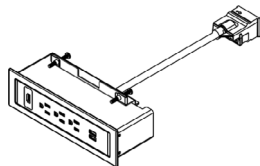

01-PTRIOBEZELW	White	9	2½	3	1	0.2	\$ 691
01-PTRIOBEZELB	Black						
01-PTRIOBEZELS	Silver						

Description

- Sits on Table Top and Includes: Three (3), Power, Two (2) USB, One (1) Open Data, 12” Cord, and All Mounting Hardware
- HDMI, VGA, or RJ45 Accessory for Open Data Port Specified Separately, See Below
- Requires Daisy Chain Power Box, Specified Separately, [See Details](#)
- Non-Sequential System Allows up to Eight (8) Modules to be Connected with Jumper Cord, [See Details](#)
- Independent USB Circuit Controllers Deliver up to 2.1 Amps to Each Post
- FCC Part 15A, RU Listed and UL Recognized for Horizontal and Vertical Applications
- Works with Tri-One Modular, Meeting, and Training Tables

HDMI DATA PORT ACCESSORY FOR TRIO UNITS

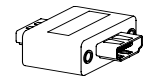

01-LCOMHDMI		-	-	-	1	0.2	\$ 160
-------------	--	---	---	---	---	-----	--------

Description

- HDMI Port for Trio Units

OPEN MARKET ONLY

VGA DATA PORT ACCESSORY FOR TRIO UNITS

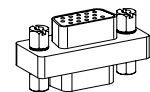

01-LCOMVGA		-	-	-	1	0.2	\$ 117
------------	--	---	---	---	---	-----	--------

Description

- VGA Port for Trio Units

RJ45 DATA PORT ACCESSORY FOR TRIO UNITS

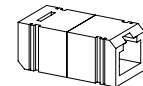

01-LCOMRJ45		-	-	-	1	0.2	\$ 76
-------------	--	---	---	---	---	-----	-------

Description

- RJ45 Port for Trio Units

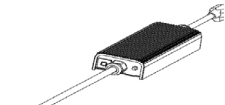
Item	Model No.	W	D	H	Ship Wt	Cubic Ft	List Price
 DAISY CHAIN POWER BOX	01-PPOWER	-	-	-	1	0.2	\$ 749
	<i>76" Perimeter, 36" Power Cord</i>						
	01-PPOWER2	-	-	-	1	0.2	\$ 769
	<i>24" Perimeter, 144" Power Cord</i>						

Description

- Powers up to Eight (8) Duo and Trio Daisy Chain Units
- One (1) Nema Plug and One (1) Daisy Chain Plug
- 12-Amp System Rating
- 15-Amp Over-Current Protection

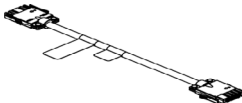
 DAISY CHAIN JUMPER CORD	01-6JUMP	<i>72" Long</i>	-	-	-	1	0.2	\$ 289
	01-5JUMP	<i>60" Long</i>	-	-	-	1	0.2	\$ 274
	01-4JUMP	<i>48" Long</i>	-	-	-	1	0.2	\$ 232
	01-2JUMP	<i>24" Long</i>	-	-	-	1	0.2	\$ 213

Description

- Connects Duo and Trio Daisy Chain Units
- Non-Sequential System Allows up to 8 Modules to be Connected

 POWER STRIP	01-PRSP		9	2	2	1	-	\$ 198
---	---------	--	---	---	---	---	---	--------

Description

- Includes Four (4) Outlets and Two (2) Phone Jacks
- Black Plastic with Rocker On/Off Switch
- 13 Amp Circuit Breaker
- 10' Power Cord and Two (2) 14' Phone Hook Up Cords
- UL and CSA Recognized
- Suitable for Surface or Recessed Mounting
- Ships via UPS Only

[See Tri-One Overview For Ordering Options](#)



Occasional Tables

SURFACE MATERIAL DIGITAL IMAGES & BROCHURE

The finishes represented on Indiana Furniture's Surface Material Finish Brochure were reproduced using the finest technology available. Samples of our finishes and laminates are available for order through our Collateral Store. Please verify your desired finish before ordering as such orders are not subject to return to Indiana Furniture.

Contact your local Indiana Furniture Sales Representative or our Customer Service team should you need assistance.

GLIDES

All tables ship with non-marring glides, some series offering leveling glides as standard. See pricing pages for each series for more information.

FINISH

Indiana Furniture standard occasional table finishes correspond to casegoods and conferencing finishes and laminates. Minor variations in finish color and value may occur due to the natural characteristics of wood. Consult this price list for specific finish availability within each series.

Special Finishes: Indiana Furniture is able to accommodate our customer's needs for specific finish matches. Please submit a 3"x5" sample panel to Customer Service for quotation and lead time.

An overview of our finishes and laminate options can be found on the inside of the back cover of this price list.

Arlington offers all the grace and embellishments associated with traditional styling with an added emphasis on value. Finely crafted in select solids with walnut and cherry veneers and high pressure laminate worksurfaces, Arlington ensures quality and expert craftsmanship with a selection of configurations for today's functional workspaces.

CONSTRUCTION

- Veneers on exposed surfaces feature select grade, plain sliced American Black Walnut or Cherry veneers, carefully selected and matched to assure proper balance and consistency
- Veneer tops have a 5-ply balanced construction, 1 3/16" thick with solid hardwood rims with butt corners
- HPL tops have a 3-ply balanced construction, 1 3/16" thick, with solid hardwood rims with butt corners
- Grain direction runs left to right
- All units ship with heavy duty, adjustable leveling glides to ensure proper leveling and compensation for uneven floors
- Some Assembly Required

HOW TO ORDER EXAMPLE

Model No.	Description	Example
29-2124ET	Top Material Finish	W CO

VENEER (W) OPTIONS

Veneer features UVAdvantage, an ultra-violet finish, on all exposed surfaces by utilizing roll-coat UV technology. Apron rails and table legs use a multi-step, hand finished process with a catalyzed finish

AW	Artisan Walnut	HW	Harvest Walnut
CO	Columbian Walnut	LW	Legacy Walnut
DC	Dark Cherry	MW	Mahogany Walnut
DFW	Dark Forest Walnut	PNW	Pinnacle Walnut
EW	Espresso	SCH	Select Cherry
GC	Golden Cherry	SKC	Shaker Cherry
HNW	Henna Walnut	WC	Williamsburg Cherry

HPL (P) TOP OPTIONS

WOODGRAIN

CO	Columbian Walnut	PNW	Pinnacle Walnut
EF	Espresso	SCH	Select Cherry
GC	Golden Cherry	SKC	Shaker Cherry
MW	Mahogany Walnut	WC	Williamsburg Cherry

TABLE EDGE PROFILE



Arlington

CERTIFICATIONS & COMPLIANCE

- Intertek Sustainability Certified
- BIFMA level® Certified
- BIFMA Compliant® Certified
- TSCA Title VI (CARB) Compliance
- US Green Building's LEED® Contribution

STATEMENT OF LINE



29-2124ET:
End Table
[\(See Details\)](#)

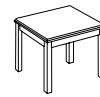

29-2424LT:
Lamp Table
[\(See Details\)](#)

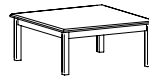

29-3636MT:
Square Magazine
Table
[\(See Details\)](#)

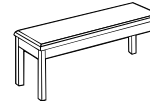

29-1847MT:
Magazine Table
[\(See Details\)](#)

Item	Model No.	W	D	H	Ship Wt	Cubic Ft	List Price	
END TABLE	29-2124ET	21	24	21½	25	2.0	P\$ 992	W\$ 1157

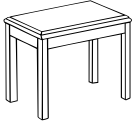

Must Specify (in this order):

Model #
Top Material
Finish/Color

Description

- Available with Veneer (W) or HPL (P) Top, Must Specify
- Hardwood Legs
- Some Assembly Required

LAMP TABLE	29-2424LT	24	24	21½	25	2.0	P\$ 1110	W\$ 1191
------------	-----------	----	----	-----	----	-----	----------	----------

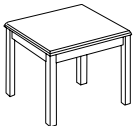

Must Specify (in this order):

Model #
Top Material
Finish/Color

Description

- Available with Veneer (W) or HPL (P) Top, Must Specify
- Hardwood Legs
- Some Assembly Required

MAGAZINE TABLE	29-1847MT	47	18	16	47	3.4	P\$ 1191	W\$ 1389
----------------	-----------	----	----	----	----	-----	----------	----------

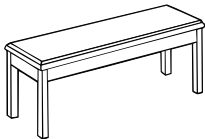

Must Specify (in this order):

Model #
Top Material
Finish/Color
Leg

Description

- Available with Veneer (W) or HPL (P) Top, Must Specify
- Left to Right Grain Direction on Worksurface
- Hardwood Legs
- Some Assembly Required
- Optional 30" Legs; See Below

Desk Base Molding Options: Must Specify and Add

SH-36	Optional 30" H Legs	\$ 215
-------	---------------------	--------

SQUARE MAGAZINE TABLE	29-3636MT	36	36	16	60	5.5	P\$ 1272	W\$ 1486
-----------------------	-----------	----	----	----	----	-----	----------	----------

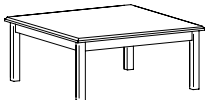

Must Specify (in this order):

Model #
Top Material
Finish/Color

Description

- Available with Veneer (W) or HPL (P) Top, Must Specify
- Hardwood Legs
- Some Assembly Required



Wilmington/Arlington

P = HPL W = Veneer

[See Intro Overview For Ordering Options](#)

From lounge areas, to private office, to conference settings, the Bailey Collection can make a statement. Bailey tables are offered in square and rectangular cocktail tables, as well as end tables, in a wide range of veneers and laminates with two edge profiles. Pair Bailey tables with the collection's chairs, settees, sofas, and ottomans.

CONSTRUCTION

- Bases for tables are manufactured using steel frames with a chrome finish
- The wood veneer tops are made of select grade sliced Black Walnut, Cherry, Maple, or composite veneers for maximum grain and color consistency
- Veneer tops are ¾" with 1mm veneer edge bands
- Laminate tops are ¾" with 1mm PVC edge bands; Designer White, Sugar Maple, and Williamsburg Cherry feature ABS rims
- Ships fully assembled

HOW TO ORDER EXAMPLE

Model No.	Description	Example
720-3030SQ	Finish	TK

TFL (T) AND HPL (P) LAMINATE OPTIONS

WOODGRAIN

AS	Asian Night	PNW	Pinnacle Walnut
BW	Beigewood	SCH	Select Cherry
CO	Columbian Walnut	SKC	Shaker Cherry
EF	Espresso	SBP	Smoky Brown Pear
GC	Golden Cherry	TK	Studio Teak
HVM	Harvest Maple	SM	Sugar Maple
MW	Mahogany Walnut	WTA	Weathered Ash
ORW	Oak Riftwood	WC	Williamsburg Cherry

SOLID

BL	Black	PPD	Pepperdust
WH	Designer White	SG	Slate Grey
FHG	Fashion Grey	WHS	White Sand

VENEER (W) OPTIONS AVAILABLE

Veneer tops feature UVAdvantage, an ultra-violet finish, on all exposed surfaces by utilizing roll-coat UV technology.

AW	Artisan Walnut	MW	Mahogany Walnut
AS	Asian Night	MO	Medium Oak*
CO	Columbian Walnut	ORW	Oak Riftwood*
DC	Dark Cherry	SCH	Select Cherry
DFW	Dark Forest Walnut	SKC	Shaker Cherry
EF	Espresso	SBP	Smoky Brown Pear
FO	Fawn Oak*	SM	Sugar Maple
GC	Golden Cherry	SW	Sunglow Walnut
HVM	Harvest Maple	WTA	Weathered Ash*
HW	Harvest Walnut	WC	Williamsburg Cherry
LW	Legacy Walnut		

* Finish is Low Sheen

TABLE EDGE PROFILES

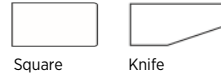

CERTIFICATIONS & COMPLIANCE

- Intertek Sustainability Certified
- BIFMA level® Certified
- BIFMA Compliant® Certified
- TSCA Title VI (CARB) Compliance
- US Green Building's LEED® Contribution

STATEMENT OF LINE

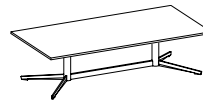

Rectangular
Cocktail Tables
[\(See Details\)](#)

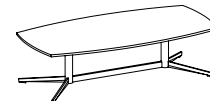

Soft Rectangular
Cocktail Tables
[\(See Details\)](#)



Square
Cocktail Tables
[\(See Details\)](#)



Soft Square
Cocktail Tables
[\(See Details\)](#)



Square
End Tables
[\(See Details\)](#)

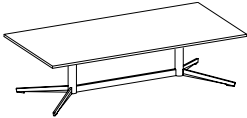
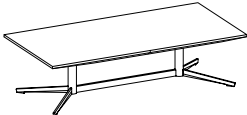

Soft Square
End Tables
[\(See Details\)](#)

Item	Model No.		W	D	H	Ship Wt	Cubic Ft	List Price		
RECTANGULAR COCKTAIL TABLE  	SQUARE EDGE									
	720-2550RT	TFL	25	50	14	34.9	3.2	T\$	1391	
	720-2550RTH	HPL	25	50	14	34.9	3.2	P\$	1634	
	719-2550RT	Wood	25	50	14	34.9	3.2	W\$	1976	
	KNIFE EDGE									
	720-2550RTKH	HPL	25	50	14	34.9	3.2	P\$	2025	
719-2550RTK	Wood	25	50	14	34.9	3.2	W\$	2121		

Must Specify (in this order):

Model #
Finish/Color

Description

- Standard with: Chrome Base
- Table Ships Fully Assembled

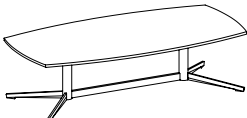
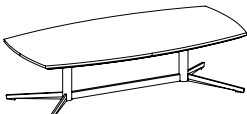
SOFT RECTANGULAR COCKTAIL TABLE  	SQUARE EDGE									
	720-2550SRT	TFL	25	50	14	34.9	3.2	T\$	1391	
	720-2550SRTH	HPL	25	50	14	34.9	3.2	P\$	1634	
	719-2550SRT	Wood	25	50	14	34.9	3.2	W\$	1976	
	KNIFE EDGE									
	720-2550SRTKH	HPL	25	50	14	34.9	3.2	P\$	2025	
719-2550SRTK	Wood	25	50	14	34.9	3.2	W\$	2121		

Must Specify (in this order):

Model #
Finish/Color

Description

- Standard with: Chrome Base
- Table Ships Fully Assembled





Square



Knife

T = TFL P = HPL W = Veneer

[See Intro Overview For Ordering Options](#)



Item	Model No.		W	D	H	Ship Wt	Cubic Ft	List Price		
SQUARE COCKTAIL TABLE  	SQUARE EDGE									
	720-3030SQ	TFL	30	30	14	29.7	2.80	T\$	863	
	720-3030SQH	HPL	30	30	14	29.7	2.80	P\$	1171	
	719-3030SQ	Wood	30	30	14	29.7	2.80	W\$	1359	
	KNIFE EDGE									
	720-3030SQKH	HPL	30	30	14	29.7	2.80	P\$	1476	
719-3030SQK	Wood	30	30	14	29.7	2.80	W\$	1478		

Must Specify (in this order):

Model #
Finish/Color

Description

- Standard with: Chrome Base
- Table Ships Fully Assembled

Item	Model No.		W	D	H	Ship Wt	Cubic Ft	List Price		
SOFT SQUARE COCKTAIL TABLE  	SQUARE EDGE									
	720-3030SSQ	TFL	30	30	14	29.7	2.80	T\$	863	
	720-3030SSQH	HPL	30	30	14	29.7	2.80	P\$	1171	
	719-3030SSQ	Wood	30	30	14	29.7	2.80	W\$	1359	
	KNIFE EDGE									
	720-3030SSQKH	HPL	30	30	14	29.7	2.80	P\$	1476	
719-3030SSQK	Wood	30	30	14	29.7	2.80	W\$	1478		

Must Specify (in this order):

Model #
Finish/Color

Description

- Standard with: Chrome Base
- Table Ships Fully Assembled



Square



Knife

T = TFL P = HPL W = Veneer

[See Intro Overview For Ordering Options](#)

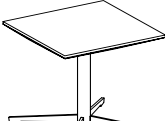
Item	Model No.		W	D	H	Ship Wt	Cubic Ft	List Price	
	SQUARE EDGE								
	720-2020ET	TFL	20	20	20	20	2.0	T\$	943
	720-2020ETH	HPL	20	20	20	20	2.0	P\$	1170
	719-2020ET	Wood	20	20	20	20	2.0	W\$	1241
	KNIFE EDGE								
	720-2020ETKH	HPL	20	20	20	20	2.0	P\$	1303
	719-2020ETK	Wood	20	20	20	20	2.0	W\$	1363

Description

- Standard with: Chrome Base
- Table Ships Fully Assembled

Must Specify (in this order):
Model #
Finish/Color

Item	Model No.		W	D	H	Ship Wt	Cubic Ft	List Price	
	SQUARE EDGE								
	720-2020SET	TFL	20	20	20	20	2.0	T\$	943
	720-2020SETH	HPL	20	20	20	20	2.0	P\$	1170
	719-2020SET	Wood	20	20	20	20	2.0	W\$	1241
	KNIFE EDGE								
	720-2020SETKH	HPL	20	20	20	20	2.0	P\$	1303
	719-2020SETK	Wood	20	20	20	20	2.0	W\$	1363

Description

- Standard with: Chrome Base
- Table Ships Fully Assembled

Must Specify (in this order):
Model #
Finish/Color

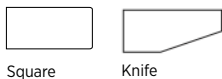

T = TFL P = HPL W = Veneer

[See Intro Overview For Ordering Options](#)

The Britta Collection showcases a Mid-Century Scandinavian aesthetic with an appealing contemporary feel. Available in two edge styles and a broad range of finishes to create an inviting space with warm and energetic sensibility. Pair Britta tables with the collection's guest, single lounge, and settee options, which all feature a wall-saver design, to create an entire setting.

CONSTRUCTION

- The wood veneer table tops are 1" thick and are made of select grade sliced Walnut, Cherry, or Maple veneers for maximum grain and color consistency
- The knife edge profile features a 5-ply balanced construction with a solid hardwood rim; the square edge profile features a 3-ply balanced construction with a 3mm veneer edge band
- The aprons and legs are solid maple hardwood and ship with adjustable glides
- Ships fully assembled

HOW TO ORDER EXAMPLE

Model No.	Description	Example
231-1818ET	Finish Edge Profile	DFW K

VENEER (W) OPTIONS

Veneer tops feature UVAdvantage, an ultra-violet finish, on all exposed surfaces by utilizing roll-coat UV technology. Apron rails and table legs use a multi-step, hand finished process with a catalyzed finish.

AW	Artisan Walnut	LW	Legacy Walnut
CO	Columbian Walnut	MW	Mahogany Walnut
DC	Dark Cherry	MTS	Metropolis Sky
DFW	Dark Forest Walnut	SCH	Select Cherry
EF	Espresso	SKC	Shaker Cherry
GC	Golden Cherry	SM	Sugar Maple
HW	Harvest Walnut	WC	Williamsburg Cherry
HNW	Henna Walnut	PNW	Pinnacle Walnut

TABLE EDGE PROFILE

Y	Square Edge
K	Knife Edge



Square



Knife

CERTIFICATIONS & COMPLIANCE

- Intertek Sustainability Certified
- BIFMA level® Certified
- BIFMA Compliant® Certified
- TSCA Title VI (CARB) Compliance
- US Green Building's LEED® Contribution

STATEMENT OF LINE



231-1818ET: Square
End Table
[\(See Details\)](#)

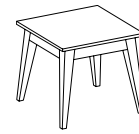

231-2323SCT: Square
Cocktail Table
[\(See Details\)](#)

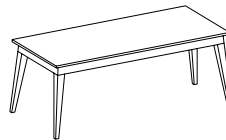

231-4723RCT: Rectangular
Cocktail Table
[\(See Details\)](#)

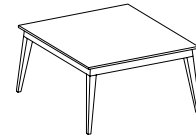

231-3535SCT: Square
Cocktail Table
[\(See Details\)](#)

Item	Model No.		W	D	H	Ship Wt	Cubic Ft	List Price	
END TABLE	231-1818ET	Square Edge	18	18	20	18	10.8	Y\$	1389
		Knife Edge						K\$	Bad Tag!



Must Specify (in this order):

Model #
Finish
Edge

Description

- Standard with: Adjustable Glides
- Available with [Square \(Y\)](#) or [Knife \(K\) Edge](#); Must Specify
- Ships Fully Assembled

SMALL SQUARE COCKTAIL TABLE	231-2323SCT	Square Edge	23	23	16	21	10.8	Y\$	1420
		Knife Edge						K\$	Bad Tag!



Must Specify (in this order):

Model #
Finish
Edge

Description

- Standard with: Adjustable Glides
- Available with [Square \(Y\)](#) or [Knife \(K\) Edge](#); Must Specify
- Ships Fully Assembled

SQUARE COCKTAIL TABLE	231-3535SCT	Square Edge	34 $\frac{7}{8}$	34 $\frac{7}{8}$	16	45	25.7	Y\$	1702
		Knife Edge						K\$	Bad Tag!

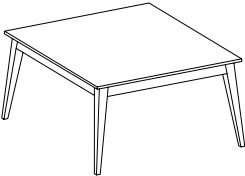

Must Specify (in this order):

Model #
Finish
Edge

Description

- Standard with: Adjustable Glides
- Available with [Square \(Y\)](#) or [Knife \(K\) Edge](#); Must Specify
- Ships Fully Assembled

RECTANGULAR COCKTAIL TABLE	231-4723RCT	Square Edge	46 $\frac{7}{8}$	23	16	36	23.1	Y\$	1666
		Knife Edge						K\$	Bad Tag!

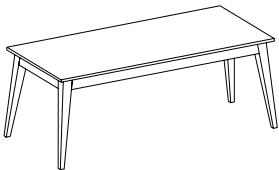

Must Specify (in this order):

Model #
Finish
Edge

Description

- Standard with: Adjustable Glides
- Available with [Square \(Y\)](#) or [Knife \(K\) Edge](#); Must Specify
- Ships Fully Assembled



Square



Knife

[See Intro Overview For Ordering Options](#)

Always stylish, comfortable and effortlessly adaptable, Canvas enlivens environments with refined aesthetics. Project a fresh, polished attitude with our enhanced selection of multidimensional components. Your creation of an ultra-functional workspace is limited only by your imagination.

CONSTRUCTION

- Exposed surfaces are produced from wood-grained or solid color laminates fused to a particle-board core.
- TFL chassis are fastened by screws and heavy-duty metal fasteners
- Tops are 1" thick thermally-fused (TFL) or high-pressure (HPL) laminate using 3mm PVC rims on profiled edges; Designer White, Sugar Maple, and Williamsburg Cherry feature ABS rims
- Grain direction runs left to right
- Slab ends come standard with adjustable levelers
- Ships fully assembled

HOW TO ORDER EXAMPLE

Model No.	Description	Example
66-2424ET	Top Material	T
	Top Color	FHG
	Edge Profile	F
	Chassis Color	WTA

TFL (T) AND HPL (P) LAMINATE OPTIONS

WOODGRAIN

AS	Asian Night	PTK	Portico Teak
BW	Beigewood	RC	River Cherry
CO	Columbian Walnut	SPW	Sepia Walnut
EF	Espresso	SKC	Shaker Cherry
FLW	Florence Walnut	SBP	Smoky Brown Pear
KHE	Kirsche	TK	Studio Teak
MNR	Midnight Run	SM	Sugar Maple
NTM	Natural Marrone	WTA	Weathered Ash
ORW	Oak Riftwood	WC	Williamsburg Cherry
PNW	Pinnacle Walnut	WNB	White Nebbia

SOLID

BL	Black	FHG	Fashion Grey
WH	Designer White	SG	Slate Grey

TABLE EDGE PROFILE

F	Double Kerf
G	Duo
Y	Square

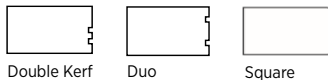

Double Kerf Duo Square

CERTIFICATIONS & COMPLIANCE

- Intertek Sustainability Certified
- BIFMA level® Certified
- BIFMA Compliant® Certified
- TSCA Title VI (CARB) Compliance
- US Green Building's LEED® Contribution

STATEMENT OF LINE

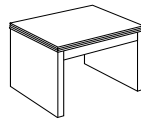

66-2424ET:
End Table
([See Details](#))

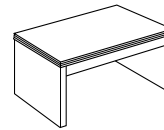

66-2442MT:
Magazine Table
([See Details](#))

Item	Model No.		W	D	H	Ship Wt	Cubic Ft	List Price	
END TABLE	66-2424ET	TFL	24	24	22	65	9.4	T\$	921
		HPL						P\$	1057

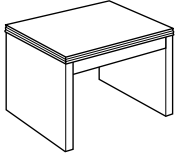

Must Specify (in this order):

- Model #
- Top Material
- Top Color
- Edge
- Chassis Color

Description

- Standard with: TFL Slab Ends and Apron Rail, with Adjustable Glides
- Available in Contrasting Top and Chassis Color
- Choose from TFL (T) or HPL (P) Top
- Ships Fully Assembled

MAGAZINE TABLE	66-2442MT	TFL	42	24	16	70	11.9	T\$	970
		HPL						P\$	1136

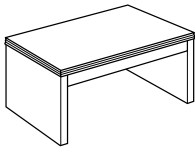

Must Specify (in this order):

- Model #
- Top Material
- Top Color
- Edge
- Chassis Color

Description

- Standard with: TFL Slab Ends and Apron Rail, with Adjustable Glides
- Available in Contrasting Top and Chassis Color
- Choose from TFL (T) or HPL (P) Top
- Ships Fully Assembled

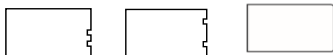

Double Kerf Duo Square

T=TFL P=HPL

[See Intro Overview For Ordering Options](#)

Carefully matched select veneer tops with solid hardwood legs and aprons form a collection of beautiful wood tables suitable for nearly any application.

CONSTRUCTION

- Constructed of a 5-ply veneer top, 1½" thick
- Legs are solid Maple hardwood and ship with nylon glides
- Aprons are steam bent with Maple veneer faces
- Grain direction runs left to right
- Elliptical Magazine and Rounded End Tables ship fully assembled; all other models require some assembly

HOW TO ORDER EXAMPLE

Model No.	Description	Example
294-4222EMT	Finish	HW

VENEER (W) OPTIONS

Veneer tops feature UVAAdvantage, an ultra-violet finish, on all exposed surfaces by utilizing roll-coat UV technology. Apron rails and table legs use a multi-step, hand finished process with a catalyzed finish

AW	Artisan Walnut	LW	Legacy Walnut
CO	Columbian Walnut	MW	Mahogany Walnut
DC	Dark Cherry	MTS	Metropolis Sky
DFW	Dark Forest Walnut	SCH	Select Cherry
EF	Espresso	SKC	Shaker Cherry
GC	Golden Cherry	SM	Sugar Maple
HW	Harvest Walnut	WC	Williamsburg Cherry
HNW	Henna Walnut	PNW	Pinnacle Walnut

TABLE EDGE PROFILE

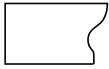

Phoenix

CERTIFICATIONS & COMPLIANCE

- Intertek Sustainability Certified
- BIFMA level® Certified
- BIFMA Compliant® Certified
- TSCA Title VI (CARB) Compliance
- US Green Building's LEED® Contribution

STATEMENT OF LINE

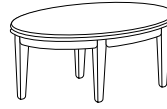

294-4222EMT:
Elliptical
Magazine Table
[\(See Details\)](#)

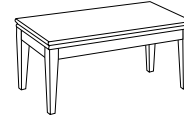

294-4222MT:
Magazine Table
[\(See Details\)](#)

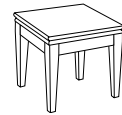

294-2222LT:
Lamp Table
[\(See Details\)](#)



294-2622ET:
End Table
[\(See Details\)](#)



294-2222RET:
Rounded End Table
[\(See Details\)](#)

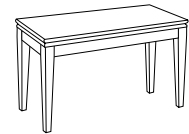

294-4216CT:
Console Table
[\(See Details\)](#)

Item	Model No.	W	D	H	Ship Wt	Cubic Ft	List Price
ELLIPTICAL MAGAZINE TABLE	294-4222EMT	42	22	16	48	14.4	\$ 2892

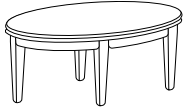
**Description**

- Ships Assembled

Must Specify (in this order):

Model #
Finish

MAGAZINE TABLE	294-4222MT	42	22	16	33	3.7	\$ 1865
----------------	------------	----	----	----	----	-----	---------

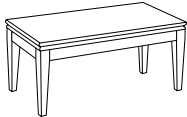
**Description**

- Some Assembly Required

Must Specify (in this order):

Model #
Finish

LAMP TABLE	294-2222LT	22	22	22	27	2.4	\$ 1423
------------	------------	----	----	----	----	-----	---------

**Description**

- Some Assembly Required

Must Specify (in this order):

Model #
Finish

END TABLE	294-2622ET	26	22	22	36	2.8	\$ 1500
-----------	------------	----	----	----	----	-----	---------

**Description**

- Some Assembly Required

Must Specify (in this order):

Model #
Finish

ROUNDED END TABLE	294-2222RET	22	22	22	24	2.4	\$ 1975
-------------------	-------------	----	----	----	----	-----	---------

**Description**

- Ships Assembled

Must Specify (in this order):

Model #
Finish

CONSOLE TABLE	294-4216CT	42	16	30	36	3.9	\$ 1778
---------------	------------	----	----	----	----	-----	---------

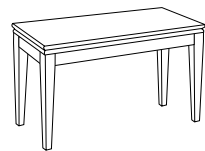
**Description**

- Some Assembly Required

Must Specify (in this order):

Model #
Finish

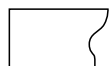

Phoenix

[See Intro Overview For Ordering Options](#)

A foundational suite of casegoods and tables primed to evolve with your needs. Gesso allows you to combine luxurious veneers, top grade laminates and other materials to create stylish, reconfigurable work spaces.

CONSTRUCTION

- Exposed surfaces feature select grade plain sliced hardwood veneers in Cherry, Maple, American Black Walnut, White Oak, or composite veneers
- Veneer and standard high pressure laminate tops are 3-ply balanced construction and 1 $\frac{3}{8}$ " thick, with 3mm wood edge-banded rims contoured to the selected profile
- Grain direction runs left to right
- All units ship with heavy duty, adjustable leveling glides to ensure proper leveling and compensation for uneven floors
- Ships fully assembled

HOW TO ORDER EXAMPLE

Model No.	Description	Example
65-2424ET	Top Material	W
	Finish	LW
	Edge Profile	G

VENEER (W) OPTIONS

Veneer tops feature UVAdvantage, an ultra-violet finish, on all exposed surfaces by utilizing roll-coat UV technology.

AW	Artisan Walnut	MW	Mahogany Walnut
AS	Asian Night	MAS	Mesa Sunset
CO	Columbian Walnut	MTS	Metropolis Sky
DC	Dark Cherry	PNW	Pinnacle Walnut
DFW	Dark Forest Walnut	ORW	Oak Riftwood*
EW	Espresso	SCH	Select Cherry
FO	Fawn Oak*	SKC	Shaker Cherry
GC	Golden Cherry	SM	Sugar Maple
HW	Harvest Walnut	WTA	Weathered Ash*
HNW	Henna Walnut	WC	Williamsburg Cherry
LW	Legacy Walnut		

* Finish is Low Sheen

HPL (P) LAMINATE OPTIONS

WOODGRAIN

AS	Asian Night	SCH	Select Cherry
CO	Columbian Walnut	SKC	Shaker Cherry
EF	Espresso	SBP	Smoky Brown Pear
GC	Golden Cherry	SM	Sugar Maple
MW	Mahogany Walnut	WTA	Weathered Ash
ORW	Oak Riftwood	WC	Williamsburg Cherry
PNW	Pinnacle Walnut		

SOLID

BL	Black	FHG	Fashion Grey
WH	Designer White	SG	Slate Grey

TABLE EDGE PROFILE

- F Double Kerf
- G Duo
- Y Square

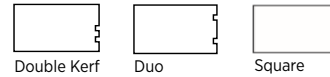

CERTIFICATIONS & COMPLIANCE

- Intertek Sustainability Certified
- BIFMA level® Certified
- BIFMA Compliant® Certified
- TSCA Title VI (CARB) Compliance
- US Green Building's LEED® Contribution

STATEMENT OF LINE

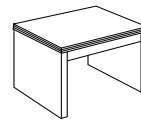

65-2424ET:
End Table
([See Details](#))

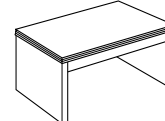

65-2442MT:
Magazine Table
([See Details](#))

Item	Model No.	W	D	H	Ship Wt	Cubic Ft	List Price
END TABLE	65-2424ET	24	24	22	65	9.4	W/P\$ 1577

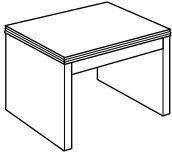

Description

- Standard with: Veneer Slab Ends and Apron Rail, with Adjustable Glides
- Choose from HPL (P) or Veneer (W) Top; Must Specify
- Ships Fully Assembled

Must Specify (in this order):

Model #
Top Material
Finish/Color
Edge

MAGAZINE TABLE	65-2442MT	42	24	16	70	11.9	W/P\$ 1660
----------------	-----------	----	----	----	----	------	------------

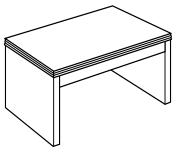

Description

- Standard with: Veneer Slab Ends and Apron Rail, with Adjustable Glides
- Choose from HPL (P) or Veneer (W) Top; Must Specify
- Ships Fully Assembled

Must Specify (in this order):

Model #
Top Material
Finish/Color
Edge



Double Kerf



Duo



Square

P = HPL W = Veneer

[See Intro Overview For Ordering Options](#)

Open spaces really come together with Isla Lounge & Tables Collection. Create conversation settings or private areas by mixing components to fit the space and needs of the environment. Power and data options keep everyone working on-the-go.

CONSTRUCTION

- External wood parts are kiln-dried hardwoods; internal parts are structurally engineered plywood; European Beech on legs
- Joints are double-doweled or mortised and tenoned, screwed, and glued for maximum strength and durability
- Tops are ¾" thick on occasional tables, 1" thick on Laminate tops, and 1 ⅜" on Veneer tops
- Non-marring adjustable nylon guides included in each leg at floor level
- Ships fully assembled

HOW TO ORDER EXAMPLES

378-1626ET	Top Material	T
	Finish	AS
	Upholstery	Mayer Fedora Topaz
	Leg	WLEG, AS
	Power	PWRUSBA

TFL (T) LAMINATE TABLE TOP OPTIONS

WOODGRAIN

AS	Asian Night	PTK	Portico Teak
BW	Beigewood	RC	River Cherry
CO	Columbian Walnut	SPW	Sepia Walnut
EF	Espresso	SKC	Shaker Cherry
FLW	Florence Walnut	SBP	Smoky Brown Pear
KHE	Kirsche	TK	Studio Teak
MNR	Midnight Run	SM	Sugar Maple
NTM	Natural Marrone	WTA	Weathered Ash
ORW	Oak Riftwood	WC	Williamsburg Cherry
PNW	Pinnacle Walnut	WNB	White Nebbia

SOLID

BL	Black	FHG	Fashion Grey
WH	Designer White	SG	Slate Grey

VENEER (W) TABLE TOP OPTIONS

Veneer tops feature UVAdvantage, an ultra-violet finish, on all exposed surfaces by utilizing roll-coat UV technology.

AW	Artisan Walnut	MW	Mahogany Walnut
AS	Asian Night	MAS	Mesa Sunset
CO	Columbian Walnut	MTS	Metropolis Sky
DC	Dark Cherry	ORW	Oak Riftwood*
DFW	Dark Forest Walnut	PNW	Pinnacle Walnut
EF	Espresso	SCH	Select Cherry
FO	Fawn Oak*	SKC	Shaker Cherry
GC	Golden Cherry	SM	Sugar Maple
HW	Harvest Walnut	WTA	Weathered Ash*
HNW	Henna Walnut	WC	Williamsburg Cherry
LW	Legacy Walnut		

* Finish is Low Sheen

SOLID SURFACE (S) TABLE TOP OPTIONS

AR	Arroyo	SNW	Snow White
PE	Pebble Beach	SN	Starry Night
SE	Sedona	TN	Tundra

SOLID SURFACE EDGE PROFILE OPTIONS

SI Straight



LEG OPTIONS

WLEG	Wood Leg, Specify Finish		Std
CLEG	Chrome Leg		\$ N/C
PLEG	Aluminum Leg		\$ 208
	ALUM Aluminum	BLK Black	
	MIST Mist	OYST Oyster	
	SUGC Sugar Cookie		

LEG WOOD FINISHES

Indiana Furniture uses a multi-step, hand-finishing process on all exposed wood frames. Legs feature a catalyzed varnish finish offering durability, lasting beauty, and resistance to normal wear.

AW	Artisan Walnut	MAS	Mesa Sunset
AS	Asian Night	MTS	Metropolis Sky
BW	Beigewood*	MNR	Midnight Run
BL	Black	NTM	Natural Marrone
CO	Columbian Walnut	ORW	Oak Riftwood*
DC	Dark Cherry	PNW	Pinnacle Walnut
DFW	Dark Forest Walnut*	PTK	Portico Teak
WH	Designer White	RC	River Cherry
EF	Espresso	SCH	Select Cherry
FO	Fawn Oak*	SPW	Sepia Walnut
FLW	Florence Walnut	SKC	Shaker Cherry
GC	Golden Cherry	SBP	Smoky Brown Pear
HW	Harvest Walnut	TK	Studio Teak
HNW	Henna Walnut	SM	Sugar Maple
KHE	Kirsche	WTA	Weathered Ash*
LW	Legacy Walnut	WNB	White Nebbia
MW	Mahogany Walnut	WC	Williamsburg Cherry

* Finish is Low Sheen

UPHOLSTERY OPTIONS

Available in single upholstery in a wide variety of graded-in or contract options, including fabric, vinyl, and leather.

POWER OPTIONS

PWRUSBA	Power and Two USB Ports, Aluminum	\$ 854
---------	-----------------------------------	--------

CERTIFICATIONS & COMPLIANCE

- CAL 117-2013 Compliance
- Intertek Sustainability Certified
- BIFMA level® Certified
- BIFMA Compliant® Certified
- TSCA Title VI (CARB) Compliance
- US Green Building's LEED® Contribution

Freestanding Tables (Upholstered Chassis with TFL, Veneer, or Solid Surface Top)



End Table:
378-1626ET
[\(See Details\)](#)

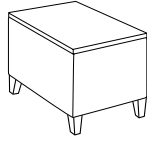

Lamp Table:
378-2226ET
[\(See Details\)](#)

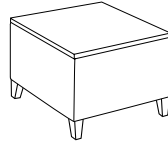

Magazine Table:
378-2626MT
[\(See Details\)](#)

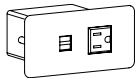

1 Electrical Power
and 2 USB Outlets

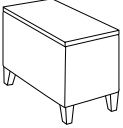
Item	Model No.		W	D	H	Ship Wt	Cubic Ft	List Price	
END TABLE 	378-1626ET	TFL	16	26½	15½	42	11.0	T\$	926
		Veneer						W\$	1031
		Solid Surface						S\$	1696

Description

- Standard with: Upholstered Chassis and Wood Legs
- Choose TFL (T), Veneer (W), or Solid Surface (S) Top
- Add Upholstery Grade Pricing to Top Material Price
- Optional Leg and Power

Must Specify (in this order):

- Model #
- Top Material
- Finish/Color
- Fabric
- Leg/Color
- Power

Add List Price/Grade	Yards	COM/1	2	3	4	5	6	7	8	9	10	L1	L2
Single Upholstery	1.00	\$ 0	50	93	134	197	261	352	446	557	684	319	455

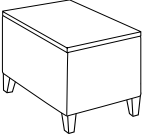
LAMP TABLE 	378-2226ET	TFL	22	26½	15½	48	12.0	T\$	971
		Veneer						W\$	1193
		Solid Surface						S\$	2009

Description

- Standard with: Upholstered Chassis and Wood Legs
- Choose TFL (T), Veneer (W), or Solid Surface (S) Top
- Add Upholstery Grade Pricing to Top Material Price
- Optional Leg and Power

Must Specify (in this order):

- Model #
- Top Material
- Finish/Color
- Fabric
- Leg/Color
- Power

Add List Price/Grade	Yards	COM/1	2	3	4	5	6	7	8	9	10	L1	L2
Single Upholstery	1.00	\$ 0	50	93	134	352	261	352	446	557	684	319	455

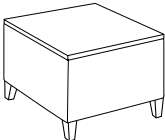
MAGAZINE TABLE 	378-2626MT	TFL	26½	26½	15½	57	15.0	T\$	1028
		Veneer						W\$	1264
		Solid Surface						S\$	2284

Description

- Standard with: Upholstered Chassis and Ganging Hardware
- Choose TFL (T), Veneer (W), or Solid Surface (S) Top
- Add Upholstery Grade Pricing to Top Material Price
- Optional Leg and Power

Must Specify (in this order):

- Model #
- Top Material
- Finish/Color
- Fabric
- Leg/Color
- Power

Add List Price/Grade	Yards	COM/1	2	3	4	5	6	7	8	9	10	L1	L2
Single Upholstery	1.00	\$ 0	50	93	134	197	261	352	446	557	684	319	455

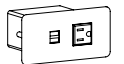

1 Electrical Power and 2 USB Outlets

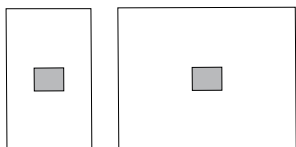

Power is centered into End, Lamp, and Magazine Tables, as shown above

T = TFL W = Veneer S = Solid Surface

[See Intro Overview For Ordering Options](#)

Jefferson echoes history and creates a timeless foundation for today's sophisticated work place. Finely crafted in select solids with walnut veneers, the tailored details of this collection accentuate our expert craftsmanship and perfect attention to detail.

CONSTRUCTION

- Veneers on exposed surfaces are select grade sliced American Black Walnut and Cherry are carefully selected and matched to assure proper balance and consistency
- Veneer and HPL tops featuring the C2 tops are 5-ply balanced construction, 1 $\frac{3}{16}$ " thick, with solid hardwood mitered rims
- Grain direction runs left to right
- All units ship with heavy duty, adjustable leveling glides to ensure proper leveling and compensation for uneven floors
- Some assembly required

HOW TO ORDER EXAMPLE

Model No.	Description	Example
46-1824ET	Top Material	W
	Finish	LW

VENEER (W) AND PREMIUM VENEER (PV) OPTIONS

Veneer tops feature UVAdvantage, an ultra-violet finish, on all exposed surfaces by utilizing roll-coat UV technology. Apron rails and table legs use a multi-step, hand finished process with a catalyzed finish.

AW	Artisan Walnut	LW	Legacy Walnut
CO	Columbian Walnut	MW	Mahogany Walnut
DC	Dark Cherry	MTS	Metropolis Sky
DFW	Dark Forest Walnut	PNW	Pinnacle Walnut
EW	Espresso	SCH	Select Cherry
GC	Golden Cherry	SKC	Shaker Cherry
HNW	Henna Walnut	WC	Williamsburg Cherry
HW	Harvest Walnut		

HPL (P) TOP OPTIONS

WOODGRAIN

CO	Columbian Walnut	PNW	Pinnacle Walnut
EF	Espresso	SCH	Select Cherry
GC	Golden Cherry	SKC	Shaker Cherry
MW	Mahogany Walnut	WC	Williamsburg Cherry

TABLE EDGE PROFILE



C2

CERTIFICATIONS & COMPLIANCE

- Intertek Sustainability Certified
- BIFMA level® Certified
- BIFMA Compliant® Certified
- TSCA Title VI (CARB) Compliance
- US Green Building's LEED® Contribution

STATEMENT OF LINE

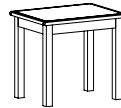

46-1824ET:
End Table
[\(See Details\)](#)

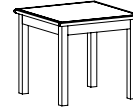

46-2424LT:
Lamp Table
[\(See Details\)](#)

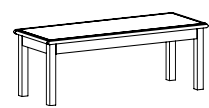

46-1847MT:
Magazine Table
[\(See Details\)](#)

Item	Model No.	W	D	H	Ship Wt	Cubic Ft	List Price	
END TABLE	46-1824ET	24	18	21 ¹³ / ₁₆	25	2.0	W/P\$	1311
							PV\$	1470

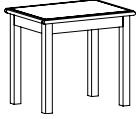

Description

- Available with Premium/Standard Veneer (PV/W) or HPL (P) Top; Must Specify
- Hardwood Legs
- Some Assembly Required

Must Specify (in this order):

Model #
Top Material
Finish/Color

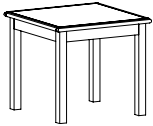
Item	Model No.	W	D	H	Ship Wt	Cubic Ft	List Price	
LAMP TABLE	46-2424LT	24	24	21 ¹³ / ₁₆	37	3.3	W/P\$	1670
							PV\$	1870



Description

- Available with Premium/Standard Veneer (PV/W) or HPL (P) Top; Must Specify
- Hardwood Legs
- Some Assembly Required

Must Specify (in this order):

Model #
Top Material
Finish/Color

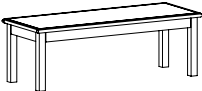
Item	Model No.	W	D	H	Ship Wt	Cubic Ft	List Price	
MAGAZINE TABLE	46-1847MT	47	18	16	42	3.4	W/P\$	1577
							PV\$	1766

Description

- Available with Premium/Standard Veneer (PV/W) or HPL (P) Top; Must Specify
- Hardwood Legs
- Optional 30"H Legs
- Some Assembly Required

Must Specify (in this order):

Model #
Top Material
Finish/Color
Optional 30"H Leg

Options: Specify & Add

SH-46	Optional 30"H Legs	\$	215
-------	--------------------	----	-----



C2

P = HPL W = Veneer

[See Intro Overview For Ordering Options](#)

Discover the perfect table collection that goes anywhere. With a mix of materials, Jot complements a diverse range of interiors from ultra modern to classic. Its metal base, available in five refreshed colors, supports tops in solid surface, veneer, or laminate. Scaled for a perfect fit, Jot makes a great first impression front and center or corner-tucked for convenient storage. Jot's UV Advantage finish features a crystal clear topcoat developed for durability in high traffic areas.

CONSTRUCTION

- Veneer tops are ¾" thick with veneer edge bands; made of select grade, sliced Black Walnut, Cherry, Maple, or Composite species
- TFL tops are ¾" thick with a 1mm PVC edge band; Designer White, Sugar Maple, and Williamsburg Cherry feature ABS rims
- Solid surface tops are ¾" thick and are available in six colors and two edge profiles
- Bases are manufactured using ¾" steel frames and powder coated in your choice of five standard colors
- Joints on bases are mitered and fully welded for maximum strength and durability
- Tops are securely fastened to the bases with metal screws
- Ships fully assembled

HOW TO ORDER EXAMPLES

410-1412AT	Top Material	T
	Finish	TK
	Edge Detail (if applicable)	-
	Metal Base Color	ALUM

TFL (T) LAMINATE TABLE TOP OPTIONS

WOODGRAIN

AS	Asian Night	PTK	Portico Teak
BW	Beigewood	RC	River Cherry
CO	Columbian Walnut	SPW	Sepia Walnut
EF	Espresso	SKC	Shaker Cherry
FLW	Florence Walnut	SBP	Smoky Brown Pear
KHE	Kirsche	TK	Studio Teak
MNR	Midnight Run	SM	Sugar Maple
NTM	Natural Marrone	WTA	Weathered Ash
ORW	Oak Riftwood	WC	Williamsburg Cherry
PNW	Pinnacle Walnut	WNB	White Nebbia

SOLID

BL	Black	FHG	Fashion Grey
WH	Designer White	SG	Slate Grey

VENEER (W) TABLE TOP OPTIONS

Tops feature UV Advantage, an ultra-violet finish, on all exposed surfaces by utilizing roll-coat UV technology.

AW	Artisan Walnut	MW	Mahogany Walnut
AS	Asian Night	MAS	Mesa Sunset
CO	Columbian Walnut	MTS	Metropolis Sky
DC	Dark Cherry	ORW	Oak Riftwood*
DFW	Dark Forest Walnut	PNW	Pinnacle Walnut
EF	Espresso	SCH	Select Cherry
FO	Fawn Oak*	SKC	Shaker Cherry
GC	Golden Cherry	SM	Sugar Maple
HW	Harvest Walnut	WTA	Weathered Ash*
HNW	Henna Walnut	WC	Williamsburg Cherry
LW	Legacy Walnut		

* Finish is Low Sheen

SOLID SURFACE (S) TABLE TOP OPTIONS

AR	Arroyo	SNW	Snow White
PE	Pebble Beach	SN	Starry Night
SE	Sedona	TN	Tundra

SOLID SURFACE EDGE PROFILE OPTIONS

S1	Straight
S2	Roman

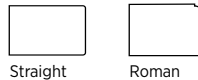

METAL BASE OPTIONS

ALUM	Aluminum	OYST	Oyster
BLK	Black	SUGC	Sugar Cookie
MIST	Mist		

CERTIFICATIONS & COMPLIANCE

- Intertek Sustainability Certified
- BIFMA level® Certified
- BIFMA Compliant® Certified
- TSCA Title VI (CARB) Compliance
- US Green Building's LEED® Contribution

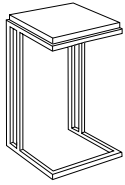

410-1412AT:
Auxiliary Table
[\(See Details\)](#)

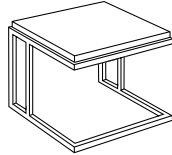

Square End Tables
410-1818ET: 18"
410-2424ET: 24"
[\(See Details\)](#)

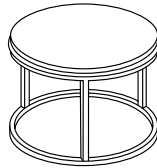

410-2020CT:
Circular End Table
[\(See Details\)](#)

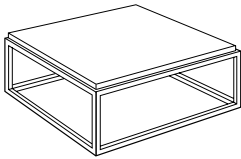

410-3636SQ:
Square Cocktail
Table
[\(See Details\)](#)

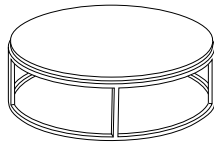

410-3636CT:
Circular Cocktail
Table
[\(See Details\)](#)

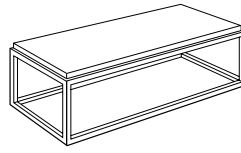

410-2248MT:
Rectangular Cocktail
Table
[\(See Details\)](#)

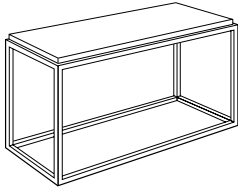

410-1848ST:
Console Table
[\(See Details\)](#)

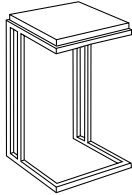
Item	Model No.		W	D	H	Ship Wt	Cubic Ft	List Price
AUXILIARY TABLE 	410-1412AT	TFL	12½	14	26½	46	8.6	T\$Bad Tag!
		Veneer						W\$Bad Tag!
		Solid Surface						S\$Bad Tag!

Description

- Standard with: Decorative Metal Base and Nylon Glides
- Select Your Choice of TFL (T), Veneer (W), or Solid Surface (S) Top
- [See Top Options, Base Color Options and Specify](#)

Must Specify (in this order):

Model #
Top Material
Finish/Color
Edge Profile (if applicable)
Base Color

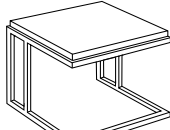
Item	Model No.		W	D	H	Ship Wt	Cubic Ft	List Price
SQUARE END TABLE 	410-2424ET	TFL	24	24	20	46	8.6	T\$ 1238
		Veneer						W\$ 1512
		Solid Surface						S\$ 2677
	410-1818ET	TFL	18	18	20	34	5.1	T\$ 1156
		Veneer						W\$ 1363
		Solid Surface						S\$ 2226

Description

- Standard with: Decorative Metal Base and Nylon Glides
- Select Your Choice of TFL (T), Veneer (W), or Solid Surface (S) Top
- [See Top Options, Base Color Options and Specify](#)

Must Specify (in this order):

Model #
Top Material
Finish/Color
Edge Profile (if applicable)
Base Color

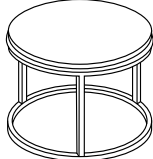
Item	Model No.		W	D	H	Ship Wt	Cubic Ft	List Price
CIRCULAR END TABLE 	410-2020CT	TFL	20	20	20	36	6.2	T\$ 1123
		Veneer						W\$ 1434
		Solid Surface						S\$ 4183

Description

- Standard with: Decorative Metal Base and Adjustable Levelers
- Select Your Choice of TFL (T), Veneer (W), or Solid Surface (S) Top
- [See Top Options, Base Color Options and Specify](#)

Must Specify (in this order):

Model #
Top Material
Finish/Color
Edge Profile (if applicable)
Base Color

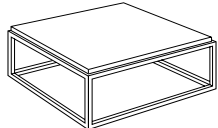
Item	Model No.		W	D	H	Ship Wt	Cubic Ft	List Price
SQUARE COCKTAIL TABLE 	410-3636SQ	TFL	36	36	15	68	13.4	T\$ 1483
		Veneer						W\$ 1794
		Solid Surface						S\$ 4439

Description

- Standard with: Decorative Metal Base and Nylon Glides
- Select Your Choice of TFL (T), Veneer (W), or Solid Surface (S) Top
- [See Top Options, Base Color Options and Specify](#)

Must Specify (in this order):

Model #
Top Material
Finish/Color
Edge Profile (if applicable)
Base Color

T = TFL W = Veneer S = Solid Surface

[See Intro Overview For Ordering Options](#)

Item	Model No.		W	D	H	Ship Wt	Cubic Ft	List Price
RECTANGULAR COCKTAIL TABLE	410-2248MT	TFL	48	22	15	92	11.0	T\$ 1413
		Veneer						W\$ 1672
		Solid Surface						S\$ 3632

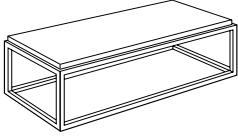

Must Specify (in this order):

Model #
Top Material
Finish/Color
Edge Profile (if applicable)
Base Color

Description

- Standard with: Decorative Metal Base and Nylon Glides
- Select Your Choice of TFL (T), Veneer (W), or Solid Surface (S) Top
- [See Top Options, Base Color Options and Specify](#)

CIRCULAR COCKTAIL TABLE	410-3636CT	TFL	36	36	15	68	13.4	T\$ 1402
		Veneer						W\$ 1782
		Solid Surface						S\$ 6393

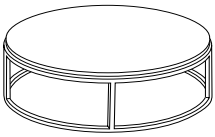

Must Specify (in this order):

Model #
Top Material
Finish/Color
Edge Profile (if applicable)
Base Color

Description

- Standard with: Decorative Metal Base and Adjustable Levelers
- Select Your Choice of TFL (T), Veneer (W), or Solid Surface (S) Top
- [See Top Options, Base Color Options and Specify](#)

CONSOLE TABLE	410-1848ST	TFL	48	18	28	86	17.4	T\$ 1520
		Veneer						W\$ 1808
		Solid Surface						S\$ 3442

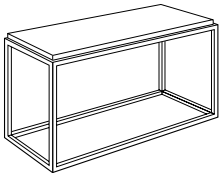

Must Specify (in this order):

Model #
Top Material
Finish/Color
Edge Profile (if applicable)
Base Color

Description

- Standard with: Decorative Metal Base and Adjustable Levelers
- Select Your Choice of TFL (T), Veneer (W), or Solid Surface (S) Top
- [See Top Options, Base Color Options and Specify](#)

T = TFL W = Veneer S = Solid Surface

[See Intro Overview For Ordering Options](#)

Create a variety of looks from refined transitional to clean contemporary with an abundance of finishes and edge details. Madera features ultra violet finish for long lasting beauty in corporate environments, as well as a premium veneer option, which offers a grade of veneer exceeding the general commercial market standards.

CONSTRUCTION

- Choose from premium veneer or select veneer on exposed surfaces in American Black Walnut, White Oak, Cherry, or Maple species
- Veneer tops are available in the 6 edge profiles and have a 5-ply balanced construction, 1 $\frac{3}{16}$ " thick, with hardwood rims
- High pressure laminate (HPL) tops have a 3-ply balanced construction, 1 $\frac{3}{16}$ " thick, with solid hardwood rims
- Grain direction runs left to right
- All units ship with heavy duty, adjustable leveling glides to ensure proper leveling and compensation for uneven floors
- Ships fully assembled

HOW TO ORDER EXAMPLE

Model No.	Description	Example
14-1824ET	Top Material	W
	Finish	AW
	Edge Profile	X

VENEER (W) AND PREMIUM VENEER (PV) OPTIONS

Veneer tops feature UVAdvantage, an ultra-violet finish, on all exposed surfaces by utilizing roll-coat UV technology.

AS	Asian Night	MW	Mahogany Walnut
AW	Artisan Walnut	MAS	Mesa Sunset
CO	Columbian Walnut	MTS	Metropolis Sky
DC	Dark Cherry	ORW	Oak Riftwood
DFW	Dark Forest Walnut	PNW	Pinnacle Walnut
EW	Espresso	SCH	Select Cherry
FO	Fawn Oak*	SKC	Shaker Cherry
GC	Golden Cherry	SM	Sugar Maple
HW	Harvest Walnut	WC	Williamsburg Cherry
HNW	Henna Walnut	WTA	Weathered Ash
LW	Legacy Walnut		

* Finish is Low Sheen

HPL (P) LAMINATE OPTIONS

AS	Asian Night	PNW	Pinnacle Walnut
CO	Columbian Walnut	SCH	Select Cherry
EF	Espresso	SKC	Shaker Cherry
GC	Golden Cherry	SM	Sugar Maple
MW	Mahogany Walnut	WC	Williamsburg Cherry
ORW	Oak Riftwood	WTA	Weathered Ash

TABLE EDGE PROFILE

- B Bevel
- D Bullnose
- A Radius
- Y Square
- E Tri-Round

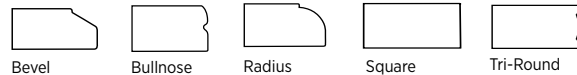

CERTIFICATIONS & COMPLIANCE

- Intertek Sustainability Certified
- BIFMA level® Certified
- BIFMA Compliant® Certified
- TSCA Title VI (CARB) Compliance
- US Green Building's LEED® Contribution

STATEMENT OF LINE

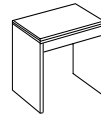

End Table:
14-1824ET
[\(See Details\)](#)

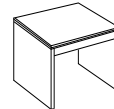

Lamp Table:
14-2828LT
[\(See Details\)](#)

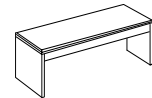

Magazine Table:
14-1847MT
[\(See Details\)](#)

Item	Model No.		W	D	H	Ship Wt	Cubic Ft	List Price	
END TABLE	14-1824ET	Veneer or HPL	24	18	21 ¹ / ₆	48	7.6	W/P\$	1319
		Premium Veneer						PV\$	1545

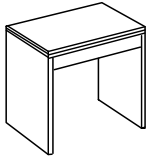

Description

- Standard with: Left to Right Grain Direction on Worksurface, Vertical Grain Direction on Solid End Panels
- Available in Premium Veneer (PV) or Standard Veneer (W); Must Specify
- Available with Veneer (PV/W) or HPL (P) Top; Must Specify
- Ships Assembled

Must Specify (in this order):

- Model
- Premium or Standard Veneer
- Chassis
- Top Material
- Finish/Color
- Edge Profile

LAMP TABLE	14-2828LT	Veneer or HPL	28	28	21 ¹ / ₆	56	12.3	W/P\$	1708
		Premium Veneer						PV\$	2002

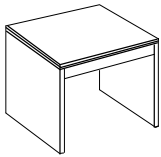

Description

- Standard with: Left to Right Grain Direction on Worksurface, Vertical Grain Direction on Solid End Panels
- Available in Premium Veneer (PV) or Standard Veneer (W); Must Specify
- Available with Veneer (PV/W) or HPL (P) Top; Must Specify
- Ships Assembled

Must Specify (in this order):

- Model
- Premium or Standard Veneer
- Chassis
- Top Material
- Finish/Color
- Edge Profile

MAGAZINE TABLE	14-1847MT	Veneer or HPL	47	18	15 ¹ / ₆	75	9.9	W/P\$	1442
		Premium Veneer						PV\$	1688

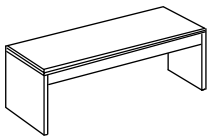

Description

- Standard with: Left to Right Grain Direction on Worksurface, Vertical Grain Direction on Solid End Panels
- Available in Premium Veneer (PV) or Standard Veneer (W); Must Specify
- Available with Veneer (PV/W) or HPL (P) Top; Must Specify
- Ships Assembled

Must Specify (in this order):

- Model #
- Top Material
- Finish/Color
- Edge Profile



Bevel Bullnose Radius Square Tri-Round

P = HPL W = Veneer PV = Premium Veneer

See Intro Overview For Ordering Options

In partnership with Edge Design, a UK-based company, we welcome Me, Myself & I.

With the growth of open and breakout areas in the working environments, Me, Myself & I provides a relaxed and collective seating and tables solution.

CONSTRUCTION

- Exposed parts are manufactured using European Beech
- Joints are double-doweled or mortised and tenoned, screwed, and glued for maximum strength and durability
- Frames are individually hand assembled and sanded prior to being finished; Legs are 9¾"H on the rectangular table and 14"H on the square table
- Non-marring nylon glides included in each leg at floor level
- Tables have 1½" thick HPL surface with 1mm PVC edge band
- Square edge profile; Designer White, Sugar Maple, and Williamsburg Cherry feature ABS rims
- Ships fully assembled

HOW TO ORDER EXAMPLE

Model No.	Description	Example
MMIT-2	Leg Finish	BW
	Top Color	WH

HPL (P) LAMINATE OPTIONS ON TABLE TOPS

WOODGRAIN

AS	Asian Night	PTK	Portico Teak
BW	Beigewood	RC	River Cherry
CO	Columbian Walnut	SCH	Select Cherry
EF	Espresso	SPW	Sepia Walnut
FLW	Florence Walnut	SKC	Shaker Cherry
GC	Golden Cherry	SBP	Smoky Brown Pear
KHE	Kirsche	TK	Studio Teak
MW	Mahogany Walnut	SM	Sugar Maple
MNR	Midnight Run	WTA	Weathered Ash
NTM	Natural Marrone	WNB	White Nebbia
ORW	Oak Riftwood	WC	Williamsburg Cherry
PNW	Pinnacle Walnut		

SOLID

WH	Designer White
----	----------------

WOOD FINISHES AVAILABLE ON LEGS

AW	Artisan Walnut	MAS	Mesa Sunset
AS	Asian Night	MTS	Metropolis Sky
BW	Beigewood*	MNR	Midnight Run
BL	Black	NTM	Natural Marrone
CO	Columbian Walnut	ORW	Oak Riftwood*
DC	Dark Cherry	PNW	Pinnacle Walnut
DFW	Dark Forest Walnut*	PTK	Portico Teak
WH	Designer White	RC	River Cherry
EF	Espresso	SCH	Select Cherry
FO	Fawn Oak*	SPW	Sepia Walnut
FLW	Florence Walnut	SKC	Shaker Cherry
GC	Golden Cherry	SBP	Smoky Brown Pear
HW	Harvest Walnut	TK	Studio Teak
HNW	Henna Walnut	SM	Sugar Maple
KHE	Kirsche	WTA	Weathered Ash*
LW	Legacy Walnut	WNB	White Nebbia
MW	Mahogany Walnut	WC	Williamsburg Cherry

* Finish is Low Sheen

TABLE EDGE PROFILE



Square

CERTIFICATIONS & COMPLIANCE

- Intertek Sustainability Certified
- BIFMA level® Certified
- BIFMA Compliant® Certified
- TSCA Title VI (CARB) Compliance
- US Green Building's LEED® Contribution

STATEMENT OF LINE

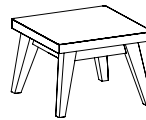

MMIT-1:
Square Table
[\(See Details\)](#)

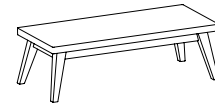

MMIT-2:
Rectangle Table
[\(See Details\)](#)

Item	Model No.	W	D	H	Ship Wt	Cubic Ft	List Price
SQUARE TABLE	MMIT-1	22	22	16	31	10.8	\$ 979

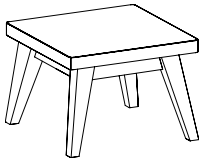

Description

- Features Square Edge Profile
- Available with Contrasting Top and Leg Color

Must Specify (in this order):

Model #
Leg Finish
Top Color

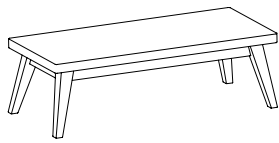
RECTANGLE TABLE	MMIT-2	51	22	16	66	25.9	\$ 1334
-----------------	--------	----	----	----	----	------	---------

Description

- Features Square Edge Profile
- Available in Contrasting Surface and Leg Color

Must Specify (in this order):

Model #
Leg Finish
Top Color



Square

[See Intro Overview For Ordering Options](#)

Crafted in American veneers, Phoenix's clean, transitional styling is at ease in both contemporary and traditional settings. It is a perfect choice for value-minded companies who want a sophisticated, yet uncomplicated, solution.

CONSTRUCTION

- Veneers on exposed surfaces are select grade sliced American Black Walnut and Cherry, and are carefully selected and matched to assure proper balance and consistency
- Veneer tops are 5-ply balanced construction and 1 $\frac{1}{32}$ " thick. High pressure laminate (HPL) tops are 3-ply balanced construction and 1 $\frac{1}{32}$ " thick
- Grain direction runs left to right
- All units ship with heavy duty, adjustable leveling glides to ensure proper leveling and compensation for uneven floors
- Some assembly required

HOW TO ORDER EXAMPLE

Model No.	Description	Example
21-1847MT	Top Material	P
	Finish	SKC

VENEER (W) OPTIONS

Veneer features UVAdvantage, an ultra-violet finish, on all exposed surfaces by utilizing roll-coat UV technology. Apron rails and table legs use a multi-step, hand finished process with a catalyzed finish.

AW	Artisan Walnut	LW	Legacy Walnut
CO	Columbian Walnut	MW	Mahogany Walnut
DC	Dark Cherry	MTS	Metropolis Sky
DFW	Dark Forest Walnut	PNW	Pinnacle Walnut
EW	Espresso	SCH	Select Cherry
GC	Golden Cherry	SKC	Shaker Cherry
HW	Harvest Walnut	WC	Williamsburg Cherry
HNW	Henna Walnut		

HPL (P) TOP OPTIONS

CO	Columbian Walnut	PNW	Pinnacle Walnut
EF	Espresso	SCH	Select Cherry
GC	Golden Cherry	SKC	Shaker Cherry
MW	Mahogany Walnut	WC	Williamsburg Cherry

TABLE EDGE PROFILE



Phoenix

CERTIFICATIONS & COMPLIANCE

- Intertek Sustainability Certified
- BIFMA level® Certified
- BIFMA Compliant® Certified
- TSCA Title VI (CARB) Compliance
- US Green Building's LEED® Contribution

STATEMENT OF LINE

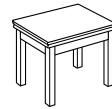

21-1824ET:
End Table
([See Details](#))

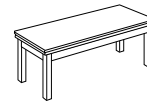

21-1847MT:
Magazine Table
([See Details](#))

Item	Model No.		W	D	H	Ship Wt	Cubic Ft	List Price
END TABLE	21-1824ET	HPL	18	24	22	25	2.0	P\$ 897
		Veneer						W\$ 947

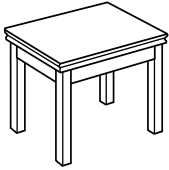

Description

- Available with Veneer (W) or HPL (P) Top, Must Specify
- Some Assembly Required

Must Specify (in this order):

Model #
Top Material
Finish/Color

MAGAZINE TABLE	21-1847MT	HPL	47	18	16	42	3.4	P\$ 1169
		Veneer						W\$ 947

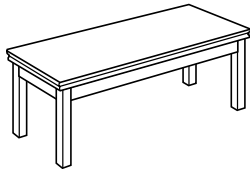

Description

- Available with Veneer (W) or HPL (P) Top, Must Specify
- Some Assembly Required
- Optional 30" Leg; See Below

Leg Option: Specify & Add

30H-2SQ	30"H Legs					20	0.9	\$ 215
---------	-----------	--	--	--	--	----	-----	--------

Must Specify (in this order):

Model #
Top Material
Finish/Color
Leg



Phoenix

P = HPL W = Veneer

[See Intro Overview For Ordering Options](#)

Plush Lounge seamlessly brings together the endurance needed for commercial spaces with the relaxed comforts of home. Introducing a smart range of freestanding and modular seating components, along with coordinating tables, that provide the flexibility and comfort needed in today's ever-changing environments.

CONSTRUCTION

- Exposed wood parts are kiln-dried hardwoods, selected from the highest grades of plain sliced hardwood veneers and are free of spirits, discoloration, pits, shakes, and wormholes
- Joints are mortised and tenoned, screwed, and glued for maximum strength and durability
- Maple Wood Legs are 2"Wx2½Dx6"H; Metal Legs are 2"Wx2"Dx6"H
- Non-marring adjustable nylon glides included at floor level
- Table tops are ¾" thick and feature a vertical square profiled edge

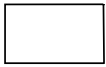

- Ships fully assembled

HOW TO ORDER EXAMPLES

TABLE

620-2445CT	Top Material	W
	Finish/Color	ORW
	Cabinet Accent	CAPPD
	Leg	PLALUM
	Leg Finish	-
	Power Location	C
	Power	01-DUOBEZELS

TABLE LEG OPTIONS

Plush cocktail table comes standard with Black or Aluminum Metal legs. Optional Wood Leg matches our Iconic Caseloads Collection. Must Specify Leg and Color.

PLBLK	Black Metal Leg	STD
PLALUM	Aluminum Metal Leg	STD
ICON	Wood Leg (<i>Matches the Iconic Collection</i>)	\$ 316

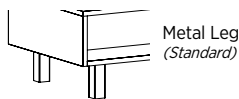

LEG WOOD FINISHES

Indiana Furniture uses a multi-step, hand finishing process on all exposed wood. Table legs feature a catalyzed varnish finish which offers durability, lasting beauty, and resistance to normal wear.

AW	Artisan Walnut	LW	Legacy Walnut
AS	Asian Night	MW	Mahogany Walnut
BW	Beigewood*	MO	Medium Oak*
BL	Black	ORW	Oak Riftwood*
CO	Columbian Walnut	PNW	Pinnacle Walnut
DC	Dark Cherry	SCH	Select Cherry
DFW	Dark Forest Walnut*	SKC	Shaker Cherry
WH	Designer White	SBP	Smoky Brown Pear*
EW	Espresso	TK	Studio Teak
FO	Fawn Oak*	SM	Sugar Maple
GC	Golden Cherry	SW	Sunglow Walnut
HVM	Harvest Maple*	WTA	Weathered Ash*
HW	Harvest Walnut	WC	Williamsburg Cherry

*Finish is Low Sheen

VENEER TABLES WITH VENEER (W) OR HPL (P) TOP OPTIONS

Veneer tables feature UV Advantage, an ultra-violet finish, on all exposed surfaces by utilizing roll-coat UV technology.

Veneer tables available with Veneer (W) or HPL (P) Top. Must specify Top Material and Finish Color. Tables are available with contrasting chassis and leg colors.

AW	Artisan Walnut	MW	Mahogany Walnut**
AS	Asian Night**	MAS	Mesa Sunset
CO	Columbian Walnut**	MTS	Metropolis Sky
DC	Dark Cherry	ORW	Oak Riftwood*, **
DFW	Dark Forest Walnut	PNW	Pinnacle Walnut**
EF	Espresso**	SCH	Select Cherry**
FO	Fawn Oak*	SKC	Shaker Cherry**
GC	Golden Cherry**	SBP	Smoky Brown Pear**
HW	Harvest Walnut	SM	Sugar Maple**
HNW	Henna Walnut	WTA	Weathered Ash*, **
LW	Legacy Walnut	WC	Williamsburg Cherry**

*Finish is Low Sheen

**HPL Color Options with Veneer Tables

TFL TABLES WITH TFL (T) OR HPL (P) TOP OPTIONS

TFL tables available with TFL (T) or HPL (P) Top. Must specify Top Material and Color.

WOODGRAIN

AS	Asian Night	PNW	Pinnacle Walnut
BW	Beigewood	PTK	Portico Teak
CO	Columbian Walnut	RC	River Cherry
EF	Espresso	SCH	Select Cherry
FLW	Florence Walnut	SKC	Shaker Cherry
GC	Golden Cherry	SPW	Sepia Walnut
HVM	Harvest Maple	SBP	Smoky Brown Pear
KHE	Kirsche	TK	Studio Teak
MW	Mahogany Walnut	SM	Sugar Maple
MNR	Midnight Run	WTA	Weathered Ash
NTM	Natural Marrone	WNB	White Nebbia
ORW	Oak Riftwood	WC	Williamsburg Cherry

SOLID

BL	Black	WH	Designer White
----	-------	----	----------------

INTERIOR CABINET TABLE ACCENT HPL (P) OPTIONS

Select Veneer tables feature an optional interior HPL accent color. See specific veneer tables for details.

CABL	Black	CAPPD	Pepperdust
CABSH	Blush	CASG	Slate Grey
CAWH	Designer White	CASV	Summer Vacation
CAENL	Enamel	CASUS	Surfin USA
CAFHG	Fashion Grey	CAWHS	White Sand
CAFK	First Kiss		

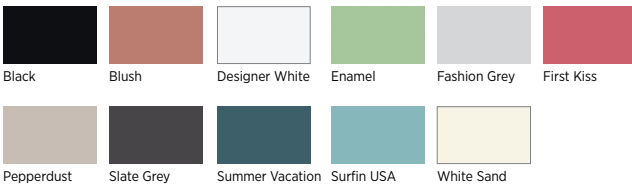

TABLE POWER OPTIONS

Power Options + Locations: Specify the grommet, power, and location.







Grommet		<i>Specify</i>		\$ 50
	Black	GBR60		
	Silver	GSR60		
Additional Power and Grommet Accessories, See Plush seating section				
D150 Wireless Charger				\$ 391
Wireless & Three (3) USB Ports				
	Black	01-DOCK150B		
	White	01-DOCK150W		
D950 Wireless & USB Charger				\$ 256
Wireless Charging				
	Black	01-DOCK950B		
	White	01-DOCK950W		
ECA Cove				\$ 942
One (1) Electrical Power and Two (2) USB Outlets				
	Black	01-COVIUBL		
	Silver	01-COVIUAL		

TABLE POWER OPTIONS CONTINUE

DUOBEZEL			\$ 652
Two (2) Electrical Power and Two (2) USB Outlets			
	Black	01-DUOBEZELB	
	White	01-DUOBEZELS	
	Silver	01-DUOBEZELW	

TRIOBEZEL			\$ 700
Three (3) Electrical Power, Two (2) USB Outlets, and One (1) Open Data Port			
	Black	01-TRIOBEZELB	
	White	01-TRIOBEZELS	
	Silver	01-TRIOBEZELW	

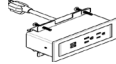
Open Port Options for TRIOBEZEL

VGA Data Port	01-LCOMVGA	\$ 117
HDMI Data Port (Open Market Only)	01-LCOMHDMI	\$ 160
RJ45 Data Port	01-LCOMRJ45	\$ 76

DPORT4			\$ 1056
--------	--	--	---------

Two (2) USB Outlets, and Two (2) Open Data Port

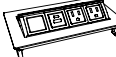
Aluminum	01-DPORT4A	
Black	01-DPORT4B	

Port Options for DPORTS

USB Port	01-USBPORT	\$ 156
Voice Coupler	01-VOICE1	\$ 71
Data Port	01-RJ4DATA	\$ 161

TABLE POWER LOCATIONS

NONE	None	LC	Left and Centered
C	Centered	RC	Right and Centered
R	Right	LR	Left and Right
L	Left	LCR	Left, Right and Centered

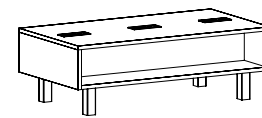

L/R: 6" from ends and 12" from front

C: 22½" from ends and 12" from front

All power options available in Left, Right and Center.

Cocktail Table Shown with Metal Leg and Three TRIOBEZEL on Left and Right and Center

CERTIFICATIONS & COMPLIANCE

- CAL 117-2013 Compliance
- Intertek Sustainability Certified
- BIFMA level® Certified
- BIFMA Compliant® Certified
- TSCA Title VI (CARB) Compliance
- US Green Building's LEED® Contribution

Item	Model No.		W	D	H	Ship Wt	Cubic Ft	List Price	
 COCKTAIL TABLE	620-2445CT	Veneer/HPL	45	24	15	77	9.4	W/P\$	2096
		Veneer Chassis							
	620-2445CTT	TFL	45	24	15	77	9.4	T\$	1280
		TFL Chassis						P\$	1398
		HPL							

Shown with Metal Leg

Must Specify (in this order):

- Model #
- Top Material
- Finish/Color
- Cabinet Accent Color (Veneer Only)
- Leg
- Leg Finish/Color
- Power Location
- Power

Description

- Standard with: Metal Legs
- Chassis Available in Veneer (W) or TFL (T)
- Top Available with Veneer (W), TFL (T) or HPL (P), Must Specify
- Primary Finish and Wood Legs Available in Contrasting Finish Colors
- 9"D Cubby Area on Both Sides of the Table
- Optional Cabinet Interior Accent Color on Veneer Tables Only; Must Specify Color, [See Color Options](#)
- Optional Wood Leg ([See Color Options](#)) and Power ([See Power Options](#))

Veneer Table Cabinet Accent Option: Specify Color & Add

Interior Cabinet Table Accent Color	Available on Veneer Tables Only; See Color Options	\$	185
-------------------------------------	--	----	-----

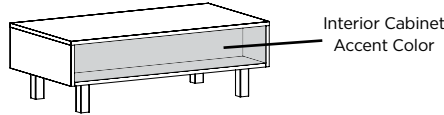

In partnership with Edge Design, a UK-based company, we welcome Spirit.

Spirit has a refined and inviting form, and capitalizes on versatility and comfort. Complete your waiting area, welcoming lobby, or office space with Spirit tables.

CONSTRUCTION

- Non-marring nylon glides included in each leg at floor level
- Tables have 1" TFL or 1½" HPL surface thickness with 1mm PVC edge band and Square edge profile; Designer White, Sugar Maple, and Williamsburg Cherry feature ABS rims
- Bases are comprised of bent wire frames or hardwood legs securely attached to a metal substructure.
- Black or Aluminum Powder Coat, and Chrome wireframes
- Ships fully assembled

HOW TO ORDER EXAMPLE

Model No.	Description	Example
ST11C	Top Color	WTA
	Base	STWFA

TFL (T) AND HPL (P) LAMINATE TABLE OPTIONS

WOODGRAIN

AS	Asian Night	PNW	Pinnacle Walnut
BW	Beigewood	PTK	Portico Teak
CO	Columbian Walnut	RC	River Cherry
EF	Espresso	SCH	Select Cherry^
FLW	Florence Walnut	SPW	Sepia Walnut
GC	Golden Cherry^	SKC	Shaker Cherry
KHE	Kirsche	SBP	Smoky Brown Pear
MW	Mahogany Walnut^	TK	Studio Teak
MNR	Midnight Run	SM	Sugar Maple
NTM	Natural Marrone	WTA	Weathered Ash
ORW	Oak Riftwood	WNB	White Nebbia
		WC	Williamsburg Cherry

^ Color is available in HPL only

SOLID

BL	Black	FHG	Fashion Grey
WH	Designer White	SG	Slate Grey

TABLE BASE OPTIONS

Not all bases are available on each model. Check availability on pricing pages.

STWFA	Wireframe, Aluminum	N/C
STWFB	Wireframe, Black	N/C
STWFC	Wireframe, Chrome	\$ 57
SLBO	4-Star Wood Base, Blonde Oak	N/C
SLSPW	4-Star Wood Base, Spiced Walnut	N/C

TABLE EDGE PROFILE



Square

CERTIFICATIONS & COMPLIANCE

- Intertek Sustainability Certified
- BIFMA level® Certified
- BIFMA Compliant® Certified
- TSCA Title VI (CARB) Compliance
- US Green Building's LEED® Contribution

STATEMENT OF LINE



Spirit Square Table

ST11C: TFL
ST11CH: HPL
([See Details](#))

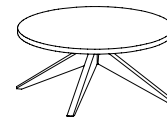

Spirit Round Table

SLT-1W: TFL
SLT-1WH: HPL
([See Details](#))

Item	Model No.		W	D	H	Ship Wt	Cubic Ft	List Price	
SPIRIT SQUARE TABLE	ST11C	TFL	27	27	17	31	11.4	T\$	821
	ST11CH	HPL	27	27	17	31	11.4	P\$	991

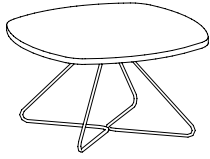

Must Specify (in this order):

- Model #
- Top Color
- Base Color

Description

- Standard with: 1" TFL Top or 1½" HPL Top and Wireframe Base; Must Specify Color
- Features Square Edge Profile

Leg Option: Specify & Add

STWFA	Wireframe, Aluminum	N/C
STWFB	Wireframe, Black	N/C
STWFC	Wireframe, Chrome	\$ 57

SPIRIT ROUND TABLE	SLT-1W	TFL	31½	31½	14½	31	11.4	T\$	1447
	SLT-1WH	HPL	31½	31½	14½	31	11.4	P\$	1604

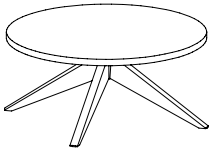

Must Specify (in this order):

- Model #
- Top Color
- Base Color

Description

- Standard with: 1" TFL Top or 1½" HPL Top and 4-Star Swivel Wood Base (Select Blonde Oak or Spiced Walnut)
- Features Square Edge Profile



Square

T = TFL P = HPL

[See Intro Overview For Ordering Options](#)

PLEDGE

Space Division

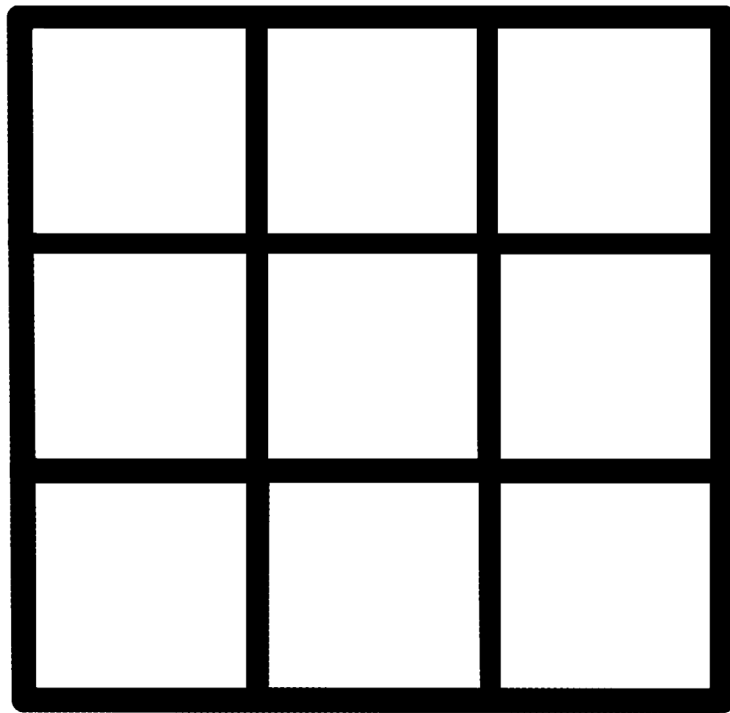

Our functional range of screens and dividers make it easy to create space division within any environment, on nearly any product. Simply add screens to your worksurface, training table, and/or reception desk to create privacy, add protection, or further define personal space.

CONSTRUCTION
ACRYLIC PANELS/SCREENS/DIVIDERS

- Clear and Frosted Acrylics are ¼" thick, while High Gloss Acrylics are ¾" thick; cut to size and machined for a clean finish

TFL PANELS/SCREENS/DIVIDERS

- Made of woodgrain and solid color laminates fused to particle-board core
- Privacy Panels and Above/Below Screens are ¾" thick
- Gallery Screens are 1" thick
- Each laminate offers lasting beauty, superior resistance to normal wear, and easy maintenance

VENEER PANELS/SCREENS/DIVIDERS

- Made of select-grade, plain sliced hardwood Cherry, Maple, American Black Walnut, White Oak, or composite veneers; selected and matched to assure proper balance and consistency
- Privacy Panels and Above/Below Screens are ¾" thick
- Gallery Screens are 1" thick
- Veneers feature Indiana Furniture's sustainable UVAdvantage, an ultra-violet topcoat finish, on all exposed surfaces by utilizing roll-coat UV technology

WIRE MANAGEMENT

- Grommets may be specified for 51"H Straight Floorstanding Gallery Screens, and are available in black or silver

CERTIFICATIONS & COMPLIANCE

- CAL 117-2013 Compliance
- Intertek Sustainability Certified
- BIFMA level® Certified
- BIFMA Compliant Certified
- TSCA Title VI (CARB) Compliance
- US Green Building's LEED Contribution

HOW TO ORDER EXAMPLES

SCREEN	QTY	MODEL NO.	DESCRIPTION	EXAMPLE
DIVIDER	2	01-4224SDCA		

ABOVE & BELOW	QTY	MODEL NO.	DESCRIPTION	EXAMPLE
	1	01-6235ABA	Hardware	ALUM

PRIVACY PANEL	QTY	MODEL NO.	DESCRIPTION	EXAMPLE
	4	01-5624PPA	Hardware	CHRM

GALLERY SCREEN	QTY	MODEL NO.	DESCRIPTION	EXAMPLE
	4	65-5173GS	Finish	WTA
			Grommet	DGL, BL
			Grommet	DGR, BL
			Grommet	DGC, BL

SUPPORT BLOCKS/ATTACHMENT HARDWARE COLOR OPTIONS

ALUM Aluminum
 CHRM Chrome

TFL (T) LAMINATE OPTIONS
WOODGRAIN

AS	Asian Night	PTK	Portico Teak
BW	Beigewood	RC	River Cherry
CO	Columbian Walnut	SPW	Sepia Walnut
EF	Espresso	SKC	Shaker Cherry
FLW	Florence Walnut	SBP	Smoky Brown Pear
KHE	Kirsche	TK	Studio Teak
MNR	Midnight Run	SM	Sugar Maple
NTM	Natural Marrone	WTA	Weathered Ash
ORW	Oak Riftwood	WC	Williamsburg Cherry
PNW	Pinnacle Walnut	WNB	White Nebbia

SOLID

BL	Black	FHG	Fashion Grey
WH	Designer White	SG	Slate Grey

VENEER (W) OPTIONS

AW	Artisan Walnut	MW	Mahogany Walnut
AS	Asian Night	MAS	Mesa Sunset*
CO	Columbian Walnut	MTS	Metropolis Sky
DC	Dark Cherry	PNW	Pinnacle Walnut
DFW	Dark Forest Walnut	ORW	Oak Riftwood*
EW	Espresso	SCH	Select Cherry
FO	Fawn Oak*	SKC	Shaker Cherry
GC	Golden Cherry	SM	Sugar Maple
HW	Harvest Walnut	WTA	Weathered Ash*
HNW	Henna Walnut	WC	Williamsburg Cherry
LW	Legacy Walnut		

* Finish is Low Sheen

HIGH GLOSS ACRYLIC OPTIONS

BLA	Black High Gloss Acrylic
GPA	Graphite High Gloss Acrylic (upcharge)
WHA	White High Gloss Acrylic

GALLERY SCREEN GROMMET OPTIONS & LOCATIONS

Multiple grommets may be ordered for each screen.
 Must Specify Model and Color: Black (BLK) or Silver (SLV).

51"H Gallery Screens

DGL	Desk Height Left; 6" from end, 5¼" from bottom	\$ 50
DGR	Desk Height Right; 6" from end, 25¼" from bottom	\$ 50
DGC	Desk Height Center; 25¼" from bottom	\$ 50
BGL	Bench Height Left; 6" from end, 15" from bottom	\$ 50
BGR	Bench Height Right; 6" from end, 15" from bottom	\$ 50
BGC	Bench Height Center; 15" from bottom	\$ 50

Grommets may be ordered in non-standard locations. Call Customer Service to assist with specification. Note additional charges and lead times may apply.

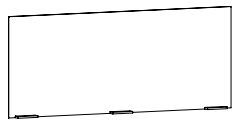

24"H Privacy Panels
 Available in Clear and Frosted Acrylic
 ([See Details](#))

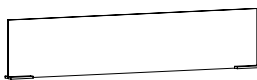

12"H Privacy Panels
 Available in Frosted and High Gloss
 Acrylic, TFL, and Veneer
 ([See Details](#))

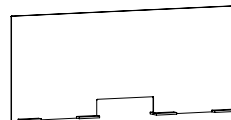

24"H Privacy Panels with Transaction Slot
 Available in Clear Acrylic
 ([See Details](#))



24"H Screen Dividers
 Available in Clear and Frosted Acrylic
 ([See Details](#))

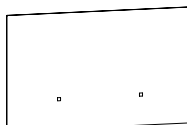

33"H Above & Below Screens
 Available in Frosted Acrylic
 ([See Details](#))

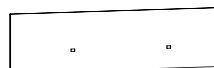

21"H Above & Below Screen
 Available in Frosted and High Gloss
 Acrylic, TFL, and Veneer
 ([See Details](#))



20"H Above & Below Screens
 Available in Frosted and High Gloss
 Acrylic, Tackboard, TFL, and Veneer
 ([See Details](#))



17"H Above & Below Screens
 Available in Frosted and High Gloss
 Acrylic, Tackboard, TFL, and Veneer
 ([See Details](#))



2-Way & 3-Way Connector Clips
 Corner, T, and Straight Connectors for
 Clear and Frosted Acrylic Options
 ([See Details](#))

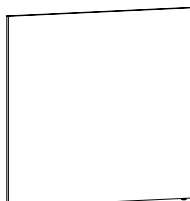

51"H Straight Gallery Screens
 Available in TFL and Veneer
 ([See Details](#))

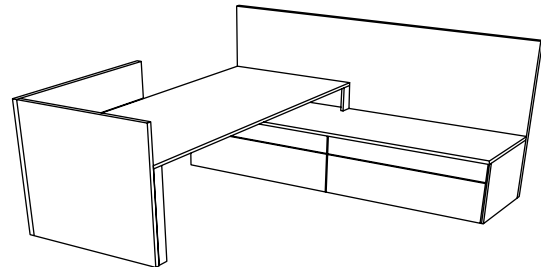
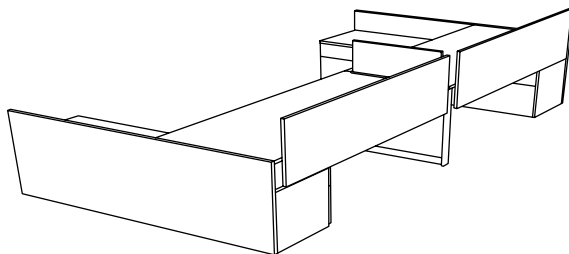
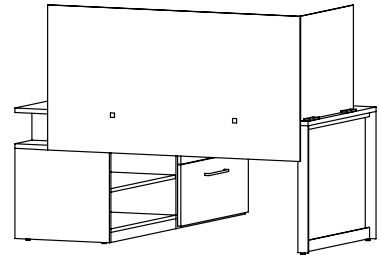
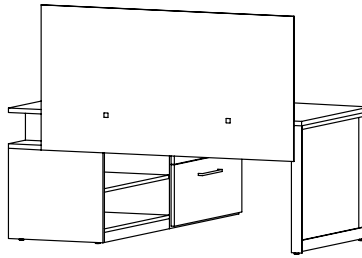
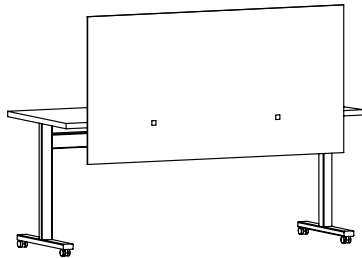
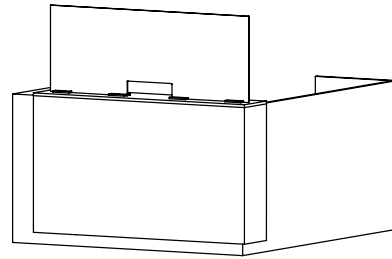
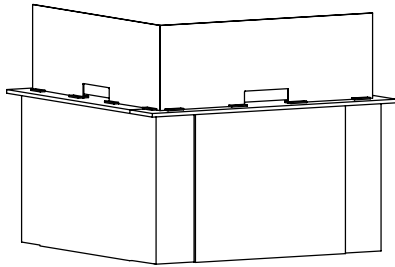
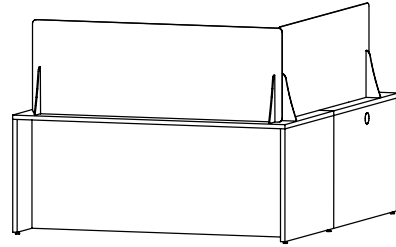
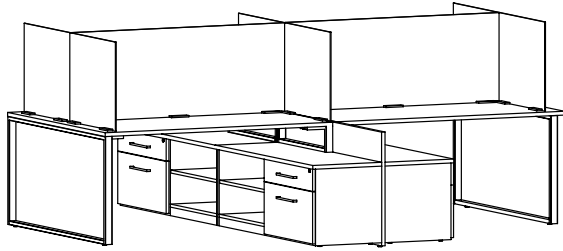

Item	Model No.		W	D	H	Ship Wt	Cubic Ft	List Price	
24"H PRIVACY PANELS 	01-6224PPCA	Clear	62	¼	23½	13.9	2.1	C\$	1123
	01-6224PPA	Frosted						F\$	1408
	01-5624PPCA	Clear	56	¼	23½	11.5	1.9	C\$	1051
	01-5624PPA	Frosted						F\$	1313
	01-2824PPCA	Clear	28	¼	23½	5.8	1.4	C\$	663
	01-2824PPA	Frosted						F\$	803
	01-2224PPCA	Clear	22	¼	23½	4.8	1.2	C\$	593
	01-2224PPA	Frosted						F\$	708

Description

- Sets on Surface; Comes with Non-Marring, Removable Adhesive Strip for Surface Attachment
- Available in Clear or Frosted Acrylic
- Acrylic Connector Clips are Recommended for Support on 90° Corner, T Shaped and Straight Applications, [See Connector Clip Details](#)
- Decorative Support Blocks; Must Specify: Aluminum (ALUM) or Chrome (CHRM)
- Some Assembly Required

Item	Model No.		W	D	H	Ship Wt	Cubic Ft	List Price	
12"H PRIVACY PANELS 	66-6812PPA	Frosted	68	¼	12	8	2.2	F\$	949
	66-6812PPGA	High Gloss	68	¾	12	25	2.3	HG\$	1015
	66-6812PPGA	High Gloss Graphite	68	¾	12	25	2.3	GR\$	1191
	66-6812PP	TFL	68	¾	12	26	2.2	T\$	430
	65-6812PP	Veneer	68	¾	12	26	2.2	W\$	735
	66-6212PPA	Frosted	62	¼	12	7	2.0	F\$	894
	66-6212PPGA	High Gloss	62	¾	12	23	2.1	HG\$	946
	66-6212PPGA	High Gloss Graphite	62	¾	12	23	2.1	GR\$	1115
	66-6212PP	TFL	62	¾	12	25	2.0	T\$	419
	65-6212PP	Veneer	62	¾	12	25	2.0	W\$	720
	66-5612PPA	Frosted	56	¼	12	6	1.8	F\$	825
	66-5612PPGA	High Gloss	56	¾	12	22	1.9	HG\$	856
	66-5612PPGA	High Gloss Graphite	56	¾	12	22	1.9	GR\$	1037
	66-5612PP	TFL	56	¾	12	23	1.8	T\$	408
	65-5612PP	Veneer	56	¾	12	23	1.8	W\$	699
	66-2812PPA	Frosted	28	¼	12	8	0.7	F\$	560
	66-2812PPGA	High Gloss	28	¾	12	13	0.9	HG\$	588
	66-2812PPGA	High Gloss Graphite	28	¾	12	13	0.9	GR\$	663
	66-2812PP	TFL	28	¾	12	12	0.9	T\$	355
	65-2812PP	Veneer	28	¾	12	12	0.9	W\$	605
	66-2212PPA	Frosted	22	¼	12	7	0.6	F\$	505
	66-2212PPGA	High Gloss	22	¾	12	11	0.7	HG\$	528
	66-2212PPGA	High Gloss Graphite	22	¾	12	11	0.7	GR\$	585
	66-2212PP	TFL	22	¾	12	10	0.7	T\$	345
	65-2212PP	Veneer	22	¾	12	10	0.7	W\$	591

Description

- Sets on Surface
- Available in Frosted or High Gloss Acrylic, TFL, or Veneer; Must Specify; See [TFL Colors](#) or [Veneer Finish](#), and See [High Gloss Acrylic Colors](#)
- Decorative Support Blocks; Must Specify: Aluminum (ALUM) or Chrome (CHRM)
- Some Assembly Required

Pricing Codes: C=Clear F= Frosted HG= High Gloss GR= High Gloss Graphite T = TFL W = Veneer

[For ordering options, see overview at the beginning of section.](#)

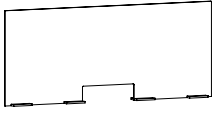
Item	Model No.		W	D	H	Ship Wt	Cubic Ft	List Price
24"H PRIVACY PANELS WITH TRANSACTION SLOT 	01-6224PPSCA	Clear	62	¼	23½	13.9	2.1	\$ 1187
	01-5624PPSCA	Clear	56	¼	23½	11.5	1.9	\$ 1115
	01-5024PPSCA	Clear	50	¼	23½	9.1	1.7	\$ 917
	01-4424PPSCA	Clear	44	¼	23½	6.7	1.5	\$ 847
	01-3824PPSCA	Clear	38	¼	23½	4.3	1.2	\$ 779

Description

- Sets on Surface; Comes with Non-Marring Adhesive Strip for Additional Surface Attachment
- Available in Clear Acrylic
- Decorative Support Blocks; Must Specify: Aluminum (ALUM) or Chrome (CHRM)
- Transaction Slot (14"Wx4"H) Always Centered On Panel Along Bottom Edge
- Some Assembly Required

Item	Model No.		W	D	H	Ship Wt	Cubic Ft	List Price
24"H SCREEN DIVIDERS 	01-6624SDCA	Clear	66	¼	23½	11.8	4.7	C\$ 1132
	01-6624SDA	Frosted						F\$ 1376
	01-6024SDCA	Clear	60	¼	23½	10.8	4.2	C\$ 1058
	01-6024SDA	Frosted						F\$ 1282
	01-5424SDCA	Clear	54	¼	23½	9.8	3.7	C\$ 984
	01-5424SDA	Frosted						F\$ 1186
	01-4824SDCA	Clear	48	¼	23½	8.8	3.2	C\$ 907
	01-4824SDA	Frosted						F\$ 1088
	01-4224SDCA	Clear	42	¼	23½	7.8	2.7	C\$ 835
	01-4224SDA	Frosted						F\$ 991
	01-3624SDCA	Clear	36	¼	23½	6.8	2.2	C\$ 736
	01-3624SDA	Frosted						F\$ 865
	01-3024SDCA	Clear	30	¼	23½	5.8	1.7	C\$ 685
	01-3024SDA	Frosted						F\$ 802
	01-2424SDCA	Clear	24	¼	23½	4.8	1.2	C\$ 578
	01-2424SDA	Frosted						F\$ 707

Description

- Freestanding on Surface
- Available in Clear and Frosted Acrylic
- Supports Constructed of Acrylic; Will Match Screen
- Some Assembly Required

Pricing Codes: C=Clear F= Frosted

[For ordering options, see overview at the beginning of section.](#)

SCREENS+DIVIDERS

MULTI-USE SPACE DIVISION

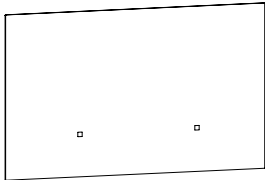
Item	Model No.		W	D	H	Ship Wt	Cubic Ft	List Price
33"H ABOVE AND BELOW SCREENS 	01-6233ABA	Frosted	62	¼	33	13	3.5	\$ 1731
	01-5633ABA	Frosted	56	¼	33	12	2.9	\$ 1602
	01-5033ABA	Frosted	50	¼	33	11	2.3	\$ 1472
	01-4433ABA	Frosted	44	¼	33	10	1.7	\$ 1342

Description

- Mounts to Surface
- Available in Frosted Acrylic
- Provides Privacy 24" Above Surface and Modesty 8" Below Surface
- Decorative Attachment Hardware; Must Specify: Aluminum (ALUM) or Chrome (CHRM)

Item	Model No.		W	D	H	Ship Wt	Cubic Ft	List Price
21"H ABOVE AND BELOW SCREENS 	66-6821ABA	Frosted	68	¼	21	14	3.3	F\$ 1306
	66-6821ABGA	High Gloss	68	¾	21	44	3.3	HG\$ 1398
	66-6821ABGA	High Gloss Graphite	68	¾	21	44	3.3	GR\$ 1822
	66-6821AB	TFL	68	¾	21	41	3.3	T\$ 471
	65-6821AB	Veneer	68	¾	21	41	3.3	W\$ 812
	66-6221ABA	Frosted	62	¼	21	12	2.8	F\$ 1222
	66-6221ABGA	High Gloss	62	¾	21	41	3	HG\$ 1299
	66-6221ABGA	High Gloss Graphite	62	¾	21	41	3	GR\$ 1688
	66-6221AB	TFL	62	¾	21	39	3	T\$ 459
	65-6221AB	Veneer	62	¾	21	39	3	W\$ 786
	66-5621ABA	Frosted	56	¼	21	10	2.6	F\$ 1137
	66-5621ABGA	High Gloss	56	¾	21	38	2.7	HG\$ 1204
	66-5621ABGA	High Gloss Graphite	56	¾	21	38	2.7	GR\$ 1552
	66-5621AB	TFL	56	¾	21	36	2.7	T\$ 441
	65-5621AB	Veneer	56	¾	21	36	2.7	W\$ 756
	66-5021ABA	Frosted	50	¼	21	9	2.2	F\$ 1051
	66-5021ABGA	High Gloss	50	¾	21	36	2.4	HG\$ 1108
	66-5021ABGA	High Gloss Graphite	50	¾	21	36	2.4	GR\$ 1420
	66-5021AB	TFL	50	¾	21	34	2.4	T\$ 425
	65-5021AB	Veneer	50	¾	21	34	2.4	W\$ 729
	66-4421ABA	Frosted	44	¼	21	8	1.2	F\$ 964
	66-4421ABGA	High Gloss	44	¾	21	33	2.2	HG\$ 1015
	66-4421ABGA	High Gloss Graphite	44	¾	21	33	2.2	GR\$ 1288
	66-4421AB	TFL	44	¾	21	31	2.2	T\$ 408
65-4421AB	Veneer	44	¾	21	31	2.2	W\$ 699	

Description

- Mounts to Surface
- Available in Frosted or High Gloss Acrylic, TFL, or Veneer; Must Specify; See [TFL Colors](#) or [Veneer Finish](#), and See [High Gloss Acrylic Colors](#)
- Provides Privacy 12" Above Surface and Modesty 8" Below Surface
- Decorative Attachment Hardware on Frosted Acrylic; Must Specify: Aluminum (ALUM) or Chrome (CHRM)

Pricing Codes: F= Frosted HG= High Gloss GR= High Gloss Graphite T = TFL W = Veneer

[For ordering options, see overview at the beginning of section.](#)

SCREENS+DIVIDERS

MULTI-USE SPACE DIVISION

Item	Model No.		W	D	H	Ship Wt	Cubic Ft	List Price
20"H ABOVE AND BELOW SCREENS 	PS-5720FA	Frosted	57	¼	20	20	2.2	F\$ 1124
	PS-5720HGA	High Gloss	57	¾	20	36	2.7	HG\$ 1188
	PS-5720HGA	High Gloss Graphite	57	¾	20	36	2.7	GR\$ 1532
	PS-5720TB	Tackboard	57	⅝	20	14	2.2	U\$ see below
	66-5720PS	TFL	57	¾	20	36	2.7	T\$ 438
	65-5720PS	Veneer	57	¾	20	36	2.7	W\$ 742
	PS-5120FA	Frosted	51	¼	20	19	2.1	F\$ 1039
	PS-5120HGA	High Gloss	51	¾	20	34	2.5	HG\$ 1093
	PS-5120HGA	High Gloss Graphite	51	¾	20	34	2.5	GR\$ 1402
	PS-5120TB	Tackboard	51	⅝	20	13	2.2	U\$ see below
	66-5120PS	TFL	51	¾	20	34	2.5	T\$ 420
	65-5120PS	Veneer	51	¾	20	34	2.5	W\$ 717
	PS-4520FA	Frosted	45	¼	20	19	2.0	F\$ 955
	PS-4520HGA	High Gloss	45	¾	20	32	2.3	HG\$ 997
	PS-4520HGA	High Gloss Graphite	45	¾	20	32	2.3	GR\$ 1269
	PS-4520TB	Tackboard	45	⅝	20	12	2.0	U\$ see below
	66-4520PS	TFL	45	¾	20	32	2.3	T\$ 405
	65-4520PS	Veneer	45	¾	20	32	2.3	W\$ 690
	PS-4120FA	Frosted	41	¼	20	18	1.9	F\$ 919
	PS-4120HGA	High Gloss	41	¾	20	30	2.2	HG\$ 957
PS-4120HGA	High Gloss Graphite	41	¾	20	30	2.2	GR\$ 1218	
PS-4120TB	Tackboard	41	⅝	20	12	1.8	U\$ see below	
66-4120PS	TFL	41	¾	20	30	2.2	T\$ 389	
65-4120PS	Veneer	41	¾	20	30	2.2	W\$ 664	
PS-3920FA	Frosted	39	¼	20	18	1.8	F\$ 887	
PS-3920HGA	High Gloss	39	¾	20	29	2.2	HG\$ 928	
PS-3920HGA	High Gloss Graphite	39	¾	20	29	2.2	GR\$ 1178	
PS-3920TB	Tackboard	39	⅝	20	11	1.8	U\$ see below	
66-3920PS	TFL	39	¾	20	29	2.2	T\$ 375	
65-3920PS	Veneer	39	¾	20	29	2.2	W\$ 640	
PS-3520FA	Frosted	35	¼	20	17	1.7	F\$ 851	
PS-3520HGA	High Gloss	35	¾	20	29	2.2	HG\$ 891	
PS-3520HGA	High Gloss Graphite	35	¾	20	29	2.2	GR\$ 1134	
PS-3520TB	Tackboard	35	⅝	20	11	1.5	U\$ see below	
66-3520PS	TFL	35	¾	20	28	2.1	T\$ 362	
65-3520PS	Veneer	35	¾	20	28	2.1	W\$ 616	
PS-3320FA	Frosted	33	¼	20	17	1.6	F\$ 820	
PS-3320HGA	High Gloss	33	¾	20	27	2.1	HG\$ 859	
PS-3320HGA	High Gloss Graphite	33	¾	20	27	2.1	GR\$ 1095	
PS-3320TB	Tackboard	33	⅝	20	10	1.5	U\$ see below	
66-3320PS	TFL	33	¾	20	27	2.1	T\$ 348	
65-3320PS	Veneer	33	¾	20	27	2.1	W\$ 593	
PS-2920FA	Frosted	29	¼	20	16	1.5	F\$ 786	
PS-2920HGA	High Gloss	29	¾	20	26	1.9	HG\$ 822	
PS-2920HGA	High Gloss Graphite	29	¾	20	26	1.9	GR\$ 1050	
PS-2920TB	Tackboard	29	⅝	20	10	1.5	U\$ see below	
66-2920PS	TFL	29	¾	20	26	1.9	T\$ 335	
65-2920PS	Veneer	29	¾	20	26	1.9	W\$ 569	

Description

- Mounts to Surface; Provides Privacy 12" Above Surface and Modesty 7" Below Surface
- Available in Frosted or High Gloss Acrylic, Tackboard, TFL, or Veneer; Must Specify; See [TFL Colors](#) or [Veneer Finish](#), See [High Gloss Acrylic Colors](#), For Upholstery, See Below
- Decorative Hardware on Frosted Acrylic & Tackboards; Must Specify: Aluminum (ALUM) or Chrome (CHRM)
- Great option for Canvas and Gesso Modular Height-Adjustable units

Tackboards - Must Specify: Model# & Fabric/Grade

Model	Ydg	COM/Grades 1, 2, 3	Grade 4	Grade 5	Grade 6	Grade 7	Grade 8	Grade 9	Grade 10
PS-5720TB	2.00	\$ 602	\$ 870	\$ 996	\$ 1124	\$ 1306	\$ 1494	\$ 1716	\$ 1970
PS-5120TB	2.00	\$ 558	\$ 826	\$ 952	\$ 1080	\$ 1262	\$ 1450	\$ 1672	\$ 1926
PS-4520TB	1.75	\$ 496	\$ 731	\$ 841	\$ 953	\$ 1112	\$ 1277	\$ 1471	\$ 1693
PS-4120TB	1.50	\$ 457	\$ 658	\$ 753	\$ 849	\$ 985	\$ 1126	\$ 1293	\$ 1483
PS-3920TB	1.50	\$ 443	\$ 644	\$ 739	\$ 835	\$ 971	\$ 1112	\$ 1279	\$ 1469
PS-3520TB	1.50	\$ 428	\$ 629	\$ 724	\$ 820	\$ 956	\$ 1097	\$ 1264	\$ 1454
PS-3320TB	1.25	\$ 390	\$ 558	\$ 636	\$ 716	\$ 830	\$ 948	\$ 1086	\$ 1245
PS-2920TB	1.25	\$ 370	\$ 538	\$ 616	\$ 696	\$ 810	\$ 928	\$ 1066	\$ 1225

For ordering options, see overview at the beginning of section.

SCREENS+DIVIDERS

MULTI-USE SPACE DIVISION

Item	Model No.		W	D	H	Ship Wt	Cubic Ft	List Price
17"H ABOVE AND BELOW SCREENS 	PS-6817FA	Frosted	68	¼	17	14	3.3	F\$ 1156
	PS-6817HGA	High Gloss	68	¾	17	24	3.3	HG\$ 1217
	PS-6817HGA	High Gloss Graphite	68	¾	17	24	3.3	GR\$ 1572
	PS-6817TB	Tackboard	68	⅝	17	15	2.5	U\$ see below
	66-6817PS	TFL	68	¾	17	24	3.3	T\$ 450
	65-6817PS	Veneer	68	¾	17	24	3.3	W\$ 764
	PS-6217FA	Frosted	62	¼	17	14	3.1	F\$ 1121
	PS-6217HGA	High Gloss	62	¾	17	22	3.1	HG\$ 1182
	PS-6217HGA	High Gloss Graphite	62	¾	17	22	3.1	GR\$ 1526
	PS-6217TB	Tackboard	62	⅝	17	14	2.5	U\$ see below
	66-6217PS	TFL	62	¾	17	22	3.1	T\$ 437
	65-6217PS	Veneer	62	¾	17	22	3.1	W\$ 741
	PS-5617FA	Frosted	56	¼	17	13	2.9	F\$ 1083
	PS-5617HGA	High Gloss	56	¾	17	20	2.7	HG\$ 1140
	PS-5617HGA	High Gloss Graphite	56	¾	17	20	2.7	GR\$ 1470
	PS-5617TB	Tackboard	56	⅝	17	13	2.2	U\$ see below
	66-5617PS	TFL	56	¾	17	20	2.7	T\$ 419
	65-5617PS	Veneer	56	¾	17	20	2.7	W\$ 716
	PS-5017FA	Frosted	50	¼	17	13	2.7	F\$ 1001
	PS-5017HGA	High Gloss	50	¾	17	18	2.5	HG\$ 1051
	PS-5017HGA	High Gloss Graphite	50	¾	17	18	2.5	GR\$ 1348
	PS-5017TB	Tackboard	50	⅝	17	12	2.0	U\$ see below
	66-5017PS	TFL	50	¾	17	18	2.5	T\$ 405
	65-5017PS	Veneer	50	¾	17	18	2.5	W\$ 690
	PS-4417FA	Frosted	44	¼	17	12	2.5	F\$ 922
	PS-4417HGA	High Gloss	44	¾	17	16	2.3	HG\$ 961
	PS-4417HGA	High Gloss Graphite	44	¾	17	16	2.3	GR\$ 1224
PS-4417TB	Tackboard	44	⅝	17	11	1.8	U\$ see below	
66-4417PS	TFL	44	¾	17	16	2.3	T\$ 390	
65-4417PS	Veneer	44	¾	17	16	2.3	W\$ 667	

Description

- Mounts to Surface
- Decorative Attachment Hardware on Frosted Acrylic & Tackboards; Must Specify: Aluminum (ALUM) or Chrome (CHRM)
- Available in Frosted or High Gloss Acrylic, Tackboard, TFL, or Veneer; Must Specify; See [TFL Colors](#) or [Veneer Finish](#), See [High Gloss Acrylic Colors](#), For Upholstery, See Below
- Provides Privacy 12" Above Surface and Modesty 4" Below Surface
- Great option for Canvas and Gesso Modular Height-Adjustable units

Tackboards - Must Specify: Model# & Fabric/Grade

Model	Ydg	COM/Grades 1, 2, 3	Grade 4	Grade 5	Grade 6	Grade 7	Grade 8	Grade 9	Grade 10
PS-6817TB	2.00	\$ 620	\$ 888	\$ 1014	\$ 1142	\$ 1324	\$ 1512	\$ 1734	\$ 1988
PS-6217TB	2.00	\$ 582	\$ 850	\$ 976	\$ 1104	\$ 1286	\$ 1474	\$ 1696	\$ 1950
PS-5617TB	2.00	\$ 530	\$ 798	\$ 924	\$ 1052	\$ 1234	\$ 1422	\$ 1644	\$ 1898
PS-5017TB	2.00	\$ 502	\$ 770	\$ 896	\$ 1024	\$ 1206	\$ 1394	\$ 1616	\$ 1870
PS-4417TB	1.75	\$ 452	\$ 687	\$ 797	\$ 909	\$ 1068	\$ 1233	\$ 1427	\$ 1649

Pricing Codes: C=Clear F= Frosted HG= High Gloss GR= High Gloss Graphite U=Tackboard T = TFL W = Veneer

[For ordering options, see overview at the beginning of section.](#)

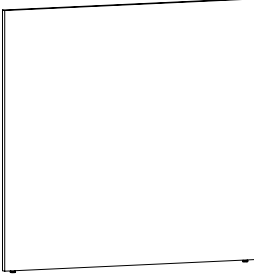

Item	Model No.		W	D	H	Ship Wt	Cubic Ft	List Price
51" GALLERY SCREEN STRAIGHT FLOORSTANDING 	66-5173GS	TFL	73	1	51¼	110	7.9	T\$ 1147
	65-5173GS	Veneer						W\$ 1967
	66-5172GS	TFL	72	1	51¼	110	7.9	T\$ 1139
	65-5172GS	Veneer						W\$ 1953
	66-5167GS	TFL	67	1	51¼	104	7.3	T\$ 1103
	65-5167GS	Veneer						W\$ 1889
	66-5166GS	TFL	66	1	51¼	104	7.3	T\$ 1096
	65-5166GS	Veneer						W\$ 1877
	66-5161GS	TFL	61	1	51¼	98	6.7	T\$ 1057
	65-5161GS	Veneer						W\$ 1811
	66-5160GS	TFL	60	1	51¼	98	6.7	T\$ 1051
	65-5160GS	Veneer						W\$ 1798
	66-5155GS	TFL	55	1	51¼	92	6.1	T\$ 1010
	65-5155GS	Veneer						W\$ 1731
	66-5154GS	TFL	54	1	51¼	92	6.1	T\$ 1003
	65-5154GS	Veneer						W\$ 1718
	66-5149GS	TFL	49	1	51¼	86	5.4	T\$ 964
	65-5149GS	Veneer						W\$ 1653
	66-5148GS	TFL	48	1	51¼	86	5.4	T\$ 957
	65-5148GS	Veneer						W\$ 1638
	66-5143GS	TFL	43	1	51¼	80	4.7	T\$ 920
	65-5143GS	Veneer						W\$ 1577
	66-5142GS	TFL	42	1	51¼	80	4.7	T\$ 913
	65-5142GS	Veneer						W\$ 1565
	66-5137GS	TFL	37	1	51¼	60	4.1	T\$ 795
	65-5137GS	Veneer						W\$ 1365
	66-5136GS	TFL	36	1	51¼	60	4.1	T\$ 772
	65-5136GS	Veneer						W\$ 1323
	66-5131GS	TFL	31	1	51¼	54	3.5	T\$ 724
	65-5131GS	Veneer						W\$ 1240
	66-5130GS	TFL	30	1	51¼	54	3.5	T\$ 713
	65-5130GS	Veneer						W\$ 1223
66-5125GS	TFL	25	1	51¼	48	2.8	T\$ 662	
65-5125GS	Veneer						W\$ 1133	
66-5124GS	TFL	24	1	51¼	48	2.8	T\$ 652	
65-5124GS	Veneer						W\$ 1115	
66-5119GS	TFL	19	1	51¼	42	2.2	T\$ 613	
65-5119GS	Veneer						W\$ 1048	
66-5118GS	TFL	18	1	51¼	42	2.2	T\$ 603	
65-5118GS	Veneer						W\$ 1034	

Description

- Horizontal Woodgrain
- Mounts to Back of Modular Credenza for Space Division
- Available in TFL and Veneer; Must Specify Finish/Color, [See Color and Finish Options](#)
- Extend up to 24" Beyond Workstation without Additional Support
- Includes Leveling Glides
- Six (6) Wire Management Grommet Location Options; Must Specify Location/Color, [See Grommet Locations](#)

Pricing Codes: T = TFL W = Veneer

For ordering options, see overview at the beginning of section.

Item	Model No.	W	D	H	Ship Wt	Cubic Ft	List Price
ACRYLIC CONNECTOR CLIPS	01-2WAY90	1¼	1¼	7⁄8	0.1	0.8	\$ 33
	<i>For Use with 2-Way, 90° Corner Connections</i>						
	01-3WAY90	2	1½	7⁄8	0.1	0.8	\$ 25
	<i>For Use with 3-Way, T-Connections</i>						
	01-2WAY180	1⅞	7⁄8	13⁄16	0.1	0.8	\$ 20
	<i>For Use with 2-Way, 180° Straight Connections</i>						

Description

- Constructed of Metal with a Chrome Finish
- For Use with ¼" Thick Clear and Frosted Acrylics
- Provides a Clean Connection For Adjacent Panels and Screens

Pricing Codes: T = TFL W = Veneer

[For ordering options, see overview at the beginning of section.](#)

STEP 1: PLANNING FOR SQUARE ONE

Planning for Square One is based on configuring 12"x24" and 24"x24" blocks in nearly any manner to create space dividing walls, coves, work zones, and more within open environments.

Idea Starters/Typicals:

When you select one of our pre-configured Typicals, everything you need comes specified together, including the blocks, caps and posts, hardware, glides, and more.

- Select the typical number (e.g., 17-4), then specify the finish and hardware color.
- Add optional accessories (see Step #5).

Make Your Own Typicals:

There are endless opportunities with Square One, giving you the ability to create unique setups to meet the specific needs of your customers.

- We recommend utilizing our Specification/Drawing Services team, who can help in bringing your vision to life and ensure all the necessary components are included. To get started, just send us a drawing. You can use our easy online request form: [Design Request Form](#)
- Steps #2 - #5 outline the process for specifying your own typical. Please provide a drawing with the order to ensure accuracy.

STEP 2: SPECIFYING BLOCKS

When making your own typical, choose the quantity of blocks needed to create your design. We offer single blocks in two styles: 24"x24" and 12"x24".

- Blocks can go up to four high (8') and do runs of five wide (10') without a supporting wall or anchor to create stability.
- We recommend using single 12" x 24" blocks on the top or ends. If placing on the bottom or in the center of the design, using two of them together will ensure alignment with the holes bored on attachment items like End Caps, Corner Posts, etc.
- When creating an "L" or "T" design, we suggest going a minimum of three blocks wide to ensure stability without additional support.

STEP 3: CAPS, POSTS, CONNECTORS, AND SPANNERS

Next, determine what Caps, Posts, Connectors, and Spanners are needed to complete the design.

- End and Top Caps are necessary to ensure a clean and balanced aesthetic (as they hide the attachment hardware/ensure no empty holes are showing where attachments would have been).
- Square One offers connection beams to create 90° turns (Corner Posts), three walls (T-Connectors), four walls (X-Connectors), and span doorways or other openings (Horizontal Beam Spanners).
- End Caps, Posts, and Connectors should always be specified to run longer (taller) than the unit so that the end of the top cap or horizontal rail will not be seen (there are only a few exceptions).

STEP 4: HARDWARE, LEVELING, AND GENERAL ASSEMBLY

Whether connecting square to square or square to post, individual components come with the necessary hardware. Should you need more, we offer separate Bolt Kits to provide proper installation.

We offer heavy-duty, adjustable leveling glides to compensate for uneven floors. A tool (6mm allen driver bit) is also available to insert the glide nuts. The glides must be ordered separately from the blocks.

We do not offer connection methods to anchor to the floor or wall. We recommend discussing this with the building's facility manager for proper connection. Indiana Furniture will not be liable for wall or floor mounts that are not properly installed.

Assembly Instructions may be found on our website.

STEP 5: ACCESSORIES

Add function without sacrificing beauty. Acrylic Inserts, Tackable and Acoustical Panels, Dry Erase Boards, and TV mounts can give your space the ability for more privacy, collaboration, or brainstorming.

- Dry Erase Boards and Tackable Panels have onset installation.
- Dry Erase Boards can be mounted either vertically or horizontally.
- Acoustical Panels are either specified onset or inset, and Acrylic Inserts are inset.
- Tackable Panels are fully upholstered, so a clean aesthetic is seen from both sides of the blocks.
- Acrylic Inserts lock into insert retainers which are installed on top of the hardware, inside of the block, allowing for a quick and tight-fitting installation.
- Frosted Acrylic Inserts can be customized with a logo or image, giving you freedom to create a personal touch. Provide a .CDR, .AI, or .EPS file. Extended lead times may apply.
- We offer the Vesta Power Data Center and other similar items to add power within your Square One spaces created.



**Space Division.
Redefined.**

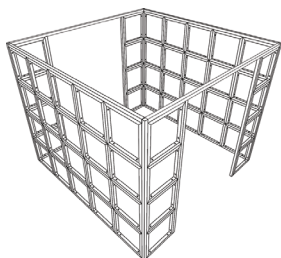

17-1 (Approximately 10' X 10' X 8')

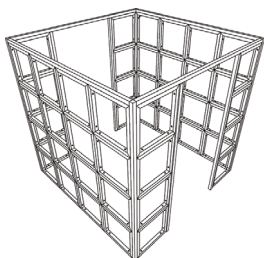

17-2 (Approximately 8' X 8' X 8')

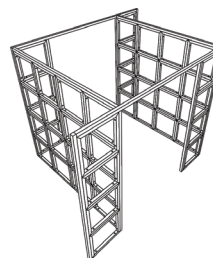

17-3 (Approximately 12' X 8' X 8')

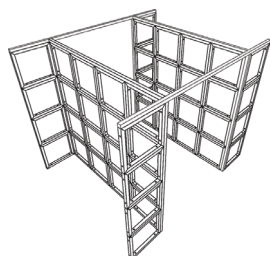

17-4 (Approximately 10' X 8' X 8')

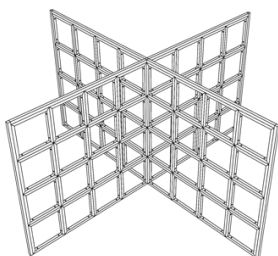

17-5 (Approximately 16' X 16' X 8')

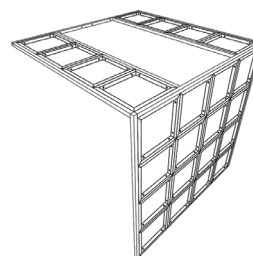

17-6 (Approximately 8' X 8' X 8')

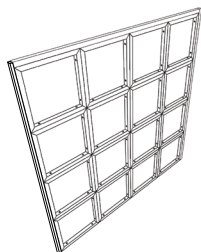

17-7 (Approximately 8' X 8')

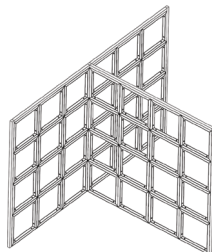

17-8 (Approximately 12' X 8' X 8')

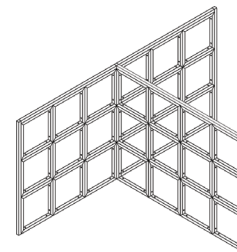

17-9 (Approximately 12' X 8' X 6')

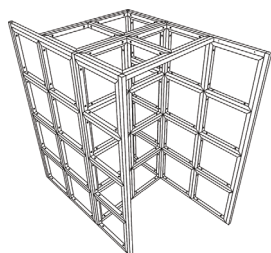

17-10 (Approximately 4' X 8' X 8')

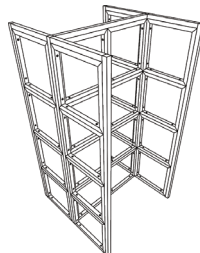

17-11 (Approximately 4' X 4' X 8')

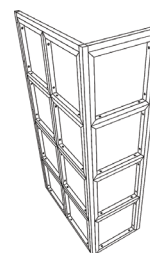

17-12 (Approximately 2' X 4' X 8')

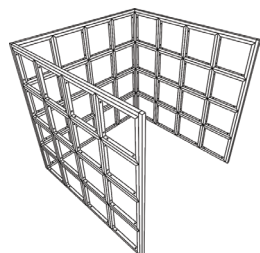

17-13 (Approximately 8' X 8' X 8')

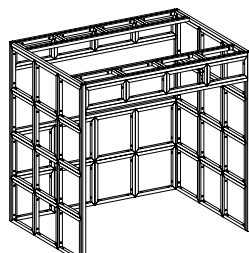

17-14 (Approximately 8' X 6' X 8')

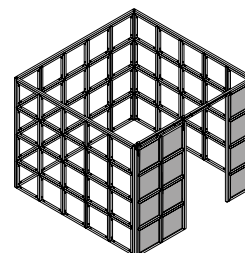

17-15 (Approximately 10' X 10' X 8')

Space Division. Redefined.

Square One is the clean, simple way to provide space division, functionality, and architectural design to any zone within the working environment. With individual building blocks that securely connect to one another and accessories like dry erase boards, barn doors, planter boxes, acrylic inserts, and tackable and acoustical panels, your personalization of Square One is only limited to your imagination. Square One is made of solid wood, providing a sustainable material for the workplace and bringing warmth and beauty to any space.

CONSTRUCTION

BLOCKS

- Blocks are manufactured using kiln-dried, solid European Beech and are attached using hardware, available in your choice of nickel or black, for durability and strength

FINISH

- Indiana Furniture uses a multi-step hand finishing process
- Blocks are pre-sanded for smoothness, then stained and finished with a catalyzed varnish finish which offers durability, lasting beauty, and resistance to normal wear
- Square One finishes were selected to complement casegoods, tables, and seating finishes which allows for easy blending of furniture components

END & TOP CAPS

- Measure 1¾"W and 1¾"D and come in a variety of lengths
- Used vertically and horizontally to provide a clean, balanced aesthetic by hiding the attachment hardware
- Caps are constructed of kiln-dried, solid European Beech and include blind threaded inserts for installation

CORNER POSTS

- Measure 1¾"W and 1¾"D and come in a variety of heights
- Used to create 90° turns
- Corner posts are constructed of kiln-dried, solid European Beech and include blind threaded inserts for installation

T-CONNECTORS

- Measure 1¾"W and 1¾"D and come in a variety of heights
- Used vertically and horizontally to create an intersection for three wall runs
- T-Connectors are constructed of kiln-dried, solid European Beech and include blind threaded inserts for installation

X-CONNECTORS

- Measure 1¾"W and 1¾"D and come in a variety of heights
- Used vertically to create an intersection for four wall runs
- X-Connectors are constructed of kiln-dried, solid European Beech and include blind threaded inserts for installation

HORIZONTAL BEAM SPANNERS

- Measure 1¾"D and 1¾"H and come in a variety of widths
- Used horizontally to provide structural support for doorways and other designed openings
- Spanners are constructed of kiln-dried, solid European Beech and include blind threaded inserts for installation

DRY ERASE BOARDS

- Available in 22½" or 46½" heights and multiple widths
- Installed onset, either vertically or horizontally
- Installation brackets are included; longer bolts for installation on-site are also included

ACOUSTICAL PANELS

- Constructed of 100% polyester made from up to 50% recycled materials without the use of adhesive or other bonding agents, Acoustical Panels are 100% recyclable
- Panels are ½" (12mm) thick and are available in multiple widths and lengths
- Sound absorption is average NRC 0.75 (50mm air gap) 1.0 NRC in mid-high frequencies
- Panels are installed inset with tabs or onset with dual-lock connectors

TACKABLE PANELS

- Tackable Panels are constructed of 7/16" corkboard and then covered, on both sides, in the textile of your choice
- Highly-skilled upholsterers hand tailor each unit to meet individual specifications
- Upholstery options include a broad range of styles, all pre-graded in this price list for ease of use
- Panels are installed onset with dual-lock connectors

ACRYLIC INSERTS

- Acrylic inserts are manufactured using high performance engineering resins and provide translucency, strength, clarity, and versatility
- Inserts are 20½"W and are available in 8½" and 20½" lengths
- Inserts are inset within the blocks with retainers for a tight-fitting installation
- Frosted acrylic options can be customized with logos and other designs as requested

LEVELING GLIDES

- Heavy-duty, adjustable leveling glides are available in black or nickel and are recommended to ensure proper leveling and compensation for uneven floors
- A tool (6mm allen driver bit) to install glides is also available to ensure proper installation

BARN DOOR HARDWARE

- Sliding system tracks are constructed of black powder coated steel
- Hardware includes tracks, hangers, track stops, screws, inserts, bracket, and sliding system
- Installation hardware will be shipped attached to components

PLANTER BOXES

- The planter box is made of ¾" thick thermally-fused laminate (TFL) fused particle-board core
- Grain direction runs horizontal
- Planter boxes are fastened together with screws and heavy-duty metal fasteners
- Optional insert is made of lightweight, fade-resistant, recyclable plastic

HOW TO ORDER EXAMPLES

IDEA STARTERS/TYPICALS

Model No.	Description	Example
17-1	Finish Hardware Color	EG BLK

BLOCKS & RAILS

Model No.	Description	Example
17-2424BL	Finish Hardware Color	NB NCKL

ACRYLIC INSERTS

Model No.	Description	Example
AI-2020AC	Acrylic Color	FSTA

PLANTER BOXES

Model No.	Description	Example
01-1909PL	TFL Color Hardware Color Optional Insert	AS BLK PBI

veneer (W) OPTIONS

Indiana Furniture uses a multi-step, hand finishing process on all exposed wood frames.

Square One models feature a catalyzed varnish finish which offers durability, lasting beauty, and resistance to normal wear.

AWH	Aspen White	OR	Orchard
EG	Ember Gray	TR	Truffle Rain
NB	Natural Beech		

TFL (T) LAMINATE OPTIONS ON PLANTER BOXES

WOODGRAIN

AS	Asian Night	PTK	Portico Teak
BW	Beigewood	RC	River Cherry
CO	Columbian Walnut	SPW	Sepia Walnut
EF	Espresso	SKC	Shaker Cherry
FLW	Florence Walnut	SBP	Smoky Brown Pear
KHE	Kirsche	TK	Studio Teak
MNR	Midnight Run	SM	Sugar Maple
NTM	Natural Marrone	WTA	Weathered Ash
ORW	Oak Riftwood	WNB	White Nebbia
PNW	Pinnacle Walnut	WC	Williamsburg Cherry

SOLID

BL	Black	FHG	Fashion Grey
WH	Designer White	SG	Slate Grey

HARDWARE/LEVELING GLIDES COLOR OPTIONS

BLK	Black	NCKL	Nickel
-----	-------	------	--------

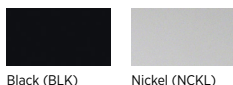

Black (BLK) Nickel (NCKL)

ACOUSTICAL PANEL OPTIONS

ASH	Ash	MLK	Milky
BLK	Black	TPE	Taupe
GRY	Grey		



ACRYLIC INSERT OPTIONS

FSTA	Frosted	TGWA	Twigwork
RAFA	Raffia	TNSA	Tinsel
WOVA	Woven		



TACKABLE PANEL OPTIONS

Available in single upholstery in a wide variety of graded-in or contract options.

CERTIFICATIONS & COMPLIANCE

- CAL 117-2013 Compliance
- Intertek Sustainability Certified
- BIFMA level® Certified
- BIFMA Compliant® Certified
- TSCA Title VI (CARB) Compliance
- US Green Building's LEED® Contribution

Building Blocks

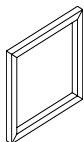

24"x24" Block
[\(See Details\)](#)

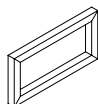

24"x12" Block
[\(See Details\)](#)

Hardware

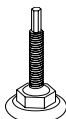

Leveling Glide Kits
[\(See Details\)](#)

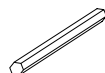

Allen Driver Bit
[\(See Details\)](#)

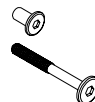

Bolt & Nut Kits
[\(See Details\)](#)

Connectors

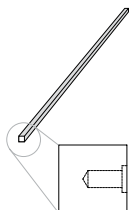

End Caps
[\(See Details\)](#)

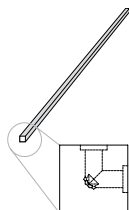

Corner Posts
[\(See Details\)](#)

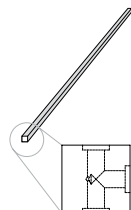

T-Connector Beams
[\(See Details\)](#)

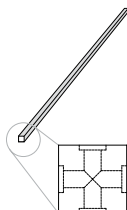

X-Connector Beams
[\(See Details\)](#)

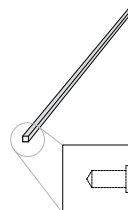

Horizontal Beam Spanners
[\(See Details\)](#)

Accessories

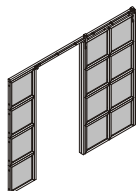

Barn Door Wall
[\(See Details\)](#)

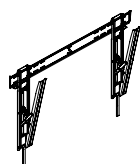

TV Mounts
[\(See Details\)](#)

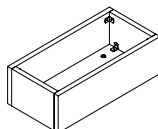

Planter Boxes
[\(See Details\)](#)



Tic-Tac-Toe Foam Game
[\(See Details\)](#)



Vesta Power Center
[\(See Details\)](#)

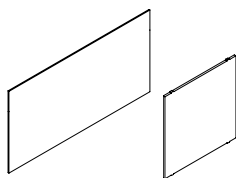

Onset & Inset Acoustical Panels
[\(See Details\)](#)

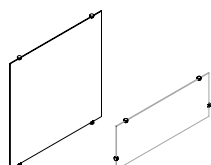

Acrylic Inset Panels
[\(See Details\)](#)



Dry Erase Boards
[\(See Details\)](#)

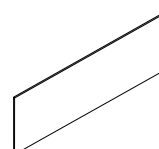

Tackable Panels
[\(See Details\)](#)

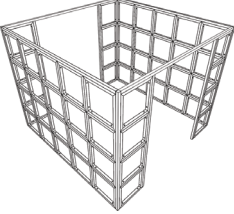
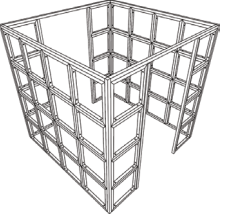
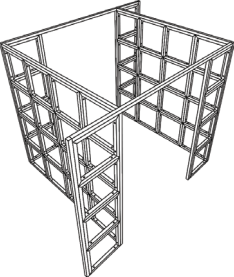
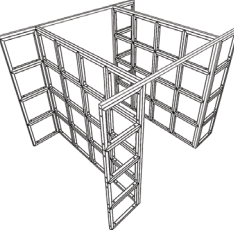
Item	Model No.	Qty	Description	List Price
HUDDLE (APPROXIMATELY 10' X 10' X 8')	17-1_1701			\$ 21286
	Consists of:			
	17-2424BL	56	Single Block, 24" x 24"	\$ 15904
	17-17596EC	4	End Cap, 96" (used vertically)	\$ 1524
	17-175120EC	2	End Cap, 120" (used horizontally)	\$ 830
	17-17597CP	4	Corner Post, 97¾"	\$ 1536
	17-175120HBS	2	Horizontal Beam Spanner, 120"	\$ 792
	17-LEVKIT	14	Leveler Kit, (2) Levelers	\$ 700
HUDDLE (APPROXIMATELY 8' X 8' X 8')	17-2			\$ 18782
	Consists of:			
	17-2424BL	48	Single Block, 24" x 24"	\$ 13632
	17-17596EC	6	End Cap, 96" (4 used vertically, 2 used horizontally)	\$ 2286
	17-17597CP	4	Corner Post, 97¾"	\$ 1536
	17-17596HBS	2	Horizontal Beam Spanner, 96"	\$ 728
	17-LEVKIT	12	Leveler Kit, (2) Levelers	\$ 600
HUDDLE (APPROXIMATELY 12' X 8' X 8')	17-3			\$ 18846
	Consists of:			
	17-2424BL	48	Single Block, 24" x 24"	\$ 13632
	17-17596EC	4	End Cap, 96" (2 used vertically, 2 used horizontally)	\$ 1524
	17-17597EC	2	End Cap, 97¾" (used vertically)	\$ 762
	17-17596CP	2	Corner Post, 96"	\$ 768
	17-17597CP	2	Corner Post, 97¾"	\$ 768
	17-175120HBS	2	Horizontal Beam Spanner, 120"	\$ 792
	17-LEVKIT	12	Leveler Kit, (2) Levelers	\$ 600
H-CONFIGURATION (APPROXIMATELY 10' X 8' X 8')	17-4			\$ 18846
	Consists of:			
	17-2424BL	48	Single Block, 24" x 24"	\$ 13632
	17-17596EC	2	End Cap, 96" (used horizontally)	\$ 762
	17-17597EC	4	End Cap, 97¾" (used vertically)	\$ 1524
	17-17596CP	4	Corner Post, 96"	\$ 1536
	17-175120HBS	2	Horizontal Beam Spanner, 120"	\$ 792
	17-LEVKIT	12	Leveler Kit, (2) Levelers	\$ 600

[See Overview for Square One Ordering Options.](#)

Item	Model No.	Qty	Description	List Price
QUAD-CONFIGURATION (APPROXIMATELY 16' X 16' X 8')	17-5			\$ 22414

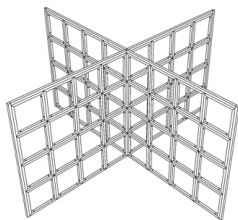
**Consists of:**

17-2424BL	64	Single Block, 24" x 24"	\$ 18176
17-17596EC	4	End Cap, 96" (used horizontally)	\$ 1524
17-17597EC	4	End Cap, 97¾" (used vertically)	\$ 1524
17-17597XB	1	X-Connector Beam, 97¾"	\$ 390
17-LEVKIT	16	Leveler Kit, (2) Levelers	\$ 800

WALL COVE (APPROXIMATELY 8' X 8' X 8')	17-6			\$ 10104
---	------	--	--	----------

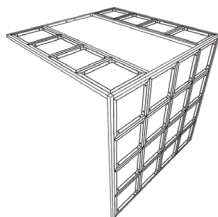
**Consists of:**

17-2424BL	24	Single Block, 24" x 24"	\$ 6816
17-17596EC	3	End Cap, 96" (used horizontally)	\$ 1143
17-17597EC	4	End Cap, 97¾" (2 used vertically, 2 used horizontally)	\$ 1524
17-17596CP	1	Corner Post, 96" (used horizontally)	\$ 384
17-LEVKIT	4	Leveler Kit, (2) Levelers	\$ 200
17-12MMBOLTKIT	1	12mm Bolt Kit, qty 8	\$ 37

** This typical is not design for freestanding applications. This unit must be secured at the top to a rigid structure. Attachment hardware not included.*

SINGLE WALL (APPROXIMATELY 8' X 8')	17-7			\$ 5887
--	------	--	--	---------

**Consists of:**

17-2424BL	16	Single Block, 24" x 24"	\$ 4544
17-17596EC	1	End Cap, 96" (used horizontally)	\$ 381
17-17597EC	2	End Cap, 97¾" (used vertically)	\$ 762
17-LEVKIT	4	Leveler Kit, (2) Levelers	\$ 200

** This typical is not design for freestanding applications. This unit must be secured at the top to a rigid structure. Attachment hardware not included.*

T-CONFIGURATION (APPROXIMATELY 12' X 8' X 8')	17-8_1708			\$ 14509
--	-----------	--	--	----------

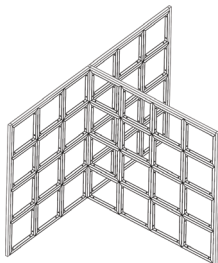
**Consists of:**

17-2424BL	40	Single Block, 24" x 24"	\$ 11360
17-17572EC	2	End Cap, 72" (used horizontally)	\$ 738
17-17596EC	1	End Cap, 96" (used horizontally)	\$ 381
17-17597EC	3	End Cap, 97¾" (used vertically)	\$ 1143
17-17597TCB	1	T-Connector Beam, 97¾"	\$ 387
17-LEVKIT	10	Leveler Kit, (2) Levelers	\$ 500

[See Overview for Square One Ordering Options.](#)

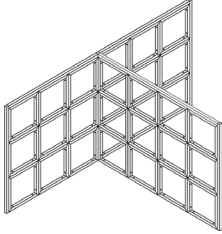
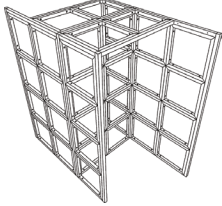
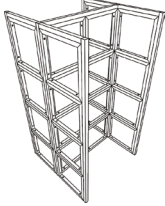
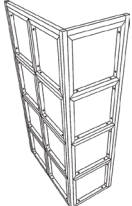
Item	Model No.	Qty	Description	List Price
T-CONFIGURATION (APPROXIMATELY 12' X 8' X 6')	17-9			\$ 11621
	Consists of:			
	17-2424BL	30	Single Block, 24" x 24"	\$ 8520
	17-17572EC	2	End Cap, 72" (used horizontally)	\$ 738
	17-17573EC	3	End Cap, 73¾" (used vertically)	\$ 1107
	17-17596EC	1	End Cap, 96" (used horizontally)	\$ 381
	17-17573TCB	1	T-Connector Beam, 73¾"	\$ 375
	17-LEVKIT	10	Leveler Kit, (2) Levelers	\$ 500
OFFSET DUAL BOOTH (APPROXIMATELY 4' X 8' X 8')	17-10			\$ 15078
	Consists of:			
	17-2424BL	36	Single Block, 24" x 24"	\$ 10224
	17-17548EC	2	End Cap, 48" (used horizontally)	\$ 608
	17-17597EC	4	End Cap, 97¾" (used vertically)	\$ 1524
	17-17524CP	2	Corner Post, 24" (used horizontally)	\$ 592
	17-17548CP	2	Corner Post, 48" (used horizontally)	\$ 612
	17-17548TCB	1	T-Connector Beam, 48"	\$ 307
	17-17596TCB	2	T-Connector Beam, 96"	\$ 774
	17-LEVKIT	8	Leveler Kit, (2) Levelers	\$ 400
	17-12MMBOLTKIT	1	12mm Bolt Kit, qty 8	\$ 37
DUAL BOOTH (APPROXIMATELY 4' X 4' X 8')	17-11			\$ 10890
	Consists of:			
	17-2424BL	24	Single Block, 24" x 24"	\$ 6816
	17-17524EC1711	4	End Cap, 24" (used horizontally)	\$ 1172
	17-17548EC1711	1	End Cap, 48" (used horizontally)	\$ 304
	17-17597EC1711	4	End Cap, 97¾" (used vertically)	\$ 1524
	17-17597TCB1711	2	T-Connector Beam, 97¾"	\$ 774
	17-LEVKIT	6	Leveler Kit, (2) Levelers	\$ 300
L COVE (APPROXIMATELY 2' X 4' X 8')	17-12			\$ 5301
	Consists of:			
	17-2424BL	12	Single Block, 24" x 24"	\$ 3408
	17-17524EC	1	End Cap, 24" (used horizontally)	\$ 293
	17-17548EC	1	End Cap, 48" (used horizontally)	\$ 304
	17-17597EC	2	End Cap, 97¾" (used vertically)	\$ 762
	17-17597CP	1	Corner Post, 97¾"	\$ 384
	17-LEVKIT	3	Leveler Kit, (2) Levelers	\$ 150

[See Overview for Square One Ordering Options.](#)

Item	Model No.	Qty	Description	List Price
C-CONFIGURATION (APPROXIMATELY 8' X 8' X 8')	17-13			\$ 16905

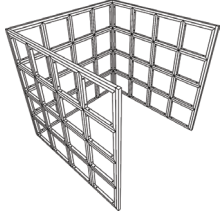
**Consists of:**

17-2424BL	48	Single Block, 24" x 24"	\$ 13632
17-17596EC	3	End Cap, 96" (used horizontally)	\$ 1143
17-17597EC	2	End Cap, 97¾" (used vertically)	\$ 762
17-17597CP	2	Corner Post, 97¾"	\$ 768
17-LEVKIT	12	Leveler Kit, (2) Levelers	\$ 600

GATEWAY COVE
(APPROXIMATELY 8' X 6' X 8')

17-14			\$ 18622
-------	--	--	----------

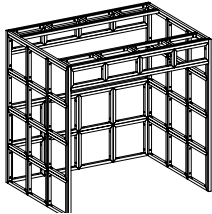
**Consists of:**

17-2424BL	32	Single Block, 24" x 24"	\$ 9088
17-2412BL	16	Single Block, 24" x 12"	\$ 3968
17-17596EC	5	End Cap, 96" (used horizontally)	\$ 1905
17-17572CP	2	Corner Post, 72" (used horizontally)	\$ 746
17-17596CP	2	Corner Post, 96" (used horizontally)	\$ 768
17-17597CP	4	Corner Post, 97¾" (used vertically)	\$ 1536
17-LEVKIT	10	Leveler Kit, (2) Levelers	\$ 500
17-12MMBOLTKIT	3	12mm Bolt Kit, qty 8	\$ 111

MEETING ROOM WITH BARN DOOR
(APPROXIMATELY 10' X 10' X 8')

17-15			\$ 29726
-------	--	--	----------

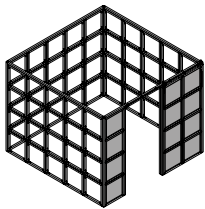
**Consists of:**

17-2424BL	60	Single Block, 24" x 24"	\$ 17040
17-175120EC	3	End Cap, 120" (used horizontally)	\$ 1245
17-17597CP	4	Corner Post, 97¾"	\$ 1536
17-4896BDBR	1	Barn Door Wall, Right	\$ 9155
17-LEVKIT	15	Leveler Kit, (2) Levelers	\$ 750

** Must Specify Acrylic and/or Acoustical Inserts for Use in Barn Door Wall (Total 20 Inserts);
Note: List Price Shown Above Does NOT Include These Required Inserts Due to Variance in Pricing. See
Page 307 for Acrylic and Acoustical Insert options.*

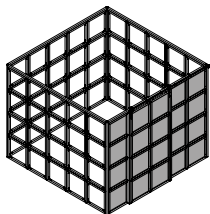

Shown as Right Barn Door

[See Overview for Square One Ordering Options.](#)

Item	Model No.	W	D	H	Ship Wt	Cubic Ft	List Price
SINGLE BLOCK 24" X 24"	17-2424BL	24	1¾	24	12	1.5	\$ 284

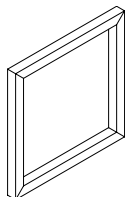

Description

- Includes Four (4) Bolts and Nuts for Installation

Must Specify (in this order):

Model # and Quantity
Finish
Hardware Color

SINGLE BLOCK 24" X 12"	17-2412BL	24	1¾	12	8	1.0	\$ 248
---------------------------	-----------	----	----	----	---	-----	--------

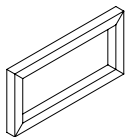

Description

- Includes Three (3) Bolts and Nuts for Installation
- Can Be Used Vertically or Horizontally
- Recommended for Use on Top or End of Configuration, Unless Used in Pairs
- We Recommend Using Single 12" x 24" Blocks on the Top or Ends. If Placing on the Bottom or In the Center of the Design, Using Two of Them Together Will Ensure Alignment with the Holes Bored on Attachment Items Like End Caps, Corner Posts, Etc.

Must Specify (in this order):

Model # and Quantity
Finish
Hardware Color

[See Overview for Square One Ordering Options.](#)

Item	Model No.	W	D	H	Ship Wt	Cubic Ft	List Price
END CAPS	17-175120EC	1¾	1¾	120	14	0.3	\$ 415
	17-175108EC	1¾	1¾	108	13	0.3	\$ 413
	17-17597EC <i>Vertical Use Only</i>	1¾	1¾	97¾	13	0.3	\$ 381
	17-17596EC	1¾	1¾	96	12	0.3	\$ 381
	17-17585EC <i>Vertical Use Only</i>	1¾	1¾	85¾	12	0.3	\$ 373
	17-17584EC	1¾	1¾	84	11	0.3	\$ 373
	17-17573EC <i>Vertical Use Only</i>	1¾	1¾	73¾	11	0.3	\$ 369
	17-17572EC	1¾	1¾	72	11	0.3	\$ 369
	17-17561EC <i>Vertical Use Only</i>	1¾	1¾	61¾	10	0.2	\$ 361
	17-17560EC	1¾	1¾	60	10	0.2	\$ 361
	17-17549EC <i>Vertical Use Only</i>	1¾	1¾	49¾	9	0.1	\$ 304
	17-17548EC	1¾	1¾	48	9	0.1	\$ 304
	17-17537EC <i>Vertical Use Only</i>	1¾	1¾	37¾	8	0.1	\$ 298
	17-17536EC	1¾	1¾	36	8	0.1	\$ 298
	17-17525EC <i>Vertical Use Only</i>	1¾	1¾	25¾	7	0.1	\$ 293
	17-17524EC	1¾	1¾	24	7	0.1	\$ 293
	17-17522EC	1¾	1¾	22¾	7	0.1	\$ 288

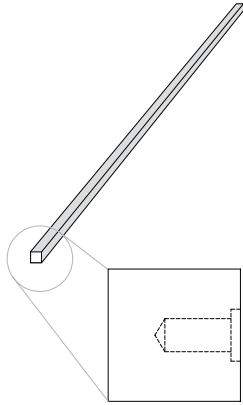

Must Specify (in this order):

Model # and Quantity
Finish
Hardware Color

Description

- Used Vertically and Horizontally to Provide a Clean, Balanced Aesthetic by Hiding Attachment Hardware
- Includes Bolts for Installation
- Blind-Threaded Insert for Installation

[See Overview for Square One Ordering Options.](#)

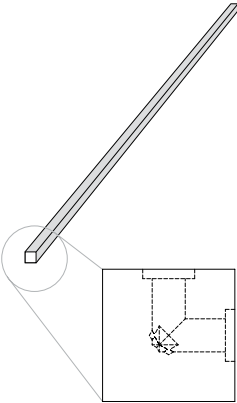
Item	Model No.	W	D	H	Ship Wt	Cubic Ft	List Price
CORNER POSTS 	17-17597CP	1¾	1¾	97¾	13	0.3	\$ 384
	17-17596CP	1¾	1¾	96	12	0.3	\$ 384
	17-17585CP	1¾	1¾	85¾	12	0.2	\$ 377
	17-17584CP	1¾	1¾	84	11	0.2	\$ 377
	17-17573CP	1¾	1¾	73¾	11	0.2	\$ 373
	17-17572CP	1¾	1¾	72	11	0.2	\$ 373
	17-17561CP	1¾	1¾	61¾	10	0.2	\$ 368
	17-17560CP	1¾	1¾	60	10	0.2	\$ 368
	17-17549CP	1¾	1¾	49¾	9	0.1	\$ 306
	17-17548CP	1¾	1¾	48	9	0.1	\$ 306
	17-17537CP	1¾	1¾	37¾	8	0.1	\$ 300
	17-17536CP	1¾	1¾	36	8	0.1	\$ 300
	17-17525CP	1¾	1¾	25¾	7	0.1	\$ 296
	17-17524CP	1¾	1¾	24	7	0.1	\$ 296
	17-17522CP	1¾	1¾	22¾	7	0.1	\$ 289

Must Specify (in this order):

Model # and Quantity

Finish

Hardware Color

Description

- Used Vertically to make 90° Turns
- Includes Bolts for Installation
- Blind-Threaded Insert for Installation

[See Overview for Square One Ordering Options.](#)

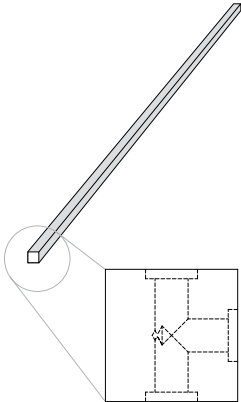
Item	Model No.	W	D	H	Ship Wt	Cubic Ft	List Price
	T-CONNECTOR BEAMS						
	17-17597TCB	1¾	1¾	97¾	13	0.3	\$ 387
	17-17596TCB	1¾	1¾	96	12	0.3	\$ 387
	17-17585TCB	1¾	1¾	85¾	12	0.2	\$ 383
	17-17584TCB	1¾	1¾	84	11	0.2	\$ 383
	17-17573TCB	1¾	1¾	73¾	11	0.2	\$ 375
	17-17572TCB	1¾	1¾	72	11	0.2	\$ 375
	17-17561TCB	1¾	1¾	61¾	10	0.2	\$ 372
	17-17560TCB	1¾	1¾	60	10	0.2	\$ 372
	17-17549TCB	1¾	1¾	49¾	9	0.1	\$ 307
	17-17548TCB	1¾	1¾	48	9	0.1	\$ 307
	17-17537TCB	1¾	1¾	37¾	8	0.1	\$ 303
	17-17536TCB	1¾	1¾	36	8	0.1	\$ 303
	17-17525TCB	1¾	1¾	25¾	7	0.1	\$ 298
	17-17524TCB	1¾	1¾	24	7	0.1	\$ 298
17-17522TCB	1¾	1¾	22¾	7	0.1	\$ 293	

Must Specify (in this order):

Model # and Quantity

Finish

Hardware Color

Description

- Used Vertically to Connect Three (3) Walls
- Includes Bolts for Installation
- Blind-Threaded Insert for Installation

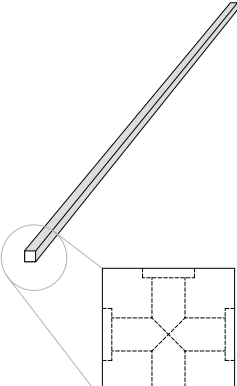
Item	Model No.	W	D	H	Ship Wt	Cubic Ft	List Price
	17-17597XB	1¾	1¾	97¾	13	0.3	\$ 390
	17-17585XB	1¾	1¾	85¾	12	0.2	\$ 386
	17-17573XB	1¾	1¾	73¾	11	0.2	\$ 382
	17-17561XB	1¾	1¾	61¾	10	0.2	\$ 375
	17-17549XB	1¾	1¾	49¾	9	0.1	\$ 309
	17-17537XB	1¾	1¾	37¾	8	0.1	\$ 305
	17-17525XB	1¾	1¾	25¾	7	0.1	\$ 299
	17-17522XB	1¾	1¾	22¾	7	0.1	\$ 296

Must Specify (in this order):

Model # and Quantity
Finish
Hardware Color

Description

- Used Vertically to Connect Four (4) Wall Runs
- Includes Bolts for Installation
- Blind-Threaded Insert for Installation

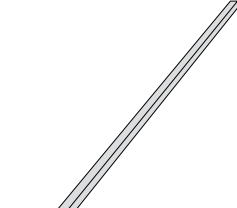
Item	Model No.	W	D	H	Ship Wt	Cubic Ft	List Price
	17-175120HBS	120	1¾	1¾	14	0.3	\$ 396
	17-175108HBS	108	1¾	1¾	12	0.3	\$ 377
	17-17596HBS	96	1¾	1¾	12	0.3	\$ 364
	17-17584HBS	84	1¾	1¾	11	0.2	\$ 345
	17-17572HBS	72	1¾	1¾	11	0.2	\$ 335

Must Specify (in this order):

Model # and Quantity
Finish
Hardware Color

Description

- Used Horizontally to Provide Structural Support for Doorways and Other Openings
- Includes Bolts for Installation
- Blind-Threaded Insert for Installation
- Holes Bored Only on Ends to Accommodate Attachment

[See Overview for Square One Ordering Options.](#)

Item	Model No.	W	D	H	Ship Wt	Cubic Ft	List Price
BARN DOOR WALL	Left	Right					
	17-4896BDBL	17-4896BDBR	120	4	103	289	271

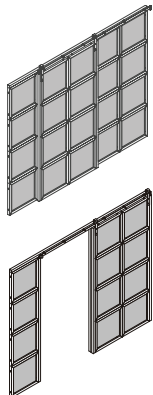

Shown as Right Barn Door

Must Specify (in this order):

Model #
Finish
Hardware Color
Acrylic or Acoustic Panels/Color

Description

- Standard with: Blocks, Beam Spanner, Four (4) End Caps, and Hardware to Create An *Approximately* 10"W x 8½"H Wall with Barn Door, including Leveling Glides
- Barn Door Features Soft Open and Soft Close to Avoid Door Slamming
- Must Specify Finish and Hardware Color (Door Track Available in Black Only)
- Must Specify Acrylic and/or Acoustical Inserts for Use in Barn Door Wall (Total 20 Inserts); Note: List Price Shown Above Does NOT Include These Required Inserts Due to Variance in Pricing

Must Specify Insert Options: 20 Acrylic and/or Acoustical Inserts (any combination)

AP-2020AP	Acoustic Insert - Must Specify Color Option and Add; See Acoustic Color Options		
MLK	Milky		\$ 251
TPE	Taupe		\$ 251
GRY	Grey		\$ 251
ASH	Ash		\$ 251
BLK	Black		\$ 251
AI-2020AC	Acrylic Insert - Must Specify Color Option and Add; See Acrylic Color Options		
FSTA	Frosted		\$ 293
TGWA	Twigwork		\$ 562
WOVA	Woven		\$ 562
RAFA	Raffia		\$ 562
TNSA	Tinsel		\$ 562

PLANTER BOX

01-1909PL	19¼	9½	6	16	2.0	\$ 550
-----------	-----	----	---	----	-----	--------

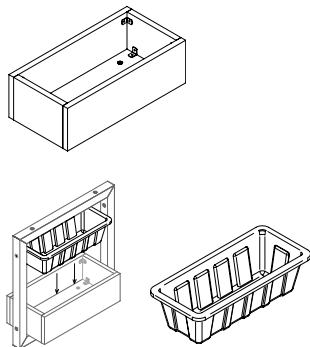
**Description**

- Material is TFL. Must Specify TFL (T) Color; [See Color Options](#)
- Planter Will Ship with Attachment Hardware: Two (2) Black and Two (2) Nickel Bolts
- Horizontal Grain
- Planter Boxes Cannot be Installed on Both Sides of a Corner
- Optional Planter Box Insert Sold Separately

Option: Specify & Add

PBI	Planter Box Insert, Black Plastic	\$ 50
-----	-----------------------------------	-------

Must Specify (in this order):

Model #
TFL Color
Optional Planter Insert

[See Overview for Square One Ordering Options.](#)

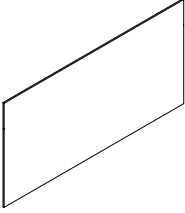
Item	Model No.	W	D	H	Ship Wt	Cubic Ft	List Price
ACOUSTICAL PANEL ONSET INSTALLATION 	46"H Panels						
	AP-4670AP	70¼	½	46¼	13	7.6	\$ 1204
	AP-4658AP	58¼	½	46¼	12	6.3	\$ 1018
	AP-4646AP	46¼	½	46¼	10	5.1	\$ 862
	22"H Panels						
	AP-2270AP	70¼	½	22¼	9	4.1	\$ 607
	AP-2258AP	58¼	½	22¼	8	3.4	\$ 507
	AP-2246AP	46¼	½	22¼	8	2.8	\$ 427
	AP-2234AP	34¼	½	22¼	7	2.1	\$ 356
	AP-2222AP	22¼	½	22¼	6	1.4	\$ 251

Must Specify (in this order):

Model #

Color

Description

- Onset Application, Installed with 9" Dual-Lock Connectors
- Sound Absorption Rating Average NRC 0.75 (50 mm Air Gap) 1.0 NRC in Mid-High Frequencies
- Cannot be Used on Same Side as TV Mount
- For Space Planning with Furniture, Note the Onset Application Will Add ½" to the Square One Blocks

Color Options: Must Specify; [See Color Options](#)

MLK Milky

TPE Taupe

GRY Grey

ASH Ash

BLK Black

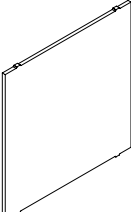
ACOUSTICAL PANEL INSET INSTALLATION 	For 24" Blocks						
	AP-2020AP	20¼	½	20¼	6	1.4	\$ 251
	For 12" Blocks						
AP-0820AP	20¼	½	8¼	3	0.8	\$ 217	

Description

- Inset Application; Includes Tabs to Secure in Place
- Sound Absorption Rating Average NRC 0.75 (50 mm Air Gap) 1.0 NRC in Mid-High Frequencies
- Cannot be Used with TV Mount

Color Options: Must Specify; [See Color Options](#)

MLK Milky

TPE Taupe

GRY Grey

ASH Ash



BLK Black

Must Specify (in this order):

Model #

Color

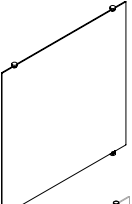
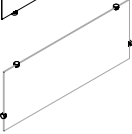
[See Overview for Square One Ordering Options.](#)

Item	Model No.	W	D	H	Ship Wt	Cubic Ft	List Price
ACRYLIC INSERTS							
For 24" Blocks							
	AI-2020AC	20¼	½	20¼	7	2.0	\$ See Below
For 12" Blocks							
	AI-2008AC	8¼	½	20¼	6	2.0	\$ See Below
	<i>Vertical Insert Applications</i>						
	AI-0820AC	20¼	½	8¼	6	2.0	\$ See Below
	<i>Horizontal Insert Applications</i>						



Must Specify (in this order):

Model #
Color
Special Custom Logo

Description

- Inserted Into 24" or 12" Blocks with Insert Retainers (Included)
- Raffia's Linear Pattern will be Installed Vertically on Both AI-2008AC (Vertical) and AI-0820AC (Horizontal)
- Frosted Acrylic Inserts can be customized with a logo or design using one of the following file types: .CDR, .AI, or .EPS. Email the image to customproduct@indianafurniture.com for a quote. Additional costs and lead times may apply. Note this as a special on your order when submitting.

Color Options: Must Specify; See Color Options

		For 12" Blocks	For 24" Blocks
FSTA	Frosted	\$ 190	293
TGWA	Twigwork	\$ 305	562
WOVA	Woven	\$ 305	562
RAFA	Raffia	\$ 305	562
TNSA	Tinsel	\$ 305	562

For 12" Blocks



Raffia (RAFA)
Vertical Installation
Standard

DRY ERASE BOARDS



46"H Panels							
	17-4670DEB	70¼	¾	46¼	11	0.2	\$ 1690
	17-4658DEB	58¼	¾	46¼	11	0.2	\$ 1402
	17-4646DEB	46¼	¾	46¼	11	0.2	\$ 1112
22"H Panels							
	17-2270DEB	70¼	¾	22¼	11	0.2	\$ 1141
	17-2258DEB	58¼	¾	22¼	11	0.2	\$ 922
	17-2246DEB	46¼	¾	22¼	11	0.2	\$ 733

Must Specify (in this order):

Model #
Color

Description

- Nuts and Bolts Included for Onset Attachment
- May be Applied Horizontally or Vertically
- For Space Planning with Furniture, Note the Onset Application Will Add ¾" to the Square One Blocks

[See Overview for Square One Ordering Options.](#)

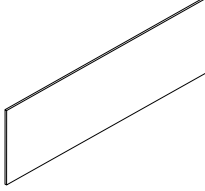
Item	Model No.	W	D	H	YARDS		GRADE COM/1/2/3	GRADE 4	GRADE 5	GRADE 6	GRADE 7	GRADE 8	GRADE 9	GRADE 10	
 <p>TACKABLE PANELS</p> <p>Must Specify (in this order): Model # Fabric Vendor/Pattern/Color</p>	46"H Panels (2 pieces)														
	TB-4670TB	70¼	⅝	46¼	8.75	\$	2085	3258	3809	4369	5165	5988	6959	8070	
	TB-4658TB	58¼	⅝	46¼	7.25	\$	1839	2811	3267	3731	4391	5073	5877	6798	
	TB-4646TB	46¼	⅝	46¼	6.00	\$	1591	2395	2773	3157	3703	4267	4933	5695	
	22"H Panels (1 piece)														
	TB-2270TB	70¼	⅝	22¼	4.50	\$	1151	1754	2038	2326	2735	3158	3658	4229	
	TB-2258TB	58¼	⅝	22¼	3.75	\$	999	1502	1738	1978	2319	2672	3088	3564	
	TB-2246TB	46¼	⅝	22¼	3.00	\$	842	1244	1433	1625	1898	2180	2513	2894	
	TB-2234TB	34¼	⅝	22¼	2.50	\$	687	1022	1180	1340	1567	1802	2080	2397	
	TB-2222TB	22¼	⅝	22¼	1.75	\$	527	762	872	984	1143	1308	1502	1724	

Description

- Installed with 9" Dual-Lock Connectors
- Tackable Panels are Fully Upholstered on Both Sides.
- For Space Planning with Furniture, Note the Onset Application Will Add ⅝" to the Square One Blocks

Item	Model No.	W	D	H	Ship Wt	Cubic Ft	List Price
TV BRACKET	01-TVBR	3½	4	3	1	1.0	\$ 134

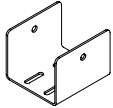

Description

- Black Metal
- Coordinates with TV Mount

TV MOUNT	01-TVMT	35¾	⅞	21⅝	15	0.5	\$ 1057
----------	---------	-----	---	-----	----	-----	---------

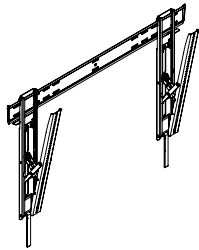

OPEN MARKET ONLY

Description

- Available in Black; Provides 12° of Smooth, Fingertip Tilt
- Compatible with Ultra-Thin TVs 2" (51 mm) Deep or Less; Typical Screen Sizes: 37" - 63"
- Weight Capacity: 100 lbs (45.4 kg)
- Can be Installed in Landscape Mode Only
- Must Order Two (2) 01-TVBR to Mount TV
- Not Compatible with Acrylic or Acoustical Inserts; Can be Used with Onset Acoustical Panels when Used on Opposite Sides

LEVELER KIT	17-LEVKIT				1	1.0	\$ 50
-------------	-----------	--	--	--	---	-----	-------

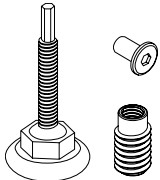

Description

- Includes Two (2) Levelers, Two (2) Insert Nuts and Two (2) Cap Nuts
- Must Specify Black (BLK) or Nickel (NCKL)

Must Specify (in this order):

Model # and Quantity
Hardware Color

[See Overview for Square One Ordering Options.](#)

Item	Model No.	W	D	H	Ship Wt	Cubic Ft	List Price
ALLEN DRIVER BIT	17-TOOL	-	-	-	1	1.0	\$ 57

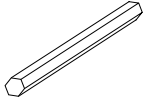
Description

- Used for Inserting Glide Insert Nuts for Levelers
- 6mm Allen Driver Bit

80MM BOLT AND NUT KIT	17-80MMBOLTKIT	-	-	-	1	1.0	\$ 48
-----------------------	----------------	---	---	---	---	-----	-------

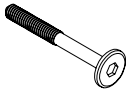

Description

- Quantity of Eight (8)
- For Connecting Block to Block
- Must Specify Black (BLK) or Nickel (NCKL)

Must Specify (in this order):

Model # and Quantity
Hardware Color

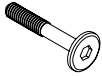
60MM BOLT AND NUT KIT	17-60MMBOLTKIT	-	-	-	1	1.0	\$ 38
-----------------------	----------------	---	---	---	---	-----	-------

Description

- Quantity of Eight (8)
- For Connecting Block to Beam, Post, or End Cap
- Must Specify Black (BLK) or Nickel (NCKL)

Must Specify (in this order):

Model # and Quantity
Hardware Color

12MM BOLT AND NUT KIT	17-12MMBOLTKIT	-	-	-	1	1.0	\$ 37
-----------------------	----------------	---	---	---	---	-----	-------

Description

- Quantity of Eight (8)
- For Covering Exposed Holes in Rails Only
- Must Specify Black (BLK) or Nickel (NCKL)

Must Specify (in this order):

Model # and Quantity
Hardware Color

[See Overview for Square One Ordering Options.](#)

Item	Model No.	W	D	H	Ship Wt	Cubic Ft	List Price
VESTA POWER CENTER	01-PDCTR	10¾	12	28¼	14	2.5	\$ 1716



Description

- Top Includes One (1) Power Outlet, Two (2) USB Ports and One (1) USBC Port; Base Includes Three (3) Outlet
- Available in White
- 120" Power Cord
- Built with Weight Distribution for Optimal Stability
- Base is 5" Tall

TIC-TAC-TOE FOAM GAME SET	17-XOSET	20¾	2	20¾	6	3.0	\$ 349
------------------------------	----------	-----	---	-----	---	-----	--------



Description

- Set Includes Five (5) Xs (Charcoal Gray) and Four (4) Os (Light Gray)
- Constructed of Polyurethane Foam

[See Overview for Square One Ordering Options.](#)

Surface Materials

Wood Finishes and Woodgrain, Solid, and 3D Laminates

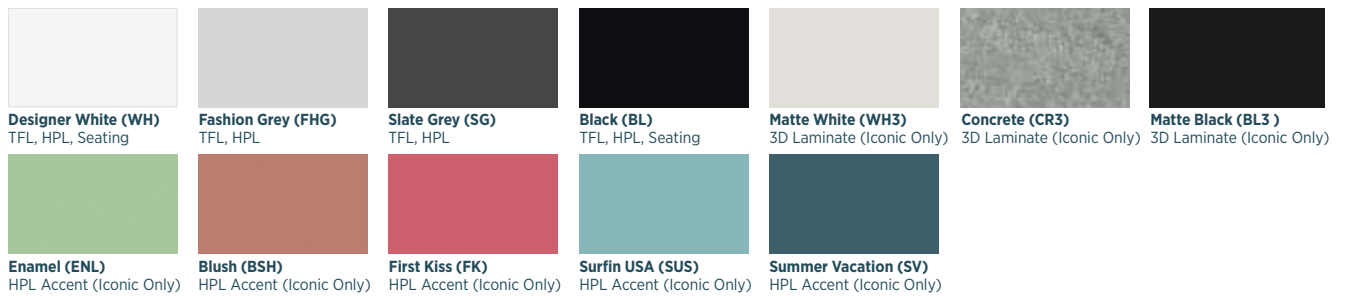

* Finish is Low Sheen

Frosted & High Gloss Acrylics



Solid Surfaces

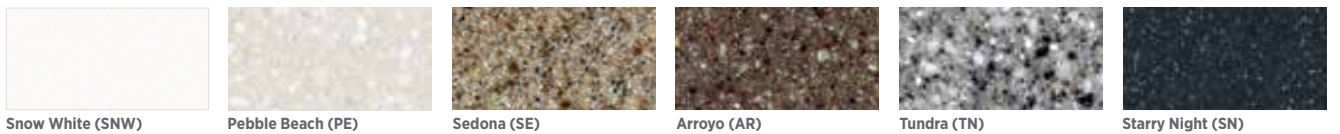

Metal Options

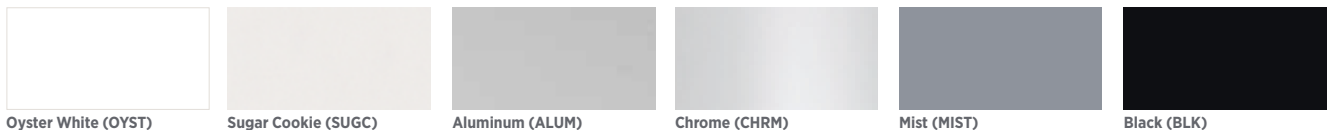

Colors represented are high-resolution reproductions and may vary slightly from the actual product. To order samples, please contact our Customer Service team or order online at www.indianafurniture.com. Graining and finish colors may vary yet will continue to complement, across Veneer, HPL, TFL, and Seating products due to the inherent differences of these materials.

Indiana[®]

FURNITURE

1224 Mill Street
PO Box 270
Jasper, Indiana 47547-0270

Tel 812.482.5727
Toll 800.422.5727
Fax 812.482.9035
sales@indianafurniture.com
www.indianafurniture.com

Federal Classification: Small Business

©2023 Indiana Furniture 11/23

